

ONTOGENY AND SYSTEMATICS OF FISHES

Based on
An International Symposium Dedicated
to the Memory of
Houbert Halvar Andersen

The Symposium was held August 22-28, 1972
La Jolla, California

Sponsored by the
National Marine Fisheries Service,
National Oceanic and Atmospheric Administration,
United States Department of Commerce

MBL/WHOI



0 0301 0017286 2

100

ONTOGENY AND SYSTEMATICS OF FISHES

Based on
An International Symposium Dedicated
to the Memory of
Elbert Halvor Ahlstrom

The Symposium was held August 15-18, 1983, La Jolla, California

Sponsored by the
National Marine Fisheries Service
National Oceanic and Atmospheric Administration
United States Department of Commerce

111111
111111

Special Publication Number 1
American Society of Ichthyologists and Herpetologists



Library of Congress Catalogue Card Number: 84-72702

ISSN No. 0748-0539

© Copyright, 1984, by The American Society of Ichthyologists and Herpetologists

Printed by Allen Press Inc., Lawrence, KS 66044 USA

Preface

The National Marine Fisheries Service organized, supported and conducted an international symposium entitled *Ontogeny and Systematics of Fishes*, held in La Jolla, California on August 15–18, 1983, and dedicated to the memory of Elbert Halvor Ahlstrom. Dr. R. Lasker served as convener. The papers presented at that symposium form the basis for this book, which is published by the American Society of Ichthyologists and Herpetologists as their Supplement to *Copeia*, Special Publication Number 1. Financial support was provided by the National Marine Fisheries Service, National Oceanic and Atmospheric Administration, U.S. Department of Commerce.

For many years, Dr. Ahlstrom planned to write a book on larval fishes and ways in which they contributed to systematics. A few years before his untimely death, he and his colleague H. G. Moser outlined such a book and began to work on the initial chapters. Dr. Ahlstrom left a vast store of notes, data, and partly completed manuscripts. Dr. Moser realized that much of the significance of these unique and important data would be lost unless they were brought to light. He approached colleagues at the Southwest Fisheries Center to gather a group of larval fish workers who had worked closely with Dr. Ahlstrom, and who were given access to his notes, to collaborate on the book. From this initiative a plan developed to conduct a symposium and publish the results in a book to accomplish the original plan of Dr. Ahlstrom and honor his memory as one of the nation's foremost fishery scientists.

A symposium steering committee was formed with H. G. Moser as Chairman and consisted of D. M. Cohen, M. P. Fahay, A. W. Kendall, Jr., W. J. Richards and S. L. Richardson. The steering committee first met in Boulder, Colorado to develop an outline for the symposium and book and invite potential contributors. The aim was to present the current state of knowledge of early life history of fishes and apply that to systematics. Originally it was intended to concentrate solely on the marine groups with which Dr. Ahlstrom had worked, but because of recent advances in freshwater and other early life history work, the plan was expanded to include all but the primitive osteoglossomorphs. Thus, the coverage was to start with the elopomorphs.

Following the Boulder meeting, potential contributors were contacted and responded enthusiastically. The Steering Committee met subsequently in Ocean Springs, Mississippi and Miami, Florida to review progress and refine plans. Because of the subject matter it seemed appropriate that the American Society of Ichthyologists and Herpetologists collaborate in publishing the papers resulting from the symposium. C. R. Robins, then President of ASIH, supported this suggestion and assisted in many ways. Subsequent to the symposium, manuscripts were reviewed and edited by the Steering Committee of the Symposium, which served as an editorial committee for this volume.

The Steering Committee thanks all of the authors of this volume among whom there was a great exchange of ideas and generous help. Much additional assistance was provided to the authors and is here acknowledged. Institutional support was provided by the National Marine Fisheries Service through contributions from each of the four Fisheries Centers—Southwest, Southeast, Northwest and Alaska and Northeast. Support was provided by the National Science Foundation through grants DEB76-82279, DEB78-26540; the National Geographic Society by grant 2535-82 from the Committee for Research and Exploration; the Robert E. Maytag Fellowship at the University of Miami; Natural History Museum of Los Angeles County; the Australian Museum Trust, the Australian Marine Science and Technologies Advisory Committee, the Commonwealth Science and Industrial Research Organization Science and Industry Endowment Fund, and the employers of the contributors.

The following individuals supplied specimens, data, technical assistance, publications, and reviewed drafts of manuscripts: M. Allen, R. M. Allen, A. Alvarino, D. Ambrose, M. E. Anderson, W. D. Anderson, Jr., F. Balbontin, C. Baldwin, E. K. Balon, P. Berrien, D. Blood, S. Boardman, S. S. Boggs, E. Böhlke, M. Bradbury, J. Brill, D. Brown, J. Bullock, M. S. Busby, J. A. Cambray, P. Camus, M. H. Carrington, B. Chernoff, T. A. Clarke, M. Culbreth, M. Cluxton, S. Coombs, A. S. Creighton, K. Davis, W. P. Davis, C. E. Dawson, M. Dehaan, N. Demir, A. Desai, H. H. DeWitt, M. DeWitt, Y. Dotsu, S. D'Vincent, B. R. Engstrand, D. Faber, N. R. Foster, P. Fourmanoir, C. Frandsen, H. J. Franke, E. Fridgerisson, W. George, R. H. Gibbs, G. Gilmore, D. Gittings, W. Gladstone, T. Goh, M. F. Gomon, B. Goldman, A. R. Gosline, W. A. Gosline, A. E. Gosztonyi, P. H. Greenwood, D. Haggner, G. R. Harbison, G. S. Hardy, K. Hartel, R. Hartwick, T. Hecht, E. Hubert, J. M. Humphries, J. C. Hureau, T. Iwamoto, S. Jewett, P. Keener, S. Kelley, F. Kirschbaum, N. Komada, Y. Konishi, D. L. Kramer, J. K. Langhammer, K. Lazara, K. Lee, S. Lincoln, J. Lobon-Cervia, V. J. Loeb, G. Lundy, N. A. Mackintosh, F. Mago-Leccia, A. M. Martinez, D. McAllister, M. McCabe, J. McCosker, R. F. McGinnis, R. McMichael, R. Meier, N. Merrett, J. Michalski, J. Mighell, R. R. Miller, C. Mills, A. Miskiewicz, G. E. E. Moodie, K. H. Moore, K. Mori, J. Moyer, J. A. Musick, T. Nakata, G. Nelson, J. Nelson, J. Nichols, J. Nielsen, T. North, S. Ochman, G. Patchell, L. R. Parenti, K. Peters, T. Pomeranz, S. Poss, L. C. Prescott, J. Quast, J. Randall, K. S. Raymond, B. Remington, C. S. Richards, T. Roberts, D. E. Rosen, R. Schoknecht, A. Sekerak, T. Senta, J. Shapiro, J. Shoemaker, P. L. Shafland, M. Shiogaki, D. L. Schultz, P. H. Skelton, P. E. Smith, J. Song, D. E. Snyder, A. Soeldner, C. Stehr, D. Stein, B. Stender, K. Steward, K. Stoddard, R. E. Strauss, G. Stroud, K. J. Sulak, A. Suzumoto, H. Sweatman, J. N. Taylor, V. R. Thomas, G. Theilacker, R. Thresher, R. Triemer, D. Tweedle, J. C. Tyler, F. Utter, F. Van Dolah, R. Vari, B. Vinter, L. Vlyman, R. Wallus, T. Watanabe, B. A. Watkins, A. Wheeler, P. Whitehead, N. Wilimovsky, A. B. Williams, L. Wood, B. L. Yeager, P. Yuschak, H. Zadoretzky, B. J. Zahuranec.

Illustrators deserve special praise and thanks. B. B. Washington illustrated a large majority of the specimens. Other illustrators include G. Mattson who served in this capacity with Dr. Ahlstrom for many years, B. Y. Sumida and H. Orr at the Southwest Fisheries Center, B. Vinter at the Northwest and Alaska Fisheries Center and J. C. Javech at the

Southeast Fisheries Center. The original illustrations are archived at the Southeast Fisheries Center, Miami and Southwest Fisheries Center, La Jolla.

During the final editorial processes, J. C. Javech and B. B. Washington mounted illustrations and remade many that were of marginal quality. C. Wolf coordinated and reviewed the literature cited section and P. Fisher typed the literature cited section as well as all last minute editorial changes.

The Editorial Committee:

H. G. Moser, Editor in Chief
W. J. Richards, Managing Editor
D. M. Cohen
M. P. Fahay
A. W. Kendall, Jr.
S. L. Richardson

CONTENTS

Welcoming Address. By <i>I. Barrett</i>	vii
Frontispiece—Photograph of Elbert Halvor Ahlstrom. By <i>J. R. Dunn</i>	viii
Dr. Ahlstrom. By <i>R. Lasker</i>	ix
INTRODUCTION	
Ontogeny, Systematics and Fisheries. By <i>J. H. S. Blaxter</i>	1
Ontogeny, Systematics and Phylogeny. By <i>D. M. Cohen</i>	7
Early Life History Stages of Fishes and Their Characters. By <i>A. W. Kendall, Jr., E. H. Ahlstrom and H. G. Moser</i>	11
TECHNIQUES AND APPROACHES	
Early Life History Descriptions. By <i>E. M. Sandknop, B. Y. Sumida and H. G. Moser</i>	23
Synopsis of Culture Methods for Marine Fish Larvae. By <i>J. R. Hunter</i>	24
Identification of Fish Eggs. By <i>A. C. Matarese and E. M. Sandknop</i>	27
Identification of Larvae. By <i>H. Powles and D. F. Markle</i>	31
Illustrating Fish Eggs and Larvae. By <i>B. Y. Sumida, B. B. Washington and W. A. Laroche</i>	33
Clearing and Staining Techniques. By <i>T. Potthoff</i>	35
Radiographic Techniques in Studies of Young Fishes. By <i>J. W. Tucker, Jr. and J. L. Laroche</i>	37
Histology. By <i>J. J. Govoni</i>	40
Scanning Electron Microscopy. By <i>G. W. Boehlert</i>	43
Developmental Osteology. By <i>J. R. Dunn</i>	48
Otolith Studies. By <i>E. B. Brothers</i>	50
Preservation and Curation. By <i>R. J. Lavenberg, G. E. McGowen and R. E. Woodsum</i>	57
DEVELOPMENT AND RELATIONSHIPS	
Elopiformes: Development. By <i>W. J. Richards</i>	60
Notacanthiformes and Anguilliformes: Development. By <i>P. H. J. Castle</i>	62
Elopiformes, Notacanthiformes and Anguilliformes: Relationships. By <i>D. G. Smith</i>	94
Ophichthidae: Development and Relationships. By <i>M. M. Leiby</i>	102
Clupeiformes: Development and Relationships. By <i>M. F. McGowan and F. H. Berry</i>	108
Ostariophysi: Development and Relationships. By <i>L. A. Fuiman</i>	126
Gonorynchiformes: Development and Relationships. By <i>W. J. Richards</i>	138
Salmoniforms: Introduction. By <i>W. L. Fink</i>	139
Esocoidae: Development and Relationships. By <i>F. D. Martin</i>	140
Salmonidae: Development and Relationships. By <i>A. W. Kendall, Jr. and R. J. Behnke</i>	142
Southern Hemisphere Freshwater Salmoniforms: Development and Relationships. By <i>R. M. McDowall</i>	150
Osmeridae: Development and Relationships. By <i>M. E. Hearne</i>	153
Argentinoidei: Development and Relationships. By <i>E. H. Ahlstrom, H. G. Moser and D. M. Cohen</i>	155
Stomiatoidea: Development. By <i>K. Kawaguchi and H. G. Moser</i>	169
Stomiiforms: Relationships. By <i>W. L. Fink</i>	181
Families Gonostomatidae, Sternoptychidae, and Associated Stomiiform Groups: Development and Relationships. By <i>E. H. Ahlstrom, W. J. Richards and S. H. Weitzman</i>	184
Giganturidae: Development and Relationships. By <i>R. K. Johnson</i>	199
Basal Euteleosts: Relationships. By <i>W. L. Fink</i>	202
Myctophiformes: Development. By <i>M. Okiyama</i>	206
Myctophidae: Development. By <i>H. G. Moser, E. H. Ahlstrom and J. R. Paxton</i>	218
Myctophidae: Relationships. By <i>J. R. Paxton, E. H. Ahlstrom and H. G. Moser</i>	239
Scopelarchidae: Development and Relationships. By <i>R. K. Johnson</i>	245
Evermannellidae: Development and Relationships. By <i>R. K. Johnson</i>	250
Myctophiformes: Relationships. By <i>M. Okiyama</i>	254
Gadiformes: Overview. By <i>D. M. Cohen</i>	259
Gadiformes: Development and Relationships. By <i>M. P. Fahay and D. F. Markle</i>	265

Gadidae: Development and Relationships. By <i>J. R. Dunn</i> and <i>A. C. Matarese</i>	283
Bregmacerotidae: Development and Relationships. By <i>E. D. Houde</i>	300
Ophidiiformes: Development and Relationships. By <i>D. J. Gordon</i> , <i>D. F. Markle</i> and <i>J. E. Olney</i>	308
Lophiiformes: Development and Relationships. By <i>T. W. Pietsch</i>	320
Ceratioidei: Development and Relationships. By <i>E. Bertelsen</i>	325
Atherinomorpha: Introduction. By <i>B. B. Collette</i>	334
Beloniformes: Development and Relationships. By <i>B. B. Collette</i> , <i>G. E. McGowen</i> , <i>N. V. Parin</i> and <i>S. Mito</i>	335
Atheriniformes: Development and Relationships. By <i>B. N. White</i> , <i>R. J. Lavenberg</i> and <i>G. E. McGowen</i>	355
Cyprinodontiformes: Development. By <i>K. W. Able</i>	362
Lampriformes: Development and Relationships. By <i>J. E. Olney</i>	368
Mirapinnatoidei: Development and Relationships. By <i>E. Bertelsen</i> and <i>N. B. Marshall</i>	380
Beryciformes: Development and Relationships. By <i>M. J. Keene</i> and <i>K. A. Tighe</i>	383
Zeiformes: Development and Relationships. By <i>K. A. Tighe</i> and <i>M. J. Keene</i>	393
Gasterosteiformes: Development and Relationships. By <i>R. A. Fritzsche</i>	398
Scorpaeniformes: Development. By <i>B. B. Washington</i> , <i>H. G. Moser</i> , <i>W. A. Laroche</i> and <i>W. J. Richards</i>	405
Cyclopteridae: Development. By <i>K. W. Able</i> , <i>D. F. Markle</i> and <i>M. P. Fahay</i>	428
Scorpaeniformes: Relationships. By <i>B. B. Washington</i> , <i>W. N. Eschmeyer</i> and <i>K. M. Howe</i>	438
Tetraodontoidei: Development. By <i>J. M. Leis</i>	447
Balistoidei: Development. By <i>A. Aboussouan</i> and <i>J. M. Leis</i>	450
Tetraodontiformes: Relationships. By <i>J. M. Leis</i>	459
Percoidei: Development and Relationships. By <i>G. D. Johnson</i>	464
Serranidae: Development and Relationships. By <i>A. W. Kendall, Jr.</i>	499
Carangidae: Development. By <i>W. A. Laroche</i> , <i>W. F. Smith-Vaniz</i> and <i>S. L. Richardson</i>	510
Carangidae: Relationships. By <i>W. F. Smith-Vaniz</i>	522
Mugiloidei: Development and Relationships. By <i>D. P. de Sylva</i>	530
Sphyraenoidei: Development and Relationships. By <i>D. P. de Sylva</i>	534
Polynemoidei: Development and Relationships. By <i>D. P. de Sylva</i>	540
Labroidei: Development and Relationships. By <i>W. J. Richards</i> and <i>J. M. Leis</i>	542
Acanthuroidei: Development and Relationships. By <i>J. M. Leis</i> and <i>W. J. Richards</i>	547
Blennioidei: Introduction. By <i>R. H. Rosenblatt</i>	551
Schindlerioidei: Development and Relationships. By <i>W. Watson</i> , <i>E. G. Stevens</i> and <i>A. C. Matarese</i>	552
Trachinoidea: Development and Relationships. By <i>W. Watson</i> , <i>A. C. Matarese</i> and <i>E. G. Stevens</i>	554
Notothenioidea: Development and Relationships. By <i>E. G. Stevens</i> , <i>W. Watson</i> and <i>A. C. Matarese</i>	561
Blennioidea: Development and Relationships. By <i>A. C. Matarese</i> , <i>W. Watson</i> and <i>E. G. Stevens</i>	565
Ammodytoidei: Development and Relationships. By <i>E. G. Stevens</i> , <i>A. C. Matarese</i> and <i>W. Watson</i>	574
Icosteoidae: Development and Relationships. By <i>A. C. Matarese</i> , <i>E. G. Stevens</i> and <i>W. Watson</i>	576
Zoarcidae: Development and Relationships. By <i>M. E. Anderson</i>	578
Gobioidei: Development. By <i>D. Ruple</i>	582
Gobioidei: Relationships. By <i>D. F. Hoese</i>	588
Scombroidei: Development and Relationships. By <i>B. B. Collette</i> , <i>T. Potthoff</i> , <i>W. J. Richards</i> , <i>S. Ueyanagi</i> , <i>J. L. Russo</i> and <i>Y. Nishikawa</i>	591
Stromateoidei: Development and Relationships. By <i>M. H. Horn</i>	620
Gobiesociformes: Development and Relationships. By <i>L. G. Allen</i>	629
Callionymidae: Development and Relationships. By <i>E. D. Houde</i>	637
Pleuronectiformes: Development. By <i>E. H. Ahlstrom</i> , <i>K. Amaoka</i> , <i>D. A. Hensley</i> , <i>H. G. Moser</i> and <i>B. Y. Su- mida</i>	640
Pleuronectiformes: Relationships. By <i>D. A. Hensley</i> and <i>E. H. Ahlstrom</i>	670
LITERATURE CITED	688
INDEX	746
PHOTOGRAPH OF SYMPOSIUM ATTENDEES	760

Welcoming Address

IZADORE BARRETT
DIRECTOR OF THE SOUTHWEST FISHERIES CENTER

ON behalf of the National Marine Fisheries Service's Center Directors, sponsors of the Symposium on the Ontogeny and Systematics of Fishes, I am pleased and honored to welcome you to La Jolla. We are here to honor the memory of an outstanding biologist, Elbert Halvor Ahlstrom, known to his friends and colleagues as Ahlie, and his contributions to fisheries science.

As fishery biologists we all recognize the vital importance and contributions of systematics and students of evolution to the development of fishery science. Less well known or appreciated is the unique role and interrelationship of the early life history studies of fishes and the assessment of the role of ontogenetic characters in fish systematics. This was, of course, the field of fisheries research to which Ahlie dedicated 40 years of his professional life and where he initially evolved the special methods and techniques which have so greatly influenced the work of fishery biologists around the world.

I know that I speak for the Directors of the four fisheries centers—the Northwest and Alaska Fisheries Center in Seattle, the Southwest Fisheries Center in La Jolla, the Northeast Fisheries Center in Woods Hole, and the Southeast Fisheries Center in Miami when I say that I am proud that the National Marine Fisheries Service is the sponsor of this symposium. I believe that this gathering will be a landmark in fisheries science, a unique event which has brought together eminent scientists from 10 countries to present 87 papers reviewing the major fish groups, with particular attention to ontogenetic characters and their utility in assessing phylogenetic relationships. I fully anticipate that the resulting symposium volume which will be based on the papers presented here will stand as a definitive work in larval fish biology for many years to come.

Again, a warm welcome to all of you and especially to Marge Ahlstrom who is seated in the audience this morning. I hope that the weather and circumstances will cooperate and that your stay here in one of the most attractive cities of the United States will be pleasant and productive.

P.O. BOX 271, LA JOLLA, CALIFORNIA 92038.



DR. AHLSTROM

REUBEN LASKER

MY colleagues have entrusted to me the pleasant task and distinct privilege of saying a few words in remembrance of Dr. Elbert H. Ahlstrom, to whom this symposium is dedicated. Like most of you I was his colleague for many years, 23 to be exact. He was also my friend and mentor to whom I could go when I needed advice and where I knew I would be heard as an individual with the bond of common scientific endeavors.

For those of you who did not know Dr. Ahlstrom I would like to capsule his enormous contribution to systematics and fishery science by outlining what I believe to be his major scientific contributions. Ahlie realized in the late 40's that the study of eggs and larvae could give us information about fish populations unobtainable from fishery statistics, the mainstay of fishery science at that time. He believed, rightly, that the ease with which eggs and larvae could be caught allowed an assessment of the geographic distribution and the seasonal extent of spawning of pelagic species. He recognized that any assessment of a fish population was dependent on surrounding that population in time and space and that this would require a major effort. He was the first, I believe, to determine the extent of a major pelagic fish population using this technique.

The simplicity and thoroughness of the plankton net made an impression on him and, while he sought to improve collecting techniques constantly, he consistently analyzed the errors of the plankton net so that this tool could be used more and more reliably. Today, it is still one of the most powerful collecting and assessment tools we have, largely because of his diligence and persistence.

The scope and thoroughness of Dr. Ahlstrom's work was particularly important. His taxonomic skills are attested to in the many papers he wrote and which stand today as mainstays of the systematic and fishery literature. He liked to use the title "Kinds and abundance of fishes" and usually provided taxonomic lists in these of several pages in length. His point, of course, was to detail the complexity and uniqueness of particular oceanic regimes and to set the ground work for ecological research which inevitably followed.

Well, what of his other attributes? I used to call him the modern Renaissance Man because I realized whenever I had occasion to meet him socially that he knew almost all there was to know about the arts and the sciences. Of his fabulous classical record collection I recall that I asked him once if he really listened to all of them. His reply was "we used to hear each one once a year, but now, since the collection has grown so large, it's once every two years." He belonged to the San Diego Great Books Society, and read them all. Engage him in conversation and you would find out quickly he knew literature, fine wines, photography and baseball, to name a few. I would like to sum up this brief eulogy by pointing out an example of one aspect of Ahlie which holds my greatest admiration; that is, his dedication to work. One incident during our relationship illustrates the point I wish to make.

When Science Fairs started to become the vogue in San Diego, Dr. Ahlstrom was asked to host a group of young Science Fair participants to teach them something about oceanography. He arranged to take out the old Bureau of Commercial Fisheries ship, the *Black Douglas*, for a day to illustrate collecting methods at sea. In fact, the day was beautiful, but there was a swell upon the sea and no sooner did we get out of the harbor than almost everyone, except Ahlie and some of the seasoned veterans, felt the effects of a rather pronounced roll for which the *Black Douglas* was famous, even in the calmest of seas. Dr. Ahlstrom proceeded with his typical dedication to illustrate Nansen bottles, plankton nets, and bathythermographs to the group of Science Fair students who were becoming less and less interested and more and more seasick.

Ahlie continued with a single-mindedness of purpose and a dedication that was so characteristic of him. Without his noticing, a caucus was held by these young students and a representative meekly asked, "Dr. Ahlstrom, may we please go home?"

Two versions of what happened next were told to me later. The first was that Ahlie responded immediately to the problem and ordered the ship to port. Another version was that Ahlie continued until he was finished, made sure he had a proper sample, and then ordered the ship into port. I'm afraid I can't tell you which is correct—I was in a bunk, seasick! I meant this story as a small illustration of Dr. Ahlstrom's dedication to his work.

He was a dedicated scientist who had an insatiable curiosity about the biotic world and who was convinced that what he was doing was important and would advance fishery science. This symposium is one piece of evidence that he was right.

Now the question must be asked—how is it that Ahlie could be so dedicated to work and yet have found time to become a true example of a Renaissance man, with a deep knowledge of art, wine, architecture, photography, sports, and much more? I pondered this with admiration for many years and I think I have the answer. He was one of those rare individuals who never cease learning, because he had a true scholar's love for learning. I like Robert Whittenton's description of Sir Thomas More when I think of Ahlie: he was, like More, "a man for all seasons."

SOUTHWEST FISHERIES CENTER, P.O. BOX 271, LA JOLLA, CALIFORNIA 92038.

← Photograph of Elbert Halvor Ahlstrom, by J. R. Dunn.

INTRODUCTION

Ontogeny, Systematics and Fisheries

J. H. S. BLAXTER

IN the inter-war years work on fish eggs and larvae was limited to studies on horizontal and vertical distribution with a view to completing our knowledge of the early life history of different species. Resources for research were then much more limited than they are today and most work was done on the important food fishes. In the 1950's a great expansion took place as fisheries biologists realised how much a study of early life history would be a key to solving some of their problems. This expansion took place on a broad geographical and international front, but great credit must be given to the foresight and imagination of E. H. Ahlstrom, who built up a team of biologists at La Jolla who then and subsequently, played a major role in leading and developing this field with special reference to the fisheries of the California Current.

In the last two decades the output of publications has risen at an exponential rate as evidenced, for example, by the 62 papers in the 1973 Early Life History Symposium held in Oban (Blaxter, 1974) and the 139 papers in the 1979 Symposium at Woods Hole (Lasker and Sherman, 1981). Furthermore, in a *selected* bibliography of pelagic fish and larva surveys prepared by Smith and Richardson (1979), some 1200 papers are listed, most of them published in the last 30 years. Ahlstrom was certainly a major catalyst in this reaction, but it is sad to record that his obituary appeared in the Proceedings of the 1979 Symposium, although he was still alive and present at the meeting itself to impart his wisdom and expertise.

It is proposed to discuss the post-war advances in our knowledge of early life history stages under five headings: (1) as they impinge on *systematics* and *taxonomy*, (2) the success and role of *experimental work* in tanks and of modelling, (3) the *scaling-up* of tank studies to large enclosures and embayments, (4) the application of *sea surveys* to test models, to investigate the stock-recruitment relationship and to measure spawning stock biomass, and (5) the *future*.

SYSTEMATICS AND TAXONOMY

A number of techniques have been developed to help in the identification and classification of fish larvae. Since the development of the skeleton and meristic characters are now so important in identification, techniques of clearing and staining or x-radiography have become standard methods for examining the internal osteology of larvae (Ahlstrom and Moser, 1981). Morphometrics and body pigmentation are also important and are used extensively by Russell (1976) in his monograph on fish eggs and larvae of the N.E. Atlantic.

Rearing experiments have shown that the sequence of developmental events may also be specific in character. For example the development of the acoustico-lateralis system and swimbladder in herring as shown by Allen, Blaxter and Denton (1976) is a long-drawn-out affair and quite different from that of the larval anchovy as described by O'Connell (1981a) or the menhaden or sprat. There are several larval features, such as

the swimbladder and other internal organs, or features of the labyrinth, which would help in the separation of similar-looking species if only they were not obscured by fixation.

Often the taxonomist (or fisheries biologist) resorts to counting meristic characters such as vertebrae, fin rays, scales or gill rakers. Yet many of these characters have been shown by experiment to be labile and to respond to environmental conditions during early development. The earlier work, mainly on freshwater species such as the sea trout, was summarised by Täning (1952). Since then a range of further studies by Fahy, Lindsey (e.g., see Fahy, 1982) and others have confirmed the earlier experiments, showing that temperature, salinity and oxygen level influence meristic counts and that there is a critical period when this influence operates. Little work has been done on marine species although Hempel and Blaxter (1961) showed that temperature and salinity both influence myotome and vertebral counts in herring (the species in which stock separation by meristic counts has been most widely applied).

It seems likely that any environmental variable which influences the relationship between differentiation and growth will affect the meristic count by determining the amount of embryonic tissue which is present when the differentiation into skeletal units takes place. The larval taxonomist needs to be cautious in interpreting small differences in meristic values, especially when they are related to clines or other types of geographical distribution. That is not to say, however, that there is no underlying genetic mechanism. The environment acts as a "fine-tuning" mechanism. Whether this fine-tuning is accidental or adaptive might well be worth discussion at the symposium.

A warning also needs to be directed at morphometrics. Rearing experiments in different-sized tanks by Theilacker (1980b) show the influence of space on growth rates. Comparisons of reared and wild fish larvae, especially of herring by Blaxter (1976), show that tank-reared fish are often shorter and fatter than their wild counterparts at the same developmental stage. There seems to be an interplay between diet and activity which is enhanced by the confinements of the rearing tank. This makes it difficult to extrapolate growth criteria from tanks, such as condition factor, to establish, for example, the nutritional status of larvae at sea (Fig. 1).

A further and serious problem identified by the handling and use of live larvae is the shrinkage caused by capture and fixation. A number of workers such as Blaxter (1971), Schnack and Rosenthal (1978), Theilacker (1980a) and Bailey (1982) have addressed this problem but the most significant findings are those of Hay (1981) on Pacific herring. Feeding larvae from rearing experiments were released into the mouth of a plankton net at sea and then fixed by various techniques after capture. Shrinkage in body length ranged from a mere 5% to a massive 43% depending on the technique. Extensive voiding of gut contents also occurred. The implications of these results in morphometric or feeding studies will not be lost on the present audience.

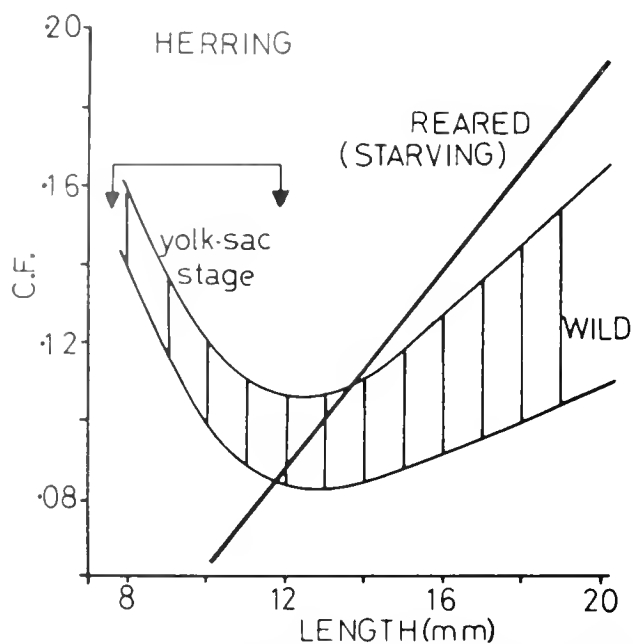

Fig. 1. Comparison between range of condition factors (C.F.) as dry weight/length³ of wild herring caught at sea by plankton net and reared herring larvae near starvation (from Blaxter, 1976).

Finally, the ageing of larvae by daily ring formation in the otoliths should be mentioned. This technique was pioneered by Brothers et al. (1976) on anchovy larvae and California grunion following Pannella's suggestion that daily increments were being laid down in the sagittae of some temperate fish species. The findings were validated by rearing larvae in tanks and sampling the population at intervals of 1–7 days. Struhsaker and Uchiyama (1976) supported these results from their work on the Hawaiian nehu and subsequently the technique was widely adopted in fisheries laboratories. Attempts by Geffen (1982) to manipulate ring formation in cod, herring, plaice, salmon and turbot larvae by varying the photoperiod, temperature and feeding regimes did not lead to any consistent result—the ring deposition was frequently not daily and the main determinant in herring and turbot seemed to be growth rate—the higher the growth rate, the higher the rate of ring deposition. Bailey (1982), however, found otolith rings deposited daily over a 10-day period in post yolk-sac Pacific hake larvae reared in tanks. Sea-caught larvae with more than about 30 increments were less satisfactory because of the appearance of different types of ring and it was not certain whether they were daily. Dale (1984) in a recent study of reared Atlantic cod otoliths using electromicroscopy, found daily rings in a 12L/12D cycle but not in the dark. Daily ring deposition only continued, however, for a few days post-hatching.

Although the ageing of anchovy and grunion from daily rings seems reliable, further validation experiments are required at sea. This is conceptually difficult on a wild stock of larvae of mixed age and it is notoriously difficult to remain over a single population of larvae for many days. Mass release of reared larvae into the sea remains an ambitious possibility. Perhaps best of all such a release should be into some large enclosure system initially free of a larval population. Validation experiments must also test the more unusual environmental condi-

tions which apply in high latitudes where, for example, daylight prevails over the full 24 hours.

EXPERIMENTAL WORK

The functional anatomy approach to taxonomy so elegantly described in a recent review by Moser (1981) shows the extent to which structure can be used to deduce function. The interaction of this approach with that of the experimentalist has yielded much useful information.

Since the 1950's increasing success in rearing marine fish larvae may have provided the taxonomists with help as well as some doubts as described in the last section. It has also led to a wide literature on the physiology, behaviour and physiological ecology of larvae (and the use of larvae in pollutant bioassay) as biologists seized the opportunity to exploit such new and valuable material. Perhaps the most credit should be given to Shelbourne (1964) for his extensive and painstaking rearing experiments on plaice, and later sole, at Port Erin, Isle of Man. These experiments undoubtedly led to the present wide practice of marine finfish aquaculture with the expanding commercial use of turbot, sole, bass, bream and gilthead.

Rearing may still be considered as something of an art and is often most successful in the hands of dedicated people with a "feel" for what is right or wrong. Undoubtedly a breakthrough was made in finding suitable food for larvae. It is significant that both plaice and sole can take *Artemia nauplii* from first feeding as can some races of herring. This resulted in another U.K. focus for rearing at Aberdeen, and later Oban, developed by Blaxter (1968) on the herring. Species with smaller larvae (with smaller mouths) were only successfully reared when Lasker's group at La Jolla (Lasker et al., 1970; Theilacker and McMaster, 1971; Hunter, 1976) developed the use of the rotifer *Brachionus plicatilis* and the naked dinoflagellate *Gymnodinium splendens* as small food items for early-stage larvae of species like northern anchovy and jack mackerel. About the same time Howell (1973) also used *Brachionus* to rear turbot larvae at Port Erin.

Subsequently a number of factors have been identified to add to our corpus of knowledge on rearing. These include the need for good water quality, with the interesting idea of "green water" culture of larvae in fairly high densities of *Chlorella* which seems to damp out fluctuations in metabolites, and perhaps enhance oxygenation as well as providing secondary feeding for the larvae (e.g., Houde, 1977; Morita, 1984). Adequate light for visually-feeding larvae and the need to prevent excessive bunching of larvae or their prey are also important, as is the quality of the food. Success or failure may now depend on the fatty-acid profile of the *Artemia nauplii* which are still used by most workers in the later stages of rearing. Artificial diets of encapsulated or particulate food are also being developed but have yet to be introduced as a standard technique for early rearing.

Before turning to the extrapolation and application of experimental data to modelling, mention must be made of Haydock's (1971) and Leong's (1971) work on the induction of spawning in the croaker and anchovy by pre-treatment with an appropriate photoperiod followed by hormone injection. This has been applied subsequently to the menhaden by Hettler (1981), and to many other species, and has become a standard method for workers requiring eggs over long periods or at a specific time.

We now have the widest knowledge of the development, behaviour and physiology of both anchovy and herring larvae (see Fig. 2) but there are several species such as cod, jack mackerel, mackerel, plaice and turbot which run them a close second.

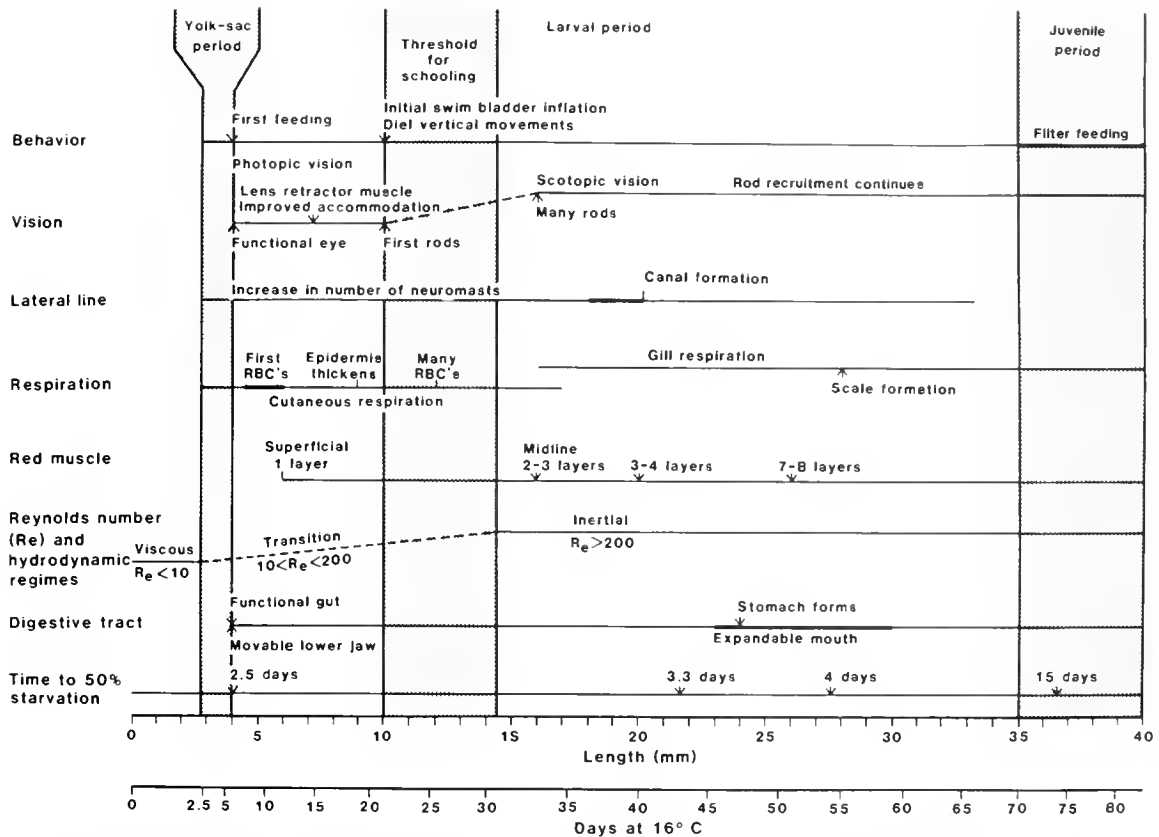

Fig. 2. Events during development of the northern anchovy. RBC = red blood cells. Time to 50% starvation is number of days to starvation at which 50% of the fish died (from Hunter and Coyne, 1982).

Much of this work is summarised by Theilacker and Dorsey (1980).

Over the past few years the assembly of much basic data has allowed the current vogue for modelling to be applied to fish larvae. Modelling is an attempt to synthesise and simplify basic data usually in mathematical form. Mathematical models are often iterative and they have the value of being in a form suitable for computers. Laurence (1981) has recently reviewed modelling work on fish larvae and the complexity and type of interaction is shown in Fig. 3. The main problem addressed has been that of feeding. The earlier models of Blaxter (1966), Rosenthal and Hempel (1970), Blaxter and Staines (1971) and Hunter (1972) estimated the feeding efficiency of larvae, the volume of water searched in unit time and the density of food required to give good survival and growth. More sophisticated models have now been developed (e.g., Jones and Hall, 1974; Beyer and Laurence, 1981) and Vluyen's (1977) model allows for the prey species being non-randomly distributed.

The need for larvae and their prey to co-exist temporally was spelled out by Cushing (1975) in his match-mismatch hypothesis. Thus the timing of reproduction appears to have evolved to synchronise the larval stages with the main phase of the annual production cycle. Spawning is probably controlled in most temperate fish species by photoperiod and temperature which are not the only determinants of plankton production. Hence a match or mismatch is possible between this production and the presence of fish larvae with a resulting influence on year class strength.

An early paradox existed in that the density of the larger micro-zooplankton such as copepod nauplii required for good growth and survival in tanks was of the order of 1 organism/ml. Such densities are rarely found in the sea as judged from normal plankton sampling. This led to the suggestion of micro-scale patchiness of food in the sea, which might occur at interfaces such as steep thermoclines and at tide- and wind-induced fronts. The integrity of such microscale patchiness would not, of course, be obvious using nets sampling large volumes.

This led Lasker (1975) to bioassay samples of water taken at different depths and places off the Californian coast, using anchovy larvae both hatched and tested on board ship. Chlorophyll-rich layers with very high densities of *Gymnodinium* were found near the thermocline. The bioassay showed good larval feeding in these water samples, suggesting that patchiness, indeed, might be a valid concept. This was to some extent confirmed by later findings that stable weather conditions (which maintained the thermocline) favoured good year classes of anchovy larvae off the Californian coast (Lasker, 1981). Owen (1980) has subsequently shown from samples taken by plankton pumps and water bottles that patchiness of microzooplankton such as copepod nauplii and tintinnids and various protozoan species and phytoplankton (some of which are known to be the food of anchovy larvae) exist off the Peruvian and Californian coasts on the scale of a few centimetres up to one metre (see Fig. 4). Only Houde and Schekter (1978) have attempted to rear larvae in simulated food patches and found that survival of sea bream was similar when they were exposed to 3 h of food per

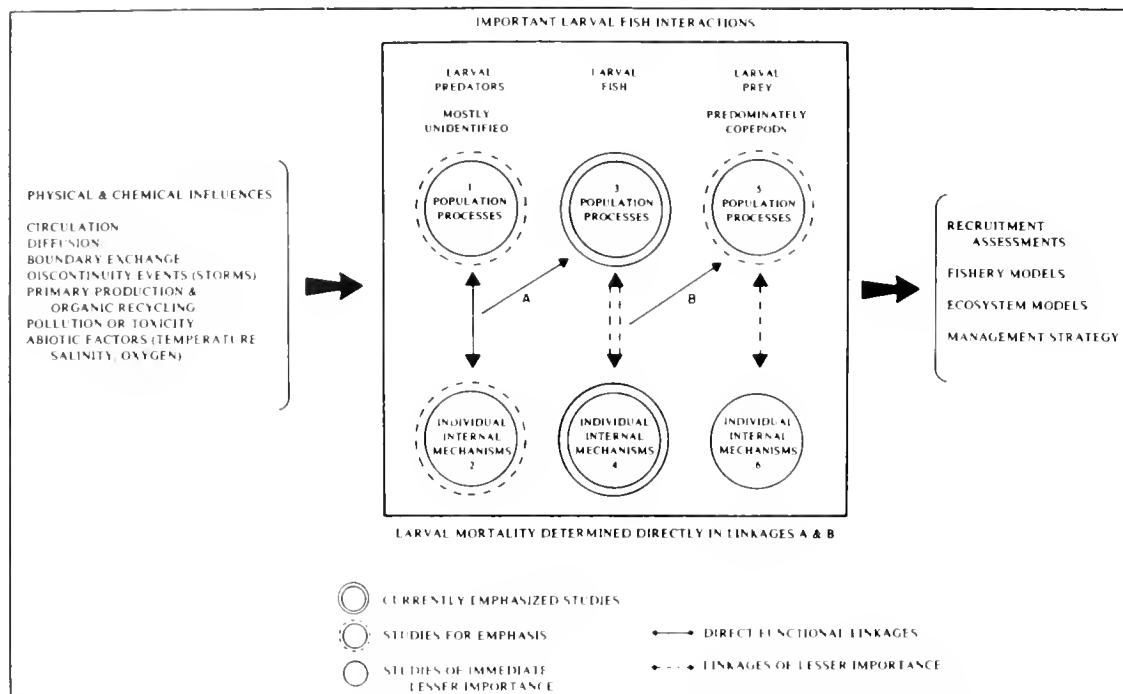

Fig. 3. A generalised scheme for the main interactions between larval fish and their biotic and abiotic environment, providing a basis for modelling (from Laurence, 1981).

day as when fed at the same food level continuously. Clearly, experiments need to be devised to test the effect of spatial rather than temporal food patchiness.

The evidence is thus accumulating, but very slowly, that larval survival may depend on the extent and stability of microscale food patches or interfaces, at least in some areas. It may be that the rather high food densities required in small-scale tank rearing do indeed apply to conditions in the sea and that such densities are only found in patches.

SCALING-UP

Two major areas may be identified where rearing work has been extended into large-scale containers. The first of these are the large onshore enclosures and embayments used by the present generation of Norwegian biologists; the second are the deep-water plastic bags used by Scottish workers in Loch Ewe on the Scottish West Coast. The Norwegians have achieved remarkable growth and survival rates for herring and cod larvae, as high as 30–70% survival from hatching to metamorphosis, in shallow 4,000–60,000 m³ enclosures (Øiestad and Moksness, 1981; Kvenseth and Øiestad, 1984). The Loch Ewe bags, which are deep cylinders, of about 300 m³, have been used for rearing herring and cod, but with much less success than the Norwegians (Gamble et al., 1981; Gamble and Houde, 1984).

Possibly volume itself is important, or more likely the ratio between volume and wall area. The interface between wall and sea water is not a natural one for fish larvae, feeding may be difficult at the interface, and food may aggregate there in an inaccessible form. Morita (1984) reports that Pacific herring larvae have recently been reared in 20 m³ tanks with a 46% survival from hatching to a mean length of about 7 cm in 112 days. This spectacular result may have been partly a feature of a fairly large onshore tank but also the "green water" technique

mentioned earlier. Hunter (1984) suggests that the high survival in some large tank or enclosure experiments is achieved by the elimination of predators. To the present author a combination of optimal feeding conditions and low predation seems to be the likely cause.

The events have been described so far in a topsy-turvy way, in that sea surveys have always been the most widely-adopted approach to problems associated with the early life history of fish. The experimental and enclosure studies are the icing on the research cake, although both Norwegian and Japanese workers are seriously considering the possibility of restocking depleted inshore fisheries or topping-up poor year-classes of cod and herring by releasing reared late-stage larvae or O-group juveniles.

SEA SURVEYS

These are expensive in terms of ship-time and manpower. Originally designed to advance our knowledge of spawning grounds, larval drift, and horizontal and vertical distribution, they are often now linked to more practical aims. Nevertheless, superb time-series exist for areas like the California Current and North Sea as a result of the patience and foresight of earlier workers like Ahlstrom and later workers like Smith and Saville (see review by Smith and Richardson, 1977). Sea surveys have always been a rich ground for innovative science, in terms of sampling techniques, interpretation and usage. Experimenters and modellers have provided a great boost for this work, allowing new interpretations to be made and new hypotheses to be tested.

No more mention will be made of the matrix-filling role of sea surveys—namely the completion of details of life history, which is still taking place and has been much aided by the vast improvement in egg and larval identification in the past two

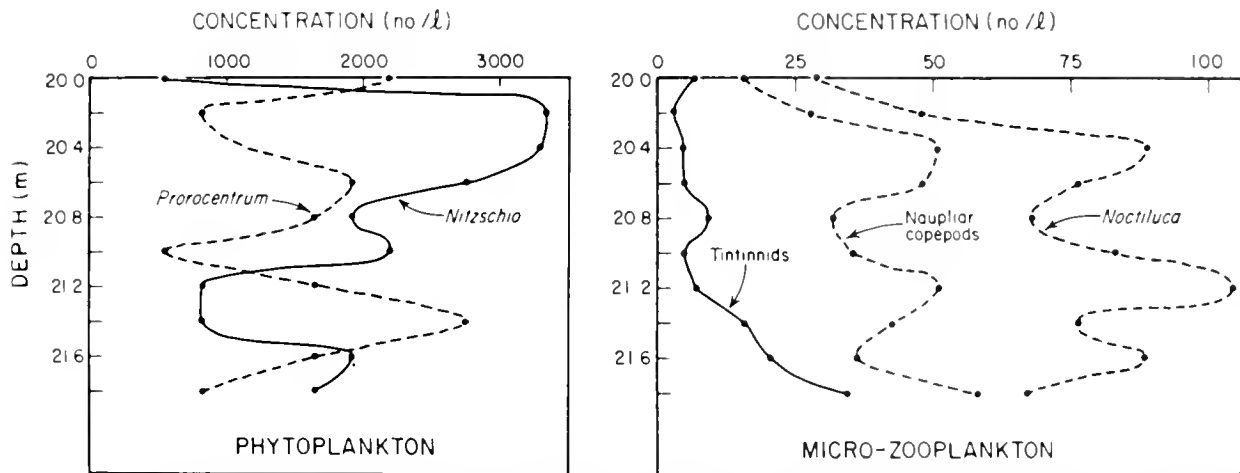

Fig. 4. Variation in concentration of microplankton in samples from 20 cm depth intervals in the chlorophyll maximum layer over the coastal shelf of the Southern California Bight during March, 1976. *Prorocentrum*, tintinnids and copepod nauplii are all food items for larval anchovy (from Owen, 1980).

decades. Improvement in plankton nets and young fish trawls means that vertical profiling and quantitative sampling have finally come-of-age. This ability to sample quantitatively is the single most important advance in allowing larval populations to be assessed reliably and for allowing models to be tested. The outcome is two-fold. The door is open for biomass estimates of spawning stock from egg and larval surveys and for testing the possible factors in the stock-recruitment relationship. Each of these will be considered in the final part of this paper.

1. Biomass estimation.—For many years population dynamists lacked good information on the absolute size of the spawning stock and regulation was largely achieved by minimum mesh and landing sizes. Of late, as a result of catastrophic declines in some species, whole fisheries have been closed or controlled by quotas and total allowable catch (TAC). The use of TAC's has been greatly aided by virtual population analysis and also by sonar-based fish counting surveys; these give an estimate of total stock size, the reliability of which depends on the extent of the survey, the ability to identify the species in question and the precision of the calibration of target strength.

To supplement the results, estimates of spawning stock size have been made on an *ad hoc* basis by counting eggs and larvae and converting them into the parental spawning stock biomass by a knowledge of fecundity, age distribution and sex ratio. Some of the pioneering work was done by Sette and Ahlstrom (1948) on Californian pilchard and Simpson (1959) on North Sea plaice. Saville, Baxter and McKay (1974) counted the demersal eggs of the herring on the small spawning ground of Ballantrae Bank in the Clyde. This was later extended by Saville and McKay (see Saville, 1981) to herring larval surveys in the North Sea and off the Scottish west coast. The biomass of Pacific herring is now routinely assessed from the intertidal egg deposition along the coast of Canada and the USA as described in the recent Nanaimo Herring Symposium (Hay, 1984; Haegele and Schweigert, 1984). Similar, but *ad hoc*, data are available for the northern anchovy from the work of Smith (1972), Parker (1980) and Picquelle and Hewitt (1983), for the Atlantic mackerel from Lockwood, Nichols and Dawson (1981) and Berrien, Naplin and Pennington (1981) and for North Sea cod from Daan

(1981). Some of these data give absolute measures, some relative ones from year-to-year, often related to biomass estimates by other means.

This survey technique has notable disadvantages. It must be done at a limited time of year and is obviously easiest to interpret for one-off spawners. The survey must be done rapidly and as near the spawning season as possible to overcome any errors caused by mortality between spawning and sampling. Although it can be applied to a closed fishery, the age structure of the population is required to compute the aggregate fecundity, hence scientific sampling of the adults is required.

2. Stock-recruitment.—The relationship between the size of the spawning stock in any year and the number of recruits it supplies to the fishery subsequently is vital information for the regulation of fisheries. This is specially true where recruitment overfishing is prevalent as in the clupeoids. Over many years a stock-recruitment relationship may be obtained empirically in any fishery, but this is time-consuming and usually contains inexplicable features. While, as might be expected, low spawning stock leads to low recruitment, high spawning stocks may also give unexpectedly low recruitment, as the result of density-dependent effects. Alternatively spawning stocks of a given size can yield enormously different brood strengths, of the order of 10–100 times, in a quite unpredictable way.

It is not surprising that the underlying causes of the control of brood strength are of much interest to fisheries biologists and have received the attention of experimentalists and modellers. Most marine fish have a very high fecundity, of the orders of tens of thousands to a few million. From such a starting point mortality must be very high and it is surprising that brood strength variations are not even more variable than is actually the case. What then do we know of the mortality rate of eggs and larvae in the sea? Are there critical periods when it is especially high? What are the causes of mortality?

Hjort's original hypothesis, now some 70 years old, expressed the view that a critical period existed after yolk resorption as the larvae sought external food sources. This hypothesis was supported by earlier rearing experiments in which very high

mortalities occurred at first feeding. Measurements of mortality rates of eggs and larvae at sea tend to show a high but continuing mortality of perhaps 5–20% per day. The results of sea surveys are, however, often difficult to interpret because of the need to sample within a discrete larval population over a long time. May (1974), in his review of this subject, concluded that starvation at the end of the yolk-sac stage may often have a major influence on brood strength but that mortality from fertilization to the O-group stage is the ultimate determinant.

The results of modelling and the tests of the patchiness hypothesis which have already been discussed support the idea that first feeding is a critical time, although not having, necessarily, the dominant effect claimed by Hjort. Experimenters and modellers have also derived further concepts for testing. The major sources of mortality are identified as starvation and predation. Starvation, of course, only operates from the end of the yolk-sac stage. Blaxter and Hempel (1963) used the expression "point-of-no-return" to express the point at which larvae, as a result of starvation, are too weak to feed even if food becomes available. Sometimes called "ecological death" or "irreversible starvation" this is a useful concept for assessing the chances of larval survival under different conditions. For larvae in a good nutritional state the time to the point-of-no-return may be only 1–2 days in a small newly feeding larva like the anchovy, but 2–3 weeks in a well grown flatfish larva like the plaice (see Theilacker and Dorsey, 1980). Implicit, also, in the concept is that larvae can live for some time *after* the point-of-no-return. During this time they may be especially liable to capture by nets and, without adequate knowledge, a false impression might be obtained of the size or nutritional state of the larval population.

The assessment of nutritional state of larvae has been of wide interest in recent years, in the hope of relating this to brood strength. Initially Blaxter (1965) measured the condition factors of tank-reared herring larvae after varying periods of starvation and then later compared the results with the condition factors of sea-caught herring larvae (Blaxter, 1971). It was found that most sea-caught larvae had much *lower* condition factors than starving tank-reared larvae and it became apparent that the extrapolation of tank criteria to the sea was invalid because the tank larvae were short and fat compared with wild larvae (see Fig. 1). This means that condition factor comparisons of wild larvae are only valid on a relative basis from year-to-year or place-to-place (e.g., Chenoweth, 1970; Vilela and Zijlstra, 1971) and only then if one can be satisfied that shrinkage after capture is consistent. The problems of tank:sea comparisons and shrinkage are unfortunately likely to be the most serious in long clupeoid larvae to which these experiments have been applied. No one has checked their validity in the more common type of larvae with a shorter body form.

These problems led to work at Oban and La Jolla on histological criteria for assessing starvation (Ehrlich et al., 1976; O'Connell, 1976; Theilacker, 1978). O'Connell's work on anchovy larvae deserves special mention. He found from screening the state of the body organs such as pancreas and gut that these showed increasing signs of degeneration as starvation proceeded. On applying his criteria to sea-caught anchovy larvae O'Connell (1981b) found evidence for quite a high percentage of larvae suffering from advanced starvation and considerable differences in the incidence of starvation in closely adjacent areas. This method is now being applied by Theilacker on jack mackerel larvae from year-to-year and is likely to be adopted on a routine basis.

The other cause of mortality, predation, has recently become fashionable following the work of Fraser, Lasker, Lillelund and Theilacker and subsequently Kuhlmann, von Westernhagen and Rosenthal, Bailey, Purcell and several other workers (See reviews of Hunter, 1981, 1984). Copepods, euphausiids, amphipods and chaetognaths are all implicated but perhaps medusae are the most voracious group of predators (Bailey and Batty, 1983), especially for inshore spawners like Pacific herring. Predation, of course, operates from the moment of spawning and Hunter and Kimbrell (1980) and MacCall (1980), in particular, have discussed the incidence of density-dependent cannibalism of spawning anchovies on their own eggs and larvae. It is generally thought that strong selection pressure exists for fast growth which will take larvae speedily through the more vulnerable early stages. Larvae have been shown experimentally to be less vulnerable when they are larger, their escape speeds are higher and their recovery from a predator attack (for predators of a given size) more likely. As Hickey (1979, 1982) has shown, an efficient wound-healing mechanism exists, allowing larvae to recover from bites, stings and other forms of damage. The high survival rates of larvae reared in the absence of predators (Kvenseth and Øiestad, 1984; Morita, 1984) suggest strongly that predation is a major source of mortality in the sea. Although it is difficult to assess the relative importance of starvation and mortality in any larval population, it is also clear that the two must interact in the sense that starving larvae will be more susceptible to predation.

THE FUTURE

In this paper modelling has been only briefly discussed. The method is now widely used for setting up hypotheses about feeding, starvation, predation, cannibalism and other factors associated with the stock-recruitment relationship and biomass estimation. This approach is likely to continue as a basis for sea surveys. It seems uncertain whether biomass will be *routinely* estimated by egg and larval surveys except perhaps in Pacific herring and northern anchovy. The cost is too high and sonar surveys, if the problems can be ironed out, seem to be a better bet.

Experimental data on predation still need to be collected and few correlations exist between predator populations and egg and larval mortality in the sea. In fact mortality studies on eggs and larvae in the sea in general need to be perfected since the problems of following discrete populations and of ageing larvae are still not fully solved. At least one source of information is largely untapped and that is the explanation for the high survival rates of larvae in large enclosures. In particular the distribution of the larvae and their food in these enclosures is not known and may throw light on the validity of the patchiness hypothesis. Information on frontal systems, and interfaces as a result of tide, wind, upwelling and thermo—and halo—clines is now quickly being assembled by hydrographers and marine biologists. The larval biologists should be ready to exploit the results.

It will be apparent to the audience how far research into the early life history of fish has advanced in the last 30 years. A major force has been the work off the Californian coast generated by Ahlstrom and his recruits at La Jolla. It is therefore very fitting that this symposium should be dedicated to his memory.

SCOTTISH MARINE BIOLOGICAL ASSOCIATION, DUNSTAFFNAGE
MARINE RESEARCH LABORATORY, P.O. BOX 3, OBAN,
ARGYLL, SCOTLAND.

Ontogeny, Systematics, and Phylogeny

D. M. COHEN

THE work of Ahlie and his students and colleagues has brought to the fore great amounts of descriptive information about the early life history (ELH) stages of fishes gathered over many years. These data are of broad provenance, many being the results of original research by the Ahlstrom school, others being taken from the literature. Only a scientist with Ahlie's capabilities—an extensive knowledge of fishes and their ontogeny, a fine sense of order in nature, and a critical intellect—could perceive pattern in the bewildering diversity represented by the early life history stages of fishes. As would any good scientist, Ahlie questioned the meaning of these patterns, and it is chiefly to further this inquiry that this symposium was convened.

Most students of comparative fish ontogeny know more about adult fishes than ichthyologists who study adults know about larval fishes; they have to. Ahlie stated in his lectures, "Larval taxonomy is just an adjunct to adult taxonomy and you have to start with the adults to know the larvae." Early on he discovered that data from early life history studies did not always confirm classifications based on adults alone. We all want to know which data sets most closely approximate phylogenetic relationships; how apparent conflicts best can be resolved; how the data of ontogeny can be integrated into the overall field of fish systematics? Answering these questions is not easy, especially within the framework dictated by the widespread adoption of new methodologies in systematics, which claim to require more stringent evaluation of characters than has been heretofore customary. Many traditional character suites are being rejected for purposes of elucidating phylogenies, and new data are needed for testing. Our purposes in this volume are to state the bases for what has come to be called larval fish taxonomy and to consider the systematics of various groups of fishes in terms of the rich and virtually untapped store of data offered by the study of early life history stages.

My own objectives in the present paper are several. First of all, I want to indicate the reasons, some obvious, some not, for the nearly exclusive use of adult fishes in systematics, which has prevailed until very recently. Secondly, I will briefly discuss the conceptual and methodological framework of classification within which early life history data is being used. Finally, I will comment on the possible importance of early life history data for the study of phylogeny with special reference to fishes.

WHY HAS THERE BEEN SO LITTLE USE OF ELH STAGES IN FISH SYSTEMATICS?

The fact that most fish classifications are based entirely or chiefly on the structure of adults was a source of concern to Ahlie and remains so to many of us, although this Symposium is an indication of positive change. I discuss below what may be some of the reasons for a long preoccupation with adults.

In the first place, zoologists have been studying adults for a longer period of time than they have early life history stages. Although the dim beginnings of classification are often placed with Aristotle, it was the great naturalists Aldrovandi, Belon, Gesner, and Rondelet who in their cataloging of nature provided our earliest adult fish classifications. Several technological desiderata would have prevented the study of early life history stages during the 16th century when these early scientists were

at work. Even though lenses had been known for a long time, appropriate microscopes were not invented until the 17th and 18th centuries (Singer, 1959) when another requisite advance occurred, the use of alcohol and other fluids as a preservative for zoological specimens (Singer, 1950). Techniques for clearing flesh and staining bone and cartilage are modern acquisitions, as is the use of X-ray photographs (Ahlstrom and Moser, 1981). The invention of fine-mesh towing nets did not occur until 1846 (Sverdrup, Johnson, and Fleming, 1942), deferring until relatively recent times the availability of suitable collections of early life history stages for scientific study.

The rearing of early stages is another valuable component of the study of larval fish taxonomy, and although fish culture is an ancient art, the staging of fry and their preservation and microscopic study is technology-dependent and relatively recent.

Lack of information on metamorphosis or of congruence of larval and adult stages has also delayed the adoption of early life history stages information into classification schemes. Of course not many kinds of fishes demonstrate an ontogenetic change as sudden and dramatic as do the eels, but the fact that this particular transformation was not described until 1897 (Grassi and Calandruccio) indicates the long advance start held by the use of adult stages. Even more recent have been discovery of the *Anoplogaster-Caulolepis* relationship (Grey, 1955a), the *Gibberichthys-Kasidoron* relationship (de Sylva and Eschmeyer, 1977), the Giganturidae-Rosauridae relationship (Johnson, this volume), and the as-yet-unpublished identity of larval forms such as *Svetovidovia*. These and other examples are described in this volume. And indeed, even when the study of the developmental biology of vertebrates commenced, early emphasis in the mid-18th century was on classical embryology, the describing of processes and structures rather than on comparing them (Rostand, 1964). Not until the early years of the present century when fishery scientists began to use larval fishes in their investigations of commercial species and required identifications were serious efforts made to compare data (Ahlstrom and Moser, 1981).

Until Ahlie commenced his now famous courses on larval fishes, there were few places where a student could learn about them; hence, there are only rare instances of attention being paid to any potential value they might have in solving problems in systematics. By now, in contrast, there are courses and seminars available in a number of universities on the study of ELH stages of fishes.

Another phenomenon that I believe has inhibited the use of early life history stages in fish systematics is what I call the curatorial mind set. Many curators of adult fish collections are wary of microscopic specimens stored in vials. Although these collections occupy small space, their maintenance and documentation are labor-intensive and their use is foreign to most ichthyologists. There are many excellent collections of larval fishes, but they are mostly in fishery, environmental and marine biology laboratories—organizations that have no institutional commitment to long-term collection storage. Collections that document important publications or have potential value in systematics should ultimately be deposited in a museum that

has a mandate to guarantee long-term archival storage and easy access. Several such institutions that presently house larval fishes or are willing to do so are the Zoological Museum of the University of Copenhagen, which maintains the extensive worldwide collections taken during the Dana Expeditions, as well as ones documenting the earlier classical studies on larval fishes by Johannes Schmidt and his students, the Harvard Museum of Comparative Zoology, the Smithsonian Institution, and the Natural History Museum of Los Angeles County. If collections of ELH stages are to realize their full potential in systematics, then it is timely for ichthyoplankton specialists to offer good developmental series, especially illustrated ones, and for museum curators to accept them.

Fossils have been studied for clues to the major classification of fishes since the days of Louis Agassiz (Patterson, 1981a) and to the extent that they were available have been widely considered as important adjuncts or indeed prerequisites to comprehending the phylogeny of particular groups. Although this view is now receiving heavy criticism (Patterson, 1981b), the fact remains that it did exist for many years and may have detracted from the potential contribution of the non-fossil suites of characters carried by early life history stages. Even so, students of fossils and of larvae share a preoccupation with the caudal fin skeleton, a structure that is often well preserved in fossils and can be studied in two dimensions and which, during the course of ontogeny, exposes a wealth of information of great value to the systematist.

Because adult stages have been the chief source of characters used in fish systematics, a perception has arisen that these characters are in some way more useful or more indicative of a phylogenetic classification than are the characters of early life history stages. How did such a view arise? For many years, systematists tended to concentrate on the search for conservative, "non-adaptive" characters (labeled the Darwin Principle by Mayr, 1969). They discarded not only ones that they believed were directly affected by the environment but also ones that appeared to smack of convergence. It seemed reasonable and proper, for example, to group together for phylogenetic purposes fishes with one spine and five soft rays in the pelvic fin because the character was apparently conservative, non-adaptive, and non-convergent. On the other hand, it seemed wrong to group together all fishes with canine teeth because the character was apparently non-conservative, adaptive, and surely convergent. With regard to larval fishes, Moser (1981) recently discussed the occurrence of a large number of apparently highly adaptive larval characters distributed across a broad taxonomic spectrum. He states, "Marine teleost larvae have evolved an enormous array of morphological specializations, such that it seems to me we are looking at a distinct evolutionary domain quite separate from that of the adults. It is reasonable to assume that these remarkable structural specializations are adaptive and reflect each species' solution to the challenge of survival in a complex and demanding environment." My point here is that if a systematist rejected adaptive characters (and many did), then he would have been unlikely to use ELH stages, and this may be another reason why they have not received sufficient attention.

HOW SYSTEMATISTS DO THEIR WORK

Even if systematists agreed among themselves about their immediate goals and how best to achieve them, the task of this

Symposium would be daunting. But contemporary systematists do not agree on either objectives or methodology. The concepts that purport to link systematics to phylogeny are being actively reassessed, and it is within the context of rapidly changing ideas in systematics that our presentations and discussions will occur.

There are basically three conceptual methods now being used by systematists, and although the bare bones of these methods are easily comprehended, in practice they become more complex and their independence from each other less clear. The interested reader who is as yet unaware of the intense debate both between and within the several schools of systematic classification is referred to the pages of the journal *Systematic Zoology* for many articles and references as well as ones cited in this section. A recent description and comparison of the three methods is given by Mayr (1981), who lists many important references. Although I do not propose to use very much space here on a redundant treatment, I will briefly describe each method and comment on its strengths and weaknesses.

The theoretically simplest method (or methods—there is more than one algorithm, and there is disagreement on which is best) is called phenetics or numerical taxonomy and is described in detail by Sokal and Sneath (1963) and Sneath and Sokal (1973). It is based on overall similarity. Many unweighted characters are used to generate clusters of OTUs (operational taxonomic units), which may be anything from individuals, populations, or species to orders, classes, or phyla. The hierarchically arranged clusters, which lack a time dimension, are called phenograms. Neither homology nor the fossil record are considered in selecting characters. Each member of a cluster bears a closer resemblance, although not necessarily genealogical relationship, to other members of its cluster than it does to members of other clusters. Some pheneticists claim that if a sufficient number of characters is analyzed, any influence of convergence becomes dampened and the phenogram will express phylogenetic relationships. Unfortunately, there seems to be no good way to ascertain how many characters are needed. Other pheneticists do not ascribe phylogenetic significance to their clusters and merely claim to be representing overall similarity. Replicability of results is the chief objective. Many classifications that purport to be based on the methods of cladistics or evolutionary classification, upon close scrutiny appear to be basically phenetic. There are apparently few fish classifications using ELH characters, which are explicitly based on phenetic methods. One example is a paper on Northeast Pacific cottid genera (Richardson, 1981a) which, according to the author, was not entirely satisfactory for phyletic purposes. Ichthyologists who restrict their data sources for a phenetic analysis to a single life history stage should consider a study by Michener (1977), who generated four different phenetic classifications of a group of bees based on different life history stages or character suites.

A second method is called cladistics or phylogenetic systematics, and although it has been more or less on the scene for many years, it is only since the revision and translation into English of its original presentation (Hennig, 1950, 1966) that it has gained wide currency and is now used, either explicitly or implicitly, by many systematic ichthyologists all around the world but particularly in North America and western Europe. A recent guide to the method is a book by Wiley (1981), and the reader is advised to consult also Brundin (1966) for a notably lucid interpretation. Cladistics requires a stringent evaluation of characters. Primitive or generalized ones (called plesiomor-

phic) for the group being analyzed are discarded for purposes of generating a phylogenetic classification; only derived characters (apomorphic) are of value, and monophyletic groups are defined by the degree to which they share such characters (synapomorphy). The distribution of derived character states among a monophyletic assemblage of taxa is analyzed and used to generate an hierarchically arranged chart called a cladogram, in which each node or branching point on the diagram gives rise to two branches that are interpreted as genealogical lineages and are called sister groups. In instances in which the data do not allow the unambiguous definition of two branches, more are often used. Each member of a monophyletic group is more closely related genealogically to other members of its group than it is to members of other groups. More than one cladogram can be generated with the same data set, and the most parsimonious, that is, the one requiring the fewest evolutionary steps, is taken as the most natural or best. According to Panchen (1982), problems in logic invalidate the use of parsimony in cladistics. Not all cladists agree about precisely what a cladogram represents, but some interpret it directly as a phylogenetic classification. One of the greatest problems in using cladistics is the difficulty in evaluating character states for primitiveness or degree of derivation. Two methods have been used; one involves ontogenetic stages and will be discussed later in this paper. A second method, called out-group comparison (Wiley, 1981, gives a good description), is the most subjective part of the entire cladistic procedure and to a certain degree may involve circular reasoning. A practical problem that cladistics has not yet conquered is that of naming, for classifications must be used by many who have no interest in theory, and naming categories on a strictly genealogical basis raises many problems, as does the practice followed by some cladists of naming all branching points. Some attributes of ELH stages that might be considered unsuitable for use in evolutionary classification are available for use in cladistics. One example concerns character states that are interpreted as being highly adaptive rather than conservative. If polarity can be ascertained, then so-called adaptive characters are available. Rates and sequences of ontogenetic change also constitute potentially valuable character suites.

The third method, presently called evolutionary classification, is more difficult to define and discuss. It has a long history and an extensive literature (Mayr, 1981). The methods of evolutionary classification are eclectic and generally more subjective than those of phenetics and cladistics. They do not easily lend themselves to overall generalization. Characters are selected and weighted by paying particular attention to homology and convergence; to the extent that they are available, evidence from embryology and palaeontology are also used. Primitive characters are admitted to the system. Data are used from ecologically oriented facets of evolution such as selection, competition, predation, and ecological biogeography. Historical biogeography, rate of evolution, and genetics are also considered. An hierarchical classification is derived, which has an inferred time axis and which may generally reflect genealogical relationships. However, degree of phenetic difference in selected characters, which is interpreted as reflecting degree of genetic difference, may be considered along with branching pattern in converting a strict genealogy into a classification. Patterson (1981b) has discussed and criticized such procedure. Whatever may be phyletic relationships, the definition of taxa is essentially subjective, and each member of a group is not necessarily more closely

related genealogically to other members of its group than it is to members of a different group. The test for goodness of a classification is pragmatic; if it has high predictive value it is good. (By prediction is meant the degree to which a classification encompasses additional data.) In commenting on evolutionary systematics Panchen (1982) writes that it, "has always been somewhat *ad hoc* in its procedure, yielding good results with competent taxonomists and bad with incompetent ones. The standard warks [sic] on procedure . . . are to some extent rationalizations of a tradition that is too largely intuitive."

As a summary, I have tried to compare in Table 1 some of the techniques, objectives, and assumptions of the three methods. Phenetics requires the fewest assumptions but would seem to offer the systematist a classification with the least information value. Cladistics has the most constraints, so many and so stringent in fact, that they may limit its practical use, although the method is particularly valuable in indicating areas for which additional or more suitable data are required. Misuse of cladistics may soon rival the long-time abuse by systematists of parametric statistics. Evolutionary classification tries to include the most information from the most sources, but the methods for doing so are not very well formalized. Cladists treat their method of classification as a general theory of biology (Nelson and Platnick, 1981), a forcing function among all evolutionary phenomena, which must therefore comply with a parsimonious model derived entirely from character state analysis. Evolutionary classification, on the other hand, incorporates information from a wide variety of biological phenomena and to that extent is forced, rather than forcing. Predictability, as a test of goodness for a classification, is more pragmatic and logically less satisfying than is parsimony. Perhaps an important question for theoretical systematists to consider is the formulation of comparable definitions for replicability, parsimony, and predictability.

ONTOGENY AND FISH PHYLOGENY

Louis Agassiz, who fought the idea of organic evolution, proposed a "threefold parallelism" of arranging organisms in a series or classification. His three parallels were palaeontology, what we would now consider to be homology, and ontogeny. Even though he failed to interpret the parallels as evidence for evolution, his keen perception of the fact that they do exist in nature and are somehow interrelated has elicited extensive comment and reinterpretation (see especially Gould, 1977) and is a suitable point of departure for addressing the importance of ontogeny as a source of information about homology, the biogenetic law, developmental stages as alternatives to outgroup comparisons in cladistics, pedomorphosis, and the application of life history stages to phylogenetic inquiry.

If characters are the meat and muscle of classification, then homology surely shapes the skeleton on which phylogenetic classifications are arranged. The worth of any allegedly phylogenetic classification is no better than the degree to which homology has been assessed, and how to do this is a major problem for the systematist. Like the weather, everyone talks about homology but does nothing about it—or almost nothing. The concept, which is so pervasive in the study of phylogeny and in evolution, has been with us since pre-Darwinian times, although not always in the way that we understand it today. The great comparative anatomist Owen defined it in 1866 as follows: "A 'homologue'

TABLE I. COMPARISON OF THREE METHODS USED IN BIOLOGICAL CLASSIFICATION.

	Phenetics	Cladistics	Evolutionary
Character weighting	No	Yes	Yes
Convergence	Not Considered	Important	Important
Homology	Not Considered	Important	Important
Fossil History	Not Considered	Not Important	Important
Eco-evolutionary Data	Not Considered	Not Important	Important
Rate of Evolution	Not Considered	Not Important	Important
No. of Characters	Many	One to Medium	One to Medium
No. of Specimens	Few	Few to Many	Few to Many
Branches from a Node	Two to Many	Two when Possible	Two to Many
End Product	Perhaps a Phylogeny	Phylogenetic Classification Based on Genealogy	Phylogenetic Classification Based on Genealogy and Degree of Difference
Test of Goodness	Replicability	Parsimony	Predictability

is the same part or organ in different animals under every variety of form and function." He goes on to note, however, that some earlier workers defined the concept as we now define analogy. But our problem remains identical with that of Owen—how to define *same*. In a recent discussion of homology, Patterson (1982) proposed similarity in ontogeny as part of a test of homology. But the use of similarity in development to help define Owen's "same" is tautological.

Palaeontologists proceed in a basically circular fashion in their use of homology. They depend upon a time series to trace the history of transformed states of a presumably homologous character along a sequence that is interpreted as a genealogy. But of course the characters are considered homologous because they are part of a genealogy. Whether they admit to it or not, most systematists use pure phenetics in the search for homology, and although this common sense, intuitive, non-scientific approach works much of the time, still, many systematists have misinterpreted as homologous characters that are actually analogous and have filled the literature with many misdiagnosed convergences. In comparative vertebrate anatomy and systematics, the convention has grown up that certain organ systems are more conservative than others and therefore provide a better method for detecting homologies. The nervous system is generally considered the best, the skeleton the next best, followed by viscera and muscles, with the integument the least good. In fishes, for example, Freihof (1963, 1970) has used the patterns of the *ramus lateralis accessorius* and *ramus canalis lateralis* nerve systems relative to elements of the skeleton to propose groupings of fishes. But even here the possibility of convergence cannot be ignored (Gosline, 1968), and again the problem of circularity arises because many ichthyologists define osteological features on the basis of their topographic relation to elements of the nervous system. Another example relates to homologies of photophore series in lanternfishes as determined by studies of their innervation (Ray, 1950). Here also, the conclusions based on this method appear to be equivocal (Moser and Ahlstrom, 1972).

A direct method for demonstrating the homology of structures would be to trace them back during development to their anlagen. De Beer (1951) has commented on the apparent failure of experimental embryology to validate this approach. Even so, a survey of the development of bony structure during fish ontogeny presented by Dunn (1983b) lists some observed instances of losses, gains, and modifications, chiefly in the caudal fin skeleton, which interpret homologies in adult structure; unfortu-

nately, these instances are too few. Ahlstrom had a long interest in the caudal fin skeleton, particularly of flatfishes, and the completion of his work by colleagues hopefully will constitute an additional contribution to the use of fish ontogeny in identifying homologous structures.

The concepts of ontogeny and homology are intimately associated in the idea that the study of early life history stages of an organism will reveal its adult ancestral stages—ontogeny recapitulates phylogeny—as proposed by Ernst Haeckel in the latter half of the 19th century. Taken at its most extreme, the biogenetic law has been interpreted as meaning that an entire genealogy is encapsulated in an ontogenetic series. If adults of extant species of a group were to be matched up with their closest approximations in an ontogenetic series, homology would unfold before our eyes. Of course its value to us in unraveling phylogeny would be redundant, because phylogeny would be there as well. It was soon evident however that the biogenetic model is far too crude to approximate nature. The embryologist von Baer had previously formulated four "laws" or general propositions about embryology that have been restated in various forms by many authors and applied to the interpretation of phylogeny. The following are taken from De Beer (1951): (1) In development from the egg the general characters appear before the special characters. (2) From the more general characters the less general and finally the special characters are developed. (3) During its development, an animal departs more and more from the form of other animals. (4) The young stages in the development of an animal are not like the adult stages of other animals lower down on the scale, but are like the young stages of those animals. These propositions are useful generalizations and we can all think of obvious instances of fish ontogeny that can be interpreted by one or more of them. Consider for example the bilaterally symmetrical larvae of flatfishes, the early presence and subsequent loss of a swimbladder in stromateoids (Horn, 1970a), the sequence of fusions during ontogeny in the caudal fin skeleton of myctophids (Ahlstrom and Moser, 1976), the ontogeny of the upper jaw bones and dentition in notosudids (Berry, 1964a), and the presence of a pectoral fin in larval *Tacostoma* and its loss in adults (Ahlstrom, lecture notes). On the other hand, a plethora of early life history stages of fishes manifests character states that represent morphological specializations occurring early in development. Consider the egg stages of macrourids with their hexagonal patterns, atherinomorphs with their filaments, and argentinoids with their pustules. Other

instances for which it is difficult to accept that ontogeny has recapitulated phylogeny include the leptocephalus of eels, the stalked eyes of assorted larval bathylagids, myctophids and *Idiacanthus*, the elongated guts of larval melanostomiids, the extensive armature of many spiny-rayed fishes during their larval stages, and the produced fin rays found in many kinds of larval fishes. Examples of all of these are illustrated and described in this volume. With regard to proposition three in particular, Ahlie often pointed out instances of fishes that were easily distinguished as larvae but became more similar in appearance as adults; one example is *Bathylagus milleri* and *B. pacificus*; *Myctophum aurolaternatum* and other myctophid species is another. Von Baer's propositions as applied to phylogeny are tidy and appealing but are completely operative only under the rather special condition that major evolutionary changes (except for paedomorphosis) are restricted to the adult stage (Gould, 1977; Fink, 1982).

For cladistic analysis, the polarization of characters through direct observation of their transformation during ontogeny has been discussed by Nelson (1978) and others as an alternative to the often unsatisfactory indirect method of outgroup comparison. Such use of ontogeny, which depends on von Baer's first three propositions, has been analyzed by Henning (1966), who noted its uncertainty. As examples from fish ontogeny given above indicate, ontogeny could replace or corroborate outgroup comparison but only to the extent that the biogenetic law is valid for a particular situation. Patterson's (1982) statement, "that ontogeny is the decisive criterion in determining polarity," would seem to be based on limited acquaintance with ELH stages.

Paedomorphosis refers to the presence in adults of larval characters (De Beer, 1951) and has been variously considered as

insignificant to very important in evolution. For fishes at least, I think the latter is the case. As one example, small adult size could be considered a particularly widely distributed neotenic character. In his discussion of paedomorphosis and cladistics, Fink (1982) remarked that it is difficult to identify this phenomenon without paired taxa, but surely this is not always true. Although the relationships of the curious little fish *Schindleria* are unknown, it would be difficult to deny that it has many neotenic characters (Watson, Stevens and Matarese, this volume). On a larger scale paedomorphosis may have been important in establishing novel phyletic lines as well as isolated species or genera, and the study of ELH stages will be essential in detecting these divergences.

I end this essay by noting that the most important use of all for information about fish ontogeny may be providing characters for charting fish phylogeny rather than theories about phylogeny. Distinguishing and identifying species for purposes of fish biology and management has been the chief use for what is called larval fish taxonomy, and the large resulting literature is summarized in this volume. Many of the same descriptive data are of apparent value for purposes of grouping similar species or other taxa for phyletic purposes. Published examples of synthesis are far fewer than of descriptions, but accounts using each of the three methodologies previously described are available, either cited in this volume or presented here as original research. ELH characters can meet many methodological constraints and will be used increasingly by ichthyologists. To what advantage remains to be seen, but the prognosis is good.

LIFE SCIENCES DIVISION, LOS ANGELES COUNTY MUSEUM OF NATURAL HISTORY, 900 EXPOSITION BOULEVARD, LOS ANGELES, CALIFORNIA 90007.

Early Life History Stages of Fishes and Their Characters

A. W. KENDALL, JR., E. H. AHLSTROM AND H. G. MOSER

PATTERNS OF TELEOST EARLY LIFE HISTORY

IN discovering that Atlantic cod lay free-floating planktonic eggs which develop into pelagic larvae, G. O. Sars, in 1865 (see Hempel, 1979; Ahlstrom and Moser, 1981) had also come upon an example of the widespread life history pattern of marine fishes. Most marine fishes, regardless of systematic affinities, demersal or pelagic habits, coastal or oceanic distribution, tropical or boreal ranges, spawn pelagic eggs that are fertilized externally and float individually near the surface of the sea (Fig. 5). These eggs range from about 0.6 to 4.0 mm in diameter (mode about 1 mm) and generally are spherical. Within a species there is little variation in egg characters such as size, number and size of oil globules, and pigmentation and morphology of the developing embryo. Development time is highly temperature dependent and also species-specific. The eggs hatch into relatively undeveloped yolk-sac larvae which swim feebly and

rely on their yolk for nourishment while their sensory, circulatory, muscular, and digestive systems develop to the point that they can feed on plankton. Even these yolk-sac larvae have characters (pigment patterns, body size and shape, myomere number) that reflect their heritage. After the yolk is utilized, they develop transient "larval" characters such as pigment patterns and, in some, specialized head spines and fin structures that are apparently adaptive for this phase of their life history. During this period more characteristics of the adult (e.g., meristic characters) gradually develop. At the end of the larval stage, they may go through an abrupt transformation to the juvenile stage, particularly if they move from a pelagic to demersal habitat, or the transformation may be gradual. In some fishes, there is a prolonged and specialized stage between the larval and juvenile stages. These pelagic (often neustonic) forms eventually transform into demersal juveniles. The juvenile stage is characterized by specimens having the appearance of small adults—all fin rays and scales are formed, the skeleton is almost

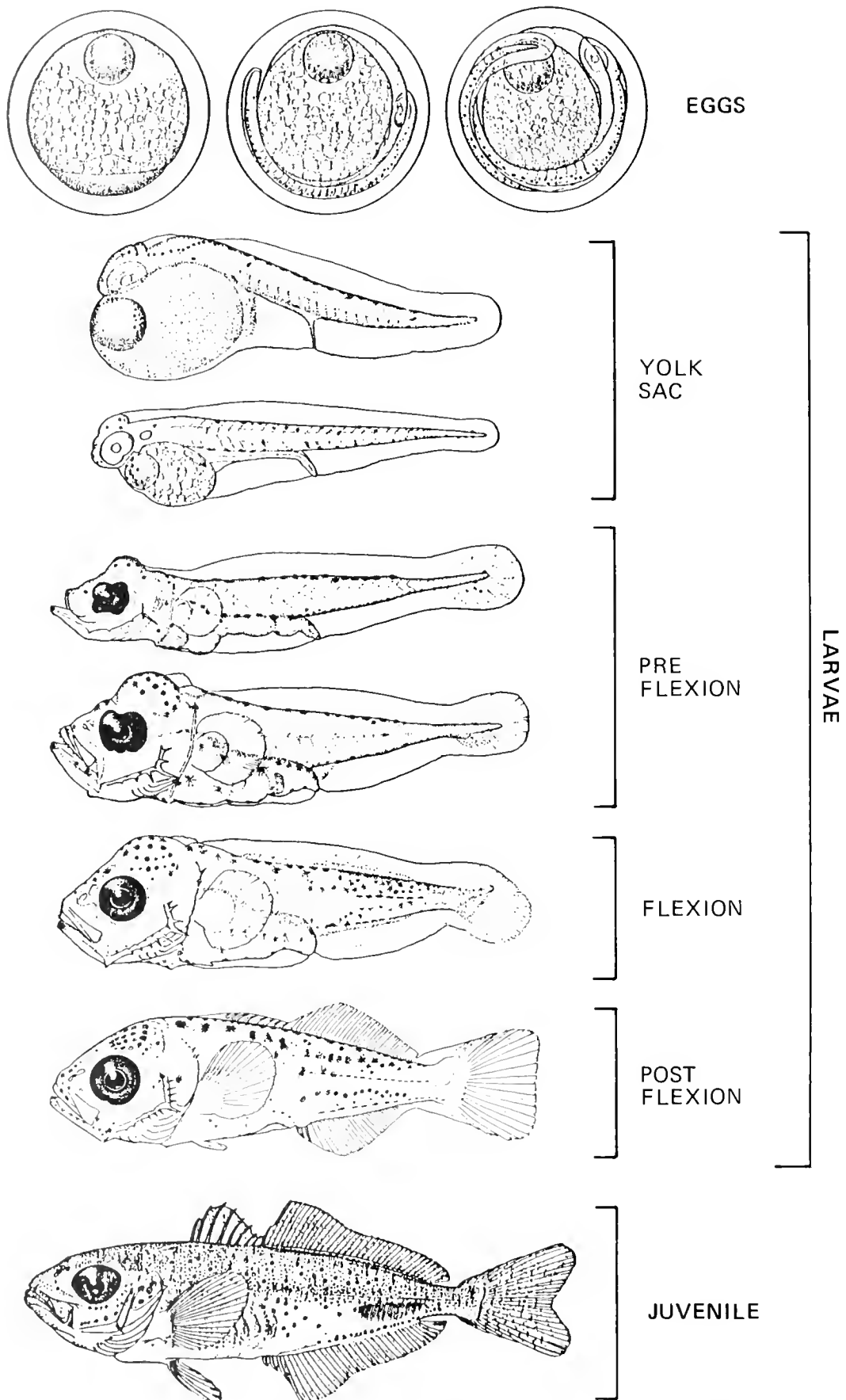

Fig. 5. Early life history stages of *Trachurus symmetricus* from Ahlstrom and Ball (1954).

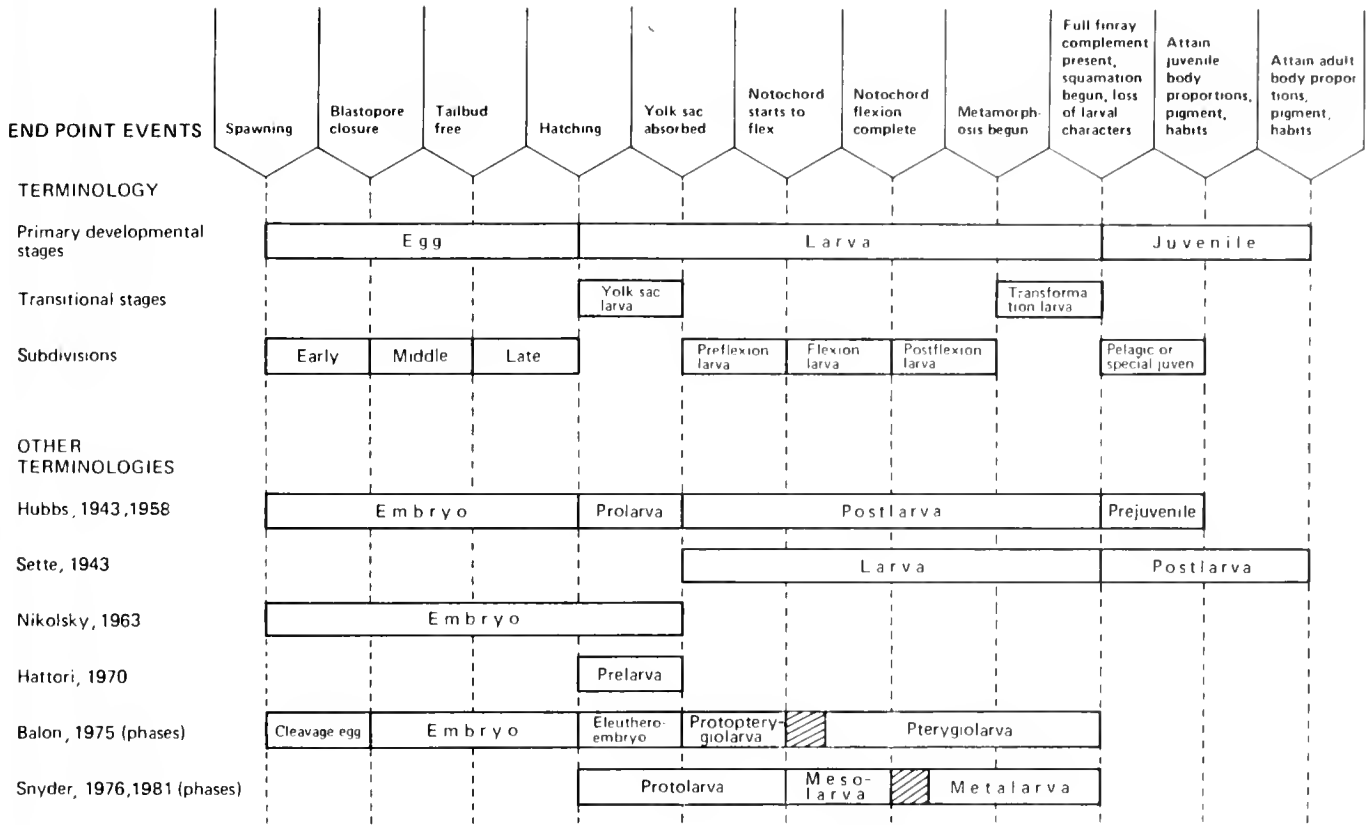

Fig. 6. Terminology of early life history stages.

completely ossified, the larval pigment pattern is overgrown or lost and replaced by dermal pigment similar to that of the adults, and the body shape approximates that of the adults.

Although this is the most frequently observed life history pattern, there are many variations (see Breder and Rosen, 1966) often related to increased parental investment in individual progeny with a concomitant decrease in fecundity and larval specializations. There is scant information on the young of many deep-sea fishes, and this may be due in part to life history strategies that do not include eggs and larvae that occur in the epipelagic zone (where most of the collecting is done). Marshall (1953) discussed life history adaptations of these fish such as the production of few, large yolkly eggs that hatch into relatively advanced larvae. These young may remain far below the more productive surface layers, and thus not be susceptible to most sampling procedures. Markle and Wenner (1979) cite evidence for demersal spawning of two species of groups (Alepocephalidae, Zoarcidae) that are seldom collected in the plankton as larvae.

Many coastal marine and nearly all freshwater fishes lay demersal eggs which are generally larger than the 1 mm mode of pelagic eggs. In such fish development from hatching through juvenile stage is direct and the larvae gradually attain adult characters of shape, pigmentation, and meristic features. The demersal eggs frequently are adhesive and laid in some sort of nest. Parental care of the nest is observed in many species, and this care may extend to the larvae after hatching (e.g., mouth brooding in cichlids, ariids). Parental care takes another form in *Sebastes*, where development through the yolk-sac stage takes

place in the ovary and first-feeding larvae are extruded. Viviparity, in which nourishment is supplied by maternal structures, has evolved many times (e.g., poeciliids, some zoarcids, embiotocids), whereby the larval stage is bypassed and the fish are extruded ("born") as juveniles (Wourms, 1981).

EARLY LIFE HISTORY STAGES

Between spawning and recruitment into the adult population, most fishes undergo dramatic changes in morphology and hab-

TABLE 2. EXAMPLES OF CHARACTERS OF PELAGIC EGGS THAT MAY BE USEFUL FOR SYSTEMATIC STUDIES OF CERTAIN FISHES.

Character	Character states	Systematic groups
Egg size	< 1 mm -> 5 mm	Pleuronectidae
	> 3 mm -> 5 mm	Anguilliformes
Egg shape	Round—oblong	Engraulidae Ostraciontidae
Envelope sculpturing	Varying distances between pores	Gadidae
	Varying length/density of filaments	Atheriniformes (Exocoetidae)
Oil globule position	Anterior to posterior in yolk sac	Perciformes
Embryonic characters	State of development of various organs organ systems at various developmental mileposts	Gadidae

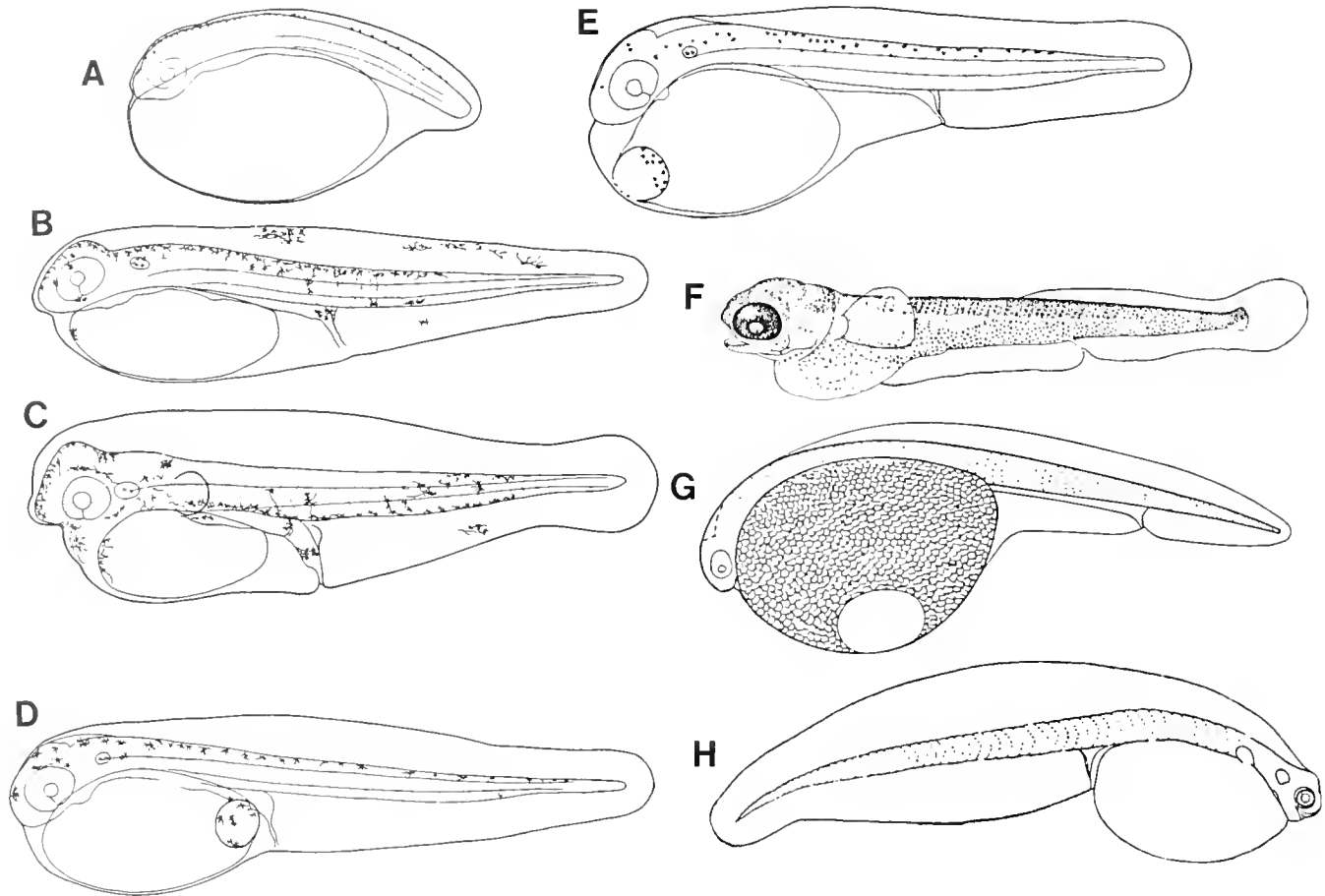

Fig. 7. Examples of features of yolk-sac larvae of teleosts. (A–C). *Paracallionymus costatus*. A. soon after hatching 0.98 mm NL; B. 1.8 mm NL; C. 1.9 mm NL. From Brownell (1979). Features demonstrated in: (A) include the small size of the larva, the lack of an oil globule, the segmented yolk, and the dorsally arranged melanophores; (B) demonstrates the migration of melanophores ventrally and the formation of the anus producing a preanal finfold; (C) demonstrates further ventral migration of melanophores, beginning of larval pectoral fin formation, the decrease in yolk-sac size, and beginning of pigment in the eye; (D) *Diplodus sargus*. 2.4 mm NL. From Brownell (1979). Single pigmented oil globule posterior in the unsegmented yolk and a short preanal finfold are demonstrated; (E) *Trachurus t. capensis*. 2.2 mm NL. From Brownell (1979). Single pigmented oil globule anterior in segmented yolk with moderately long preanal finfold demonstrated; (F) *Cololabis saira*. 5.1 mm SL. (original). Well-developed, heavily pigmented yolk-sac larva at hatching with notochord flexion beginning and some caudal rays formed; (G) *Argentina silus*. 7.7 mm. Redrawn from Schmidt (1906c). A large but poorly developed yolk-sac larva at hatching with a large oil globule; and (H) *Hippoglossus stenolepis*. 9.5 mm. From Pertseva-Ostroumova (1961). A large but poorly developed yolk-sac larva at hatching with no oil globule.

its. As mentioned earlier, at hatching, particularly in marine fishes with pelagic eggs, the fish is in an extremely undeveloped state and then, as a free-living individual, it gradually develops the adult characters. This process is continuous, but there are morphological and ecological mileposts that are significant in the life of the fish and which allow us to subdivide this process so that we can communicate results of our studies and compare different fishes at the same moment in development.

Fish early life history has been and continues to be studied from a number of different perspectives (Ahlstrom and Moser, 1976). Some studies deal directly with embryology and later ontogeny, others emphasize functional morphology of larval structures, apply larval features to taxonomic and systematic studies, investigate the ecology of eggs and larvae, or use these stages to address fishery-related problems such as assessment of spawning stock size and recruitment success. All of these

studies have in common the need to subdivide early life history and communicate information based on processes and events occurring during these subdivisions. As with any communication, it is vitally important to use terms that are clearly defined and this is particularly true with the diverse disciplines that are involved in larval fish studies. Historically, several disciplines have used different names for the same stage, or subdivided development differently [see Okiyama (1979a) and Fig. 6 in this paper]. This has led to confusion rather than communication.

Several criteria seem appropriate for defining stages of development to be used by students of any discipline. The variety of developmental patterns should be recognized and the definitions should apply to as many patterns as possible. Thus, stages should be based on very widespread, fundamental features of development. The stages should have some significance in the life history of the fish, both morphologically and func-

	From demersal eggs	From pelagic eggs
Clupeiformes	 <p><i>Clupea harengus harengus</i> egg diameter = 1.2-1.5mm NL at hatching = 4.9mm</p> <p>Krevasoski 1956</p>	 <p><i>Etrumeus teres</i> egg diameter = 1.3mm NL at hatching = 4.8mm</p> <p>Mito 1961</p>
Gadiformes	 <p><i>Gadus macrocephalus</i> egg diameter = 0.8-1.4mm NL at hatching = 3.6mm</p> <p>Mukhacheva and Zviagina 1960</p>	 <p><i>Gadus morhua</i> egg diameter = 1.1-1.9mm NL at hatching = 3.6mm</p> <p>Colton and Marak 1961</p>
Pleuronectiformes	 <p><i>Lepidopsetta bilineata</i> egg diameter = 1.02-1.09mm NL at hatching = 3.9mm</p> <p>Pertseva-Ostroumova 1961</p>	 <p><i>Isopsetta isolepis</i> egg diameter = 0.90-0.99mm NL at hatching = 2.9mm</p> <p>Richardson et al 1980</p>

Fig. 8. Newly hatched yolk-sac larvae of related fishes with pelagic and demersal eggs of comparable sizes.

tionally, such as a particular type of nourishment or locomotion. Also the endpoints for the stages should be easily observed and sharply defined.

The most general scheme of terminology of early development of fishes includes (Fig. 5):

The "egg stage" (spawning to hatching). The egg stage is used in preference to the embryonic stage because there are characters present during this stage other than just embryonic characters (e.g., those associated with the egg envelope).

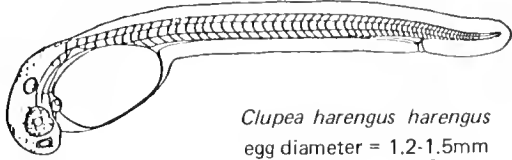
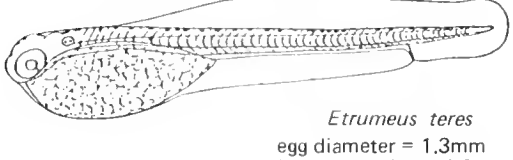
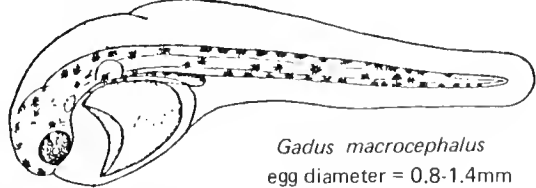
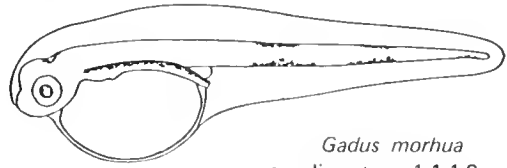
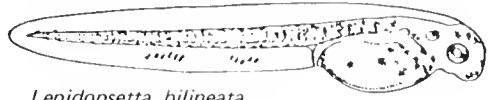
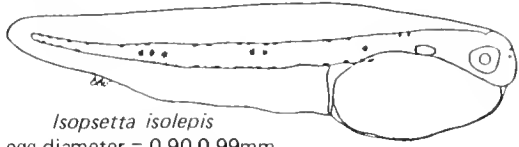
The "larval stage" (hatching to attainment of complete fin ray counts and beginning of squamation). One of the fundamental events in development of most fishes is the flexion of the notochord that accompanies the hypochordal development of the homocercal caudal fin. It is convenient to divide the larval stage on the basis of this feature into "preflexion," "flexion," and "postflexion" stages. The flexion stage in many fishes is accompanied by rapid development of fin rays, change in body shape, change in locomotive ability, and feeding techniques.

The "juvenile stage" (completion of fin ray counts and beginning of squamation until fish enters adult population or attains sexual maturity).

Transitional stages can also be recognized: the "yolk-sac larval stage" (between hatching and yolk-sac absorption); and the "transformation stage" (between larva and juvenile). Metamorphosis occurs during this stage and is considered complete when the fish assumes the general features of the juvenile.

The life histories of some fishes include other specialized ontogenetic stages that have received various names. In some cases, these are the generic names under which these stages were

described before they were recognized as larvae of other species (e.g., the leptocephalus stage of Anguilliformes, the scutatus stage of *Antennarius*, the vexillifer stage of Carapidae, and the kasidoron stage of *Gibberichthys*). In other cases, consistent features of development of a group permit useful subdivisions of stages (e.g., in leptocephali the engyodontic and euryodontic stages).

THE EGG STAGE

Hempel (1979) reviewed the egg stage relative to fisheries investigations. Ahlstrom and Moser (1980) presented a concise review of the range of characters observed in pelagic fish eggs, particularly those useful in identifying eggs in plankton samples. Sandknop and Matarese in this volume also discuss this subject in detail. The characters that have proven useful for egg identification include egg size and shape, size of perivitelline space, yolk diameter and character (homogeneous or segmented), number and size of oil globules, texture of the egg envelope (smooth or with protrusions), pigment on the yolk and embryo, and characters of the developing embryo (relative rate of development of various parts, body shape, number of somites) (Table 2).

The egg stage has been subdivided by a number of workers (e.g., Apstein, 1909). Fishery biologists need to determine the age of eggs at the time of collection for production, drift, and mortality estimates. Embryologists have designated stages to coincide with significant developmental features. While the stages of fishery biologists are designed to divide the embryonic stage into several easily recognized portions, embryologists are more

TABLE 3. EXAMPLES OF USE OF CHARACTERS OF EARLY LIFE HISTORY STAGES IN TAXONOMIC AND SYSTEMATIC STUDIES. X INDICATES RANGE OF STAGES AND TAXONOMIC LEVELS AT WHICH CHARACTERS VARY. (X) INDICATES INFREQUENT STATE.

Character	Developmental stage						Taxonomic level				References
	Egg	Larvae					Species	Genus	Family	Order	Keyed to Table 4
		Yolk-sac	Pre-flexion	Flexion	Post-flexion	Transformation					
Meristic characters											
Fin spines/soft rays			(X)	X	X			(X)	X	20	
Principal caudal rays			X	X	(X)			(X)	X	20, 29	
Pelvic fin			(X)	X	X			(X)	X	2, 38	
Dorsal/anal fin				X	X		X	X		1, 2, 11, 19, 24, 27, 39	
Pectoral fin			(X)	X	X		X			11, 19, 24, 27, 39	
Vertebrae				X	X		X	X		1, 2, 3, 5, 11, 15, 17, 19, 20, 25, 27, 28, 33, 34	
Branchiostegals			X	X	(X)			(X)	X	27, 38	
Gill rakers					X	X	X			19	
Larval characters											
Body shape		X	X	X	X	X	X	X		2, 3, 4, 5, 10, 11, 13, 14, 19, 20, 23, 24, 25, 26, 27, 28, 29, 31*, 33, 37, 40	
Snout shape			X	X	X		X	X		28, 33, 35, 36, 38	
Pigment patterns	X	X	X	X	X	X	X	X	X	1, 2, 3, 4, 8, 9, 11, 13, 14, 15, 17, 19, 20, 21, 22, 25, 27, 28, 29, 33, 36, 38, 39, 40	
Head spines			X	X	X		X	X	X	9, 11, 23, 24, 25, 27, 36, 38, 40	
Fin ray elongation			X	X	X		X	X		1, 9, 14, 23, 27, 29, 33	
Fin ray ornamentation			X	X	X		X			14, 27, 29	
Fin ray serration				X	X		X			27	
Finfold size/shape		X	X				X			8, 10, 14	
Preal anal finfold		X	X				X			36	
Pectoral size shape			X	X	X		X			8, 14, 15, 33	
Larval gut											
Shape		X	X	X	X		X			20, 33, 38, 39	
Length		(X)	X	X	X		X			14, 20, 29, 33, 38	
Larval eye											
Shape			X	X	X		X			8, 10, 14, 20, 33	
Stalked			X	X	X		X			14, 20, 33	
Choroid tissue			X	X	X		X			10, 14, 20	
Migration						X			X	29	
Other characters											
Egg characters	X						X	X		6, 19, 20, 30, 32	
Osteological development			(X)	X	X	X	X	X	X	7, 16, 19, 23, 29, 33, 40	
Scale formation				X	(X)	X	X			11, 27	
Photophore formation					X	X	X	X		12, 14, 21	
Size at developmental stage	X	X	X	X	X	X	X	X		10, 11, 22, 23, 29, 30, 39	
Fin development sequence			(X)	X	X		X	X		13, 14, 20, 26, 27, 34	

* Emphasis on oil globule placement in yolk-sac larvae

interested in tracing the sequence of development. The embryologist's approach will probably provide more useful information for systematic investigations.

Although excellent, early descriptive work was done on teleost embryology (e.g. Wilson, 1891), comparative research on development needs to be done to allow an evaluation of its value to systematics, a subject that has proven so fruitful among invertebrates. It appears, from the characters that have been studied in greatest detail, that convergence may overshadow phylogenetically significant information. For instance, the egg envelope sculpturing on *Pleuronichthys*, a pleuronectiform, was found

even on scanning electron microscope examination to be quite similar to that on *Synodus*, a myctophiform (Sumida et al., 1979). Phylogenetically diverse fishes often have round pelagic eggs, about 1 mm in diameter, with a single oil globule. Demersal eggs from equally diverse fishes are generally larger than 1 mm and develop a vitelline circulatory system. Yolk segmentation seems to be a character of more primitive fishes, but some carangids and other perciforms have yolks that are secondarily segmented in an evolutionary sense. Detailed studies are needed to sort out these and other features of the teleost egg and its embryonic development in a systematic context.

TABLE 4. SOME CONTRIBUTIONS IN WHICH ONTOGENETIC CHARACTERS HAVE BEEN USED TO EXAMINE SYSTEMATIC RELATIONSHIPS (UPDATED FROM AHLSTROM AND MOSER, 1981).

No.	References	Date	Group dealt with	Stages			Larval characters showing relationships			
				Egg	Larvae	Juv ad	Among species	Among genera	Among subfam or families	Among orders
1, 3, 5	Ege, V.	1930, 53, 57	Paralepididae	—	+	±	X	X		
2	Bertelsen, E.	1951	Ceratioidei	—	+	+	X	X	X	
4	Bertelsen, E., and N. B. Marshall	1956	Miripinnati	—	+	±	X	X	X	
6	Pertseva-Ostroumova, T. A.	1961	Pleuronectidae	+	+	±	X	X		
7	Berry, F. H.	1964a	Mar. teleosts	—	+	—				X
8	Pertseva-Ostroumova, T. A.	1964	Myctophidae	—	+	—		X		
9	Gutherz, E. J.	1970	Bothidae	—	+	—		X		
10, 14	Moser, H. G., and E. H. Ahlstrom	1970, 74	Myctophidae	—	+	±	X	X	X	
11	Mead, G. W.	1972	Bramidae	—	+	±	X	X		
12	Ahlstrom, E. H.	1974	Sternoptychidae	—	+	±		X		
13	Johnson, R. K.	1974b	Scopelarchidae	—	+	+	X	X		
15	Okiyama, M.	1974a	Myctophiformes	—	+	—		X	X	
16	Potthoff, T.	1974	Scombridae	—	+	+	X			
17	Richards, W. J., and T. Potthoff	1974	Scombridae	—	+	±	X			
18	Aboussouan, A.	1975	Carangidae	—	+	—		X		
19	Ahlstrom, E. H., J. L. Butler, and B. Y. Sumida	1976	Stromateoidei	±	+	±	X	X	X	
20	Ahlstrom, E. H., and H. G. Moser	1976	Mar. teleosts	+	+	+				X
21	Ahlstrom, E. H., H. G. Moser, and M. J. O'Toole	1976	Myctophidae	—	+	+		X		
22	Bertelsen, E., G. Krefft, and N. B. Marshall	1976	Notosudidae	—	+	±	X	X		
23	Futch, C. R.	1977	Bothidae	—	+	—		X	X	
24	Moser, H. G., E. H. Ahlstrom, and E. Sandknop	1977	Scorpaenidae	—	+	±	X	X	X	
25	Okiyama, M., and S. Ueyanagi	1978	Scombridae	—	+	—		X	X	
26	Powles, H., and B. W. Stender	1978	Sciaenidae	—	+	±		X		
27	Kendall, A. W., Jr.	1979	Serranidae	—	+	+		X	X	
28	Ueyanagi, S., and M. Okiyama	1979	Scombridae, Istiophoridae	—	+	+		X		
29	Amaoka, K.	1979	Pleuronectiformes (in part)	—	+	—		X	X	
30	Dotsu, Y.	1979	Gobiidae	+	+	—		X		
31	Suzuki, K., and S. Hioki	1979a	Percoidei	±	+	—		X	X	
32	Mito, S.	1979a, b	Mar. teleosts	+	—	—		X	X	
33	Okiyama, M.	1979b	Myctophoidei	—	+	—		X	X	
34	Potthoff, T., W. J. Richards, and S. Ueyanagi	1980	Scombrolabracidae	—	+	+		X	X	
35	Zahuranc, B. J.	1980	Myctophidae (Nannobranchium)	—	+	+	X	X		
36, 37	Richardson, S. L.	1981a,c	Cottidae	—	+	+		X		
38	Washington, B. B.	1981	Cottidae	—	+	+	X	X		
39	Johnson, R. K.	1982	Scopelarchidae Evermannellidae	—	+	+	X	X	X	
40	Kendall, A. W., Jr., and B. Vinter	1984	Hexagrammidae	—	+	+	X	X		

THE YOLK-SAC LARVAL STAGE

At hatching, larvae can be at various states of development, dependent to a large degree on the size of the yolk (Fig. 7). Larvae from eggs with small yolks are less developed at hatching than those that hatch from eggs with larger yolks. Since the bulk of marine fish spawn eggs that are about 1 mm in diameter and have a narrow perivitelline space, the yolk is only slightly less than 1 mm. Larvae from such eggs generally lack a functional mouth, eye pigment, and differentiated fins. They possess a large yolk sac relative to the size of the larva which supplies nourishment while the larvae develop to become self-feeding. Newly hatched larvae from demersal eggs are generally further ad-

vanced in development than larvae from pelagic eggs of comparable size (Fig. 8). In these and other fish with large eggs, hatching may be delayed until the yolk sac is absorbed and the larvae are ready to feed at hatching, having bypassed the yolk-sac larval stage. The delayed absorption of yolk reaches an extreme in fishes such as salmonines in which the yolk-sac larva transforms directly into a juvenile; Hubbs (1943) proposed the term "alevin" be applied to this yolk-sac larval stage.

At hatching, locomotion and orientation of most yolk-sac larvae are aided by a continuous median finfold (dorsal, caudal, anal) and larval pectoral fins. During egg development, many fish embryos develop melanophores that originate in the neural

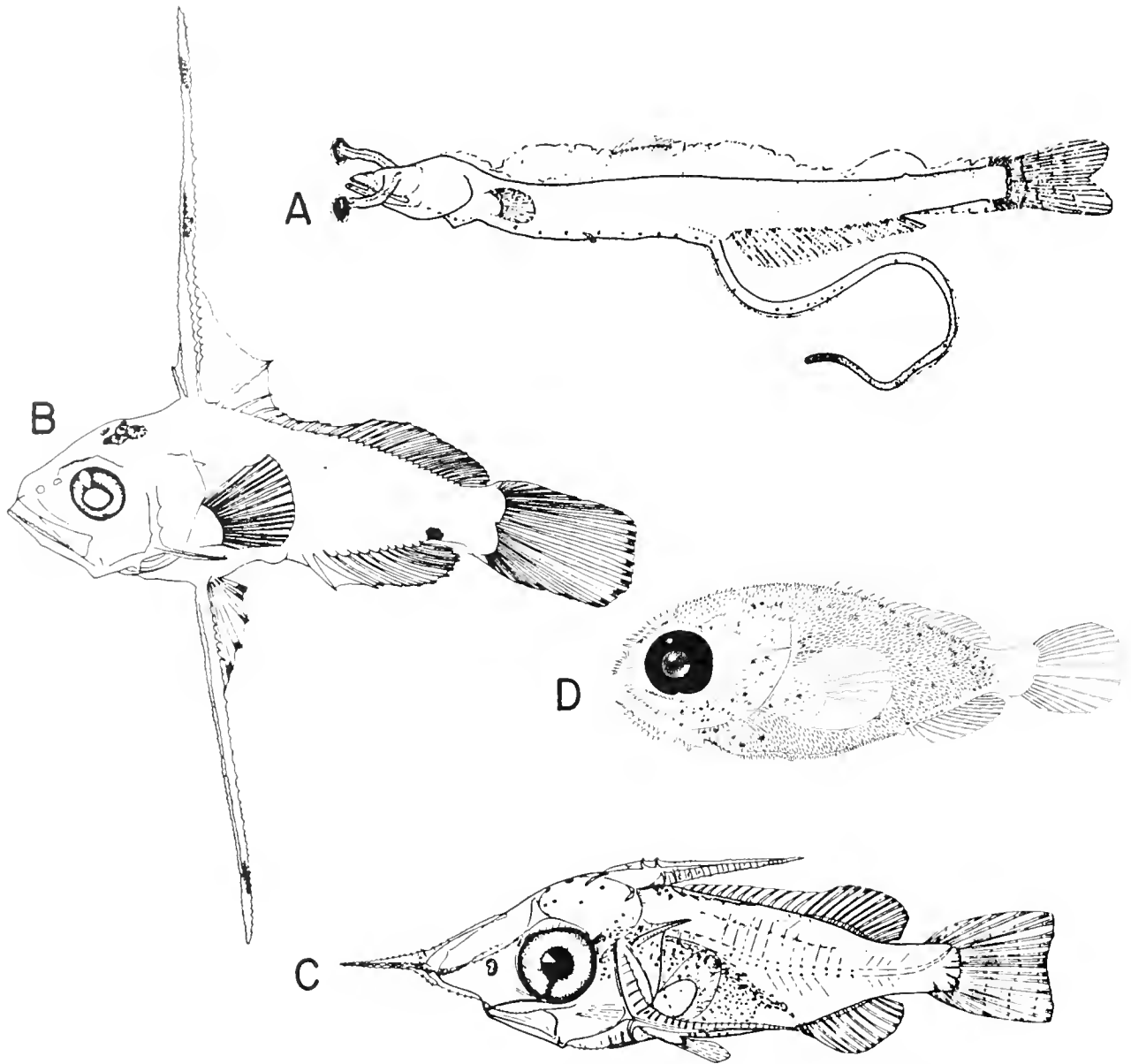

Fig. 9. Examples of teleost larvae illustrating extremes of some systematically useful larval characters. (A) *Myctophum aurolaternatum*, 26.0 mm (Moser and Ahlstrom, 1974). Note stalked oval eye with choroid tissue, trailing gut, and dorsal fin developing in finfold; (B) *Epinephelus* sp., 8.4 mm (Kendall, 1979). Note elongate, serrate dorsal and pelvic spines; (C) *Adioryx (Holocentrus) vexillarius*, 8.5 mm (McKenney, 1959). Note head spines; and (D) *Lopholatilus chamaeleonticeps*, 6.0 mm (Fahay and Berrien, 1981). Note spines on head and body.

crest and are generally aligned along the dorsal surface of the embryo. During the yolk-sac stage, these melanophores move laterally and ventrally to establish the beginning of the larval pigment pattern. Orton (1953a) describes these events in detail in *Sardinops sagax*. This realignment may begin during the late embryonic stages, before hatching. Some species hatch with few if any melanophores, and when they first appear, they are in ventral positions. Apparently, the pigment cells migrate before pigment formation occurs.

The presence and position of oil globules in yolk-sac larvae vary and can be of diagnostic value. In fishes with single oil globules, it can be far forward (e.g., labrids, most carangids, mullids, and lethrinids), in the middle of the yolk sac (e.g., some clupeids, serranids, and argentinids), or more usually near the

rear of the yolk sac. The shape and relative size of the yolk sac itself are variable and provide additional taxonomic characters.

In summary, although the yolk-sac stage starts at hatching and ends when the yolk is absorbed, fish are at different stages of development with regard to such features as pigmentation, eye development, and fin formation during this stage. The striking pigment rearrangements that occur during this stage provide further emphasis that the yolk-sac stage is a transitional stage between the egg and larval stages.

THE LARVAL STAGE

During the larval stage many ontogenetic changes occur (Moser, 1981). Some of these relate directly to the development of the adult form while other changes and structures are specialized

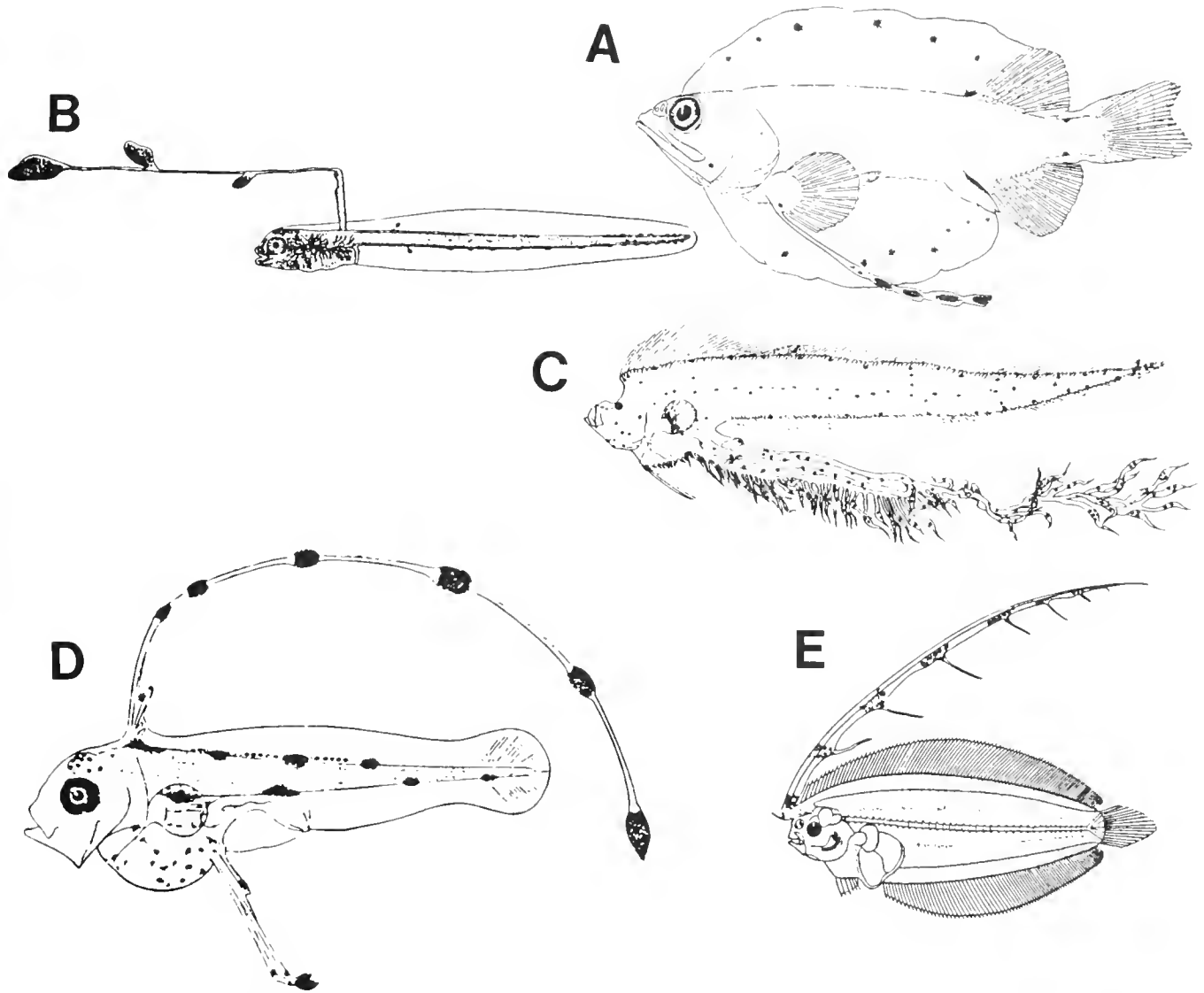

Fig. 10. Apparent convergence in siphonophore-mimicking appendages on larval fish. (A) *Loweina rara*, 17.6 mm. Note lower pectoral fin ray (Moser and Ahlstrom, 1970); (B) *Carapus* sp., 3.8 mm (Padoa, 1956j). Note elongate dorsal fin ray; (C) *Exerilium* larva, 64 mm. Note trailing gut (Moser, 1981); (D) *Lophous* sp., 12.1 mm. Note elongate dorsal and pelvic ray (Sanzo, 1940); and (E) *Arnoglossus japonicus*, 30.5 mm. Note elongate dorsal ray (Amaoka, 1973).

and of presumed functional significance primarily for planktonic existence (Fig. 9). These latter features are of particular interest in systematic studies of larval fish ontogeny. They include pigment pattern, larval body shape, armature on head bones, and precocious (early forming), elongate, or serrate fin spines. The sequence and way of developing adult structures, such as the skeleton and fin rays, are also useful larval characters. All of the characters of the larvae—whether they are specialized larval characters or merely characters observable in the larvae—may have potential systematic value at some taxonomic level; however, the usefulness of most of the characters has not been evaluated (Tables 3 and 4).

Among the most taxonomically useful larval characters, generally at the specific or generic level, is the pigment pattern. Usually, each species has a distinct larval pigment pattern. In some the number and placement of individual melanophores

are diagnostic, while in others the location, shape, and size of groups of melanophores are key characters. At a higher taxonomic level, in the myctophiforms for example, the peritoneal pigment blotches seem to indicate relationships on a suborder-family level. Problems associated with the usefulness of pigment patterns include 1) the widespread distribution of some patterns, and 2) the variable state of melanophore contraction on larvae of the same species. An example of the first problem is the frequent occurrence of a row of small melanophores along the ventral midline from just behind the anus to the tip of the tail. Another example is a pigmented area midlaterally on the caudal peduncle which occurs in numerous groups. A ventral spot at the junction of the cleithra is also quite common. These are just a few examples of widespread, presumably convergent pigment patterns that limit the usefulness of pigment in systematic studies of larvae. The causes for the observed differences in degree

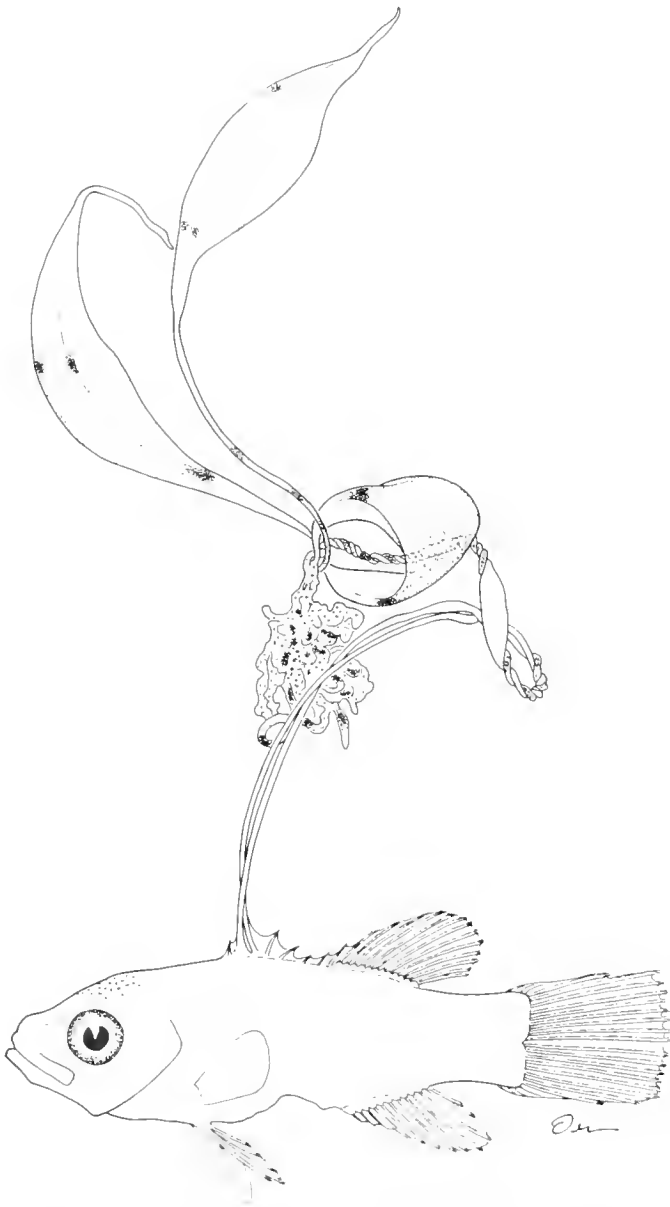

Fig. 11. *Liopropoma* sp., 11.0 mm. Collected by G. R. Harbison, 16 May 1981, 6°31.8'S, 150°21.8'E. Note elongate dorsal spines.

of contraction of melanophores are not well understood although they may be partially related to ambient light intensity. The relative size and placement of melanophores are genetically determined and therefore useful in a systematic context, while the degree of contraction seems to be physiologically determined.

In general, the body shape and size at various stages of de-

velopment are characteristic of larvae at the generic or familial level, although subtle differences in body shape may be characteristic of species. Size at stage of development can be environmentally modified (e.g., by temperature or food) to some extent, but is primarily genetically determined. There appears to be some convergence in larval body shape, such as on a long tubular body in several divergent groups (e.g., Clupeiformes, Argentinidae, Blennioidea), just as there is on the "herring" morph of adults.

A valuable and fairly widespread set of larval characters concerns the development of spines and armature on bones of the head and cleithral region. Such armature has provided diagnostic larval characters as well as material for systematic inference at levels from species to order. Larval head armature appears to be a mark of the Acanthopterygii. Only a few scattered examples of such armature appear in fishes which have only soft rays as adults (e.g., *Sudis*). Within the spiny-rayed fishes, beryciforms are quite heavily armed with spines on many head bones. Perciforms usually do not have spines on the parietals but the supraoccipital is armed in some. The Scorpaeniformes are just the opposite: they tend to have head armature that includes spines on the parietals but do not have spines on the supraoccipital.

Nowhere are larval specializations more evident or varied than in the fins. Elongation of particular spines or soft rays or enlargement of whole fins are frequently seen. Such elongations have been described for rays of the dorsal, pelvic, pectoral, and caudal fins; thus they occur with both spines and soft rays. In some, these long rays may bear pigmented "bulbs" or appear like flagellae. Such specialized rays are produced in the dorsal, pectoral, or pelvic fins of taxonomically diverse fishes. The extended gut of "exteriorium" ophidioid larvae (Fraser and Smith, 1974) and the serial pigment pattern of some leptocephali (Smith, 1979) may give the same appearance to potential predators as these elongate rays. All of these structures may be mimicking siphonophores: a remarkable example of convergence (Fig. 10 and 11). Elongate fin spines are heavy and armed with serrations in some. Elongated rays are often precocious in development, with some even forming in the egg. These fin characters seem to vary at the family-species levels. Other characters associated with fin development include the sequence of formation and movement and loss of whole fins or some of the rays. Dorsal and anal fins move forward along the body during larval development in elopiform and clupeiform fishes. They develop in "streamers" in the finfold of argentinoids and attach to the body proper just before or during transformation. The shape of the finfold, presence or absence of a preanal finfold, and shape of the pectoral fin base provide additional characters at the family-genus level.

Gut characters of fish larvae include length and shape as well as the development of a protruding, trailing hindgut in some. In fishes with photophores, their placement and sequence of development are excellent characters at the subfamily-species levels. The eye of a larva is specialized in a number of ways.

Fig. 12. Examples of special juvenile stages. (A) *Hexagrammos lagocephalus*, 28.0 mm. A neustonic or epipelagic form of a species that is demersal as an adult (from Kendall and Vinter, 1984); (B) *Forcipiger longirostris*, 17 mm. A spiny form that lives on tropical reefs as an adult (from Kendall and Goldsborough, 1911); (C) *Sebastolobus altivelis*, 26.8 mm. A barred pelagic form of a species that is demersal on the continental slope as an adult (from Moser et al., 1977); (D) *Oncorhynchus kisutch*, 37 mm. The freshwater alevin or parr stage of an anadromous salmonid (from Auer, 1982); and (E) *Kali macrodon*, 45 mm. The juvenile of a bathypelagic species. Originally described as *Gargaropteron pterodactylops* (see Johnson and Cohen, 1974).

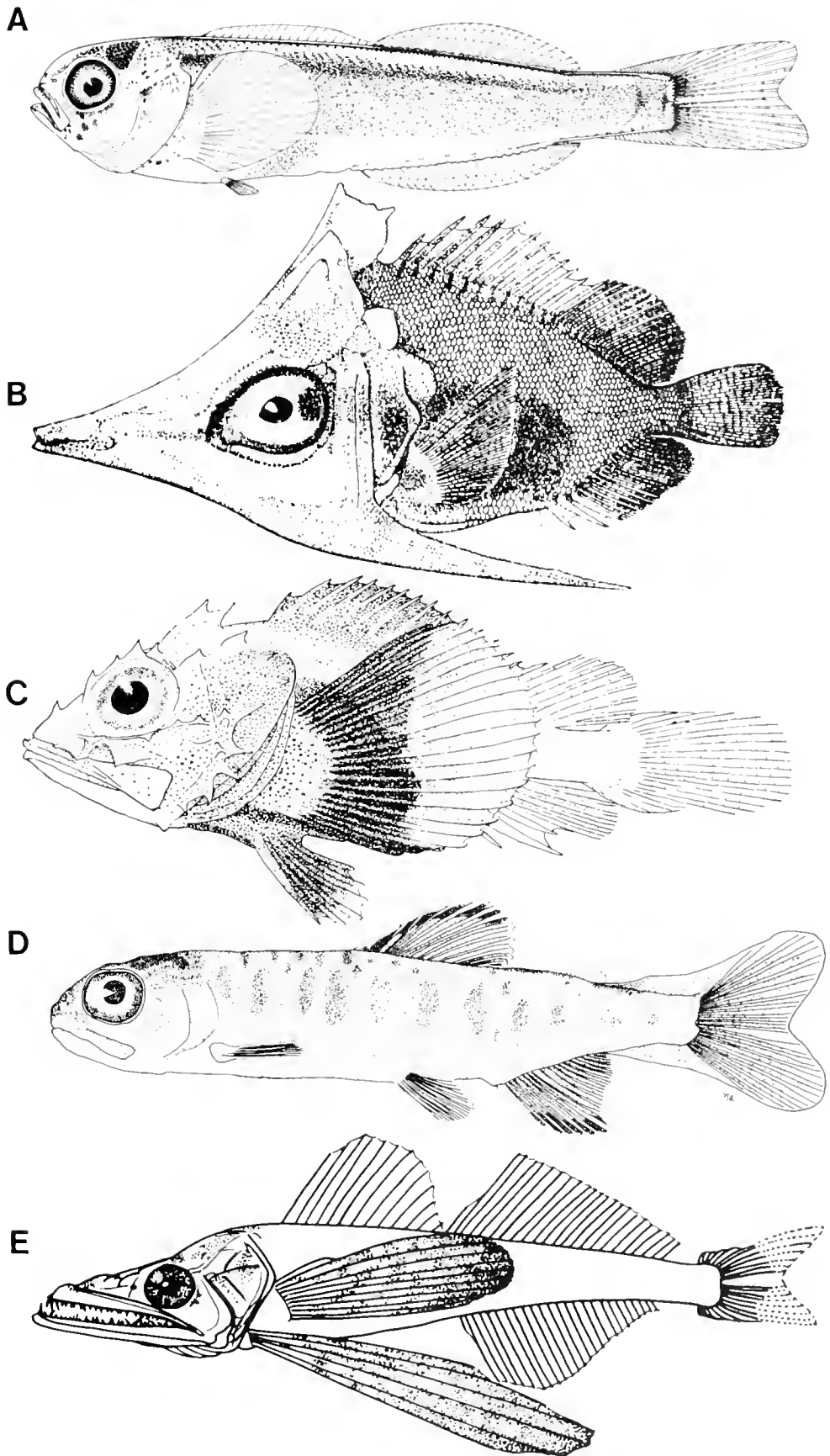

Its size and rate of development are useful, as well as whether it is round or oval. Some fish larvae have eyes borne on stalks that reach an extreme in *Idiacanthus*, while others develop an area of choroid tissue. Migration of the eye in flatfish larvae from a symmetrical position to one side of the head is well known. The sequence of development of ossified structures is proving to be a powerful tool in systematic studies of fish larvae. The losses and fusions of bones, which are generally assumed based only on adult material, can and should be tested using developmental studies. The caudal fin skeleton has provided excellent developmental characters to be used for systematic inferences, mainly at the order-generic levels. The development of scales has been little studied but may prove valuable, especially in fishes with precocious scales (e.g., some anthiins, holocentrids).

THE TRANSFORMATION STAGE

Between the larval and juvenile stages, there is a transitional stage which may be abrupt or prolonged and which, in many fish, is accompanied by a change from planktonic habits to demersal or schooling pelagic habits (Fig. 12). In some fishes migration to a "nursery" ground occurs during or just before this stage. Morphologically the transformation stage is characterized by a change from larval body form and characters to juvenile-adult body form and characters. At the end of this stage the fish generally looks similar to the adult, with major differences only in pigmentation patterns. Two ontogenetic processes occur during this stage of transition between the larva and juvenile: 1) loss of specialized larval characters, and 2) attainment of juvenile-adult characters. Changes that occur during this stage include pigment pattern, body shape, fin migration (e.g., in elupeids and engraulids), photophore formation, loss of elongate fin rays and head spines (e.g., in epinepheline serranids and holocentrids), eye migration (pleuronectiforms), and scale formation.

In several groups, where the transformation stage is prolonged, the fish have developed specializations that are distinct from both the larvae and juveniles. This stage has been designated the prejuvenile stage (Hubbs, 1943). The specializations generally involve body shape and pigmentation. In many, the morph resembles a herring-like fish and is apparently adapted for neustonic life. The dorsal aspect of the fish is dark green or blue and the lateral and ventral is silvery or white. The body tends to be herring shaped and the mouth terminal. Fins are generally unpigmented. Such a stage is present in Gadiformes (*Urophycis*), Beryciformes (*Holocentrus*), Perciformes (e.g., *Pomatomus*, Mullidae, Mugilidae) and Scorpaeniformes (e.g., *Scorpaenichthys*, *Hexagrammos*). In other fishes, such as some myctophiforms and carapids, the prolonged transformation stage may have distinctive body and fin shapes.

IMPLICATIONS OF LARVAL FISH MORPHOLOGY

When studying the appearance of larval fishes, one is immediately struck with their diversity and morphological dissimilarity to adults. This dissimilarity led early workers to establish

names for several of these forms, not realizing that they were the young stages of known adults. After establishing the identity of many fish larvae in a variety of groups, we hypothesize that the larvae of all species are recognizably distinct. The use of diversity of larval form in vertebrate systematics was discussed some time ago by Orton (1953b, 1955c, 1957) and in this volume we examine this use in detail in numerous groups of fishes.

Why are the larvae so diverse?—Despite the tremendous mortality associated with living in the planktonic realm during the larval period, survival must be sufficient to maintain the species and provide a dispersal mechanism for it. To different degrees, various taxa apparently rely on survival and longevity of individual larvae. The amount of reliance is presumably related to fecundity and importance of dispersal and colonization to the taxon. A number of structures have evolved that would be expected to enhance larval survival in the plankton. Practically no experimental work has been done to investigate the function of larval structures, but some structures probably assist flotation and feeding while others decrease predator mortality. Convergence on characters that are apparently functionally important to larval survival in the plankton is seen. These specializations develop in conjunction with the basic ontogeny of the taxon. In studying systematics using larval fishes, both the basic pattern of development and the specialized structures must be analyzed.

Why are these larvae so morphologically unlike the adults?—Most larvae are adapted to survive in an ecological realm (generally the plankton) that is far different from that of the adult. These are small organisms, compared to adults, and they live in the plankton, having to find and capture food there and avoid becoming food. They float and migrate vertically in a milieu that may be moving much faster than they are. During this larval period, these fish undergo extreme changes in morphology yet remain a functioning (eating, avoiding predators) organism and eventually end up in a suitable nursery area for the juvenile stage.

How then can larval morphology help us understand the evolution of these fishes?—After recognizing that each species has a morphologically distinctive larva, generally we see that species of the same genus are phenetically similar, and larvae of members of a family also share common features. Even larvae of suborders and orders share some larval characters. This would be expected since evolution operates on all stages in the life cycle, not just the adult. Evolutionary pressures on the larval stage seem to be particularly intense in those groups that rely on the larvae for widespread dispersal in the ocean. Here the larvae appear well adapted for life in the planktonic realm, and it can truly be said that the larva and the adult perform in "two quite separate evolutionary theaters" (Moser and Ahlstrom, 1974). In this volume we are focusing on what we know to date about larval evolution within various groups of fishes (Table 4).

NORTHWEST AND ALASKA FISHERIES CENTER, 2725 MONTLAKE BLVD. E., SEATTLE, WASHINGTON 98112 AND SOUTHWEST FISHERIES CENTER, P.O. BOX 271, LA JOLLA, CALIFORNIA 92038.

TECHNIQUES AND APPROACHES

Early Life History Descriptions

E. M. SANDKNOP, B. Y. SUMIDA AND H. G. MOSER

FISHERIES studies require accurate identification of subject species. Identification of the developmental stages of fishes is complicated by the small size of the specimens, their fragility, and the relatively great changes in their structure and pigmentation. Experience has shown that major changes can occur over very small growth increments and these can only be documented by a continuous growth series. Published descriptions of developmental series vary in quality, perhaps more than do species descriptions of adults. Prior to Bertelsen (1951) and Ahlstrom and Ball (1954), most published descriptions were based on relatively few specimens, which were described individually. In their study of the early life history stages of the jack mackerel (*Trachurus symmetricus*), Ahlstrom and Ball (1954) used over 500 eggs and a series of about 250 larvae, transforming specimens, and juveniles to describe development. Changes in structure and pigmentation were thus described as a dynamic continuum, with emphasis on variation, in contrast to the approach of most previous workers. Developmental osteology was considered an integral part of the description as were seasonal and geographic distributions of eggs and larvae. This paper was followed by several others (Ahlstrom and Counts, 1955, 1958; Uchida et al., 1958; Kramer, 1960) and these became models for subsequent descriptive papers, including some which treated several species in various taxonomic groups (Moser and Ahlstrom, 1970; Ahlstrom, 1974; Ahlstrom et al., 1976; Moser et al., 1977; Kendall, 1979; Brownell, 1979; Richardson and Washington, 1980; Fahay, 1983; Leis and Rennis, 1983). The following is a brief account of the elements involved in preparing early life history accounts of teleosts.

SOURCES

The major source of material is plankton collections. Typical survey tows strain a column of water 200 m to the surface and sample eggs and subsequent larval stages of a major portion of the fish fauna (Smith and Richardson, 1977). Fishes which have highly stratified vertical distributions are undersampled by oblique tows and require special gear or tow strategies. For example, surface dwellers can be sampled by neuston nets (Zaitsev, 1970; Nellen and Hempel, 1970; Hempel and Weikert, 1972; Nellen, 1973a; Ahlstrom and Stevens, 1976) and those species residing near the bottom may be sampled by epi-benthic plankton nets (Schlotterbeck and Connally, 1982). Larger larvae and transforming stages are poorly sampled by typical survey tows principally because of accumulated mortality, increased avoidance capacity, and migration out of the sampling zone. These stages are more effectively sampled by trawls (Tranter, 1968), dip-netting with attractor lights (Klawe, 1960), light traps (Faber, 1982), and fish predators (Haedrich and Nielsen, 1966). Recently, scuba divers have collected oceanic larvae with their delicate structures intact (Harbison et al., 1978; Govoni et al., 1984). Developmental series may also be obtained by rearing

larvae from eggs collected at sea or from captive brood stock (Houde et al., 1970, 1974; Houde and Swanson, 1975; Richards et al., 1974; Houde and Potthoff, 1976; Moser and Butler, 1981). This method becomes essential when working with speciose faunas (e.g., *Sebastes*, warm water shorefishes), if only to determine which species cannot be identified.

USE OF SPECIMENS

The characters and techniques used in identifying developmental stages are discussed elsewhere in this volume (see Kendall et al.; Matarese and Sandknop; Powles and Markle). From the continuous developmental series two subseries are assembled and these form the basis for the description. The first series is used to describe morphology and pigmentation. Specimens in the second series are cleared and stained by a variety of techniques to describe the development of cartilaginous and osseous features (Potthoff, this volume).

The number of specimens used to construct these series is dependent on several factors: 1) specimen availability, 2) length (duration) of the development period, and 3) complexity of developmental change. A guideline is that there should be enough specimens to demonstrate the beginning, progression and completion of significant developmental changes in morphology and pigmentation. Usually more specimens are required for species which have extended larval periods; however, many fishes which transform at small sizes undergo great change over small length intervals. For example, lined sole (*Achirus lineatus*) hatch at 1.6 mm, transform at about 4.0 mm, and complete a large suite of developmental changes over a 2.5 mm length interval (Houde et al., 1970). The majority of marine teleosts transform between 10 and 30 mm and, for these, major developmental events can be documented by specimen length increments of 0.5–1.0 mm. Multiple samples representing 1 mm-intervals are required to study fine-scale character variation; however, such studies have rarely been done (Ahlstrom and Moser, 1981).

A table of morphometric measurements constructed from the unstained series provides data on the size at important developmental milestones (e.g., hatching, notochord flexion, fin formation, transformation) and provides a basis for analyzing structural change and allometric growth. These specimens can be used to construct character matrices of complex or diagnostic pigment changes. Illustration specimens chosen from the series provide an integrated view of major characters and also, if accurately executed, are themselves morphometric and meristic documents (Sumida et al., this volume).

The stained series is used to construct a meristic table that forms the basis for following the development of fin rays and supporting elements, the axial skeleton and cranial bones (Dunn, this volume). Fine bony structures, such as cranial spines are also apparent in these preparations.

Published descriptions employing these basic elements are

the basis for ontogenetic studies of fishes. These are essential for the identification of ichthyoplankton collections, and also present characters for systematic analysis. Data provided in

these descriptions have proved useful in studies of the physiology, behavior and ecology of the early stages of fishes.

NATIONAL MARINE FISHERIES SERVICE, SOUTHWEST FISHERIES CENTER, P.O. BOX 271, LA JOLLA, CALIFORNIA 92038.

Synopsis of Culture Methods for Marine Fish Larvae

J. R. HUNTER

THE objective of this paper is to provide a synopsis of present technology for small-scale laboratory culture of marine fish larvae. The technology of marine fish culture is relevant to this book because it is one of the best ways to obtain a taxonomic series. "Ahlie" Ahlstrom was a strong proponent of this approach and I lectured on the subject at his request for his courses on larval fish systematics. Marine fish culture has often been reviewed (May, 1970; Houde, 1972a; Houde and Taniguchi, 1979; Shelbourne, 1964; Kinne, 1977) and many additional references may be found in the previous reviews. The key feature of my review is that it is a condensed practical guide and key to the literature for beginners interested in small-scale laboratory culture of marine fish larvae; culture of freshwater fishes is not considered.

EGGS

Sources.—Pelagic fish eggs can be obtained from plankton tows, by catching ripe fish and fertilizing the eggs, and by induction of spawning of laboratory brood stock.

Let eggs taken in plankton tows stand in quart bottles for 0.5 h, then remove plankton from bottom of jar and add fresh sea water (a second decanting may be required). Jars are stored on their sides in an insulated ice box with a refrigerant for 24 h or longer with the temperature kept within spawning range.

Virtually all marine clupeoid fishes (Blaxter and Hunter, 1982) and probably most other pelagic marine fishes spawn at night, hence running ripe fish are more common at night or just before sunset (final egg maturation or hydration occurs just before spawning). After an egg is spawned in sea water its fertility decreases but the maximum time for it to become infertile is highly variable among species, varying from 6 minutes to over 3 hours (Ginzburg, 1972). Sperm in sea water may remain fertile for days (Ginzburg, 1972) although fertility periods as short as 30 seconds have been observed (Haydock, 1971). Owing to the great variation in the time eggs and sperm remain fertile it is preferable that sperm and eggs be mixed immediately after they are obtained.

Storage of gametes may be helpful since mature males and females are not always available simultaneously and crosses between subpopulations may be desired. It is well known that sperm can be stored for extended periods (10 or more hours) if kept cool and maintained in the concentrated form and not activated by sea water (Ginzburg, 1972; Erdahl and Graham, 1980). Fertilization of *Clupea harengus* eggs may be obtained

after 6–7 days dry storage at 4° C but a high hatching rate is expected only after periods less than 36 h (Blaxter and Holliday, 1963). It is now possible to extend the life of fish sperm for much longer periods using cryopreservation techniques (–196° C) (Erdahl and Graham, 1980). Various cryoprotective agents have been used to freeze sperm of marine fishes including glycerol (Blaxter and Holliday, 1963), glucose, NaCl, Ringer's solution and fish serum (Hara et al., 1982).

The stress of capture causes female *Katsuwonus pelamis* to ovulate and spawn within 24 h after capture but eggs are often not viable (Kaya et al., 1982). Maturing marine fish in the laboratory and spawning them by hormone injections has become routine in recent years and is preferable to stress techniques. Examples include *Engraulis mordax* (Leong, 1971), *Scomber japonicus* (Leong, 1977), *Chanos chanos* (Liao et al., 1979), *Bairdiella icistia* (Haydock, 1971), *Paralichthys dentatus* and *Pseudopleuronectes americanus* (Smigielski, 1975a, b) and others (see review of Lam, 1982). Induction of spawning in the laboratory may require an open sea water system, large holding tanks (e.g., ~3 m dia. or larger), temperature and light control.

Handling and stocking.—To count eggs without damaging them we recommend a polished wide bore (~3 mm) pipette; count 30–50 late stage eggs at a time in a depression slide under a dissection microscope, and wash eggs off the slide by immersion of the entire slide in sea water. Counting eggs is critical because higher mortalities and slower growth result from excess stocking densities (Houde, 1975 and 1977). As a rule stocking densities in rearing tanks of 8 eggs/l or less seems preferable and most rearing successes have occurred when stocking did not exceed 20 eggs/l (Houde, 1975). Similarly, the mortality of *Mugil cephalus* larvae seems to remain constant (2–3% loss/day) at stocking densities of 1–30 larvae/l (Kraul, 1983).

APPARATUS

Containers and lighting.—Larvae appear to grow faster and show fewer signs of starvation when reared in large containers (100 l) rather than in smaller ones (10 l) (Theilacker, 1980b). Optimum container size doubtless varies with species but 40 l containers are probably the minimum size that should be used and I prefer 100–400 l containers. We use cylindrical black fiberglass containers although excellent results are obtained using ordinary rectangular glass aquaria (Houde, 1975).

It is traditional to provide a daily cycle of illumination to

larvae in rearing containers although constant illumination is occasionally used. Typically fluorescent lamps are used which provide 2,000–3,000 lux at the water surface (Houde, 1978; Hunter, 1976). Night light levels vary; we provide no light at night whereas Houde (1978) provides a dim light of 40–90 lux at night, which is substantially above the visual threshold for feeding for larval *E. mordax* (6 mm larvae 50% feeding threshold = 6 lux, and 10–15 mm larvae 50% threshold = 0.6 lux, Bagarinao and Hunter, 1983). Clearly, longer periods for visual feeding will probably enhance growth if food is limited. Rearing at high light intensities such as natural sunlight may greatly increase production of algae and zooplankton in the culture tank and thereby increase larval survival (Kraul, 1983). On the other hand, solar UV radiation is clearly lethal to younger larvae (Hunter et al., 1982) and use of deep tanks, or shaded or covered tanks (screen cloth, acrylic plastic, glass or mylar film) is recommended for the first 1–2 weeks of larval life if tanks are to be exposed to solar radiation.

Water quality.—Closed, non-circulating systems are typically used to rear marine fish larvae at least during the younger stages, because in an open system planktonic larvae and their foods are easily lost. Older (nektonic) larvae are able to resist the current and to consume a daily ration in a short period so a partially open system can be used. We fill our rearing containers with UV treated sea water that is passed through three, in line, cartridge filters (5, 3 and 1 μm pore).¹ Although not a common practice in small scale rearing work, the addition to rearing tanks of antibiotics (sodium penicillin G at 50 i.u./ml plus streptomycin sulphate at 0.05 g/ml) slightly improved survival of *Pleuronectes platessa* eggs through hatching, but surprisingly this single treatment greatly improved survival of larvae through metamorphosis (Shelbourne, 1975).

Use of a closed system requires attention to water quality, a problem which may be intensified at higher rearing temperatures. In the most complete study of water quality in rearing tanks for marine fish larvae, Brownell (1980a, b) considered seven variables (pH, dissolved oxygen, carbon dioxide, ammonia, nitrite and nitrate), but only high pH, low dissolved oxygen and un-ionized ammonia had effects at levels likely to be encountered in rearing tanks. First feeding incidence declined by 50% in all species he studied when dissolved oxygen concentrations were between 4 and 4.75 mg/l (49–58% saturation). Dissolved oxygen in our rearing containers usually is not saturated after planktonic foods are added, and typically it is about 80% saturation even with aeration. Clearly water quality is improved by aeration and frequent water changes and tank cleaning. Werner and Blaxter (1980) exchanged 20% of the water in *Clupea harengus* cultures (9° C) 3 times per week but at high temperatures greater replacement rates are required. For example Houde (1977) replaced 20% of the tank sea water on alternate days while culturing *Anchoa mitchilli* and *Achirus lineatus* at 26–28° C. Frequent tank cleaning is important as heavy mortalities may result from toxins produced by debris on the container bottom (Kraul, 1983). Aeration, unless very gentle, can cause heavy mortalities among delicate eggs and newly hatched larvae. In fact, Shelbourne (1964) recommends no aer-

ation for *Pleuronectes platessa* larvae. I recommend very gentle aeration but not until a week or so beyond the first feeding stage.

The mortality of cultured fish larvae often increases during the period of initial swim bladder inflation in physoclistous fishes (Doroshev et al., 1981; Kuhlmann et al., 1981) and this could be related to water quality. Symptoms include delay or complete failure of inflation or excessive inflation; in either case normal swimming patterns are disrupted and death frequently results. The causes of abnormal inflation are not clear; prevention of larvae from reaching the water surface prevented excess inflation in *M. cephalus* larvae (Nash et al., 1977), whereas the same treatment in *Atractoscion nobilis* larvae had no effect. In *A. nobilis* excess inflation was associated with abnormal development of gas secretory tissue suggesting a more complex etiology (SWFC, unpubl. data). Failure to inflate the swim bladder is a common problem in *Morone saxatilis* culture and turbulent aeration may reduce the incidence of this disease (Doroshev and Cornacchia, 1979) but it now appears that reduction in salinity from 17 ppt to 4 ppt has a much greater effect in reducing the incidence of swim bladder malfunction (S. Doroshev and J. Merritt, U. Cal. Davis, pers. comm.).

FOOD

The most critical aspect of rearing marine larvae is management of their food. Food must be the correct density, size, nutritionally adequate and must remain suspended in the water column which usually requires the use of living pelagic organisms.

Food size.—Typical pelagic fish larvae are 2.5–4.0 mm when they begin feeding and acceptable prey are 20–150 μm in breadth (Houde and Taniguchi, 1979). Some large larvae, e.g., larval *C. harengus* (Blaxter, 1965), *Pleuronectes platessa* (Riley, 1966) or small larvae with large mouths, e.g., *Merluccius productus* (Sumida and Moser, 1980), can begin feeding on prey 300 μm or larger in breadth. The optimal food size increases as larvae grow (Hunter, 1981), so any culture technique should provide a steadily increasing range of food sizes, because if the food is too small growth slows and mortality occurs (Hunter, 1981). Food size requirements can be expressed in terms of the ratio of prey width to mouth width. The 50% threshold for feeding on a prey of a particular width occurs when this ratio is about 0.75, although occasionally larvae consume prey as wide as the width of their mouth (ratio = 1) (Hunter, 1981). At the onset of first feeding a small prey of about $\frac{1}{4}$ the mouth width seems to be preferable as capture success is low at this time but within a few days larvae are able to consume food of about $\frac{1}{2}$ the mouth width.

Wild zooplankton.—Wild zooplankton, primarily the naupliar and copepodite stages of marine copepods but also mollusc veligers, tintinnids, cladocera, and appendicularia larvae, are the natural foods of most marine fish larvae and probably also the best source of food for rearing a larval taxonomic series. Wild zooplankton provide a wide range of sizes and types and are probably nutritionally superior to cultured rotifers and *Artemia* nauplii (Kuhlmann et al., 1981). Collection of wild zooplankton may require less effort than production of cultured food except for brine shrimp nauplii (see below). Zooplankton is collected in nets of about 50 μm , and is graded by size in the laboratory using various nylon nets (Houde, 1977, 1978). This eliminates the larger zooplankton which larvae would be unable

¹ Aqua-Pure model AP10, AMF Cuno Division, Inc., Meriden, Connecticut USA.

to consume and which may be larval predators. Fish larvae, particularly yolk-sac stages, are vulnerable to various carnivorous copepods, amphipods, euphausiids and chaetognaths (Hunter, 1981).

Cultured foods.—Two cultured foods, the rotifer *Brachionus plicatilis*, and nauplii of the brine shrimp, *Artemia*, should be considered as potential foods for rearing marine fish larvae as many fish larvae can be reared on a combination of these two foods. These two foods may also be used as a supplement to diets of wild plankton. Groups of fishes that have been reared to metamorphosis on a combination of *Brachionus* and *Artemia* or on *Artemia* alone include *C. harengus*, species of serranids, scombrids, atherinids, various flatfishes, sciaenids, and saganids (May, 1970; May et al., 1974; and unpubl. SWFC data). *Artemia* nauplii are recommended only for larvae with differentiated guts as they are quite resistant to digestion whereas copepods are not (Rosenthal, 1969).

Methods for culturing rotifers using algae are given by Theilacker and McMaster (1971); culture methods employing formulated artificial diets or freeze dried algae (Gatesoupe and Robin, 1981; Gatesoupe and Luquet, 1981) and ones using brewers yeast also exist. Many of the essential facts given in these original papers will not be repeated here but I will point out a few practical points regarding rotifer culture using algae. Suitable algae species for rotifer culture include *Dunaliella*, *Nannochloris*, *Tetraselmis*, and *Chlorella* which may be grown using standard culture media (Guillard, 1975) or using liquid commercial plant fertilizers (dosage for fertilizer containing 8% total nitrogen = 0.1 ml of fertilizer/l; dosage among brands is adjusted depending on total N content). We prefer commercial plant fertilizers that have an organic base such as liquid fish fertilizers and avoid those that have soil penetrants. A daily doubling rate can be expected in healthy rotifer cultures, and cultures can be maintained for weeks or even months by adding fresh algae or nutrients and sea water, although single batch harvesting after about 2 weeks gives more dependable results. Rotifers are harvested using gravity flow through a nylon filter (20–40 μm mesh) as pumps may kill rotifers.

Production of *Artemia* nauplii is simple since all that is needed is to hatch the cysts ("Artemia eggs"). Cysts from a variety of strains of *Artemia* are commercially available. The strains differ considerably in average naupliar size (423–775 μm length), in pesticide content (DDT, PCB, and chlordane) and in certain fatty acids (Klein-MacPhee et al., 1982). These authors show that very low survival (15%) of *P. americanus* larvae occurred when they were fed San Pablo Bay (San Francisco) nauplii whereas survival of larvae fed other strains varied from 60–80%. Beck et al. (1980) gave similar results for *Menidia menidia* larvae. Of all the strains tested in these papers the Australian and Brazilian strains seem the most suitable for rearing larvae and the San Pablo Bay (USA) the least.²

Artemia hatcheries vary from a jar to complex automated systems. The J. D. Riley *Artemia* hatching box has been used with slight modification in many laboratories for over 20 years. It is a sea water filled box separated in half by a sliding partition; *Artemia* cysts are added to one side (1 g/l) and they hatch 1–2

days later depending on the temperature selected (23–30° C). The tank is then illuminated, the partition raised slightly off the bottom, and the nauplii, attracted by the light, swim beneath the partition leaving behind the hatching debris and unhatched cysts (Shelbourne, 1964). A semiautomatic version of this system is described by Nash (1973), and various other improvements in aeration, illumination, temperature, and other factors have increased yields to 10⁶ nauplii per 4.8 g of cysts (San Francisco Bay Brand) (Dye, 1980). In recent years decapsulation of *Artemia* cysts using hypochlorite bleach has become popular because it increases yields, increases the dry weight of the nauplius (Bruggeman et al., 1980) and eliminates contamination of larval fish rearing tanks with unhatched cysts.

It should also be noted that freshly hatched *Artemia* nauplii are clearly more nutritious than older starving individuals and consequently new batches should be frequently produced. In general, prey with full stomachs are probably nutritionally preferable to ones with empty stomachs. Similarly, more *Dicentrarchus labrax* larvae seem to survive when rotifers are nutritionally enhanced by 30 min immersion in a solution containing vitamins and soluble proteins (Gatesoupe and Luquet, 1981).

Mass culture of marine copepods is difficult and laborious and therefore not recommended when a taxonomic series is the sole objective. Nevertheless, culture of marine copepods may be the only way some fish larvae can be reared if wild zooplankton is not readily available and larvae die when fed *Artemia* nauplii (rarely are more than a single strain of *Artemia* tested, however). Harpacticoid copepods (*Tigriopus* sp., *Tisbe* sp., and *Euterpina* sp.) are the most frequently used copepods because of ease of culture; for culture techniques see Kahan et al. (1982) and Hunter (1976). *Euterpina* may be preferable to *Tigriopus* or *Tisbe* because the nauplii and copepodites of *Euterpina* are pelagic and therefore available to the larvae whereas nauplii and copepodites of *Tigriopus* and *Tisbe* tend to remain on surfaces and are therefore less available (Kraul, 1983). See Nassogne (1970) and Zurlini et al. (1978) for laboratory culture of *Euterpina*.

Food density.—The optimal food density for fish larvae depends upon the size of the food organism and size or age of the larvae. Densities of 1–3 organisms/ml have been routinely used for larvae fed wild zooplankton (largely copepod nauplii) during the first 1–2 weeks of feeding (Houde and Taniguchi, 1979). The same density range is used when cultured *Artemia* nauplii are the food. A higher density range (10–20/ml) is used for cultured *B. plicatilis* which are about 1/10 of the weight of an *Artemia* nauplius (Theilacker and McMaster, 1971). A very small food particle, the dinoflagellate *Gymnodinium splendens* (40 μm dia), is used for the first 2 days of feeding in northern anchovy larvae (Lasker et al., 1970; Hunter, 1976) at a high density of about 100/ml. In very active species such as *S. japonicus* or the siganid *Siganus canaliculatus* high food densities can cause heavy mortality because of overfeeding since most larval fishes seem to lack a satiation mechanism (May et al., 1974; Hunter, 1981). Overfeeding seems to occur only when such easily captured prey as *Artemia* nauplii are used as food.

Piscivorous fish larvae.—Piscivorous fish larvae such as the scombrids, *Sphyræna* and others pose special problems in culture. Fish larvae are an ideal food for such larvae; in fact, our only success in rearing *Katsuwonus pelamis* larvae to metamorphosis was probably related to an abundant supply of yolk-

² Exotic *Artemia* cysts are available from: Artemia Inc., P.O. Box 2891, Castro Valley, California 94546 USA and Biomarine Research, 4643 W. Rosecrans, Hawthorne, California 90250 USA.

sac fish larvae as food. Zooplankton is the initial food until piscivorous feeding habits develop (Houde, 1972b; Mayo, 1973; Hunter and Kimbrell, 1980). Piscivorous larvae manipulate their larval prey and consequently are less dependent on mouth size when consuming larval fish. Sibling cannibalism is common under rearing conditions in such fishes. Increasing the food density may increase survival as may elevating the temperature, thereby accelerating growth through the most cannibalistic sizes; at least in scombroids sibling cannibalism declines at metamorphosis (Mayo, 1973; Hunter and Kimbrell, 1980). Sorting by size and isolating the larger larvae is probably the only certain method for controlling losses due to cannibalism, however.

PHYTOPLANKTON

Phytoplankton blooms are often maintained in larval culture tanks to reduce the detrimental effects of metabolic by-products which accumulate in static rearing tanks (Houde, 1974) and to provide food for larval food organisms. In many cases dense blooms of phytoplankton enhance larval growth and survival and I recommend the practice but the mechanism is obscure. The phytoplankters used are various, easily grown, small species such as *Chlorella*, *Anacystis*, *Nannochloris*, *Tetraselmis*, *Dunaliella*, *Isochrysis*, *Phaeodactylum* and others.³ They are maintained at high densities (10,000 or more cells/ml) in the rearing tanks. At high cell densities larvae ingest these small phytoplankters, perhaps inadvertently (Moffatt, 1981) but they appear not to be able to exist on them as a sole food source (Houde, 1974; Scura and Jerde, 1977). They may supplement the food

³ For a nominal fee starter cultures of marine phytoplankton can be obtained from R. R. L. Guillard, Bigelow Laboratory for Ocean Sciences, McKown Point, West Boothbay Harbor, Maine 04575 USA; culture methods are discussed by Guillard (1975).

ration either directly or indirectly through the ingestion of prey having guts full of algal cells (Moffatt, 1981). Evidence now exists that enhancement of growth and survival of larval *Scophthalmus maximus* by blooms of *Isochrysis* and *Phaeodactylum* is due to the inclusion in the diet of certain polyunsaturated fatty acids not occurring in the normal laboratory rotifer diet (Scott and Middleton, 1979). It is interesting in this regard that *Dunaliella* which lacks the fatty acids did not enhance *S. maximus* larval growth or survival.

EFFECTS OF CULTURE

Extrapolation from cultured larvae to natural populations must be done with caution because culture may affect the morphology, behavior and biochemistry of larvae (Blaxter, 1976). The morphological characteristics most susceptible to modification in tanks are those partially controlled by environmental conditions such as vertebrae and fin ray counts. Reared larvae also may be more heavily pigmented than sea caught specimens (Watson, 1982). This appears to be related to the expanded nature of the melanophores, not to added numbers of pigment cells. In addition, pigmentation events may occur at smaller sizes in reared material (S. Richardson, Gulf Coast Research Laboratory, Ocean Springs, Mississippi, pers. comm.). Laboratory reared larvae are often heavier and have deeper bodies than their wild counterparts, making some morphometric measurements on laboratory specimens useless (Blaxter, 1975). The differences in preservation and handling between laboratory and sea-caught larvae also make direct size-specific comparisons difficult. Shrinkage in length may vary greatly depending on the duration larvae remain in plankton nets and shrinkage differences between reared and wild specimens can be misinterpreted as morphological differences (Theilacker, 1980a).

NATIONAL MARINE FISHERIES SERVICE, SOUTHWEST FISHERIES CENTER, P.O. BOX 271, LA JOLLA, CALIFORNIA 92038.

Identification of Fish Eggs

A. C. MATARESE AND E. M. SANDKNOP

A wide variety of egg types exists among teleost fishes in both freshwater and marine environments. Eggs may be pelagic and nonadhesive or demersal and either adhesive or not. They may possess a variety of specialized structures aiding in flotation or attachment. Depending on egg type and associated reproductive ecology, many characters are useful in identification. These characters have been reviewed for pelagic marine eggs by Rass (1973), Robertson (1975a), Russell (1976), and Ahlstrom and Moser (1980); we have liberally and extensively drawn from the latter. Important characters for other egg types have been discussed in part by Balon (1975a, 1981a), Hardy (1978a, b), Jones et al. (1978), and Snyder (1981). Characters such as size and possession of oil globules are important for all types; however, perivitelline space and chorion sculpturing are more important in pelagic eggs, while in demersal eggs special coatings,

chorion thickness, or nature of egg deposition may be more useful.

A wealth of potential characters useful in egg identification exists; however, it is still difficult to identify eggs of most species with certainty. Except for late stages, few may be recognized at the species level. Some characters are useful at a family level, but presently it is not productive to speculate on the systematic significance of any characters (see Kendall et al., this volume). Presently, the main goal of taxonomy with respect to fish eggs is identification.

Regardless of egg type or reproductive ecology, a summary of identification characters useful to an egg taxonomist is presented. Additionally, we recommend using available literature for reference and encourage the building of local fish egg collections. We follow Ahlstrom and Ball (1954) in subdividing

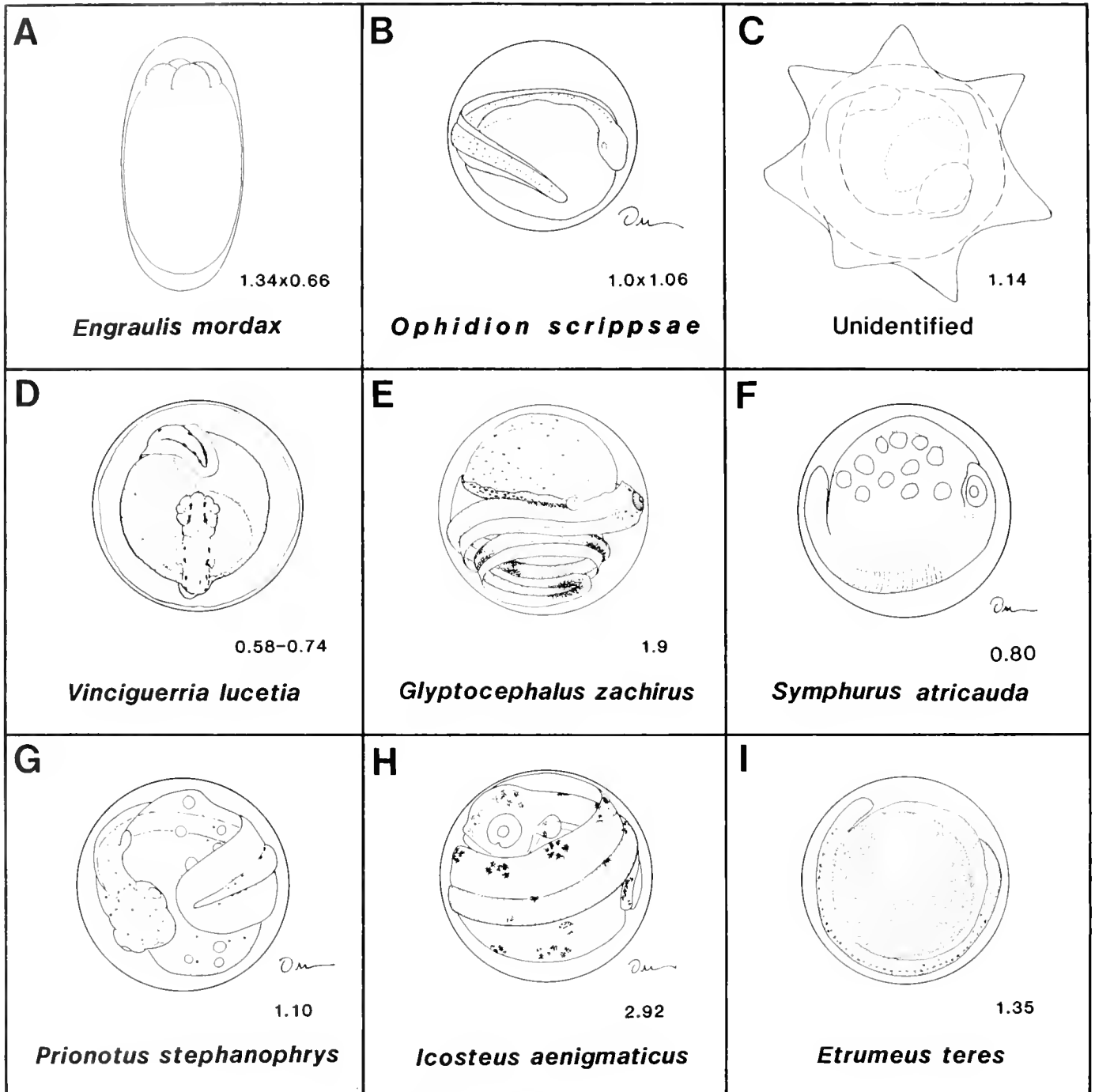

Fig. 13. Fish eggs. Captions under each illustration indicate the species and the diameter or dimensions of the egg in millimeters. A. *Engraulis mordax*, original; B. *Ophidion scrippsae*, original; C. Unidentified, original; D. *Vinciguerria lucetia*, from Ahlstrom and Counts (1958); E. *Glyptocephalus zachirus*, from Ahlstrom and Moser (1980); F. *Symphurus atricauda*, original; G. *Prionotus stephanophrys*, original; H. *Icosteus aenigmaticus*, original; and I. *Etrumeus teres*, original.

egg development as follows: Early—from fertilization to closure of blastopore, Middle—from closure of blastopore to tail bud lifting off yolk, and Late—from tail bud lifting off yolk to time of hatching.

IDENTIFICATION CHARACTERS

Shape.—The vast majority of all egg types are spherical. Exceptions include ellipsoidal eggs as found in anchovies, *Engraulis* and *Anchoa*, and slightly flattened or ovoid eggs as seen in members of the families Gobiidae, Scaridae, and Ophidiidae (Fig. 13A, B). A number of demersal eggs have somewhat irregular shapes, especially those associated with large egg masses. The perciform family Congrogadidae has cruciform shaped eggs (Herwig and Dewey, 1982). An unidentified, star-shaped egg is encountered infrequently in the Alaska region (Fig. 13C).

Size.—The average marine and freshwater fish egg size is about 1.0 mm. According to Ahlstrom and Moser (1980), pelagic fish eggs range from 0.5 mm [*Vinciguerria* (Fig. 13D)] to about 5.5 mm (Muraenidae). Demersal eggs may range higher in size (up to 7.0–8.0 mm), e.g., members of the families Salmonidae, Anarhichadidae, and Zoarcidae. Mouth brooders, e.g., in the catfish family Ariidae, have among the largest eggs with sizes from 14 mm to 26 mm.

Oil globules.—The oil globule provides useful characters in fish egg identification; these include presence or absence, number, size, position, color, and pigmentation. Among both pelagic and demersal eggs, the most common form contains a single oil globule. Eggs may lack an oil globule as in most gadines and pleuronectids (*Glyptocephalus*), contain only one (*Icosteus*), or have multiple oil globules as in the cynoglossids and triglids (*Symphurus* and *Prionotus*) (Fig. 13E, F, G, and H). In pelagic eggs with a single oil globule, the size ranges from <0.10 mm to >1.0 mm (Ahlstrom and Moser, 1980). The position of the oil globule within the yolk sac is usually posterior, but several groups contain species that have an anterior placement (e.g., labrids and carangids) and others have an intermediate placement (argentinids). In some fishes, oil globules migrate during embryonic development. Some members of the family Bathylagidae initially possess multiple oil globules that eventually coalesce into a single globule (Ahlstrom, 1969). Although not a totally reliable character, the oil globule color can be useful, especially in the identification of freshly taken demersal eggs. Lastly, many species have oil globules with melanistic pigment, *Icosteus* (Fig. 13H) and *Icichthys*.

Yolk.—The degree of yolk segmentation is an important identification character. Yolk is usually segmented in primitive forms, e.g., *Etrumeus* (Fig. 13I), and homogeneous in higher forms (Rass, 1973; Ahlstrom and Moser, 1980). The opaqueness of yolk found in catfishes, salmonids, and gars can be diagnostic.¹ Pigment, which may also be diagnostic, can be present during various developmental stages from middle to late. Yolk color is often important especially in demersal eggs. Among demersal eggs vitelline circulation patterns within the yolk sac are useful in identification.¹

Chorion.—A number of characteristics associated with the chorion or egg envelope can be useful in identifying fish eggs and have been shown to be highly adapted to the environmental conditions under which an embryo develops (Ivankov and Kurdyayeva, 1973; Stehr and Hawkes, 1979; Laale, 1980; Stehr, 1982). The most important character of the chorion is whether it is smooth, as is in most fishes, or sculptured. Among fish eggs with patterns, the size and texture (e.g., raised hexagons, pustules) of the design are diagnostic. Raised polygonal surfaces are found in several unrelated species (Stehr, 1982), e.g., *Synodus* and *Pleuronichthys* (Sumida et al., 1979), and pustules occur among some bathylagids and argentinids. *Mugil cephalus* eggs (Fig. 14A), previously considered to have a smooth chorion, have a raised patterned surface visible by scanning electron microscope (Boehlert, this volume). In many groups of fishes, the chorion has various degrees of ornamentation consisting of projections, threads, filaments, or stalks which may aid in flotation (pelagic) or attachment (demersal). In some scomberesocids, e.g., *Cololabis* (Fig. 14B), some exocoetids and atherinids, pelagic eggs are attached to each other or to a substrate by filaments. Spines are found in some myctophiforms and exocoetids, and stalks occur in some demersal egg groups, e.g., blenniids and *Osmerus mordax*. In ostraciid eggs, a patch of pustules is present near the micropyle (Fig. 14C).

Recently, thickness of the chorion has been of diagnostic value (Ivankov and Kurdyayeva, 1973; Boehlert, this volume). Stehr and Hawkes (1979), using scanning electron microscopy, found that most marine teleosts with pelagic eggs have thin chorions in relation to egg diameter whereas demersal eggs tend to develop much thicker chorions. Color of the chorion is an important diagnostic character, especially for freshly taken demersal eggs in the marine intertidal environment (Matarese and Marliave, 1982). A number of freshwater demersal fishes have eggs that possess a special coating associated with the chorion which can be either gelatinous or adhesive, e.g., *Perca*, *Ictalurus*, and *Notropis* (Snyder, 1981).

Perivitelline space.—Most fish eggs have a narrow- to medium-width perivitelline space, but wide spaces are common in some groups, especially among the more primitive fishes that have a segmented yolk, e.g., Clupeiformes (*Sardinops*, Fig. 14D), Anguilliformes, and Salmoniformes (*Chauliodus*, Fig. 14E) (Ahlstrom and Moser, 1980). Large perivitelline spaces are also found among some unrelated higher forms, such as cyprinids (*Notropis*), percichthyids (*Morone saxatilis*), or pleuronectids (*Hippoglossoides*).

Embryonic characters.—Characters associated with the developing embryo are extremely useful in egg identification, particularly in the middle and late stages of development. Many eggs not identifiable in the early stages are easily recognizable using embryonic characters such as pigment on embryo or finfold and morphology. In some fishes, embryonic pigment in the late stages has already undergone sufficient migration and rearrangement to the point where it resembles the yolk-sac larva; this is common in several groups including gadiformes, e.g., *Merluccius* (Fig. 14F), *Gadus*, and *Theragra*, and heavily pigmented flatfishes like *Pleuronichthys* and *Hypsopsetta*. Characteristic late-stage pigment bands appear in *Glyptocephalus* (Fig. 13E). In most freshwater species, pigment is not present prior to pigment cell migration but appears sometime after the cells have mi-

¹ F. Douglas Martin, Chesapeake Biological Laboratory, P.O. Box 38, Solomons, Maryland 20688. Personal communication, October 1982.

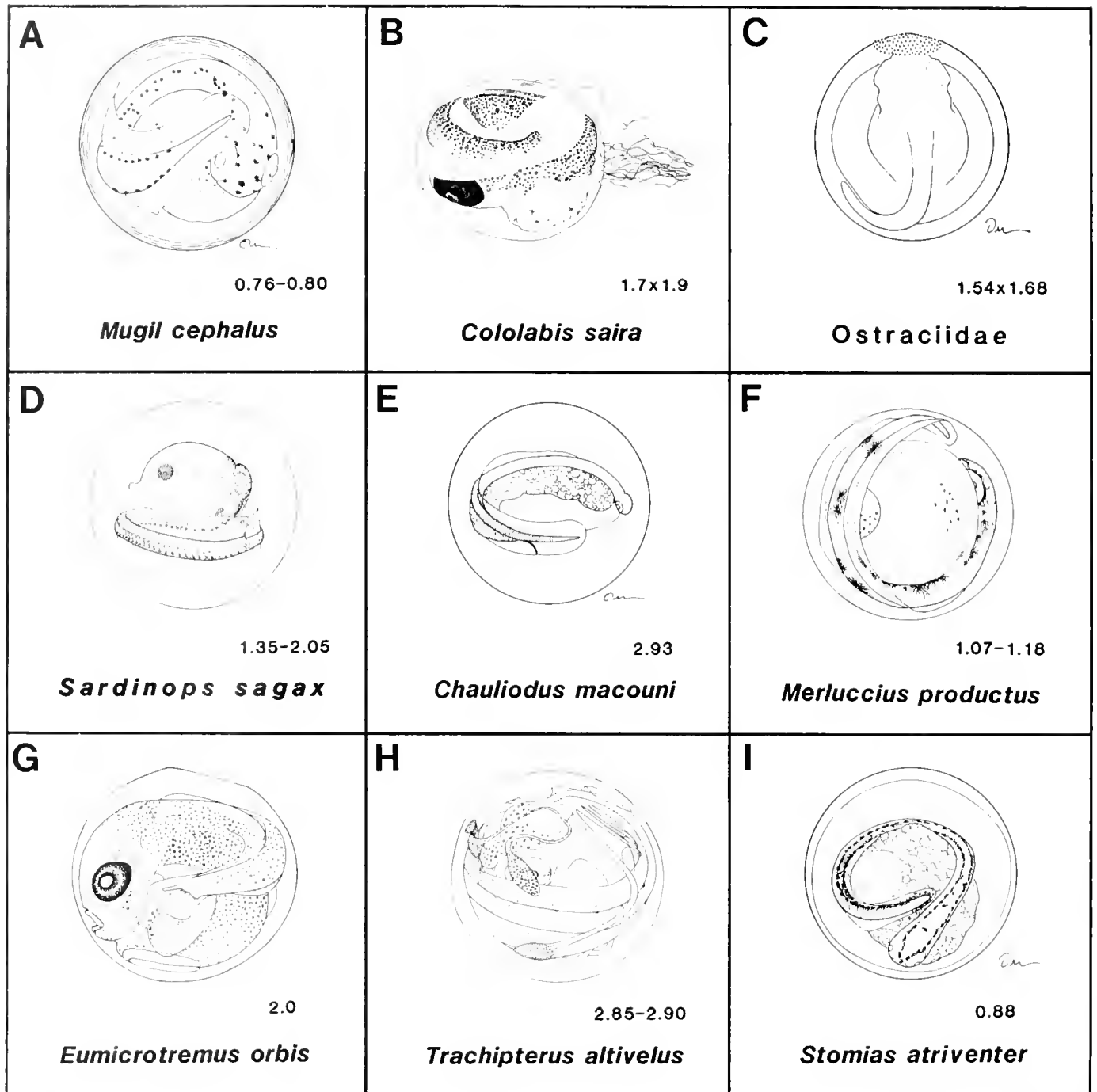

Fig. 14. Fish eggs. Captions under each illustration indicate the species and the diameter or dimensions of the egg in millimeters. A. *Mugil cephalus*, original; B. *Cololabis saira*, original; C. Ostraciidae, original; D. *Sardinops sagax*, original; E. *Chauliodus macouni*, original; F. *Merluccius productus*, from Ahlstrom and Counts (1955); G. *Eumicrotremus orbis*, from Matarese and Borton unpubl. MS; H. *Trachipterus altivelus*, original; and I. *Stomias atriventer*, original.

grated to their actual destinations (Snyder, 1981). As seen in the cyclopterid, *Eumicrotremus*, most late-stage demersal embryos resemble the newly hatched larva with respect to all characters (Fig. 14G). The morphology of the head, gut, and postanal

body as well as the number of myomeres is used for identification within all fish egg groups. A number of specialized characters associated with the embryo are essential for identification when present, e.g., elongated fin rays—*Trachipterus* (Fig. 14H),

precocious fin development (caudal—exocoetids and *Trichodon*; pelvic—*Trachinus*), and pelvic disc development in some cyclopterids (*Eumicrotremus*) (Fig. 14G).

Miscellaneous characters.—The presence of a secondary membrane inside the chorion occurs in some groups, although it is lacking in most fishes. *Stomias atriventer* eggs have a double membrane (Fig. 14I). These membranes occur in some of the more primitive fishes including members of the Anguilliformes, Clupeiformes, and Salmoniformes. In some species, like the freshwater cyprinid *Abbottina rivularis* (Nakamura, 1969), the secondary membrane is thick and gelatinous. The presence and size of the micropyle are diagnostic in other fishes, particularly freshwater demersal eggs (Laale, 1980; Richl, 1980). Among freshwater fishes, the cleavage pattern is important for egg identification. In the more primitive families (Acipenseridae, Polyodontidae, Lepisosteidae, and Amiidae), cleavage pattern is typically semiholoblastic as opposed to the meroblastic pattern seen in the higher teleosts. Genetic studies have shown differences in LDH A zymograms to be a useful, diagnostic tool for the identification of *Gadus morhua* and *Melanogrammus aeglefinus* eggs (Mork et al., 1983).

Ecological and behavioral considerations.—A number of considerations related to mode of reproduction and collection rather than the characters of the eggs themselves are essential when identifying any type of fish egg. In identifying demersal eggs one must consider where they were collected—on rocks, on plants, in masses, and if parental care is involved. Nest type, nature of egg deposition, and the presence of guarding parents can all be essential clues to proper identification. Also, for any egg type

one must note spawning time (season), location depth, and gear used for collection. In addition, the rearing of unknown eggs to an identifiable larval stage is useful in species determination as shown by Stevens and Moser (1982) for the blenny, *Hypsoblennius*. Of course, a necessary prerequisite to accurate identification of eggs is a thorough knowledge of the species present in any given area and their breeding seasonality.

SUMMARY OF CHARACTERS

Characters most useful in identification of fish eggs are the following: (1) egg shape—spherical, ellipsoidal, irregular, or otherwise; (2) egg size—fish eggs range in size from 0.5 to 26.0 mm; (3) oil globules—presence or absence, number, size, color, position, and pigmentation; (4) yolk—segmented or homogeneous, nature of segmentation, color, pigmentation, and circulation pattern; (5) chorion—smooth or ornamented, type of ornamentation, thickness, color, and coatings; (6) perivitelline space—width; (7) embryonic characters—morphological features, pigment patterns, and special structures; (8) miscellaneous characters—inner or secondary membrane (presence or absence, location), cleavage pattern, micropyle (size), and biochemical analysis; and (9) ecological and behavioral considerations—collection (gear, location, season, etc.), and mode of reproduction (nests, parental care, etc.).

(A.C.M.) NATIONAL MARINE FISHERIES SERVICE, NORTHWEST AND ALASKA FISHERIES CENTER, 2725 MONTLAKE BOULEVARD EAST, SEATTLE, WASHINGTON 98112; (E.M.S.) SOUTHWEST FISHERIES CENTER, P.O. BOX 271, LA JOLLA, CALIFORNIA 92038.

Identification of Larvae

H. POWLES AND D. F. MARKLE

MINOR errors in identification of larval fishes can lead to major misinterpretations of ecological and taxonomic phenomena. Fish identification and taxonomy are largely based on adult characteristics and since these develop during the larval period, new characters must be discovered and validated in order to identify larval fishes. Usually larvae possess fewer characters than adults and are more fragile. Identification can, therefore, be difficult and, frequently, must be based on a combination of character states.

Since larval anatomy is by its nature dynamic (a given specimen being a snapshot of the process linking embryos to adults), developmental series are essential to identification. Three different approaches are used to identify larvae, the first two of which are based on developmental series: 1) to raise eggs and larvae from fertilized eggs of known parents; 2) to work backwards from the adult utilizing characters common to successively earlier ontogenetic stages; and 3) to extrapolate from pre-

vious results obtained by (1) or (2) to synthesize generic or familial diagnoses and identify by process of elimination or limited corroboration (Ahlstrom in Berry and Richards, 1973; Leiby, 1981).

There are pitfalls in all approaches. Laboratory-reared larvae are frequently more heavily pigmented than wild-caught specimens and may show greater meristic variation (Lau and Shaf-land, 1982). Laboratory rearing may be financially and logistically difficult or impossible for fishes of interest. Ontogenetic transformations are based on associations of adult diagnostic characters with characters that persist in progressively earlier ontogenetic stages. This method requires careful attention to methodology, as well as good ontogenetic series which are not always available. Purely descriptive accounts of larval series (laboratory-reared or reconstructed) may not be useful for identification purposes if no diagnostic characters that will distinguish sympatric congeners and/or similar-looking forms are pre-

sented. Novel sorts of characters or ways of manipulating data are sometimes needed to identify larvae and the data required may not be retrievable from "standard" descriptive accounts. Synthesis and elimination is the normal procedure used by taxonomists to identify adult fishes. It has been called the "look-alike" system when applied to larval fishes (Leiby, 1981). It is basically a simple procedure but the pitfalls are numerous and subtle. As with some early adult fish taxonomy, premature synthesis may often be based on the wrong characters (e.g. convergent characters) and lead to spurious identifications.

General references on larval fish identification include Berry and Richards (1973), Ahlstrom and Moser (1976) and Moser (1981). Some recent works which provide exposure to a wide range of larval forms and literature are Ahlstrom and Moser (1981) and Fahay (1983) for marine taxa, and Auer (1982) and Balon (1975a, 1981a) for freshwater taxa.

The purpose of the following is to describe the tools—preferably sharpened, polished and comfortable to use—which should be at hand when the ichthyologist sits down to identify larval fishes. Our emphasis is on three main factors: 1) the larval fish—its anatomy, ontogeny, and phyletic relationships; 2) the study area—its ecology and zoogeography and 3) the investigator—his experience, knowledge and ingenuity.

SYSTEMATICS, ONTOGENY AND ANATOMY

Perhaps the most important type of character for identification of larvae is meristic, as counts usually do not increase or decrease once established. All meristic characters can be important, but vertebra/myomere counts and fin element counts are of particular value. Meristic variables are useful at different taxonomic levels, e.g., principal caudal fin ray and pelvic fin element counts at the family or order level, median fin elements at the genus/species level, pectoral fin ray counts at the species level. Frequency distributions of meristic counts are extremely important (particularly when it is uncertain whether development of a character is complete) but often are not given in published literature. Some important characters may not be included in published studies (e.g., pectoral fin rays, procurrent caudal rays). Differences in methodology and variable attention to detail may also affect the quality of published meristic data. Thus, published studies must be treated with caution and one must be prepared to collect and compile one's own information when opportunities arise. Despite potential problems with published works, these are the obvious place to start with compilations. Few "regional" meristic publications as exemplified by Miller and Jorgensen (1973) exist, but many publications on larval fishes include extensive tabulations of meristic information.

Various ways exist for facilitating use of meristic compilations. A simple taxonomic listing (e.g., Miller and Jorgensen, 1973) can be time-consuming to use, while a "gazetteer" format, with species arrayed in order of counts (e.g., Fahay, 1983) may be more practical. X-Y plots of two meristic variables (e.g., Berry, 1959b) can include frequency distributions and be very useful for separating closely-related forms.

A second suite of characters of broad use is specialized larval characters which may characterize whole groups. These include but are not limited to: characteristic shapes (e.g., Anguilliformes, Elopiformes, Pleuronectiformes), spination (Acanthuridae, Holocentridae), fin development patterns (argentinoids), fin element development (Pleuronectiformes, epinepheline Ser-

ranidae), fin placement (pelvic fin placement in Pleuronectiformes), eye shape (myctophid subfamilies, salmoniform groups), and photophore development pattern (Gonostomidae). The elucidation of such characters is a focus of this volume, and reference should be made to specific chapters for further detail. The important point is that a broad knowledge of larval fishes is frequently necessary for accurate, efficient identification of larvae.

Finally, identification of larvae depends on a suite of dynamic characters (pigmentation, body form, spination, fin development pattern, etc.), which may change rapidly and differentially over a small size range. Generally, a combination of such characters is required for accurate identification; this is particularly true in early stages. These characters can vary extensively, even within a species, due to regional differences; method, time or area of collection; preservation method or duration. Developmental changes can be extremely rapid (e.g., changes in melanophore distribution from some yolk-sac to post-yolk-sac larvae). Again, no extensive treatment of these characters is possible here, but the important point is that detailed, disciplined observations of larvae are essential for accurate identification.

The importance of osteological characters for larval identification is increasingly recognized (Dunn, this volume). Use of these depends on clearing and staining techniques (Potthoff, this volume) or X-ray techniques (Tucker and Laroche, this volume). As with meristics, osteological characters may be useful at different taxonomic levels. Caudal osteology has been widely used because of its early development and relative simplicity, but cranial osteology and pterygiophore patterns are also useful. Recent application of cartilage-staining techniques has permitted use of cartilaginous structures in identifying larvae (e.g., Fritzsche and Johnson, 1980). Other internal characters such as gut shape (Ahlstrom and Moser, 1976; Govoni, 1980) may also be useful.

Keys have not generally been used in larval fish identification because of the dynamic nature of characters (a separate key would be required for each size class or development stage) and because of "incompleteness" of information (i.e., it has usually been impossible to completely cover a defined region or systematic group with a key). Generally, much more information is required to identify a larva than an adult, and summarizing this in a key has been impractical (the information-organizing capacity of computers may eventually help to permit this). Exceptions, such as Bertelsen's (1951) key to larval Ceratioidea, Johnson's (1974b) key to genera of larval scopolarchids, and the key of Bertelsen et al. (1976) to notosudids do exist.

Because of the complexity of identification of larvae, a wide ichthyological background is important. A good knowledge of fish anatomy is essential, particularly when (as often occurs) damaged specimens must be identified. Published descriptions exist, for example, which interpret broken branchiostegal rays as jugular pelvic fin rays. A general knowledge of suspected phylogenies and inter-relationships (e.g., Greenwood et al., 1966; Nelson, 1976) is essential if attempting to identify by synthesis or elimination. This should at least cover those groups to be expected in a given area, but wider knowledge is desirable, particularly in the marine environment where exotic larvae may be transported great distances (e.g., Markle et al., 1980). Finally, thorough familiarity with the ontogenetic continuum is necessary to place unknown specimens in perspective. Absorption of the yolk sac, flexion of the notochord in the caudal region, development of median fins, and transformation from larval to

juvenile stages (as defined by completion of fin element development, development of scales, etc.) are major events in fish development which have been used by various authors to define stages (e.g., Ahlstrom, 1968; Snyder, 1976).

ECOLOGICAL CONSIDERATIONS

There are two basic ecological or zoogeographic considerations when identifying larvae: the expected composition of the larval ichthyofauna of the study area and the potential for influx from "upstream" areas.

Thorough knowledge of the adult ichthyofauna of the study area is essential in order to know what larvae may occur; thus, the most complete possible list of adult species is required. Literature may be incomplete or erroneous, so this list should be based on unpublished or personal observations as well as on standard faunal works or other literature. For ease of use, the list should be organized by systematic groups (e.g., Greenwood et al., 1966; Nelson, 1976).

In addition to knowledge of the adult ichthyofauna, knowledge of spawning seasons is central to prediction of the larval fish composition. As with meristic or anatomical information, published information may be incomplete so that personal collections and unpublished information may be important. Although capture location and season can be important in eliminating some species from consideration, caution is essential here as with other "elimination" methods.

Since most marine fishes have planktonic eggs and/or larvae and many have a prolonged planktonic life the basic hydrography of a study area must be understood. A "downstream" study area is potentially vulnerable to an influx of larvae from "upstream" spawning. In addition, the direction of "streams" can differ at different depths of the water column so the influx may come from more than one direction. On the shelf off Nova Scotia the general circulation is from the northeast but there is a strong influence from the Gulf Stream, both from eddies and mixing which produces Slope Water. Thus, for some species, the "downstream" effect comes from the northeast while for tropical and oceanic species it comes from the southeast.

Knowledge of an area's fish communities may help in inferring which larvae may occur together—for example, an unknown specimen taken together with larvae from a coastal community

is probably not a mesopelagic species. Again, however, such inferences should be considered critically.

One sort of ecological observation may be misleading—although spawning biomass may be calculated from egg and larval abundance for some species, the relative apparent abundance of adults is not always in proportion to the relative abundance of planktonic larvae. Cryptic species may appear rare in collections of adults but larvae may be extremely abundant (e.g., Gobiidae in tropical and subtropical waters) while species which appear extremely abundant as adults may be rare as planktonic larvae (e.g., the clupeid *Jenkinsia lamprotaenia* in the Caribbean, Powles, 1977).

SOME GENERAL CONSIDERATIONS

Like larval development, identification of larvae is a dynamic process—the cumulative knowledge of the student is the key to accurate identification. The complexity of larval identification requires that a wealth of information be applied to the task, and for this reason some degree of specialization in identification of larvae is required for all but the simplest identification problems. There are many examples of superficially similar but systematically very different larvae, and most students, including the authors, have experienced embarrassment at an uncritical identification. Identification of larvae is frequently comparative, by elimination, so that wide knowledge of larval fishes as well as caution are necessary.

The student must have information of the kinds identified above. Organization and ingenuity are required in order to keep this information usable—card files, looseleaf binders, drawings and sketches, and well-curated reference series should be developed or readily available.

Finally, although many beginning students are hesitant to draw, sketching and drawing (freehand, on squared paper, or with camera lucida) is one of the best ways to "see" and understand larval anatomy. The process is painstaking and often frustrating in the early stages, but will pay off in the long term with increased understanding.

(H.P.) FISHERIES AND OCEANS, P.O. BOX 15500, QUEBEC G1K 7Y7, CANADA; (D.F.M.) HUNTSMAN MARINE LABORATORY, BRANDY COVE, ST. ANDREWS, NEW BRUNSWICK, E0G 2X0 CANADA.

Illustrating Fish Eggs and Larvae

B. Y. SUMIDA, B. B. WASHINGTON AND W. A. LAROCHE

SCIENTIFIC illustrations of fish eggs and larvae are an indispensable component of any descriptive work, providing a visual reference of form and structure which is not possible to express by written descriptions and measurements alone. Illustrations facilitate identification by emphasizing distinctive but often subtle morphological characters and allow for comparison of features at different developmental stages and with morphologically similar taxa. These qualities make illustrations

the preferred and most frequently used aid for taxonomic identification of fish eggs and larvae.

The broad range of morphological diversity found among larval fishes requires flexibility in technique and style to produce effective illustrations, but the criteria of accuracy, clarity, and consistency of style should be met. The basic concept behind illustrating a fish larva involves accurately representing a three-dimensional, somewhat transparent organism on a two-dimen-

sional sheet while emphasizing characters which are most useful in identifying the actual larva from the drawing. Such characters include the fins, pigmentation patterns, and details of the head such as the jaws, spines and eyes. Internal structures such as myomeres, the gut, cleithrum, and posterior end of the notochord may also be emphasized but without masking important external characters. Details of other internal structures as well as shading or stippling for contrast are best excluded or de-emphasized to maintain clarity. Pigmentation is important in identification of most larvae and should be depicted clearly. External melanophores can be drawn with a fine-tipped pen as realistically as possible. Internal pigmentation can be effectively represented by using light stippling with a smaller sized pen-point. Care must be taken to avoid confusion of internal structures with pigmentation.

Specimens selected for illustration should ideally be those of the best condition available and representative of the particular developmental stage in both pigmentation pattern and morphology. The number of specimens to be illustrated is determined by the nature and objective of the publication, the amount of material available in various size groups, and the degree of morphological and pigmentation change undergone by the particular species during ontogeny. Specimens from described series should be archived in a museum collection for proper care and future reference after completion of the illustrations, and catalog numbers should be published.

The detailed drawing begins with an accurate body outline showing the proper body proportions and position of fins and critical pigment spots. This is most easily achieved by drawing in light or blue pencil from a camera lucida-equipped microscope. Other methods include drawing from a projection of a slide transparency of the specimen or tracing a photograph. By convention the lateral view of the larva is drawn, with the head to the left. The exception to this is made with right-eyed pleuronectiforms. In some instances a dorsal or ventral view is also necessary to clarify a pigment pattern or laterally projecting morphological structures. If sketching through a camera lucida, it is helpful to use a magnification which allows the entire specimen to be in the field of vision as long as important details remain visible. Any resulting distortions at the periphery of the field can be compensated for by differentially focusing the microscope on the particular region involved while carefully pencilling along the image, then reconstructing a smooth line where disjointed lines meet. Problems involving specimens that are too large or too small can often be overcome by using lens adapters or eyepieces of lower or higher magnification. Large specimens may require being drawn in sections which are later pieced together. This original sketch should be made large enough to clearly indicate fine details such as the full complement of fin rays, but not excessively so with the result of producing lines which bleed in the final reduction for publication. Related to this is the use of appropriate sizes of pen points which produce lines fine enough to draw minute details yet not be lost in reproduction. Therefore, in determining the original size of each drawing, thought should be given to the desired reduction ratio as well as the number of illustrations comprising each plate. An opaque projector is most useful for obtaining a specific size for the final drawing from the initial sketch, but photocopy reductions also work well. With this final pencilled sketch, the illustrator can work with the larva under a microscope as a reference to complete details of the drawing before attempting to ink it. A light table can be helpful when tracing or inking over a rough

pencilled sketch. The illustrator should always have a set of meristics of the specimen being drawn and an understanding of the important characters to be emphasized. A thorough inspection for accuracy is essential to insure agreement between illustrations and descriptive text, especially concerning pigmentation and meristic elements with size and stage of development. Ideally exact counts and measurements can be obtained directly from the illustration, allowing easy identification of the larva.

Illustrations are often designed for comparison of features at different stages of development or for comparison of similar features which occur among different taxa. Special care should be taken to represent similar features in a consistent style from illustration to illustration. For example, a partially ossified fin ray element, an ossified fin ray, and a fin spine may each be depicted in a consistent but slightly different manner so that the illustration not only shows the number and position of fin elements but also the type of element and its relative stage of development.

Literature dealing with larval fishes contains a broad array of illustrative styles, techniques, and quality. Many of these are of limited use since they fail to meet the criteria discussed above. Photographs frequently yield unsatisfactory results due to difficulties in focusing on small, transparent organisms so that all body parts appear equally sharp, and they preclude emphasizing inconspicuous but important features for identification. Color illustrations in a variety of media, although potentially valuable, particularly for xanthophores, are limited due to prohibitive publication costs, poor reproducibility, and the absence of a long-lasting color preservative. Half-tone illustrations (see Ahlstrom, 1965) are effective but difficult to reproduce. These latter two techniques may become more practical with advances in photocopy technology. The preferred technique in widespread use consists of pen and ink drawings done in black india ink. Various styles of illustrations of diverse groups of larvae are represented in Moser (1981) and in this volume which serves as a useful overview. Poul Winther, George Mattson, and other artists (Ahlstrom and Ball, 1954; Ahlstrom and Counts, 1955; Bertelsen and Marshall, 1956; Ege, 1953, 1957, and 1958; Grey, 1955b; Moser, Ahlstrom and Sandknop, 1977; Moser and Ahlstrom, 1970; Tåning, 1961; Richardson and Washington, 1980) have been instrumental in establishing a fine style of pen and ink drawings which we emulate and have found most effective in its applicability to larval fish identification. We maintain a degree of flexibility in technique and style which varies with the taxonomic group under consideration but falls within the general framework discussed above.

Illustrating a fish egg poses a more difficult problem than illustrating a fish larva and will be limited to a brief discussion. Encapsulation by the chorion necessitates representing the three-dimensional quality of the egg in the drawing while showing important morphological and pigmentation characters of internal structures (Ahlstrom and Moser, 1980; Matarese and Sandknop, this volume) with as much clarity as possible. Difficulties arise due to the superimposing of these characters from a two-dimensional perspective, particularly when the chorion is ornamented, when an oil globule(s) is present, and when the developing embryo is fully coiled.

In spite of the more complex structural representation required, the same criteria of accuracy, clarity and consistency of style apply to egg illustrations. The relative proportions of the egg size to the size of the embryo, oil globule(s), and width of perivitelline space, the number of myomeres, and length of gut

need to be accurately drawn. An effective balance between showing important characters for identification and three-dimensional realism of the egg is required to maintain clarity. Several illustrations of the egg at different stages of development and from different perspectives are helpful in demonstrating key characters such as embryonic pigmentation, myomeres, and position of the oil globule(s) in the yolk sac. Adherence to a consistent illustrative style is primarily critical for a developmental series of eggs. As with fish larvae, pen and ink drawings provide the most practical technique for illustrating fish eggs, but the specific style of illustrating and details shown depend upon the character of the egg and its stage of development. Many kinds

of illustrative styles and techniques are found in the literature (see Ahlstrom and Moser, 1980 and references cited therein) and examination of these is most helpful in effectively illustrating a particular type of fish egg.

(B.Y.S.) NATIONAL MARINE FISHERIES SERVICE, 8604 LA JOLLA SHORES DRIVE, LA JOLLA, CALIFORNIA 92038; (B.W.) GULF COAST RESEARCH LABORATORY, EAST BEACH DRIVE, OCEAN SPRINGS, MISSISSIPPI 39564; (W.L.) DEPARTMENT OF FISHERIES, HUMBOLDT STATE UNIVERSITY, ARCATA, CALIFORNIA 95521.

Clearing and Staining Techniques

T. POTTHOFF

THE clearing of tissues and the staining of cartilage and bone are indispensable in the study of larval and juvenile fishes. At the National Marine Fisheries Service Miami Laboratory modifications of the clearing and differential cartilage-bone staining technique proposed by Simons and Van Horn (1971) and Dingerkus and Uhler (1977) are used. The modifications are in part based upon an unpublished manuscript by W. R. Taylor and G. C. Van Dyke from the National Museum of Natural History, Washington, D.C. A wide size range of fish from 3 mm NL to larger than 500 mm SL can be cleared and stained. The technique works well for all sizes, but adjustments in the various solution soaking times are made dependent on fish size (Table 5).

METHOD

Fixation.—Specimens are fixed in 10–15% marble chip buffered formalin. Samples previously fixed in formalin of lower than 10–15% concentration and specimens presently in alcohol or fixed in alcohol should be refixed in 10–15% formalin for best results. Eighty to 90% of all larvae of different perciform families fixed in alcohol totally disarticulated during clearing and staining. In juvenile and adult fish >100 mm SL the flesh is routinely removed from the left side before or after fixation.

Dehydration.—This is an important step, because even small amounts of water interfere with the staining of cartilage. Place specimen from the formalin into solution of 50 parts of 95% ethanol and 50 parts distilled water. Do not wash or soak specimens with water during transfer from formalin to alcohol. After one day for larvae <20 mm SL and two days for specimens 20–80 mm SL and three to five days for specimens >80 mm SL transfer from 50% ethanol into absolute (100% or 200 proof) ethyl alcohol. If absolute ethanol is not available, 190 proof or 95% ethanol can be substituted for the absolute, although staining of cartilage will not be as intense. A second change of absolute alcohol is desirable in larger than 20 mm SL specimens. Leave larvae <20 mm SL for one day in the absolute alcohol

and juveniles 20–80 mm SL for 2 days. Adult and juvenile fish 80–200 mm SL should be kept in absolute ethanol for 3 days and fish >200 mm SL should be soaked for one week. An intermediate absolute alcohol change should be given to all specimens with longer than one day soaking time.

Cartilage staining.—This is accomplished by placing specimens in an acidified alcohol solution of the alcian blue stain. For best results 70 parts of absolute alcohol should be mixed with 30 parts of acetic acid 99% glacial. To every 100 ml of acidified alcohol 20 mg of alcian blue powder should be added. The above solution should be used on larvae and juveniles from 3 mm NL to 80 mm SL. For larger fish, a staining solution of 60 parts absolute alcohol and 40 parts of acid with 30 mg of alcian blue for every 100 ml of acidified alcohol should be used. Fish larvae and juveniles <80 mm SL should be left in the alcian staining solution no longer than 24 hours. Larger juveniles and adults should be stained no longer than 36 hours. Specimens >500 mm SL can remain 48 hours in the alcian staining solution. After the specified time in the alcian solution the stain is permanently fixed in the cartilage and cannot be removed with any chemicals used in the clearing and staining process. Staining solution can be used twice for staining larvae but should be discarded after staining a juvenile or adult fish.

Neutralization.—This process raises the pH within the specimen thus allowing proper subsequent bleaching. The higher pH prevents further calcium loss from the bones for better alizarin red stain. To neutralize the specimen remove it directly from the alcian staining solution and place it in a saturated sodium borate solution for 12 hours for specimens <80 mm SL and for 48 hours for larger specimens. For the juveniles and adults that soak for 48 hours, change the sodium borate solution once.

Bleaching (an optional step).—Larvae with little pigment on their body (e.g., Scombridae) should not be bleached. Larvae covered with pigment (e.g., Istiophoridae) and all juveniles and adults must be bleached. Prepare bleaching solution by mixing

TABLE 5. METHOD OF CLEARING AND STAINING CARTILAGE AND BONE IN LARVAE, JUVENILE AND ADULT FISH.

Steps	Length in mm, NL or SL													
	10	20	30	40	50	60	70	80	90	100	200	300	400	500
Fixation: 10–15% formalin marble chip buffered.	-----2 days-----▶ --- 3 days ---▶ ----- 5 days, flesh removed-----▶ on left side													
Dehydration: 1. 50% distilled H ₂ O, 50% of 95% ethanol.	----1 day----▶ ----- 2 days -----▶ --- 3 days -----▶ -----5 days-----▶													
2. Absolute ethanol (95% ethanol may be substituted).	----1 day----▶ ----- 2 days -----▶ --- 3 days -----▶ -----7 days-----▶ -----one intermediate change-----▶													
Staining cartilage: 100 ml solution: A. 70 ml absolute ethanol, 30 ml acetic acid, 20 mg alcian blue.	-----1 day-----▶ -----1½ days-----▶ ---2 days---▶ -----Solution A-----▶ -----Solution B-----▶													
100 ml solution: B. 60 ml absolute ethanol, 40 ml acetic acid, 30 mg alcian blue.														
Neutralization: saturated sodium borate solution.	-----½ day-----▶ ----- 2 days-----▶ -----one intermediate change-----▶													
Bleaching: pigmented specimens only.	-20 min.----▶ -----40 min.-----▶ --- 1 hour -----▶ -----1½ hours-----▶													
100 ml solution: 15 ml 3% H ₂ O ₂ , 85 ml 1% KOH.														
Trypsin digestion: 100 ml solution: 35 ml saturated sodium borate, 65 ml distilled H ₂ O, trypsin powder.	-----Keep in solution until 60% clear, change to fresh solution every 10 days-----▶													
Staining bone: 1% KOH solution with alizarin red stain.	-----1 day-----▶ --- 2 days -----▶ -----4 days -----▶													
Destaining: 100 ml solution: 35 ml saturated sodium borate, 65 ml distilled H ₂ O, trypsin powder.	----2 days----▶ ----- Change to fresh solution every 10 days until solution remains-----▶ unstained and specimen is clear													
Preservation: 30% glycerin and 70% of 1% KOH. 60% of glycerin and 40% of 1% KOH. 100% glycerin with thymol as final preservative*.	--- 1 week---▶ ----- 2 weeks -----▶ ----- 4 weeks-----▶													

* Direct sunlight and 100% glycerine help to clear and destain difficult specimens

15 parts of 3% hydrogen peroxide solution with 85 parts of 1% potassium hydroxide solution. Bleach larvae and small juveniles up to 80 mm SL for 20 to 40 minutes depending on size. Larger juvenile fish and adults may be bleached 1 to 1½ hours.

Trypsin digestion and alizarin red staining.—The clearing and alizarin staining process has been well described by Taylor (1967) and need not be repeated here. Simply continue after bleaching

with the Trypsin digestion, which are Taylor's steps 4 and 5. We saw no need in modifying Taylor's method.

Removal of semitransparent tissue.—When studying cleared and stained material of large fish, the structures studied (caudal complex, pectoral fin supports, pterygiophores, vertebral column, etc.) may have to be dissected out and adhering tissue removed. This can be accomplished by time consuming picking with tweezers or by placing the material in a two-phase phenol so-

lution with the addition of heat (Miller and Van Landingham, 1969). With this method the bones are not disarticulated, but some bone distortion was experienced.

Variables affecting results.—The results of the clearing and staining procedure are not always satisfactory because of known and unknown variables. Results can never be predicted with certainty. The known variables are: (1) Time and ambient temperature the organism is subjected to between death and fixation. The longer an organism remains unpreserved after death and the higher the temperature, the less the tissues will clear. For best results, specimens should be killed in the fixative, or if that is not possible, they should be kept cool or frozen before fixation. (2) Effect of fixative and preservative. Marble chip buffered formalin is a good fixative for larval fish if specimens are removed from it after 24 hours. Buffered formalin as a preservative destroys first the stain uptake in cartilage. Bone decalcifies as buffered formalin becomes acid over a longer time period and decalcified bone will not stain. Therefore, it is best to fix specimens in 10% formalin and then to preserve them in 70–95% ethanol. Specimens fixed and preserved in ethanol should be re-fixed in formalin before clearing and staining. (3) Time in a preservative. The longer a specimen has been preserved, the less predictable the clearing and staining outcome will be. Some fish larvae from the Dana collection in the 1920's were cleared and stained. The results were startling for both Formalin and alcohol preserved material because some specimens cleared and stained well, but most were unfit for study.

Other variables which affect the results of clearing and staining exist, but are not understood. No matter how carefully one adheres to the procedures, the clearing and staining results are not predictable.

Interpretation of results.—Frequently specimens will remain opaque and overstain with alcian or alizarin for unknown reasons. This makes viewing of cartilage and bone structure difficult or impossible. Such specimens can be used for study of fin ray development and for fin ray counts.

Cartilage or bone does not always stain but can be made

visible in cleared preparations by changing light conditions at the microscope and manipulating the substage mirror. Cartilage appears reticulated in structure whereas bone is structurally clear and hyaline.

Erroneous conclusions can be made if one solely relies on color to determine cartilage and bone. In general, cartilage will appear blue and bone red, but often alcian blue is taken up by bones and rarely alizarin red by cartilage. For instance, developing fin rays often appear blue.

Generally larger developed cartilage structures will stain better than small developing ones. Thus, in the same specimen one may find brightly blue stained cartilage, pale blue cartilage, and cartilage with no stain at all. Therefore, special care is indicated when viewing newly developed cartilage.

The ossification onset in cartilage is difficult to determine. A thin layer of bone forming all around the cartilage can be detected by examining the outer edges of the cartilage structure: a shiny hyaline line forms there, probably only a cell layer thick.

Investigators are often discouraged by clearing and staining results, particularly when their sample is small. In a larval developmental series I usually clear and stain 200 to 400 specimens, and I am able to study each aspect and area of development that I wish to examine because of the large sample size at hand. For example, in a specimen in which the pectoral fin support area is unclear and stained poorly the caudal area may be clear and stained well. Thus, this specimen is utilized only for caudal development, whereas in another specimen the pectoral area may be clearer and better stained. Thus, with a large sample size, the uncertainties and vagaries of the clearing and staining procedure are overcome.

Application of clearing and staining.—Clearing and staining is helpful in identification of fish larvae when external characters are inadequate. It also aids systematic and phylogenetic studies of larvae to adult fishes. This subject has been discussed in detail by Dunn (1983b).

NATIONAL MARINE FISHERIES SERVICE, SOUTHEAST FISHERIES CENTER, MIAMI LABORATORY, 75 VIRGINIA BEACH DRIVE, MIAMI, FLORIDA 33149.

Radiographic Techniques in Studies of Young Fishes

J. W. TUCKER, JR. AND J. L. LAROCHE

RADIOGRAPHY is useful for obtaining skeletal information in studies of fish taxonomy and morphology. Although clearing and staining provides more detail, radiography has other advantages. It produces an easily stored, long-term record of the skeleton and does not permanently alter the condition of the specimen. In many cases, counts can be obtained more accurately from radiographs than from the specimens

themselves. If an x-ray unit and darkroom are available, radiography is usually faster and easier than clearing and staining. The time saved may be of value in studies of population variation, in which many specimens must be examined. Radiography has also been used to monitor decalcification of larvae stored in formalin (Tucker and Chester, in press), and has been suggested for use in toxicological studies to check large numbers

of larvae for skeletal deformities. The consensus among ichthyologists who have used both techniques is that, although clearing and staining methods provide the detail necessary for describing developmental osteology, radiography is a simple and quick way of obtaining counts from large numbers of specimens.

Hard (shortwave) x-rays have been used to form shadow pictures, or radiographs, of large, well-ossified fish for almost four decades (Gosline, 1948; Bartlett and Haedrich, 1966), but the use of soft (longwave) x-rays for small specimens is relatively new. Although first suggested by Bonham and Bayliff (1953) and used by Watson and Mather (1961 unpubl. manusc.), useful techniques for larval radiography have only recently been described (Miller and Tucker, 1979). Potential larval fish radiographers should consult Miller and Tucker's paper for methodological details and Quinn and Sigl (1980) for basic radiographic principles. Although specimen fragility determines the minimum size of larvae that can be x-rayed, sensitivity of the technique, which depends to a large degree on spectral characteristics of the radiation, determines the amount of detail present in the finished radiograph. This section, therefore, reviews the principles and current methods useful for maximizing detail in radiographs of fish larvae.

Radiographic sensitivity refers to the clarity of details in the radiographic image and depends on a combination of two factors, definition and radiographic contrast. Definition is sharpness of the image. Radiographic contrast refers to the density (darkness) range of the image and depends on two factors, subject contrast and film contrast. Subject contrast refers to the ratio of radiation intensities that pass through different parts of the specimen. Film contrast refers to the ratio of densities in parts of the film that have received different degrees of exposure.

In larval fish work, radiographic sensitivity can be improved by several means. Definition can be improved by using the longest possible radiation wavelengths, by using the finest grained film available, and by minimizing geometric production of overlapping shadows at tissue discontinuities in the specimen. Absorption by x-rays of a given wavelength depends mostly on the atomic numbers of components in the x-rayed material, and to a lesser degree on thickness and density of the material. Larval skeletons, which are thin, poorly calcified, and of relatively uniform composition and thickness, do not contrast radiographically with the rest of the body as much as in older fish. High contrast techniques should, therefore, be employed. Subject contrast can be increased by increasing wavelengths and by decreasing the thickness of non-skeletal tissue by dehydrating the specimen. Film contrast can be increased by using a high contrast film and by increasing development time; however, overdevelopment will also increase graininess and reduce definition, and probably should be avoided.

The longwave (soft) end of the x-ray spectrum is the portion most useful for x-raying small fish, because this low energy radiation does not pass through materials as easily as that at the shortwave (hard) end. Decreasing the tube voltage (kv) causes a shift of the emitted spectrum toward longer wavelengths. Resultant elimination of some of the hard radiation contributes to better subject contrast and improves definition by reducing clumping of silver grains in the film emulsion (graininess). The x-ray unit should be equipped with a thin beryllium window, which allows passage of soft rays. A 25 mil (0.63 mm) window allows work at a kv of 20; a 10 mil (0.25 mm) window extends capabilities to about 8 kv (Joseph Fowler, Hewlett Packard, pers. comm.). However, the lower practical limit for fish larvae may

be governed by restrictions on exposure time, rather than kv limitations.

Another relevant factor is the source-to-specimen distance, to which image definition is directly related. Increasing the source-to-specimen distance improves definition by minimizing enlargement and distortion. Practical limits are set by air attenuation, loss of radiation intensity (roughly as the square of the ratio of the distances), and dimensions of the x-ray unit. Geometric unsharpness is the maximum width of the zone of overlapping shadows that are caused by a non-point source. This factor can be calculated to determine the minimum source to specimen distance that can be tolerated. Use of the minimum distance will permit the shortest possible exposure time and reduce relative attenuation of soft rays, thus contributing to subject contrast. The formula for geometric unsharpness, U_g (Quinn and Sigl, 1980) is:

$$U_g = F \left(\frac{t}{D_0} \right)$$

in which F is the radiation source size, D_0 is the source-to-specimen distance, and t is the specimen to film distance (maximum specimen thickness). For $F = 0.5$ mm, $D_0 = 460$ mm, and $t = 1$ mm, U_g is 0.001 mm. This level of unsharpness would not be visible without magnification and could be tolerated at moderate magnification depending on the requirements of the investigator. To ensure that geometric unsharpness is not large enough to affect quality of radiographs, it should be calculated for the set of factors relevant to each operation, keeping in mind the level of magnification to be used. With most modern x-ray units, a distance of 46 cm or less can be used.

Because air attenuates soft rays more than hard, elimination of air between the x-ray source and specimen allows a greater proportion of soft radiation to reach the specimen. Decreasing the source to specimen distance helps some, but also increases geometric unsharpness, unless the source is very small. A vacuum would be ideal but is impractical. Replacement of the air in a cabinet unit with helium allows the use of lower kv with reasonably short exposure times and provides an increase in subject contrast. Helium can be conserved and reused if it is placed in a small volume plastic cylinder that has its ends sealed with dry-cleaning plastic.

Before a specimen is x-rayed it should be dehydrated as much as can be tolerated to increase the signal (skeleton) to noise (non-skeleton) ratio. For best results, the specimen should be placed in 50–75% ethyl alcohol for a short period, maybe 30–60 min, depending on size. Then the specimen should be placed on the film holder, blotted to remove surface liquid and bubbles, and quickly x-rayed and returned to a container of liquid before desiccation damage occurs.

The specimen should be placed as close as possible to the film emulsion. This can be accomplished without wetting the film by sandwiching it between two thin sheets of black polyethylene. Details for construction of a convenient film holder (cassette) are presented in Miller and Tucker (1979). Polyethylene is transparent to soft x-rays and is good cassette material. Vinyl, as well as wood, paper, and any metal are relatively opaque to soft x-rays, and vinyl or metal make good labels.

Single coated Type R (now Type XAR) film has provided the best quality radiographs of larvae. High resolution plates give better resolution but are too slow. Type R film is slow relative to other films but within practical limits. It has ultra-fine grain

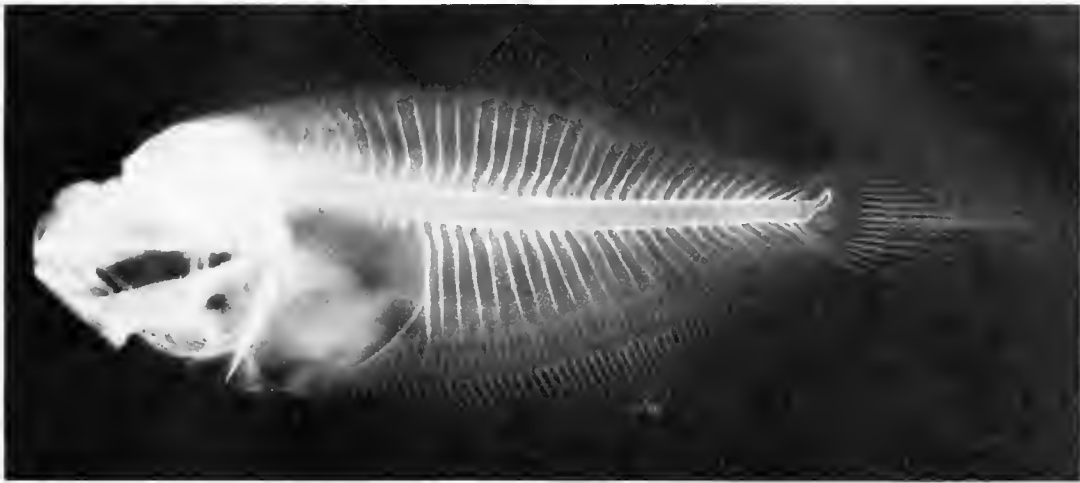

Fig. 15. Positive image of radiograph of a southern flounder (*Paralichthys lethostigma*) larva, 9.7 mm SL, stored in 7% borax buffered seawater formalin for seven years. Radiographic exposure data: Faxitron Model 43805N; Kodak Type R film; source to film distance, 46 cm; 9 kv; 600 mAs; under helium. Internegative processing data: radiograph was projected onto 4 in \times 5 in professional copy film (Kodak 4125) with an Omega (4 in \times 5 in) Pro Lab Enlarger; exposure was 1 s at f 8½; film was developed in Kodak HC110 (dilution E) for 5 min at 23 C. Print processing data: a positive print was made on Kodak Polycontrast Rapid 11 RCF paper using a polycontrast no. 3 filter in the Omega enlarger; exposure was 5 s at f 5.6; print was developed in Kodak Ektaflo diluted to simulate Dektol 1:1, at 23 C. (The internegative and printing procedure was devised and performed by Tom Smoyer of Harbor Branch Foundation.)

and high contrast. The single emulsion is necessary for avoiding two images (on both sides of the film). Coarser grained and lower contrast films will produce inferior radiographs.

Exposures should not be longer than about 5 min, and for many specimens 5 min is too long. Larvae will quickly desiccate, and even if not damaged, may shrink and cause blurred images. Specimen damage or image blurring will determine the minimum size of larvae that can be x-rayed. Specimens can be protected by an overlying sheet of dry-cleaning plastic if care is taken to remove bubbles. During exposure, unneeded portions of the film can be protected for later use with lead vinyl masks.

The manufacturers' instructions for mixing chemicals and processing films should be followed as closely as possible. Frequent agitation of the film while it is developing, rinsing, and fixing is important to ensure uniformity of chemical reactions. Both undeveloped and developed films should be stored away from light, heat, humidity, and chemical fumes (particularly formalin, alcohol, and hydrogen peroxide). Radiographs are best observed directly, emulsion side up, with a dissecting or phase contrast microscope. Printing of radiographs is best done via an internegative (Fig. 15). This compresses the tonal range so that finer detail can be preserved in the print.

The major limitation of the technique is probably inadequate radiation intensity at low kv. This limit may have been reached with x-ray units equipped with 10 mil beryllium windows. Satisfactory radiographs of 4–15 mm larvae have been made at 8–10 kv and 300–800 mAs (milliamperes \times seconds). Some improvement can be expected if the air is replaced with helium; however, exposure time will eventually become prohibitively long.

Because machine and specimen characteristics vary, a standard formula for producing high-quality radiographs cannot be provided. At least initially, the larval fish radiographer must proceed by trial and error with the machine and specimens at hand. As familiarity develops, the results will improve significantly. We stress that an accurate and detailed logbook containing specimen and exposure data should be kept, and that procedures should be standardized.

(J.W.T.) HARBOR BRANCH INSTITUTION, INC., RR 1, BOX 196-A, FORT PIERCE, FLORIDA 33450; (J.L.L.) GULF COAST RESEARCH LABORATORY, EAST BEACH DRIVE, OCEAN SPRINGS, MISSISSIPPI 39564.

Histology

J. J. GOVONI

WHILE contemporary systematists rely upon a broad scope of biological features to infer relationships among taxa, the definition and comparison of morphological characters remains one of their most useful tools. The small size and often altricial development of fish larvae, however, make it difficult to resolve the morphology of structures other than skeletal elements. By clarifying tissue composition and by enhancing morphological resolution, histological techniques may aid the systematist in defining characters at the tissue as well as at the microanatomical level, thereby providing additional character states to be examined for synapomorphies and perhaps ontogenetic precedence. Because of their small size, sections of whole larvae can be prepared (Fig. 16) and structural relationships of organ systems examined. Insofar as there is no clear separation between gross and micro-anatomy beyond the limits of human visual resolution, histological techniques may offer yet another tool useful in phylogenetic analysis.

TECHNIQUES

Fixation.—Inasmuch as autolysis is rapid in larval tissue (Theilacker, 1978), fixation is difficult (Richards and Dove, 1971).

Specimens reared in the laboratory or specimens taken from brief plankton tows (O'Connell, 1980) are the most suitable for histological preparation and study; specimens sorted from field collections fixed in formalin and seawater will usually yield poor quality preparations. Neutral buffered (phosphate buffers) formalin (see Humason, 1979) enhanced with <4% acrolein (van der Veer, 1982) is recommended for rapid and thorough fixation. Glutaraldehyde (2.5%) is also a useful fixative (Hulet, 1978).

Difference in the osmolality of tissues and ambient water may distort cells and tissues, especially of marine larvae. Such artifacts have not been observed in preparations of clupeiform and perciform larvae, but may be of concern in the preparation of anguilliform leptocephali (Hulet, 1978). Forster and Hong (1958) and Hulet (1978) provided applicable saline solutions that may eliminate distortion and enhance staining.

Sectioning and staining.—Standard animal tissue techniques (e.g., Humason, 1979)—dehydration, paraffin embedding, and sectioning—have been used to trace the development of organ systems (O'Connell, 1981a), as well as to assess the pathology of starvation in fish larvae (Umeda and Ochiai, 1975; O'Con-

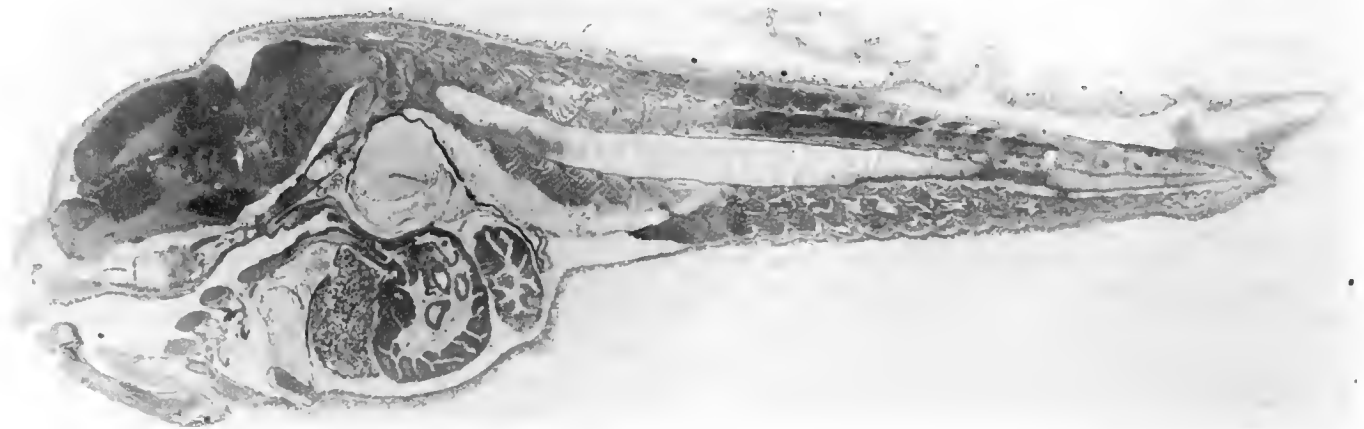
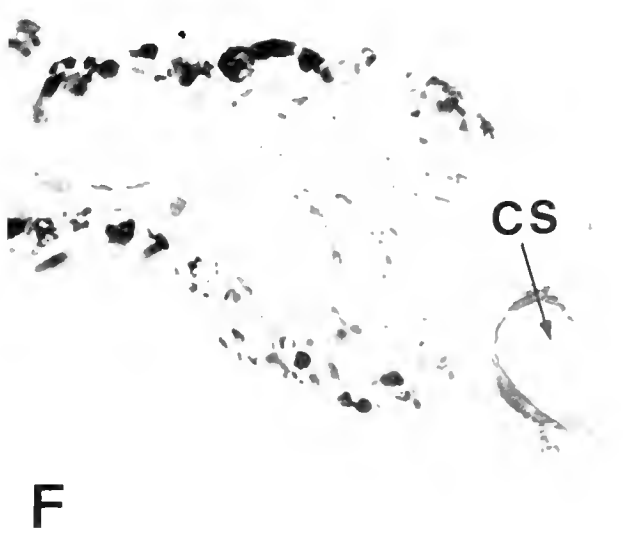
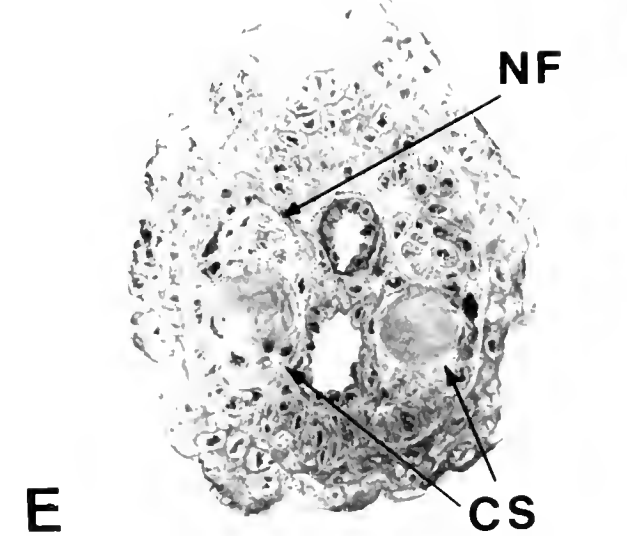
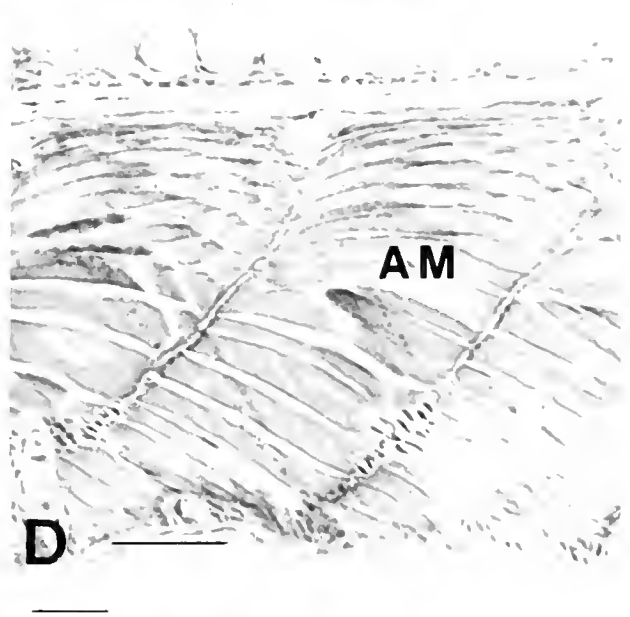
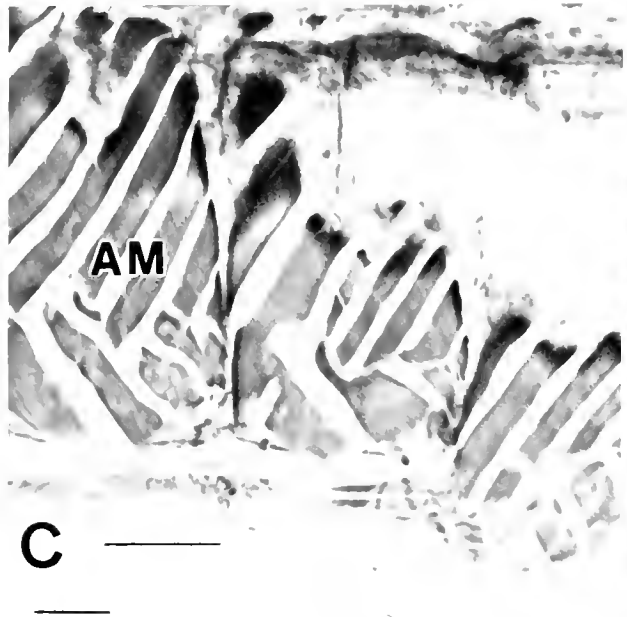
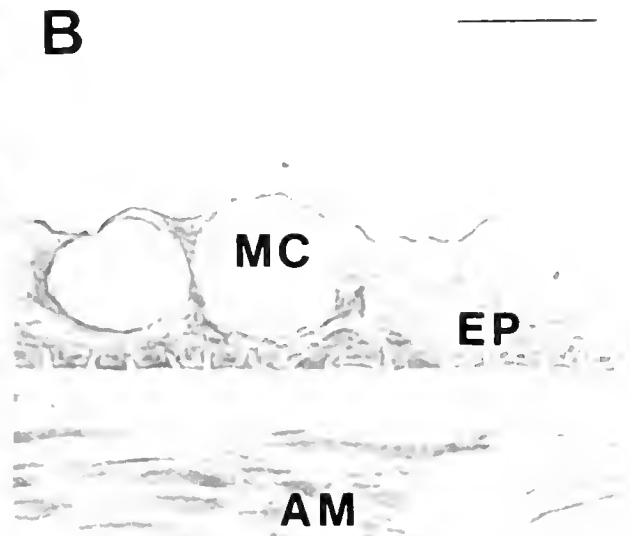
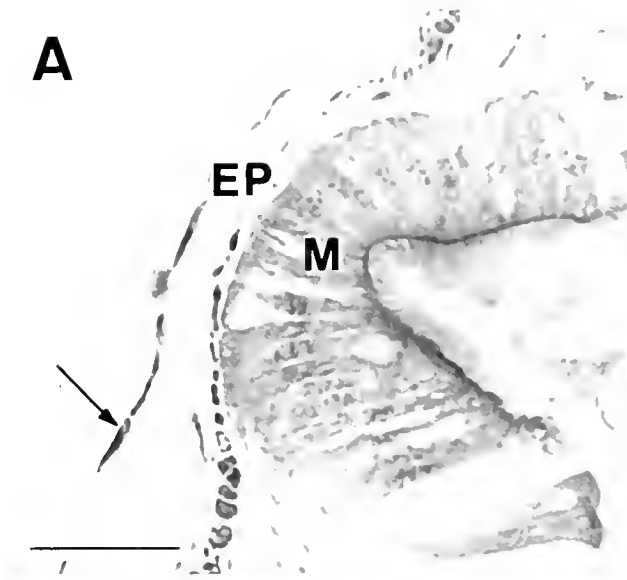

Fig. 16. Sagittal section of a *Leiosomus xanthurus* larva, 4.4 mm notochord length (glycol methacrylate section stained with alkali blue 6B—neutral red).

Fig. 17. Example comparisons of larval fish tissue and microanatomy. Abbreviations: AM, axial musculature; CS, collagenous supporting shafts; EP, epidermal cells; M, midgut; MC, mucous cell; NF, nerve fiber. (A) The integumentary epithelium of a *Brevoortia patronus* larva showing hyaline plates (arrow), a tissue characteristic of some clupeiform larvae. Note that erosion of the outer layer of epithelium is evident. (Scale bar = 20 μ m; glycol methacrylate section stained with acid fuchsin—toluidine blue.) (B) The integumentary epithelium of a *Leiosomus xanthurus* larva showing lack of hyaline plates in epithelial cells. (Scale bar = 10 μ m; glycol methacrylate section stained with alkali blue 6B—neutral red.) (C) Axial musculature of a *Brevoortia patronus* larva showing two opposing layers of muscle fibers, a tissue characteristic of clupeiform larvae. (Scale bar = 50 μ m; glycol methacrylate section stained with acid fuchsin—toluidine blue.) (D) Axial musculature of a *Leiosomus xanthurus* larva showing muscle fiber layers in parallel alignment, a tissue characteristic of perciform larvae. (Scale bar = 50 μ m; glycol methacrylate section stained with alkali blue 6B—neutral red.) (E) Cross section of the elongate dorsal ray of an *Echiodon dawsoni* larva. (Scale bar = 20 μ m; glycol methacrylate section from Govoni et al., 1984.) (F) Cross section of the elongate dorsal ray of a *Bregmaceros atlanticus* larva. (Scale bar = 15 μ m; glycol methacrylate section stained with acid fuchsin—toluidine blue.)



nell, 1976; Theilacker, 1978). These techniques will suffice for the examination of soft tissue morphology given adequately fixed specimens. To avoid their loss, small specimens may be prestained with borax-carmin before embedding and sectioning; this stain can be washed out before subsequent histological staining (Engen, 1968).

Plastic embedding (Bennett et al., 1976) is advantageous for examination of small delicate structures, for precise records of specimen orientation and section plane, and for the resolution of fine cellular detail. Glycol methacrylate (Bennett et al., 1976), epoxy resins (Humason, 1979), and other low viscosity plastics (Hulet, 1978; L. R. White resin, London Resin Company Limited) are useful embedding media. Small specimens that can become indistinguishable or even lost in paraffin blocks can be easily observed in the plastic block during sectioning. As whole mounts, specimens can be examined, measured, and meristic characters counted before sectioning (Hulet, 1978). Techniques developed by Ruddell (in press) reduce swelling of tissues, an artifact sometimes encountered with glycol methacrylate embedding. While the spectrum of histological and histochemical stains applicable to plastic sections is somewhat limited, toluidine blue counter stained with acid fuchsin has staining reactions analogous to the more commonly used hematoxylin and eosin. Other stain combinations also are applicable to larval tissue embedded in glycol methacrylate (for examples see Govoni, 1980; Govoni et al., 1984): alkali blue 6B counter stained with neutral red reveals fine cellular structure; VanGieson's picric acid counter stained with acid fuchsin reveals collagenous fibers, the anlagen of actinotrichia; periodic acid-Schiff reagent reacts strongly with acid mucopolysaccharides, including chondromucin, and can be used to reveal cartilaginous precursors of cartilage (endochondral) bone; alizarin red S reacts with Ca^{++} ions and can reveal both calcified cartilage and bone.

EXAMPLES OF APPLICATION

Histological preparations may serve the systematist in two ways: by clarifying tissue composition and by resolving structure, thereby allowing for the determination of ontogenetic presence or absence of tissues and by offering comparisons of tissue organization among taxa.

An example of the first use is in the identification of cartilage and bone. The literature is replete with errors that result from the naive interpretation of alcian blue and alizarin red S reactions with cartilage and bone tissue in whole mounts. Alcian blue reacts histochemically with the sulfate and carboxyl groups of mucopolysaccharides (Pearse, 1968) including chondromucin, the ground substance of cartilage, but it may also react with developing bone matrices, which are rich in mucopolysaccharides as well (Belanger, 1973). An alcian blue reaction, therefore, may indicate cartilage when developing membrane (dermal) bone is present. The reaction of alizarin red S with calcium ions (Pearse, 1968) may indicate calcified cartilage as well as true bone. While the clearing and staining of skeletal elements remains a powerful tool (Potthoff, this volume), histological preparations can clarify the identity of cartilage and bone tissue in extremely small specimens wherein their identity may not be clear in whole mounts.

To date, comparisons of larval fish characters revealed by histological techniques have not been extensive and examples

of application are few. Comparative histological sections of elopomorph and clupeomorph larvae illustrate the unique character of the elopomorph leptocephalus (Smith, this volume). The unique configuration of organs and tissues is apparently inclusive of anguilliform, elopiform, and notocanthiform leptocephali. Inasmuch as Hulet (1978) also found peculiarities in the kidney structure of the eel leptocephalus that may be unique among vertebrates, the kidney structure of anguilliform leptocephali should be compared with that of other elopomorph leptocephali. Transient, hyaline plates occur in the basal end of the outer integumentary epithelium of some clupeiform larvae (Jones et al., 1966; Lasker and Threadgold, 1968; O'Connell, 1981a; Fig. 17A), but this feature was not mentioned in the integumentary descriptions of anguilliforms (Hulet, 1978) and pleuronectiforms (Wellings and Brown, 1969; Roberts et al., 1973), nor is it apparent in the perciform *Leiostomus xanthurus* (Fig. 17B). These plates presumably function as osmotic barriers (O'Connell, 1981a), but their systematic presence or absence is not completely established and remains unexplained. The organization of axial musculature is another histological difference among higher taxa. The two-layered musculature of clupeiform larvae is aligned in opposing directions within myotomal segments (Blaxter, 1969b; O'Connell, 1981a; Fig. 17C), whereas in perciform larvae the orientation of axial muscle fibers is closely parallel (O'Connell, 1981a; Fig. 17D); this difference may have a functional basis related to gross body form and swimming postures (O'Connell, 1981a).

An example of the use of histological preparations to compare microanatomical characters is the differences exhibited in elongate dorsal fin rays. Elongate dorsal fin rays are features of many unrelated taxa of fish larvae (Moser, 1981), but the microanatomical structure of these homologous derivatives differs among taxa (Govoni et al., 1984). A major difference is the bilateral, paired, collagenous supporting elements of the carapid elongate ray, as in *Echiodon dawsoni* (Fig. 17E), and the singular supports of elongate rays of the bregmacerotid *Bregmaceros atlanticus* (Fig. 17F) and the serranid *Liopropoma* (Kotthaus, 1970). Monophyly in carapids has been inferred, in part, from the distinctiveness of this synapomorphy, the elongate first dorsal ray of their highly specialized larvae (Olney and Markle, 1979; Markle and Olney, 1980; Gordon et al., this volume).

The often remarkable similarity of cells and tissues, even among phyla (Andrew, 1959), and the development of tissues from the undifferentiated to the complex, may limit the use of a histological approach to systematics. Yet, the unusual diversity that characterizes ontogenetic patterns of fishes (Wourms and Whitt, 1981), and some apparent contrasts in tissue organization and composition that correlate with current supraordinal classification, make histological comparisons tenable. The preceding examples of tissue and microanatomical dissimilarities may serve to illustrate the kinds of comparisons that may prove useful in inferring relationships as more information becomes available. Histological techniques may provide a potentially useful tool to the systematist; more comparative work is clearly warranted.

NATIONAL MARINE FISHERIES SERVICE, SOUTHEAST FISHERIES CENTER, BEAUFORT LABORATORY, BEAUFORT, NORTH CAROLINA 28516.

Scanning Electron Microscopy

G. W. BOEHLERT

SCANNING electron microscopy is an ideal tool for description of microstructure in taxonomic studies. The scanning electron microscope (SEM) provides a surface image characterized by high resolution and depth of field and a three-dimensional quality unavailable with other techniques. In many cases this allows one to objectively describe microstructure where only subjective descriptions were available in the past. It is the purpose of this contribution to describe the techniques and use of scanning electron microscopy and its application to systematic investigations of fish eggs and larvae.

The SEM has been used in a wide variety of systematic and evolutionary investigations. With available magnifications from 10 to greater than 100,000 times, the SEM covers the range from dissecting and compound light microscopy to transmission electron microscopes. It has thus been immensely important to progress in classification in the study of micropaleontology, botany, insects and mites, and a wide variety of microorganisms, among other taxa (Heywood, 1971; Kormandy, 1975). Taxonomic applications of the SEM to fishes have been more limited. Several studies have used the SEM for studies of morphology, including epidermis, gill tissue, optic capsules, eggs, sperm, and embryos of fishes (Dobbs, 1974, 1975).

Microstructural analysis of otoliths of fishes with the SEM is now common (Pannella, 1980). For early life history stages, the most frequent use in identification and classification has been with the egg stage. The chorion, or external membrane, of many species is variously ornamented with filaments, spines, patterns of ridges, loops, blebs, and pustules (Ahlstrom and Moser, 1980; Robertson, 1981; Matarese and Sandknop, this volume). These ornamentations and the ultrastructure of the chorion are species-specific (Ivankov and Kurdyayeva, 1973; Lonning, 1972). While many of these structures may be easily visualized with light microscopy (Hubbs and Kampa, 1946; Kovalevskaya, 1982), the SEM often provides the best means of adequately describing structures which are very small or transparent under the light microscope. The egg chorion of *Maurolticus muelleri*, for example, was described as "drawn up into hexagonally arranged points," by Robertson (1976) based upon light microscopy but as "drawn up into hexagonal ridges . . . and slightly raised at the point of intersection" under the SEM (Robertson, 1981). Similarly, Boyd and Simmonds (1974), among others, suggested that the chorion of southern populations of *Fundulus heteroclitus* lacked fibrils using light microscopy, whereas the SEM showed the presence of numerous short and thin fibrils (Brummett and Dumont, 1981). Thus for purposes of classification, the SEM allows visualization of surface structures that are difficult to describe with light microscopy.

METHODOLOGY

Preparation of biological material for examination under the SEM is concerned with preservation, dehydration, and coating with a conductive material. Fixation of labile biological specimens is necessary because removal of water during the stages

of dehydration may result in collapse of cells and other artifacts. Depending upon the method of fixation and dehydration, the artifacts can range from shrinkage to collapse or fracture of the structures to be observed. It is preferable to begin with fresh, live material. For eggs this requires either laboratory spawning or abundant eggs from the field which can be reliably collected. For larvae at different stages, it is difficult without laboratory rearing facilities. Results with formalin-fixed material from plankton collections will generally be satisfactory for lower magnification analysis of surface morphology, but may not reflect the quality of freshly prepared material.

Fresh material should be fixed for electron microscopy. Larval stages may first be relaxed in anesthetant solution (such as MS-222). Initial fixatives for both eggs and larvae are generally based upon glutaraldehyde, with concentrations ranging from 0.5 to 4.0%; lower concentrations are typically followed by post-fixation. A fixative which I have found acceptable is that from Dobbs (1974) as follows: 70% glutaraldehyde—2.0 ml, flounder saline—34 ml, and distilled water—34 ml. The flounder saline follows Forster and Hong (1958) and contains the following (in grams per liter): NaCl, 7.890; KCl, 0.186; CaCl₂, 0.167; MgCl₂·6H₂O, 0.203; NaH₂PO₄·H₂O, 0.069; NaHCO₃, 0.84. The fixative has a final osmolarity of 380 mOsm/l. Fixation should be for 24 hours. Other authors provide several other fixatives. One suggested by Stehr and Hawkes (1979), while more difficult to prepare, is also useful should transmission electron microscopy be desired for the same material. Post-fixation in osmium tetroxide is recommended by several authors as a means of hardening particularly soft tissues. Generally, 1–2% osmium tetroxide in buffered saline is used. I have found this unnecessary with fish eggs and larvae, as suggested by Dobbs (1974) and Stehr and Hawkes (1979). It may be considered, however, if collapse is a problem. Lonning and Hagstrom (1975) suggested that egg chorions not post-fixed would rupture under the electron beam; I have not noticed this.

It is the process of dehydration where the greatest artifacts are likely to occur. With larvae, shrinkage of tissue may occur, while eggs may suffer complete collapse. On larger eggs, puncturing the chorion with a sharpened dissecting needle may facilitate transfer of fluids and prevent this collapse (Stehr and Hawkes, 1979).

Removal of water from the tissues is prerequisite to coating and observation, which are both conducted under high vacuum. Two methods are available, freeze drying and critical point drying. For freeze drying, unfixed fresh material may be used. Fixed material should first be rinsed with distilled water to remove salts, and then plunged with little adhering water into liquid nitrogen. Damage here may result from formation of ice crystals if freezing rate is too slow, but this is typically not a problem with small eggs and larvae in liquid nitrogen. Boyde and Wood (1969) recommend using 20 ml chloroform per liter of distilled water to increase nucleation rates and decrease ice crystal formation. After freezing, the material is immediately

introduced into the freeze dryer, where water sublimates, leaving the specimen dry and intact. Critical point drying, on the other hand, requires dehydration through a graded series of alcohols (20% for 24 h, then 10–20 min each in 50%, 70%, 80%, 90%, 95%, and two changes of absolute ethanol). The ethanol is then replaced with either freon or acetone depending on whether freon or carbon dioxide critical point dryers are used. The steps of dehydration and transfer can be done in small specimen holders to minimize handling and possible surface damage. After dehydration, specimens must be mounted on SEM studs with any of several available adhesives and tapes. The dried specimens are particularly delicate and should be handled with a small camel-hair brush to avoid damage to the surface. They are then oriented onto the stud under a dissecting microscope. Before coating, no further preparation is necessary with larvae, but eggs have only a small area of electrical contact with the stud. It is therefore advisable to use a conductive adhesive (such as silver paint) to make a more complete electrical connection and prevent charging, which decreases image quality. This paint should be allowed to become tacky prior to positioning the eggs, or it may cover portions of the egg itself. Finally, specimens are coated with a thin conductive layer, typically of gold or gold-palladium, by either vacuum evaporation or ion sputtering, prior to viewing on the SEM. At most facilities, trained SEM technicians are available; their advice and assistance are invaluable and should be sought.

RESULTS AND DISCUSSION

Shrinkage and other artifacts will vary depending upon the type of material, preservation, and method of dehydration. For fresh material preserved in a mixture of formalin, glutaraldehyde, and acrolein, Stehr and Hawkes (1979) observed a shrinkage of approximately 10% in the eggs of *Platichthys stellatus* and *Oncorhynchus gorbusha*; the latter had been punctured prior to dehydration. In the present study, eggs of *Maurolicus muelleri* initially preserved in 5% buffered formalin showed varying degrees of shrinkage and collapse depending upon subsequent treatment. The least shrinkage (12%, Fig. 18B) was noted in material which was freeze dried, whereas post-fixation and dehydration through freon 113 associated with critical point drying resulted in shrinkage of up to 67% of the original diameter (Fig. 18D). Eggs of this species show a hexagonal sculpturing; under the light microscope the sculpturing is hyaline and difficult to interpret (Fig. 18A). Eggs prepared by freeze drying clearly show the surface sculpturing; note particularly the ridges, which are more clearly defined (Fig. 18B). For comparison, an egg which had partially collapsed during dehydration is shown (Fig. 18D). The obvious differences in shrinkage point out the importance of specifying method, initial size, and shrinkage values, particularly for comparative or taxonomic studies.

Eggs from other species are shown to give an idea of the range of chorion structures which may be observed. The hexagonal pattern on *M. muelleri* overlies a highly porous surface structure

Fig. 18. (A) Egg of *Maurolicus muelleri* from off South Africa taken under the compound light microscope with transmitted, polarized light. Note the emphasis of the points on the hyaline chorion, which represent the intersections of ridges. Bar = 100 μ m. (B) Egg of *M. muelleri* under the scanning electron microscope. Note the areas between what one would interpret as points on Figure 18A, which are now seen as polygonal facets or ridges. Bar = 500 μ m. (C) Individual facet of the egg of *M. muelleri*. Note the porous and diaphanous nature of the egg surface. Bar = 50 μ m. (D) Egg of *M. muelleri* post-fixed in osmium tetroxide and critical point dried. The shrinkage of this specimen is approximately 65%. Note the differences in morphology of the ridges and surface of the egg. Bar = 100 μ m. (E) Egg of *Pleuronichthys coenosus*. The facets are relatively small by comparison with *M. muelleri* and the pattern units are more regularly hexagonal. Bar = 100 μ m. (F) Detail of two hexagons from the egg of *P. coenosus*. Note the morphological differences between both the ridges and chorion surface as compared to *M. muelleri*. Bar = 10 μ m.

Fig. 19. (A) Egg of *Atherinopsis californiensis*. The filaments are single, terminate in loose ends, and are distributed over the entire egg surface. Bar = 1,000 μ m. (B) Egg of *Atherinops affinis*. The egg of this species is characterized by filaments which are looped, with no free ends (Curlless, 1979). This differentiates it from the egg of *A. californiensis*, as do filament length, abundance, and basal morphology. Closed-loop filaments have also been noted in *Antennarius caudimaculatus* eggs by Pietsch and Grobecker (1980). Bar = 1,000 μ m. (C) Chorion of *Paracallionymus costatus* collected off South Africa. The surface features are irregular and cover the entire egg surface. This differs from species of *Callionymus*, which have hexagonal patterns. Bar = 10 μ m. (D) Chorion surface of *Mugil cephalus*. These structures are irregular and cover the entire egg surface. Note the superficial similarity to *Paracallionymus*. Bar = 10 μ m. (E) Chorion surface of an advanced ovarian egg of *Coryphaenoides filifer*. Note that the surface "blebs" are arranged in hexagonal patterns and may be the precursors of a hexagonal pattern typical on eggs in this family. The pelagic egg of this species has not been described. Bar = 10 μ m. (F) Chorion surface of an advanced ovarian egg of *Coryphaenoides acrolepis*. The hexagonal ridges are better developed than in Fig. 19E. There are holes under the ridges between the intersections, which might indicate that this species, whose egg is also undescribed, may have the hexagonal network supported on "stilts" as described for eggs of *Coelorhynchus* spp. (Robertson, 1981; Sanzo, 1933a). Bar = 10 μ m.

Fig. 20. (A) Spines on the chorion surface of *Oxyporhamphus micropterus*. These are distributed over the entire surface of the egg. Bar = 100 μ m. (B) Chorion surface from *Scomberesox saurus* collected off South Africa. The tufts are characterized by a relatively complex basal morphology and depending upon method of fixation, may resemble small bundles of hairs or, as here, simply coalesced tufts. Bar = 10 μ m. (C) Micropyle and associated pores of the egg of *Lactoria diaphana* from the Eastern Tropical Pacific. The pores shown here are restricted to this region around the micropyle and appear to penetrate the outer layer of the chorion. Bar = 50 μ m. (D) Secondary, smaller pit structures on the remainder of the egg of *Lactoria diaphana*. I refer to these depressions as "pits" because closer examination does not reveal penetration through any layer of the chorion, as opposed to the pores surrounding the micropyle in 20C. Bar = 1 μ m. (E) Head region of a larval *Sebastes melanops* shortly after parturition. Polygonal epidermal cells may be noted on some parts of the body. Bar = 100 μ m. (F) Epidermis on the dorsal surface, just posterior to the head, on an embryonic *S. melanops* approximately 28 days post fertilization. Note the distinct microridges and cell borders characteristic of developing teleost epidermis. Bar = 10 μ m.

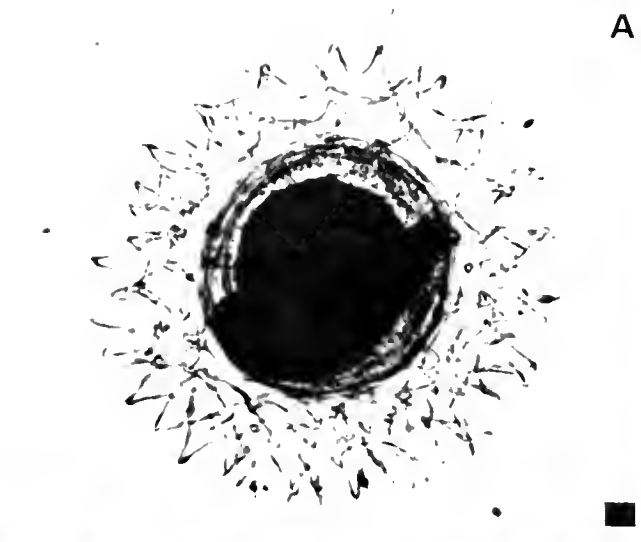

A

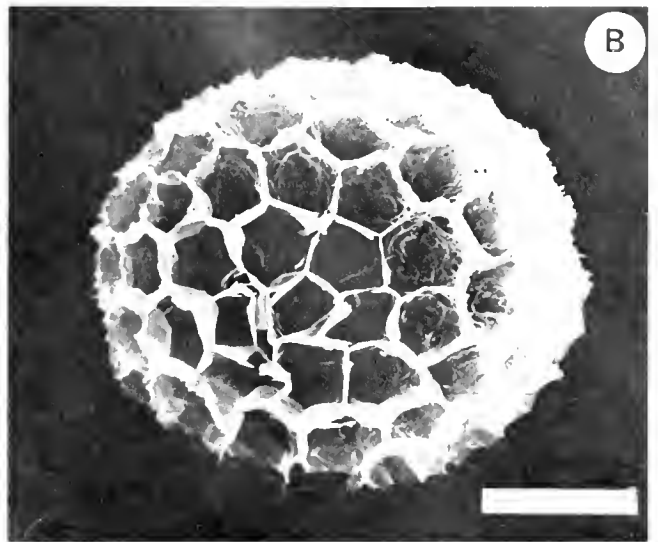

B

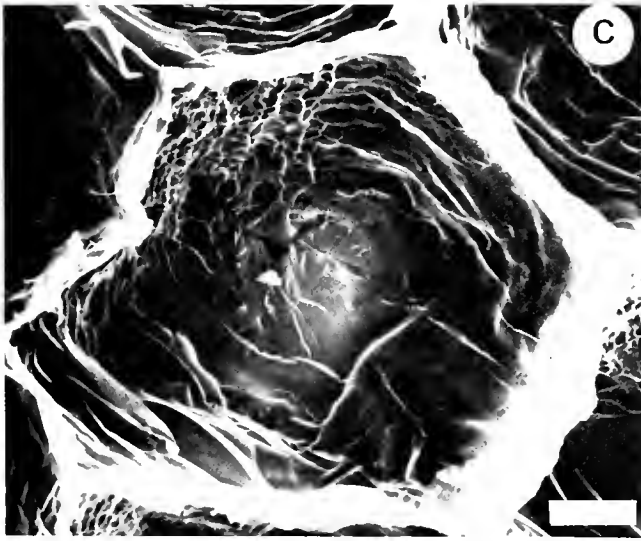

C

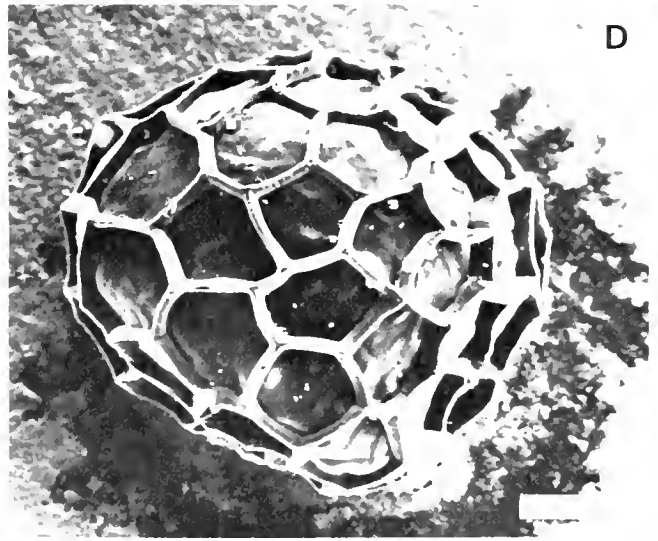

D

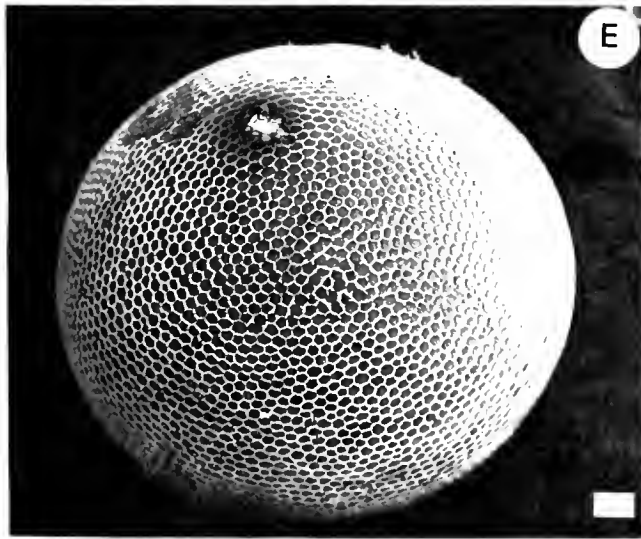

E

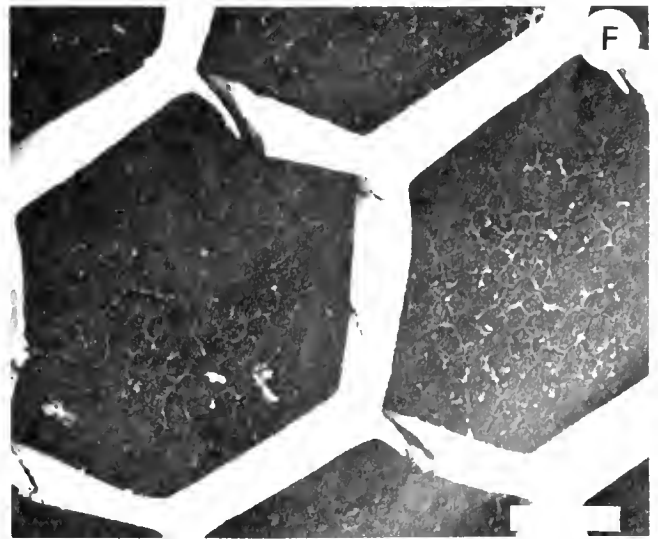

F

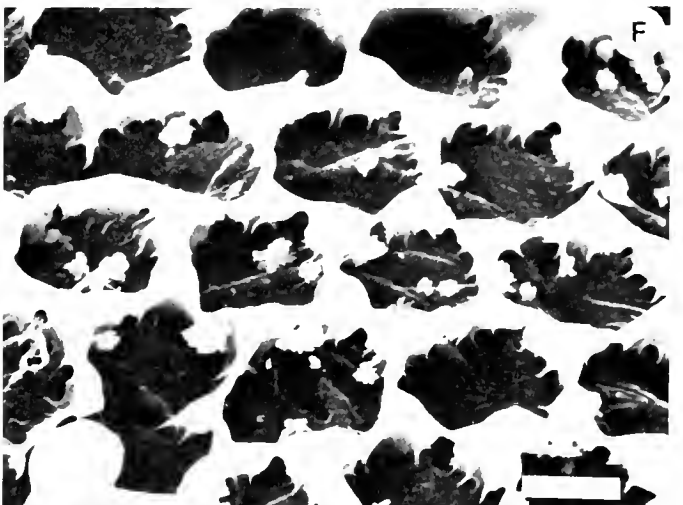
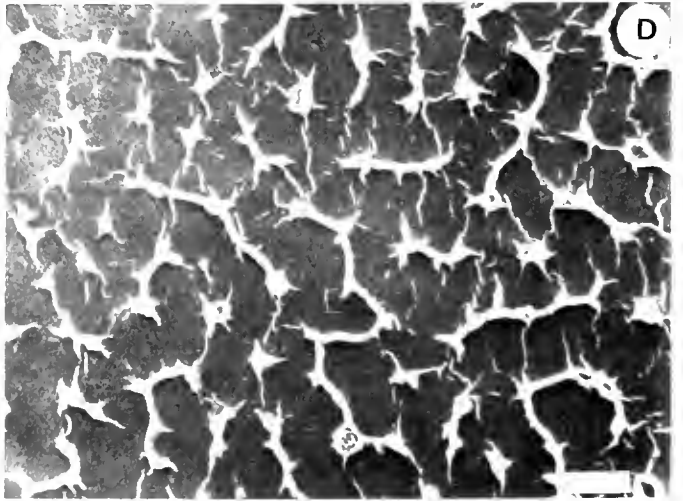
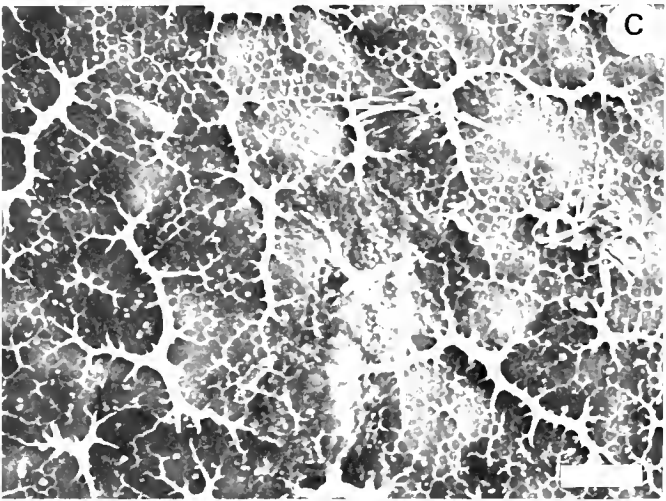
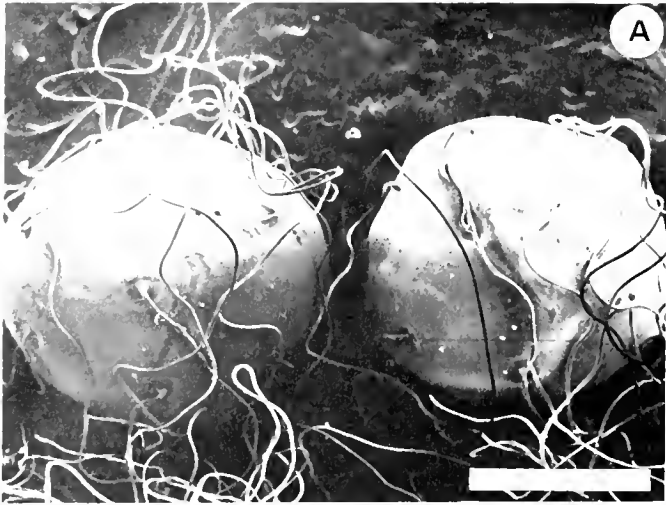

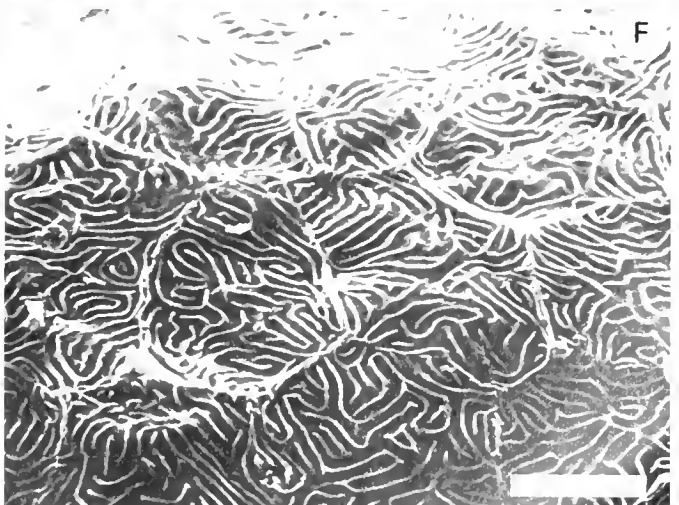
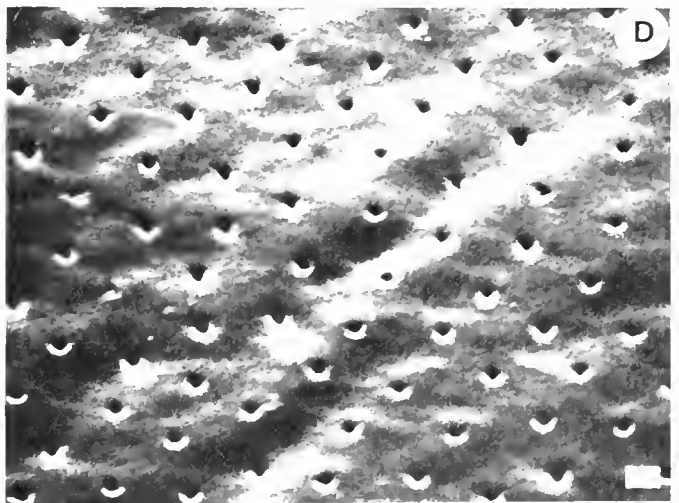
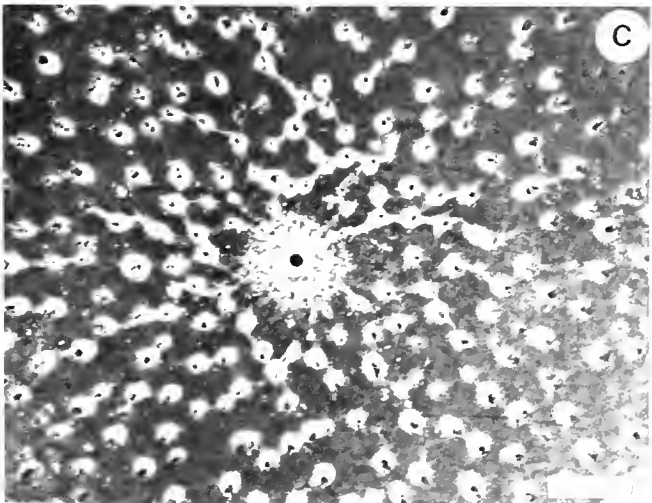
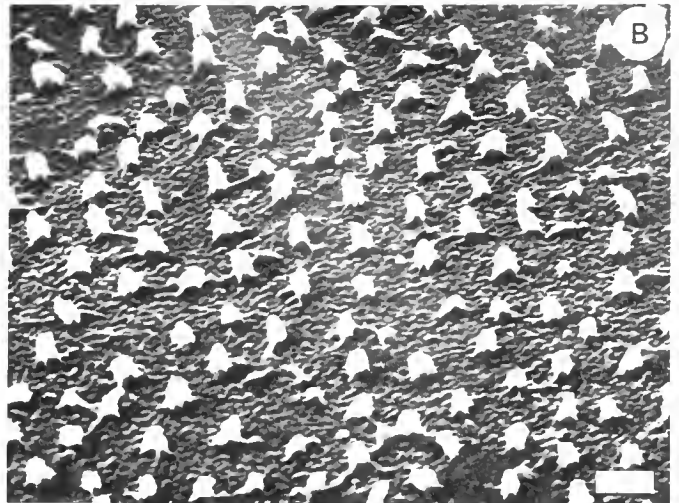
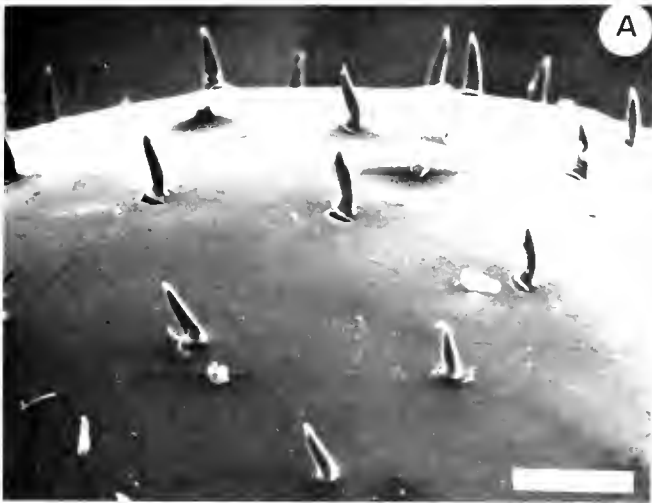

(Fig. 18C) as compared to that of *Pleuronichthys coenosus* (Fig. 18E, F). Here, the hexagons are not only smaller, but the area within the facets does not appear porous. SEM was used for this species and its congeners for egg description by Sumida et al. (1979). It is interesting to note that these authors discussed the similarity in chorion structure of *Pleuronichthys* spp. with that of *Synodus lucioceps*. While there were slight differences in sizes of the polygons, the superficial similarity of chorion structure on these phylogenetically distant genera supports a functional role (Robertson, 1981) and independent derivation. In this instance, however, SEM was valuable for understanding and interpreting the differences between species and genera subsequently observed under the light microscope (Sumida et al., 1979). Similarly, Keevin et al. (1980) used chorion ornamentation to distinguish among genera of killifishes.

Other ornamentations include more random ridges (*Paracallionymus costatus*, Fig. 19C, and *Mugil cephalus*, Fig. 19D), filaments of varied length, diameter, and base morphology (*Atherinopsis californiensis* and *Atherinops affinis*, Fig. 19A, B; see also Hubbs and Kampa, 1946), tufts (*Scomberesox saurus*, Fig. 20B), spines (*Oxyporhamphus micropterus*, Fig. 20A), and pits and pores (*Lactoria diaphana*, Fig. 20C, D). In the callionymids, the small eggs of species of *Callionymus* have hexagonal sculpturing similar to that of *Pleuronichthys* (Fig. 18E). In *Paracallionymus costatus* (Fig. 19C), however, random ridges similar to those in *Mugil cephalus* are apparent.

Since chorion microstructure is formed by follicle cells during oogenesis (Sponaugle and Wourms, 1979; Stehr, 1979), patterns may also be discerned in ovarian eggs. The pelagic eggs of mac-

rourids are poorly known but have been described for selected species by Sanzo (1933a), Robertson (1981), and Grigor'ev and Serebryakov (1981). For Pacific species of *Coryphaenoides*, pelagic eggs remain poorly known but apparently have hexagonal patterns as in other members of the genus; this is clearly shown in ovarian eggs near the maximum size observed by Stein and Pearey (1982; Fig. 19E, F). Thus SEM of developing ovarian eggs may be used to discern differences which then aid in identification of eggs from plankton samples.

For larval stages, SEM has been used for the description of development of several surface structures, such as the olfactory organ (Elston et al., 1981) and lateral line neuromasts (Dobbs, 1974). For taxonomic studies, differentiation of fine-scale morphological differences, such as dentition or fine-scale spine serration, may be useful. Its most valuable use may therefore be for later larval development, since pigmentation and other characteristics in early larvae are better seen with conventional methods (Fig. 20E, F).

To conclude, SEM may serve as an adjunct to traditional methods in the description of fine structure in fish eggs and larvae. For high magnification, high resolution visualization of surface morphology, it remains the most effective tool available. Under lower magnifications, it may allow one to clearly visualize structures which are difficult to interpret using standard microscopical methods (Fig. 18A, B).

OREGON STATE UNIVERSITY, MARINE SCIENCE CENTER, NEWPORT, OREGON 97365.

Developmental Osteology

J. R. DUNN

ONE legacy left by Elbert H. Ahlstrom was an appreciation of the value of developmental osteology of teleosts as a taxonomic aid and as an indicator of phylogenetic affinities. Although numerous studies have been made on the growth of various bones in teleosts, such descriptions have not been widely used in assessing relationships of fishes. I have recently reviewed, in some depth, the application of developmental osteology in taxonomic and systematic studies of teleost larvae (Dunn, 1983b). Here I present a brief overview of some skeletal structures in teleosts whose ontogeny offers potential utility in inferring phylogenetic affinities. It is hoped that this precis will encourage ichthyologists to examine the development of bones in the course of their systematic studies.

ONTOGENETIC CHANGES IN SKELETAL STRUCTURES

Cranial and associated bones.—Cranial osteology has, of course, been the foundation of systematic studies of adult fishes, but the development of cranial bones has been little used in phylogenetic studies. Numerous descriptions of the ontogeny of

cranial bones exist in the literature (e.g., Bhargava, 1958; Bertmar, 1959; Kadam, 1961; Weisel, 1967; Moser and Ahlstrom, 1970; Mook, 1977; Leiby, 1979b; Yuschak, 1982). Additionally, the sequence of ossification of head bones has been described for a variety of taxa (e.g., Moser, 1972; Aprieto, 1974; Leiby, 1979a; Dunn, 1983a; Kendall and Vinter, 1984). The development of certain cranial structures has also been shown to be of taxonomic value (Fritzsche and Johnson, 1980), yet comparative studies of the developmental osteology of the skull of related groups of teleosts seem rare (e.g., Norman, 1926b; De Beer, 1937).

Available evidence suggests that the sequence of ossification of the skull of teleosts is a conservative (i.e., relatively constant among different phyletic groups) process (De Beer, 1937; Mook, 1977). Among the bones which ossify first are those in areas of high stress, such as feeding (jaw bones) and respiration (branchial region), as noted by De Beer (1937), Weisel (1967), Moser and Ahlstrom (1970), Mook (1977), Yuschak (1982).

Examples of ontogenetic changes in skull bones which suggest that these structures might offer insight into phylogenetic affin-

ities include upper jaw bones (Berry, 1964a), head spines (Kendall, 1979; Washington, 1981; Yuschak, 1982; Washington and Richardson, MS), gill arches (Leiby, 1979b; Yuschak, 1982; Potthoff et al., 1984), and lateral skull bones (Leiby, 1979b).

Patterns of chondrification may also be of value in inferring phylogenetic relationships. Washington and Richardson (MS) noted that while chondrification of skeletal bones in most scorpaeniform fishes is a relatively brief process, occurring in preflexion and early flexion larvae, chondrification was prolonged (occurring through most larval development) in hexagrammids and in three genera of cottids. These authors also considered a unique pattern of ossification of cartilaginous rings in the regions of the parietal and frontal spines as a synapomorphic character uniting three genera of cottids.

Vertebral column and associated bones.—Vertebral centra, neural and haemal spines, apophyses, and ribs all undergo variable changes in configuration with growth. A number of workers have documented the development of the vertebral column and associated bones in a variety of taxa, but attempts have not been made to analyze the phylogenetic significance of the ontogeny of these structures. The sequence and direction of ossification of vertebral centra is known to vary among taxa (e.g., Moser and Ahlstrom, 1970; Mook, 1977; Potthoff et al., 1984), but this character has yet to be analyzed among groups of fishes.

Among those elements of the vertebral column which have been studied in various taxa, Potthoff and Kelley (1982) noted that the neural and haemal arches in *Xiphias* first develop distally opened, whereas in other perciforms studied, split arches were observed in small larvae on the anterior two centra only. Washington and Richardson (MS), in their study of cottid larvae and scorpaeniform outgroups, noted in various taxa the reduction or absence of the first neural spine, presence or absence of autogenous neural arches on centrum one, shape of anterior neural arches, and whether or not the first neural arch was distally fused or open. Potthoff and Kelley (1982) cited the unique position and development of ribs in *Xiphias* compared to other perciforms studied, and Washington and Richardson (MS) examined the location, number, and position of ribs in cottids and perciform outgroups.

Fins and their supports.—Dorsal and anal fins—The sequence of formation of dorsal and anal fins as well as the order of development of their constituent spines and/or rays varies among taxa (Dunn, 1983b). This succession of formation may be relatively constant among related groups or it may vary, but the phylogenetic significance of these events, if any, has yet to be analyzed. Additionally, numerous taxa of larvae possess transient, often bizarre, structures, such as elongate dorsal spines or rays or anal rays (e.g., Kendall, 1979; Moser, 1981). These structures are of taxonomic value and may contain phylogenetic information, but the homologies of these structures, if any, are not known (Govoni, this volume).

Potthoff et al. (1984) indicated that the second dorsal and anal fins are the first to develop in most perciform fishes. However, in generally more advanced species, dorsal fin rays (or spines) develop first anteriorly and second dorsal and anal fin ray development starts after the first dorsal fin is either partially or fully developed. Fahay and Markle (this volume) described the sequence of fin formation in gadiform fishes. Usually the vertical fins ossify at nearly the same time, but two or more centers of ossification are present in those genera (e.g., *Molva*,

Merluccius) with a single long dorsal fin (or a short first dorsal fin preceding a longer second dorsal fin).

The ontogeny of pterygiophores has received considerable attention from Potthoff and colleagues (e.g., Potthoff, 1975, 1980; Potthoff et al., 1980, 1984). The developmental pattern of fin pterygiophores may suggest phylogenetic relationships. Potthoff and Kelley (1982) noted that the first dorsal pterygiophore in *Xiphias* arose from either one or two pieces of cartilage, as is the case in *Morone* (Fritzsche and Johnson, 1980), but not in scombrids. Washington and Richardson (MS) observed the ontogenetic migration of dorsal fin pterygiophores, relative to neural arch position, in three cottid genera. Proximal and distal radials may fuse during ontogeny (Yuschak, 1982) and the presence or absence of medial radials may characterize certain groups of fishes (Potthoff and Kelley, 1982).

Pectoral and pelvic fins and their supports.—With some exceptions, pectoral fins develop rays later in the larval period than median fins (Dunn, 1983b). Transient, elongate spines and rays also develop in the pectoral fins of some taxa (Moser and Ahlstrom, 1974; Moser, 1981); such structures may be of taxonomic value, but their phylogenetic significance, if any, and their homologies are not known. Relatively few descriptions have been published on the development of the pectoral fin (e.g., Houde and Potthoff, 1976; Potthoff, 1980; Potthoff and Kelley, 1982; Yuschak, 1982; Potthoff et al., 1984), and few systematic inferences have been drawn. Potthoff et al. (1984) noted, in *Anisotremus virginicus*, the ontogenetic fusion of the supratemporal-intertemporal, the elongation of the anterior coraco-scapular cartilage, and the reduction in length of the posterior process. Washington and Richardson (MS) examined the orientation of the cleithrum, as well as its outer lip, the length of the scapulo-coracoid complex, the base of the cleithrum, and the cleithral extension over the pelvic bone (among other characters of the pectoral girdle) in their analyses of cottids and their allies.

The ontogeny of the pelvic fin and its supporting structures also has been little investigated (Potthoff, 1980; Potthoff et al., 1980; Fritzsche and Johnson, 1980) and infrequently used in systematic studies. Dunn and Matarese (this volume) indicated that in gadid larvae the length of the posterior-lateral process of the basipterygia differed among subfamilies and tended to be reduced or wanting in those genera presently considered advanced.

Caudal fin.—The development of the caudal fin in teleosts, a subject Dr. Ahlstrom was extremely interested in (e.g., Ahlstrom and Moser, 1976), seems to have received more study than other bony structures. However, few workers have attempted to interpret the phylogenetic significance of the development of this fin (Dunn, 1983b).

The fusion of bones, reduction in size of structures, or loss of elements by absorption can frequently be observed in the development of the caudal fin in some fishes. Additionally, based on ontogenetic evidence, the structure of this fin may differ from that commonly accepted based on adult specimens (Dunn, 1983b).

Ontogenetic changes in the caudal fin and associated bones which have been used to infer phylogenetic relationships include the reduction through fusion of ural centra (Moser and Ahlstrom, 1970; and others), discreet or fused hypural bones (Washington and Richardson, MS; Dunn and Matarese, this volume), absence of the parhypural in certain taxa which normally possess one (Washington and Richardson, MS), characteristics (e.g.,

shape, modification, autogenous or fused to the centra) of neural and haemal spines on preural centra associated with the caudal fin (Washington and Richardson, MS; Dunn and Matarese, this volume), and number of vertebral centra supporting the caudal fin (Washington and Richardson, MS; Fahay and Markle, this volume).

Attention has recently been directed toward the presence of radial cartilages (their position and shape during development) in the caudal fin of certain teleosts (Kendall¹; Potthoff et al., 1984). These structures may contain information of value in assessing phylogenetic relationships.

Squamation.—The development of scales in teleosts has been described for a variety of taxa (e.g., Berry, 1960; Burdak, 1969; Fujita, 1971; White, 1977; Potthoff and Kelley, 1982). The sequence of development of scales and their origin on the fish differs among taxa, and scales undergo changes with ontogeny (e.g., White, 1977; Potthoff and Kelley, 1982). The acquisition

of scales on fish usually occurs during their transformation to the juvenile stage; however, a number of groups (e.g., *Zaniolepis*, serranids, holocentrids, and xiphiids) acquire scales during the larval period. Such developmental changes have apparently not been analyzed among diverse groups of fishes.

PERSPECTIVE

Developmental osteology of teleosts appears to be an under-exploited approach of potential value in increasing our understanding of the relationships of fishes. Studies of developmental osteology of teleosts may contribute much to our understanding of homology, the central concept of all biological comparisons (Inglis, 1966; Bock, 1969; Wake, 1979) in our search for primitive and derived character states. A number of investigators present at this symposium are actively engaged in evaluating ontogenetic changes in ossified structures in their studies of various taxa of larval fishes. An appraisal of this method may well be in the future, but evidence provided during the course of this meeting will contribute to such an evaluation.

NORTHWEST AND ALASKA FISHERIES CENTER, NATIONAL MARINE FISHERIES SERVICE, 2725 MONTLAKE BOULEVARD EAST, SEATTLE, WASHINGTON 98112.

¹ Kendall, A. W., Jr. 1981. Ventral caudal radials—oft overlooked structures. (Paper presented at annual meeting Amer. Soc. Ichthyol. Herpetol., Corvallis, OR, June 1981; Abstract in *Copeia* 1981:935).

Otolith Studies

E. B. BROTHERS

ALTHOUGH the value of otolith studies in systematic ichthyology is well established, essentially all studies to date deal with the otoliths of adults, or only incidentally juveniles, and are usually limited to the external morphology of the typically largest otolith, the sagitta (see reviews of Weiler, 1968; Casteel, 1974; Hecht, 1978; Huygebaert and Nolf, 1979). Otoliths of larvae, which are of recent interest in terms of age, growth, mortality, and life history studies (Brothers et al., 1976; Struhsaker and Uchiyama, 1976; Methot and Kramer, 1979; Townsend and Graham, 1981; Kendall and Gordon, 1981; Laroche et al., 1982; Lough et al., 1982; Bailey, 1982; Brothers et al., 1983) have been ignored from a taxonomic point of view. This is perhaps not surprising due to their very small size and generally simpler form, with an apparent lack of obvious distinguishing external features. Although the internal structure of larval otoliths appears to be more variable than the external form, no comparative taxonomic studies have been attempted to date. In addition, relatively little has been done on comparisons of these features of adult otoliths, noting that in a real sense, the internal anatomy of the adult otolith is just the cumulative historical record of ontogenetic changes in external structure and growth patterns. Comparative studies on features other than external appearance have tended to be at the crystallographic, mineralogical and chemical level. Carlstrom's (1963) research on the crystallographic structure of fish otoliths and otoconia was a pioneering attempt to apply structural and com-

positional information to understanding the broad outlines of vertebrate evolution. A few studies have followed this line of investigation (Lowenstam, 1980, 1981; Lowenstam and Fitch, 1978, 1981), however the discrimination ability of crystallographic techniques is certain to be limited by the relatively few crystalline varieties known to exist in ear stones. Analysis of the amino acid composition of the major organic fraction of otoliths (Degens et al., 1969) offers another possibility for taxonomic information, however it is unlikely to be useful for specific identification of individuals. Finally, trace element analysis of otoliths (Gauldie et al., 1980; Papadopoulou et al., 1978, 1980) may allow for stock and perhaps species discrimination, but again the small sample sizes offered by larval otoliths impose severe or impossible methodological problems unless x-ray microprobes or ion microscopes are employed. New analytic tools for chemical studies could offer unique insights into fish systematics.

Recently renewed interest in fish otoliths, due primarily to the recognition of daily growth increments (Pannella, 1971, 1980), has resulted in an expanding effort toward collecting, examining and cataloging the otoliths of larval fishes. As we begin to study the external and internal structure of this material for systematically useful characters, we should begin to develop a new set of morphological criteria for species identification, taxonomic relationships, and perhaps phylogenetic reconstruction.

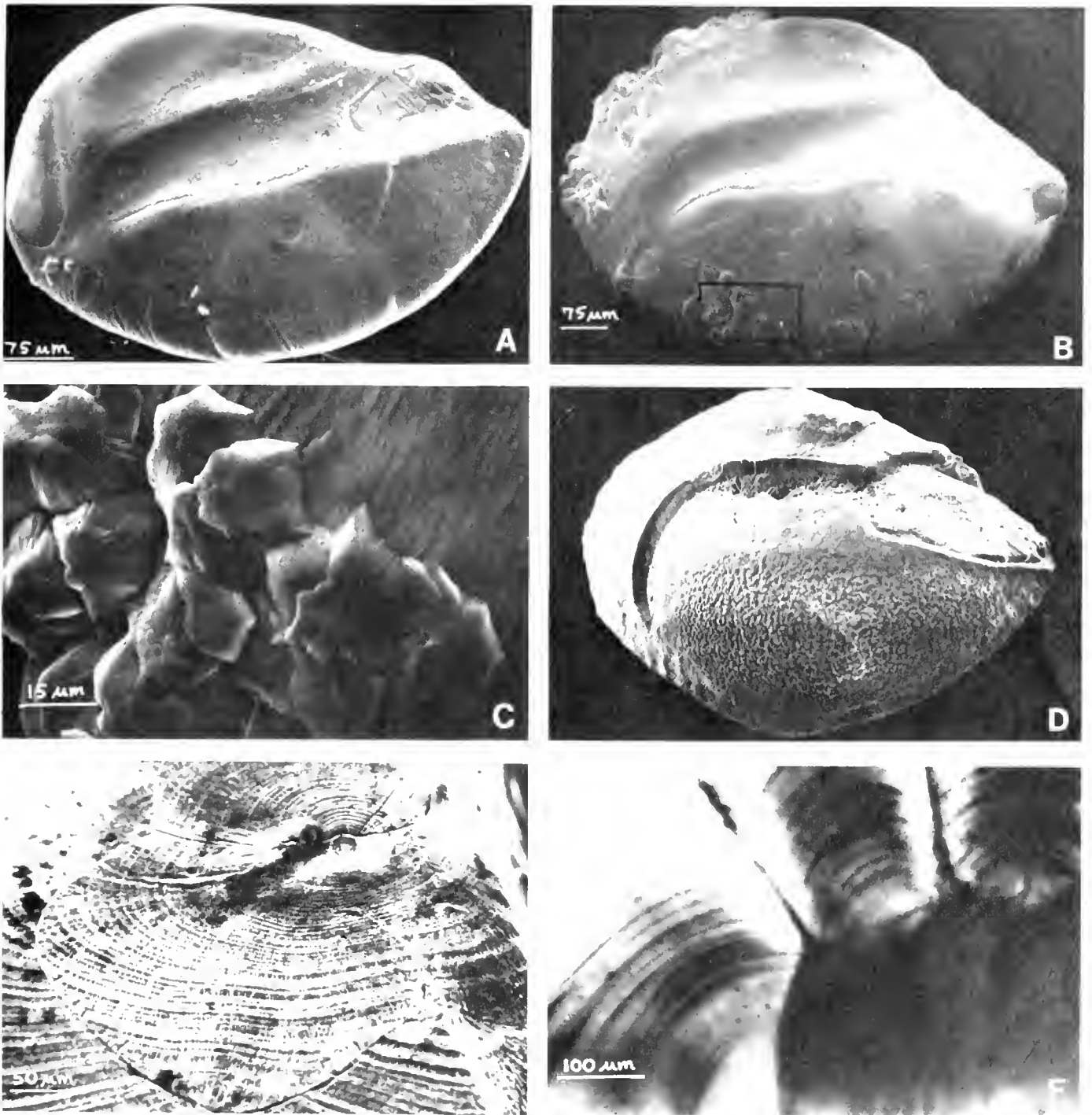

Fig. 21 Abrupt changes in external and internal morphology of the sagitta associated with the end of the larval stage. (A) Scanning electron micrograph of the medial face of the left sagitta (9 mm SL) of a french grunt (*Haemulon flavolineatum*) (B) 12 mm SL, showing development of "secondary growth centers." (C) Enlargement of area in previous specimen. (D) 44 mm SL. Scale omitted: 12 mm = 500 μ m (E) SEM of ground and etched hake (*Merluccius* sp.) sagitta, showing growth centers around the larval otolith. (F) Photomicrograph of ground sagitta of a largemouth bass, *Micropterus salmoides*. The larval portion of the otolith is in the lower right corner

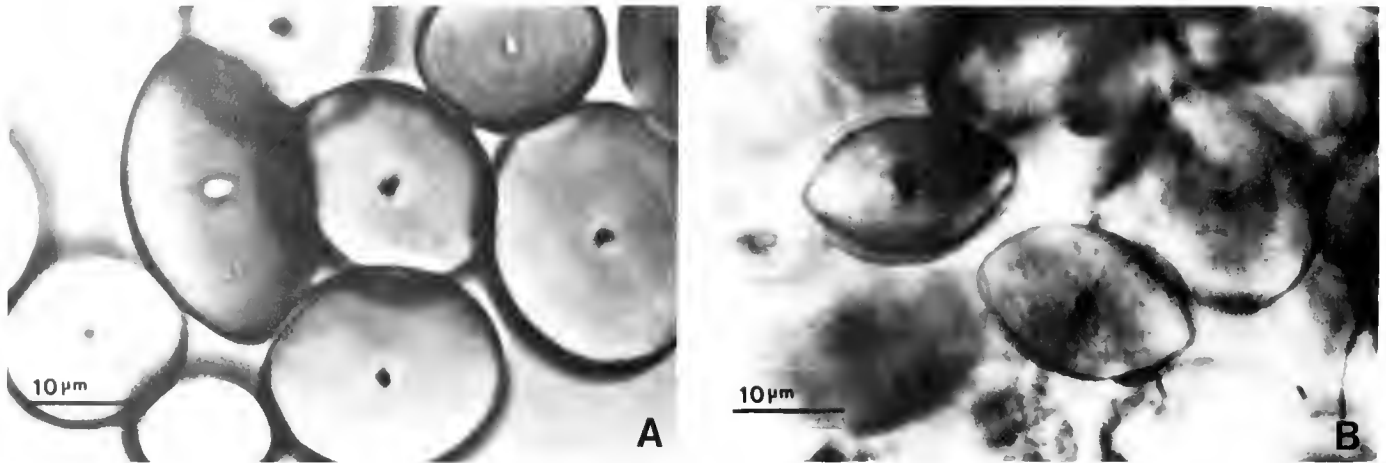

Fig. 22. Photomicrographs of otoconia in teleosts. (A) Bonefish, *Albula vulpes*, free otoconia. (B) Bonefish, otoconia embedded in the sagitta.

GENERAL METHODOLOGY

The otoliths (sagittae, lapilli, and asterisci) of larval fish are usually the first calcified structures to appear in the development of an individual. At least some of the otoliths are frequently evident before hatching. Over the larval life, they vary in size from a few to several hundred micra for different taxa and ages. Because of their composition and small size (high surface to volume ratio), larval otoliths are very sensitive to degradation, decalcification, and dissolution in acidic solutions (McMahon and Tash, 1979), and great care must be exercised in preserving larval fish and otoliths. Improper handling results in rapid and irreversible damage. Fresh larvae are best stored for later otolith extraction in three ways: 1) frozen, 2) fixed and maintained in strong ethanol solutions (preferably 95%), 3) dried (e.g., on glass slides). The last technique is least preferred due to increased difficulties in otolith removal and general damage to the larvae. Removal from embryos and larvae involves microscopic dissection with fine needles. The use of crossed polarized filters is sometimes helpful in locating the otoliths, although they are generally clearly visible in the otocysts or otic capsules with standard transmitted illumination. Dissection is best carried out in water, and opaque larva can be cleared by brief exposure to a weak KOH (1%) solution. Air dried otoliths should be transferred on the tips of oil wetted (immersion) needles, and for light microscopy may be stored in oil on slides or permanently mounted under coverslips with a neutral medium (non-acidic). In the latter case, care must be taken to prevent the otoliths from being cracked or crushed as the mounting medium shrinks and pulls down the coverslip. In most cases larval otoliths are small and thin enough to preclude a need for grinding. Light microscopy is best applied to studies of internal structures, although some external features can be viewed with either surface microscopy or transmitted light and wide openings of the condenser diaphragm. Compound microscopes should have high quality oil immersion optics (preferably to at least 1,000 \times) and polarizing filters. For the latter, a single, rotatable field polarizer helps in resolving internal structures, while an analyzing polarizer can be employed to locate the very small, but highly birefringent otoliths on slides. A moderately high resolution (at least 500 lines) black and white video system is an additional, but invaluable accessory. Such a system reduces eye fatigue, sim-

plifies group viewing, measurement and photography, and most importantly can substantially enhance image quality by electronic adjustment. It is also a necessary component in a variety of automatic and semi-automatic image analysis systems.

Scanning electron microscopy is most useful for high resolution views of external structures, for examination of fine (<1 μ m) internal features, and for confirmation of suspected optical artifacts. However the technique is also more expensive and time consuming and may necessitate critical preparation. Whole, cleaned and air-dried otoliths can be mounted and coated by standard techniques. Internal views require embedding, grinding, polishing and etching before stub mounting and coating. The most recent important development in SEM preparation is the use of etching solutions other than the initially preferred HCl. Haake et al. (in press) summarize a technique for SEM preparation of larval otoliths.

OTOLITH MORPHOLOGY AND EARLY ONTOGENY

There are a number of papers which deal with the general structure and composition (Hickling, 1931; Degens et al., 1969; Blackler, 1974; Pannella, 1980), mechanism of growth (Iric, 1960; Dunkelburger et al., 1980; Campana, 1983), and functions of the otoliths and otolith organs (Popper and Coombs, 1980a,b; Platt and Popper, 1981). This work has not specifically dealt with larvae, however the gross morphology and processes should be comparable with older fishes.

The otic capsule or otocyst forms very early in the ontogeny of fishes and is an obvious landmark in the head of newly hatched larvae. The earliest evidence of the otoliths is one to several small (usually less than 10 μ m) optically dense bodies, referred to here as primordia. From their physical appearance and etching properties, the primordia are assumed to be substantially composed of organic matrix (probably the fibroprotein otolin), and are soon calcified and surrounded by an accreted layer of calcium carbonate and matrix. There are distinct differences between certain taxa, usually at the supraspecific level, with regards to the morphology of the primordia. Distinctions also exist between the sagitta, lapillus, and asteriscus, so comparative studies must be careful to properly identify the otoliths examined. Variation in primordial form involves the size, shape, and number per otolith. Surrounding the primordium (partic-

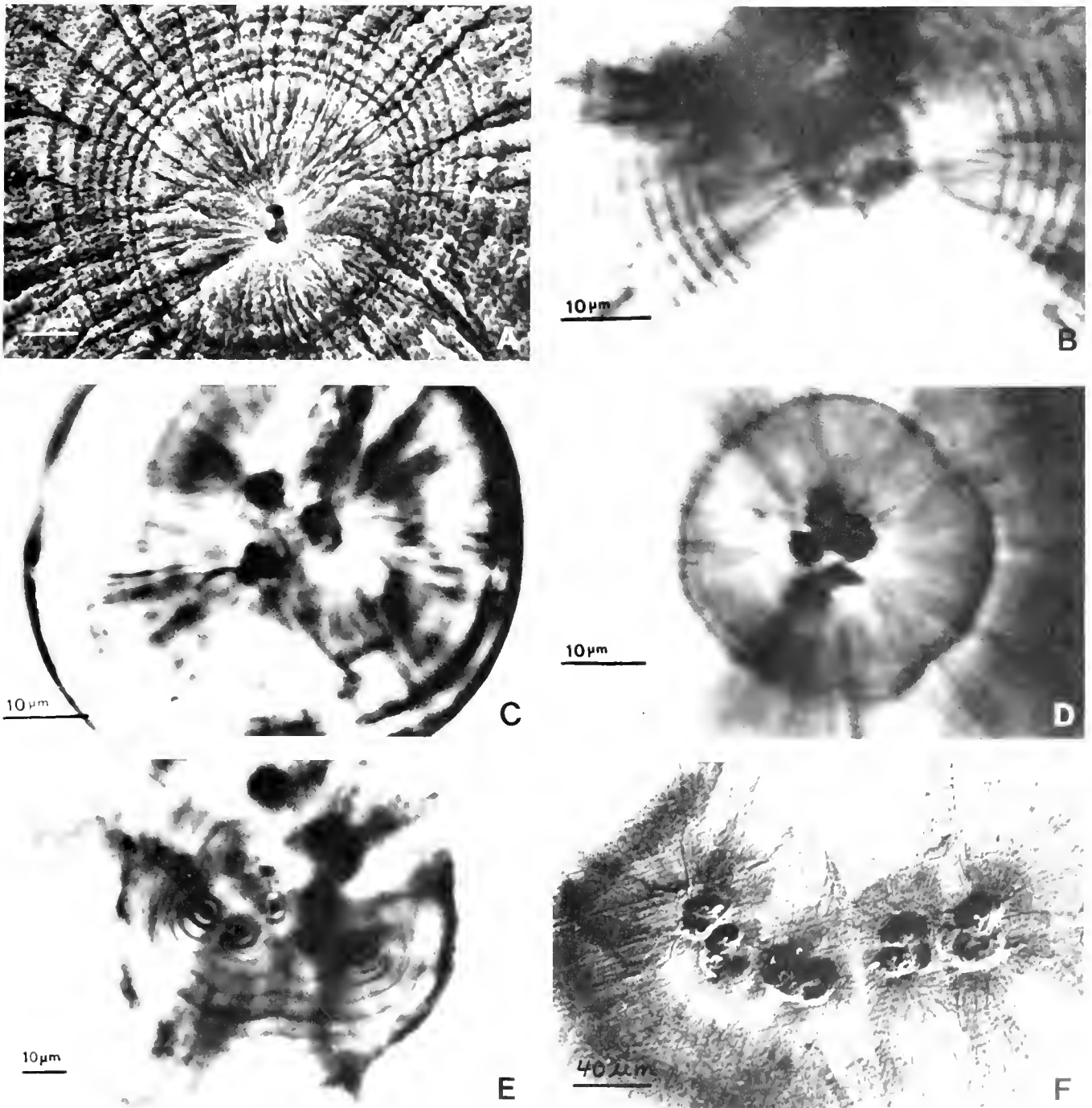

Fig. 23. Otolith primordia and cores. (A) SEM of single primordium and core in a french grunt (*Haemulon flavolineatum*) lapillus. (B) Photomicrograph of single primordium and core in a mimic blenny (*Labrisomus guppyi*) sagitta. (C) Multiple primordia in the lapillus of a white sucker (*Catostomus commersoni*). (D) Multiple primordia in the sagitta of a seahorse (*Hippocampus* sp.). (E) Multiple primordia and cores in the lapillus of a banded killifish (*Fundulus diaphanus*). (F) SEM of multiple primordia and cores in the sagitta of a rainbow trout (*Salmo gairdneri*).

ularly in the sagitta and lapillus) is a discrete, relatively homogeneous zone of calcified material usually delimited by a distinct, thin, optically dense (matrix-rich) layer. This layer defines the boundary of the core. In some cases, careful examination of the core may reveal diffuse, very faint, or extremely

fine growth increments, however, they are easily distinguished from the more distinct incremental growth pattern distal to the core. Taxonomically related differences in core size, shape and number generally parallel differences in the primordia.

The external morphology of larval fish otoliths is much less

TABLE 6. OCCURRENCE OF MULTIPLE PRIMORDIA IN FISH OTOLITHS (SEE TEXT FOR EXPLANATION).

Order Mormyriformes
Mormyridae
Order Salmoniformes
Esocidae
Umbridae
Salmonidae (including Coregoninae)
Osmeridae
Order Cypriniformes
Characidae
Cyprinidae
Catostomidae
Order Siluriformes
Ictaluridae
Bagridae
Order Atheriniformes
Exocoetidae
Oryziatidae
Cyprinodontidae
Belonidae
Anablepidae
Poeciliidae
Atherinidae
Order Syngnathiformes
Gasterosteidae
Syngnathidae
Order Scorpaeniformes
Cyclopteridae (Cyclopterinae and Liparinae)
Order Gobiesociformes
Gobiesocidae
Order Perciformes
Istiophoridae
Stichaeidae
Percichthyidae
Order Pleuronectiformes
Pleuronectidae

variable than seen for adults. Similarity between taxa is greatest in the youngest and smallest individuals, in which the otoliths, particularly the sagittae and lapilli, tend to resemble flattened spheroids or hemispheres. Landmark features used in characterizing adult otoliths such as the form of the sulcus, rostral projections, cristae, colliculi, ostia etc. are initially not evident or weakly developed in most fishes. Exceptions to this generalization may prove to be useful taxonomic characters (e.g., in various istiophorids, the sulcus acousticus is clearly developed in larvae only 6 mm SL). Exaggerated or distinctive morphological features of adult otoliths of some taxa may also begin to develop in the early larval stages. For example, if a species has a markedly elongate sagitta, such as found in some callionymids or fistulariids, then the larval otolith may show a tendency for greater growth along the antero-posterior axis. Unfortunately, such early evidence for adult otolith characters is often not present, particularly for the many species which show an abrupt change in otolith growth patterns at the end of the larval phase. Nevertheless, there are other unique or distinctive larval otolith features in many taxa, and they are potentially valuable for systematic studies.

Aside from shape, there are at least two other "external" otolith characters which may be used for taxonomic work; these involve the relative sizes and times of formation of the different otoliths; the sagittae, lapilli, and asterisci. In certain taxa, such as the Ostariophysi, the sagitta is highly modified from the typical teleost condition, being smaller and very elongate; and the asteriscus is relatively enlarged. In clupeids, the lapillus is unusually small and distinctively shaped. Differences of this sort exist to a lesser degree at lower taxonomic levels and may be used in larvae for distinguishing groups. The time of appearance of the otoliths in development is also a variable feature of fish ontogeny. Many or perhaps most species have sagittae and lapilli at hatching, the former usually noticeably larger even at this stage. There is a general positive relationship between egg size, time to hatching and state of otolith development at hatching. Fishes with very large eggs and corresponding hatching size may also have the asterisci present at this early stage, however for the majority of fishes, these otoliths appear later, and are sometimes not apparent until the end of the larval stage. The asterisci are distinctive in other respects as well; all species I have looked at have a poorly defined core with multiple primordia; the calcium carbonate is deposited as vaterite (Lowenstam and Fitch, 1981) rather than the aragonite of the sagittae and lapilli; and there are qualitative differences in the appearance of growth increments.

Internal structures other than the primordium and core may also have direct or indirect systematic applications. It is well documented that otoliths grow by the addition of layers which are deposited on a diel cycle (see earlier references on larvae, plus review by Pannella, 1980; also Barkman, 1978; Wilson and Larkin, 1980; Steffensen, 1980; Victor, 1982; Victor and Brothers, 1982). These daily growth increments are usually simple bipartite structures composed of one protein-rich and one protein-poor calcareous layer. In certain situations (especially fast growth and large otoliths) subdaily increments (formed over shorter time intervals) of similar structure may also be present. The timing of the production of the defining boundary of the core, which also corresponds to the onset of incremental growth around the core, is another "internal" character that varies between taxa. Some groups start incremental growth before hatching, others at hatching, and still others at about the time of yolk absorption and the onset of exogenous feeding (Brothers et al., 1976; Radtke and Waiwood, 1980; Radtke and Dean, 1982; Radtke, 1984). There appear to be clear taxonomic trends in these characters which are also related to other trends in egg size and developmental rate and pattern.

SOME EXAMPLES OF TAXONOMICALLY RELATED TRENDS IN LARVAL OTOLITH FORM: EXTERNAL MORPHOLOGY

The development of the general form of the adult sagitta is a gradual process in many species, whereas in others there may be one or more relatively abrupt changes in growth form, particularly around the time of transformation from larva to juvenile. This change involves the development of "secondary growth centers" which first appear externally as angular to rounded protuberances on the sagitta surface (Fig. 21; internal structure is discussed below). The result of the expanding growth around these centers is the eventual surrounding of a discrete larval otolith and the stronger development of form and surface characters of the adult sagitta. In examining the otoliths of over

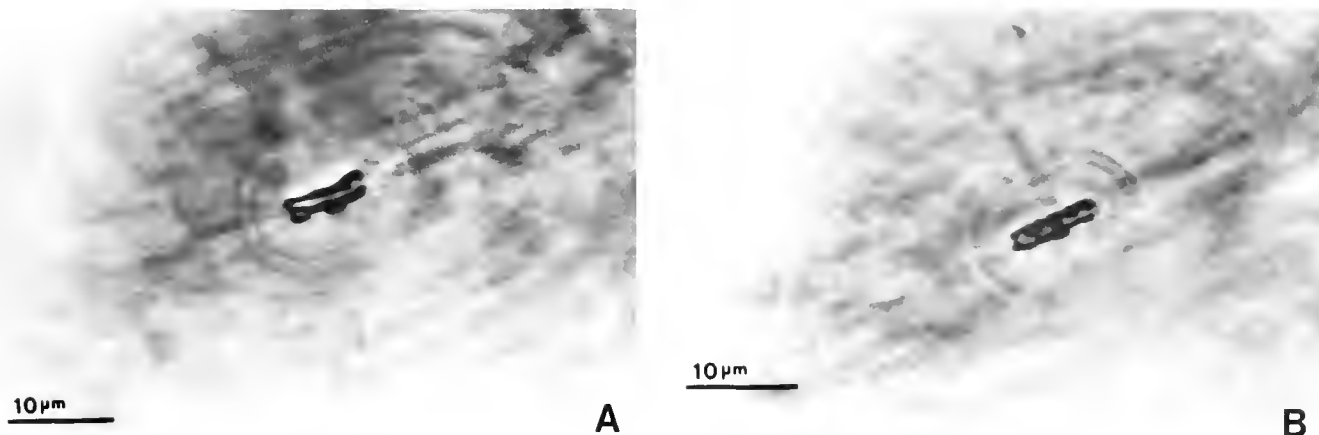

Fig. 24. Primordia and cores of goby otoliths. (A) Sagitta of adult sirajo goby (*Sicydium plumieri*). (B) Sagitta from an unidentified goby larva.

100 families of fishes, this sort of sagittal growth pattern appears to be characteristic in a number of higher level taxa (e.g., many, but not all, perciform families; some myctophids; certain but not all anguilloid families, pleuronectiform, gadiform and scorpaeniform fishes; *Percopsis*, and others). It is not certain whether the presence of this character is consistent enough to be used as a diagnostic feature, and it also occurs too late in development to be of use in larval identification. Lapilli and asterisci tend to show more gradual changes in shape and growth (Brothers and McFarland, 1981) and I have not observed the discontinuous pattern described above. Lapilli undergo transitions in incremental patterns at about the same time that the sagitta changes in growth form (Brothers and McFarland, 1981; Brothers, unpublished), however these are not obviously evidenced in external morphology of the former.

An unusual and surprising character has been found in a preliminary survey of several of the "lower" teleosts. This feature, the presence of otoconia in the sacculus and/or utriculus in addition to the otoliths, has only been noted for non-teleostean bony fishes, i.e., holosteans, chondrosteans, brachiopterygians, dipnoans (Carlstrom, 1963) and probably *Latimeria* (Brothers, unpublished). Osteichthyan otoconia or statoconia are numerous (hundreds to thousands), small (from a few to 100 μm) calcareous bodies (vateritic, sometimes aragonitic) which are found in close association with the otolith (Fig. 22). They generally have a very characteristic lens shape, although some may tend towards an hexagonal outline. Internal features are variously developed; a primordium-like body is usually present and incremental growth is seen in some. Unexpectedly, otoconia were found in representatives of the following teleost families: Albulidae, Congridae, Anguillidae, Muraenidae, Moringuidae, Notopteridae, Osteoglossidae and Pantodontidae. The character appears to be an example of a synplesiomorphy shared between non-teleostean osteichthyans and two teleostean superorders, and Osteoglossomorpha and the Elopomorpha. Not all species and possibly families in the latter two groups show the character, so apparently it has been lost independently more than once. The presence of otoconia is usually not apparent until the early juvenile stage, they are not seen in the few larvae I've had available, however, their taxonomic interest warrants mention here.

INTERNAL MORPHOLOGY

There are a number of taxonomically related trends in the size and shape of the primordium and core of sagittae and lapilli. Table 6 lists all the families (of 113 sampled) found to have representatives with multiple or clustered primordia (inclusion in the table does not necessarily indicate that *all* family members have the character). In some, particularly the salmonids and related families, the primordia are clearly separated and may each be surrounded by discrete multiple cores, whereas in others, such as the Atheriniformes and Gasterosteiformes, the multiple primordia are more tightly grouped and are usually surrounded by a single core (Fig. 23).

Two other primordium and core characters have been found to be unique to certain taxa. In the gobies and related families (15 genera; Gobiidae, Microdesmidae, Eleotridae, and Gobioididae) all species invariably have an elongate primordium in the sagittae and lapilli (usually with a slight central constriction, Fig. 24) which has not been seen in any other group. Since this feature is present at hatching, it allows for rapid and certain identification of these speciose families. The parrotfishes (Scaridae, 4 genera examined) appear to have a family-specific early growth pattern in the sagitta which also allows for the identification of very young larvae. The nearly spherical primordium and core grow asymmetrically for about the first 5 days, adding new increments in a restricted area on the distal face before the growth pattern changes to one producing a hemispherical larval otolith. The result of this pattern (Fig. 25) is that the core is clearly on a different focal plane from a section normal to the majority of larval growth increments. The core is therefore asymmetrically placed nearer to the proximal or internal face of the sagitta. This feature is easily observed in whole larval otoliths and has not been found in related families such as the labrids, although these families share other larval otolith characters.

A second class of internal features has obvious external manifestations described above, although they may be distinguished externally for only a discrete period in development. "Secondary growth centers" appear in optical sections or SEM views as foci for increment formation removed from the core (Fig. 21). Species in which otoconia occur are also found to have these bodies

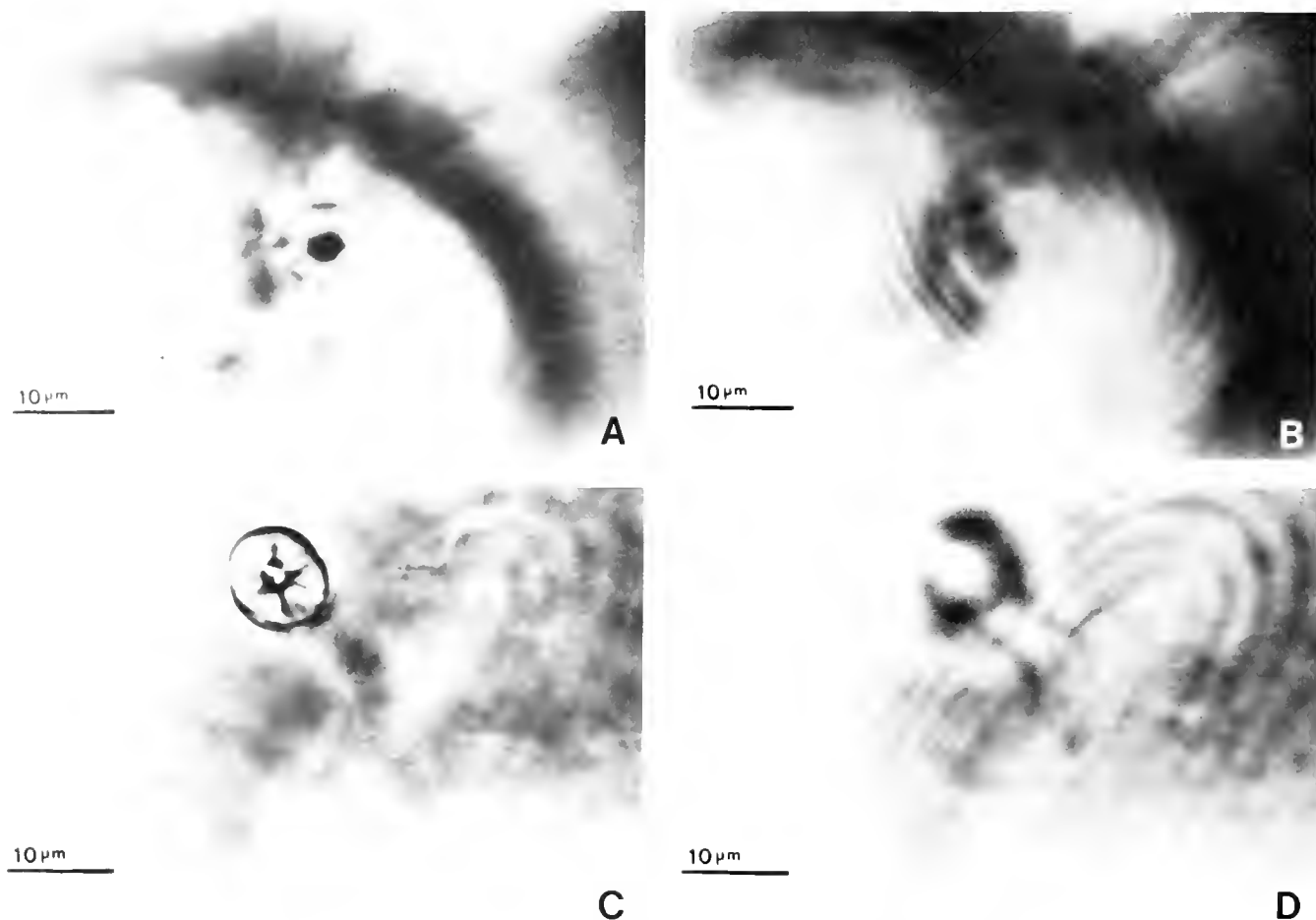

Fig. 25. Primordia and cores of parrotfish sagittae. (A) Unidentified scarid larva, medial face up, core in focus. The dark crescent is a portion of the crista on the surface. (B) Same as previous, but with increments in focus. (C) Suspected scarid larva, core in focus. (D) Same as (C), increments in focus.

incorporated into the otoliths. The mechanism appears to be that the otoconia adhering to the otolith surface are surrounded by new material accreting on the otolith, and eventually these "included" otoconia are found deep within the otoliths of larger fish. In some species, such as *Anguilla rostrata* otoconia are found in dense bands corresponding to annual zones. "Included" otoconia have only been observed in juveniles or older individuals.

Transitions in otolith microstructure involving changes in the width and optical density of growth increments (Fig. 26) may be related to a variety of morphological and eco-behavioral changes in the early life history of fish (Pannella, 1980; Brothers, 1981; Brothers and McFarland, 1981; and numerous other papers; also related works by Postuma, 1974, and McKern et al., 1974). Hatching, yolk absorption, changes in feeding and habitat, postlarval transformation, and settlement can all potentially influence the deposition pattern of daily and subdaily growth increments. To the extent that life history patterns consistently differ between taxa, we may expect to find microstructural evidence of events in the early life history which are of systematic value. Differences between taxa will then be expressed as differences in the timing of marks (e.g., hatching) and otolith tran-

sitions and in their intensity and duration. Thus we may use otoliths to record ecological information which may then be applied to systematic studies. An even simpler approach might just be a quantitative comparison of growth rates as determined from daily growth records (once validated, and the fish growth-otolith growth relationships are known), however care should be taken to avoid problems due to high intraspecific variability in growth rate (e.g., Methot, 1981; Bailey, 1982; Brothers et al., 1984). Another possibility is the use of larval life duration as a taxonomic character. There is evidence to both species specificity and very limited variability in some taxa, as well as variability or flexibility in others (Brothers et al., 1983; Thresher and Brothers, in press; Brothers and Thresher, MS.; Brothers and Erdman, unpublished), so caution must be exercised in using this character as a taxonomic tool.

A final ecologically related application is the determination of spawning time (and perhaps place, by correction for current drift) by age determination of larvae, with correction for the lag between fertilization and increment initiation (Townsend and Graham, 1981; McFarland et al., unpublished). When differences in spawning times are suspected or known to exist for taxa, then larval age may be used to help in assigning identifi-

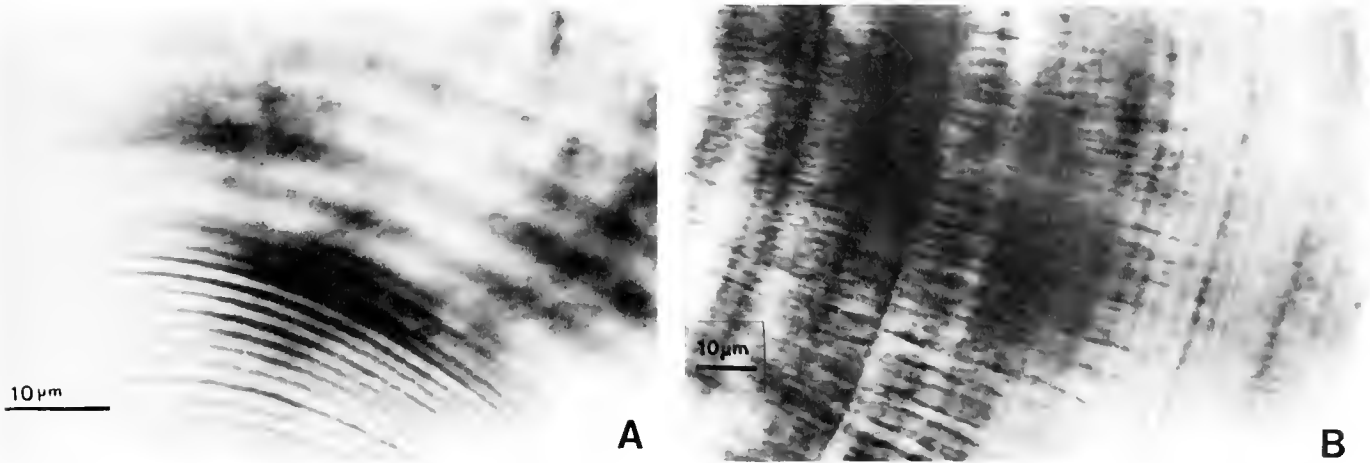

Fig. 26. Transitions in otolith microstructure associated with settlement and transformation from the larval to juvenile stage. (A) Striped parrotfish (*Scarus iserti*) sagitta. (B) Queen angelfish (*Holacanthus ciliaris*) sagitta.

cation. Under the best of circumstances, when spawning is relatively discrete in time, differences of only a few days could potentially be resolved.

The last area in which otolith studies might be of value in systematic studies is in the presentation of descriptive papers on fish development. Until now all illustrations and descriptions of development of wild caught larvae were related to body size since we had no information on the age of these specimens. We suspect, and in some cases have direct knowledge (cited earlier) that growth rates of larvae are moderately to highly variable, yet we have no data on the relationship between age and growth rate and the appearance and form of standard characters such as pigment, ossification, meristics, and morphometrics. Perhaps some of the variability seen in size specific descriptive accounts is the result of the effects of different growth rates on the char-

acters. I urge that we should make an extra effort to determine the age of wild-caught larvae, used in descriptive studies so we may be able to establish age and/or growth rate specific accounts as well as size specific ones. Of course another problem with size is the highly variable shrinkage rates caused by handling and preservation. Alternately we should perform laboratory experiments to examine the relationship between growth rate and developmental rate. In this way we may be able to understand some of the underlying causes for intraspecific variation in larval fish characters.

SECTION OF ECOLOGY AND SYSTEMATICS, CORNELL UNIVERSITY,
ITHACA, NEW YORK 14853. PRESENT ADDRESS: 3 SUNSET
WEST, ITHACA, NEW YORK 14850.

Preservation and Curation

R. J. LAVENBERG, G. E. MCGOWEN AND R. E. WOODSUM

THOSE processes by which we fix or kill living tissues without significantly altering their gross anatomy, and preserve or maintain these tissues on a long-term basis have routinely required the use of formalin solutions (Fink et al., MS; Markle, 1984). This certainly is the case for fish eggs and larvae. The protocols for use of formalin as a fixative and preservative for ichthyoplankton have been reviewed and standardized in several techniques manuals (Ahlstrom, 1976; Castle, 1976; Smith and Richardson, 1977). These protocols are well established and it is not our intention to repeat them here. Rather we wish to elaborate on some of the problems associated with preservation and curation, and to propose recommendations to resolve those areas of real or potential conflict.

There are two areas of special concern to us that dictated how our investigations proceeded. First, we wish to ensure that embryonic pigment is retained in both the egg and larval stages in both the fixation and long-term preservation procedures. Second, for ontogenetic stages of larvae we were guided by a concern for protection of mineralized structures, guarding particularly against their loss.

Specimens that are well-fixed and properly preserved are important not only to ichthyoplanktologists but to a broad spectrum of biologists, fish systematists, and museum curators. Among fixatives, buffers and preservatives there is no unanimous agreement on the most appropriate ones. The problems that plague our understanding of the processes associated with



Fig. 27. A proposed method to archive the early life history stages of fishes. In the left foreground is a series of three vials, the first contains the specimens and preservation fluid and is capped with a polyseal closure. This first vial is placed into the second with the documentation. The third vial is a complete unit. As evaporation occurs the outer vial pops free of its plastic closure, indicating that the vial requires curatorial attention. The vials can be placed together in commercially available paper trays, which can be arranged in commercially available wooden trays much like entomological collections are maintained.

these chemicals and prevent us from standardizing a protocol are not biological ones but rather those of chemistry.

Fixatives.—Formalin generally is accepted as the most appropriate fixative. However, it must be used in a specific concentration, polymerizes with age and with contact with metals, and is a poison. Tucker and Chester (in press) found that formalin used with salt water causes significant shrinkage, whereas an unbuffered 4% solution of formalin mixed with freshwater caused the least amount of shrinkage and distortion during fixation. They found that pigment preserves best in a solution of unbuffered freshwater formalin. Although the pigment holds up well in this solution, the skeleton decalcifies and reduces or may even prevent staining for either bone or cartilage using the methods of Dingerkus and Uhler (1977). In the absence of a suitable,

inexpensive substitute we recommend that formalin be used for fixing zooplankton samples, using the standard ichthyoplankton protocols described by Smith and Richardson (1977). This protocol could be modified so as to use freshwater rather than seawater in preserving the sample (Smith and Richardson, 1977: 16—section 2.1.3.1) so as to reduce shrinkage.

Buffers.—The problems associated with buffers are more difficult to unravel. Buffers have been used in an attempt to control fluctuating pH during fixation and preservation. Buffers are needed to prevent a reduced pH in either the fixative or preservation solution to avoid excessive acidity in formalin that may decalcify bone (Taylor, 1977). However, tissues clear when the buffer makes the solution alkaline. Taylor's (1977) data indicate that pH can fluctuate only in a narrow range without

causing some degree of specimen damage. A pH of less than 6.4 begins the process of decalcification, mineral loss in bone, whereas a pH in excess of 7.0 initiates the clearing process that results in translucency.

Tueker and Chester (in press) recommend that sodium borate not be used as a buffer on the basis that it results in high pH, i.e., loss of pigment may occur. Calcium carbonate also is not recommended because it tends to precipitate out of solution and onto the larvae. Hexamine should not be used at all because it tends to clear specimens independent of pH, and to damage them (Steedman, 1976)

Markle (1984) summarized five years of data for phosphate buffered formalin solutions used as a preservative. He used the standard ichthyoplankton protocol for fixation of his samples. He gives compelling reasons for using a phosphate buffer to control pH of formalin solutions used as a preservative for fish larvae, on the basis that the amount of the buffer can be adjusted to control pH.

A review of the ichthyoplankton protocols indicates that sodium borate (borax) and calcium carbonate (marble chips) are the preferred buffers, although Tueker and Chester (in press) recommend sodium acetate. We wish to stress that our knowledge is inadequate, particularly in understanding the chemistry of these processes. Clearly, a study of the chemistry of fixation and preservation must occur before a recommendation of an acceptable buffer can be made. However, we agree with Markle (1984) that phosphate buffers offer the best alternative to borax and marble chips for long-term preservation on the basis of their versatility in adjusting pH.

Preservatives.—After the fixation process is completed, the zooplankton collections are processed to obtain data on plankton volumes. Then the samples are sorted to remove the ichthyoplankton component, the eggs and larvae of fishes. After the identification, enumeration, and measurements of fish eggs and larvae, they are ready for long-term archival preservation. Through this process the collections are usually maintained in a buffered formalin solution. However, Ahlstrom (1976) indicated that if an investigator was sensitive to formalin then ethanol or a similar preservative was acceptable.

For final long-term archival preservation Ahlstrom (1976) indicated that fish eggs and larvae were separately vialled, and placed in fresh preservative. This fresh preservative was a one percent buffered formalin solution made with freshwater. According to Ahlstrom (1976) the larvae remained in excellent condition for a period of 15–20 years. Tucker and Chester (in press) recommend a long-term preservative consisting of a 4% formalin solution made from distilled water with sodium acetate used as a buffer. Whenever formalin is used as the basis for a long-term preservation fluid for fish eggs and larvae there will be problems of pH. Phosphate buffers apparently control pH best as they are capable of maintaining pH within a narrow range between 6.4 and 7.0. Unfortunately the use of formalin as a final preservative has the potential to incur considerable curatorial expenses just to monitor pH levels.

We recommend that 70% ethanol be used as the final preservation fluid on the basis that it renders the pH problem moot, eliminates working with the fumes of formalin, and eliminates problems associated with the staining process. In recommending ethanol we wish to reduce or eliminate the buffering problems and their associated pH problems in formalin solutions. After fixation, the concentration of formalin can be reduced to a 1%

solution, then this fluid can be drained off during the volume determination process and replaced with ethanol. It is important to transfer the collections directly from the 1% formalin solution into ethanol without washing them through a water bath. Thus a small concentration of formalin fixative will be retained in the ethanol preservative. Also, the transfer should be a staged one through a series of ethanol solutions, from 1% formalin to 20% ethanol to 45% ethanol to 70% ethanol, rather than a direct transfer. Zooplankton collections should be stored in the dark, specifically avoiding light. Also, the storage facility should be as cold as possible, and it should avoid fluctuating temperatures.

In summary, we recommend that formalin be the fixative of record until a suitable alternative can be established. Buffers should be investigated to determine how they affect long-term effects of fixation and preservation. Phosphate buffered formalin is recommended as the most suitable one to control pH within a narrow range to prevent melanistic pigment loss and demineralization. We recommend that ethanol replace formalin as a preservative fluid. Finally, the chemistry of fixation and preservation should be addressed by a chemist to establish a suitable protocol for processing zooplankton samples.

Curation.—The chief problems with storage and curation of larval fish collections are to prevent fluid loss, stabilize collections, and to allow for retrieval availability.

Fluid losses through evaporation in small containers, such as vials, can be disastrous. There are means to reduce evaporation. We propose that a double vialing procedure be established (Fig. 27). First, evaporation may be significantly reduced, and second, a double vialing system provides a mechanism to eliminate abrasion and damage to fish eggs and larvae. The procedure calls for an inner vial containing the specimens and preservation fluid sealed with a poly-seal closure. This vial is inserted into another glass vial, which leaves sufficient space for labels and specimen documentation. The second vial is sealed with a plastic closure. The outer vial is placed upside down over the inner one. The procedure here is to allow gravity to work on vapor evaporating from the inner vial in such a manner that it must be compressed before escaping from the outer vial. Essentially an equilibrium would be achieved that would act to prevent further evaporation. In addition, a means for specimen documentation can be achieved that allows for maximizing these data for curation without causing abrasion or damage to the delicate specimens.

Another important aspect of this curation technique would be its contribution to retrieval availability. The vials can be integrated into an existing ichthyological system so as to make them immediately available to researchers while offering to maximize long-term archival preservation protection.

We would like to thank all of our colleagues who provided us with information relative to the fixation, preservation and curation of the early life history stages of fishes.

On behalf of the steering committee of the Ahlstrom Symposium we would like to recommend that the National Museum of Natural History in Washington, D.C., the Museum of Comparative Zoology (Harvard University), and the Natural History Museum of Los Angeles County in Los Angeles be considered for the deposition of the early life history stages of fishes for long-term archival care.

SECTION OF FISHES, NATURAL HISTORY MUSEUM OF LOS ANGELES COUNTY, 900 EXPOSITION BOULEVARD, LOS ANGELES, CALIFORNIA 90007.

DEVELOPMENT AND RELATIONSHIPS

Elopiformes: Development

W. J. RICHARDS

THE Elopiformes comprises four genera of recent fishes and each of these genera is composed of at least two species. The species are found in tropical waters of the Atlantic, Indian and Pacific oceans. *Elops*, a cosmopolitan genus, is composed of several species and *Megalops* is composed of two species. *M. atlantica* Valenciennes is found in both the eastern and western Atlantic and *M. cyprinoides* (Broussonet) is found in the Indian and western Pacific Oceans. *Albula* has two recognized species. *A. vulpes* is cosmopolitan and *A. nemoptera* is found on the Atlantic and Pacific coasts of the Americas. Recent electrophoretic work indicates that there may be additional species (Shaklee and Tamaru, 1981). *Pterothrissus* has one species along the coast of West Africa, *P. belloci* Cadenat, and one off Japan, *P. gissu* Hilgendorf.

Larval stages of elopiform fishes have attracted great interest among ichthyologists because of their unusual leptocephalus development, a stage found in no other group but the Anguilliformes and Notacanthiformes. Consequently most recent classifications have combined all fish with leptocephalus larvae into the Elopomorpha (Patterson and Rosen, 1977). Forked tails of the elopiform leptocephali provide an easy means of separating them from other leptocephali which have reduced or no tails at all. The non-fork tailed leptocephali are treated separately in the three subsequent papers in this volume.

Recent classifications have altered our classical view of elopiform fishes by suggesting a much closer relationship with eels. Greenwood et al. (1966) included all fishes with leptocephalus larvae in the superorder (Elopomorpha). This superorder contained: Elopiformes with two suborders, the Elopoidei (Elopidae and Megalopidae) and the Albuloidei (Albulidae including Pterothrissidae); Anguilliformes with two suborders, the Anguilloidei and Saccopharyngoidei; and Notacanthiformes with two families (Notacanthidae and Halosauridae). A number of papers have discussed this proposed classification and a majority has sustained the opinion that the Elopomorpha is a monophyletic assemblage. Forey (1973a) discussed the intragroup relationships and made some interesting observations on leptocephali in a second paper (1973b). Two significant classifications appeared in 1977, one by Greenwood and one by Patterson and Rosen. Both classifications concluded that Elopomorpha is a natural, monophyletic group and that *Albula* and *Pterothrissus* are related to the Halosauridae and Notacanthidae. Greenwood (1977) presented a concept of Elopomorpha as a Cohort Taeniopaedia with two superorders: Elopomorpha comprised of *Elops* and *Megalops* in the Order Elopiformes (Suborder Elopoidei) and Anguillomorpha comprised of two orders, the Albuliformes with two suborders (Albuloidei and Halosauroidae) and the Anguilliformes. Patterson and Rosen (1977) defined a cohort Elopomorpha of three orders: Elopiformes, Megalopiformes and Anguilliformes, the latter with two suborders—the Anguilloidei and Albuloidei. Patterson and Rosen (1977) con-

cluded that the interrelationships of the Elopidae, Megalopidae and Anguilliformes are best represented by an unresolved trichotomy. However, it would seem that those with forked tails would be monophyletic and the reduced or tailless leptocephali would be derived from those with tails. The trichotomy scheme results in paraphyletic forked tailed forms.

With the exception of the species of *Pterothrissus*, the species of the remaining genera are coastal with some stages entering hyposaline environments. *Pterothrissus belloci* occurs benthically from 70 to 500 m, most abundantly from 120 to 250 m, off the coast of West Africa from 9°N latitude to 20°S latitude (Poll, 1953). All elopiforms are presumed to have pelagic eggs although the eggs of all are undescribed. According to Smith and Potthoff (1975) the eggs and early larvae of *Harengula jaguana* were erroneously attributed to *Megalops atlanticus* by Breder (1944), Mansueti and Hardy (1967), and Mercado and Ciardelli (1972).

The larval stages have been well described for all genera and are unique (Fig. 28). The larval stage is represented by the leptocephalus which has been defined by Hulet (1978) and Smith (1979). The leptocephalus is compressed, transparent and leaf-like with a mucinous pouch which distinguishes it from all other fish larvae. It grows to large size compared to other fish larvae, it has fang-like teeth at the early stages which are subsequently lost (possibly reabsorbed), its viscera is confined to a narrow strand along the ventral midline, its musculature forms a thin layer outside of the mucinous pouch and the remainder of the pouch consists of a mass of acellular material composed of mucoproteins and polysaccharides enclosed by a continuous layer of epithelial cells. Its gut is in two sections, an esophagus and an intestine which are separated by a gastric region composed of the stomach, liver and gallbladder. The kidney, of various lengths, lies over the gut beginning near the gastric region and continuing posteriorly. Ventral blood vessels conspicuously appear between the aorta and the kidney and gut. In elopiform leptocephali dorsal, anal, pectoral and pelvic fins are present and the caudal fin is large and forked.

Genera of elopiform leptocephali are easily identified except at small sizes prior to caudal development when myomeres are difficult to count. The number of myomeres for elopiforms ranges from 51 to 92 whereas most anguilliform leptocephali have more than 95. Leptocephali of the Cyemidae have 80 myomeres. Smith (1979) provides a key, characterizations and illustrations of the genera. Many other workers have described complete series or individual stages. Complete series of *Elops* have been described by Gehringer (1959a), *Megalops* by Wade (1962), *Albula* by Alexander (1961), and *Pterothrissus* by Matsubara (1942). Among other papers which describe and illustrate various stages are: of *Megalops* by Delsman (1926b), Mercado and Ciardelli (1972), Gehringer (1959b), Eldred (1967b, 1972) and Richards (1969); of *Pterothrissus* by Smith (1966b) and Rich-



Fig. 28. Elopiform leptocephali. Top to bottom: *Elops* sp., 33.8 mm SL, Luanda, Angola (redrawn from Richards, 1969); *Megalops atlanticus*, 22.8 mm SL, Luanda, Angola (redrawn from Richards, 1969); *Pterothrissus bellocci*, 123.9 mm SL, off Angola (redrawn from Richards, 1969); and *Albula vulpes*, 64.2 mm (redrawn from Alexander, 1961).

ards (1969); of *Elops* by Hildebrand (1963a), Eldred and Lyons (1966), Gomez Gaspar (1981), Richards (1969); and of *Albula* by Eldred (1967a), Poll (1953), Gomez Gaspar (1981) and Hildebrand (1963b). The *Albula* leptocephali heads illustrated by Meyer-Rochow (1974) may be incorrect.

The characters used for distinguishing the families and genera (following Smith, 1979) are as follows: *Albula* and *Pterothrissus* leptocephali have the origin of the anal fin well behind the dorsal fin by a distance exceeding the length of the anal fin base whereas *Elops* and *Megalops* have the origin under the dorsal fin or close

TABLE 7. MERISTIC CHARACTERS FOR SELECTED ELOPIFORM LEPTOCEPHALI.

Taxon	Source	Dorsal rays	Number of anal rays	Myomeres
<i>Elops</i>				
<i>saurus</i>	Gehring (1959a)	21-26 usually 22-24	12-15 usually 13-14	78-82 usually 79-80
spp.	Richards (1969)	20	15-17	70-73
<i>Megalops</i>				
<i>atlantica</i>	Wade (1962)	9-13 usually 12	16-22 usually 19-21	51-57
<i>cyprinoides</i>	Wade (1962)	10-17 usually 12-17	18-25 usually 23-25	59-68 usually 62-67
<i>Albula</i>				
<i>vulpes</i>	Alexander (1961)	16	7	65-70 usually 67-68
<i>nemoptera</i>	Rivas (1967)	—	—	69-74
<i>Pterothrissus</i>				
<i>bellocci</i>	Richards (1969)	51-56	10-13	85-92

behind it, by a distance not exceeding the length of the anal fin base. *Elops* and *Megalops* leptocephali have lateral pigment but *Albula* and *Pterothrissus* leptocephali do not have lateral pigment. *Elops* is distinguished from *Megalops* by having a depressed head, more dorsal than anal rays and the origin of the anal fin is under the posterior end of the dorsal fin or slightly behind it. *Megalops* does not have a depressed head, has fewer dorsal rays than anal rays and the origin of the anal fin is under the middle of the dorsal fin. *Albula* leptocephali are separable from *Pterothrissus* leptocephali by the distance between the posterior end of the dorsal fin and the origin of the anal fin. In

Albula this distance is about 2.5 times the length of the dorsal fin base and in *Pterothrissus* this distance is about 6–7 times the length of the dorsal fin base. Also the snout is short in *Albula* and prolonged in *Pterothrissus*. Within genera, meristic characters are useful in identification of the species (Table 7).

The interrelationships of the elopiform fishes are discussed by Smith in a subsequent paper in this volume.

NATIONAL MARINE FISHERIES SERVICE, SOUTHEAST FISHERIES CENTER, 75 VIRGINIA BEACH DRIVE, MIAMI, FLORIDA 33149.

Notacanthiformes and Anguilliformes: Development

P. H. J. CASTLE

THE Notacanthiformes (spiny eels) and Anguilliformes (true eels) were united with the Elopiformes (tenpounders, tarpons, bonefishes) by Greenwood et al. (1966) as the superorder Elopomorpha. These authors noted that members of the three orders share osteological similarities, swim bladder not connected with ear (except for *Megalops*), and a distinctive larval phase (leptocephalus). More recent authors (Nelson, 1973; Forey, 1973b; Patterson and Rosen, 1977) recognised this relationship, though not precisely in this form. There seems little doubt that they are indeed closely related, but in being exclusively elongate fishes the notacanth and eels are readily distinguished externally from the short-bodied, herring-like Elopiformes.

NOTACANTIFORMES

McDowell (1973) reviewed the notacanth, a morphologically discrete group of fishes, found on or near the bottom on the deeper continental slope into the deep sea, recognising 2 suborders, 3 families, 6 genera and 22 extant species (Table 8). He chose to give subordinal distinction to the Halosauridae on the one hand, and the Notacanthidae and Lipogenyidae jointly on the other, although Marshall (1962) had already demonstrated major structural similarities between these families.

The Notacanthiformes have in common with the Anguilliformes a leptocephalus phase, an elongate body form, the associated lengthening of the anal fin, and a reduced caudal fin. Members of the two orders are otherwise dissimilar. Notacanth has well developed pelvic fins; a compact, dorsal fin with spines in some species; scales present and prominent in some; and a large gill opening and opercular flap. Eels lack pelvic fins; the dorsal, unless secondarily reduced or lost, is always long and is supported by delicate rays; scales, if present, are greatly reduced; and the gill opening and its supporting structures are also reduced. Furthermore, notacanth leptocephali are as distinctive from those of the true eels as are their adults (Fig. 29). They are greatly elongate (up to 180 cm), having a thin post-caudal filament in place of a normal caudal fin; dorsal and pelvic fins are represented by compact, short-based structures present at some stage of larval growth; there is a minute pectoral, straight gut, subterminal anus and the myomeres are V-shaped, not W-shaped;

pigment occurs in a ventral series and (rarely) below the mid-lateral level.

Several quite different notacanth leptocephali of this type are known, some almost certainly halosaurids (*Tiluroopsis*, *Leptocephalus attenuatus*), some possibly notacanthids (*Tilurus*) and others of unknown identity (*Leptocephalus giganteus*). Eggs and early larvae have not yet been identified and information on vertebral numbers is mostly lacking for the group. Until confirmed identifications have been made and more information is forthcoming from leptocephali, ontogeny is unlikely to contribute further to the little that is known of relationships in this order.

ANGUILLIFORMES

The Anguilliformes make up a much larger and more diverse assemblage. I recognize 21 families, 153 genera and 720 species for the group (Table 9).

Within the Anguilliformes itself, Böhlke (1966) reviewed the

TABLE 8. COMPOSITION, DISTRIBUTION AND HABITAT OF THE NOTACANTIFORMES. + = All or most species; (+) = some species only.

	Halosauridae	Notacanthidae	Lipogenyidae
Taxonomic components:			
Known genera (adults)	3	2	1
Known genera (larvae)	?1	?1	0
Known species (adults)	13	8	1
Distribution:			
Atlantic: Genera	3	2	1
Species	7	3	1
E. Pacific: Genera	1	1	0
Species	2	1	0
I.-W. Pacific: Genera	2	2	0
Species	5	4	0
Habitat (species):			
Shelf		(+)	
Slope	(+)	(+)	+
Abysal	(+)	(+)	

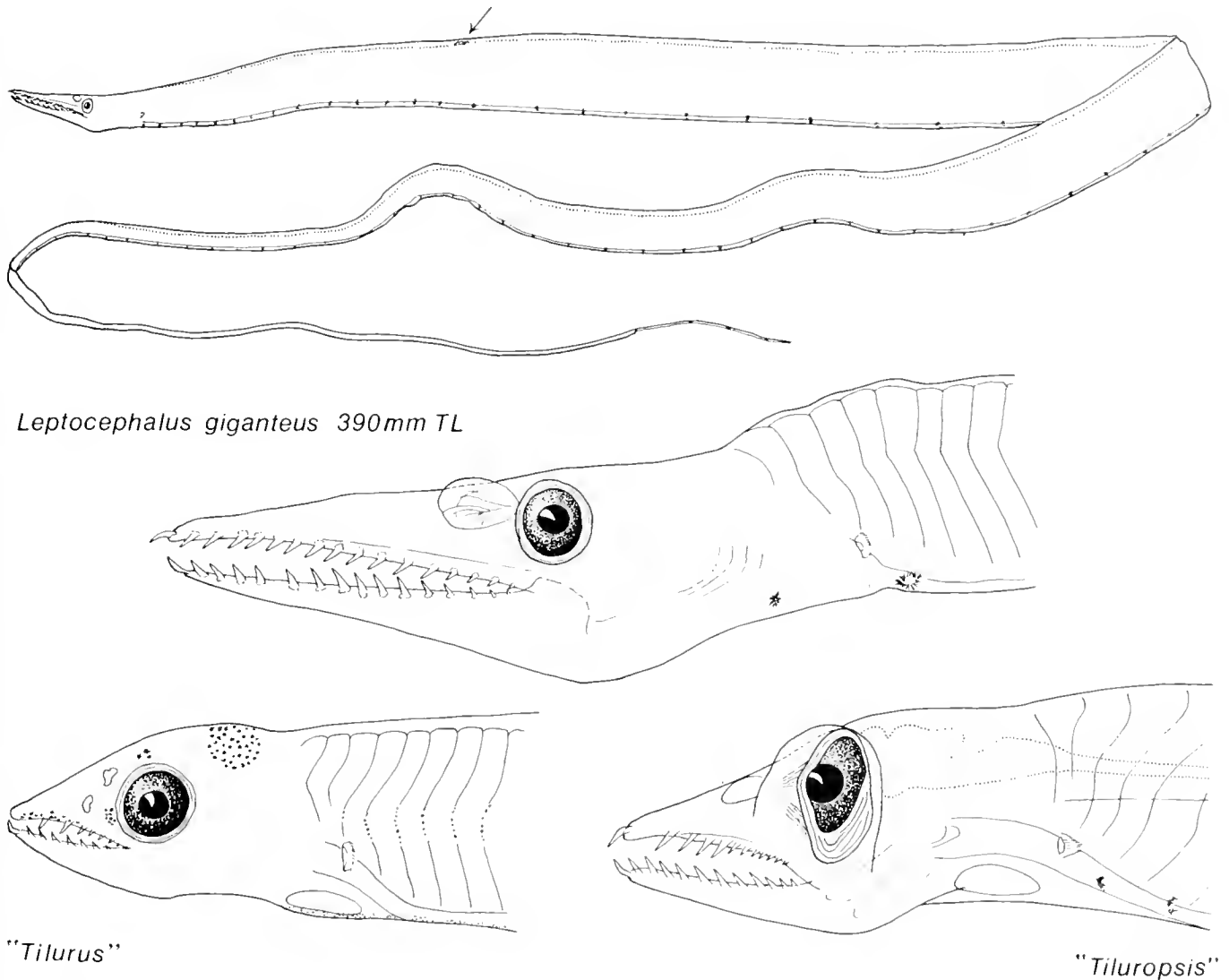

Fig. 29. The three major forms of notacanth leptocephali showing in upper two the elongate snout, distinct dorsal (arrow), and ventral melanophore series; in lower left the myoseptal pigment; and in lower right the oval eye.

superfamily Saccopharyngoidea (gulpers), a small group of 3 families, 4 genera and 8 species of highly modified mid-water, oceanic eels, unmistakable in body form and possessing a leptocephalus of distinctive type. Although they are currently accepted to be true eels, they are so highly aberrant in form and osteology that a case could be made for their retention in a separate suborder, as indeed was proposed by Greenwood et al. (1966). Other eel families have been studied in some detail, notably the Congridae (Smith, 1971), Synphobranchioidea (Robins and Robins, 1976), Ophichthidae (McCosker, 1977), Nemichthyidae (Nielsen and Smith, 1978) and others, but there are several major gaps and the order has never been comprehensively reviewed.

With some exceptions, the families and genera of eels occur worldwide (Table 9) while eel species have a more restricted distribution in one or other of the major oceans. Some mesopelagic, slope/abyssal species and just a few shelf species are

known from both Indo-west Pacific and Atlantic. As for many other teleosts, the Indo-west Pacific is richest in genera and species, despite relatively limited collecting there, and information is scattered (Alcock, 1889 *et sequ.*; Fowler, 1934; Asano, 1962; Karrer, 1982). The eel fauna of the Atlantic is rather better known (Blache, 1977; Böhlke, 1978) but by comparison the group is rather poorly represented in the East Pacific.

Characters.—The families and genera of Anguilliformes are distinguished principally by external characters, including morphometrics (Table 10) but the limits are not yet firmly established for all families in the order. Osteological characters, which mostly reflect these external modifications are also of value at family and generic levels (Table 11) but are inadequately known, especially in the Congridae and related families, and the Muraenidae. Too few genera have been identified in their larval form for ontogenetic characters to have been used extensively

TABLE 9. COMPOSITION, DISTRIBUTION AND HABITAT OF THE ANGUILLIFORMES. + = All or most species; (+) = some species only.

	Synapho- branchi- dae	Dysom- matidae	Simen- chelyidae	Ophich- thi- dae	Con- gridae	Muraene- socidae	Netta- stomati- dae	Colo- congridae	Derich- thyi- dae	Serrivo- meridae	Anguil- lidae	Moring- uidae	Heter- enchelyi- dae
Taxonomic components:													
Known genera (adults)	3	9	1	55	28	9	6	1	2	3	1	2	2
Known genera (larvae)	1	2	0	25	15	4	5	1	2	3	1	2	2
Known species (adults)	7	16	1	250	131	16	32	4	3	12	15	13	8
Distribution:													
Atlantic: Genera	3	5	1	29	17	2	6	1	2	2	1	2	2
Species	7	6	1	73	32	5	13	2	3	6	2	2	7
E. Pacific: Genera	0	1	0	17	10	2	3	0	1	1	0	1	1
Species	0	2	0	39	12	2	3	0	1	1	0	1	1
I.-W. Pacific: Genera	4	6	1	35	24	7	6	1	2	2	1	1	0
Species	8	8	1	137	63	9	8	2	3	6	13	10	0
Habitat (species):													
Freshwater				(+)							+	(+)	(+)
Shelf: Tropical				+	+	+	(+)					+	+
Temperate				(+)	(+)		(+)						
Slope/abyssal	+	+	+	(+)	(+)	(+)	+	+	(+)				
Pelagic				(+)					(+)	+			

in determining relationships. Eel species are principally distinguished externally, by teeth and cephalic pore patterns and by meristics, especially the number of vertebrae. The latter reflects the number of myomeres in the leptocephali.

Many of the adult characters by which the families and genera differ from one another appear to be correlated with the extent to which the rather sedentary mode of life associated with burrowing, crevice-dwelling or pelagic habits has been elaborated throughout the group. In most families of eels there are species in which the body is very slender, with vertebrae numbering 180 or more (Table 10). The pectoral fins are reduced or lost variously in families (Muraenidae, Heterenchelyidae), genera (Ophichthidae, Xencongridae), or even within the life span of

individuals (*Moringua*). The median fins may also be reduced to vestiges either in height or in length by a posteriorwards shift of their origin, or they may be entirely lost, though pterygiophores can be retained. Scales occur only in some of the synaphobranchoids and in the Anguillidae.

Other characters are not so clearly associated with the adoption of fossorial, cryptic or pelagic habits. These include the ventral displacement of the gill openings (the extreme development being in some Synaphobranchidae and a few Ophichthidae where they are confluent ventrally); the ventral displacement of the posterior nostril (most Ophichthidae, Xencongridae, to some extent the Synaphobranchidae) so that it may even open within the mouth; or its dorsal displacement (Muraenidae),

TABLE 10. SOME MORPHOLOGICAL CHARACTERS OF THE ANGUILLIFORMES. + = All or most species; (+) = some species only; * = presumed primitive condition.

	Synapho- branchi- dae	Dysom- matidae	Simen- chelyidae	Ophichthi- dae	Con- gridae	Muraene- socidae	Netta- stomati- dae	Colo- congridae	Derich- thyidae	
Vertebrae: Min.*	126	107	121	110	105	120	186	148	126	
Max.	172	204	125	270	225	261	290	163	159	
Scales: Present*	+	(+)	+							
Absent	(+)	+		+	+	+	+	+	+	
Pectoral: Present*	+	+	+	(+)	+	+				
Reduced	(+)	(+)		(+)	(+)		(+)	+	+	
Absent		(+)		(+)	(+)	(+)	+			
Caudal: Present*	+	+	+		+	+	+	+	+	
Reduced				(+)	(+)					
Absent				+						
Dorsal origin:										
Over pectoral/gill opening*	+	+	+	+	+	+	+	+	+	
Between pectoral and anus				(+)					+	
Over or behind anus				(+)						
Gill openings: Lateral*										
Displaced ventrally	+	+	+	(+)					+	
Posterior nostril: Before eye*				+		+		+	+	
Displaced dorsally						(+)	(+)			
Displaced ventrally	+	+	+	+	(+)		(+)			
Lateral line: Complete*										
Incomplete		+						+	+	

TABLE 11. SOME OSTEOLOGICAL CHARACTERS OF THE ANGUILLIFORMES. + = All or most species; (+) = some species; * = presumed primitive condition.

	Synaphobranchidae	Dysommataidae	Simenichelyidae	Ophichthidae	Congridae	Muraenocidae	Nettastomatidae	Colocongridae	Derichthyidae
Frontals: Separate*									
Fused	+	+	+	+	+	+	+	+	+
Pterygoid: Present*			+		+		+		+
Reduced	+	(+)		+		+	(+)		
Absent		(+)							
Hyomandibula: Forward*			+		+	+	+	+	+
Vertical	(+)	(+)		(+)					
Backward	+	+		+					
Lateral line ossifications:									
Present				+	+	+	+		
Absent*	+	+	+					+	+
Gill arches:									
More or less complete*	+		+	(+)	+	+	+		(+)
Variously reduced		+			(+)				(+)

because only a few species have been studied from just six families. Major characters of eggs of these families are collated in Table 12, which also includes selected references. Eggs and earliest larvae of *Ophichthus cruentifer* are illustrated as an example in Fig. 30.

Eel eggs are large; the chorion is thin and clear, but may have minute chromatophores; the perivitelline space is wide; the yolk makes up about one half of the egg diameter and is segmented, with or without chromatophores. Oil globules are usually present (absent in Muraenidae and Nettastomatidae) but the number and size may vary during development. Development takes around 4 days at about 20 C in *Gnathopis mystax* (Thom-

poulos, 1956) and in *O. cruentifer* (Naplin and Obenchain, 1980) but may be several days longer. The yolk reduces in size and the embryo reaches a hatching length of about 4.5–5.5 mm, coiling once or more around the yolk. While the late embryo may possess conspicuous melanophores and segmentation, the definitive number of myomeres and the characteristic pigmentation of the larvae, if any, are not usually fully established until after hatching.

Leptocephali.—The yolk-sac larva ("preleptocephalus" or enygodontic stage) which is liberated from the egg is characteristically elongate, with a tear-drop shaped to elongate yolk. It

TABLE 12. CHARACTERS OF ANGUILLIFORM EGGS.

Character	Family							
	1							2
	<i>Ophichthus cruentifer</i>	<i>Ophichthus remicaudus</i>	<i>Dalophis umberbis</i>	<i>Apterichtus caecus</i>	<i>Ophisurus serpens</i>	<i>Echelus myrus</i>	Ophichthid (unident.)	<i>Facciolella oxyrhyncha</i>
Diameter of chorion: Min.	1.62	2.10	2.20	3.00	3.04	3.04	3.40	2.96
Max.	2.89	2.40	2.40	3.60	4.00	3.80	3.68	3.24
Diameter of yolk: Min.		1.32	1.32	1.68	2.10	1.60	1.32	1.48
Max.	1.60	1.60	1.60	1.92	2.20	1.85	1.80	1.84
Oil globule(s): Absent								+
Present	+	+	+	+	+	+	+	
Number Min.	1	6	1	3	11	1		
Max.	1	22	4	40	28	1	11	
Size Min.	0.26				0.08	0.32		
Max.	0.65				0.16	0.36	0.36	
Pigment of embryo:								
Present on caudal			+	+		+	+	+
Present on gut			+	+		+	+	+
Present on spinal cord								
Chorion smooth:	+	+	+	+	+	+	+	+
Yolk segmented:	+	+	+	+	+	+	+	+
Reference	a	b	b	c	d	e	f	g
Families represented:	References:		a—Naplin and Obenchain, 1980			h—Sparta, 1942a		
1 Ophichthidae			b—Sparta, 1937			i—Sparta, 1939d		
2 Nettastomatidae			c—Sparta, 1938a			j—Sparta, 1939b		
3 Xenocongridae			d—Sparta, 1939c			k—Sparta, 1938b		
4 Congridae			e—Sparta, 1940a			l—Castle and Robertson, 1974		
5 Muraenidae			f—Sparta, 1940b			m—Marinaro, 1971		
6 Anguillidae			g—Sanzo, 1938a			n—Eldred, 1969		
						o—Yevseyenko, 1974		

TABLE 11. EXTENDED.

Serrivomeridae	Anguillidae	Moringidae	Heterenchelyidae	Muraenidae	Myrocongridae	Xencongridae	Nemichthyidae	Cyematidae	Saccopharyngidae	Eurypharyngidae	Monognathidae
+	+	+	+	+	+	+	+	+	+	+	+
+	+	+	+	+	+	+	+	+	+	+	+
+	+	+	+	+	+	+	+	+	+	+	+
+	+	+	+	+	+	+	+	+	+	+	+
+	+	+	+	+	+	+	+	+	+	+	+
+	+	+	+	+	+	+	+	+	+	+	+
+	+	+	+	+	+	+	+	+	+	+	+

somewhat resembles later stages but the development of larval characters is progressive. There may be substantial differences in pigmentation between this stage and the fully grown leptocephalus (e.g., the congrid *Ariosoma*, Table 17 E₁, M₂, O and Fig. 37); typically the pigmentation pattern is much less complex. The engyodontic stage has few, needle-like teeth, lower jaws equal to, or longer than upper, an unformed nasal capsule, and undifferentiated median fin-folds and hypurals.

At about 20 mm TL the leptocephalus then enters the euryodontic stage which lasts until metamorphosis. It begins with shedding of the engyodontic teeth and their replacement by 3 series (usually) of shorter, broad-based teeth, the lower jaw

shortens relative to the upper, the head decreases in relative length, and the fins and hypurals differentiate. At this stage leptocephali are highly distinctive and well-known forms amongst fish larvae. At full growth they are typically around 50–80 mm but may attain 300–400 mm (Nemichthyidae) or 1,800 mm (Notacanthiformes). They are almost transparent except for eye and other pigmentation and the blood lacks erythrocytes and haemoglobin. The body is greatly compressed and leaf-shaped or filamentous, typically with a small head, prominent, forwardly-directed larval teeth and a posteriorly placed anus. The electrolyte make-up of their body fluids differs markedly from that of postmetamorphic forms (Hulet, 1978).

TABLE 12. EXTENDED.

Family									
2	3	4			5		6		
<i>Nettastoma melanurum</i>	<i>Chlopsis bicolor</i>	<i>Conger conger?</i>	<i>Ariosoma balearicum</i>	<i>Gnathopis sp.</i>	<i>Gnathopis mystax</i>	<i>Muraena helena</i>	<i>Gymnothorax unicolor</i>	<i>G. nigromarginatus</i>	<i>Anguilla anguilla?</i>
2.40	2.72		1.80	2.93	2.50	5.0	2.3	3.3	2.3
3.00	3.04	2.60	1.92	3.43	3.00	5.5	3.4	4.0	2.9
1.44	1.40		1.00	1.25	1.50			1.5	1.3
1.48	1.48	1.7	1.04	1.50	1.85			2.0	1.6
+					+	+	+	+	
	+	+	+	+					+
	13	1	1	1					1
	0.04		5	9					2
	0.08	0.40	0.30	0.03					0.31
				0.10					0.42
			+						
			+						
+	+	+	+	+	+	+	+	+	+
+	+	+	+	+	+	+	+	+	+
h	i	j	k	l	m	m	m	n	o

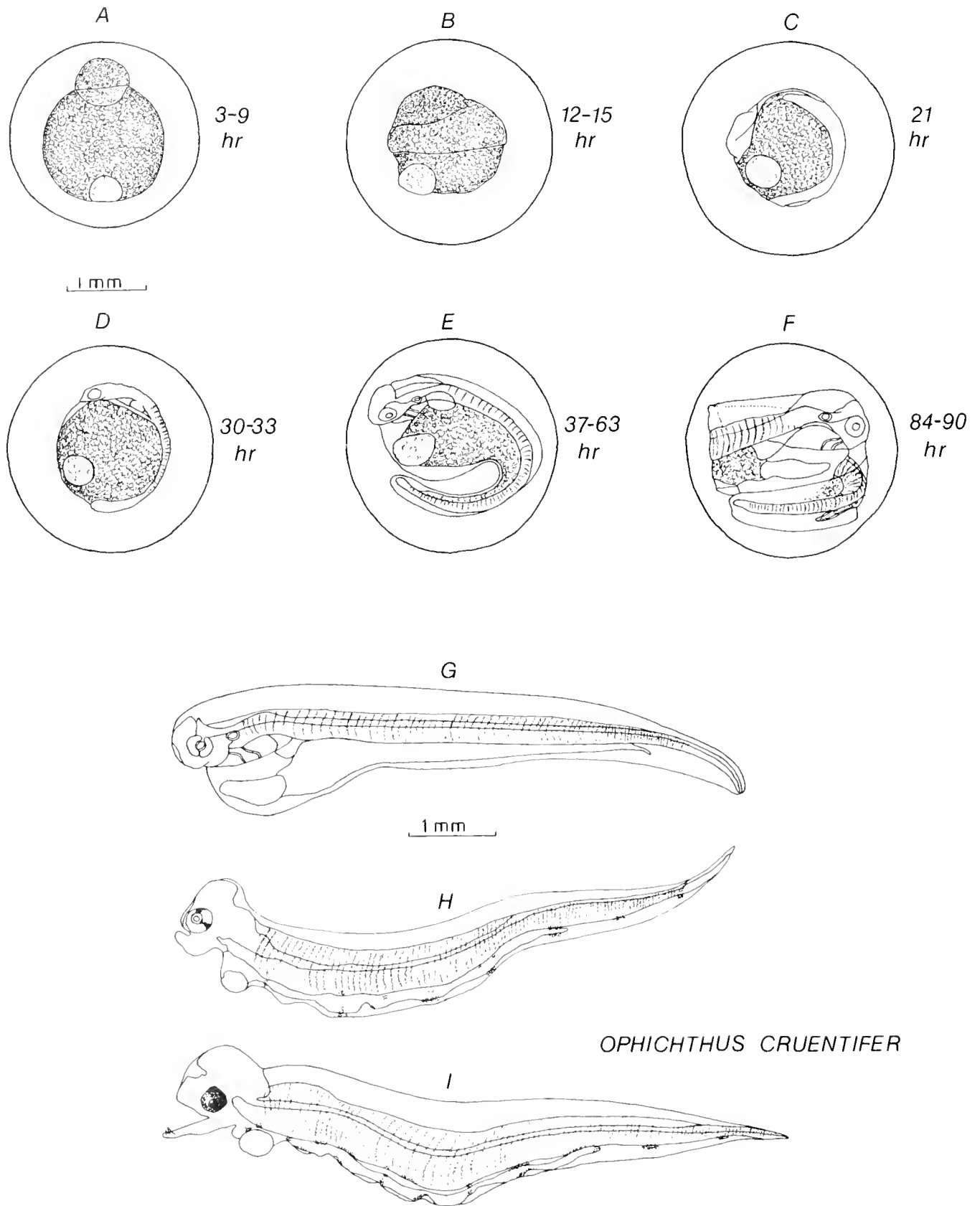

Fig. 30. Embryonic and early engyodontic stages of *Ophichthus cruentifer* (adapted from Naplin and Obenchain, 1980).

Metamorphosis follows the euryodontic stage. It is relatively abrupt and involves the replacement of many of the characteristic leptocephalus features by those of the juvenile. The body rounds up in section, tissue transparency is lost, the postorbital portion of the head lengthens, the larval teeth are lost and the definitive teeth are gradually substituted. The anus and median fin origins move forwards, though not in all species. Pectoral and caudal fins are lost late in metamorphosis in those species which lack the fin in the juvenile and adult. There may be a substantial reduction in body length, extremely so in the Notacanthiformes. The principal characters which are retained are the definitive number of myomeres/vertebrae which is established very early in larval life, the number of dorsal and anal fin-rays which is attained rather late in development, and for some species the larval pigment. The maintenance of larval pigment through metamorphosis is of prime importance in identification at the generic level. However, metamorphic larvae are relatively rare in collections, possibly because they are in any case a transient stage; metamorphics are also benthic and hence less accessible to collection. Information on these important stages is therefore sparse.

IDENTIFICATION

Leptocephali are thus readily recognisable amongst other fish larvae, apparently abundant in the warmer ocean, and accessible near the surface. Large collections of leptocephali have accumulated, for some families and genera there being many more specimens available than of the adults (e.g., the moringuid, *Neoconger*, Smith and Castle, 1972; the Nettastomatidae, Smith and Castle, 1982). The availability of such collections and the need for identification of leptocephali have resulted in the recent rapid advance of larval studies (Castle, 1969; Blache, 1977; Smith, 1979; Fahay, 1983). These studies have, understandably, emphasized identification rather than inter-relationships based on larval characters.

Larvae of all but the monotypic families Simenchelyidae and Myrocongridae and those of about half (82) of the genera are known. Several distinctive larval forms, possibly of undescribed genera rather than families, are also known (e.g., the congrid-like *Leptocephalus thorianus* Schmidt, Smith, 1979). Family identification, largely by morphological and pigment characters, may be arrived at from Table 13, which incorporates information set out in key form by Smith (1979) and Fahay (1983). This "look-alike" approach to identifying leptocephali largely suffices at the family level but is less satisfactory in identifying genera, especially of the Ophichthidae and Congridae (Leiby, 1981). More detailed information may be necessary, especially for species identification, but this will be slow to accumulate. Some attempt to collate available data for identification purposes is made in Tables 14–23, with their complementary figures (Figs. 34 to 43).

More than 500 different leptocephali have been described, 200 as nominal species of the invalid genus *Leptocephalus* Gronovius, 1763. The procedure of formally naming eel larvae in this way has been both opposed (Böhlke and Smith, 1968) and advocated (Castle, 1969). However, nomenclatural problems associated with naming larval forms will not be readily overcome by ignoring the priority of larval names or attempting to apply a blanket restriction on their use. Some alternative reference scheme, or at least an agreed descriptive procedure, does seem appropriate (Fahay and Obenchain, 1978) to accommodate the large number of distinctive ontogenetic stages of eels.

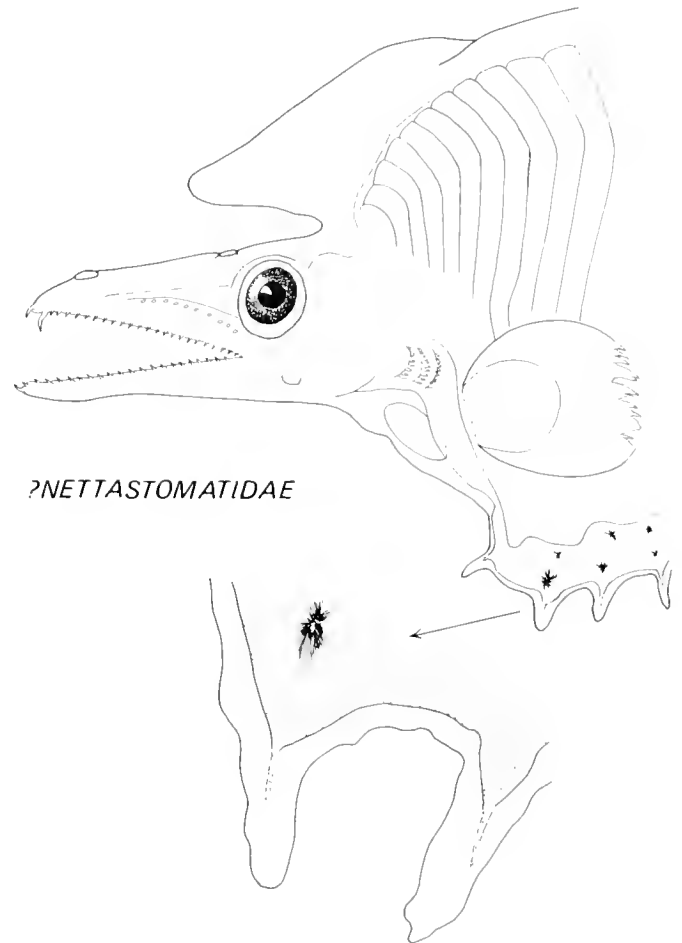

Fig. 31. Anterior region of leptocephalus of an unidentified ?nettastomatid (DANA St. 4181 II, 34°23'N, 25°53'W, 9 June 1931), showing tab-like extensions of the intestine.

Few complete growth series have been described and illustrated, and developmental osteology is known only for *Anguilla anguilla* (Norman, 1926b), *Serrivomer* spp. (Bauchot, 1959), *Ariosoma balearicum* (Hulet, 1977), *Ophichthus gomesi* (Leiby, 1979a), and *Myrophis punctatus* (Leiby, 1979b). At least in *Ophichthus gomesi* ossification of the head skeleton does not occur for most elements until metamorphosis, although the jaws, suspensorium and branchial skeleton are present as cartilage during the pre-metamorphic stage. Leiby's recent papers (1979b, 1981) contain detailed information on the sequence of development of the skeleton and emphasize the relevance of a more thorough evaluation of developmental osteology in identification of leptocephali.

In overall body form leptocephali range from the greatly elongate notacanth (Castle, 1973, for references; Smith, 1979; Fig. 29), *Nemichthys* (Nielsen and Smith, 1978; Smith, 1979; Table 19) and some Nettastomatidae (Smith and Castle, 1982) to the short, deep larvae of *Thalassenchelys* (Castle and Raju, 1975; Table 22 and Fig. 42), the Xenocongridae (Smith, 1969; Table 22 and Fig. 42) and *Cyema atrum* (Smith, 1979; Table 23 and Fig. 43).

The snout is typically rather sharp, especially so in some Notacanthiformes (Fig. 29), Dysommidae (Table 14 and Fig.

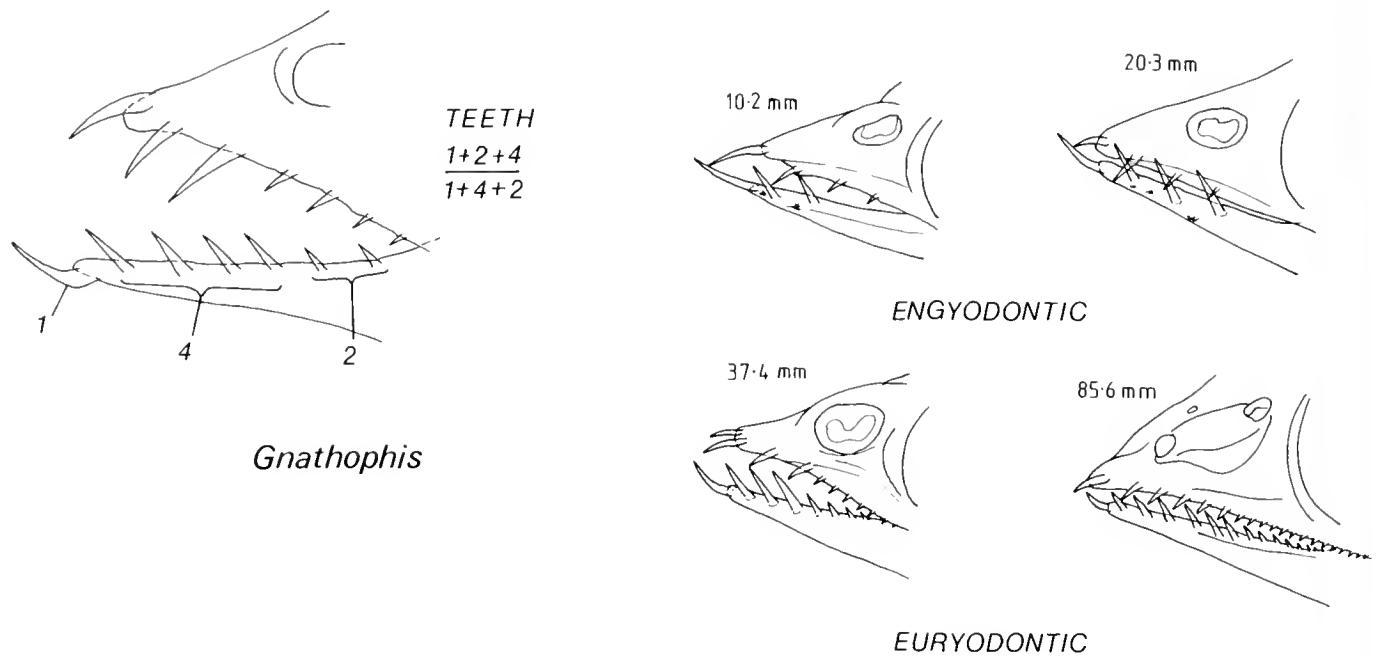

Fig. 32. Development of teeth-series in the congrid *Gnathophis*.

34), Nettastomatidae (Table 19 and Fig. 39) and Cyematidae (Table 23 and Fig. 43), but characteristically short and rounded in the Heterenchelyidae (Table 18 and Fig. 38) and Muraenidae (Table 21 and Fig. 41), especially near metamorphosis. In some Dysommataidae (Table 14 and Fig. 34) it is produced forwards as a conspicuous, narrow, ethmoid rostrum bearing at its tip a pair of "premaxillary" teeth and, in some also, fleshy tabs or tentacles along its length. The rostrum itself is lost at metamorphosis so that the snouts of post-metamorphic dysommataids, apart from their characteristic papillae and plicae, are similar to those of other eels.

In full-grown leptocephali the anus lies just in advance of the midpoint (some Nettastomatidae, Table 19 and Fig. 39; some Muraenidae, Table 21 and Fig. 41; some Xenocongridae, Table 22 and Fig. 42), well behind the midpoint (most genera), or is subterminal (the congrid group *Ariosoma-Bathymyrus*, Table 17 and Fig. 37). For those in which it is subterminal, it advances during metamorphosis, taking with it the anal fin origin and the developing pterygiophores and actinotrichia. Its position in these species is thus a very rough measure of the stage of metamorphosis. Broadly speaking, the amount of forward movement of the anus is correlated with the length of larval life, generally long in Notacanthiformes, Anguillidae (1–3 years) and Congridae (10 months for species of *Gnathophis*, Castle, 1968; Castle and Robertson, 1974) but much shorter in Moringuidae (3½ months for *Moringua edwardsi*, Castle, 1979) and probably also for Muraenidae, Xenocongridae and many Ophichthidae. However, little is known of the duration of larval life in most eels.

A special feature of some *Ariosoma-Bathymyrus* larvae is an exterrilium or external intestine (Mochioka et al., 1982; Table 17Q and Fig. 37) and in the unidentified larva illustrated by Weber (1913) and Smith (1979), there are tab-like extensions of the intestine, of unknown significance (Fig. 31).

The olfactory organ is a round to oval sac immediately in

front of the eye. As growth proceeds its single aperture progressively becomes vertically subdivided by flaps growing from the upper and lower margins. After separation of the two nostrils, the olfactory sac lengthens in many leptocephali, except the Cyematidae, Nemichthyidae and Serrivomeridae, so that the anterior nostril moves forwards to near the tip of the snout. There it becomes subtubular and often turns downwards; late in metamorphosis the posterior nostril may move dorsally or ventrally to adopt its final position above or behind the eye or ventrally on or through the upper lip.

The eye is usually round, but in the notacanthiform larvae referred to the larval genus *Tiluropsis*, and in *Leptocephalus attenuatus*, it is characteristically oval, with the long axis vertical. In all Synaphobranchioidea, probably also including the Simenchelyidae, the eye assumes a so-called "telescopic" or "tubular" shape (Table 14 and Fig. 34) and the body of the eye faces anterodorsally and is elongate, with a very deep retina.

Teeth develop shortly after hatching. These engyodontic teeth (Fig. 32) are few, needle-like, forwardly directed, each one progressively shorter along the rami of the jaws; typically there is a pair of larger teeth anteriorly. The engyodontic teeth are shed at the beginning of the euryodontic growth stage and are progressively replaced with the 3 series of shorter, broad-based teeth in upper and lower jaws; the upper teeth are preceded by an anteriormost pair, slightly smaller than the first maxillary pair, which are very large in the supposed xenocongrid *Thalassenchelys* (Table 22 and Fig. 42). As growth proceeds teeth are added progressively, to reach 40–50 at metamorphosis. They are blade-like and slightly recurved in *Paraconger*, bicuspid in *Coloconger* (Table 18 and Fig. 38), or needle-like and distinctly spaced in the Heterenchelyidae (Table 18 and Fig. 38). Leiby (1979b) notes that the splanchnocranium is so weakly developed in the engyodontic stage of the ophichthid *Myrophis punctatus* that the first series of larval teeth cannot be used in feeding.

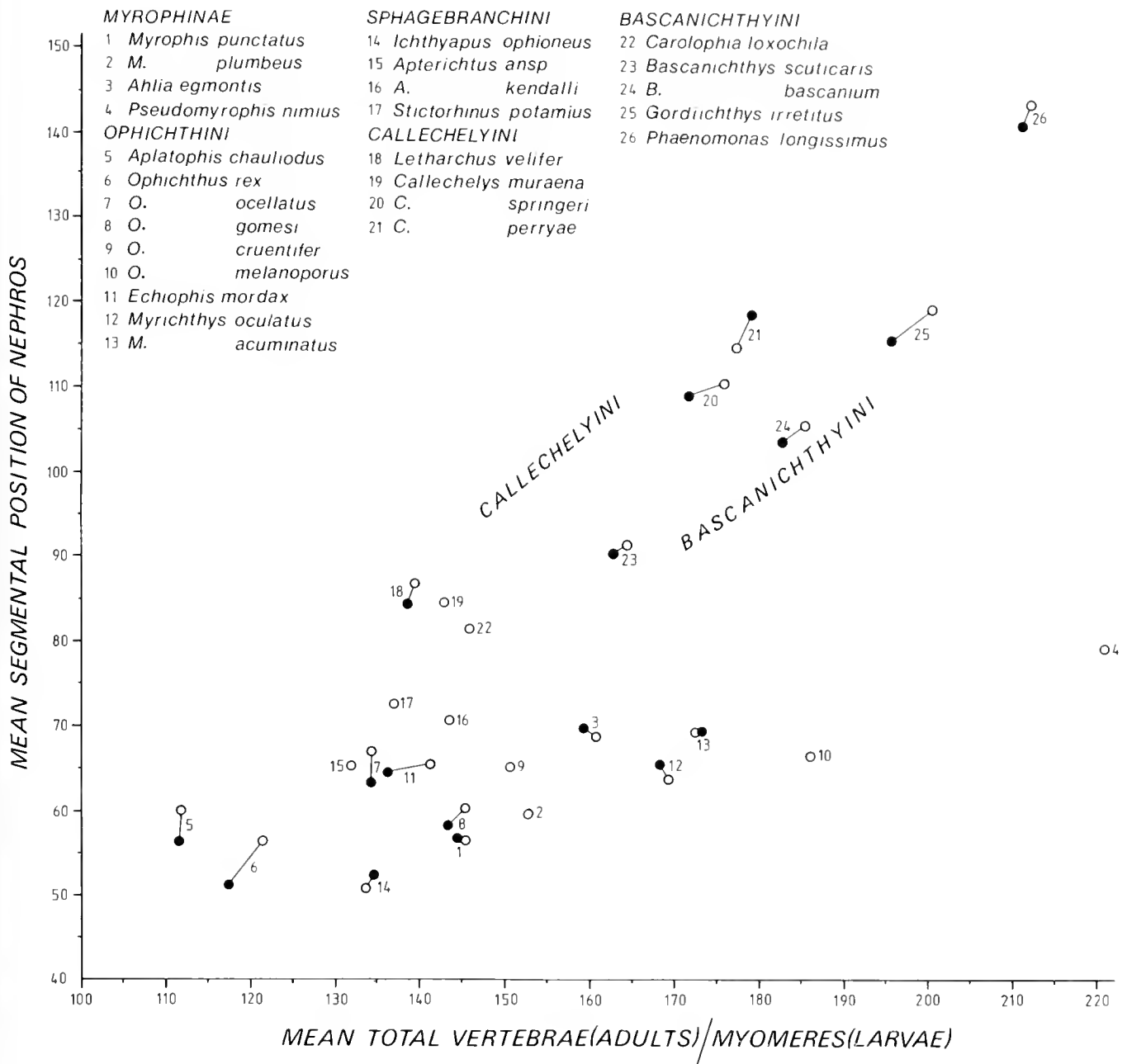

Fig. 33. Position of kidney in adults and larvae of 26 species of Western Atlantic Ophichthidae; black circles adults, open circles larvae. Adults of not all species shown.

The gill opening is anteroventral to the pectoral base and any movement to take up an adult ventral position (Synphobranchioidea, Ophichthidae) does not occur until very late in metamorphosis.

Pectoral fins are present as fleshy tabs in all very early leptocephali. If absent or much reduced in the post-metamorphic stage, the loss does not occur until late in larval life or at metamorphosis (Muraenidae, Ophichthidae, the muraenesocid *Gavialiceps*). Actinotrichia do not develop until late in the euryodontic stage and lepidotrichia not until metamorphosis. The range is 8-22 among the species of eels.

Median fins are first visible as undifferentiated folds of tissue and remain so until the beginning of the euryodontic stage. The dorsal and anal fin skeletons begin to develop posteriorly first, and then progressively forwards, the anal more rapidly than the dorsal. Pterygiophores and associated muscle blocks appear before the actinotrichia but lepidotrichia do not complete development until metamorphosis is complete. The anal fin supports are usually closely packed before the anus moves forwards during metamorphosis. The dorsal origin is less easy to define until late in the euryodontic stage and may not take up its final position until well into metamorphosis. In the muraenids *Anar-*

TABLE 13. MAJOR MORPHOLOGICAL AND PIGMENT CHARACTERS OF ANGUILLIFORM LEPTOCEPHALI (FAMILIES). + = All or most species; (+) = some species only.

	Synaphobranchidae	Dysommataidae	Simenchelyidae	Ophichthidae	Congridae	Muraenesocidae	Nettastomatidae	Colocongridae	Derichthyidae
Eye: Tubular	+	+	?+						
Normal				+	+	+	+	+	+
Hyomandibula: Backwardly oblique									
Normal	+	+	?+	+	+	+	+	+	+
Gut: A simple, straight tube	+				+	+		+	+
with swellings or loops									
1 Swelling				+	(+)		(+)		
2 Swellings							(+)		
3 Or more		+					(+)		
Body depth: $\geq 50\%$ TL									
Much $< 50\%$ TL	+	+		+	+	+	+	+	+
Tail tip: Broad, rounded									
Narrow	+	+		+	+	+	+	+	+
Gut length: \leq Half TL				(+)			(+)		
$>$ Half TL	+	+		+	+	+	(+)	+	+
Head: Elongate					(+)		(+)		
Short	+	+		+	(+)	+	(+)	+	+
Snout: Rounded									
Acute	+	+		+	+	+	+	+	+
Pigment: Entirely absent									
At least some present	+	+		+	+	+	+	+	+
None on gut	+								+
Present on gut		+		+	+	+	+	+	
Present dorsally in orbit									(+)
Absent from orbit	+	+		+	+	+	+	+	(+)
Present on spinal cord					(+)				
Absent from spinal cord	+	+		+	+	+	+	+	+
Patch below iris					+				
Absent below iris	+	+		+	(+)	+	+	+	+

chias, *Uropterygius* and to a lesser extent *Channomuraena* the dorsal and anal fins are much restricted and distinctive as such early in the euryodontic stage (Table 21 and Fig. 41). At least in the Ophichthidae (Leiby, 1982), even in those species which lack a dorsal fin in the adult, pterygiophores and actinotrichia develop in the larvae. There is also a marked correlation between position of dorsal fin origin in larvae and adults. In the congrid *Ariosoma* and related genera, the anus is subterminal and the dorsal and anal are also restricted but develop progressively forwards during late larval growth (Table 17 and Fig. 37). Dorsal fin-rays range in number from 110 in *Neocyema erythrosoma* to 600–700 in some ophichthids, anal rays usually being somewhat fewer. The large number and apparent considerable variability of median fin rays in most eels has resulted in this meristic character being neglected, but it may be of considerable use in larval identification (Leiby, 1981).

The caudal fin develops at least as early as the anal, its supporting structure being 3 hypurals, the first two joined distally, enclosing a foramen. Typically hypurals 1 and 2 support 4 rays, hypural 3 supports 5 rays, but the hypurals are much broader in the Synaphobranchoidea, supporting about 16 rays. The fin is resorbed, the rays shorten, and finally become embedded in the tail tip of heterocongrin and many ophichthid larvae shortly before metamorphosis.

Myomeres differentiate during embryonic development but because of their relatively high number and small size it is not known for any species whether the definitive number of the adult is established then, or after hatching. However, differentiation of the most posterior myomeres, as evidenced visually, appears to occur during the engyodontic stage, even for species

with very high total numbers of myomeres. Total counts for species with more than about 180 are difficult to make accurately, even in fully grown leptocephali. Myomeres are less readily counted as body transparency is lost at metamorphosis. The range in myomere number across the Anguilliformes is 74–78 in the short-bodied *Cyema atrum* to more than 400 in the greatly elongate *Nemichthys scolopaceus* (Table 10) with ranges for species of about 10 myomeres at the lower end (e.g., for *Anguilla*, Jespersen, 1942) to about 30 in the range 200–300 (e.g., for Nettastomatidae, Smith and Castle, 1982).

Vertebrae first begin to differentiate posteriorly just before metamorphosis with the constriction of the terminal portion of the notochord proceeding anteriorly.

The value of vertebral counts in defining eel species has become firmly established in eel studies (Böhlke, 1978). The correlation of vertebral number with number of myomeres in larvae was demonstrated by Jespersen (1942) for *Anguilla* and taken up extensively in recent years (Blache, 1977; Smith, 1979; Smith and Castle, 1982). In utilizing this agreement between larvae and adults, associated phenomena need to be further explored and assessed, e.g., pleomerism (the correlation in related species of vertebral number and maximum body length attained: Lindsey, 1975), "Jordan's Rule" (the tendency for fishes in polar or cool waters to have more vertebrae or other meristic parts than have related forms in tropical warm waters, Jordan, 1892), and sexual dimorphism in vertebral number (as occurs in *Moringua edwardsi*, Castle and Böhlke, 1976).

The existence of latitudinal clines in vertebral number in eels has been proposed, but not convincingly demonstrated, except possibly for the muraenid *Gymnothorax panamensis* which

TABLE 13. EXTENDED.

Serrivomeridae	Anguillidae	Moraenidae	Heterenchelyidae	Muraenidae	Myrocongridae	Xenococongridae	Nemichthyidae	Cyematidae	Saccopharyngidae	Eurypharyngidae	Monognathidae
+	+	+	+	+		+	+	+	+	+	+
+	+	+	+	+		+	+	+	+	+	+
+	+		+	+		+	+				
		+							+	+	+
						(+)		+			
+	+	+	+	+			+		+	+	+
+	+	+	+	+		(+)					
+	+	+	+		(+)	+	+	+	+	+	+
+	+	+	+	+		+	+	+	+	+	+
+	+	+	+	+		+	+	+	+	+	+
+	+	+	+	+		+	+	+	+	+	+
+	+		+	+		+	+	+	+	+	+
+	+		+	+		+	+	+	+	+	+
+	+	+	+	+		+	+	+	+	+	+
+	+	+	+	+		+	+	+	+	+	+
+	+	+	+	+		(+)		+	+	+	+
+	+	+	+	+		+	+	+	+	+	+

Randall and McCosker (1975) show to have a mean vertebral range of 143 in Chile and 125 in the Gulf of California. Variation across longitude is apparently not usual but may be considerable; for example, McCosker (1977, 1979) demonstrates that the ophichthid *Myrichthys maculatus* has a mean vertebral count of 153 in the East Pacific to 195 in the Red Sea.

Two other problems arise in using vertebral/myomere characters in matching leptocephali with their adult species. These are the prevalence of damaged tails in adults of some species, especially those that are slender-tailed (Nattastomatidae, some Congridae and Muraenocidae) and hence the unavailability of vertebral counts; and the overlap or near concordance of vertebral numbers within species groups. For example, in the western Indian Ocean there are 15–20 species of the muraenid genus *Gymnothorax* which have vertebral numbers within the range 130–145. Unless other characters (e.g., fin-ray numbers) can be shown to differ significantly between these species, it is likely that their leptocephali, all having rather similar pigmentation, will prove difficult, if not impossible, to identify.

However, there is a reliable correlation between the segmental position of the larval kidney and that of the adult. The larval nephros (opisthonephros) is typically an elongate sac lying above the gut approximately in the middle of the body, i.e., near the anus in those larvae with a relatively short gut (Xenococongridae, Nattastomatidae, Ophichthidae) or some distance in front of it in those having a long gut (Congridae). The segmental position of the kidney changes little, if at all, during larval life and through metamorphosis into the juvenile. Its position then very approximately agrees with the end of the body cavity and the first caudal vertebra. The correlation in the nephros position has

been successfully employed as an identification character for the Muraenidae and other families (Blache, 1977) and for some Ophichthidae (Leiby, 1981) but its value has not yet been comprehensively explored across the Anguilliformes as a whole. Further evidence for the stability of nephros position from larva to adult, at least in the Ophichthidae, is provided in Fig. 33. The figure expresses the mean segmental positions of the end of the nephros in the larvae and adults of various western Atlantic ophichthids of the subfamily Myrophinae and the four tribes of the subfamily Ophichthinae. There is close agreement in position of the nephros between larvae and adults of all species. Furthermore, the position of the kidney (and first caudal vertebra) is conspicuously further back along the body in the tribes Callechelyini and Bascanichthyini. These are readily recognisable short-tailed ophichthids whose larvae can be immediately identified as such by the posterior position of the nephros. There is considerable overlap in this character between the Myrophinae, Sphagebranchini and Ophichthinae although individually the species are distinct.

The larval nephros is typically supplied and drained by two prominent blood vessels passing vertically between the lateral muscles to the aorta and cardinal veins below the vertebral column. The segmental position of the last of these vessels in the leptocephalus and its correlation with the position of the first caudal vertebra in the adult has been emphasised in larval identification. However, it seems simpler to use nephros position instead.

In those groups of larvae in which the anus does not move forwards during metamorphosis, there is some agreement between number of preanal myomeres and preanal vertebrae.

TABLE 14. PIGMENT AND MORPHOLOGICAL CHARACTERS OF THE SYNAPHOBRACHOIDEA. + = All or most species; (+) = some species only. Refer to Fig. 34.

Characters	Taxa						
	<i>Synaphobranchus</i>	<i>Nettodarus</i>	<i>Dysommuna</i>	Type			
				A	B	C	D
Lateral pigment							
A. A large midlateral patch at about level of anus	(+)						
B. On caudal only	+						
C. A midlateral row of compact or dendritic spots							
1. Row complete			+		(+)		(+)
2. Postanal row only					(+)		(+)
D. A dorsolateral row			+		(+)		(+)
E. A ventrolateral row			+		(+)		(+)
F. A ventral row			+		(+)		(+)
G. A postanal row		(+)	+	+	(+)		(+)
Gut pigment							
H. Absent	+						
I. An irregular series of dendritic melanophores along its length		+	+	+	+	+	+
Morphological							
J. Posterior flexures of myomeres rounded	+						
K. An opaque midlateral area of myomeres along length of body	+						
L. Posterior flexures of myomeres angular		+	+	+	+	+	+
M. Rostrum absent	+	+		+	+		
N. Rostrum present			+			+	+
O. Gut straight	+						
P. Gut swollen or lightly arched at points along its length		+	+	+	+	+	+
Q. Posterior end of gut markedly flexed downwards					(+)		

However, this character is not generally applicable in larval identification because of forward movement of the anus during metamorphosis in some species.

The gut is most often a narrow straight tube, flexed downwards under the pectoral fin and following the ventral margin to the posteriorly placed anus. The stomach is usually visible as a finger-like sac at about segment 10. The most frequent modifications of the gut tube are loops or swellings at intervals along its length, each usually accompanied by groups of melanophores (Ophichthidae, Tables 15–16 and Figs. 35, 36; *Aeromycter*, Table 18 and Fig. 38; some Nettastomatidae, Table 19 and Fig. 39). The number and state of development (low, moderate or conspicuous) of the swellings may be diagnostic at family, genus or species level but is not always so (Leiby, 1981).

The liver, with associated gall bladder, fills much of the space anteriorly between the gut and the ventral margin of the lateral muscles. It has two or three lobes in the Ophichthidae (Table 15 and Fig. 35), the gall bladder on the second or third lobe, and the lobes may be distinct or connected by a thin band of liver tissue.

Larval pigment is present in larvae of all families except the Anguillidae and may be highly elaborated to form complex and distinctive patterns. The pigmentation, if present, is usually much simpler in the engyodontic stage than later stages. Melanophores may begin to appear in the embryo (in some Ophichthidae as several pigment patches on the gut similar to those in the larvae;

in some Muraenidae on the spinal cord) but typically do not do so until the early engyodontic stage. Pigmentation sometimes reaches its full expression by the beginning of the euryodontic stage but typically the complex patterns characteristic of the Ophichthidae and other families are not complete until full larval growth. Subsequently pigment may be lost during metamorphosis (the congrid *Ariosoma*), but may serve as a highly important character in matching larvae with adults.

Individually, melanophores may be dendritic (Dysommidae, Table 14 C₁–C₂ and Fig. 34), ocellate (Congridae, Table 18B and Fig. 38B), compact (Muraenidae, Table 21D and Fig. 41) or rather diffuse (Moringuidae, Table 23 C₂ and Fig. 43). They may be isolated, grouped in clusters to form conspicuous pigment patches (the congrid *Bathymyrus*, Table 17G and Fig. 37), or they may form well defined lines, series or patterns. In most families they occur on the lateral body surface, including the caudal fin, on the myosepta (*Ariosoma*, Table 17E and Fig. 37; *Bathymyrus*, Table 17E and Fig. 37; many Ophichthidae, Table 16 and Fig. 36), or on the ventral body wall (Dysommidae, Table 14I and Fig. 34; Congridae, Table 18L and Fig. 38). They may occur deeper in the tissues, either on the gut, liver, kidney, suspended in the mucinous space between the lateral muscles, associated with the spinal cord or vertebral column or, frequently, on the bases of the caudal, anal and dorsal fin-rays.

Although Blache (1977) and Fahay and Obenchain (1978) have attempted to summarise pigment patterns in some groups

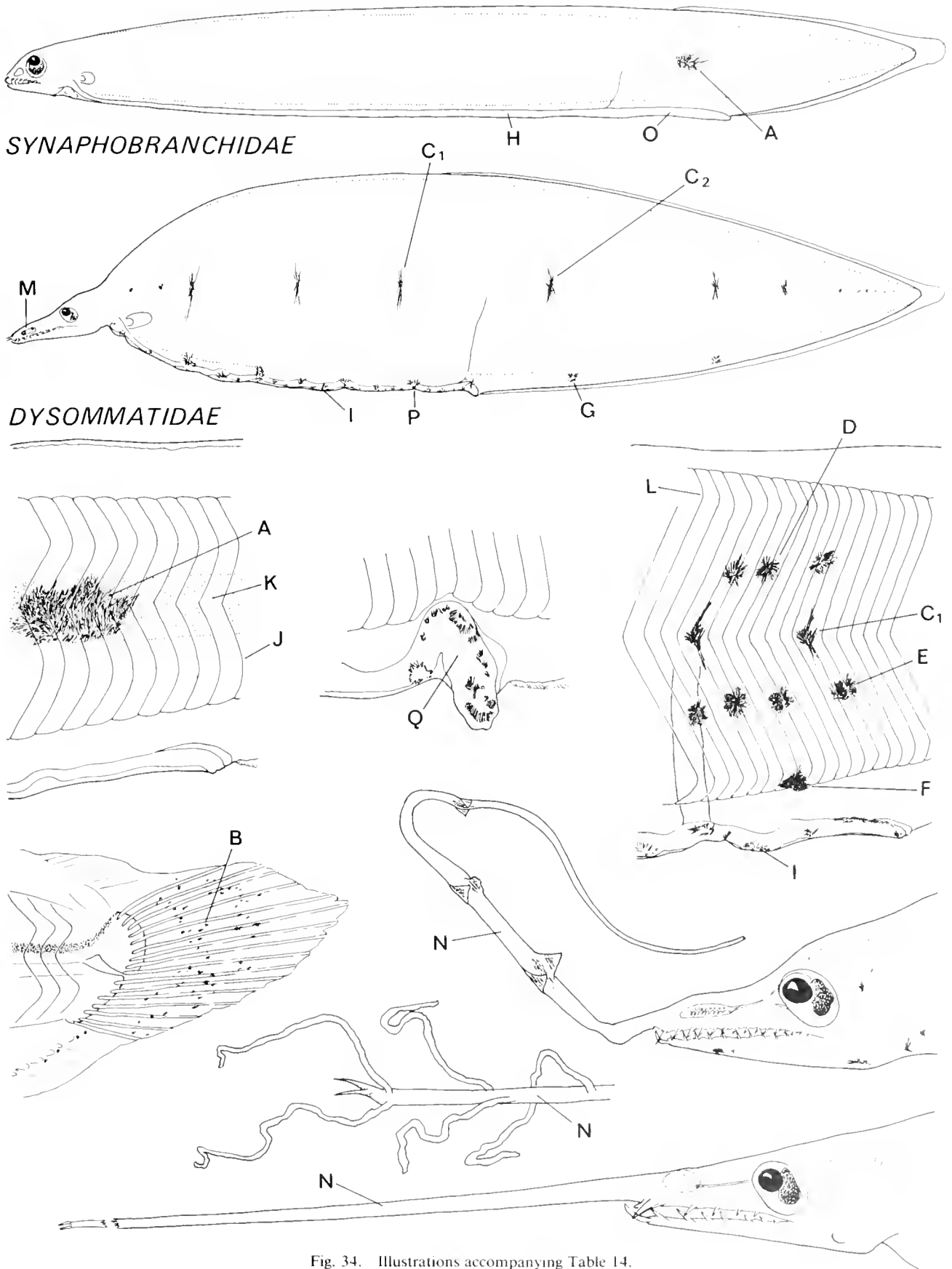

Fig. 34. Illustrations accompanying Table 14.

TABLE 15. MORPHOLOGICAL CHARACTERS OF OPHICHTHIDAE (MYROPHINAE AND OPHICHTHINAE). + = All or most species; (+) = some species only. Refer to Fig. 35.

Characters	Taxa								
	Myrophinae					Ophichthinae			
	<i>Athia</i>	<i>Muraenichthys</i>	<i>Myrophis</i>	<i>Nemichelys</i>	<i>Pseudomyrophis</i>	Ophichthini	Sphagbranchini	Bascanichthyini	Callichelyini
A. Body depth (euryodontic stage)									
1. >10% TL	+	(+)	+	+	+				
2. <10% TL						+	+	+	+
B. Gut loops or swellings									
1. Low	+	(+)	+	+		+	+	(+)	
2. Moderate to pronounced					+			(+)	+
C. End of nephros									
1. Above or just before anus	+	+	+	+	+	(+)	+	+	+
2. 4–14 myomeres before anus		(+)				+			
D. Liver lobes and oesophageal swellings									
1. Two			(+)	+		+	+	+	+
2. Three	+	+	+		+				
E. Caudal fin at metamorphosis									
1. Present, normal	+	(+)	+	+	+				
2. Absent (or much reduced)						+	+	+	+
F. Dorsal pterygiophores and rays before metamorphosis									
1. Well developed; dorsal origin migrates forwards 4–6 myomeres	+	(+)	+	+	+				
2. Weakly developed; origin migrates forwards 5–50 myomeres (or resorbed)						+	+	+	+

of larvae, the significance of these has not yet been comprehensively reviewed across the Anguilliformes. Furthermore, the extent of intraspecific variability of pigment patterns has also not been assessed. Any present discussion as to the significance or otherwise of similarities and differences in larval pigmentation must therefore be preliminary.

The range of pigmentation in genera for which larvae have been identified, and for some other forms, is summarized in Tables 14–23, family by family. These tables, with their accompanying figures and morphological information, may be used as a guide to generic identification, and also as a synopsis of pigment patterns. Because these are both complex and diverse in some families, they cannot always be simply displayed in keys. In the Ophichthidae also, and other families, further pigment patterns are known, probably representing other genera. This is particularly so of Indo-Pacific Anguilliformes which have not been extensively studied.

These tables and figures highlight common features of pigmentation: (1) on the gut or its adjacent body wall, often as a regular, spaced series from throat to anus (Notacanthiformes, Congrinae, Heterocongrinae, Heterenchelyidae, Colocongridae), or as an interrupted series (Nettastomatidae, Muraenesocidae, Dysommataidae, Ophichthidae) or in some other form (Bathymyrinae, Heterocongrinae, Muraenidae, Nemichthyidae, Xencongridae); (2) on the lateral body surface (Dysommataidae, Congrinae, Nettastomatidae, Xencongridae), often associated in some way with the myosepta (Ophichthidae, Bathymyrinae,

Heterocongrinae, Serrivomeridae, Derichthyidae); (3) on the spinal cord (Nemichthyidae, Muraenidae); or (4) on the bases of the dorsal, anal and caudal fins.

The broad perspective on the ontogeny of the Anguilliformes and Notacanthiformes given by the preceding deserves comment.

As adults, eels have adopted a somewhat conformist body plan notable for reduction and loss of external features, though the component families of the group are more or less discrete osteologically. In contrast, through elaboration of the leaflike body form and pigment patterns their larvae display a diversity which matches that of any other group of teleosts. This diversity involves some distinctive larval characters (morphological and pigmentary) which allow leptocephali to be identified at the family level. These characters have not been comprehensively assessed; further definitive identification of larval forms will aid any future analysis. Within families, larvae are generally similar in body form and pigmentation but there are several remarkable exceptions. There are some discernible character gradients in larvae (e.g., the complexity of gut swellings or loops in Ophichthidae; pigmentation of Congridae), but these may or may not be matched by adult character gradients. Detailed meristic information, as forthcoming throughout larval development, is the only satisfactory medium for species identification, especially in the larger eel families.

ZOOLOGY DEPARTMENT, VICTORIA UNIVERSITY OF WELLINGTON,
WELLINGTON, NEW ZEALAND.

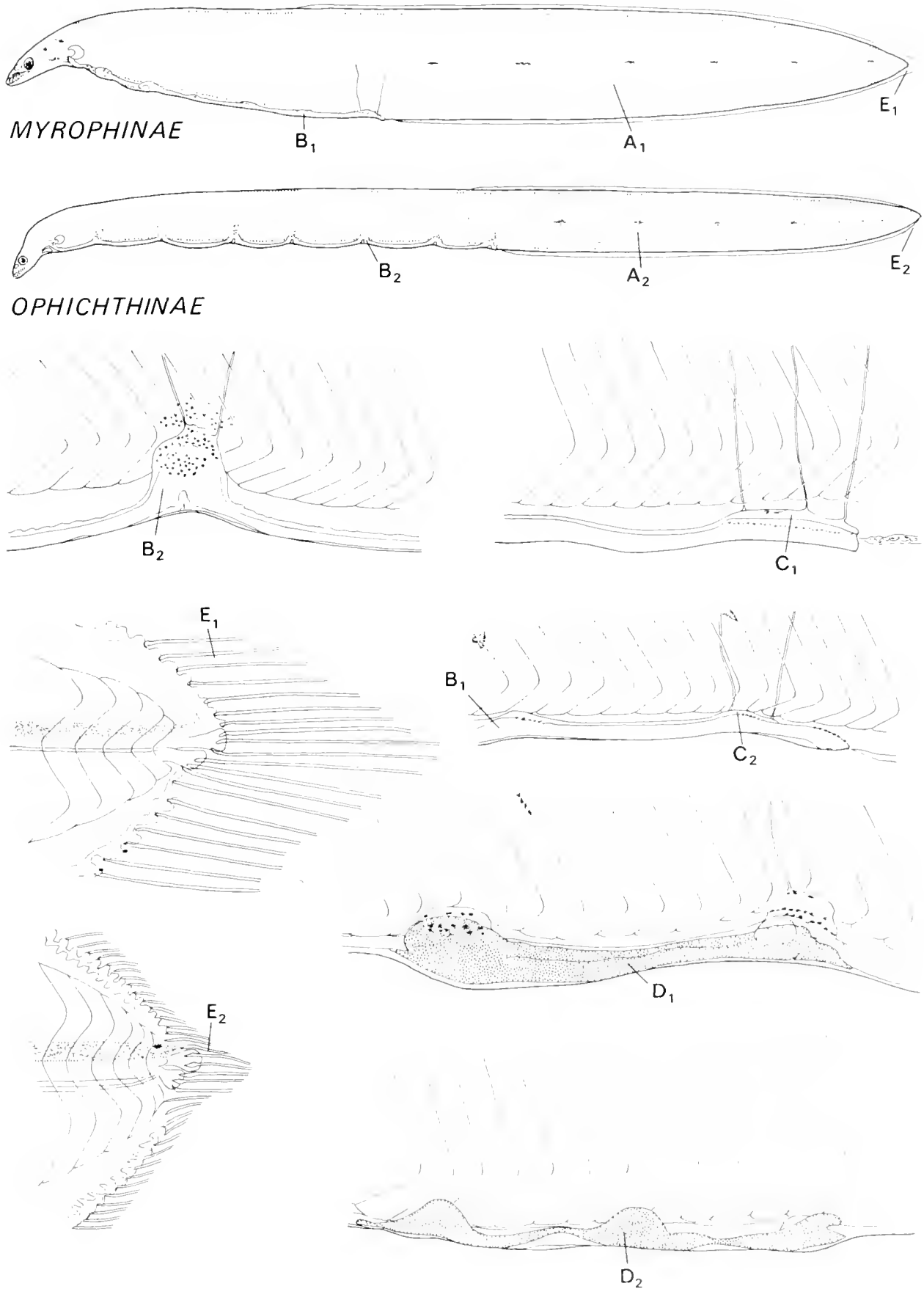

Fig. 35. Illustrations accompanying Table 15.

OPHICHTHIDAE

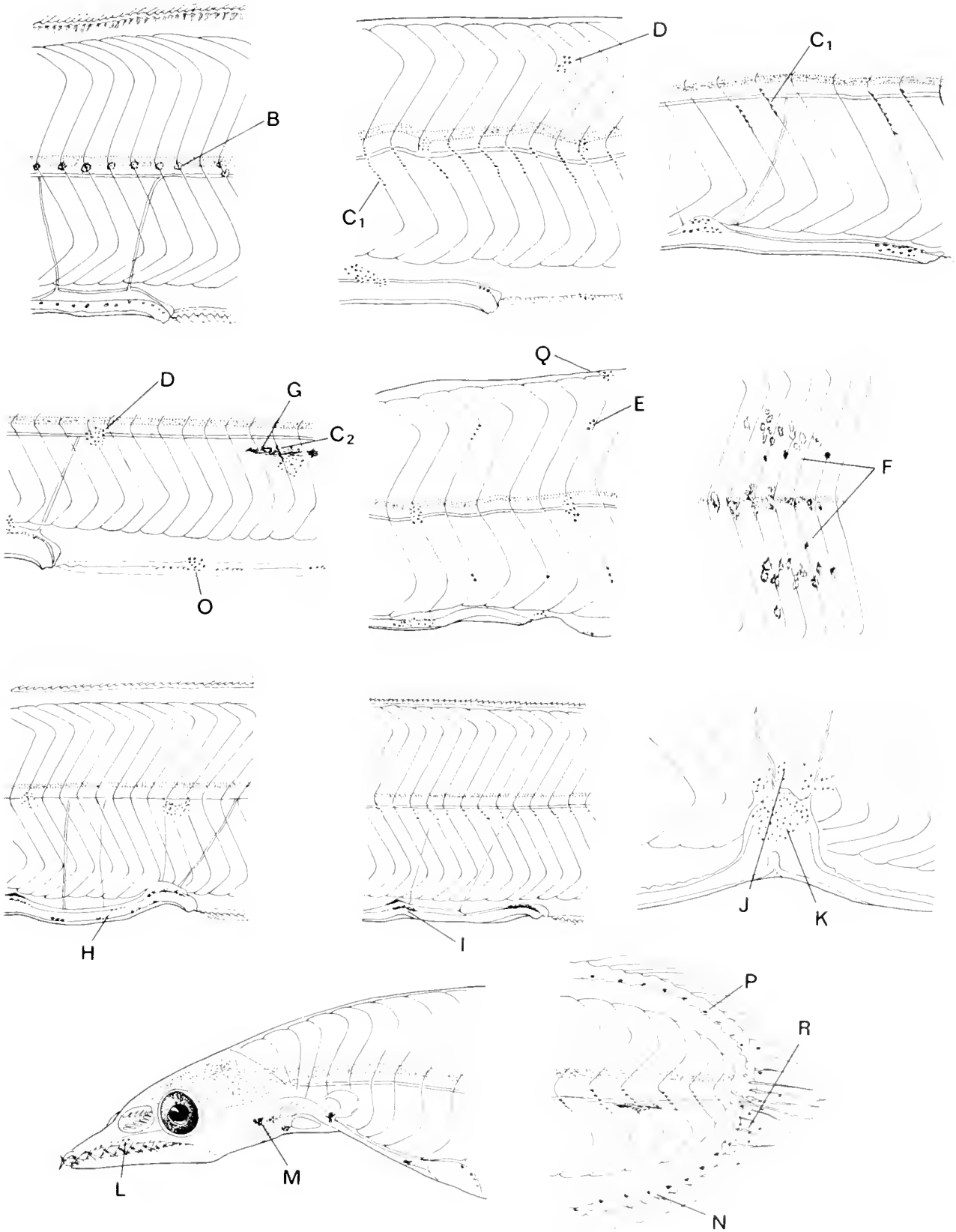

Fig. 36. Illustrations accompanying Table 16.

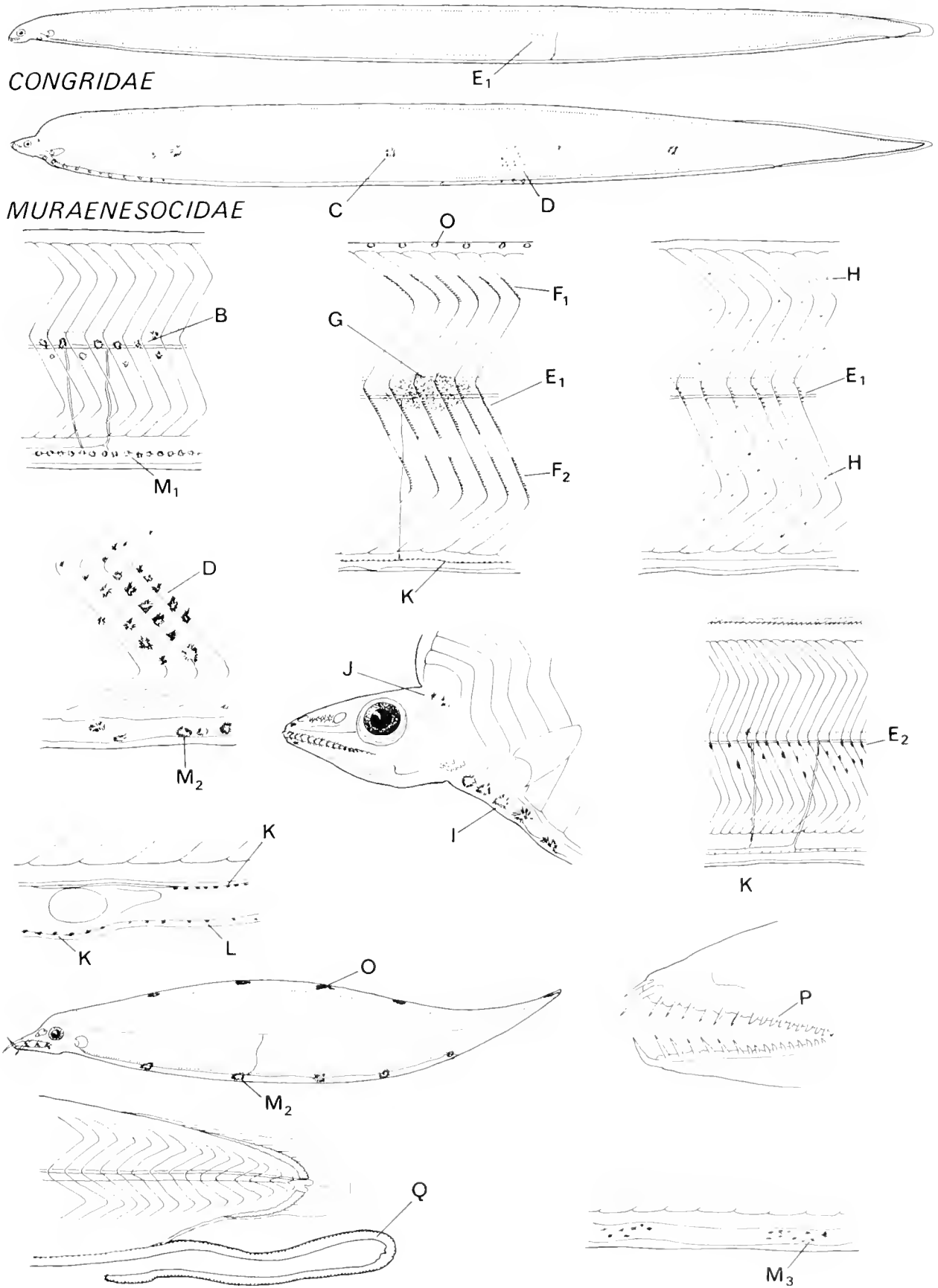
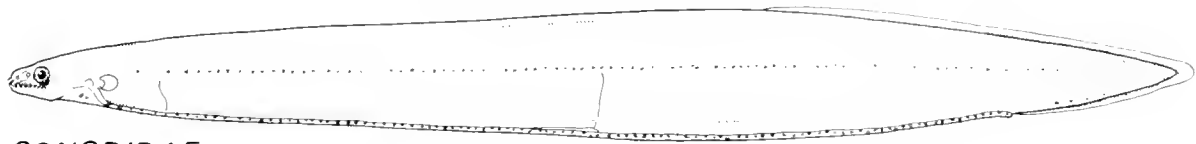
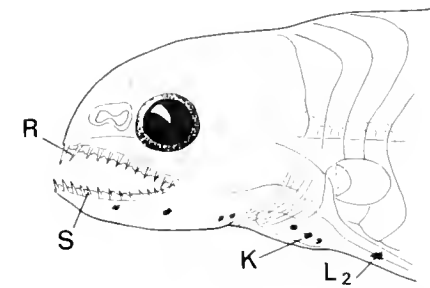
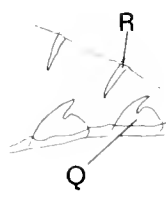
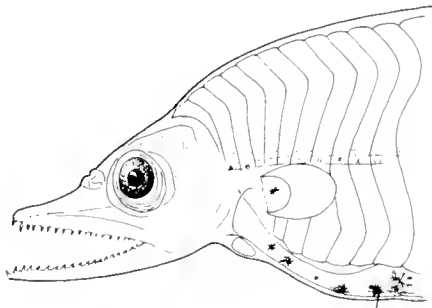

Fig. 37. Illustrations accompanying Table 17.



CONGRIDAE



COLOCONGRIDAE

HETERENCHELYIDAE

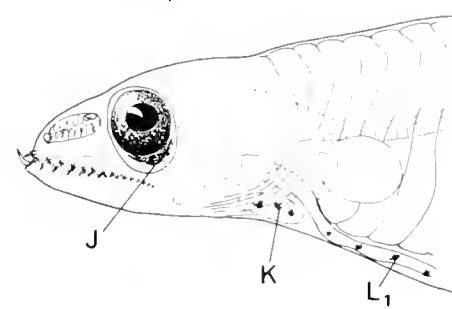
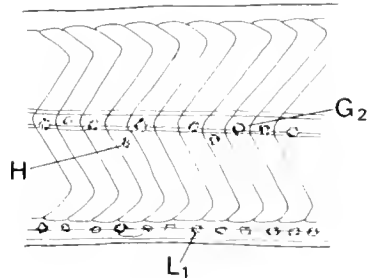
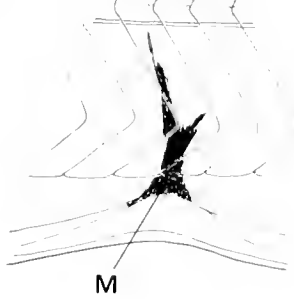
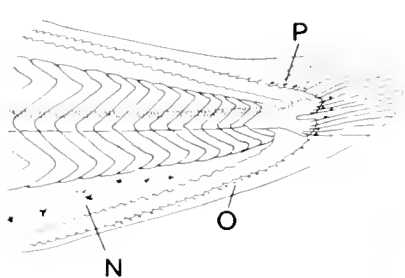
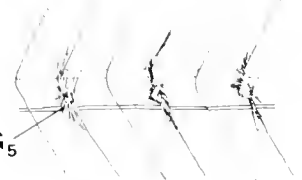
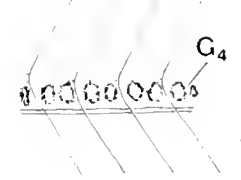
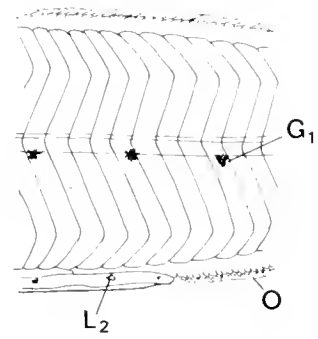
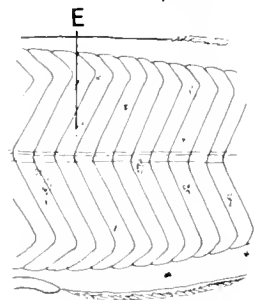
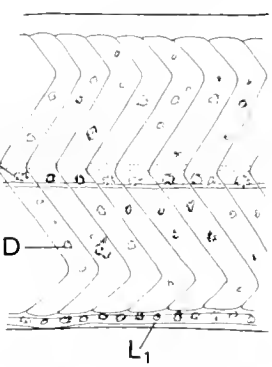
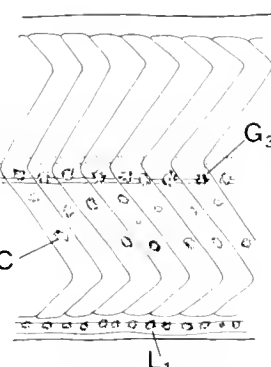
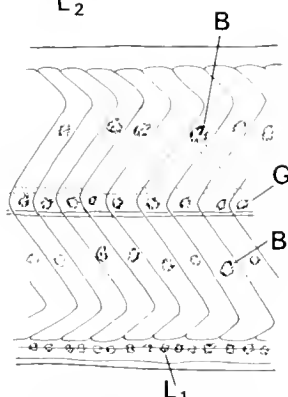
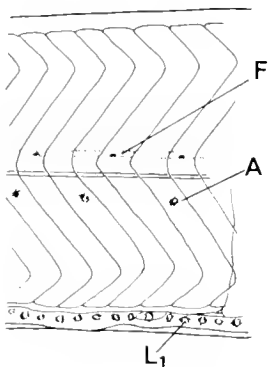

Fig. 38. Illustrations accompanying Table 18.

TABLE 19. PIGMENT AND MYOMERE CHARACTERS OF NEMICHTHYIDAE AND NETTASTOMATIDAE. + = All or most species; (+) some species only; * = larva unidentified. Refer to Fig. 39.

Characters	Taxa									
	<i>Avocet- tina</i>	<i>Labich- thys</i> *	<i>Nemich- thys</i>	<i>Facci- olella</i>	<i>Netta- stoma</i>	<i>Netten- chelys</i>	<i>Netten- chelys</i>	<i>Hop- lunnis</i>	<i>Sauren- chelys</i>	<i>Vene- hea</i> *
Axial pigment										
A. Deep on vertebral column										
1. Single spot, or bipartite					+	+				
2. Several spots along body					+		+		+	
B. Small spots on top of spinal cord, at least posteriorly	+		+							
Head pigment										
C. On snout and lower jaw				(+)	+	+	+		(+)	
D. Deep behind eye				(+)	+	+	+		(+)	
Gut pigment										
E. A ventral row of minute spots before stomach	+									
F. A row of minute spots above gut along its length	+									
G. A patch of minute spots on liver					+	+	+		+	
H. A patch of minute spots below kidney					+	+	+		+	
I. Spots scattered between liver and kidney patches									(+)	
J. A regular longitudinal series					+				(+)	
Other pigment										
K. Several groups of internal spots along body subaxially										
1. One or two in each group			+							
2. Each group multiple (4)	+									
L. Spots on ventral body wall postanally					(+)				(+)	
M. Minute spots on dorsal and anal bases	+				+				+	
Myomeres/vertebrae										
Min.	177	174	ca.	238	186	209	ca.	192		ca.
Max.	216	191	400+	294	246	273	257	276		224

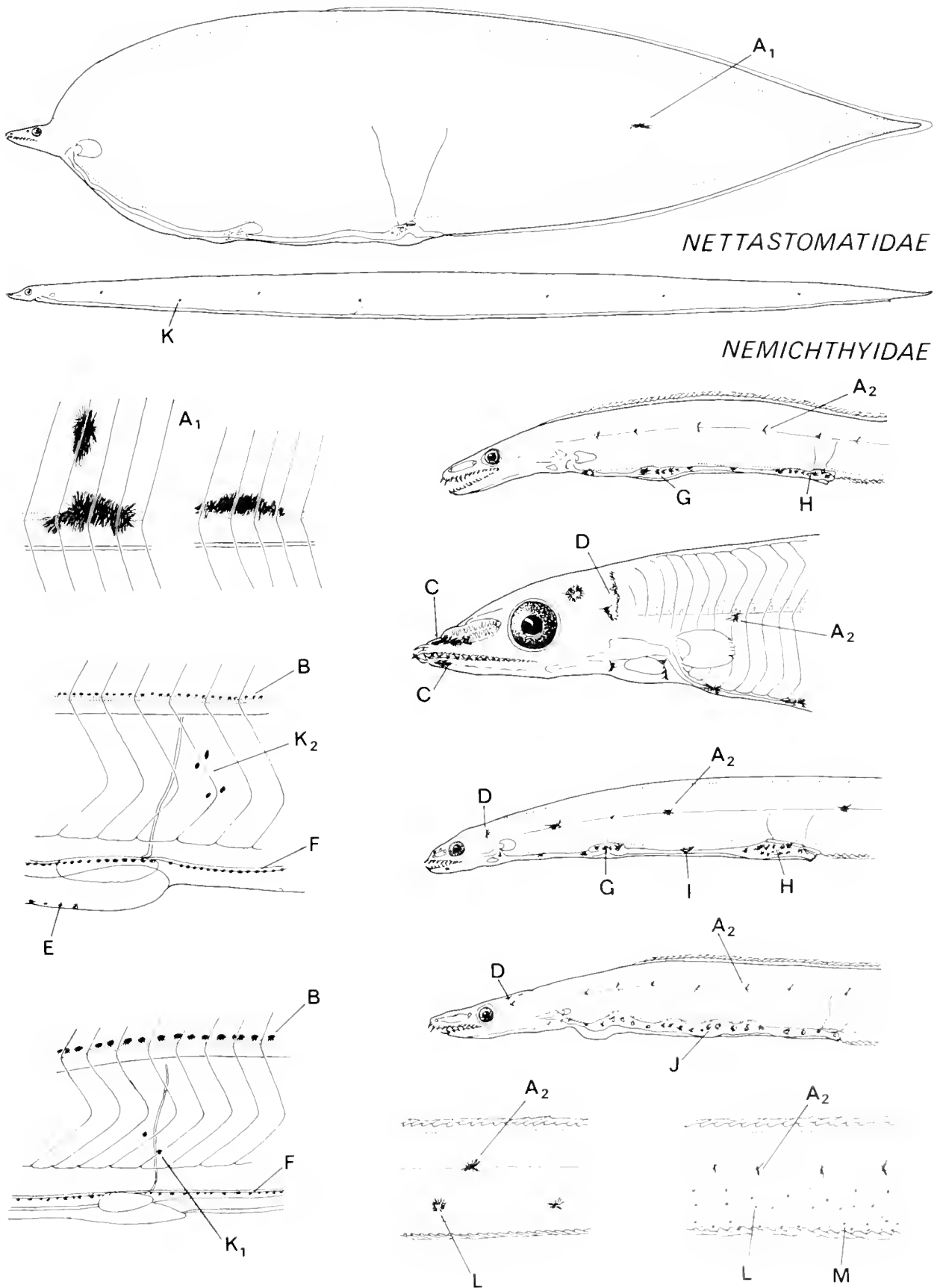

Fig. 39. Illustrations accompanying Table 19.

TABLE 20. PIGMENT, MORPHOLOGICAL AND MYOMERE CHARACTERS OF ANGUILLIDAE, DERICHTHYIDAE AND SERRIVOMERIDAE. + = All or most species; (+) = some species only. Refer to Fig. 40.

Characters	Taxa					
	<i>Anguilla</i>	<i>Derichthys</i>	<i>Nessorhamphus</i>	<i>Platuronides</i>	<i>Serrivomer</i>	<i>Stemondium</i>
Lateral pigment						
A. Absent	+					
B. Minute compact spots just below midline on nearly every segment					(+)	+
C. Midline spots restricted to postanal region (a few spots further forwards)		+	+	+	(+)	
D. A series of minute spots on body wall postanally					(+)	+
E. Minute spots on anal and dorsal bases					+	+
Head pigment						
F. Absent	+	+		+		
G. A cluster of minute spots in orbit above eye			+		+	+
Morphological						
H. Gut length						
1. 0.7 total length	+					
2. 0.75 total length		+			+	+
3. 0.9 total length			+	+		
I. Dorsal fin origin						
1. Just anterior to anus	+				+	+
2. Just behind midlength			+			
3. At about midlength		+		+		
J. Position of last vertical vessel						
1. Behind mid-gut	+	+	+	?		
2. Before mid-gut				?	+	+
Myomeres/vertebrae						
Min.	100	126	135	153	147	137
Max.	119	134	139	170	169	141

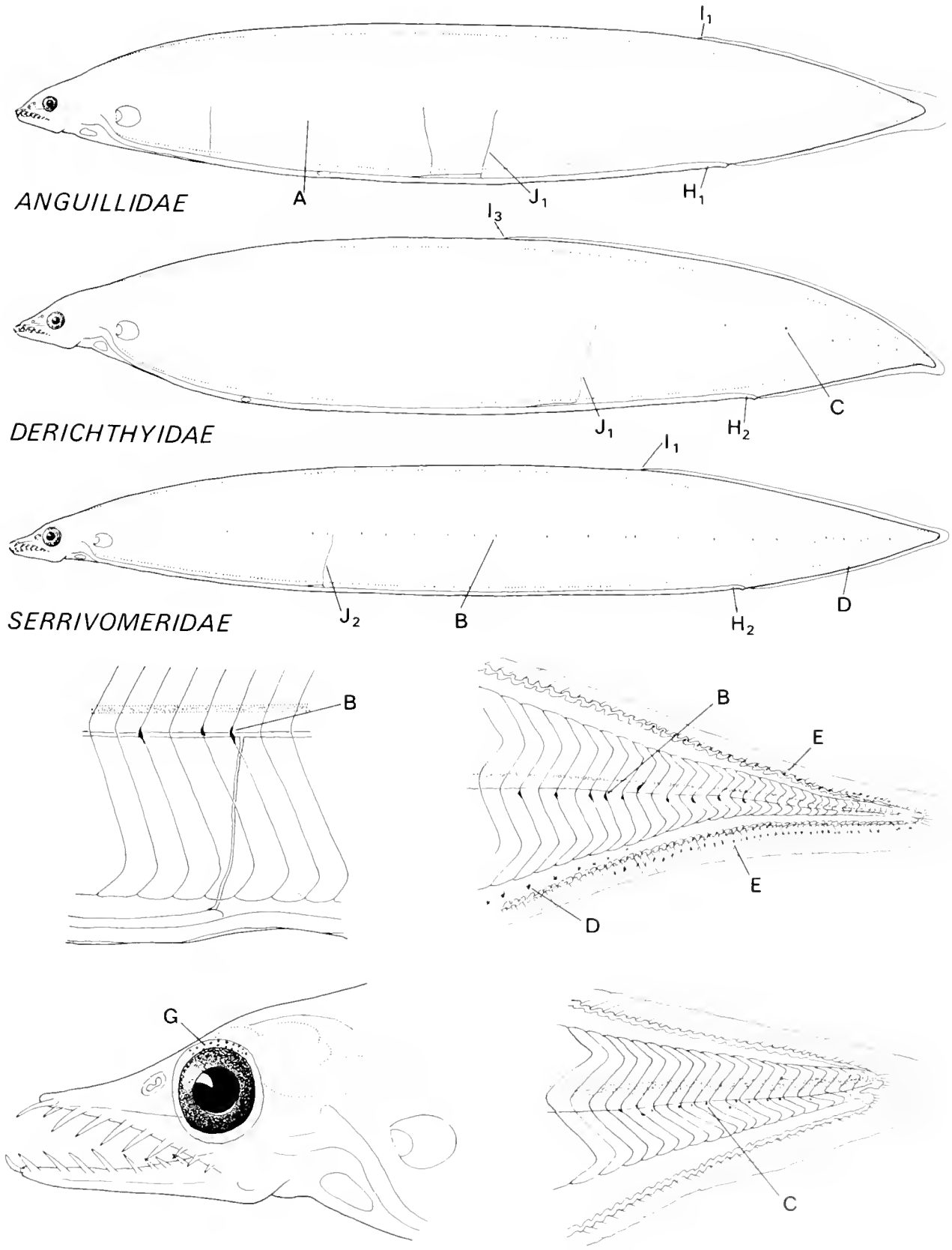

Fig. 40. Illustrations accompanying Table 20.

TABLE 21. PIGMENT, MORPHOLOGICAL AND MYOMERE CHARACTERS OF MURAENIDAE. + = All or most species; (+) = some species only; * = unidentified. Refer to Fig. 41.

Characters	Taxa								
	<i>Anarchias</i>	<i>Channo- muraena</i>	<i>Uro- pterygus</i>	<i>Enchely- core</i>	<i>Gymno- thorax</i>	<i>Muraena</i>	<i>Thyrso- idea</i>	Uniden- tified*	Uniden- tified*
Lateral pigment									
A. Minute spots scattered over body surface								+	
Axial pigment									
B. Small compact spots ventrally on spinal cord, at least posteriorly			+		+	+		+	+
Head pigment									
C. Few to many, small, scattered spots, often compact			+		+	+	+	+	+
D. Similar spots on brain								+	+
Gut pigment									
E. Ventral row behind stomach only	(+)				(+)				
F. Ventral row along whole of length			+					+	
G. Ventral row before stomach, dorsal row behind stomach					+		+	+	
H. Short row before anus dorsally					(+)				
I. In disjunct groups ventrally					+				
Other pigment									
J. Before dorsal base			+		+			+	
K. Along dorsal base		+	+		+	(+)	+	+	
L. Before anal base	(+)		+						
M. Along anal base		+	+		+	(+)	+	+	
N. Scattered over ventral surface anteriorly									+
Morphological									
O. Dorsal and anal fins restricted to tip of caudal	+	+	+						
P. Dorsal origin at myomere 30-40						+			+
Q. Dorsal origin at myomere 40-75					+		?	+	

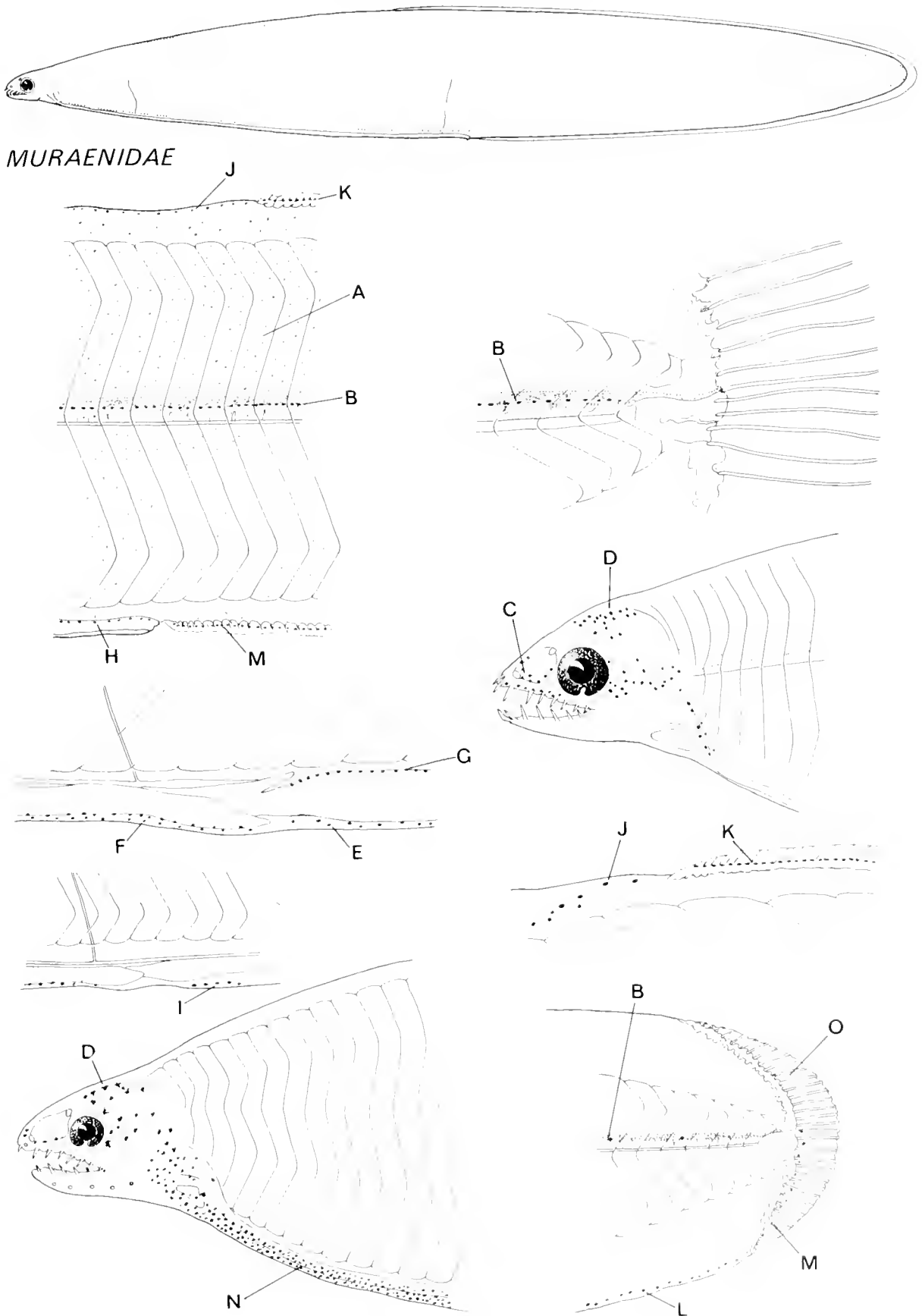
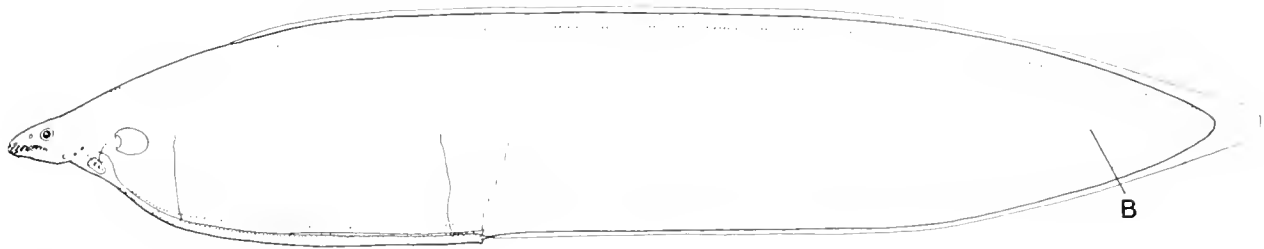

Fig. 41. Illustrations accompanying Table 21.

TABLE 22. PIGMENT AND MYOMERE CHARACTERS OF XENCONGRIDAE. + = All or most species; (+) some species only; * = larva unidentified. Refer to Fig. 42.

Characters	Taxa										
	<i>Cates- bya</i>	<i>Chilo- rhinus</i>	<i>Chlop- sis</i>	<i>Kau- pichthys</i>	<i>Powell- ichthys*</i>	<i>Robin- sia</i>	<i>Xeno- conger*</i>	Uniden- tified*	Uniden- tified*	Uniden- tified*	<i>Thalassen- chelys</i>
Lateral pigment											
A. Absent (first pair maxillary and mandibular teeth very large)										+	+
Midlateral pigment present											
B. Irregular double row of minute spots along body			+								
C. One minute spot per segment		+									
D. Round groups of minute spots along body								+			
E. Large spots, widely spaced						+					
F. Axial spots confined posteriorly				(+)							
Pigment elsewhere											
G. W-shaped rows of minute spots on anterior margin of segments	+			+							
H. Round groups of minute spots all over body									+		
Head pigment											
I. Scattered spots behind eye and on heart	+	+	+	+				+	+		+
J. A row of spots along upper and lower jaws				+							
K. A patch below iris			(+)	+							
L. A few spots on snout tip or on olfactory organ								+	+		+
Gut pigment											
M. Minute spots ventrally before stomach and dorsally behind stomach		+	+	+							
N. Minute scattered spots dorsally along gut to anus or only posteriorly	+									+	
O. Minute spots below gut				+				+	+		
P. Large widely spaced spots						+					
Q. Minute spots on liver											+
R. Round groups of spots on gut								+	+		
Other pigment											
S. Spots on anal base or rays				+				+	+		
Myomeres/vertebrae											
Min.	136	98	116	97		130	ca.				142
Max.	141	107	5	125		136	157				163



XENOCOGRIDAE

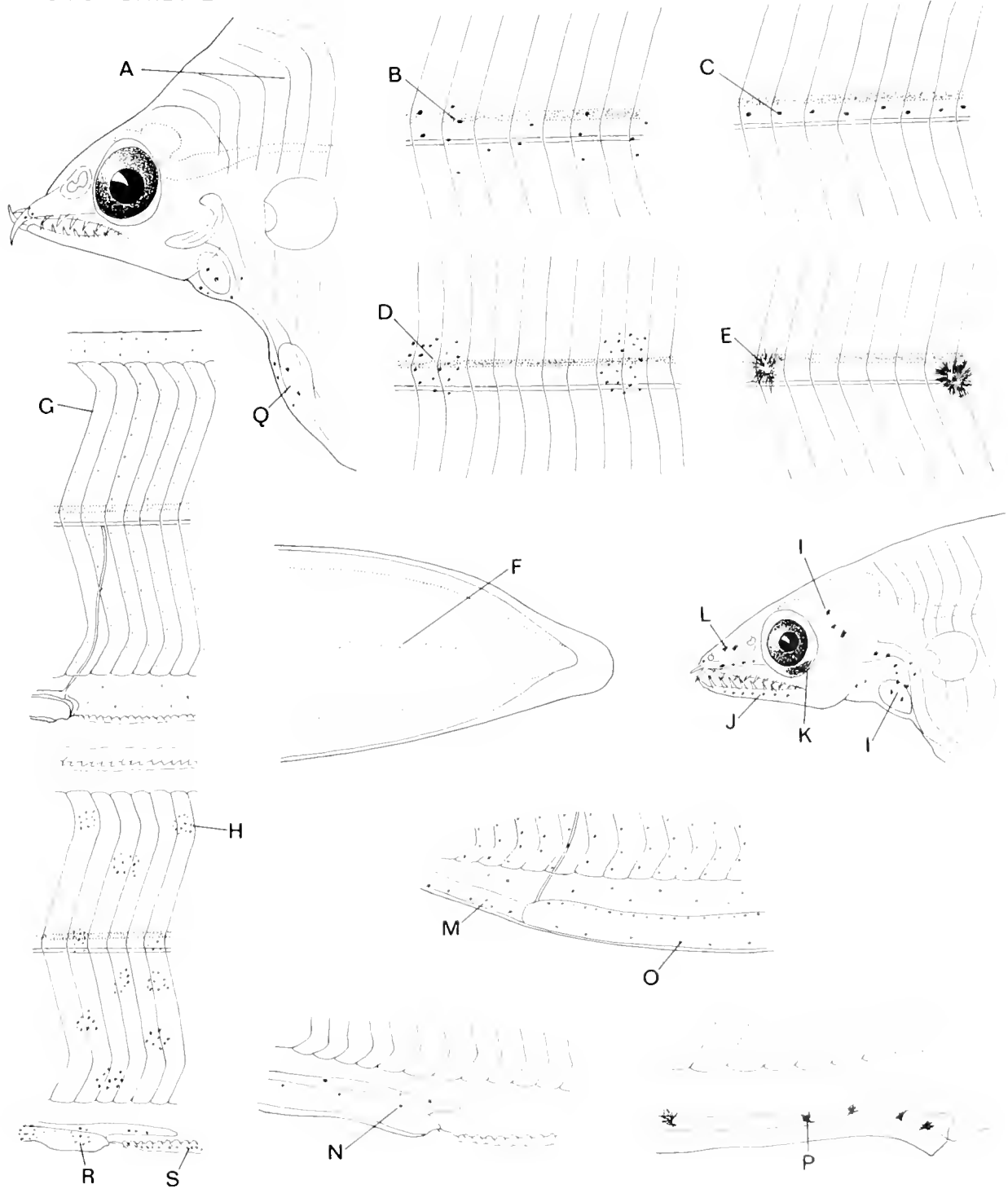

Fig. 42. Illustrations accompanying Table 22.

TABLE 23. PIGMENT AND MYOMERE CHARACTERS OF MORINGUIDAE, CYEMATIDAE AND SACCOPHARYNGOIDEA. + = All species; † = Smith, 1979; †† = Castle and Raju, 1975; * = Larva unidentified. Refer to Fig. 43.

Characters	Taxa									
	<i>Moringua</i>	<i>Neoconger</i>	Unidentified†	<i>Cyema</i>	<i>Neocyema</i> *	<i>L. holti</i> group*	<i>Sacropharynx</i>	<i>Eurypharynx</i>	<i>Mono-gnathus</i>	Unidentified††
Lateral pigment										
A. Absent			+				+	+	+	+
B. Scattered over lateral surface				+						
C. Midlateral series										
1. Single spot behind anus		+								
2. Multiple spots along body (5-11)	+					+				
D. Short rows of spots on myotomes dorsally and ventrally (juvenile pigment)									+	
Head pigment										
E. On snout and lower jaw										
1. Present				+		+				
2. Absent	+	+	+				+	+	+	+
Gut pigment										
F. One large posterior spot	+	+	+							
G. One small anterior spot		+								
H. Series of spots along gut				+		+				
I. Minute spots scattered over posterior surface							+	+	+	+
J. Few small spots on liver										+
Myomeres/vertebrae										
Min.	107	96	121	74		102	138	97	94	ca.
Max.	180	110	132	78		104	250	125	113	105

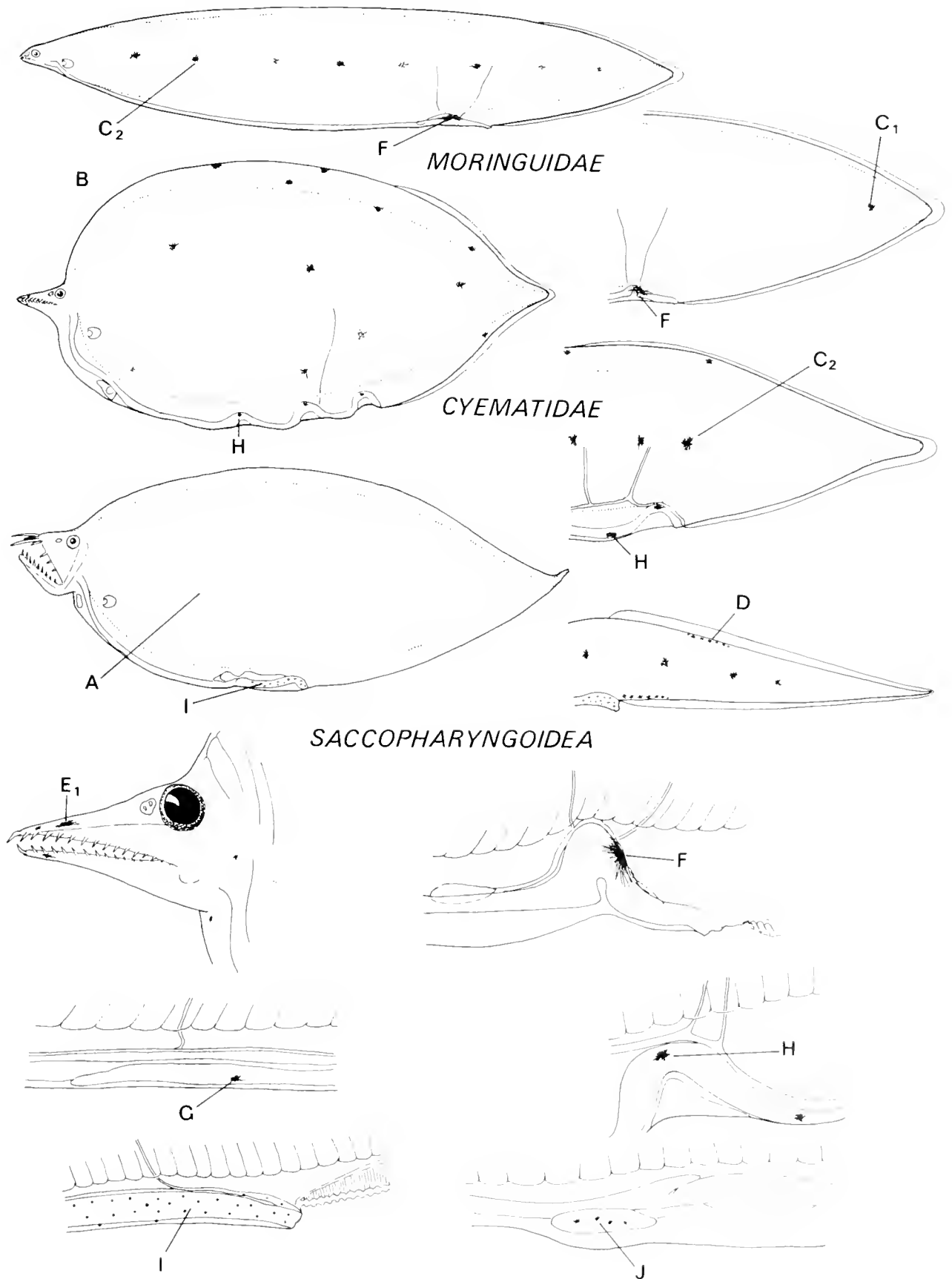

Fig. 43. Illustrations accompanying Table 23.

Elopiformes, Notacanthiformes and Anguilliformes: Relationships

D. G. SMITH

NOTACANTHIFORMES

THE Notacanthiformes is composed of two clearly defined families, the Halosauridae and Notacanthidae. Overall, the Halosauridae is the more primitive family. McDowell (1973) divided it into two subfamilies: the Halosaurinae, containing only *Halosaurus*, and the Halosauropsinae, containing *Halosauropsis* and *Aldrovandia*. The notacanthids show a number of specializations not found in the halosaurs, involving mainly the mouth and dorsal fin. The Notacanthidae contains either two or three genera, depending on the placement of *Lipogenys*. McDowell recognized only *Notacanthus* and *Polyacanthonotus* in the Notacanthidae while assigning *Lipogenys* to a separate family. He considered the Lipogenyidae and Notacanthidae to form a suborder of the Notacanthiformes, the Notacanthoidei, which stood opposed to the Halosauroidae. Greenwood (1977), however, felt that *Lipogenys* was closely related cladistically to *Polyacanthonotus* and that those two genera formed the sister group of *Notacanthus*. A classification of the Notacanthiformes based on Greenwood's interpretation would be as in Fig. 44.

Notacanthiform larvae cannot yet be identified confidently below the ordinal level and hence can tell us little about relationships within the order. Smith (1970) gave reasons to suspect that the *Tiluropsis* form (short head, vertically elongate eye) belongs to the Halosauridae. Circumstantial evidence suggests that the *Tilurus* form (short head, normal eye) is the larva of the Notacanthidae. *Tilurus* is the only notacanthiform larva found in the Mediterranean. Although adult notacanthids of both *Notacanthus* and *Polyacanthonotus* occur in the Mediterranean, halosaurs apparently do not (McDowell, 1973). The identity of the third basic type of notacanthiform larva, known as *Leptocephalus giganteus* (long head, normal eye), cannot even be guessed at this point.

ANGUILLIFORMES

The Anguilliformes, the true eels, is the largest and most specialized of the elopomorph orders. A definitive classification of the Anguilliformes does not yet exist. The scheme that follows can be considered an outline that will be filled in and modified as studies continue.

The eels can be divided into two groups: those in which the frontal bones are fused, and those in which they remain as separate right and left elements. This observation dates back to Regan (1912), but its phylogenetic significance has not always been agreed upon. Regan himself said nothing about it one way or another; he simply used it as a key character. A case can be made for the view that the fusion of the frontals was a single event that occurred quite early in the evolutionary history of eels and therefore reflects a real phylogenetic division. On the whole the fused-frontal group contains more primitive members than the divided-frontal group, although the fused condition is itself a derived character state. Except for *Anguilla*, all the divided-frontal eels are markedly specialized, including pelagic and fossorial representatives. Yet in none of these lines has a fusion of the frontals been among the modifications. Of the more

specialized members of the fused-frontal group, all but the Serrivomeridae can be clearly traced back to more primitive members, all with perfectly fused frontals. It is more parsimonious to assume that fusion took place once at a point early in anguilliform evolution than to assume that it occurred several times early but not at all later on.

The number of families in the fused-frontal group is still somewhat uncertain. Ten are provisionally recognized here. The Synphobranchidae, Simenchelyidae, and Dysommataidae are closely related and could easily be considered subfamilies of the Synphobranchidae (Robins and Robins, 1976). They combine some very primitive characters with some peculiar specializations and do not seem to be intimately related to any of the other families. The Nettastomatidae shares several advanced characters with certain congrid and could be considered a derivative of that group. The interrelationships of the remaining families are not clear; the resemblances involve mainly primitive characters. The Ophichthidae is a large and morphologically diverse family containing both generalized and highly modified forms. It is united by certain specialized characters such as a ventrally displaced posterior nostril, a reduced caudal fin, and numerous branchiostegal rays that overlap on the ventral midline. The Congridae (including Macrocephenchelyidae) is also a large family, but without the extreme variety of external morphology found in the Ophichthidae. Its specializations are more subtle and consist mainly of trends in several characters. The Colocongridae and Muraenesocidae have at various times been included in the Congridae, but again the resemblances are mainly in primitive characters. Neither family fits the pattern of character modification found in the Congridae, and both show at least one primitive character that is absent in nearly all congrid: separate hypohyals. The Muraenesocidae is here restricted to *Muraenesox* itself and its close relatives *Congresox*, *Cynoponticus* and *Sauromuraenesox*. Of the other genera previously referred to this family, *Hoplunnis* has been removed to the Nettastomatidae (Smith, 1979; Smith and Castle, 1982), and *Xenomystax* (including *Paraxenomystax*) probably belongs in the Congridae. The Derichthyidae and Serrivomeridae are midwater eels, the former relatively little modified, the latter highly modified. The Serrivomeridae was formerly associated with the Nemichthyidae, but this seems unlikely. The completely fused frontals and massive palatopterygoid arcade of serrivomerids differ strikingly from the partially fused frontals and reduced pterygoid found in nemichthyids.

There are eleven families of eels with divided frontals: the Anguillidae, Moringuidae, Heterenchelyidae, Myrocongridae, Xenocongridae, Muraenidae, Nemichthyidae, Cyematidae, Saccopharyngidae, Eurypharyngidae, and Monognathidae (the monognathids actually have fused frontals, but they are clearly related to the saccopharyngids and eurypharyngids and the fusion seems secondary). Although they are more clearly defined than the fused-frontal families, their interrelationships are still uncertain. Except for the Anguillidae, they are all distinctly specialized, either for burrowing (Moringuidae, Heterenchelyidae), for midwater life (Nemichthyidae, Cyematidae, Sacco-

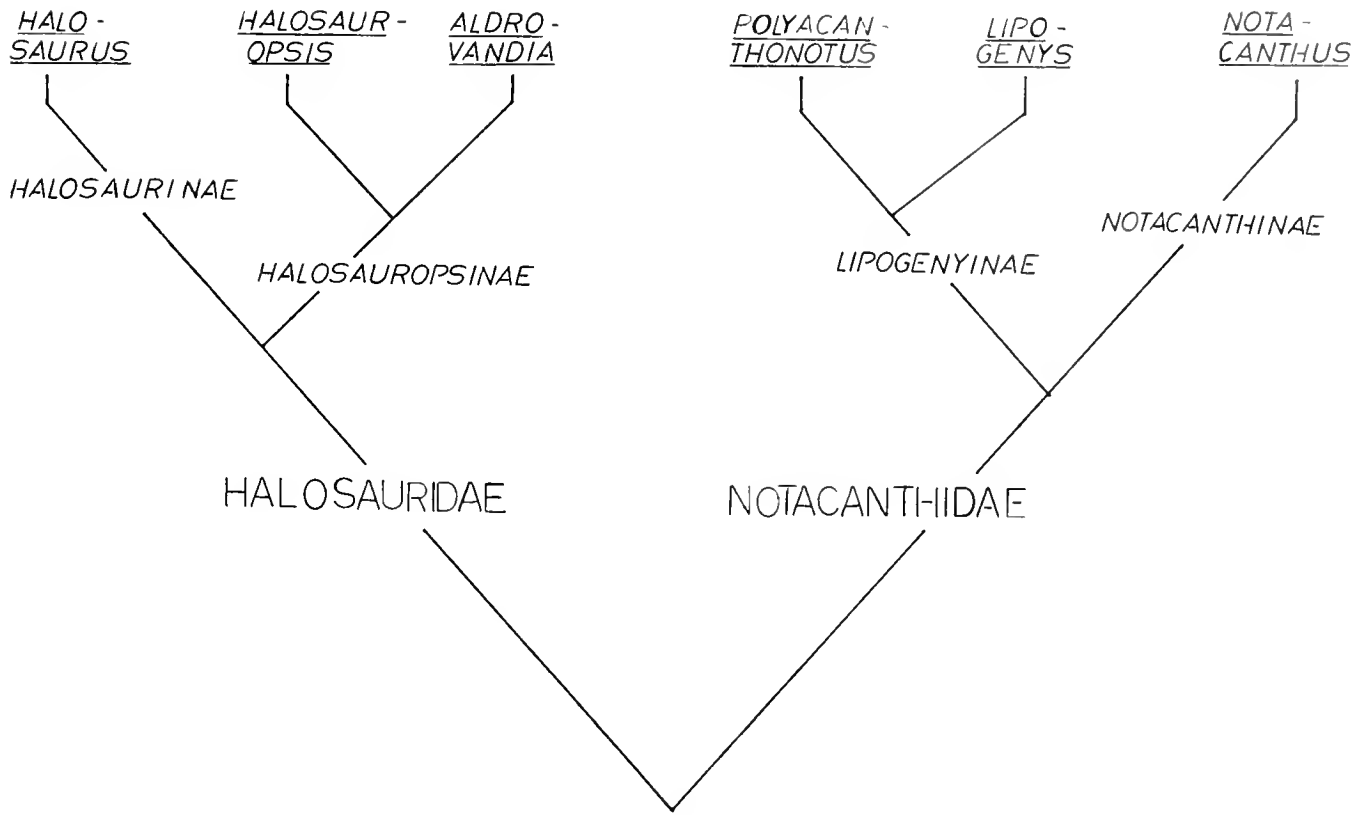

Fig. 44. Hypothesis of relationships within the Notacanthiformes.

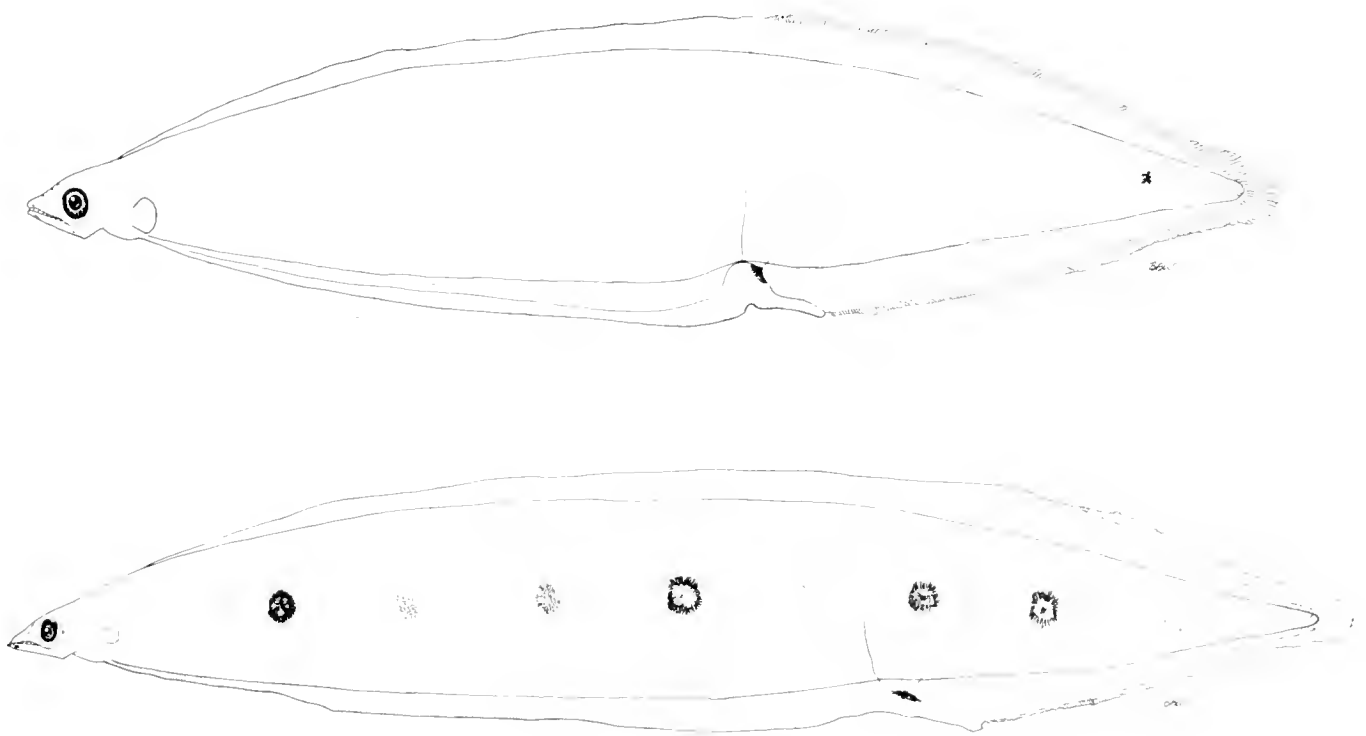

Fig. 45. Leptocephali of *Neoconger* (above) and *Moringua* (below) (Moringuidae).

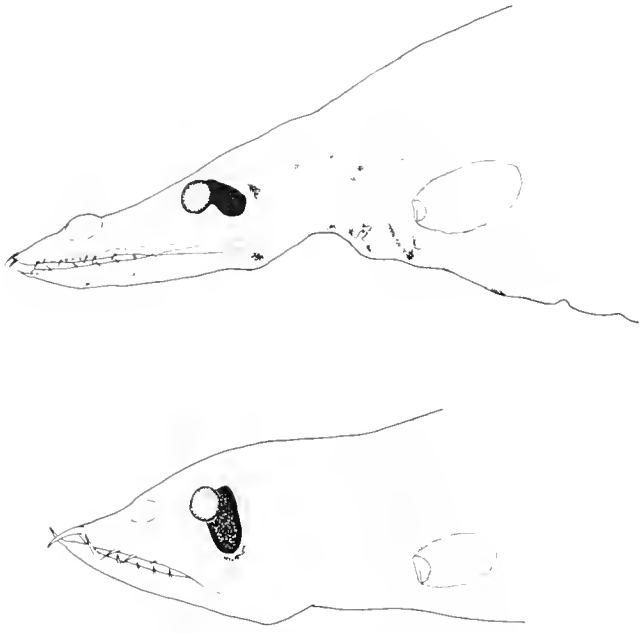

Fig. 46. Heads of leptocephali of Dysommataidae (above) and Synphobranchidae (below), showing telescopic eye.

pharyngidae, Eurypharyngidae, Monognathidae), or as cryptic forms with modified lateral-line and gill-arch characters (Myrocongridae, Xenocongridae, Muraenidae). Two clear associations are evident within this group. One contains the Myrocongridae, Xenocongridae, and Muraenidae. These three families are relatively generalized externally but share a marked reduction in gill-arch elements and in the lateral line. The second association contains the three families Saccopharyngidae, Eurypharyngidae, and Monognathidae, the so-called gulper eels. These are highly modified midwater eels with a greatly enlarged mouth and an elongated, posteriorly directed suspensorium. The gulpers show extreme reduction in all the skeletal elements, and their relationship to other eels is difficult to determine. Among the remaining families, the Anguillidae is quite primitive morphologically, but it seems to have no advanced characters clearly linking it to any of the other families. The Mo-

ringuidae and Heterenchelyidae are fossorial forms that nevertheless show substantial internal differences from each other (Smith and Castle, 1972). Their resemblances may simply be convergent adaptations to a similar way of life. The Nemichthyidae and Cyematidae both have prolonged, nonocclusible jaws studded with tiny recurved teeth, but they differ markedly in almost every other character; their traditional association must be questioned.

Larval characters have so far proved more useful in elucidating relationships within families than between them. Some examples will illustrate the contribution that larvae have made to systematics.

The Moringuidae consists of two genera, *Moringua* and *Neoconger*. Although both are basically fossorial forms, they differ enough in external appearance that for more than a century they were placed in different families. It was only the striking similarity of the larvae (Fig. 45) that prompted a critical comparison of the adults (Smith and Castle, 1972). In this case, the larvae show the relationship much more clearly than do the adults.

The close relationship between the Synphobranchidae and Dysommataidae is supported by a unique feature of the larvae—the telescopic eye (Fig. 46).

The genus *Hoplunnis* has long been placed in the family Muraenesocidae because of its possession of a pectoral fin and its enlarged median vomerine teeth. *Saurenchelys* was always considered a nettastomatid because it lacked a pectoral fin. Smith and Castle (1982) showed that the larvae of these genera are indistinguishable (Fig. 47). On that basis and because of many similarities in the adults, *Hoplunnis* and *Saurenchelys* were shown to be closely related and to belong in the Nettastomatidae. The two characteristic swellings in the gut of larval *Hoplunnis* and *Saurenchelys* are also found in the larvae of *Nettastoma* and *Nettenchelys*.

The major problem in eel systematics today is the relationship between the families, and here larvae provide little help. Similarities occur between larvae of families which otherwise show no evidence of close relationship. For example, the larvae of the Anguillidae and Derichthyidae are quite similar (the larva of *Derichthys* was even named *Leptocephalus anguilloides*), but the two families do not seem especially close and fall on opposite sides of the fused-frontals vs. divided-frontals dichotomy. The larvae of the Heterenchelyidae resemble those of certain congrid, but heterenchelyids have divided frontals and congrid have fused frontals. Larvae of the congrid genus *Acromycter*

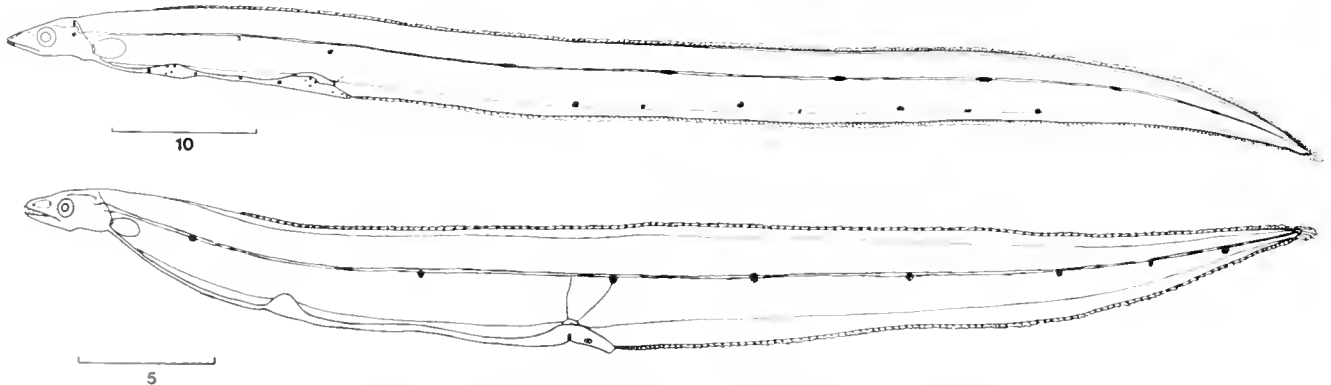

Fig. 47. Leptocephali of *Hoplunnis tenuis* (above) and *Saurenchelys* sp. (below) (Nettastomatidae).

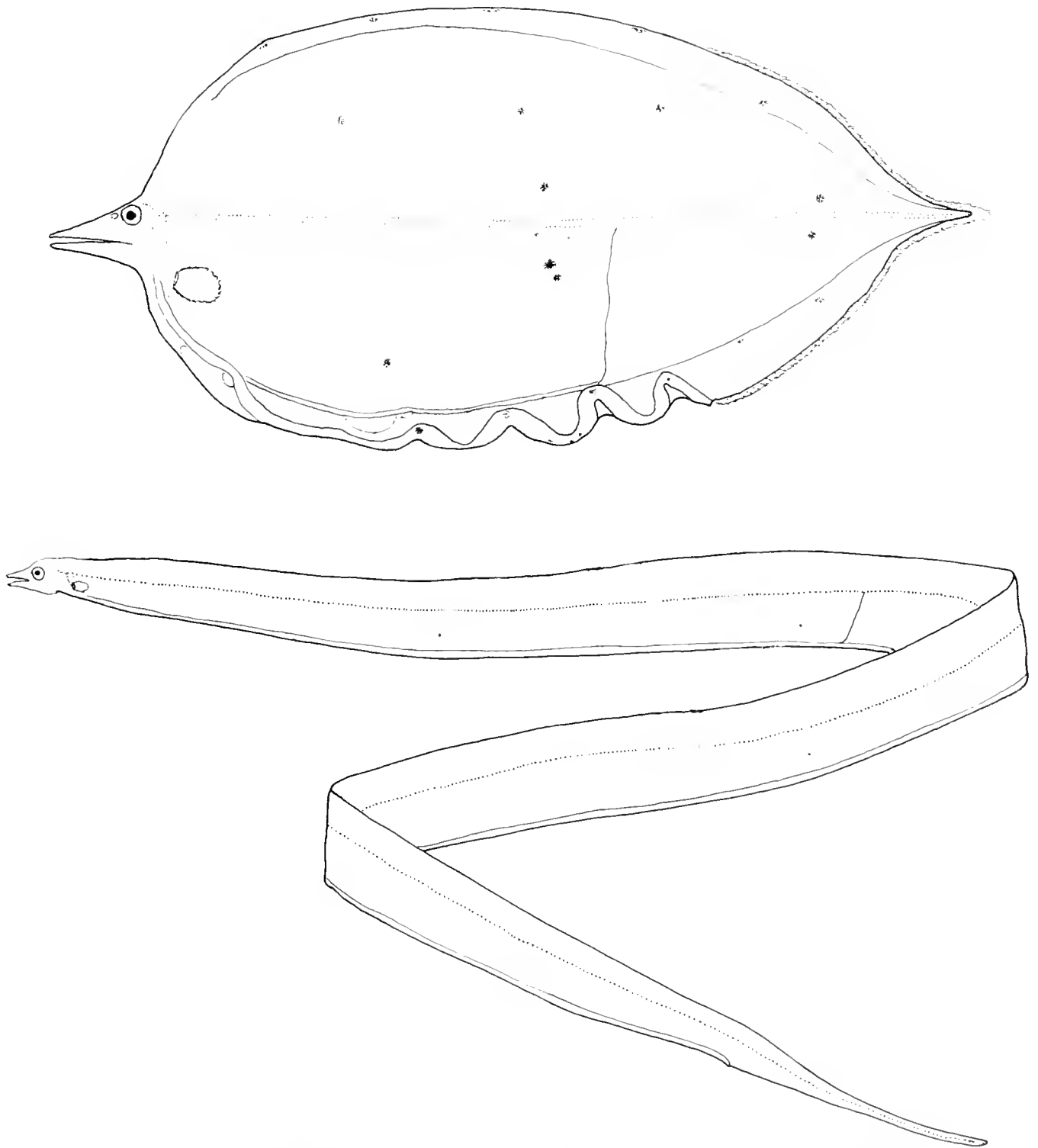

Fig. 48. Leptocephali of *Cyema atrum* (Cyematidae) (above) and *Nemichthys scolopaceus* (Nemichthyidae) (below).

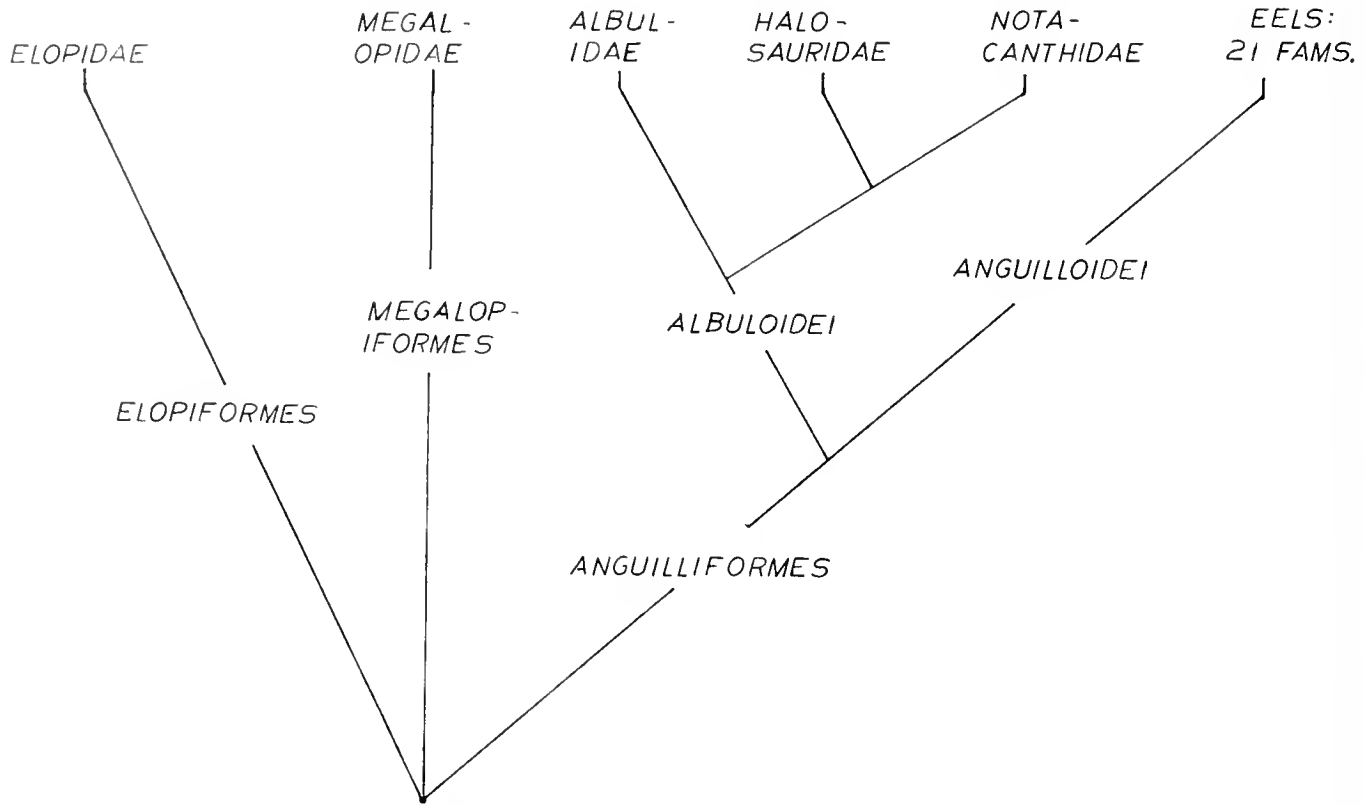

Fig. 49. Hypothesis of relationships between major groups of elopomorphs.

(Fig. 52E) have a looped gut and superficially resemble certain ophichthids (Fig. 51A); on the other hand, some ophichthid larvae (for example, *Basicanichthys*, Fig. 52D) have a weakly looped gut and superficially resemble congrid larvae (Smith and Leiby, 1980).

A contraindication of relationship may be shown by the larvae of the Nemichthyidae and Cyematidae. It was mentioned above that these two families differ in many characters and that their traditional association must be questioned. The larvae of these families are as different from each other as any two leptocephali can be. Nemichthyid larvae are long and slender with a simple gut that reaches almost to the tip of the tail. Cyematid larvae, on the other hand, are high and deep and their gut contains several characteristic loops (Fig. 48). Some observers have noticed a resemblance between cyematid larvae and saccopharyngoid larvae and have suggested that these families are related (Bertin, 1937; Raju, 1974).

Despite the caveats that must be invoked when dealing with the systematic implications of leptocephali, these larvae play an important role in systematic studies of eels. They provide additional characters to be used in systematic analysis, and they are often more readily accessible than adults. The cryptic or burrowing habits of most adult eels make them difficult to collect in large numbers. The larvae, on the other hand, live in open water near the surface and can easily be collected with plankton nets or midwater trawls. In many cases, larvae provide data on distribution and species structure that are unavailable from adults (Smith and Castle, 1972, 1982).

ELOPOMORPHS

The Notacanthiformes and Anguilliformes belong to a group of fishes called elopomorphs, along with the Megalopidae, Elopidae, and Albulidae (including Pterothrissidae). Current concepts of the interrelationships of the major groups of elopomorphs are illustrated in Fig. 49 (Greenwood, 1977; Patterson and Rosen, 1977; Lauder and Liem, 1983). The trichotomy exists because there seem to be no derived characters that clearly link any of the three main branches with any of the others.

Elops and *Megalops* (including *Tarpon*) seem more similar to each other than either is to *Albula*, but this may be because they are both midwater feeders with terminal mouths, whereas *Albula* is a bottom feeder. *Albula* has several specializations (enlarged cephalic canals, prolonged snout) that are lacking in *Elops* and *Megalops*. Most if not all of the resemblances between *Elops* and *Megalops* may be explained either as primitive characters or as adaptations to a similar way of life. *Megalops* has several derived characters not found in *Elops*, most notably the vascular air bladder and the otophysic connection. *Elops* does not seem to have any feature that is derived relative to other elopomorphs.

Several synapomorphies can be cited to link the Notacanthiformes and the Albulidae (Nelson, 1973; Greenwood, 1977). The eels are usually placed on the albulid branch as well, but this is still an open question. The Anguilliformes and Notacanthiformes share a similar elongate body form, but this feature has evolved so many times in fishes that it means little by itself.

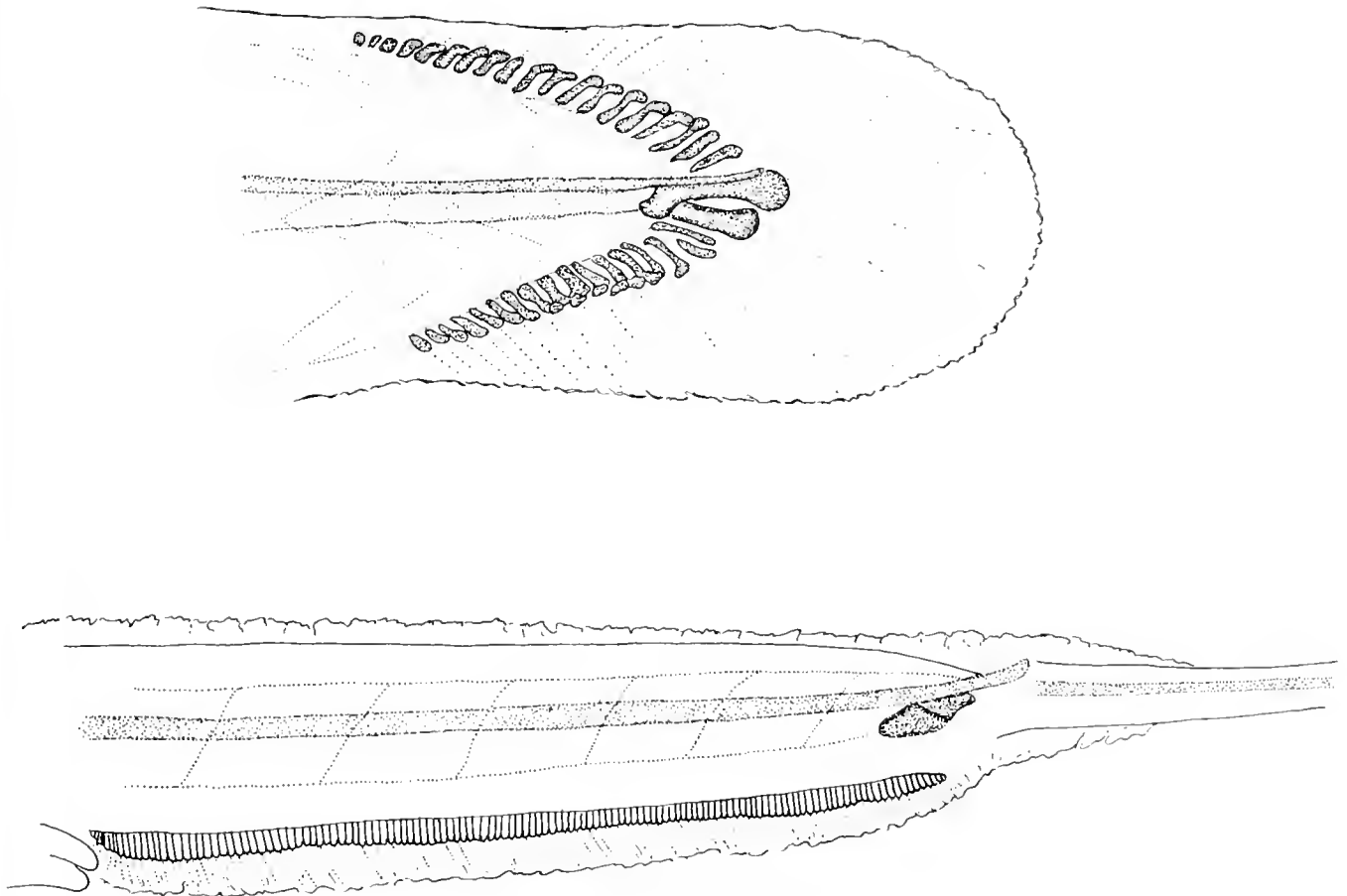

Fig. 50. Caudal structure of an anguilliform leptocephalus (above) and a notacanthiform leptocephalus (below).

The only real character seems to be the swim-bladder morphology of the two groups (Marshall, 1962), but a critical comparison with the swim bladders of *Elops* and *Megalops* has not been made. Until that is done, it cannot be determined whether the swim bladders of eels and notacanthiforms represent a synapomorphy or simply a general condition of elopomorphs.

Larvae probably cannot resolve the trichotomy. A classification based on larvae would also yield three groups, but they would not be the same three groups. The three main groups of larvae are the fork-tailed group, the notacanthiform group, and the anguilliform group. These simply represent the condition in the adults. The forked tail is a primitive condition retained in the Elopidae, Megalopidae, and Albulidae.

Larvae do not reveal much about relationships within the fork-tailed group either. The larvae of *Elops* and *Megalops* resemble each other more than they do that of *Albula*. They are smaller, the gut is shorter, and the dorsal fin is above or nearly above the anal fin. *Albula* shows a trend toward elongation, although the myomeres are no more numerous than those of *Elops*. The gut is very long, ending under the hypural, and the dorsal fin is much farther forward than the anal fin. *Pterothrissus* is even more elongated and grows larger before metamorphosis than *Albula*. In albulids the myomeres are more V-shaped than W-shaped. If the primitive condition is small size and relatively

short larval life, then *Megalops* has the most primitive larva. It is the smallest known leptocephalus, metamorphosing before it reaches 30 mm standard length, at an age of two to three months (Smith, 1980). Larvae of *Elops* are closer in size and form to those of *Megalops* than to *Albula*, but this does not necessarily demonstrate that the two former genera are more closely related to each other cladistically than either is to *Albula*. It could simply mean that *Elops* and *Megalops* retain a more primitive larval form and that, once again, they merely lack a specialization found in albulids.

The larvae of the Notacanthiformes and Anguilliformes do not indicate a particularly close relationship between the two groups. The elongated form simply reflects the condition in the adults, and in several respects the two groups are quite different. The short-based dorsal fin and the presence of pelvic fins in notacanthiform larvae immediately separate them from anguilliform larvae. Eels lack pelvic fins and their dorsal fin is long and confluent with the caudal and anal fins. In both these characters the notacanthiforms show the more primitive state. In the structure of the tail, however, the notacanthiforms are more highly modified. Eels, despite their elongate form, retain a caudal fin complete with hypural plates and caudal fin rays. To be sure, the caudal fin is greatly reduced and shows much fusion of elements, but it clearly exists, in larvae as well as adults (Fig.

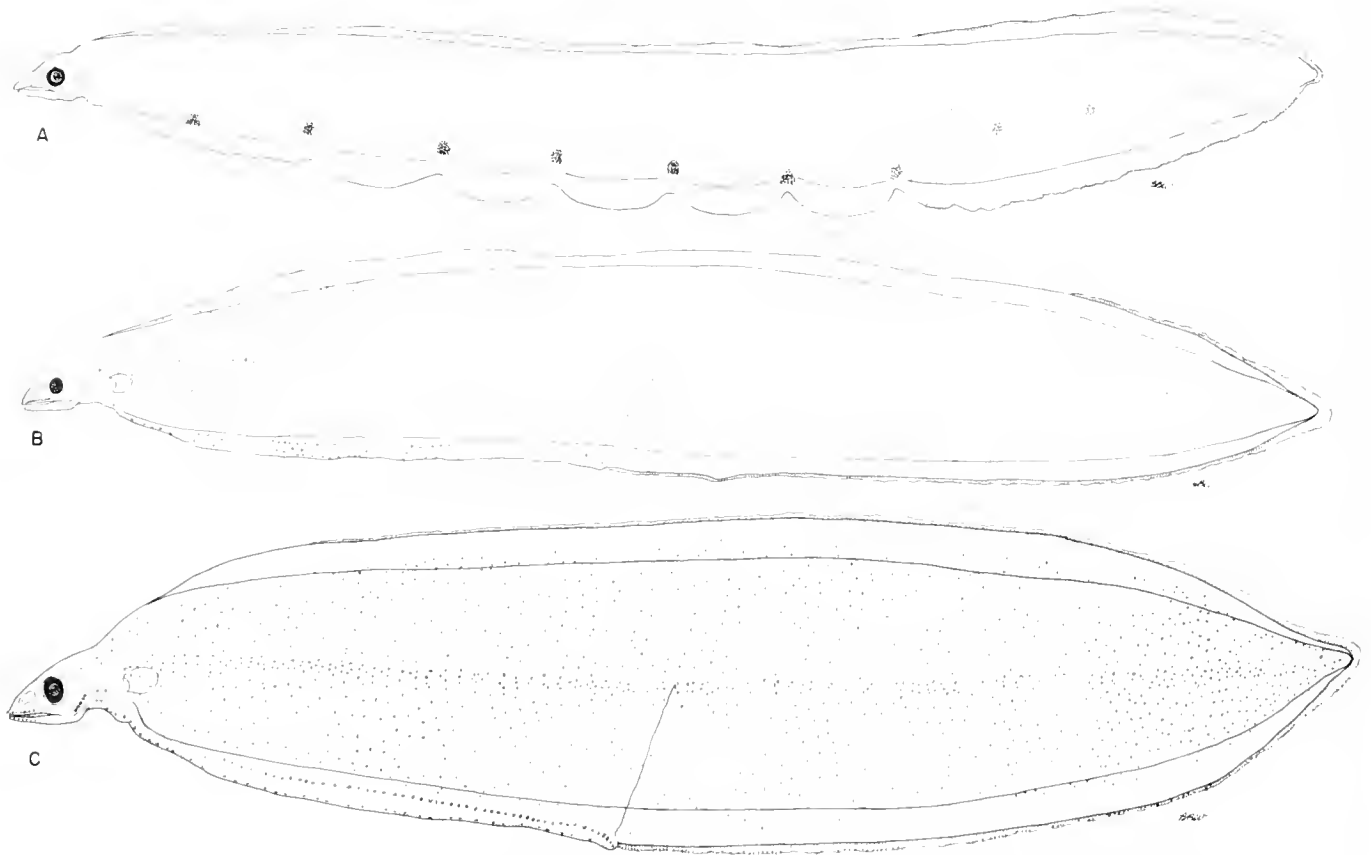

Fig. 51. Leptocephali of (A) *Callecheilus* sp.; (B) *Catesbya pseudomuraena*; and (C) *Kaupichthys hypoprooides*.

50, top). Notacanthiforms have no true caudal fin. In adult notacanthiforms the vertebrae approaching the tip of the tail become progressively less ossified, the centra being reduced to rings around the notochord separated from the neural and hemal arches. Finally the vertebrae disappear, leaving the notochord freely exposed (McDowell, 1973). There is no hypural structure, and caudal fin rays, if they exist, are indistinguishable from the posterior anal fin rays. The notacanthiform larva likewise has no caudal fin (Fig. 50, bottom); the notochord ends freely, but there are two structures that may be hypural elements. Posterior to these and to the notochord is a single filament that trails freely for a variable distance and might represent a caudal fin ray. The anal fin occupies the short space between the anus and the end of the tail proper (excluding the caudal filament). The important point here is that lumping notacanthiform and anguilliform larvae as pointed-tail leptocephali is unwarranted, because the caudal structure is quite different in the two groups. Returning to the diagram in Fig. 49, the fork-tailed leptocephali can be viewed as the primitive type of leptocephalus present in the elopid and megalopid branches and retained in the Albulidae as well. Two points of transformation occur, one in the notacanthiform line and one in the anguilliform line. The modifications in each reflect modifications in the adults and by themselves are not indications of a special relationship. Additional leptocephali illustrations were prepared and are presented here without further comment (Figs. 51, 52).

RELATIONSHIPS BETWEEN ELOPOMORPHS AND OTHER TELEOSTS

A widely favored view today is that the teleosts consist of four major groups in a cladistic sense: the Osteoglossomorpha, Elopomorpha, Clupeomorpha, and Euteleostei (Greenwood et al., 1966; Greenwood, 1973; Nelson, 1973; Patterson and Rosen, 1977). These groups are arranged in a hierarchy with the Osteoglossomorpha as the sister group of the remaining three, the Elopomorpha as the sister group of the remaining two, and the Clupeomorpha as the sister group of the Euteleostei (Fig. 53). This classification is based on a few characters that are thought to represent synapomorphies. It is essential, therefore, to evaluate these characters carefully, because the whole classification stands or falls on their reliability.

The Elopomorpha is united by three characters: 1) the presence of rostral and prenasal ossicles; 2) the initial fusion of the angular and retroarticular bones in the lower jaw; 3) the presence of a leptocephalus larva. It is not certain that eels have rostral ossicles. Considering the extreme fusion that has taken place in the anterior extremity of the skull in eels, it should not be surprising if the rostral ossicles were lost as well. Still, it means that the character may not be wholly inclusive of the group. The second character, the fusion of the angular and retroarticular, seems to hold for eels (Leiby, 1979b) and appears to be a true synapomorphy. That leaves the leptocephalus, and its role is

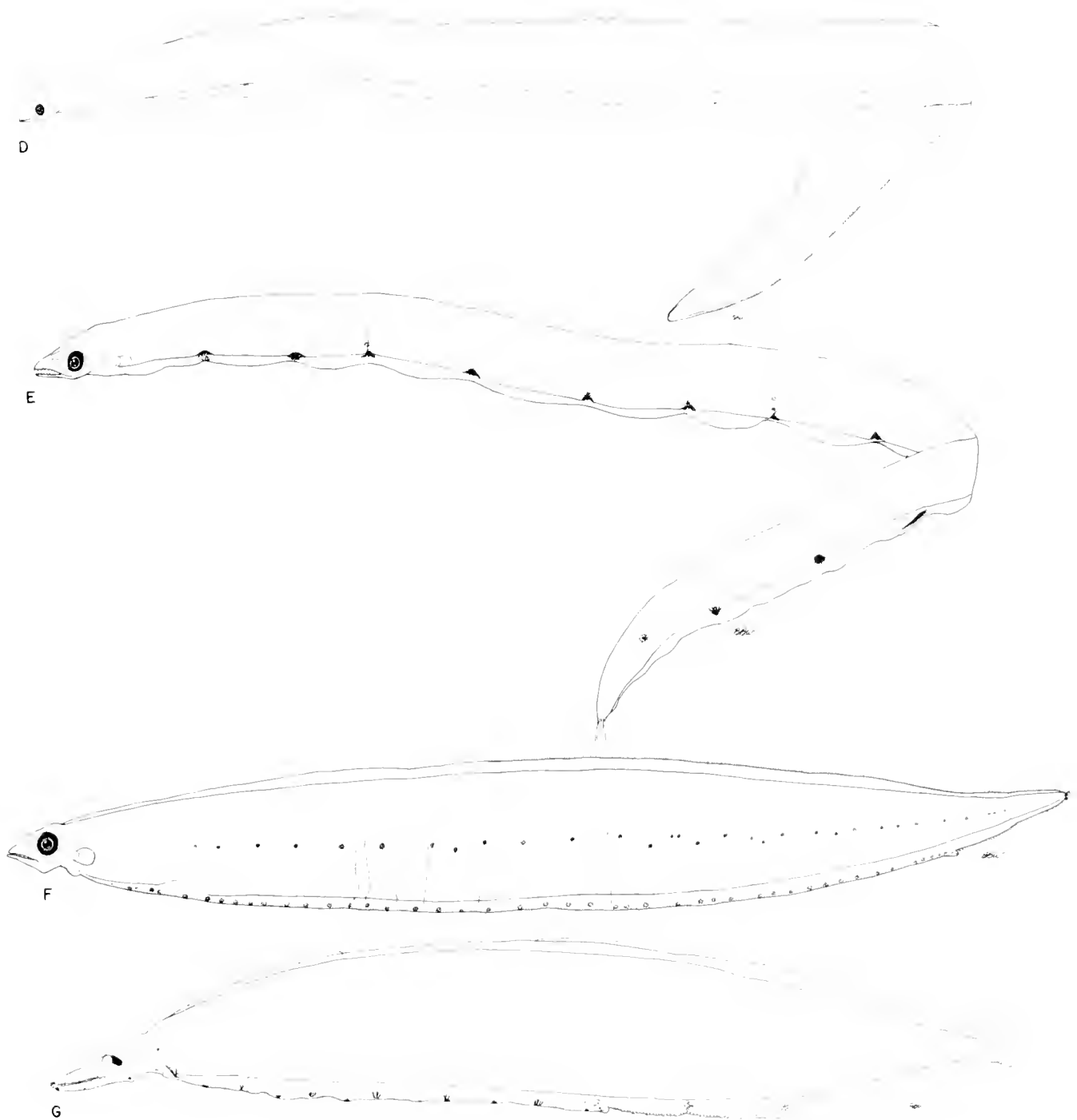

Fig. 52. Leptocephali of (D) *Bascanichthys* sp.; (E) *Acromycter* sp.; (F) *Hildebrandia*; and (G) *Dysomma angullare*

crucial. If it is a synapomorphy, then the congruence between it and the lower-jaw character reinforces the naturalness of the Elopomorpha. Furthermore, it is a more complex character, thus less likely to show parallelism than a simple process like the fusion of two bones in the lower jaw (which, indeed, has happened independently in some osteoglossomorphs).

To explore this matter, we must first establish clearly what a leptocephalus is. If, as some have maintained, it were simply a ribbon-like larva with a posterior anus and a dorsal fin that moves forward at metamorphosis, then it would tell us little about elopomorph phylogeny. Many lower teleosts have such larvae. A leptocephalus is considerably more than this, however.

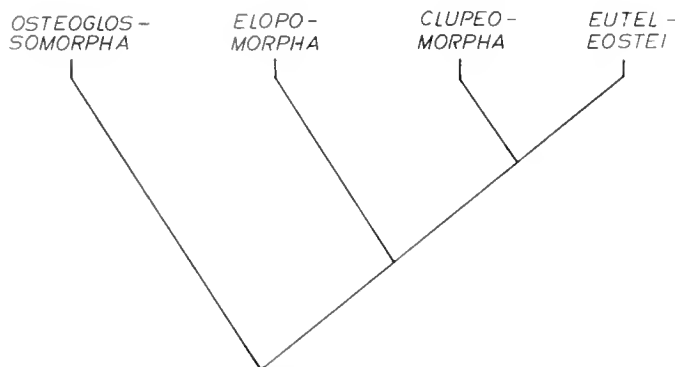

Fig. 53. Hypothesis of relationships between major groups of Teleostei.

The unique structure of a leptocephalus can be appreciated best in cross section (Fig. 54, left). The viscera lie along the ventral margin in a narrow strand. The notochord, dorsal nerve cord, and dorsal aorta lie together in the longitudinal axis of the body about midway between the dorsal and ventral margins. The myomeres form a thin layer on the outside. Filling the rest of the interior of the body is an acellular mucinous material bounded by a continuous layer of epithelial cells. The mucinous pouch separates the viscera, the notochord and the two sides of the body musculature from each other and gives form and rigidity to the body. The characteristic shrinkage of the leptocephalus at metamorphosis is due to the loss (presumably by resorption) of the internal mucinous material. A typical clupeid larva such as *Etrumeus teres* (Fig. 54, right) is constructed much differently. Here there is no mucinous pouch. The notochord occupies a large part of the cross-sectional area and is surrounded immediately by the thick axial musculature to form a solid, compact structure. The viscera lie immediately below the dorsal aorta. Leptocephali have a small head and a set of long, sharp teeth whose function is uncertain, since leptocephali do not seem to be predatory. The basic structure of a leptocephalus is the same whether it is an elopiform, notacanthiform or anguilliform. A leptocephalus larva is known for every family of elopomorphs except the rare, monotypic Myrocongridae, so the character seems entirely inclusive of the group. Nothing even remotely comparable is found outside the Elopomorpha.

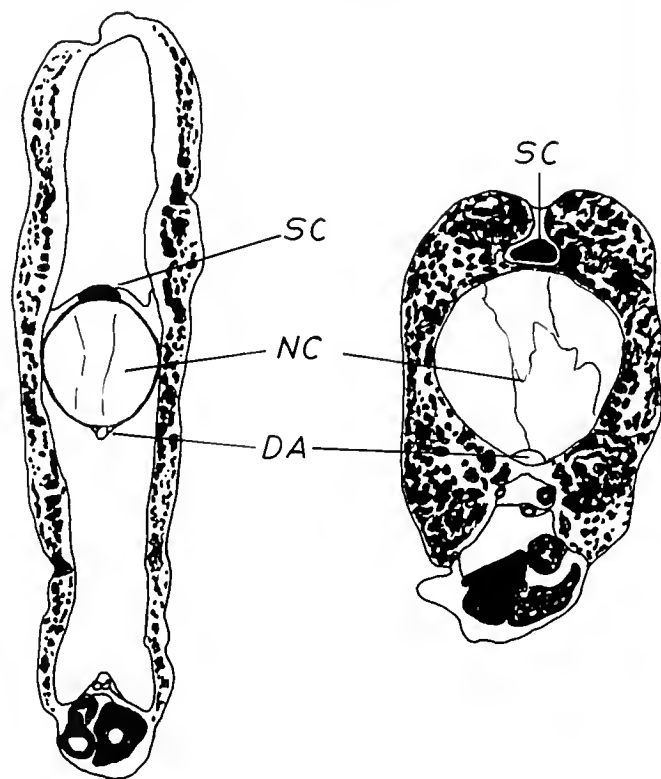

Fig. 54. Cross section through the bodies of a leptocephalus (*Megalops atlanticus*) (left) and a clupeid larva (*Etrumeus teres*) (right). DA, dorsal aorta; NC, notochord; SC, spinal cord.

The leptocephalus, then, must be considered a true synapomorphy and powerful evidence in favor of the monophyly of the Elopomorpha. Perhaps nowhere else in fish systematics have larval stages played a more important role.

THE MARINE BIOMEDICAL INSTITUTE, THE UNIVERSITY OF TEXAS
MEDICAL BRANCH AT GALVESTON, 200 UNIVERSITY BOULEVARD,
GALVESTON, TEXAS 77550.

Ophichthidae: Development and Relationships

M. M. LEIBY

THE family Ophichthidae, comprising approximately 250 nominal species and 53 recognized genera, is arranged in six tribes and two subfamilies (McCosker, 1977) (Fig. 55). The subfamilies, Myrophinae and Ophichthinae, are separated by a

number of characters. All adult Myrophinae have a well-developed caudal fin which is continuous with the dorsal and anal fin. Adult Ophichthinae, except for *Echelus* in the tribe Ophichthini and *Leptenchelys* in the tribe Bascanichthyini, lack a caudal

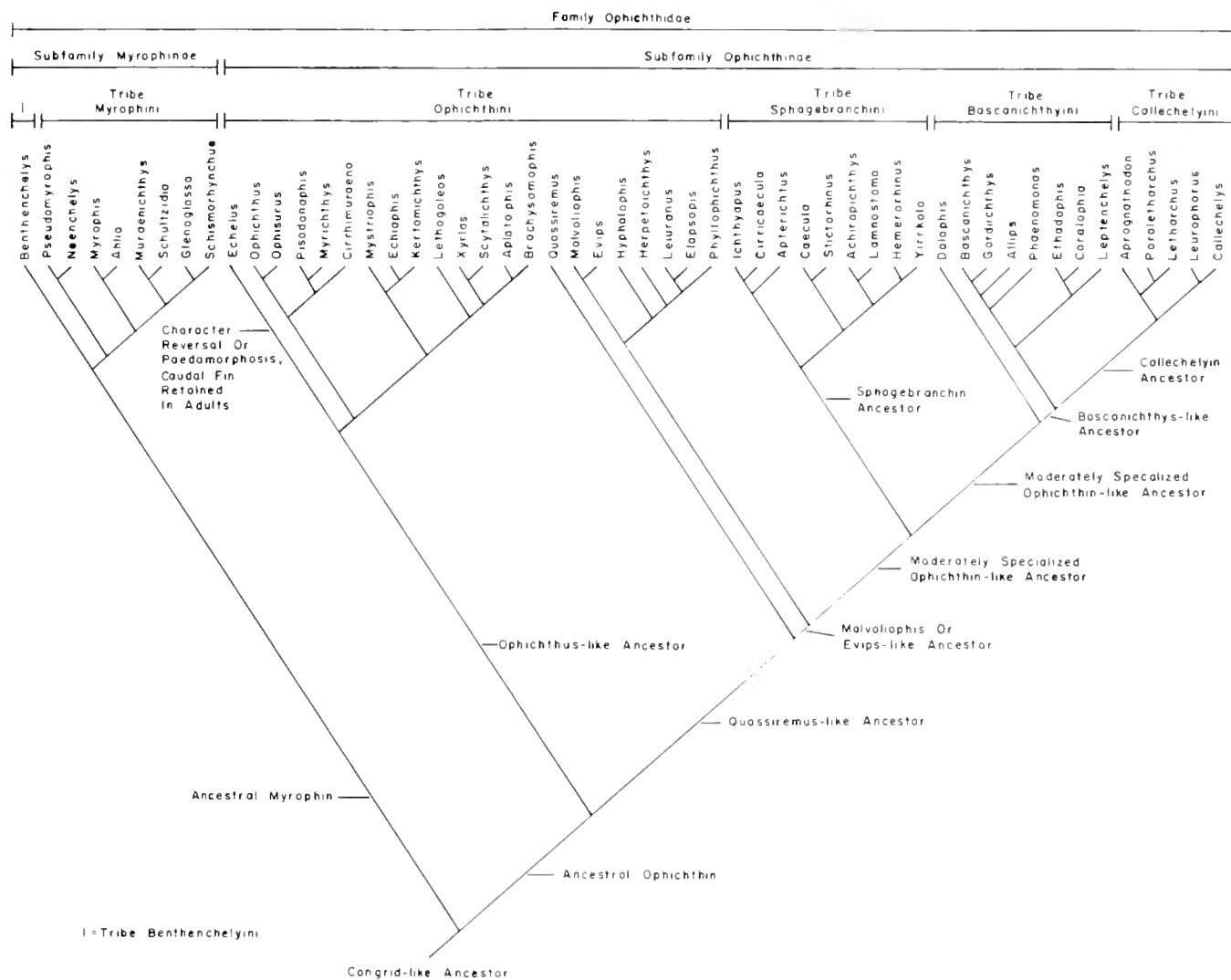

Fig. 55. Hypothesized relationships of the subfamilies and genera of the eel family Ophichthidae.

fin having instead a hardened tail tip with, at most, a few rudimentary caudal rays embedded in the flesh of the tail. The monotypic genus *Leptenchelys*, known only from the 115 mm type specimen, has caudal-fin rays, but they are weakly developed compared to those of a myrophin (McCosker, 1977). Since all ophichthid larvae have a well-developed caudal fin until the onset of metamorphosis, the presence of weakly developed rays in the only known specimen of *Leptenchelys* may be an anomaly resulting from incomplete resorption during metamorphosis. The well developed caudal fin of *Echelus* has prompted most earlier authors to place it in the family Echelidae (=Ophichthidae, in part) or to ally it with the subfamily Myrophinae (e.g., Dean, 1972; Blache, 1977); however, the osteology of the genus (McCosker, 1977) and its larval morphology (Blache, 1977: Figs. 72 and 74) clearly place *Echelus* in the subfamily Ophichthinae and ally it with the tribe Ophichthini.

Adult Myrophinae have four to seven branchiostegal rays attached to the epihyal and ceratohyal and 13–45 free (unattached) branchiostegal rays which originate posterior to the tips

of the epihyals. Most adult Ophichthinae have the majority of their branchiostegal rays attached to the epihyal and ceratohyal. The free branchiostegal rays of all Ophichthinae originate anterior to the tips of the epihyals.

The ceratohyal, epihyal and hypohyal of both the Myrophinae and the Ophichthinae originate from a single block of cartilage with the first center of ossification being a thin strip along the lateral face of the cartilage (Leiby, 1979a, b; 1981). When development is complete, the ceratohyal of the Myrophinae is a simple bone which terminates about midpoint along the lateral face of the epihyal (Dean, 1972; McCosker, 1977; Leiby, 1979b). The ceratohyal of the Ophichthinae has a slender, elongate distal portion which terminates about midpoint along the lateral face of the epihyal and a medial portion which is attached to the proximal end of the epihyal by a cartilage (McCosker, 1977; Leiby, 1981).

The urohyal of the Myrophinae and Ophichthinae ossifies in a bifurcated medial ligament which is attached to the developing hypohyals. In the Myrophinae, the urohyal is generally limited

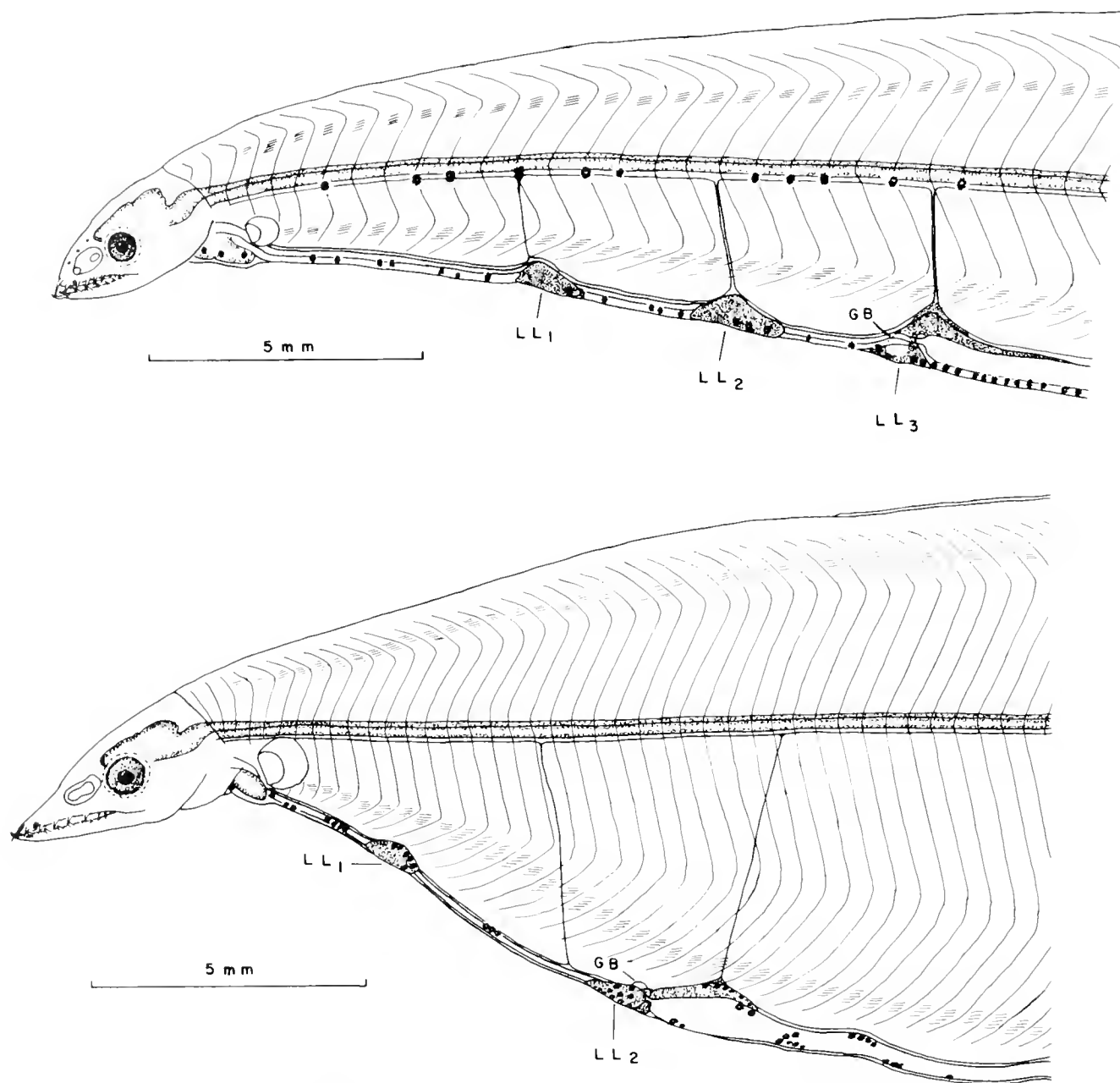

Fig. 56. (Upper.) Anterior portion of *Myrophis punctatus* larva depicting typical myrophin gut morphology. Abbreviations: LL₁₋₃, liver lobes 1-3; GB, gall bladder. (Lower.) Anterior portion of *Neechelys microretetus* larva depicting gut morphology. Abbreviations: LL₁₋₂, liver lobes 1-2; GB, gall bladder.

to a basal plate which ossifies from the hypohyal to the bifurcation of the ligament. The urohyal of the Ophichthinae generally ossifies to include a spike which extends well posterior to the area of the bifurcation.

The gill openings of the Myrophinae are midlateral and constricted. Ophichthine gill openings are variable in position, their major axis ranging from midlateral to ventral, but always unconstricted.

Leptocephali belonging to five of the nine myrophin genera

have been identified. Larvae of four of these five genera have three unconnected liver lobes with the gall bladder on the third lobe (Fig. 56-upper). Larvae of the fifth genus, *Neechelys*, which differ trenchantly from all other ophichthid larvae, have two unconnected liver lobes with the gall bladder on the second lobe (Fig. 56-lower). Leptocephali belonging to twenty of the forty-four ophichthid genera have been identified. All twenty of these genera have two connected liver lobes with the gall bladder on the second lobe (Fig. 57-upper).

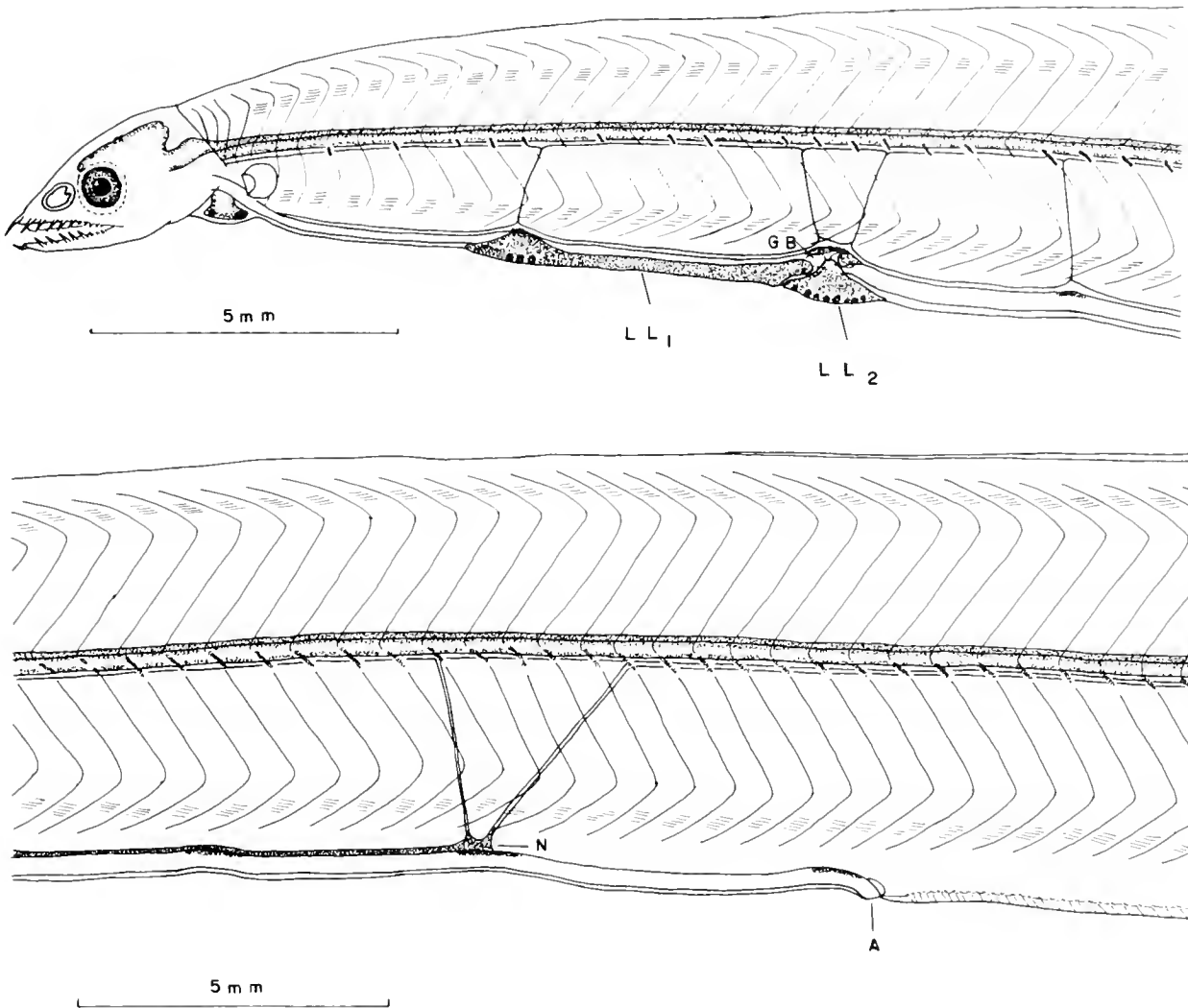

Fig. 57. (Upper.) Anterior portion of *Ophichthus gomesi* larva depicting typical ophichthin gut morphology. Abbreviations: LL₁₋₂, liver lobes 1-2; GB, gall bladder. (Lower.) Middle portion of *Ophichthus gomesi* larva depicting position of nephros relative to anus in some members of the *Ophichthus* lineage of the tribe Ophichthini. Abbreviations: N, nephros; A, anus.

The dorsal fin of known myrophin larvae has well-developed pterygiophores and fin rays prior to the onset of metamorphosis and migrates only a few myomeres anteriorly (4-6) during metamorphosis to reach its adult position. The dorsal fin of known ophichthin larvae, which is weakly developed having only pterygiophores and rudimentary rays in its anterior portion prior to metamorphosis, must migrate 5-20 myomeres anteriorly during metamorphosis in species having the dorsal fin anterior to the branchial aperture as adults, and 20-50 myomeres in species having the dorsal fin posterior to the branchial aperture as adults, and is resorbed in species which are finless as adults.

The subfamily Myrophinae contains two tribes (sensu McCosker, 1977), the Myrophini and the Benthenchelyini. Osteological examination of adults in the tribe Myrophini indicated the presence of three lineages consisting of *Pseudomyrophis* and *Neenchelys*; *Myrophis*, *Ahlia*, and a currently undescribed genus; and *Muraenichthys* and its allies. The *Myrophis* and *Muraenichthys* lineages share a common ancestor

(Fig. 55). Larval morphology of *Myrophis*, *Ahlia* and *Muraenichthys* is very similar and supports the determination of a close relationship for the two lineages. Larvae of these three genera have three unconnected liver lobes, similar gut and opisthonephros morphology, and similar body length to depth ratios (Fahay and Obenchain, 1978; Leiby, 1979b; Ochiai and Nozawa, 1980). *Pseudomyrophis* larvae have three unconnected liver lobes and a body length to depth ratio which is similar to that of the *Myrophis* and *Muraenichthys* lineages, but gut and opisthonephros morphology is significantly different from that seen in the *Myrophis* and *Muraenichthys* lineages and supports the conclusion drawn from adult data that the *Pseudomyrophis* lineage is distinct from the *Myrophis* and *Muraenichthys* lineages. Nelson (1966a) suggested that *Pseudomyrophis micropinna*, the type of the genus, was congeneric with *Neenchelys buitendijki*, but that *P. nimius*, while belonging to the same lineage, was separable at the generic level from either of the other two species. Dean (1972) also felt that the differences

between *P. micropinna* and *P. nimius* warranted a separate genus for *P. nimius*. However, McCosker (1977, 1982) demonstrated that *Pseudomyrophis* and *Neenchelys* are both valid genera and that *P. micropinna*, *P. nimius*, *P. atlanticus* and an undescribed *Pseudomyrophis* from the eastern Pacific are congeneric. Dean (1972) indicated that *Myrophis frio* properly belongs in the *Pseudomyrophis* lineage. Evidence from larval morphology supports McCosker's (1977, 1982) recognition of *Pseudomyrophis* and *Neenchelys* as valid genera, and supports the recognition of *P. micropinna*, *P. nimius*, *P. atlanticus*, the undescribed *Pseudomyrophis* from the eastern Pacific, two undescribed *Pseudomyrophis* known only from their larvae in the western Atlantic, one undescribed *Pseudomyrophis* from the eastern Atlantic known only from its larva and erroneously identified as *P. nimius* (Blache, 1977), and *Myrophis frio* as congeneric. *Pseudomyrophis* larvae are readily distinguishable from all other ophichthid larvae by a combination of the following characters: three unconnected liver lobes, undulating gut and nephros, characteristic head shape, and pigmentation (Blache, 1977; Leiby, in press a). *Neenchelys* larvae differ trenchantly from *Pseudomyrophis* larvae in having two, rather than three, unconnected liver lobes, a gut lacking the marked undulations seen in *Pseudomyrophis* larvae, and a much deeper body than any other known ophichthid (Castle, 1980; this paper, Fig. 56-lower). Studies of adult *Pseudomyrophis* and *Neenchelys* have clearly demonstrated that the two genera are more closely related to each other than either is to any other genus (McCosker, 1977, 1982). In the light of this information, the most parsimonious interpretation of the data on the larval morphology of the two genera is that *Neenchelys* was derived from *Pseudomyrophis* or a *Pseudomyrophis*-like ancestor. *Pseudomyrophis* and all other known myrophin larvae except *Neenchelys* have three unconnected liver lobes and similar body length to depth ratios. It seems likely, therefore, that larvae of the ancestral myrophin also had three unconnected liver lobes and a similar body length to depth ratio. *Neenchelys* larval morphology can be easily derived from this proposed ancestral larval morphology by significantly deepening the body and foreshortening the gut so that one liver lobe is lost. Derivation of *Pseudomyrophis* larval morphology from a *Neenchelys*-like ancestor requires a change from the ancestral larval morphology body plan to the *Neenchelys* larval body plan and a later re-emergence of the ancestral larval myrophin body plan in *Pseudomyrophis*.

Benthenchelys cartieri, a highly specialized pelagic eel (Castle, 1972) is the sole member of the tribe Benthenchelyini. The larvae of this species have not yet been described, but based on the hypothesized evolutionary history of the Ophichthidae (Fig. 55), it seems likely that the larvae of *B. cartieri* will have three unconnected liver lobes, a well-developed dorsal fin which migrates little during metamorphosis, and a body length to depth ratio that is typical of the Ophichthidae. Discovery of these larvae should help clarify relationships within the Myrophinae.

The subfamily Ophichthinae contains four tribes (sensu McCosker, 1977); the Ophichthini, Sphagebranchini, Bascanichthyini and Callechelyini. The tribe Ophichthini lies at the evolutionary base of the subfamily Ophichthinae, and contains the most primitive, least specialized members of the subfamily. The ancestral ophichthin was probably *Ophichthus*-like. The tribe Ophichthini, which contains two lineages, and the tribe Sphagebranchini can be easily derived from the generalized ophichthin character states which are represented in the genus

Ophichthus (sensu McCosker, 1977). One lineage in the tribe Ophichthini appears to be directly derived from the generalized *Ophichthus* condition. The genus *Echelus* has been represented as belonging to its own unique lineage in the Ophichthinae and has been considered the most primitive member of the tribe Ophichthini because in addition to having all the primitive characters of its closest relative *Ophichthus*, it possesses a well-developed caudal fin. A re-examination of adult *Echelus* characters in conjunction with the larval characters of *Echelus* suggests, however, that *Echelus* belongs to the *Ophichthus* lineage and that the caudal fin of *Echelus* is either a case of character reversal or paedomorphosis which resulted in *Echelus* retaining the larval caudal fin rather than losing it, as is apparently the case in all other members of the Ophichthinae. In addition to the generalized genera *Echelus*, *Ophichthus*, and *Ophisurus*, the *Ophichthus* lineage contains two groups of specialized genera which are closely tied to *Ophichthus* by a nearly continuous character series. The *Pisodonophis-Myrichthys-Cirrhimuraena* group differ from the basic *Ophichthus* body plan by having an increased number of branchiostegals, multiserial dentition, and individual specializations found in each genus. The second group, containing *Mystriophis* and seven allied genera, are specialized for the capture of large active prey by having a strengthened suspensorium and enlarged dentition. The close relationship of this group to *Ophichthus* is emphasized by similar adaptations in some species of *Ophichthus* (McCosker, 1977). The close relationship of the *Ophichthus* lineage is further emphasized by the unique positioning of the nephros relative to the anus found in many members of this lineage. Larvae from seven of the fourteen genera in the *Ophichthus* lineage have been identified. While there is considerable inter- and intragenetic variability in the general morphology of these larvae, five of the seven genera (*Echelus*, *Ophichthus*, *Ophisurus*, *Echiophis*, and *Aplatophis*) are generally characterized by having larvae with a nephros which terminates 4–14 myomeres anterior to the anus on the next to last gut loop or between the last and next to last gut loop (Fig. 57-lower). This condition has not been observed in any genera of the Ophichthinae outside of the *Ophichthus* lineage of the Ophichthini. The larvae of *Myrichthys*, one of the specialized genera in the *Ophichthus* lineage, has a nephros which terminates above or just anterior to the anus (Leiby, in press a). Blache (1977) identified a series of larvae as *Brachysomophis atlanticus*. This series of larvae differs from the larvae of the closely related genus *Aplatophis* in having the nephros terminating above or just anterior to the anus. Larvae of the western Pacific species of *Brachysomophis* have not yet been identified. Consequently, it is unknown whether this nephric position is a secondarily derived character of the genus *Brachysomophis* or whether it is limited to the eastern Atlantic species *B. atlanticus*.

The other lineage to arise from the generalized *Ophichthus*-like ancestor contains eight genera including *Quassiremus* and *Malvoliophis* (Fig. 55), which are characterized by various reductions and modifications of the generalized *Ophichthus*-like condition such as reduced gill arches, cephalic lateralis systems, and pectoral fins. This lineage probably gave rise to the Sphagebranchini and subsequent lineages by continued modification, reduction, and specialization of the ophichthin condition (McCosker, 1977). The larvae of the *Quassiremus-Malvoliophis* lineage are virtually unknown. Leiby (in press) tentatively identified three larvae as *Quassiremus productus*, but no other larvae from this lineage have been identified. There is a natural

progression in larval morphology from some *Ophichthus* spp. through *Quassiremus* morphology to sphagebranchin morphology which tends to support McCosker's (1977) hypothesis that the other ophichthin lineages arose through modification, reduction, and specialization of the ancestral *Ophichthus*-like condition. *Quassiremus* larvae look much like the larvae of some *Ophichthus* spp., but differ in having the nephros terminate over or just anterior to the anus, and in having reduced gill arches.

The tribe Sphagebranchini is distinguished from the other tribes of the Ophichthinae by a combination of the following adult characters: the pectoral girdle is reduced; the pectoral fin is absent; the gill openings are low to entirely ventral; the neurocranium is elongate (neurocranium depth going 4 or more times into its length), generally depressed, and truncate posteriorly; the gill arches are generally much reduced; the body is equal to or shorter than the tail; the tail tip is sharply pointed; and, the cephalic lateralis system is generally better developed than in other tribes (McCosker, 1977). Larval characters which distinguish this tribe from other tribes in the Ophichthinae or which distinguish lineages within the tribe, are reflections of the adult characters (e.g., reduced gill arches, short gut, dorsal fin origin) (Leiby, 1982). As yet, there are no independent larval characters which confirm the monophyletic origin of this tribe or which confirm the proposed lineages within the tribe, although the larval morphology is similar to, and sometimes difficult to distinguish from, the larval morphology of some Ophichthini and is consistent with the hypothesis of modification, reduction, and specialization of the ancestral ophichthin condition which has been proposed based on adult data.

The tribe Bascanichthyini, apparently derived from a moderately specialized ophichthin-like ancestor (McCosker, 1977), is distinguishable from the other tribes of the Ophichthinae by a combination of the following adult characters: the body is equal to, or longer than the tail; the gill openings are low lateral and crescentic, never entirely ventral; dorsal-fin origin is on the head in most genera; the pectoral fin is reduced or absent; the cephalic lateralis system is reduced; and, the gill arches are generally much reduced (McCosker, 1977). The genus *Dalophis* is provisionally placed in the Bascanichthyini despite its possession of a gill arch skeleton and a body length which are more ophichthin than bascanichthyin, due to its reductions, general cephalic appearance and several osteological characters (McCosker, 1977). If this placement of *Dalophis* is correct, it seems likely that the ancestral bascanichthyin was similar in appearance to *Dalophis*. Larval characters which distinguish this tribe from other tribes in the Ophichthinae are reflections of adult characters (e.g., reduced gill arches, relatively long gut and opisthonephros, and dorsal-fin origin). Larvae have been identified from each of the three proposed bascanichthyin lineages [e.g., *Dalophis* (Blache, 1977; Palomera and Fortuno, 1981), *Bascanichthys* (Blache, 1977; Leiby, 1981), *Gordlichthys* (Leiby, in press), *Caralophia* (Leiby, in press)], but there are currently no clear larval characters which are useful for elucidating relationships within the Bascanichthyini. With one exception, all of the larvae assigned to the Bascanichthyini are characterized by extremely low to moderately developed gut loops and, except for gut length, nephros length and dorsal-fin origin, look much like larvae of the Sphagebranchini. One larval form which cannot yet be assigned to a genus, has tentatively been placed in the Bascanichthyini based on gill arch and caudal osteology although its

gut morphology is more like some Callechelyini than Bascanichthyini (Leiby, in press). Discovery of the adults of this species may help clarify relationships within the Bascanichthyini.

The tribe Callechelyini is apparently derived from a bascanichthyin-like ancestor. Adults of this tribe are distinguished by a short neurocranium (neurocranium depth $\geq 33\%$ of its length); the dorsal-fin origin on the head or nape; the body longer than the tail; absence of a pectoral fin; low lateral to entirely ventral anteriorly convergent gill openings; reduced gill arches; reduced cephalic lateralis system; laterally compressed body; small eyes; and, a stout hyoid (McCosker, 1977). Larvae of three of the five known Callechelyin genera have been identified (Leiby, 1984) and are readily distinguishable from larvae of the other ophichthin tribes. Callechelyin larvae are characterized by moderate to pronounced gut loops; variable but distinctive pigmentation (see Leiby, in press b, for full descriptions); anterior dorsal-fin origin; nephric myomeres more than 56% of total myomeres; a distinct fourth hypobranchial which may be separate from or united with a reduced fifth ceratobranchial (a remnant of the fourth hypobranchial united with a reduced fifth ceratobranchial may occasionally be found in gill arches of larval Sphagebranchini and Bascanichthyini; a distinct fourth hypobranchial is found in some larval Ophichthini, but, when present, is united with a well developed fifth ceratobranchial); and usually two hypurals rather than the three seen in other ophichthids. McCosker and Rosenblatt (1972) and McCosker (1977) recognized the presence of subgeneric lines in the genus *Callechelys*. Evidence from larval morphology confirms the presence of two subgeneric lineages in *Callechelys* (Leiby, 1984). Adults of one subgenus have a split urohyal and two rod-shaped elements in the pectoral girdle. The larvae of this subgenus have pronounced gut loops; the fourth hypobranchial free from the fifth ceratobranchial; most or all of the myosepta without pigment; most or all of the anal pterygiophores without pigment; no pigment on the esophagus; pigment on the dorsal surface of each gut loop but no pigment between gut loops; pronounced, round pigment patches in the body wall lateral to each gut loop; and, three to five pronounced, circular postanal pigment patches which consist of subcutaneous and body-wall pigment. Adults of the second subgenus have a simple urohyal and one or two rod-shaped elements in the pectoral girdle. The larvae of this subgenus have moderate gut loops; the fourth hypobranchial united with the fifth ceratobranchial; dark pigment every third to eleventh myoseptum, or light pigment on every myoseptum; round or saddle-shaped patches of pigment in the body wall on the ventral margin of the tail extending onto the anal pterygiophores, or pigment on every anal pterygiophore but none in the ventral body wall; pigment on the esophagus, on the dorsal surface of each gut loop, and between each gut loop; occasionally some body-wall pigment lateral to each gut loop; four to seven irregular, subcutaneous pigment patches on the tail, usually not flanked by body-wall pigment.

Relationships to other taxa

The family Ophichthidae is generally considered to be a cohesive group which is the sole member of the superfamily Ophichthoidea. The unique nature of ophichthid larvae supports this allocation. Most workers (e.g., Goshne, 1951; Nelson, 1966b; McCosker, 1977) consider the Ophichthidae to be a specialized offshoot of the Congridae, although Dean (1972) decried the

value of the characters used to associate the Ophichthoidea with the Congroidea and implied that the Ophichthidae could just as easily be a specialized offshoot of the Anguilloidea. While the only known larvae which could be confused with the Ophichthidae are members of the family Congridae (e.g., *Acromycter* larvae have pronounced gut loops, *Nystactichthys* larvae have a gut which expands abruptly between the esophagus and intestine), there are no known larval characters which un-

equivocally establish the evolutionary relationships of the Ophichthidae. Careful osteological studies of ontogenetic series of eel larvae from the various families may eventually clear the currently clouded picture.

DEPARTMENT OF NATURAL RESOURCES, MARINE RESOURCES LABORATORY, 100 EIGHTH AVENUE SOUTHEAST, SAINT PETERSBURG, FLORIDA 33701.

Clupeiformes: Development and Relationships

M. F. MCGOWAN AND F. H. BERRY

THE order Clupeiformes contains four families of fishes: the herrings, Clupeidae; the anchovies, Engraulidae; the wolf-herrings, Chirocentridae; and the denticle herring, Denticipitidae (Nelson, 1976). *Denticeps clupeoides*, the monotypic denticipitid, occurs in freshwater in southwest Nigeria (Clausen, 1959). Two species of *Chirocentrus* occur in marine waters of the Indo-Pacific region from the Red Sea to the western Pacific (Whitehead, 1972). They are unusual among the Clupeiformes in that they are piscivorous. The herrings and anchovies are, in general, small schooling planktivores of marine coastal waters. The Indo-Pacific shad, *Tenuulosa reevesii*, reaches 509 mm standard length; the West African riverine species, *Thrattidion noctivagus* and *Sierrathrissa leonensis*, are mature at 18 mm (Wongratana, 1980). There are 192 species of clupeids in 62 genera and 122 species of engraulids in 16 genera (Table 24) based on our review of the literature. Herrings and anchovies are most speciose in the tropics, and individual species are most abundant in cold temperate regions and eastern boundary currents (Longhurst, 1971). Some are found in fresh or brackish water; some are anadromous. They support major fisheries worldwide. Their biology has been reviewed most recently by Blaxter and Hunter (1982).

DEVELOPMENT

The eggs and the larvae of *Chirocentrus* are known (Delsman, 1923, 1930b); the egg and larva of *Denticeps* are unknown; and the eggs or larvae of at least one species in a genus have been described for approximately one-half the genera of herrings and anchovies but for only one-third of all species. Ontogenetic stages of herrings and anchovies are best known for species of commercial interest or potential commercial interest in regions with low clupeoid diversity such as the northeast Atlantic (e.g., *Clupea*, *Sprattus*, *Sardina*, *Engraulis*) and the California current (e.g., *Sardinops*, *Etrumeus*, *Engraulis*). The ontogeny of morphology and behavior, and the requirements for growth and survival of the herring, *Clupea harengus*, and the anchovy, *Engraulis mordax*, are well known (Blaxter and Hunter, 1982). Very little detailed information exists for clupeids from species-rich areas, especially western African freshwaters and the New World tropics. Descriptive taxonomy is still needed in these areas. Table 25 lists the clupeiform fishes for which we found some information about eggs and larvae.

Published descriptions of clupeoid eggs and larvae may not

be adequate for systematic studies for a variety of reasons. When there are few species in an area with which to confuse the described species, only the key identifying features are described. When eggs are hatched but the larvae are not reared to metamorphosis, usually an atypical starving early larva is described. When a well-described series of field-caught larvae is compared with a laboratory-reared series there may be differences in pigmentation and size at a particular stage of development due to the rearing environment. Future descriptions should describe the eggs and yolk-sac larvae thoroughly because these stages have characters other than those such as meristics which, because they are shared with the adults, are redundant for systematic purposes. Future descriptions should also try to describe the development of characters which are of phylogenetic importance in adult-based classifications because the ontogenetic transformation of a character provides information about the polarity of states of that character (Nelson, 1978).

Because the eggs and larvae of so many clupeiform genera are undescribed and because existing descriptions vary in completeness, it is premature to attempt a phylogenetic classification of the Clupeiformes based on early life history stages. However, because many species' eggs and larvae have been described it is possible to identify and describe characters of taxonomic and phylogenetic value, to discuss their distribution among the Clupeiformes, and to point out some similarities and conflicts between the distribution of egg and larval characters and current hypotheses of clupeiform phylogeny.

Taxonomic characters of eggs and larvae

The taxonomic characters of clupeoid eggs include size, shape, chorion thickness and sculpturing, width of perivitelline space, degree of yolk segmentation, number and size of oil globules if present, whether they are pelagic or demersal, whether they are adhesive or not, and whether they are spawned in fresh, brackish or full seawater.

The egg of *Chirocentrus* is 1.60–1.65 mm in diameter, has a very small perivitelline space, is pelagic, spherical, and is abundant near shore, especially around river mouths (Delsman, 1930b). The egg of *Chirocentrus nudus* has a chorion with fine hexagonal sculpturing (unique among clupeiforms) and up to 9 small oil globules, while the egg of *C. dorab* has a smooth chorion and may have a single oil globule (Delsman, 1923, 1930b).

The eggs of clupeids are all globular and they range in size

TABLE 24. FAMILIES, SUBFAMILIES, GENERA, AND SPECIES OF CLUPEIFORMES WITH SELECTED MERISTICS. Classification follows Whitehead (1972) and Nelson (1976) for subfamilies; Wongratana (1980, 1983) and Nelson (1983) where pertinent for genera and species; otherwise the nomenclature is that of the author cited in the table. Data compiled by F. H. Berry for species presumed valid. A: Atlantic; P: Pacific; c: central; e: east; n: north; s: south; w: west; FW: Freshwater; ICp: Indo-central Pacific; IwP: Indo-west Pacific; I: India; Aust: Australia; Philipp: Philippines; US: United States of America; Braz: Brazil; Venz: Venezuela; Arg: Argentina.

	Location	Dorsal	Anal	P2	Gillrakers		Vertebrae	Reference
					Upper	Lower		
DENTICIPITIDAE								
<i>Denticeps clupeioides</i>	Nigeria	9	26-27		5	10	41	Clausen, 1959
CHIROCENTRIDAE								
<i>Chirocentrus dorab</i>	ICp-Aust						72-74	Delsman, 1923; Whitehead, 1973
<i>nudus</i>	IwP							
CLUPEIDAE								
Clupeinae								
<i>Sardinella</i>								
<i>longiceps</i>	I	17-19	14-18	9	117-241	150-253		Wongratana, 1980
<i>neglecta</i>	sc Africa	17-19	16-18	9	108-166	143-188		Wongratana, 1983
<i>lemuru</i>	China-Aust	17-19	15-19	9	51-153	77-188		Wongratana, 1980
<i>jussieui</i>	China-Aust	19-20	19-21	8	52-61	88-101		Wongratana, 1980
<i>sundensis</i>	I	17-20	17-21	8	16-46	38-77		Wongratana, 1980
<i>gibbosa</i>	IwP	17-20	17-22	8	16-36	38-66		Wongratana, 1980
<i>fimbriata</i>	IwP	18-20	19-22	8	27-47	54-82		Wongratana, 1980
<i>albella</i>	IwP	18-20	18-23	8	20-36	41-68		Wongratana, 1980
<i>dayi</i>	I	18-19	19-20	8	51-103	87-134		Wongratana, 1980
<i>fijiense</i>	N. Guinea	17-18	18-19	8	33-40	61-74		Wongratana, 1980
<i>tawilis</i>	Philipp	18-19	1-22					Wongratana, 1980
<i>hauiliensis</i>	Taiwan	18-20	19-22	8				Wongratana, 1980
<i>brachysoma</i>	I-Aust	17-20	18-22	8	25-39	48-67		Wongratana, 1980
<i>richardsoni</i>	China	18-19	18-22	8	36-42	63-74		Wongratana, 1983
<i>zunasi</i>	China-Japan	17-19	17-21	8	21-23	42-58		Wongratana, 1980
<i>marquesensis</i>	Marquesas	16-18	17-21	7-8	15-58	27-85	42-44	Wongratana, 1980
<i>melanura</i>	ICp	16-18	17-20	8	20-41	38-74		Wongratana, 1980
<i>atricauda</i>	se Asia	18-19	17-18	8	20-26	39-43		Wongratana, 1980
<i>aurita</i>	wAeA	17-20	16-18	9	56-81	95-132	45-47	Wongratana, 1980
<i>brasiliensis</i>	wA	17-18	18-20	9		>150	46	Hildebrand, 1963d; Whitehead, 1973; Berry
<i>maderensis</i>	eA			8		>70		Whitehead, 1981
<i>rouxi</i>	ecA			8		34-40		Whitehead, 1981
<i>Amblygaster</i>								
<i>sirm</i>	IwP	18-20	17-22		14-18	36-43		Wongratana, 1980
<i>clupeioides</i>	wP	18-19	17-19		12-14	26-31		Wongratana, 1980
<i>leiogaster</i>	IwP	19	17-20		13-16	31-33		Wongratana, 1980
<i>Herklotsichthys</i>								
<i>quadrifasciatus</i>	IwP-Aust	18-20	16-21		13-17	30-37		Wongratana, 1980
<i>konigsbergi</i>	wP-Aust	18-19	19-22		15-17	30-34		Wongratana, 1980
<i>castelnau</i>	wP-Aust	17-20	17-22		18-22	39-52		Wongratana, 1980
<i>gotoi</i>	N. Guinea	19	17		16	34		Wongratana, 1983
<i>lossei</i>	Persian G.	18-19	15-18		12-15	29-35		Wongratana, 1983
<i>spilura</i>	I	17-19	15-18		12-15	29-34		Wongratana, 1980
<i>punctatus</i>	Red Sea	17-20	13-18		12-17	31-39		Wongratana, 1980
<i>dispilonotus</i>	se Asia	17-20	16-19		14-17	34-38		Wongratana, 1980
<i>Escualosa</i>								
<i>elongata</i>	Thailand	16	19		26	41		Wongratana, 1983
<i>thoracata</i>	IwP-Aust	15-17	17-21		16-25	29-40		Wongratana, 1980
<i>Opisthonema</i>								
<i>bulleri</i>	cP	18-21	20-23	8-9	35-47	65-83	46-48	Berry and Barrett, 1963
<i>medrastrae</i>	cP	17-20	19-23	8-9	70-99	110-156	45-48	Berry and Barrett, 1963
<i>berlangai</i>	Galapagos	19-20	19-22	8-9	75-117	133-171	46-48	Berry and Barrett, 1963
<i>libertate</i>	cP	17-20	19-22	8-9	1-149	161-224	44-48	Berry and Barrett, 1963
<i>oglinum</i>	wA	18-22	22-25	8-9	43-60	72-107	45-49	Berry and Barrett, 1963
<i>captivai</i>	Colombia A	19-20	18-21	8		(c25-28)	49	Rivas, 1972; Berry

TABLE 24. CONTINUED.

	Location	Dorsal	Anal	P2	Gillrakers		Vertebrae	Reference
					Upper	Lower		
<i>Harengula</i>								
<i>humeralis</i>	wA	18	16	8	13-15	26-29	40-41	Whitehead, 1973; Berry
<i>clupeola</i>	wA	18	18	8	14-16	27-31	41-42	Whitehead, 1973; Berry
<i>jaguana</i>	wA	17-18	17-18	7-8	16-20	31-35	41-43	Whitehead, 1973; Berry
<i>peruana</i>	esP	18-19	15-17	8	15-19	31-51	40-42	Berry
<i>thrissina</i>	enP	16-20	14-17	8-9	9-18	24-33	40-43	Hildebrand, 1946; Berry; Miller and Lea, 1972
<i>Ramnogaster</i>								
<i>arcuata</i>	Arg			7				Whitehead, 1973, 1965
<i>melanostoma</i>	Arg							Whitehead, 1965
<i>pallida</i>	Arg							Whitehead, 1965
<i>Platamichthys</i>								
<i>platana</i>	Braz	14	16	7	13	25		Whitehead, 1973
<i>Sardinops</i>								
<i>sagax sagax</i>	esP	17-20	17-20	8			49-54	Ahlstrom
<i>sagax caerulea</i>	enP	17-20	17-20	8	21-23	44-45	48-54	Berry; Miller and Lea, 1972
<i>neopilchardus</i>	Aust	18-20	17-21			58-93	50-52	Berry
<i>melanosticta</i>	e Asia							
<i>ocellata</i>	s Africa			8				Whitehead, 1981
<i>Sardina</i>								
<i>pilchardus</i>	enA	17-18	17-18	8		44-106	50-53	Whitehead, 1981
<i>Rhinosardinia</i>								
<i>amazonica</i>	Guyanas	13-16	15-19	8	ca. 20	33-43		Hildebrand, 1963d; Whitehead, 1973; Berry
<i>bahiensis</i>	Braz	17	18					Hildebrand, 1963d
<i>Lile</i>								
<i>piquitunga</i>	wcA	15-17	17-19	7-8	12-17	30-36	38-41	Whitehead, 1973; Berry
<i>stohfiera</i>	eP	17-18	17-23	8	13-18	32-36	42-44	Hildebrand, 1946
<i>Chupea</i>								
<i>harengus</i>	nA	16-20	16-20			37-52	53-60	Hildebrand, 1963d; Wheeler, 1969
<i>pallasi</i>	nP	13-21	14-20		20	45	46-55	Berry, 1964b, Ahlstrom; Miller and Lea, 1972
<i>bentinecki</i>	Chile							Whitehead, 1965
<i>Sprattus</i>								
<i>sprattus</i>	enA	16-19	18-20	7-8			46-49	Whitehead, 1965; Wheeler, 1969
<i>antipodum</i>	Aust			8				Whitehead, 1965
<i>muelleri</i>	Aust			8				Whitehead, 1965
<i>bassensis</i>	Aust			8			46	Whitehead, 1965
<i>fuergensis</i>	Chile			8			49-51	Whitehead, 1965
<i>Chupeonella</i>								
<i>cultiventris</i>								Whitehead, 1965
<i>grimmii</i>								Whitehead, 1965
<i>engrauhiformis</i>								Whitehead, 1965
<i>abrau</i>								Whitehead, 1965
<i>Dussumieriinae</i>								
<i>Etrumeus</i>								
<i>teres</i>	Cosmop.	18-22	10-19	8-9	12-15	28-35	48-50	Wongratana, 1980; Miller et al., 1979; Miller and Lea, 1972
<i>whiteheadi</i>	S. Africa	18-20	12-13	8	16-18	36-39	54-56	Wongratana, 1983
<i>Dussumeria</i>								
<i>elopsodes</i>	IcP	18-23	14-18	8	11-16	21-32	54-55	Wongratana, 1980; Delsman, 1925
<i>acuta</i>	I-China	19-22	14-18	8	11-15	19-26	54-55	Wongratana, 1980; Delsman, 1925

TABLE 24. CONTINUED.

	Location	Dorsal	Anal	P2	Gillrakers		Vertebrae	Reference
					Upper	Lower		
Spratelloidinae								
<i>Spratelloides</i>								
<i>gracilis</i>	IwP Aust	11-14	11-14	8	10-12	28-37		Wongratana, 1980
<i>lewisi</i>	N. Guinea	11-13	10-13	8	9-11	28-32		Wongratana, 1983
<i>delicatulus</i>	IwP Aust	10-14	9-11	8	9-12	26-32	44-45	Wongratana, 1980; Miller et al., 1979
<i>robustus</i>	Aust	12-13	10-11	8	9-11	28-35		Wongratana, 1980
<i>Jenkinsia</i>								
<i>lamprotaenia</i>	wcA	12-13	13-16	8		19-24	39-40	Whitehead, 1973; Berry; Cervigon and Velazquez, 1978
<i>stolifera</i>	wcA	9-12	13-16			18-25		Whitehead, 1973
<i>majua</i>	wcA		11-13			21-28		Whitehead, 1973
<i>parvula</i>	Venz	10-13	12-16			20-24	38-39	Cervigon and Velaz- quez, 1978
Dorosomatinae								
<i>Clupanodon</i>								
<i>thrissa</i>	wP	16	21-26	8	(190-480)	(200-420)		Wongratana, 1980
<i>Konosirus</i>								
<i>punctatus</i>	China	16-19	21-25	8	(145-270)	(160-250)		Wongratana, 1980
<i>Nematalosa</i>								
<i>erebi</i>	Aust	14-16	19-22	8	(155-370)	(145-370)		Wongratana, 1980
<i>chanpole</i>	IwP	15-17	22-26	8	(250-315)	(255-355)		Wongratana, 1980
<i>arabica</i>	I	17-19	18-20	8	(145-335)	(180-390)		Wongratana, 1980
<i>come</i>	I-Aust	17-18	20-24	8	(175-245)	(170-250)		Wongratana, 1980
<i>nasus</i>	I-wP	15-19	20-26	8	(155-310)	(165-315)		Wongratana, 1980
<i>japonica</i>	wP	16-18	19-22	8	149-205	156-193		Wongratana, 1980
<i>vlaminghi</i>	Aust	16-17	19-25	8	216-300	239-328		Wongratana, 1980
<i>paubuenis</i>	N. Guinea	14-16	22-27	8	72-342	82-309		Wongratana, 1980
<i>flyensis</i>	N. Guinea	14-16	21-26	8	152-553	195-508		Wongratana, 1983
<i>Gonialosa</i>								
<i>whiteheadi</i>	Burma	15	27	8	(92)	90-93		Wongratana, 1983
<i>mamminna</i>	I	14-16	22-27	8	87-160	96-166		Wongratana, 1980
<i>modesta</i>	Burma	15-17	24-28	8	(125-170)	(140-185)		Wongratana, 1980
<i>Anodontostoma</i>								
<i>chacunda</i>	IwP	17-21	17-22	8	52-98	54-96		Wongratana, 1980
<i>selangkat</i>	wP	18-20	17-21	8	129-186	100-166		Wongratana, 1980
<i>thailandiae</i>	IwP	17-20	18-23	8	43-125	46-140		Wongratana, 1983
<i>Dorosoma</i>								
<i>cepedianum</i>	wnP	10-13	25-36	7-8	(ca. 300- 400)		48-51	Miller, 1960; Berry
<i>petenense</i>	wnA	11-14	17-27	7-8	(ca. 300- 400)		40-45	Miller, 1960; Berry
<i>anale</i>	eMexico		29-38					Miller, 1960
<i>chavesi</i>	eNicaragua	12-14	(22-31)					Miller, 1960
<i>smithi</i>	wMexico	9-13	(22-31)				43-46	Hildebrand, 1963d; Miller, 1960 Berry
Congothrissinae								
<i>Congothrissa</i>								
<i>gosset</i>	Congo	14-16	15-17	7-8			ca. 40	Poll, 1964
Alosinae								
<i>Hulsa</i>								
<i>kelee</i>	IwP	16-19	17-22	8	(45-105)	(70-180)		Wongratana, 1980
<i>Tenualosa</i>								
<i>tolii</i>	IwP	17-18	15-21	8	(38-55)	(60-95)		Wongratana, 1980
<i>macrura</i>	Java	19	21-22	8	(46-52)	(63-74)		Wongratana, 1980
<i>reevesii</i>	wP	17-19	16-20	8	53-131	80-248		Wongratana, 1980
<i>ilisha</i>	wP	17-20	18-23	8	46-196	62-272		Wongratana, 1980
<i>thibaudecaui</i>	Thailand	16-18	19-23	8	(170-248)	(205-320)		Wongratana, 1980

TABLE 24. CONTINUED.

	Location	Dorsal	Anal	P2	Gillrakers		Vertebrae	Reference
					Upper	Lower		
<i>Gadusia</i>								
<i>chapra</i>	Pakistan	14-18	21-25	8	(160-235)	(170-255)		Wongratana, 1980
<i>variegata</i>	Burma	16-17	25-27	8	(250-270)	(252-270)		Wongratana, 1980
<i>Alosa</i>								
<i>sapidissima</i>	wnA-enP	17-20	20-23	9		59-73	54-59	Hildebrand, 1963d; Berry
<i>pseudoharengus</i>	eUS-Canada	15-19	17-21	9		38-43	46-50	Hildebrand, 1963d; Berry
<i>mediocris</i>	eUS	15-20	19-23	9		18-23	54-55	Hildebrand, 1963d; Berry
<i>chrysochloris</i>	eUS	16-21	18-21	9		20-24	53-55	Hildebrand, 1963d; Berry
<i>alabamae</i>	eUS	16-20	19-22	9		42-48	55	Hildebrand, 1963d; Berry
<i>aestivalis</i>	eUS, Canada	15-20	16-21	9		41-51	49-53	Hildebrand, 1963d; Berry
<i>fallax</i>	enA	18-21	19-23			20-40	55-59	Whitehead, 1981; Wheeler, 1969
<i>alosa</i>	enA	18-21	20-26			55-85	57-58	Whitehead, 1981; Wheeler, 1969
<i>Ethmalosa</i>								
<i>fimbriata</i>	eA	18	22	8	53	136	44	Whitehead, 1981; Berry
<i>Brevoortia</i>								
<i>aurea</i>	Braz							
<i>gunteri</i>	Gulf Mexico	17-20	20-25	7		144	42-44	Hildebrand, 1963d
<i>patonus</i>	Gulf Mexico	17-21	20-23	7		138-142	42-48	Hildebrand, 1963d; Berry
<i>smithi</i>	eUS	18-20	22-23	7		151	45-47	Hildebrand, 1963d; Berry
<i>tyrannus</i>	eUS, Canada	18-22	18-24	7		137-145	45-50	Hildebrand, 1963d; Berry
<i>Ethmidium</i>								
<i>chilcae</i>	Chile-Peru	18-23	15-18	7-8	123-129	147-159	48-50	Hildebrand, 1946; Berry
Pellonulinae								
<i>Ehirava</i>								
<i>fluviatilis</i>	l	14-16	12-18	8	12-14	24-30		Wongratana, 1980
<i>madagascarensis</i>								Nelson, 1970
<i>Dayella</i>								
<i>malabarica</i>	l	14	17	8	10-11	24-27		Wongratana, 1980
<i>Clupeoides</i>								
<i>borneensis</i>	Borneo	15-18	15-19	8	9-12	18-24		Wongratana, 1980
<i>hypselosoma</i>	Borneo	14-15	16-18	8	10	12-19		Wongratana, 1980
<i>paupensis</i>	Borneo	13-16	17-22	8	9-11	15-19		Wongratana, 1980
<i>venulosus</i>	N. Guinea	13-15	20-22	8				
<i>Corica</i>								
<i>lacinata</i>	Borneo	15-17	13-16 + 2	8	10-13	23-27		Wongratana, 1980
<i>soborna</i>	l	15-16	14-15 + 2	8	9-11	19-21		Wongratana, 1980
Pellonuhnae								
<i>Laeviscutella</i>								
<i>dekumpei</i>								Nelson, 1970
<i>Odaxothrissa</i>								
<i>losera</i>								Nelson, 1970
<i>Potamothrissa</i>								
<i>acutirostris</i>								Nelson, 1970
<i>Spratellomorpha</i>								
<i>bianalis</i>								Nelson, 1970
Pristigasterinae								
<i>Ilisha</i>								
<i>sirishai</i>	l	17-18	39-43	7	8-12	22-26		Wongratana, 1980
<i>novacula</i>	Burma	16	43-45	7	10-12	21-23		Wongratana, 1980
<i>megaloptera</i>	l	16-19	38-53	7	8-11	19-23	47-48	Wongratana, 1980; Berry
<i>elongata</i>	l-China	16-20	43-53	7	9-13	21-25		Wongratana, 1980
<i>filigera</i>	l	17-21	46-52	7	9-12	19-23	50-52	Wongratana, 1980; Berry
<i>macrogaster</i>	l	18-19	49	7	11-12	23-25		Wongratana, 1980
<i>pristigastroides</i>	Java	17-18	47-48	7	9-10	17		Wongratana, 1980
<i>kampeni</i>	l	16-18	38-46	7	9-12	20-24		Wongratana, 1983
<i>striatula</i>	l	15-18	40-48	7	10-13	21-24		Wongratana, 1980
<i>melastroma</i>	lWP	15-18	35-48	7	10-13	21-25		Wongratana, 1983

TABLE 24. CONTINUED.

	Location	Dorsal	Anal	P2	Gillrakers		Vertebrae	Reference
					Upper	Lower		
<i>obfuscata</i>	I	16	39-42	7	12-13	27-28		Wongratana, 1980
<i>africana</i>	ecA	15	47					Whitehead, 1981
<i>amazonica</i>	Braz	20	34	6	15	29		Hildebrand, 1963d
<i>furthii</i>	ecP	15-17	46-50		11-12	20-25	50-52	Peterson, 1956; Hildebrand, 1946; Meek and Hildebrand, 1923
<i>Neopisthopterus</i>								
<i>cubanus</i>	Cuba	12-15	39-43	0	10	17-19	47	Hildebrand, 1963d, Berry
<i>tropicus</i>		15	43-48	0	8	20	45-47	Peterson, 1956; Hildebrand, 1946
Pellonulinae								
<i>Clupeichthys</i>								
<i>bleekeri</i>	Borneo	14-15	16-18 + 2	8	8-10	16-18		Wongratana, 1980
<i>aesarnensis</i>	Thailand	13-15	14-16 + 2	8	8-10	17-19		Wongratana, 1983
<i>gomognathus</i>	Thailand	14-15	15-17 + 2	8	8	15-16		Wongratana, 1980
<i>perakensis</i>	Malaya	13-15	14-17 + 2	7	5-9	13-15		Wongratana, 1980
<i>Pellonula</i>								
<i>leonensis</i>	ecA			8		20-30		Whitehead, 1981
<i>vorax</i>	ecA							Whitehead, 1981
<i>Microthrissa</i>								
<i>royauxi</i>								Nelson, 1970
<i>Poecilothrissa</i>								
<i>congica</i>								Nelson, 1970
<i>Hyperlophus</i>								
<i>vittata</i>								Nelson, 1970
<i>Cynothrissa</i>								
<i>ansorgii</i>								Whitehead, 1981
<i>mento</i>								
<i>Potamalosa</i>								
<i>richmondia</i>								Wongratana, 1980
<i>Gilchristella</i>								
<i>aestuarius</i>								Wongratana, 1980
<i>Lumothrissa</i>								
<i>modon</i>								Wongratana, 1980
<i>Stolothrissa</i>								
<i>tanganicae</i>								Wongratana, 1980
Pristigasterinae								
<i>Pristigaster</i>								
<i>cayana</i>	Brazil	13-16	44-55	0	10	20-23	43-44	Hildebrand, 1963d; Berry
<i>Opisthopterus</i>								
<i>valenciennesi</i>	China	16-18	54-65	7	9-12	23-25		Wongratana, 1980
<i>tardoore</i>	I	14-17	51-63	7	8-12	22-28	50-52	Wongratana, 1980; Berry
<i>dovu</i>	ecP	12-13	53-62	0		17-18	51-52	Meek and Hildebrand, 1923; Ahlstrom
<i>equatorialis</i>	esP	11-12	59-62	0	10	25	46-47	Hildebrand, 1946; Ahlstrom
<i>Raconda</i>								
<i>russehana</i>	I	0	81-92		8-11	23-27	62	Wongratana, 1980; Berry
<i>Pellona</i>								
<i>ditchela</i>	I-Aust	16-19	34-41	7	10-14	22-27	42	Wongratana, 1980; Berry
<i>dayi</i>	I	17-18	35-42	7	9-11	20-21		Wongratana, 1983
<i>altamazonica</i>	Braz	18	37-40	6-7	9	12-14		Hildebrand, 1963d; Berry
<i>castelnacana</i>	Braz-Venz	18-20	34-42	6-7	13-14	24-25	45-46	Hildebrand, 1963d; Whitehead, 1973; Berry
<i>flavipinnis</i>	Braz-Arg	17-21	38-47	7	14-15	28-31	43	Hildebrand, 1963d; Whitehead, 1973; Berry
<i>harroweri</i>	weA	14-17	36-42	5-6	12-13	24-28	38-40	Hildebrand, 1963d; Whitehead, 1973; Berry

TABLE 24. CONTINUED.

	Location	Dorsal	Anal	P2	Gillrakers		Vertebrae	Reference
					Upper	Lower		
<i>Odontognathus mucronatus</i>	wsA	10-12	74-85	0	7-9	22-26	53-54	Hildebrand, 1963d; Whitehead, 1973; Berry
<i>compressus</i>	wcA	10-14	52-62	0	9	18-23	46-47	Hildebrand, 1963d; Whitehead, 1973; Berry, Meek and Hildebrand, 1923
<i>panamensis</i>	ecP	11-12	61-68	0		ca. 21	51-53	Peterson, 1956; Meek and Hildebrand, 1923
<i>Chirocentron bleekeriianus</i>	wcA	14-16	38-45	6-7	4-6	15-17	44-45	Hildebrand, 1963d; Whitehead, 1973; Berry
<i>Phosteostoma lutipinnis macrops</i>	ecP	49-51	0			50-51		Peterson, 1956; Berry
CLUPEIDAE								
Status not verified								
Alosinae								
<i>Caspialosa maotica</i>								Nelson, 1970
Clupeinae								
<i>Clupeonella delicatula</i>								Nelson, 1970
Dorosomatinae								
<i>Nematalosa horm</i>								Nelson, 1970
<i>Thrattudion noctivagus</i>								
<i>Sierrathrissa leonensis</i>								
ENGRAULIDAE								
Coilinae								
<i>Coilha</i>								
<i>ramcarati</i>	I	14-16		9-10	21-23	29-30		Wongratana, 1980
<i>borneensis</i>	Borneo	14-15		7	21-23	32		Wongratana, 1980
<i>reynaldi</i>	I	13-14		7	20-27	28-36		Wongratana, 1980
<i>coomansi</i>	Borneo	14		7	21-24	31-33		Wongratana, 1980
<i>rebentischii</i>	Borneo	14-15		7	15-19	22-27		Wongratana, 1980
<i>neglecta</i>	I	13-15		7	17-19	21-27		Wongratana, 1980
<i>dussumieri</i>	I	13-15		7	17-20	23-26		Wongratana, 1980
<i>rendahli</i>	China	13-15		7				
<i>grayii</i>	1-China	13-14		7	21-23	28-31		Wongratana, 1980
<i>lundmani</i>	Thailand	12-15		7	18-25	29-34		Wongratana, 1980
<i>macrognathos</i>	Borneo	14-15		7	15-16	22-24		Wongratana, 1980
<i>mystus</i>	China	13-15	79-89	6-7	17-22	25-29		Wongratana, 1980
<i>nasus</i>	China-Japan	13-15	87-117	7	16-20	23-26		Wongratana, 1980
Engraulinae								
<i>Engraulis</i>								
<i>japonicus</i>	1wP	14-17	14-22		22-34	26-39		Wongratana, 1980
(= <i>australis</i>)	eA							
(= <i>encrasicolus</i>)	eA							Wongratana, 1980
(= <i>capensis</i>)	sAfrica							Wongratana, 1980
<i>anchota</i>	swA							Whitehead, 1973
<i>eurystole</i>	nwA	15-16	16-19	7		28-31	43-45	Whitehead, 1973
<i>ringens</i>	seP	15-18	19-24		35-43	38-48	46-49	Hildebrand, 1946; Berry
<i>mordax</i>	neP	14-19	19-26		28-41	37-45	43-47	Miller and Lea, 1972
" <i>juruensis</i> "	Amazon							Whitehead, 1973
<i>Inchovia</i>								
<i>clupeoides</i>	swA	14	31	7		105	41	Whitehead, 1973
<i>rastralis</i>	eP	12-14	26-30			ca. 50		Meek and Hildebrand, 1923; Whitehead, 1973

TABLE 24. CONTINUED.

	Location	Dorsal	Anal	P2	Gillrakers		Vertebrae	Reference
					Upper	Lower		
<i>surinamensis</i>	ewA	13-15	25-28	7		47-62		Whitehead, 1973
<i>macrolepidota</i>	eP	12-14	27-33			ca. 95	40-42	Meek and Hildebrand, 1923; Whitehead, 1973; Peterson, 1956
<i>magdalenae</i>	neP							
<i>Anchoa spinifer</i>	wcA-ecP	15-17	30-40	7	12-16	12-18	19-21 ± 21-22	Hildebrand, 1963c; Whitehead, 1973; Peterson, 1956; Cervigon, 1966; Nelson, 1983
<i>trinitatis</i>	Venz	13-15	26-32		19-21	32-40	41	Whitehead, 1973; Cervigon, 1966; Hildebrand, 1963c
<i>cubana</i>	wA	14-16	20-24	7	17-23	23-33	42-43	Whitehead, 1973
<i>parva</i>	wcA	15-16	21-25	7	17-20	23-28	38-41	Whitehead, 1973; Hildebrand, 1964
<i>lamprotacma</i>	wA	13-16	19-27	7	13-18	16-22	39-42	Whitehead, 1973; Hildebrand, 1964
<i>hepsetus</i>	wA	13-16	18-24	7	15-21	19-25	40-44	Whitehead, 1973; Hildebrand, 1964
<i>filifera</i>	wcA	13-15	19-23	7	17-19	20-26	39-40	Whitehead, 1973; Hildebrand, 1964
<i>lyolepis</i>	wA	12-16	19-27	7	16-23	20-27	41-43	Whitehead, 1973; Cervigon, 1966; Hildebrand, 1963c
<i>ginsburgi</i>	Venz	14-15	18-22		16-18	20-22	44-45	Cervigon, 1966; Hildebrand, 1963c
<i>tricolor</i>	wsA	14-16	18-22		18-22	24-28	40-42	Hildebrand, 1963c
<i>choerostoma</i>	Bermuda	13-15	22-24		17-20	23-26	41-42	Hildebrand, 1963c
<i>januaria</i>	wsA	14-15	21-24		20-23	23-26	41-42	Hildebrand, 1963c
<i>mitschilli</i>	wnA	14-16	24-30		15-19	20-26	38-44	Hildebrand, 1963c
<i>pectoralis</i>	Braz	14-16	25-27		13-14	17-19	42	Hildebrand, 1963c
<i>cayorum</i>	wA	13-15	25-29		13-15	15-17	43	Hildebrand, 1963c
<i>argenteus</i>	Venz	16	32		14	19		Hildebrand, 1963c
<i>argentivittata</i>	ecP		18-20	14-19	17-21	24-25 + 19-22		Peterson, 1956; Nelson, 1983
<i>ischana</i>	enP		18-21		19-21	22-24 + 19-21		Peterson, 1956; Nelson, 1983
<i>panamensis</i>	ecP	12	32-26		22-24	18-20 + 21-24		Peterson, 1956; Nelson, 1983; Hildebrand, 1946
<i>compressa</i>						18-19 + 20-22		Nelson, 1983
<i>mundeolooides</i>						18-20 + 21-23		Nelson, 1983
<i>walkeri</i>						18-20 + 21-24		Nelson, 1983
<i>analis</i>						17-19 + 20-23		Nelson, 1983
<i>curta</i>	ecP		23-25		22-25	19-22 + 19-22		Peterson, 1956; Nelson, 1983
<i>delicatissima</i>	P	13-15	23-26	18-21	23-26	19-21 + 19-21		Nelson, 1983; Miller and Lea, 1972
<i>helleri</i>	P					20-23 + 18-21		Nelson, 1983; Miller and Lea, 1972
<i>starksi</i>	ecP		20-23		22-26	20-22 + 19-21		Peterson, 1956; Nelson, 1983
<i>clarki</i>	P					21 + 21		Nelson, 1983
<i>eigenmannia</i>	ecP			18-21	12-13	17-21 + 20-25		Peterson, 1956; Nelson, 1983
<i>scotlandi</i>	P					20-22 + 21-23		Nelson, 1983
<i>lucida</i>	ecP		25-28		19-22	17-20 + 19-22		Peterson, 1956; Nelson, 1983

TABLE 24. CONTINUED.

	Location	Dorsal	Anal	P2	Gillrakers		Vertebrae	Reference
					Upper	Lower		
<i>naso</i>	ecP	14–16	23–27	21–24	23–27	19–21 + 19–22		Peterson, 1956; Nelson, 1983; Hildebrand, 1946
<i>chamensis</i>	eP					21 + 22		Nelson, 1983
<i>nasus</i>	ecP	15–16	21–27	21–25	24–28	20–21 + 20–22		Nelson, 1983; Hildebrand, 1946
<i>exigua</i>	ecP		17–22		23–25	43–45		Peterson, 1956; Nelson, 1983
<i>Anchoviella</i>								
<i>lepidentostole</i>	wsA	14–16	22–25	7	17–18	19–23		Whitehead, 1973; Cervigon, 1966
<i>ureivirostris</i>	wsA	16–18	18–20	7		24–27		Whitehead, 1973
<i>guianensis</i>	wcsA	14–15	18–20	7		23–26	40	Whitehead, 1973
<i>cayennensis</i>	weA	13	16	7		30		Whitehead, 1973
<i>nattereri</i>	Braz	12	25–29					Whitehead, 1973; Cervigon, 1966
<i>perfasciata</i>	wnA	12–15	15–19		18–23	25–28	42–44	Cervigon, 1966
<i>elongata</i>	Panama A	13–14	22–24		17–18	22–24	39	Cervigon, 1966
<i>blackburni</i>	Venz	13–15	25–27		10–12	15–17	43	Cervigon, 1966
<i>jamesi</i>	Braz	12–13	19–21		12–13	20–21	40	Cervigon, 1966
<i>vallanti</i>			23			19		Whitehead, 1973
<i>carrikeri</i>			17–18			14–15		Whitehead, 1973
<i>Stolephorus</i>								
<i>indicus</i>	lwP	14–17	17–22		16–20	20–28	20–23 + 19–21	Wongratana, 1980
<i>commersonii</i>	lwP	15–17	20–23		12–27	21–35		Wongratana, 1980
<i>brachycephalus</i>	Papua	16–17	22–25		15–17	20–22		Wongratana, 1983
<i>chinensis</i>	China	16–18	20–23		18–19	26–27		Wongratana, 1980
<i>waiteri</i>	I-Aust	15–17	19–24		14–17	1–4		Wongratana, 1980
<i>holodon</i>	seAfr	15–18	20–23		17–22	24–29		Wongratana, 1980
<i>andhraensis</i>	eI-Papua	15–17	19–23		14–15	20–21		Wongratana, 1980
<i>tysoni</i>	Papua	15–17	21–25		15–18	21–25		Wongratana, 1983
<i>insularis</i>	I-China	14–17	19–23		16–20	22–28		Wongratana, 1980
<i>dubiosus</i>	I	14–16	19–24		19–24	25–31		Wongratana, 1980
<i>baganensis</i>	I	14–16	20–23		16–19	20–24		Wongratana, 1980
<i>tri</i>	Thailand	14–15	19–22		15–17	19–22		Wongratana, 1980
<i>oligobranchus</i>	Philipp	14–16	18	7	13–14	17–18		Wongratana, 1983
<i>Thryssa</i>								
<i>baelama</i>	lwP	15	29–34		14–20	19–26		Wongratana, 1980
<i>cheffiensis</i>	China	14	29–34		23–28	27–30		Wongratana, 1980
<i>rastrorsa</i>	N. Guinea	14–15	32–35		39–44	55–61		Wongratana, 1980
<i>scratchleyi</i>	N. G.-Aust	14	33–36		15–18	18–20		Wongratana, 1980
<i>aestuaria</i>	N. G.-Aust	13–15	32–36		22–25	27–29		Wongratana, 1980
<i>kammalensis</i>	Thailand	14–15	32–37		23–27	28–32		Wongratana, 1980
<i>kammalensoides</i>	I	14	34–35		18	24–25		Wongratana, 1983
<i>vitrostris</i>	e Africa	13–15	34–43		14–17	20–23		Wongratana, 1980
<i>adclae</i>	China	13–14	38–44		13–16	20–22		Wongratana, 1980
<i>dussumeri</i>	I-Taiwan	12–15	34–38		13–16	17–19		Wongratana, 1980
<i>mystax</i>	I-China	13–15	35–39		9–11	13–16		Wongratana, 1980
<i>polybranchialis</i>	I	13–15	38–42		18–21	25–27		Wongratana, 1983
<i>guatamiensis</i>	I	13–15	36–40		11–13	17–19		Wongratana, 1980
<i>malabarica</i>	I	13–15	37–41		14–16	17–19		Wongratana, 1980
<i>hamiltoni</i>	lwP	13–15	35–41		7–10	11–15		Wongratana, 1980
<i>whiteheadi</i>	Pers. G.	12–14	42–46		13–15	18–20		Wongratana, 1983
<i>purava</i>	I	12–14	42–47		14–16	18–19		Wongratana, 1980
<i>stenosoma</i>	I	12–14	43–48		13–15	17–19		Wongratana, 1983
<i>davi</i>	I	13–14	44–49		10–13	14–18		Wongratana, 1983
<i>spindens</i>	I-Thai	12–14	44–48		9–11	13–15		Wongratana, 1980
<i>setrostris</i>	I-China	13–15	32–39		5–6	10–12		Wongratana, 1980
<i>Encrasicholina</i>								
<i>purpurea</i>	Hawaii	12–15	14–18	7	15–22	23–29	41–44	Muller et al., 1979; Wongratana, 1980; Nelson, 1983

from 0.59–0.75 mm in *Sardinella jussieu* (Bensam, 1970) to 2.5–3.8 mm in *Alosa sapidissima* (Jones et al., 1978). Most clupeid eggs are 1–2 mm in diameter. All have a segmented yolk. The chorion is not ornamented or sculptured. The perivitelline space varies in thickness among species. It may be as large as 45% of the egg diameter (*Sardinella zunasi*) or as small as 5–10% (*Anodontostoma*, *Opisthopterus*). The egg yolk may shrink relative to the egg diameter when preserved (Bensam, 1967) and the yolk decreases in size during the development of the embryo. Oil globules are present in the eggs of most clupeids. One is often present (e.g., *Sardinella*, *Harengula*, *Sardinops*); *Escualosa thoracata* has nine (Delsman, 1932a, described as *Clupeoides lile*). The eggs of clupeids which lay demersal adhesive eggs (*Clupea*, *Dorosoma*, *Spratelloides*) have a gelatinous covering around the egg. The pelagic egg of *Tenualosa ilisha* is also covered by a gelatinous sheath. In *Dorosoma petenense* the adhesive layer is composed of transformed ovarian follicular epithelium, an unusual feature among teleosts (Shelton, 1978).

Eggs of anchovies, family *Engraulidae*, range in size from 0.7 mm (*Lycengraulis*) to 1.75 mm (*Stolephorus*, long axis). Their shape varies from globular to extremely elliptical. The ratio of the long axis of the ellipse to the short axis has been used to identify anchovy eggs (Peterson, 1956; Phonlor, 1978). Some *Stolephorus* species have a distinct knob on one end of the egg surrounding the micropyle. A perivitelline space is present but smaller and less noticeable than in clupeid eggs because of the elliptical shape. Oil globules are absent except in the genera *Coilia* and *Setipinna*, which have spherical eggs like clupeids, and the Indo-Pacific species of *Stolephorus*. Fig. 58 illustrates representative eggs of clupeiforms.

Yolk-sac larvae are characterized by their size at hatching (2–5 mm), which is related to yolk size; whether the yolk-sac is rounded or pointed posteriorly, the number and position of oil globules, number of myomeres and pigmentation. Larvae from demersal adhesive eggs may hatch with pigmented eyes (*Clupea harengus*); those from pelagic eggs hatch with unpigmented eyes. Oil globules may be present in the anterior, ventral, or posterior part of the yolk sac. Multiple oil globules in early embryos coalesce into a single large one before hatching in *Setipinna phasa* (John, 1951a). A spherical yolk sac usually remains spherical although shrinking in size during development (*Sardinella zunasi*), while a yolk sac which is pointed posteriorly may become more rounded as yolk is utilized (*Coilia* sp.). Larval clupeiforms are slender and elongate with long straight guts. Series of melanophores are variously arranged above and below the gut and along the ventral body wall. Subtle differences in pigmentation are very useful for identifying co-occurring larval clupeoids prior to fin development. Larvae of *Engraulis mordax*, *Sardinops sagax*, and *Etrumeus teres* are illustrated for comparison in Moser (1981). Median dorsal melanophores in clupeid embryos migrate, reaching their characteristic ventral positions soon after hatching (Orton, 1953a). In engraulids, pigment cells are presumed to migrate similarly but they don't become

pigmented until after hatching. Melanophores are commonly present ventrally just anterior to the pectoral symphysis in small larvae, (e.g., *Opisthonema*, *Harengula*, *Engraulis*, *Sardinops*, *Etrumeus*). During development external rows of melanophores become dark streaks and internal melanophores may increase in size and number at first but disappear or become occluded at transformation. A thorough description of pigment development of laboratory-reared *Opisthonema oglinum* larvae complete with dorsal, lateral, and ventral illustrations is given by Richards et al. (1974). Prenatal myomere number is taxonomically useful but it does not correspond exactly with precaudal vertebral count in the adult because of changes during transformation. Pectoral fin buds and a continuous dorsal–caudal–anal finfold are present at hatching. Fin rays first appear in the caudal fin then in the dorsal, then the anal, next the pelvic, and last the pectoral fin. Ossification of fin rays proceeds in the same order. A full complement of fin rays is not attained until transformation, which occurs at approximately 20 mm standard length (e.g., *Harengula jaguana*, Houde et al., 1974; *Opisthonema oglinum* Richards et al., 1974). Figs. 59 and 60 illustrate yolk sac larvae of herrings and anchovies.

The most useful single character for identifying larval clupeiforms is total myomere or vertebral number. Pigment patterns are useful when vertebral counts overlap. The relative positions of dorsal and anal fins and the length of the gut can be used to separate clupeids from engraulids: clupeids have a longer gut relative to body length and there is a gap between the posterior margin of the dorsal fin and the anterior margin of the anal fin; engraulids have a shorter gut and tend to have the posterior margin of the dorsal over the anterior insertion of the anal fin. The number of myomeres between dorsal and anal fins has been used as a taxonomic character in larvae of certain size classes (Houde and Fore, 1973) and in clupeid adults (Svetovidov, 1963). During metamorphosis the position of the gut and the dorsal and anal fins shift forward relative to myomere number. The dorsal insertion moves 10 myomeres forward in *Sardinops sagax* (Ahlstrom, 1968); it moves eight myomeres in *Harengula jaguana* (Houde et al., 1974). The migration of the fin takes place at approximately the time when the fin ray number stabilizes. The pelvic fin migrates posteriorly in *Clupea harengus* (Lebour, 1921). Because of these dramatic changes in morphology during development different characters must often be used at different stages to separate species. However some morphometric characters show a small but consistent difference between species at all sizes as between *Alosa pseudoharengus* and *A. aestivalis* (Chambers et al., 1976). Additional care must be taken when using information from laboratory-reared specimens to identify field samples. Fin development began at 4 mm in laboratory-reared *Opisthonema oglinum*, but was not observed in wild-caught larvae less than 7 mm long (Richards et al., 1974). Shrinkage due to preservation and handling (Theilacker, 1980a) also presents problems when comparing development of larvae based on length. Meristic characters in *Clupea*

Fig. 58. Eggs of Clupeiformes illustrating taxonomic characters: number and size of oil globules, width of perivitelline space, degree of yolk segmentation, shape, size. (A) *Chirocentrus nudus*, 1.56 mm, Delsman, 1923; (B) *Etrumeus teres*, 1.35 mm, Ahlstrom and Moser, 1980; (C) *Opisthopterus tardoore*, 0.85 mm, Bensam, 1967; (D) *Dussumieria*, 1.5 mm, Delsman, 1925; (E) *Anodontostoma chacunda*, 0.92 mm, Delsman, 1926c; (F) *Sardinops melanosticta*, 1.60 mm, Mito, 1961; (G) *Coilia*, 1.04 mm, Delsman, 1932b; (H) *Setipinna phasa*, 1.10 mm, Jones and Menon, 1950; (I) *Anchoa mitchilli*, 0.84 × 0.65, Kuntz, 1914b; (J) *Engraulis mordax*, 1.40 × 0.74, Bolin, 1936a; (K) *Stolephorus insularis*, 1.92 × 0.69, Delsman, 1931; (L) *Stolephorus indicus* or *commersonii*, 1.15 × 0.81, Delsman, 1931. All redrawn by J. Javech.

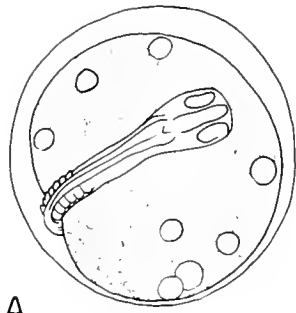

A

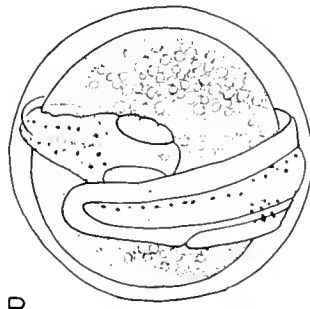

B

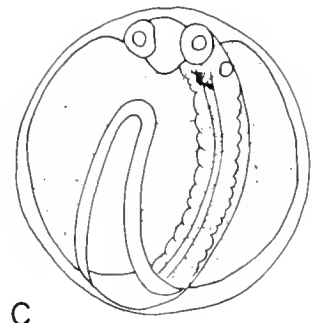

C

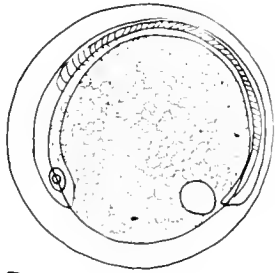

D

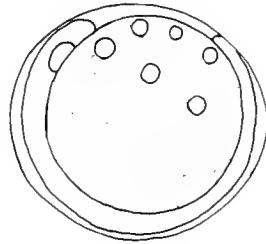

E

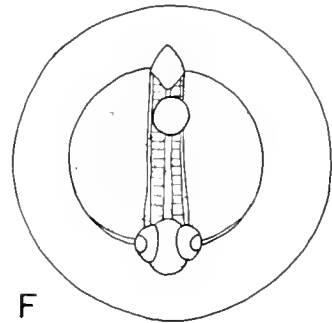

F

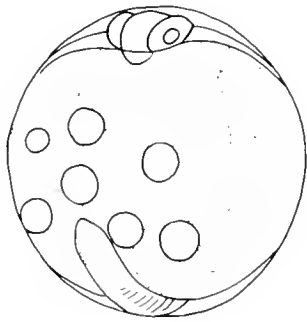

G

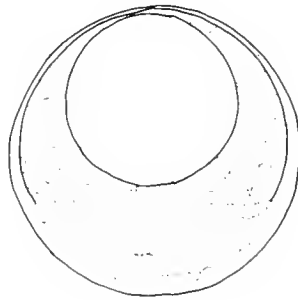

H

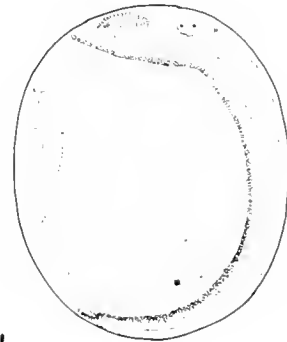

I

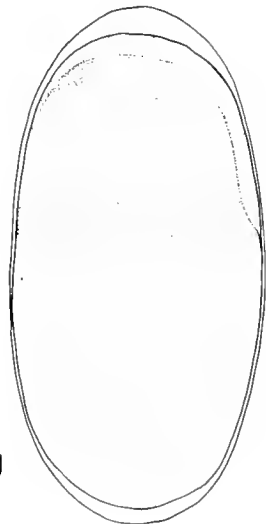

J

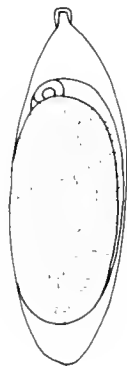

K

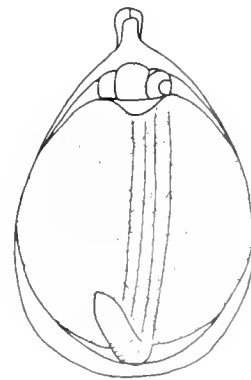

L

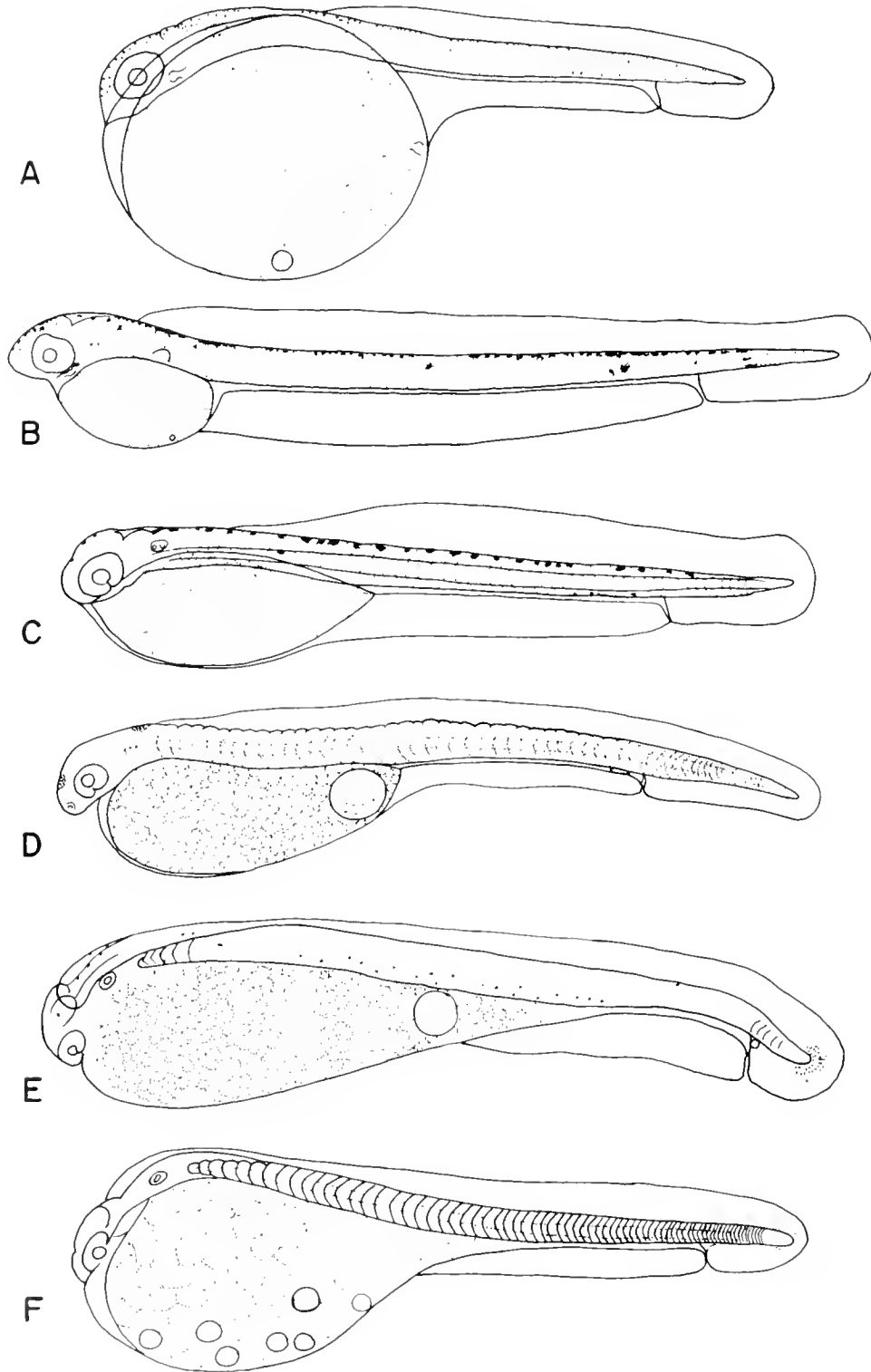

Fig. 59. Yolk-sac larvae of Clupeidae and *Chirocentrus* illustrating taxonomic characters: number, size, and position of oil globules; shape of yolk sac; degree of segmentation of yolk; preanal myomeres. (A) *Sardinella zunasi*, 2.71 mm, Takita, 1966; (B) *Sardinella zunasi*, 4.79 mm, Takita, 1966; (C) *Etrumeus teres*, 4.84 mm, Mito, 1961; (D) *Ilisha elongata*, 5.59 mm, Sha and Ruan, 1981; (E) *Dussumiera*, 3.17 mm, Delsman, 1925; (F) *Chirocentrus nudus*, 3.79 mm, Delsman, 1923. All redrawn by J. Javech.

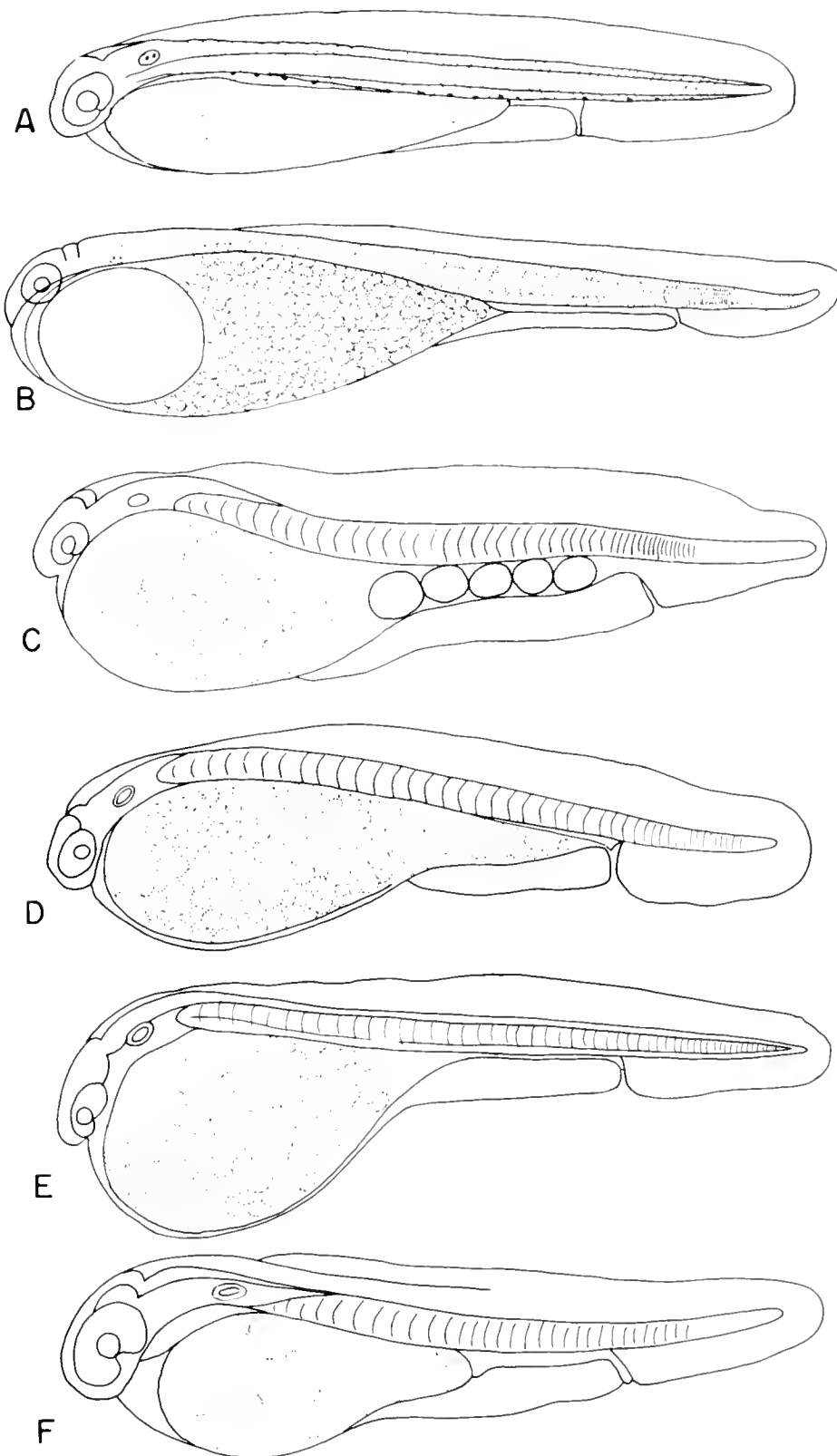

Fig. 60. Yolk-sac larvae of Engraulidae illustrating taxonomic characters: oil globules, shape of yolk sac, yolk segmentation, preanal myomeres. (A) *Engraulis japonicus*, 3.02 mm, Mito, 1961; (B) *Coilia*, 2.83 mm, Takita, 1967; (C) *Coilia*, 2.46 mm, Delsman, 1932b; (D) *Stolephorus insularis*, 2.19 mm, Delsman, 1931; (E) *Thryssa hamiltoni*, 2.42 mm, Delsman, 1929a; (F) *Cetengraulis mysticetus*, 1.99 mm, Simpson, 1959. All redrawn by J. Javech.

harengus larvae were shown to be affected by temperature and salinity (Hempel and Blaxter, 1961); morphometric characters in *Gilchristella aestuarius* adults were found to differ between estuaries with different types of prey items (Blaber et al., 1981).

There are several characters which may be useful in systematics when they are described for more clupeiform species. The melanophores on the caudal fin dorsal and/or ventral to the notochord tip in small larvae have been described for a few species. *Harengula jaguana* has dorsal melanophores only at first, then both dorsal and ventral (Houde et al., 1974). *Opisthonema oglinum* has ventral ones (Richards et al., 1974). *Sardinella brasiliensis*, *S. maderensis* and *S. zunasi* have just ventral melanophores but *Sardinella rouxi* has both. Slight differences in pigmentation over the brain and on the mid-dorsal and mid-ventral postanal body midline have been used to identify scombrid larvae. Small scombrid larvae are otherwise very similar to each other as are clupeoid larvae. The development of free neuromasts and the lateral line has been described for a few species (Blaxter et al., 1983). Development of the swimbladder and its unique connection with the inner ear should be useful (Hoss and Blaxter, 1982). Ephemeral basihyal teeth were observed on *Opisthonema oglinum* and *Harengula jaguana* larvae (Richards et al., 1974; Houde et al., 1974). Two patterns of nasal epithelium cells have been observed with scanning electron microscopy (Yamamoto and Ueda, 1978). *Harengula*, *Sardinops* and *Konosirus* had one pattern while *Etrumeus* (a clupeid) had the same pattern as *Engraulis*, an engraulid.

Although the eggs and yolk-sac larvae of clupeiforms have many characters of potential systematic importance, the taxonomic characters of the older larvae (meristics, fin position, and pigmentation) will tend to be redundant with the same adult characters. However, clupeoids are easily reared in the laboratory so direct experimental evaluation of the polarity of adult character states by comparative developmental studies is possible.

RELATIONSHIPS

The clupeiform fishes are considered a well-defined monophyletic group based on their unique otophysic connection, the caudal skeleton, and other characters (Greenwood et al., 1966). The distribution of species within genera, genera within subfamilies, and number and taxonomic rank of categories within the group are not agreed upon (Gosline, 1971, 1980; Miller, 1969; Nelson, 1967, 1970, 1973; Whitehead, 1972, 1973). J. S. Nelson (1976) lists the families Chirocentridae, Denticipitidae, Clupeidae, and Engraulidae. He gives seven subfamilies of herrings (Dussumieriinae, Clupeinae, Pellonulinae, Alosinae, Dorosomatinae, Pristigasterinae, and Congothriissinae) and two subfamilies of anchovies (Engraulinae and Coiliinae). *Spratelloides* is separated from the Dussumieriinae and given subfamily rank by Whitehead (1972, 1973). *Jenkinsia* is the western Atlantic spratelloid.

Based on the gill arches Nelson (1967) concluded that the Dussumieriinae (including *Spratelloides* and *Jenkinsia*) were the most primitive clupeid family; the Pristigasterinae were also primitive but with distinctive specializations; the Clupeinae were more advanced, but linked to the Dussumieriinae by *Clupea* and *Sprattus*; the Alosinae and Dorosomatinae were closely related and perhaps both derived from the Clupeinae; and the Pellonulinae, lacking the specializations of the Alosinae and Dorosomatinae, most resembled the Clupeinae. Expanding his

study of gill arches in the Clupeidae to the hyobranchial apparatus in the Clupeiformes, Nelson (1970) divided the order into the superfamilies Chirocentroidea, Engrauloidea, Pristigasteroidea, and Clupeoidea. The Clupeoidea were suggested to consist of two families: the Clupeidae composed of the Dussumieriinae, Pellonulinae, and Alosinae in part; and the Dorosomatinae composed of the Dorosomatinae plus *Hilsa* from the Alosinae and *Harengula* and *Sardinella* from the Clupeinae. *Sardina* and *Alosa* were aligned with *Clupea*, *Potamalosa*, and *Etrumeus* in his tree depicting relationships of representative genera (Nelson, 1970: Fig. 11).

Whitehead (1972, 1973) acknowledged that radical changes in clupeid classification could be expected but retained the subfamilies Dussumieriinae, Spratelloidinae, Clupeinae, Pellonulinae, Alosinae, Dorosomatinae, and Pristigasterinae in his works which were chiefly concerned with the identification of genera and species.

The most recent comprehensive work is that of Wongratana (1980) on the Clupeidae and Engraulidae of the Indo-Pacific. He examined over 14,000 specimens and considered many meristic and morphological characters including gill rakers, epibranchial organs, predorsal bones, caudal osteology, circumorbital bones, gut form, the gas bladder, scale striae, and the patterns of scale distribution on the body. No numerical, cladistic, or phenetic analyses were done. Taxonomic characters were discussed with respect to apparent evolutionary trends and relative importance. Wongratana retained the subfamilies of Whitehead (1972). The Spratelloidinae were diagnosed by a bony process on the 6th and 12th principal caudal rays. *Spratelloides* is also unique among Indo-Pacific clupeids in having a single epural. *Jenkinsia*, the spratelloidin in the Western Atlantic, also has a single epural (Hollister, 1936). The Alosinae and Dorosomatinae were kept separate and the Pristigasterinae were accorded subfamily status although considered quite distinct from the other clupeids. The Dussumieriinae and Pellonulinae were considered the most primitive groups, the Alosinae and Dorosomatinae the most advanced, and the Spratelloidinae and Clupeinae were considered intermediate. Within the anchovies, the Coiliinae have one epural while the Engraulinae have two (*Engraulis*) or three (*Papuengraulis*). The Coiliinae were considered primitive relative to the Engraulinae although specialized in many respects.

Wongratana (1980) found that the number of predorsal bones varies from one to thirty in the clupeids and engraulids (*Chirocentrus* has none). Some engraulids and pellonulins have a gap between the posterior predorsal bone and the first dorsal pterygiophore which he interpreted as evidence that the dorsal fin has migrated posteriad during evolution. It would be interesting to compare the patterns of dorsal bones and the anteriop migration of the dorsal fin during larval metamorphosis. The "dorsal scutes" of *Clupanodon thrissa* were found to be the exposed tips of predorsal bones (Wongratana, 1980). The only double-armed herrings known now are *Potamalosa* and *Hyporlophus* in the Pellonulinae, and *Ethmidium* in the Alosinae. Dorsal scutes are interesting because they occurred in herring-like fossils (*Diplomystus*, *Knightia*, and *Gasteroclupea*) which resemble pristigasterins (Nelson 1970).

Because he examined so many species from such a wide area Wongratana (1980) was able to clear up many nomenclatural questions and to correct previous misidentifications which had been based on limited material. He also described 24 new species

(Wongratana, 1983) and provided keys to all Indo-Pacific species (Wongratana, 1980). However no direct comparison between his classification and that of Nelson (1967, 1970, 1973) is possible because he only examined Indo-Pacific material while Nelson included West African and New World material.

Evidence from eggs and larvae

There are two major problems with using characters of eggs and larvae to criticize classifications based on adult characters. First, the planktonic stages of fishes are exposed to different selective pressures than the adults so they may show patterns of specializations for planktonic life which are not congruent with the distribution of adult character states. Second, relatively few genera of clupeiform fishes have had the eggs or larvae described for even one species in the genus. The first problem must be dealt with the same as any character complex in a group with more than one character complex. More knowledge of the ecology of the larvae in the sea would identify species with different functional requirements for their larvae. The second problem may be resolved by using the available evidence in a parsimonious fashion.

Eggs and young larvae are similar within genera. Seven species of *Sardinella* (Table 25) all have moderately sized clupeid-type eggs with a wide perivitelline space and a single oil globule. The egg described by Takita (1966) and Chang et al. (1981) as that of *Harengula zunasi* is similar. Wongratana (1980) places *zunasi* in *Sardinella*.

Within subfamilies there is little apparent consistency in egg morphology among genera. *Etrumeus* has no oil droplet but *Dussumieria* does. *Brevoortia* has eggs 1.3 mm or larger with a single oil globule; *Hilsa kelee* has 1.00–1.07 mm eggs with several small oil droplets. *Clupea* has demersal adhesive eggs while *Sprattus* has pelagic eggs with a small perivitelline space. The Indo-Pacific pristigasterin species of *Hisha* have large eggs with adhesive coatings and a single large oil globule but *Opisthopterus tardoore* and the eastern Pacific *O. dovii* have small eggs with small perivitelline spaces and no oil droplets.

The functional significance of egg characters is unknown. Separate lineages within the group which have radiated into several habitats could show parallel adaptations such as oil droplets for buoyancy or nutrition, adhesive coating for retention nearshore or demersally, and egg size as a trade-off between broadcasting and parental investment. Alternatively, different types of eggs within taxonomic categories could also support splitting the category. The anchovy genus *Stolephorus* contains species with eggs which range from oval with no oil globule to varying degrees of eccentricity with an oil droplet, to unusually shaped eggs with knobs on one end (Delsman, 1931). Nelson (1983) separated *Stolephorus* into two groups, a *Stolephorus* group with 13 species and an *Encrasicholina* (new usage) group of 5 species which he considered more closely related to New World anchovies than to the 13 *Stolephorus* species. The three *Encrasicholina* species whose eggs are known have an oval egg without a knob. One of the three, *E. heterolobus*, was reported by Delsman (1931) to have a small oil droplet and to be relatively more abundant near shore than *Stolephorus zolingeri*. The other two, *E. purpureus* and *E. punctifer* (= *buccaneeri*, Strasburg, 1960; = *zolingeri*, Delsman, 1931), occur in Hawaii and neither has an egg with an oil droplet. New World anchovies don't have eggs with knobs or oil droplets; therefore, the evidence from eggs supports

Nelson's revision and in addition provides some basis for zoogeographic speculation.

Whether the pristigasterins should be given equal rank with the clupeids and engraulids cannot be answered with the available ontogenetic information. There are two very different egg types in the group, small with small perivitelline space and large with gelatinous coating, both of which could be considered specializations. *Etrumeus*, *Jenkinsia*, *Spratelloides*, *Clupea*, *Sprattus*, and *Potamalosa* were linked based on a foramen in the fourth epibranchial (Nelson, 1970). Eggs of *Spratelloides* and *Clupea* are both demersal and adhesive. The planktonic eggs of *Etrumeus* and *Sprattus* both have narrow perivitelline spaces and lack oil globules. Eggs of *Potamalosa* and *Jenkinsia* are unknown. *Jenkinsia* is related to *Spratelloides* and has demersal larvae (Powles, 1977) so it may have demersal eggs. The developmental osteology of these genera could be studied to determine if the shared foramen is phylogenetically homologous. The egg of *Anodontostoma*, Dorosominae, is similar to eggs of the Alosinae in that it has multiple small oil droplets. Otherwise both the Alosinae and Dorosomatinae contain species with demersal adhesive eggs and species with buoyant planktonic eggs.

Other suggestions of Nelson (1970) that *Sardinella*, *Opisthonema*, *Harengula*, and *Herklotsichthys* should be placed with the Dorosomatinae and *Sardina* and *Sardinops* with the Alosinae and then that the Alosinae and Dorosomatinae should be combined leaving just Clupeinae and Dorosomatinae cannot be critically evaluated with existing ontogenetic data. These hypotheses could be tested by comparing the osteological development of the characters used by Nelson, augmented by other early life history characters.

Relationships of the Clupeiformes

Greenwood et al., (1966) placed the Clupeomorpha and Elopomorpha together in their Division One but gave serious consideration to the possibility that the Clupeomorpha should be recognized as a separate division. Using information on the gut and lower jaw, Nelson (1973) proposed that the Clupeomorpha were distinct from the Elopomorpha but perhaps related to the non-osteoglossomorph teleosts. Gosline (1980) concluded that the clupeiform fishes should be grouped with the elopiform, the salmoniform, gonorynchiform, and ostariophysine fishes; separated on one side from the osteoglossiform fishes and from the iniomous—acanthopterygian teleosts on the other. His conclusions were based on five morphological character complexes: the caudal skeleton, the swim bladder-ear connection, the postcleithrum, the structures associated with pectoral fin movement, and the various types of premaxillary movements and jaw protrusion (Gosline, 1980).

Gosline (1980) considered the elopomorphs to be an early offshoot from a basal lower teleostean group. He considered the gonorynchiforms and ostariophysines to be more closely related to each other than to the clupeiforms. A clupeiform—osteoglossiform link has also been mentioned (Greenwood, 1973). J. S. Nelson (1976), who put the superorders Clupeomorpha (Clupeiformes) and Elopomorpha (Elopiformes, Albuliformes, Anguilliformes) into Division Taeniopaedia, stated succinctly that "the relation of superorders recognized here is poorly known and they are essentially 'loose ends.'" Lauder and Liem (1983) provisionally follow Nelson (1970) for most groups within the Clupeomorpha but represent the interrelationships of clupeoid lineages as an unresolved polytomy. Lauder and Liem (1983)

TABLE 25. SOURCES OF EARLY LIFE HISTORY INFORMATION FOR CLUPEIFORMES. Reviews and readily available works with superior illustrations are cited rather than original descriptions in some cases.

Genus species	Eggs	Larvae	Juveniles	Morphology	Meristics	Fins	Pigmentation	Osteology	Fecundity	Spawning region	Spawning season	Keys or comparisons with others species	Reared specimens	Wild-caught specimens	References
<i>Chirocentrus dorab</i>	X	X		X	X							X	X		Delsman, 1923, 1930b
<i>Chirocentrus nudus</i>	X	X		X	X							X	X		Delsman, 1923, 1930b
<i>Sardinella zunasi</i>	X	X	X	X	X		X			X	X		X		Takita, 1966; Chang et al., 1981
<i>Sardinella jussieu</i>	X	X	X	X	X		X			X	X	X		X	Bensam, 1970
<i>Sardinella aurita</i>	X	X	X	X	X	X	X		X	X	X	X		X	Jones et al., 1978; Houde and Fore, 1973
<i>Sardinella albella</i>	X	X										X	X	X	Delsman, 1933b
<i>Sardinella fimbriata</i>	X	X			X							X	X	X	Delsman, 1926
<i>Sardinella brachysoma</i>	X	X		X	X		X					X	X	X	Delsman, 1926
<i>Sardinella brasiliensis</i>		X	X	X	X	X	X	X	X			X		X	Matsuura, 1975
<i>Sardinella longiceps</i>	X	X			X		X		X	X	X	X		X	Nair, 1960
<i>Sardinella maderensis</i>		X		X	X	X	X			X	X	X		X	Conand, 1978; Conand and Fagetti, 1971
<i>Sardinella rouxi</i>		X			X									X	Conand, 1978
<i>Clupea harengus</i>	X	X	X	X	X	X	X		X	X	X	X	X	X	Jones et al., 1978; Fahay, 1983
<i>Clupea pallasi</i>	X	X	X	X	X	X	X		X	X	X	X		X	Wang, 1981
<i>Clupea bentincki</i>		X	X	X	X	X	X			X	X	X		X	Orellana and Balbontin, 1983
<i>Sprattus sprattus</i>	X	X	X	X	X	X	X			X	X	X		X	Saville, 1964
<i>Sprattus antipodum</i>	X														Russell, 1976; Robertson, 1975a
<i>Etrumeus teres</i>	X	X	X	X			X							X	Mito, 1961a
<i>Etrumeus whiteheadi</i>	X	X		X	X		X			X	X		X	X	Brownell, 1979; O'Toole and King, 1974
<i>Dussumeria</i> sp.	X	X		X	X									X	Delsman, 1925
<i>Spratelloides delicatulus</i>	X	X	X	X	X	X	X					X		X	Uchida et al., 1958; Miller et al., 1979
<i>Jenkinsia lamprotaenia</i>		X	X	X	X	X	X					X		X	Powles, 1977
<i>Konosirus punctatus</i>	X	X		X	X		X							X	Mito, 1961a
<i>Anodontostoma chacunda</i>	X	X	X	X	X	X	X						X	X	Delsman, 1933a
<i>Dorosoma petenense</i>	X	X	X	X	X	X	X		X	X	X	X	X	X	Shelton and Stephens, 1980; Jones et al., 1978
<i>Amblygaster leiogaster</i>	X	X		X	X		X					X	X		Delsman, 1926b
<i>Amblygaster sirm</i>	X	X													John, 1951a
<i>Escualosa thoracata</i>	X	X			X							X	X		Delsman, 1926c, 1934a
<i>Opisthonema libertate</i>	X										X				Peterson, 1956
<i>Opisthonema oglinum</i>	X	X	X	X	X	X	X	X	X	X	X	X	X	X	Richards et al., 1974; Jones et al., 1978
<i>Harengula jaguana</i>	X	X	X	X	X	X	X	X				X	X	X	Houde et al., 1974; Gorbunova and Zvyagina 1975; Houde and Fore, 1973
<i>Harengula peruana</i>	X													X	Peterson, 1956
<i>Sardinops sagax caerulea</i>	X	X		X			X						X	X	Ahlstrom, 1943; Miller, 1952
<i>Sardinops sagax musca</i>	X	X	X	X	X	X	X			X	X	X		X	Santander and de Castillo, 1977; Orellana and Balbontin, 1983
<i>Sardinops melanosticta</i>	X	X		X			X					X			Mito, 1961a
<i>Sardinops ocellata</i>	X	X	X	X	X		X			X	X		X	X	Brownell, 1979; Louw and O'Toole, 1977
<i>Sardina pilchardus</i>	X	X	X	X	X	X	X					X		X	Saville, 1964; Russell, 1976
<i>Lile stolifera</i>	X										X			X	Peterson, 1956
<i>Dorosoma cepedianum</i>	X	X	X	X	X	X	X		X	X	X	X	X	X	Shelton and Stephens, 1980; Jones et al., 1978; Cooper, 1978
<i>Hilsa kelee</i>	X	X		X	X	X	X			X	X		X		Rao, 1973
<i>Tenuulosa ihsha</i>	X	X		X	X										Kulkarni, 1950
<i>Alosa sapidissima</i>	X	X	X	X	X	X	X		X	X	X	X	X	X	Bainbridge, 1962; Jones et al., 1978
<i>Alosa pseudoharengus</i>	X	X	X	X	X	X	X		X	X	X	X	X	X	Jones et al., 1978; Chambers et al., 1976

TABLE 25. CONTINUED.

Genus species	Eggs	Larvae	Juveniles	Morphology	Mensities	Fins	Pigmentation	Osteology	Fecundity	Spawning region	Spawning season	Keys or comparisons with others species	Reared specimens	Wild-caught specimens	References
<i>Alosa mediocris</i>	X	X	X	X	X	X				X	X	X	X	X	Jones et al., 1978; Chambers et al., 1976
<i>Alosa aestivalis</i>	X	X	X	X	X	X	X		X	X	X	X	X	X	Jones et al., 1978
<i>Caspialosa</i> sp.	X														Pertseva, 1936
<i>Ethmalosa fimbriata</i>	X	X		X	X	X	X				X	X	X	X	Bainbridge, 1961
<i>Brevoortia aurea</i>	X	X		X			X			X	X		X		Conand 1978; de Ciechowski, 1968
<i>Brevoortia patronus</i>	X	X	X		X					X	X			X	Houde and Fore, 1973
<i>Ethmidium maculata</i>		X	X	X	X	X	X			X	X	X		X	Orellana and Balbontin, 1983
<i>Gilchristella aestuarius</i>	X													X	Brownell, 1979
<i>Laeviscutella dekimpei</i>		X	X	X	X		X					X		X	Conand, 1978
<i>Pellonula vorax</i>		X		X	X										Bainbridge, 1962; Conand, 1978
<i>Ilisha elongata</i>	X	X		X									X	X	Delsman, 1930a; Uchida et al., 1958
<i>Ilisha melastoma</i>	X	X			X								X		Delsman, 1930a
<i>Ilisha africana</i>		X	X	X		X	X			X	X			X	Dessier, 1969
<i>Ilisha furthi</i>	X														Peterson, 1956
<i>Neopisthopterus tropicus</i>	X														Peterson, 1956
<i>Opisthopterus tardoore</i>	X	X		X		X	X			X	X		X		Bensam, 1967
<i>Opisthopterus dovi</i>	X														Peterson, 1956
<i>Opisthopterus equatorialis</i>	X														Peterson, 1956
<i>Odontognathus panamensis</i>	X														Peterson, 1956
<i>Anchoa ischana</i>	X													X	Peterson, 1956
<i>Anchoa panamensis</i>	X													X	Peterson, 1956
<i>Anchoa curta</i>	X													X	Peterson, 1956
<i>Anchoa lucida</i>	X													X	Peterson, 1956
<i>Anchoa naso</i>	X													X	Peterson, 1956
<i>Anchoa exigua</i>	X													X	Peterson, 1956
<i>Anchoa arenicola</i>	X													X	Peterson, 1956
<i>Anchoa marini</i>	X	X		X						X	X			X	de Ciechowski, 1968
<i>Anchoa hepsetus</i>	X	X	X	X	X	X	X			X	X			X	Jones et al., 1978
<i>Anchoa mitchilli</i>	X	X	X	X	X	X	X			X	X			X	Jones et al., 1978
<i>Anchovia macrolepidota</i>	X													X	Peterson, 1956
<i>Engraulis japonicus</i>	X														Mito, 1961a; Brownell, 1979; Russell, 1976
<i>Engraulis eurystole</i>	X	X	X	X	X	X	X			X	X			X	Jones et al., 1978
<i>Engraulis anchoita</i>	X	X		X	X		X			X	X			X	de Ciechowski, 1965
<i>Engraulis mordax</i>	X	X	X	X	X	X	X	X	X	X	X		X	X	Bolin, 1936a; Ahlstrom, 1965; Ahlstrom, unpublished
<i>Engraulis encrasicolus</i>	X	X	X	X	X	X	X			X	X	X		X	D'Ancona, 1931a; Saville, 1964; Marchal, 1966
<i>Engraulis ringens</i>	X	X	X	X	X	X	X			X	X	X	X	X	Orellana and Balbontin, 1983; Fischer, 1958b; Einarsson and Rojas de Mendiola, 1963
<i>Stolephorus purpureus</i>	X	X	X	X	X	X	X					X		X	Miller et al., 1979
<i>Stolephorus buccaneeri</i>	X	X	X	X	X		X					X		X	Delsman, 1931; John, 1951a
<i>Stolephorus heterolobus</i>	X	X										X		X	Delsman, 1931
<i>Stolephorus tri</i>	X	X										X		X	Delsman, 1931; John, 1951a
<i>Thryssa hamiltonii</i>	X	X										X		X	Delsman, 1929a
<i>Thryssa</i> sp.	X	X												X	John, 1951a
<i>Lycengraulis poeyi</i>	X													X	Peterson, 1956
<i>Lycengraulis grossidens</i>	X	X												X	Phonlor, 1978
<i>Cetengraulis mysticetus</i>	X	X								X	X	X		X	Simpson, 1959
<i>Setipinna melanochir</i>	X	X			X							X		X	Delsman, 1932a
<i>Setipinna taty</i>	X	X			X							X		X	Delsman, 1932
<i>Setipinna phasa</i>	X	X			X					X	X	X		X	Jones and Menon, 1950
<i>Heterothrissa breviceps</i>	X	X			X							X		X	Delsman, 1932a
<i>Coilia</i> sp.	X	X		X			X						X		Takita, 1967
<i>Coilia</i> sp.	X	X			X								X		Delsman, 1932b

place the clupeomorpha nearer to the next most advanced clade, the Euteleostei, than to the next least advanced clade, the Elopomorpha.

Evidence from eggs and larvae

Relevant ontogenetic evidence concerning the relationships of the Clupeiformes is meager. Elopiform eggs are unknown. Anguilliform eggs resemble clupeid eggs in having perivitelline spaces, segmented yolks, and may have oil droplets. Eel eggs can be much larger than herring eggs: 5.5 mm diameter in *Muraena*, 2.43 mm in an anguillid (Ahlstrom and Moser, 1980). Osteoglossomorphs have pelagic or demersal eggs which may be 0.5–4.0 mm in diameter, may be dark blue, and may have a very wide perivitelline space as in *Hiodon* (Breder and Rosen, 1966). The coincidence of demersal adhesive eggs in both the osteoglossomorphs and the Dorosomatinae is extremely unlikely to be a shared derived character from a common ancestor. Clupeid and anguillid eggs are considered unspecialized relative to eggs of the higher teleosts (Ahlstrom and Moser, 1980). Very little else may be said. Perhaps electron microscopy will reveal patterns of chorion sculpturing which will be informative.

The larvae of Clupeiformes are unspecialized and undergo a fairly uneventful metamorphosis. The migration of the dorsal fin during transformation also occurs in the elopiforms. The larva of *Chanos*, a primitive gonorynchiform (Fink and Fink, 1981), superficially resembles clupeids or engraulids but apparently does not have the same migration of the dorsal fin (Richards, this volume).

If the Elopomorpha and the Clupeomorpha share a common ancestor it is possible that the Clupeomorpha retained the unspecialized, rapidly developing larvae while the adults evolved towards a specialized schooling planktivore body plan. The leptocephalus found in the elopiforms, albuliforms, and anguilliforms could have evolved for dispersal or to reduce predation or to take advantage of larval drift the way *Anguilla* does in the North Atlantic and the way herring do in the North Atlantic with their circuit of migration (Cushing, 1977). The leptocephalus could have arisen in the common ancestor of anguilliforms and elopiforms or in parallel, in response to the same selective influence, after the adult eels had begun their divergence from the still unspecialized elopiform fishes. The leptocephalus is considered a specialized character by Forey (1973a), who suggested that it arose before the elopid-albulid dichotomy. Transforming elopoid leptocephali resemble transforming clupeiform larvae (*Megalops*—Harrington, 1958: Plate 1; *Elops*—Sato and Yasuda, 1980: Fig. 1; *Albula*—Hildebrand, 1963b: Fig. 23).

The egg and larval evidence thus is consistent with a relationship between the Elopomorpha and the Clupeomorpha based on primitive characters but is not helpful in aligning this Division (J. S. Nelson's usage, 1976) closer to any other.

Summary and recommendations

The eggs and early larval stages of the Clupeiformes provide many taxonomic characters with potential value for testing phylogenetic hypotheses. Most of the discrete characters, such as number of oil globules, have more than two states and the continuous characters, such as degree of egg eccentricity, have at least a moderate range of values. Although the fraction of species whose eggs and larvae have been described is low and the descriptions are uneven in quality and not distributed uniformly among taxa, egg and larval characters appear consistent within genera. Within nominal subfamilies they are not consistent, but the subfamilies show parallel trends in adult characters and, in addition, the distribution of genera in higher taxa is not yet agreed upon by all workers.

Most descriptions of clupeiform larvae have been to enable identification of regional species. Differences between larvae usually involve subtle features of pigmentation or morphometry, or counts of meristic characters which converge with the meristics of the adult. Phylogenetically significant characters such as ephemeral dentition, osteological development, and the comparative ontogeny of characters used in the taxonomy of the adults are rarely mentioned.

Future descriptions of eggs and larvae should address systematic characters as well as those needed for identification. Eggs and larvae of many species should be redescribed to give complete series through metamorphosis. Ontogenetic characters should be used in revisions of the group. Classifications of the Clupeiformes which are based on just a few characters should be tested by comparing the ontogeny of those characters because there are many apparently parallel trends in the group. Additional studies of the physiology and ecology of the eggs and larvae should be done to determine the functional significance of observed characters. It would also be useful to perform quantitative phenetic and cladistic analyses now of the Clupeiformes for those regions or taxa for which information is already fairly complete.

NATIONAL MARINE FISHERIES SERVICE, SOUTHEAST FISHERIES CENTER, 75 VIRGINIA BEACH DRIVE, MIAMI, FLORIDA 33149.

Ostariophysii: Development and Relationships

L. A. FUIMAN

OSTARIOPHYSII, as regarded here, include all fishes whose four or five anteriormost vertebrae are modified to form an otophysic connection, the Weberian apparatus (Rosen and Greenwood, 1970). These primarily freshwater fishes comprise

3 orders, about 55 families, and more than 5,000 species, thereby accounting for over 70% of the world's freshwater fish species. Ostariophysans occupy most freshwater habitats worldwide, from torrential Himalayan streams to still tropical lakes, as well as



Fig. 61. Egg of *Ctenolucius hujeta* (18 hours postfertilization) showing the membranous pedestal by which the egg attaches to plants. Photograph by H.-J. Franke.

coastal marine waters (the latter by a few characids, cyprinids, and aspredinids, as well as all ariid and plotosid catfishes). The presence of a Weberian apparatus has overshadowed the suite of remaining diagnostic characters for the group which includes an axe-shaped endochondral portion of the metapterygoid, anteriorly bifurcate pelvic girdle, second hypural fused to the compound terminal centrum, and elongate olfactory tracts (all detailed by Fink and Fink, 1981). Additional characters include a pheromone-mediated alarm reaction and horny dermal projections called unculi (Roberts, 1982b).

According to the classification of Fink and Fink (1981), the orders of Ostariophysi (their Otophysi) are: Cypriniformes, Characiformes, and Siluriformes (the latter including Siluroidei and Gymnoidei). Cypriniforms (with over 1,800 species in 5 families) uniquely share peculiarities of the following: kinethmoid bone, palatine-mesopterygoid articulation, fifth ceratobranchial, and lateral process of the second vertebral centrum.

They lack jaw teeth and an adipose fin. They are found in North America, Eurasia, and Africa. Characiforms (comprising at least 1,000 species in 14 families) are characterized by multicuspid teeth, a prootic foramen, dorsomedial opening in the posttemporal fossa, enlarged lagenar capsule, and a gap between the compound terminal centrum and hypural 1. They occur in Africa, South America, and southernmost North America. Siluroids (with about 2,000 species in 31 families) are distributed nearly worldwide. Although quite diverse morphologically, they commonly lack scales and several bones (including the symplectic, subopercle, and separate parietals). They show considerable fusion of portions of the first five vertebrae and pectoral and dorsal fin rays. The electrogenic gymnotoids are characterized by an extremely long anal fin and substantial reductions or losses, such as the loss of dorsal and pelvic fins, and palatine and ectopterygoid bones. They are confined to South America and southernmost North America.

DEVELOPMENT

Knowledge of the early life history stages of ostariophysans is rather spotty and concentrated on fishes from a few geographic regions. Major descriptive works cover portions of the Soviet Union (Kryzhanovskii, 1949; Kryzhanovskii et al., 1951; Koblitskaia, 1981), Japan (Okada, 1960; Nakamura, 1969), and the United States (Jones et al., 1978; Snyder, 1981; Auer, 1982; Fuiman et al., 1983). Most of these works concentrate on cypriniforms. Additional descriptive data are available as individual papers on Indian major carps (Cyprinidae) and Indian siluroids (reviewed by Jhingran, 1975). African and South American ostariophysan eggs and larvae remain little known.

Of the six families of cypriniforms, nothing is known of the eggs and larvae of the families with fewest species, Gyrinocheilidae and Psilorhynchidae. Catostomids are known well. Cyprinids, cobitids, and homalopterids are known to a lesser degree. Scattered notes are available for nine characiform families but only a few descriptions of ontogeny exist. Brief descriptions of larvae of representatives from seven families of siluroids are available, and notes on eight additional families exist. Photographs of larvae of two gymnotoids, *Eigenmannia virescens* and *Apteronotus leptorhynchus* are published (Kirschbaum and Westby, 1975; Kirschbaum and Denizot, 1975; Kirschbaum, 1984) but without morphological descriptions. Most information on ostariophysan larvae deals with external morphology. Osteological studies are few (Bertmar, 1959; Hoedeman, 1960a-d).

Eggs

Ostariophysan eggs vary considerably in their morphology and the habitat they occupy. Most are spherical, demersal, 1 to 5 mm in diameter, with pale yellow, somewhat granular yolk

TABLE 26. LARVAL CHARACTERS OF MAJOR GROUPS OF OSTARIOPHYSANS.

Character	Cypriniformes	Characiformes	Siluroidei	Gymnoidei
Size at hatching (mm TL)	2-10	2-5	3-8	5
Yolk-sac shape	pyriform or tubular	elliptical	elliptical	elliptical
Gap between yolk sac and anus	absent	present	present	absent
Barbels:				
Presence	present or absent	absent	present	absent
Timing of development	late or early	-	early	-
Size at finfold absorption (mm TL)	15-25	10-20	11-23	15

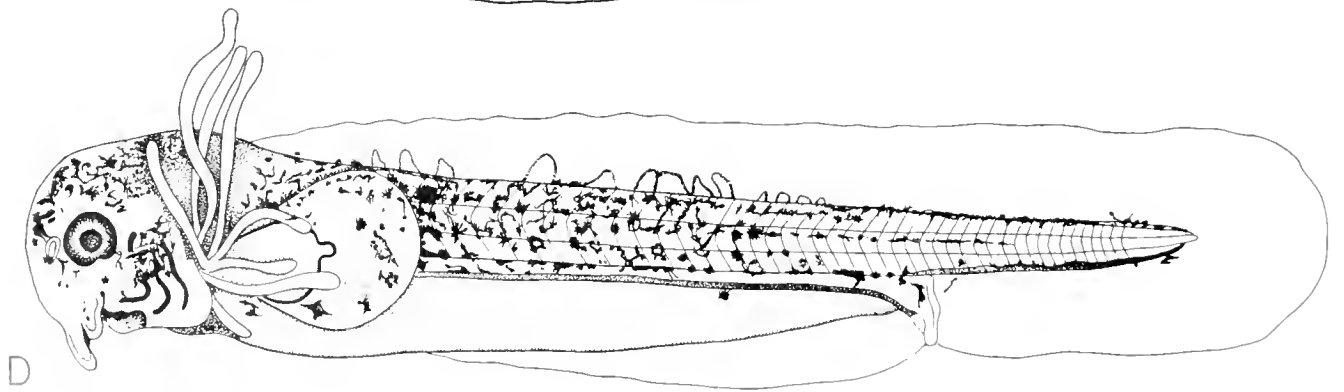
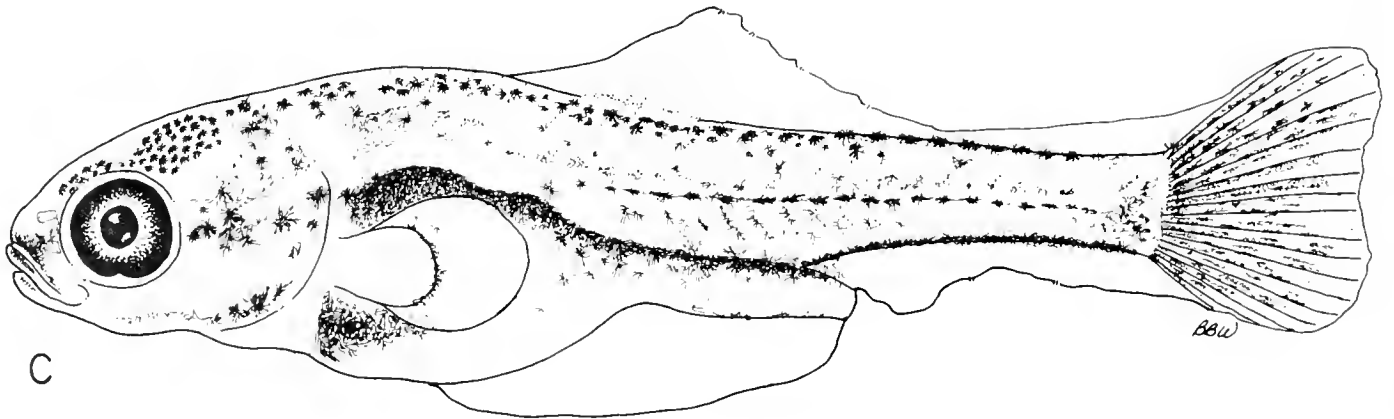
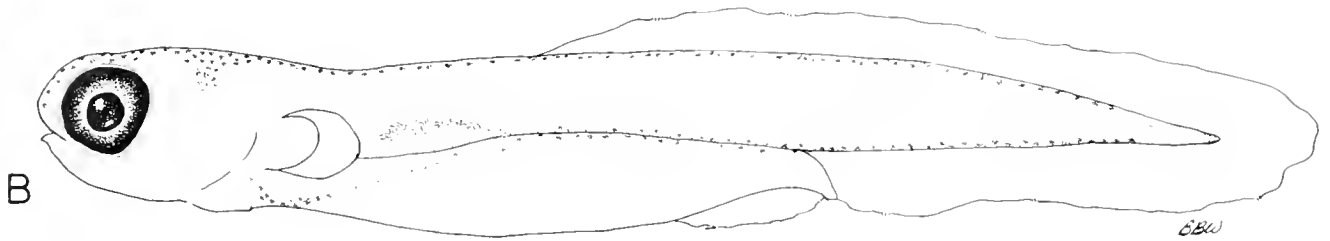
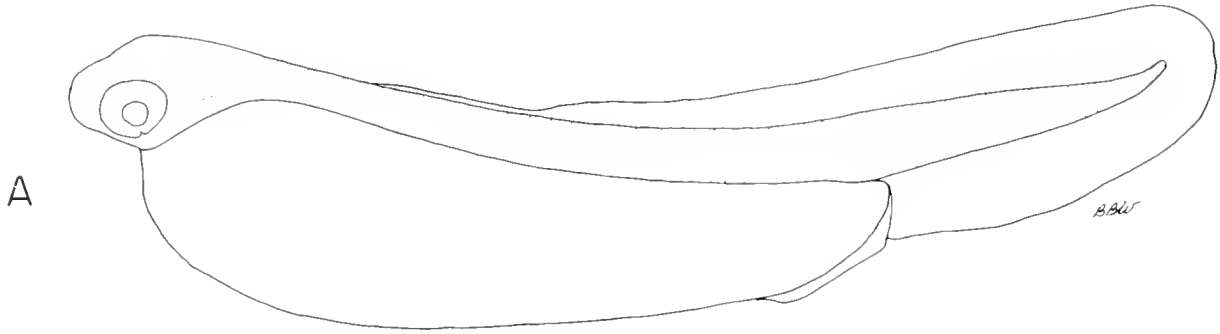

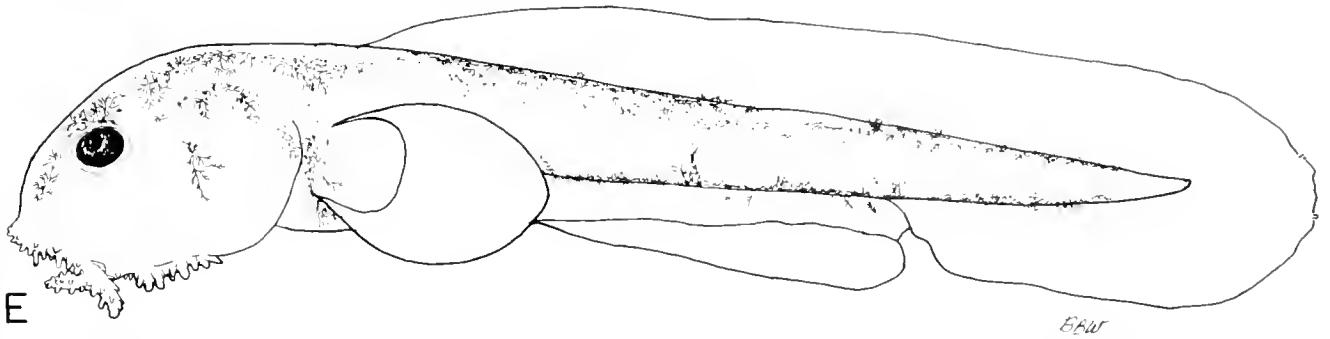

Fig. 62. Representative cypriniform larvae. (A–C) Cyprinidae: (A) *Tribolodon hakonensis* (UMMZ 212151) 9.2 mm TL; (B) *Semotilus atromaculatus* 8.6 mm TL; (C) *Barbus* (= *Capoeta*) *tuteya* (UMMZ 212148) 6.0 mm TL; (D, E) Cobitidae: (D) *Misgurnus fossilis* 6.9 mm TL, after Kryzhanovskii (1949); (E) *Acanthopthalmus cf. kuhni* 4.0 mm TL (specimen from S. S. Boggs).

lacking oil globules. Eggs may be strongly adhesive (e.g., Cypriniformes: *Nemacheilus* [= *Barbatula*] *toni* [Kobayasi and Moriyana, 1957]; Characiformes: *Gymnocorymbus ternetzi* [pers. obs.]; Siluriformes: *Loricaria cataphracta* [pers. obs.]), nonadhesive (e.g., Cypriniformes: *Ctenopharyngodon idella* [Inaba et al., 1957]; Siluriformes: *Tandanus tandanus* [Lake, 1967]), or weakly adhesive (e.g., Cypriniformes: *Catostomus commersoni* [pers. obs.]; Characiformes: *Serrasalmus nattereri* [pers. obs.]; Siluriformes: *Bagarius bagarius* [David, 1961]). Adhesive filaments or other apparent modifications of the egg surface are almost entirely unknown.

Representatives of outgroups (Gonorynchiformes, Clupeomorpha, "Salmoniformes," and Osteoglossomorpha) share the spherical egg with yellow, granular or segmented yolk. Their eggs are pelagic or demersal, usually 1.0 to 1.3 mm in diameter,

adhesive (in *Osmerus*) or nonadhesive (in *Chanos*, *Alosa*, and *Hiodon*), without oil globules (*Chanos*) or with one to several (in *Alosa* and *Osmerus*).

Exceptions to this characterization of ostariophysan eggs exist. Among cypriniforms, the cyprinid subfamily Acheilognathinae (Gosline, 1978) exhibits elliptical to pyriform eggs which are deposited in the mantle cavity of a bivalve mollusc (Kryzhanovskii et al., 1951; Nakamura, 1969; Makeeva, 1976). Their irregular shape may be the important mechanism preventing the eggs from being expelled. Some cyprinid eggs are pelagic (e.g., *Hypophthalmichthys molitrix* [Nakamura, 1969; Koblitskaia, 1981]) and have a larger diameter (ca. 5 to 6 mm) due to the considerable perivitelline space. Only one ostariophysan, the cypriniform *Cobitis biwae*, was reported to have 12 to 13 small oil globules in the yolk (Okada and Seiishi, 1938; Okada,

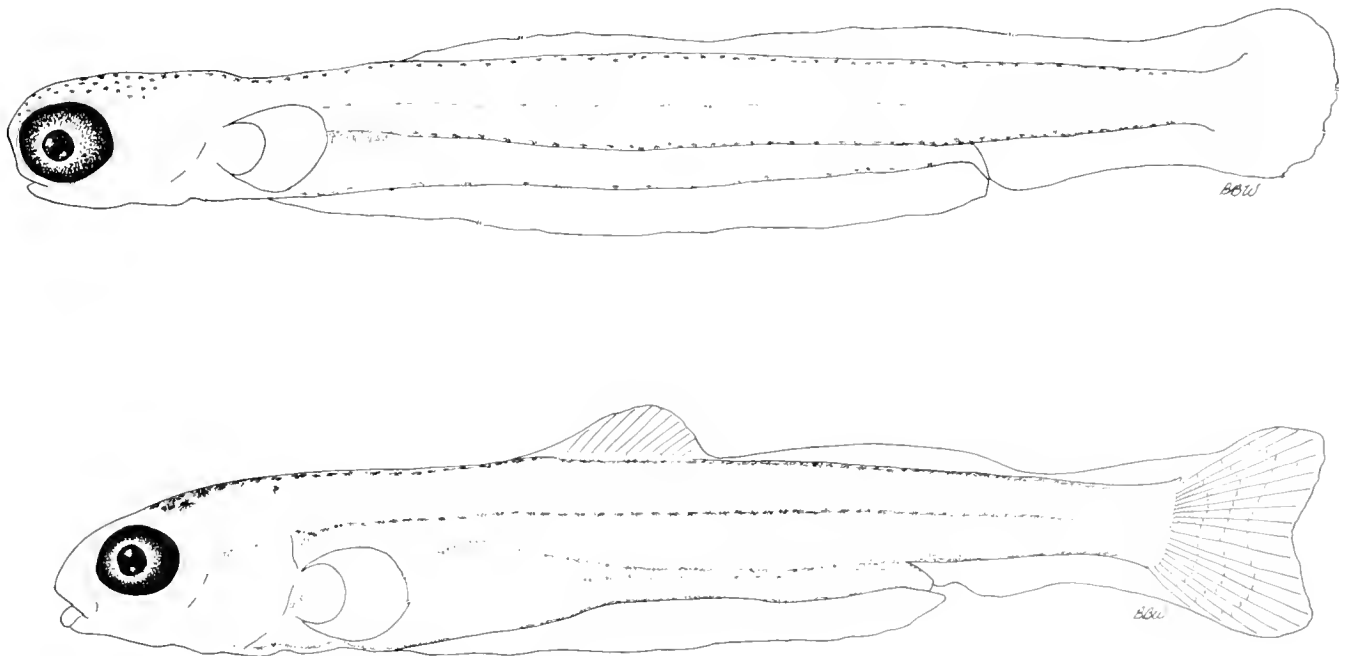

Fig. 63. Representative cypriniform larvae (continued). Catostomidae: *Hypentelium etowanum* (upper) 13.1 mm and (lower) 15.0 mm TL.

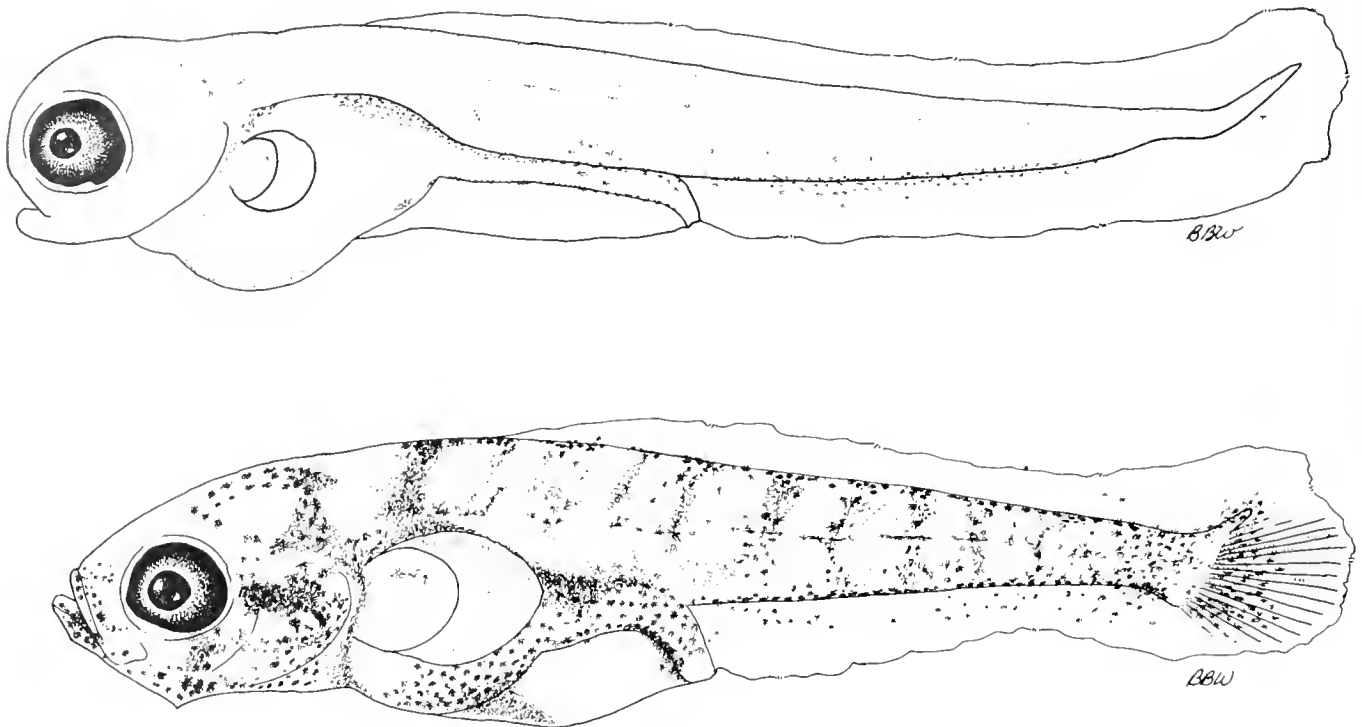

Fig. 64. Representative characiform larvae. Serrasalminidae: *Serrasalminus nattereri* (UMMZ 211677) 8.2 mm TL (upper). Characidae: *Hyphessobrycon cf. callistus* (UMMZ 211676) 6.6 mm TL (lower).

1960), but this is in doubt (N. Komada, pers. comm.) and has not since been confirmed.

Characiform eggs are poorly known; most information is from the aquarium hobby literature. Known characid (*sensu* Gery, 1977) eggs are small (0.8 to 1.2 mm). However other families have eggs between 2 and 4 mm (e.g., Alestidae, Anostomidae, Curimatidae, Hepsetidae, Serrasalminidae). Apparently most species have eggs that adhere to plants. Franke (1981) described adhesive threads (*gallertigen Klebfäden*) on the surface of the egg of *Ctenolucius hujeta* (Ctenoluciidae) and noted that this was the mechanism by which they attached to plants. My examination of eggs supplied by Dr. Franke found the adhesive structure to be a membranous pedestal rather than adhesive threads (Fig. 61). This is the only known chorionic modification of ostariophysans.

Most siluroids have demersal, medium sized eggs (1 to 4 mm). Some are tended by one or both parents [e.g., *Clarias batrachus* (Mookerjee, 1946; Mookerjee and Mazumdar, 1950), *Ictalurus punctatus* (Tin, 1982c)]; others are not given parental care [e.g., *Clarias gariepinus* (Holl, 1968; Bruton, 1979), *Pangasius sutchi* (Varikul and Boonsom, 1969)]. The eggs are typically spherical; however, *Clarias* eggs are often slightly elliptical (Mookerjee, 1946; Greenwood, 1955; Bruton, 1979). Some callichthyids deposit small eggs (ca. 1.0 mm) in a foam nest on the surface of still waters (Kryzhanovskii, 1949). Parents in several families carry their eggs. Some loricariids (e.g., *Loricaria* spp.) carry a mass of eggs by means of fleshy appendages of the lower lip. *Aspredo laevis* eggs apparently are attached by vascularized stalks to the venter of the female (Wyman, 1859). Finally, ariids are oral incubators with perhaps the largest eggs of all oviparous

teleosts (10 to 25 mm) (Chidambaram, 1942; Gudger, 1912, 1916, 1918; and other authors). Although yolk is usually yellow to slightly orange or brown, several species have unmistakably green yolk [e.g., *Bagarius bagarius* (David, 1961), *Clarias batrachus* (Mookerjee, 1946; Mookerjee and Mazumdar, 1950), *Heteropneustes fossilis* (Pal and Khan, 1969), *Loricariichthys* sp. (Taylor, 1983), *Phractura ansorgei* (Foersch, 1966)]. At least one siluroid, the silurid *Ompok bimaculatus*, has reddish brown yolk (Chaudhuri, 1962). A few species have a jelly-like coat surrounding the chorion [e.g., *Bagarius bagarius* (David, 1961), *Parasilurus asotus* (Kryzhanovskii et al., 1951), *Phractura ansorgei* (Foersch, 1966), *Trachycorystes insignis* (Burgess, 1982)].

Larvae

Most ostariophysans hatch in an altricial state at about the time when pectoral buds form, but before the head becomes free from the yolk sac and retinal pigment develops, although there is variability in the exact stage. The yolk sac is usually large and cumbersome, enforcing a stationary existence during the first days, either on the substrate (most commonly) or attached to plants by means of a cephalic adhesive mechanism (found in most characiforms and a few cyprinids, but structurally different in these groups). Caudal fin rays differentiate first, followed by nearly simultaneous formation of dorsal and anal fin rays. Pectoral and pelvic fin rays develop near the end of the larval period. The gonorynchiform *Chanos* hatches at about the same stage of development as ostariophysans, but *Alosa* and *Osmerus* hatch somewhat later (i.e., pectoral buds and retinal pigment are clearly developed). These outgroups generally have pelagic larvae at hatching. Fin rays in *Chanos* develop in the

same order as described above, but the sequence differs for *Alosa* and again for *Osmerus*.

Within Ostariophysi, cypriniform larvae (Figs. 62, 63) are largest at hatching (Table 26), the largest sizes represented mostly by catostomids. The pyriform yolk sac extends from below the head posteriorly to the anus (Fig. 62a). Barbels, when present, develop very late in Cyprinidae but early in Cobitoidea (*sensu* Sawada, 1982). Cyprinids display considerable variation in the elaboration of the larval circulatory system. Temporary networks of blood vessels invade portions of the finfolds and the surface of the yolk sac in a variety of patterns to form the larval respiratory system (Kryzhanovskii, 1947). Cobitoideans usually have greatly expanded finfolds, especially those of the pectoral buds. Pronounced external gill filaments are known in the cobitine genera *Cobitis* (Kryzhanovskii, 1949; Okada, 1960; Sterba, 1962), *Lepidocephalus* (Bhimachar and David, 1945), and *Misgurnus* (Kryzhanovskii, 1949; Okada, 1960), but not in the non-cobitine cobitoidean genera *Botia*, *Lefua*, or *Nemacheilus*, nor in other ostariophysans. Cyprinids with cephalic adhesive glands include: *Abramis brama* (Penaz and Gajdusek, 1979); *Brachydanio rerio* (Frank, 1978); *Cyprinus carpio* (Hoda and Tsukahara, 1971); *Danio malabaricus* (Jones, 1938); and *Notemigonus crysoleucas* (Snyder et al., 1977; Loos et al., 1979).

In characiforms, the yolk sac is short and rounded, not extending to the anus posteriorly (Fig. 64). Most known characids (*sensu stricto*) and a hepsetid (Bertmar, 1959; Budgett, 1902, 1903), erythrinid (de Azevedo and Gomes, 1942), and curimatid (de Azevedo et al., 1938) have a temporary larval cephalic adhesive organ (more distinct than the apparent glandular mechanism in cyprinids). Those without such an organ include: *Serrasalmus nattereri* (pers. obs.), *Metynnis maculatus* (Azuma, 1982), and *Brycinus longipinnis* (Frank, 1972). The adipose fin appears to develop *de novo* toward the end of the larval period, not as a remnant of the median finfold. However, the small size of the adipose fin and lack of specimens, photographs, illustrations, and descriptions of late larval characiforms prevents verification of this inference.

Although few species are known as larvae, Siluroidei may contain the greatest diversity of larval characters among Ostariophysi (Fig. 65). Most siluroids hatch as altricial larvae with a physiognomy similar to that of characiforms. Ictalurids are more precocial and lack a postlarval (*sensu* Hubbs, 1943) phase. Ariids (Gudger, 1918; Ward, 1957) and some loricariids (Lopez and Machado, 1975; Machado and Lopez, 1975) hatch in a highly precocial state, resembling the adult in many aspects of external morphology but retaining a large yolk sac (Fig. 65C). In most families, barbels are usually present at hatching or soon thereafter (Fig. 65a). Cephalic adhesive organs are usually absent, but at least one loricariid (*Ancistrus* sp.) possesses these (Frank, 1979). *Clarias gariepinus* (= *C. mossambicus*) and *Ompok bimaculatus* have an adhesive organ on the venter of the yolk sac (Greenwood, 1955, 1956; Chaudhuri, 1962; Holl, 1968; Bruton, 1979). The adipose fin is clearly a remnant of the median finfold, as in "salmoniforms." Larvae of a single gymnotoid, *Eigenmannia virescens*, are known (Fig. 65D, E; Table 26; Kirschbaum and Balon, in prep.).

RELATIONSHIPS

The Ostariophysi are thought to be the sister group of the Gonorynchiformes (Greenwood et al., 1966; Rosen and Greenwood, 1970; Gosline, 1971; Fink and Fink, 1981). The next

closest relatives are Clupeiformes (Gosline, 1971) or "Salmoniformes" (Greenwood et al., 1966; Fink and Weitzman, 1982).

All concepts of Ostariophysi (those with a Weberian apparatus) recognize four major groupings, "cyprinoids," "characoids," "gymnotoids," and "siluroids." The traditional view of relationships holds that "characoids" are the ancestral stock, giving rise to the remaining lineages, with "gymnotoids" being modified "characoids," and "cyprinoids" being the closest relatives of the "characoids" plus "gymnotoids." Fink and Fink (1981) gave a detailed history of the classification schemes for the Ostariophysi and their relatives as an introduction to their work on the subject, which is the only attempt to reconstruct the phylogeny on the basis of a large set of data (127 characters). Their proposed cladistic phylogeny differs significantly from the traditional one by aligning "gymnotoids" with "siluroids" as the Siluriformes (Fig. 66).

Developmental characters in systematics

Few attempts have been made to apply developmental characters to the systematics of ostariophysans. Kryzhanovskii (1947) grouped cyprinids into four subfamilies according to details of the larval respiratory system. He also included characters relating to reproductive guild (later elaborated in Kryzhanovskii, 1948), original (ontogenetically) position of the mouth, and relative size of the pectoral buds. He supported these subfamilial designations with experimental results on the morphology and viability of larvae produced by artificial hybridizations within and among the proposed subfamilies.

Nakamura (1969) dealt with the cyprinids of Japan. In his English summary, he stated that currently proposed closely related forms (meaning genera, species, and subspecies) have similar life history characteristics. He noted a few exceptions, such as similar (as adults) species of *Moroco* whose early larvae differ morphologically and ecologically. In contrast, he noted that the eggs and early larvae of *Ctenopharyngodon idella* and *Hypophthalmichthys molitrix* were very similar although the species were placed in different subfamilies. He used differences in egg and larval morphology to support the previously uncertain separation of the genera *Squalidus* and *Gnathopogon*.

In a similar survey, Loos and Fuiman (1978) attempted to characterize the subgenera of the New World cyprinid genus *Notropis* in terms of their egg and larval morphology. However, they found substantial variability within the established subgenera and were unable to characterize them precisely.

Each of these attempts to apply developmental characters to systematics was concerned only with establishing group membership and not with determining relationships among the groups. Further, none of the work was based on a large data set nor was it approached in a rigorous manner. The difficulties encountered by Nakamura (1969), and especially by Loos and Fuiman (1978), probably were due to the apparently convergent ecomorphotypes expressed by unrelated taxa. The low taxonomic level investigated, combined with the morphological similarity implied by von Baer's law, probably accounted for much of the remaining difficulty in detecting consistent differences among taxa.

Fink and Fink's (1981) classification is based largely on osteological characters. The great size and diversity of Ostariophysi make a detailed study of developmental osteology and concomitant investigations of bone homologies impractical at this time. Yet, available information permits a preliminary eval-

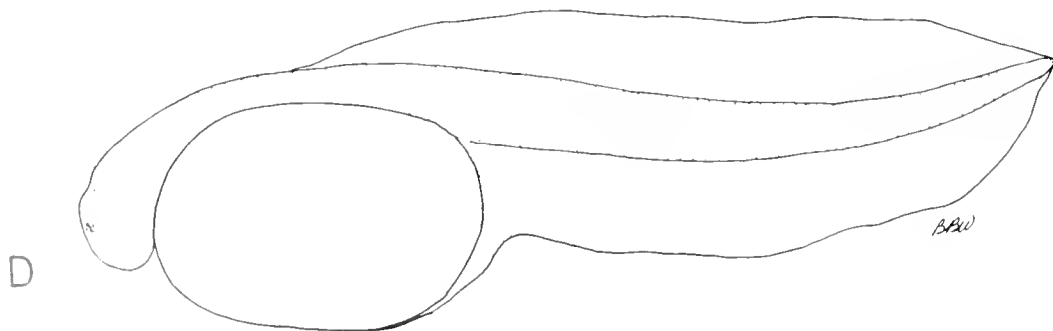
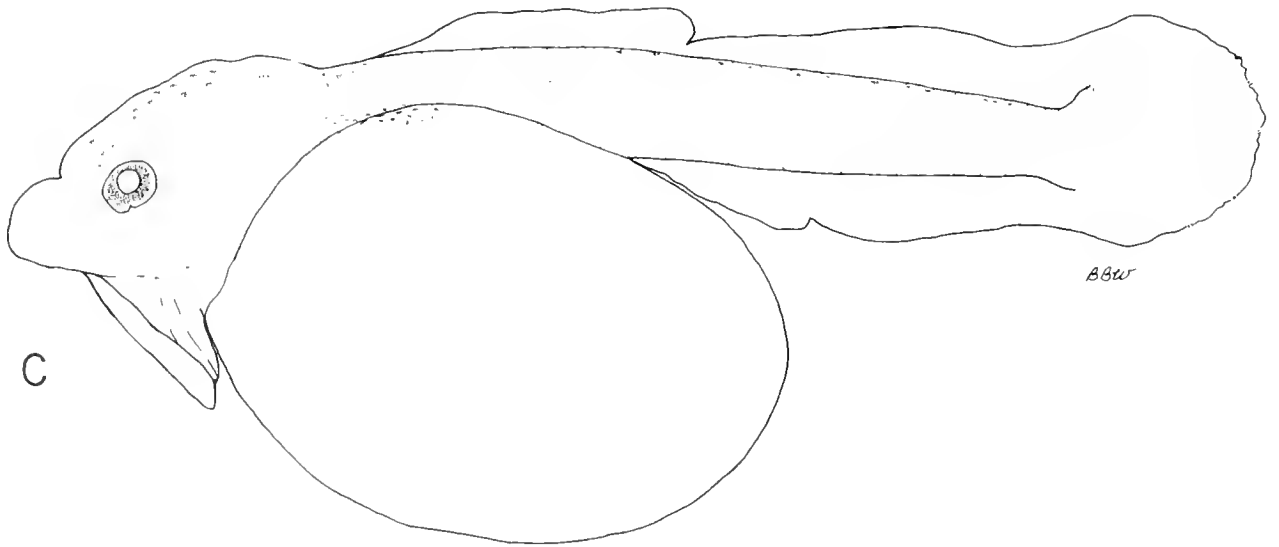
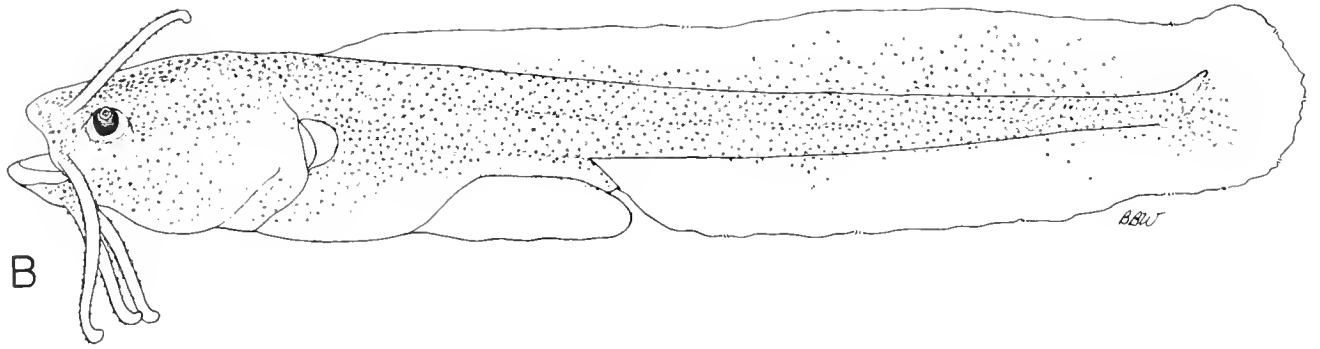
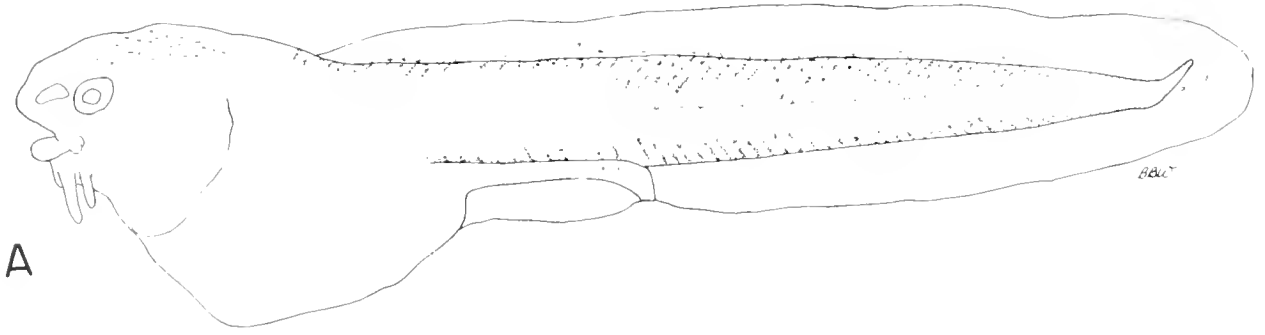

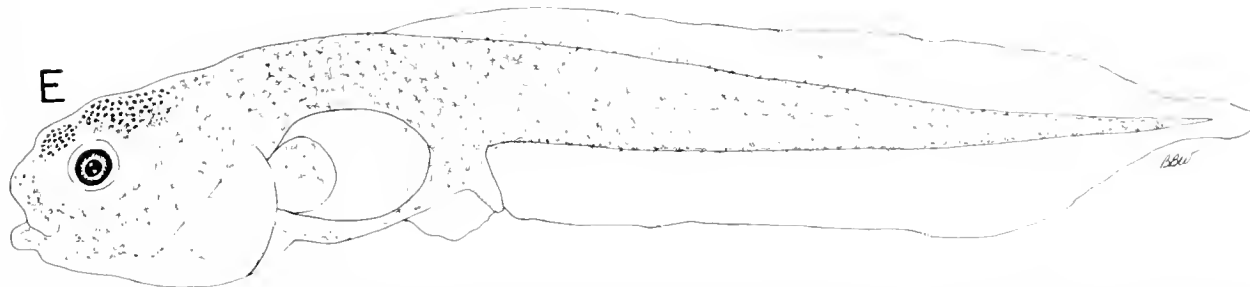

Fig. 65. Representative siluriform larvae. (A–B) Clariidae: *Clarias gariepinus* (British Museum of Natural History, uncataloged) (A) 6.6 mm and (B) 8.4 mm TL; (C) Loricariidae: *Ancistrus spinosus* (UMMZ 212152) 8.3 mm TL; (D–E) Rhamphichthyidae: *Eigenmannia virescens* (D) 5.0 and (E) 8.1 mm TL.

uation of relationships based on developmental characters. The following analysis attempts to evaluate the contribution of selected developmental characters to ostariophysan systematics by constructing an independent assessment of phylogeny based on developmental characters. That the assessment should be independent was attested by Moser and Ahlstrom (1974): “we are increasingly impressed with the functional independence of larval and adult characters. It is apparent that the world of the larvae and the world of the adults are two quite separate evolutionary theaters.”

Representative ontogenetic series of all families of ostariophysans are nearly impossible to obtain because of the large size and wide geographic distribution of the group and the dearth of ichthyologists studying larvae. Consequently, the analyses employed here were based on specimens generated from laboratory breeding experiments, wild-caught material, and data published in apparently accurate accounts of ontogeny. Species used in the analyses included four outgroups to the Ostariophysa (Gonorynchiformes, Clupeomorpha, “Salmoniformes,” and Osteoglossomorpha), all characiforms and siluriforms with sufficient morphometric and developmental data for analysis, and a sample of five species from the most primitive cypriniform family, Cyprinidae. These cyprinid species possess different combinations of larval characters (determined by their location on a Wagner tree generated for 33 larval cyprinids [Fuiman, 1983a]). Although not used directly, incomplete data on approximately 85 additional non-cyprinid ostariophysans provided corroborative information.

Species included in the analysis of relationships and their

sources are listed below. Initials denote specimens borrowed from, or information provided by: Florida State Board of Conservation (FSBC), University of Michigan Museum of Zoology (UMMZ), or Frank Kirschbaum (FK).

OSTEOGLOSSIFORMES: *Hyodon tergisus* [Snyder and Douglas (1978); Wallus (1981, pers. comm.)].

SALMONIFORMES: *Osmerus mordax* [Cooper (1978); Tin (1982b)].

CLUPEIFORMES: *Alosa pseudoharengus* [Jones et al. (1978); Tin (1982a)].

GONORYNCHIFORMES: *Chanos chanos* [Chaudhuri et al. (1978); Liao et al. (1979); Miller et al. (1979)].

CYPRINIFORMES: Cyprinidae—*Cyprinus carpio* [UMMZ 211678; Hoda and Tsukahara (1971); Nakamura (1969); Okada (1960)]; *Leuciscus cephalus* [Cerny (1977); Kryzhanovskii (1949); Penaz (1968); Prokes and Penaz (1980)]; *Opsariichthys uncirostris* [Kryzhanovskii et al. (1951); Makeeva and Ryabov (1973); Nakamura (1951, 1969)]; *Parabramis pekinensis* [Institute of Hydrobiology (1976); Kryzhanovskii et al. (1951)]; *Squalidus gracilis* [Nakamura (1969)].

CHARACIFORMES: Alestidae—*Alestes baremose* [Durand and Loubens (1971)]; Erythrinidae—*Hoplias malabaricus* [FSBC 8962, 8963, 9593; de Azevedo and Gomes (1942); Hensley (1976); Moreira (1920); von Ihering et al. (1928)]. Characidae—*Hyphessobrycon cf. callistus* [UMMZ 211676]. Serrasalminidae—*Serrasalmus nattereri* [UMMZ 211677; Azuma (1975)].

SILURIFORMES: Siluroidei: Bagridae—*Mystus seenghala* [Saigal and Motwani (1962)]; *Rita rita* [Karamchandani and Mot-

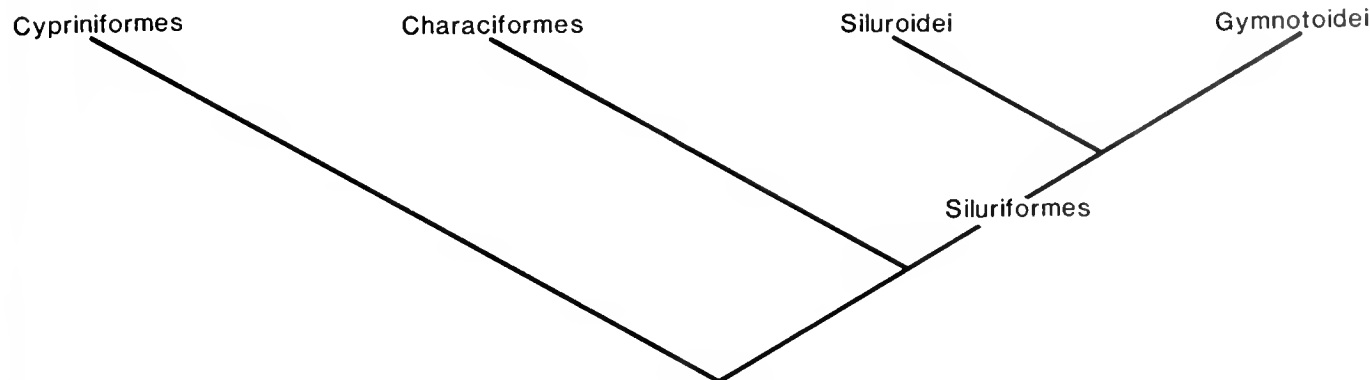

Fig. 66. Cladogram of ostariophysan relationships derived from adult characters by Fink and Fink (1981). Stem lengths imply no special significance.

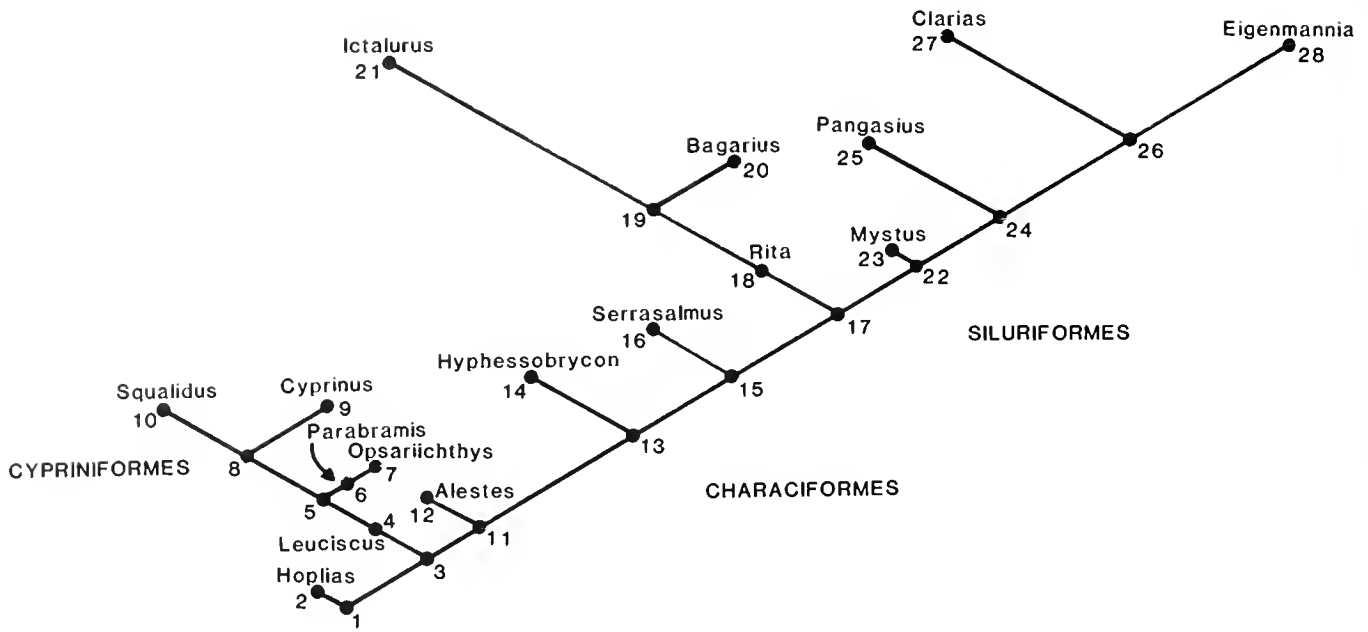

Fig. 67. Wagner tree of ostariophysan phylogeny based on larval characters. Stem lengths are proportional to the number of character-state changes on a given stem.

wani (1955). Clariidae—*Clarias batrachus* [UMMZ 186690, 209039; Devaraj et al. (1972); Mookerjee (1946); Mookerjee and Mazumdar (1950)]. Ictaluridae—*Ictalurus nebulosus* [Armstrong (1962); Tin (1982c)]. Pangasiidae—*Pangasius sutchi* [Varikul and Boonsom (1969)]. Sisoridae—*Bagarius bagarius* [David (1961)]. Gymnotoidei: Rhamphichthyidae—*Eigenmannia vrescens* [FK, Kirschbaum and Westby (1975)].

Phylogenetic methods

The phylogenetic reconstruction based on developmental characters was generated by the cladistic Wagner tree method (described by Kluge and Farris, 1969; Farris, 1970; Lundberg, 1972; and Jensen, 1981). Characters were chosen by virtue of their availability in published accounts. Nearly all were recorded as continuous measures, but individual modes with their neighboring values and disjunct portions of distributions separated

TABLE 27. RANGES OF VALUES FOR CODED CHARACTER STATES OF 16 OSTARIOPHYSANS. Character numbers correspond to those given in the text. Primitive states are given in boldface type.

Character number	Character state					
	a	b	c	d	e	f
1	2.27-3.42	3.74-3.74	4.74-4.90			
2	3.93-5.06	5.65-6.28	7.06-7.40	8.86-8.86		
3	1.35-1.53	1.92-2.58	2.98-4.03			
4	1.19-1.19	2.09-2.09	2.46-3.39	3.78-5.14		
5	0.97-1.61	2.18-2.18				
6	2.06-2.46	2.62-2.86	3.25-3.31			
7	0.13-0.28	0.36-0.52				
8	0.14-0.28	0.42-0.58	0.71-0.82			
9	0.72-1.00	1.29-1.29				
10	1.26-1.68	1.97-2.11				
11	-1.22--0.94	-0.67--0.23	0.06-0.06			
12	0.70-1.04	1.15-1.40				
13	0.22-0.39	0.54-0.84				
14	15.3-19.0	21.6-22.5	25.0-26.3	28.5-30.3	32.7-32.7	
15	8.0-8.0	12.0-20.0	25.5-25.6	29.0-29.0	38.7-38.7	45.9-45.9
16	0.28-0.29	0.39-0.44	0.52-0.70	0.81-0.81		
17	0.35-0.35	0.52-0.55	0.70-0.96	1.06-1.10		
18	0.22-0.38	0.42-0.56				
19	0.0-0.05	0.12-0.28	0.44-0.44			
20	0.0-0.03	0.07-0.15	0.22-0.33			
21	0-0	1-1				
22	0-0	1-1				
23	0-0	1-1				
24	0-0	1-1				

TABLE 28. CHARACTER-STATE CHANGES ON STEMS LEADING TO HYPOTHETICAL ANCESTORS (NODES) AND TERMINAL TAXA ON THE WAGNER TREE OF OSTARIOPHYSI. Numbered character states correspond to those given in Table 27. Uniquely derived, unreversed character states are given in boldface type. Reversed characters are noted by (r). Node numbers correspond to those given in Fig. 67.

Node	Character state
1	8c, 11b, 12b, 14b, 20b, 20c, 24b
2	6b
3	14d, 15b, 18b
4	13a, 21a
5	18a(r), 20b(r)
6	16b
7	17b
8	14c, 20a(r), 23b
9	6b, 19a, 24a(r)
10	3b, 11a(r), 12a(r), 14b
11	11a(r), 22b
12	6b, 6c
13	3b, 4c , 12b(r), 14a, 14b, 14c
14	3a, 4b, 18a(r), 20b(r)
15	10b, 11b, 24a(r)
16	12b, 17b, 14b(r)
17	2b, 6b, 7a, 8b(r)
18	8a, 16b, 20b(r)
19	12b, 16a , 18a(r), 20a(r)
20	2a(r), 6a(r), 10a(r)
21	5b , 6c, 7b(r), 8b(r), 9b , 11c, 15c, 17a , 17b, 19a
22	10a(r), 15c, 15d
23	14b(r)
24	1b , 2c, 17d
25	6a(r), 11a(r), 15c(r), 16d , 19c
26	1c , 15e , 19a, 20b(r), 22a
27	2d , 8a, 14b(r), 14c(r), 17b, 17c(r), 18a(r)
28	4a , 4b, 6c, 10b, 15f

by measurable gaps were coded individually. Characters were polarized by outgroup comparison (Table 27). The evolutionary transformation series for each continuous, multiple state character was assumed to be linear (i.e., with one or two adjacent states for a given state). Consequently, a character coded with *n* states had *n* - 1 different changes from one state to another, disregarding the direction of change. These transitions were termed "two-state factors." All two-state factors and their states for each species were generated by the FACTOR computing program (Estabrook et al., 1976). The output from this program included an input file for the WAGNER 78 computing program which was used to construct Wagner trees. The data deck was resequenced and a new Wagner tree generated several times in order to identify the shortest (most parsimonious) tree (Jensen, 1981).

Characters

Morphometric characters.—To develop morphometric characters for phylogenetic analysis, the following lengths were measured along the longitudinal axis of the fish: total length, preanal length, head length, and eye diameter. Two vertical measurements, head depth and body depth at anus, were meant to represent size and shape in the dorso-ventral direction. All measurements were defined by Fuiman (1979). They were made reasonably independent of one another by subtracting preanal length from total length to yield peduncle length, and head length from preanal length to yield trunk length. Peduncle length, trunk length, head length, eye diameter, body depth, and head depth comprised the basic morphometric characters.

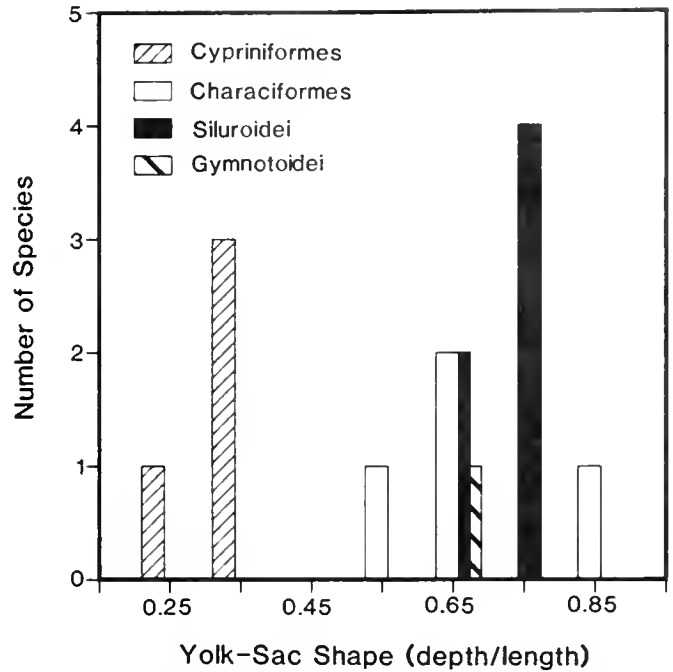

Fig. 68. Frequency distribution of yolk-sac shape for recently hatched ostariophysan species.

Body dimensions of larvae are strongly influenced by allometry (Fuiman, 1983b). Such measures cannot be expressed as simple proportions, because the proportions are not constant within a species throughout the larval period. The effect of size on shape must be eliminated in comparisons of shape. Further, any single measure which accounts for size in one taxon may be an inappropriate measure of size in a distantly related taxon. Within-group principal component analysis can be used to extract a size component, PC1 (Humphries et al., 1981), that is a linear combination of several variables, each containing information on size and shape. Thus, PC1 includes more information on size than any single measure and is a better comparison across taxa.

Univariate and multivariate methods of allometry relate distance measures log-linearly (Huxley, 1932; Jolicoer, 1963). Thus, a within-species principal component analysis of the logarithms of the six basic morphometric characters, based on the covariance matrix, was performed to extract the size component (PC1). The extreme PC1 scores for all taxa were compared and two values (0.00 and 0.60), one near each end of the larval period, were chosen as standard sizes for comparing morphometry. The six morphometric measures were reconstructed for each of these sizes by means of the regressions of the logarithm of the character on PC1. By selecting two sizes to compare, the phylogenetic analysis included information on changing shape (allometry) as well as static shape. The final 12 character values were recorded as predicted lengths (in mm) for each morphometric measure at each of 2 standard sizes. However, body depth at the anus contained no discontinuous, phyletic variability. The final morphometric characters were: (Characters 1 and 2) Peduncle length (smaller and larger standard size, respectively), (3 and 4) Trunk length, (5 and 6) Head length, (7 and 8) Eye length, (9 and 10) Head depth. Three additional morphometric characters were

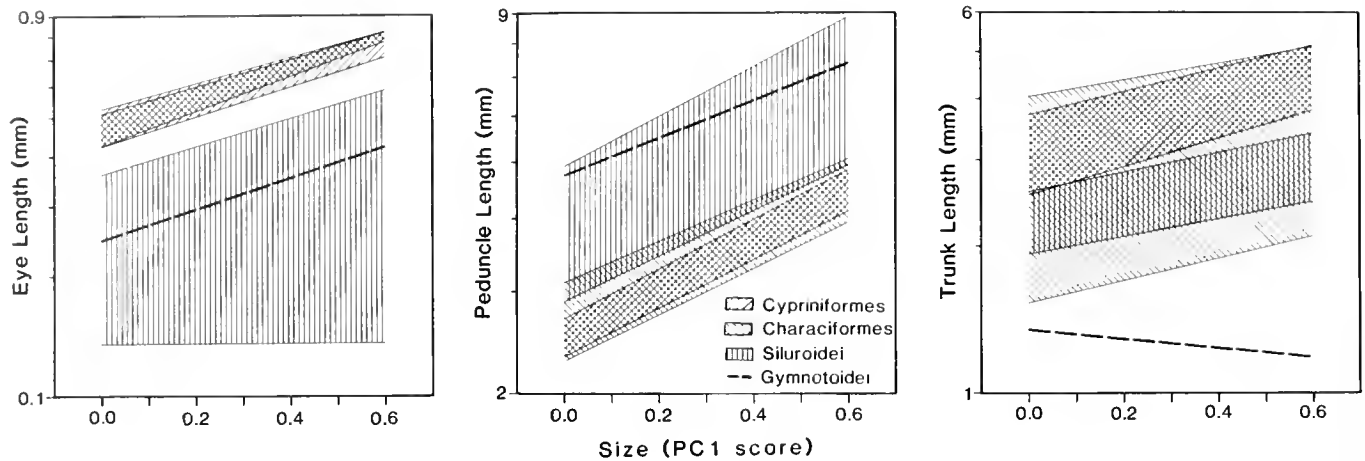

Fig. 69. Morphometric characters important in defining major groups of ostariophysan larvae. Shaded areas and individual lines enclose all regression-predicted values at two standard sizes (0.0 and 0.6) of a given taxon.

included: (11) Size at hatching (PC1 score at total length for hatching, based on the regression of PC1 on the logarithm of total length), (12) Size at complete finfold absorption (PC1 score at total length for complete finfold absorption, based on the regression of PC1 on the logarithm of total length), (13) Yolk-sac shape (ratio of the greatest vertical length [depth] of the yolk sac to its greatest horizontal length in recently hatched individuals).

Meristic characters.—These include: (14) Preanal myomeres (all myomeres at least partly anterior to a vertical line projected from the anus, including an occipital segment) and (15) Postanal myomeres (all myomeres entirely posterior to a vertical line projected from the anus, including a urostylar segment).

Missing myomere data for *Hoplias malabaricus* were taken from vertebral counts made from radiographs of adults (UMMZ 66435). The one-to-one ontogenetic relationship of myosepta to neural spines in monospondylous fishes (Lauder, 1980) permitted estimation of myomere number from vertebral number only by inclusion of myomeres for an occipital segment, a urostylar segment, and the four (five in siluroids) obscured Weberian vertebrae (Fuiman, 1982a).

Ontogenetic characters.—Size, rather than chronological age, is most closely related to development (Gerking and Rausch, 1979). Thus, total length at the onset of selected developmental events was recorded. To compare these sizes among species with differing initial lengths and ranges of lengths for the larval period,

the logarithm of the hatching length was subtracted from the logarithm of the length at a given event. This difference was divided by the difference of the logarithms of length at complete finfold absorption and at hatching (the criteria used here to delimit the larval period). The resultant character was the percentage of the larval period that occurred prior to the event, an estimate of relative timing of the event. When characters were present at hatching or did not develop until after complete finfold absorption they were coded as 0.00 or 1.10, respectively. The following events were recorded: (16) Anal fin rays (first distinct ray), (17) All median fin rays (all median fin rays present, finfolds may persist, fin margins may be incomplete), (18) Yolk absorption (complete absorption of yolk), (19) Head straight (head free from yolk sac and not deflected downward), (20) Eye pigment (first uniform pigmentation of retina).

Presence/absence characters.—Presence (coded as 1) or absence (0) of the following structures at any time during the larval period was recorded: (21) Jaw teeth (teeth on the premaxilla, maxilla, or dentary), (22) Adipose fin, (23) Caudal spot (congregation of melanophores at the base of the caudal fin forming a distinct spot), (24) Lateral stripe (melanophores on the mid-lateral myoseptum forming a continuous, longitudinal stripe).

Phylogenetic results

The Wagner tree (Fig. 67, Table 28) contains 101 steps for the 46 two-state factors ("characters"). Members of each major

TABLE 29. DISTRIBUTION STATISTICS OF PREANAL, POSTANAL, AND TOTAL MYOMERE NUMBER FOR OSTARIOPHYSAN LARVAE. Values are based on means for each species.

Taxon	Number of species	Preanal myomeres		Postanal myomeres		Total myomeres	
		Mean	Extremes	Mean	Extremes	Mean	Extremes
Cypriniformes ¹	52	29.4	18.5–38.8	12.4	7.0–18.8	41.7	32.8–50.7
Characiformes	4	25.5	17.8–32.7	15.2	8.0–20.0	42.0	36.1–50.0
Siluroidei	6	19.7	15.3–26.3	25.9	16.5–38.7	45.4	33.0–65.0
Gymnotoidei	1	17.3		45.9		63.2	

¹Including Cyprinidae, Catostomidae, and Cobitoidea.

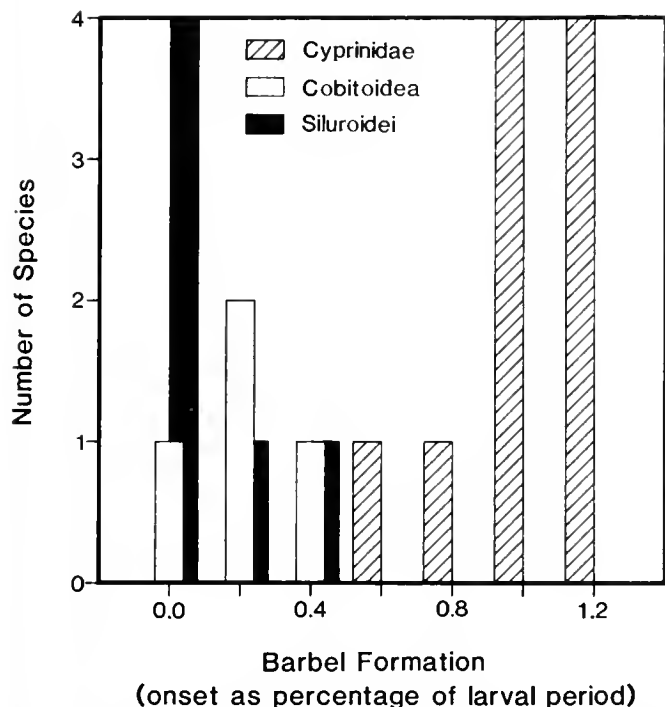

Fig. 70. Frequency distribution of relative timing of barbel formation in ostariophysan species. Cyprinids are represented by 10 barbelled species, not all of which are discussed in the text.

taxon (Cypriniformes, Characiformes, Siluroidei) are placed near one another, but larval characters are insufficient to demonstrate the monophyly of characiforms or siluroidei. The largest number of primitive characters is found in *Hoplias* (Characiformes), but the cypriniform lineage differs from *Hoplias* by only three character state changes (node 3). As suggested by Fink and Fink (1981), the gymnotoids are most closely related to siluroidei (node 26).

The cypriniform lineage (node 4) is united by two unreversed synapomorphies: an elongate yolk sac (Figs. 62A and 68) and the absence of jaw teeth. Cypriniforms and characiforms uniquely share large eyes at the larger standard size ($PC1 = 0.6$; Fig. 69). This character reverses to a plesiomorphous condition for the siluriform lineage. Synapomorphies of siluriforms include a long peduncle at the larger size (Fig. 69) (a unique state for the group, except for a single reversal in *Bagarius*), short head at the larger size (highly homoplasious), and small eyes at the smaller size ($PC1 = 0.0$; Fig. 69) (unique except for a reversal in *Ictalurus*). The gymnotoid, *Eigenmannia* (node 28), expresses six autapomorphies, two unique and two occurring in only one other place on the tree. The uniquely derived conditions are a short trunk at the larger size (Fig. 69) and numerous postanal myomeres (Table 29).

Several morphometric characters make valuable contributions to the phylogenetic reconstruction. The axial measurements (head, trunk, and peduncle lengths) exhibit a clear trend for increasing head and peduncle lengths at the expense of trunk length through the cypriniform → characiform → siluroid → gymnotoid phyletic sequence. A portion of the variation in peduncle size is attributable to migration of the anus anteriorly in

this phyletic sequence, as evidenced by decreasing preanal and increasing postanal myomere counts (Table 29). However, the remaining peduncle variation and that of the head length are the result of allometry.

In Fink and Fink's (1981) study, a single character involving the evolution of a new structure, a pair of barbels, conflicted with their adult-based cladogram. Ontogenetic evidence supports their contention that the presence or absence of barbels is a poor indicator of relationship in ostariophysans. An ontogenetic character for timing of barbel development (constructed in the same manner as described earlier for other ontogenetic characters) displays two distinct modes (Fig. 70). Cyprinids develop barbels during the latter third of the larval period, often after finfold absorption (i.e., as juveniles). Siluroidei and cobitoideans¹ do so during the first third of the larval period, sometimes prior to hatching. Although the sample size of cobitoideans is small, it appears that they develop barbels somewhat later than the siluroidei. Thus, although barbels are present in adults of all three groups, there is an important difference in these structures between the groups: heterochrony. That heterochrony is a major cause of evolutionary change was amply attested by Gould (1977).

Heterochrony in barbels may be an important consideration for classification within siluroidei. The number of pairs of barbels (usually counted in the adult stage) is an important character for recognizing siluroidei families. At least one pangasiid, *Silonia silondia*, has been described in which the larvae have three pairs of barbels (nasal, maxillary, and mandibular) that gradually become smaller until only one pair of minute maxillary barbels are present on the surface of adults (Karamchandani and Motwani, 1956).

The phylogenetic analysis presented here is based on developmental characters. It shows general congruence with the most thoroughly researched adult-based cladogram (Fink and Fink, 1981); however, larval characters alone are not as informative as adult characters. Larval characters support the new idea that gymnotoids are more closely related to siluroidei than to characiforms. Characiforms appear to be primitive ostariophysans by virtue of the basal location of the relatively primitive characiform *Hoplias*. The apparent paraphyly of characiforms and siluroidei is due to the lack of shared characters for each of these groups and would be altered by the reasonable addition of the numerous adult autapomorphies discussed by Fink and Fink (1981). Once monophyly is demonstrated by adding adult characters, *Hoplias* would probably occupy a basal position (with respect to the other three characiforms examined here) on a characiform lineage. However, the position of this lineage with respect to that of the cypriniforms may or may not agree with Fink and Fink's (1981) adult-based cladogram.

SCHOOL OF NATURAL RESOURCES, S. T. DANA BUILDING,
UNIVERSITY OF MICHIGAN, ANN ARBOR, MICHIGAN 48109.

¹ Cobitoideans included here and in Fig. 70 were: Cobitidae—*Botta xanthi* (Changjiang, 1976); *Cobitis taenia* (Chyung, 1961; Koblitkaia, 1981; Kokhanova, 1957; Kryzhanovskii, 1949; Kryzhanovskii et al., 1951; Menasse, 1970); *Misgurnus anguillicaudatus* (Chyung, 1961; Kobayasi and Moriyana, 1957; Okada, 1960; Okada and Seiishi, 1938; Suzuki, 1955, 1968); Homalopteridae—*Nemacheilus dorsalis* (Kryzhanovskii, 1949).

Gonorynchiformes: Development and Relationships

W. J. RICHARDS

THE Gonorynchiformes is a small group of fishes which have been allied with the clupeiforms or salmoniforms and most recently have been placed as a lineage, within the ostariophysan group, which includes also the Cypriniformes, Characiformes, and Siluriformes (Fink and Fink, 1981). The group is comprised of seven genera classified in about four or five families. The most widely known species is *Chanos chanos* Forsskål placed in the monotypic family Chanidae. The Gonorynchidae is a marine family of one genus *Gonorynchus* and several species found in tropical waters of all but the western Atlantic and eastern Pacific. The remaining twelve or so species are African freshwater forms in the genera *Kneria*, *Parakneria*, *Grasseichthys* and *Phractolaemus*, which may represent two or three families. The early life history of *Chanos* is very well known because of the extensive culturing; *Gonorynchus* is poorly known. The early life histories of the freshwater species are unknown. Pellegrin (1935) notes that young specimens of *Cromeria nilotica* have a superficial resemblance to young *Albula*. It is apparent that this resemblance is to the shape of juveniles and not

to a leptocephalus stage. Several subsequent papers have erroneously reported that Pellegrin said that *Cromeria* resembled larval *Albula*.

DEVELOPMENT

The early life history of *Chanos chanos*, the milkfish, has been described by Delsman (1926d, 1929b). Since *Chanos* is an important aquaculture organism, several recent papers have described various aspects of development, among them the description by Liao et al. (1979) is the most complete. Miller et al. (1979) provides a good account for separating them from common marine larvae. To summarize, the eggs and larvae superficially resemble clupeids and engraulids but differ in several trenchant characters. The eggs as described by Delsman (1929b) are spherical, 1.2 mm in diameter, lack oil droplets and have a weakly segmented yolk which may be similar to the granular yolks seen in ostariophysans. Yolk-sac larvae have melanophores scattered over the body and fin folds and a myomere formula of 34 + 10 (preanal and postanal). As development

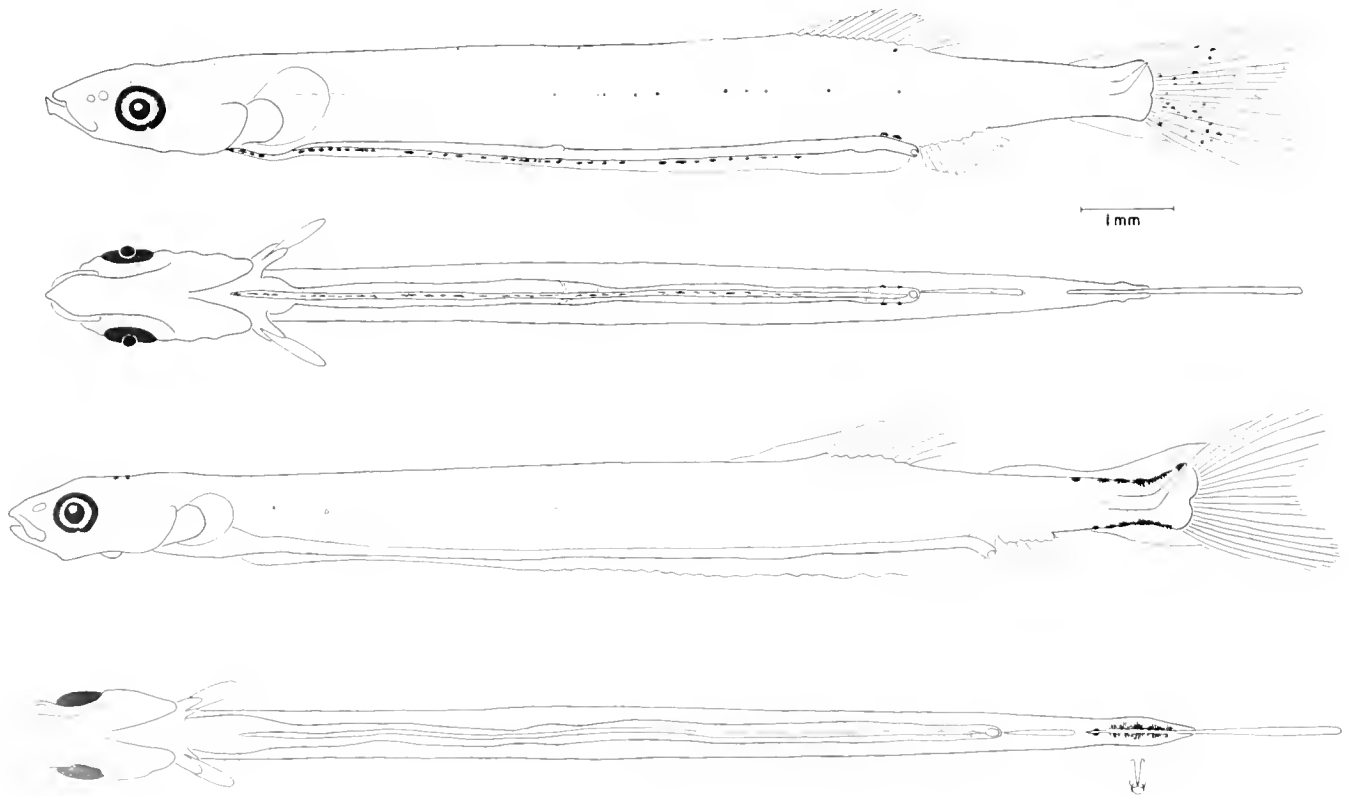

Fig. 71. Lateral and ventral views from top to bottom: *Chanos chanos*, 11.7 mm SL from Kumano, Tanegashima collected August 19, 1978, drawn by J. C. Javech; and *Gonorynchus abbreviatus*, 12.8 mm SL from R/V Shoyo Maru station 25, 35°05'N, 144°24.3'E, collected on November 10, 1963; drawn by J. C. Javech.

progresses, the melanophores collect along the dorsal and ventral midlines of the trunk. In larvae 10–15 mm SL (Fig. 71) pigmentation is variable with melanophores on the dorsal midline varying from one to many and melanophores on the lateral line varying from none to many. The ventral midline has a continuous streak of melanophores in sharp contrast to clupeids and engraulids which have melanophores laterally on each side of the gut thus presenting two parallel streaks in ventral view. The anal fin of *Chanos* originates beneath the dorsal fin as in engraulids. In Hawaiian waters meristics separate *Chanos* from *Gonorynchus* and other clupeids and engraulids. *Chanos* has 40–46 vertebrae [44–46 according to Miller et al. (1979) and 40–45 according to Senta and Kumagai (1977)]. Dorsal rays are 14–16, anal rays 8–11, pectoral rays 17 and pelvic rays 10–12 (Miller et al., 1979).

Much less is known about the early life history stages of *Gonorynchus*. Furukawa (1951) described the larvae of *G. abbreviatus* and illustrated 18 and 23 mm specimens. He based his identification on dorsal (11–12) and anal (7–8) fin rays, vertebral counts (55) and the posterior position of the dorsal and anal fins. Hattori (1964) illustrated and briefly described a series of *G. abbreviatus* from 8.6 to 90.5 mm. He noted that the positions of the dorsal and anal fins do not shift during development. Mito (1966) illustrates two larval *G. abbreviatus*. I examined a series of *G. abbreviatus* specimens and one is illustrated here (Fig. 71). The larvae resemble clupeids with the wide separation of the dorsal and anal fin. Pigment occurs dorsally and ventrally

on the caudal peduncle and extends posteriad into the bases of the procurrent caudal rays. Internal pigment occurs above the hindgut and behind the brain. A few external melanophores are present on the top of the head. Additional external melanophores appear with growth. These include a series which develops as lateral spots increasing in number with growth. In a few specimens examined a 15.9 mm larva had one spot and these increased in number to 18. At 23 mm SL pigment also appeared on the opercle and ventral rim of the orbit. The pelvic fin is discernible as a bud in small larvae but fin rays are not defined until 18 mm SL. A swimbladder is not discernible on any of the specimens as it is in clupeids and *Chanos*.

RELATIONSHIPS

The relationships of the Gonorynchiformes have been discussed most recently by Fink and Fink (1981). They conclude that this order is the sister group of the Otophysi (the taxon which includes fishes with the Weberian apparatus). *Chanos* and *Gonorynchus* larvae more closely and superficially resemble clupeoid larvae than any other group. This matter should be thoroughly investigated when early life history aspects of the freshwater species become better known. It will be interesting to see if those larvae resemble the marine species or freshwater Otophysi.

NATIONAL MARINE FISHERIES SERVICE, SOUTHEAST FISHERIES CENTER, 75 VIRGINIA BEACH DRIVE, MIAMI, FLORIDA 33149.

Salmoniforms: Introduction

W. L. FINK

ORIGINALLY a major portion of the Protacanthopterygii of Greenwood, et al. (1966), the order Salmoniformes is now the only portion left in that group, and the former term has ceased to have a useful function. This erosion of the Protacanthopterygii has resulted from the search for and taxonomic recognition of natural groups of primitive euteleosts, a practice that has and is continuing to have profound effects on fish classification at all levels. This part of the symposium, concentrating on the "salmoniforms," places its participants in the middle of a continually changing set of problems, some of which have been longstanding. One of the questions we address here is whether the Salmoniformes as conceived by Greenwood et al. is itself useful any more, and if not, what are the relationships of the formerly included groups. In the years since it was delineated, the Salmoniformes has undergone attrition, most notably at the hands of Rosen (1973). Of particular concern to us is whether there is one large monophyletic unit which can be called Salmoniformes, as maintained by Rosen (1974), or whether there are several units, as suggested by Fink and Weitzman (1982), thus requiring us to modify our conclusions and classifications. The basic questions are these: (1) What are the relationships of the Esocoidei (*sensu* Rosen, 1974), both to one another and to other primitive euteleosts? (2) What are the relationships of the Ostariophysii, (*sensu* Rosen and Greenwood,

1970)? Do these fishes lie above or below the Esocoidei in the phylogeny? (3) What is the pattern of relationships among the traditionally recognized "salmoniform" taxa, exclusive of the Esocoidei and Ostariophysii? Is this a natural division? (4) What are the phylogenetic relationships of and within the Argentinoidae (*sensu* Greenwood and Rosen, 1971)? (5) What are the phylogenetic relationships of and within the Osmeroidei? (6) What are the phylogenetic relationships of and within the Salmonidae? (7) Where does *Lepidogalaxias* belong? (8) What are the interrelationships within the stomiiform fishes? (9) What of the Myctophoidae, as recognized by Greenwood, et al. (1966)? This "group" has been most recently addressed by Rosen (1973) in his discussion on the Eurypterygii and Neoteleostei. Parts of these groups overlap into areas covered by this particular part of the symposium, such as placement of giganturids, and other parts into non-"salmoniform" portions such as that on myctophiforms.

In many ways this symposium is a report on the state of the science of fish classification, will summarize current ideas of relationships and, especially, will point to where the greatest need for further research lies.

MUSEUM OF ZOOLOGY, UNIVERSITY OF MICHIGAN, ANN ARBOR, MICHIGAN 48109.

Esocoidei: Development and Relationships

F. D. MARTIN

THE Esocoidei consist of two families, Esocidae and Umbridae, with one and three genera respectively (Nelson, 1976). Table 30 lists all currently accepted species and gives their geographic ranges. All recent classifications consider the esocoids as members of the Salmoniformes (Greenwood et al., 1966; Gosline, 1971; Rosen, 1974; Nelson, 1976; and others). All esocoid fishes live in freshwater and occur in temperate and arctic waters of the Northern Hemisphere. All species are predatory with *Esox* being primarily piscivorous. They are distinguished from other salmoniform fishes by the lack of the mesoracoid, lack of pyloric caeca, a single rudimentary arch over PUI, and a single uroneural (Rosen, 1974). Table 31 gives developmental features that characterize esocoid fishes and contrasts them with Salmonidae and Osmeridae.

DEVELOPMENT

Eggs are demersal and adhesive in most species (Breder and Rosen, 1966) but *Esox niger* eggs become buoyant at later stages of development and are not adhesive after water hardening (Jones et al., 1978). Eggs are of moderate size (1.0 to 2.2 mm usually) (Jones et al., 1978) and are either scattered as by *Esox* or are in nests as with *Umbr*a and *Novumbr*a (Breder and Rosen, 1966).

Multiple oil droplets occur with a unique set of movements producing alternating clustering and dispersion as ontogeny proceeds (Malloy and Martin, 1982).

Larvae of nearly all species are known, and developmental series have been described and illustrated. Figs. 72 and 73 show representative larvae of *Esox* and *Umbr*a. Those described hatch relatively undeveloped, with head flexed over and attached to the large yolk sac; the eyes are unpigmented. In all species the notochord is stout and reaches nearly to the margin of the caudal finfold. During flexion the notochord extends well beyond the developing hypurals and may form a separate lobe to the developing caudal fin until the hypurals are complete. In *Umbr*a and *Esox* the pectoral fin is the first to begin differentiation (but not form rays) with the pelvic fin the last to develop fin rays. All median fins differentiate more or less simultaneously with caudal starting differentiation slightly ahead of the others. Changes in body form are gradual with no noticeable point of metamorphosis. Before fin differentiation is complete the body

TABLE 30. GENERA AND SPECIES OF ESOCOID FISHES AND GEOGRAPHICAL RANGES.

Esocidae	
<i>Esox</i>	
<i>E. lucius</i>	Holarctic (Crossman <i>in</i> Lee et al., 1980).
<i>E. reicherti</i>	Amur River region of Siberia (Berg, 1948).
<i>E. masquinongy</i>	Eastern North America, primarily Great Lakes and Upper Mississippi drainage (Crossman <i>in</i> Lee et al., 1980).
<i>E. niger</i>	East Coast drainage of North America, also lower Mississippi drainage (Crossman <i>in</i> Lee et al., 1980).
<i>E. americanus</i>	Eastern half of North America (Crossman <i>in</i> Lee et al., 1980).
Umbridae	
<i>Novumbra</i>	
<i>N. hubbsi</i>	Olympic Peninsula of Washington State (Meldrim <i>in</i> Lee et al., 1980).
<i>Umbr</i> a	
<i>U. krameri</i>	Middle and lower Danube System and lower Dniester River (Berg, 1948).
<i>U. limi</i>	Southern Canada and Central United States (Gilbert <i>in</i> Lee et al., 1980).
<i>U. pygmaea</i>	Southeastern New York to Northern Florida, mostly on Coastal Plain (Gilbert <i>in</i> Lee et al., 1980).
<i>Dalhia</i>	
<i>D. pectoralis</i>	Arctic and sub-Arctic Alaska and eastern tip of Siberia (Rohde <i>in</i> Lee et al., 1980).
<i>D. asmirabilis</i>	Anguema River basin of Siberia (Chereshnev and Balushkin, 1980).

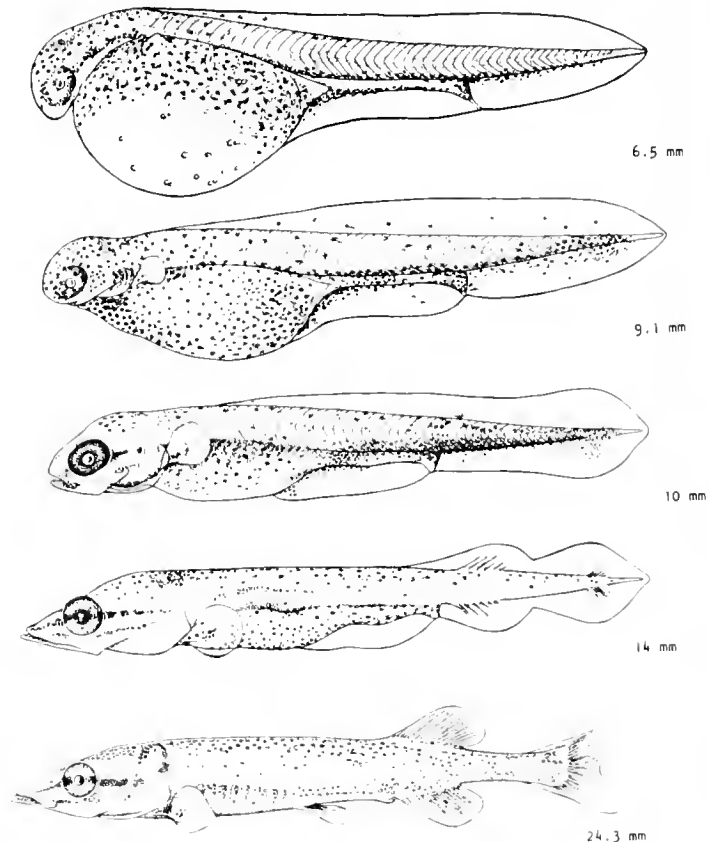

Fig. 72. Development of *Esox niger* from hatching to juvenile. Lengths are total lengths. (From Mansueti and Hardy, 1967.)

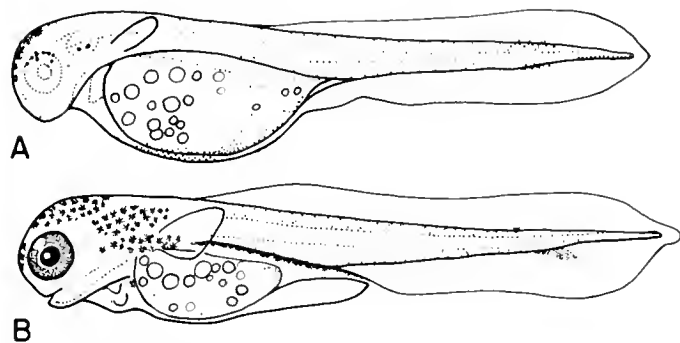

Fig. 73. Early yolk-sac and late yolk-sac larvae of *Umbra pygmaea*. (From Wang and Kernehan, 1979.)

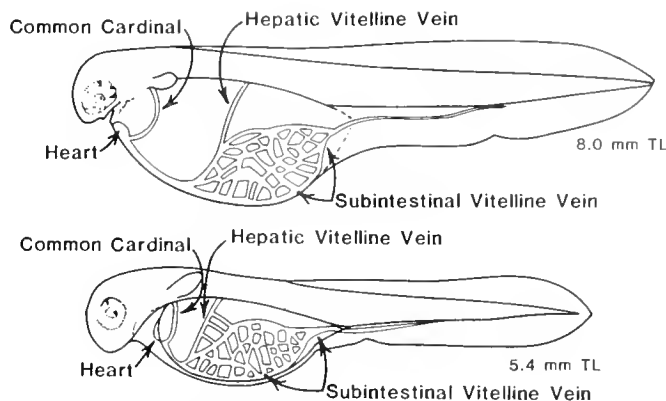

Fig. 74. Schematic representations of the vitelline venous systems of *Esox americanus* (upper) and *Umbra pygmaea* (lower)—based in part on figure from Wang and Kernehan, 1979.

TABLE 31. A COMPARISON OF EGGS AND LARVAE OF ESOCOID, SALMONOID AND OSMEROID FISHES. Unless otherwise noted information on Umbridae and Esocidae taken from Malloy and Martin (1982).

	Umbridae	Esocidae	Salmonidae	Osmereidae
Egg				
Demersal	+	+	¹ +	¹ +
Adhesive	+	+ or ¹² ±	¹ ± (mostly -)	² +
Oil droplets	multiple	multiple	^{3,4,12} multiple or ^{8,12} single	² single or ^{11,15} multiple
Size	⁵ 1-2.2 mm	⁶ 1.9-2.3, 4 mm	¹² 1.5-7.0 mm	²¹ 1 mm
In nests	¹ +	¹ -	¹ +	¹ ±
Embryo and yolk-sac larva				
Head deflexed, adherent to yolk-sac	+	+	^{3,4} -	² -
Eye pigmented at hatching	-	-	^{3,4} +	^{2,15} +
Vitelline circulation				
Common cardinals	+	+	^{9,10*} -	?
Hepatic vitelline vein	+	+	^{9,10} +	?
Subintestinal vitelline vein	+	+	^{9,10} -	?
Subintestinal v.v. forming rete	+	+	^{9,10} -	?
Hepatic v.v. forming rete	-	-	^{9,10} +	?
Larva				
Vertebrae (myomeres)	¹³ 32- ^{13,14} 42	¹³ 43-67	¹⁶ 46-75	¹⁷ 55-70
Adipose fin	-	-	^{3,18} +	² +
Dorsal origin over or behind anus	+	+	^{16,18} -	^{2,4} -
Notochord forming a urostyle extending length of hypural complex past hypurals	+	+	^{4,18} -	^{2,11} -
Juvenile and adult				
Pyloric caeca	0	0	¹⁷ 13-222	¹⁷ 0-11
Anterior constriction of vertebra	²⁰ **+	²⁰ ***-, +	²⁰ -	²⁰ -
Pharyngobranchial 1	-	-	+	+
Epurals	0-2	2	^{19,2} or 3	^{19,2} or 3
Hypurals	5 or 6	6	^{19,7}	^{19,6}
Neural spine on preural 1	+	+	¹⁹ - or reduced	¹⁹ - or reduced
Neural spine on preural 2	fully developed	fully developed	reduced or not	¹⁹ fully developed

* Present but does not run on surface of yolk sac.
 ** In *Novembra* and *Dallia* only present in midabdominal region of juveniles
 *** When present there is also posterior constriction

¹ Breder and Rosen, 1966.
² Cooper, 1978
³ Rajagopal, 1979
⁴ Watling and Brown, 1955
⁵ Baugh, 1980

⁶ Jones et al., 1978
⁷ Carbine, 1944
⁸ Leach, 1923.
⁹ Soin, 1966
¹⁰ Kunz, 1966

¹¹ Bigelow and Schroeder, 1963
¹² Iuman, 1982h
¹³ Nelson, 1972.
¹⁴ Auer, 1981
¹⁵ Yanagawa, 1978

¹⁶ Scott and Crossman, 1973
¹⁷ Hart, 1973
¹⁸ Nagiec, 1979
¹⁹ Greenwood and Rosen, 1971
²⁰ Cavender, 1969

form is basically that of the adult. Guts are simple with no elaborations in all species. At hatching *Umbra* has a shorter gut and fewer myomeres than *Esox* and this is reflected in there being 5 myomeres between the yolk sac and the anus in newly hatching *U. pygmaea* and 12 in *E. americanus* (Malloy and Martin, 1982).

RELATIONSHIPS

Malloy and Martin (1982) point out three ontogenetic characteristics shared by *Esox* and *Umbra*, which indicate close relationship. The position of the heart at the time of formation is on the yolk sac anterior to and left of the head. All other fish for which position of the forming heart is noted have it forming under the head in the pericardial cavity or, as in the Atheriniformes, near the midline and anterior to the head. The yolk-sac circulatory pattern consists of paired simple common cardinals, a posterior rete formed by the subintestinal vitelline vein and paired or single hepatic vitelline veins which enter the rete before the subintestinal vitelline vein joins the common cardinals at the heart (see Fig. 74). This differs from all other salmoniform fish for which the pattern is described (Kunz, 1964; Soin, 1966). The oil droplets go through a predictable series of clustering and dispersion. Oil droplet movement of this sort has only been documented previously by Ahlstrom (1968) for bathylagid smelts of the genera *Bathylagus* and *Leuroglossus*.

McDowall (1969) recognized a salmonoid-osmeroid-esocoid lineage but states "Where esocoids fit into this series of suborders and families is not clear to me." Rosen (1973) likewise

considers the esocoids and salmonoids to probably be closely related but considers this alignment to be provisional. Fink and Weitzman (1982), in contrast, state that they find no evidence to consider the esocoids closely related to the other Protacanthopterygii (*sensu* Rosen, 1974), which are the Agentinoidei and Salmonoidei (including the Salmonoidea plus Osmeroidea). Fink and Weitzman list the esocoids as *sedis mutabilis* at the euteleostean level or as the sister group to all other euteleosts. Soin (1980), on the basis of egg development patterns, feels that the esocoid fish are incorrectly placed as a suborder of the Salmoniformes, however he gives no guidance as to correct placement. While the ontogenetic evidence presented in Table 30 is not conclusive it suggests that there is a large difference between the esocoids and the Salmonoidei and this is consistent with the opinions of Fink and Weitzman.

The vertebrae of Umbrids have a pronounced anterior constriction, giving them an asymmetrical appearance, however *Novumbra* and *Dallia* show this characteristic only while young and most noticeably in the mid-abdominal region. In *Esox* the vertebrae are either unconstricted or are constricted both anteriorly and posteriorly so that they appear symmetrical (Cavender, 1969). Other differences between the Esocidae and the Umbridae are seen in the Umbridae having nine or fewer branchiostegals, fewer infraorbitals, no supratemporals or intercalars and usually fewer than 41 vertebrae (Wilson and Veilleux, 1982).

CHESAPEAKE BIOLOGICAL LABORATORY, UNIVERSITY OF MARYLAND, BOX 38, SOLOMONS, MARYLAND 20688.

Salmonidae: Development and Relationships

A. W. Kendall, Jr. and R. J. Behnke

SALMONIDS (whitefishes, ciscoes, grayling, trout, and salmon) are highly important in terms of aesthetic appreciation, commercial and recreational value, and scientific study. Studies of the development of salmonids from hatching until the time of yolk depletion, and of the relationships among subfamilies and genera have been largely neglected [see review of systematics by Dorofeyeva et al. (1980)] despite the large body of literature on early embryological development and relationships among species and populations. Salmonids all spawn in fresh or brackish water; some are anadromous while others are strictly freshwater. The family is composed of about 10 genera in three subfamilies: Coregoninae, Thymallinae, and Salmoninae (Table 32) (Nelson, 1976).

Along with a precise homing ability, salmonids tend to form genetically isolated populations. They seem to be able to occupy new niches and habitats as these become available in the cold temperate parts of the Northern Hemisphere. One result of this adaptability is the existence of taxonomic problems mainly at the species-population levels (Utter, 1981).

DEVELOPMENT

Post-hatching development of salmonids has been little studied (Table 33), and only a superficial analysis of comparative developmental stages has been attempted (Soin, 1980). *Thymallus* and the salmonines share apparently advanced features of development such as large yolk sac with an extensive vitelline circulatory system and development of rather uniform intense pigment, while coregonines develop larvae that are more typical of other freshwater fishes (Faber, 1970). *Thymallus* seems intermediate between the coregonines with a "normal" larval stage and the salmonines in which the larval stage is largely bypassed (the young have fully formed fins by the time the yolk is absorbed). Parr marks (vertical blotches or bars of pigment over the trunk of juveniles) are present in all salmonids except *Coregonus* and *Stenodus* but are not seen in juveniles of other fishes. Norden (1961) incorrectly considered the early stages of *Coregonus artedii* as figured by Fish (1932) to be similar to those of *Thymallus arcticus*. He also stated that "the development of

TABLE 32. CHARACTERS THAT VARY AMONG THE SALMONID SUBFAMILIES.

Character	Subfamily		
	Coregoninae	Thymallinae	Salmoninae
General			
Genera	<i>Coregonus</i> , <i>Prosopium</i> , <i>Stenodus</i>	<i>Thymallus</i>	<i>Brachymystax</i> , <i>Hucho</i> , <i>Salvelinus</i> , <i>Salmo</i> , <i>Parasalmo</i> , <i>Oncorhynchus</i>
Species	30	4	32
Habitat	freshwater, few anadromous	freshwater	freshwater and anadromous
Egg size	1.8–3.7 mm	2.5 mm	3.7–6.8 mm
Diploid chromosome numbers	64–82	102	52–92
Dorsal fin rays	10–15	17–25	8–12
Dentition¹			
Tooth character	narrow, sharp, 2–3 sections	uniform in size	vary in size
Maxillary	toothless	toothed	toothed
Dentary	minute teeth restricted to anterior end	narrow, teeth of uniform size all along bone	numerous teeth of varying size all along bone
Vomer	small and toothless (except in <i>Stenodus</i> and some <i>Coregonus</i>)	small, with teeth	long, with teeth
Premaxillary	small	large	large
Caudal skeleton²			
Epurals	3	3	2–3 ⁴
Stegural	little developed	little developed	well developed
Neural and hemal spine expansion	little	moderate	large
Urodermal	present	absent	absent
Neural spine on PU ₁	absent	absent	present
Neural spine on PU ₂	not fully developed	not fully developed	fully developed ⁴
Cranial osteology³			
Orbitosphenoid	present	absent	present
Suprapreopercular	absent	absent	present
Parietals meet at midline	yes	yes	no
Hypethmoid	present	absent	usually absent
Basisphenoid	usually absent	present	present
Uppermost orbital ⁵	present	present	absent

¹ Vladykov (1970).² Cavender (1970).³ Norden (1961).⁴ Some variation within Salmoninae in these two characters. Those with 2 epurals usually have most extensive neural spine development.⁵ Sometimes erroneously termed dermosphenotic; sometimes present in Salmoninae; see Behnke (1968, p. 9–10).

the young grayling has much in common with that of both the coregonines and salmonines" (Norden, 1961:743).

Among the coregonines, larvae of *Prosopium* (Faber, 1970; Auer, 1982), *Leucichthys* (Fish, 1932; Faber, 1970; Auer, 1982), and *Coregonus* (Fish, 1932; Faber, 1970; Auer, 1982) have been illustrated and briefly described. All show similar larval morphology (Fig. 75). They are rather slender with a long preanal finfold—the yolk being confined to the anterior trunk region. The yolk-sac length is <35% total length (TL), eye diameter is <7% TL, and body depth at anus is usually <10% TL (Auer, 1982). The yolk is exhausted before any of the fins, except the caudal, possess full complements of rays. *Prosopium* eggs have multiple oil globules, while *Leucichthys* and *Coregonus* eggs have a single oil globule (Auer, 1982). Pigment in preflexion and flexion larvae is mainly associated with the dorsal and ventral midlines. Later, the body becomes more uniformly pigmented. *Prosopium* develops parr marks during the juvenile period. Larvae of *Stenodus* are undescribed and they may differ from those described above, since adults of this genus appear quite divergent from the others in this subfamily.

Early development of *Thymallus thymallus* has been fully described (Penaz, 1975). They hatch with a large, anteriorly placed yolk sac that is covered by a rather extensive vitelline circulatory system, and the preanal and postanal finfolds are about equal in length (Fig. 75). The yolk sac is exhausted during notochord flexion and by that time some fin rays have developed in all of the fins. The larvae are rather heavily pigmented during this period. When the fins have developed their adult complement of rays, the fish appear like juveniles and parr marks begin to form.

Early development of all the salmonine genera and most subgenera is known, although several are inadequately described (Table 33). Described development of all salmonines is quite similar (Figs. 76, 77). Their eggs are among the largest of all teleosts. They all hatch with large yolk sacs and well developed vitelline circulatory systems. The preanal finfold is shorter than the postanal finfold (except in *Hucho* where they are about equal). The preanal finfold extends somewhat down the posterior of the yolk sac in *Oncorhynchus*. The notochord is slightly flexed and some caudal rays are present. Yolk-sac length is

TABLE 33. MERISTIC VALUES AND REFERENCES TO DESCRIPTIONS OF LARVAE OF SALMONIDS. Total reported ranges of meristic values are given, although the extremes of the ranges may be rarely observed.

Subfamily Genus Subgenus	References with illustrations of flexion stage larvae	Ranges of meristic values								Primary source	
		Verte- brae ¹	Dorsal fin ²	Anal fin ²	Pec- toral fin	Pelvic fin	Total gill rakers	Lateral line scales	Branchi- ostegal rays		
Coregoninae											
<i>Stenodus</i>		64-69	12-19	15-18	16-17	11	19-24	90-110	9-12	Scott and Cross- man (1973)	
<i>Prosopnum</i>	Faber (1970), Auer (1982)	50-65	10-15	10-14	13-18	9-12	11-44	50-108	6-10	Scott and Cross- man (1973)	
<i>Coregonus</i>											
<i>Leucichthys</i>	Fish (1932); Faber (1970), Auer (1982)	50-67	8-15	9-16	13-18	8-13	21-64	58-110	7-10	Scott and Cross- man (1973)	
<i>Coregonus</i>	Fish (1932), Faber (1970), Auer (1982)	55-64	10-13	9-14	14-17	11-12	15-78	70-102	6-10	Scott and Cross- man (1973)	
Thymallinae											
<i>Thymallus</i>	Penaz (1975)	58-62	17-25	11-15	14-16	10-11	16-33	81-103	7-9	Scott and Cross- man (1973)	
Salmoninae											
<i>Brachymystax</i>	Smol'yanov (1961)	58-62	12-15	11-14	15-18	9-10	20-30	120-150	10-13	Behnke (1968) and original	
<i>Hucho</i>											
<i>Hucho</i>	Balon (1956)	64-71	12-14	11-13	15-18	10	10-17	120-150	9-12	Behnke (1968) and original	
<i>Parahucho</i>		57-62	12-14	12-14	14-17	9	14-20	110-120	9-12	Behnke (1968) and original	
<i>Salvelinus</i>											
<i>Salvelinus</i>	Balon (1980)	57-71	10-12	8-10	14-16	9-11	11-51	105-152	10-15	Scott and Cross- man (1973)	
<i>Baione</i>	Balon (1980), Auer (1982), Martinez (1983)	57-62	10-14	9-13	11-14	8-9	14-22	110-130	9-13	Scott and Cross- man (1973)	
<i>Cristivomer</i>	Fish (1932), Balon (1980), Auer (1982)	61-69	8-10	8-10	12-17	9-10	16-26	116-138	10-14	Scott and Cross- man (1973)	
<i>Salmo</i>											
<i>Salmo</i>	Auer (1982), Martinez (1983)	54-62	10-15	8-13	12-16	9-10	14-25	100-130	10-12	Behnke (1968) and original	
<i>Salmothymus</i>		56-60	13-15	11-13	12-14	9-10	25-32	100-115	10-12	Behnke (1968) and original	
<i>Acantholingua</i>		52-59	11-13	10-12	11-13	9-10	18-22	95-110	9-11	Behnke (1968) and original	
<i>Platysalmo</i>		57-59	13	11	14	9	23-24	109-110	10-11	Behnke (1968) and original	
<i>Parasalmo</i>	Auer (1982), Martinez (1983)	55-67	8-12	8-12	11-17	9-10	14-28	100-150	9-13	Scott and Cross- man (1973)	
<i>Oncorhynchus</i>	Auer (1982)	61-75	9-16	12-19	11-21	9-11	18-43	120-160	11-19	Scott and Cross- man (1973)	
Overall ranges		50-75	8-25	8-19	11-21	8-13	10-78	50-160	6-19		

¹ Variations exist in the literature in how many of last 3 upturned vertebrae are counted, some authors omit the last 3 upturned vertebrae.² Includes rudiments where specified. A variation of 2-3 rays may result from different methods of counting (whether unbranched or rudimentary rays are included)

>35% TL, eye diameter >7% TL, and body depth at anus usually >10% TL (Auer, 1982). Pigmentation is uniformly heavy at hatching or later in the yolk-sac stage. The median fins develop rays before the paired fins. By the time the yolk is absorbed the finrays have completed formation and the fish takes on a juvenile appearance. Thus, the yolk remains a source of nutrition throughout the larval stage.

RELATIONSHIPS

Although salmonids are considered to be living representatives of the basal stock from which euteleostean evolution proceeded, there is no clear consensus on their relationships to other fishes. Since there are differing opinions on the relationships

between the major teleostean lineages (i.e., the divisions of Greenwood et al.; 1966), it is difficult to select representatives of outgroups to compare with the salmonids. Recent studies (Rosen, 1974; Fink and Weitzman, 1982; Fink, this volume) have pointed out that the Protacanthopterygii and even the Salmoniformes are probably not monophyletic taxa. The salmonids along with the galaxioids, osmeroids, and argentinoids, may form a group (Salmonae) that is the primitive sister group of the neoteleostei. However, the relationships among these groups is not clear, and the salmonids may be closer to the neoteleostei than to these other groups with which they have frequently been aligned (Fink and Weitzman, 1982; Lauder and Liem, 1983; Fink, this volume). Some primitive teleost traits

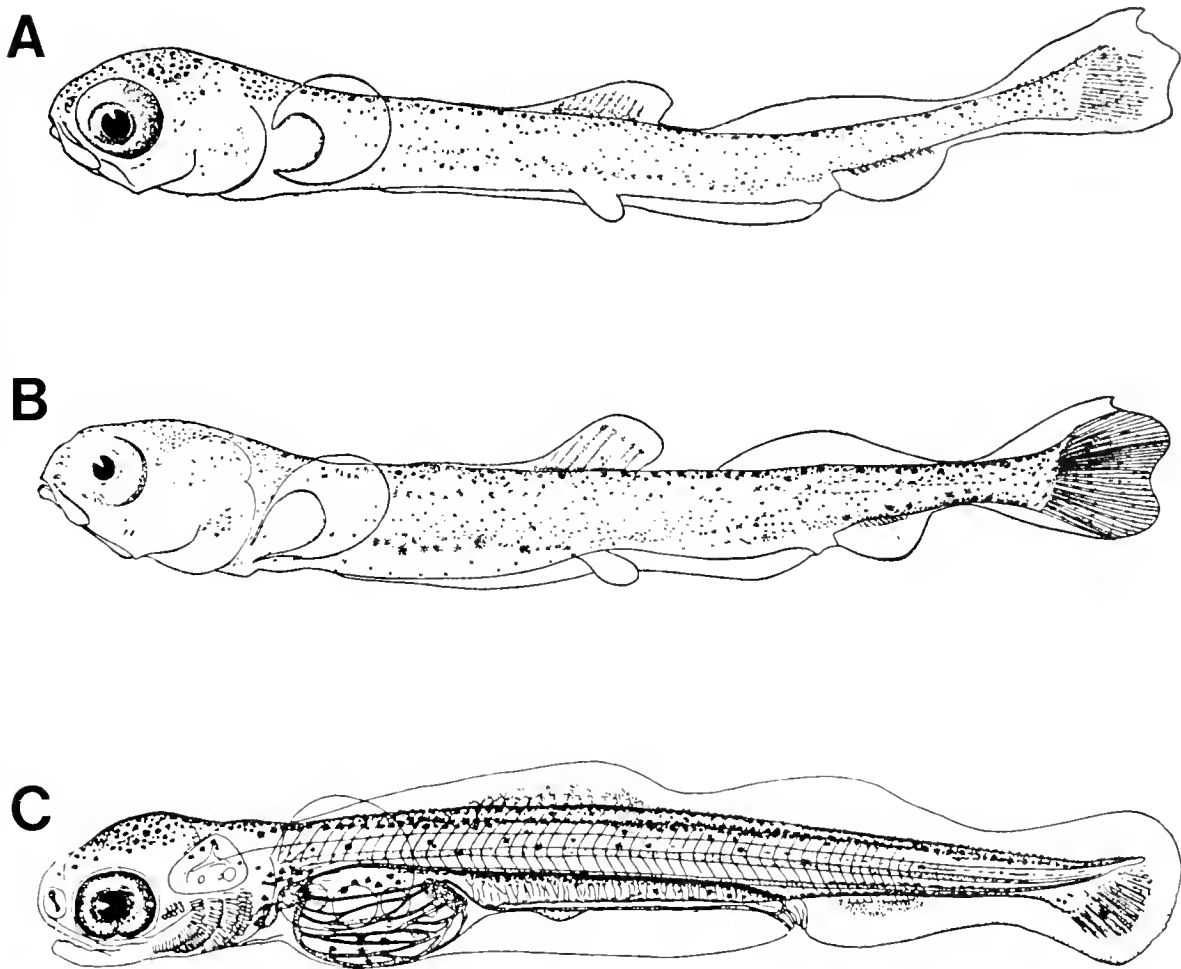

Fig. 75. Flexion stage larvae of: (A) *Coregonus (Leucichthys) artedu* (17.5 mm); (B) *Coregonus (Coregonus) clupeaformis* (18.5 mm); (C) *Thymallus thymallus* (16.0 mm). A and B from Fish (1932), C from Penaz (1975).

TABLE 34. CHARACTERS THAT VARY AMONG THE COREGONINE GENERA AND SUBGENERA (SG) MAINLY FROM NORDEN (1961) AND CAVENDER (1970).

Character	<i>Coregonus</i>			
	<i>Coregonus</i> (sg)	<i>Leucichthys</i> (sg)	<i>Prosopium</i>	<i>Stenodus</i>
Species	8	17	7	1
Habitat	Some occasionally anadromous	Several anadromous	Freshwater	Anadromous
Basibranchial plate	Absent	Absent	Present	Absent
Parietal bones meet along midline	Yes	Yes	Yes	No: narrowly separated
Postorbitals in contact with preopercle	Yes	Yes	Yes	No
Parr marks	Absent	Absent	Present in some	Absent
Flaps between nostrils	2	2	1	2
Mouth size	Small	Moderately large	Small	Large
Teeth	Weak or none	Weak or none	Weak or none	Many, small
Mouth position	Subterminal	Superior or terminal	Subterminal	Terminal
Vomer	Small, toothed in some	Small, toothed in some	Small, toothless	Large, toothed
First supraorbital	Moderate	Moderate	Short	Long
Supraethmoid	Short	Short	Long	Short

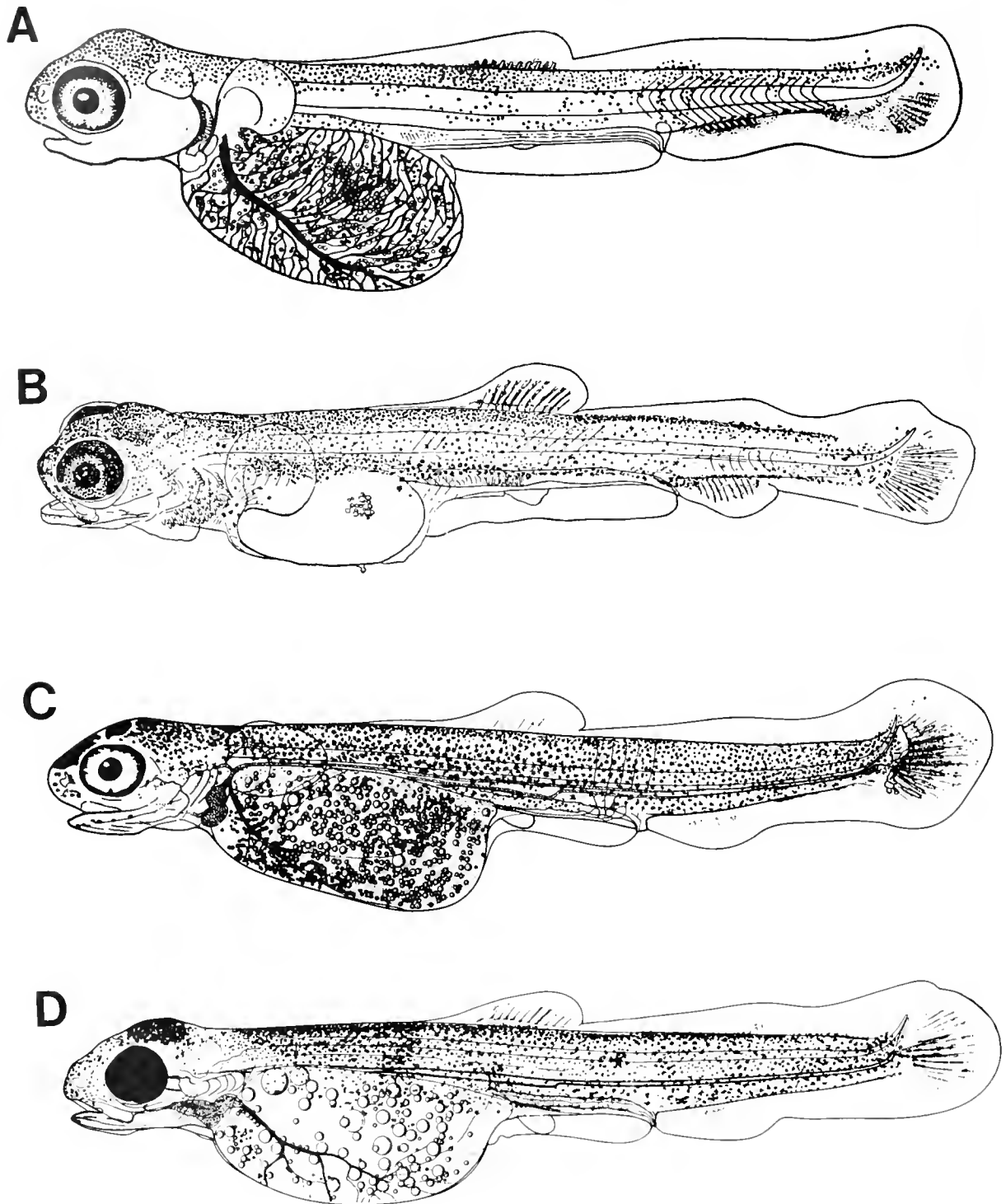
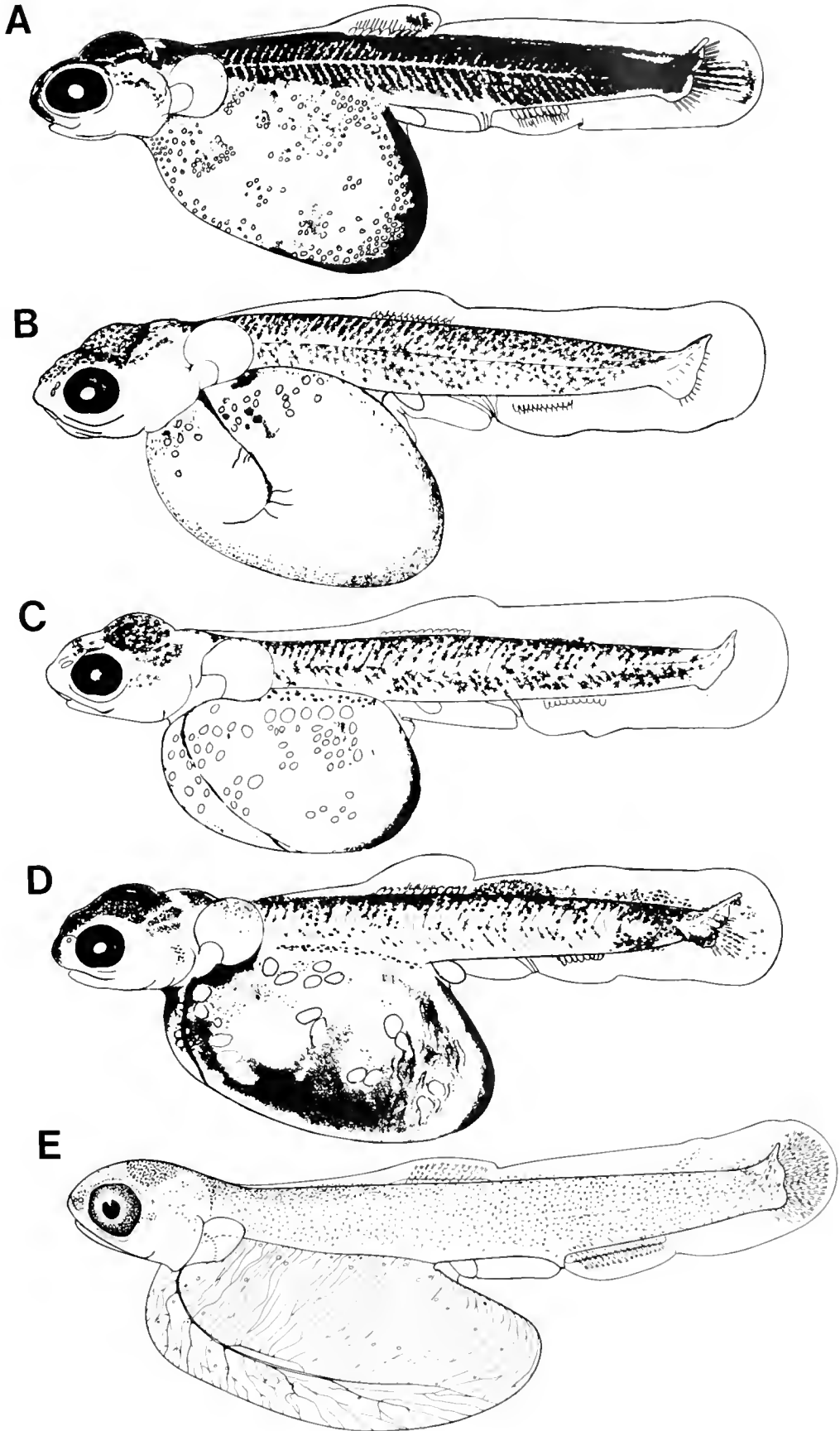

Fig. 76. Flexion stage larvae of: (A) *Brachymystax lenox* (17.2 mm); (B) *Hucho (Hucho) hucho* (20.8 mm); (C) *Salvelinus (Salvelinus) alpinus* (19.8 mm); (D) *Salvelinus (Cristivomer) namaycush* (approx. 20.4 mm). A from Smol'yanov (1961), B from Balon (1956), C and D from Balon (1980).

Fig. 77. Flexion stage larvae of: (A) *Salvelinus (Baione) fontinalis* (14.0 mm); (B) *Parasalmo gairdneri* (14.0 mm); (C) *Parasalmo clarki* (14.2 mm); (D) *Salmo trutta* (14.0 mm); (E) *Oncorhynchus tshawytscha* (25.0 mm). A–D from Martinez (1983), E original.



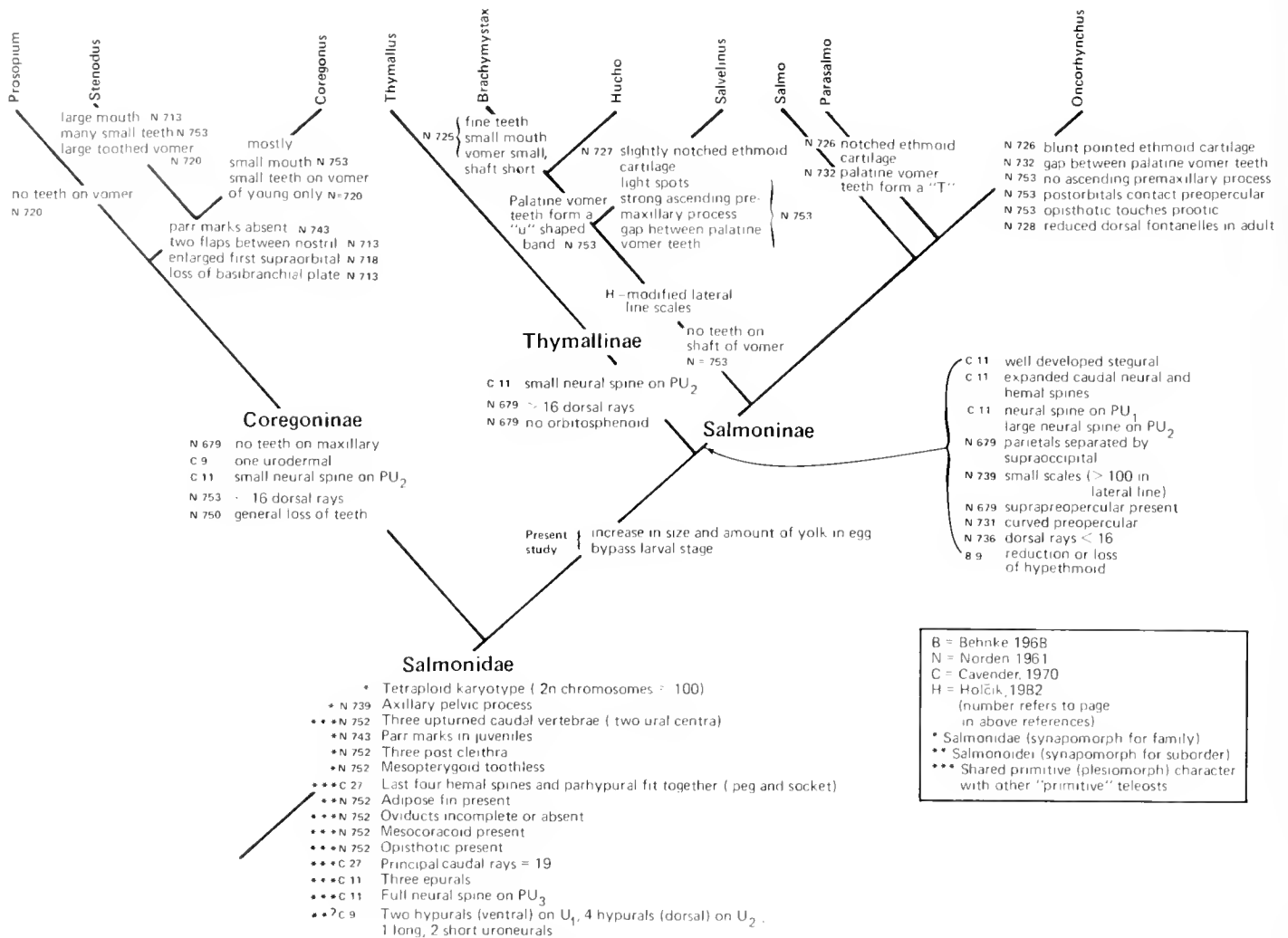

Fig. 78. Hypothesis of relationships among extant salmonid genera. Groupings and branching points are based largely on a consensus of recent literature and are not the result of a strict cladistic analysis.

possessed by salmonids include lack of oviducts, presence of abdominal pores, and three upturned caudal vertebrae supporting the hypurals. Salmonids are autapomorphic with about twice the DNA content of other "salmoniform" families, apparently the result of having a common tetraploid ancestor. The salmonids possess an adipose fin, a mesocoracoid, pyloric caeca, and the vestige of a spiral valve intestine. The gill membranes extend far forward free from the isthmus and there is a pelvic axillary process. Two shared derived features of the salmonids and neoteleostei are: 1) the articulation of both the basioccipital and exoccipital with the first vertebra, and 2) the presence of a medial cartilage between the ethmoid and premaxilla (Fink and Weitzman, 1982).

Although it is not possible at present to perform a meaningful cladistic analysis of the salmonids, some evidence is available in the literature which can contribute to such an analysis (Fig. 78). Cavender (1970) compared the osteology of leptolepids, extinct fish thought to represent the basal teleost condition, with that of the salmonids. He found several characters that indicated 1) that the salmonids are monophyletic, and 2) how the three subfamilies of salmonids are interrelated. The coregonines ap-

peared to be most similar to the leptolepids, the thymallines more derived than the coregonines, and the salmonines more derived than the thymallines. Reshetnikov (1975), on the basis of several types of characters, suggested elevating the subfamilies to familial status.

Coregoninae contains about 30 species in three genera. They are mainly freshwater, and produce rather small eggs, compared to those of the other two subfamilies. They share several advanced characters with the other subfamilies, indicating that salmonids are monophyletic, but lack a number of advanced character states possessed by the other two subfamilies, as these branched off after the coregonines. Within the coregonines, *Prosopium* seems least diverged (Table 34). *Stenodus* shows several, possibly secondarily derived character states concordant with feeding on large active prey (expanded dentition, large mouth). *Coregonus*, which seems to be a sister group to *Stenodus*, is separated into two subgenera: *Leucichthys* with adaptations for plankton feeding, and *Coregonus* which are mainly benthic feeders.

Thymallinae contains one genus, *Thymallus*, with about four species in freshwater of the colder parts of the Northern Hemi-

TABLE 35. Characters that vary among the Salmonine Genera.

Characters	<i>Brachymystax</i>	<i>Hucho</i>	<i>Salvelinus</i>	<i>Salmo</i> ¹	<i>Parasalmo</i> ¹	<i>Oncorhynchus</i> ¹
Subgenera		<i>Hucho</i> , <i>Para-hucho</i>	<i>Salvelinus</i> , <i>Baione</i> , <i>Cristivomer</i>	<i>Salmo</i> , <i>Salmothymus</i> , <i>Acantholingua</i> , <i>Platysalmo</i>		
Species	2	3-5	8	8	5	6
Habitat	freshwater	freshwater and anadromous	freshwater and anadromous	freshwater and anadromous	freshwater and anadromous	usually anadromous
Mouth size	small	large	large	large	large	large
Teeth on shaft of vomer	no	no	no	yes	yes	yes
Palatine-vomerine teeth	U-shaped band	U-shaped band	teeth narrowly separated	teeth narrowly separated	teeth narrowly separated	teeth widely separated
Postorbitals contact preopercle	no	no	no	no	no	yes
Supraethmoid shape	long, with numerous posterior projections	broad, with numerous short posterior projections	long, with numerous posterior projections	notched posteriorly	notched posteriorly	deeply notched posteriorly
Ascending premaxillary process	intermediate sized	intermediate sized	extended and well developed	intermediate sized	intermediate sized	none
Opisthotic touches prootic	no	no	no	no	no	yes
Dorsal fontanelles	persistent	persistent	persistent	persistent	persistent	reduced in adult ²
Egg size	4-5 mm	large	4-5 mm	5-7 mm	large	large
Diploid chromosomes	92	84	78-84	56, 80-82 ³	56-70	52-74
Dark spots-light background	yes	yes	no	yes ⁴	yes	yes

¹ There is lack of agreement on the relationships between these taxa, e.g., some consider *Parasalmo* a subgenus in *Salmo*, while others would also consider *Oncorhynchus* a subgenus of *Salmo*.

² Retained in *O. masou*.

³ *Salmo salar* has 56-60 diploid chromosomes.

⁴ *Salmo marmoratus* and *S. platycephalus* have no dark spots.

sphere. They have several character states that seem advanced over those seen in coregonines. They are moderate-sized, generalized insectivores (Table 32).

Salmoninae contains four to six genera, depending on opinions over the relationships among the species in *Salmo*, *Parasalmo*, and *Oncorhynchus* (Table 35). These seem to be the most advanced of the salmonids, and share several character states that are derived compared to the other two subfamilies (Table 35). Holcik (1982) presented evidence which suggests that the genera *Hucho*, *Brachymystax*, and *Salvelinus* form one lineage; *Parasalmo* and *Salmo* another; and *Oncorhynchus* a third. Salmonines are mainly active predators and most tend toward an anadromous life history.

Early life history and developmental information should contribute to the rigorous analysis of characters that will be required

to validate the foregoing hypotheses about relationships. Such information is not presently available in the literature, but should be readily obtainable, since so many of these fishes are routinely reared in laboratories and hatcheries. Developmental information seems particularly promising in this family, since a wide range of the life history patterns are present and larvae can be superficially grouped according to their representative subfamilies.

(A.W.K.) NORTHWEST AND ALASKA FISHERIES CENTER, 2725 MONTLAKE BLVD. E., SEATTLE, WASHINGTON 98112 AND (R.J.B.) DEPARTMENT OF FISHERY AND WILDLIFE BIOLOGY, COLORADO STATE UNIVERSITY, FORT COLLINS, COLORADO 80523.

Southern Hemisphere Freshwater Salmoniforms: Development and Relationships

R. M. McDOWALL

SEVERAL family-level groups of diadromous salmoniform fishes are found in cool-temperate southern hemisphere fresh waters, forming an obvious ecological counterpart to the northern cool-temperate Salmonidae, Osmeridae, Plecoglossidae, Salangidae, etc. With the exception of a single species, in a high elevation lake in New Caledonia, they are all south of about latitude 28°S. They occupy all of the main land masses (Australia, New Zealand, South America, South Africa) and some of the more distant southern islands (Lord Howe, Chatham, Aucklands, Campbell, Falklands). Diagnostic familial and generic characters are listed in Table 36.

Familial arrangement of these fish varies from including all in a single purportedly monophyletic family Galaxiidae (Nelson, 1972), through two families in separate sub-orders (Rosen, 1974) to four families in one or two suborders. There are two obvious and widely accepted familial groupings: Galaxiidae—Aplochitonidae and Retropinnidae—Prototroctidae (McDowall, 1969). The most recent view (Fink and Weitzman, 1982) suggests that these four family level taxa are possibly all of osmeroid derivation agreeing with my own evaluation (McDowall, 1969), and in contrast with Rosen (1974—he links galaxiids and aplochitonids with salmonoids; retropinnids and prototroctids with osmeroids). The southern taxa are all clearly primitive protacanthopterygians of salmoniform type. Beyond that little can be said other than that a further search of additional character complexes is needed to clarify relationships.

Within-family relationships are little studied. Three of the southern families (Retropinnidae, Prototroctidae, Aplochitonidae) can be dealt with more simply than the fourth (Galaxiidae).

Retropinnidae (Australia and New Zealand—see McDowall, 1979).—Four species in two genera: Present state of knowledge does not permit explicit recognition of affinities. Elongation of the alveolar process in the premaxilla of *Stokellia anisodon* is an advanced character which leaves three species of *Retropinna* with the primitive condition (alveolar process short, maxilla sometimes toothed). *Stokellia* also has unossified gill rakers (an “advanced” but “loss” condition) and high scale count (100 compared with 70 or less in *Retropinna*—which is the derived condition?)

Prototroctidae (Australia and New Zealand—see McDowall, 1976).—Two species in one genus. Two congeneric species pose no phylogenetic problems. The only significant question to ask is “How do these species relate to the Retropinnidae?” Answers to this question have not yet been sought.

Aplochitonidae (Tasmania and South America—see McDowall, 1971a).—Three (perhaps four) species in two genera. Monophyly of the Aplochitonidae (*Aplochiton* and *Lovettia*) should not be assumed. Inclusion of *Lovettia* in the *Galaxias-Aplochiton* assemblage is supported by characters in Table 36 but *Lovettia* has such reduced osteology that a search for characters

in other structural systems is needed before its relationships can be clarified. Inclusion of *Lovettia* in the Aplochitonidae is based, in part, on history (it has always been there!) and in part, on the fact that it is a “galaxioid” with the dorsal fin over the pelvics and an adipose fin present (like *Aplochiton* and unlike *Galaxias*).

Galaxiidae (Australia, New Caledonia, Lord Howe, New Zealand, South America, South Africa).—Six genera with 37 species distributed as follows: *Galaxias*, 24—all areas but New Caledonia; *Paragalaxias*, 4—Tasmania; *Neochanna*, 3—New Zealand; *Galaxiella*, 3—Australia; *Brachygalaxias*, 2—South America; *Nesogalaxias*, 1—New Caledonia. This larger and more complex family offers scope for phylogenetic analysis that has had little attention.

RELATIONSHIPS

Previous studies of within-family relationships have been based on morphological similarity (McDowall, 1970), phenetics based on muscle myogens (Mitchell and Scott, 1979), or dendrograms derived from cluster analysis of morphometric or meristic data (Campos, 1979). Johnson et al. (1981, 1983) have sought to establish relationship on the basis of karyotypes and multivariate analysis of morphometric and meristic characters in the diverse Tasmanian fauna.

The only attempt at a “strictly phylogenetic” interpretation of within-family relationships, by Rosen (1978), was based on misinterpretation of character states and a limited perception of variation in the family, and achieved nothing (McDowall, 1980). A broad and strictly phylogenetic analysis of galaxiid inter-relationships is not yet available and probably depends on examination of additional character complexes.

On the basis of out-group comparisons (all salmonoid—osmeroid—galaxioid families have members that are diadromous) it is my view that diadromy in the Galaxiidae is a primitive character. It is represented in at least six species.

Diadromous species tend to be large and generalised in character, but with specific adaptations to habitats occupied during freshwater life. Vertebral numbers are high (>60) and ray counts in pelvic (7) and caudal (16) fins very stable.

There are indications of close relationships with diadromous stocks, e.g., *Galaxias maculatus* seems likely to be a neotenus derivative of some other diadromous galaxiid; distinctive juvenile colour patterns may relate *G. argenteus* to *G. fasciatus* and perhaps *G. truttaceus*.

There are numerous landlocked populations of diadromous species, and present interpretations are that several species are derived by isolation following landlocking, e.g., *G. auratus* (landlocked) derived from *G. truttaceus* (diadromous) in Tasmania; *G. gracilis* from *G. maculatus* in New Zealand.

Wholly freshwater species tend to be the more specialised members, in which there is often dwarfing, reduced vertebral counts, greater meristic instability, as well as the loss of the distinctive marine juvenile stage. Some freshwater groups have

not yet recognised origins within the diadromous stocks and there is identifiable speciation related to known geo-tectonic events. The relationships of some of the more distinctive species groups—*Neochanna* (New Zealand), *Galaxiella* (Australia), and including geographical outliers like *Galaxias zebratus* (South Africa) and *Nesogalaxias neocaledonicus* (New Caledonia)—remain obscure. Previous inclusion of Australian and South American species in *Brachygalaxias* is ill-founded, on present data, and confuses the understanding of relationships.

An interesting phylogenetic problem in the Galaxiidae involves the diminutive Tasmanian *Paragalaxias*, with four species in high elevation lakes that probably pre-date Pleistocene glaciations. *Paragalaxias* is distinctive in having the dorsal fin origin only a little behind the pelvic bases. In this regard it resembles aplochitonids differing from all other galaxiids in which the dorsal origin is close to the level of the vent/anal origin. Thus is *Paragalaxias* a galaxiid in which the dorsal fin has migrated forwards, the resemblance to *Aplochiton* being convergent or is it an aplochitonid in which the anterior dorsal fin position is primitive but in which the adipose fin has been lost? Examination of additional character complexes in which galaxiids and aplochitonids differ is needed to clarify this question.

The preceding discussion makes it evident that relationships between and within the southern diadromous salmoniforms remain in need of clarification. Only the Galaxiidae is large and diverse enough to provide fertile ground for a study of within-family phylogeny. In all the families, species and characters are conservative in nature and lack distinctive or extreme specialisation. Inter-specific differences tend to be expressed as changes in meristic characters (like vertebral and fin ray counts), often to presence/absence character states (pyloric caeca, canine teeth) and sometimes to distinctive and stable differences in colour patterning. There are few readily evident characters that are indicative of major phyletic lineages. Possibly investigation of laterosensory papillary rows will be informative. At present, establishment of phylogenies appears difficult. A study of relationships using DNA hybridisation techniques (Sibley and Ahlquist, 1981) is at present in early planning stages.

LIFE HISTORY PATTERNS AND REPRODUCTION

In general life history patterns are understood although details are sparse. There are broad similarities in patterns.

Retropinnidae.—Aspects of early life history have been described by Milward (1966—*Retropinna semoni*—Australia), Jolly (1967—*R. retropinna*—N.Z.) and McMillan (1961—*Stokellia anisodon*—N.Z.). The eggs are tiny—0.5 to 0.6 mm in lacustrine *R. retropinna*, 0.95 mm in *R. semoni*. They are demersal and adhesive, spherical, without distinctive features. They are a pale straw colour. They are deposited on sandy bottoms in lower river reaches or estuaries (around lake shores in land-locked populations), where development occurs; development is relatively slow (10–20 days) and description of development shows nothing distinctive (Fig. 79). Newly hatched larvae in some species go to sea. In others they are lacustrine or riverine. Larvae at hatching are small (2–5 mm), very slender and elongated, the yolk sac with a single oil globule, and situated anteriorly beneath the opercular openings/pectoral fins. The gut is long, the vent at about 70% of length. A continuous finfold encompasses the trunk. Pectoral fin buds are present. Newly hatched larvae are positively phototropic. Pigmentation and later development are undescribed. Juveniles from a summer-

TABLE 36. CHARACTER STATES IN PRINCIPAL GENERA OF SOUTHERN FRESHWATER SALMONIFORMS. (* except *Paragalaxias*; + present, – absent; u uniserial; m multiserial; 1 parhypural + hypurals; 2 tubercles in *Lovettia* may not be comparable with others). Figures are "usual" although variants are known. The divergent galaxiid genera are excluded (*Paragalaxias*, *Galaxiella*, *Neochanna*, etc.).

Characters	Galaxiidae	Aplochitonidae		Proto-troctidae	Retropinnidae
	<i>Galaxias</i>	<i>Aplochiton</i>	<i>Lovettia</i>	<i>Proto-troctes</i>	<i>Retropinna</i>
Dorsal fin					
Over pelvics		x	x	x	x
Over anal	x*				x
Adipose	–	+	+	+	+
Scales	–	–	–	+	+
Horny keel	–	–	–	+	+
Cucumber odour	–	–	–	+	+
Pyloric caeca	+	+	+	–	–
Vomerine shaft	long	–	long	short	short
Vomerine teeth	–	–	–	+	+
Basibranchial teeth	–	–	–	+	+
Palatine teeth	–	–	–	+	+
Mesopterygoidal teeth	u	u	u	m	m
Extrascapular	–	–	–	+	+
Ectopterygoid	–	slender splint	–	+	+
Coracoid-cleithrum process	–	–	–	+	+
Posterior pubic symphysis	–	–	–	+	+
Pubic foramen	–	–	–	+	+
Caudal skeleton	1 + 5	1 + 5	1 + 5	1 + 6	1 + 6
Branched caudal rays	14	14	14	16	16
Nuptial tubercles	–	–	+	+	+
Ovaries	both	both	both	left	left

autumn spawning may return to fresh water the following spring and are transparent and elongate; mostly mature adults return one year later (age about 2 years) to spawn and die (see Jolly, 1967; McMillan, 1961; Milward, 1966).

Prototroctidae.—Little is known of this family, with one species extinct the other rare. McDowall (1976) and Berra (1982) have described what is known of life histories. The eggs are small (≈ 1 mm) round and demersal, and are probably deposited in upstream fresh waters. The larvae are not known but believed to be carried to estuaries or the sea to develop, probably for about six months, and return to freshwater in spring as slender transparent juveniles (Fig. 80).

Aplochitonidae.—In *Lovettia*, mature adults migrate from the sea in spring to spawn in fresh water, and are strongly dimorphic. The male's reproductive opening migrates forward to the isthmus and the opercular flaps become elongated and papillated. Fecundity is very low (≈ 150 –200). The tiny eggs (≈ 1 mm) are demersal and spherical, and are attached in clusters to hard surfaces (logs, stones, etc.) taking up to 23 days to hatch, and the larvae drift downstream to sea. The post spawning adults die. The life cycle is essentially annual. Larvae at hatching are



Fig. 79. Young of *Retropinna retropinna*, 35 mm (above); and *Aplochiton* sp., 24 mm (below).

5–7 mm long with little yolk anteriorly below pectoral fins. They are very elongate, the vent posterior at more than 75% body length, the trunk encompassed by a low finfold from head around tail to yolk sac. Small pedunculate pectoral fins occur. Pigmentation is confined to the eyes and a narrow band in mid-ventral between head and vent. Newly hatched larvae disperse to sea and are not further studied (see Blackburn, 1950).

Aplochiton taeniatus is recorded spawning in fresh water during winter, the small (1.5 mm), spherical eggs being demersal and attached to firm benthic objects, fecundity 2,500–3,000 and development about 20 days. The larvae are very elongate and

slender with a yolk sac beneath the pectoral fins. The vent is at about 75% of body length. A finfold encompasses the trunk and tail. Campos (1969) shows a single large melanophore just in front of the vent. His figure of a larva presumably 8 mm long (he states 80 mm) shows a series of melanophores along the abdomen and a few on the lower caudal peduncle. Recent collections of larval *Aplochiton* from Fiordo Aisen in southern Chile show that some movement to sea occurs. At a length of 24 mm the late larva has well differentiated rays in the dorsal, caudal, anal and pectoral fins and distinct pelvic fin buds are evident (Fig. 79). An adipose fin is also differentiated. Pigmen-

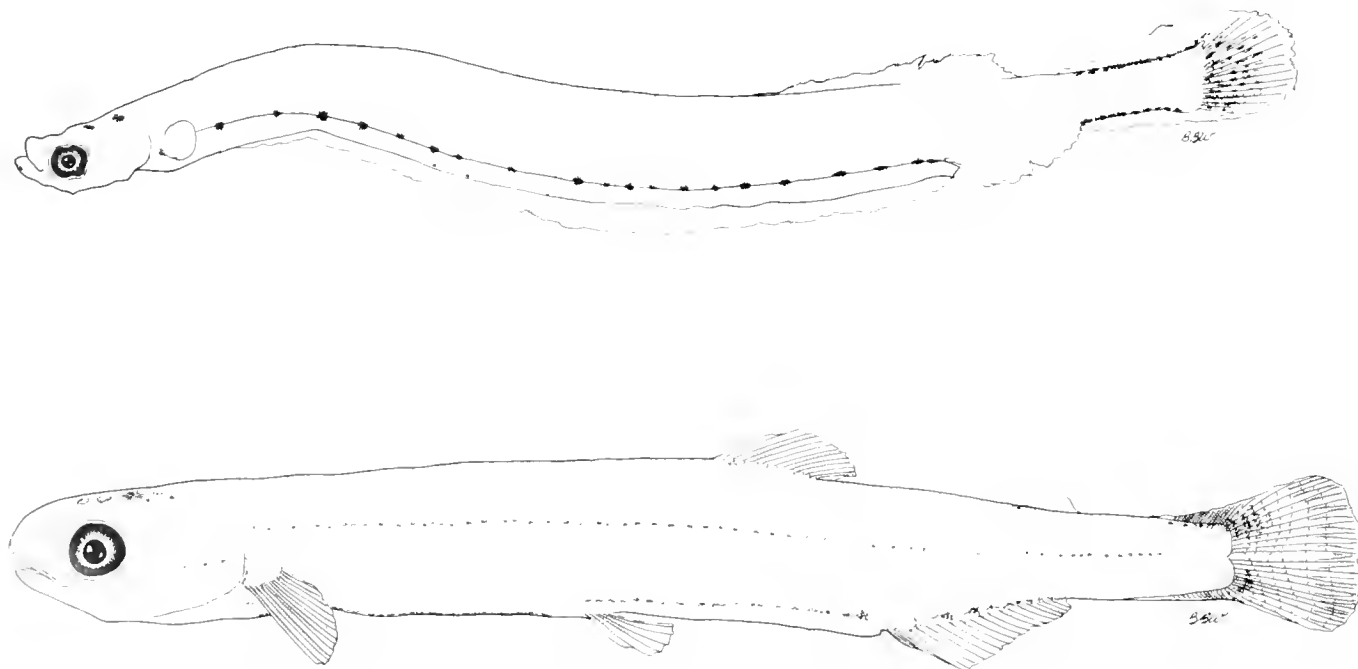

Fig. 80. Young of *Galaxias maculatus*, 14.5 mm (above); and *Prototroctes maraena* 35 mm (below).

tation is sparse, limited to spaced melanophores along the abdomen. The larva remains very elongate, the vent at about 85% of total length. Eigenmann (1928) reported that *A. marinus* (= *A. taeniatus*) spawns in the sea but this has never been corroborated (see Campos, 1969).

Galaxiidae. — Diadromous species: Spawning is usually in freshwater. Eggs of *Galaxias fasciatus* are deposited in autumn–winter on stream-side forest debris during floods and develop out of water, hatching when re-immersed during a subsequent flood. The larvae go to sea on hatching, returning in spring as elongate, transparent juveniles about 45 mm long. A minor metamorphosis involves shrinkage at freshwater entry. The eggs are of moderate size (≈ 2 mm) and number many thousands; development takes about 30 days. Most other diadromous species have unobserved habits. *G. maculatus* spawns in tidal estuaries where streamside vegetation is inundated at high spring tides and development takes place between successive series of spring tides. Most adults die after spawning and larval life is marine. The eggs are simple, spherical, demersal and adhesive, varying from 1–2 mm diameter and more or less colourless. Benzie (1968a) described eggs of *G. maculatus* as “finely etched.” Larvae at hatching have a well developed yolk sac, with a single oil globule, the sac below and behind the pectoral fins. The larvae are slender and elongate at hatching, 7–8 mm long, and have the finfold continuous from about mid dorsal around tail to yolk sac. The vent is posterior, at about 75% of total length.

Non-diadromous species: Most species in the family are non-diadromous (31 of 37 species). Those known spawn on substrates near adult habitats and the pelagic “whitebait” juvenile stage is omitted. Eggs are laid in aggregations (*G. vulgaris*). Larvae on hatching, where described, resemble those of *G. maculatus*.

Galaxiella pusilla is distinctive in being sexually dimorphic, spawning in pairs, the females laying eggs individually on stream vegetation. Individual placement of eggs is also reported for

Brachygalaxias bullocki. The ability to aestivate is recorded for some species (*Neochanna*, New Zealand) and spawning follows restoration of water. It is suspected in others (*Galaxiella*, Australia; *Brachygalaxias*, Chile) and may involve drought survival of eggs (see Benzie, 1968a, b; Backhouse and Vanner, 1978; Cadwallader, 1976; Campos, 1972; McDowall 1968b, 1978; McDowall et al., 1975; Mitchell and Penlington, 1982).

Little is known about the marine larval/juvenile life of any of these southern salmoniforms. Small numbers of *Galaxias* larvae (Fig. 80) have been collected at sea (McDowall et al., 1975), as have a few, usually pre-migratory *Retropinna*. The presence of a pelagic-living, transparent, elongate, migratory juvenile seems to be common to most species that are marine or lacustrine at some stage—*Galaxias*, *Retropinna*, *Prototroctes*, *Aplochiton*. This is likely to have little phylogenetic significance but to relate more to their pelagic, oceanic habits. These small fish resemble many other unrelated fish with pelagic juveniles. The marine, pelagic phase is followed in all instances by a minor metamorphosis on entry to fresh water. Principally this involves rapid assumption of pigmentation and in some species a distinct change in body form. Shrinkage is recorded in a few species.

Identification of oceanic larvae and juveniles to family is assisted by dorsal fin position and the early development of an adipose fin in all but galaxiids. The elongate form with the vent at about 75% of total length is helpful. Differences have been recorded in pigment patterns between some of the diadromous galaxiid juveniles although insufficiently to use as diagnostic differences (McDowall and Eldon, 1980). Meristic differences between species are of little value for specific identification owing to their wide ranges and latitudinal variability. Identification remains a difficulty and improvement will depend on the capture and examination of additional material.

FISHERIES RESEARCH DIVISION, MINISTRY OF AGRICULTURE AND FISHERIES, CHRISTCHURCH, NEW ZEALAND.

Osmeridae: Development and Relationships

M. E. HEARNE

OSMERIDAE, the true smelts, are a small family of northern hemisphere salmoniform fishes. The family includes 2 subfamilies, 6 genera, 10 species, and 13 forms (monotypic and subspecies). They have marine, anadromous or landlocked and freshwater life histories in the Pacific, Arctic and Atlantic oceans and their drainages (McAllister, 1963). These silvery tasty little fishes are captured by both recreational and commercial pursuits along the open coast beaches and rivers during their spawning runs.

DEVELOPMENT

The smelts are highly selective spawners, choosing to spawn on very specific sub-tidal areas, beaches and rivers. Some species

spawn in the daytime, and some spawn at night. The eggs of osmerids possess an adhesive membrane that attaches to sand grains and plant material. This anchor membrane results from the rupturing of an outer “chorion” during spawning, which turns out and onto the substrate. This adaptation for demersal spawning is observed in all 10 species of osmerids (Hamanda, 1961; Thompson et al., 1936; Morris, 1951; McAllister, 1963; Simonsen, 1978; DeLacy and Batts, 1963; Hearne, 1983).

The first description of smelt development was made by Ehrenbaum (1894) for the Elbe River smelt, *Osmerus eperlans* illustrating embryological stages, yolk-sac larva, transforming larva, and the juvenile. Up to now, the yolk-sac stage of many of these species has been at least illustrated or photographed.

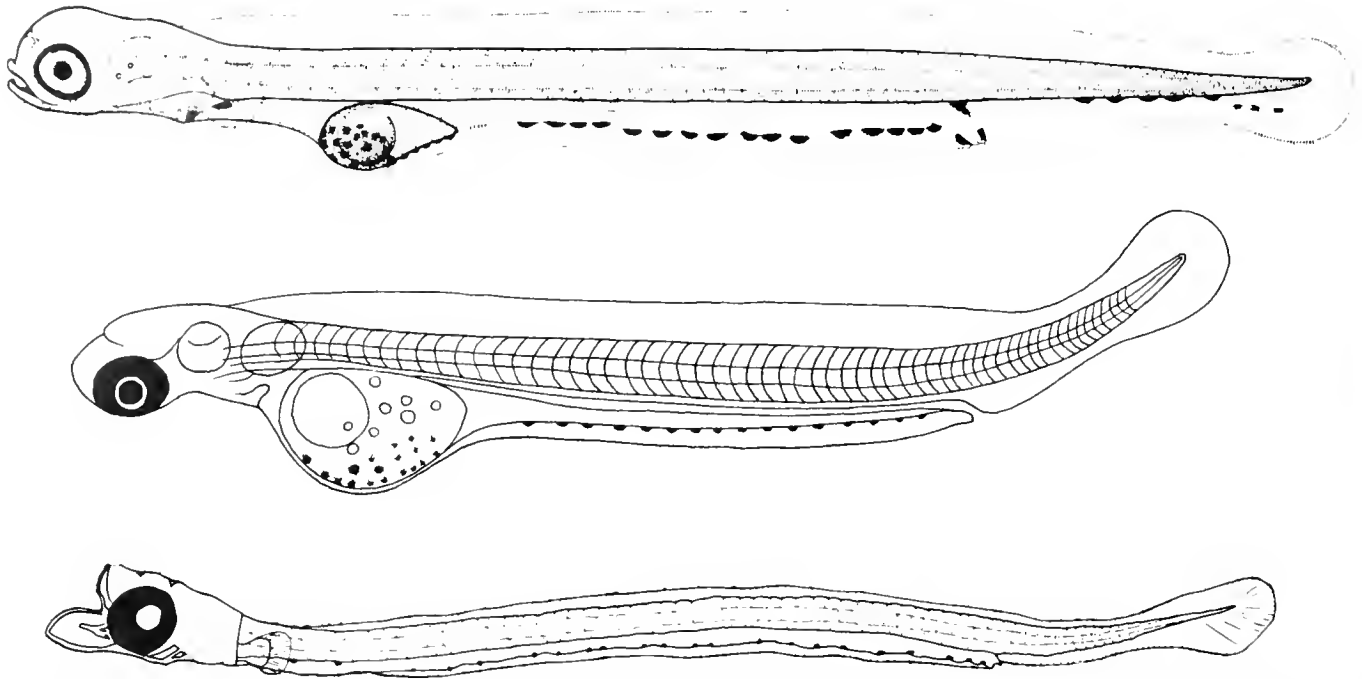

Fig. 81. (A) Yolk-sac larvae of *Spirinchus starksi*, Osmeridae, 7.4 mm, from Morris (1951); (B) Yolk-sac larvae of *Plecoglossus altivelis*, Plecoglossidae, ca. 6.0 mm, from Okada (1960); (C) Post yolk-sac larva of *Salangichthys microdon* (Salangidae), ca. 7.0 mm, drawn from two specimens in CAS 50415.

Ahlstrom (pers. comm.) determined that, in general, osmerid larvae were unique from other elongate larvae in the California Current system by having a single mid-ventral row of melanophores below the gut. Based on all the available larval descriptions for osmerids, including the Atlantic forms, this single row of melanophores appears to be a hallmark of the family. Listed in Table 37 are sources of larval and juvenile descriptions for the ten species of smelts.

These descriptions use various characteristics for each species and are not comparative in design. Melanophore counts are referred to by Yapchionges (1949), Follett (1952), Simonsen (1978), Morris (1951), Dryfoos (1965) and Moulton (1970). Myomere counts were used by Delacy and Batts (1963). Cooper (1978) and Morris (1951) used both myomere and melanophore counts.

Larval osmerids have the following external features in common: elongate body shape; gut about 75% body length; mouth sub-terminal; head dorso-ventrally flattened; lower jaw not well-developed in early larvae; conspicuous choroid fissure in ventral third of eye with ventral rim of clear choroid tissue; stalked pectorals, stalk becoming more pronounced in late larvae; yolk sac positioned 6–12 myomeres posterior to the pectoral base; finfold extending from midbrain area to tail, from mid-yolk sac to anus, and from anus to tail; no dorsal melanophores; scattered melanophores (20–50) on ventral half of yolk sac; 0–2 melanophores on posterior ventral half of yolk sac; single row of melanophores along ventral midline of gut, sometimes extending into finfold; 1–3 melanophores on dorsal surface of gut at the anal bend; single row of melanophores on ventral midline of tail; conspicuous opaque liver ventral to foregut (Ehrenbaum, 1894; Yapchionges, 1949; Morris, 1951; DeLacy and Batts 1963;

Dryfoos, 1965; Eldridge, 1970; Blackburn, 1973; Cooper, 1978; Hearne, 1983).

A comparative study of four of the species off Oregon (Hearne, 1983) used ventral melanophore counts and myomere counts in an attempt to characterize the larvae of these species. Tendencies in these counts showed *Hypomesus pretiosus* and *Spirinchus starksi* to have high ventral melanophore counts while *Spirinchus thaleichthys* and *Thaleichthys pacificus* have lower melanophore counts. Myomere counts showed tendencies that further separated each similarly pigmented pair.

TABLE 37. Sources of Larval and Juvenile Descriptions of Smelts. (x = no description found.)

Taxon	Larvae	Juveniles
<i>Hypomesus pretiosus</i>	Yapchionges, 1949	Follett, 1952
<i>Hypomesus transpacificus</i>	x	Simonsen, 1978
<i>Spirinchus lanceolatus</i>	Hikita, 1958	Hikita, 1958
<i>Spirinchus starksi</i>	Morris, 1951	Hearne, 1983
<i>Spirinchus thaleichthys</i>	Dryfoos, 1965; Moulton, 1970	Simonsen, 1978
<i>Thaleichthys pacificus</i>	DeLacy and Batts, 1963	Baraclough, 1964
<i>Allosmerus elongatus</i>	x	Hearne, 1983
<i>Mallotus villosus</i>	Schmidt, 1906c	Templeman, 1948
<i>Osmerus mordax</i>	Cooper, 1978	Cooper, 1978
<i>Osmerus eperlanus</i>	Ehrenbaum, 1894	Ehrenbaum, 1894

The transformational stages of osmerids are not fully known, since complete developmental series have not been reported for all of the species. However, it is apparent from rearing studies (Morris, 1951; Cooper, 1978) that caudal flexion occurs after yolk absorption and along with median fin formation. The pelvic fins arise from the ventral body musculature as prominent buds after the median fin rays have formed, and appear stalked, becoming inserted as the ventral musculature joins ventrally. The pectoral fins are present at hatching and remain pedunculate until postflexion stages acquire adult-like pigmentation.

During flexion an additional series of melanophores forms along the ventro-lateral edge of the body musculature and appears as a double row of spots from ventral view. There are also count differences between the species in these secondary melanophores (Hearne, 1983), and they may aid in identification of flexion and postflexion stages.

The postflexion stages of two species of osmerids have been erroneously described as new species belonging to other families by Chapman (1939). Hubbs (1951) has shown that one of these smelts, placed in the family Paralepididae as *Lestidium parri*, is actually a late postflexion stage of *Thaleichthys pacificus*, and the other one, placed in the family Sudidae as *Sudis squamosa*, is a postflexion *Mallotus villosus*. The blackened gut cavities of the postflexion stages of these two species, lend a distinct resemblance to the midwater-inhabiting sudids and paralepidids, and also suggest a unique departure from the developmental trend of the other species that may warrant the use of the term "pre-juvenile" as defined by Hubbs (1943).

RELATIONSHIPS

In a recent statement on classification, Rosen (1974) proposed an infraorder Salmonae to include two suborders, the Argentinoidi and Salmonoidi, the Osmeridae being placed in the latter under the superfamily Osmeroidea (with the Plecoglossidae, Retropinnidae, and Salangidae). On the basis of embryological and larval features, Soin (1980) characterized different types of salmoniform fishes. He placed the Plecoglossidae and Osmeridae in the same category based on similar egg morphology (presence of an anchor membrane), degree of development at time of hatching and at time of yolk absorption. In a study of stomiiform fishes using adult characters, Fink and

Weitzman (1982) placed the families Osmeridae, Salangidae, Plecoglossidae, Retropinnidae, and Galaxiidae all together as "unresolved sister taxa."

The larvae of osmerids (*Spirinchus starksi*, Fig. 81A) are strikingly similar to larval plecoglossids (*Plecoglossus altivelis*, Fig. 81B). The yolk sac of these two families is positioned such that its posterior edge is near myomere 11-12. The plecoglossids also have a single median ventral row of melanophores and, as development proceeds, another latero-ventral row of spots appears along the ventral edge of the body musculature, just as in osmerid development.

Photographs of the yolk-sac stage of *Salangichthys microdon*, Salangidae, (Okada, 1960: pl. 17) show that the yolk-sac morphology is different than in the Osmeridae and Plecoglossidae. The yolk sac of *Salangichthys microdon* is co-extensive with the undersurface of the gut and is more oblong shaped (pyriform) than the more rounded, anteriorly placed yolk sac of the osmerids and plecoglossids. The post yolk-sac larvae of salangids (Fig. 81C) are nearly identical to those of osmerids and plecoglossids, exhibiting the single median ventral row of melanophores. Also, the eggs of salangids are different than the osmerid-plecoglossid type by having, instead of an anchor membrane, an anchoring structure that is composed of various kinds of filaments that turn out and onto the substrate (Wakiya and Takahashi, 1913). Larval development is not yet documented for the Sundasalangidae, however adults of this minute family of salangoid fishes have ventral pigment patterns (Roberts 1981: fig. 1) that are strikingly similar to the postflexion pigment patterns of osmerids. The same ventral pigment patterns (single ventral midline, paired latero-ventral melanophores) can also be seen in adults of Salangidae (Okada, 1960).

One interpretation may be that the similarities in ventral pigment patterns and egg morphology may be the retention of a trait of an ancestor common to the Osmeridae, Plecoglossidae, and Salangidae, and give support to theories arising from systematic observations of adult salmonoids that these families are closely related to each other and not to the other salmoniform families.

184 DAY STREET, SAN FRANCISCO, CALIFORNIA 94131.

Argentinoidei: Development and Relationships

E. H. AHLSTROM, H. G. MOSER AND D. M. COHEN

THE argentinoid fishes as here discussed have been considered a suborder by Cohen (1964b) and many other authors and a super-family of an expanded suborder that also includes the alepocephaloids by Greenwood and Rosen (1971). The latter group is not treated at length in this book, because little information on alepocephaloid ELH stages has appeared since Beebe's (1933a) survey which showed they hatch from large eggs and have direct development. The argentinoids *sensu strictu* appear to be monophyletic on the basis of four derived characters. One character concerns the development of rays in the finfold of the

larva and is described later in this paper. A second character is the development of pustules on the inner surface of the chorion (not known for opisthoproctids). A third character relates to the swimbladder, which, when present, is served by a unique kind of rete mirabile, first described by Fange (1958) and further investigated by Marshall (1960) who named these structures micro-retia mirabilia. A fourth unique character, and one which never has been adequately studied and documented, is the tendency in the group for the vomer and palatines to assume the functions of the premaxillary and maxillary.

TABLE 38. LITERATURE REFERENCES FOR ONTOGENETIC STAGES OF ARGENTINOIDS.

Species	Egg	Larva	Transformation stage
Argentinidae			
<i>Argentina elongata</i>	Robertson, 1975a	—	—
<i>A. silus</i>	Schmidt, 1906c	Holt, 1898; Schmidt, 1906c	—
<i>A. sphyraena</i>	Sanzo, 1931d	Schmidt, 1906c; Sanzo, 1931d	Schmidt, 1906
<i>Glossanodon leoglossus</i>	Sanzo, 1931d	Schmidt, 1918; Sanzo, 1931d	Sanzo, 1931d
<i>G. polli</i>	—	—	Poll, 1953
<i>G. semifasciatus</i>	Nishimura, 1966	Nishimura, 1966	Nishimura, 1966
<i>Microstoma microstoma</i>	Sanzo, 1931d	Lo Bianco, 1903; Schmidt, 1918; Sanzo, 1931d	Schmidt, 1918
<i>Nansenia groenlandica</i>	—	Schmidt, 1918	Schmidt, 1918
<i>N. oblata</i>	Sanzo, 1931d	Schmidt, 1918; Sanzo, 1931d	Schmidt, 1918
<i>Xenophthalmichthys danae</i>	—	—	Bertelsen, 1958
Bathylagidae			
<i>Bathylagus antarcticus</i>	Yefremenko, 1982	Yefremenko, 1979a, 1983	—
<i>B. euryops</i>	—	Brauer, 1906; Täning, 1931	Täning, 1931
<i>B. longirostris</i>	—	Ehrenbaum, 1905–09; Murray and Hjort, 1912; Roule and Angel, 1930; Beebe, 1933b	Beebe, 1933b
<i>B. nigrigenys</i>	Pertseva-Ostroumova and Rass, 1973	Pertseva-Ostroumova and Rass, 1973	—
<i>B. ochotensis</i>	—	Ahlstrom, 1972b	Ahlstrom, 1972b
<i>B. schmidtii</i>	Ahlstrom, 1969	Dunn, 1983a	Dunn, 1983a
<i>B. stilbuis</i>	Ahlstrom, 1969	Ahlstrom, 1965, 1972b	—
<i>B. wesethi</i>	Ahlstrom, 1969	Ahlstrom, 1965, 1972b	—
Opisthoproctidae			
<i>Bathylchnops exilis</i>	—	—	Cohen, 1960
<i>Dolichopteryx</i> spp.	—	Roule and Angel, 1930	—
<i>Dolichopteryx longipes</i>	—	Beebe, 1933a	—
<i>Macropinna microstoma</i>	—	Chapman, 1939	—
<i>Opisthoproctus grimaldii</i>	—	Schmidt, 1918	—
<i>Rhynchohyalus natalensis</i>	—	Bertelsen et al., 1965	—
<i>Winteria telescopa</i>	—	Belyanina, 1982b	—

Although now there seems to be general agreement as to the genera to be included in the group, their internal arrangement is an unsettled matter. Opinions range from those of C. L. Hubbs (1953), who relegated all to a single family, to those of Chapman (1948 and papers cited therein), who advocated eight different families. Subsequently Cohen (1964b) classified the group in three families using inadequately evaluated characters.

Family Argentinidae (most genera are probably worldwide):

Subfamily Argentininae (benthopelagic, outer shelf to slope):

Argentina (12 species) and

Glossanodon (seven or more species).

Subfamily Microstomatinae (mesopelagic)¹:

Microstoma (one or two species),

Nansenia (13 species) and

Xenophthalmichthys (one or two species).

Family Bathylagidae (meso-to bathypelagic):

Bathylagus (including *Leuoglossus* and *Therobromus*; about a dozen to 15 species; several species in the Arctic and Antarctic).

Family Opisthoproctidae (mesopelagic):

Group I:

Macropinna (one species; restricted to N. Pacific and eastern S. Pacific),

Opisthoproctus (two species),

Rhynchohyalus (one species; Atlantic and Indian Oceans) and *Winteria* (one species).

Group II:

Bathylchnops (one or more species), and

Dolichopteryx (perhaps half a dozen species).

An alternate arrangement presented by Greenwood and Rosen (1971) and essentially based on inadequately evaluated characters in the branchial arches and caudal fin skeleton proposed two families within a superfamily Argentinoidea: Family Argentinidae and Family Bathylagidae with Subfamily Bathylaginae (including Microstomatidae) and Subfamily Opisthoproctinae.

Unanswered questions concerning the systematics of the group are numerous and exist at all levels. Following is a summary. (1) What are the external relationships of the argentinoids? (2) How many distinct lineages exist within the group, how should they best be arranged with respect to each other, and how many families should be recognized? (3) Do *Argentina* and *Glossanodon* constitute a monophyletic group? If not, where does each belong? (4) How many genera should be recognized among the bathylagids? (5) Within the opisthoproct group do the elongate species in the *Bathylchnops-Dolichopteryx* group and the short-bodied species in the *Opisthoproctus* group constitute monophyletic lineages and if so should they be named? (6) Since species complements of genera are inadequately known, espe-

¹ Herein considered a distinct family.

TABLE 39. CHARACTERS OF THE EGGS OF ARGENTINOIDEI.

Species	Diameter	Number of oil globules	Distribution of oil globules	Diameter of oil globules	Source
<i>Argentina sialis</i>	1.31-1.66	1	vegetal pole	0.27-0.46	Original
<i>Argentina silus</i>	3.0-3.5	1	vegetal pole	0.95-1.16	Schmidt, 1906c
<i>Argentina sphyraena</i> (Mediterranean)	1.60-1.68	1	vegetal pole	0.44	Sanzo, 1931d
(North Sea)	1.70-1.85	1	vegetal pole	0.37-0.47	Schmidt, 1906c
<i>Argentina elongata</i>	1.67-1.80	1	vegetal pole	0.35-0.45	Robertson, 1975a
<i>Glossanodon leioglossus</i>	1.44-1.52	1	vegetal pole	0.36	Sanzo, 1931d
<i>Glossanodon semifasciatus</i>	1.5-1.6	1	vegetal pole	0.36	Nishimura, 1966
<i>Microstoma microstoma</i> (Atlantic)	1.60-1.72	1	vegetal pole	0.48-0.52	Sanzo, 1931d
(Pacific)	2.05-2.38	1	vegetal pole	0.49-0.82	Original
<i>Nansenia candida</i>	1.39-1.56	1	vegetal pole	0.41-0.49	Original
<i>Nansenia crassa</i>	1.05-1.30	1	vegetal pole	0.30-0.35	Original
<i>Nansenia oblita</i>	1.39-1.56	1	vegetal pole	0.40-0.53	Sanzo, 1931d
<i>Bathylagus antarcticus</i>	1.8-2.2	3-8	*	0.2-0.3	Yefremenko, 1982
<i>Bathylagus schmidti</i>	1.65-1.90	up to 9	*		Ahlstrom, 1969
<i>Bathylagus stilbius</i>	1.01-1.21	15-25	*		Ahlstrom, 1969
<i>Bathylagus urotronus</i>	1.03-1.21	15-25	*		Pertseva-Ostroumova and Rass, 1973, and original
<i>Bathylagus ochotensis</i>	0.92-1.1	many to two clumps	**		Original
<i>Bathylagus wesethi</i>	0.90-1.10	12-20	**		Ahlstrom, 1969
<i>Bathylagus nigrigenys</i>	0.83-1.09	12-20	**		Pertseva-Ostroumova and Rass, 1973, and original

* First grouped at vegetal pole, then move to beneath embryo, then coalesce to one at each equatorial pole
 ** Numerous globules at vegetal pole then coalesce to one clump at each equatorial pole.

cially the mesopelagic ones, do presently available early life history specimens help define the species composition of argentinoid genera?

DEVELOPMENT

Eggs are known for 13 species of argentinoids and larvae for 22 species (Table 38). We present in this paper eggs of 5 additional argentinoid species and larvae of 8 additional species. These are: eggs and larvae of *Argentina sialis*, *Microstoma* sp., *Nansenia candida* and *N. crassa*; larvae only for *Bathylagus argyrogaster*, *B. bericoides*, *B. pacificus* and *Bathylagnops exilis*; eggs only for *Bathylagus ochotensis*.

Eggs

The eggs of argentinoids are pelagic, round, have a moderate to narrow perivitelline space, segmented yolk and a chorion with distinctive pustules on the inner surface (Table 39, Fig. 82). Egg diameters and oil globule characters are given in Table 39.

Argentinoid larvae hatch as relatively undifferentiated yolk-sac larvae, regardless of egg size. That is, yolk-sac larvae of *A. silus* at 7.5 mm, newly hatched from eggs 3.0-3.5 mm diameter, are at about the same stage of development as 3 mm bathylagid yolk-sac larvae which hatch from 1 mm eggs. In most marine fishes larger eggs produce more highly differentiated hatchlings.

Larvae

Body form. - Argentinid and bathylagid larvae are slender, those of microstomatids are deeper-bodied, and opisthoproctids have a wide variety of body shapes ranging from the slender larvae of *Bathylagnops* to the deep-bodied *Opisthoproctus* (Table 40, Figs. 83-87).

The gut is elongate and straight in argentinids and bathylagids, with the exception of *B. milleri* where the gut is straight but only about half the body length. In argentinids the gut is lined with transverse rugae for almost the entire length. In most bathylagids the gut has two distinct sections: an anterior section with longitudinal internal ridges, separated by a valve from a shorter posterior section with transverse rugae. The anterior section in *B. bericoides* and *B. longirostris* is markedly smaller in diameter compared with other species. Larvae of *B. wesethi*, *B. nigrigenys* and *B. argyrogaster* have transverse rugae along the entire length of the gut and the anterior section is relatively larger in diameter and thin-walled. Also the posterior section is subdivided by a second valve. *B. ochotensis* larvae develop a similar structure.

The gut in microstomatid larvae is long, but anteriorly has an elongate S-shaped fold that lies flat on the left side (Fig. 84). The lumen of the anterior folded section is characterized by longitudinal ridges whereas the posterior straight section has transverse rugae. The short pyloric section has longitudinal ridges. Schmidt (1918) shows the gut extended beyond the finfold margin in *Nansenia oblita* and trailing in early stage *Microstoma microstoma* larvae but we have not seen this in any specimens of these genera.

In opisthoproctids the gut is elongate in *Bathylagnops* and *Dolichopteryx* and relatively shorter in the deeper-bodied genera, *Macropinna*, *Rhyncholyalus* and *Opisthoproctus*. In all genera there is a sac-like stomach, which exits through a constricted pyloric section to the intestine. In *Bathylagnops* and *Dolichopteryx* the sac is elongate and pointed at its tip whereas in the other genera it is more rounded in form. The sac lies on the left side, except in *Bathylagnops* where it lies on the right. In the latter genus the pyloric constriction leads into a short but prominent bulbous section. *Dolichopteryx* is similar but lacks

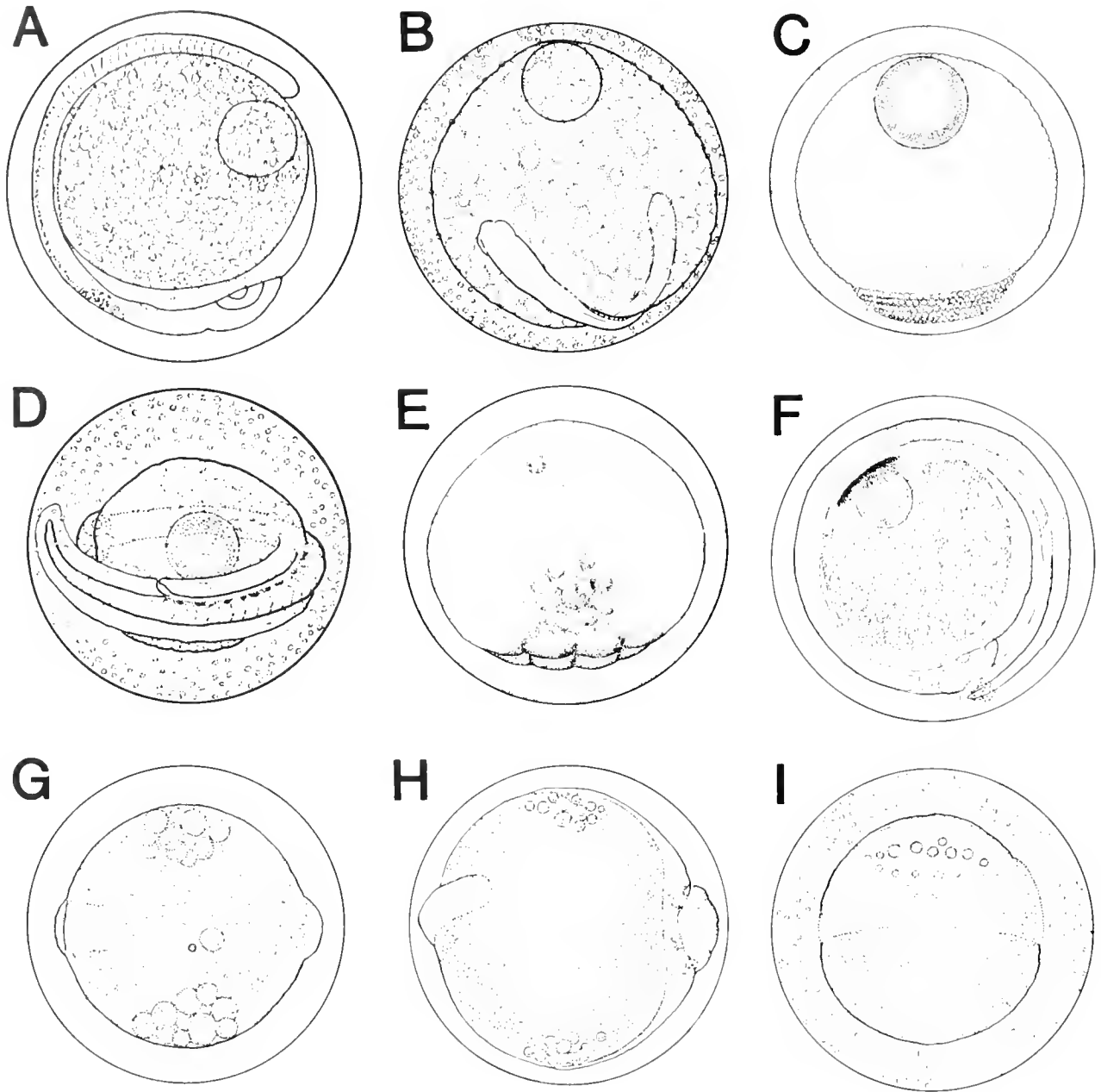

Fig. 82. Eggs of argentinoids. (A) *Argentina siahus*, 1.5 mm, CalCOFI 5103, Sta. 117.35; (B) *Microstoma* sp., 2.2 mm, CalCOFI 7511, Sta. 87.90; (C) *Nansenia candida*, 1.4 mm, CalCOFI Sta. 60.90; (D) *N. crassa*, 1.5 mm, CalCOFI; (E) *Bathylagus stilbius*, 1.1 mm, from Ahlstrom (1969); (F) *B. schmidt*, 1.8 mm, from Ahlstrom (1969); (G) *B. ochotensis*, 1.1 mm, CalCOFI 5002 Sta. 60.90; (H) *B. wesethi*, 1.0 mm, Ahlstrom (1969); (I) *B. mgrigenys*, 0.96 mm, CalCOFI 5106 Sta. 157.20.

the post-pyloric bulb. In *Macropinna* and *Opisthoproctus* there is a straight section leading posteriorly from the pylorus, which ends in an S-shaped fold and an enlarged rectal bulb, the latter described by Bertelsen and Munk (1964). The anterior section including the sac and pylorus have longitudinal internal ridges while sections posterior to this have transverse rugae. In late larval stages the entire section posterior to the pylorus becomes part of the S-shaped coil.

The head is relatively small in argentinids and has a rounded blunted anterior profile (Fig. 83, Table 40). It is slightly larger

in most microstomatids, with the exception of *Microstoma* sp. (Pacific form) which has a small head. In most microstomatids the head has a rounded, blunted anterior profile and is bent slightly downward from the longitudinal axis. In both families the eye is either round or slightly ellipsoidal. In bathylagids the head is moderate in size but highly various in shape (Figs. 85, 86; Table 40). The snout is generally longer than in Argentinidae and Microstomatidae.

Eye shape and structure vary greatly within the bathylagids. *Bathylagus milleri* has a large, nearly round eye in contrast to

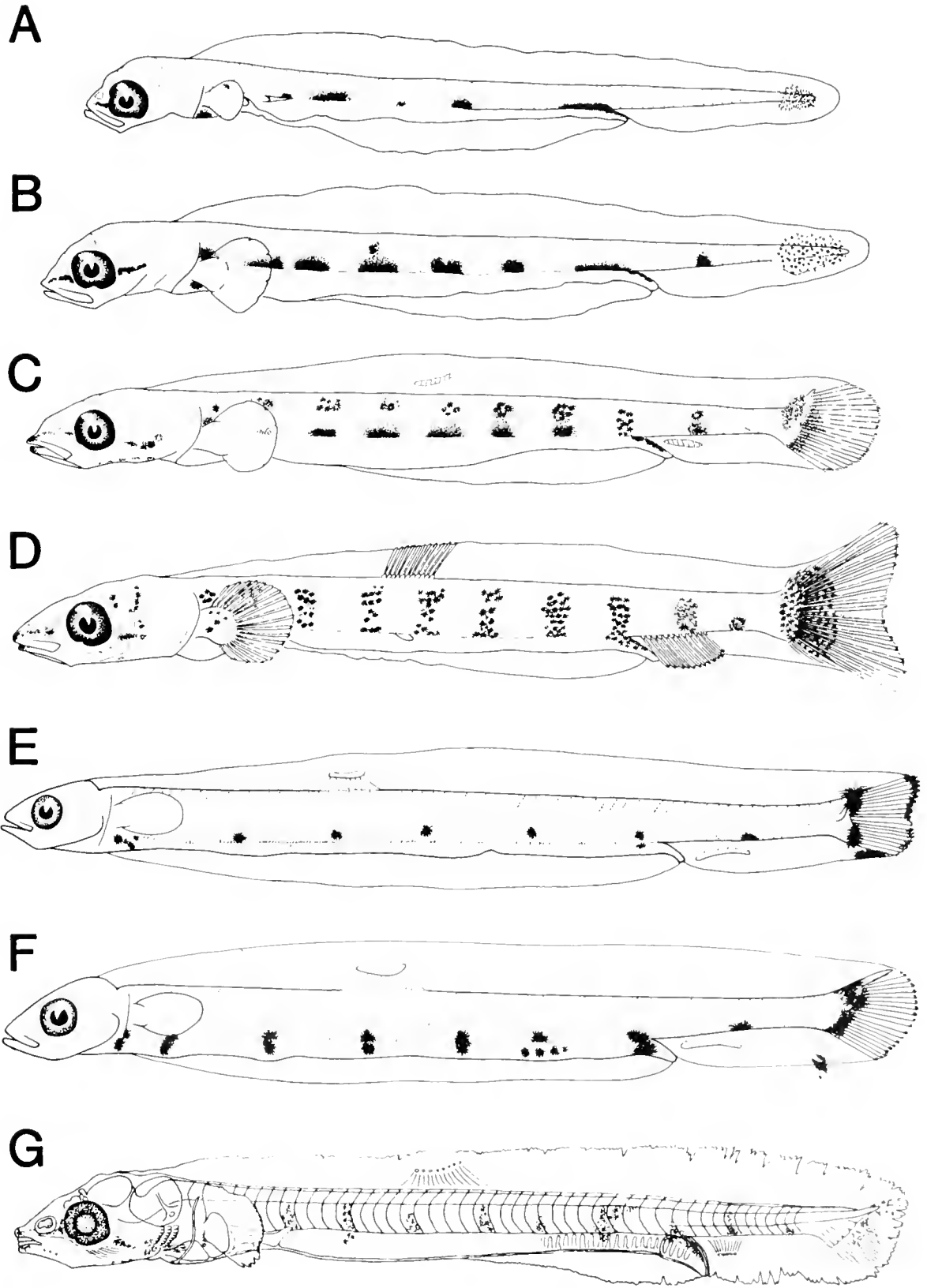

Fig. 83. Larvae of Argentinidae. (A) *Argentina sialis*, 7.0 mm, CalCOFI 5103 Sta. 117.35; (B) *A. sialis*, 9.0 mm, CalCOFI 5104 Sta. 97.40; (C) *A. sialis*, 17.5 mm, CalCOFI 5103 Sta. 120.35; (D) *A. sialis*, 21.0 mm, CalCOFI 5105 Sta. 123.40; (E) *A. silus*, 32.5 mm, redrawn from Schmidt (1906c); (F) *A. sphyraena*, 19.2 mm, *ibid*; (G) *Glossanodon semifasciatus*, 12.5 mm, from Nishimura (1966).

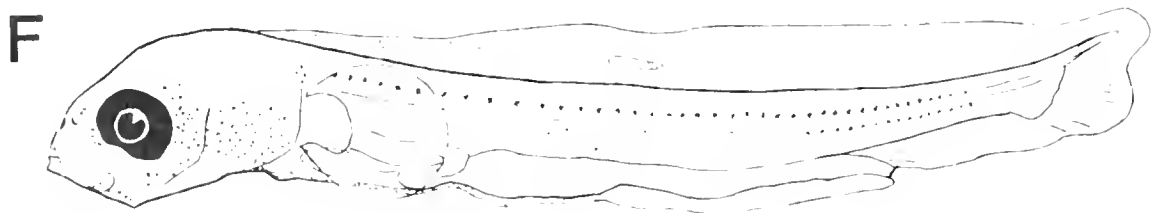
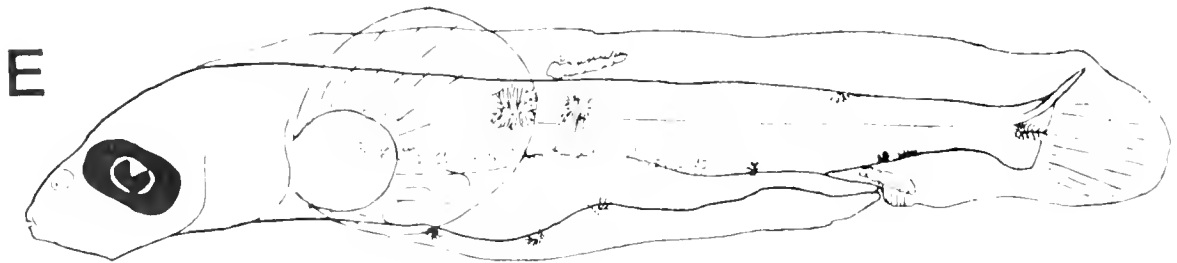
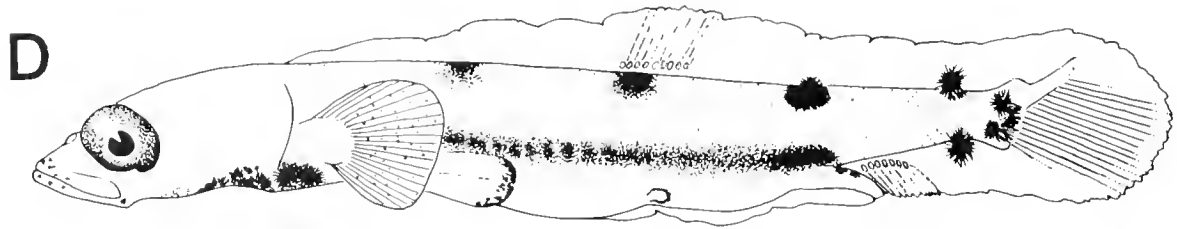
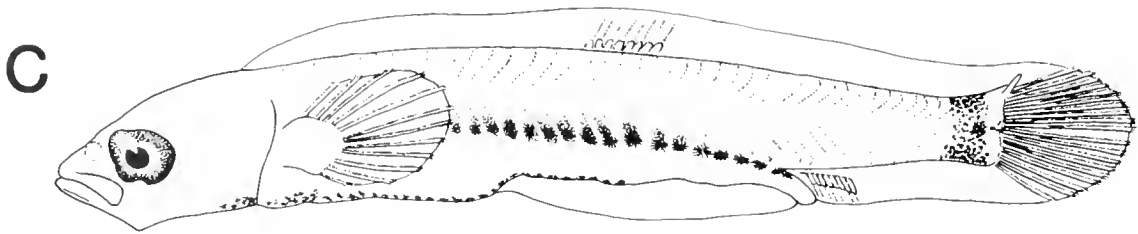
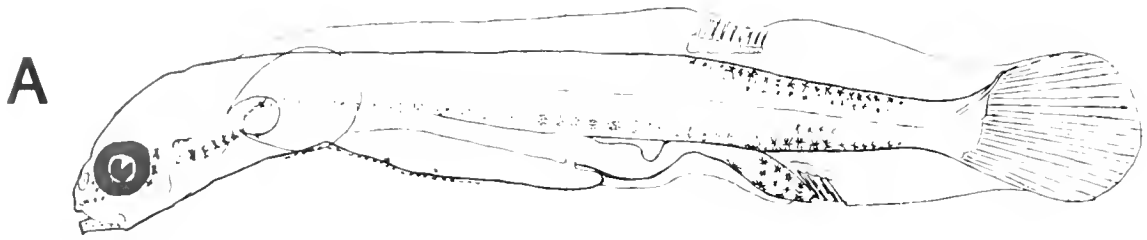

TABLE 40. COMPARATIVE MORPHOMETRY OF ARGENTINOID LARVAE. Mean values (%) of body proportions for three ontogenetic stages (preflexion-flexion-postflexion) are listed.

Species	Snout-anus distance	Head length	Head width	Eye length	Eye stalk length	Body depth	Snout-anal fin distance	Snout-dorsal fin distance	Snout-pelvic fin distance
	Body length	Body length	Head length	Head length	Head length	Body length	Body length	Body length	Body length
<i>Argentina sialis</i>	76-78-84	17-21-22	54-44-41	28-24-24	—	9-10-10	0-78-81	0-46-47	0-0-49
<i>Microstoma microstoma</i>	?-?-80	?-?-23	?-?-45	?-?-27	—	?-?-13	?-?-80	?-?-68	0-?-64
<i>Microstoma</i> sp. (Pacific)	76-79-80	17-19-19	53-49-44	31-29-27	—	8-10-10	0-78-81	0-70-72	0-64-67
<i>Nansenia candida</i>	74-77-82	21-25-26	60-50-44	36-28-28	—	12-14-16	0-75-82	0-54-58	0-56-61
<i>Nansenia crassa</i>	74-78-80	22-25-28	58-50-44	36-29-24	—	10-12-15	0-76-80	0-52-57	0-56-60
<i>Nansenia groenlandica</i>	?-78-80	?-27-25	?-50-42	?-21-23	—	?-15-15	?-77-80	?-52-52	?-54-57
<i>Xenophthalmichthys danae</i>	?-?-82	?-?-24	?-?-48	?-?-21	—	?-?-12	?-?-86	?-?-74	?-?-52
<i>Bathylagus milleri</i>	59-57-61	20-19-26	56-54-52	31-27-26	—	9-9-15	0-0-71	0-0-50	0-0-45
<i>Bathylagus schmidti</i>	72-76-78	16-19-22	50-52-46	39-26-25	.04-0-0	7-8-10	0-0-79	0-0-57	0-0-55
<i>Bathylagus stilbius</i>	74-77-80	20-22-24	54-53-47	32-25-20	.03-0-0	8-10-13	0-0-79	0-0-57	0-0-55
<i>Bathylagus urotramus</i>	78-82-81	20-24-28	56-53-46	27-18-21	.03-0-0	10-10-12	0-0-81	0-0-61	0-0-59
<i>Bathylagus pacificus</i>	76-85-81	22-24-25	39-42-44	29-22-18	28-29-20	8-10-13	0-81-80	0-49-48	0-51-51
<i>Bathylagus euryops</i>	78-80-82	18-20-20	46-50-50	31-26-25	10-7-3	10-11-12	0-78-80	0-45-48	0-0-47
<i>Bathylagus bercoides</i>	84-85-89	25-26-26	34-38-36	27-25-22	60-64-36	8-8-9	0-83-88	0-0-52	0-0-53
<i>Bathylagus longirostris</i>	85-88-92	26-27-25	34-34-34	24-20-19	54-48-27	8-10-10	0-88-90	0-0-53	0-0-57
<i>Bathylagus ochotensis</i>	81-85-90	20-23-23	44-44-44	32-21-21	17-15-15	8-10-11	0-83-87	0-53-54	0-56-56
<i>Bathylagus wesethi</i>	79-89-94	13-26-27	59-53-50	27-16-13	—	9-14-16	0-85-90	0-58-60	0-57-59
<i>Bathylagus nigrigenys</i>	80-86-93	20-29-28	78-60-53	30-18-14	—	12-16-18	0-86-90	0-57-60	0-0-60
<i>Bathylachnops exilis</i>	?-80-82	?-21-22	?-42-38	?-22-18	—	?-8-7	?-82-84	?-71-73	?-66-67
<i>Dolichopteryx longipes</i>	?-74-75	?-24-26	?-44-34	?-22-16	—	?-8-10	?-0-77	?-0-71	?-62-62
<i>Macropinna microstoma</i>	?-64-59	?-26-35	?-52-47	?-22-21	—	?-15-21	?-0-70	?-0-66	?-43-48
<i>Opisthoproctus soleatus</i>	?-?-80	?-?-37	?-?-46	?-?-18	—	?-?-18	?-?-83	?-?-63	?-?-40

other species which have relatively smaller, more elliptical eyes. Eyes are sessile in *B. milleri* and in the *B. wesethi* group but are stalked to some degree in all other species known. In *B. stilbius* and relatives (*B. urotramus*, and *B. schmidti*) the stalks are short and found only in early larvae. Stalks are longer and persist into later larval stages in other species, reaching a maximum of 65% of the head length in *B. bercoides*.

In opisthoproctids the head is moderate in size in the slender forms, *Bathylachnops* and *Dolichopteryx*, and longer and more massive, with a pronounced hump or bend at the nape, in the deep-bodied genera. All genera have an elongate snout and *Bathylachnops* has a unique triangular flap at its tip. *Bathylachnops* has round eyes that are rotated slightly dorsoanteriorly. In the other genera, the eyes are tubular and directed dorsally, even in the smallest larvae available. Eye diverticulae with associated accessory retinæ, characteristic of opisthoproctid adults, begin to form at the end of the larval period.

Fins.—A major feature of all argentinoid larvae is the development of a prominent median finfold in which the dorsal and anal fins develop, connected to the trunk by a series of hyaline strands (Figs. 83–87). The first fins to form are the pectorals. In argentinids and bathylagids they are relatively small and develop rays late in the larval period. Microstomatid and opisthoproctid pectoral fins are generally larger; however, there is a wide size range, from relatively small fins in *Microstoma* to large, fan-like fins in some species of *Nansenia* (e.g., *N. groenlandica*) to very elongate pectorals in *Dolichopteryx binocularis*.

Ossification of rays begins earlier in these groups, usually before notochord flexion.

After the pectorals, the caudal fin is usually the next to form. In argentinids notochord flexion and development of principal caudal rays occurs at a size about midway in larval growth whereas in opisthoproctids this occurs earlier in the larval period. In bathylagids the process is somewhat delayed and in some species (e.g., *B. euryops*, *B. milleri*) notochord flexion may not be completed until near the end of the larval period.

The dorsal and anal fins begin to form at about the stage of notochord flexion in all argentinoids except opisthoproctids, where notochord flexion slightly precedes the appearance of dorsal and anal fins. The anal fin begins forming far posteriorly in argentinoids, just posterior to the anus or the point of deflection of the free terminal gut section. In *B. milleri* and in the deep-bodied opisthoproctids with coiled guts there is a space between the anus and the anal fin origin.

The position of the dorsal fin is varied among argentinoids and forms in the larvae in approximately the same position that it will occupy in the adult. The fin has its most anterior location in *Argentina* where its origin is well forward of the midpoint of the body (Fig. 83). The extreme case is found in *A. silus* where snout to dorsal origin is about 38% of the body length in larvae and about 43% in adults. In most bathylagids the dorsal origin is slightly anterior to mid-body. The exceptions are *B. stilbius* and relatives, where the dorsal origin is slightly posterior to mid-body, and *B. wesethi* and relatives where it is located still further posteriorly.

Fig. 84. Larvae of Microstomatidae. (A) *Microstoma microstoma*, 11.0 mm, from Schmidt (1918); (B) *Microstoma* sp., 12.0 mm, CalCOFI 5104 Sta. 90.52; (C) *Nansenia candida*, 8.4 mm, CalCOFI 5007 Sta. 100.70; (D) *N. crassa*, 8.5 mm, CalCOFI 5103 Sta. 137.50; (E) *N. groenlandica*, 10.0 mm, from Schmidt (1918); (F) *N. oblita*, 9.0 mm, *ibid*; (G) *Xenophthalmichthys danae*, 16.5 mm, from Bertelsen (1958).

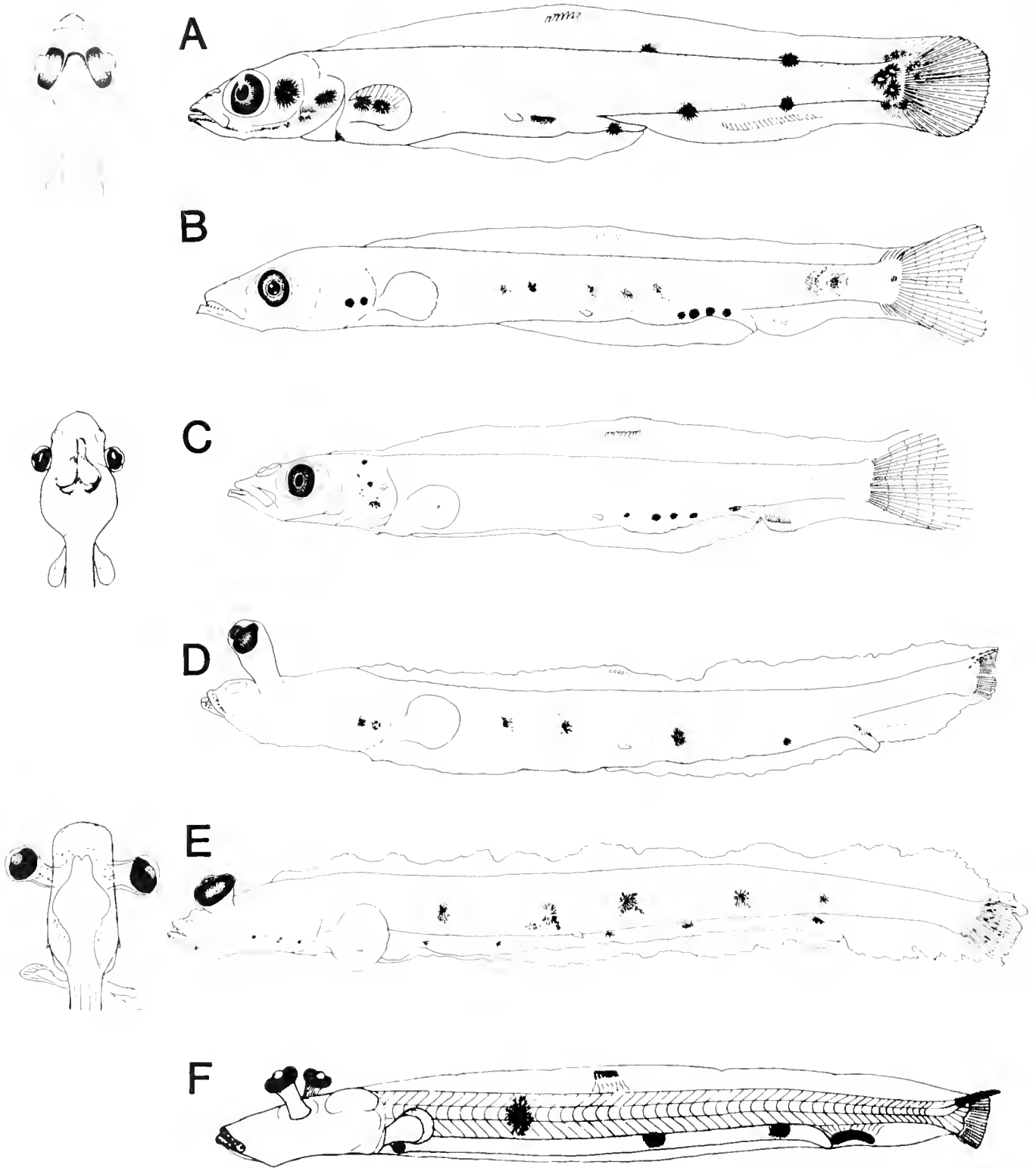

Fig. 85. Larvae of *Bathylagus*. (A) *B. mulleri*, 27.5 mm, CalCOFI 5106 Sta. 70.60, dorsal view of 9.5 mm specimen at left; (B) *B. schmidtii*, 31.5 mm, CalCOFI Northern Holiday Exped. Sta. 31; (C) *B. silbus*, 23.2 mm, CalCOFI 4905 Sta. 111.38, dorsal view of 8.5 mm specimen at left; (D) *B. pacificus*, 21.4 mm, CalCOFI 7905 Sta. 63.60; (E) *B. euryops* 24.0 mm, dorsal view of 14.0 mm specimen at left, from Tåning (1931); (F) *B. antarcticus*, 26.5 mm, from Yefremenko (1983).

TABLE 41. MERISTICS OF ARGENTINOID FISHES.

Species	Vertebrae	Branchiostegal rays	Dorsal fin rays	Anal fin rays	Pectoral fin rays	Pelvic fin rays	Procurent caudal fin rays
<i>Argentina</i>							
<i>alicae</i>	43-46	5	11-13	13-15	16-18	10-12	
<i>australiae</i>	50-53	5	10-12	12-13	13-14	11-13	
<i>brucei</i>	45-47	5	10-12	11-13	18-20	13-14	
<i>clongata</i>	52-55	5	10-12	11-14	13-16	11-12	
<i>euchus</i>	48-49	5	12	13-15	16-18	10-11	
<i>georgei</i>	48-51	5	10-12	10-13	16-19	12-14	
<i>kagoshimae</i>	51-52	5	10-12	11-13	15-17	11-12	
<i>sialis</i>	47-51	5	10-13	12-15	11-18	10-12	12+11
<i>silus</i>	65-70	6	11-13	11-17	15-18	12-13	
<i>sphyraena</i>	46-55	6	10-12	11-15	12-15	10-12	
<i>stewarti</i>	53-54	5	10-12	12-13	18-21	13-15	
<i>striata</i>	48-52	5	10-12	11-14	18-21	11-15	10+9
<i>Glossanodon</i>							
<i>leiglossus</i>	49-51	5	12-14	10-13	19-22	11-12	
<i>lineatus</i>		4	11-13	15	18-21	11-13	
<i>mildredae</i>	50-52	5	13	13	23	12-13	
<i>polli</i>		5	12-14	11-14	19-22	12-13	
<i>pygmaeus</i>	43-44	5	10-12	11-13	12-14	10-12	
<i>semifasciatus</i>	49	5	11-13	11-13	18-21	10-12	
<i>struhsakeri</i>	51-53		12-14	12-13	23-25	13-15	
<i>Microstoma</i>							
<i>microstoma</i>	45-47	3-4	11-12	8-9	8	9-11	11+11
sp. (Pacific)	49-50	4	9-11	7-8	11	9	10-11+10
<i>Xenophthalmichthys</i>							
<i>danae</i>		3	10-12	9-10	7	8-9	10+9
<i>Nansenia</i>							
<i>atlantica</i>	41-42	4	9-10	8-9	12-13	10-11	
<i>ardesiaca</i>	46-48	4	9-10	9-10	11-14	10-12	
<i>candida</i>	44-47	3	9-10	8-9	9-11	9-11	11+14
<i>crassa</i>	43-46	4	9-10	8-9	11-13	10-11	
<i>groenlandica</i>	42-45	3	9-10	8-10	11-13	10-12	
<i>oblita</i>	42-45	4	10-11	9-10	10-11	10-11	
<i>Bathylagus</i>							
<i>antarcticus</i>		2	9-11	21-25		9-10	
<i>argyrogaster</i>		2	12	14-15		8	
<i>bericoides</i>	48-53	2	10-11	18-22	10-12	9-10	
<i>curyops</i>	44-46	2	9-11	16-19	7-12	7-9	
<i>greyae</i>		2	11-13	13	12-13	10-11	
<i>longirostris</i>	48-51	2	10-12	19-21	9-12	9-10	
<i>milleri</i>	51-55	2	6-9	20-28	11-16	6-8	16-18+15-17
<i>nigrigenys</i>	41	2	11-12	14-17	10	8-10	
<i>ochotensis</i>	47-49	2	9-12	12-15	9-11	9-10	13-14+15-16
<i>pacificus</i>	45-49	2	8-9	15-22	7-11	7-10	13+13-14
<i>schmidtii</i>	47-52	2	10-11	11-14	8-9	8-9	16-17+16
<i>stilhius</i>	38-42	2	9-11	11-14	8-11	8-10	12-16+13-15
<i>urotramus</i>	39-42	2	9-10	10-11	9-11	7-8	12-14+12-13
<i>wesethi</i>	43-46	2	12-13	14-16	10-11	9-11	14-15+14-15
<i>Dolichopteryx</i>							
<i>anascopa</i>		2	10	12	14	12	
<i>binocularis</i>		2	15	11	14	9	
<i>brachyrhynchus</i>		2	13	12	13	8	
<i>longipes</i>	41-44	2	10-11	8-9	13	8-9	
<i>Bathylchnops</i>							
<i>exilis</i>	81-84	2	14-16	13-14	12-13	7	
<i>Rhynchichthyalus</i>							
<i>natalensis</i>		4	10-12	10	19-20	11-12	
<i>Macropinna</i>							
<i>microstoma</i>	36	3	11-12	14	17-19	10	
<i>Winteria</i>							
<i>telescopa</i>			8	8	12-14	9	

TABLE 41. CONTINUED.

Species	Vertebrae	Branchiostegal rays	Dorsal fin rays	Anal fin rays	Pectoral fin rays	Pelvic fin rays	Procurent caudal fin rays
<i>Opisthoproctus</i>							
<i>grimaldii</i>		2	12-14	8	11	10	
<i>soleatus</i>	31	2	10-12	13-14	9-11		

The dorsal fin forms in a variety of positions among microstomatids. In most species of *Nansenia*, the dorsal fin originates slightly posterior to mid-body, although in some species (e.g., *N. groenlandica*), its origin is slightly anterior to mid-body. The dorsal origin is further posterior in *Microstoma*. In *M. microstoma* predorsal length is about 67-68% of the body length and assumes a more anterior position in adults (ca. 63%). In larvae of the Pacific species predorsal length is about 75% of the body length, and is slightly more posterior in adults. In adult *Xenophthalmichthys* the dorsal origin is at mid-body; however, in the 16.5 mm specimen from the Atlantic (Bertelsen, 1958) predorsal length is 62% of the body length. In our single larva (12.2 mm) from the Pacific predorsal length is 75% of body length, indicating a marked anterior migration during ontogeny or strong allometric growth posterior to the dorsal fin. Alternatively, the Pacific form may prove to be distinct when adult specimens are captured.

The dorsal fin in opisthoproctids is located posterior on the body. This is most marked in the slender forms, *Bathylachnops* and *Dolichopteryx*, and reaches an extreme in *D. binocularis* where predorsal length is greater than $\frac{3}{4}$ of the body length. In the deep-bodied genera the dorsal origin is posterior to mid-body, but less so than in the slender-bodied forms.

The pelvic fins are the last fins to form in most argentinoids, usually late in the larval period. The exception is opisthoproctids where the pelvic fins form early in the larval period. In argentinids, bathylagids and microstomatids the pelvic fins form at about mid-body, below the dorsal fin. In the slender opisthoproctid genera the pelvics form well back on the body, but anterior to the dorsal fin. Among the deep-bodied genera, *Opisthoproctus* forms the pelvics far back on the body, beneath the dorsal fin. In *Rhynchohyalus* and *Macropinna* the pelvics develop just posterior to mid-body and anterior to the dorsal fin. In the larvae the fins are elevated to the sides of the body. This position persists in juvenile and adult *Macropinna* where the fins are located just behind and below the pectoral fin bases. The pelvic fins become elongate in *Dolichopteryx* and the deep-bodied genera. The pelvic fin base is pedunculate in opisthoproctid larvae, a condition that persists into the adults of some genera, notably *Dolichopteryx*. Argentinoids, except *Microstoma*, *Xenophthalmichthys* and some species of *Dolichopteryx*, develop adipose fins late in the larval period.

A summary of meristics of argentinoids is given in Table 41. The sequence of ossification of fins and other skeletal elements of *Bathylagus schmidtii* is described by Dunn (1983a).

Pigmentation.—In argentinids, pigmentation consists of a series of 6-8 ventral trunk blotches that extend from the pectoral fin base to the end of the gut (Fig. 83). The series is continued posteriorly as 1 or 2 median ventral blotches and ends as a large blotch at the caudal region. The number of blotches is constant for each species, as is the sequence of formation. In *Argentina sialis* and *Glossanodon* the ventral blotches expand dorsally as lateral bars, but this does not occur in *A. silus* and *A. sphyraena*. These latter species differ additionally in lacking the internal head pigment which develops in *A. sialis* and *Glossanodon* larvae.

A feature common to most microstomatid larvae is a heavy line of embedded pigment above the gut (Fig. 84). In *Microstoma* this pigment continues forward to the gill arches and within the head anteriorly to the snout. In *Nansenia*, head pigmentation is superficial, or concentrated ventrally on the head. In *Microstoma*, an embedded dorsal line of pigment is located posterior to the dorsal fin. Dorsal pigmentation in *Nansenia* may take the form of a series of embedded blotches (e.g., *N. crassa*) or an embedded line of melanophores running the length of the body (e.g., *N. oblita*). Most microstomatids have conspicuous melanistic pigment associated with the caudal fin region. A notable feature of *Microstoma* and some *Nansenia* (e.g., *N. crassa*) is the presence of heavy melanistic pigment at the curve of the gut loop. Our single damaged specimen of *Xenophthalmichthys* (12.2 mm) has pigmentation similar to *Microstoma* but lacks the posterior dorsal body pigment and has a series of slanted melanophores along the hypaxial myosepta.

Pigment patterns in bathylagids may be grouped into two categories—those species with large isolated melanophores (Fig. 85) and those with linear series of smaller melanophores (Fig. 86). *Bathylagus milleri* has a unique pattern of opposing dorsal and ventral midline melanophores, large melanophores on the head and pectoral fin base and a large lateral blotch on the notochord tip.

Bathylagus stilbius and *B. urotramus* develop a series of 5-6 melanophores on each side of the posterior section of the gut. A single large melanophore, is found on the lower trunk midway between the pectoral fin and the anus and the head has melanophores, chiefly on the upper and lower jaws and opercle (Fig. 85). *B. schmidtii* differs in having a series of lower trunk blotches and 1 or 2 postanal lateral blotches.

Bathylagus curyops has a series of 3-6 melanophores on the lateral surface of the gut and 3-5 large melanophores on the lateral surface of the trunk (Fig. 85). Other pigmentation consists

Fig. 86. Larvae of *Bathylagus*. (A) *B. bercoides*, 17.7 mm, Dana Sta. 4007, dorsal view of 11.8 mm specimen at left; (B) *B. longirostris*, 20.1 mm, SIO/STOW XIII Exped., dorsal view of 12.4 mm specimen at left; (C) *B. ochotensis*, 21.5 mm, CalCOFI 5106 Sta. 77.65, dorsal view of 8.5 mm specimen at left; (D) *B. wesethi*, 11.3 mm, from Ahlstrom (1972b), dorsal view of 8.5 mm specimen at left; (E) *B. nigrogenys*, 21.8 mm, SIO Shellback Exped. Sta. 92, dorsal view of 8.7 mm specimen at left; (F) *B. argyrogaster*, 17.1 mm, Dana Sta. 4003.

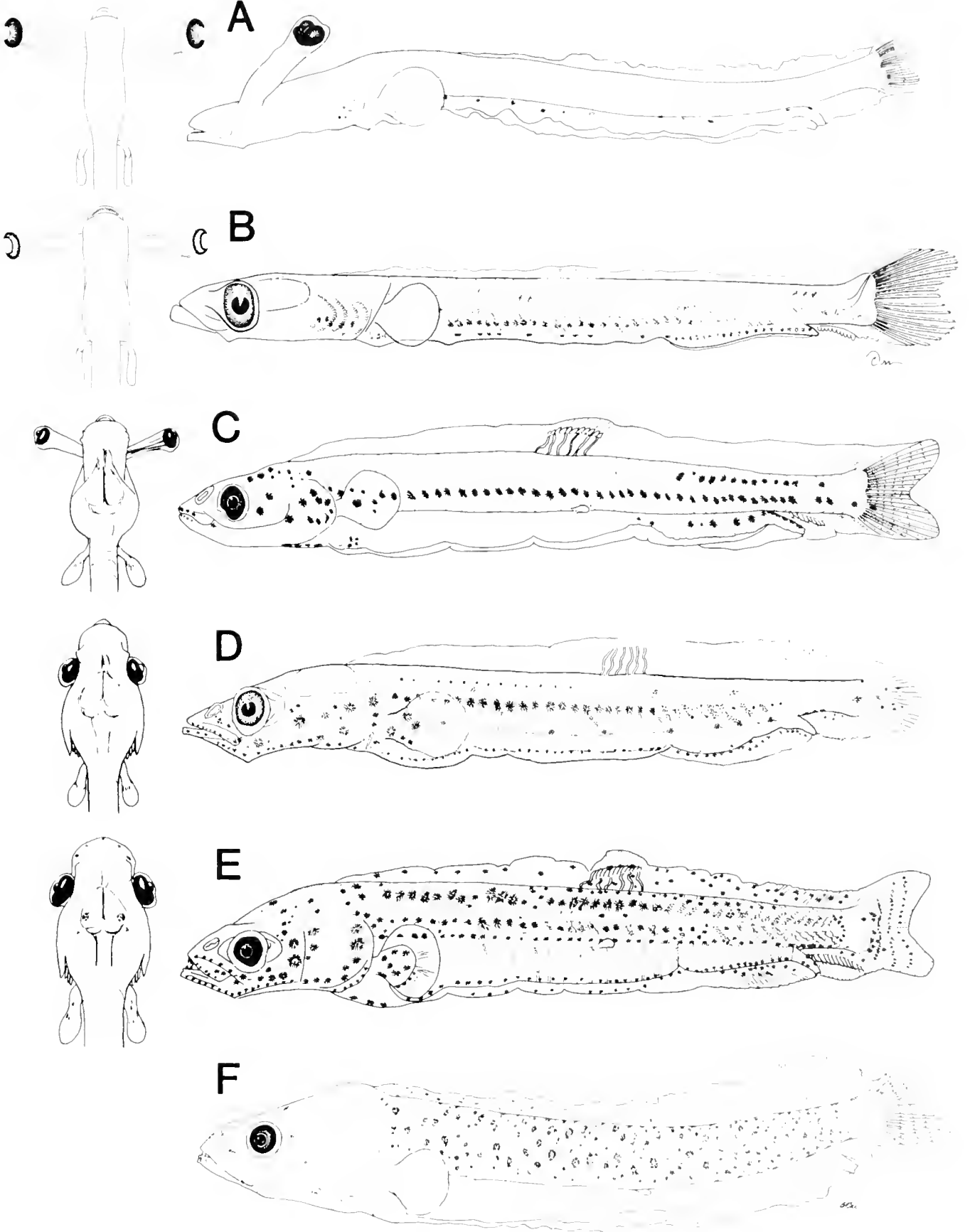

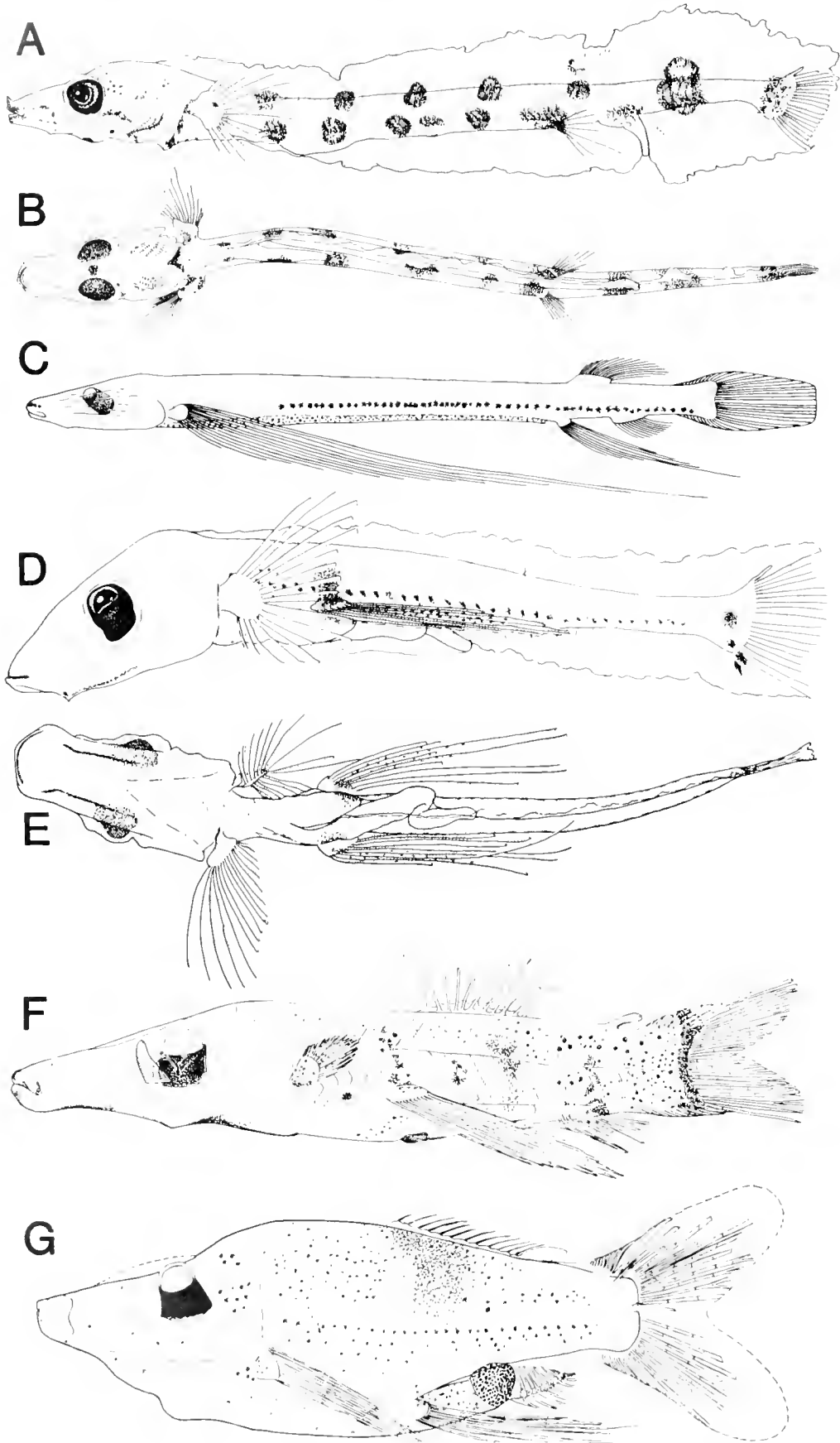

TABLE 42. CHARACTERS USED IN ANALYSIS OF FOUR ARGENTINOID GROUPS.

Character number	Derived character state	Outgroup	Reference
1	Accessory cartilage at posterior tip ceratobr. 5	Osmerids	Greenwood and Rosen, 1971
2	PU ₁ + U ₁ fused	Teleosts in general	Goody, 1969
3	Light organs present	Teleosts in general	Bertelsen and Munk, 1964
4	Frontals fused	Teleosts in general	Cohen, 1964b
5	Epibr. 4 with one post. art. surface	Osmerids	Greenwood and Rosen, 1971
6	Larval gut with stomach	Osmerids	This paper, Hearne (this volume)
7	Pelvic fins form early and large	Osmerids	This paper, Hearne (this volume)
8	Swimbladder absent	Teleosts in general	Cohen, 1964b
9	Urodermal absent	Teleosts in general	Greenwood and Rosen, 1971
10	LL scales extend onto caudal fin	Teleosts in general	
11	Larval gut folded	Osmerids	Hearne (this volume)
12	Extrascapular attached to pterotic	Teleosts in general	Chapman, 1942
13	Uncinate process lacking on epibr. 4	Osmerids	Greenwood and Rosen, 1971
14	Pectoral fin forms early and large	Osmerids	This paper, Hearne (this volume)

of a line of small melanophores above and below the notochord tip, a patch of melanophores on the opercle and groups of small melanophores on the upper and lower jaws. *Bathylagus antarcticus* has 3 lateral gut spots, a large lateral trunk melanophore at the 10th–12th myomere, and head and notochord pigment similar to that of *B. euryops*. Early larvae of *B. pacificus* have a large lateral blotch at mid-body and another one posteriorly on the body. Initially these melanophores are located at the junction of the gut and body but in later larvae are located on the trunk. Later a 3rd blotch forms midway between these two. A 4th lateral trunk blotch forms in some late larval specimens between the pectoral fin and the large mid-body blotch and melanophores form lateral to the liver and at the free terminal section of the gut. Head and notochord pigment is similar to *B. euryops* and *B. antarcticus*.

Bathylagus bericoides is unusual in having only a series of as many as 18 lateral gut melanophores (Fig. 86). Late postflexion larvae develop pigment on the lower jaw, isthmus, opercle, pectoral fin base and lateral caudal peduncle. *Bathylagus longirostris* develops a heavier pattern of pigmentation, beginning with a series of small melanophores on the posterior section of the gut in early larvae. Also in preflexion larvae a series of rectangular-shaped melanophores develops on the hypaxial myomeres. Later in the larval period the lateral gut series is extended forward along the entire gut, although with wider spacing than on the posterior gut section. Also, the epaxial myomeres develop rectangular-shaped melanophores, beginning posteriorly and accruing anteriorly. The head develops pigmentation from the opercle to the jaws (Fig. 86). *Bathylagus ochotensis* develops a similar pigment pattern except that the melanophores on the posterior gut section are comparatively larger and fewer, the anterior region of the gut lacks melanophores and the epaxial myomere series is limited to the posterior region.

Larvae of *B. wesethi*, *B. nigrigenys* and *B. argyrogastrer* have a similar pigment pattern that differs markedly from that of other *Bathylagus* (Fig. 86). Initially there is a series of paired

melanophores dorsolateral to the gut, extending from the pectoral fin base to the terminal section. These remain throughout the larval period but become embedded and obscured in late larvae. *Bathylagus nigrigenys* begins with about 8 pairs, which increase to 10, whereas *B. wesethi* begins with 6 pairs and has 7–8 during most of the larval period. Both species develop pigment at the notochord tip; *B. wesethi* has a dorsal and ventral spot, while *B. nigrigenys* has only a ventral spot. At notochord flexion a series of melanophores appears along the hypaxial region of the body and, soon after, a series develops along the epaxial myomeres. More lateral series are added and in late larvae the entire body is covered. Melanophores also form in the median finfold of advanced larvae. Initially head pigmentation consists of melanophores on the opercle and jaws but in later larvae the entire head is covered.

Opisthoproctid larvae have distinctive and, in some genera, heavy pigment patterns (Fig. 87). *Bathylachnops* has a dorsal series of 6 large paired blotches that permeate the musculature, bridge across the longitudinal septum and expand onto the finfold. A series of 8 large ventrolateral blotches alternate with those of the dorsal series, with the exception that the postanal blotch lies opposite the dorsal blotch and expands to form a band. A large blotch covers the base of the caudal fin. The head is heavily pigmented with superficial melanophores on the branchiostegals, urohyal and lateral brain and deeply embedded melanophores in the snout, jaws, cheek and ventral brain region. The lower limbs of the gill arches and their filaments are heavily pigmented as are both the pectoral and pelvic fin bases.

The species of *Dolichopteryx* have lateral series of melanophores above the gut and some species develop serial melanophores on the hypaxial myomeres (Fig. 87). Head pigment consists of melanophores on the jaws, gill arches and, in most species, the internal snout region. *Macropinna* develops a series of slanted melanophores, one on each hypaxial myomere, and a heavy embedded blotch at the pelvic fin base, that expands both dorsal and ventrad as a band. The caudal fin base has a large blotch

Fig. 87. Larvae of Opisthoproctidae. (A) *Bathylachnops exilis*, 15.6 mm, CalCOFI 7203 Sta. 67.80; (B) Ventral view of above; (C) *Dolichopteryx binocularis*, 58.0 mm, redrawn from Roule and Angel (1930); (D) *Macropinna microstoma*, 11.7 mm, CalCOFI 7412 Sta. 120.50; (E) Ventral view of above; (F) *Rhynchohyalus natalensis*, 23.0 mm, from Bertelsen et al. (1965); (G) *Opisthoproctus grimaldii*, 14.0 mm from Schmidt (1918).

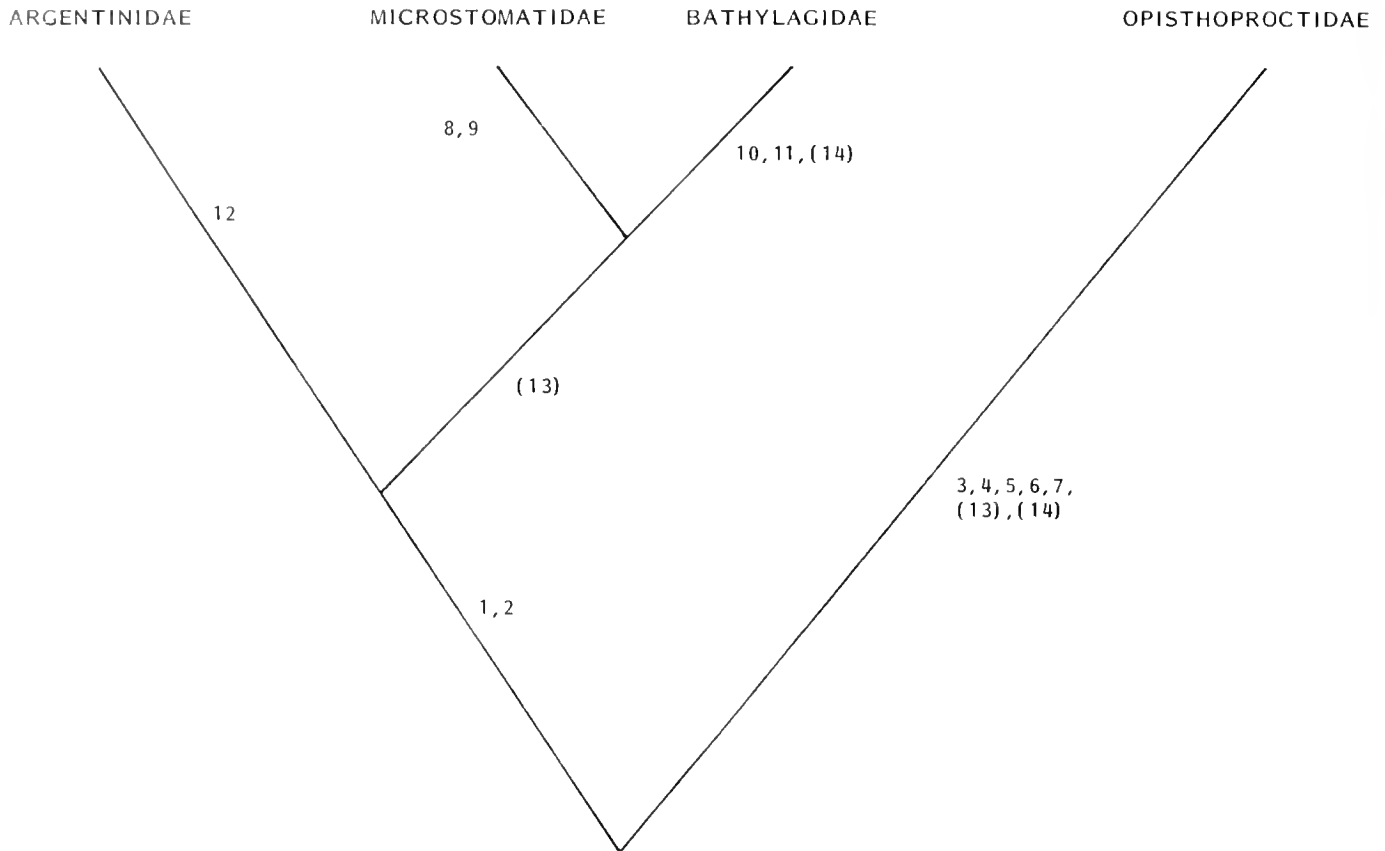

Fig. 88. Cladogram showing the distribution of character states in four nominal families of argentinoid fishes. Numbers refer to characters in Tables 42 and 43. Parentheses indicate character reversals.

and in the gut region there is pigment above the terminal section and ventral to the liver. Head pigment is confined to the lower jaw. The pigment pattern of *Rhynchohyalus* as described by Bertelsen et al. (1965) consists of a series of four dusky bars beginning at the pelvic fin and ending at the caudal fin base. Embedded beneath these is a layer of diffuse melanophores which becomes denser toward the caudal. The pectoral fin bases are pigmented and in the ventral region there are melanophores on the isthmus and gut. The anal light organ is covered with a melanistic sheath. The late larval specimen of *Opisthoproctus grimaldii* illustrated by Schmidt (1918) shows a diffuse covering of melanophores over the body and a dusky bar extending down from the dorsal fin. A 10 mm larva of *O. soleatus* in our collection has a pigment pattern similar to *Macropinna*, with a series of slanted melanophores on the hypaxial myomeres, embedded blotches at the pelvic and caudal fin bases, pigment at the liver and ventrally at the angles of the lower jaw.

Transformation stage

In argentinids transformation from larva to demersal juvenile is a prolonged process and pelagic juveniles with the retained larval pigment blotches or bars have been reported many times (see Cohen, 1958; Nishimura, 1966). Morphological changes (e.g., deepening of the body, prolongation of the snout, eye enlargement) and the masking of the larval pigment occur gradually. The beginning of this stage may be defined by the folding of the anterior gut region to form a stomach. This occurs at 25–

30 mm in *Argentina sialis*, but has not been documented for other species. Pelagic juveniles of *Glossanodon* and *A. sialis* develop a silvery stripe at the lateral line region. This has not been reported for pelagic juveniles of *A. silus* and *A. sphyraena* and may afford an additional character for separating *Argentina* into two groups. The end of the pelagic juvenile stage, marked by the development of scales and silvery integument, is attained

TABLE 43. DISTRIBUTION OF CHARACTER STATES IN FOUR NOMINAL FAMILIES OF ARGENTINOID FISHES. Direction of transformation A → B.

Character number	Argentinidae	Microstomatidae	Bathylagidae	Opisthoproctidae
1	B	B	B	A
2	B	B	B	A
3	A	A	A	B
4	A	A	A	B
5	A	A	A	B
6	A	A	A	B
7	A	A	A	B
8	A	A	B	A
9	A	A	B	A
10	A	B	A	A
11	A	B	A	A
12	B	A	A	A
13	A	B	B	B
14	A	B	A	B

at various lengths by different species. Schmidt (1906c) reports complete transformation at about 50 mm in *A. sphyraena* and at a much larger size in *A. silus*. Size at completion of transformation in *Glossanodon* species is also in the 50–100 mm size range (Nishimura, 1966).

Microstomatids develop a lustrous guanine layer on the integument in late larvae and some species develop distinct juvenile pigmentation. In *Microstoma* juveniles the region of the body from the dorsal fin origin posteriad is more darkly pigmented than the rest of the body, and grades to a solid black pigment at the caudal fin base. Juveniles of some *Nansenia* species develop heavy melanistic pigment at the base of the caudal fin and often at the base of the adipose fin (Schmidt, 1918; Kawaguchi and Butler, in press).

Bathylagids have a direct transformation and undergo a marked morphological change from the slender larval form to the juvenile form, characterized by a large head and eyes and deeper body. The gut becomes coiled and covered by a black peritoneal sheath. The head becomes heavily pigmented but the body is slower to develop the black pigment characteristic of all *Bathylagus* species (other than the *B. stilbius* group) and, in species such as *B. euryops* and *B. milleri*, the large larval melanophores are visible in specimens up to 30 mm and 50 mm respectively.

In the deep-bodied opisthoproctid genera transformation to the juvenile stage is marked by deepening of the body and attainment of melanistic integument and large scales. Cohen (1960) described the large (up to 124 mm) transitional specimens of *Bathylchnops* which are semi-transparent and retain the large larval pigment blotches. Sexually mature specimens of *Dolichopteryx* are semi-transparent, have a membranous body envelope, poorly developed musculature, an exposed gut covered only by peritoneum, weakly attached fins and melanistic pigment of the type usually associated with larvae (Cohen, 1960).

RELATIONSHIPS

Our survey of argentinoid ontogenetic characters provides insight into some of the systematic questions posed at the beginning of the paper. A close relationship between argentinoids and alepocephaloids is not supported since the latter hatch from large eggs (estimated at 3–4 mm based on size of yolk-sac larvae), have direct development, and share no specialized ontogenetic characters with argentinoids. Four major argentinoid lineages can be defined by specializations of the eggs and larvae and thus four families recognized: Argentinidae, Microstomatidae, Bathylagidae, and Opisthoproctidae. *Argentina* and *Glos-*

sanodon have generalized larvae except that all known species have distinct lateral series of melanistic blotches or bands, not found elsewhere among argentinoids. The pattern of banding does not separate the two genera.

All known bathylagid eggs have multiple oil globules. A number of bathylagid groups are apparent from larval characters: 1) *milleri*, 2) *stilbius-schmidti-urotramus*, 3) *euryops-pacificus-antarcticus*, 4) *bericoides-longirostris*, 5) *wesethi-argyrogaster-nigrigenys*. Of these groups, *stilbius-schmidti-urotramus* has the most generalized morphology and pigmentation, lending no support for its separation as a distinct genus.

Opisthoproctid larvae share a number of neotenic features, including a saccular stomach. Except for body shape, *Dolichopteryx* shares more derived larval characters with the deep-bodied genera than with *Bathylchnops*, and the latter has a number of characters unique to opisthoproctids. Division of the family based on body shape is not supported by ontogenetic evidence.

Ontogeny offers little information on species composition of genera, because only a fraction of argentinoid eggs and larvae are known. However, egg and larval characters clearly separate Atlantic and Pacific *Microstoma* as distinct species. *Bathylagus bericoides* larvae from the Atlantic and Pacific are indistinguishable. The same is true for *B. longirostris* from all oceans. *Bathylagus nigrigenys* and *B. argyrogaster* larvae are indistinguishable, lending support for a single circumtropical species. *Bathylagus stilbius* eggs and larvae are indistinguishable from those of *B. urotramus*.

We have attempted to analyze the distribution among four nominal groups of argentinoids, of 14 characters, four of which are taken from developmental stages and 10 from the adult (Table 42). We have used teleosts in general and osmerids as our outgroup following Fink and Weitzman (1982). Distribution of character states are presented in Table 43.

A possible arrangement of groups based on the fewest number of character reversals is presented in Figure 88. Opisthoproctidae appears to be a well-founded family. More precise interpretation of the inter-relationships and nomenclatural ranking for argentinids, microstomatids, and bathylagids requires additional data.

(H.G.M.) SOUTHWEST FISHERIES CENTER, P.O. BOX 271, LA JOLLA, CALIFORNIA 92038; (D.M.C.) NATURAL HISTORY MUSEUM LOS ANGELES COUNTY 900 EXPOSITION BOULEVARD, LOS ANGELES, CALIFORNIA 90036.

Stomiatoidea: Development

K. KAWAGUCHI AND H. G. MOSER

FISHES of this group of midwater predators are characterized by their dark coloration, serial photophores, large jaws, fang-like teeth, and chin barbels. Traditionally they have been grouped in six families allied to the lightfishes and hatchfishes (Weitzman, 1974), and together are now considered monophy-

letic and given ordinal status (Rosen, 1973; Fink and Weitzman, 1982). Fink (this volume) gives evidence for reducing the six stomiatoid families to one. Because knowledge of stomiatoid ontogeny lags far behind that of the adults, for convenience of discussion we use Weitzman's (1974) grouping of the families

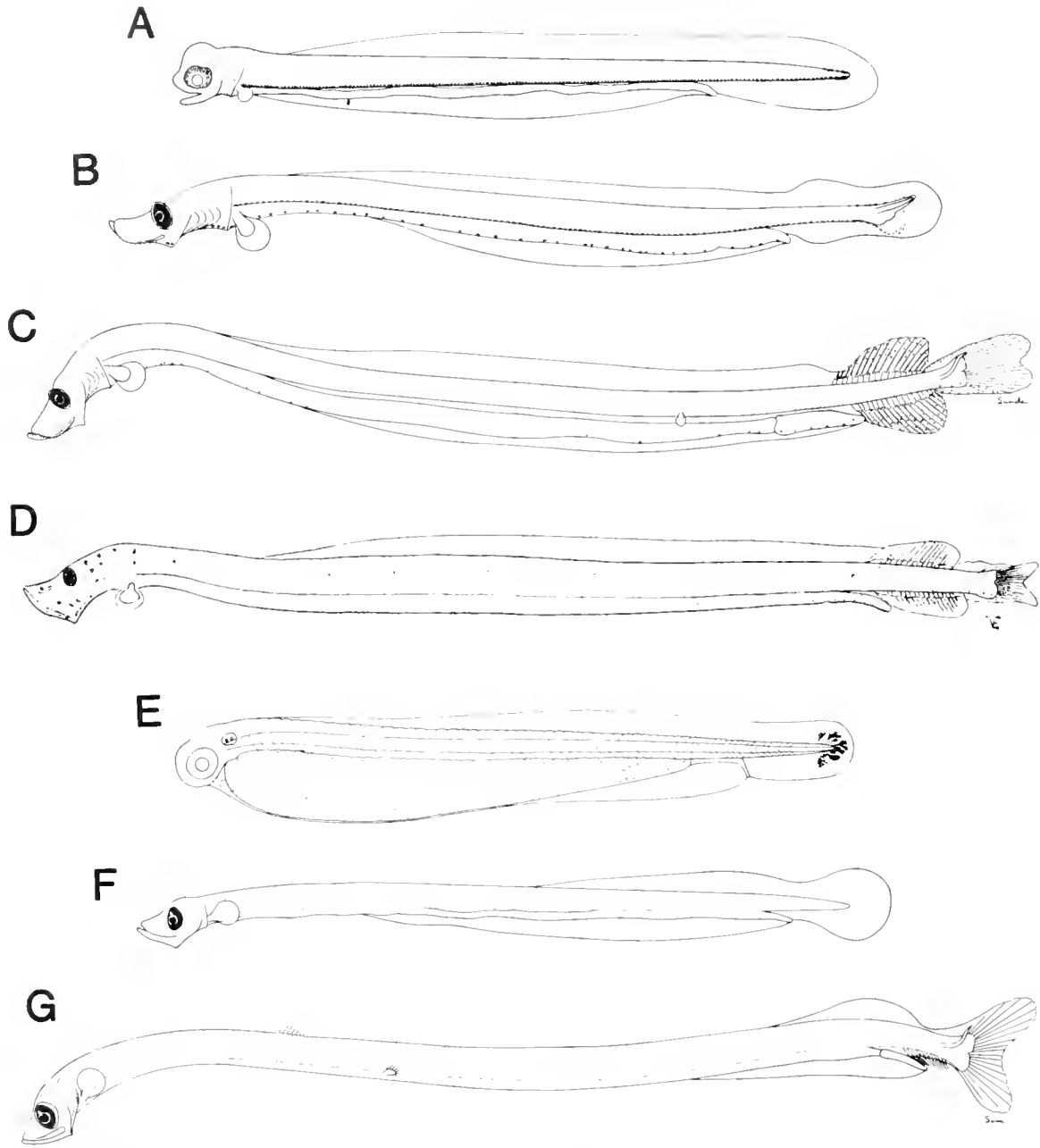

Fig. 89. Larvae of *Stomias* and *Chauliodus*. (A) *S. atriventer*, 4.6 mm, CalCOFI 7501 Sta. 97.60; (B) *S. atriventer*, 10.0 mm, CalCOFI 6604 Sta. 107.65; (C) *S. atriventer*, 22.2 mm; CalCOFI 6604 Sta. 107.65; (D) *S. ferox*, 30 mm, from Ege, (1918); (E) *C. sloani*, 6.0 mm; from Mito (1961a); (F) *C. macouni*, 15.0 mm, CalCOFI 6204 Sta. 60.60; (G) *C. macouni*, 45.2 mm, CalCOFI 5707 Sta. 67.60.

Astronesthidae, Stomiidae, Chauliodontidae, Melanostomiidae, Malacosteidae, and Idiakanthidae, in the Superfamily Stomiatoidea.

EGGS

Eggs are known for *Chauliodus*, *Stomias*, and *Tactostoma* and have in common a round shape, smooth chorion, and segmented yolk. *Chauliodus* eggs have a wide perivitelline space and lack an oil globule. Egg diameters are: *C. sloani*, 2.2–2.5

mm (Sanzo, 1931d); *C. barbatus*, 3.1–3.6 mm (Pertseva-Ostroumova and Rass, 1973); *C. macouni*, 2.7–3.1 mm, with an initial yolk diameter of 1.3–1.5 mm (original data). Mito (1961a) described an egg, referred to *C. sloani*, 2.12 mm in diameter with no oil globule but with a second membrane. *Stomias* eggs have a second membrane, a single oil globule and the following diameters: *S. colubrinus*, 1.3–1.5 mm, with inner membrane 1.05–1.1 mm (Pertseva-Ostroumova and Rass, 1973); *S. atriventer*, 0.88–0.92 mm, inner membrane diameter is 0.82–0.84

TABLE 44. MERISTIC COUNTS OF STOMIATOID GENERA. Most frequent count or range is followed by overall range or infrequent count in parentheses. Data from Gibbs (1964a,b), Gibbs et al. (1983), Morrow (1964a, b, c), Morrow and Gibbs (1964), Bolin (1939a), Imai (1941), original counts.

Family and genus	Vertebrae	Fin rays			
		Dorsal	Anal	Pectoral	Pelvic
Stomiidae					
<i>Macrostomias</i>	164	13,14	16 (15-18)	7 (6)	4
<i>Stomias</i>	64-83	17-20 (16-22)	19-21 (18-25)	6-7 (6-9)	5 (4)
Chauliodontidae					
<i>Chauliodus</i>	51-62	6,7 (5-7)	10-12 (10-13)	12,13 (11-14)	7 (6-8)
Astronesthidae					
<i>Astronesthes</i>	46-58	15 (10-21)	12-22	8 (5-9)	7 (6-8)
<i>Borostomias</i>	53-55	13 (10-14)	13-16 (10-19)	7 (6-9)	7
<i>Heterophotus</i>	66	11 (13)	12-15 (17)	7	7
<i>Neonesthes</i>	53	9-11 (12)	25-27 (22-28)	8 (7)	7 (6-8)
<i>Rhadinesthes</i>	67	11 (12,13)	18 (19-21)	7 (6-8)	7
Melanostomiidae					
<i>Bathophilus</i>	38-45 (33-50)	13-16 (9-18)	15-16 (9-18)	1-37	11-16 (4-26)
<i>Chirostomias</i>	54-55	18-20	22-26	6	7
<i>Echiostoma</i>	57-59	11-14 (11-16)	13-18 (13-19)	1+3	8
<i>Eustomias</i>	56-69	21-25 (20-30)	32-46	0-13	7 (6-8)
<i>Flagellostomias</i>	65	16 (14-17)	23-25 (21-26)	1+8-9+11	7
<i>Grammatostomias</i>	50-56	18-21	21-23 (20-24)	4-11	7-8
<i>Leptostomias</i>	77-80 (75-83)	16-22	20-29	10 (9-11)	7 (8)
<i>Melanostomias</i>	50-57	12-17	16-20	5 (4-6)	7 (8)
<i>Opostomias</i>	60	21	24	1+4	8
<i>Pachystomias</i>	48	22 (21-24)	27 (25-29)	5-6	8-9 (7)
<i>Photonectes</i>	49-64	15-24	17-24	0-3	7 (6)
<i>Tactostoma</i>	80-82	14-16	19-22	0	8-10
<i>Thysanactis</i>	61	17-18	21-25	1+10,11	7
<i>Trigonolampa</i>	61-62	19-20 (18)	18 (19)	5	7
Malacosteidae					
<i>Aristostomias</i>	44-56	18-26	24-32	6-10 (3-17)	6
<i>Malacosteus</i>	49	14-19 (20)	17-21 (23)	3-4 (5)	6
<i>Photostomias</i>	52-58	22-28	25-32	0	6
Idiacanthidae					
<i>Idiacanthus</i>	79-85	54-74	34 (33-39)	0	6

mm, oil globule diameter of 0.20-0.25 mm, initial yolk diameter of 0.70 mm (original data). *Tactostoma macropus* eggs have a single membrane, 1.44-1.54 mm in diameter, an oil globule 0.30-0.40 mm in diameter and an initial yolk diameter of 0.78-0.80 mm (original data). Eggs of *C. macouni* and *S. atriventer* are illustrated in Matarese and Sandknop (this volume).

LARVAE

Larvae of Stomiatoidea occur in the upper water column, some at the surface. In most groups the larvae are elongate, have a large head, elliptical eyes that protrude slightly from the dorsal head profile, an elongate, straight gut (trailing from the body in some species), a well developed finfold, large paddle-shaped pectoral fins that lack rays until transformation, and late-forming pelvic fins. Melanophore patterns provide a useful set of characters and genera usually have a distinct pattern. The larval melanophores are retained in a subcutaneous position in transforming specimens and provide a means for identifying larvae. During transformation, photophores form simultaneously and initially are unpigmented. Counts of fin rays, vertebrae, and photophores are summarized in Tables 44 and 45.

Stomiidae (Fig. 89).—Larvae of five species are known (Table

46). Larvae are 3-4 mm at hatching and have an elongate yolk sac. The slender body is round in cross-section, but becomes slightly deeper by late postflexion. The head is relatively small with a slightly flattened snout. The eyes are elliptical. The elongate gut extends almost the entire length of the body and has a slightly enlarged terminal section that reaches the anal fin origin. The median finfold is small and best developed posteriorly. The opposing dorsal and anal fins develop far posteriorly on the body in early postflexion larvae, but the pelvic fins do not appear until just before transformation.

Late-stage embryos of *Stomias* have melanophores along the dorsum, which migrate ventrad and form a distinct series between the body and gut. This series extends to the tip of the notochord. The series is lost before notochord flexion but, in most species, another sparser series develops along the ventral midline of the gut, from the isthmus to the anus. *S. boa* and *S. ferox* develop a mid-lateral series of melanophores along the body and *S. colubrinus* has scattered melanophores along the entire hypaxial body region. These species also develop extensive dorsal and lateral head pigment. All species form scattered pigment on the dorsal, anal, and caudal fins.

A 75-mm specimen (MCZ Cat. No. 59858) with an extremely slender body form (body depth 1.3% of body length) has fin and

TABLE 45. PHOTOPHORE COUNTS OF STOMIATOID GENERA. Most frequent count or range is followed by overall range or infrequent count in parentheses. Data sources as in Table 1. Photophore groups as defined by Morrow (1964a).

Family and genus	Photophore groups					
	IP	PV	VAV	AC	OV	VAL
Stomiidae						
<i>Macrostomias</i>	11 (12)	80-86	58-67	19-22	79-85	58-68
<i>Stomias</i>	9-13	32-51	5-16	14-20	32-50	4-17
Chauliodontidae						
<i>Chauliodus</i>	8-11	17-23	22-30	8-13	17-21	22-29
Astronesthidae						
<i>Astronesthes</i>	5-12	6-20	7-27	7-13	5-19	7-26
<i>Borostomias</i>	10-13	20-31	15-25	9-15	21-29	16-25
<i>Heterophotus</i>	10-11	32-35	13-14	12-15	33-36	16-20
<i>Neonesthes</i>	9-12	14-17	16-21	13-18	13-15	13-21
<i>Rhadinesthes</i>	10 (6)	25 (26)	20-23	16	22-24	27
Melanostomiidae						
<i>Bathophilus</i>	5 (4-6)	12-18	11-13 (11-17)	5-7 (5-9)	13-14 (10-16)	9-11 (8-17)
<i>Chirostomias</i>	9 (8)	25-27 (28)	19-20 (16)	9 (10)	23 (24-25)	19-20 (16)
<i>Echostoma</i>	8+2	25-28	14-18	12-13 (11)	24-31	13-17 (18)
<i>Eustomias</i>	7-8 (9)	27-33 (24-36)	13-17 (11-21)	17-23 (15-25)	26-33 (24-37)	13-18 (12-22)
<i>Flagellostomias</i>	9-10 (8)	31-34	14-16	16-18 (15)	31-32 (30)	14-15 (12-17)
<i>Grammatostomias</i>	7 (6)	15-18	19-22	10-13	15-18	19-22
<i>Leptostomias</i>	10 (11)	42-45 (39-48)	20-23 (24)	11-13 (14)	40-43 (39-48)	20-22 (23-24)
<i>Melanostomias</i>	8+2 or 3	23-30	12-15	9-11	22-28	11-15
<i>Opostomias</i>	4+4	27	17	16	27	17
<i>Pachystomias</i>	8-9	14-16 (17)	13-14	8-9	17-18	14-15
<i>Photonectes</i>	8-11	19-24, 34-38	11-15 (16-18)	10-13 (9)	19-24 (17), 30-36	11-14 (15-17)
<i>Tactostoma</i>	8	46	19	12	43	18
<i>Thysanactis</i>	20	31-32	14-16	11-12	30-32	14-16
<i>Trigonolampa</i>	11	23-24 (22)	22 (24)	10-11	22-24	23-24 (26)
Malacosteidae						
<i>Aristostomias</i>	5+3	15-17 (14-19)	15-18	9-11 (12)	16-19 (14-20)	15-17 (14-18)
<i>Malacosteus</i>	(Serial photophores absent or uncountable)					
<i>Photostomias</i>	5+2	13-16	21-25	12-15	12-17	20-23
Idiacanthidae						
<i>Idiacanthus</i>	IP+PV = 31-36		16-18 (15)	13-18	22-25	31-35 (30-36)

vertebral counts that match *Macrostomias longibarbatius*. Its morphology is that of a highly attenuate *Stomias* larva. Pigmentation is restricted to a series of small melanophores along the ventral midline of the gut. The ventral photophore rows are beginning to form.

Chauliodontidae (Fig. 89).—Larvae of five species are known (Table 46). Larvae are 6-7 mm long at hatching, with an elongate yolk sac. The body is slender with a circular cross-section, and remains so throughout development. The head is relatively small, with elliptical eyes and a short, acute snout. The gut has a smaller diameter than in *Stomias* but is relatively longer. The short terminal section extends beyond the anal fin origin. The median finfold is small and best developed rearward on the body. The dorsal, anal, and pelvic fins form in late postflexion larvae in the adult position. A fan-shaped array of melanophores occurs in the caudal region of yolk-sac larvae but is soon lost. No other pigment develops. Larvae of some species reach 46 mm SL and there appears to be marked shrinkage at transformation.

Astronesthidae (Fig. 90).—Astronesthid larvae have been illustrated and described briefly by Roule and Angel (1930), Whitley (1941), Pertseva-Ostroumova and Rass (1973), and Belyanina (1982b); however only two of these were identified to genus (Table 46). We have examined more than 10 types of astronesthid larvae, 7 of which are listed in Table 46. Astronesthid larvae display a great variety of structure and pigmentation, but hold in common the advanced position of the dorsal fin, in contrast to other Stomiatoidea, except *Chauliodus*. The types differ fundamentally in gut shape and body form: Types I and II are laterally compressed, relatively deep-bodied, and have a non-trailing or slightly trailing gut with terminal section as in melanostomiids; Types III-VII have a slender body and a trailing gut; in Types III-V the gut is deflected ventrad from the body just anterior to the anal fin base and in Type VI and VII at midbody, anterior to the dorsal fin (Figure 90).

Type I (Fig. 90A).—larvae up to 26.5 mm; laterally compressed; head shallow with acute snout; eyes relatively large, slightly

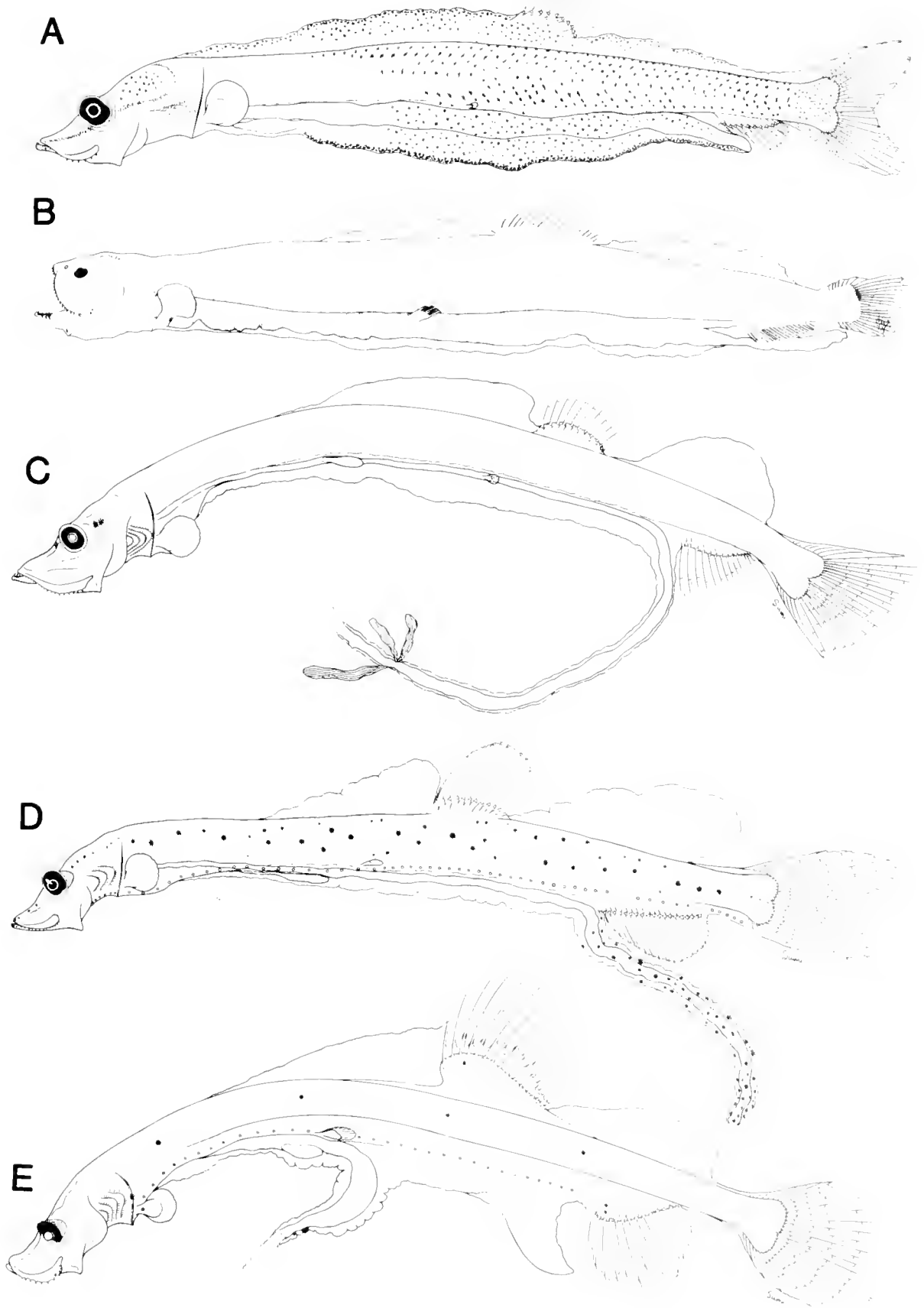

TABLE 46. PIGMENT CHARACTERS AND GUT STRUCTURE IN LARVAE AND TRANSFORMING SPECIMENS OF STOMIATOIDEA. (NT = not trailing, ST = slightly trailing, T = trailing freely).

Species	Length of larvae (mm)	Length of transforming specimens (mm)	Dorsal myomere melanophores (no./myomere)	Epaxial myoseptum melanophores (no./myoseptum)	Hypaxial myoseptum melanophores (no. myoseptum)	Gut structure	Source
Stomiidae							
<i>Stomias boa</i>	—	38	0	0	0	NT	Sanzo, 1912a
<i>Stomias boa</i>	10.4–30.4	41.5	0	0	0	NT	Sanzo, 1931d
<i>Stomias boa</i>	9.0–32	—	0	0	0	NT	Ege, 1918
<i>Stomias ferox</i>	9.0–44	—	0	0	0	NT	Ege, 1918
<i>Stomias colubrinus</i>	3.3–16	—	0	0	0	NT	Pertseva-Ostroumova and Rass, 1973
<i>Stomias atriventer</i>	4.6–32	—	0	0	0	NT	original
<i>Macrostomias longibarbatu</i>	—	75	0	0	0	NT	original
Chauliodontidae							
<i>Chauliodus sloani</i>	33.6	41.6	0	0	0	NT	Sanzo, 1915a
<i>Chauliodus sloani</i>	5.7–41.6	27.1	0	0	0	NT	Sanzo, 1931d
<i>Chauliodus sloani</i>	2.1	—	0	0	0	NT	Mito, 1961a
<i>Chauliodus danae</i>	22.5–25	—	0	0	0	NT	Belyanina, 1977
<i>Chauliodus macoum</i>	38.0–49	35–44	0	0	0	NT	Belyanina, 1977
<i>Chauliodus mimmus</i>	23.5–35	—	0	0	0	NT	Belyanina, 1977
<i>Chauliodus pammelas</i>	10.6–40	—	0	0	0	NT	Belyanina, 1977
<i>Chauliodus sloani</i>	7.4–35	27–34.2	0	0	0	NT	Belyanina, 1977
<i>Chauliodus macoum</i>	5.6–46	—	0	0	0	NT	original
Astronesthidae							
Unidentified	14.0–23	—	0	0	0	T, NT	Roule and Angel, 1930
<i>Astronesthes lupina</i>	20	—	0	0	0	T	Whitley, 1941
<i>Borostomias panamense</i>	5.0–17	—	0	0	0	T	Pertseva-Ostroumova and Rass, 1973
Unidentified	16	—	?	+	+	NT	Belyanina, 1982b
Unidentified	17.7	—	2 total	0	0	T	Belyanina, 1982b
Type I	12.3–26.5	—	several	several to many	several to many	NT	original
Type II	14.9–26	29, 40	0	0	0	ST	original
Type III	16.2	20.5, 22.5	0	0	0	T	original
Type IV	14.4–34.5	40.5	0	0	0	T	original
Type V	17.4–19.4	20, 22	0	0	0	T	original
Type VI	—	28	0	0	0	T	original
Type VII	—	28	0	0	0	T	original
Melanostomiidae							
<i>Tactostoma macropus</i>	5.0–44	49	0–1	0	1–3	NT	original
<i>Melanostomias spilorhynchus</i>	17	21–32	1	0	ca. 3	NT	Beebe and Crane, 1939
<i>Melanostomias biseriatus</i>	—	21–25	1	0	ca. 3	NT	Beebe and Crane, 1939
<i>Melanostomias valdiviae</i>	—	25	1	0	2–3	NT	original
<i>Melanostomias</i> sp.	13.4–17.2	16.4–22	1	0	2–4	NT	original
<i>Echostoma tanneri</i>	20, 25	—	1	0	2–5	NT	Beebe and Crane, 1939
<i>Echostoma</i> sp.?	13.8	—	1	0	2–4	NT	Belyanina, 1982b
<i>Echostoma barbatum</i>	—	34	1	0	1–2	NT	original
<i>Photonectes dinema</i>	—	24 and >	1 (?)	0	3–4	NT	Beebe and Crane, 1939
<i>Photonectes leucospilus</i>	—	25 and >	1 (?)	0	3–4	NT	Beebe and Crane, 1939
<i>Photonectes alpinus</i>	—	16–22	1	0	2–3	NT	original
<i>Photonectes</i> sp.	11.0–12.5	—	1	0	4–5	NT	original
<i>Photonectes parvimanus</i>	12.0–26	25	3–6	0	3–4	NT	Beebe and Crane, 1939
<i>Photonectes parvimanus</i>	27	—	3–4	0	2–4	NT	original
<i>Photonectes parvimanus</i>	—	28	1–2	0	2–4	NT	original
<i>Photonectes</i> sp.	5.4–22.2	—	ca. 7	0	5–7	NT	original
<i>Opostomias mitsu</i>	15.0–21	—	1	0–1 (2–3 posteriorly)	1–2 (3–5 post.)	NT	original
<i>Flagellostomias boureci</i>	20.0–21	34, 39	1	0	1	NT	Beebe and Crane, 1939
<i>Flagellostomias boureci</i>	10.8–36.4	—	1	0	1–2	NT	original
<i>Odontostomias micropogon</i>	—	42	1	1–?	2–4	NT	Beebe and Crane, 1939
<i>Leptostomias gladiator</i>	12.0–30	38–45	1+several	1–5	2–4	NT	Beebe and Crane, 1939
<i>Leptostomias gracilis</i>	—	37.8	1+1–5	5–7	6–9	NT	original
<i>Leptostomias</i> sp.	25	—	1+1–3	4–5	4–6	NT	original
<i>Bathophilus nigerrimus</i>	11.6	21.7	1 or >	0	0	NT	Sanzo, 1915a
<i>Bathophilus nigerrimus</i>	5.9, 14.0	19.2–21.7	1 or >	0	0	NT	Sanzo, 1931d

TABLE 46. CONTINUED.

Species	Length of larvae (mm)	Length of transforming specimens (mm)	Dorsal myomere melanophores (no./myomere)	Epaxial myoseptum melanophores (no./myoseptum)	Hypaxial myoseptum melanophores (no./myoseptum)	Gut structure	Source
<i>Bathophilus metallicus</i>	—	25	3 or >	0	0	NT	Beebe and Crane, 1939
<i>Bathophilus</i> sp.	11, 12	—	1 or >	0	0	NT	Beebe and Crane, 1939
<i>Bathophilus</i> sp.	7	—	1 or >	0	0	NT	Beebe and Crane, 1939
<i>Bathophilus</i> sp.	15	—	(?)	0	0	NT	Roule and Angel, 1930
<i>Bathophilus</i> sp.	18.2	—	1 or >	0	0	NT	de Sylva and Scotten, 1972
<i>Bathophilus filifer</i>	4–10	—	1 or >	0	0	NT	Pertseva-Ostroumova and Rass 1973
<i>Bathophilus brevis</i>	15.7	—	1 or >	0	0	NT	original
<i>Bathophilus flemingi</i>	2.9–23.8	—	1 to several	0	0	NT	original
<i>Eustomias</i> sp.	33	—	7 total	0	0	T	Regan, 1916
<i>Eustomias</i> sp.	13	—	7 total	0	0	T	Beebe and Crane, 1939
<i>Eustomias</i> spp. (4 types)	6.0–45	—	5–11 total	0	0	T	original
Malacosteidae							
<i>Aristostomias scintillans</i>	4.3–47	45	14 total	0	0	T	original
<i>Photostomias guernei</i>	20.0–27.5	30, 31	to many 8 pairs	0	0	T	original
Unidentified	12	—	total	0	0	T	Beebe and Crane, 1939
Unidentified	34.5	—	12 total	0	0	T	original
Idiacanthidae							
<i>Idiacanthus fasciola</i>	16.0–28	35–48	0	0	1	T	Beebe, 1934
<i>Idiacanthus</i> sp.	7.0–39	—	0	0	1	T	Pertseva-Ostroumova and Rass, 1973
<i>Idiacanthus antrostomus</i>	4.5–71	67–>	0	0	1	T	original

elliptical; gut moderately slender, thin-walled; finfold moderate; pigment pattern consists entirely of minute melanophores, increasing in number with development, principally in the epaxial and hypaxial myosepta; other pigment above brain, paired internal streaks in snout, melanophores in dorsal and ventral finfold, dorsal fin base, and on posterior half of gut.

Type II (Fig. 90B).—larvae reach at least 26 mm; deep-bodied and laterally compressed in late-stage larvae; head deep; eyes small, slightly elliptical; gut slightly trailing and with larger diameter than in Type I; dorsal finfold relatively deep; pigment above brain, along lower jaw and at angular and gular region; blotch at posterior margin of superior hypural complex and one midway out on inferior group of caudal rays; fin ray and vertebral counts and photophore counts match *Astronesthes gemmifer*.

Type III.—larvae reach at least 16.2 mm; body slender; head and eyes moderate in size; eyes elliptical; slender gut trails free from body at anal fin origin; finfold moderately developed, except posterior to dorsal fin the finfold appears as an enlarged adipose fin; pigment restricted to a series of melanophores along lower jaw and between upper and lower hypural complexes; counts match *Astronesthes richardsoni*.

Type IV (Fig. 90C).—larvae reach 40 mm; morphology similar to Type III, except head relatively longer and eyes almost round; gut with leaf-like appendages on trailing section; pigment restricted to postorbital blotch and interorbital band; fin and vertebral counts and photophore arrangement match *Heterophotus*.

Type V (Fig. 90D).—larvae reach about 20 mm; morphology as in Types III and IV; eyes slightly elliptical; pigment heavy; melanophores on head, lateral to posterior brain region, on snout and lower jaw symphysis; lateral surface of body covered with an irregular pattern of large melanophores; melanophores on trailing gut. Pertseva-Ostroumova and Rass (1973) identified larvae of this type as *Borostomias panamense*.

Type VI.—specimen transforming at 28 mm; morphology similar to Types II–V, except trailing gut deflected from body far in advance of anal fin origin; eyes elliptical; dorsal finfold highly developed and ventral finfold anterior to anal fin is rudder-like; pigment lacking; meristics indicate it is in the genus *Astronesthes*.

Type VII (Fig. 90E).—specimen transforming at 28 mm; morphology similar to Type VI; dorsal and anal fins supported on cartilaginous pedestals; a series of 4 melanophores along horizontal septum; some melanophores on anterior region of dorsal and anal fin bases and on preanal finfold. Whitley (1941) described a larva similar to this as *Astronesthes lupina*.

Melanostomatidae (Figs. 91–92).—Larvae have been identified for 10 of the 15 genera (Table 46). *Bathophilus* was the first to be identified (Sanzo, 1915a). The only comprehensive work on melanostomiid ontogeny is that of Beebe and Crane (1939) who identified larvae of 8 genera and 5 species by the use of transforming series. Since then, the only other melanostomiid larvae that have been described are *Bathophilus filifer* (Pertseva-Ostroumova and Rass, 1973), *Bathophilus* sp. (de Sylva and Scotten, 1972), and *Echiostoma* (?) sp. (Belyanina, 1982b). De-

scriptions of *Opostomias* and *Tactostoma* are included in this paper. Larvae of *Tactostoma* were initially identified by E. H. Ahlstrom.

Larval representatives of the 10 genera are highly various in form and pigmentation, however, with the exception of *Eustomias*, they share the following structural features: body elliptical in cross-section; head laterally compressed; eyes small and elliptical; gut terminated in an elongate muscular bulb that may extend beyond the anal fin origin but not beyond the margin of the finfold; dorsal and anal fins form in adult position posteriorly on the body; body pigment consists of one or more melanophores dorsal to each myomere, one or more melanophores on the hypaxial myosepta and, in some genera, on the epaxial myosepta. Dorsal and lateral pigmentation tends to be heavier in forms with higher meristic counts. The genera differ principally in body size, relative body depth, relative head size, jaw size, gut diameter, size and shape of the terminal gut section, finfold height, and pigment pattern.

Present knowledge indicates that genera apparently have distinct facies, tentative descriptions of which are presented below. Confirmation awaits identification of additional species.

Tactostoma (Fig. 91A).—larvae reach 44 mm in length; body extremely slender; head flat and elongate initially, becoming less flat and relatively smaller with development; eye size moderate; gut slender; finfold moderate; pectoral fin lost at transformation; early larvae develop one melanophore per myomere along dorsum and 1–3 melanophores on the hypaxial myosepta; post-flexion larvae gradually lose the dorsal melanophores and then the hypaxial myosepta pigment, in contrast with other genera in which body pigment increases with development; pigment on lower jaw symphysis, isthmus, pectoral fin base, cleithrum, and above gut terminus; dorsal and ventral pigment accentuated at caudal peduncle.

Melanostomias (Fig. 91B).—transforming specimens as small as 16.4 mm; body slender; head small; snout short; eye size moderate; gut slender; finfold relatively small; one melanophore per myomere along dorsum in one form and in another form the zone between the 7th–10th myomere and the dorsal fin lacks dorsal pigment; 2–3 melanophores in hypaxial myosepta; pigment above and below head, below liver, on terminal gut section, and along finfold margins. Larvae tentatively identified as *Echiostoma* have similar characters (Table 46).

Photonectes (Fig. 91C).—larvae of different forms transform at sizes between 16 and 28 mm; body somewhat deep; head size and snout length moderate; eyes small, highly elliptical; several forms of dorsal myomere pigment (1 melanophore per myomere in Subgenus *Photonectes* and 3–7 per myomere in Subgenus *Trachinostomias*); hypaxial myosepta with 2–7 melanophores depending on form (Table 46); extensive pattern of minute melanophores on head, finfold, and median fins.

Flagellostomias (Fig. 91D).—larvae may reach 30–40 mm; body somewhat deep; head large, deep, with steeply sloping snout and

large jaws; eyes small; gut diameter relatively large; finfolds large, accentuating body depth; one large melanophore per myomere along dorsum; 1–3 melanophores in hypaxial myosepta; some scattered lateral melanophores in median fin region; other pigment scant; a few melanophores in head region, some on finfold in posterior gut region, and on dorsal and anal fins.

Opostomias (Fig. 91E).—body moderately deep; head large, deep posteriorly with elongate sloping snout; eyes small; gut slender; finfold large; one melanophore per myomere along dorsum; 1–2 melanophores in hypaxial myosepta; epaxial and hypaxial myosepta below dorsal fin base have several melanophores, giving this region a banded appearance; melanophores on dorsal head region, gill arch and gut terminus.

Leptostomias (Fig. 91F).—larvae may reach about 40 mm; body somewhat deep; head moderately large, deep; eyes small; gut slender; finfold moderate; pigmentation heavy; one large melanophore and 1–5 smaller ones per myomere along dorsum; numerous melanophores on epaxial and hypaxial myosepta, increasing with development to completely outline myosepta; pigment extensive on dorsal and ventral head regions, on gill arches; pigment below liver, on finfold margins, above gut terminus and on dorsal and anal fins.

Bathophilus (Figs. 92A–C).—larvae transform at 25 mm or less; deep-bodied compared with other genera; head and jaws large; barbel forms in late postflexion larvae, particularly in *B. brevis*; eye size moderate; gut large to voluminous, with highly developed s-shaped terminal section; finfolds, particularly dorsal, large; one or several melanophores per myomere along dorsum and an opposing series of melanophores along ventral surface of myomeres; no lateral pigment; head, finfolds and median fins pigmented.

Eustomias (Fig. 92D).—larvae of some species reach 45 mm; body slender, and round in cross-section; head elongate and flat with large spatulate snout; large jaws; eyes moderate in size, slightly elliptical to round; gut slender, deflected ventrad at anal fin origin and trailing from body; body pigment consists of 5–11 large melanophores along the dorsal midline; usually pigment at lower jaw symphysis.

Malacosteidae (Fig. 93).—Larvae of this group have not been described, although the 12-mm larva illustrated by Beebe and Crane (1939) and referred to “*Eustomias*” is apparently *Aristostomias*. We have examined larval series and transforming specimens of *A. scintillans* and *Photostomias guernei* (Table 46).

Aristostomias scintillans (Fig. 93A).—larvae reach 47 mm length; body slender; head large, flat; snout elongate; jaws large; eyes slightly elliptical; opercle markedly reduced; gut slender, deflected ventrad at anal fin origin and trailing from body; finfold moderate; dorsal and anal fins form in adult position at about flexion stage; pelvics form late; initial pigment pattern is a series of paired melanophores along the dorsum, beginning with 14

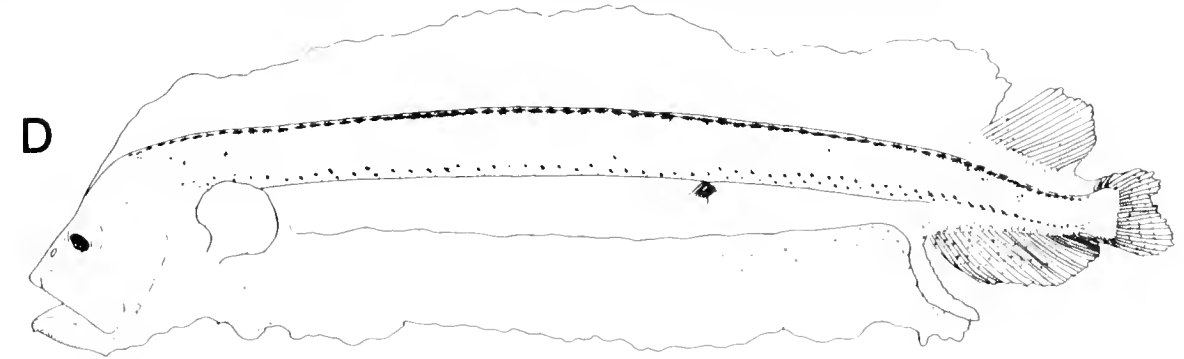
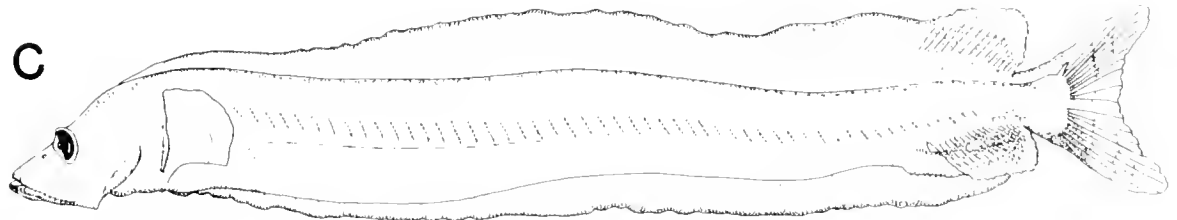
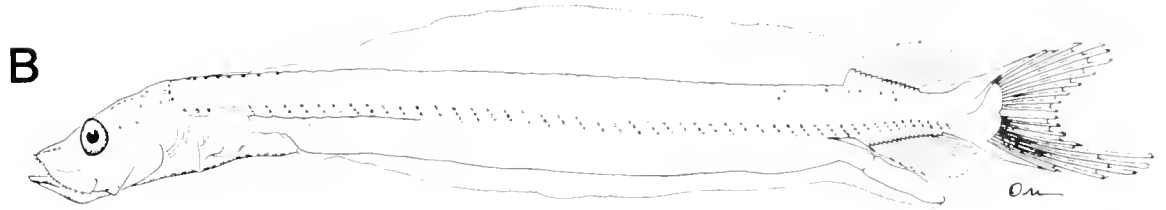

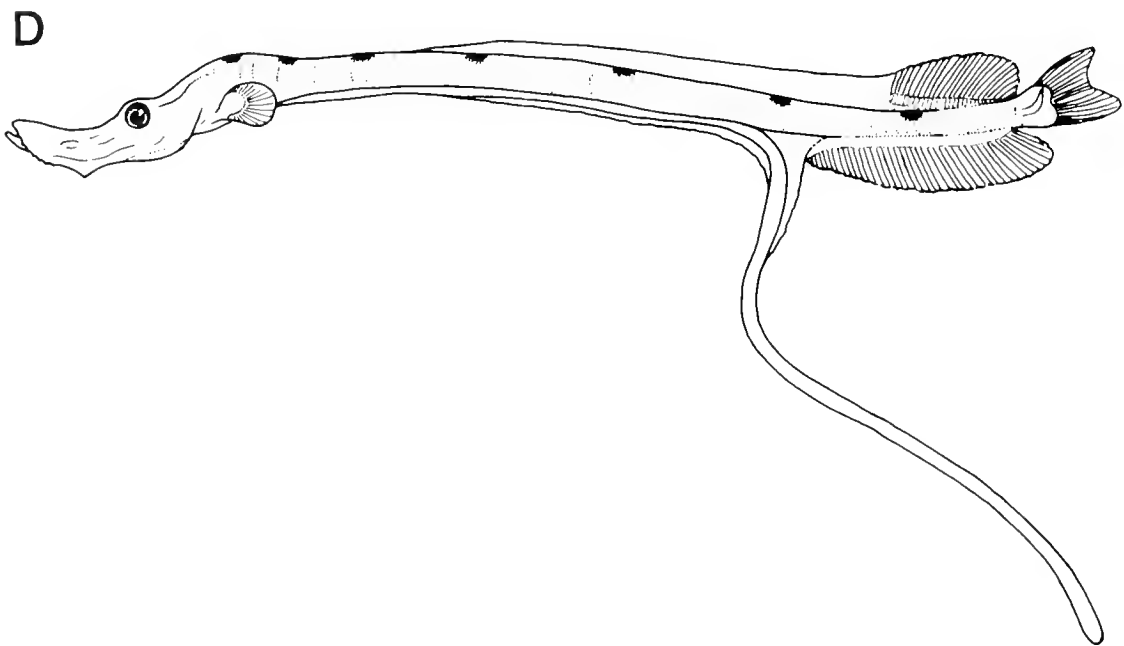
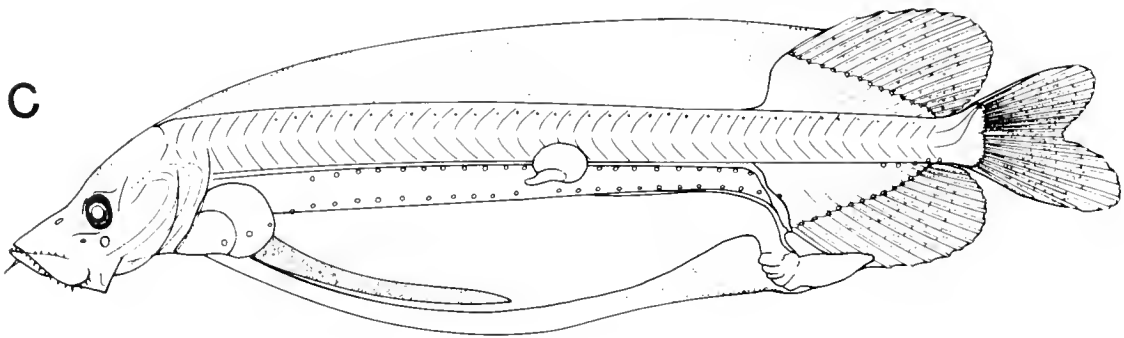
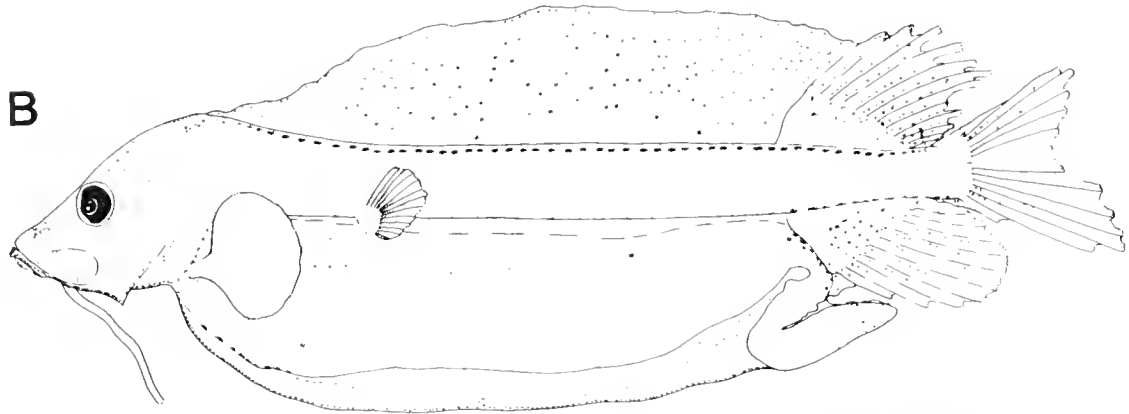
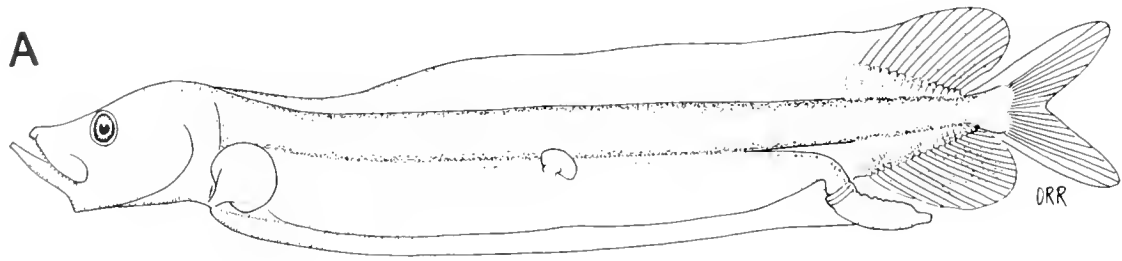

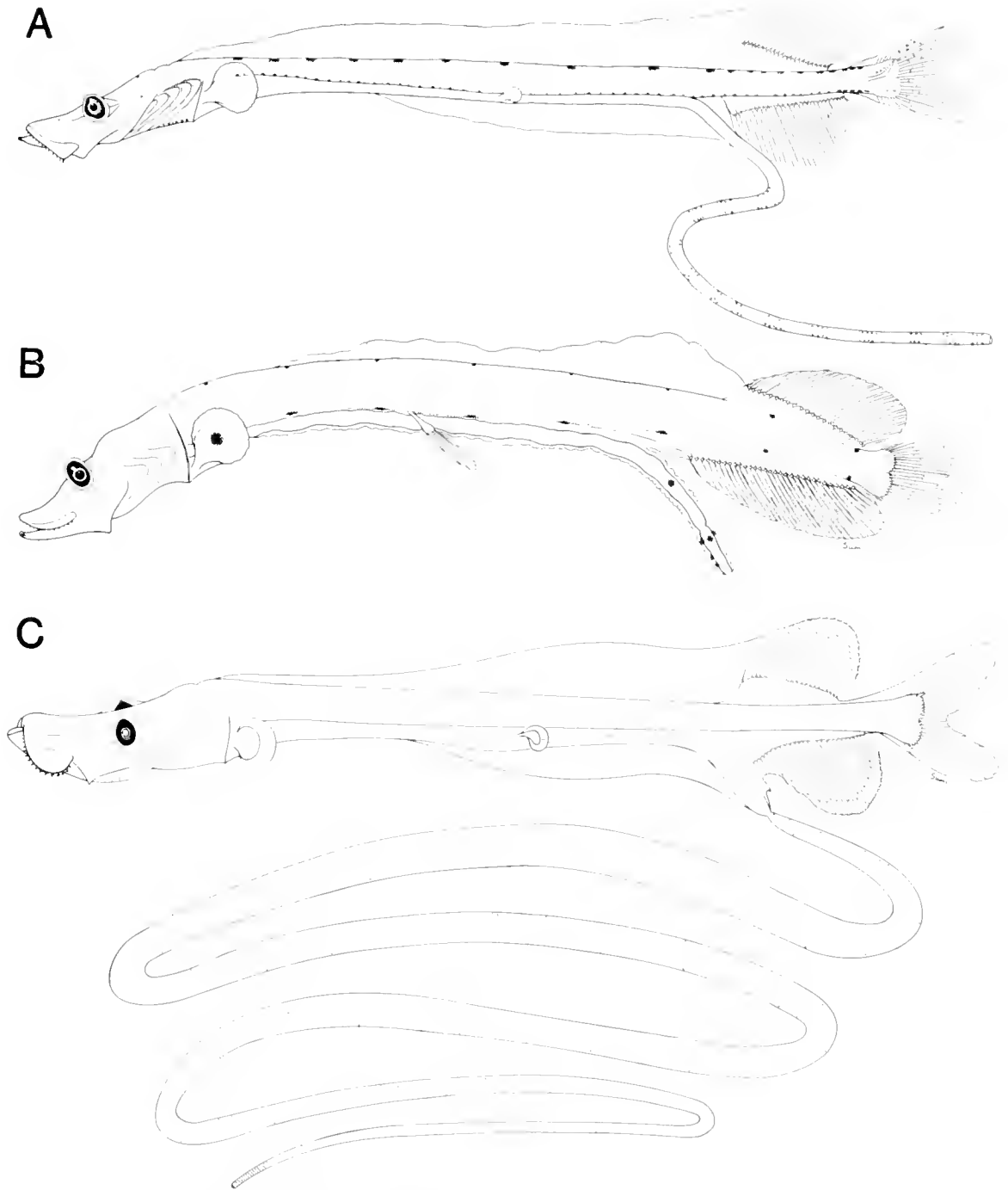

Fig. 93. Larvae of Malacosteidae. (A) *Aristostomias scintillans*, 34.7 mm, CalCOFI 5008 Sta. 70.30; (B) *Photostomias* sp., 26.7 mm, ORI KH 73-5 Sta. 55-13, Bn 24-12; (C) Malacosteidae, 34.5 mm, from Moser (1981).

Fig. 92. Larvae of Melanostomiidae. (A) *Bathophilus flemingi*, 25.5 mm, CalCOFI 4910, Sta. 80.137; (B) *B. brevis*, 15.7 mm, ORI KH 81-1, Sta. 17; (C) *B. nigerrimus*, 21.7 mm, redrawn from Sanzo (1931d); (D) *Eustomias* sp. 33 mm, redrawn from Regan (1916).

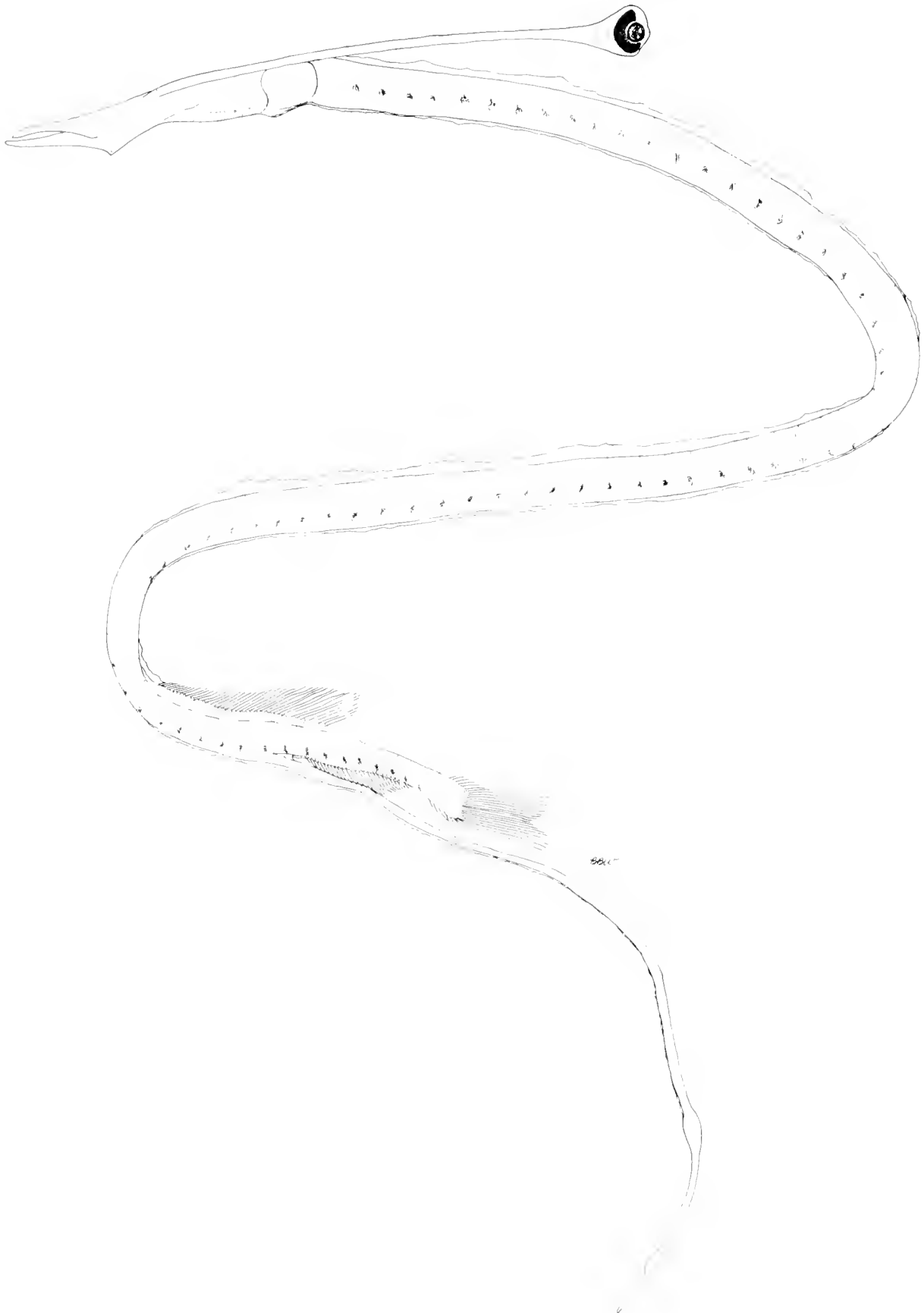

Fig. 94. Larva of *Idiacanthus antrostomus*, 55 mm, CalCOFI 6207 Sta. 90.120.

pairs and increasing in numbers with development to cover the entire dorsum; paired ventral series develop, initially posteriorly, and increase in numbers so that all myomeres have melanophores on the ventral surface; pigment on brain, snout, lower jaw, gular-isthmus region, otic region, caudal fin, and in vague rings along trailing gut. *Aristostomias* larvae were identified initially by E. H. Ahlstrom.

Photostomias guernei (Fig. 93B).—larvae reach about 30 mm; morphology similar to *A. scintillans* except eyes smaller and narrower and pelvic fins somewhat elongate; body pigment consists of a series of 8 minute dorsal melanophore pairs and 8 slightly larger opposing pairs along the ventral surfaces of the myomeres; melanophores at lower jaw symphysis, large melanophore on each pectoral fin base, sparse melanistic rings along trailing gut.

Malacosteid C (Fig. 93C).—intact specimen (captured by Dr. Richard Harbison, WHOI) has morphological and meristic characters of malacosteid larvae but lacks pigment except on the extensive gut. Shallow capture locality of this specimen and our capture of large *A. scintillans* larvae in MANTA nets indicates late-stage malacosteid larvae have a shallow distribution in the water column.

Idiacanthidae (Fig. 94).—Brauer (1906, 1908) described the remarkable larvae of *Idiacanthus* and named them *Stylophthalminus paradoxus*. Beebe (1934) correctly identified the larvae and described them in detail. *Idiacanthus* larvae are extremely slender, reaching a length of 35–70 mm depending on the species. Other characteristics are: elongate and extremely flat head; elliptical eyes on long stalks with cartilaginous supporting rods; stalk length up to 27% of body length in *I. antrostomus* (Weihs and Moser, 1981); gut slender, deflected at anal fin origin and trailing; finfold small; dorsal fin begins forming in preflexion larvae; dorsal fin larger than anal fin and slightly in advance of it in postflexion larvae; during transformation, rays added sequentially anteriorly so that in adults the dorsal extends about $\frac{2}{3}$ of the body length and the anal about $\frac{1}{3}$; pectoral fins well developed but lost at transformation and pelvic fins develop in transforming females, but not at all in males; pigment pattern consists of a melanophore on the posterior margin of each hypaxial myomere, spreading into the myosepta when expanded, several elongate internal blotches in the isthmus region, and a series of melanophores along the trailing gut; adult males of *I. fasciola* reach 32–42 mm SL, lack teeth and paired fins and have relatively larger eyes and an enormous luminous gland.

RELATIONSHIPS

Information on larval characters of 18 of the 26 stomiatoidean genera recognized by Fink (this volume), representing all 6 of the families recognized by Weitzman (1974), permits some preliminary generalizations and conclusions: (1) Larvae of Stomiidae and Chauliodontidae are similar in morphology and are distinct from other stomiatoideans. Pigmentation provides further evidence of this; *Chauliodus* larvae are unique among known stomiatoideans in lacking pigment after the yolk-sac stage and the median series of gut melanophores of *Stomias* also appear to be unique. (2) Larvae of Astronesthidae are diverse in morphology and pigmentation and most of the larval specializations that appear in other stomiatoidean families are found among astronesthid genera. Larval specializations of some genera (e.g., ornamented trailing gut, trailing gut deflected at mid-body, rudder-like finfolds) are not found elsewhere in Stomiatoidea. Heterogeneity of larval characters in Astronesthidae supports Fink's view that the group is paraphyletic. (3) In the Melanostomiidae, larvae of *Melanostomias*, *Photonectes*, *Echiostoma*, *Opostomias*, *Flagellostomias*, *Odontostomias* and *Leptostomias* are similar in morphology, have paired melanophore series on the dorsum, and differ chiefly in head size, body depth, and in the extent of myosepta pigment. *Tactostoma* larvae have the characters of this group of genera except that the body is extremely slender and the pigmentation is lost in the postflexion stage. Larvae of *Bathophilus* differ from those of the above group in a number of characters (voluminous gut with specialized terminal section, melanophore series on the ventral surface of the myomeres, lack of myosepta pigment). Larvae of *Eustomias* are different from all known larvae of Melanostomiidae in having a trailing gut, flat head and snout, and a pigment pattern consisting of a median series of up to 11 large melanophores on the dorsum. Except for this latter feature, *Eustomias* larvae are similar to those of Malacosteidae. (4) *Idiacanthus* larvae have a combination of characters unique among stomiatoideans. The stalked eyes are autapomorphic. Larval characters provide no support for Fink's hypothesis that this genus is closely related to *Tactostoma*.

OCEAN RESEARCH INSTITUTE, UNIVERSITY OF TOKYO, 1-15-1, MINAMIDAI, NAKANO-KU, TOKYO 164, JAPAN, AND NATIONAL MARINE FISHERIES SERVICE, SOUTHWEST FISHERIES CENTER, 8604 LA JOLLA SHORES DRIVE, LA JOLLA, CALIFORNIA 92038.

Stomiiforms: Relationships

W. L. FINK

STOMIIFORMS are well known as a major component of the midwater oceanic fauna. Past concepts of their relationships to other primitive euteleosts were reviewed by Fink and Weitzman (1982), but in brief, in this century, they have

been considered isospondyls (Parr, 1927; Regan, 1923; Morrow, 1964) or, more recently, salmoniform protacanthopterygians (Greenwood et al., 1966). In 1973, Rosen placed these fishes as a separate order (Stomiiformes) within the Neoteleostei, as

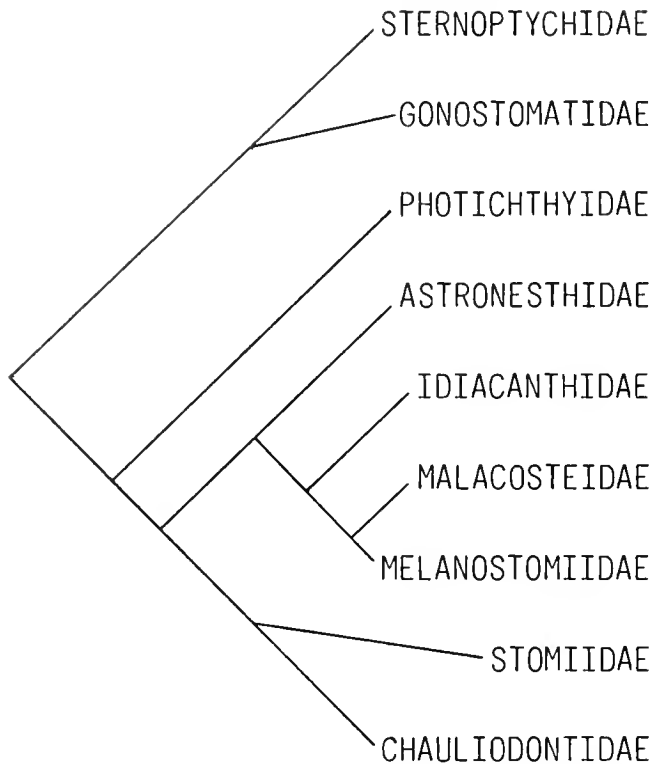

Fig. 95. Weitzman's (1974) hypothesis of relationships of the stomiiform fishes. The Gonostomatidae and Sternoptychidae comprise the Gonostomata and the remaining families comprise the Photichthya.

sister group to the Eurypterygii. Fink and Weitzman (1982) agreed with this placement, provided more characters to substantiate it, and demonstrated monophyly of the stomiiforms. Steyskal (1980) has presented arguments that the root of the family-group names demands that these be altered from Stomiidae and Stomiiformes to Stomiidae and Stomiiformes, respectively, and I use these forms throughout this paper.

As recognized by Weitzman (1974), there are two major stomiiform lineages, Gonostomata and Photichthya, both classified at infraordinal rank, with families Gonostomatidae and Sternoptychidae in the former and families Photichthyidae, Stomiidae, Chauliodontidae, Astronesthidae, Melanostomiidae, Malacosteidae, and Idiacanthidae in the latter (Fig. 95). I have no disagreement with Weitzman's hypotheses of monophyly of the Sternoptychidae, but our recent work on *Diplophos* (Fink and Weitzman, 1982) caused us to question the monophyly of the Gonostomatidae and Photichthyidae, and my work on the barbelled stomiiforms, comprising the remaining families, has cast doubt on the entire traditional arrangement of the included 26 genera as well as on the monophyly of the Photichthya. I have found features which support new hypotheses of relationship within the stomiiforms and will present some of these ideas below. Some are more tentative than others. Weitzman is currently working on the genera he placed in the Gonostomatidae and Photichthyidae.

First, I have found no evidence that *Diplophos* is the sister group of any other genus of stomiiform and it may be, as Fink and Weitzman (1982) suggested, the sister group of the rest of the order. Specializations in the adductor muscles indicate that

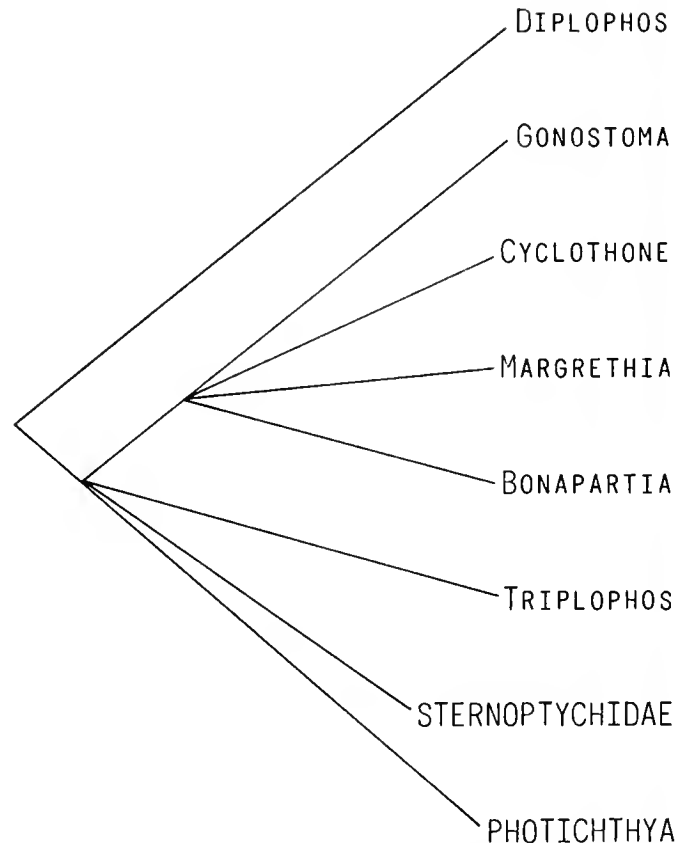

Fig. 96. Hypotheses of stomiiforms as discussed herein. See text for explanation.

Gonostoma, *Cyclothone*, *Margrethia*, and *Bonapartia* form a monophyletic group, but what relationships within that group are I cannot say, and presumably this will be treated by Weitzman. These hypotheses would cause a redefinition of the Gonostomatidae, restricting it to the four genera mentioned just above. Relationships of *Triplophos* are also unclear, and there is evidence in the hyoid apparatus that it may be related to some of the "photichthyans," rather than the gonostomatids, as Weitzman (1974) supposed. Weitzman (1974) established monophyly of the Sternoptychidae, and I have nothing to add to his conclusions. Nevertheless, since he did not deal with monophyly of the Gonostomatidae or with the sister group relationship of the Sternoptychidae, there is no current evidence that the latter is more closely related to some subset of the former, and I leave that part of the phylogeny unresolved. These hypotheses are summarized in Fig. 96. See also the paper by Ahlstrom, Richards, and Weitzman (this volume) on the Gonostomatidae, Sternoptychidae and other stomiiforms.

Within the "Photichthya," we have the same problem as with the Gonostomatidae; that is, there is a diagnosable monophyletic unit (the barbelled forms) and an undiagnosed grade group, the Photichthyidae.

My own efforts have been on the barbelled forms, currently distributed in six families, as listed above. There have been no strictly phylogenetic studies of relationships within the group, but they were examined in a traditional sense by Parr (1927), Regan and Trewavas (1929, 1930), and Beebe and Crane (1939).

My hypotheses are based on a study of 330 characters, mostly taken from the skeleton, but with some from the head muscles, photophores, and other parts of the soft anatomy. The conclusions are presented in Fig. 97. Traditional families are not recognizable in this scheme of relationships.

Evidence for the arrangement of the genera is presented elsewhere (Fink, in prep.), but some characters will be discussed below, particularly those relevant to some of the larger portions of the tree or in areas that might seem controversial to some readers. For ease of communication, I will state here that my choice of classification for this group is an expansion of the traditional Stomiidae of Regan and Trewavas (see Fig. 97).

Monophyly of the Stomiidae is established on the basis of up to 17 characters, including 1) presence of a mental barbel, 2) 5 hypurals in the caudal skeleton rather than 6, 3) lack of gill rakers in adults, 4) a divided geniohyoideus muscle, and 5) a portion of the adductor mandibulae inserting on the postorbital photophore.

The Astronesthidae, as most recently discussed by Weitzman (1967), consisted of *Astronesthes*, *Borostomias*, *Heterophotus*, *Neonesthes*, and *Rhadinesthes*. As can be seen in Fig. 97, the group is clearly not monophyletic. *Neonesthes* is the sister group of all other stomiids, a hypothesis borne out by many characters shared by the remaining stomiid genera, including lack of toothplates on basibranchial 1, epibranchial 4, and on the posterior edges of gill arches 1–4, and presence of rector muscles attaching to the fifth ceratobranchial. The several equally parsimonious constructions of stomiid relationships leave an unresolved trichotomy at the next level, there being insufficient evidence regarding the positions of *Astronesthes*, *Borostomias*, and the remaining stomiids. This problem will be further discussed by Fink (in prep.).

The remaining stomiids are united by such traits as lack of toothplates on basibranchial 3 and position of the basihyal-hypohyal ligament, as well as specializations of the dorsal and anal fin skeletons. At this point there lies another unresolved trichotomy, involving the groups *Heterophotus* plus *Rhadinesthes*, *Stomias* plus *Chauliodus*, and the remaining stomiids. *Heterophotus* and *Rhadinesthes* are documented as sister taxa by several characters, including an elongate dorsal spine on the cleithrum and a preopercle that is narrow at the area of the symplectic-hyomandibular joint. That *Chauliodus* and *Stomias* are sister taxa is supported by numerous characters, including a nasal bone which forms a cup-like wall to the nasal capsule; distribution of the palatine teeth into two areas, one anterior and one well posterior; branchiostegals deeply bifurcated dorsally; and a distinct hexagonal pigment pattern in the skin. I do not recognize the genus *Macrostomias* since work in progress shows that those species are the sister group to a derived group within *Stomias*.

The remaining genera, comprising the traditional families Melanostomiidae, Malacosteidae, and Idiakanthidae, are united by presence of many features, including no more than one pair of toothplates associated with any basibranchial ossification, and reduction of the distal radials of the pectoral fins.

As postulated by Regan and Trewavas (1930), I have also found that *Chirostomias* and *Trigonolampa* are sister taxa based on features such as fusion of the bilateral toothplates of basibranchials 2 and 3 and reduction of the supramaxilla to a sliver of bone. These genera are the sister group to the remaining genera, a hypothesis supported by several characters, including fewer than 6 branchiostegals articulating with the posterior cer-

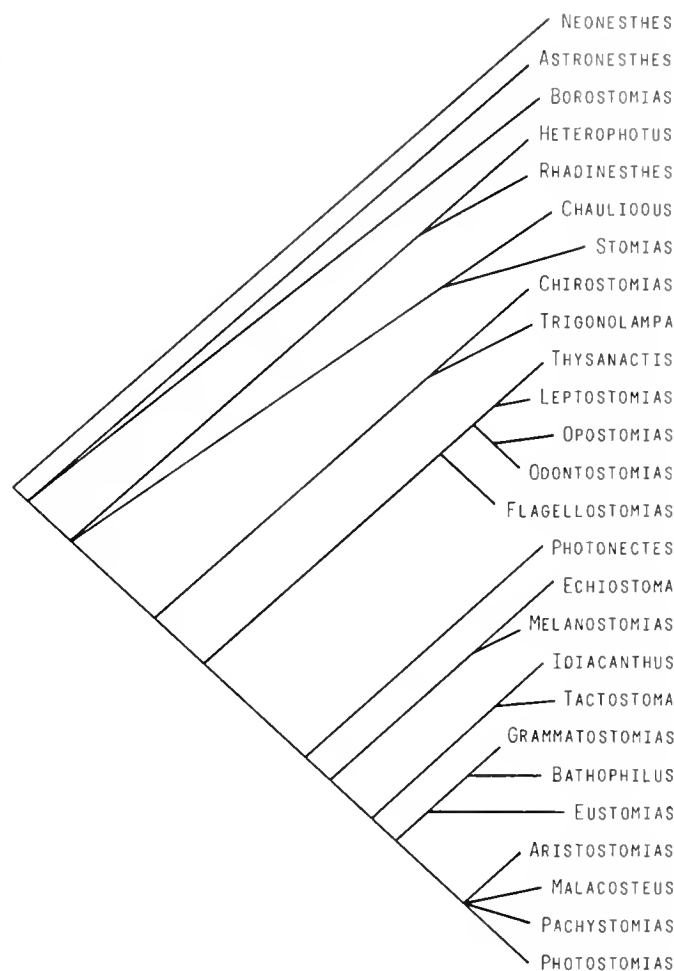

Fig. 97. Hypothesis of relationships within the Stomiidae, as discussed herein.

atohyal ossification, 3 or fewer distal pectoral fin radials, and presence of a modification of the anterior pectoral fin rays into a structure I call the "rod-ray complex."

For the remaining genera, I will concentrate on establishing the major lineages as monophyletic and on areas that affect traditional familial classifications of the group, particularly the relationships of the "malacosteids" and *Idiacanthus*.

One monophyletic group is comprised of *Flagellostomias*, *Leptostomias*, *Odontostomias*, *Opostomias*, and *Thysanactis*. Among the diagnostic features are fusion of the distal cartilaginous tips of the lateral ethmoid and supraethmoid, and an elongate opercular process of the hyomandibula.

The remaining genera are supported as monophyletic by numerous characters, among them being lack of a retroarticular (also lacking in *Trigonolampa*), and the form of the articulation of the interhyal. The latter element articulates anterior to the front margin of the cartilage between the hyomandibula and symplectic and is bound to the metapterygoid by a ligament from the anterior margin of the interhyal.

The Malacosteidae has traditionally been comprised of three genera, *Aristostomias*, *Malacosteus*, and *Photostomias*, all of which lack a floor to the mouth. The evidence shows that *Pachy-*

stomias also belongs to this group, and not with the other "melanostomiids." This finding is not particularly radical, since other authors have noted the close morphological resemblance of that genus to the other three and indeed, it has been kept out of the Malacosteidae mostly because the mouth floor is still present, though thin, in members of the genus. The data are insufficient to allow an unambiguous resolution of the interrelationships of these genera, but numerous characters support the monophyly of the assemblage, including the suborbital photophore being ventral or posteroventral to the eye and the cartilage of the palatine arch being interrupted between the posterior margin of the palatine and the rest of the arch.

Idiacanthus has usually been placed in a family by itself, as was done, for example, by Beebe (1934), primarily on the basis of the specialized stalked-eyed larval stages and the degree of sexual dimorphism. Beebe recognized that the genus was "closely related to the Melanostomiidae," as did Gibbs (1964b). Neither author suggested more precise relationships, and Beebe and Crane (1939) showed *Idiacanthus* in a large multichotomy in their figure of "relationships." Regan and Trewavas (1930) considered *Idiacanthus* to belong with *Melanostomias*, *Echiosstoma*, and *Photonectes*, but did not say precisely where. My data support placement of the genus as sister group to *Tactostoma*, a genus described in 1939. These two are then related to a group of genera as shown in Fig. 97. Note that *Melanostomias* and *Echiosstoma* are excluded, being the sister group of the entire assemblage. I am confident of the placement of *Idiacanthus* and *Tactostoma* together, based on an array of characters, including reduction of the basihyal to a thin, cylindrical element, origin of the dorsal section of the medial division of the adductor mandibulae muscle anterior to the insertion of the levator arcus palatini muscle, and an extremely elongate body. But I am not particularly confident in the placement of these two genera with the others, even though the data appear impressive at first glance. This lack of confidence is attributable to the fact that most of those characters change at least three times in the entire tree, leaving but one, lack of a posttemporal bone, as the only unreversed character supporting the hypothesis.

Another possibility is that *Idiacanthus* and *Tactostoma* are the sister group of *Melanostomias* and *Echiosstoma*, as suggested in part by Regan and Trewavas (1930), apparently based on the close morphological resemblance of *Idiacanthus* with the latter two genera. Such a hypothesis would require some additional reversals or independent losses, but as just noted, most of these

characters change several times even in the most parsimonious tree. This part of the total phylogeny deserves more critical examination, and it is hoped that larval specializations will be found which will be found which will cause one hypothesis to be clearly preferred over the other.

Regarding classification of the stomiiform fishes, it appears that most of the traditional groups will cease to be recognized, a move that was initiated by Weitzman (1974). A period of flux should be expected until his current work is completed, but such temporary instability is the current state of teleostean classification at all levels, as phylogenetic methodology is applied with increasing frequency. One might expect, however, that classification within the Stomiiformes will be stable sooner than that in many other groups, because phylogenetic methods already have been applied to it for several years. I will not present a classification here, but I do provide such for the Stomiidae in my revision of the group (Fink, in prep).

In summary, there is still much to be done in unravelling the phylogenetic history of the main lineages of stomiiform fishes. I have outlined above areas where our knowledge is either incomplete or poorly developed, and these should be the areas where workers now concentrate their attention—to establish monophyletic groups among the "primitive" stomiiforms and to critically reexamine some of the hypotheses I have produced within the barbelled stomiiforms. Some of this work is underway, using adult and sub-adult specimens, but the usefulness of larvae is as yet unknown. The data presented in Ahlstrom's (1974) work on patterns of metamorphosis in "gonostomatid" fishes corroborate, when analyzed by phylogenetic methods, the placement by Weitzman (1974) of many of those genera in an expanded Sternoptychidae. An example of this is the presence of photophores in clusters with common bases in those fishes recognized by Weitzman as sternoptychids. Kawaguchi and Moser (this volume) present the most comprehensive information to date of stomiid larvae. Their data indicate that there should be a plethora of characters for phylogenetic analysis and that study of larvae should indeed prove useful in testing hypotheses of stomiid relationships. However, even a cursory examination of their data indicates that, as with characters in adults, there appears to be a high degree of homoplasy. This is an interesting phenomenon deserving further study.

MUSEUM OF ZOOLOGY, UNIVERSITY OF MICHIGAN, ANN ARBOR,
MICHIGAN 48109.

Families Gonostomatidae, Sternoptychidae, and Associated Stomiiform Groups: Development and Relationships

E. H. AHLSTROM, W. J. RICHARDS AND S. H. WEITZMAN

A summary of known information about the larvae and relationships of the stomiiforms with elongate gill rakers in adults was published by Ahlstrom (1974). The present paper is an addendum to that contribution and includes additional in-

formation, both published and unpublished, gleaned from early life history stages and from adults. We also append some tentative new hypotheses of relationships within this "group" of stomiiforms.

TABLE 47. SUMMARY OF DIAGNOSTIC CHARACTERS FOR EGGS OF CERTAIN STOMIIFORM FISHES.

Species	Egg diameter	Oil globule	Diameter	Yolk	Special features	Illustrated	Source
<i>Argyropelecus hemigymnus</i>	0.92–1.04	1	0.26–0.28	segmented	large oil globule	Yes	Sanzo, 1928
<i>Ichthyococcus ovatus</i>	0.80	1	0.24	segmented	large oil globule	Yes	Sanzo, 1930b
<i>Maurolicus muelleri</i>	1.63	1	0.25	segmented	hexagonal pattern on shell	Yes	Mito, 1961a
	1.32–1.58	1	0.26–0.28	segmented		Yes	Sanzo, 1931d
<i>Vinciguerria lucetia</i>	0.58–0.74	none		irregularly segmented	thin inner shell membrane	Yes	Ahlstrom and Counts, 1958
<i>poweriae</i>	0.75–0.85	1	0.17–0.19	segmented	no thin inner shell membrane	Yes	Ahlstrom and Counts, 1958
<i>numbaria</i>	0.64–0.72	none		irregularly segmented	thin inner shell membrane	No	Ahlstrom and Counts, 1958
<i>attenuata</i>	0.84–0.92	1	0.18–0.195	segmented	no thin inner shell membrane	No	Sanzo, 1931d
<i>Gonostoma demudatum</i>	0.80–0.81	1	0.20–0.21	—	—	No	Sanzo, 1931d

Ahlstrom (1974:672) favored recognition of one family for those stomiiforms with elongate gill rakers in adults. According to the rules of priority this would be the Sternoptychidae. Weitzman (1974:338) recognized three families, Gonostomatidae, Photichthyidae, and Sternoptychidae, for the same stomiiforms, the last family including the "maurolicin" genera formerly assigned to the Gonostomatidae and the deep-bodied sternoptychids traditionally assigned to the family. In a phylogenetic or cladistic analysis this elongate gill raker bearing "group," if recognized as a single family, is paraphyletic if one considers certain of its subgroups as equivalent or higher taxonomic categories. For example, recognition of Ahlstrom's Sternoptychidae, which would include the Stomiidae, a monophyletic group with its members having a median barbel attached to the ventral surface of the head in association with the hyoid bone and lacking elongate gill rakers in adults, is incompatible with a phylogenetic classification based on nested monophyletic groups, since the Stomiidae is the sister group of another group within Ahlstrom's Sternoptychidae. Furthermore, the character used here to "define" the paraphyletic Sternoptychidae, the presence of elongate gill rakers in adults, is excellent for use in a key for identification purposes, but cannot be used as a synapomorphy relating these fishes because it is primitive for stomiiforms. Ahlstrom's Sternoptychidae is undefinable in a phylogenetic analysis based on the information at hand. A resolution of the use of familial and subordinal names in stomiiform fishes must await completion of ongoing phylogenetic studies of these fishes. Because these studies are incomplete, it is difficult to make recommendations for names of certain stomiiform subgroups. Among the stomiiforms with elongate gill rakers in adults, the "family" problem is more complex than that recognized by Ahlstrom (1974) or Weitzman (1974). We here recognize two family names but these apply to only some of the 24 genera listed below. We recognize the Sternoptychidae of Weitzman (1974) and the Gonostomatidae in a new and restricted sense. See discussion below.

The stomiiforms discussed here include the following 24 genera, listed alphabetically, which have been variously recognized as belonging to the families Gonostomatidae, Sternoptychidae, Maurolicidae, and Photichthyidae:

Araiophos Grey (two species), *Argyripnus* Gilbert and Cramer (four, possibly a few more), *Argyropelecus* Cocco (about seven), *Bonapartia* Goode and Bean (one), *Cyclothone* Goode and Bean (twelve), *Danaphos* Bruun (one, possibly two), *Diplophos* Günther (two), *Gonostoma* Rafinesque (six), *Ichthyococcus* Bonaparte (three), *Manducus* Goode and Bean (two),¹ *Margrethia* Jespersen and Tåning (one, possibly two), *Maurolicus* Cocco (one, possibly two), *Photichthys* Hutton (one), *Pollichthys* Grey (one), *Polyipnus* Günther (about sixteen), *Polymetme* McCulloch (one, possibly four), *Sonoda* Grey (two), *Sternoptyx* Hermann (two or three), *Thorophos* Bruun (two, including *Neophos* Myers), *Triplophos* Brauer (one), *Valenciennellus* Jordan and Evermann (one, possibly two), *Vinciguerria* Jordan and Evermann (five), *Woodisia* Grey (one), and *Yarella* Goode and Bean (one).

¹ Grey (1964:88) recognized *Manducus* Goode and Bean, 1896 as a junior synonym of *Diplophos* Günther, 1873 because, as she stated "... the differences appear to be of a specific rather than a generic nature ...". This was in the context of the kinds of differences Grey noted separating other species of "gonostomatids." She did recognize both as subgenera of *Diplophos*. We recognize both as genera. The species were most recently reviewed by Mukhacheva (1978) who recognized four species, *D. maderensis* (Johnson), *D. rebainsti* Krefft and Parin, *D. greyae* R. K. Johnson, and *D. taenia* Günther. We have examined all four species and find that *D. taenia* and *D. rebainsti* have the cartilages of the two medial proximal pectoral radials, radials III and IV in the terminology of Fink and Weitzman (1982:66), fused while retaining two bony elements separate as reported for *D. taenia* by Fink and Weitzman (1982:65–67). Furthermore, one of the distal radials is out of line, not in a single series in these two species. These characters are specialized for these species. In *Manducus maderensis* and *M. greyae* there are four completely distinct proximal radials and the distal radials are all in a simple straight series. Because the pectoral radial morphology in *Diplophos taenia* and *D. rebainsti* may be an intermediate stage of a transition series between radials such as are found in *Manducus maderensis* and *M. greyae* and those in the "photichthyid" genera, we recognize *Manducus* as a genus and apparent sister group of the "photichthyid" genera as well as the Stomiidae, nearly all of which have the radials III and IV completely fused to one bone. A few stomiids have an apparent neomorph condition in which the third proximal radial is divided into two radials, giving a total of four proximal radials. See also text discussion.

TABLE 48. SUMMARY OF MERISTIC CHARACTERS FOR ADULTS OF CERTAIN STOMIIFORM FISHES.

Genera	No species	Fin rays				Branchi-ostegal rays	No. of vertebrae	No. of gill rakers
		Dorsal	Anal	Pectoral	Pelvic			
<i>Araïophos</i>	2	13-20	20-29	16-18	5	9-11	43-45	2-3 + 12-19 = 14-22
<i>Argyripnus</i>	4+	11-12	11-15 + 8-12 = 22-29	15-19	6-7	8-10	41-46	4-7 + 12-19 = 16-26
<i>Argyropelecus</i>	7	(8) 9 (10)	6-8 + 5-6 = 11-13	10-11	?	?	34-40	15-24
<i>Bonapartia</i>	1	17-20	29-31	14-16	7-8	13-16	37	5-6 + 11-12 = 16-18
<i>Cyclothone</i>	12+	12-15	16-21	9-13	6-7	10-14	29-33	4-10 + 9-18 = 14-27
<i>Danaphos</i>	1	6	24-25	13-14	6	9-10	38	2 + 11-13 = 13-15
<i>Diplophos</i>	2	10-13	47-69	8-9	7	10-14	44-94	3 + 7-9 = 10-12
<i>Gonostoma</i>	6	10-18	21-31	9-13	6-8	10-13	37-40	5-11 + 10-17 = 15-27
<i>Ichthyococcus</i>	3	10-15	13-17	7-8	6-7	11-12	38-47	7-11 + 15-26 = 22-37
<i>Manducus</i>	2	11-13	36-59	9-11	8	11-14	63-76	3-5 + 8-10 = 12-14
<i>Margrethia</i>	1	15-16	21-26	13-15	8	13	34	5 + 10-11 = 15-16
<i>Maurollicus</i>	1	9-12	8-10 + 11-15 = 19-27	17-20	6-7	9-10	33-35	4-8 + 17-22 = 22-30
<i>Photichthys</i>	1	12-13	23-26	9	6-7	20-21	51	4-5 + 11 = 15-16
<i>Pollichthys</i>	1	10-12	22-30	8	6-7	11-12	40	4-5 + 11-12 = 15-17
<i>Polyipnus</i>	17	10-17	13-19	12-16	?	?	31-36	10-28
<i>Polymetme</i>	3	11-13	24-33	9-11	7 (8?)	12-14	44-45	5-8 + 9-12 = 15-19
<i>Sonoda</i>	2	8-9	8-10 + 14-16 = 22-25	13-15	6	8-10	40?	3-5 + 15-18 = 18-21
<i>Sternoptyx</i>	3	8-11	14-16	10-11	?	?	28-31	7-9
<i>Triplophos</i>	1	10-12	53-63	9-11	6-7	11-14	ca 60	9 + 14-16 = 23-25
<i>Thorophos</i>	2	8	38	13	7	7-8	40-45	5 + 13-14 = 18-19
<i>Valenciennellus</i>	2 or 3	7-12	22-25	12-13	6-9	9-10	32-33?	2-3 + 12 = 14-15
<i>Vinciguerria</i>	4	13-16	12-17	9-10	7	10-12	38-42	3 + 11-23-11 = 15-33
<i>Woodsia</i>	1	11-12	14	9-10	7-8	17	42-45	3-5 + 13 = 16-18
<i>Yarella</i>	2	14-16 (17)	(28) 29-31	8-10	6-7	13-16	45-54	6-7 + 12-16 = 18-22

TABLE 49. POSITION OF THE DORSAL AND ANAL FIN AND CONDITION OF THE ADIPOSE FIN IN CERTAIN STOMIIFORM FISHES.

Genus	Dorsal fin position		Adipose fin
	Adult	Larvae	
<i>Araïophos</i>	Anal origin in advance of dorsal fin. Dorsal origin opposite 5th or 6th anal ray	Anal opposite dorsal at 8 mm, adult position at 11 m	Present or absent
<i>Argyripnus</i>	Anal origin opposite dorsal origin	Anal origin opposite dorsal origin	Present
<i>Argyropelecus</i>	Anal origin opposite last dorsal fin ray	Anal origin behind dorsal fin	Present or absent
<i>Bonapartia</i>	Anal origin well in advance of dorsal by 9 rays	Same as adult	Absent
<i>Cyclothone</i>	Anal origin opposite dorsal fin or slightly behind	Same as adult	Absent
<i>Danaphos</i>	Anal origin behind dorsal fin	Same as adult	Absent
<i>Diplophos</i>	Anal origin beneath 5th ray or behind dorsal fin	Anal origin beneath end of or behind dorsal fin	Absent
<i>Gonostoma</i>	Anal origin opposite or 3-4 rays in advance of dorsal origin	Same as adult	Present or absent
<i>Ichthyococcus</i>	Anal origin behind dorsal fin by a space = 1/2 dorsal base	Anal origin behind dorsal fin	Present
<i>Manducus</i>	Anal origin beneath 3rd from last or last dorsal fin ray	Unknown	Absent
<i>Margrethia</i>	Anal origin beneath 5th dorsal fin ray	Same as adult	Present
<i>Maurollicus</i>	Anal origin beneath last dorsal fin ray	Anal origin beneath middle of dorsal fin, advances to adult condition as juveniles	Present
<i>Photichthys</i>	Anal origin behind dorsal fin	Unknown	Present
<i>Pollichthys</i>	Anal origin beneath 3rd dorsal fin ray	Anal origin advances forward beneath dorsal fin	Present
<i>Polyipnus</i>	Anal origin usually beneath middle of dorsal fin	Same as adult	Present or absent
<i>Polymetme</i>	Anal origin beneath end of dorsal fin	Unknown	Present
<i>Sonoda</i>	Anal origin in advance of dorsal. Dorsal origin above 5th anal ray	Unknown	Absent
<i>Sternoptyx</i>	Anal origin opposite dorsal origin	Anal origin behind dorsal fin	Present
<i>Triplophos</i>	Anal origin beneath end of dorsal fin	Unknown	Absent
<i>Thorophos</i>	Anal origin in advance of dorsal origin by 3 or 4 rays	Unknown	Present or absent
<i>Valenciennellus</i>	Anal origin 1 or 2 rays in advance of dorsal origin	Same as adult	Present
<i>Vinciguerria</i>	Anal origin beneath middle of dorsal fin	Same as adult	Present
<i>Woodsia</i>	Anal origin behind middle of dorsal fin by distance about = dorsal base	Same as adult	Present
<i>Yarella</i>	Anal origin beneath middle of dorsal fin	Same as adult	Absent

TABLE 50. DEFINITION OF ALPHABETICAL SYMBOLS USED FOR DESIGNATING PHOTOPHORES IN DEEP BODIED STERNOPTYCHIDS AND OTHER STOMIIFORM FISHES.

Other stomiiforms		Deep bodied sternoptychids	
Code	Definition	Code	Definition
SO	Symphyseal photophores (organs) located at tip of lower jaw.	SO	Subopercle photophore which is equivalent to posteriormost photophore in opercular series of gonostomatids.
Orb	Photophores associated with the eye located anterior and posterior of orbit.	PO	Photophore located anterior to orbit.
Op	Photophores on opercle series generally three, coded as follows 1/(1 + 1).	PTO	Photophore located posterior to orbit and may be equivalent to upper photophore of opercular series of gonostomatids.
Br(BRP)	Photophores located on the branchiostegal membranes.	PRO	Preopercular photophore, used for an PO photophore dorsal to ventral limb or preopercle.
Is(l)	Photophores located on the isthmus.	Br	Same as gonostomatid definition.
IP	Photophores of the ventral series found from the isthmus to the base of the pectoral fin.	Is	Same as gonostomatid definition.
PV	Photophores of the ventral series found from the pectoral fin base to the pelvic (ventral) fin base.	AB	Photophores of ventral series located abdominally between pectoral fin base and pelvic fin base and equivalent to PV in gonostomatids, plus a few posterior photophores of the IP series.
VAV	Photophores of the ventral series found from the pelvic (ventral) fin base to the anal fin base.	PAN	Photophores found anterior to anal fin and may be equivalent to VAV or VA in gonostomatids.
AC	Photophores of the ventral series found from the anal fin base to caudal fin base of the ventral series.	AN	Photophores found above anal fin.
IC	Summary of photophores of the ventral series from the isthmus to caudal fin base (IP+PV+VAV+AC).	SC	Photophores found on lower (sub) caudal peduncle. Together with AN group may be equivalent to AC in gonostomatids.
IV	Summary of photophores of the ventral series from isthmus to pelvic (ventral) fin base (IP+PV).	SAB	Photophores located above (supra) to the abdominal series and may be equivalent to VA in gonostomatids.
OV	Photophores of the lateral series from the opercle to pelvic (ventral) fin base.	SP	Photophores located above (supra) the pectoral fin and may be equivalent to OV in gonostomatids.
VA(VALA)	Photophores of the lateral series from the pelvic (ventral) fin base to the anal fin base.	L	Photophore located laterally above PAN (found only in <i>Polyipnus</i>).
OAA	Summary of photophores of OV plus VA series.	SAN	Photophores located above (supra) to anal photophores and equivalent to part of AC series.
OA(OAB)	Summary of lateral photophores from the opercle to anal fin base (OV+VA).		
OAC(OC)	Entire lateral series on body sides just dorsal to ventral series and extending from opercular border, or just medial to it, over anal fin to caudal fin base.		
ODM	Photophores (organs) found dorsal to the lateral midline (found only in <i>Gonostoma gracile</i>).		

Some genera are extremely rare (i.e., *Thorophos* and *Sonoda*) while others represent the most abundant vertebrate animals on earth (*Cyclothone* and *Vinciguerria*).

Developmental information has been published for 16 of these genera (12 prior to Ahlstrom, 1974; 3 by Ahlstrom, 1974; and one by Ozawa, 1976).

DEVELOPMENT

Eggs.—Eggs were described for *Argyropelecus hemigymnus* by Sanzo (1928); for *Ichthyococcus ovatus* by Sanzo (1930b); for *Maurolicus muelleri* by Sanzo (1931d), Mito (1961a), and Okiyama (1971); for *Vinciguerria lucetia*, *V. poweriae*, and *V. nimbaria* by Ahlstrom and Counts (1958); for *V. attenuata* by Sanzo (1931d); and for *Gonostoma demudatum* by Sanzo (1931d). Other accounts provide minimal details of ovarian eggs of other species. The details of egg characters are summarized in Table 47.

Larvae.—Much has been accomplished for the identification of the larvae of these stomiiform genera and now descriptions are

available for all except *Manducus*, *Triplophos*, *Polymetme*, *Photichthys*, *Thorophos*, and *Sonoda*. The larvae tentatively identified as *Polymetme* by Ahlstrom (1974), on further examination by one of us (Richards), were determined to be *Pollichthys*. One stomiiform larval form has been described but not assigned to a genus [designated "Maurolicine Alpha" by Ahlstrom (1974: 670)]. It presumably is the larva of some sternoptychid (as defined by Weitzman, 1974). Descriptive details and illustrations of several species were given by Ahlstrom (1974). Here we provide new or additional data including characters useful in identifying these larvae and illustrations of all the species described to date, including some illustrated for the first time.

The identification of stomiiform larvae with elongate gill rakers as adults requires a knowledge of developmental data from larvae, juveniles, and data from adults of the following characters: counts of fin rays, teeth, and other meristic characters as photophores; patterns of photophore development; and distributions (patterns) of dark chromatophores (dark pigment cells). With those sets of data, nearly all species should be identifiable at least to genus, and in cases of complete data, to species. A

TABLE 51. PHOTOPHORE DISTRIBUTION IN CERTAIN STOMIIFORM GENERA. Refer to text and Table 50 for definition of codes.

	No. of rows	SO	ORB	OP	BR	IS	IV	VAV	AC	Photo-phores in group of glands
<i>Araiophos</i>	1	No	1	1	5-7	Yes	(2) + (3) + 3-4 + (2) = 10-11	3-5	6-8	Yes
<i>Argyripnus</i>	2	No	1	3	6	Yes	(6) + (10)	(18-28)	(4-5) + (12-18) = 35-51	Yes
<i>Argyropelecus</i>	2	No	2	2	6	Yes	18	4	10	Yes
<i>Bonapartia</i>	1	Yes	1	3	11-13	No	14-16	5-6	18-20	No
<i>Cyclothone</i>	2	No	1	2	8-11	No	12-14	4-5	12-16	No
<i>Danaphos</i>	2	No	1	2-3	6	Yes	18	5	22-26	Yes
<i>Diplophus</i>	3+	Yes	1	3	7-12 + 0-3	Yes	33-49	13-17	33-49	No
<i>Gonostoma</i>	2	Yes	1	2-3	9	No	11-16	3-10	15-23	No
<i>Ichthyococcus</i>	2	No	2	3	11-12	Yes	25-28	9-14	12-14	No
<i>Manducus</i>	2+	Yes	1	3	8-13	Yes	30-33	12-14	28-39	No
<i>Margrethia</i>	1	No	1	3	9-12	No	13-15	4	17	No
<i>Maurolicus</i>	2	Yes	1	3	(6)	Yes	(6) + (12-13) = 18-19	(6)	1 + (14-18) + (7-9) = 22-27	Yes
<i>Photichthys</i>	2	Yes	2	3	17-18	Yes	10 + 14-15 = 24-25	15-17	16-18	Yes
<i>Pollichthys</i>	2	Yes	2	3	8	Yes	21-23	7-9	18-21	No
<i>Polyipnus</i>	2	No	2	2	6	Yes	16	5	10-18	Yes
<i>Polymetme</i>	2	Yes	1	3	9-10	Yes	19-21	7-8	21-25	No
<i>Sonoda</i>	2	No	1	3	6-7	Yes	6 + 10 = 16	7-8	(16-21) + (19-24) or (5-6) + (5-6) + (5-6) = 36-43	Yes
<i>Sternoptyx</i>	2	No	2	2	3	Yes	15	3	7	Yes
<i>Triplophos</i>	2 + 3 or 4	Yes	1	3	8-13	Yes	24-30	5-7	35-41	No
<i>Thorophos</i>	2	Yes & no	1	3	6	Yes	17	5	13-15	Yes
<i>Valenciennellus</i>	2	No	1	3	6	Yes	(3) + (4) + (16-17) = 23-24	(4)-(5)	3-6 or 9-17	Yes
<i>Vinciguerrina</i>	2	Yes or no	2	3	7-9	Yes	21-24	7-11	12-15	No
<i>Woodsia</i>	2	Yes	2	3	14	Yes	25	11-12	12	No
<i>Yarella</i>	2+ sev	Yes	1	3	11-13	Yes	23-25	9-12	20-28	No

summary of several meristic characters for genera is given in Table 48. The position of the dorsal and anal fins is also a helpful aid, but caution must be used since their positions relative to other structures may change with growth. Also, the presence or absence of the adipose fin is helpful, but again, caution is in order because this fin is fragile and often damaged or lost due to contact with a net. These fin features are given in Table 49. Of special importance in identifying larvae and adults is the distribution and patterns of the photophores. This includes the number in each series, the patterns of their distribution in relation to each other, and especially the sequence of development which Ahlstrom (1974) stressed. Some confusion appears in the literature because more than one alphanumeric code has been developed to indicate, in some cases, the same sets of photophores in different stomiiform groups. A further complication is that the deep-bodied sternoptychids have a different code because of their altered body shape as adults and homologies were considered uncertain. Weitzman (1974:461), because he united the "maurolicin" and deep-bodied stomiiforms as one family considered the different terminologies "artificial" and as obscuring homologies. He therefore discussed and presented a synonymy of stomiiform photophores. We have defined the alphabetical codes in Table 50 and included what we believe are equivalent photophores in stomiiforms. In this code, parenthetical numbers indicate photophores found in common glands whereas non-parenthetical numbers indicate that the photophores are single. The distribution of photophores for each

genus is given in Table 51. Table 52 provides sequences of photophore formation for *Bonapartia*, *Margrethia*, and *Gonostoma*. Table 53 provides similar information for *Araiophos*, *Maurolicus*, *Danaphos*, *Valenciennellus*, and *Argyripnus*; while Table 54 provides similar data for *Polyipnus*, *Argyropelecus*, and *Sternoptyx*. Diagnostic pigmentation and morphometric characters are summarized in Table 55. Illustrations (Figs. 98 to 104) are provided for the genera for which larvae are known and for many of the known species. In addition, the following authors provide specific information which will aid in larval identifications: Jespersen and Tåning (1919, 1926), Sanzo (1931d), Ahlstrom and Counts (1958), Ahlstrom and Moser (1969), Ozawa (1976), Grey (1964), Badcock and Merrett (1972), Kawaguchi and Marumo (1967), Okiyama (1971), Badcock (1982), Rudometkina (1981), Gorbunova (1981), Mukhacheva (1964), and Ahlstrom (1974).

RELATIONSHIPS

There has been a dichotomy of opinions about the interrelationships of the genera and the use of family names based on the use of larval versus adult morphological characters. Ahlstrom (1974:670-672) presented his views on this group based on larval characters, principally the mode of photophore formation. The suggested relationships resulting from his analysis contrasted in part with those of Weitzman (1974:472), whose views were based on study of adult osteology and soft anatomy. Both Ahlstrom and Weitzman in addition to their own data,

TABLE 52. Sequence of Photophore Formation in *Bonapartia*, *Margrethia*, and *Gonostoma*

		ORB	OP	SO	BR	PV	VAV	AC	OA + ODM	Source
<i>Bonapartia pedaliota</i>	adult	1	3	1	11-13	14-15	5-(6)	16-18 + 2-3	0	Grey, 1964
	9.5	0	1	0	2	3	0	0	0	Grey, 1964
	11.5	0	1	0	3	5	2	0	0	Original
	12.0	0	1	0	4	5	2	0	0	Grey, 1964
	14.0	1	1	0	5	10	4	3 + 1	0	Grey, 1964
	15.0	1	1	0	5	9	3	1 + 1	0	Original
	16.0	1	1	0	6	11	5	5 + 2	0	Jespersen and Täning, 1919
23.0	1	3	0	11	14	5	14 + 2	0	Grey, 1964	
<i>Margrethia obtusirostra</i>	adult	1	3	0	9-12	13-15	4	13-14 + 3-4	0	Grey, 1964
	5.8	0	1	0	0	2	0	0	0	Ahlstrom, 1974
	6.4	0	1	0	0	6	2	1 + 2	0	Ahlstrom, 1974
	8.0	0	1	0	2	10	4	1 + 2	0	Ahlstrom, 1974
	11.3	—	2	0	6	14	4	5 + 3	0	Ahlstrom, 1974
	15.0	1	3	0	9	14	4	11 + 4	0	Ahlstrom, 1974
<i>Gonostoma elongatum</i>	adult	1	3	1	9	15	(4)-5	21-23	13-15	Grey, 1964
	6.0	0	1	0	0	0	0	0	0	Ahlstrom, 1974
	7.5	0	1	0	0	5	0	0	0	Ahlstrom, 1974
	7.9	0	1	0	0	4	0	0	0	Original
	10.2	0	1	0	2/1	10	2	0	0	Ahlstrom, 1974
	13.0	0	1	0	2	11	3	0	0	Ahlstrom, 1974
	14.0	1	1	0	2	11	2/3	1+	0	Grey, 1964
	16.7	1	1	0	3	11	4	1+	0	Jespersen and Täning, 1919
	22.5	1	3	1	9	15	5	22	13	Grey, 1964
<i>Gonostoma denudatum</i>	adult	1	3	1	9	15-16	5	17-20	13-15	Grey, 1964
	18.25	0	1	0	0	1	0	0	0	Sanzo, 1912b
	19.0	0	1	0	0	2	0	+2	0	Sanzo, 1912b
	20.75	0	1	0	1	3	1	+3	0	Sanzo, 1912b
	24.75	0	1	0	3	6	3	3 + 3	0	Sanzo, 1912b
	29.65	0	2	0	5	14	5	11 + 3	0	Sanzo, 1912b
	34.0	1	3	0	9	16	5	15 + 5	13	Sanzo, 1912b
	39.0	1	3	1	9	16	5	15 + 5	13	Sanzo, 1912b
<i>Gonostoma gracile</i>	adult	1	2	1	9	13-15	4-5	17-19	11-12 + 6-7	Kawaguchi and Marumo, 1967
	15.5-5-17.0	0	1	0	0	0	0	0	0	Kawaguchi and Marumo, 1967
	20.0	1	2	1	2	13	5	17	0	Kawaguchi and Marumo, 1967
	22.0	1	2	1	9	14	4	18	12 + 4	Kawaguchi and Marumo, 1967
<i>Gonostoma ebelingi</i>	adult	1	2	1	9	15	10	19	21	Grey, 1964
	13.8	0	1	0	0	7	0	0	0	Ahlstrom, 1974
	15.0	0	1	0	0	9	0	0	0	Ahlstrom, 1974
<i>Gonostoma bathyphulum</i>	adult	1	2	0	9	11-12	4-5	20-21	14	Grey, 1964
	11.0	0	1	0	0	5	0	0	0	Ahlstrom, 1974
	14.8	1	1	0	4	10	2	0	0	Ahlstrom, 1974
<i>Gonostoma atlanticum</i>	adult	1	2	1	9	15-16	5	19	13	Grey, 1964
	12.0	0	1	0	0	0	0	0	0	Ahlstrom, 1974
	13.0	0	1	0	0	1	0	0	0	Ahlstrom, 1974
	14.5	0	1	0	0	2	0	0	0	Ahlstrom, 1974
	17.8	1	1	0	4	13	3	1	0	Original
	18.8	1	2	0	9	16	5	19	0	Ahlstrom, 1974
23.8	1	3	0	9	16	5	19	13	Original	

used the results of photophore anatomy research by Bassot (1966, 1971) to support their conclusions. These results seemingly completely supported Weitzman's referral of genera to family groups and agreed with Ahlstrom except for placement of three genera—*Cyclothone*, *Diplophos* (including *Manducus*), and *Triplophos*.

One of us (Weitzman), continues to study relationships of the stomiiforms with elongate gill rakers in adults and we offer the following analysis as a current comment on the status of our knowledge of these fishes. The two concepts of relationships by Ahlstrom and Weitzman may be compared as follows: Ahlstrom

(1974:670-672) stressed relationships of taxa based on photophore patterns and development. Ahlstrom (1974:672) considered the stomiiforms with elongate gill rakers in adults as a group comprised of three groups of genera, with any subdivision being into two subfamilies based on photophores occurring individually or in clustered groups. These groups of genera include: (1) Those with individual separate photophores, most of the photophores developing simultaneously and initiated as a "white" photophore stage. This group includes *Manducus*, *Diplophos*, *Cyclothone*, *Yarella*, *Pollichthys*, *Vinciguerria*, *Woodisia*, *Ichthyococcus*, and presumably *Triplophos* and *Polymetme*,

TABLE 53. SEQUENCE OF PHOTOPHORE FORMATION IN *ARAIOPHOS*, *MAUROLICUS*, *DANAPHOS*, *VALENCIENNELUS*, AND *ARGYRIPNUS*.

		ORB	OP	SO	BR	IP	PV	VAV	AC	OA	Source	
<i>Araiophos castropas</i>	adult	1	1	0	(6)	(2)	(3) + 3- 4 + (2)	(3)	(2) + 2 + (2)	No	Ahlstrom and Moser, 1969	
	11.2	0	0	0	(3)	0	(2)	0	0	—	Ahlstrom and Moser, 1969	
<i>Maurolicus muelleri</i>	adult	1	3	1	(6)	(6)	(12)	(6)	3/(4) + (8)	(2) + 7	Ahlstrom, 1974	
	5.5	0	0	0	(1/2)	0	0	0	0	0	Ahlstrom, 1974	
	6.2	0	0	0	(2)	0	(2)	0	0	0	Ahlstrom, 1974	
	6.5	0	0	0	(2)	0	(4)	0	0	0	Ahlstrom, 1974	
	6.7	0	1	0	(3)	0	(5)	0	0	0	Ahlstrom, 1974	
	6.9	1	1	0	(4)	0	(8)	0	0	0	Ahlstrom, 1974	
	7.5	1	1	0	(4)	1	(9)	0	0 + (2) + 0	0	Ahlstrom, 1974	
	8.6	1	2	0	(5)	(3)	(12)	(2)	0 + (3) + (3)	0	Ahlstrom, 1974	
	9.0	1	2	0	(5)	(3)	(11)	(2)	0 + (3) + (3)	1	Ahlstrom, 1974	
	9.7	1	3	0	(5)	(5)	(11)	(3)	0 + (4) + (6)	(2) + 1	Ahlstrom, 1974	
	10.8	1	3	0	(6)	(5)	(12)	(4)	0 + (5) + (6)	(2) + 2	Ahlstrom, 1974	
13.5	1	3	0	(6)	(6)	(12)	(6)	0 + (9) + (7)	(2) + 6	Ahlstrom, 1974		
<i>Danaphos oculatus</i>	adult	1	3	0	(6)	(3) + (4)	(11)	(5)	(3) + 16 + (4) + 1	6	Ahlstrom, 1974	
	16.5	0	0	0	(2)	0	0	0	0	0	Ahlstrom, 1974	
	16.5	0	0	0	(3)	0	(3)	0	0	0	Ahlstrom, 1974	
	19.2	0	0	0	(4)	0	(10)	0	0	0	Ahlstrom, 1974	
	21.0	1	1	0	(5)	(2) + (4)	(10/11)	0	(2) + 0 + 0 + 0	0	Ahlstrom, 1974	
	21.3	1	1	0	(4/5)	(3) + (4)	(10)	0	(3) + 0 + (2) + 0	0	Ahlstrom, 1974	
	21.8	1	2	0	(5)	(3) + (4)	(11)	(2)	(3) + 8 + (4) + 0	2	Ahlstrom, 1974	
	24.2	1	2	0	(6)	(3) + (4)	(11)	(2)	(3) + 9 + (4) + 0	2	Ahlstrom, 1974	
	<i>Valenciennellus tripunculatus</i>	adult	1	3	0	(6)	(3) + (4)	(16-17)	(4-5)	(3) + (3) + (3) + (2) + (4)	(2) + 3	Ahlstrom, 1974
7.8		0	0	0	0	0	0	0	0	0	Original	
8.6		0	0	0	(3)	0	(3)	0	0	0	Ahlstrom, 1974	
9.5		0	0	0	(4)	0	(6)	0	0	0	Ahlstrom, 1974	
11.0		0	0	0	(4)	0	(10)	0	0	0	Original	
12.0		0	0	0	(4)	0	(13)	(2)	0	0	Ahlstrom, 1974	
12.4		1	0	0	(5)	0	(15)	(2)	0	0	Original	
13.0		1	0	0	(5)	(2)	(15)	(2)	0	0	Original	
13.2		0	0	0	(4)	0	(14)	(3)	0	0	Ahlstrom, 1974	
14.0		1	0	0	(5)	(4)	(15)	(5)	0	0	Original	
17.0		1	2	0	(4-5)	(3) + (4)	(15)	(5)	(3) + (3) + 0 + (3) + (4)	(2)	Grey, 1964	
<i>Argyripnus atlanticus</i>		adult	1	3	0	(6)	(6)	(10)	(26)	(5) + (17)	(3) + 4	Badcock and Merrett, 1972
		18.7	1	2	0	(6)	(3)	(10)	(3)	(4) + (4)	0	Badcock and Merrett, 1972
	16.8	1	2	0	(6)	(3)	(10)	(2)	(4) + (3)	0	Badcock and Merrett, 1972	

although their development is not known. (2) Those with individual, separate photophores that have a gradual, protracted metamorphosis. This group includes *Bonapartia*, *Margrethia*, and *Gonostoma*. (3) Those with some individual photophores but some or most of the photophores with common bases [actually a common lumen, during development at least] and having a gradual, protracted metamorphosis. This group includes *Araiophos*, *Maurolicus*, *Danaphos*, *Valenciennellus*, *Argyripnus*, *Polyipnus*, *Argyropelecus*, *Sternoptyx*, and presumably *Thorophos* and *Sonoda* although their development is unknown. Groups (1) and (2) comprised the subfamily Gonostomatinae and Group (3) comprised the Sternoptychinae in Ahlstrom's concept. Group (3) is equivalent to Weitzman's Sternoptychidae. The genus *Gonostoma* was considered "pivotal" by Ahlstrom; that is, its relationships could be with either the gonostomatines or the sternoptychines of his concept. In Ahlstrom's conclusions, the photophore pattern of Group (1) is most like that of the stomiid groups discussed by Fink in this volume.

Weitzman's classification (1974) concentrated in most detail on a hypothesis of phylogenetic relationships within the family Sternoptychidae as he defined it. Weitzman (1974) pointed out

that more detailed studies should be conducted on other stomiiform genera in the future, but he did discuss their possible relationships. Based on the number of proximal pectoral-fin radials, he established two infraorders for stomiiform fishes. Members of the Infraorder Gonostomata were considered to have four proximal pectoral-fin radials (except *Cyclothone* with one). This infraorder was divided into two families based principally on Bassot's photophore findings; Family Gonostomatidae with Beta type photophores comprised of *Diplophos* including *Manducus*, *Triplophos*, *Bonapartia*, *Margrethia*, *Gonostoma*, and *Cyclothone* and the Family Sternoptychidae with Alpha type photophores comprised of *Thorophos*, *Araiophos*, *Maurolicus*, *Danaphos*, *Valenciennellus*, *Argyripnus*, *Sonoda*, *Polyipnus*, *Argyropelecus*, and *Sternoptyx*. The problem with Weitzman's Gonostomata is that it was based on a primitive character for the stomiiforms, four pectoral-fin radials, and this character cannot be used as a synapomorphy to define a subgroup of stomiiforms. The non-sternoptychid and non-gonostomatid genera, along with the stomiiform families possessing barbels originating from the hyoid bone and lacking elongate gill rakers in the adults (the Stomiidae of Fink, this volume),

TABLE 54. SEQUENCE OF PHOTOPHORE FORMATION IN *POLYIPNUS*, *ARGYROPELECUS* AND *STERNOPTYX*.

	Size	PO	PTO	BR	IS	OP PRO + SO	SP	AB	SAB	PAN	AN	SAN	LSC	Source
<i>Polyipnus polli</i>	adult	1	1	6	6	1 + 1	3	10	3	5	8	3	14	Baird, 1971
	4.3	0	0	2	0	0 + 1	0	1	0	0	0	0	0	Original
	4.8	1	0	4	2	1 + 1	0	3	0	0	0	0	0	Original
	5.5	1	1	6	4	1 + 1	2	8	0	0	0	0	0	Original
	6.0	1	1	6	6	1 + 1	2	10	0	1	0	0	0	Original
	7.5	1	1	6	6	1 + 1	2	10	0	3	0	0	0	Original
	9.0	1	1	6	6	1 + 1	2	10	0	3	2	0	2	Original
	9.6	1	1	6	6	1 + 1	2	10	1	3	2	0	2	Original
	13.5	1	1	6	6	1 + 1	3	10	3	5	4	0	14	Original
	15.3	1	1	6	6	1 + 1	3	10	3	5	4	1	14	Original
	17.0	1	1	6	6	1 + 1	3	10	3	5	4	2	14	Original
	18.4	1	1	6	6	1 + 1	3	10	3	5	6	3	14	Original
	23.5	1	1	6	6	1 + 1	3	10	3	5	7	3	14	Original
<i>Argyropelecus hemigymnus</i>	adult	1	1	6	6	1 + 1	2	12	6	4	6	0	4	Baird, 1971
	10.92	0	0	4	6	0 + 1	0	7	0	0	1	0	2	Sanzo, 1931d
	9.92	0	0	6	6	0 + 1	0	9	0	0	2	0	3	Sanzo, 1931d
	7.84	1	0	6	6	1 + 1	2	12	0	0	3	0	4	Sanzo, 1931d
	11.20	1	1	6	6	1 + 1	2	12	2	3	4	0	4	Sanzo, 1931d
<i>Argyropelecus</i> sp.	adult	1	1	6	6	1 + 1	2	12	6	4	6	0	4	Baird, 1971
	4.5	0	0	0	0	0 + 0	0	0	0	0	0	0	0	Original
	9.5	0	0	6	6	0 + 1	0	6	0	0	1	0	0	Original
	9.5	0	0	6	6	0 + 1	0	8	0	0	3	0	0	Original
	7.0	1	0	6	6	1 + 1	2	12	0	0	3	0	3	Original
	7.0	1	0	6	6	1 + 1	2	10	0	0	3	0	4	Original
	7.4	1	1	6	6	1 + 1	2	12	4	4	4	0	3	Original
	10.0	1	1	6	6	1 + 1	2	12	5	4	5	0	4	Original
<i>Sternoptyx</i> sp.	adult	1	1	3	5	1 + 1	3	10	0	3	3	1	4	Baird, 1971
	4.8	0	0	0	0	0 + 1	0	0	0	0	0	0	0	Original
	7.5	0	0	0	0	0 + 1	0	0	0	0	0	0	0	Original
	7.8	0	1	2	3	0 + 1	0	4	0	0	0	0	0	Original
	8.1	0	1	2	4	0 + 1	2	7	0	0	0	0	0	Original
	7.6	0	1	2	5	0 + 1	3	10	0	1	3	0	1	Original

TABLE 55. DIAGNOSTIC PIGMENT CHARACTERS AND UNUSUAL MORPHOMETRIC FEATURES OF SOME STOMIIFORM LARVAE.

Genus/species	Diagnostic character
<i>Diplophos taenia</i>	Pigment spots on dorsal and ventral midline. Extremely elongated larvae.
<i>Bonapartia pedaliota</i>	Similar to <i>Gonostoma</i> but lacks deep pigment spot behind eyes and has pigment on medial portion of caudal peduncle.
<i>Margrethia obtusirostre</i>	A distinct vertical streak of pigment on caudal peduncle in most specimens.
<i>Gonostoma</i>	All species usually have deep pigment spot behind eyes. Specific differences among the species are as follows: <i>G. elongatum</i> , <i>G. gracile</i> and <i>G. ebelngi</i> lack pigment on caudal peduncle; <i>G. bathyphilum</i> has pigment spots on dorsal edge of caudal peduncle; <i>G. atlanticum</i> has pigment over medial portion of caudal peduncle (closely resembles <i>Cyclothone</i> in ventral pigmentation and swimbladder position); <i>G. denudatum</i> has broad streak of pigment diagonally over caudal fin base from dorsal caudal peduncle to base of lower caudal fin rays.
<i>Cyclothone</i>	A distinct, dark streak or intense melanophore over and parallel to the parhypural on the caudal fin base, pigmentation over gut and along ventral margin of tail and a conspicuous swimbladder.
<i>Yarella blackfordi</i>	Myosepta pigmented over caudal peduncle giving chevron appearance.
<i>Pollichthys mauli</i>	No pigment except for the eyes. Very similar to <i>Vinciguerria</i> in other aspects.
<i>Vinciguerria</i>	All species have medial or ventral margin caudal pigment spot. <i>V. nimbaria</i> and <i>V. lucetia</i> have the caudal pigment spot restricted to the ventral margin of the caudal fin base and pigment above the anal fin. <i>V. attenuata</i> and <i>V. poweriae</i> has the caudal pigment spot in a medial position and no pigment above the anal fin. <i>V. attenuata</i> has pigment over the airbladder which is lacking in <i>V. poweriae</i> . <i>V. poweriae</i> has a structure above the anal papilla which may appear as pigment. <i>V. mabahus</i> is similar to <i>V. nimbaria</i> and is restricted to the Red Sea (Johnson and Feltes, 1984).
<i>Woodsia nonsuchae</i>	Melanophores profusely distributed on all myomeres below the lateral midline. Broad pigment band along roof of mouth continuous with trunk pigment. Also has a trailing gut and elongated rays on pectoral fin, both of which may be missing.
<i>Ichthyococcus ovatus</i>	Pigment profusely distributed on all myomeres below the lateral midline. Elongate pectoral fin rays and a trailing gut, both of which may be missing.

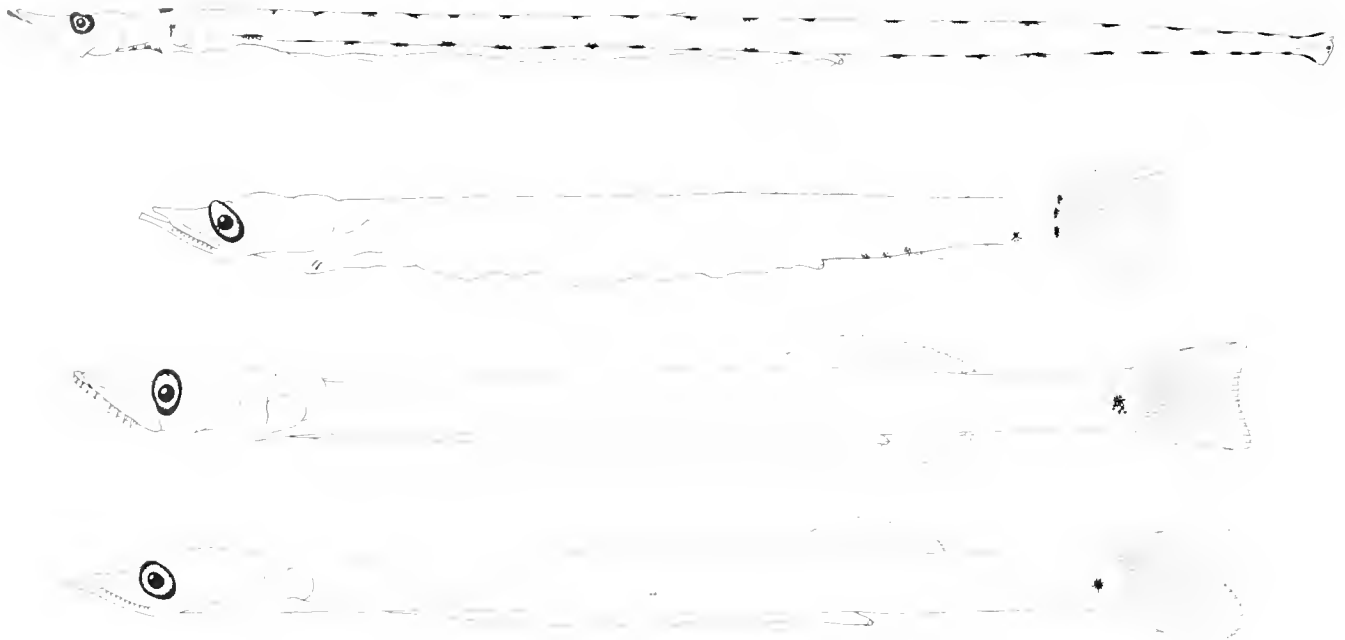

Fig. 98. Lateral views from top to bottom: *Diplophos taenia* 22.0 mm SL, R/V OREGON II Cr. 126, Sta. 36754, 27°30'N, 092°30'W, May 10, 1982, drawn by J. C. Javech; *Vinciguerria lucetia* 9.0 mm SL modified after Ahlstrom and Counts (1958); *Vinciguerria poweriae* 11.5 mm SL, R/V OREGON II Cr. 126, Sta. 36746, 27°59.9'N, 088°00'W, May 8, 1982, drawn by J. C. Javech; and *Vinciguerria attenuata* 9.7 mm SL modified after Jespersen and Tåning (1926).

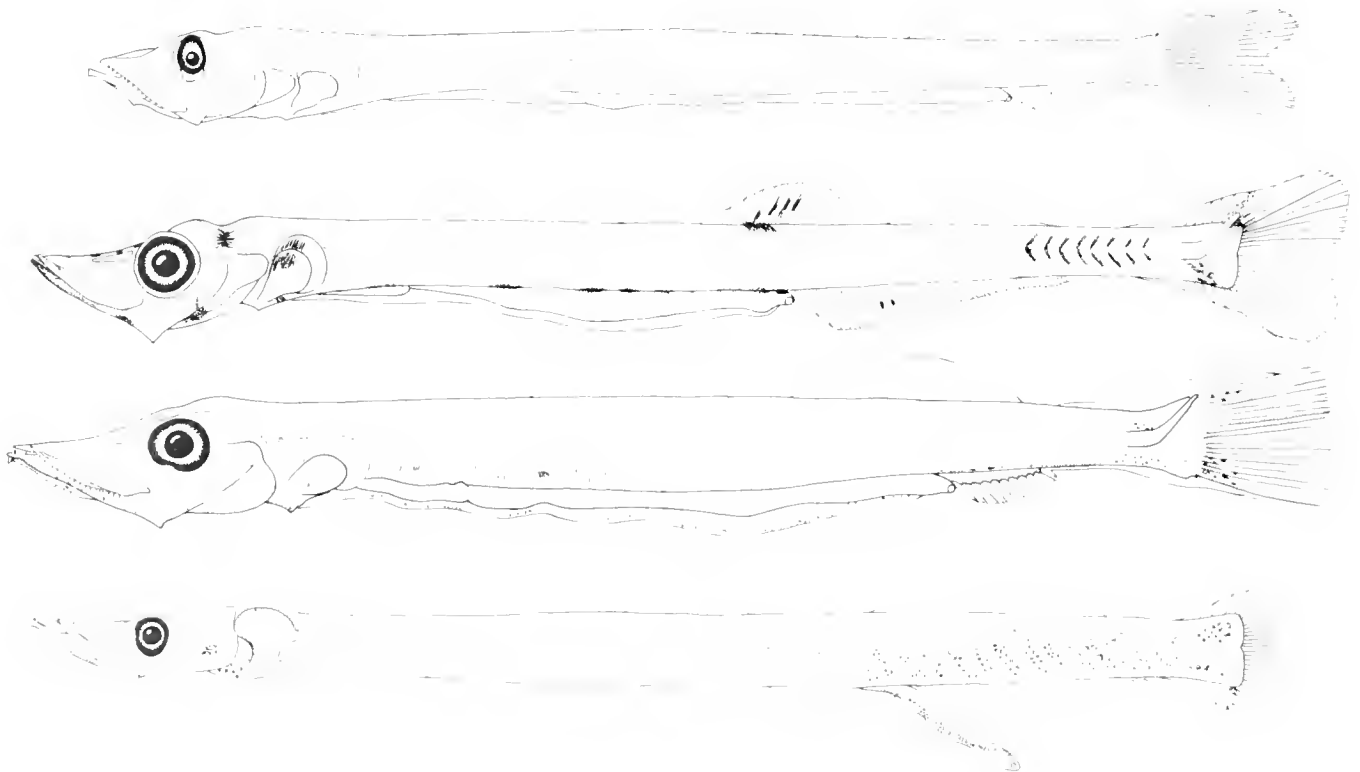

Fig. 99. Lateral views from top to bottom: *Pollichthys mauli* 14.5 mm SL, R/V OREGON II Cr. 126, Sta. 36688, 26°00.5'N, 088°00.4'W, April 20, 1982, drawn by J. C. Javech; *Yarella blackfordi* 23.5 mm SL, R/V OREGON II Cr. 126, Sta. 36752, 27°30'N, 094°30.3'W, May 9, 1982, drawn by J. C. Javech; *Woodsia nonsuchae* 11.5 mm SL, Eastropac, Sta. 75.225, drawn by J. C. Javech; and *Ichthyococcus ovatus* 18.1 mm SL, R/V OREGON II Cr. 126, Sta. 36746, 27°59.9'N, 088°00'W, May 8, 1982, drawn by J. C. Javech.

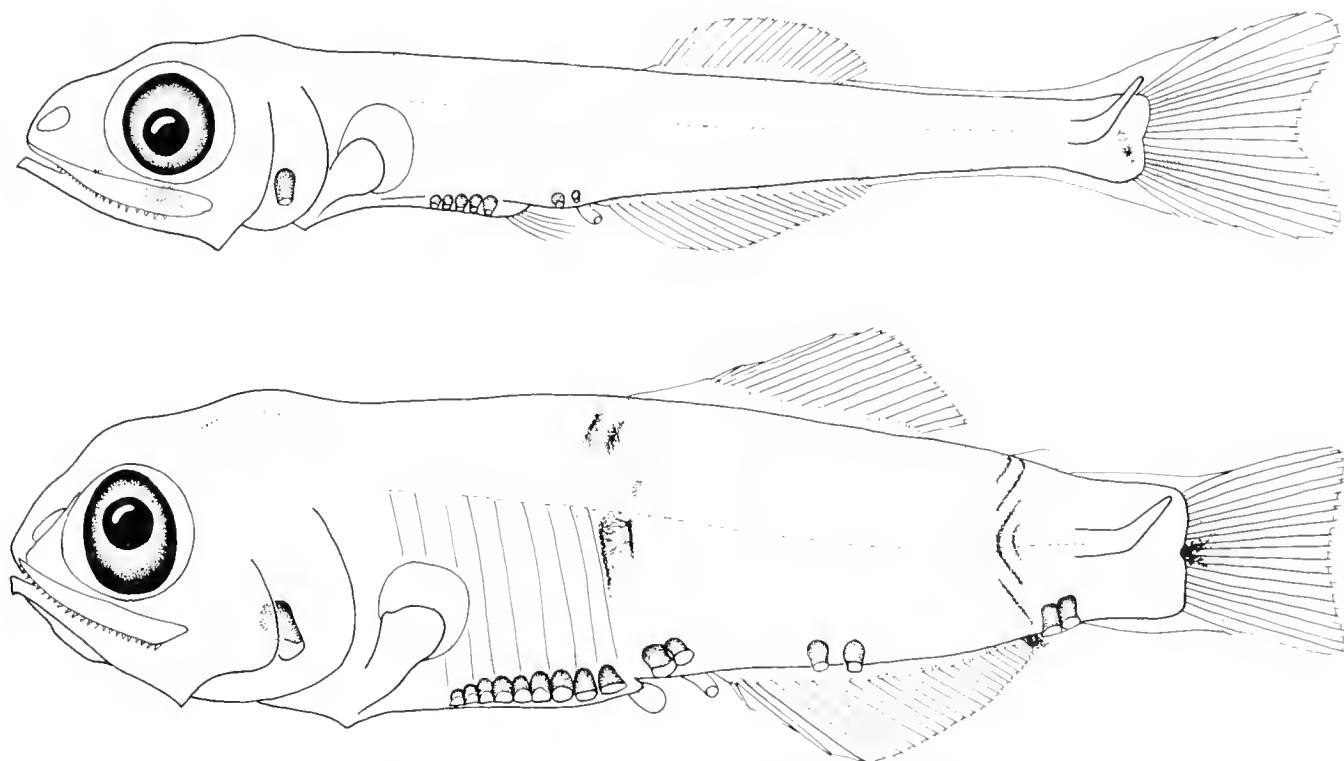

Fig. 100. Lateral views from top to bottom: *Bonapartia pedaliota* 11.5 mm SL, R/V OREGON II Cr. 126, Sta. 36688, 26°00.5'N, 088°00.4'W, April 20, 1982, drawn by J. C. Javech; *Margrethia obtusirostra* 6.7 mm SL, R/V OREGON II Cr. 126, Sta. 36773, 26°00.1'N, 094°00.2'W, May 23, 1982, drawn by J. C. Javech.

were placed in the Infraorder Photichthya. Nearly all have three, or rarely fewer, proximal pectoral-fin radials, a specialized character which can be used as a synapomorphy uniting this group. As noted above, there are a few exceptions which bear four proximal radials but these appear to be either reversals or are neomorphic. Within the Infraorder Photichthya the stomiiform genera with elongate gill rakers in adults were placed in the Family Photichthyidae comprised of the genera *Polymetme*, *Yarella*, *Pollichthys*, *Photichthys*, *Vinciguerria*, *Woodsia*, and *Ichthyococcus*. This placement was done on the basis of the presence of Type Gamma photophores in at least most of the genera, a specialization for the group (as well as for at least some of the stomiid genera) and therefore a synapomorphy. The presence of elongate gill rakers in this group is not a synapomorphy because it is primitive for the group.

Essentially, Ahlstrom and Weitzman disagreed on the relationships of three genera. Ahlstrom's Group (1) was mostly equivalent to Weitzman's Photichthyidae but included three genera, *Cyclothone*, *Diplophos* (including *Manducus*), and *Triplophos*, placed in the Gonostomatidae by Weitzman. Otherwise, Weitzman's Gonostomatidae was equivalent to Ahlstrom's Group (2). Based on evidence available to Ahlstrom and Weitzman, on some supplementary evidence provided by Fink and Weitzman (1982), and on some of our own data, we here present a somewhat different arrangement based on a more rigorous phylogenetic analysis than done by Weitzman (1974). It turns out that Weitzman's analysis of the Sternoptychidae and its genera is consistently phylogenetic but that of outgroup stomiiforms is not. Ahlstrom (1974) did not attempt to analyze his groups phylogenetically. The evidence available now seems

to resolve the conflict between Ahlstrom (1974) and Weitzman (1974). However, we would note that the analysis below is to be regarded as a guide to future studies rather than any sort of well-corroborated phylogeny. Parts, at least, of the arrangement need much additional study. Furthermore, the relationships of the genera in contention by Ahlstrom and Weitzman are still not fully clear. Some of these genera, *Manducus*, *Diplophos*, and perhaps *Triplophos*, are relatively primitive within stomiiforms with few characters specialized beyond the stomiiform level. This makes placing them in stomiiform subgroups difficult. *Cyclothone* is more derived but retains certain primitive stomiiform features and its relationship, although in our view is undoubtedly with the gonostomatids, at this time is somewhat uncertain because our data are not fully analyzed.

The conflict between Ahlstrom (1974) and Weitzman (1974) arose in part because they both utilized one or the other of certain characters. Type Beta photophores and "white" photophore development, as though they were shared specialized characters, synapomorphies indicating relationships. Instead, we believe these features are plesiomorphous for stomiiform subgroups and cannot be used to support a hypothesis of relationships among stomiiform genera. Our current analysis is as follows.

Fink and Weitzman (1982:69-75) list and discuss eight synapomorphies for stomiiform fishes. One of these, stomiiform-type photophores, was described in some detail based in part on Bassot (1966, 1971). Bassot (1966:574-576), Weitzman (1974:338), and Fink and Weitzman (1982:70) recognized Type Beta photophores as primitive for stomiiforms. Bassot (1966, 1971) recognized two other types of photophores, Type Alpha

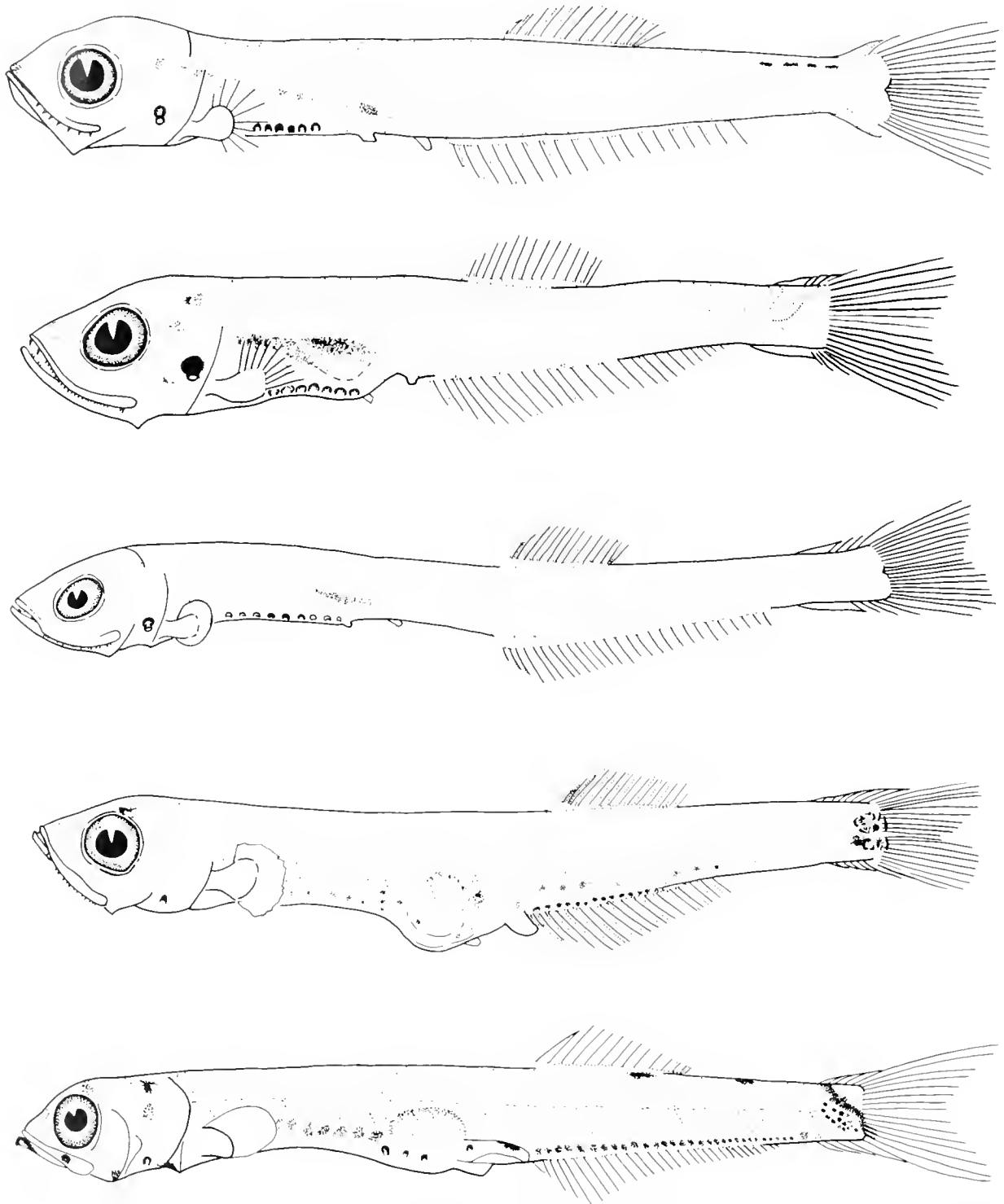

Fig. 101. Lateral view from top to bottom: *Gonostoma bathyphium* 11.0 mm SL modified after Ahlstrom (1974); *Gonostoma elongatum* 9.8 mm SL modified after Ahlstrom (1974); *Gonostoma ebelingi* 15.0 mm SL modified after Ahlstrom (1974); *Gonostoma atlanticum* 12.0 mm SL modified after Ahlstrom (1974); *Gonostoma denudatum* 20.7 mm SL modified after Sanzo (1931d).

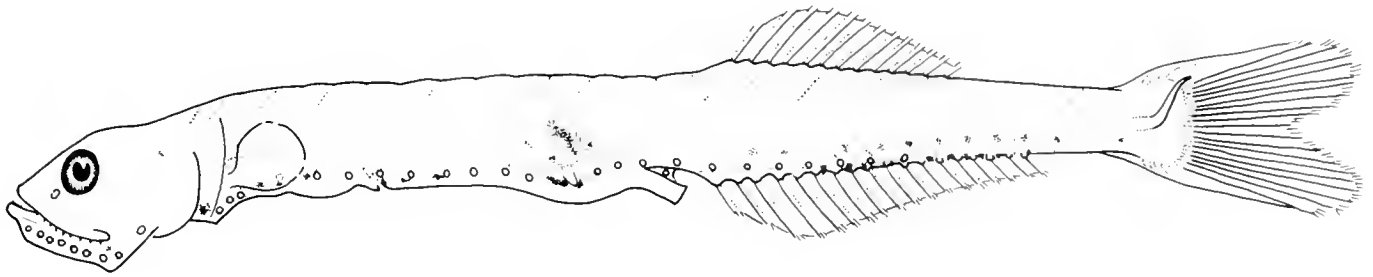

Fig. 102. *Cyclothone signata* 9.0 mm SL, drawn by H. Orr.

and Type Gamma, as being more specialized. This recognition, although not stated by these authors, is based on a concept that Types Alpha and Gamma photophores of some stomiiformes appear to be elaborations of Type Beta photophores. In other words, their particular features appear to be developmental terminal additions to Type Beta photophores and are therefore available for use as synapomorphies for stomiiform subgroups. Although more detailed analyses of these features are needed, for the sake of discussion we here accept that Type Beta photophores are primitive for stomiiforms.

Weitzman (1974:338), on the basis of outgroup comparison (not described or discussed in his text), considered four proximal pectoral-fin radials to be primitive for stomiiforms, their reduction to three or fewer to be specialized. We see no reason to change that analysis. Thus three or fewer proximal pectoral-fin radials are available as synapomorphous characters for stomiiform subgroups.

Ahlstrom (1974:660) described what can be labeled as "white" photophore development in which most, or at least the ventral series of photophores, are "laid down initially during a white photophore stage [before black pigment develops] and only a few photophores are late forming." One form or another of "white" photophore development is common to all stomiiforms except those including the gonostomatid genera *Bonapartia*, *Margrethia*, and *Gonostoma*, and the sternoptychids of Weitzman (1974). Members of these gonostomatid and sternoptychid genera have a protracted metamorphosis from the larval stage as well as a gradual, more extended photophore formation. This latter type of photophore development appears to be an elaboration of "white" photophore development and thus we consider white photophore development primitive with respect to the more complicated forms having prolonged photophore development. Again, much information of an anatomical and developmental nature remains to be gathered from the process of photophore development.

If "white" photophore development and Type Beta photophores are primitive in regard to stomiiform subgroups and therefore unavailable as synapomorphies for stomiiform subgroups, then the conflict regarding the distribution of characters among taxa between Ahlstrom (1974) and Weitzman (1974) disappears in a phylogenetic analysis by somewhat altering certain of the groups of both authors as follows.

In our tentative scheme of relationships, Weitzman's Sternoptychidae and Ahlstrom's Group (2) genera (Ahlstrom, 1974: 671), *Bonapartia*, *Margrethia*, and *Gonostoma*, the Gonostomatidae in the strictest sense, are united by a synapomorphy consisting of a specialized form of prolonged metamorphosis

and photophore development described by Ahlstrom (1974: 660–661). See also Tables 52–54 herein. These three gonostomatid genera and *Cyclothone* apparently share derived characters of the jaws and associated head parts which will be explained in a later contribution. These four genera retain the primitive Type Beta photophores, a character relating stomiiforms only at the ordinal level. In our opinion these four genera constitute the Gonostomatidae and *Cyclothone* may have lost prolonged photophore development through pedomorphic reversal associated with the small size of most of its members, a situation needing further study.

The Sternoptychidae have specialized Type Alpha photophores and the several other synapomorphies listed by Weitzman (1974:446–448). In addition they apparently share a unique photophore growth pattern previously unrecorded. One of us (Weitzman) has been studying photophore development in relation to phylogenetic studies in stomiiforms and has found that each cluster or group of photophores of the sternoptychids appears to develop by budding from one single photophore rather than by fusion at a later growth stage of separately developed photophores. This is a terminal developmental addition in photophore ontogeny and both outgroup comparison and developmental information indicate that this pattern of photophore formation is a specialization in comparison to the simpler appearance of single, separate body photophores (usually one per scale in any given series found in other stomiiforms). This growth character appears to be present in all sternoptychid genera for which we have developmental information. It is therefore a likely synapomorphy for the group.

Manducus (based on the type species, *Gonostoma maderense* Johnson) is a primitive stomiiform, having ordinal-level characters with no known specialized characters except the absence of an adipose fin and a short neural spine on the preural centrum. The latter may be a primitive rather than a specialized stomiiform feature. *Diplophos* (based on the type species *Diplophos taenia* Günther) appears to have a transitional stage pectoral radial morphology between *Manducus* on the one hand and the Photichthyidae of Weitzman (1974) (an ill-defined group) and the Stomiidae on the other. In *Manducus* the cartilages and bones of proximal pectoral-fin radials III and IV remain separate whereas *Diplophos* has the cartilages, but not the bones, of the two elements fused, Fink and Weitzman (1982:65–67). In the "photichthyids" and stomiids the cartilages and bones of the two medial pectoral-fin radials are fused. This represents the terminal condition in the transition series except that in some genera there is a reversal of radial numbers and in *Eustomias* there occurs a further specialized, reduced pectoral-fin radial

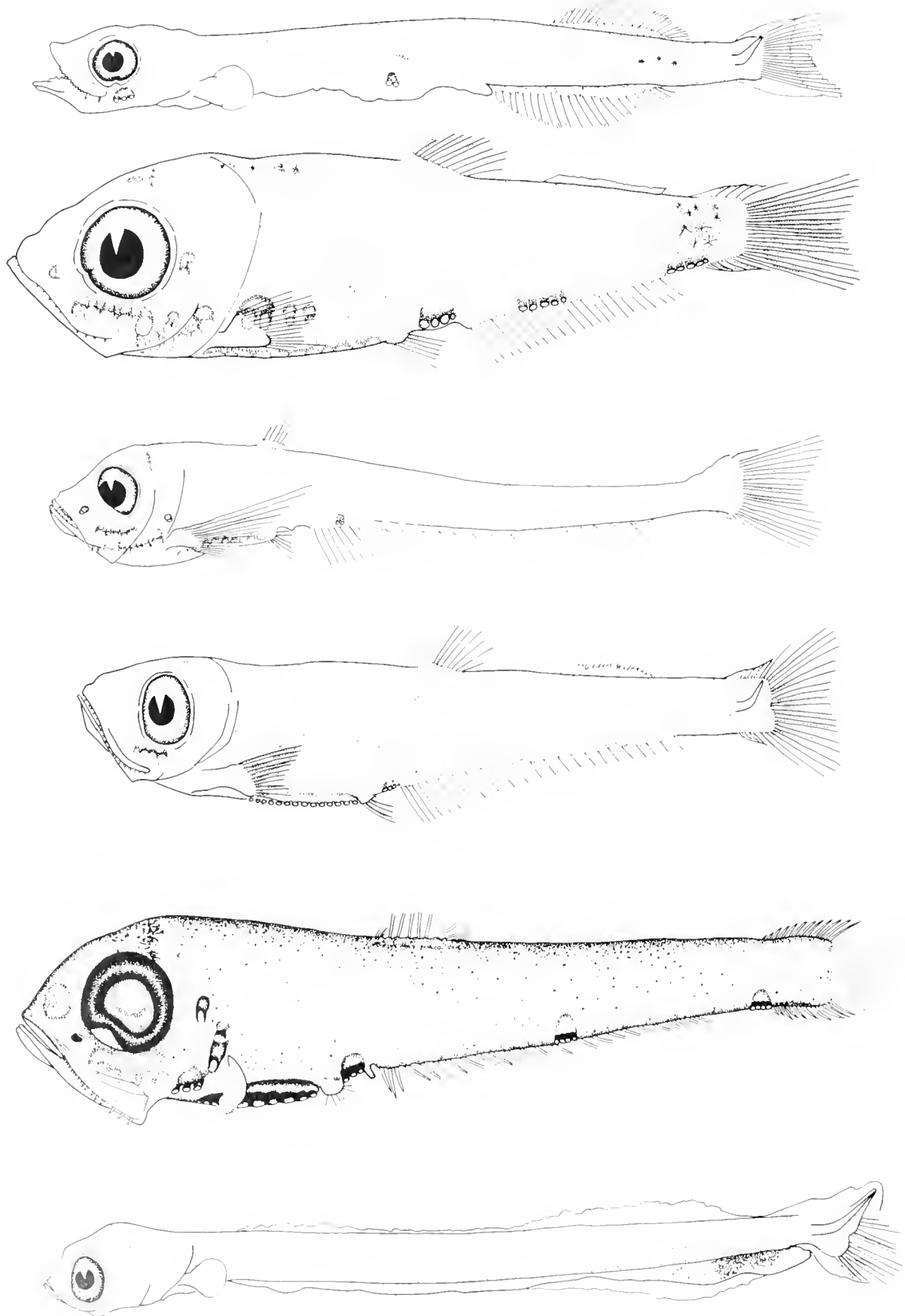

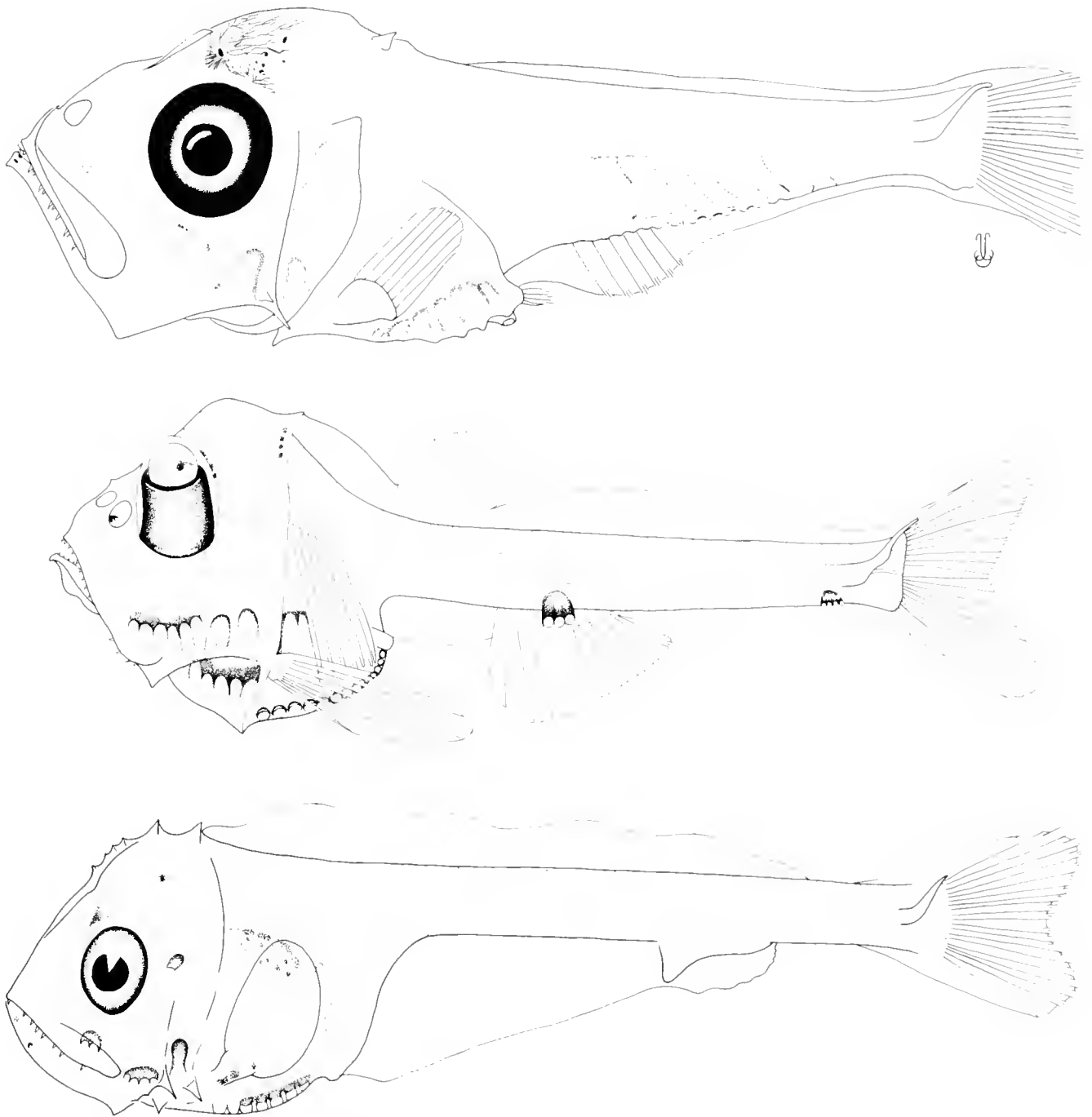

Fig. 104. Lateral views from top to bottom: *Polyipnus polli* 5.2 mm SL R/V GERONIMO Cr. 2, Sta. 155, 05°28'S, 01°120'E, August 21, 1963, drawn by J. C. Javech; *Argyropelecus hemigymnus* 7.8 mm SL modified after Sanzo (1931d); and *Sternoptyx* sp. 8.8 mm SL, drawn by H. C. Orr.

Fig. 103. Lateral views from top to bottom: *Araiophos eastropas* 8.8 mm SL modified after Ahlstrom and Moser (1969); *Maurolicus muelleri* 10.8 mm SL modified after Ahlstrom (1974); *Danaphos oculatus* middle metamorphosis modified after Ahlstrom (1974); *Valenciennellus tripunctulatus* middle metamorphosis modified after Ahlstrom (1974); *Argyripinus atlanticus* 18.7 mm SL modified after Badcock and Merrett (1972); and maurolicine Alpha 7.5 mm SL modified after Ahlstrom (1974).

condition. The "photichthyids" and stomiids have specialized Type Gamma photophores, although it is not known that all genera in these groups have Type Gamma photophores; this is a problem for further investigation. *Manducus* and *Diplophos* retain Type Beta photophores and all of these fishes apparently retain "white" photophore development of one kind or another. These two characters are only useful at the ordinal level as synapomorphies. Again, further research on "white" photophore formation is needed since there appears to be more than one form of this development.

The monotypic *Triplophos* may or may not be related to *Manducus* and/or *Diplophos*. *Triplophos* has a variety of derived features not shared by *Manducus* or *Diplophos*. However, this tells us nothing about its possible relationships with these genera. *Triplophos* has four proximal pectoral-fin radials but with some reduction in radial IV, Type Beta photophores, and probably "white" photophore development, the last two characters synapomorphic only at the ordinal level. Four pectoral-fin radials are not a synapomorphy for stomiiforms at any level since the feature is found in most teleost outgroups. *Triplophos* appears to be a primitive stomiiform with certain autapomorphic features associated with an elongate body. Its relationships are uncertain and there may be indications in the head and pectoral girdle anatomy of a relationship with certain photichthyid genera. The problem needs much study.

Cyclothone retains Type Beta photophores and "white" photophore development but has its own specialized features such as only one pectoral-fin radial. It has a modified head and jaws, which resemble and are, in our opinion, synapomorphic with those of *Gonostoma*. The single pectoral-fin radial might be thought of as a terminal stage in a transition series from *Manducus* (with four pectoral-fin radials) to *Diplophos* to some members of the "Photichthyidae" and then to *Cyclothone*. However, *Cyclothone* does not have specialized Type Gamma photophores of the "photichthyid" genera. The phylogenetic relationships of *Cyclothone* may not be certain as yet, but in many respects it bears a resemblance to the three gonostomatid genera and we favor its placement with these genera. See also discussion above.

Although we have perhaps resolved the differences between Ahlstrom (1974) and Weitzman (1974), we have not achieved a useful phylogeny of most stomiiform groups. Rather, we have attempted to outline certain suggested hypotheses of relationships to be investigated in the future with additional data. Adult morphological data of the kind used by Weitzman to define and relate the sternoptychid genera are available in abundance and may be useful for other stomiiform groups. A closer look at growth stages with the specific purpose of looking for possible developmental specializations and terminal additions to characters found in outgroups should greatly aid in delineating relationships among the stomiiform genera. However, problems associated with a high percentage of homoplasy can be expected for some groups. The answers to problems of stomiiform interrelationships will not come easily.

Consideration of certain features is in order. For example, larvae of *Diplophos* superficially resemble those of *Chauliodus* with their prolonged development to a large larval size and great elongation with bodies that are circular in cross section. Are these convergent larval specializations or primitive stomiiform features found only in certain stomiiform genera? The ventral pigmentation on the body of developing *Diplophos* resembles

that of developing paralepidids and myctophoids. Is this a primitive stomiiform feature of *Diplophos* shared with certain stomiiform outgroups or a gross convergence of pigment patterns?

Woodsia and *Ichthyococcus* share with certain stomiid genera (for example, *Eustomias*) such developmental features as elongate pectoral-fin rays, trailing guts, pigmentation patterns, and bodies with a circular cross section. Some, if not all, of these may be shared larval specializations. But again, independent appearance of these characters indicated by a high degree of homoplasy may be a vexing problem. Larvae of other genera such as *Vinciguerria*, *Pollichthys*, and *Cyclothone* have body shapes and certain other features that closely, but presumably superficially, resemble those of clupeoid larvae. Detailed comparisons of these similarities may possibly distinguish between homology and convergence among these taxa.

In summary, a future phylogenetic analysis based on much additional data may clear up many of the problems of stomiiform generic relationships. However, at present we are left with numerous phylogenetic problems and assignment of certain genera to family-level groups at this time would be misleading. The above analysis retains Weitzman's Sternoptychidae. It restricts the Gonostomatidae to the genera *Bonapartia*, *Margrethia*, and *Gonostoma*, and we recommend the inclusion of *Cyclothone*.

The other groups of non-stomiid stomiiforms remain unclear as to family relationships. We agree with Fink and Weitzman (1982) that *Manducus* and *Diplophos* are primitive stomiiforms, but we cannot provide a stable classification for *Manducus*, *Diplophos*, and *Triplophos*. *Manducus* and *Diplophos* might seem to be sister taxa because of their similarity of appearance. However, they share no known specialized character or characters that would unite them as a stomiiform subgroup except the absence of an adipose fin and possibly a short neural spine on the preural centrum. Currently all their other shared characters seem primitive for stomiiforms. Further analysis of this situation is needed.

Triplophos is again very much like a primitive stomiiform in its head especially, but it has a number of specialized stomiiform features as listed by Grey (1964:106) and may show some relationship to some of the "photichthyid" genera.

That the genera classified in the "Photichthyidae" by Weitzman (1974) form some kind of related group seems reasonable. However, relationships among these genera are not known. That these "photichthyid" genera are related to *Diplophos* is possible, and that the stomiids are related to the "photichthyids" is, in our view, very probable. The larval specializations of *Woodsia* and *Ichthyococcus* noted above, may be important here because they may be synapomorphies relating these genera to the stomiids.

Until the developmental and adult morphological features of many stomiiform genera are analyzed in detail, certain aspects of their developmental stages outlined, and detailed outgroup analysis performed on all putatively useful characters, we can make no certain predictions about relationships and classification.

(W.J.R.) NATIONAL MARINE FISHERIES SERVICE, SOUTHEAST FISHERIES CENTER, 75 VIRGINIA BEACH DRIVE, MIAMI, FLORIDA 33149; (S.H.W.) DIVISION OF FISHES, NATIONAL MUSEUM OF NATURAL HISTORY, SMITHSONIAN INSTITUTION, WASHINGTON, D.C. 20560.

Giganturidae: Development and Relationships

R. K. JOHNSON

THE Giganturidae contains two highly-specialized bathypelagic species placed in two monotypic genera: *Gigantura chuni* Brauer, 1901 and *Rosaura indica* (Brauer, 1901). Adults now placed in *Rosaura* were formerly recognized as *Bathyleptus* Walters, 1961. Morphological specializations of giganturids are sufficiently divergent and numerous that the group has usually been accorded subordinal or ordinal status somewhere within the group now recognized as basal neoteleosts (Stomiiformes + "Aulopiformes" + "Myctophiformes," see Rosen, 1973; Johnson, 1982; Fink and Weitzman, 1982).

Giganturids are oceanic and deep mesopelagic or bathypelagic as juveniles and adults. Most hauls successful for juveniles and adults have been at depths in excess of 500 m (with closing net captures as deep as 2,000–2,500 m). There is no evidence for diel vertical migration. *G. chuni* is tropical, *R. indica* tropical-subtropical (*sensu* Johnson, 1982:185). Giganturids are unknown from the Southern Ocean, Pacific Subarctic, temperate North Atlantic (including Mediterranean), and only a single specimen (*G. chuni*) is known from the eastern tropical Pacific.

Giganturids are relatively large-bodied with adults of *Rosaura* achieving more than 220 mm SL, adults of *Gigantura* more than 170 mm SL. Giganturids are well-known swallowers with greatly expandable pouchlike stomachs. Most identifiable gut contents have been fishes, often single large fish ingested whole (e.g., Regan, 1925). Transformed giganturids are distinguished from most or all other teleosts by the following combination of characters: (A) eyes tubular, directed straight forward, in parallel with main axis of body; (B) gape of mouth extends far behind eye; teeth fang-like, unbarbed, recurved, depressible; teeth biserial on each jaw, a medial row of enlarged canines and a lateral, more irregular row of smaller canines; anteriormost canine in each jaw recurving anteriorly; (C) bases of pectoral fins nearly horizontal, above the gill openings; pectoral fins with a very high fin-ray count, 37 to 43 in *Rosaura*, 30–33 in *Gigantura*; (D) caudal forked, middle rays of lower lobe lengthened enormously; in one 120.3 mm SL specimen of *G. chuni* the filamentous extension of the lower caudal lobe adds 243 mm to the length of the fish; (E) skin loose, scaleless, with a thick layer of mesenchymal jelly adding substantially to an overall characteristic flabbiness; (F) stomach a thickwalled blind pouch, giving rise to the intestine ventrally, near midline; intestine passing laterad and dorsad, to right, continuing along dorsal contour of stomach until finally turning ventrad behind posterior terminus of stomach and ending at anal papilla; (G) lack of pelvic fins, dorsal adipose fin, branchiostegal rays, gill rakers; loss of most of gill arch elements on arches I–III, but with strong, recurved teeth on 3rd pharyngobranchial (pb) and 4th pb toothplate; loss of numerous other skeletal elements (cf. Regan, 1925; Walters, 1961, 1964; Rosen, 1973); and (H) considerable consolidation of caudal fin skeleton with two presumably compound hypurals (Rosen, 1973).

DEVELOPMENT

Eggs of giganturids are unknown. Larvae are known for both species but only the larva of *Rosaura* (a single 8.4 mm specimen,

Fig. 105) has been illustrated (Tucker, 1954). For both species larvae have commonly been taken in the upper 100 m. The distributional ranges of larvae and adults are coextensive and there is no evidence for seasonality in reproductive effort (with only ca 400 known larval specimens, the data are far from complete). The sexes are separate and according to Clarke and Wagner (1976) the females may reach twice the size of males, although available data are sparse. Osteological examination has been confined to adults except for those elements visible and described in Tucker's (1954) astonishingly detailed description of the holotype of *Rosaura rotunda*. Development is direct but transformation is abrupt with the change from larval to adult morphology occurring over the approximate size range of 30–40 mm SL in *Gigantura* and 40–60 mm SL in *Rosaura*. Transformation series are now known for both species (only 8 transforming specimens of *Gigantura* are known, for *Rosaura* the count stands at 34) but these results remain unpublished. The interim account below is thus based on work in progress.

Gross aspect (Fig. 105).—"*Rosaura*" larvae are short, deep, globose, translucent and virtually colorless. The forehead is steep, the eyes small, round and directed laterad. The snout is pointed. The body is deepest at a vertical through the center of the opercle. The pectoral insertion is nearly vertical. A dorsal adipose and distinct partly-stalked 5-rayed pelvic fins are present. Large, readily visible, rather platelike branchiostegal rays are present. Raptorial jaw teeth are present in the smallest known larvae (4 mm SL). Teeth on the jaws are biserial with an inner series of prominent canines and an outer series of shorter more broadbased teeth on the premaxillaries and dentaries. There are 2–4 recurved smaller fangs on the basihyal. The maxillary is included in the gape but is edentulous. The abdominal body wall is nearly transparent and balloonlike, enclosing an expansive gut cavity. The body form remains essentially unchanged over a period of larval growth extending to ca 30 mm SL (*Gigantura*) and to ca 35 mm SL (*Rosaura*), when transformation begins. Changes during transformation are striking, as described below. At all stages—larvae, transforming specimens, and juveniles and adults—the species can be distinguished on the basis of relative depth of the caudal peduncle. The value of this character varies ontogenetically but the relative peduncle depth is always greater in *Gigantura*.

Meristic characters.—Counts of fin rays do not differ between larvae and adults except that semi-stalked pelvic fins (5 rayed) are universally present in larvae and early transforming specimens but are completely lost during transformation. Values for anal-fin ray counts (8 to 10 in *G. chuni*, 11 to 14 in *R. indica*) and pectoral-fin ray counts (30 to 33 in *G. chuni*, 36 to 42 in *R. indica*) separate the two species without overlap. Dorsal-fin ray counts (16 to 19) have the same range in both species. The caudal is the first fin to form; it is asymmetric with 10 + 6(7) principle caudal rays and (3)4(5) procurrent caudal rays above and below. Next to form, in order, are the dorsal + anal fins, pelvic fins, and pectoral fins (the dorsalmost pectoral rays begin

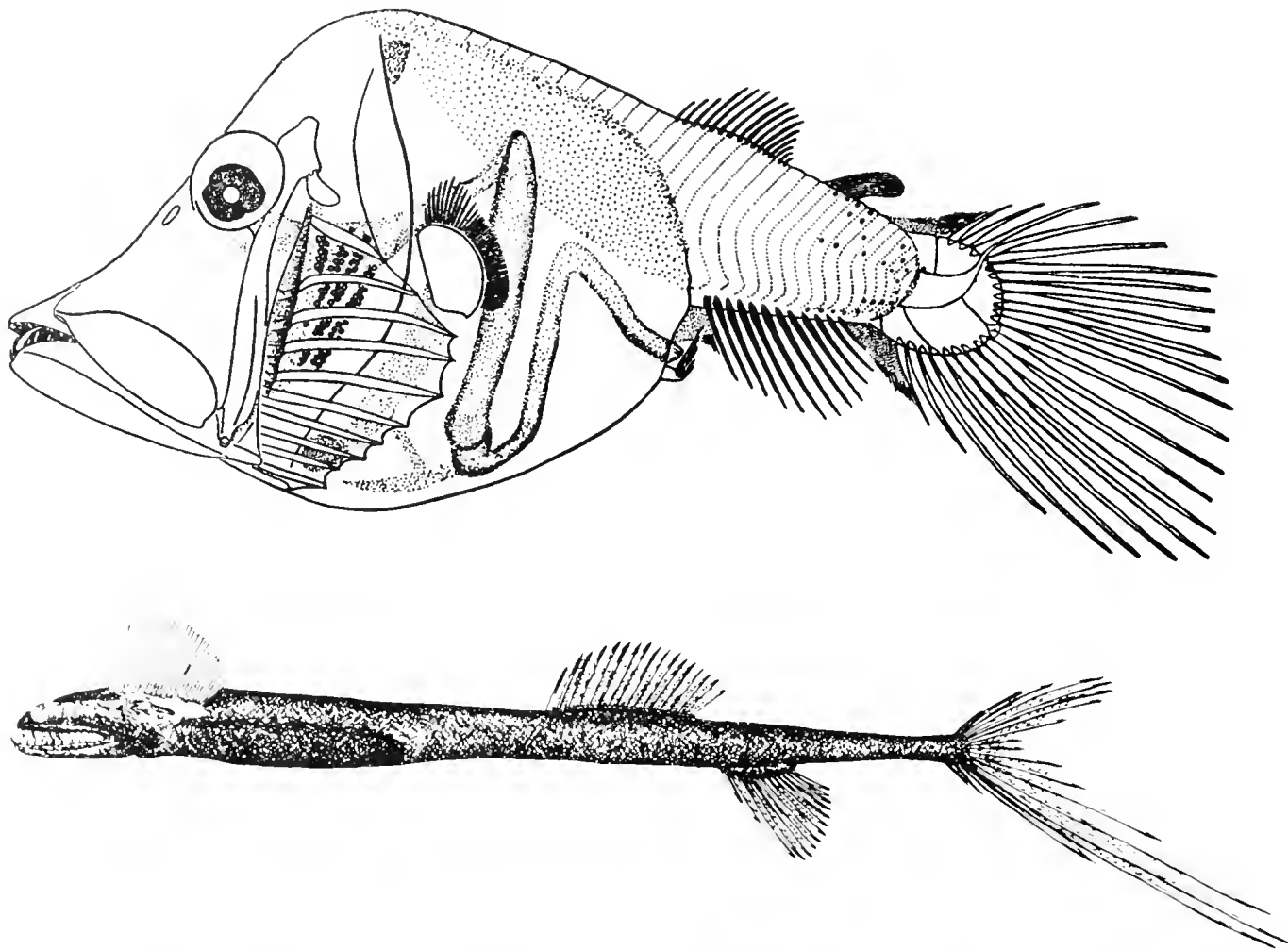

Fig. 105. Giganturidae. (Upper) Larva of *Rosaura indica*, 8.4 mm SL (=holotype of *Rosaura rotunda* from Tucker, 1954). (Lower) Adult *Rosaura indica*, 182 mm SL (from Berry and Perkins, 1966).

to differentiate in larvae as small as 5.5 mm SL, but the ventral-most pectoral rays are the last fin rays to be formed). The pelvic fins appear just below the dorsal-fin origin and do not greatly shift in relative position until transformation. A dorsal finfold connects the incipient dorsal fin with the caudal fin in small larvae, but loses this connection in larvae larger than 6 mm SL, and shrinks in extent but remains as a highly visible adipose fin until transformation, when it is resorbed.

Peritoneal pigment sections.—A single peritoneal pigment section characterizes the larvae of both species. This section lies just above and posterior to the dorsal transverse limb of the intestine. The section is never paired as in synodontoids and remains proportionately constant in size throughout larval life and is represented in adults as a small, intensely-black oval pigment patch above the stomach (growth of the section apparently ceases at about the onset of transformation, but the section apparently remains in both juveniles and adults of both species). The dense brown or black pigment enclosing the gut is not derived from this peritoneal pigment section, as is true for many "inioms" (see Johnson, 1982) but develops separately

during transformation (as in *Alepisaurus* and *Omosudis*, Wassersug and Johnson, 1976).

Other pigmentation.—In both species pigmentation in larvae occurs in three areas (other than the peritoneal section), the eyes, over the optic lobes, and on the sides of the body posterior to the dorsal-fin base. In some but not all pre-transformation specimens of *Gigantura*, very small punctate melanophores appear over the still otherwise essentially transparent lateral abdominal body wall.

Gut morphology.—The stomach is enlarged and sac-like. The intestine leaves the pyloric region of the stomach, descends round the left margin of the abdominal cavity, crosses transversely upon the ventral body wall, reascends the right side and then turns again, descending abruptly and obliquely down and posteriad to the vent.

Transformation.—Changes during transformation are numerous and striking: (A) Body shape. The body changes in shape from short, rotund and deep, rather as in some ceratioid larvae

(Bertelsen, 1951) or the larvae of certain scopolarchids (Johnson, 1974b, 1982) to the elongate, shallow, slender shape of the giganturids. The head while still massive is proportionately much less so ($\frac{1}{8}$ vs $\frac{1}{4}$ SL in *Rosaura*) and the dorsal head profile is essentially horizontal rather than steeply oblique (Fig. 105). (B) Eyes. Eyes in larvae are round, small and directed laterad; eyes in adults are fully tubular and directed rostrad. (C) Fins. Distinct, partly-stalked, 5-rayed pelvic fins are present in larvae, resorbed or shed during transformation, and lacking in adults. The line of insertion of the pectoral-fin rays is obliquely vertical in larvae, essentially horizontal in adults. In larvae the pectoral insertion is behind the gill slit, in adults (especially prominent in *Gigantura*) the pectoral insertion is substantially above the gill slit. A distinct dorsal adipose fin is present in larvae, absent in adults. Procurrent caudal fin rays number (3)4(5) in larvae and are prominent, in adults procurrent caudal rays are frequently embedded in the skin, difficult to see, and number (0)1(2,3). (D) Teeth. Among the most striking changes occurring during transformation is the total loss of all larval teeth (including basihyal teeth). Transforming specimens are characterized by a scalloped, irregularly-emarginate jaw edge (upper and lower) which is edentulous. None of the 40 known transforming specimens shows development of adult teeth and the smallest known post-transformation specimen (36.4 mm SL, *G. chuni*; 47.9 mm SL, *Rosaura indica*) possess a full complement of adult teeth. (E) Color. Larvae are essentially translucent with very little development of pigment, adults are entirely blackish/brown (often with the development of an iridescent finish in *Gigantura*). Onset of transformation is indicated by the "sudden" widespread development of pigmentation. (F) Loss of skeletal elements. Larvae possess at least the following skeletal elements not seen in adults: symplectic, coracoid, cleithrum, posttemporal, supracleithrum, branchiostegal rays.

RELATIONSHIPS

The first association of "*Rosaura*" with the giganturids was by Ahlstrom and Berry about 1960 (letters and mss material made available by H. G. Moser) with the first published suggestion made in Berry and Perkins (1966). Key characters suggesting relationship included the very high pectoral-fin ray count and the highly unusual 10+6(7) distribution of principle caudal rays, apparently unique to "*Rosaura*" and the giganturids. The disparities between "*Rosaura*" larvae and adult giganturids—briefly outlined above—left doubt in many minds, but the capture of essentially complete transformation series (to be described and illustrated in detail elsewhere) make it unquestionable that "*Rosaura*" is the larval form of the giganturids. With a caudal peduncle depth of ca 9.9% of SL (Tucker, 1954:168) there is likewise no doubt that the type of *Rosaura rotunda*

represents a larva of "*Bathyleptus*," requiring recognition of the more elongate, shallow-bodied species as *Rosaura indica* (Brauer, 1901). The deeper-bodied species is *Gigantura chuni* Brauer, 1901 (other species have been described but the characters used to distinguish them do not work, nor has other evidence been found to support the hypothesis of more than two species). Of the two, Walters (1961, 1964) argued for the more apomorphic condition of *Gigantura* but his characters need to be re-examined in light of outgroup comparisons and in conjunction with other characters.

Various authors have allied giganturids with such disparate groups as Stylephoridae, Saccopharyngiformes and "... a line [leading] from a subiniomous group such as the esocoids toward the synodontoid inioms, and this line later may have given rise to the Cetunculi ..." (Walters, 1961). Rosen (1973:438-441) has offered evidence that the original placement by Regan (1925: 57) of giganturids with synodontoids was correct. Rosen calls particular attention to similarities in upper jaw and infraorbital configuration with synodontoids and the presence of a retractor dorsalis (=RAB in Rosen, 1973; see Winterbottom, 1974b) muscle configuration state characteristic of the synodontoid/alepisauroid line (Johnson, 1982:85, 95). An important character (Johnson, 1982:71; Okiyama, this volume) uniting synodontoids with alepisauroids is the presence in larvae of multiple (3 or more) peritoneal pigment sections. Uniting synodontids and harpadontids (*sensu* Sulak, 1977) is the fact that in larvae of these fishes the sections are paired ... and *not* connected over the gut. The condition in "*Rosaura*" is that seen in aulopids, chlorophthalmids, primitive scopolarchids, and ipnopids, *viz.* a single section situated over the gut. This is the state thought primitive for inioms. Also distinguishing the giganturids is a unique conformation of the gut. In larvae the gut arises from the pylorus, descends round the left margin of the abdominal cavity, crosses transversely midventrally, reascends the right side, turns abruptly mediad, then turns again, descending abruptly and obliquely to the vent. In adults the intestine arises midventrally, makes a few small twists, ascends the right side, and passes posteriad *above* the dorsal contour of the expanded stomach, only descending to the vent posterior to the terminus of the stomach. In all the inioms I have examined the intestine arises midventrally and passes essentially straight back to the vent along the midventral wall of the abdominal cavity. For the time being, the available evidence suggests that the giganturids are neoteleosts (retractor dorsalis muscle), allied with the inioms (discrete peritoneal pigment section), diverging early from the rest and acquiring characters making them among the most specialized and distinctive of teleosts.

FIELD MUSEUM OF NATURAL HISTORY, ROOSEVELT ROAD AT LAKE SHORE DRIVE, CHICAGO, ILLINOIS 60605.

Basal Euteleosts: Relationships

W. L. FINK

As mentioned in the introduction to this section of the symposium, the order Salmoniformes has had a history of attrition, such that today I would recognize it as coextensive with the Salmonidae. Previously included taxa are now scattered, primarily as unresolved lineages at or near the base of the Euteleostei. What follows is a preliminary analysis, a sketch of alternative hypotheses of interrelationships of the basal euteleosts. Fully resolving these problems will take more time and more material than I have had available to me, and I hope that work stimulated by this symposium will provide insights which have not been forthcoming using traditional material and characters.

Unfortunately, very little information of a comparative nature is available on the larvae of basal euteleosts, and when these larvae have been discussed, only rarely have characters or character transformations useful at large clade levels been mentioned. Since adult specimens are more easily available in most collections, that is what I have relied on, with examination of larvae when possible.

RESULTS

The Euteleostei is a large group of modern teleosts which is poorly diagnosed in terms of unique traits, and most more phylogenetically advanced members lack some of the diagnostic characters. Patterson and Rosen (1977) considered the following as euteleostean traits: 1) an adipose fin, 2) nuptial tubercles, and 3) an anterior membranous component to the first uroneural.

Near the "base" of the Euteleostei, Fink and Weitzman (1982) recognized several lineages, including the Esocoidei, Ostariophysii, Argentinoidei, Osmeroidei, Salmonidae, and Neoteleostei. All were considered monophyletic, but the interrelations of these large clades were left unresolved (Fig. 106). Below is a review of each of the groups, with new information included when possible.

Esocoidei or *Esocae*.—These fishes have been a continuing problem for ichthyologists. They are considered as euteleosts on the basis of an anterior membranous component to the first uroneural, although it is not extensive. No esocoids can have an adipose fin as the dorsal fin is posteriorly situated. Neither do they have breeding tubercles. Rosen (1974) provided diagnostic characters documenting monophyly of the group. Fink and Weitzman (1982) suggested that esocoids could be the sister group of all other euteleosts based on the lack in the latter of a toothplate on the 4th basibranchial, a bone which is present in esocoids and other primitive teleosts (see those authors for a discussion of the distribution of this character). Wilson and Veilleux (1982) have recently reviewed interrelationships in the Umbridae, and they place *Umbra* and *Dallia* as sister taxa, with *Novumbra* as their sister group; all these together are placed as the sister group of *Esox*. This corroborates the hypothesis of Nelson (1972).

Rosen (1974) considered *Lepidogalaxias* to be a member of this assemblage, which he termed the Esocae. Fink and Weitz-

man (1982) questioned that hypothesis, leaving the genus unplaced. I have further comments and a new hypothesis of its relationships below. I have nothing to add to what Fink and Weitzman (1982) did with esocoids *sensu stricto*, and until more is forthcoming, consider them the likely sister group to other euteleosts.

Ostariophysii.—In terms of numbers of species and morphological diversity, this is the dominant basal euteleostean group. Fink and Weitzman (1982) did not consider the relations of these fishes to other euteleosts, primarily because their survey was intended to establish the placement of stomiiforms, and there was no evidence suggesting relationship between the two groups. No phylogenetic examination of ostariophysian relationships to other teleosts has been done since Rosen and Greenwood (1970) expanded traditional concepts of the group by adding the previously protacanthopterygian gonorynchiforms. Fink and Fink (1981) examined relationships within the group, placing siluroids and gymnotoids as sister taxa (order Siluriformes), these the sister taxon of characiforms, and these together the sister group of cypriniforms (the Otophysi, inclusive); sister group relationship of the gonorynchiforms to the Otophysi was corroborated. This entire assemblage was considered monophyletic on the basis of numerous characters, including lack of a dermopalatine, unique gasbladder morphology, specializations of the vertebrae, and adductor mandibulae anatomy.

Argentinoidei.—Greenwood and Rosen (1971) combined the alepocephaloid and argentinoid fishes into an expanded Argentinoidei, in the Salmoniformes. Fink and Weitzman (1982) agreed with the combination of the two groups and used the formal subordinal name to include both subgroups. However, Fink and Weitzman (1982) were unable to provide evidence bearing on relationships of these fishes, even though their cladogram (Fig. 23, Fig. 106 herein) showed them as the sister group of the osmeroidei. I have similarly been unable to place them, in part because of lack of adequate material.

Osmeroidei.—This group, which includes the northern and southern smelts, galaxiids (here including *Lovettia* and *Aplochiton*), *Plecoglossus*, and salangids, can be diagnosed as monophyletic based on several characters, including presence of one or more rows of teeth near the medial border of the mesopterygoid, loss or appearance late in ontogeny of the articular bone, and presence of a foramen in the posterior plate of the pelvic bone. Some subgroups of osmeroidei have lost various of these diagnostic characters, but the patterns of loss allow other features to provide evidence of relationship in the group.

Nevertheless, relationships within the suborder remain problematical. The following review is based upon examination of specimens, the literature, and the contributions to this symposium. Incidentally, I have not attempted to diagnose the various genera, but McDowall's comments (this volume and 1969) indicate that such needs to be done. The phylogenetic hypoth-

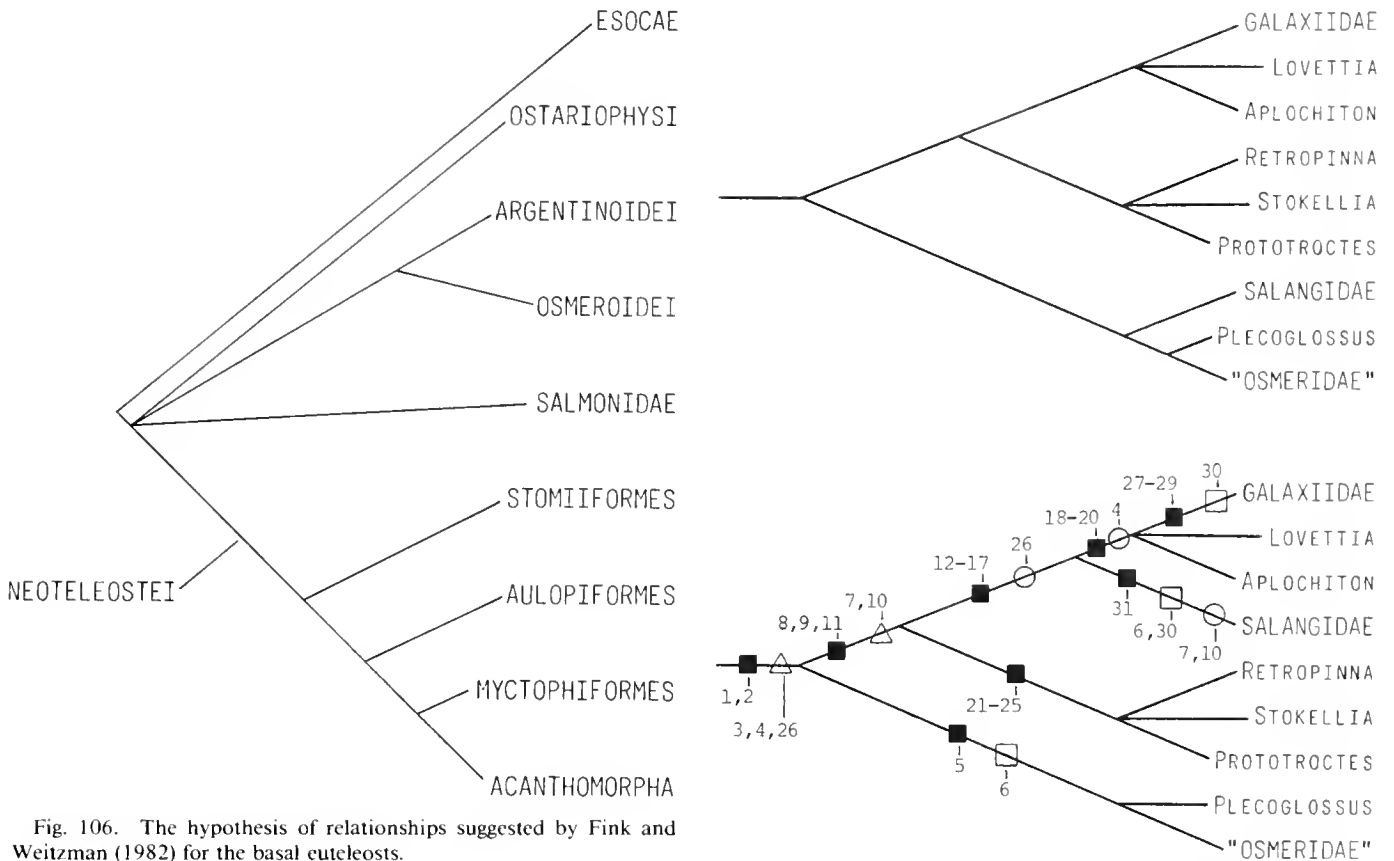

Fig. 106. The hypothesis of relationships suggested by Fink and Weitzman (1982) for the basal euteleosts.

eses and data are included in Fig. 107 and its caption. The data used in this analysis were chosen partly because they have been used traditionally in osmeroid systematics but I have little confidence in some of them; as a result this analysis represents a preliminary sketch of a more detailed study.

The most striking thing about osmeroid systematics is that we still have questions about some very basic things, such as the status of the Osmeridae. As noted by Nelson (1970) and Rosen (1974), no evidence has ever been presented that the family is a monophyletic group. Indeed, it seems quite possible that *Plecoglossus* could be more closely related to some "osmerids" than to others, and this would render the family paraphyletic. A minimal requirement of any future work on systematics of the group should be documentation of whether it is natural.

Fig. 107. Alternate cladograms of relationships within the Osmeroidei. The bottom figure represents the hypothesis supported when all characters are given equal weight and paedomorphic traits are considered homologous. The top figure represents the hypothesis which considers the paedomorphic reductive traits of salangids and galaxiids as non-homologous. For discussion, see text.

The supporting characters are listed below, with the derived condition indicated by a 1, the primitive by a 0. Each character number is indicated on the cladogram where it is in the derived state. Dark squares indicate unique appearance of a trait; empty squares indicate multiple appear-

ance of a trait; triangles indicate a trait that is reversed at a lower level of generality; and circles indicate those characters in the reversed state.

1. Posterior shaft of vomer (0) long (1) short.
2. Articular bone (0) present and fused with angular (1) absent or greatly reduced.
3. Mesopterygoid teeth (0) over much of bone ventral surface (1) restricted to medial border of ventral surface or lacking.
4. Pelvic foramen (0) absent (1) present.
5. Anchor membrane of egg (0) absent (1) present.
6. Caudal skeleton fusion patterns (0) none or rudimentary neural arches fusing with centrum and then, if at all, to the uroneural (1) rudimentary neural arch fusing with uroneural first, then these to the centrum.
7. Infraorbital sensory canals (0) curved posterodorsally (1) curved posteroventrally.
8. Mesocoracoid (0) present (1) absent.
9. Dorsal fin position (0) forward (1) posterior.
10. Principal caudal fin rays (0) 10/9 (1) 9/9 or fewer.
11. Palatine teeth (0) present (1) absent.
12. Ectopterygoid bone (0) present (1) absent.
13. Extrascapular (0) present (1) absent.
14. Coracoid-cleithrum process (0) present (1) absent.
15. Posterior pubic symphysis (0) present (1) absent.
16. Scales (0) present (1) absent.
17. Vomerine teeth (0) present (1) absent.
18. Posterior border of bones of suspensorium (0) smooth (1) deeply incised or emarginate.
19. Principal caudal fin rays (0) 9/9 (1) 8/8.
20. Hypural number (0) 6 (1) 5.
21. Infraorbital sensory canals (0) not extending to preopercle (1) extending to preopercle.
22. Ceratohyal ventral border (0) more or less straight, branchiostegals along most of its length (1) deeply concave anteriorly, branchiostegals restricted to area posterior to concavity.
23. Horny abdominal keel (0) not present (1) present.
24. Ovaries (0) both present (1) left only.
25. Ectopterygoid bone (0) posterior to autopalatine (1) ventral to autopalatine (coded as present in *Stokellia* based on McDowall, 1969).
26. Cucumber odor (0) absent (1) present.
27. Basioccipital lateral pegs (0) none (1) present.
28. Lateral hyomandibular spur (0) not present (1) present.
29. Caudal fin posterior border (0) deeply forked (1) rounded or emarginate.
30. Adipose fin (0) present (1) absent.
31. Mesopterygoid teeth (see also Character 3) (0) restricted to ventromedial area of bone (1) absent.

Salangids have been associated in the past with various members of the osmeroid assemblage, but even this was questioned by Nelson (1970). Rosen (1974) presented evidence from the caudal skeleton which shows that salangids are osmeroids, but no evidence about their placement within the group has been presented to date. Fink and Weitzman (1982) agreed with Rosen and placed the Salangidae as *incertae sedis* in the Osmeroidei.

What little evidence I have been able to find about the relationships of salangids is equivocal. If examined by a standard parsimony procedure, as represented by the Wagner analysis shown in Fig. 107 (bottom), the numerous reductive traits of salangids place them within the "southern smelt" plus galaxiid assemblage. On the other hand, salangids share with *Plecoglossus* and the "osmerids" a complex caudal skeleton character involving fusion of uroneural 1 to a compound centrum made up of PU1, U1, and U2, followed ontogenetically in some forms by fusion of rudimentary neural arches with the uroneural portion of the complex. This latter character is in contrast to the autogenous uroneurals of most galaxiids, the "southern smelts," and other primitive teleosts. Further, when uroneurals and rudimentary neural arches are fused in galaxiids, the fusion sequence is rudimentary neural arch to the compound centrum, followed by fusion with the uroneural, rather than the reverse. The hypothesis that emerges from these observations is illustrated in Fig. 107 (top), showing salangids, *Plecoglossus*, and "osmerids" in an unresolved trichotomy. For further discussion of caudal fin morphology, see Greenwood and Rosen (1971), Rosen (1974), and Fink and Weitzman (1982).

Any choice of these alternate hypotheses of salangid relationships would rest on whether or not one wished to accept the numerous reductive traits that unite the salangids with the "southern smelts" and galaxiids as homologues. Such choice is based on criteria which cannot be discussed in detail at this point due to space restrictions, but I have commented elsewhere (Fink, 1982) on hypothesis choice forced by confrontation with apparent paedomorphosis. In this case, for example, some of the general morphological attributes that salangids share with the members of those groups differ when examined in detail. Although this lack of close correspondence in similarity is certainly no guarantee that the reductions are not homologous, it does raise the issue. Further, the highly developed caudal skeleton of salangids is identical to that of "osmerids," and thus more differentiated than that of either the southern smelts or galaxiids. This incongruity in degree of morphological differentiation suggests that in this case, one should be cautious in assuming homology in the reductive process and search for other, non-reductive characters to resolve possible misplacements.

The family Sundasalangidae is not accepted herein because in every case in which Roberts (1981) contrasted sundasalangids and salangids, the character for salangids was primitive. I suggest that recognition of family rank for *Sundasalanx* would probably render the Salangidae paraphyletic and thus defined only by the absence of characters present in *Sundasalanx*. This is unacceptable both because it forces recognition of a group based on characters its members lack and because it artificially breaks up a group all of whose members share a unique evolutionary history.

Regarding the "southern smelt assemblage" (including galaxiids, but excluding salangids), I am less pessimistic than McDowall (this volume). I have taken the liberty of using the data he has presented and combined them with my own limited

survey of specimens and the literature to produce the hypotheses shown in Fig. 107. The group can be diagnosed by presence of a posteroventral deflection of the infraorbital sensory canal (Nelson, 1972) and 9/9 or fewer principal caudal-fin rays (vs a posterodorsal curvature of the canal and 10/9 rays in outgroups). Several characters support the placement of *Retropinna* and *Prototroctes* as sister taxa including presence of an abdominal horny keel, loss of the right ovary, and ceratohyal morphology. I have no specimens of *Stokellia* on hand, but McDowall's work (1979) clearly shows that the genus is diagnosable and that it is related to *Retropinna* and *Prototroctes*. Unfortunately, when contrasted with *Stokellia*, it is not clear that *Retropinna* is diagnosable, since the latter is then differentiated by primitive characters present in other taxa.

Relationship among *Aplochiton*, *Lovettia* and the galaxiids is supported by numerous characters, as shown in Fig. 107. I have been unable to find any features that link the former two genera together, however, and more work needs to be done with them. Galaxiids themselves can be shown to be monophyletic based on such characters as basioccipital "pegs" extending lateral to the anterior centrum (McDowall, 1969, Figs. 2B, 10A, but note lack of "pegs" in *G. paucispondylus*, Fig. 10B).

In summary, it is suggested that the broad outlines of relationships among the osmeroids are beginning to emerge, much as suggested by Gosline (1960a), with a "southern smelt" assemblage and an "osmerid" assemblage. Interrelationships within these groups remain problematical, the most obvious problems being establishment of the natural groups within the "osmerids" and placement of the salangids.

Salmonids.—Monophyly of this group is based primarily on a single character, apparent polyploidy of the karyotype (Gold, 1979). Several investigators have studied interrelationships of salmonids, most notably Behnke (1968) and Norden (1961), but these works were not phylogenetic and changes can be expected. I have examined phylogeny within the group only to establish polarities for characters relevant to relationships with other teleosts. Regarding the latter relationships, there have been several opinions, with most workers approaching salmonids with an eye to finding ancestors of other groups (see, e.g., Gosline, 1960, Diagram 2). The only phylogenetic analysis to date is that of Rosen (1974), which was discussed by Fink and Weitzman (1982). The latter authors presented data which they considered suggestive of neoteleostean relationship for salmonids: presence in some members of paired cartilages anterior to the ethmoid region (resembling the median rostral cartilage of neoteleosts) and the exoccipital forming part of the occipital condyle. The anterior cartilages were reported by Fink and Weitzman (1982) to be prominent in *Prosopium*, an observation which I can confirm from additional specimens. In addition, examination of small juvenile cichlids shows that the rostral cartilage appears to develop ontogenetically from bilateral cartilage bodies which fuse at the midline; this is suggestive of corroboration of Fink and Weitzman's (1982) hypothesis that the rostral cartilage evolved from paired cartilages anterior to the ethmoid region like those in *Prosopium*. More work needs to be done on the homology of "accessory" ethmoid cartilages, using double staining techniques and histology on a wide variety of teleosts.

I can also add to what Fink and Weitzman (1982) noted about the occipital condyle. I have confirmed that the exoccipital forms part of the condyle in *Thymallus* and "salmonins." This morphology is also present in *Prosopium*, but is lacking in other

coregonins. In a number of features, including the morphology of the nares, *Prosopium* stands as the sister group of other coregonins, and this, plus the presence in the outgroup Salmoninae and *Thymallus* of exoccipital participation in the condyle, implies that phylogenetically derived coregonins have secondarily lost that morphology. As noted by Fink and Weitzman (1982), the condyle structure as found in salmonids is found also in neoteleosts. It is also present in *Lepidogalaxias* (see below) and in some osteoglossomorphs. I do not wish to belabor the possible importance of this character, especially since more careful ontogenetic and morphological studies need to be done and other characteristics evaluated.

A few observations from my survey of salmonids may be added here. I have found but two characters in the literature which diagnose the coregonins; one of these needs modification and the other needs to be more concisely put. Lack of maxillary teeth has been used to diagnose the group, relative to other salmonids (Norden, 1961), but this needs to be emended to lack of the teeth in adults, since I have found maxillary teeth in *Prosopium* of around 19 mm SL. I have not yet examined specimens this small of other coregonins so do not know the generality of this primitive state. The other character is reduction in the teeth in general; this needs to be quantified relative to the outgroups.

The salmonines and *Thymallus* can be placed together based on lack of ossification of the supraethmoid (hypethmoid of Norden, 1961; Behnke, 1968), and apparently on yolk characteristics, and larval size (Kendall and Behnke, this volume). Regarding other relationships within salmonids, I have nothing to add.

Lepidogalaxias.—The position of *Lepidogalaxias* is controversial. I remain unconvinced by Rosen's (1974) hypothesis that the genus belongs with the esocoids. When I previously discussed this genus (Fink and Weitzman, 1982), I had not seen any specimens, but R. M. McDowall has generously made several available for dissection and clearing and staining. There is no question that this little fish is a potpourri of contradictory and reductive characters and it is no wonder that it has been so difficult to place. Pursuing the potential of relationship of this species to galaxiids, extensive comparisons with members of that group have been made. *Lepidogalaxias* shares a host of reductive characters with galaxiids. While these may indeed be synapomorphic traits, in cases where extensive paedomorphosis is suspected, and this appears to be so in the morphological similarities involved, one hopes to find some innovative, non-reductive characters which supply evidence for grouping. I have found two such characters which suggest that *Lepidogalaxias* is related to neither esocoids nor osmeroids, but rather may be the sister group of the Neoteleostei, as diagnosed by Rosen (1973) and Fink and Weitzman (1982). This is supported by the presence in *Lepidogalaxias* of two non-reductive traits, a *retractor dorsalis* muscle and occipital condyle composed of both the basioccipital and exoccipital bones. As discussed just above and by Fink and Weitzman (1982), the latter trait is also shared with salmonids. *Lepidogalaxias* lacks a rostral cartilage or its homologue and type 4 teeth (hinged teeth with a posterior axis of rotation, Fink, 1981) and this would prevent its placement within the neoteleostean assemblage. Placing *Lepidogalaxias* as the neoteleostean sister group and leaving salmonids as their sister taxon presumes either that rostral cartilage homologues in the salmonids have been lost in *Lepidogalaxias* or are

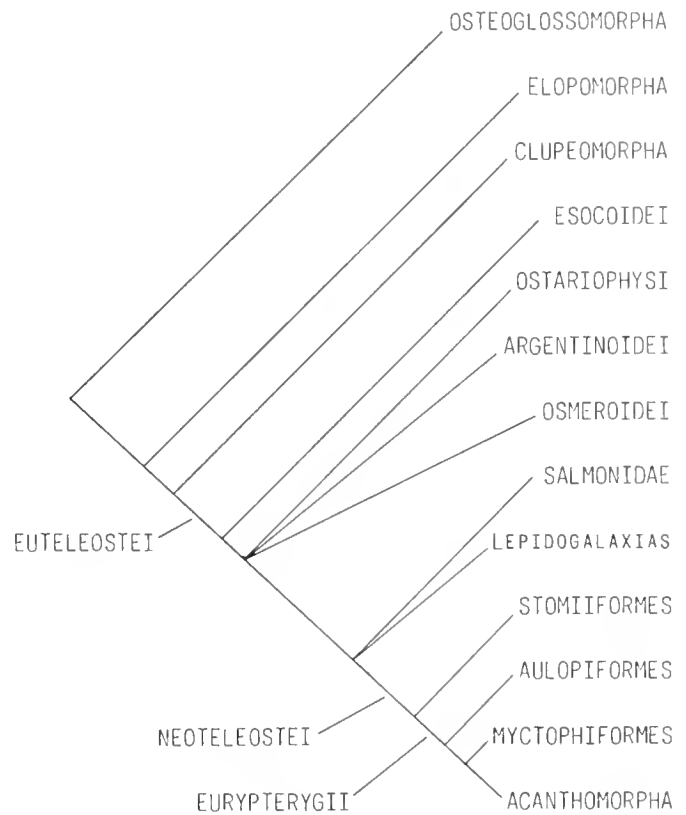

Fig. 108. Summary cladogram of relationships and characters discussed in the text.

not homologues after all. This ambiguity is reflected in Fig. 108 by a trichotomy. Clearly, more work remains to be done before we can be really confident in the phylogenetic placement of this intriguing fish.

Lepidogalaxias can be diagnosed by a number of characters, the most striking of which is fusion of the frontal bones into a single ossification (Rosen, 1974, Fig. 40B). In their comments on this species, Fink and Weitzman (1982) noted that there was a disagreement about whether there are mesopterygoid teeth present; Rosen's statement that teeth are lacking is correct.

Stomiiformes.—Fink and Weitzman (1982) recently examined the monophyly and relationships of stomiiforms to the other basal euteleosts and corroborated Rosen's (1973) hypothesis that they are the sister group to the rest of the Neoteleostei, removing them from the "salmoniforms." This placement is supported by several apomorphic traits, including presence of *retractor dorsalis* muscles and type 4 tooth attachment, as well as exoccipital participation in the cranial condyle and a rostral cartilage. Weitzman (1974) presented a hypothesis of relationships at the "family" level within the stomiiforms, as well as a detailed phylogeny of the Sternoptychidae. In this volume, I present a generic-level phylogeny for the barbeled stomiiforms (Family Stomiidae) and some brief comments on the "gonostomatid-photichthyid" genera. Weitzman is currently working on relationships of the latter fishes and has made considerable comments in this volume (see Ahlstrom, Richards and Weitzman, this volume).

Eurypterygii.—Finally, a few comments are due on the Myctophoidei of Greenwood et al. (1966). This group was dismantled by Rosen (1973), and divided into two large groups, Aulopiformes and Myctophiformes. These two groups, together with the Paracanthopterygii and Acanthopterygii, were classified into a new group, Eurypterygii. Aulopiformes was placed as the sister group of all other eurypterygians, and myctophiforms as the sister group to paracanthopterygians and acanthopterygians. All of these, together with stomiiforms, form the Neoteleostei. Fink and Weitzman (1982) tentatively accepted monophyly of the Eurypterygii based on the presence in its members of a toothplate fused with the third epibranchial. Aulopiformes contains a large number of families, including the Giganturidae, covered in this portion of the symposium. About the latter family I have little to say except that my own dissections corroborate Rosen's placement of it.

SUMMARY

A summary of the hypotheses I have discussed above is given in Fig. 108. The most striking aspect of it is the degree of uncertainty about relationships among the clades. This may be in part due to the limitations of my study, but it does seem to me to be a fair summary of the status of well corroborated hypotheses we now have about this level of teleostean phylogeny. There are certainly other arrangements that can be made, depending on which characters one wishes to stress, and none of these should be discarded out of hand. As examples, I will cite two characters and their implications.

First, lack of the posterior shaft of the vomer suggests that salmonids and osmeroids are sister taxa. Appropriate outgroups have the shaft ranging from "moderate" (e.g., *Chanos*) to "elongate" (argentinoids). My own opinion, based on occipital condyle structure of salmonids, is that the reduction in vomer length has occurred independently in the two lineages (it has also been reversed within both); the ultimate value of the occipital character remains to be seen.

The second character, presence of breeding tubercles, is now considered a euteleostean trait. Note, however, that tubercles

are lacking in esocoids and argentinoids but are present in os-tariophysans, osmeroids, and salmonids, indicating that these three clades form a monophyletic group. Again, there are characters that contradict this grouping, but it nevertheless is worthy of consideration.

It is always frustrating when one sets out to solve a particular problem and then comes to the end of the allotted time without a resolution. Although I have been able to shed some light on several problems relevant to the goals of this part of the symposium, I have not been able to unravel the interrelationships among the major basal euteleostean clades. Clearly more work is needed, especially with character suites which have been traditionally neglected. Almost all of our concepts of relationships at this level are based on features of the adult caudal skeleton and branchial basket. Some work on soft anatomy, particularly the muscles of the head, has been informative at these levels and one hopes that other parts of the soft anatomy will be equally profitable. One area virtually untouched is larval anatomy. It might be expected that not many important features will be found because of the preponderance of primitive characters in larvae. But larval characters have proven useful, as is shown by the ontogenetic transformation in tooth types in stomiiforms (from type 4 to type 3; see Fink, 1981) as well as the specialized fin traits discussed by Ahlstrom et al. (this volume) for argentinoids. It is in both these areas, ontogenetic character transformations and presence of specializations for larval life, that study of larval fishes promises rewards. The inclusion of larval morphology in studies of higher level relationships should provide a richer data base than we currently have and perhaps will reveal some crucial characters for resolving the basic questions I have addressed above. This symposium has already stimulated in a major way the examination of larvae for phylogenetic analyses, and I predict that it, combined with the new ways now emerging of analyzing ontogenetic information, will mark a new phase in the modern study of fish classification.

MUSEUM OF ZOOLOGY, UNIVERSITY OF MICHIGAN, ANN ARBOR,
MICHIGAN 48109.

Myctophiformes: Development

M. OKIYAMA

MYCTOPHIFORMES is currently adopted as a distinct order with intermediate affinity between the lower and higher teleost groups, whereas no one feature would satisfactorily separate all of them from all Salmoniformes (Gosline et al., 1966). Except Rosen (1973), recent workers agree well with the familial composition of this order despite slight differences in the familial or subordinal definition.

Table 56 shows the recent classification given by Johnson (1982) based on the most comprehensive knowledge now available. Important points of this scheme are the exclusion of Seopelarchidae from Alepisauroides and Pseudotriconotidae from Myctophiformes. Further details in this connection will be mentioned again in my paper on relationships (this volume).

Exploitation of the vast hydrosphere covering the pelagic as well as benthic habitat between the surface and abyssal or ultraabyssal plain by diversified members of this group is doubtlessly the important aspect in discussing the ontogenetic problems of the myctophiform lineage. Of the five suborders, Myctophoidei and Alepisauroides are exclusively pelagic and the remaining are demersal including secondary pelagic genera such as *Parasudis* and *Harpadon*. Synchronous hermaphroditism is common to the deep-water and offshore forms belonging to Chlorophthalmoidei and Alepisauroides with the single exception of Bathysauridae in Synodontoidei (Table 56).

In general, the systematics of this order are rather well understood except for several families or genera. As is clearly shown

TABLE 56. SYSTEMATIC STATUS AND THE CURRENT KNOWLEDGE ON EARLY LIFE STAGES IN MYCTOPHIFORMES.

Suborder and family	Genus	No. species	Reproduction ^a	Information		Main sources
				Eggs	Larvae	
Aulopoidei						
Aulopidae	<i>Aulopus</i>	7+	G	+ ^c	++ ^d	Okiyama (1974b)
Myctophoidaei						
Myctophidae ^a	<i>Diaphus</i> , etc.	Ca. 300	G	+	++	Moser and Ahlstrom (1970, 1974)
Neoscopelidae	<i>Neoscopelus</i>	3	G	(+)	+	Okiyama (1974b)
	<i>Scopelogys</i>	2	?	-	+	Okiyama (1974b), Butler and Ahlstrom (1976)
	<i>Solvomer</i>	1	?	-	-	
Chlorophthalmoidaei						
Chlorophthalmidae	<i>Chlorophthalmus</i>	18+	H	-	++	Tåning (1918)
	<i>Parasudis</i>	2	H	-	-	
	<i>Bathysauropsis</i>	3	?	-	-	
Ipnopidae	<i>Ipnops</i>	3	H	(+)	+	Okiyama (1981)
	<i>Bathytrophops</i>	2	H	(+)	++	Okiyama (1972), Parin and Belyanina (1972)
	<i>Bathymicrops</i>	2	H	(+)	+	Okiyama (this study)
	<i>Bathypterois</i>	18	H	(+)	++	Sanzo (1938b), Okiyama (1974b)
Notosudidae	<i>Ahlesaurus</i>	2	H	(+)	++	Bertelsen et al. (1976), Ozawa (1978)
	<i>Scopelosaurus</i>	13	H	-	++	Bertelsen et al. (1976), Ozawa (1978)
	<i>Luciosudis</i>	1	H	(+)	++	Bertelsen et al. (1976)
Scopelarchidae ^a	<i>Scopelarchus</i> , etc.	17	H	-	++	Johnson (1974b, 1982)
Synodontoidaei						
Bathysauridae	<i>Bathysaurus</i>	2	H	-	+	Marshall (1961), Rosen (1971), Johnson (1974a)
Harpadontidae	<i>Harpadon</i>	4	G	+	+	Okiyama (1979b)
	<i>Saurida</i>	15	G	+	++	Mito (1961a), Okiyama (1974b), Ozawa (1983)
Synodontidae	<i>Synodus</i>	Ca. 30	G	+	++	Gibbs (1959), Okiyama (1974b), Ozawa (1983)
	<i>Trachinocephalus</i>	1	G	+	++	Okiyama (1974b)
Alepisauroidaei						
Alepisauridae	<i>Alepisaurus</i>	2	H	-	++	Rofen (1966b)
Anotopteridae	<i>Anotopterus</i>	1	H	-	++	Okiyama (this study)
Evermannellidae ^a	<i>Evermannella</i> , etc.	7	H	-	++	Johnson (1982)
Omosudidae	<i>Omosudis</i>	1	H	-	++	Ege (1958), Rofen (1966b), Belyanina (1981)
Paralepididae	<i>Paralepis</i>	5	H	-	++	Ege (1930, 1957), Rofen (1966a)
	<i>Notolepis</i>	3	H	-	++	Rofen (1966a)
	<i>Maulichthys</i>	1	H	-	-	
	<i>Lestidium</i>	4	H	-	++	Rofen (1966a)
	<i>Lestidiops</i>	20	H	-	++	Rofen (1966a)
	<i>Uncisudis</i>	4	H	-	+	Rofen (1966a)
	<i>Lestrolepis</i>	3	H	-	++	Rofen (1966a)
	<i>Stermonosudis</i>	13	H	-	++	Rofen (1966a)
	<i>Macroparalepis</i>	7	H	-	++	Rofen (1966a)
	<i>Dolichosudis</i>	1	H	-	-	
	<i>Sudis</i>	2	H	-	++	Sanzo (1917), Rofen (1966a), Shores (1969), Belyanina (1981)

^a For the details, see relevant section. ^b G: gonochorism; H: hermaphroditism. ^c Parentheses indicate information available for transparent ovarian eggs. ^d Double crosses mean that a series of early developmental stages is available at least for a single species.

in Table 56, information on the reproduction and development is abundant even for the deep-water species contrary to the situation of about 20 years ago (Gosline et al., 1966). General larval characteristics of this order were summarized by Ahlstrom and Moser (1976). Selected meristic characters including many original data are given in Table 57.

Aulopidae (Fig. 109A-B).—This bottom-fish family is generally considered the most primitive representative of the order. Its systematics are inadequately known; at least seven nominal and two undescribed species (Yamakawa, pers. comm.) occur in the warm waters of the world except for the Indian Ocean.

Complete early life history series including egg stages are known only for *Aulopus japonicus* (Okiyama, 1974b, 1980). Fragmentary larval accounts are also available for some unidentifiable

species. Suggested dichotomy in the larval morphology in this family (Okiyama, 1974b) is apparently wrong due to the erroneous identification of the early stages of "*Aulopus filamentosus*" in Sanzo (1938b) and Tåning (1918), which are now ascribed to *Bathypterois* of the Ipnopidae.

Eggs of *A. japonicus* are spherical (1.18–1.14 mm in diameter), pelagic, transparent, without an oil globule, and with irregularly raised meshes on the chorion surface. Similar features are not present in the matured ovarian eggs of *A. filamentosus* (1.36–1.44 mm in diameter) with numerous oil globules (Sanzo, 1938b). The known larvae differ in gut structure, size of the prominent pigment section and relative width of the slightly narrow eyes. However, the following features are shared in common: single prominent peritoneal pigment section located at the middle or slightly anterior region of the body; gently curved

TABLE 57. SELECTED MERISTIC CHARACTERS OF MYCTOPHIFORM GENERA.

Suborder and family	Genus	Dorsal	Anal	Pectoral	Pelvic	Branchiostegals	Vertebrae
Aulopoidei							
Aulopidae	<i>Aulopus</i>	14–22	8–14	11–14	9	10–17	36–53
Myctophoidaei							
Mytophidae*	<i>Diaphus</i> , etc.	10–26	12–27	0–22	8	6–12	28–45
Neoscopelidae	<i>Neoscopelus</i>	11–13	10–13	15–19	8–9	8–9	30–31
	<i>Scopelengys</i>	11–13	12–14	12–17	7–8	8	29–35
	<i>Solvomer</i>	12–14	9–11	14–16	8	9–11	40–41
Chlorophthalmoidaei							
Chlorophthalmidae	<i>Chlorophthalmus</i>	9–13	7–11	15–19	8–9	8	40–50
	<i>Parasudis</i>	10	8–9	17	9	8	38–39
	<i>Bathysauropsis</i>	10–12	10–11	17–24	9	8–9	44–56
Ipnopidae	<i>Ipnops</i>	8–11	11–19	12–16	8	9–12	54–61
	<i>Bathytrophops</i>	11–13	13–17	12–15	8	14–17	62–66
	<i>Bathymicrops</i>	8–10	9–15	9–10	7–8	8–10	65–80
	<i>Bathypterois</i>	12–16	7–13	13–22	8–9	10–14	49–65
Notosudidae	<i>Ahiesurus</i>	9–11	17–21	10–12	9	10	42–50
	<i>Scopelosaurus</i>	9–13	15–21	10–15	9–10	10	53–67
	<i>Luciosudis</i>	10–13	17–20	12–14	9–10	10	57–59
Scopelarchidae*	<i>Scopelarchus</i> , etc.	5–10	17–39	18–28	9	8	40–65
Synodontoidaei							
Bathysauridae	<i>Bathysaurus</i>	15–18	11–14	15–17	7–8	8–12	50–63
Harpadontidae	<i>Harpadon</i>	10–15	11–15	11–13	9	16–26	39–56
	<i>Saurida</i>	10–13	9–13	11–16	9	13–16	43–67
Synodontidae	<i>Synodus</i>	10–15	8–15	10–15	8	12–18	49–65
	<i>Trachinocephalus</i>	11–13	14–16	11–13	8	14	54–58
Alepisauroidaei							
Alepisauridae	<i>Alepisaurus</i>	29–49	11–19	12–16	7–10	7	47–51
Anotopteridae	<i>Anotopterus</i>	0	14–16	12–15	9–11	8	78–83
Evermannellidae*	<i>Evermannella</i> , etc.	10–13	26–37	11–13	9	8	45–54
Omosudidae	<i>Omosudis</i>	9–12	14–16	11–13	8	8	39–41
Paralepididae	<i>Paralepis</i>	9–12	20–26	14–17	8	8	60–77
	<i>Notolepis</i>	8–11	23–34	9–13	8–9	8	74–90
	<i>Maulichthys</i>	10–12	22–24	15–17	9	8	64–65
	<i>Lestidium</i>	9–11	26–33	11–13	9	8	75–91
	<i>Lestidiops</i>	8–13	25–35	10–13	6?	8	75–100
	<i>Uncisudis</i>	10–11	25–31	11–13	9	8	75–79
	<i>Lestrolepis</i>	9–11	31–44	10–12	8	8	82–98
	<i>Stemonosudis</i>	7–12	29–50	10–13	8–9	8	84–121
	<i>Macroparalepis</i>	11–14	21–32	10–12	9	8	80–110
	<i>Dolichosudis</i>	10	36–37	11–12	9	8	101
	<i>Sudis</i>	12–16	21–24	13–15	9	8	52–61

* For the details, see relevant section

head profile; short fins; anus far forward with wide preanal interspace; anteriorly placed dorsal and pelvic fins. A size series of *A. japonicus* reveals the gradual and direct development, with scant pigmentation throughout the pelagic stages; melanophores are restricted to the eyes and the caudal and postanal regions, other than the peritoneal section which increases in size in older larvae. Sequence of fin formation is C-D-A-P₁-P₂. Full ray complements are visible at about 13.3 mm, but vertebral ossification is delayed until about 20 mm, the smallest bottom specimen available in my collection. Ontogeny of the upper jaw bones is remarkable in possessing maxillary teeth (1–3) in larvae smaller than 11 mm. Two supramaxillaries, peculiar to this family, are ossifying in metamorphosed juveniles.

Myctophidae (see Moser, Ahlstrom, Paxton, this volume).

Neoscopelidae (Fig. 109C–D).—Systematics of this deep-sea pelagic and benthopelagic family are well understood (Butler and

Ahlstrom, 1976; Nafpaktitis, 1977), except for *Solvomer* which is restricted to the tropical Western Pacific. The remaining two genera are known from the world oceans. Developing eggs are unknown. Mature ovarian eggs of *Neoscopelus macrolepidotus* (0.83–0.98 mm in diameter) contain a large single oil globule of 0.39–0.61 mm (Maruyama, 1970). Advanced larval stages have been described and illustrated for *Neoscopelus* sp. (Okiyama, 1974b) and two species of *Scopelengys* (Butler and Ahlstrom, 1976). They are characterized by large fan-shaped pectoral fins, large head with blunt snout tip, small round eyes, laterally compressed deep body, and an oval patch of melanophores in the peritoneum, distinct from the solid peritoneal pigment sections of most other myctophiforms. All fins differentiate rapidly with the possible sequence as P₁-D-A-C-P₂, full counts being attained at a small size (less than 10 mm). Pigmentation is clearly different between the two genera. *Scopelengys* lacks the pigment patch lying along the dorsum of the rectum in *Neoscopelus*. *Scopelengys* uniquely develops a hori-

TABLE 58. COMPARISON OF THE LARVAL CHARACTERS AMONG FOUR GENERA OF THE IPNOPIDAE.

Characters	<i>Ipnopis</i>	<i>Bathytrophops</i>	<i>Bathymicrops</i>	<i>Bathypterois</i>
Head profile	slung down; flat top	slightly slung down; flat top	slung down; flat top	slung down; flat top
Pectoral fin	bilobed; rays long	elongated; fan-shaped	elongated	elongated; fan-shaped
Gut size	short	short	long	long
Anus position; close to	pelvic fin	pelvic fin	pelvic fin; slightly	anal fin
Anus-anal fin space	wide	wide	wide	narrow
Peritoneal pigment section	absent	single	absent	*numerous (12–20) or absent
Body pigment (melanophores)	scant	scant	abundant	scant
Possible sequence of fin formation	P ₁ -C-A-D-P ₂	P ₁ -C-A-D-P ₂	P ₁ -C-A-D-P ₂	P ₁ -C-A-D-P ₂
Transformation complete	ca. 42 mm SL	43–93 mm SL	70–90 mm SL	ca. 42–43 mm SL

* Details are mentioned in the text

zontal pigment bar across the head. Small preopercular spines are known only in *Neoscopeus* whereas a long snout is peculiar to *Scopelengys*.

Chlorophthalmidae (Fig. 109E–F).—Of the three genera of this benthic family, the cosmopolitan *Chlorophthalmus* is particularly diverse and abundant. Extensive revision of this genus is needed, since there are many undescribed species from the Western Pacific and the known species can be divided into two distinct groups, each warranting generic status (Doi and Okamura, 1983).

Eggs are not known. Despite the abundance of adults, few larvae have been reported. Complete developmental series are available for only *C. agassizi* (Tåning, 1918). Known larvae of other species such as *C. mento*, *C. proridens* and *Chlorophthalmus* spp. (Pertseva-Ostroumova and Rass, 1973; Miller et al., 1979; Okiyama, unpubl.) show close resemblance to *C. agassizi* having the extremely short gut with large preanal interspace, a similar pigment pattern composed of a single peritoneal pigment section lying at the pectoral fin base and a melanophore at the hypural complex, short fins and anteriorly placed dorsal and pelvic fins (as in Aulopidae). There are possible specific differences in the size at appearance of the peritoneal pigment section (ca. 7 mm in *C. proridens* vs 5–6.6 mm in *C. mento*) and in the arrangement of the few small melanophores on the dorsal and ventral margin of the tail near the notochord tip in early larvae. Meristic characters are useful in discriminating the particular species or species groups, although early developmental stages are usually very difficult to identify to species.

Larval osteology was studied in detail for *C. agassizi* (Rosen, 1971) but the sequence of fin formation is not clear except that the pectoral fin develops early. Principal changes during the gradual metamorphosis include the rotation of the eyes dorsally which takes place at sizes less than 40 mm (Ahlstrom, 1972a).

Unusual larvae with a pigmentation pattern similar to the above described forms are found in ORI collections from the Kuroshio area (Fig. 109A). These are distinct in that the head is markedly depressed, bowed with duckbilled appearance, and a single peritoneal pigment section is large enough to cover the dorsal half of the short gut. Their meristic characters (ca. 42 myomeres and ca. 17 pectoral rays) suggest a possible affinity with *Chlorophthalmus* (sensu lato). These two larval types seem to substantiate the suggested dichotomy of this genus. No information is available for larvae of the other two genera (*Parasudis* and *Bathysauropsis*).

Ipnopidae (Fig. 110A–E).—Four benthic genera compose this family which has been variously classified (e.g., Nielsen, 1966; Sulak, 1977). Despite their deep-sea mode of existence, larval stages of all genera have been mostly obtained from the surface waters. Developing eggs are not known. Mature ovarian eggs are known for all genera with virtually identical features such as a spherical shape, diameter of about 1.0–1.2 mm, and the presence of a single large oil globule (Nielsen, 1966; Sulak, 1977 and pers. comm.; Merrett, 1980). Although intergeneric differences of the early larval stages are remarkable (Table 58), they share several conspicuous characters including the more or less hung-down head profile and the elongated precocious pectoral fins. At metamorphosis these become less prominent in association with the drastic change in the mouth size from moderate to huge and the appearance of heavy body pigmentation.

Two larvae (13.9, 10.6 mm) are known for *Ipnopis*; the larger specimen referred to *I. agassizi* was described in considerable detail and illustrated (Okiyama, 1981). The smaller one may be *I. meadi* in view of its higher anal ray count (ca. 13). A divided pectoral fin with elongated upper rays is peculiar to this genus (Table 58). Principal changes at metamorphosis include the development of the unique eye plaque, a depressed head with straight profile, and the disappearance of the peculiar feature of the pectoral fins along with the loss of several rays. Metamorphosis may be rapid, but the smallest benthic juvenile of 40 mm still bears the immature eye plaque (Sulak, 1977).

Bathytrophops includes only two species, *B. sewelli* and *S. marionae* (Merrett, 1980). A larva of this genus was first described under the name *Macristiella perlucens* of uncertain affinity (Berry and Robins, 1967). The known "Macristiella" (19 specimens, 7–43 mm) are all referable to *B. marionae* except for the 37 mm larva from the Indian Ocean and the smallest specimen (Parin and Belyanina, 1972). The Indian Ocean specimen may be identified as *B. sewelli* on the basis of the higher anal ray count (18), a unique character for this species.

Early stage larvae have little melanistic pigmentation, but some bluish or violet coloration is present on the fins and various body parts in living specimens (Berry and Robins, 1967). Preserved individuals sometimes retain this feature, usually on the large pectoral or pelvic fins. Reduction of the relative size of eyes, and the loss or replacement of the teeth as well as gill rakers are among the major changes at metamorphosis, in addition to those common to the family. Otherwise, larval development is rather direct and the relative position of the fins and the anus changes little throughout ontogeny. The osteology

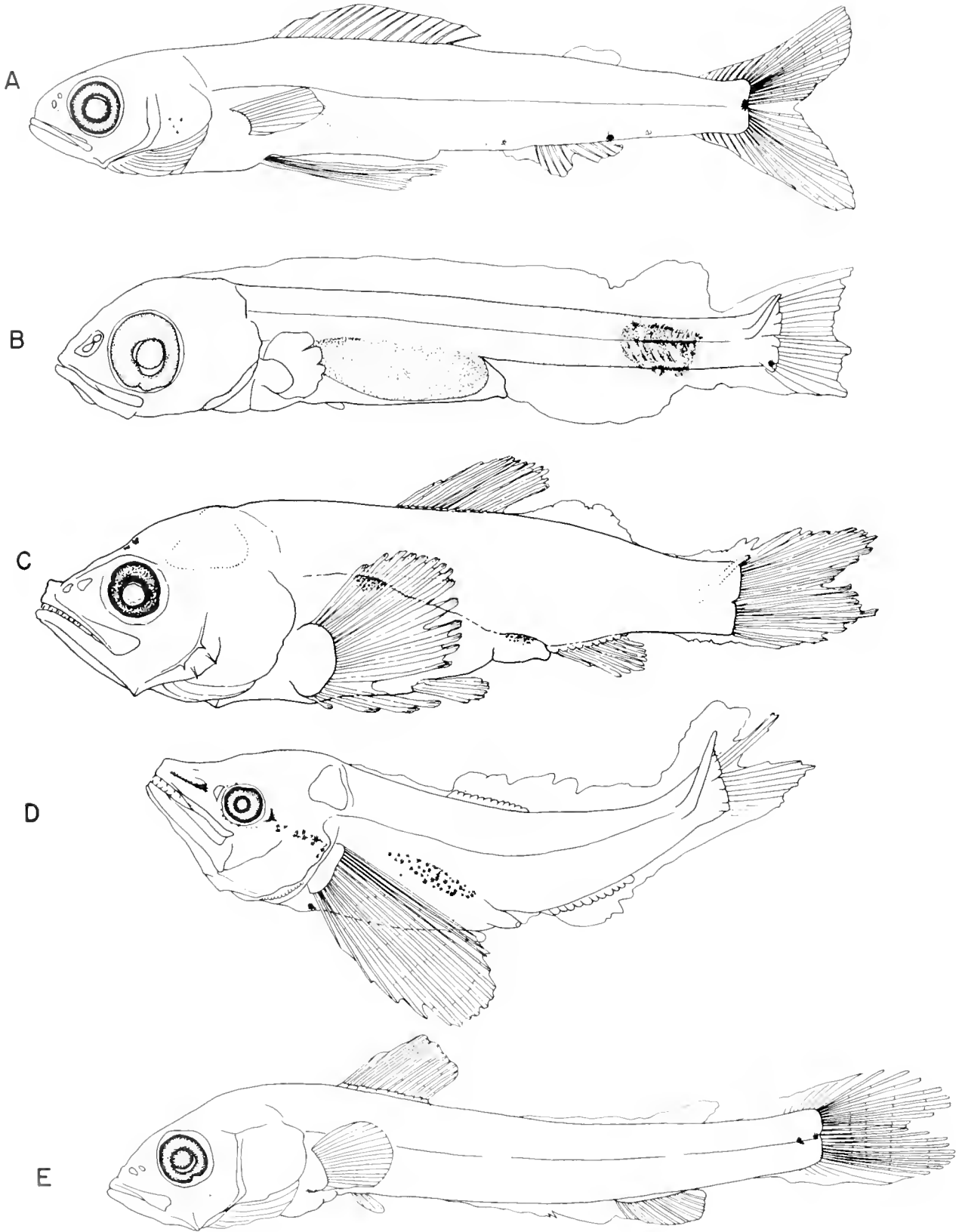

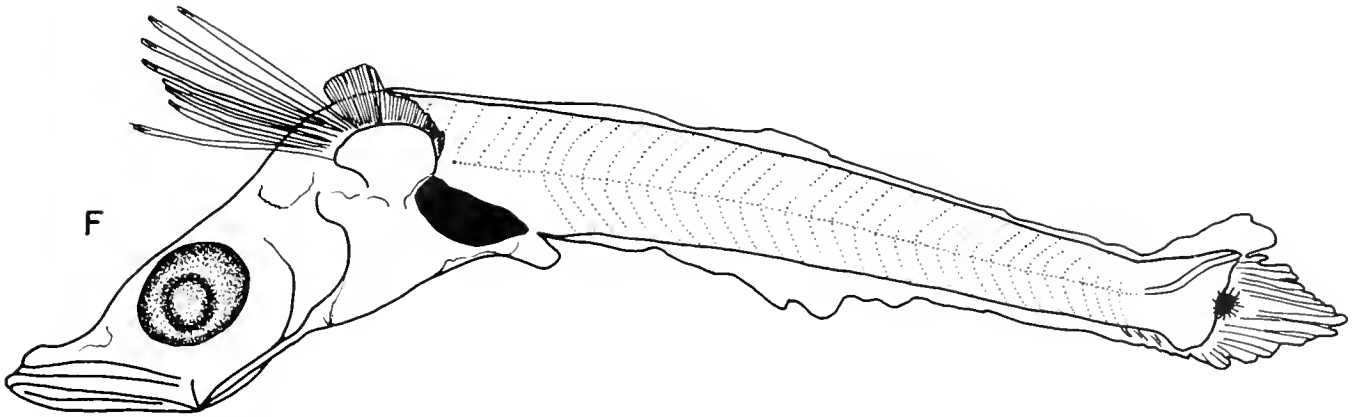

Fig. 109. (A) *Aulopus japonicus*, 11.5 mm SL, from Okiyama (1974b); (B) *Aulopus* sp., 12.3 mm, from Okiyama (1974b); (C) *Neoscopelus* sp., 7.9 mm, from southwestern Japan, Ocean Research Institute (ORI) collection; (D) *Scopelogadus dispar*, 6.3 mm, from Okiyama (1974b); (E) *Chlorophthalmus* sp., 17.1 mm, from Indian Ocean, ORI collection; (F) *Chlorophthalmus* (?) sp., 7.5 mm, from Kuroshio waters off Japan, ORI collection.

of both larvae and adults is well known (Okiyama, 1972; Parin and Belyanina, 1972; Sulak, 1977).

Bathymicrops represents the deepest living myctophiform. Two species, *B. regis* and *B. brevianalis*, are known from extremely limited material from 4225–5900 m (Nielsen, 1966; Merrett and Marshall, 1981). Pelagic eggs are unknown. A total of five larvae and juveniles (13.0–70.0 mm) are available; the smallest two larvae (13.0, 14.7 mm) from Hawaiian waters are unidentifiable; a 20 mm larva from the North Atlantic (= *Stomatella* B in Roule and Angel, 1930: Pl. 1, Fig. 7) is ascribed to *B. regis*; the largest two juveniles (62.5, 70.0 mm) from the tropical Pacific are tentatively identified as *B. brevianalis*.

Despite conspicuous variation among specimens, scattered melanophore patches and an extremely slender body are diagnostic for this genus. The precocious pectoral fins are greatly elongated even in the smallest larva, but the raised bases of the dorsal and anal fins and the prominent finfolds are peculiar to the advanced stages, which also have reduced eye size and a slightly shorter gut. Size at metamorphosis is unusually large, attaining 70–90 mm.

Bathypterois is the most speciose genus in this family. Three subgenera (*Benthosaurus*, *Bathypterois* and *Bathycygnus*) and 18 species are currently included (Sulak, 1977). Known bathymetric ranges are 250–5,990 m. Published information of the developmental stages is scant. Pelagic eggs are not known. A single larva of 14.1 mm (Okiyama, 1974b) was identified as *B. (Bathycygnus) longipes* by Sulak (1977). As stated before, the known early stages of "*Aulopus filamentosus*" are all referable to those of *Bathypterois*, probably *B. (Bathypterois) mediterraneus* in view of their localities. Complete series of early stages are confined to this species, but at least three additional larval forms are now available. These known larvae share the distinct forward shift of the ventral hypural elements in addition to the features given in Table 58.

Known larvae are provisionally divided into two groups on the basis of the peritoneal pigment sections, those with many sections and those which lack peritoneal pigment. Except for two larvae, *B. (B.) longipes* and *B. (Benthosaurus) viridensis* (33.1 mm) from the Atlantic (Fahay, 1983), all specimens have

the former character state. The number of peritoneal pigment sections can be a useful tool in discriminating the larvae, but ranges of variation often overlap among species. A western Pacific form with 12–18 pigment sections bears close resemblance to *B. (B.) mediterraneus* larvae whereas decidedly lower myomere counts of the former (45–48) readily separate these two. *B. viridensis* larvae have, in addition to the complete absence of the peritoneal pigment sections, several peculiar features such as a slightly telescopic eye, a protruding gut, and a long anal fin and short tail. Comparison with the smallest demersal specimen (43 mm) of the same species (Sulak, 1977) indicates that principal metamorphic changes include the absorption of the produced gut, lengthening of the posterior body and fin shrinkage. This may represent the most pronounced metamorphosis in this genus, since less remarkable transformation predominated in the other species. Identification of the other larval types remains to be determined.

Notosudidae (Fig. 111A–B). — Bertelsen et al. (1976) extensively revised this oceanic midwater family, including information on early developmental stages of all species (except *Scopelosaurus cradockeii*). Supplemental information on the early stages is available in Ozawa (1978). Pelagic eggs are unknown. Maturing ovarian eggs of *Ahliesaurus* (ca. 0.3 mm in diameter) and *Luciosudis* (0.4–0.5 mm) suggest that pelagic eggs are uncommonly small for this order.

General characteristics of these larvae are extremely similar throughout the family: long, slender subcylindrical body, becoming increasingly compressed toward the tail; markedly depressed head with wedge-like snout; posteriorly protruding lobes in corpus cerebelli; narrow eye with longer horizontal axis; a more or less distinct conical mass of choroid tissue on the posterior part of slightly stalked eye; anus at about midbody (except *Ahliesaurus*) widely separated from anal fin origin; slight increase of gut length with growth during the early larval stages; absence of the peritoneal pigment. Maxillary teeth peculiar to larvae help diagnose this family but are not unique (see, Aulopidae). Possible sequence of fin formation is C·A·D·P₁·P₂,

last elements being rarely visible in larvae less than 20 mm. Apart from the length at metamorphosis varying between 25 and 45 mm among species, pigmentation pattern is usually the only useful character for specific identification. Once established these pigment patterns, mostly restricted to the tail, are retained throughout the larval stages, although a few species are known to be unpigmented throughout all or part of the larval period.

Scopelarchidae (see R. K. Johnson, this volume).

Bathysauridae (Fig. 111C).—This deep-water benthic family consists of two species of synchronous hermaphrodites, *Bathysaurus mollis* and *B. ferox* (= *B. agassizi*) (Sulak, pers. comm.; Wenner, 1978).

Pelagic eggs are unknown. Maximum size of mature ovarian eggs in *B. ferox* is 1.2 mm in diameter (Wenner, 1978). So-called "Macristium" forms are now proved to be larval *Bathysaurus* (Rosen, 1971; Johnson, 1974a); at least several of the five known "Macristium" larvae (20–83 mm) are positively identified with *B. mollis*. Morphology and osteology of these specimens have been closely studied, revealing many characteristic features such as unusually elongated fins, anterior placement of dorsal and pelvic fins, raised bases of dorsal and anal fins, long gut (coiled or uncoiled) terminating just in front of anal fin origin, six peritoneal saddle-shaped pigment sections all evenly spaced, and development of a pattern of lateral bars in some specimens. Besides this last feature, meristic differences serve to distinguish two species despite considerable variation.

Metamorphosis may take place gradually at exceptionally large sizes (more than 83 mm). Accompanying changes include shortening of fins, expansion of the gape with necessary associated changes in head bones and associated anatomy, backward shift of the dorsal fin origin, and darkening of the body surface, oral cavity and peritoneum.

Harpadontidae (Fig. 111D–E).—Two genera are recently included here (Sulak, 1977; Johnson, 1982). *Harpadon* comprises at least four species living in nearshore waters, estuarine and relatively deep continental shelf waters of the Indo-Pacific. Critical systematic revision of this genus is now in progress (Schmitz, pers. comm.). A pelagic egg referred to *H. nehereus* in Delsman (1929e) appears invalid (Delsman and Hardenberg, 1934). Early developmental stages are poorly studied; only two specimens of *H. nehereus* (25.2, and ca. 40 mm) have been illustrated and/or briefly described (Delsman and Hardenberg, 1934; Okiyama, 1979b). A juvenile of 55 mm is the smallest specimen of the deep water congener, *H. microchir*, available in ORI collections.

Early stages are readily discriminated from most other myc-

tophiform larvae by the exceptionally high numbers of branchiostegal rays (16–27) and the following characters: elongate compressed body with large head and mouth, short snout (due to the forward shift of eyes), scant pigmentation except seven pairs of peritoneal pigment sections, the last two closer together than the others, and extension of the lateral line scales onto the caudal fin. Of these rather advanced developmental features, pigmentation pattern may be common to the earlier stages. Apparently, long pectoral and pelvic fins are peculiar to *H. nehereus*. Also, *H. microchir* is more lightly pigmented than *H. nehereus* at similar lengths.

Metamorphosis seems gradual. If the occurrence of melanophores over the stomach is of significance in defining this process, transformation is completed by 35 mm in *H. nehereus*.

There are about 15 species of *Saurida* with highest diversity in the Western Pacific. Planktonic eggs are known for *S. elongata*, *S. wanieso*, and *S. tumbil* besides several unidentifiable species (Mito, 1961a; Zvjagina, 1965a; Venkataramanjan and Ramanoorthi, 1981). These are spherical, 1.0–1.3 mm in diameter, transparent, without oil globules and with a narrow perivitelline space. Hexagonal sculpturing on the chorion (0.03–0.05 mm in mesh size) is either present (*S. wanieso* and *S. tumbil*) or absent (*S. elongata*). Early developmental stages are known for 9 species. Of these, complete developmental series are available for at least 4 Pacific species, *S. tumbil*, *S. elongata*, *S. wanieso* and *S. gracilis* (Dileep, 1977; Ozawa, 1983) and the Atlantic species, *S. brasiliensis* (Rudometkina, 1980). These larvae are extremely similar to those of *Harpadon*, except for the lower numbers of branchiostegals and invariably short fins. Complete absence of the preanal finfold in the early stages is peculiar to this genus (Ozawa, 1983). Except for *S. brasiliensis*, however, these are divided into two types on the basis of pigmentation pattern. One of these consisting of *S. gracilis* and probably some Atlantic congeners is characterized by evenly spaced peritoneal pigment sections of similar size and simultaneous differentiation. In addition, prominent pigment along the anal fin base and on the caudal fins may be diagnostic for this type. *S. gracilis* larvae uniquely develop a small choroid mass on the ventral side of narrow eyes (Ozawa, 1983) while nothing is mentioned in this regard for Hawaiian larvae (Miller et al., 1979). Remaining larvae belong to the second type in which the terminal pigment section is smaller and later-appearing than the anterior sections. Other pigment is also scarce or absent in this latter type, where specific differences are known in the size of pigment sections and vertebral numbers. Metamorphosis occurs fairly gradually with considerable variation in size among species, but is usually complete before 40 mm (Gibbs, 1959).

Fig. 110. (A) *Ipnotops agassizi*, 13.9 mm SL, from Okiyama (1981); (B) *Bathytyphlops marionae*, 13.1 mm, from Okiyama (1972); (C) *Bathymicrops brevianalis*, 70.0 mm, from tropical central Pacific, ORI collection; (D) *Bathypterois* sp. (pigmented type), from northeast of Australia, Southwest Fisheries Center (SWFC) collection; (E) *Bathypterois viridensis* (unpigmented type), from Fahay (1983).

Fig. 111. (A) *Scopelosaurus smithii*, 13.4 mm SL, from southwestern Pacific, ORI collection; (B) the same, dorsal view of head; (C) *Bathysaurus ferox*, 33.0 mm, from Marshall (1961); (D) *Harpadon nehereus*, 25.2 mm, from East China Sea, ORI collection; (E) *Saurida undosquamis*, 15.6 mm, from Okiyama (1974b); (F) *Synodus luoiceps*, 10.5 mm, from California current region, SWFC collection; (G) *Trachinocephalus myops*, 21.3 mm, from Zvjagina (1965a).

Fig. 112. (A) *Alepisaurus brevirostris*, 12.1 mm, from Rofen (1966b); (B) *A. ferox*, 10.0 mm, from central Pacific near Hawaii, SWFC collection; (C) *Anotopterus pharao*, 14.2 mm, from California current region, SWFC collection; (D) *Omosudis lowei* (central western Atlantic specimen), 11.8 mm, from Rofen (1966b); (E–F) *O. lowei*, 22.5 mm, from tropical western Pacific, ORI collection, showing dorsal view of head.

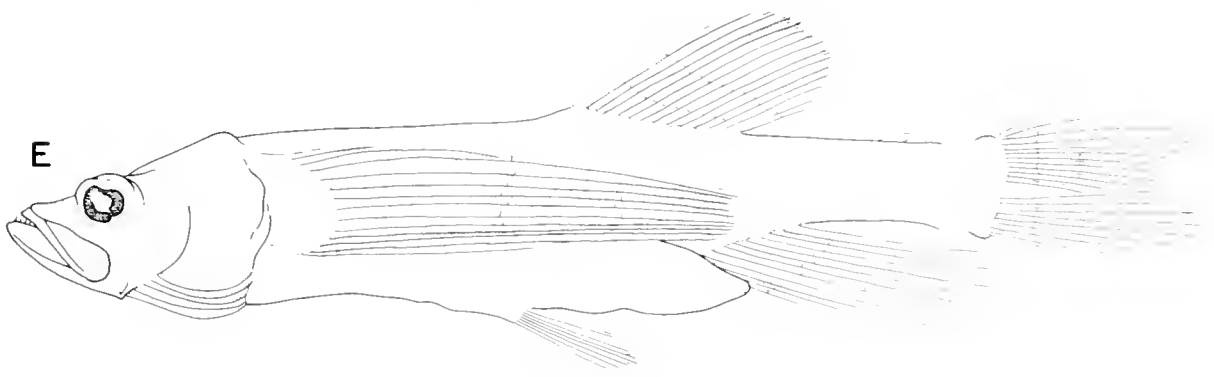
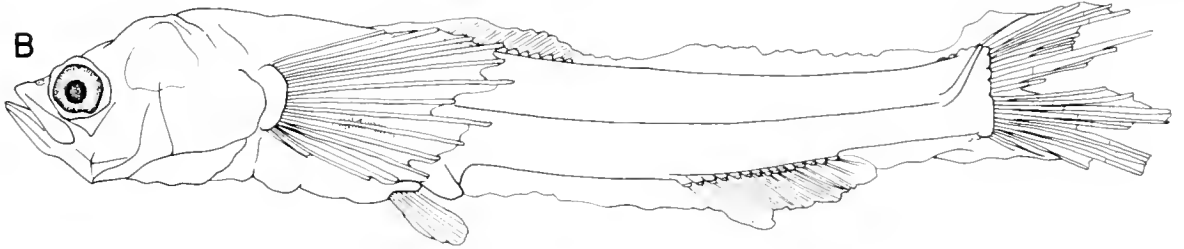
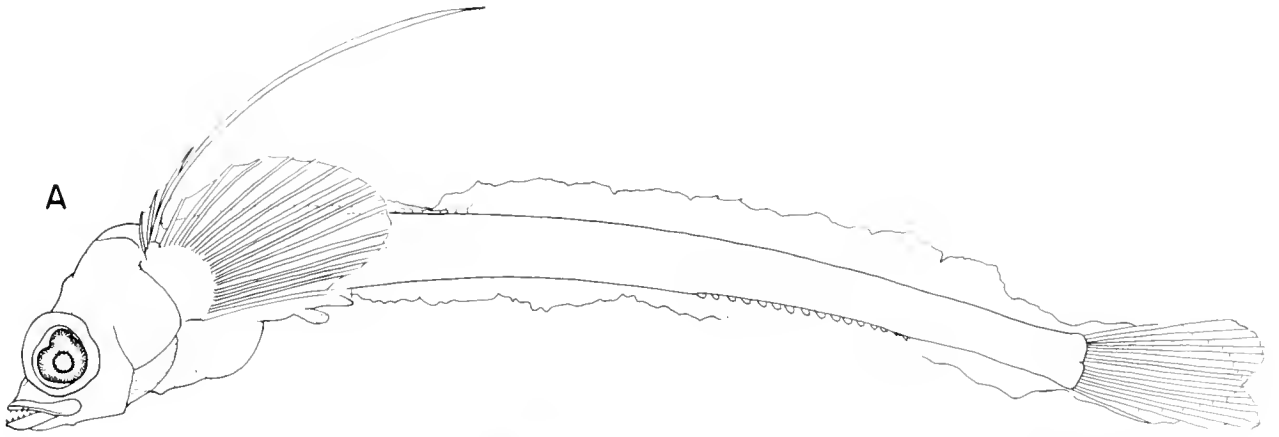

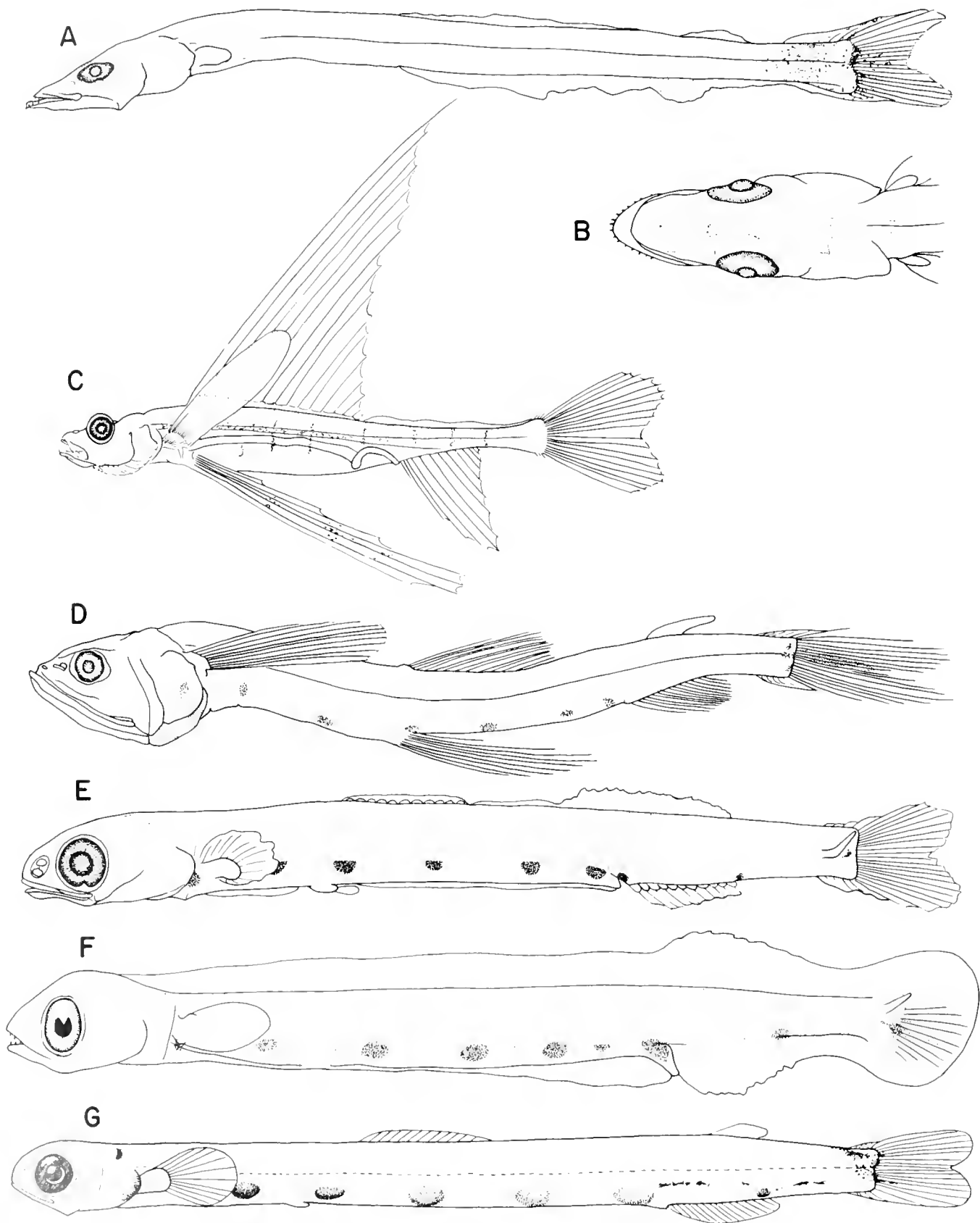

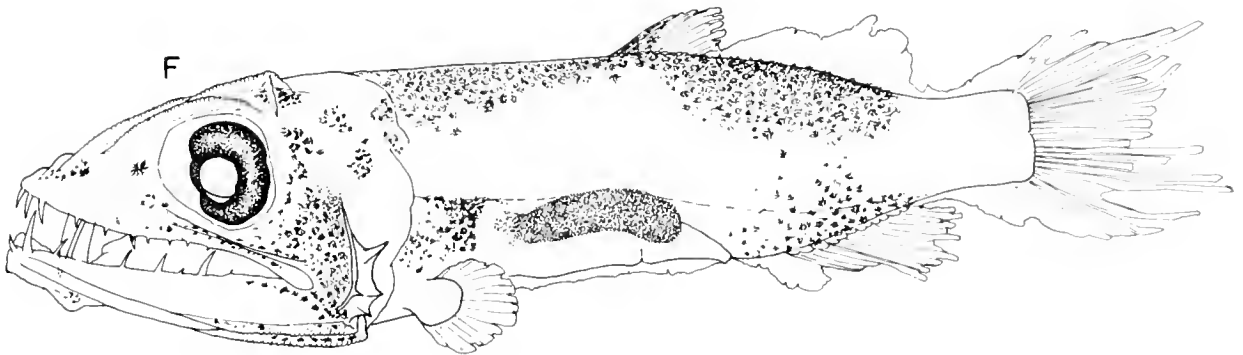
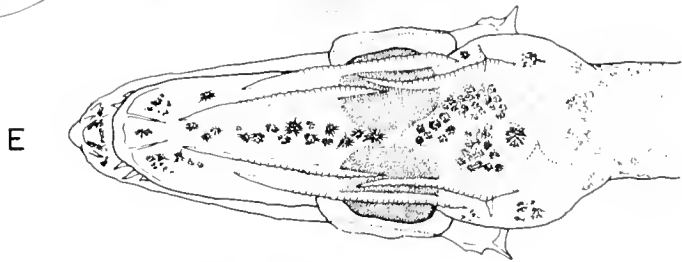
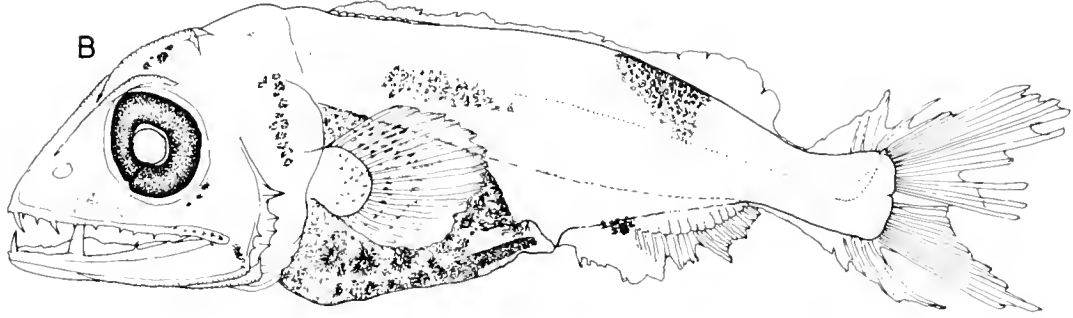
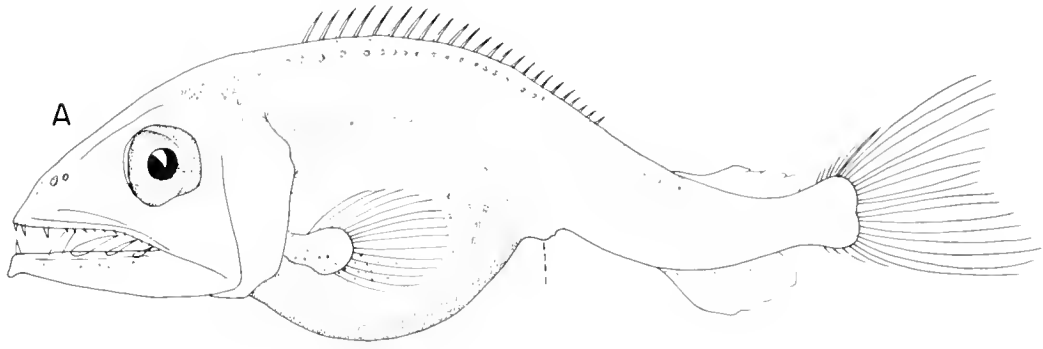

Synodontidae (Fig. 111F–G).—*Synodus* includes about 30 species and has a circumglobal distribution with distinctly high diversity in the Indo-Pacific. Another monotypic genus of this family (*Trachinocephalus*) shows world-wide distribution. A recent revision of the Indo-Pacific *Synodus* (Cressey, 1981), including many new species, critically changed its systematic status. Thus, most of the known eggs and larvae are subject to nomenclatural revision. Early stages of this family can be separated from those of the previous family by the presence of the preanal finfold (Ozawa, 1983).

Trachinocephalus myops larvae are distinct in possessing six pairs of large peritoneal pigment sections of uniform size, a rounded head with short snout, and additional unique pigmentation (Rudometkina, 1980; Ozawa, 1983). This species and most species of *Synodus* have an extremely elongated body. An exception is the eastern Pacific species, *S. lucioceps*, which has a slightly deeper body. A complete developmental series is known only for this species in *Synodus*; eggs are spherical, 1.33–1.44 mm in diameter, without an oil globule, with moderately broad perivitelline space and hexagonally sculptured chorion; larvae are characterized by 7 evenly spaced pairs of pigment sections formed gradually, a ventral melanophore lying at the midpoint of tail, and one near the notochord tip.

As in the Harpadontidae, meristic characters and pigmentation patterns are of particular aid in identifying the early stages of this family. If established pigmentation patterns are retained in the metamorphosed juveniles or adults, numbers of the peritoneal pigment sections of all Indo-Pacific species of *Synodus* (Cressey, 1981) vary between 0 and 17 with a maximum range of infraspecific variation of 0–3 in *S. binotatus* and 14–17 in *S. usitatus*; some species appear to lack this pigment (i.e., *S. kaianus* and *S. binotatus*), however this needs to be documented by complete developmental series. Another point of interest is the asymmetry and size disparity of the pigment pairs known in "*S. variegatus*" of Okiyama (1974b).

Size at metamorphosis and sequence of fin formation of this family appear to be identical to those in Harpadontidae. Ozawa (1983) revealed the following pattern of fin formation: C-A-D-P₁-P₂.

Alepisauridae (Fig. 112A–B).—This widely distributed bathypelagic family includes only two species, *Alepisaurus ferox* and *A. brevirostris*, with slightly different ranges; the latter is apparently absent from the North Pacific (Francis, 1981). Eggs are unknown. A series of early developmental stages of *Alepisaurus* sp. (6.9–17.2 mm) has been described and illustrated (Rofen, 1966b). In addition, three larvae (9.6–16.5 mm) from the collection of the Southwest Fisheries Center, La Jolla have different features. They share with previous specimens a large head and mouth, prominent canine teeth on the dentary, small fins including pigmented pectorals of moderate size, gently curved head profile and short gut with heavy pigmentation. The peritoneal pigment section is indistinct. This new material is unique in having 4 small preopercular spines, pigment patches at the anal fin origin, and distinct bony ridges dorsally on the head. Judging from the locality of these specimens, near Hawaii in the North Pacific, *Alepisaurus* sp. larvae of Rofen (1966b) can be identified with *A. brevirostris*, and these with *A. ferox*.

Metamorphosis may be gradual with possible sequence of fin formation P₁-C-D-A-P₂.

Anopteridae (Fig. 112C).—One world-wide species, *Anopterus pharao*, constitutes this open ocean family, uniquely lack-

ing the dorsal fin. Eggs are not known. A larva (ca. 15 mm) has been briefly described without illustration (Nybelin, 1948); this specimen is unavailable now (Thulin, pers. comm.). Another larva of similar size (14.2 mm) is available from the collection of the Southwest Fisheries Center, La Jolla. It is characterized by a slender thin body, absence of peritoneal pigment sections, large head with pointed snout, a fleshy prolongation at the tips of both jaws, two large canine teeth on each palatine, and a fairly long gut extending beyond midbody. Pigmentation is scattered on various parts of body including the snout, jaw tips, dorsal midline of body, near the tail tip, and peritoneum (particularly along the dorsum of gut). Except for the pectoral fin, fin anlagen are lacking. A juvenile of about 50 mm illustrated in Rolén (1966c) is similar to the described larva, except all fins are differentiated including the adipose fin; body pigmentation is remarkable in this juvenile. Perhaps, this species has the most direct pattern of early development in this order.

Evermannellidae (see R. K. Johnson, this volume).

Omosudidae (Fig. 112D–F).—A single mesopelagic species, *Omosudis lowei*, constitutes this cosmopolitan family. Pelagic eggs are not known. Excellent developmental series have been described and illustrated, chiefly based on Atlantic material ranging from 5.7 to 75.2 mm (Ege, 1958; Rofen, 1966b). Recently, a larva (11.5 mm) with different features was briefly described and illustrated (Belyanina, 1982b). Its locality in the tropical western Pacific is peculiar and additional specimens are available in ORI collections (pers. obs.).

These have in common a very large head and mouth, stubby body, long pointed snout, straight head profile, small fins, particularly the pectoral, large canine teeth on dentary and palatine, and several closely spaced peritoneal pigment sections. However, trenchant morphological differences between the Atlantic and Pacific specimens are known: head smooth vs armed (along edge of preopercle and dorsum of head); pigmentation light vs dense at a similar size; pigmented band above posterior part of anal fin absent vs present. For this first character, there is a possibility that the minute preopercular spines have been overlooked in the Atlantic larvae.

Sequence of fin formation known in the Atlantic specimens is C-D-A-P₂-P₁. Metamorphosis is gradual with possible differences in the size of completion between the two types as suggested above. The presence of two larval types is in sharp contrast with the current concept of a monotypic family. In this connection, Ege's comments (1958) on the significant differences in dorsal ray numbers between the populations from the South China Sea and north Atlantic are of particular interest.

Paralepididae (Fig. 113A–G).—This oceanic pelagic family includes about 11 genera and 50 species and constitutes the second largest group in the order after Myctophidae. Some genera are still in need of critical revision, while the two established subfamilies seem valid. Paralepidiinae includes two tribes, the Paralepidiini (3 genera) and Lestidiini (7 genera), and Sudinae has 1 genus (*Sudis*). Ege (1930) and Rofen (1966a) included early larval stages in their extensive studies of this family. Eggs are not known but developmental stages are known for 9 out of 11 genera. Larval development of *Sudis* has been closely studied for *S. hyalina* and *S. atrox* (Sanzo, 1917; Shores, 1969; Belyanina, 1981). These unusual larvae are readily discriminated from those of the other subfamily by the relatively short body with large head, long pectoral fins, long gut and early

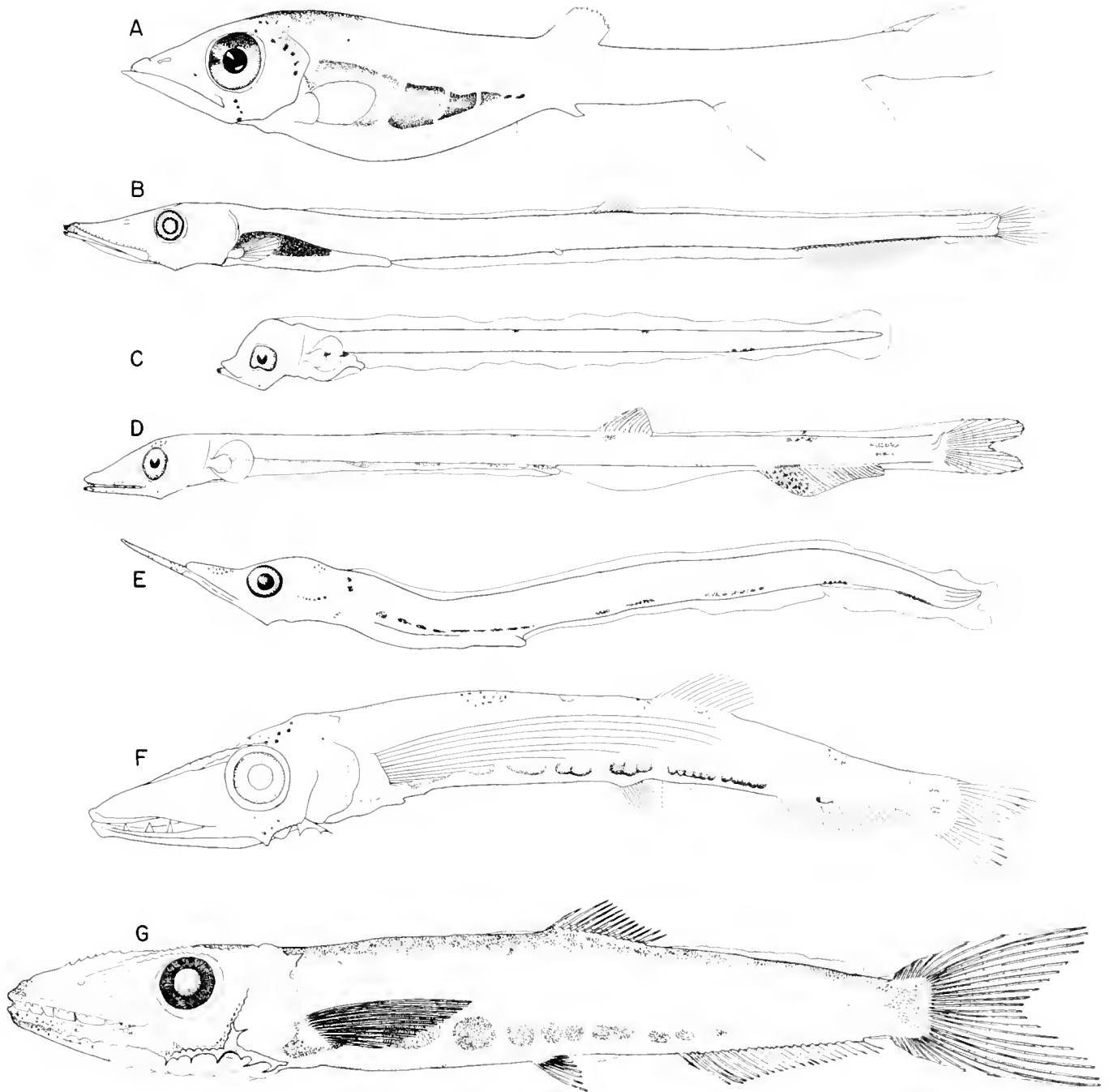

Fig. 113. (A) *Paralepis elongata*, 16.7 mm SL, from Rofen (1966a); (B) *Notolepis coatsi*, 60.5 mm, from Efremenko (1983); (C) *Lestidhops ringens*, 9.4 mm, from California current region, SWFC collection; (D) the same, 28.5 mm; (E) *Stemonosudis macrura*, 11.2 mm, from Ege (1957); (F) *Sudis hyalina*, 16.1 mm, from Shores (1969); (G) *S. atrox*, 21.5 mm, from Berry and Perkins (1966).

established complement of peritoneal pigment sections, spine-tipped flanges on ventral region of preoperculum, over eye, and snout. *S. atrox* has a spine-tipped flange along lower jaw, and the large spine at the preopercular angle is serrated only in *S. atrox*. The precocious pectoral fin is relatively short until about 15 mm in *S. atrox* whereas it is very long even in 8.0 mm larvae of *S. hyalina*. The number of peritoneal pigment sections is 6

(5 in early larvae) in *S. atrox* vs 7–8 in *S. hyalina*. Trunk pigment is evenly distributed in *S. atrox* vs patchy in *S. hyalina*.

Except for this genus, the developmental features of this family are remarkably cohesive. Known larvae have a very long compressed body, a short trunk in early larvae, large head in advanced larvae, elongated pointed snout with straight head profile, various numbers of peritoneal pigment sections sequen-

tially formed with gradual lengthening of gut, well developed preanal finfolds and apparently precocious anal fin rays. Additionally, during ontogeny eye shape changes from ovoid to round, and body pigmentation changes from light to dense. These larvae are too similar in general appearances to determine trenchant characters that define genera or tribes. Peritoneal pigment sections, are of prime importance in identifying early stages, but show extreme variability with respect to their number and sequential development. Of particular interest in this connection is *Notolepis*. *N. rissoi* develops 12 pigment sections, the largest number in the family except *Stemonosudis* (31), whereas the Antarctic congener, *N. coatsi*, has only a single section which increases in size with growth (Efremenko, 1978, 1983a). Among the various genera the primary section develops at 5–10 mm and full complements are formed variously by the species between 15–45 mm. Usually, metamorphosis takes place around this size accompanied by the development of a black peritoneum.

In addition to the exceptionally higher number of pigment sections, *Stemonosudis* is peculiar in having a filamentous pro-

jection on the lower jaw tip (in larvae of *S. macrura* and in juveniles and adults of *S. intermedia* and *S. elongata*). Likewise, *Uncisudis* (= *Pontosudis*) uniquely develops an elongated pelvic fin.

Patterns of melanophores are extremely diverse but of use in identifying species or species groups; pigment patches on the caudal peduncle, dorsum of body, and caudal and pectoral fins are particularly important. Rofen (1966a) suggested that the single larval character discriminating the two tribes in Paralepidiinae, i.e., Paralepidiini and Lestidiini, is whether the rearward shift of the anus occurs early or late in ontogeny.

Incertae cedis.—Peculiar eggs described by Delsman (1938) and Mito (1961a) are currently considered to be those of myctophiform fishes other than Myctophidae (Moser and Ahlstrom, 1970). These eggs are spherical, 1.12–1.37 mm in diameter, with a single oil globule and bear numerous short appendages on the chorion. Two types are known only from Asian waters.

OCEAN RESEARCH INSTITUTE, UNIVERSITY OF TOKYO, 1-15-1, MINAMIDAI, NAKANO-KU, TOKYO 164, JAPAN.

Myctophidae: Development

H. G. MOSER, E. H. AHLSTROM AND J. R. PAXTON

LANTERNFISHES of the family Myctophidae are found in all oceans of the world. Some 230–250 species are arranged in 36 generic/subgeneric taxa (Table 59). All nominal species are listed in Paxton (1979). Characteristic of the family is the presence of light organs or photophores on the head and body (Fig. 114). The different patterns of photophores have been used, along with meristics (Table 60), in species diagnoses and as a basis for classification within the family since the late 1800's.

Most authors have placed the Myctophidae and closely related Neoscopelidae with the families Aulopidae, Chlorophthalmidae and related families in an order or suborder variously named the Iniomi, Myctophoidea or Myctophiformes (Gosline et al., 1966; Greenwood et al., 1966; Nelson, 1976; Johnson, 1982), although Rosen (1973) separated the Myctophidae and Neoscopelidae as a restricted order Myctophiformes. Moser and Ahlstrom (1970, 1972, 1974), Ahlstrom et al. (1976) and Paxton (1972) are the most recent papers considering relationships within the family; characteristics of larvae and bones and photophores of adults were primarily utilized in the respective studies. Paxton's (1972) classification, including genera recognized subsequently, is as follows:

Subfamily Myctophinae

Tribe Electronini

Genera: *Protomyctophum*, *Krefflichthys*¹, *Electrona*, *Metelectrona*²

Tribe Myctophini

Genera: *Benthoosema*, *Diogenichthys*, *Hygophum*, *Myctophum*, *Symbolophorus*

Tribe Gonichthyini

Genera: *Loweina*, *Tarletonbeania*, *Gonichthys*, *Centrobanchus*

Subfamily Lampanyctinae

Tribe Notolychnini

Genus *Notolychnus*

Tribe Lampanyctini

Genera: *Taaningichthys*, *Lampadena*, *Bolinichthys*, *Lepidophanes*, *Ceratoscopelus*, *Stenobranchius*, *Lampanyctus*, *Triphoturus*, *Parvilux*³

Tribe Diaphini

Genera: *Lobianchia*, *Diaphus*, *Idiolychnus*⁴

Tribe Gymnoscopelini

Genera: *Lampanyctodes*, *Gymnoscopelus*, *Notoscopelus*, *Lampichthys*, *Scopelopsis*, *Hintonia*

There has not been a family revision at the species level since Fraser-Brunner's (1949) study. A large number of more recent generic revisions and regional studies are currently the primary sources for species identifications; most of these have been utilized in compiling the generic distribution limits (Table 59). The most recent zoogeographic studies are those of Backus et al.

¹ Hulley (1981).

² Wisner (1963).

³ Hubbs and Wisner (1964).

⁴ Nafpaktitis and Paxton (1978).

TABLE 59. GEOGRAPHIC DISTRIBUTION OF THE GENERA AND SUBGENERA OF MYCTOPHIDAE. References marked * are useful for the identification of species. The division of the Atlantic and Indian Oceans is arbitrarily taken at 20°E, the Indian-Pacific Ocean boundary at 130°E.

Genus	No. of species	Ocean	Lat. extremes	References
<i>Krefflichthys</i>	1	Atlantic	34°S–60°S	*Hulley (1981:12)
		Indian	43°S–66°S	*Hulley (1972:217); Andriashev (1962:224)
		Pacific	34°S–72°S	Andriashev (1962:225); McGinnis (1982:11)
<i>Protomyctophum</i> (<i>Protomyctophum</i>)	7	Atlantic	34°S–60°S	*Hulley (1981:29, 19)
		Indian	44°S–65°S	Hulley (1972:218); *McGinnis (1982:17)
		Pacific	40°S–70°S	*Andriashev (1962); *McGinnis (1982:16, 17)
<i>Protomyctophum</i> (<i>Hierops</i>)	7	Atlantic	70°N–56°S	Nafpaktitis et al. (1977:31); *Hulley (1981:36)
		Indian	35°S–52°S	*Nafpaktitis and Nafpaktitis (1969:7); *McGinnis (1982:18)
		Pacific	57°N–67°S	*Wisner (1976:20); *McGinnis (1982:18)
<i>Electrona</i>	5	Atlantic	55°N–70°S	*Hulley (1981:40, 46); *McGinnis (1982:21)
		Indian	2°N–68°S	Nafpaktitis and Nafpaktitis (1969:10); *McGinnis (1982:21)
		Pacific	42°N–70°S	*Andriashev (1962); Ebeling (1962:140); *McGinnis (1982:21)
<i>Metelectrona</i>	2	Atlantic	35°S–51°S	*Hulley (1981:53)
		Indian	35°S–47°S	*McGinnis (1982:25)
		Pacific	33°S–55°S	*Bussing (1965:200); *McGinnis (1982:25)
<i>Benthoosema</i>	5	Atlantic	80°N–38°S	*Nafpaktitis et al. (1977:52); Hulley (1972:220); (the specimen from 55°S is possibly mislabeled, McGinnis, (1982:26, 29))
		Indian	21°N–35°S	Kotthaus (1972:18); *Nafpaktitis and Nafpaktitis (1969:11)
		Pacific	71°N–42°S	*Wisner (1976); Nafpaktitis et al. (1977:52); Robertson et al. (1978:302)
<i>Diogenichthys</i>	3	Atlantic	50°N–48°S	Nafpaktitis et al. (1977:58); Hulley (1981:58)
		Indian	18°N–45°S	*Nafpaktitis and Nafpaktitis (1969:15)
		Pacific	37°N–41°S	*Wisner (1976:49); Rass (1960:149)
<i>Hygophum</i>	9–11	Atlantic	49°N–48°S	*Bekker (1965); *Nafpaktitis et al. (1977:38); *Hulley (1981:61)
		Indian	20°N–42°S	*Bekker (1965:80); Hulley (1972:222)
		Pacific	39°N–46°S	*Wisner (1976); *Bekker (1965:94); McGinnis (1982:30)
<i>Symbolophorus</i>	7–9	Atlantic	59°N–51°S	*Hulley (1981:101)
		Indian	21°N–41°S	Kotthaus (1972:27); *Nafpaktitis and Nafpaktitis (1969:29)
		Pacific	50°N–59°S	*Wisner (1976); Frost and McCrone (1979:755); *McGinnis (1982:33)
<i>Myctophum</i>	13–14	Atlantic	65°N–40°S	*Nafpaktitis et al. (1977:62); *Hulley (1981:87)
		Indian	20°N–34°S	Nafpaktitis and Nafpaktitis (1969); *Bekker and Borodulina (1978:120); McGinnis (1982:34)
		Pacific	42°N–42°S	*Kawaguchi and Aioi (1972); *Wisner (1976); Kawaguchi et al. (1972:27); Paxton and Nafpaktitis (ms)
<i>Loweina</i>	3–4	Atlantic	44°N–38°S	*Nafpaktitis et al. (1977:85)
		Indian	10°S–40°S	*Bekker (1964:23); *Nafpaktitis and Nafpaktitis (1969:31)
		Pacific	32°N–40°S	*Wisner (1976); *Bekker (1964:23); McGinnis (1982:37)
<i>Tarletonbeania</i>	1–2	Atlantic	—	
		Indian	—	
		Pacific	50°N–30°N	*Bekker (1963:160); *Wisner (1976:82)
<i>Gonichthys</i>	3–4	Atlantic	47°N–40°S	Nafpaktitis et al. (1977:88); Hulley (1981:107)
		Indian	25°S–39°S	*Bekker (1964:38)
		Pacific	31°N–42°S	*Bekker (1964); *Wisner (1976:86); McGinnis (1982:36)
<i>Centrobranchus</i>	3–4	Atlantic	46°N–35°S	*Nafpaktitis et al. (1977:91)
		Indian	15°N–33°S	*Bekker (1964:51, 58)
		Pacific	37°N–37°S	*Bekker (1964:58)
<i>Notolychnus</i>	1	Atlantic	56°N–38°S	*Nafpaktitis et al. (1977:94); *Hulley (1972:222)
		Indian	11°N–40°S	Kotthaus (1972:30); McGinnis (1982:37)
		Pacific	34°N–44°S	Ebeling (1962:141); McGinnis (1982:37)
<i>Lobianchia</i>	2	Atlantic	61°N–51°S	*Nafpaktitis et al. (1977); Bekker (1967:98); McGinnis (1982:51)
		Indian	2°N–40°S	*Nafpaktitis (1978:7); McGinnis (1982:51)
		Pacific	32°N–47°S	*Wisner (1976:96); McGinnis (1982:51)
<i>Diaphus</i>	65–75	Atlantic	62°N–52°S	*Nafpaktitis et al. (1977:158); McGinnis (1982:52)
		Indian	23°N–48°S	*Nafpaktitis (1978:62, 78)
		Pacific	55°N–58°S	*Nafpaktitis (1978:62); McGinnis (1982:52)
<i>Idiolychnus</i>	1	Atlantic	—	
		Indian	13°S–24°S	*Nafpaktitis and Paxton (1978:495)
		Pacific	21°N	*Nafpaktitis and Paxton (1978:495–496)

TABLE 59. CONTINUED.

Genus	No. of species	Ocean	Lat extremes	References
<i>Lampanyctodes</i>	1	Atlantic Indian Pacific	19°S–34°S 35°S 34°S–51°S	*Ahlstrom et al. (1976:146); Grindley and Penrith (1965:283) Paxton and Nafpaktitis (in prep.) *Wisner (1976:158–159); McGinnis (1982:55)
<i>Gymnoscopelus</i> (<i>Gymnoscopelus</i>)	4	Atlantic Indian Pacific	34°S–66°S 60°S–65°S 40°S–72°S	*Hulley (1981:254); *McGinnis (1982:59) *Andriashev (1962:267); *McGinnis (1982:59) *McGinnis (1982:61, 58)
<i>Gymnoscopelus</i> (<i>Nasolychnus</i>)	4–5	Atlantic Indian Pacific	34°S–57°S 24°S–65°S 40°S–70°S	*Hulley (1981:261); (03°S, Fraser-Brunner (1931:224) presumably a waif) Smith (1933a:126); *McGinnis (1982:64) *Andriashev (1962); McGinnis (1982:64)
<i>Scopelopsis</i>	1	Atlantic Indian Pacific	11°S–48°S 9°S–40°S 15°S–35°S	*Hulley (1981:241) Legand (1967:49); McGinnis (1982:57) *Wisner (1976:222); Paxton and Nafpaktitis (in prep.)
<i>Lampichthys</i>	1	Atlantic Indian Pacific	30°S–48°S 35°S–40°S 7°S–49°S	Hulley (1981:242) McGinnis (1982:57) *Wisner (1976:215); McGinnis (1982:57)
<i>Notoscopelus</i> (<i>Notoscopelus</i>)	5	Atlantic Indian Pacific	65°N–60°S 8°S–36°S 50°N–37°S	*Nafpaktitis et al. (1977:254) Andriashev (1962:278) Nafpaktitis and Nafpaktitis (1969:35); Grindley and Penrith (1965:283) *Fujikii and Uyeno (1976); Frost and McCrone (1979:755); Collins and Baron (1981:11)
<i>Notoscopelus</i> (<i>Parieophus</i>)	1	Atlantic Indian Pacific	50°N–21°N — —	*Nafpaktitis et al. (1977:257)
<i>Hintonia</i>	1	Atlantic Indian Pacific	39°S–48°S 47°S–51°S 40°S–50°S	*Hulley (1981:239) McGinnis (1982:55) *Wisner (1976:220); McGinnis (1982:55)
<i>Lampadena</i> (<i>Lampadena</i>)	8–9	Atlantic Indian Pacific	65°N–48°S 6°N–49°S 41°N–49°S	*Kreff (1970:285); Hulley (1981:180) *Nafpaktitis and Paxton (1968:20, 21) *Nafpaktitis and Paxton (1968:20, 21)
<i>Lampadena</i> (<i>Dorsadena</i>)	1	Atlantic Indian Pacific	— — 45°N	*Coleman and Nafpaktitis (1972:2)
<i>Taaningichthys</i>	3	Atlantic Indian Pacific	43°N–44°S 8°N–30°S 41°N–68°S	*Hulley (1981:167); *Davy (1972) *Nafpaktitis and Nafpaktitis (1969:40) *Davy (1972:72); *Nafpaktitis et al. (1977:191)
<i>Ceratoscopelus</i>	3	Atlantic Indian Pacific	52°N–45°S 20°N–43°S 43°N–42°S	*Nafpaktitis et al. (1977:243); Hulley (1981:237) *Bekker and Borodulina (1968:792); *Nafpaktitis and Nafpaktitis (1969:65) *Wisner (1976:207); Robertson et al. (1978:302)
<i>Lepidophanes</i>	2	Atlantic Indian Pacific	43°N–48°S — —	*Nafpaktitis et al. (1977:225); *Hulley (1981:223)
<i>Bohnuchthys</i>	7	Atlantic Indian Pacific	53°N–41°S 21°N–44°S 31°N–43°S	*Nafpaktitis et al. (1977:240); *Hulley (1981:229) Kotthaus (1972:18); *Nafpaktitis and Nafpaktitis (1969:60) *Johnson (1975:58); Nafpaktitis et al. (1977:234)
<i>Triphoturus</i>	3–4	Atlantic Indian Pacific	— 8°N–14°S 38°N–35°S	Hulley (1981:205) *Nafpaktitis and Nafpaktitis (1969:51) *Wisner (1976:165)
<i>Stenobranchius</i>	2	Atlantic Indian Pacific	— — 57°N–30°N	*Wisner (1976:160)
<i>Parvilux</i>	2	Atlantic Indian Pacific	— — 40°N–14°S	*Wisner (1976:163, 164)
<i>Lampanyctus</i>	40	Atlantic Indian Pacific	65°N–60°S 16°N–60°S 59°N–72°S	*Nafpaktitis et al. (1977:196); *Hulley (1981:183); Zahuranec (1980) *Nafpaktitis and Nafpaktitis (1969); Kotthaus (1972:35); *McGinnis (1982:42); Zahuranec (1980) *Wisner (1976:191); McGinnis (1982:42); Zahuranec (1980)

TABLE 60. MERISTICS OF THE GENERA AND SUBGENERA OF MYCTOPHIDAE.

	Fin rays							
	Dorsal	Anal	Pectoral	Pelvic	Procurent caudal	Vertebrae	Branchio- stegals	Gill rakers
<i>Krefflichthys</i>	11-14	17-19	14-16	8-9	8-9 + 7-9	36-39		6-8 + 19-23
<i>Protomyctomphum</i>	10-14	21*-27	14-17	8-9	7-9 + 6-9	35-41	8-10	4-7 + 14-21
<i>P. Hierops</i>	11-13	20-27	15-18	8	7-11 + 6-9	36-42	9-10	3-5 + 13-18
<i>Electrona</i>	12-16	18-22	11-17	8	6-10 + 6-9	33-41	7-8	3-10 + 12-25
<i>Metelectrona</i>	13-15	19-22	14-16	8	10 + 9	35-38	8	4-7 + 16-20
<i>Benthoosema</i>	11-15	16-22	10-17	8-9	7-9 + 7-9	31-37	9	3-10 + 10-21
<i>Diogenichthys</i>	10-13	14-18	10-14	7-8	7-9 + 7-9	29-34	7	2-4 + 10-12
<i>Hygophum</i>	10-15	18-25	12-17	8-9	6-9 + 6-9	34-40	9	3-6 + 12-16
<i>Myctophum</i>	11-15	16-27	12-22	7-8	7-9 + 7-9	35-46	8-9	4-8 + 10-21
<i>Symbolophorus</i>	12-16	18-24	12-20	8	8-10 + 7-9	36-42	9	4-7 + 12-19
<i>Loweina</i>	10-13	13-17	9-12	7-9	6-7 + 6-7	37-39	9	2-3 + 5-10
<i>Tarletonbeania</i>	11-15	16-20	11-16	8	5-8 + 5-8	40-42	8	4-6 + 10-12
<i>Gonichthys</i>	10-13	17-24	11-18	6-8	5-6 + 5-6	38-41	9	3-6 + 7-12
<i>Centrobranchus</i>	9-12	16-20	11-17	8	5-7 + 5-7	35-40	7-8	0
<i>Notolychnus</i>	10-12	12-15	11-15	6-7	7-9 + 7-9	27-31	9-10	2 + 8-9
<i>Lobianchia</i>	15-18	13-15	11-15	8	5-7 + 5-6	33-35	9	4-6 + 11-16
<i>Diaphus</i>	10-19	11-19	9-14	8	5-8 + 5-8	31-37	8-9	4-11 + 9-21
<i>Idolychnus</i>	14-15	14-16	13-15	8		34		6-7 + 14-15
<i>Lampanyctodes</i>	13-14	14-17	12-14	8	8-10 + 9-10	36-39	9-11	10-11 + 20-23
<i>Gymnoscopelus</i>	14-21	16-22	12-16	8-9	10-12 + 11-15	41-45	10	6-12 + 14-26
<i>G. Nasolychnus</i>	16-20	16-20	12-15	8	8-13 + 10-15	41-45	10-11	7-12 + 17-25
<i>Scopelopsis</i>	20-24	23-27	10-12	7-8	9-11 + 11-12	38-39	9-10	7-9 + 16-18
<i>Lampichthys</i>	16-18	21-23	11-15	8	10 + 12	40-41	9	4-6 + 13-16
<i>Notoscopelus</i>	21-27	18-21	11-14	8-9	10-14 + 10-15	35-40	10	4-10 + 9-22
<i>N. Parieophus</i>	23-26	18-20	12-14			37-38		8-10 + 18-20
<i>Hintonia</i>	14-16	12-14	13-15	8	10-11 + 13	37-39	9	6-7 + 11-14
<i>Lampadena</i>	13-16	12-15	13-18	8	8 + 8-9	35-40	9	3-8 + 9-18
<i>L. Dorsadena</i>	14-15	12-14	15-16	8-9				4-5 + 12
<i>Taaningichthys</i>	11-14	11-14	12-17	8	7-10 + 6-10	34-41	8-9	2-5 + 6-14
<i>Ceratoscopelus</i>	13-15	13-16	12-15	8	6-7 + 6-7	35-38	9	3-5 + 9-16
<i>Lepidophanes</i>	11-15	13-16	11-14	8-9	6-7 + 6-8	33-37	9	3-4 + 8-11
<i>Bolinichthys</i>	11-15	11-15	11-15	8	7 + 7-8	33-36	9	3-7 + 11-17
<i>Triphoturus</i>	12-16	13-18	8-10	8	5-7 + 6-7	30-36	10-11	2-4 + 8-11
<i>Stenobrachius</i>	12-15	14-16	8-10	8	6-8 + 7-9	35-38	9-10	5-6 + 12-14
<i>Parvilux</i>	14-17	15-18	10-13	8	8 + 8-9	35-38	10-11	4-6 + 11-15
<i>Lampanyctus</i>	10-19	14-21	0-17	8	6-8 + 6-8	30-40	8-11	3-8 + 9-19

* Incorrectly 15-27 in Paxton, 1972.

(1977) and Hulley (1981) on Atlantic species and McGinnis (1982) on Southern Ocean species.

Most lanternfishes make extensive vertical migrations from mesopelagic depths to the upper waters at night, some reaching the surface (Paxton, 1967). The fisheries potential of myctophids and other mesopelagic fishes has recently been reviewed (Gjosæter and Kawaguchi, 1980). Adults range in size from 20-300 mm (Krefft, 1974) and have a life span of from one year in some tropical species (Clarke, 1973) to more than five years in the few temperate species that have been studied (Smoker and Pearcy, 1970; Gjosæter, 1973; Kawaguchi and Mauchline, 1982).

EGGS

Myctophids are oviparous and presumably all produce planktonic eggs although such have been reported for only two species. Sanzo (1939a) indicated that mature ovarian eggs of *E. rissoi* have the following characteristics: round shape; 0.80-0.84 mm diameter; segmented yolk; single oil globule, ca. 0.28 mm diameter; smooth chorion. He illustrated a planktonic egg with similar characteristics and tentatively identified it as that of *E. rissoi*. Robertson (1977) described the planktonic egg of *Lampanyctodes hectoris* as follows: weakly oval; long axis 0.74-0.83

mm, short axis 0.65-0.72 mm; strongly segmented yolk: single oil droplet, 0.21-0.23 mm diameter; narrow perivitelline space; chorion smooth and delicate. He based his identification on the similarity of these eggs and mature ovarian eggs of running ripe *L. hectoris* captured at the same time by trawl.

We have observed planktonic eggs similar to those described by Robertson (1977) but have not found them with advanced embryos that could be matched with co-occurring yolk-sac myctophid larvae. The fact that these and other types of eggs tentatively identified as myctophids occur in relatively low abundance compared with myctophid larvae led Moser and Ahlstrom (1970) to suggest that the fragile chorion breaks in contact with plankton nets and the embryo is extruded through the mesh.

LARVAE

Moser and Ahlstrom (1970) reviewed the literature on myctophid larvae; however, numerous recent contributions have advanced our knowledge of the group and are listed in Table 61. Of the 32 recognized genera of myctophids, larvae have been described for all but *Hintonia*. The larval stages of myctophids provide sets of characters that are useful at levels of systematic analysis from species separation to hypotheses of

TABLE 61. SUMMARY OF LITERATURE CONTAINING ILLUSTRATIONS OF DEVELOPMENTAL STAGES OF MYCTOPHIDS. Frequently cited authors are abbreviated as follows: Ahlstrom (A), Belyanina and Kovalevskaya (B + K), Dekhnik and Sinyukova (D + S), Moser and Ahlstrom (M + A), Pertseva-Ostroumova (P-O), Shiganova (S), Tåning (T).

Species	Single larval stage	Multiple larval stages	Transforming stage	Juvenile stage
<i>Benthoosema</i>				
<i>fibulatum</i>	M + A, 1974	P-O, 1974	—	—
<i>glaciale</i>	Holt, 1898; S, 1977	T, 1918; Sparta, 1951; M + A, 1974	Holt, 1898; T, 1918; Sparta, 1951	Holt, 1898; T, 1918; Sparta, 1951
<i>panamense</i>	—	M + A, 1970	M + A, 1970	M + A, 1970
<i>pterota</i>	M + A, 1974; P-O, 1974	Tsokur, 1981	—	Tsokur, 1981
<i>suborbitale</i>	P-O, 1964; M + A, 1974	P-O, 1974; Badcock and Merrett, 1976; S, 1977	P-O, 1974; S, 1977	S, 1977
<i>Bolinichthys</i>				
<i>distofax</i>	M + A, 1974	—	—	—
<i>pyrsobohus</i>	P-O, 1964	—	—	—
<i>Centrobranchus</i>				
<i>andrae</i>	P-O, 1974	—	P-O, 1974	—
<i>brevirostris</i>	P-O, 1964	P-O, 1974	—	—
<i>choerocephalus</i>	M + A, 1974	M + A, 1970	—	M + A, 1970
<i>ngroocellatus</i>	P-O, 1974	—	—	—
<i>Ceratoscopelus</i>				
<i>maderensis</i>	M + A, 1972; S, 1977	T, 1918; D + S, 1966	T, 1918	T, 1918; S, 1977
<i>townsendi</i>	M + A, 1974	—	—	—
<i>warmungi</i>	Miller et al., 1979; Belyanina, 1982b	S, 1977	S, 1977	—
<i>Diaphus</i>				
<i>agassizii</i>	—	P-O, 1975	P-O, 1975	P-O, 1975
<i>holtii</i>	D + S, 1966	T, 1918	T, 1918	T, 1918
<i>malayamus</i>	—	Tsokur, 1975	Tsokur, 1975	Tsokur, 1975
<i>metapoclampus</i>	—	Sparta, 1952	Sparta, 1952	Sparta, 1952
<i>mollis</i>	—	S, 1977	S, 1977	S, 1977
<i>pacificus</i>	M + A, 1974	—	—	—
<i>rafinesqueti</i>	—	T, 1918	T, 1918	T, 1918
<i>theta</i>	P-O, 1964; M + A, 1974	—	—	—
<i>Diogenichthys</i>				
<i>atlanticus</i>	P-O, 1964	T, 1918; A, 1965; M + A, 1970; P-O, 1974; S, 1977	T, 1918; M + A, 1970; S, 1977	T, 1918; M + A, 1970; S, 1977
<i>laternatus</i>	—	A, 1965; M + A, 1970	M + A, 1970	M + A, 1970
<i>panurgus</i>	—	P-O, 1974	P-O, 1974	—
<i>Electrona</i>				
<i>antarctica</i>	M + A, 1974	P-O, 1967; B + K, 1979	—	—
<i>carlsbergi</i>	M + A, 1974	B + K, 1979	—	—
<i>rissoi</i>	—	T, 1918; Sanzo, 1939a; D + S, 1966; M + A, 1970	Sanzo, 1939a	T, 1918; Sanzo, 1939a; M + A, 1970
<i>subaspera</i>	M + A, 1974	—	—	—
<i>Gonichthys</i>				
<i>coccoi</i>	—	T, 1918; S, 1977; D + S, 1966	—	T, 1918; S, 1977
<i>tenuculus</i>	M + A, 1974	M + A, 1970	M + A, 1970	—
<i>Gymnoscopelus</i>				
<i>bolini</i>	—	S, 1977	S, 1977	S, 1977
<i>braueri</i>	P-O, 1964	P-O, 1977; B + K, 1979	—	—
<i>fraseri</i>	—	P-O, 1977	—	—
<i>nicholsti</i>	P-O, 1964	M + A, 1972; P-O, 1977; B + K, 1979	M + A, 1972	—
<i>opisthopterus</i>	—	Yefremenko, 1977	—	—
<i>Hygophum</i>				
<i>atratum</i>	—	M + A, 1970	M + A, 1970	M + A, 1970
<i>benotti</i>	—	T, 1918; S, 1974	T, 1918; S, 1974	T, 1918; S, 1974
<i>brunni</i>	M + A, 1974	—	—	—
<i>hansem</i>	—	S, 1977	S, 1977	S, 1977
<i>hygomi</i>	M + A, 1974	T, 1918; P-O, 1974; S, 1977	T, 1918; P-O, 1974; S, 1977	T, 1918; S, 1977

TABLE 61. CONTINUED.

Species	Single larval stage	Multiple larval stages	Transforming stage	Juvenile stage
<i>macrochir</i>	M + A, 1974	S, 1975	S, 1975	S, 1975
<i>proximum</i>	M + A, 1974; Miller et al., 1979	P-O, 1974	P-O, 1974	—
<i>reinhardtii</i>	M + A, 1974	M + A, 1970; S, 1977	M + A, 1970; S, 1977	M + A, 1970; S, 1977
<i>taanwngi</i>	M + A, 1974	—	—	—
<i>Idolychnus</i>				
<i>urolampus</i>	M + A, 1974	—	—	—
<i>Krefflichthys</i>				
<i>anderssoni</i>	M + A, 1974	Yefremenko, 1976; B + K, 1979	Yefremenko, 1976	Yefremenko, 1976
<i>Lampadena</i>				
<i>luminosa</i>	M + A, 1974; Miller et al., 1979	—	—	—
<i>urophaos</i>	—	M + A, 1972	M + A, 1972	—
<i>Lampanyctodes</i>				
<i>hectoris</i>	—	Ahlstrom et al., 1976	Ahlstrom et al., 1976	Ahlstrom et al., 1976
<i>Lampanyctus</i>				
<i>achurus</i>	M + A, 1974	—	—	—
<i>crocodilus</i>	—	T, 1918; D + S, 1966	T, 1918	T, 1918
<i>jordani</i>	P-O, 1964	—	—	—
<i>nobilis</i>	Miller et al., 1979	—	—	—
<i>pusillus</i>	—	T, 1918; D + S, 1966	T, 1918	T, 1918
<i>regalis</i>	M + A, 1974	—	Bolin, 1939b	—
<i>ritteri</i>	M + A, 1974	A, 1965	—	—
<i>Lampichthys</i>				
<i>procerus</i>	—	M + A, 1972	M + A, 1972	—
<i>Lepidophanes</i>				
<i>gaussi</i>	M + A, 1974	—	—	—
<i>guentheri</i>	M + A, 1972	S, 1977	M + A, 1972; S, 1977	—
<i>Lobianchia</i>				
<i>dofleui</i>	M + A, 1974	T, 1918; D + S, 1966; S, 1977	T, 1918; S, 1977	T, 1918; S, 1977
<i>gemellari</i>	Sanzo, 1931c; P-O, 1964; M + A, 1974	T, 1918	T, 1918	T, 1918
<i>Loweina</i>				
<i>rara</i>	M + A, 1974	M + A, 1970; P-O, 1974	M + A, 1970	M + A, 1970
<i>terminata</i>	Belyanina, 1982b	—	—	—
<i>Metelectrona</i>				
<i>ventralis</i>	M + A, 1974	—	—	—
<i>Myctophum</i>				
<i>asperum</i>	P-O, 1964; M + A, 1974	Imai, 1958; P-O, 1974	—	Imai, 1958; P-O, 1974
<i>aurolaternatum</i>	M + A, 1974	—	—	—
<i>brachygnathum</i>	M + A, 1974	—	—	—
<i>lychnobium</i>	M + A, 1974; P-O, 1974	—	P-O, 1974	—
<i>nutidulum</i>	M + A, 1974	M + A, 1970; P-O, 1974	—	M + A, 1970
<i>obtusirostre</i>	M + A, 1974	—	—	—
<i>punctatum</i>	M + A, 1974	Sanzo, 1915b; T, 1918; S, 1977	Sanzo, 1915b; T, 1918; S, 1977	T, 1918; S, 1977
<i>selenops</i>	M + A, 1974	—	—	—
<i>spinosum</i>	M + A, 1974	P-O, 1974	P-O, 1974	P-O, 1974
<i>Notolychnus</i>				
<i>valdiviae</i>	P-O, 1964; M + A, 1974	T, 1918	T, 1918	T, 1918
<i>Notoscopelus</i>				
<i>caudispinosus</i>	Belyanina, 1982b	—	—	—
<i>elongatus</i>	—	T, 1918	T, 1918	T, 1918
<i>resplendens</i>	M + A, 1974	M + A, 1972; Badcock and Merrett, 1976; S, 1977	M + A, 1972; S, 1977	—

TABLE 61. CONTINUED.

Species	Single larval stage	Multiple larval stages	Transforming stage	Juvenile stage
<i>Parvilux</i> <i>ingens</i>	M + A, 1974	—	—	—
<i>Protomyctophum</i> <i>arcticum</i>	—	T, 1918	T, 1918	T, 1918
<i>bolini</i>	—	P-O, 1967; B + K, 1979	—	—
<i>chilensis</i>	M + A, 1974	—	—	—
<i>crockeri</i>	—	M + A, 1970	—	M + A, 1970
<i>normani</i>	P-O, 1967; M + A, 1974	—	—	P-O, 1967
<i>parallellum</i>	—	P-O, 1967; B + K, 1979	—	—
<i>subparallellum</i>	M + A, 1974	—	—	—
<i>tenisoni</i>	M + A, 1974	—	—	—
<i>thompsoni</i>	P-O, 1964	P-O, 1967; M + A, 1970	—	M + A, 1970
<i>Scopelopsis</i> <i>multipunctatus</i>	—	M + A, 1972; P-O, 1972	M + A, 1972; P-O, 1972; M + A, 1974	M + A, 1972
<i>Stenobranchius</i> <i>leucopsarus</i>	P-O, 1964; M + A, 1974	Fast, 1960; A, 1965; A, 1972b	Fast, 1960	Fast, 1960
<i>Symbolophours</i> <i>boops</i>	—	P-O, 1974	—	—
<i>californense</i>	P-O, 1964; M + A, 1974	A, 1965; M + A, 1970; P-O, 1974	M + A, 1970; P-O, 1974	—
<i>evermanni</i>	P-O, 1964	P-O, 1974	P-O, 1974	P-O, 1974
<i>veranyi</i>	—	Sanzo, 1915b; T, 1918; D + S, 1966	Sanzo, 1915b; T, 1918	Sanzo, 1915b, T, 1918
<i>Taaningichthys</i> <i>minimus</i>	—	M + A, 1972	—	—
<i>Tarletonbeania</i> <i>crenularis</i>	P-O, 1964; M + A, 1974; P-O, 1974	A, 1965; M + A, 1970	Bolin, 1939b; M + A, 1970	M + A, 1970
<i>Triphoturus</i> <i>mexicanus</i>	M + A, 1974	A, 1965; A, 1972b	—	—
<i>nigrescens</i>	Moser, 1981	—	—	—

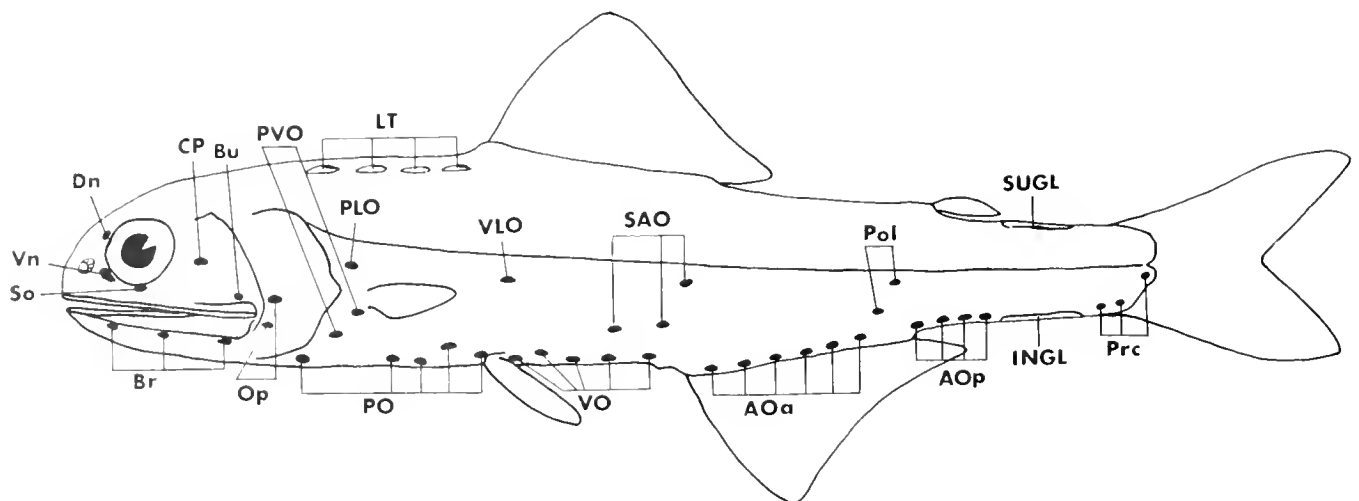

Fig. 114. Hypothetical myctophid showing photophore terminology, from Paxton (1972).

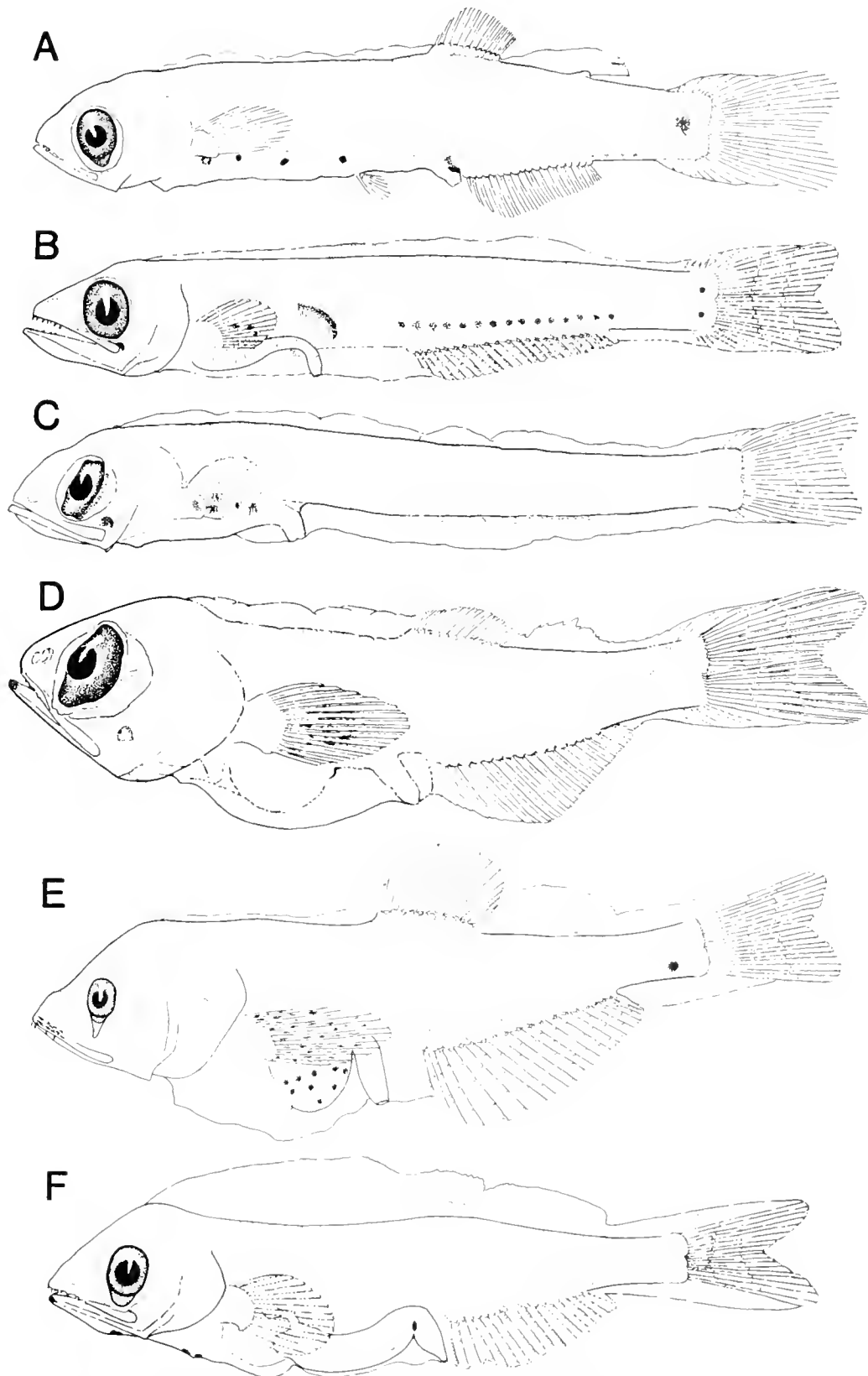

Fig. 115. Larvae of Electronini. (A) *Krefftichthys anderssoni*, 15.7 mm; (B) *Protomyctophum norman*, 15.2 mm; (C) *P. Heurops thompsoni*, 13.8 mm; (D) *Electrona rissoi*, 7.9 mm; (E) *E. antarctica*, 12.7 mm; (F) *Metelectrona ventralis*, 10.3 mm. A, B, E, F from Moser and Ahlstrom (1974); C and D from Moser and Ahlstrom (1970).

TABLE 62. SEQUENCE OF FORMATION OF PHOTOPHORES WHICH APPEAR IN FOURTEEN GENERA OF MYCTOPHIDAE. The Br₂ appear first in all genera listed. Parentheses indicate photophores appear late in larval period.

	Br ₁	Br ₂	Dn	Vn	OP ₂	PO ₁	PO ₂	PO ₃	PO ₄	PO ₅	PVO ₁	PVO ₂	PLO	VLO	VO ₁	VO ₂	AOa ₁	AOa ₂
<i>Benthoosema</i>																		
<i>suborbitale</i>	2	2	—	—	2	1	1	3	3	3	—	—	—	—	—	—	3	3
<i>glaciale</i>	—	—	—	—	(1)	(1)	(1)	(1)	(1)	(1)	—	—	—	—	—	—	—	—
<i>pteroia</i>	—	—	1	—	4	6	—	—	—	2	3	5	—	—	5	—	6	—
<i>fibulatum</i>	—	—	1	—	—	3	5	—	—	2	—	—	—	6	—	—	4	6
<i>Diogenichthys</i>																		
<i>laternatus</i>	—	—	—	—	—	—	—	—	—	1	—	—	—	—	—	—	—	—
<i>atlanticus</i>	—	—	—	—	—	—	1	—	—	2	—	—	—	—	—	—	3	—
<i>Myctophum</i>																		
<i>spinosum</i>	—	—	1	—	—	—	—	—	—	—	—	—	2	—	—	—	—	—
<i>lychnobium</i>	—	—	1	—	—	—	—	—	—	—	—	—	2	—	—	—	—	—
<i>asperum</i>	—	—	1	—	—	—	—	—	—	—	—	—	2	—	—	—	—	—
<i>brachygnathum</i>	—	—	1	—	—	2	—	—	—	—	—	—	2	—	—	—	—	—
<i>obtusirostre</i>	—	—	1	—	—	3	—	—	—	—	—	—	2	—	—	—	—	—
<i>selenops</i>	—	—	1	—	—	3	—	—	—	—	—	—	2	—	—	—	—	—
<i>Lobianchia</i>																		
<i>theta</i>	—	—	—	—	(5)	2	(4)	(7)	(8)	1	—	—	—	(9)	(3)	(6)	—	—
<i>pacificus</i>	—	—	—	—	—	2	(3)	(5)	—	1	(4)	—	—	—	(6)	—	—	—
<i>Gymnoscopelus</i>																		
<i>Lampanyctodes</i>	—	—	—	1	—	4	—	—	—	2	—	—	3	—	—	—	—	—
<i>Scopelopsis</i>	—	—	—	2	—	—	—	—	—	1	—	—	—	3	—	—	—	—
<i>Lampichthys</i>	—	—	—	2	—	4	—	—	—	1	—	—	3	—	—	—	—	—
<i>Notoscopelus</i>	—	—	—	2	—	—	—	—	—	1	—	—	3	—	—	—	—	—
<i>Lampadena</i>	—	—	—	3	—	3	—	—	—	2	—	—	1	—	—	—	—	—
<i>Ceratoscopelus</i>	—	—	—	1	—	—	—	—	—	3	—	—	2	—	—	—	—	—
<i>Lepidophanes</i>	—	—	—	1	—	—	—	—	—	1	—	—	1	—	—	—	—	—
<i>Bolinichthys</i>	—	—	—	(1)	—	—	—	—	—	(1)	—	—	(1)	—	—	—	—	—

ordinal relationships. One set is the size at various developmental milestones. Myctophid larvae hatch at about 2 mm length with a yolk-sac remnant. Notochord flexion occurs in a narrow size interval (0.5–2.0 mm) and the size at mid-flexion is typically about half the maximum larval size. Size at transformation also occurs within a short length interval, usually not exceeding 2 mm. Most myctophid species transform in the length range of 12–19 mm, although some (e.g., *Electrona rissoi*, *Notolychnus valdiviae*) are as small as 9–10 mm at transformation and some species of *Symbolophorus* reach about 23 mm before transformation. *Gymnoscopelus nicholsi* has the largest larvae recorded, up to 28 mm.

Head, body, and gut shape are distinctive for most species and within most genera there is a similarity of shape (Figs. 115–124). While most myctophid larvae are moderately slender, body shape can range from highly attenuate (e.g., *Hygophum reinhardtii*) to markedly robust (e.g., some *Myctophum* and *Lampanyctus* species). Some are deep-bodied but laterally compressed (e.g., Gonichthyini). Robust larvae and deep-bodied, laterally compressed forms tend to have large heads and jaws, while attenuate forms have flat heads.

The eye is varied in size and shape and provides numerous

characters. In the Myctophinae the eyes are elliptical in outline in contrast to most Lampanyctinae which have rounded eyes. Further specializations in Myctophinae are the presence of variously shaped choroid tissue on the ventral surface of the eye in most genera and eye stalks in several genera. Among lampanyctine genera eyes are sessile and only *Lobianchia dofleini* and species of *Triphoturus* have markedly narrowed eyes with choroid tissue.

The gut has distinctive transverse rugae and ranges from short, to elongate, to trailing free from the body. In most myctophids it extends to about the midpoint of the body and is slightly S-shaped. The curvature tends to be more pronounced in taxa with short guts. In two myctophine genera (*Metelectrona* and some *Hygophum* species) the anterior section of the gut is small in diameter and opens dorsally into the relatively larger posterior section.

In most myctophids, ray formation and ossification of fins proceeds in the following sequence: caudal, pectoral, anal, dorsal, and pelvic. However, in some *Symbolophorus* species the pelvic fin forms early and ossification of rays precedes that of the anal and dorsal fins. In most species the pectoral fin is relatively small, but deep-bodied and robust forms in both

A

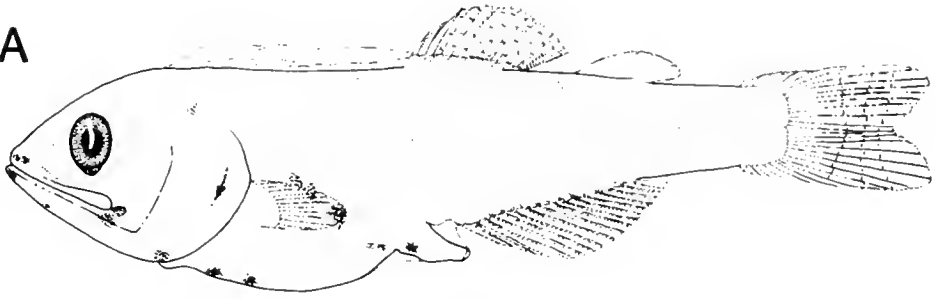

B



C

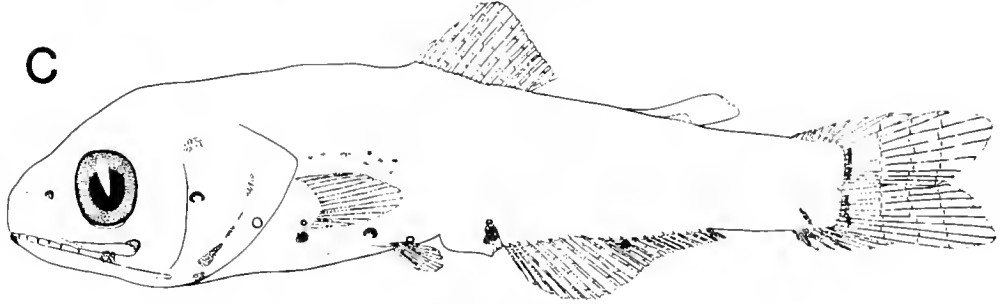

D

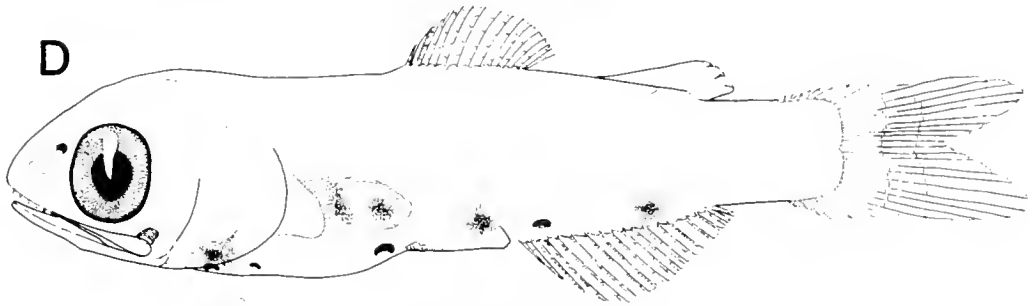

E



F

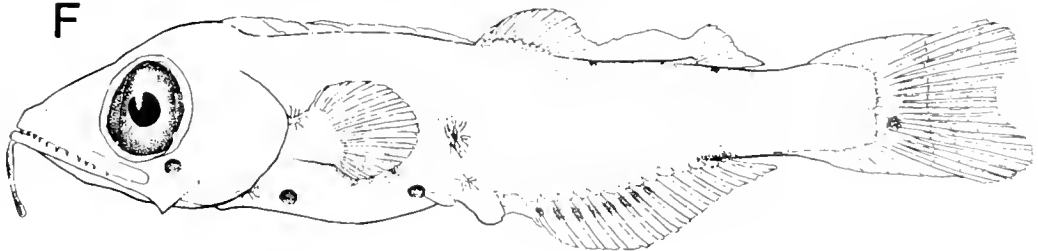

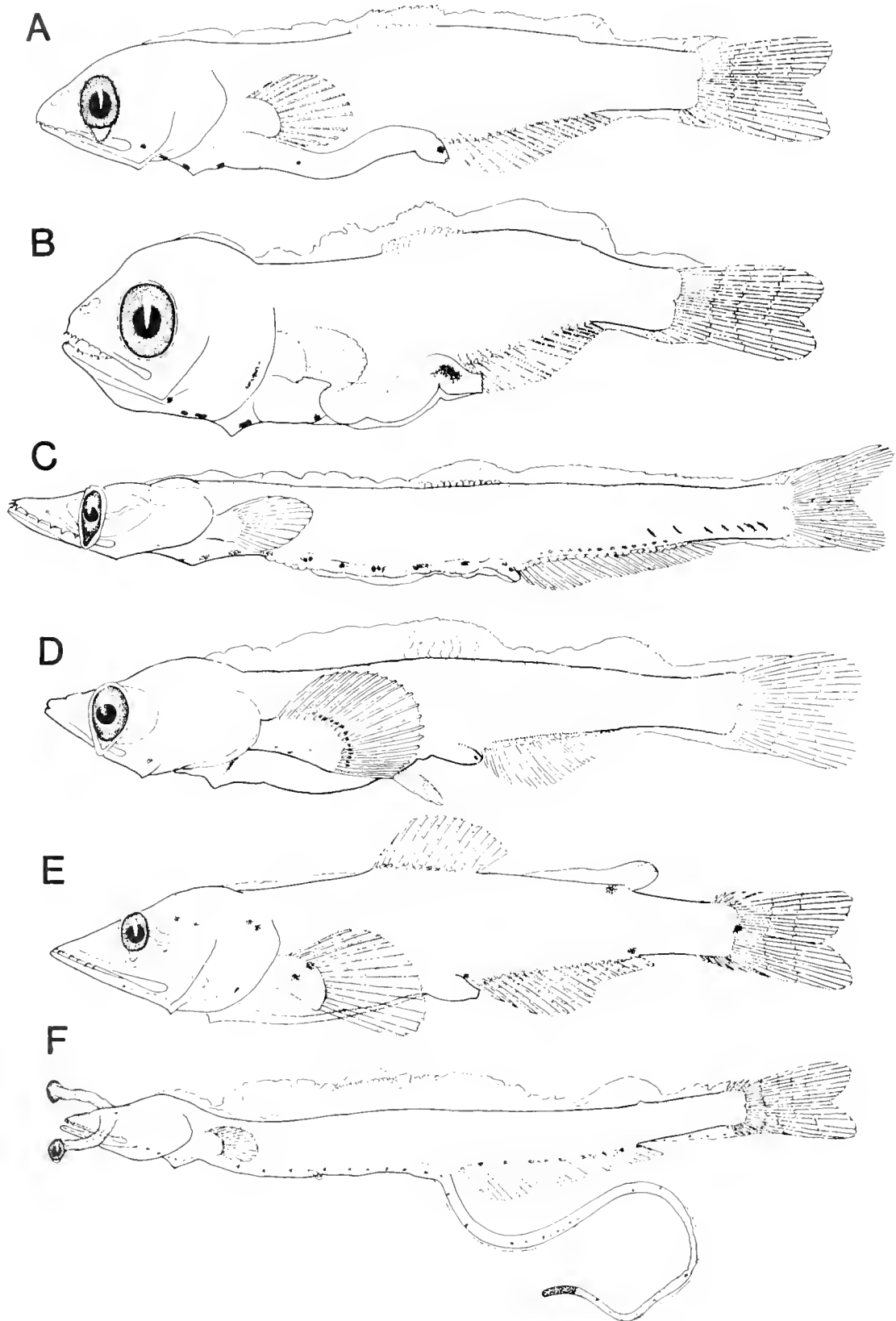

Fig. 117. Larvae of Myctophini. (A) *Hygophum proximum*, 8.9 mm; (B) *H. taanungi*, 6.8 mm; (C) *H. reinhardti*, 12.8 mm; (D) *Symbolophorus californense*, 11.5 mm; (E) *Myctophum punctatum*, 13.6 mm; (F) *M. aivolaternatum*, 26.0 mm. A, B, E, F from Moser and Ahlstrom (1974); C and D from Moser and Ahlstrom (1970).

subfamilies have large fins and fin bases. In *Symbolophorus* the fin base is uniquely shaped and in *Lobianchia* the fin blade has a unique shape. In two genera (*Loweina*, *Tarletonbeania*) the lowermost pectoral ray is elongate and ornamented. The finfold is enlarged in many myctophine genera and greatly enlarged in one myctophine tribe, the Gonichthyini.

Myctophids, with the exception of *Notolychnus* and *Taaningichthys*, develop the middle branchiostegal photophore (Br_2) during the larval period. It is located posteroventral to the orbit but during transformation assumes a position beneath the orbit on the branchiostegal membrane. Three myctophine genera and 11 lampanyctine genera develop additional photophores during the larval period; however, the Br_2 is always the first to develop. The larval photophore complements and the sequence of appearance of constituent photophores are useful characters.

Myctophid species have distinct melanophore patterns, with the exception of the large genus *Diaphus*, for which only a few specific patterns have been identified. Most genera may be separated by overall similarity of pattern among their species and some have unique melanophore loci. There are no clear patterns for tribes or subfamilies although certain pigment loci are persistent in some tribes (e.g., caudal fin base spots in diaphines; dorsal midline series in gymnoscopelines).

In the following summary of key larval characters, the genera are listed for convenience as in Moser and Ahlstrom (1970, 1972, 1974) and the sequence does not necessarily imply relationship. Likewise, the species groups serve only to identify phenotypically similar larval types. Larvae of a majority of myctophid genera have a moderately slender body, a head of moderate size, with a slightly convex dorsal profile and a pointed snout of moderate length. Body and head shape are noted only when they depart from this morph. In Myctophinae eye shape is noted when it is markedly elliptical and size is noted only when larger or smaller than typical. In Lampanyctinae eye shape is noted only when it departs from the round condition and eye size only when larger or smaller than typical. Choroid tissue is described only when it is present. Gut length and shape are described only if there is a departure from the typical morph—a slightly S-shaped gut that extends to about midbody. The most persistent pigment locus in myctophid larvae is above or to the side of the free terminal section of the gut, thus only the lack of this pigment is noted. Larval photophores, in addition to the Br_2 , and their sequence of appearance are shown in Table 62.

MYCTOPHINAE

Krefflichthys.—Fig. 115A; head small with short snout; conical choroid tissue; gut straight, extending beyond midbody; dorsal fin displaced posteriorly; lateral gut and postanal median ventral melanophore series; large lateral hypural pigment patch.

Protomyctophum.—Fig. 115B, C; two subgenera; head small to moderate in size; gut short, wide space between anus and anal fin; head pigment lacking except in otic region of *P. Heirops chilensis*; some species may have melanophores on lateral gut, above gut on trunk, above gas bladder, in postanal ventral midline series, prominent pigment on lateral hypural region. *P. Heirops*: Fig. 115C; characters similar to *P. Protomyctophum* except eye narrower.

Electrona.—Fig. 115D, E; body moderately slender to moderately deep; head moderately large; snout blunt or pointed; gut short, somewhat saccular, strongly S-shaped; space between anus and anal fin not as large as in *Protomyctophum*; three morphs. *E. subaspera-E. carlsbergi*: eye slightly elliptical, small lunate choroid mass in *E. carlsbergi*; pigment above gut; *E. subaspera* has pigment lateral to cleithrum. *E. rissoi*: Fig. 115D; head large, broad; eye very narrow; pigment at lower jaw symphysis, on pectoral fin blade. *E. antarctica*: Fig. 115E; body and head laterally compressed; gut mass protrudes ventrally from body profile; eye small, narrow, with bicolored elongate conical choroid mass; pigment on upper jaw, pectoral fin blade, lateral gut, lateral hypural region.

Metelectrona.—Fig. 115F; body and head laterally compressed; dorsal finfold enlarged with fin base initially separated from body; lunate choroid mass; anterior gut section with small diameter, opening dorsally into somewhat saccular posterior section; pigment below lower jaw and on isthmus.

Benthoosema.—Fig. 116A–D; two morphs; photophores (Table 62). *B. glaciale-B. suborbitale*: Fig. 116A, B; eyes narrow, with small lunate choroid mass; gut moderately short in preflexion larvae with space between anus and anal fin; pigment on snout, lower jaw, hindbrain, lateral and ventral cleithral region; pigment above gut in *B. glaciale*. *B. pterota-B. fibulatum*: Fig. 116C, D; eyes less narrow than in above morph, with sliver of choroid tissue or none; gut extends to about midbody with no space between anus and anal fin; preflexion larvae with melanophore series on lateral gut and on postanal ventral midline, coalescing to a single melanophore; lateral cleithral pigment; lower jaw pigment in *B. pterota*.

Diogenichthys.—Fig. 116E, F; eyes very narrow in preflexion stage, less so in postflexion; photophores (Table 62); pigment series on lateral gut and on postanal ventral midline, increasing with development; spot at caudal fin base; pigment on tip of lower jaw in *D. laternatus*; *D. atlanticus* has spot on trunk above terminal gut flexure and pigment on symphyseal barbel.

Fig. 118. Larvae of *Myctophum*. (A) *M. phengodes*, 9.8 mm; (B) *M. asperum*, 6.8 mm; (C) *M. brachygnathum*, 7.5 mm; (D) *M. selenops*, 7.8 mm; (E) *M. spinosum*, 9.0 mm. From Moser and Ahlstrom (1974).

Fig. 119. Larvae of Gonichthyini. (A) *Loweina rara*, 17.6 mm; (B) *Tarletonbeania crenularis*, 18.9 mm; (C) *Gomchthys tenuiculus*, 7.7 mm; (D) *Centrobranchus choerocephalus*, 7.3 mm. From Moser and Ahlstrom (1970).

Fig. 120. Larvae of Lampanyctinae. (A) *Notolychnus valdiviae*, 8.7 mm; (B) *Lobianchia dofleini*, 8.2 mm; (C) *L. gemellari*, 6.7 mm; (D) *Diaphus theta*, 6.9 mm; (E) *D. pacificus*, 5.2 mm; (F) *Gymnoscopelus nicholsi*, 23.5 mm. A–E from Moser and Ahlstrom (1974); F from Moser and Ahlstrom (1972).

Fig. 121. Larvae of Lampanyctinae. (A) *Lampanyctodes hectoris*, 13.0 mm; (B) *Scopelopsis multipunctatus*, 13.4 mm; (C) *Lampichthys procerus*, 14.5 mm; (D) *Notoscopelus resplendens*, 11.2 mm; (E) *Lampadena luminosa*, 12.8 mm; (F) *Taaningichthys minimus*, 14.4 mm. A from Ahlstrom et al. (1976); B, C, F from Moser and Ahlstrom (1972); D and E from Moser and Ahlstrom (1974).

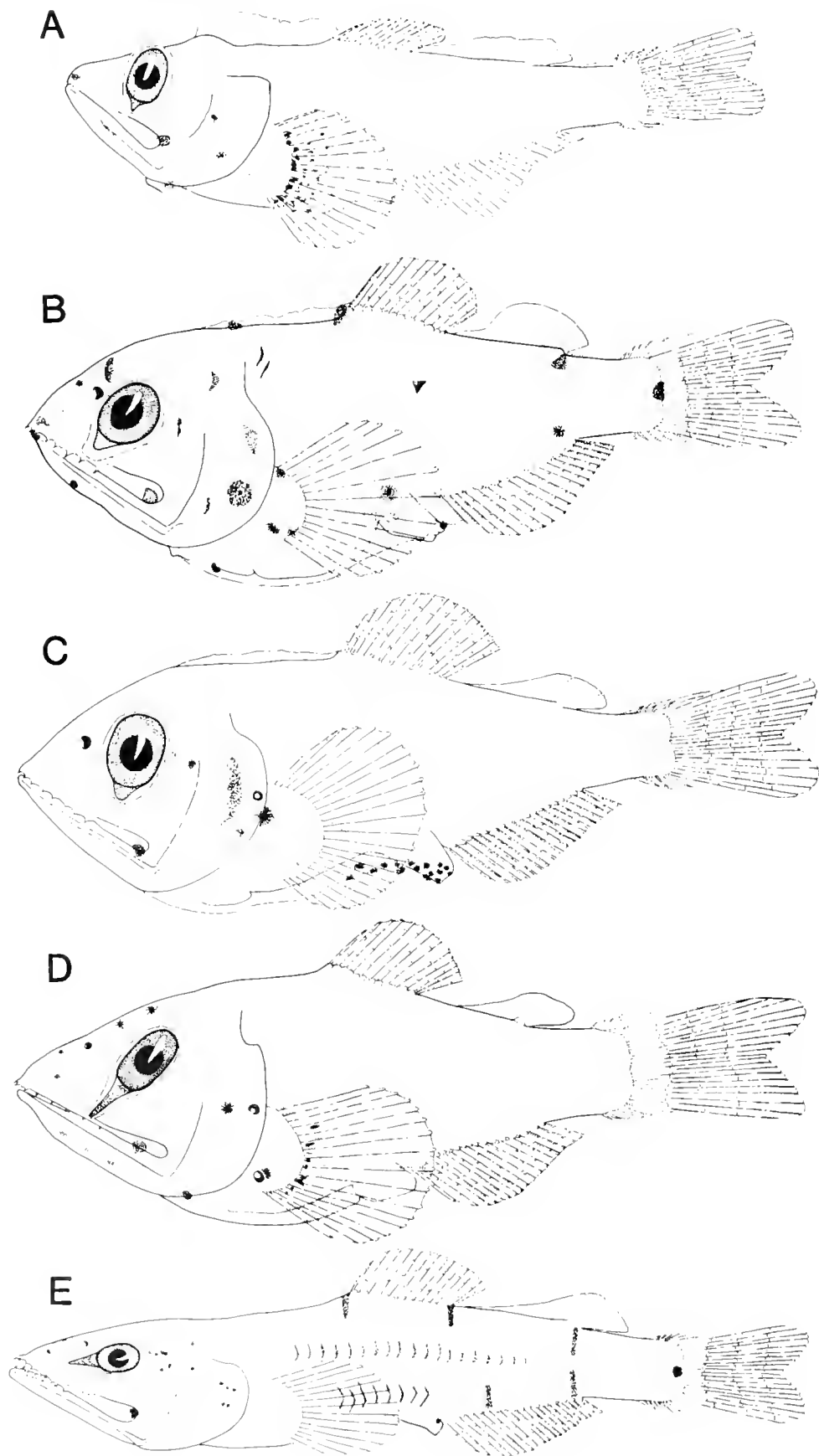

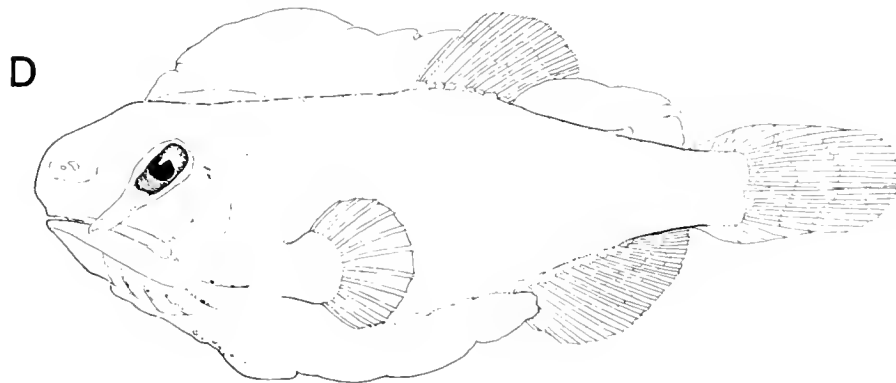
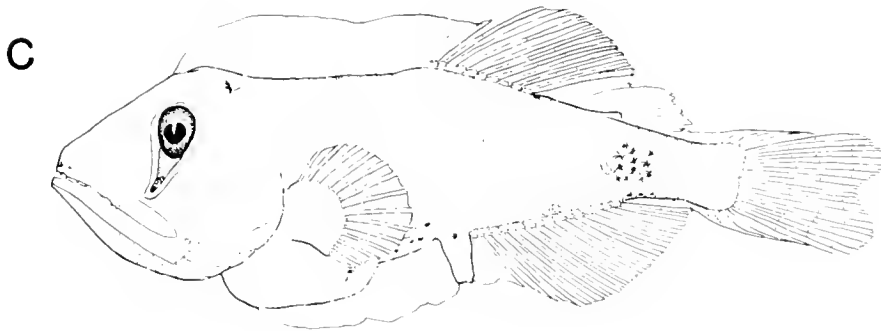
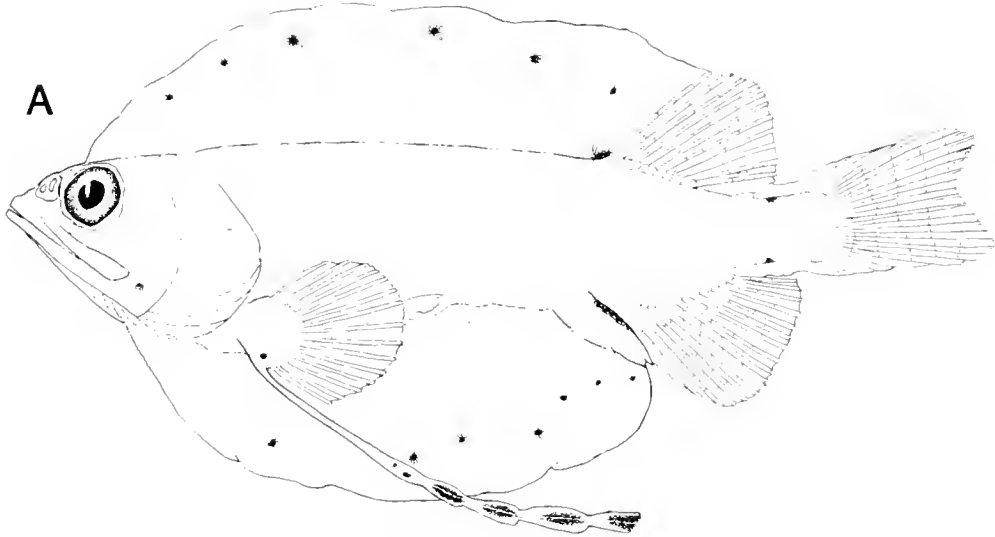

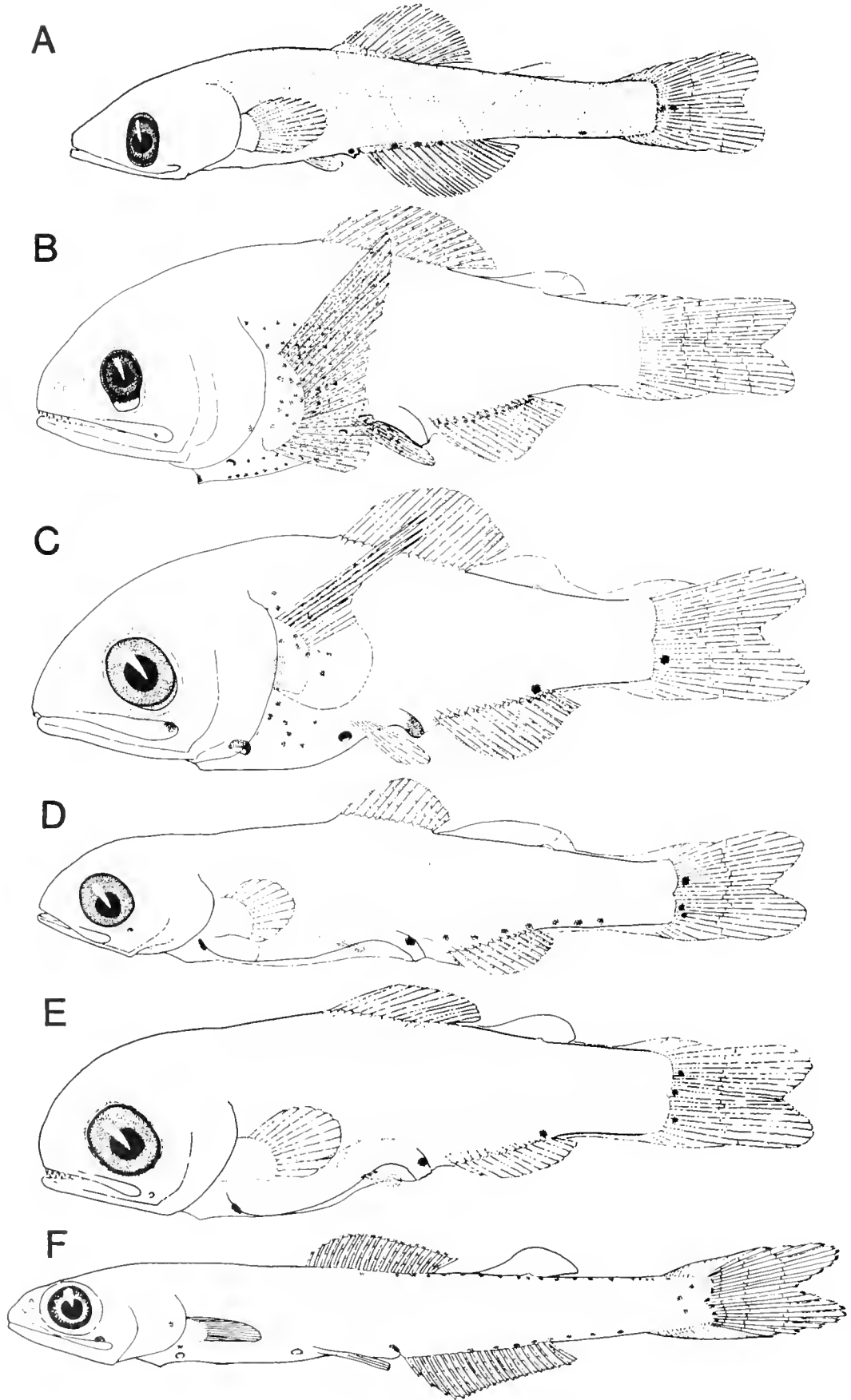

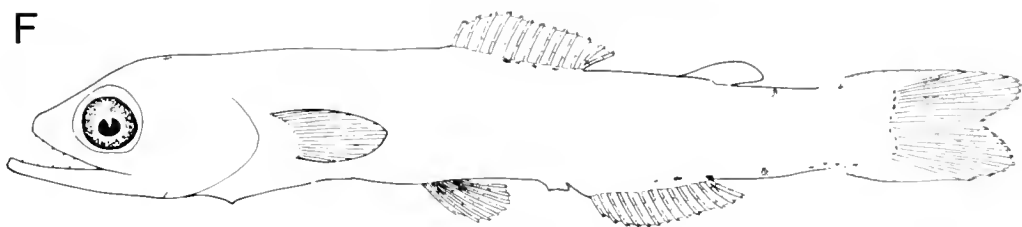
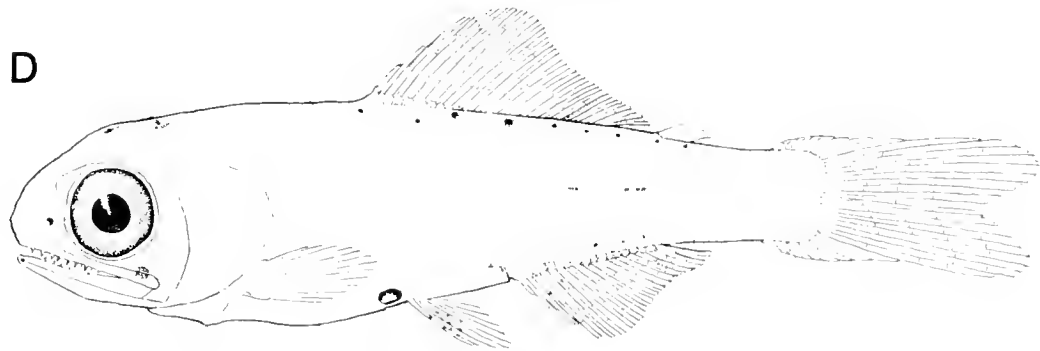
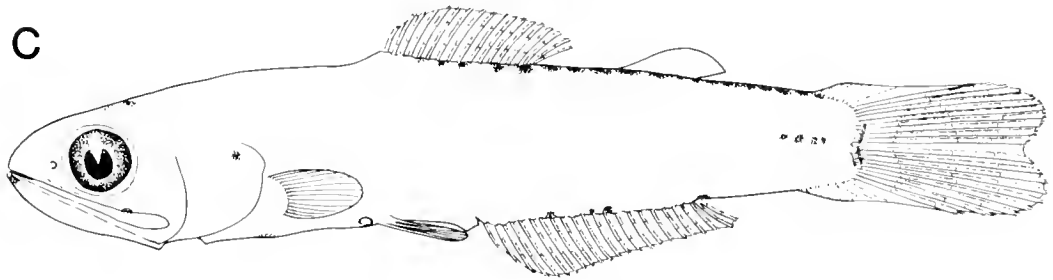
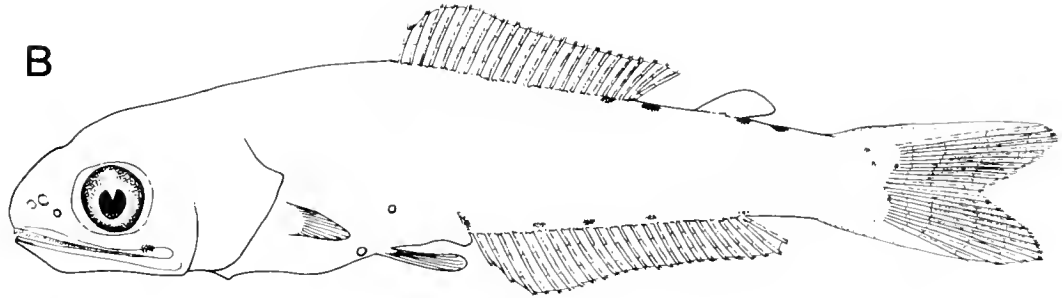
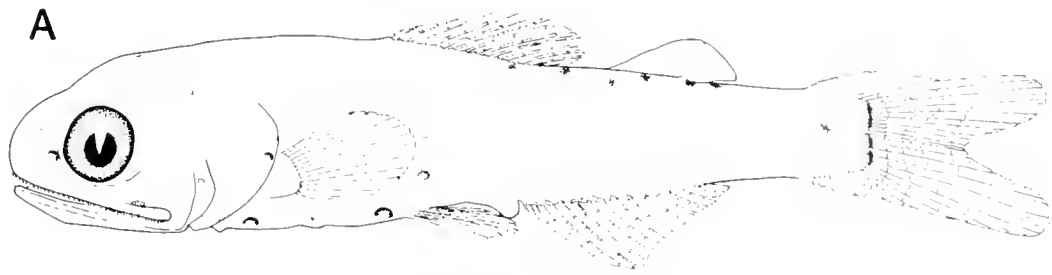

Hygophum.—Fig. 117A–C; diagnostic pattern of melanophores at the cleithral symphysis and isthmus region consisting of paired pigment dashes that form a median line as the series extends forward on the isthmus; Br₂ photophore forms late in larval period; three morphs. *H. proximum*–*H. hygomi*–*H. benoiti*–*H. hanseni*–*H. brunni*: Fig. 117A; eye moderately narrow with conical choroid tissue; pigment sparse in most species with some lateral gut spots in all species; some species may have pigment on hypaxial myosepta, jaws, lateral cleithral region, base of caudal rays. *H. atratum*–*H. reinhardtii*: Fig. 117C; body very slender; head flat; eyes very narrow, on short stalks; elongate conical choroid mass; gut almost straight, small diameter; pigment series along lateral gut and hypaxial myosepta; pigment at caudal fin base; pigment on lower jaw symphysis in *H. atratum*. *H. macrochir*–*H. taaningi*: Fig. 117B; body and head deep and laterally compressed; eyes large, relatively wide; no choroid tissue; anterior gut section narrow in diameter, opening dorsally into somewhat saccular posterior section; *H. macrochir* has pigment on upper and lower jaw and a patch of melanophores on posterior gut section; *H. taaningi* has pigment on gular region and lateral surface of cleithrum.

Symbolophorus.—Fig. 117D; head broad, somewhat flat; eyes slightly stalked, conical choroid mass; pectoral fin large with supernumerary rays, base wing-shaped, rays ossify early; pelvic fin large, early-forming in some species; dorsal finfold well developed with fin base forming in it; pigment series on lateral gut and postanal ventral midline in preflexion larvae; pigment on snout, hindbrain, lateral cleithral region, isthmus, paired fins.

Myctophum.—Figs. 117E, F and 118A–E; at least five distinct morphs, all but *M. aurolaternatum* with enlarged fan-shaped pectoral fins, some with supernumerary rays and early ossification; conical choroid mass. *M. aurolaternatum*: Fig. 117F; body very slender; head somewhat flat; eyes small, on elongate stalks; gut straight, at midbody becomes trailing, extending to well beyond caudal fin; dorsal finfold well developed, fin base forms at its margin; pigment series on lateral gut, evenly distributed on trailing section, except heavier near terminus; pigment on jaws, isthmus, opercle, branchiostegal membrane, pectoral fin, anal fin base, caudal fin. *M. nitidulum*–*M. punctatum*: Fig. 117E; body moderately slender to slightly deep; head broad, somewhat flat in preflexion stage; eyes on short stalks; numerous small melanophores on snout, jaws, brain, isthmus, branchiostegal membrane; two rows of melanophores on ventral surface of gut; opposing melanophores on postanal dorsal and ventral midline; pigment on pectoral fin base and blade and at base of caudal rays. *M. phengodes*: Fig. 118A; body and head moderately deep; similar to *M. nitidulum*, except pigment sparse and eyes not stalked; pigment at base of pectoral fin rays. *M. spinosum*–*M. lychnobium*: Fig. 118E; head with convex dorsal profile and long snout giving the larva a fusiform appearance; long axis of eye rotated towards horizontal; photophores (Table 62); head heavily pigmented on jaws, brain, postorbital and opercular regions; pigment above gut on trunk, embedded in myosepta in *M. spinosum*; opposing dorsal and ventral midline blotches, larger and more deeply embedded in *M. spinosum* with embedded myoseptal pigment along horizontal septum; blotch at base of caudal rays. *M. asperum*–*M. brachygnathum*–*M. obtusirostre*–*M. selenops*: Fig. 118B–D; body deep, robust; head broad, deep with convex dorsal profile and large snout; eye relatively larger than in other morphs; choroid tissue broadly

conical, except in *M. selenops* where it is elongate and pigmented at tip; photophores (Table 62); head pigment similar to *M. spinosum*; most species have heavy pigment lateral to cleithra and on pectoral fin bases; all species lack trunk and tail pigment, except *M. asperum* which has extensive embedded myoseptal and dorsal/ventral midline blotches.

Loweina.—Fig. 119A; body and head moderately deep, laterally compressed; dorsal and anal fins displaced far posteriad; dorsal and ventral finfolds greatly enlarged and conspicuously pigmented to produce a disc-shaped profile; eyes large; gut with expanded anterior section and enlarged terminal section; pectoral fin large with lower-most ray elongate, ornamented with pigmented spatulations; interorbital pigment band; pigment at lateral cleithral surface, dorsal fin origin, and opposing midline blotches at caudal peduncle region.

Tarletonbeania.—Fig. 119B; similar to *Loweina*, except median fins displaced less posteriad; eye narrower and with lunate choroid mass; four melanophores on periphery of brain, two melanophore series on ventrum of gut.

Gonichthys.—Fig. 119C; body and head deep and laterally compressed, leaf-like; snout large, angulate in profile; eye small with elongate conical choroid mass, pigmented at tip; enlarged dorsal and ventral finfolds; pectoral fins moderately large; pigment on snout, jaws, midline of brain, postorbital and opercular regions; pigment on lateral hindgut and on trunk above gut; series of embedded blotches on dorsal midline of body, opposing blotches on postanal ventral midline; large pigment patch on lateral caudal peduncle region in *G. tenuiculus*; heavy embedded pigment streak along horizontal septum in *G. coccoi*.

Centrobranchus.—Fig. 119D; morphology similar to *Gonichthys* except snout markedly blunt and rounded and terminal gut flexure less acute; two morphs. *C. choerocephalus*–*C. brevirostris*–*C. nigroocellatus*: Fig. 119D; eye very narrow with unpigmented choroid mass that exceeds it in length; pigment sparse; some at postorbital–opercular region, branchiostegal membrane, ventral surface of liver. *C. andrae*: eye wider than in above morph and with short conical choroid mass; pigment extensive, on snout, upper jaw, dorsal brain, opercle, branchiostegal membrane, lateral hindgut, ventral surface of liver, pectoral fin base; embedded spots along dorsal midline with opposing spots along postanal ventral midline; embedded spots along horizontal septum in caudal peduncle region.

LAMPANYCTINAE

Notolychnus.—Fig. 120A; head relatively large with moderately elongate snout; eyes usually narrow, often irregular in shape; gut short, more so in preflexion stage; no photophores, even Br₂ lacking; pigment on lateral hindgut, gas bladder, base of caudal rays; a persistent but sparse postanal ventral midline series.

Lobianchia.—Fig. 120B, C; body deep, robust; head broad with large snout; pectoral fins large; blade wing-shaped with upper rays longer than others; photophores (Table 62); head unpigmented; pigment on trunk, on gut below pectoral fin base, on pectoral fin base and blade, embedded in gut region anterior to pectoral fin base, along anal fin base, and at base of caudal rays; embedded melanophores in myosepta above pectoral fin becoming extensive in postflexion stage; two morphs. *L. dofleini*: Fig. 120B; eye small, narrow, with lunate to squarish choroid

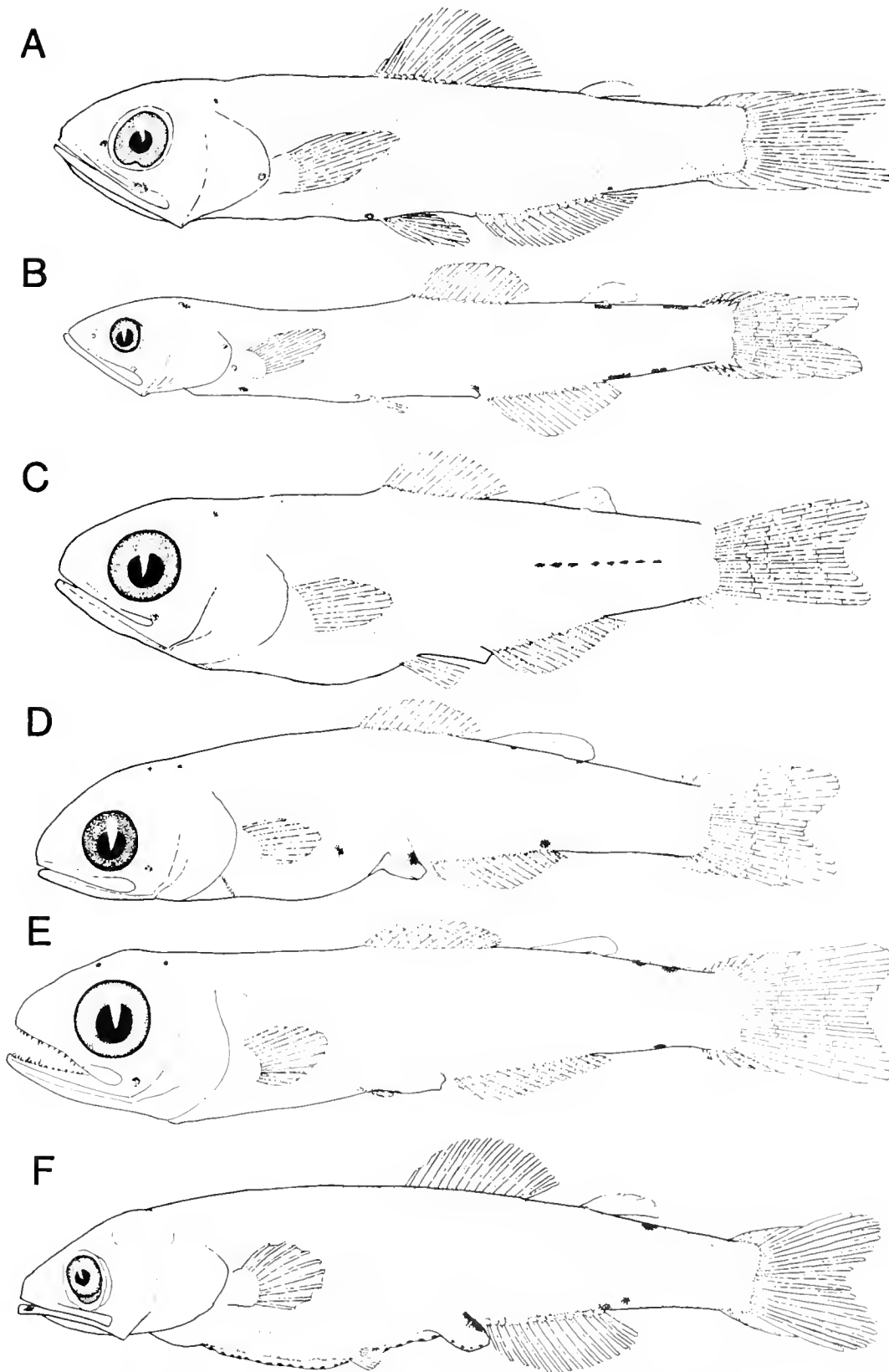

Fig. 122. Larvae of Lampanyctinae. (A) *Ceratoscopelus townsendi*, 16.6 mm; (B) *Lepidophanes gaussi*, 13.5 mm; (C) *Bolinichthys distofax*, 9.4 mm; (D) *Stenobranchius leucopsarus*, 10.4 mm; (E) *Parvilux ingens*, 14.4 mm; (F) *Triphoturus mexicanus*, 10.5 mm. A-E from Moser and Ahlstrom (1974); F from Ahlstrom (1972b).

mass; gradual transition from lower pectoral rays to longer upper rays. *L. gemellari*: Fig. 120C; eye large, almost round, choroid mass a lunate sliver; abrupt transition between lower pectoral rays and long upper rays.

Diaphus.—Fig. 120D, E; pigment lacking on head; melanophore at anteroventral surface of liver, one or more at midgut region, one or more at base of caudal rays; gas bladder pigmented; two morphs. *D. theta*: Fig. 120D; body moderately slender; head moderate in size; photophores (Table 62); numerous melanophores in postanal ventral midline series, persisting into postflexion stage. *D. pacificus*: Fig. 120E; body moderately deep, somewhat robust; head moderately large; photophores (Table 62); a few melanophores in postanal ventral midline series, usually coalescing to one before flexion stage.

Gymnoscopelus.—Fig. 120F; photophores (Table 62); pigment above brain, at lateral cleithral region, above midgut, above gas bladder; postanal ventral midline series present but, in some species, restricted to caudal peduncle region; melanophore series on each side of dorsal midline, in most species extending between caudal and dorsal fins, in others extending forward to dorsal fin origin, and in others restricted to caudal peduncle region; pigment at base of caudal rays; some species have pigment on lateral hypural region; lateral pigment patch at caudal peduncle in *G. opisthopterus*, which also has embedded melanophores above vertebral column.

Lampanyctodes.—Fig. 121A; photophores (Table 62); pigment above brain, at anteroventral surface of liver, above gas bladder; a postanal ventral midline series and a series on each side of dorsal midline between dorsal and caudal fins; pigment at base of caudal rays and at lateral hypural region.

Scopelopsis.—Fig. 121B; photophores (Table 62); pigment similar to *Lampanyctodes* except additional melanophores on hindbrain, nape, lateral cleithral region; pigment rows along dorsum irregular.

Lampichthys.—Fig. 121C; photophores (Table 62); pigment similar to *Scopelopsis* except dorsal rows consist of large closely-spaced melanophores which at maximal development extend from caudal fin to dorsal fin origin; a short melanophore series along horizontal septum on caudal peduncle in late postflexion stage.

Notoscopelus.—Fig. 121D; photophores (Table 62); body moderately deep; head moderately large; eye large; snout becomes somewhat bulbous at flexion stage; gut short in early preflexion stage, elongates to about midbody by late preflexion; pigment at tips of jaws, above brain, above gas bladder and at lateral cleithral region in early postflexion larvae; additional pigment develops below lower jaw, on hindbrain and nape; series of melanophores on each side of dorsal midline, beginning at midbody and gradually developing along entire dorsum; series along horizontal septum and along anal fin base; pigment on base of caudal rays and on pelvic and anal rays in some species at late

postflexion stage; extensive embedded myoseptal pigment on trunk or tail in postflexion stages of some species.

Lampadena.—Fig. 121E; photophores (Table 62); pigment above brain, nape, gut, gas bladder; most species have large melanophores along dorsal midline, with opposing postanal ventral midline melanophores; some species with smaller, more numerous melanophores in dorsal and ventral series; embedded pigment above spinal column in some species.

Taaningichthys.—Fig. 121F; body slender; lower jaw projects beyond upper; no photophores, even Br₂ lacking; pigment above brain, in otic region, one to several opposing melanophores at postanal dorsal and ventral midline; late postflexion larvae may develop minute melanophores along each side of dorsal midline; pigment at base of caudal rays; series of embedded melanophores above spinal column.

Ceratoscopelus.—Fig. 122A; eye elliptical in early larvae; photophores (Table 62); pigment above gut; postanal ventral midline series in early larvae, coalesces to a single spot in postflexion larvae; *C. maderensis* has short series at dorsal and ventral midline in caudal peduncle region; embedded pigment above posterior region of spinal column in some species.

Lepidophanes.—Fig. 122B; eye small; photophores (Table 62); usually two melanophore pairs at dorsal midline in caudal peduncle region and one or two ventral midline melanophores; *L. gausi* has median melanophore above hindbrain and median ventral melanophore below pectoral fin base.

Bolinichthys.—Fig. 122C; moderately deep-bodied; snout blunt; eye large; photophores (Table 62); sparse pigment; midline spot above brain, embedded otic spot, embedded pigment above gut; some species with a sparse postanal median ventral series that coalesces to a single melanophore; *B. distofax* has a short series on horizontal septum; embedded pigment above posterior region of spinal column in some species.

Triphoturus.—Fig. 122F; eye elliptical with choroid mass; pigment at tip of lower jaw, at angular region of jaw, at lateral cleithral region; early preflexion larvae have paired lateral gut spots near pectoral fin base and at midgut; anterior pair coalesces to a median position anteroventral to liver, the posterior pair becomes dorsal to gut; pigment above gas bladder; early preflexion larvae have postanal median ventral series that coalesces to one or two spots; pigment along margin of preanal finfolds; a single dorsal spot at adipose fin in *T. mexicanus*; a series of pigment dashes on horizontal septum in *T. nigrescens*.

Stenobranchius.—Fig. 122D; gut melanophores and postanal median ventral series similar to *Triphoturus*; pigment above brain and nape in postflexion stage; late postflexion larvae have embedded melanophores in trunk myosepta and melanophore series on each side of dorsal midline.

Parvilux.—Fig. 122E; head, eyes large; tapered body; gut short

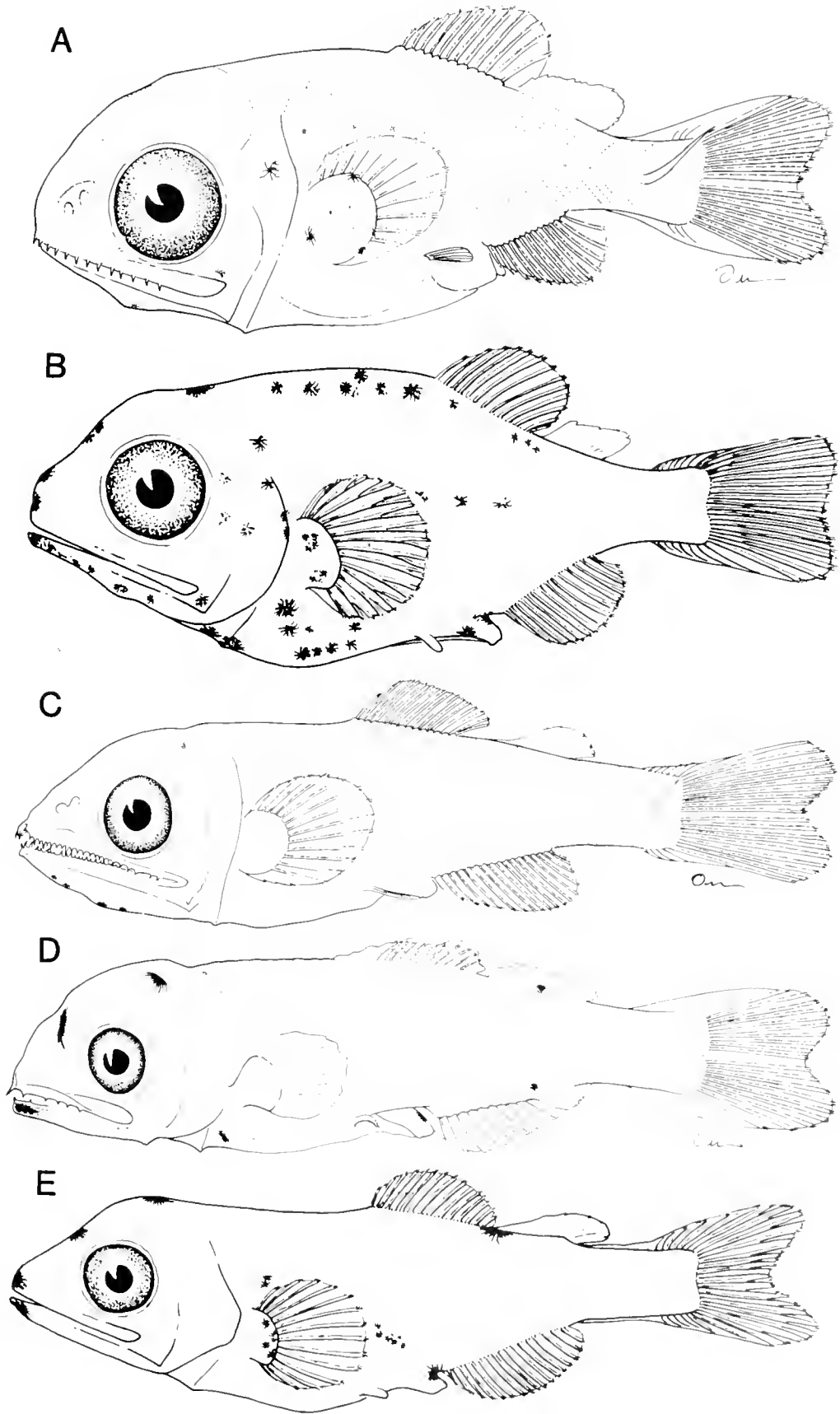

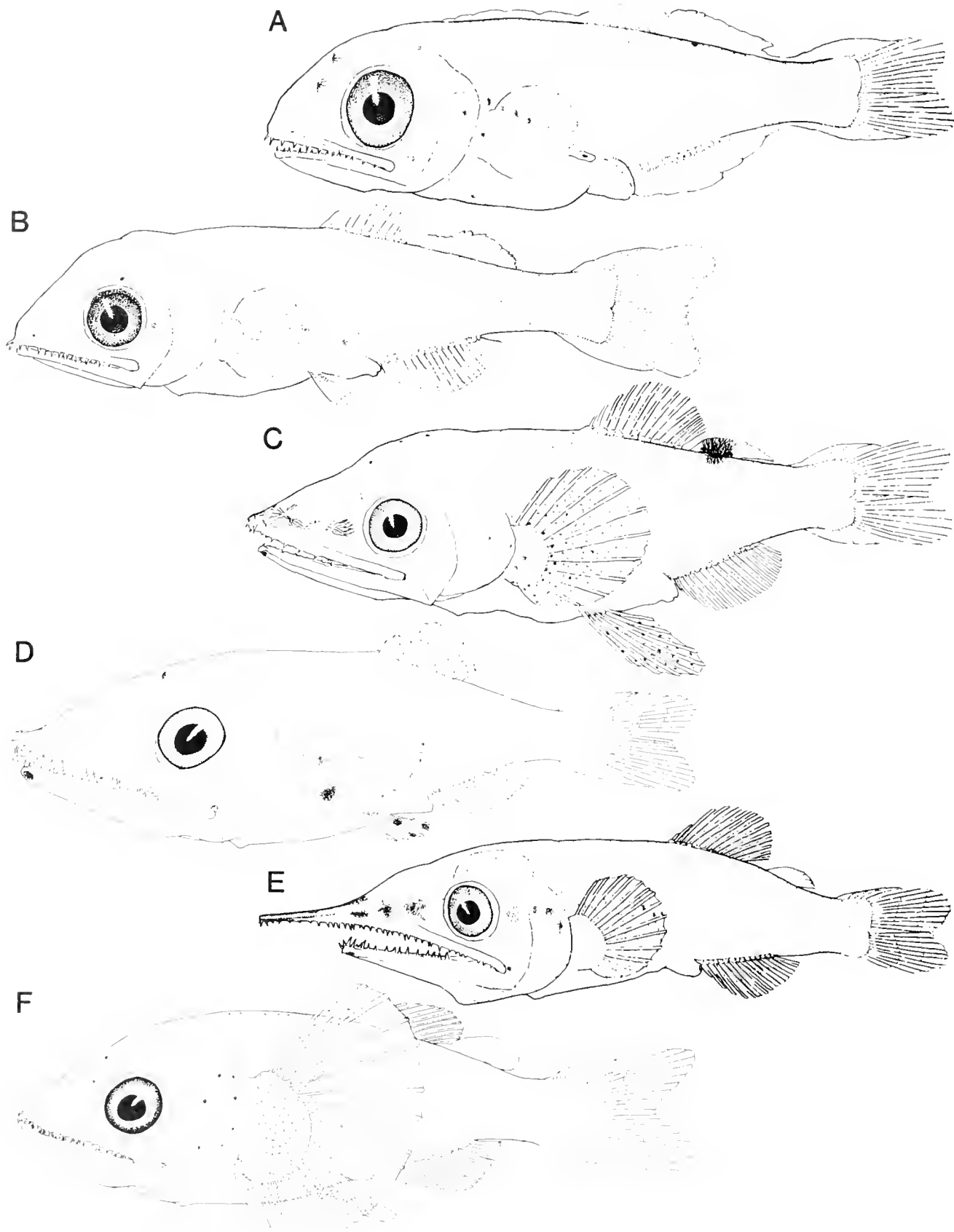

Fig. 124 Larvae of *Lampanyctus*. (A) *L. ruteri*, 10.1 mm; (B) *L. idostigma*, 7.2 mm, CalCOFI 6002 Sta. 133.45; (C) *L. regalis*, 13.0 mm; (D) *Lampanyctus* sp., 8.7 mm; (E) *L. achirus*, 13.4 mm; (F) *Lampanyctus* sp., 9.4 mm. A, C, D, E from Moser and Ahlstrom (1974); F from Moser (1981).

in early preflexion stage, elongates to midbody by flexion stage; in postflexion stage pigment above brain, embedded in otic region, lateral to cleithrum, at anteroventral region of liver; one to several dorsal median melanophores and one ventral median melanophore at caudal peduncle.

Lampanyctus.—Figs. 123, 124; body slender; head deep; gut short in early preflexion stage; during preflexion stage gut lengthens to midbody, body deepens and becomes somewhat robust in most species; pigment above brain in most species; postflexion larvae develop trunk myoseptal pigment that increases to cover most of the anterior trunk at transformation; at least 6 morphs. *L. nobilis*-*L. parvicauda*-*L. omostigma*-*L. crocodilus*-*L. ritteri*-*L. idostigma*: Figs. 123C-E, 124A, B; body and head moderately deep; eyes, jaws, pectoral fins moderate in size; pigment may be present at snout, lower jaw, opercle, above gut, anteroventral surface of liver, at dorsal or ventral midline on tail. *L. pusillus*-*L. steinbecki*: Fig. 123A, B; deep, broad body and head, very robust; snout blunt; eyes large; dorsal and anal fins displaced posteriorly; pectoral fins moderately large; *L. pusillus* heavily pigmented on head, body, pectoral fin base; series along horizontal septum; *L. steinbecki* with pigment below lower jaw, on opercle, pectoral fin base; series along horizontal septum and embedded pigment on tail in postflexion larvae. *L. regalis*-

L. ater: Fig. 124C; deep, large head and body; snout elongate, jaws large, teeth well developed, especially at tip of upper jaw; preopercular spines in some species; dorsal and anal fins displaced posteriorly; pectoral fins moderate to large; pigment may be present at tips of jaws, embedded in snout, at postorbital and opercular regions, pectoral and pelvic fins; spot at adipose fin in *L. regalis*; one or two dorsal spots in *L. ater*. Information on *L. ater* from H. Zadoretzky (Dept. Zoology, Univ. of Rhode Island, pers. comm.). *L. achirus*: Fig. 124E; body moderately deep; head and jaws large with snout produced into toothy rostrum; dorsal and anal fins displaced posteriorly; pectoral fins moderately large; pigment on tips of jaws, embedded in snout, and present at postorbital and opercular regions. *L. lineatus*-*L. cuprarius*: body moderately elongate; snout elongate, jaws large; head pigment as in *L. achirus*; *L. lineatus* pigment consists of numerous melanophores along dorsum and ventrum and at base of caudal rays; *L. cuprarius* has pigment above gut and an irregular bar below dorsal fin. Information from H. Zadoretzky (pers. comm.).

(H.G.M.) NATIONAL MARINE FISHERIES SERVICE, SOUTHWEST FISHERIES CENTER, P.O. BOX 271, LA JOLLA, CALIFORNIA 92038; (J.R.P.) THE AUSTRALIAN MUSEUM, 6-8 COLLEGE STREET, SYDNEY 2000, AUSTRALIA.

Myctophidae: Relationships

J. R. PAXTON, E. H. AHLSTROM AND H. G. MOSER

THE family Myctophidae has usually been placed in the order Myctophiformes (Iniomii, Scopeliformes) since the work of Regan (1911a), who recognized two suborders, the Myctophoidea and Alepisaurioidea (ateleopodids, given a third suborder, are currently placed elsewhere). The families Myctophidae and Neoscopelidae have long been considered close relatives; they were placed in one family until 1949 (Smith). Although Greenwood et al. (1966:371) relegated the order to a subordinal level within the Salmoniformes, they pointed out that myctophids, and neoscopelids in particular, possess advanced characters that indicate they may be ancestral to the paracanthopterygian radiation. Paxton (1972:54-55) considered myctophids and neoscopelids most closely related to the Chlorophthalmidae, with that evolutionary line of the Myctophoidea arising from an aulopid-like ancestor. Moser and Ahlstrom (1970:141-142) described the larval similarities in the families Chlorophthalmidae, Neoscopelidae and Myctophidae.

FAMILY RELATIONSHIPS

Rosen (1973, 1982) split off the Myctophidae and Neoscopelidae as a restricted order Myctophiformes which he considered the primitive sister group of both the Paracanthopterygii and Acanthopterygii; the remaining myctophiform families were placed in a new order Aulopiformes. Matsuoka and Iwai (1983) found cartilage in the adipose fin of only the Myctophidae and

Neoscopelidae in the five 'iniomous' families they studied. Okuyama (1974b) studied the relationships of the suborder Myctophoidea (*sensu* Gosline et al., 1966) and based on larval peritoneal pigment spots and the relationship of abdominal to caudal vertebrae, three familial groups were recognized: Aulopidae-Synodontidae-Bathysauridae, Chlorophthalmidae-Ipnopidae and Neoscopelidae-Myctophidae. Sulak (1977) lumped the Ipnopidae and Bathypteroidae into the Chlorophthalmidae and the Harpadontidae and Bathysauridae into the Synodontidae, considering both groups arose from the Aulopidae; he did not consider the position of the Myctophidae. Schwarzhan (1978) considered myctophids and neoscopelids most closely related and distinct from Aulopiformes on the basis of otolith morphology.

In his excellent study of the Evermannellidae, Johnson (1982) presented a rigorous analysis of 51 characters involving mostly adult but some larval features. He concluded that neoscopelids and myctophids are most closely related to each other, sharing eight derived character states, but that they were the sister group of four families (Notosudidae, Scopelarchidae, Chlorophthalmidae and Ipnopidae) constituting a chlorophthalmoid group within the Myctophiformes. However, he noted only a single shared derived character in those six families, and it is shared with part of another line. Johnson (1982:95) placed the Aulopidae in a second line and all remaining families in the third

TABLE 63. CHARACTERS OF THE MYCTOPHIDAE. (0) = plesiomorphic state, (1) = apomorphic state, (2) = different or advanced apomorphic state, 1 = by outgroup comparison, 2 = raised photophore, 3 = generalized larva, * = discussed in text.

Characters
1. Jaws long (0), moderate (1), short (2)—*
2. Extrascapulars 2 (0), 1 from fusion (1), 1 from loss (2)—*
3. Cleithral shelf absent (0), present (1)—1.
4. Prc 3-9 (0?), 1-2 (1?)—*
5. Larval eyes round (0), narrow (1)—1, 3.
6. Dn present (0?), absent (1?)—*
7. Moderately or strongly hooked teeth in posterior dentary absent (0), present (1)—1.
8. Procurent ventral rays 5-10 (0), 9-15 (1)—1.
9. Supramaxillary present (0), absent (1)—1, *
10. PO ₄ level (0), raised (1)—2.
11. Pubic plate narrow (0), wide (1)—1.
12. PO ₃ and PO ₅ level (0), raised (1)—2.
13. VO ₃ level (0), raised (1)—2.
14. PVO horizontal (0), angled (1), vertical (2)—2.
15. Caudal luminous organs present (0), absent (1)—*
16. AOa ₁ level (0), raised (1)—2.
17. Pol angled (0), horizontal (1)—2, *
18. Enlarged teeth in dentary absent (0), present (1)—1.
19. Vertebrae 28-41 (0), 41-45, (1)—1, *
20. VO ₂ level (0), elevated (1)—2.
21. Enlarged denterigerous area on anterior premaxillary absent (0), present (1)—1.
22. Secondary photophores absent (0), present (1)—1.
23. Larval gut moderate (0), initially short (1), long (2)—3, *.
24. Larval trunk myoseptal pigment absent (0), present (1)—1, 3.
25. Slightly hooked teeth in posterior dentary absent (0), present (1)—1.
26. Caudal luminous organs not sexually dimorphic (0), sexually dimorphic (1)—*
27. Larval photophores (except Br ₂) absent (0), present (1)—1, 3, *.
28. Hyomandibular foramen behind anterior head (0), in anterior head (1)—1.
29. Accessory luminous tissue absent (0), present (1)—1.
30. Caudal luminous organs any other state (0), homogeneous and translucent (1)—*
31. Procurent ventral rays without hooks (0), with hooks (1)—1.
32. Procurent dorsal rays without hooks (0), with hooks (1)—1.
33. Crescent of white tissue on posterior iris absent (0), present (1)—1.
34. Pol 0 (0), 1 (1), 2-3 (2)—2, *.
35. Dorsal process of opercular head of hyomandibula absent (0), present (1)—1.
36. SAOs weakly angled (0), strongly angled (1)—2, *.
37. Larval eyes moderate (0), very large (1)—1, 3.
38. PLO level with PVO ₁ (0), above PVO ₁ (1)—2.
39. SAO 2, close to VO and AO series (0), 2-3 above VO and AO series (1)—2.
40. Larval pectoral fin moderate (0), large (1)—3, *.
41. Mouth terminal (0), subterminal (1)—1.
42. Antorbital broad (0), thin (1)—1.
43. Larval fin fold small (0), extensive (1)—1, 3.
44. PLO below (0) opposite or proximate to upper pectoral base (1), far above upper pectoral base (2)—2.
45. Lower pharyngeal teeth conical (0), pegs or plates (1)—1.
46. Nasal trough-shaped (0), convex (1)—1.
47. Larval lower pectoral ray not elongate (0), elongate (1)—1, 3.
48. Gill rakers lathe-like (0), as tooth plates (1)—1.
49. Dorsal hypurals 4 (0), 3-2 (1), 1 (2)—1.
50. Coracoid fenestra present (0), absent (1)—1.
51. Double row of isthmus pigment in larvae absent (0), present (1)—1, 3.
52. Premaxillary teeth conical (0), flattened (1)—1.
53. Larval pectoral base fan-shaped (0), wing shaped (1)—1, 3.
54. Larval head pigment present (0), absent (1)—1, 3.

TABLE 63. CONTINUED.

- | |
|---|
| 55. Larval choroid tissue absent (0), present (1)—1, 3. |
| 56. Larval body width moderate (0), thin (1)—1, 3. |
| 57. Larval gut uniform (0), bipartite (1)—1, 3. |
| 58. Ossified distal pectoral radials 0 (0), 1-7 (1)—1, 3. |
| 59. CO ₅ keel or ridge absent (0), present (1)—1, *. |

group (the alepisauroids plus synodontoids) in his arrangement of the order. We do not have further evidence to present in favour of any of the above hypotheses (but do note the coiled gut of neoscopelid larvae resembles the condition found in higher groups).

GENERIC RELATIONSHIPS

Paxton (1972) analyzed features of the osteology and photophore patterns of the Myctophidae and presented a taxonomy outlining his views of evolutionary relationships that included two subfamilies (Myctophinae and Lampanyctinae), six tribes (Myctophini, Gonichthyini, Notolychnini, Lampanyctini, Diaphini and Gymnoscopelini), 28 genera and two subgenera. The Myctophinae was considered the more primitive of the subfamilies, while the monotypic Notolychnini was provisionally placed in the Lampanyctinae. In four papers Moser and Ahlstrom (1970, 1972, 1974; Ahlstrom et al., 1976) detailed the larval characteristics of all but two genera of Myctophidae and translated their findings into a picture of evolutionary relationships. The relationships proposed by Paxton and Moser and Ahlstrom were strikingly similar overall and in many details. The larval studies supported the recognition of two subfamilies composed of the same genera indicated by the adult analysis, highlighted the enigmatic features of *Notolychnus*, and recognized three additional tribes in the Lampanyctinae. Notable differences in the conclusions of the two studies included consideration of the Lampanyctinae as the most primitive subfamily by Moser and Ahlstrom, non-recognition of the tribe Gonichthyini (*Tarleton-beania*, *Loweina*, *Gonichthys*, *Centrobranchus*) as a monophyletic taxon in the larval study, inclusion of the genera *Taaningichthys*, *Lampadena*, *Bolinchthys*, *Lepidophanes* and *Ceratoscopelus* in the tribe Gymnoscopelini by Moser and Ahlstrom and the tribe Lampanyctini by Paxton, and recognition of the genera *Metellectrona* and *Parvilux* as valid genera on the basis of larval characters, which Paxton had synonymized with *Electrona* and *Lampanyctus* respectively on the basis of adult features. Neither study restricted characters to the derived state and the proposed phylogenies were based on overall similarities. The present work will attempt an analysis of derived character states and re-examine the proposed relationships within the family.

We have used as character states (Table 63) features of adult osteology and photophore patterns as described by Paxton (1972), and features of larvae as described by Moser and Ahlstrom (1970, 1972, 1974) and Ahlstrom et al. (1976) summarized in Moser et al. (this volume). The distribution of the character states among the genera (we have not considered subgenera in this analysis) is tabularized (Table 64). The criteria for determining apomorphic character states have been considered by many, including Marx and Rabb (1972) and Zehren (1979:153). We have used three criteria, the numbers of which are listed after each character in Table 63: (1) Outgroup com-

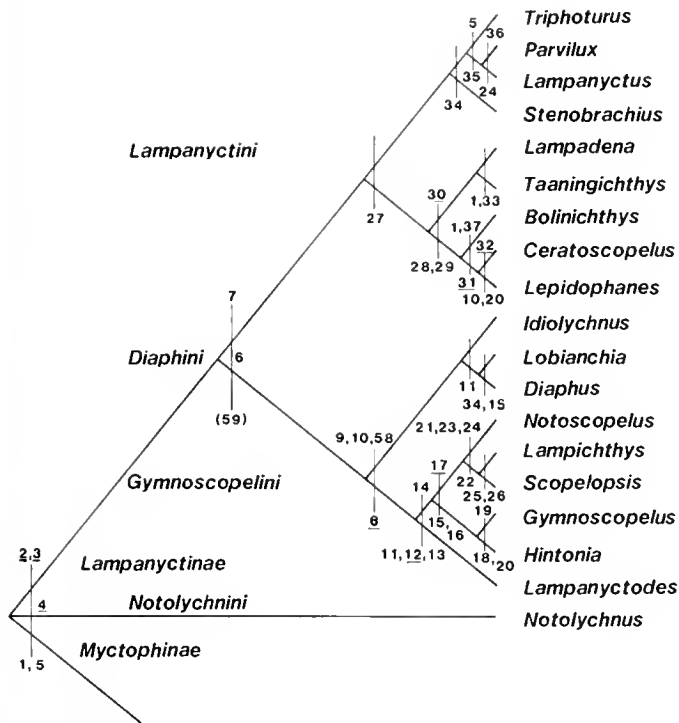

Fig. 125. Phylogenetic diagram of the Myctophidae, subfamily Lampanyctinae. Numbers refer to the apomorphic characters described in Table 63. Numbers in the middle of vertical lines (e.g., 4, 6) refer to characters for which the apomorphic state is unknown. Underlined numbers refer to apomorphic states unique to all members of a given lineage; bracketed numbers (e.g., 59) refer to apomorphic states that have secondarily reversed in at least one member of the lineage; non-bracketed, non-underlined numbers refer to character states found in all members of a given lineage but also by convergence in at least one other taxon in the family.

parison. All previous workers have considered the Myctophidae and Neoscopelidae as sister groups; we have taken the character state in the Neoscopelidae to be the plesiomorphic condition for the Myctophidae. Paxton (1972:57) described the parallel evolutionary trends in the neoscopelids and myctophids, with *Solvomer* similar to the Lampanyctinae and *Neoscopelus* similar to the Myctophinae. We have largely limited our analysis to those characters which display only one state in the Neoscopelidae. Where variation occurs within the family, the character is discussed individually below. (2) Linear photophores. We have considered a photophore elevated out of linear series to be apomorphic. One line of support for this decision occurs in the ontogeny of those myctophid species with a larval PLO photophore, which develops on the pectoral base (where it presumably has a different function from that of the adult) and moves dorsally during development (Ahlstrom et al., 1976:Fig. 4). Also the photophores of *Neoscopelus*, the only luminous neoscopelid genus, are largely linear. However there is some question of the homology of *Neoscopelus* and myctophid photophores. O'Day (1972:71) described the ultrastructure of myctophid photophores and "... confirm(s) Brauer's (1908) original recognition of the close resemblance of photogenic tissue in the Neoscopelidae to that found in the Myctophidae." However Herring and Morin (1978:318) considered photophores of *Neoscopelus* and the myctophids to be very different, on the basis

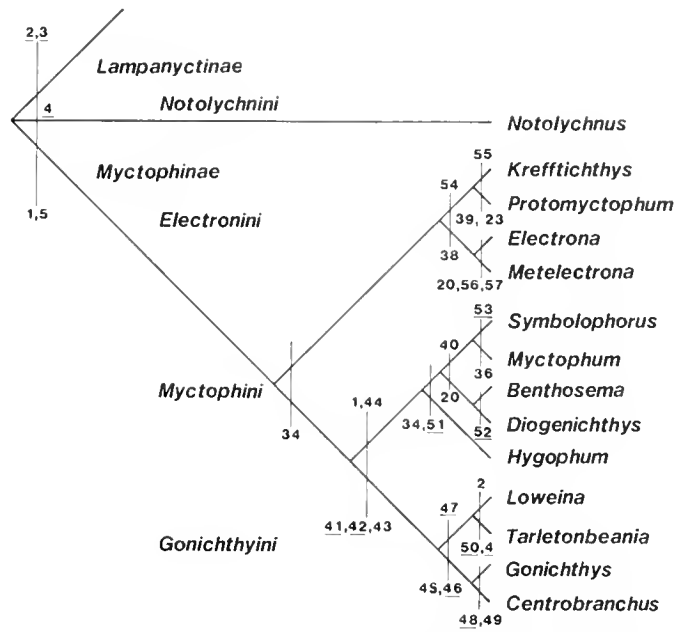

Fig. 126. Phylogenetic diagram of the Myctophidae, subfamily Myctophinae. Numbers are defined as in Fig. 125.

of Kuwabara's (1954) description of *Neoscopelus* compared to that of Brauer (1908). As ventral photophores have evolved independently at least one other time in the stomiiform fishes (Fink and Weitzman 1982:71), the potential for such evolution in deeper water fishes is high enough that one cannot consider their mere existence a case for homology. A study of the ultrastructure of *Neoscopelus* photophores would be of value. (3) Generalized larvae. The larvae of neoscopelids are highly specialized with a robust body, a large head and jaws with prominent teeth, a long gut that may be coiled and large pectoral fins. We do not think these features were present in the ancestors of the two families, and where they are present in the myctophids, consider they have evolved independently. We have used only one such feature, large pectoral fins (40, Table 63) in our analysis. We consider the generalized larva of the myctophid ancestor had the following characters, based on the distribution of larval features in myctophids and other teleosts: body moderately slender, gut slightly S-shaped, extending to about midbody, head moderate in size, eyes round or nearly so, without stalks or choroid tissue, small or moderate finfold and fins and Br₂ the only larval photophores present.

We have used a total of 59 characters, far fewer than the total described in the previous studies. For many we were unable to determine a derived state, as they displayed two or more states or were absent in the neoscopelids. In the osteological descriptions small shape differences or classifications of a continuum were often found in both families and were not included. A number of the characters utilized require comment or explanation: (1) Jaws are long in *Solvomer* and short in *Neoscopelus*, and following our ground rules should not be utilized. However, they appear to be of such fundamental importance, affecting many correlated characters and appearing to represent a major subfamilial difference (Paxton, 1972), that they are included here. Paxton (1972:58) considered short jaws to be primitive, primarily because they occurred in *Protomyctophum*, thought

TABLE 64. CHARACTER STATES IN THE GENERA OF MYCTOPHIDAE. The 59 characters are described in Table 1. 0 = plesiomorphic state, 1 = apomorphic state, 2 = different or advanced apomorphic state, 9 = unknown or both states.

	1	2	3	4	5	6	7	8	9	10	11	12	13	14	15	16	17	18	19	20	21	22	23	24	25	26	27	
<i>Krefflichthys</i>	2	0	0	1	1	0	0	0	1	0	0	0	0	0	0	0	0	0	0	0	0	0	0	0	0	1	0	
<i>Protomyctophum</i>	2	0	0	1	1	9	0	0	1	0	0	0	0	0	0	0	0	0	0	0	0	0	0	1	0	0	1	0
<i>Electrona</i>	2	0	0	1	1	0	0	0	1	0	0	0	0	1	0	0	0	0	0	0	0	0	0	1	0	0	1	0
<i>Metelectrona</i>	2	0	0	1	1	0	0	0	1	0	0	0	0	1	0	0	0	0	0	1	0	0	0	0	0	0	1	0
<i>Bentho sema</i>	2	0	0	1	1	9	0	0	1	0	0	0	0	0	0	0	0	0	1	0	0	9	0	0	0	1	1	
<i>Diogenichthys</i>	2	0	0	1	1	0	1	0	1	0	0	0	0	0	0	0	0	0	1	0	0	0	0	0	0	1	1	
<i>Hygophum</i>	2	0	0	1	1	0	0	0	1	0	0	0	0	1	0	0	0	0	0	0	0	0	0	0	0	0	1	0
<i>Myctophum</i>	2	0	0	1	1	0	0	0	1	0	0	0	0	1	0	0	0	0	0	0	0	0	9	0	0	1	9	
<i>Symbolophorus</i>	2	0	0	1	1	0	0	0	1	0	0	0	0	1	0	0	0	9	0	0	0	0	0	0	0	1	0	
<i>Lowena</i>	1	2	0	1	1	0	0	0	1	0	0	0	0	1	0	0	0	1	0	0	0	2	0	0	1	0	0	
<i>Tarletonbeania</i>	1	0	0	1	1	0	0	0	1	0	0	0	0	1	0	0	0	0	0	0	0	0	0	2	0	0	1	0
<i>Gonichthys</i>	1	0	0	1	1	0	0	0	1	0	0	0	0	1	0	0	0	0	0	0	0	0	0	0	0	1	0	
<i>Centrobranchius</i>	1	0	0	1	1	0	0	0	1	0	0	0	0	1	0	0	0	0	0	0	0	0	0	0	0	1	0	
<i>Notolychnus</i>	0	9	0	1	9	0	0	0	1	9	0	0	0	1	0	0	0	0	1	0	0	1	0	0	1	0	0	
<i>Lobianchia</i>	0	1	1	0	9	0	0	0	1	1	1	0	1	1	0	0	0	0	1	0	0	0	1	0	1	0	1	
<i>Diaphus</i>	9	1	1	0	0	0	0	0	1	1	1	0	1	1	1	9	0	9	0	1	0	0	0	0	0	0	1	
<i>Idolychnus</i>	0	1	1	0	9	0	0	0	1	1	0	0	1	1	0	1	0	0	0	1	0	0	9	9	0	1	9	
<i>Lampanyctodes</i>	0	1	1	0	0	0	0	1	0	0	1	1	1	0	0	0	0	0	1	0	0	0	0	0	0	0	1	
<i>Gymnoscopelus</i>	0	1	1	0	0	0	0	1	0	0	0	0	0	2	1	1	0	0	1	0	0	0	0	0	0	0	1	
<i>Scopelopsis</i>	0	1	1	0	0	0	0	1	0	0	0	0	0	2	0	0	1	0	0	9	0	1	0	0	1	1	1	
<i>Lampichthys</i>	0	1	1	0	0	0	0	1	0	0	0	0	0	2	0	0	1	0	0	0	1	0	0	0	0	0	1	
<i>Notoscopelus</i>	0	1	1	0	0	0	0	1	0	0	0	0	0	2	0	0	1	1	0	0	1	0	1	1	1	1	1	
<i>Hintonia</i>	0	1	1	0	9	0	0	1	9	0	0	0	0	2	1	0	9	1	0	1	0	1	9	9	1	0	9	
<i>Lampadena</i>	0	1	1	0	0	1	1	0	1	9	0	0	0	2	0	0	0	1	0	0	1	0	0	0	0	0	1	
<i>Taaningichthys</i>	1	1	1	0	0	1	1	0	1	0	0	0	0	2	0	0	0	0	0	1	0	0	0	0	0	0	0	
<i>Ceratoscopelus</i>	1	1	1	0	0	1	1	0	1	0	0	0	0	2	0	0	0	0	0	0	0	0	0	0	0	0	1	
<i>Lepidophanes</i>	0	1	1	0	0	1	1	0	1	1	0	0	0	2	0	0	0	0	0	1	0	0	0	0	0	0	1	
<i>Bolinichthys</i>	2	1	1	0	0	1	1	0	1	1	0	0	0	2	0	0	0	0	0	1	1	9	0	0	0	0	1	
<i>Triphoturus</i>	0	1	1	0	1	1	0	1	1	0	0	0	0	2	0	0	0	0	0	1	0	0	0	0	0	0	0	
<i>Stenobranchius</i>	0	1	1	0	0	1	1	0	1	1	0	0	0	2	0	0	0	0	0	0	0	0	0	1	0	0	0	
<i>Parvilux</i>	0	1	1	0	0	1	1	0	1	1	0	0	0	2	0	0	0	0	0	0	0	0	0	0	0	0	0	
<i>Lampanyctus</i>	0	1	1	0	0	1	1	0	1	1	0	0	0	2	0	0	0	0	9	0	9	0	1	0	0	0	0	
<i>Solivomer</i>	0	1	0	9	9	1	0	0	0	9	0	9	9	9	1	9	9	0	9	0	0	9	9	0	9	0	9	
<i>Neoscopelus</i>	2	1	0	9	0	1	0	0	0	9	0	9	9	9	1	9	9	0	0	9	0	0	0	0	0	0	0	
<i>Scopelengys</i>	0	1	0	9	0	1	0	0	0	9	0	9	9	9	1	9	9	0	0	9	0	0	0	0	0	0	0	

to represent the most primitive myctophid based on photophore pattern. However Myers (1958) has shown that short jaws have arisen from the long-jawed condition a number of times in teleost evolution, and discussed their adaptive advantages. We consider short jaws to be the apomorphic condition within both the Myctophidae and Neoscopelidae, and moderate jaws also to be derived from long jaws. (2) Extrascapulars are single in neoscopelids; therefore two extrascapulars in some myctophids should be the derived condition. However Paxton (1972:58) described how the neoscopelid extrascapular differs in position and shape from that of myctophids. Following Williston's Rule we consider a single extrascapular to be derived from the fusion of two elements, independently attained in each family. In *Lowena* the single condition has arisen through the loss of the dorsal extrascapular. (4) With no outgroup with similar photophores for comparison, we are unable to determine whether 1-2 or 3-9 Prcs is the apomorphic state. However the two character states follow subfamilial limits, and one of the states must be derived and definitive for its subfamily. (6) All myctophids have at least one of the orbital light organs, Dn and Vn, and most have both. We are not sure whether the presence or the absence of a Dn is apomorphic, but one of those states defines a major line within the Lampanyctinae. (9) Although the Neoscopelidae have a supramaxillary, Paxton (1972:62) considered the supramaxillary of some Myctophidae to be an independently derived feature,

due to a difference in shape and its required loss at least four times within the family if considered primitive. However, Johnson (1974b:205, 1982:79) has shown the presence of supra-maxilla(e) to be primitive in other myctophiforms (*sensu lato*); the absence of a supramaxilla in myctophids is here considered a derived state through loss. (15) Although caudal luminous organs are not present in neoscopelids, they are present in all but three myctophid genera, where their loss is here considered derived. No other characters indicate that any of the three genera (*Diaphus*, *Gymnoscopelus*, *Hintonia*) are the most primitive in the family. (17) Two or three horizontal Pcls are in a linear position and should be considered the plesiomorphic condition. However in those genera with horizontal Pcls (*Notoscopelus*, *Lampichthys* and *Scopelopsis*) the photophores are high, close to the lateral line. We consider the primitive myctophid state to be one with low photophores with none or one Pol (character 34). We therefore consider the horizontal position of Pcls to be derived, while noting the state in *Hintonia* is intermediate between angled and horizontal. (19) Although Johnson (1982:76) considered a higher number of vertebrae (42-62) plesiomorphic for inionous fishes, lower numbers of vertebrae in neoscopelids and almost all myctophids indicate the higher number in *Gymnoscopelus* is a secondary specialization in these families. (23) The larval gut of some neoscopelids is long and coiled, clearly a specialization foreshadowing the condition of

TABLE 64. EXTENDED.

28	29	30	31	32	33	34	35	36	37	38	39	40	41	42	43	44	45	46	47	48	49	50	51	52	53	54	55	56	57	58	59	
1	0	0	0	0	0	0	0	0	0	0	0	0	0	0	0	0	0	0	0	0	0	0	0	0	0	1	1	0	0	0	0	
1	0	0	0	0	0	0	0	0	0	0	1	0	0	0	0	0	0	0	0	0	0	0	0	0	0	1	0	0	0	9	0	
1	0	0	0	0	0	0	0	9	0	1	1	0	0	0	0	0	0	0	0	0	0	0	0	0	0	0	9	0	0	9	0	
1	0	0	0	0	0	9	0	1	0	1	1	0	0	0	1	0	0	0	0	0	0	0	1	0	0	0	0	1	1	1	0	
1	0	0	0	0	0	1	0	9	0	1	1	0	0	0	0	2	0	0	0	0	0	0	0	0	0	0	9	0	0	1	0	
1	0	0	0	0	0	1	0	0	0	1	1	0	0	0	0	2	0	0	0	0	1	0	0	1	0	0	0	0	0	0	1	0
1	0	0	0	0	0	2	0	9	0	1	1	0	0	0	0	2	0	0	0	0	0	0	1	0	0	0	9	9	9	1	0	
1	0	0	0	0	0	1	0	0	0	1	1	0	0	0	9	2	9	0	0	0	9	0	0	0	0	0	1	0	0	9	0	
1	0	0	0	0	0	1	0	1	0	1	1	1	0	0	0	2	0	0	0	0	0	0	0	0	1	0	1	0	0	9	0	
1	0	0	0	0	0	1	0	0	0	1	1	1	1	1	1	1	0	0	1	0	1	0	0	0	0	0	0	1	0	1	0	
1	0	0	0	0	0	1	0	0	0	1	1	1	1	1	1	1	1	1	0	0	1	0	0	0	0	0	1	1	0	0	0	
1	0	0	0	0	0	1	0	0	0	1	1	1	1	1	1	1	1	1	0	0	1	2	0	0	0	0	1	1	0	1	0	
0	0	0	0	0	0	2	0	0	0	0	1	0	0	0	0	2	0	0	0	0	2	0	0	0	0	0	0	0	0	0	9	
1	0	0	0	0	0	9	0	0	0	1	1	1	0	0	0	2	0	0	0	0	9	0	0	0	0	1	9	0	0	1	1	
9	9	0	0	0	0	9	0	0	0	1	1	0	0	0	0	2	0	0	0	0	9	0	0	0	0	1	0	0	0	1	9	
1	0	0	0	0	0	2	0	0	9	1	1	9	0	0	9	2	0	0	9	0	9	0	9	0	9	9	9	9	9	1	9	
0	1	0	0	0	0	1	0	0	0	1	1	0	0	0	0	2	0	0	0	0	0	0	0	0	0	0	0	0	0	0	1	
9	1	0	0	0	0	2	9	0	0	1	1	0	0	0	0	2	0	0	0	0	9	0	0	0	0	0	0	0	0	0	1	
1	1	0	0	0	0	2	1	0	0	1	1	0	0	0	0	2	0	0	0	0	0	0	0	0	0	0	0	0	0	0	1	
1	1	0	0	0	0	2	1	0	0	1	1	0	0	0	0	2	0	0	0	0	0	0	0	0	0	0	0	0	0	0	1	
0	1	0	0	0	0	2	0	0	9	1	1	9	0	0	9	2	0	0	9	0	0	0	9	0	9	9	9	9	9	9	0	0
0	9	1	0	0	0	1	0	0	0	1	1	0	0	0	0	2	0	0	0	0	0	0	0	0	0	0	0	0	0	0	0	0
0	0	1	0	0	1	1	0	0	0	1	1	0	0	0	0	2	0	0	0	0	0	0	0	0	0	0	0	0	0	0	0	0
1	1	0	1	1	0	2	0	0	0	1	1	0	0	0	0	2	0	0	0	0	0	0	0	0	0	0	0	0	0	0	0	0
1	1	0	1	0	0	2	1	1	0	1	1	0	0	0	0	2	0	0	0	0	0	0	0	0	0	0	0	0	0	0	1	0
1	1	0	0	0	1	2	0	0	1	1	1	0	0	0	0	2	0	0	0	0	0	0	0	0	0	0	0	0	0	0	0	1
0	0	0	0	0	0	2	0	1	0	1	1	0	0	0	0	2	0	0	0	0	0	0	0	0	0	0	1	0	0	0	0	0
0	0	0	0	0	0	1	9	0	0	1	1	0	0	0	0	2	0	0	0	0	9	0	0	0	0	0	0	0	0	0	0	0
0	0	0	0	0	0	2	1	0	1	1	1	0	0	0	0	2	0	0	0	0	0	0	0	0	0	0	0	0	0	0	0	0
0	9	0	0	0	0	2	1	1	9	1	1	9	0	0	0	2	0	0	0	0	9	0	0	0	0	0	0	0	0	0	0	0
0	0	0	0	0	0	9	0	9	9	9	9	9	0	0	9	9	0	0	9	0	0	0	9	0	9	9	9	9	9	9	0	0
0	0	0	0	0	0	9	0	9	0	9	9	1	0	0	0	9	0	0	0	0	0	0	0	0	0	0	0	0	0	0	0	0
0	0	0	0	0	0	9	0	9	0	9	9	1	0	0	0	9	0	0	0	0	0	0	0	0	0	0	0	0	0	0	0	0

some acanthopterygians. Although it could be argued that the short gut that lengthens during development in a few forms of myctophids represents the primitive condition, we consider the primitive myctophid condition a moderate-lengthed gut, with different derived states, short and long. (26) Although the caudal luminous organs are sexually dimorphic in about half the genera, we assume the original caudal organs were not sexually dimorphic. (27) No photophores are present on the described larvae of *Neoscopelus*. However the Br₂ develops in all larval myctophids except *Taaningichthys* and *Notolychnus*, and its universality indicates it was present in the ancestral myctophid. Other larval photophores however are present in fewer than half of the genera and we consider their presence derived. (30) The strongly developed caudal luminous organs found in *Lampadena* and *Taaningichthys* are clearly a more specialized state than the relatively unstructured organs found in many other genera. (34) See the discussion of character 17. (36) Although a strongly angled set of SAOs represents a linear position for the first two photophores, we consider this condition developed by the SAO₁ rising from a lower position in the weakly angled, plesiomorphic position. (59) We consider the absence of a keel or ridge on the fifth circumorbital of *Hintonia* to be secondarily derived through loss. This is the only character state we have used which is not present in all examined members of the line it defines.

We have thus attempted to determine polarity for 25 osteological, 17 larval and 17 photophore characters. We initially attempted a phylogenetic analysis utilizing the distribution of 23 larval characters at the species level. The resulting diagram split some genera into as many as three unrelated lines. We remain convinced that the myctophid genera as currently defined by larval morph, photophore pattern and osteology represent monophyletic lines (even though such genera as *Diaphus*, *Lampanyctus*, *Myctophum* and *Hygophum* may be formally divided as subgenera or genera by future work). These genera we use as the starting point in the present study. We have constructed a phylogenetic tree (Figs. 125, 126) based on our knowledge of the family and used the apomorphic states of the 59 characters to define the various branching points, which is the basis of the following discussion.

The subfamily Lampanyctinae is defined by two apomorphies restricted to all members of the subfamily (those characters found in all members of a lineage and nowhere else in the family are underlined in Figs. 125 and 126), the presence of a cleithral shelf and a single, fused extrascapular. The subfamily Myctophinae is defined by two apomorphies, short or moderate jaws and narrow larval eyes, but these features are also found in a few genera of the Lampanyctinae. The number of Pre photophores defines all members of one of the subfamilies (see discussion of character 4 above).

Notolychnus valdiviae, here considered a monotypic tribe, could not be placed with certainty in either subfamily. Moser and Ahlstrom (1970:138, 1974:409) and Paxton (1972:61) discussed the characters and problems of this enigmatic species. With long jaws and the lack of a cleithral shelf both considered plesiomorphies, the apomorphic number of Prc photophores unknown, and the larval eyes variable and intermediate in shape, future work is required to resolve this trichotomy.

We recognize three tribes in the subfamily Lampanyctinae (Fig. 125). The tribe Lampanyctini, with nine genera, is defined by the presence of a row of moderately to strongly hooked teeth in the posterior dentary; the only other genus with this feature is the myctophine *Diogenichthys*. These nine genera are also the only lampanyctines to lack a Dn orbital photophore, but we are unsure if this is a derived state (see discussion of character 6 above). Moser and Ahlstrom (1972) and Ahlstrom et al. (1976: 148) placed five of these genera (*Lampadena*, *Taaningichthys*, *Bolinichthys*, *Lepidophanes*, *Ceratoscopelus*) in the tribe Gymnoscopelini, based primarily on larval photophore pattern. Photophores which appear in larvae of Lampanyctinae are essentially the same ones which develop in myctophine larvae (Moser et al., this volume) and, if they are adaptive as Moser (1981) has suggested, it is likely that they have appeared in these typical sites independently in a number of lineages. Moreover, these photophores develop at the end of the larval period, if at all, in *Bolinichthys* and no photophores develop in *Taaningichthys* larvae. Likewise, the larval pigment characters do not support the inclusion of these five genera in the Gymnoscopelini.

In addition to the distribution of hooked dentary teeth and Dn photophores, other features influenced our decision about these five genera. The ischial ligament is medium or long in all Lampanyctini except *Taaningichthys* (and some species of *Diaphus*), while the fifth circumorbital has a ridge or keel in all gymnoscopelines (but is lacking in some species of *Diaphus*) and no lampanyctines except *Bolinichthys* (thus the brackets around character 59 in Fig. 125). Finally all of the gymnoscopeline genera except *Notoscopelus* are restricted to the southern ocean (Moser et al., this volume: Table 59), while the Lampanyctini are found both north and south (except *Stenobranchius*) of the equator. Placement of the five genera in the Lampanyctini requires fewer character reversals and parallelisms.

Within the Lampanyctini, the development of larval photophores in addition to Br₂ (character 27) unites the five genera discussed above. We recognize *Dorsadena* as a subgenus of *Lampadena* until specimens other than the types are available for osteological study and the larvae are discovered. We have not found an apomorphic character that defines the line including *Stenobranchius*, *Triphoturus*, *Lampanyctus* and *Parvilux*. We are recognizing *Parvilux* on the basis of a weakly angled SAO and larval shape and pigmentation.

We consider the tribe Diaphini to be the sister group of the Gymnoscopelini. The relationships among the three genera of Diaphini are not clear. One of us (HGM) has re-examined the specimens on which the larval features of *Idiolychnus urolampus* were based (see Moser and Ahlstrom, 1974:405–406; Nafpaktitis and Paxton, 1978), and now thinks they could represent *Lobianchia gemellari*, with the larvae of *Idiolychnus* still un-

known. Two characters shared by *Lobianchia* and *Idiolychnus*, the presence of caudal organs and the absence of a luminous patch above the pectoral fin, are considered plesiomorphic, while the absence of a Vn and differences of photophore positions are not clearly apomorphic. The most unequivocal derived state is the presence of a wide pubic plate, indicating *Lobianchia* and *Diaphus* are the sister group pair.

Within the Gymnoscopelini the proposed generic relationships are based almost entirely on characters of the photophores and luminous tissue. No consistent osteological or larval features define generic groupings. Southern ocean larvae require more study. The larvae of *Hintonia* are unknown and not enough species of *Gymnoscopelus* have been studied to ascertain if the subgenus *Nasolychnus* can be defined by any larval characters. The species of *Notoscopelus* should also be studied to find supporting characters of the subgenus *Parieophus*.

Within the subfamily Myctophinae (Fig. 126), we also recognize three tribes, the Electronini, Myctophini and Gonichthyini. The Gonichthyini is clearly a derived lineage, with a number of osteological, photophore and larval characters distinguishing the four genera from the rest of the subfamily. We think the larval specializations of eyes and pectoral fins arose after the split of the two generic pairs.

Paxton (1972) was unable to find osteological characters to clearly separate the remaining genera of the Myctophinae into two lineages. We have utilized photophores to distinguish the Myctophini from the Electronini, while recognizing there is a mosaic of osteological and larval characters within these nine genera. We have little question of the sister group relationship of the generic pairs *Krefflichthys*—*Protomyctophum*, *Myctophum*—*Symbolophorus* and *Bentosema*—*Diogenichthys*. However two larval features, thin head and body and a bipartite gut, are shared by *Metelectrona* and some species of *Ilygophum*. Since we think *Ilygophum* is a monophyletic line, we consider these shared larval features parallelisms that do not indicate common ancestry. Paxton (1972) considered *Metelectrona* a synonym of *Electrona*. The description of a second species of *Metelectrona* (Hulley, 1981), coupled with its larval and photophore characters, convinced us to recognize the genus.

Of the 59 derived characters utilized in our analysis, only 20 are restricted to members of the lineage they define, and eight of these are autapomorphic at the generic level. The remaining 39 characters are not found in the apomorphic state in any member of the opposite lineage from the defined branching point, but are found in some members of other lineages within the family. This presumed homoplasy of larval, photophore and even osteological characters indicates that the proposed phylogeny was arrived at with some difficulty. Ten of our proposed lineages are undefined by derived characters. We think that future work will support our proposed phylogeny, although some details may be modified, and that new, less plastic characters and better definitions of polarity will help resolve the problems.

(J. R. P.) THE AUSTRALIAN MUSEUM, 6–8 COLLEGE STREET, SYDNEY 2000, AUSTRALIA; (H.G.M.) NATIONAL MARINE FISHERIES SERVICE, SOUTHWEST FISHERIES CENTER, P.O. BOX 271, LA JOLLA, CALIFORNIA 92038.

Scopelarchidae: Development and Relationships

R. K. JOHNSON

THE Scopelarchidae has traditionally been included with the primarily oceanic Alepisauroidae (Marshall, 1955; Gosline et al., 1966; Rosen, 1973; Johnson, 1974b, the most recent complete revision). Johnson (1982) excludes the scopelarchids from the alepisauroids, rejects putative sister-group relationship with the Evermannellidae, and provisionally allies the scopelarchids with the chlorophthalmoids. All scopelarchids are oceanic and meso- or bathypelagic. The majority of known adult specimens were taken in hauls to depths between 500 and 1,000 m. For most species there exists no evidence to suggest diel migration, however, Merrett et al. (1973:39–40) present limited evidence for diel migration (“considerably dispersed vertically”) in *Benthalbella infans*. Scopelarchids are relatively large-bodied (to 302 mm SL; Iwami and Abe, 1980). All Scopelarchidae are tubular-eyed predators (see Munk, 1966; Lockett, 1970; Muntz, 1976; Johnson, 1982) concentrating most frequently on fish, not capable of engorgement of enormously large food particles (unlike evermannellids, *Omosudis*, *Alepisaurus*, *Antopterus* and at least some paralepidids). Luminous tissue occurs in *Benthalbella infans* (Merrett et al., 1973) and probably occurs in *Scopelarchoides kreffii* (Johnson, 1974b). The family contains 17 species arranged in four genera and occurs throughout the world ocean except that no scopelarchid inhabits the Arctic Ocean or the Mediterranean Sea. Among inionomous fishes, the Scopelarchidae is distinguished by the following combination of characters: (1) basihyal short to elongate but well-ossified; (2) lingual teeth strong, straight to strongly hooked, invariably present over basihyal, present or absent over basibranchials; (3) body and postorbital regions of head completely covered with cycloid scales; (4) lateral line scales large, differing distinctively in exact conformation between all species (Johnson, 1974b: Fig. 2); (5) parietal bones, when present, small, widely separated by frontals and supraoccipital; (6) coracoid broadly expanded; (7) two postcleithra, widely separated in vertical dimension; (8) unossified gap (filled by tube-like structure of fibrous connective tissue) between skull and first vertebral centrum (see Merrett et al., 1973:17); (9) posttemporal unforked; (10) no basisphenoid, orbitosphenoid, gill rakers, or free second ural centrum; (11) eyes tubular, directed straight upward (except in 3 species where directed dorsoanteriorly); (12) larvae with 0, 1 or 3 peritoneal pigment sections. The genera and species are distinguished by gross morphological, meristic, morphometric, osteological, pigment and larval characters (Tables 65 and 66).

DEVELOPMENT

Eggs of scopelarchids are unknown. Larvae are known for all species except *Scopelarchoides kreffii* and developmental series have been illustrated and described (Rosen, 1973; Merrett et al., 1973; Johnson, 1974b; Belyanina, 1981, 1982a; Moser, 1981). Except for limited information on *Benthalbella infans* in Merrett et al. (1973), osteological description has been confined to adults. Except in *Benthalbella*, development is direct, adult characters are essentially acquired one by one, with completion of transformation at 30 to more than 80 mm SL depending upon the

species. Larvae of *Benthalbella* undergo very rapid (i.e., small size increment) transformation after a prolonged period of growth while retaining larval form (see below). Larvae of most species are known from hauls within the top 100 m and the larvae of a number of species have been taken in the top 50 m. Contrariwise the larvae of one species, *Benthalbella dentata*, have not been taken in hauls shallower than 150 m and most were taken in hauls to depths in excess of 500 m. Except possibly the cases of *Benthalbella elongata* and *B. macropinna* (see Johnson, 1974b:228), the distributional ranges of larvae and adults are coextensive. There is no evidence (the data are quite incomplete) for seasonality in reproductive effort. Scopelarchids are synchronous hermaphrodites.

The following paragraphs describe those characters most evident in the early life history of scopelarchids, including those of value in distinguishing genera and species.

Gross aspect (Fig. 127).—Larvae range from extremely elongate and shallow (*Benthalbella*) to quite short and deep (some species of *Scopelarchus* and *Scopelarchoides*). Small larvae are translucent, scaleless, colorless (except for peritoneal pigment sections, when present), with a characteristic “bowed down” anterior dorsal profile. The body is deepest at the pectoral girdle and the trunk elongate. Anteriorly the hypaxial muscles do not embrace the abdominal cavity walls which are therefore highly translucent. Only the muscles of the pelvic girdle are visibly evident. The abdominal cavity is triangular, deep anteriorly. Peritoneal pigment appears early except in *Benthalbella* which lacks peritoneal pigment until transformation. The gut is midventral. In larvae the anus is anterior (relative to distance between pelvic fin insertion and anal fin origin) to position in adults, far anterior in some (*Benthalbella*). The head is very

TABLE 65. COMPARISON OF SELECTED MERISTIC CHARACTERS AMONG SCOPELARCHID SPECIES.

	Dorsal	Anal	Pectoral	Lateral line scales	Vertebrae
<i>alatus</i>	8–9	20–22	23–26	47–49	46–47
<i>hubbsi</i>	8–9	23–25	21–23	53	49
<i>volucris</i>	9–10	21–24	23–26	48–51	49–51
<i>stephensi</i>	8	20–22	18–20	41–44	42–43
<i>michaelsarsi</i>	7–9	18–21	18–21	40–44	40–44
<i>analis</i>	7–9	21–26	18–22	45–50	44–49
<i>guentheri</i>	7–8	24–29	18–21	47–52	47–51
<i>danae</i>	6–9	24–27	20–22	50–52	48–50
<i>nicholsi</i>	6–7	20–23	20–23	46–50	45–48
<i>kreffii</i>	9	25–27	23–25	58–59	55–57
<i>climax</i>	7–8	25–27	25	53	49
<i>signifer</i>	9–10	26–29	22–25	49–52	48–49
<i>macropinna</i>	5–6	35–39	25–27	62–65	60–62
<i>dentata</i>	6–8	17–20	21–24	54–58	54–55
<i>elongata</i>	9–10	24–28	19–23	61–65	62–65
<i>infans</i>	8–9	20–26	25–28	55–59	55–58
<i>hngudens</i>	8–9	28–30	24–25	66	64

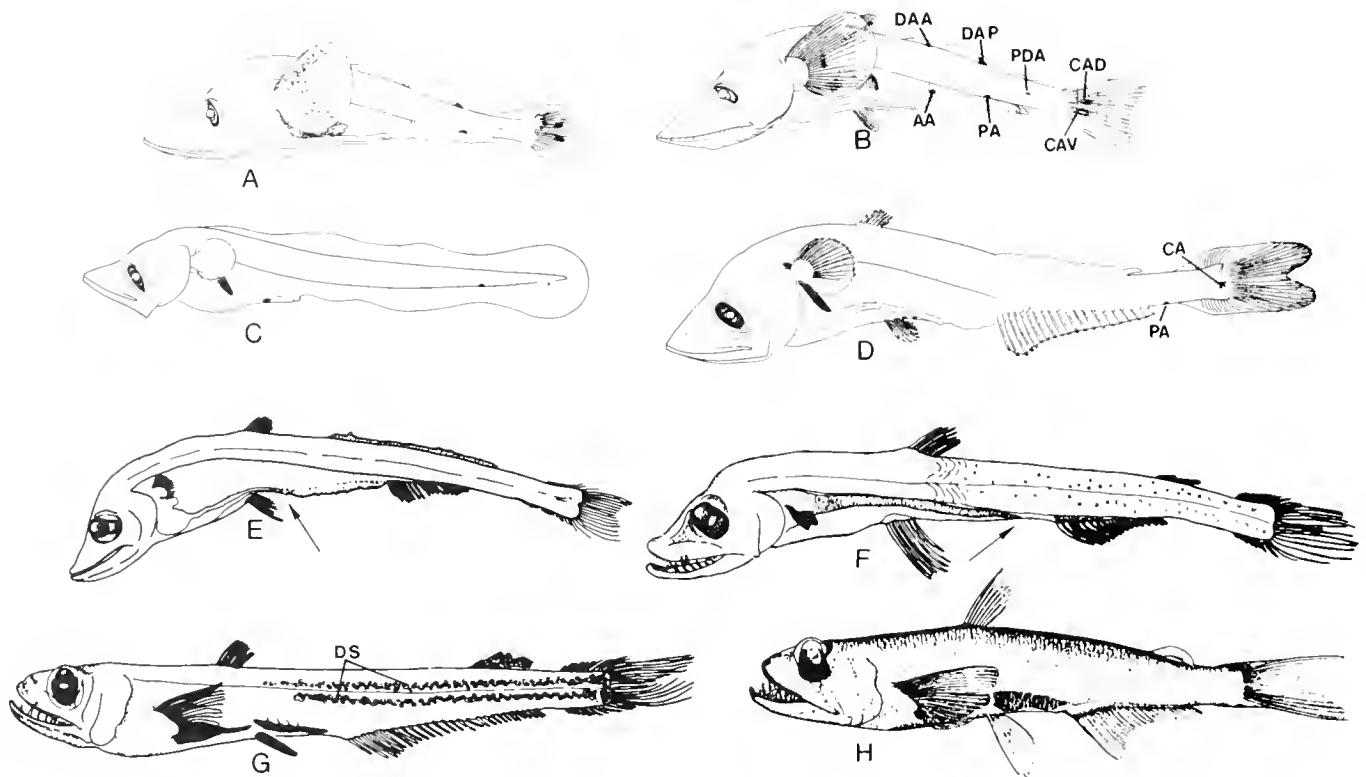

Fig. 127. Larvae, juveniles and adult of Scopelarchidae. (A, B) *Rosenblattichthys volucris*, A = 14.5 mm SL, B = 26.0 mm SL, letters refer to pigment spots; (C, D) *Scopelarchoides nicholsi*, C = 7.5 mm SL, D = 23.0 mm SL, letters refer to larval pigment spots; (E, F) *Benthallbella dentata*, E = larva, 42.8 mm SL, F = transforming specimen, 53.0 mm SL, arrows indicate position of anus; (G) *Scopelarchus guentheri*, juvenile, 48.5 mm SL, DS = dermal pigment stripes; (H) *Scopelarchus analis*, adult, 112.5 mm SL.

large and massive, exceeding 30% of the SL in *Rosenblattichthys*, and large but not as large in other genera. The eye is elliptically narrowed, and initially small in comparison with the size of the bony orbit. The interorbital is initially broad and narrows during transformation. Development of the eyes is described for *Benthallbella infans* in Merrett et al. (1973). The snout is pointed. The mouth is large and low, with teeth appearing in very small larvae. The most striking changes take place during a period of transformation, which, as described below, can either be within a very short interval (ca. 10 mm in *Benthallbella dentata*) of growth (any statements implying time sequence are based solely on increments of length) as in *Benthallbella*, or over a long (20 mm) to very long (50 mm) interval.

Meristic characters.—Counts of fin rays (Table 65) do not differ between larval and adult specimens. Most scopelarchid species can be uniquely distinguished from all other species on the basis of meristic characters alone (Johnson, 1974b:14). *Rosenblattichthys* is unique in precocious ossification of the pectoral fin rays, well in advance of the pelvic or median fins (except caudal). In all other scopelarchids the lowermost 5 or 6 pectoral fin rays are the last to be formed and the order of fin ray ossification is caudal > dorsal, anal, dorsal pectoral > pelvic > ventral pectoral. As in all iniioms the caudal is formed of 10 + 9 principle rays. In *Scopelarchoides* and *Rosenblattichthys* the pelvic fins appear as buds on the midlateral abdominal cavity wall, well above the level of the intestine. In *Benthallbella* and *Scopelar-*

chus the pelvic fin buds appear ventrolaterally, at or beneath the level of the intestine. In *Benthallbella* (except *B. macropinna*) the pelvic fin insertion in larvae is distinctly in advance of the dorsal fin origin. In other scopelarchid larvae the pelvic fin insertion is beneath or behind the dorsal fin base (but comes to be slightly in advance of dorsal fin origin in adult *Rosenblattichthys* and distinctly in advance of dorsal fin origin in all adult *Benthallbella*). The adipose fin develops within the dorsal finfold which extends between the dorsal and caudal fin in small larvae. In adults the adipose fin is inserted over the posterior one-third of the anal fin base (except *B. dentata* where inserted posterior to a vertical through base of last anal-fin ray). Ventral finfold extending from vent to anal-fin origin in smaller larvae, and is completely reabsorbed in early transformation.

Peritoneal pigment sections.—In all adult scopelarchids (except *B. elongata*) the gut is enclosed by a uniform tube of brown to jet-black pigment. In larvae this pigment appears in discrete sections (except in *Benthallbella* where peritoneal pigment is lacking prior to transformation) and in a conformation characteristic for each genus or group of apparently related species. All larvae larger than 20 to 22 mm possess peritoneal pigment (except in *Benthallbella*). One section only, unpaired, forming a saddle-like canopy over the gut, is present in *Rosenblattichthys*, *Scopelarchoides signifer*, and *S. climax* (larvae of *S. kreffii* are unknown). Three sections, a single anterior section as above and two paired posterior sections are found in *Scopelarchoides nich-*

olsi, *S. danae*, and *Scopelarchus*. However in *S. nicholsi* and *S. danae* the posterior sections appear significantly "later" and appear above (*S. danae*) or anterior (*S. nicholsi*) to the pelvic fin bases. In *Scopelarchus* all 3 sections appear in near synchrony and the posterior sections appear well to the rear of the pelvic fin bases. In all cases the pigment section(s) expand during transformation and for all genera except *Benthalbella* the completion of transformation can be defined as acquisition of the adult state of a complete and unbroken tube of peritoneal pigmentation. In *Benthalbella* the first appearance of peritoneal pigment (not in discrete section but uniformly in mesentary dorsal to gut from between pectoral fin bases to behind pelvic fin bases) signals the onset of the period of "rapid" transformation.

Other larval pigment.—The larvae of *Scopelarchoides* and *Rosenblattichthys* are characterized by the presence of well-defined pigment spots or areas (accessory pigment of Johnson, 1974b; complementary pigment of Belyanina, 1982a) apparent in the smallest (6–12 mm SL) known larvae. The presence and location of spots is uniquely diagnostic for each species possessing them. Pigment spots are present in all larvae of *Scopelarchoides* and *Rosenblattichthys*, absent in *Benthalbella* and *Scopelarchus*. In *Scopelarchoides* the middorsal spot, if present, and the mid-ventral spot are entirely behind the adipose base and anal fin base respectively. In *Rosenblattichthys* the middorsal and mid-ventral (where present) spots are entirely in advance of the bases of these fins.

Transformation pigmentation.—Johnson (1974b:20) distinguishes "dermal" vs "epidermal" pigmentation in scopelarchids. Dermal pigmentation refers to the major pigment stripes present in some genera and species. These develop "early" during transformation and persist in the adult. In most cases the dermal pigment comes to be partially or completely overlain by the epidermal pigmentation associated primarily with the scale pockets. Dermal pigment is present in all 4 species of *Scopelarchus* and in certain *Scopelarchoides* and *Rosenblattichthys*, it is absent in *Benthalbella*. The subequal pigment stripes of *Scopelarchus* (Fig. 127), situated above and below the lateral line, are diagnostic for the genus.

Gut morphology.—In all scopelarchids the stomach is a heavily muscularized, greatly elongate blind pouch. In small larvae the stomach does not reach the pelvic fin base, but it expands posteriorly during transformation, very "rapidly" so in *Benthalbella*, and in all adults extends to or nearly to a vertical through the anus (which in all is closely-adjacent to the anal fin origin). Johnson (1974b) and Wassersug and Johnson (1976) note that the tremendous expansion of the stomach allows ingestion of fairly large particles and hypothesize that the blind pouch arrangement is a device for maximal recovery of food energy.

Transformation.—Larvae of *Benthalbella* undergo rapid transformation after a prolonged period of growth while retaining larval form. The onset of transformation (size of smallest known transforming specimen = 49.6 mm SL in *B. dentata*; 89.1 mm SL in *B. elongata*; 55.1 mm SL in *B. infans*; 65.1 mm SL in *B. macropinna*; no transforming specimens of *B. linguoidens* are known, but the largest known larva is 85.5 mm SL) is signaled by appearance of a lens pad, appearance of peritoneal pigment, and invasion of the abdominal body wall by musculature. Other changes occurring during transformation include rapid elonga-

tion of gut and stomach, "migration" of anus from just behind pelvic fin base to just anterior to anal fin origin, appearance of gonad, appearance of scales (especially lateral line scales), appearance of head and body pigmentation, reabsorption of ventral adipose fin, great restriction of base of dorsal adipose fin, ossification of vertebral column, change (from dorsally convex to dorsally concave) in curvature in vertical plane of anterior portion of vertebral column (Merrett et al., 1973; Johnson, 1974b). The result is a miniature adult at the end of a transformation period covering as little as 10 mm of growth (Johnson, 1974b:68). In other scopelarchid genera these and other adult characters are acquired essentially one by one over an increment of growth ranging from 15 to 50 or more mm SL [in most transformation occurs over an actual size (SL) range of 15 mm to 40 or 50 mm]. Implications of changes in morphology during transformation in terms of activity, buoyancy, feeding and other aspects of biology are discussed for *B. infans* in Merrett et al. (1973).

RELATIONSHIPS

The scopelarchids were poorly known until the completion of Johnson's (1974b) revision. Currently recognized are 17 species grouped in 4 genera. Phylogenetic analysis involving hypothesized derived states of 19 characters or character complexes (Table 66) supports allocation of species among 3 of the 4 genera. As will be shown, *Scopelarchoides* remains a problem. In the listing that follows characters are given a character number (derived state number). Documentation of character state categorization and hypothesized polarity are given in references listed in the key to Table 66. Of the 19 characters for which polarity is indicated, 6 involve larval features (Table 65: 18, 19, 20, 22, 23, 24). Of 13 adult characters, 5 represented novel autapomorphies (Table 65: 1, 4, 13, 14, 15), 3 occur in a sequence of 3 or more steps (Table 65: 5, 11, 16), and 5 represent reductive characters (Table 65: 6, 7, 8, 9, 12). *Rosenblattichthys* is distinctive in having a greatly enlarged head in larvae 19 (19) and precocious development of the pectoral fins 20 (20). A single reductive character 8 (7) putatively links the remaining 14 species of scopelarchids. *Scopelarchus* is specialized in having subequal dermal pigment stripes above and below the lateral line 4 (2), unique support of the first epibranchial 16 (17); unique conformation of the three peritoneal pigment sections 22 (24), and in three reductive characters 9 (8), 12 (11), and 23 (25). *Scopelarchus analis* is linked with *S. michaelsarsi* and *S. stephensi* by one reductive character 11 (10). *Scopelarchus stephensi* and *S. michaelsarsi* are linked by a reduced number of vertebrae 5 (3) and by early onset and completion of metamorphosis 24 (26). *Benthalbella* is specialized in having delayed but then extremely "rapid" metamorphosis 24 (27) and in three reductive characters 6 (5), 22 (21), and 23 (25). Linking *Benthalbella dentata*, *B. infans*, *B. linguoidens* and *B. elongata* is the unique presence of a hooklike process on the urohyal 15 (14) and two reductive characters 9 (8) and 11 (9).

In dealing with the 5 species included by Johnson (1974b) in the genus *Scopelarchoides* the evidence available (Table 66, Fig. 128) suggests that this group is both unnatural and paraphyletic. Linking *S. nicholsi*, *S. danae* and *Scopelarchus* are unique sequential and fully correlated novel autapomorphies: support of the first epibranchial character 16 (states 15 → 16 → 17), and number and position of peritoneal pigment sections, character 22 (states 22 → 23 → 24). Further linking *S. nicholsi* with *S. danae* and *Scopelarchus* are relative size of the opercle and

TABLE 66. CHARACTERISTICS OF THE SCOPELARCHIDAE. Characters and character states are defined and listed below. Positive integers indicate derived states, zeroes indicate primitive states, letters denote states of characters where polarity could not be determined.

Char- acters	<i>Rosenblattichthys</i>			<i>Scopelarchus</i>				"Scopelarchoides"				<i>Benthalbella</i>					
	<i>alatus</i>	<i>hubbst</i>	<i>volucris</i>	<i>stephensi</i>	<i>michael-sarsi</i>	<i>analys</i>	<i>guentheri</i>	<i>danae</i>	<i>nicholsi</i>	<i>krefftii</i>	<i>climax</i>	<i>signifer</i>	<i>macro-pinna</i>	<i>dentata</i>	<i>elongata</i>	<i>infans</i>	<i>lingu-dens</i>
Gross morphology																	
1	0	0	0	0	0	0	0	0	0	?	1	0	0	0	0	1	0
2	a	a	a	b	b	b	b	b	b	a	b	b	a	a	a	a	a
3	c	a	a	b	b	b	b	c	c	c	b	c	c	c	c	c	?
4	0	0	0	2	2	2	2	0	0	0	0	0	0	0	0	0	0
Meristic characters																	
5	0	0	0	3	3	0	0	0	0	4	0	0	4	4	4	4	4
Osteological characters																	
6	?	?	0	?	0	0	0	0	?	?	?	0	5	5	5	5	?
7	?	?	0	?	6	6	6	6	6	?	?	0	0	0	0	0	?
8	?	0	0	7	7	7	7	7	7	7	?	7	7	7	7	7	?
9	0	0	0	8	8	8	8	0	0	0	0	0	0	8	8	8	?
10	b	b	b	a	a	a	a	a	a	b	b	a	b	b	b	b	?
11	0	0	0	10	10	10	9	9	9	0	0	0	0	9	9	9	?
12	0	?	0	?	11	11	11	0	0	?	?	0	0	0	0	0	?
13	0	0	0	12	12	12	12	12	12	0	0	0	0	0	0	0	?
14	?	0	0	0	0	0	0	0	0	13	13	13	13	13	13	13	?
15	?	?	0	0	0	0	0	0	0	?	?	0	0	14	14	14	?
16	?	?	0	?	17	17	17	16	15	?	?	0	0	0	0	0	?
Developmental characters																	
17	b	a	a	a	a	a	a	a	a	a	b	b	b	b	b	b	?
18	0	0	0	18	18	18	18	18	0	?	0	0	0	0	0	0	?
19	19	19	19	0	0	0	0	0	0	?	0	0	0	0	0	0	?
20	20	20	20	0	0	0	0	0	0	?	0	0	0	0	0	0	?
21	a	a	a	b	b	b	b	a	a	?	a	a	b	b	b	b	?
22	0	0	0	24	24	24	24	23	22	?	0	0	21	21	21	21	?
23	0	0	0	25	25	25	25	0	0	?	0	0	25	25	25	25	?
24	0	0	0	26	26	0	0	0	0	?	0	0	27	27	27	27	?

KEY:

Character state classification and hypothesized polarity based on detailed information presented in Johnson (1974b, 1982) and Iwami and Abe (1980). Both characters (boldface, in brackets) and character states (in parentheses) are numbered sequentially.

Gross morphology—[1] Luminous tissue is (0) absent, (1) present, [2] pelvic-fin insertion is (a) anterior to dorsal-fin origin, (b) posterior to dorsal-fin origin, [3] length of pectoral fin is (a) subequal to, (b) distinctly longer than, (c) distinctly shorter than length of pelvic fin; [4] dermal pigment stripes as equal or subequal stripes above and below lateral line are (0) absent, (2) present.

Meristic characters—[5] Modal number of vertebrae. Occurs within span of (3) 40 to 44, (0) 45 to 51, (4) 54 to 65, hypothesized character state sequence: 3 - 0 - 4.

Osteological characters—[6] An anteroventrally directed prong from opisthotic reaching or nearly reaching border of prootic is (0) present, (5) absent, [7] parental bones are (0) present, (6) absent, [8] supraorbital bones are (0) present, (7) absent, [9] antorbital bones are (0) present, (8) absent, [10] Ethmoid process on first infraorbital bone is (a) present, (b) absent, [11] Supramaxillary bones are (0) large, one-third to one-fourth the maxillary length, (9) splintlike, less than one-ninth of maxillary length, (10) absent; hypothesized character state sequence 0 - 9 - 10, [12] Discrete posterior arm of hyomandibular bone which articulates with opercle is (0) present, (11) absent, represented only by a rounded ridge, [13] Opercle—(0) subequal to or less than, (12) distinctly greater than—subopercle in size, [14] (0) basibranchial teeth present, basihyal short, (13) basibranchial teeth absent, basihyal long, [15] Hook-like process on anterodorsal surface of urohyal is (0) absent, (14) present, [16] (0) suspensory pharyngobranchial (PB1) present, uncinatate process (UP) of first epibranchial (EB1) and second pharyngobranchial (PB2) connected by a ligament, (15) PB1 lacking, support of EB1 near proximal end of PB2—UP of EB1 and PB2 connected by a ligament, (16) PB1 lacking, support of EB1 near middle of PB2, no UP, (17) PB1 lacking, support of EB1 at point of articulation between PB2 and EB2, no UP. Hypothesized character state sequence: 0 - 15 - 16 - 17.

Developmental characters—[17] Dermal pigmentation as defined in text is (a) present, (b) absent, [18] Adipose fin (0) remains elongate (extending antenad to over anterior anal-fin base) throughout transformation period, (18) is reabsorbed early in transformation, exhibiting adult proportions in specimens 20 to 22 mm SL and larger, [19] Head length in larvae (=28 mm SL) (0) not exceeding 30% SL, (19) exceeding 30% SL, [20] Pectoral fin (0) not precocious, all other fins with completely differentiated rays prior to ossification of ventralmost rays (at least) of pectoral fin, (20) precocious, all rays completely differentiated prior to formation of complete complement of rays of all other fins (except caudal fin), [21] Pelvic fin buds (a) form midlaterally, well above level of intestine, (b) form ventrolaterally, at or below level of intestine, [22] Number of peritoneal pigment sections in larvae (21) = 0, (0) = 1, (22) = 3, the posterior paired sections appearing much later in development than the single anterior section, and appearing entirely anterior to the pelvic-fin bases, (23) = 3, the posterior paired sections appearing much later in development than the single anterior section, and appearing over the pelvic-fin bases, (24) = 3, the posterior paired sections appearing in near synchrony with the single anterior section and appearing entirely posterior to the pelvic-fin bases. Hypothesized character state sequence: 21 - 0 - 22 - 23 - 24, [23] Other pigment spots or areas (as defined in text) are (0) present, (25) absent, [24] Transformation is (26) gradual, onset at 12-14 mm SL or smaller, completion at 30-35 mm SL or smaller, (0) gradual, onset at 16-22 mm SL or larger, completion at 40-60 mm SL [most species, *R. alatus* is extreme with onset at 9-10 mm SL and not yet complete in 6 (39.9-80.1 mm SL) juveniles examined by Johnson (1974b)], (27) abrupt, onset at 49.6-89.1 mm SL or larger, completion at 68.3-98.6 mm SL or larger (size for both onset and completion of metamorphosis varies among the 5 species of *Benthalbella*). Hypothesized character state sequence: 26 - 0 -

27

subopercle 13 (12) and two reductive characters 7 (6) and 11 (9). Further linking *S. danae* with *Scopelarchus* is a unique early restriction of the base of the dorsal adipose fin 18 (18). I am convinced that the characters previously detailed warrant generic level recognition for the group of 4 species assigned to *Scopelarchus*. Thus *Scopelarchoides* (type-species *S. nicholsi*) should be restricted to *S. nicholsi* and *S. danae*.

This leaves the three species currently assigned to *Scopelarchoides*, viz. *S. signifer*, *S. climax*, and *S. krefftii*. These three share no known derived character unique to just this group.

They share a single presumably derivative character—loss of basibranchial teeth, extension of length of basihyal tooth row 14 (13)—with *Benthalbella* but as noted by Johnson (1974b: 204) this may represent adult retention of a larval character state common to all scopelarchids. *Scopelarchoides krefftii*, a subtropical convergence species, shares with *Benthalbella* an increase in the number of vertebrae 5 (4) and probably shares with *B. infans* the presence of luminous tissue 1 (1). Most osteological characters are unknown for *S. climax* and *S. krefftii* (as a result of paucity of available material) and the larvae of

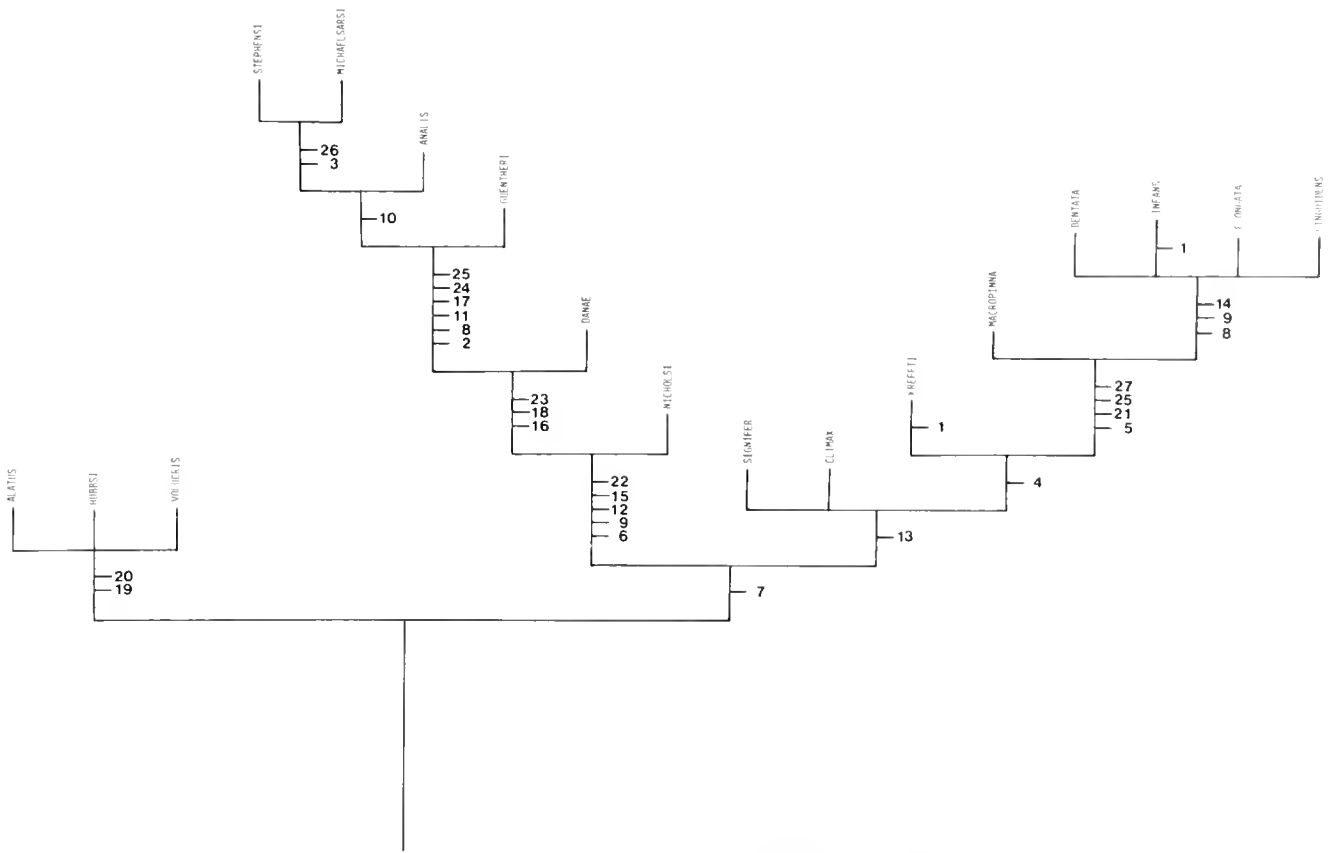

Fig. 128. Proposed relationships among scopelarchid species based on adult and larval characters. Integers indicate derived character states, listed in Table 66, possessed by taxa above indicated point in dendrogram.

S. krefftii are unknown. I would argue that the specializations of *Benthalbella*, especially in larval characters relating to a unique, rapid pattern of transformation preclude addition of *S. signifer*, *S. climax*, and presumably *S. krefftii* to *Benthalbella*. But with *S. climax* and *S. krefftii* very poorly known and with the only "character" uniting this "group" of three being that they are "left over," I remain with my 1974b (p. 217) compromise. Uniting all 5 species of "*Scopelarchoides*" and diagnostically separating them from *Scopelarchus* and *Benthalbella* are development and conformation of accessory pigment spots character 23, and lateral appearance of the pelvic fin bud, character 21. It is possible that the state exhibited by *Scopelarchoides* larvae is primitive in both cases (I doubt that lateral appearance of the pelvic fin buds is primitive) but until this can be shown through adequate outgroup comparison and until *S. climax* and *S. krefftii* are better known, I refrain from attempting the description of an additional genus. Thus, for now, the possibly paraphyletic genus "*Scopelarchoides*" is retained.

A summary of the contribution of 6 ontogenetic characters to this analysis is presented below.

Dermal pigmentation (character #17).—Dermal pigmentation and/or dermal pigment stripes are found in all scopelarchid genera except *Benthalbella*, however, the fixation of such pigment into subequal stripes above and below the lateral line is diagnostic of and unique to the four species of *Scopelarchus*. This fixation is regarded as autapomorphous for this genus.

Adipose fin (character #18).—*Scopelarchoides danae* shares with *Scopelarchus* an early reabsorption of most of the adipose fin, resulting in restriction to essentially adult proportions of the base of this fin in specimens 20–22 mm SL. In other *Scopelarchoides* as in *Benthalbella* and *Rosenblattichthys* the adipose fin remains elongate, to over the anterior anal fin rays, throughout transformation, assuming adult proportions in specimens >30 mm SL. In combination with other characters uniting *S. danae* with *Scopelarchus* (Fig. 128) fixation of early restriction of the dorsal adipose base is regarded as apomorphous for this group.

Head length (character #19).—The head in larval *Rosenblattichthys* is unusually large, deep and massive, the head length exceeding 30% of the SL. The head length in other scopelarchid larvae does not exceed 30% of the SL and this is apparently the case in chlorophthalmoids (Tåning, 1918; Okiyama, 1972, 1974b, 1981) and most alepisauroids (Rofen, 1966a; Johnson, 1982). Larvae of *Omosudis* and *Alepisaurus* do exhibit exceptionally large heads (Rofen, 1966b). The fixation of this character in *Rosenblattichthys* alone among scopelarchids is presumed to be apomorphous.

Pectoral fin development (character #20).—The order of fin ray differentiation varies within and between iniomous families. Precocious pectoral fin development is unique to *Rosenblattichthys* among scopelarchids. It is also found in ipnopsids (Okiyama, 1972, 1981) and myctophids (Moser and Ahlstrom, 1970) but

not evermannellids, *Omosudis*, or chlorophthalmids (Tåning, 1918; Rofen, 1966b; Johnson, 1982). It is presumed that precocious pectoral fin development in *Rosenblattichthys* is the derived state.

Peritoneal pigment sections (character #22).—For an overview of the distribution of peritoneal pigment sections in inioms see Johnson (1982) and the account of the Evermannellidae in the present work. The single, transverse section seen in *Rosenblattichthys*, *Scopelarchoides climax*, *S. signifer* and presumably *S. krefftii* is here considered the primitive state. Loss of peritoneal pigment in the larvae of *Benthalbella* is clearly apomorphic. The single and paired conformation of the 3 sections in *Scopelarchoides nicholsi*, *S. danae* and *Scopelarchus* is unique to this lineage among inioms. The seemingly sequential progression of states 22 → 23 → 24 (Table 66: character 22) and the correlation of these states with states 15 → 16 → 17 of character 16 strongly reinforce the concept of monophyly for this lineage.

Larval pigment spots (character #23).—Deep-lying pigment spots or areas occur widely among iniomous fishes (Tåning, 1918; Gibbs, 1959; Anderson et al., 1966; Rofen, 1966a; Moser and Ahlstrom, 1970; Johnson, 1982) and their presence is here presumed to be primitive. As noted above, the position and relative size of the spots differs between and is diagnostic of *Scopelarchoides* (all 5 species) vs *Rosenblattichthys*.

Transformation (character #24).—Larvae of *Benthalbella* are unique among scopelarchids and possibly among inioms in achieving very large size—50 to 100 mm or more (varying by species) while retaining a purely larval form and then exhibiting a very “rapid” (based on size increment relative to total size) transformation. This pattern is regarded as autapomorphic for this genus. Larvae of two central-water species of *Scopelarchus*, *S. stephensi* and *S. michaelsarsi*, exhibit a gradual transformation typical for most inioms, but, relative to other scopelarchids, exhibit onset and completion of transformation at substantially smaller sizes. This is regarded as an apomorphic

feature linking these two species (as does the possibly redundant character 5, reduction in number of vertebrae).

Johnson (1982:62–101) reviews some 49 characters seemingly related to the question of sister-group relationship of the scopelarchids and evermannellids. Found were derived states in eight characters—multiple peritoneal pigment sections, lateral attachment of dermosphenotic, restricted insertion of RAB (Rosen, 1973) muscle, reduction in number of supraneurals, and loss of the following: sclerotic bones, antorbital bones, tooth-plate of second pharyngobranchial and basibranchial dentition—characteristic of all alepisauroids (Alepisauroidea, Anopteroptera, Evermannellidae, Omosudidae, Paralepididae) but not the Scopelarchidae (at least primitively). Also found were 5 derived states characteristic of the Evermannellidae + Alepisauroidea + Omosudidae but not the Scopelarchidae, viz. possession of eight infraorbital bones, reduction in number of epurals and loss of the following: body scales, lateral line scales, suspensory pharyngobranchial. Admittedly many of the features listed are “loss” characters and thus potentially worrisome, but why should they uniformly be absent in the groups indicated and not in the Scopelarchidae if their correlated loss is not indicative of relationship? On the basis of the large number of derived states shared among alepisauroids but not shared by scopelarchids Johnson (1982) excludes the scopelarchids from the alepisauroids and links them (tentatively) with chlorophthalmoids. Only a single derived state—gap in ossification between first centrum and the skull—links the scopelarchids with chlorophthalmoids, but this feature is found in no alepisauroid. It should be reemphasized that the characters discussed in Johnson (1982) were specifically chosen to explore the hypothesis of sister-group relationship of evermannellids and scopelarchids—a notion rejected. Many additional characters need to be studied for any rigorous analysis of iniom relationships. It is clear that the contribution of larval characters to this analysis will be great.

FIELD MUSEUM OF NATURAL HISTORY, ROOSEVELT ROAD AT LAKE SHORE DRIVE, CHICAGO, ILLINOIS 60605.

Evermannellidae: Development and Relationships

R. K. JOHNSON

THE Evermannellidae is one of five families included by Johnson (1982, the most recent revision) in the primarily oceanic Alepisauroidei. Excluded from this group are the Scopelarchidae, long the supposed sister group of the evermannellids, but tentatively allied by Johnson with the chlorophthalmoids. All evermannellids are oceanic and mesopelagic, occupying (as juveniles and adults) a wide vertical range in the upper 1,000 m, and are not known to exhibit diel vertical migration. Evermannellids are relatively large-bodied (to 184.5 mm SL) predators, capable of engorging large food particles, and concentrating most frequently on fish although *Coccorella* may more frequently prey on squid. The family contains 7 species

arranged in 3 genera. Evermannellids are distinguished among other alepisauroids by the following combination of characters: (1) an externally visible tripartite division of the tail musculature with the epaxial and hypaxial muscles separated by a midlateral band of muscle tissue, the lateralis superficialis; (2) lack of scales; (3) greatly reduced, edentate basihyal; (4) restriction of gill teeth to ceratobranchial of second arch; (5) presence of tubular or semitubular eyes in 6 of 7 species; (6) lack of external keels on body. The genera and species are distinguished by gross morphological (eye, laterosensory pores, gut morphology, luminous tissue), meristic, morphometric, osteological, pigment and larval characters (Table 67).

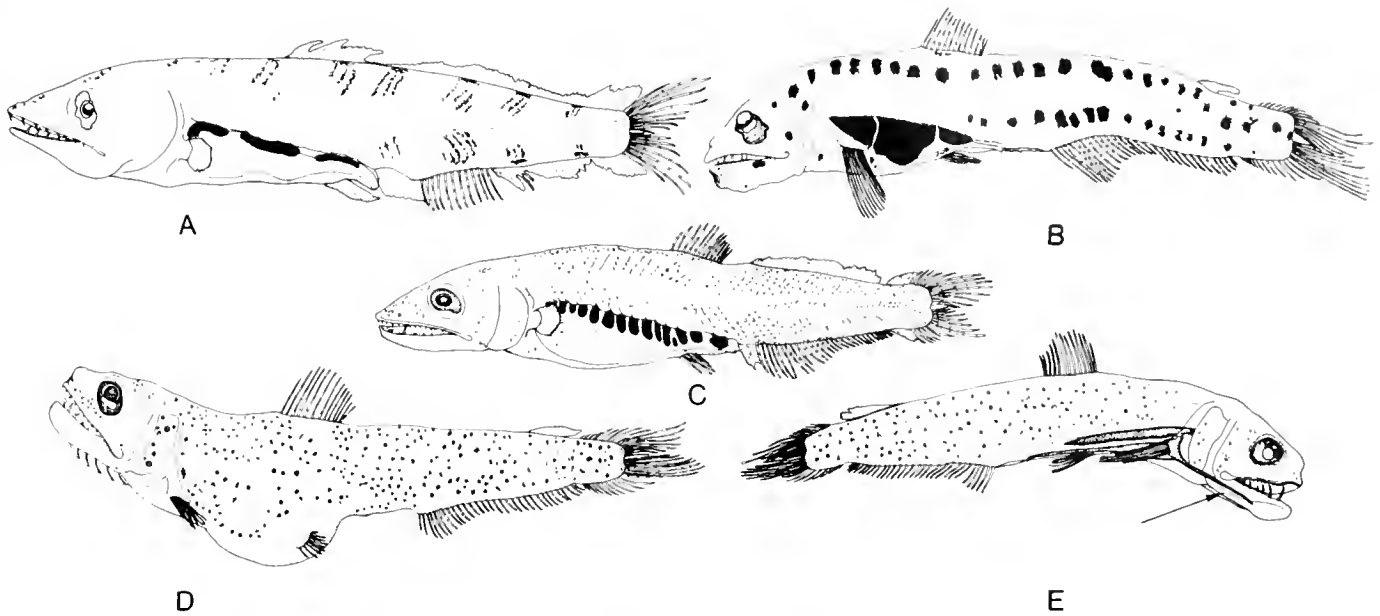

Fig. 129. Larvae and juveniles and Evermannellidae. (A) *E. balbo*, showing larval phase pigmentation, D 3553 II, 8–10 mm SL; (B) *E. indica*, showing juvenile phase pigmentation, ORSTOM CY III-5, 28.0 mm SL; (C) *O. normalops*, illustrating larval phase pigmentation and multiple peritoneal pigment sections (shown in solid black), UH 73/8/38, 10.5 mm SL; (D) *C. atlantica*, showing juvenile phase pigmentation, RHB 2960, 6.3 mm SL; (E) *C. atlantica*, arrow shows location of cephalic extension of pyloric caecum, ACRE 12–18A, 25.2 mm SL (peritoneal pigment sections not shown).

DEVELOPMENT

Eggs of evermannellids are unknown. Larvae are known for all species and developmental series have been partly illustrated and described (Schmidt, 1918; Rofen, 1966d; Wassersug and Johnson, 1976; Johnson, 1982). Osteological examination has been confined to adults. Development is direct, transformation gradual, adult characteristics are acquired essentially one by one but for the most part such acquisition is complete in specimens exceeding 30 mm SL.

For all species the great majority of larval specimens has been taken in the upper 100 m but only the larvae of three species (*Evermannella balbo*, *E. indica*, *Odontostomops normalops*) have been commonly taken in hauls to 50 m or less. The distributional ranges of larvae and adults are coextensive and there is no evidence (the data are very incomplete) for seasonality in reproductive effort. Evermannellids are synchronous hermaphrodites.

The following paragraphs describe those characters most evident in the early life history of evermannellids including those of value in distinguishing genera and species.

Gross aspect (Fig. 129).—Larvae and smaller juveniles of all three genera are similar in general proportions and in having a relatively smaller eye, smaller lens, broader interorbital, and larger snout than larger juveniles and adults. The body is deepest just behind the pectoral fin base. The anterior dorsal profile descends gradually and is not bowed down. The eye in larvae of *Evermannella* and *Coccorella* but not *Odontostomops* is elliptically narrowed, broader dorsoventrally than antero-posteriorly. The gut cavity is essentially triangular and quite deep anteriorly. The snout is pointed, the mouth large, and teeth appear in very small larvae. The most striking changes in body

proportions, in all evermannellid larvae, are correlated with the transition from individuals with a “larval phase” pigment pattern to those with a “juvenile phase” pigment pattern (see pigmentation, below), with the result that individuals exceeding ca. 25 mm in the latter category are essentially miniature adults.

Meristic characters.—Counts of fin rays (Table 67) do not differ between larval and adult specimens. The caudal is the first fin to form, it develops 10 + 9 principal rays, as in all Aulopiformes and Myctophiformes (*sensu* Rosen, 1973). Next to form, in order, are the dorsal, pelvic, anal and pectoral fins. The pelvic fins do not greatly change position during ontogeny, they appear ventrolaterally beneath the posterior half of the dorsal fin and are inserted beneath the anterior half of the dorsal fin in adults. An adipose fin connects the incipient dorsal fin with the caudal fin in small larvae but loses this connection and shrinks in extent with growth of the individual, inserted over posterior one-third of anal fin base in adults. There is apparently no variation in the above-described features among evermannellid larvae.

Peritoneal pigment sections (Fig. 129).—In all adult evermannellids the gut is completely enclosed by a uniform tube of dark brown to black peritoneal pigment. In larvae, this peritoneal pigment appears in discrete sections. In *Odontostomops* there are 12 or more peritoneal pigment sections, typically 13 to 15. In *Evermannella* and *Coccorella* there are invariably 3 sections, one centered over and medial to the pectoral fin insertion, one centered (or nearly so) under the dorsal fin insertion, and one (roughly) centered between the posteriormost pelvic fin ray base and the anal fin origin. In all cases the sections are unpaired and are connected broadly over the dorsal surface of the stomach. In small larvae the sections form canopy-like continuous

TABLE 67. CHARACTERISTICS OF THE EVERMANNELLIDAE. In the list that follows only characters useful in distinguishing evermannellid taxa are included. Those characters also included in phylogenetic analysis are numbered; presumed primitive states denoted by 0, presumed derivative states by integers.

Characters	<i>Coccorella atlantica</i>	<i>Coccorella atrata</i>	<i>Evermannella ahlstromi</i>	<i>Evermannella balbo</i>	<i>Evermannella indica</i>	<i>Evermannella megalops</i>	<i>Odontostomops normalops</i>
Gross morphology							
(1) Eye (each state includes a suite of presumably correlated features listed in Johnson, 1982, p. 68): (0) nontubular, (1) semitubular, (2) tubular	1	1	2	2	2	2	0
(2) Pyloric caecum with cephalic extension: (0) absent, (3) present	3	3	0	0	0	0	0
(3) Luminous tissue, associated with ventral wall of intestine and pyloric caecum: (0) absent, (4) present	4	4	0	0	0	0	0
(4) Medial snout-pad pore (Johnson, 1982, p. 8) is: (0) present, (5) absent	0	0	0	0	0	5	0
Meristic characters							
(5) Dorsal fin, modal number of rays: (0) 12 or 13, (6) 10 or 11	0	0	6	0	0	6	0
(6) Number of lateral line segments: (0) ≤ 43 , (7) ≤ 34 , (8) ≤ 18	7	7	8	8	8	8	0
—Anal fin rays	26–30	27–29	29–32	33–37	27–31	29–31	30–35
—Vertebrae	48–50	45–47	47–49	52–54	48–52	48–50	48–52
Morphometric characters (as thousandths of SL)							
—Body depth at anal-fin origin	144–191	171–210	173–200	145–181	136–173	148–162	135–170
—Horizontal diameter of eye	40–65	47–65	67–81	52–72	49–93	74–85	27–42
—Vertical diameter of eye	42–76	54–70	69–87	59–81	60–97	86–110	28–40
—Interorbital width	32–47	47–61	17–26	9–19	8–20	4–17	36–52
—Length of longest palatine tooth	71–96	80–100	46–69	54–69	48–73	61–69	53–69
Osteological characters							
(7) Basisphenoid: (0) present, (9) absent	0	0	0	0	0	0	9
(8) Ethmoid cartilage: (0) not forming orbital septum, (10) considerably expanded posteriorly forming an orbital septum	10	10	0	0	0	0	0
(9) Supraorbitals: (0) present, (11) absent	0	0	0	0	0	0	11
(10) Vertically elongate fossa centered at dentary symphysis: (0) absent, (12) present	0	0	12	12	12	12	0
(11) Jaw and palatine teeth: (0) dentary teeth in two series, at least some dentary and palatine fangs barbed, (13) dentary teeth uniserial, all fangs unbarbed	13	13	0	0	0	0	0
(12) Basihyal toothplate: (0) covers dorsal and dorsolateral surface of basihyal, (14) covers only posterior 2/3 of dorsum of basihyal, (15) absent	14	15	0	0	0	0	0
(13) Toothplate of fourth pharyngobranchial: (0) bears teeth, (16) edentate	0	16	0	0	0	0	0
(14) Toothplate of fifth ceratobranchial: (0) bears teeth, (17) edentate	17	17	17	0	17	17	0
Developmental characters							
(15) Number of peritoneal pigment sections: (0) three, (18) twelve or more	0	0	0	0	0	0	18
(16) Juvenile phase pigmentation: (19) characterized by development of three distinct rows of very large melanophores, each row associated with one of three main divisions of tail musculature, (0) juvenile phase pigmentation not as above, with many more melanophores and no distinct trilateral pattern	0	0	19	19	19	19	0

sheets over the dorsal and dorsolateral margins of the gut and these sections expand ventrad as well as longitudinally with growth. In specimens larger than 35 to 45 mm SL the peritoneal pigment sections coalesce to form the complete gut-enclosing pigment tube characteristic of adults.

Other pigmentation (Fig. 129).—The major pattern of body pigmentation in evermannellid larvae occurs in two phases, a larval phase and a juvenile phase, with a gradual transition between the phases. In smaller larvae (less than 12–15 mm SL) the most prominent body pigmentation consists of a pattern of pigment bands arranged along the myosepta. Typically these bands are arranged in groups (symmetrically distributed in epaxial and hypaxial myotomal bands in the tail region, nonsymmetrical and predominantly epaxial in the trunk region), resulting in a characteristic barred appearance. In larvae larger than 12 to 15 mm SL the body pigmentation characteristic of adults begins to appear. In *Odontostomops* juvenile phase pigmentation is characterized by the development of numerous highly punctate melanophores generally distributed over the head and body. In *Evermannella* the juvenile phase is typically characterized by the development of three rows of very large melanophores, each row associated with one of the 3 main divisions of the trunk/tail musculature. The median row, that associated with the lateralis superficialis, is limited to the tail. Both of the other rows, epaxial and hypaxial, extend the length of the body, from the posterior border of the head (or nearly so) to the caudal peduncle. In *Coccorella* the juvenile phase pigmentation tends to be intermediate in state between that of *Odontostomops* and *Evermannella*, the developing melanophores tend to be larger and more prominent than in *Odontostomops*, but much more numerous and not arranged in rows as in *Evermannella*. Body pigmentation in juveniles larger than 25 to 30 mm SL is similar to that in adults. Development of adult pigmentation in evermannellid larvae is associated with gradual (all statements implying time course are based solely on size increments) disappearance of the larval myoseptal pigment bands. Four of the seven evermannellid species (*Coccorella atlantica*, *C. atrata*, *Evermannella megalops*, *Odontostomops normalops*) are highly melanistic as adults. In *Evermannella balbo*, *E. indica*, and especially *E. ahlstromi* the pigmentation in adults tends to be much more mottled, with numerous, variably-sized melanophores (some very large) on a light brown (in alcohol) ground color. Obscured in adults is the longitudinal trilateral melanophore pattern characteristic of juveniles.

Gut morphology (Fig. 129).—In all evermannellids the stomach is a heavily muscularized blind sac. The stomach expands posteriorly with larval growth reaching its full extension (to a vertical just behind the pelvic fin base) in specimens exceeding 20–25 mm SL. Larvae of *Coccorella* are distinguished by the unique possession of a pyloric caecum that expands anteriorly with growth and enters the head in larger larvae, juveniles and adults (Fig. 129E). The caecum is visible as a short, blind, bud-like sac on the ventro-anterior margin of the intestine in the smallest known larvae of *Coccorella*. Wassersug and Johnson (1976) describe in detail the structure and development of this remarkable organ. Neither *Evermannella* nor *Odontostomops* nor (as far as is known) any other alepisauroid possess a pyloric caecum.

Transformation.—Development of juvenile phase pigmentation signals the onset of transformation in all evermannellid larvae.

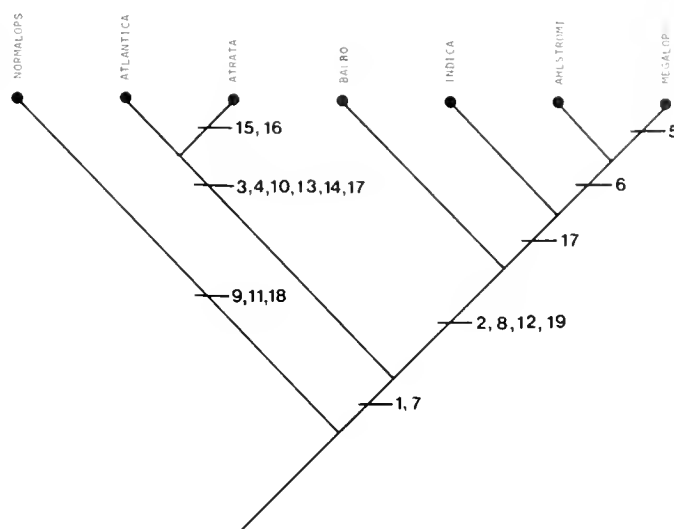

Fig. 130. Proposed relationships among evermannellid species based on adult and larval characters. Integers indicate derived character states, listed in Table 67, possessed by taxa above indicated point in dendrogram.

Transformation in Evermannellidae is gradual, adult characters are essentially acquired one by one, and there are no abrupt and radical changes in morphology. In all evermannellid species, individuals larger than 25 to 30 mm SL are (except for final fusion of peritoneal pigment) essentially miniature adults and can be distinguished readily on the basis of adult characters (e.g., eye morphology, presence or absence of dentary fossa, posterior extent of lateral line, arrangement of cephalic latero-sensory pores, dentition, pigmentation, meristic and morphometric characters). Final fusion of the peritoneal pigment sections occurs by about 35 mm SL (*Coccorella*, *Evermannella*) or by about 45 mm SL (*Odontostomops*).

RELATIONSHIPS

The evermannellids were poorly known until the completion of Johnson's (1982) revision. Currently recognized are 7 species in 3 genera (Fig. 130). Phylogenetic analysis involving presumably derived states of 16 characters or character complexes supported previous allocation of species among the 3 genera. In the listing that follows characters are given as character number (derived state number). Of the 16 characters, 2 involved larval features (Table 67: 15, 16). Of the 14 adult characters, 5 represented novel autapomorphies (Table 67: 2, 3, 8, 10, 11), 3 exhibited a sequence of 3 steps (Table 67: 1, 6, 12) and 6 represent reductive characters (Table 67: 4, 5, 7, 9, 13, 14). *Odontostomops* is specialized in having 12 or more serially arranged peritoneal pigment sections 15 (18) and in two reductive characters 7 (9) and 9 (11). *Coccorella* exhibits autapomorphies in four characters: cephalic extension of pyloric caecum 2 (3), presence of luminous tissue 3 (4), posterior expansion of ethmoid cartilage 8 (10), arrangement and morphology of dentary and palatine teeth 11 (13) and is apomorphic in two additional reductive characters 12 (14) and 14 (17). *Coccorella atrata* is apomorphic in two reductive characters, 12 (15) and 13 (16). Linking *Coccorella* and *Evermannella* are intermediate states in the two 3-step characters 1 (1) and 6 (7). *Evermannella* shows

autapomorphies in three characters: unique pattern of juvenile phase pigmentation 16 (19) and presence of vertically elongate fossa at dentary symphysis 10 (12), presence of fully tubular eye, 1 (2), unique to them among evermannellids, and show further reduction in the number of lateral line segments 6 (8). A single reductive character 14 (17) also shared with *Coccorella* links *E. indica* and *E. ahlstromi* and *E. megalops*. A final, questionable character 5 (6) links the latter two. In each case well-defined autapomorphous features support the hypothesis of monophyly of each genus and the information available appears to adequately support most of the proposed scheme.

Details concerning the contribution of two larval characters to this analysis are discussed below.

Peritoneal pigment sections.—Discrete peritoneal pigment sections are striking features of most aulopiform but not myctophiform fishes (Johnson, 1974b, 1982; Okiyama, 1974b, this volume). A single dorsomedial section characterizes the larvae of all *Aulopus* (Okiyama, this volume), chlorophthalmoids and (primitively) scopelarchids. Multiple (3 or more, serially arranged, paired or unpaired) sections occur in ipnopids (*Bathypterois*), bathysaurids, synodontids, harpadontids, paralepidids, *Omosudis* and evermannellids. Peritoneal pigment sections are paired, left and right, in synodontoids (*sensu* Johnson, 1982) but single and connected dorsomedially over the gut in alepisauroids. Peritoneal pigment sections are apparently lacking in notosudids, some ipnopids, *Alepisaurus*, neoscopelids (peritoneal pigment present but not in a discrete section, see Okiyama,

this volume) and myctophids. Johnson (1982) concludes that a single dorsomedial section is primitive for aulopiform fishes. Three unpaired sections are found in larvae of *Coccorella*, *Evermannella*, *Omosudis* and the paralepidine barracudina *Paralepis atlantica* (said by Rofen, 1966a:238, to be "... the most primitive species in the Paralepididae."). Larvae of *Odontostomops normalops* exhibit 12 or more unpaired peritoneal pigment sections, unique in the order, and a feature regarded as autapomorphous.

Juvenile phase pigmentation.—Johnson (1982) regarded fixation of the trilateral longitudinal pattern of juvenile phase pigmentation, as described above, as autapomorphous for the genus *Evermannella*.

It has long been supposed (Gregory and Conrad, 1936; Marshall, 1955; Gosline et al., 1966) that the Scopelarchidae and Evermannellidae are closely related. This supposition was based mainly on the occurrence of tubular eyes in both groups. Johnson (1982) argues against this notion, rejecting any close relationship of the Evermannellidae and Scopelarchidae, placing the latter (tentatively) among the chlorophthalmoids, and placing the Evermannellidae as the sister group of the Omosudidae plus Alepisauridae. The evidence for these conclusions is presented in Johnson (1982) and briefly summarized in the account of the Scopelarchidae in the present work.

FIELD MUSEUM OF NATURAL HISTORY, ROOSEVELT ROAD AT LAKE SHORE DRIVE, CHICAGO, ILLINOIS 60605.

Myctophiformes: Relationships

M. OKIYAMA

IN the traditional concept, the order Myctophiformes is considered to be a monophyletic assemblage with taxa having much the same levels of organization, even though they have undergone considerable adaptive radiation including some extremely specialized forms for particular habitats (Goody, 1969; Marshall and Staiger, 1975; Johnson, 1982).

Modern definition of the order including 16 families was first established by Gosline et al. (1966). They recognized the following two suborders:

Myctophoidei: Aulopidae, Synodontidae, Bathysauridae, Harpadontidae, Bathypteroidae, Ipnopidae, Chlorophthalmidae, Myctophidae and Neoscopelidae.

Alepisauroides: Notosudidae (=Scopelosauridae), Paralepididae, Omosudidae, Alepisauridae, Anopteridae, Evermannellidae and Scopelarchidae.

This dichotomous system has been generally followed by recent workers (Rosen and Patterson, 1969; Marshall and Staiger, 1975; Sulak, 1977), despite some minor changes or disagreements in the definition of family limits. On the other hand, Gosline (1971) proposed the idea of splitting the order into four groups (!) without giving rigorous evidence.

Rosen (1973) reevaluated the relationships among the Myctophiformes and produced a very different provisional classi-

fication based on a cladistic analysis of the group, where all of the myctophiform fishes (except Myctophidae and Neoscopelidae) form a monophyletic group, and likewise all the alepisauroid families (except Giganturidae) form a monophyletic assemblage. His phyletic hypothesis is radically different from those of Gosline et al. (1966) and Johnson (1982).

Notosudidae was later transferred from Alepisauroides to Myctophoidei (Bertelsen et al., 1976), and furthermore, Scopelarchidae was removed from Alepisauroides (*sensu lato*) in the recent study of Johnson (1982) who further subdivided the order into five possible major groups in three perceived lineages (Fig. 131).

Among these studies, Johnson (1982) is unique in carefully evaluating larval characters such as the peritoneal pigment sections and the stomach pigmentation in juveniles, in considering myctophiform phylogeny with special references to Scopelarchidae and Evermannellidae.

As finely reviewed by Kendall (1982), myctophiforms provide an excellent example for elucidating systematic relationships among fishes using larval characters, because larvae are known for representatives of most of the families and in some cases nearly all of the species within the families. Potential usefulness of the larval groups in this connection has been well documented for several families such as Myctophidae (Mosser and Ahlstrom,

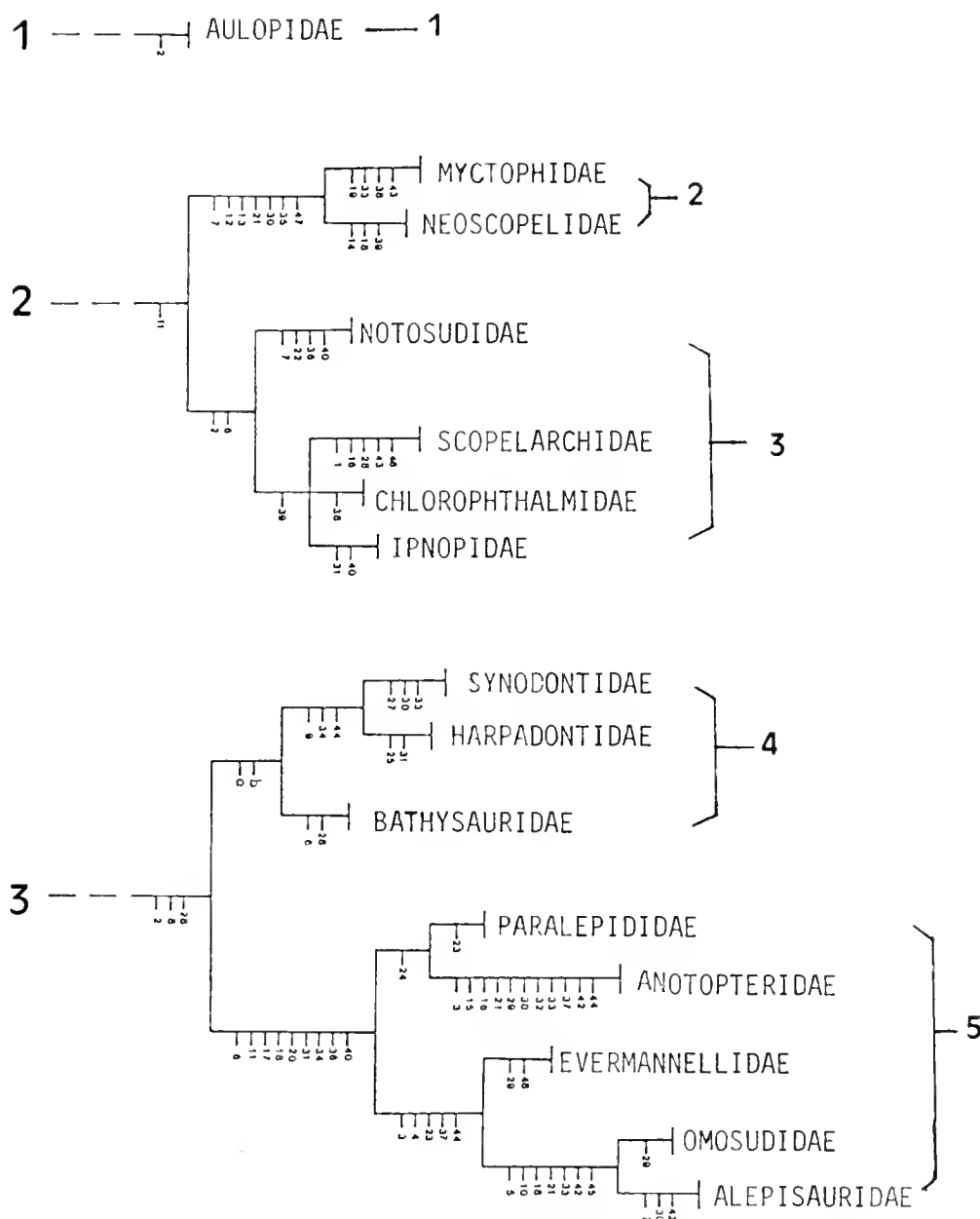

Fig. 131. Possible interrelationships among myctophiform fishes (Johnson, 1982).

1972, 1974), Scopelarchidae (Johnson, 1974b, 1982), Notosudidae (Bertelsen et al., 1976) and Evermannellidae (Johnson, 1982). At higher taxonomic levels, Okiyama (1974b, 1979b, 1981) considered the relationships among families with particular reference to the peritoneal pigment sections in association with the meristic features of the axial skeleton, notably precaudal and caudal vertebrae. Larval characters of possible systematic importance among Myctophoidae in Okiyama (1979b) have been closely analyzed by Kendall (1982) in establishing familial interrelationships on the basis of the cladistic method, although several larval stages critical to this were not available at that time.

Since current knowledge reveals slightly different conclusions for larval characters of potential phylogenetic importance from

those employed in Okiyama (1979b), some comments are given below for a revised character catalogue with a discussion of possible evolutionary direction. The determination of this directional change is generally based on the assumption that the family Aulopidae, as presently considered, represents the primitive character state.

In the following discussion, the character states believed to be primitive are all identified with a "0," and those believed to be derived are designated by a positive integer.

Peritoneal pigment sections (1).—The development of the discrete peritoneal pigment sections is a remarkable feature of larval myctophiform fishes. Nothing is known of their function, but the systematic importance of this unique structure has been

TABLE 68. DISTRIBUTION OF LARVAL CHARACTER STATES AMONG MYCTOPHIFORM FAMILIES.

Family	Characters								D*	
	1	2	3	4	5	6	7	8		
Aulopidae (Au)	0	0	0	0	0	0	0	0	0	3
Myctophidae (My)	3	1	0	1	0	0	0	0	0	3
Neoscopelidae (Ne)	3	1	0	1	0	1	2	0	0	5
Chlorophthalmidae (Ch)	0	0	0	0	0	0	0	0	0	0
Ipnopidae (Ip)	0	0	1	1	0	0	0	0	0	2
Notosudidae (No)	3	0	0	0	1	0	1	0	0	3
Scopelarchidae (Sc)	0	1	0	0	1	0	0	0	0	2
Bathysauridae (Ba)	1	1	2	0?	0	0	1	1	1	5
Harpadontidae (Ha)	2	1	0	0	0	0	1	0	0	3
Synodontidae (Sy)	2	1	0	0	0	0	1	0	0	3
Alepisauridae (Al)	3	0	1	1	0	1	2	1	1	6
Anopteroideae (An)	3	0	0	0	0	0	1	1	1	3
Evermannellidae (Ev)	1	1	0	0	1	0	2	1	1	5
Omosudidae (Om)	1	0	0	0	0	1	2	1	1	4
Paralepididae (Pa)	1	0	0	0	0	0	1	1	1	3

* Number of derived character states.

repeatedly emphasized (i.e., Okiyama, 1974b, 1979b, 1981; Johnson, 1974b, 1982). Contrary to earlier understanding (Okiyama, 1974b), much diversity of this character has been revealed. Based on the number and shape of the sections, a provisional classification is as follows: (A) Dorsomedial pigment sections; (A-1) Single patch—Aulopidae, *Chlorophthalmus*, *Bathytrophops*, *Rosenblattichthys*, *Scopelarchoides* (in part); (A-2) Many (three or more)—Bathysauridae, *Bathytrophis* (in part), *Sudis*, Omosudidae, Evermannellidae; (A-3) Single to many patches with growth—Paralepididae (except *Sudis*). (B) Paired pigment sections—Harpadontidae, Synodontidae. (C) Dorsomedial and paired pigment sections—*Scopelarchoides* (in part), *Scopelarchus*. (D) No pigment sections—Neoscopelidae (except *Solivomer*), Myctophidae, *Ipnops*, *Bathymicrops*, *Bathytrophis* (in part), *Benthalbella*, Notosudidae, Alepisauridae, Anopteroideae.

Rare exceptions are also known for several of these types. The only known exception to the presence of the A-3 type in paralepidids is in *Notolepis coatsi* with a single pigment section throughout all stages (Efremenko, 1978, 1983a). However, the ontogenetic development of this section into the extensive peritoneal pigment tube around the gut as in other paralepidids reveals little phylogenetic difference for this exception. Among those having B-type, some *Synodus* reportedly lack the peritoneal pigment sections and may represent an extremely specialized character state (Cressey, 1981). On the contrary, a myctophid, *Protomyctophum anderssoni*, is known to develop the serially arranged paired pigment patches similar to those of B-type (Moser and Ahlstrom, 1974; Efremenko, 1976). Their overall resemblance including this pigmentation may be a result of a simple convergence.

As is clear from the above classification, character states are remarkably diverse in the Scopelarchidae and Ipnopidae. C-type, peculiar to the former, is of particular significance in suggesting the possible direction differentiating the paired and unpaired character states (Johnson, 1974b). Unclear limits of the family are partly responsible for the confusion in Ipnopidae.

It is generally agreed that the presence of a single, dorsomedial peritoneal pigment section (A-1 type) represents the primitive state. Since A-3 and C types are referable to the ranges of either A-1 or 2, four states are recognized as in Johnson (1982): (0) =

A single, dorsomedial peritoneal pigment section. (1) = Multiple (3 or more), serially arranged, unpaired peritoneal pigment sections. (2) = Multiple (3 or more), serially arranged, paired peritoneal pigment sections. (3) = Peritoneal pigment section absent.

Position of anus (2).—Contrary to the usual pattern of the anus location immediately anterior to the anal fin origin in much teleosts, a more or less wide preanal interspace is commonly shared by many taxa of this order. This character can be of much use in distinguishing the groups of Myctophiformes (Rosen, 1971; Okiyama, 1979b). The character states of the diverse anus location relative to the pelvic fins are not recognized herewith due to the unclear patterns of occurrence.

The ontogenetic rearward shift of the anus is restricted to some speciose families such as Scopelarchidae, Paralepididae (except *Sudis*), Notosudidae, and Myctophidae (in part). There is, however, a sharp contrast in the final condition among them: no preanal interspace in Myctophidae and Scopelarchidae vs a distinct space in the remaining two. As in Kendall (1982), who employed this character in the first step of branching, two character states are recognized. (0) = Anus with interspace from the origin of the anal fin. (1) = Anus just in front of the origin of the anal fin.

Fin features (3).—Except Bathysauridae with magnificently enlarged fins, the elongated pectoral fins are the pronounced larval character found in many representatives of this order. The Ipnopidae displays the most diverse pattern of specialized pectoral form in being bifid, large and fan-like, or extremely elongated. Parallel features are known to occur sporadically in some specialized myctophidae (Moser and Ahlstrom, 1970, 1974). Scopelarchidae is another member of less cohesiveness in this character; prominent pectoral fins are peculiar to *Rosenblattichthys*, the most specialized genus in this family (Johnson, 1974b). Likewise, only the aberrant genus *Sudis* has elongated pectoral fins in Paralepididae. The character states recognized are: (0) = All fins short. (1) = Only pectoral fins elongated. (2) = All fins elongated.

Sequence of fin formation (4).—Although current knowledge is far from complete, dichotomous patterns can be recognized in the sequence of fin formation, especially in the pectoral fins. Johnson (1982) defined the derived character state of *Rosenblattichthys* by the development of pectorals prior to all fins except caudal. The precocious nature of this fin apparently represents the derived state. (0) = Pectoral fins not precocious. (1) = Pectoral fins precocious.

Eye shape (5).—Moser and Ahlstrom (1974) showed that two types of eyes, i.e., round and narrow, reflect the major two lineages of Myctophidae with several exceptions. These patterns are commonly duplicated at familial levels in this order. In view of the specialized morphology of the narrow eyes including the peculiar choroid tissue and following the suggested phylogeny of Myctophidae (Moser and Ahlstrom, 1974), round or nearly round eyes are regarded primitive. The states recognized are: (0) = Eyes rounded or nearly rounded. (1) = Eyes narrowed.

Head armature (6).—The development of head spines is rare or rather exceptional particularly in the adult myctophiform fishes. However, larvae of at least five families have head armature. These include preopercular spines and supraorbital and/

TABLE 69. SIMILARITY MATRIX OF 15 FAMILIES OF MYCTOPHIFORMES. Based on the total number of characters shared in the same state regardless of the primitive or derived (below the diagonal) and that of the shared derived states (above the diagonal, with similarity index in parentheses). Subordinal groups are indicated by enclosure. Similarity index is calculated by the following formula: $P_{ij} = (C_{ij}/\sqrt{S_i \cdot S_j}) \times 100$, where S_i and S_j are number of derived characters in families i and j , and C_{ij} is number of the shared derived states between the same set of families.

	Au	My	Ne	Ch	Ip	No	Sc	Ba	Ha	Sy	Al	An	Ev	Om	Pa
Au	—	0	0	0	0	0	0	0	0	0	0	0	0	0	0
My	5	—	3 (77)	0	1 (40)	1 (33)	1 (40)	1 (26)	1 (33)	1 (33)	2 (47)	1 (33)	1 (26)	0	0
Ne	3	6	—	0	1 (22)	1 (26)	1 (32)	1 (20)	1 (26)	1 (26)	1 (55)	1 (26)	2 (40)	2 (45)	0
Ch	8	5	3	—	0	0	0	0	0	0	0	0	0	0	0
Ip	6	5	3	6	—	0	0	1 (32)	0	0	2 (58)	0	0	0	0
No	5	4	3	5	3	—	1 (45)	1 (20)	1 (33)	1 (33)	1 (24)	2 (67)	1 (26)	0	1 (33)
Sc	6	5	3	6	4	5	—	1 (32)	1 (41)	1 (41)	0	0	2 (64)	0	0
Ba	3	3	2	3	2	2	—	—	2 (52)	2 (52)	0	1 (26)	1 (20)	0	1 (26)
Ha	5	5	4	5	3	5	5	—	—	3 (100)	0	1 (33)	1 (26)	0	1 (33)
Sy	5	5	4	5	3	5	5	5	—	—	0	1 (33)	1 (26)	0	1 (33)
Al	2	4	5	2	4	2	0	2	1	1	—	—	2 (47)	2 (37)	3 (61)
An	5	4	3	5	3	6	3	5	5	5	4	—	—	1 (26)	1 (29)
Ev	3	3	3	3	2	4	5	5	5	5	2	4	—	—	3 (67)
Om	4	2	4	4	2	3	2	4	3	3	5	5	5	—	—
Pa	5	3	2	5	3	4	3	6	5	5	3	7	5	6	—

or frontal ridges. Development of head armature generally occurs in the forms with a massive head more than 30% of body length, thus suggesting the specialized condition of this character. Several myctophid species (*Lampanyctus*) having preopercular spines provide a fine example of this trend, while this is not the case in Scopelarchidae. According to Nafpaktitis (1977), the character state of *Neoscopelus* is assigned to the Neoscopelidae. The states recognized are: (0) = Head armature absent. (1) = Head armature present.

Body shape (7).—The general body shape can range from extremely slender and elongate to stubby and deep. These are tentatively grouped into three character states with possible evolutionary trends towards the opposing directions from the moderately slender body shape shared by primitive groups such as Aulopidae and Chlorophthalmidae. The character states recognized are: (0) = Body moderately elongate. (1) = Body extremely slender and elongate. (2) = Body stubby and deep.

Pigment spots or area (8).—Johnson (1982) suggested the potential importance of pigmentation other than the peritoneal sections in the systematics of the Myctophiformes, even at high taxonomic levels. A difficulty in this regard is how to recognize the meaningful character states. Based on the various pigmentation patterns in the tails of larvae (posterior to the anus except for the caudal fin) such as (a) absent, (b) present along only the ventral midline, and (c) present along lateral or dorsal surfaces of body sometimes forming clear bands, formal recognition of this character is undertaken. Since patterns (a) and (b) are shared commonly during the ontogeny of the same species, two character states are recognized with the assumption that (c) represents the derived state. (0) = Pigment spots or areas in tail absent or present along only the ventral midline. (1) = Pigment spots or areas in tail present along lateral or dorsal surface.

The primitive or derived states for these eight characters are summarized in Table 68. Family level designation of character

states is mostly based on the assumption of Johnson (1982) that "possession by one or more representatives of a particular OTU of a state considered primitive indicates (except where contrary evidence can be cited) the primitiveness of that state for that OTU."

A similarity matrix based on the total numbers of characters shared in the same state, regardless of whether the states are primitive or derived, is given below the diagonal in Table 69. Above the diagonal are shown the numbers of derived characters shared in the same state and the similarity index calculated on the same data. These two sets of figures are expected to reveal certain clues to clarify the interfamilial associations of this order from the larval standpoint.

AULOPOIDEI: AULOPIIDAE

So far as the selected larval characters are concerned, the Aulopidae can not be separated from the Chlorophthalmidae. This unclear distinction is due to the limited numbers of characters selected, because other larval and adult features shown in Table 70 reveal the trenchant differences between them. Of these, the possession of maxillary teeth and fuleral scales, and the earlier differentiation of the peritoneal pigment spots well justify the distinct and less specialized systematic status of the Aulopidae. Other aspects of sharp contrast such as in the dentition, particularly of the basihyal, and gut morphology substantiate the above conclusion.

Although the diversity within the Aulopidae once suggested on the basis of larval characters (Okuyama, 1974b) has proved to be unacceptable, there still remain problems concerning the monotypic nature of this family. As mentioned elsewhere (Okuyama, 1979b), it is likely that the Myctophiformes evolved along several lines, one of the major trends being the elongation of the body shape accompanying an increase in vertebral number. Obviously, aulopids lie near the base of this trend with clear orientation toward an increase in the number of abdominal components. The uniquely elongated larval oesophagus in *A.*

TABLE 70. ANATOMICAL DIFFERENCES OF EARLY STAGES BETWEEN *AULOPUS* AND *CHLOROPHTHALMUS*.

Characters	<i>Aulopus</i>	<i>Chlorophthalmus</i> [after Rosen (1971) and Sulak (1977)]
Maxillary teeth	Present	Absent
Vomerine teeth	Only two widely separated at opposing anterolateral corner	Transverse row of six teeth divided into two rows of three each
Basihyal	Ovoidal with slightly indented tip; teeth absent	Triangular with similar anterior indentation; a transverse row of six teeth divided into two series
Fulcral scale	Present	Present(?)
Gut morphology	Moderately elongated, straight; intestine slightly fat	Short, compact with slender stomach; intestine fat
Peritoneal pigment sections	Single; distinct at less than 3.5 mm SL	Single; distinct at more than 5 mm SL

japonicus is a probable indication of this evolutionary trend (Okiyama, 1974b). Among recent congeners, *A. damasi* may be the most generalized species in view of its smallest number of vertebrae (20 + 16) similar to the known counts in the fossil aulopids (Goody, 1969; Rosen and Patterson, 1969). Furthermore, this species is clearly separable from congeners by the mode of direct association between the first haemal spine and anal pterygiophores (Okiyama, 1979b). A look at the larvae of *A. damasi* would be enlightening in clarifying the problem in question.

MYCTOPHOIDEI: NEOSCOPELIDAE,
MYCTOPHIDAE

The two families of this suborder are readily discriminated from the others by the greatest similarity index value based on a suite of derived characters (1 and 2) not shared by any other families. The smaller sizes at metamorphosis are also peculiar to these families. These larval evidences offer strong support for the views of Moser and Ahlstrom (1974) and Johnson (1982), warranting a distinct subordinal ranking. My observation of the vertebrae of *Solivomer* (see Table 57 in my Myctophiformes: Development, this volume) also disclosed their closer linkage than assumed by Johnson (1982).

The similarity matrix in Table 69 would offer little support for Rosen's scheme to transfer these families to a different order.

CHLOROPHTHALMOIDEI: NOTOSUDIDAE,
SCOPELARCHIDAE, CHLOROPHTHALMIDAE,
IPNOPIDAE

The larval character states indexed in Table 71 are less promising in support of this familial assemblage, because only the Notosudidae and Scopelarchidae share a single derived character state (narrow eye). It seems that this ambiguity is also associated with the inadequate numbers of characters in question.

Although the admitted cohesiveness of larval characters of Chlorophthalmidae may be altered by the discovery of larval *Bathysauropsis* or *Parasudis*, larval characters support the traditional view that it is one of the basal stocks of this order, lying

TABLE 71. DISTRIBUTION OF LARVAL CHARACTER STATES AMONG FOUR GENERA OF THE IPNOPIDAE.

Genus	Characters								D*
	1	2	3	4	5	6	7	8	
<i>Bathytyphlops</i>	0	0	1	1	0	0	0	0	2
<i>Ipnoops</i>	3	0	1	1	0	0	1	0	4
<i>Bathymicrops</i>	3	0	1	1	0	0	1	0	4
<i>Bathypterois</i>	1	1	1	1	0	0	0	1	5

* Number of derived character states.

at a somewhat advanced place along a line different from the Aulopidae. Trenchant characters in this connection such as the dentition and the mode of anal fin support are shared with the IpnoPIDAE.

Members of the Notosudidae, the most cohesive family in this suborder, have the greatest numbers of derived characters of the group. Marshall (1966a) and Bertelsen et al. (1976) stated that it seems most closely related to Chlorophthalmidae. The superficial resemblance of larval stages between this and the Paralepididae was also suggested (Ahlstrom, 1972a). On the other hand, the similarity matrix indicates its affinity with Anotopteridae, along with Scopelarchidae. Of these associations, the last grouping based on a single derived state in character 5 (narrow eye) appears less arguable. Other features such as the maxillary teeth and the uncommon morphology of the corpus cerebelli suggest the aberrant systematic status of this family.

Since Table 68 provides few clues to discuss the confused family limits of the IpnoPIDAE, the same coding of the character states is applied to the four genera of this family (Table 71). Except for the distinct larval status of *Bathypterois*, derived characters shared among the remaining three genera do not reveal the generic linkages suggested by Sulak (1977). By the same reasoning as discussed before concerning the relationships between Aulopidae and Chlorophthalmidae, the derived state in character 1 (peritoneal pigment sections) shared by *Ipnoops* and *Bathymicrops* includes the different states of gut morphology. It seems these genera form a loose but distinct assemblage warranting family rank. Besides the shared dentition mentioned before, the close fit of general larval morphology between *Bathytyphlops* and *Chlorophthalmus* may suggest their relationship.

The diverse larval characters of Scopelarchidae were elaborately analyzed in the light of adult systematics (Johnson, 1974b). It is remarkable that this family has no phenetic similarity with Alepisauridae in terms of catalogued characters. On the other hand, two derived states in character 2 (anus location) and 5 (eye shape) shared with Evermannellidae give the greatest similarity index value. Johnson (1982) suggested the independent occurrence of the tubular eyes in adults of both families, but traditional concepts of their close association should be reevaluated using larval evidence.

SYNODONTOIDEI: BATHYSAURIDAE,
HARPADONTIDAE, SYNODONTIDAE

Accepted linkage between Synodontidae and Harpadontidae is clearly substantiated by the larval characters, while familial allocation of *Saurida* remains to be solved. *Synodus lucioiceps*, having the intermediate state of larval characteristics between these families, may be important here. The relationships among four genera are thus indistinct from the standpoint of the larvae, but *Saurida* appears to be the most generalized. Possible phy-

logenetic association between Aulopidae and these families has been suggested on the basis of larval characters and the similar mode of anal fin support (Okiyama, 1974b, 1979b). To these can be added the peculiar structures on the chorion surface of the extremely transparent eggs, the pigmentation patterns in the newly hatched larvae, and the mode of reproduction shared by these families, characters which favor their close association.

Bathysauridae is distinguished from other families of this suborder by some trenchant differences in the peritoneal pigment sections and the mode of reproduction, while two derived states are shared by all families. The phylogenetic relationship of these families depends on whether the above mentioned differences are due to divergence. Larval stages of Bathysauridae are surely highly specialized, adapting to a prolonged pelagic life, but larval dentition described in detail by Rosen (1971) and Johnson (1974) and the character state of the axial skeleton, including the mode of anal fin support (Okiyama, 1976b) are of particular interest in showing the pattern common to Ipno-pidae.

ALEPISAUROIDEI: PARALEPIDIDAE,
ANOTOPTERIDAE, EVERMANNELLIDAE,
OMOSUDIDAE, ALEPISAUROIDAE

The similarity matrix provides certain indication of the cohesiveness of this suborder. Most remarkable is their common sharing of the derived state of character 8. Regarding the peritoneal pigment sections dividing five families into two groups, some comments are warranted for Alepisauridae. As discussed by Johnson (1982), this character state is very tentatively defined due to the inadequate state of available material. Even so, a distinct family pair of Alepisauridae and Omosudidae can be readily separated from the remaining families by the many derived character states shared by them. Although the possibility of their convergence cannot be fully rejected in view of the clear contrast in the ontogenetic aspects of the pectoral fins, the close similarity between *Alepisaurus ferox* and *Omosudis lowei* (tropical western Pacific specimen) (see my Myctophiformes: Development, Fig. 112B, E, F, this volume), in head armature and pigment pattern is extremely striking.

An association between the Anotopteridae and Paralepididae, particularly the more elongated paralepidids such as *Stemonosudis* and *Macroparalepis* (Rofen, 1966a, c), can be seen from the larval standpoint. In addition to their shared derived character states (character 7 and 8), a fleshy projection on the lower jaw tip peculiar to Anotopteridae and *Stemonosudis macrura*, and the similar larval dentition (huge canines) may substantiate the above association. Their disagreement in the character of the peritoneal pigment sections is probably associated with the odd systematic position of Anotopteridae lying at "an extreme specialized end-point of the paralepidid line" (Rofen, 1966a, c).

On the basis of the larval characters, two subfamilies of Paralepididae are well separated. As compared with the relative constancy of conservative characters in larval Paralepidinae, the many derived character states of larval Sudinae are too specialized to be consistent with the accepted subfamilial level. The latter may be an earlier offshoot preceding the remarkable paralepidine radiation. The complete lack of intermediate forms between them offer strong support for this suggestion.

As in Scopelarchidae (Johnson, 1974b), the systematics of Evermannellidae were studied in detail using a large character suite, including larval aspects (Johnson, 1982). So far as the present analysis is concerned, this family seems variously associated with families of Alepisauroidae such as Paralepididae, Alepisauridae and Omosudidae, besides Scopelarchidae. It is of interest that limited character states shared by Evermannellidae and Alepisauridae are restricted to derived ones, probably suggesting their close association. Perhaps, an Evermannellidae and Scopelarchidae linkage is much more loose, if valid.

Concerning the possible three main lineages in this order, the larval evidence is less promising. However, additional larval evidence regarding developmental sequences, including osteology as well as internal morphology, would provide much more fruitful information for elucidating the phylogeny of this interesting group.

OCEAN RESEARCH INSTITUTE, UNIVERSITY OF TOKYO, 1-15-1,
MINAMIDAI, NAKANO-KU, TOKYO 164, JAPAN.

Gadiformes: Overview

D. M. COHEN

GADIFORMES is a particularly interesting order with which to work because it encompasses a high degree of diversity that suggests the existence of several lineages, apparent convergence and reductive trends to trap the unwary, a useful fossil record that allows a consideration of the distribution in time of some important taxa and character states, and new suites of characters based on the study of ELH stages.

Although study of the classification of gadiforms dates from pre-Linnean times, there is still insufficient properly evaluated data available to derive a phyletic classification. In fact, there is not even agreement as to what should be included. Berg (1947)

restricted the order to the muraenolepids, bregmacerotids, morids, and gadids (including merlucciids) and excluded the macrourids. He noted primitive and advanced characters in his gadiforms and suggested derivation from primitive fishes. Rosen and Patterson (1969) revived an expanded Gadiformes dating at least from the time of Gill, which included not only gadoids and macrourids but also ophidioids and zoarcoids, and which they placed in a supraorder Paracanthopterygii, postulated as being, "in many ways more primitive than the acanthopterygians" and representing "a spiny-finned radiation more or less comparable morphologically with that of the Acanthopterygii"

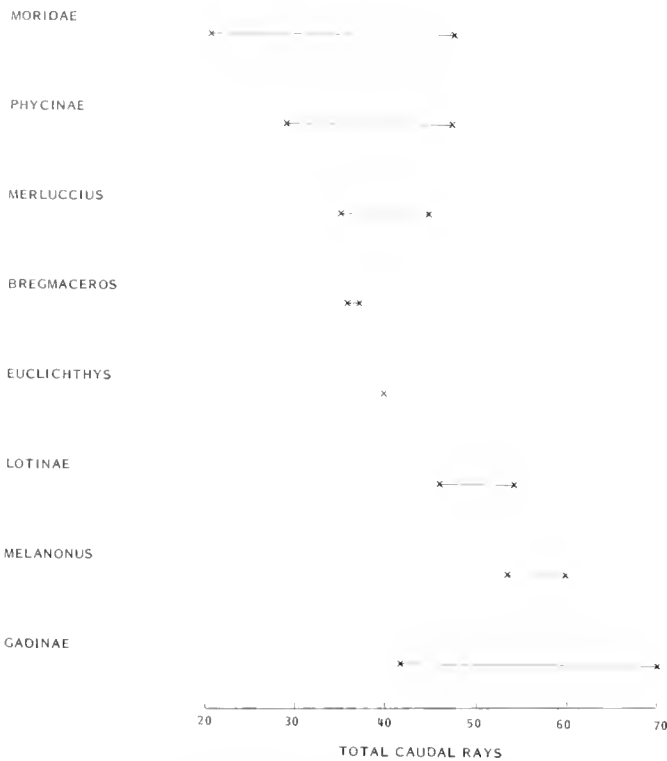

Fig. 132. Total caudal rays in eight groups of gadiform fishes. Data from Fahay and Markle (this volume) and original.

and including in addition to their gadiforms the polymixoids, percopsiforms, batrachoids, lophiiforms, and gobiesocoids. Gosline (1968) analyzed the characters used in defining the expanded Gadiformes and concluded that ophidioids and zoarcoids are perciform derivatives, while gadoids are widely separate and probably close to the percopsiforms (Gosline, 1963a). Marshall and Cohen (1973), whom I follow for present purposes, restricted the Gadiformes to the gadoids and macruroids but did not consider the question of relationships. In the following brief preliminary consideration of the order, I discuss several characters, mention the groups that I think must be considered, and outline some of my ideas about the course of evolution in the gadiforms.

CHARACTERS

Several character complexes that require consideration are discussed below. Others are noted later under groups in which they occur. Additional relevant information is presented by Fahay and Markle and Dunn and Matarese in subsequent sections of this volume.

Caudal fin.—Considering the fact that well over half the known species of gadiform fishes lack the slightest vestige of a caudal fin, it is a little astonishing how much importance has been attached to the origin and homologies of the various skeletal supports and of the fin rays themselves. There is no denying, however, that when present the gadiform caudal complex is unique in several respects. Most fish groups may be characterized by a set number of branched caudal rays. Furthermore, the branched rays are generally supported by only hypurals. In gadiforms with tail fins, the number of branched caudal rays is

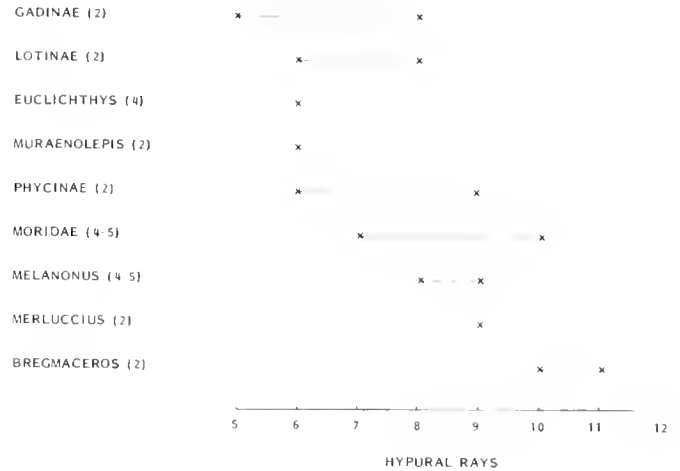

Fig. 133. Numbers of hypural bones (in parentheses) and fin rays supported by hypural bones in nine groups of gadiform fishes. Data from Fahay and Markle (this volume) and original.

highly variable, as is their skeletal support. *Bregmaceros* may have as few as 12 branched caudal rays, most of which are supported by hypurals, while at the upper end of the range, the lotine *Brosme* may have as many as 43 branched rays, which are supported by hypurals, epurals, and haemal and neural spines. This high degree of variation in an otherwise conservative anatomical complex lends credence to the idea of Boulenger (1902) and Regan (1903b) that the caudal fin of gadiforms is a structure newly evolved from an essentially tailless condition such as that of the macrourids or of some merlucciids. It was partly to test Regan's hypothesis that Barrington (1937) compared the development of the caudal fin of *Gadus* with that of *Pleuronectes* and concluded that, although the tail of *Gadus* was unique in several respects, it could have been derived from an ordinary homocercal tail that was less specialized than that of *Pleuronectes*. I agree with Barrington. Barrington commented also on the presence in gadids of a high number of procurrent caudal rays, which he interpreted as being far posterior dorsal and anal rays, so that the functional caudal of a cod is composed of elements of three fins, dorsal, anal, and caudal proper. This interpretation has been neither falsified nor verified by the study of early life history stages. Barrington coined the term pseudocaudal for what he took to be this kind of fin. In his lectures and during conversations with me, Ahlstrom disagreed with Barrington's explanation and its acceptance by Marshall and Cohen (1973) because procurrent rays lack pterygiophores. It is instructive to note in this respect the caudal fin structure of *Muraenolepis* (see Fig. 143 of Fahay and Markle in this volume), which has confluent vertical fins and in which the distinctive, elongate pterygiophores grade into hypurals. It is, in fact, impossible to distinguish between the last anal pterygiophore and the first hypural or parhypural. But see Fahay and Markle later in this volume.

A variety of controversial interpretations (Gosline, 1963a; Monod, 1968; Rosen and Patterson, 1969) have been advanced concerning supposed sequences of fusions and deletions of bony elements in gadiform tails. This particular use of caudal fin structure in phylogeny has yet to be proven, as few hypotheses have been verified or falsified.

For purposes of classification within the order, at least four

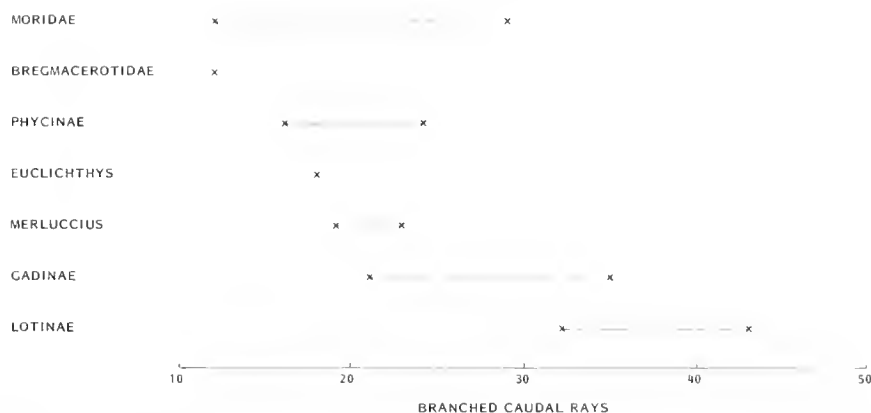

Fig. 134. Branched caudal rays in seven groups of gadiform fishes. Data from Fahay and Markle (this volume) and original.

caudal fin characters require comment. They are: 1) presence or absence of a caudal fin; 2) number of hypurals; 3) relationship between branched caudal rays, hypurals, and procurrent caudal rays; 4) presence or absence of X-Y bones.

Although vestiges of a caudal fin are sometimes found in a few macrourid species, it is essentially absent from all of them. The same is true of the merlucciid genus *Lyconus* and also *Steindachneria*. Loss of a caudal fin has certainly occurred two times and perhaps more.

The number of hypurals is a useful systematic character. There are almost always 4 or 5 in morids and *Melanonus*, and almost always 2 in gadids, *Merluccius*, *Bregmaceros*, and *Muraenolepis*; *Euclichthys* has 4, nearly fused to 2. I consider the lower number to be an advanced character; the study of developmental series has verified this interpretation for *Raniceps* at least (Dunn and Matarese, this volume). Certainly the loss of hypurals, whether through deletion or fusion has occurred several times in gadiforms.

The evolutionary complexity of the caudal fin in gadiforms is particularly apparent when considering the numbers of different kinds of caudal fin rays (Figs. 132–134 and Fahay and Markle, this volume, Table 76). Morids in general have caudal fins that are small and probably of reduced importance in propulsion, and which I interpret as a derived state; they also have generally fewer total rays, which Fahay and Markle (this volume) consider an ancestral state, and unbranched rays that tend to be short and contribute little to overall caudal fin size; yet, morids have 4–5 hypurals. *Melanonus* also has a weakly developed caudal fin but has 4–5 hypurals and many rays. Gadine fishes on the other hand, have well-developed caudal fins with many rays, both branched and unbranched, but have only 2 hypurals. Gadines are in general good swimmers, and one of the most active of all, *Pollachius virens*, has the most total caudal fin rays (70 in one specimen) of any gadiform fish. (Sluggish fishes like the lotines, *Brosme* and *Lota*, also have numerous caudal fin rays but have rounded caudal fins and must swim in a very different way, probably using the caudal fin as an extension of the body rather than as an oar.) Although numbers of different kinds of fin rays may prove useful in taxonomy, the relationship of branched to unbranched or total caudal fin rays is variable and has limited apparent value in the present context.

Many gadiform fishes have in their caudal fin skeletons a pair of bone splints resembling neural and haemal spines. These structures have been mentioned in the literature as accessory

bones or X and Y bones and have been interpreted as modified relict pterygiophores or detached neural and haemal spines whose centra have been lost (Rosen and Patterson, 1969). I agree with Markle (1982) that the absence in any gadiform of X and Y bones is a derived character.

Dorsal and anal fins.—Gadiform fishes have 1, 2, or 3 external dorsal fins and 1 or 2 external anal fins. The number, size, and location of these fins have been used for hundreds of years to characterize groups of species. Prior to the recognition of Moridae as a distinct family (Svetovidov, 1937), convergence in this character was not recognized; most ichthyologists lumped gadids and morids with similar fin patterns.

Svetovidov (1948) assumed on functional grounds that a single dorsal and single anal is the primitive condition and arranged the gadid genera in a transition series based on increasing number of fins and the distance of their separation from each other. His hypothesis is supported by the presence in all gadiforms of a single, continuous, postanal series of pterygiophores, present even over areas that lack fin rays. Complete or partial division of the exterior fin has occurred several times, for example in the gadines, *Euclichthys*, *Merluccius*, and in the morid genera *Mora*, *Halargyreus*, *Lepidion*, *Laemonema*, and *Tripterophycis*.

Although only a few gadiforms have a single dorsal fin, the condition has a broad taxonomic distribution; examples are the gadid *Brosme*, the merlucciid *Lyconus*, *Melanonus*, and the macrouroidine rattails. Nearly all gadiforms have 2 or 3 dorsals, but even in those with 3, there are only two series of pterygiophores. From fewer to more dorsals would seem to be a reasonable transition series. But it certainly has occurred more than once, even within Gadidae, as Markle (1982) has demonstrated.

Pectoral radials.—Most gadiforms have five pectoral radials. *Muraenolepis* has more; *Bregmaceros* has fewer; both are interpreted as derived conditions.

First neural spine.—Many gadiforms have the first neural spine closely adpressed to the occipital crest. I take this as a derived character. *Muraenolepis* has a free spine, but it is modified by the presence of a prominent wing-shaped enlargement extending on either side of the occipital crest.

Olfactory lobes.—In his classical monograph on the Gadidae, Svetovidov (1948) discussed the position of the olfactory lobes

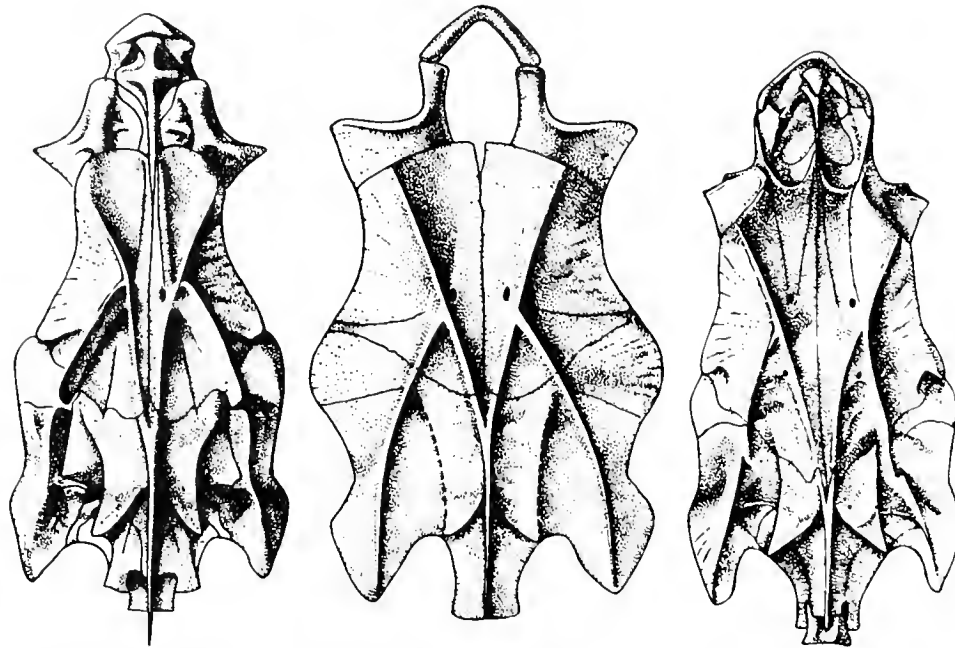

Fig. 135. Dorsal view of cranium in three genera of gadiform fishes; left, *Rhinoccephalus planiceps*; center, *Palaeogadus intergerinus*; right, *Merluccius merluccius*. From Fedotov (1976).

of the brain and used their advanced position, adjacent to the nasal capsule, as his primary character for defining the Gadiformes. This is a derived character, which has been found also in cyprinids, galaxiids, and mormyrids. Svetovidov noted that the olfactory lobe is located in an intermediate position in the gadid *Raniceps*. A posterior location of the lobe was subsequently recorded in *Melanomus* and several macrourids and an intermediate location in merlucciids, *Steindachneria*, the gadid *Raniceps*, and two macrourids (Marshall and Cohen, 1973). Svetovidov (1969) pointed out the size dependent nature of this character, especially in *Merluccius* (which I have verified in *M. bilinearis* and *M. productus*). Further investigation is required, especially in species that mature at small sizes.

V-shaped crest on skull.—As long ago as 1903b Regan noted the shared presence in *Merluccius* and *Macruronus* of prominent V-shaped ridges on the frontals, which converge on the supra-occipital crest. These structures have subsequently been found in the extinct genera *Rhinoccephalus* and *Palaeogadus* (Fig. 135) as well as in some fossil percopsiforms (Rosen and Patterson, 1969) and are present in varying degrees in *Lycomus* and *Steindachneria*.

GROUPS AND THEIR RELATIONSHIPS

In this section I briefly discuss those taxonomic units that I think require consideration and explain as best possible the reasons for their placement on Fig. 136.

"Protocodus" is an unnamed species¹ from the Paleocene of Greenland (discussed by Rosen and Patterson, 1969 and Fe-

dotov, 1976; I too have examined it), which is the oldest known non-otolith gadiform. It has a number of characters that may be interpreted as primitive for the group, including five, slender, well-separated hypurals, X-Y bones, numerous procurrent rays, and a V-shaped ridge on the frontals. It has a dorsal and anal fin configuration much like that of *Merluccius* (Rosen and Patterson, 1969).

Muraenolepis is a highly distinctive genus with four or more species. It has such primitive characters as a single anal and long-based second dorsal fin, a dermal basibranchial plate (Rosen and Patterson, 1969), the similarity of the lower hypurals to pterygiophores and to caudal fin elements, and a free first neural spine. Derived characters include 12–14 pectoral radials, a single epural, first dorsal fin a single-rayed anteriorly placed filament, vertical fins confluent around the tail, an oblique pattern of squamation, and modifications of the first neural spine. *Muraenolepis* is not obviously related to any other gadiform and appears to represent an ancient lineage.

Bregmaceros is another distinctive genus with no obvious close relatives. Like *Muraenolepis* it retains a dermal basibranchial plate, but this is a primitive character, as is possession of a uroneural and a set of X-Y bones in the tail. Derived characters include the conjunction of the first neural spine with the occipital crest, a large consolidated hypural plate supporting many branched rays, a unique lateral line system, only two pectoral radials, and a long dorsal ray on top of the head. The tropical pelagic habitat of these fishes is also different from that of any other gadiform. If fusion of the first neural spine with the occipital crest has occurred only a single time, then *Bregmaceros* must have originated after *Rhinoccephalus*.

Rhinoccephalus is an Eocene fossil, the skull of which has been described in some detail and compared with other gadiforms by Rosen and Patterson (1969). They mention and illustrate a

¹ The name "Protocodus" is used as a designation of convenience and does not have formal, nomenclatural significance.

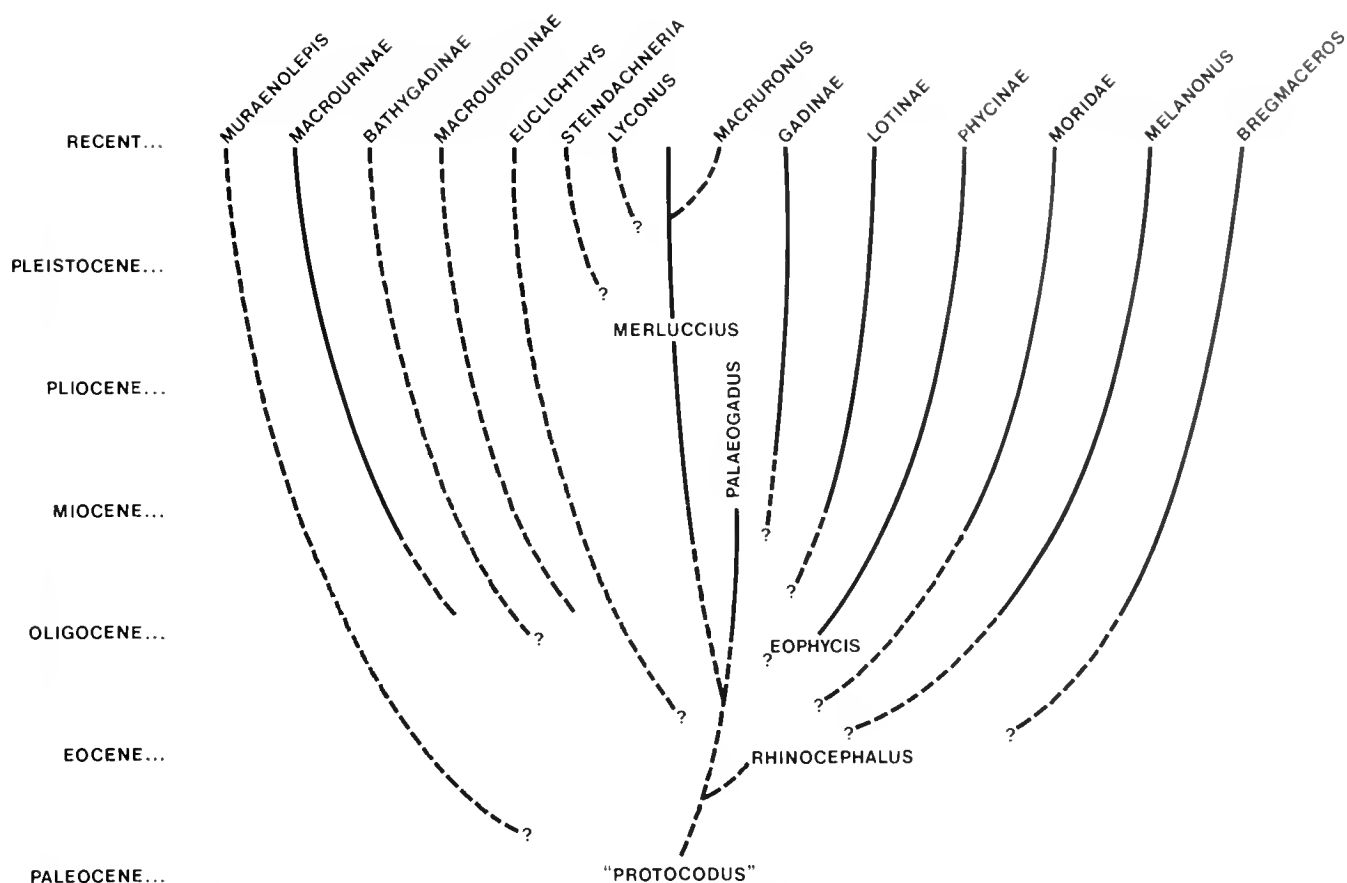

Fig. 136. Phylogenetic bush showing hypothetical inter-relationships among gadiform fishes. Beginning of solid lines based on fossils, not including otoliths or scales.

V-shaped ridge on the frontals and also lateral flanges on the rear of the skull that characterize gadines and at least some morids. They write, "The skull roof of *Rhinocephalus* shows many features common to morids, merlucciids, gadids, and macrourids . . ." In addition, the first neural spine is free from the supraoccipital crest.

Eulichthys (Fig. 137), represented by a single South Australian and New Zealand species, was incorrectly placed in Moridae but removed by Svetovidov (1969), who pointed out some similarities to Macrouridae. *Eulichthys* can not be placed in any currently recognized family. It has a free first neural spine, which may indicate an origin prior to *Palaeogadus*, lacks an otophysic connection, has four hypurals nearly fused to two, and in two specimens has only one of the X-Y bones. As in morids, which are more specialized than macrourids and could not have given rise to them, *Eulichthys* has an asymmetrical, rather reduced caudal fin. Perhaps this curious fish is a modern representative of a macrourid progenitor.

Macrouroidinae is represented by two small genera and has been treated both as a subfamily of Macrouridae (Marshall, 1973) and a separate family (Okamura, 1970a). It has single dorsal and anal fins and a number of distinctive features in the head skeleton and may represent the most primitive tail-less macrourid.

Macrourinae-Trachyrincinae, which may well constitute two

quite separate groups, has 20–25 genera and contains more than half of all gadiform species (Okamura, 1970a; Marshall, 1973). The caudal fin is absent in most, vestigial in a few; the first neural spine is free, and there is no V-shaped ridge. Eggs of the few species for which information is available have a distinctive hexagonal pattern; many species have light organs.

Bathygadinae, with two genera, differs from other macrourids in having a large, terminal mouth, dorsal rays longer than anal ones, and in a variety of other ways summarized by Okamura (1970a), who interprets most of the bathygadine characters as primitive ones. Differences in functional morphology between bathygadines as pelagic feeders and macrourines as benthic to benthopelagic feeders have been described by McLellan (1977).

Melanonus has two meso-to-bathypelagic species formerly placed in Moridae, where they do not belong as they lack an otophysic connection, have a single dorsal fin, and have lost the X-Y bones. Otherwise, they seem similar to Moridae. The first neural spine is joined to the occipital crest, suggesting an origin after *Rhinocephalus*. A separate family was proposed by Marshall (1965).

Moridae consists of 12–15 genera, some highly diverse, and all characterized by possession of an otophysic connection, 4 or 5 hypurals, X-Y bones, a joined first neural spine, and distinctive otoliths; many species have light organs. Morids probably diverged from the main *Rhinocephalus-Palaeogadus-Merluccius*

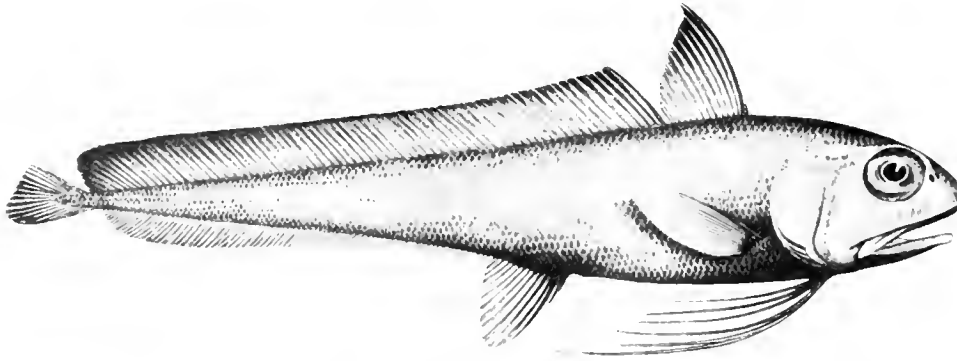

Fig. 137. *Euclichthys polynemus*, holotype. From McCulloch (1926).

line after fusion of the neural spine and at least some of their evolution is in parallel with the gadids.

Palaeogadus is a well-known Eocene fossil genus in which the V-shaped crest has been retained, but specializations include a joined first neural spine and only two hypurals. It is, in fact, very similar to modern *Merluccius*. Danil'chenko (1950), who reviewed *Palaeogadus*, believed that it gave rise independently to Lotinae and Gadinae as well as to *Merluccius*.

Phycinae, as recently modified by Markle (1982), is presently included in the family Gadidae. Fahay and Markle (this volume) would like to escort it out. An early Oligocene fossil genus, *Eophycis* (Jerzemska, 1968) has been suggested as a precursor of *Phycis* and *Urophycis*, and probably arose independently of other gadid subfamilies, which supports Fahay and Markle's position.

Lotinae is a gadid subfamily that I mainly leave to Fahay and Markle and Dunn and Matarese. I note, however, Mujib's (1967) conclusion based on cranial osteology that Lotinae could have arisen from Merlucciinae. Lotines have no V-shaped crest but retain X-Y bones. Hypurals are two, the first neural spine is joined to the occipital crest, and there are more branched rays than in any other gadid.

Gadinae has about a dozen genera, all of which have three external dorsal and two external anal fins and a large caudal, even though there are only two hypurals. Derived characters include fused frontals, absence of X-Y bones, and a joined neural spine: Fahay and Markle and Dunn and Matarese (this volume) give more.

Merluccius, with about a dozen closely related species (Inada, 1981b), has been treated as the type of a separate family or as a subfamily of Gadidae. Primitive characters include a V-shaped ridge and X-Y bones. Advanced ones are the joined first neural spine and the reduced number of hypurals. *Merluccius* appears to be the modern representative of a lineage commencing with "Protocodus" and extending through *Rhinocephalus* and *Palaeogadus*, which it closely resembles (Rosen and Patterson, 1969).

Macruronus, which has three nominal species found in temperate waters of the southern hemisphere, is basically a *Merluccius* with a much reduced caudal fin. I mention it here because it has been referred incorrectly to Macrouridae and considered by some to be a link between that family and *Merluccius*.

Lyconus, with several pelagic oceanic species, is probably re-

lated to *Merluccius*. It lacks a caudal fin and has a single dorsal fin.

Steindachneria, is a monotypic tropical western Atlantic genus with luminescent organs, a wide separation between the anus and urogenital openings, and no caudal fin. It has been placed in Macrouridae and also considered a separate family (Marshall and Cohen, 1973). It may be closer to *Merluccius* than to any other known gadiform.

CLASSIFICATION

How best to classify gadiforms for working purposes in a way that approximates their possible phylogenetic relationships is difficult because the existence of fossils, which appears to help indicate lineages, creates logical traps for the classifier. The following arrangement, unfortunately based on gaps for some groups and on a continuum for others, is an interim suggestion for further testing.

Euclichthys is accorded family status for the first time because it can not be placed in any gadiform family. Gadidae is restricted to the gadines, and Lotidae and Phycidae are recognized at the full family level (family group names for the latter two date at least from Goode and Bean, 1896), because available evidence indicates an independent origin from *Palaeogadus* for each of the three groups. If merlucciids were reduced to subfamily rank and placed with gadines, lotines, and phycines in a more inclusive family Gadidae, then consistency would require the inclusion of at least two other well-defined apparent derivatives of the *Rhinocephalus-Palaeogadus-Merluccius* stem, Moridae and Melanonidae. In the present instance I believe that splitting is more useful than lumping.

- Suborder Muraenolepoidei
 - Family Muraenolepidae
- Suborder Bregmacerotoidei
 - Family Bregmacerotidae
- Suborder Macrouroidei
 - Family Euclichthyidae
 - Family Macrouridae
 - Subfamily Macrouroididae
 - Subfamily Trachyrincinae
 - Subfamily Macrourinae
 - Subfamily Bathygadinae
- Suborder Gadoidei

Family Merlucciidae
 Subfamily Merlucciinae (including "Protocodus," *Rhinocephalus*, *Palaogadus*, *Merluccius*, *Macruronus*, and *Lyconus*)
 Subfamily Steindachneriinae
 Family Gadidae
 Family Lotidae

Family Phycidae
 Family Moridae
 Family Melanonidae

LIFE SCIENCES DIVISION, LOS ANGELES COUNTY MUSEUM OF NATURAL HISTORY, 900 EXPOSITION BOULEVARD, LOS ANGELES, CALIFORNIA 90007.

Gadiformes: Development and Relationships

M. P. FAHAY and D. F. MARKLE

AS treated herein, the Gadiformes includes about 63 genera and 400+ species (Nelson, 1976) divided into eight families (Gosline, 1968; Marshall and Cohen, 1973); (but see Cohen, this volume). They are primarily marine with familial distribution "centers" as follows: Muraenolepididae—high latitudes, southern hemisphere; Bregmacerotidae—tropical and subtropical, world-wide; Melanonidae—tropical and sub-tropical, world-wide; Moridae—world-wide; Macrouridae—deep sea, world-wide; Steindachneriidae—tropical W. Atlantic; Merlucciidae—mid-latitudes, both hemispheres; and Gadidae—high latitudes, northern hemisphere with minor freshwater and southern hemisphere components.

Meristic characters of genera within each family are presented in Table 72 (except that macrourid characters will be found in Table 75). Gadiforms characteristically have relatively high vertebral counts, with caudal centra outnumbering precaudal centra, usually by a wide margin. The first two centra lack ribs and parapophyses. Vertical fins have numerous rays and long bases, with posterior dorsal and anal rays separate from caudal fin rays except in *Muraenolepis* and macruronines. Pectoral fins are typically high on the body and pelvic fins typically thoracic or jugular in position. Mental barbels are found in many genera and mouth position ranges from terminal to inferior.

PRESENT STATE OF KNOWLEDGE AND CHARACTERS OF EARLY LIFE HISTORY STAGES

Literature on gadiform eggs and larvae is heavily weighted towards gadids and merlucciids, within which the commercially important gadines and *Merluccius* have received most attention. Gadine larvae were among the first marine fish larvae to be described. In fact, G. O. Sar's discovery, early in the 1860's, that cod eggs and larvae were pelagic, helped initiate fisheries-oriented ichthyoplankton surveys. In addition to their commercial importance, gadines and *Merluccius* are found in shelf waters where their early stages are more accessible than those of other gadiforms which are largely residents of slope and oceanic waters.

Published descriptions of gadiform early life history stages are listed in Table 73. We especially note the seminal work on young gadids done by Johannes Schmidt in the early 1900's. Although he stressed pigment patterns over other develop-

mental features, Schmidt was one of the first to look at several species in a systematic fashion.

In the following review, we summarize gadiform characters in brief family synopses as well as through a limited survey of the ontogeny of selected characters. Our purposes are, respectively, to point out what appear to be easily observed diagnostic early life history characters and to contribute to discussions of gadiform phylogeny.

Gadiformes.—The gut of gadiform larvae coils early in ontogeny and combined with a tapering postanal region and rounded head, contributes to an overall tadpole-like appearance. These features are, in part, a reflection of vertebral and vertical fin ray elements (Table 72) and are not diagnostic. Although it has not been documented in all families and is not always easily observed, yolk-sac and first-feeding gadiform larvae have an anus that exits laterally through the finfold rather than medially as is usual in teleost larvae. Some secondary caudal rays develop before some primary in forms with a caudal fin.

In Table 74 we summarize some developmental features of each family. A rather widespread trend is for the pelvic fin to be the earliest forming fin. There does not seem to be any character unique or diagnostic for young gadiforms. The features of body shape, anus morphology and pelvic fin development in combination with specific familial characters appear to be the most useful for initial identification. Transformation is gradual and direct with no striking changes in ontogeny.

Muraenolepididae.—A single planktonic juvenile (see discussion of planktonic juveniles below) of *Muraenolepis* sp. is shown in Fig. 138A. The distinctive first dorsal fin, composed of one or two rays, the confluent vertical fins, meristic characters (Tables 72 and 76), chin barbel, restricted gill opening and capture locality (53°48.7'S, 38°18.7'W) preclude all other teleosts and agree with characters described for *Muraenolepis* (Svetovidov, 1948). The lateral premaxillary spines (Fig. 138A) were not shown in a schematic illustration of an early *Muraenolepis* (North and White, 1982) or in larvae described by Efremenko (1983b) and are not reported for adults. It is possible that they are not found in larvae of all species of *Muraenolepis*, but for present purposes we consider them a unique and diagnostic larval specialization of the family.

TABLE 72. MERISTIC CHARACTERS IN GADIFORMES. (See Table 75 for characters of the Macrouridae.) Characters of the caudal fin are contained in Table 76. "Number of species" includes number of nominal species followed by number surveyed for meristic characters. Primary sources of data: Gunther, 1887; Goode and Bean, 1896; Ehrenbaum, 1905-1909; Thompson, 1916; Norman, 1930; D'Ancona, 1933a; Parr, 1946; Jensen, 1948; Svetovidov, 1948; Koefoed, 1953; Andriyashev, 1954; Rass, 1954; Smith, 1961; Scott, 1962; Lindberg and Legeza, 1969; Leim and Scott, 1966; Templeman, 1968; Fitch and Barker, 1972; Miller and Lea, 1972; Hart, 1973; Inada and Nakamura, 1975; Brownell, 1979; Cohen, 1979; Cohen and Russo, 1979; Inada, 1981a; Inada, 1981b; Matarese et al., 1981; Yabe et al., 1981; Demir, 1982; Markle, 1982; Fahay, 1983; Paulin, 1983.

Family genus	Number of species	Vertebrae			Fin rays								
		Pre- caudal	Caudal	Total	D ₁	D ₂	D ₃	D total	A ₁	A ₂	A total	Pelvic	Pectoral
Muraenolepididae													
<i>Muraenolepis</i>	4+1	20-21	46-49	67-69	1-2	127-141		129-142	98-112		98-112	4	37-38
Bregmacerotidae													
<i>Bregmaceros</i>	9+7	13-14	32-42	43-59	1	34-65		35-66	42-69 or 15-21	27-31	42-69	5-7 ¹	16-21
Melanonidae													
<i>Melanonus</i>	2/2	13	47	58-62	72-78 or 5-8	59-70		72-78	50-58		50-58	5-7	10-16
Fam. Incertae sedis													
<i>Euclithys</i>	?/1	15	55	70	15	74		89	15	77	92	5	20
Moridae													
<i>Antimora</i>	2/2	24-25	33-35	57-61	4-7	48-56		54-60	36-49		36-49	5-7	17-25
<i>Auchenoceros</i>	1/1	11	37	46-49	1-2 (+10)	13	51	65 (+10)	62-82		62-82	2 ¹	23 (holo- type)
<i>Brosmiculus</i>	1/1	17	33-34	50-51	58 or 10	53-56		58	56-62		56-62	5	—
<i>Eretmophorus</i>	1/1	—	—	—	4-5	66-77		63-66	64-73		64-73	5	22
<i>Gadella</i>	1/1	—	—	50	9-12	55-64		70-82	56-67		56-67	6-7	20-25
<i>Halargyreus</i>	1/1	—	30-35	51-58	6-8	47-60		64-74	17-26	21-29	39-53	5	17-20
<i>Laemonema</i>	14?/14	15-17	42-45	50-63	5-6	48-75		53-67	45-72		45-72	(1) 2 (3)	15-26
<i>Lepidion</i>	7?/7	17-18	42-45	54-63	4-7	49-62		54-68	40-54		40-54	(5) 6-8	17-23
<i>Lotella</i>	6?/6	13-15	27-34	41-50	5-8	46-69		53-80	42-61		42-61	7-9	19-26
<i>Microlepidium</i>	1/1	11-12	33-34	44-46	7-9	39-42		54-68	39-42		39-42	2	19-22
<i>Mora</i>	1/1	15	35	50-54	7-11	42-53		46-51	16-22	15-22	30-44	5-6	18-25
<i>Physiculus</i>	12?/12	12-16	34-42	48-59	7-11	44-71		49-60	43-79		43-79	(3) 5-7	20-28
<i>Pseudophycis</i>	3/3	—	—	42-51	8-14	40-63		53-79	39-68		39-68	5-6	19-27
<i>Rhynchogadus</i>	1/1	—	—	—	5	50-56		55-61	44-49		44-49	7	20-22
<i>Sahlota</i>	1/1	—	—	—	9-11	56		65-67	57		57	—	—
<i>Svetovidovia</i>	2/2	14-15	43	57-58	5-7	57-63		62-70	56-62		56-62	10-11	17-18
<i>Tripterothycis</i>	?/2	—	—	67-72	4-7	12-17	29-39	48-58	95-112		95-112	5	15-20
Gadidae (Lotinae)													
<i>Brosme</i>	1/1	19-21	44-46	63-66	85-108			85-108	62-77		62-77	5	22-24
<i>Lota</i>	1/1	23-26	37-39	59-66	9-16	65-93		75-108	63-85		63-85	6-8	18-21
<i>Molva</i>	3/3	25-36	37-48	63-84	10-16	61-85		74-98	57-82		57-82	6-7	18-21
Gadidae (Phycinae)													
<i>Ciliata</i>	2/2	(12) 13-15	30-34	44-48	1+	45-55		46-56+	40-46		40-46	7 ¹	15-17
<i>Enchelyopus</i>	1/1	15-17	38-39	49-55	1+	45-52		46-53+	34-49		34-49	5-6 (7) ¹	15-19
<i>Gaidropsarus</i>	14/14	13-17	32-36	44-53	1+	45-70		46-71+	38-60		38-60	5-9 ¹	14-24
<i>Phycis</i>	3/3	15-16	28-29		8-11	54-65		63-70	47-65		47-65	(2) 3 ¹	15-19
		or 18-19	or 32-35										
<i>Raniceps</i>	1/1	11	33-34	44-45	3	61-67		64-70	55-61		55-61	6	21-22
<i>Urophycis</i>	7/7	13-17	30-37	44-52	8-13	43-68		53-78	40-58		40-58	2 ²	15-18
				(56, 57)									
Gadidae (Gadinae)													
<i>Arctogadus</i>	2/2	19-22	36-40	54-62	10-16	15-24	19-25		17-24	18-25		6-7	17-23
<i>Boreogadus</i>	2?/2	18-20	35-39	49-58	9-16	12-19	16-25	49-55	14-23	18-24	39-44	6	18-21
<i>Eleginus</i>	2/2	21-24	37-41	55-64	11-16	14-24	18-24		19-27	18-26		6	18-22
<i>Gadulus</i>	1/1	—	—	39-43	9-12	11-17	15-18		12-19	15-19		6	14-15
<i>Gadus</i>	7?/3	18-22	31-37	49-58	10-17	11-24	10-22	45-62	16-27	12-25	35-48	6-7	19-22

TABLE 72. CONTINUED.

Family genus	Number of species	Vertebrae			Fin rays									
		Pre- caudal	Caudal	Total	D ₁	D ₂	D ₃	D total	A ₁	A ₂	A total	Pelvic	Pectoral	
<i>Melanogrammus</i>	1/1	19-21	33-36	52-57	14-18	19-26	19-24	56-67	21-28	20-25	45-53	6-7	19-21	
<i>Merlangius</i>	2/1	23 (?)	—	53-57	12-17	18-25	19-22		28-38	20-25		6	19-20	
<i>Microgadus</i>	2/2	17-22	34-38	53-60	9-15	15-21	16-24		(12)	16-28		6-7	(16)	
									18-29				18-19	
<i>Micromesistius</i>	2/2	24-26	30-33	54-60	11-14	10-15	21-27		33-41	22-30		6	18-23	
<i>Pollachius</i>	2/2	20-23	32	52-56	11-15	16-24	15-24		23-34	16-24		6	17-20	
<i>Theragra</i>	2/1	18-20	31-34	48-52	10-14	12-19	14-23		15-24	15-23		6-7	18-21	
<i>Trisopterus</i>	3/3	—	—	44-55	11-16	16-28	16-27		25-36	17-30		6	(13)	
													17-19	
Merlucciidae														
<i>Merluccius</i>	12/12	21-29	24-31	48-58	1, 7-12	34-45			35-46			(6) 7 (8)	12-18	
<i>Macruronus</i>	3/3	20-21 ¹	58-60 ¹	78-81 ¹	8-11	105-120			86-105		86-105	9-10	14-18	
<i>Lyconus</i>	2/1	—	—	—	90+			90+	65+		65+	10	13	
Steindachneriidae														
<i>Steindachneria</i>	1/1	13	—	—	8-12	123+			10-11 + 113			8	14-15	

¹ Four rays in larvae.² Three rays in larvae.³ n = 2 (*M. novaezealandae*).

Bregmacerotidae.—Larval and juvenile bregmacerotids appear distinctive in the early acquisition of a cephalic dorsal fin ray. Larvae have been described (Table 73), but eggs are undescribed. Characters are reviewed in this volume by Houde.

Melanonidae.—Eggs, larvae and young stages have not been previously described for melanonids (Cohen, 1973). Early stages, however, are moderately abundant in some oceanic collections. In the smallest specimens seen by us (ca. 15 mm SL) the fins are all formed and they have the general body shape of adults (Fig. 138B). Notable features of this stage are the small eye, dark peritoneum and distinctive caudal fin.

Moridae.—Considering the diversity of the family, very little is known of the early life history stages of morids. Eggs with oil globules have been described for *Physiculus dalwigkii* (De Gaetani, 1928), *Mora moro* (D'Ancona, 1933a), *Physiculus capensis* (Brownell, 1979), *Salilota australis* (de Ciechomski and Booman, 1981) and *Laemonema longipes* (Kuroda et al., 1982).

Pelagic juveniles of some morids have not yet been related to adult forms and have been placed in three genera, *Rhynchogadus* Tortonese, 1948; *Svetovidovia* Cohen, 1973 and *Eretmophorus* Giglioli, 1889. One of these forms, *S. vitellius* (Koefoed, 1953), is shown in Fig. 138C, D. This form appears to be the juvenile stage of *Laemonema*. In our largest specimen, 55 mm SL (MCZ 59773), the pelvic fin has two rays plus two or three remnants. This is a reduction from a count of 9-11 in smaller specimens. To date it has not been possible to assign this form to a known adult. A second type of *Svetovidovia* is shown in Fig. 138E. D'Ancona (1933a) suspected that *Eretmophorus kleinenbergi* was the young of *Lepidion lepidion* but Cohen (1973) apparently was not convinced of the relationship. Finally, *Rhynchogadus* Tortonese, 1948 (= *Hypsirhynchus*) is a pelagic form referable to no known adults and may also represent an early stage of a species whose adult form is known under another name.

The early stages of morids appear stocky anteriorly, with well developed to voluminous pelvic fins, frequently with more inferior than superior procurrent caudal fin rays, and relatively

voluminous posterior sections of dorsal and anal fins (see Figs. 138C-E, 139A-F). Earliest stages may be difficult to separate from some merlucciids and gadines.

Macrouridae.—There is a moderate amount of early life history information available on macrourids but considering that the family contains over a third of all extant gadiform species (Nelson, 1976), a great deal remains unknown. Eggs have been described by Gilchrist (1904), Sanzo (1933a), de Ciechomski and Booman (1981) and Grigorev and Serebryakov (1981). All described macrourid eggs range from about 1 to 4 mm (Marshall and Iwamoto, 1973). Most are less than 2 mm, have a single oil globule and characteristic honey-comb ornamentation on the chorion (see Boehlert, this volume).

Larvae and pelagic juveniles have been infrequently described and only for macrourines (Table 73). Early ontogenetic stages of trachyrhynchine and macrouroidine macrourids are still not known though Johnsen (1927) illustrated and discussed metamorphosed *Trachyrhynchus* juveniles.

Only one pelagic juvenile bathygadine is known (Fig. 140B). The specimen, tentatively referred to *Gadomus*, can be recognized by its long second dorsal (relative to anal) fin rays, short interspace between dorsal fins, moderate-sized barbel and fine jaw teeth. Other important characters of this specimen are its laterally placed thoracic pelvic fins and paired preopercular skin flaps. The general appearance of young bathygadines approaches that of morids, with the lack of caudal fin and presence of pedunculate pectoral fins the obvious differences.

Numerous macrourine larvae have been described. The specimen illustrated as Fig. 140C appears identical to Johnsen's (1927) "AH 1" macrourid larva while Fig. 140D is similar in appearance to Merrett's (1978) *Coryphaenoides rupestris*. In both cases meristic characters agree with *Coryphaenoides* (*sensu lato*), but we are unable to provide further identification at this time.

A number of more elongate types are also known. A specimen belonging to either *Cetonurus* or *Nezumia* is shown in Fig. 141A. A similar specimen, also with seven branchiostegals, is shown in Fig. 141B; its meristic characters, however, do not permit

TABLE 73. PUBLISHED DESCRIPTIONS OF EARLY LIFE HISTORY STAGES IN GENERA WITHIN EIGHT GADIFORM FAMILIES.

Family genus	Source	Family genus	Source
Muraenolepididae		<i>Gaidropsarus</i>	Roule and Angel, 1930
<i>Muraenolepis</i>	North and White, 1982 Efremenko, 1983b		D'Ancona, 1933a Vodyanitsky and Kazanova, 1954 Fives, 1970b Schmidt, 1905a, 1906a Ehrenbaum, 1905–1909 Russell, 1976 Bini, 1971 Dekhnik, 1973 Brownell, 1979 Demir, 1982 Markle, 1982
Moridae		<i>Phycis</i>	Facciola, 1882 Emery, 1886 Marion, 1894b D'Ancona, 1933a Russell, 1976
<i>Auchenoceros</i>	Robertson, 1975a Crossland, 1981 ³	<i>Raniceps</i>	Heincke and Ehrenbaum, 1900 Schmidt, 1907b Ehrenbaum, 1905–1909 Kennedy and Fitzmaurice, 1969 Russell, 1976
<i>Eretmophorus</i> ¹	Mazzarelli, 1917	<i>Urophycis</i>	Agassiz, 1882 Agassiz and Whitman, 1885 Hildebrand and Cable, 1938 Bigelow and Schroeder, 1953 Miller and Marak, 1959 Barans and Barans, 1972 Serebryakov, 1978
<i>Gadella</i>	Lo Bianco, 1911 Sparta, 1928		
<i>Mora</i>	Lo Bianco, 1911 De Gaetani, 1926 D'Ancona, 1933a		
<i>Physiculus</i>	Lo Bianco, 1911 Mancuso, 1926 De Gaetani, 1928 D'Ancona, 1933a Pertseva-Ostroumova and Rass, 1973 ² Brownell, 1979		
<i>Rhynchogadus</i> ¹	Lo Bianco, 1911 Cipria, 1927 D'Ancona, 1933a		
<i>Salilota</i>	Weiss, 1975 de Ciechowski and Booman, 1981		
<i>Svetovidovia</i>	Koefoed, 1953 Fahay, 1983 ³		
Melanonidae		Gadidae (Gadinae)	
<i>Melanonus</i>	None	<i>Arctogadus</i>	Zvyagina, 1961
Bregmacerotidae		<i>Boreogadus</i>	Schmidt, 1905a, 1906a Rass, 1949
<i>Bregmaceros</i>	Munro, 1950 Clancey, 1956 D'Ancona and Cavinato, 1965 Aboussouan, 1968c Pertseva-Ostroumova and Rass, 1973 Belyanina, 1974 Houde, 1981	<i>Eleginus</i>	Kuz-min-Karovaev, 1930 Khalidnova, 1936 Ponomareva, 1949 Rass, 1949 Mukhacheva, 1957 Aronovich et al., 1975 Dunn and Vinter, 1984 Schmidt, 1906a Roule and Angel, 1930 Heincke and Ehrenbaum, 1900 Masterman, 1901 Schmidt, 1905a, 1906a Dannevig, 1919 Uchida et al., 1958 Mukhacheva and Zvyagina, 1960 Russell, 1976 Matarese et al., 1981 McIntosh and Prince, 1890 Heincke and Ehrenbaum, 1900 Schmidt, 1905a, 1906a Dannevig, 1919 Russell, 1976
Gadidae (Lotinae)		<i>Gadiculus</i>	
<i>Brosme</i>	McIntosh, 1893 Schmidt, 1905b Ehrenbaum, 1905–1909 Rass, 1949	<i>Gadus</i>	
<i>Lota</i>	Ehrenbaum, 1905–1909 Meshkov, 1967 Jude, 1982b		
<i>Molva</i>	McIntosh, 1893 McIntosh and Masterman, 1897 Heincke and Ehrenbaum, 1900 Schmidt, 1906b, 1907b Ehrenbaum, 1905–1909 D'Ancona, 1933a Russell, 1976	<i>Melanogrammus</i>	
Gadidae (Phycinae)		<i>Merlangius</i>	
<i>Cithata</i>	Ehrenbaum, 1905–1909 Dando, 1975 Russell, 1976		
<i>Enchelyopus</i>	Agassiz, 1882 Agassiz and Whitman, 1885 Brook, 1890 Ehrenbaum and Strodman, 1904 Ehrenbaum, 1905–1909 Dannevig, 1919 Colton and Marak, 1969 Russell, 1976	<i>Microgadus</i>	
		<i>Micromesistius</i>	
			Booth, 1967 Matarese et al., 1981 Schmidt, 1905a, 1906a D'Ancona, 1933a Seaton and Bailey, 1971

TABLE 73. CONTINUED.

Family genus	Source	Family genus	Source
	Weiss, 1974	Steindachneriidae	
	Russell, 1976	<i>Steindachneria</i>	None ⁴
	Coombs and Hiby, 1979		
	de Ciechowski and Booman, 1981	Macrouridae	
<i>Pollachius</i>	Lisovenko et al., 1982	<i>Ateleobranchium</i> ⁵	Gilbert and Burke, 1912
<i>Theragra</i>	McIntosh, 1893	<i>Coelorhynchus</i>	Sanzo, 1933a
	Gorbunova, 1954		de Ciechowski and Booman, 1981
	Matarese et al., 1981		Gilchrist, 1905
<i>Trisopterus</i>	McIntosh, 1893	<i>Coryphaenoides</i>	Johnsen, 1921
	Schmidt, 1905a, 1906a		Merrett, 1978
	Ehrenbaum, 1905–1909		Stein, 1980b
	D'Ancona, 1933a		Grigorev and Serebryakov, 1981
	Rass, 1949	<i>Hymenocephalus</i>	Sanzo, 1933a
	Russell, 1976	<i>Krohnus</i> ⁶	Costa, 1869
			Smitt, 1895
Merlucciidae			Roule and Angel, 1930?
<i>Lyconus</i>	None		Sanzo, 1933a
<i>Macruronus</i>	None	"Macrouridae"	Ehrenbaum, 1905–1909 ⁷
<i>Merluccius</i>	Aggassiz and Whitman, 1885		Murray and Hjort, 1912
	Raffaëlle, 1888		Johnsen, 1927
	Schmidt, 1907a		Evseenko, 1982b
	Ehrenbaum, 1905–1909	<i>Macrourus</i>	Yanulov, 1962
	Kuntz and Radcliffe, 1917		de Ciechowski and Booman, 1981
	D'Ancona, 1933a		Efremenko, 1983a
	Ahlstrom and Counts, 1955	<i>Malacocephalus</i>	Marshall, 1964
	Miller, 1958	<i>Mesobius</i>	Hubbs and Iwamoto, 1977
	Fischer, 1959	<i>Odontomacrus</i>	Maul and Koefoed, 1950
	Marak, 1967		Maul, 1951
	Sauskan and Serebryakov, 1968		Koefoed, 1953
	Santander and de Castillo, 1969		Marshall, 1964
	Colton and Marak, 1969	<i>?Sphagebranchus</i> ⁸	Bakus et al., 1965
	de Ciechowski and Weiss, 1974	<i>Trachyrhynchus</i>	Johnsen, 1927
	Russell, 1976		
	Brownell, 1979		
	Markle et al., 1980		
	Fahay, 1983		

¹ No adult specimens.² May refer to *Svetovidovia*, a larval stage name.³ Illustration only.⁴ No published descriptions. Mead (1963) reports collection of 15 larvae, 9.0 to 66.0 mm SL (MCZ 43083).⁵ Name applied to larval stage. Referred to *Coryphaenoides acrolepis* by Johnsen (1927).⁶ Name applied to larval stage. Probably *Nezumia* (Marshall and Iwamoto, 1973).⁷ Ehrenbaum's "Macruridae" plate (fig. 108) illustrates a *Maurolicus* egg, a *Lophus* larva, a perciform larva possibly referable to Carangidae or Serranidae and a 92-mm macrourid larva resembling *Krohnus*.⁸ Possibly referable to Atlantic specimen of *Mesobius* (see Hubbs and Iwamoto, 1977).

identification by process of elimination and its identity must await further study. One of the most elongate of the known macrourid larvae is that of *Odontomacrus murrayi* (Maul and Koefoed, 1950). Among these elongate types there is a tendency for caudal spotting, either as supranal melanophores (Fig. 141A) or as midlateral spots or bars (Fig. 141B). With development, there is a marked change in mouth orientation from oblique to almost horizontal in the elongate *Mesobius berryi* (Hubbs and Iwamoto, 1977) (Fig. 142C) and in *Coryphaenoides* (Stein, 1980b).

Known macrourid larvae can be characterized by their moderate (*Gadomus*) to very elongate tail, lack of caudal fin and moderate to very elongate pectoral fin peduncle. Some adult diagnostic characters (Table 75), such as numbers of branchiostegal rays and retia mirabilia are present early and are crucial to identification (Merrett, 1978; Stein, 1980b), while others, such as dorsal spine serrations, develop late and cannot be used (Merrett, pers. comm., and unpublished observations). Addi-

tional characters (the interspace between dorsal fins, anterior extent of anal fin origin, the position of fin origins relative to centra or myomeres, the relative size and shape of pectoral fin peduncles and larval pigmentation) are not known or not reported, but appear to offer promise in characterizing groups of larval macrourids (see Table 75 and Figs. 140, 141A–B and 142C).

Steindachneriidae.—*Steindachneria* was aligned with the macrourids in early works (Jordan and Evermann, 1896–1900), with merlucciids by Norman (1966), Marshall (1966b) and Nelson (1976), and as a separate family (Marshall and Cohen, 1973). Eggs are not known and larvae have not previously been described although Mead (1963) mentions specimens, 9.0 to 66.0 mm SL (MCZ 43083). An early planktonic juvenile was available and is illustrated in Fig. 142B–C. Noteworthy features are the distinctive striated photogenic organs on the ventral surface of the gut (Cohen, 1964a), genital papilla and orifice separated

TABLE 74. DEVELOPMENTAL CHARACTERS IN GADIFORM FAMILIES AND GADID AND MERLUCCIID SUBFAMILIES.

	Muraenolepididae	Bregmacerotidae	Melanonidae	Moridae	Gadidae	
					Lotinae	Phycinae
# dorsal fins (externally)	2	1 single ray on head plus 1 fin (divided by low midsection)	1 (deeply divided)	2 (3)	1-2	2 (first sometimes modified)
# anal fins (externally)	1	1 (divided by low midsection)	1	1 (2)	1	1
First fin to form rays	Vertical fins (pelvic late)	Pelvic (or anterior dorsal ray)	?	Pelvic	Pelvic (except <i>Lota</i>)	Pelvic
# pelvic rays	4	3-4 (larvae) 5-7 (adults)	5-7	2-11	3-4 (larvae) 5-8 (adults)	3-4 (larvae) 2-9 (adults)
Pelvic fin elongate?	No	Yes	No	Yes (most)	Yes	Yes
Pectoral ray formation	?	Late	?	Midsequence to late	Late	Late
Body shape	Moderately elongate	Elongate	Moderately elongate	Tapers to narrow peduncle	Elongate	Stocky
# vertebrae	64-69	43-59	58-62	41-63	59-84	44-55
Egg diameter (mm)	1.5-1.6	?	?	0.52-1.16	1.3-1.5	0.63-0.98
Chorion	Smooth	?	?	Smooth	Pitted/smooth	Smooth
# oil globules	1	?	?	1	1	Multiple to 1
Miscellaneous	Premaxillary spines (at least 1 form); barbel forms on lower jaw		Small eye; dense pigment	Barbel forms on lower jaw; few luminescent	Barbel forms on lower jaw in juveniles	Barbels form on lower jaw (and snout in some); pterotic spines in few

	Gadidae	Merluccidae		Steindachneridae	Macrouridae
	Gadinae	Merluccinae	Macrurinae		
# dorsal fins (externally)	3	2 (second divided by low midsection)	2	2	(1) 2
# anal fins (externally)	2	1 (divided by low midsection)	1 (anterior rays elongate in <i>Macrurus</i>)	1 (anterior rays elongate)	1
First fin to form rays	Caudal (pelvic last)	Caudal (pelvic next)	Dorsal and anal (pelvic late)	?	Pelvic (with dorsal and anal)
# pelvic rays	6-7	7	7-9	8	(0) 5-17
Pelvic fin elongate?	No	Moderately	No	No	Moderately to very
Pectoral ray formation	Late	Late	Late	Late (pedunculate)	Late (pedunculate)
Body shape	Moderately elongate	Elongate	Attenuated (reduced caudal fin)	Attenuated (no caudal fin)	Attenuated (no caudal fin)
# vertebrae	39-64	48-58	77-78	?	80-116+
Egg diameter (mm)	1.0-1.9	0.8-1.2	0.99-1.16	?	1.0-2.0
Chorion	Smooth	Smooth	Smooth	?	Hexagonal pattern
# oil globules	None	1	1	?	1
Miscellaneous	Barbel forms on lower jaw during/after juvenile stage			Luminescent organ present; lacks caudal fin	Some luminescent; barbel forms on lower jaw, lacks caudal fin

Fig. 138. (A) *Muraenolepis* sp., 32.5 mm SL, British Antarctic Survey, 53°48.7'S, 38°18.7'W. (B) *Melanonus* sp., 30.6 mm SL, MCZ 58619, 35°19'S, 07°30'E. (C) *Svetovidovia*, 13.0 mm SL, Fahay, 1983. (D) *Svetovidovia*, 44.4 mm SL, HML H6901, 38°49.5'N, 54°18.0'W. (E) "*Svetovidovia*," 44.1 mm SL, HML H9455, 43°21.94'N, 60°32.34'W.

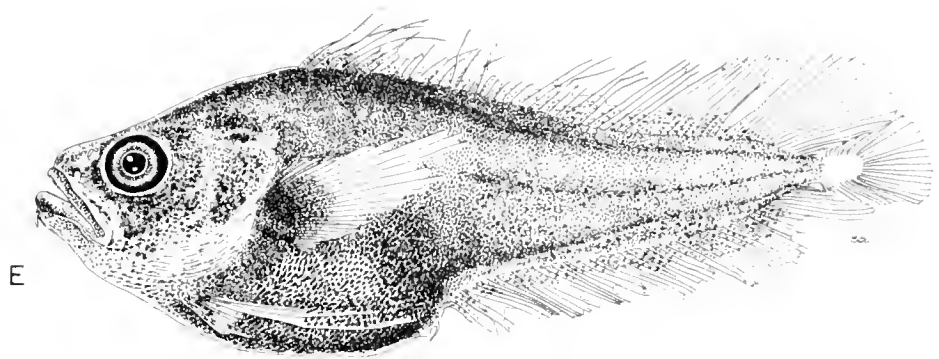
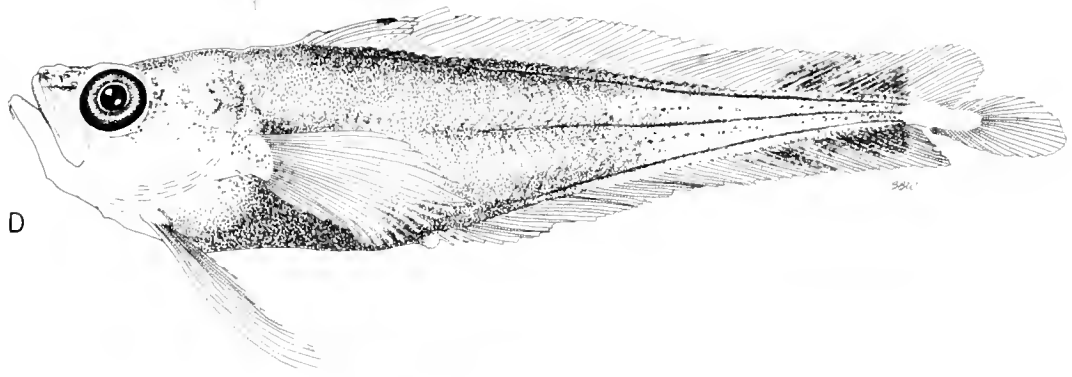
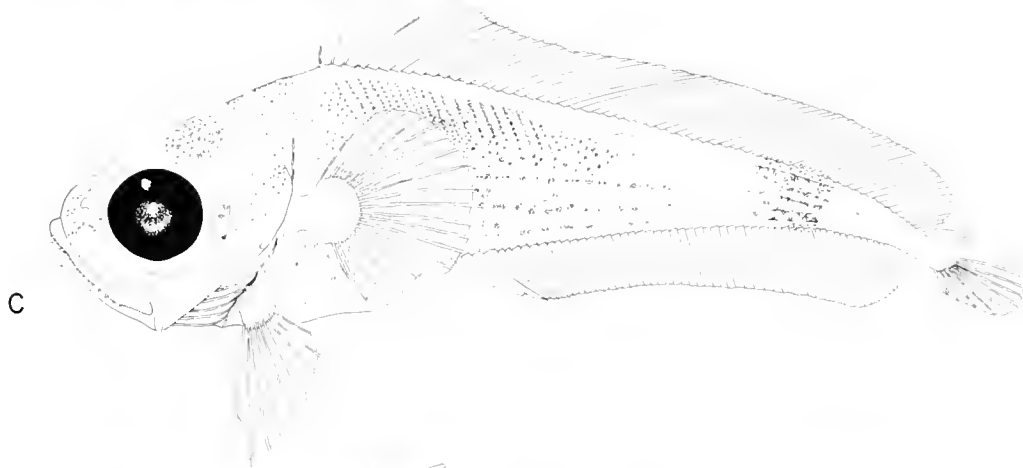
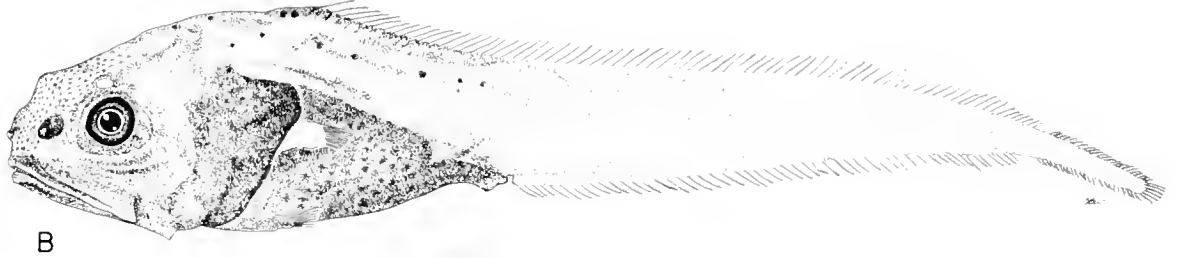

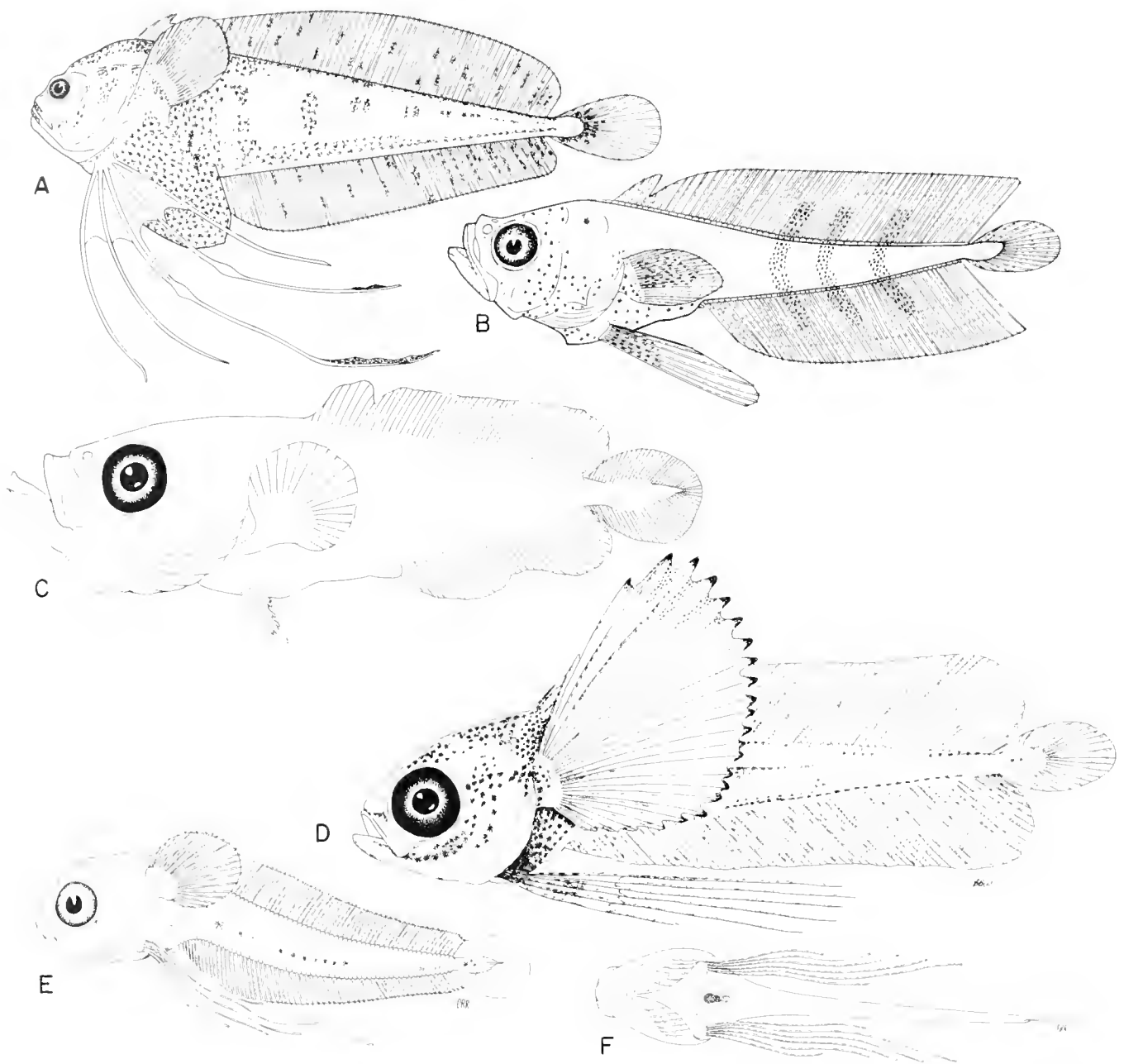

Fig. 139. (A) *Eretmophorus kleinenbergi*, 105 mm, Mazzarelli, 1917. (B) *Rhynchogadus hepaticus*, 21.9 mm, Cipria, 1927. (C) *Mora moro*, 12 mm, De Gaetani, 1926. (D) *Gadella maraldi*, 18.8 mm, Sparta, 1928. (E) *Physiculus nematopus*, 9.2 mm, CALCOFI 5604, Sta. 103 G 40. (F) *Physiculus nematopus*, 14.1 mm, ventral view, CALCOFI 5604, Sta. 103 G 40.

from the anus, small pedunculate pectoral fin, silvery eye and lack of caudal fin.

Merlucciidae.—Eggs, larvae and juveniles of *Merluccius* are well described (Table 73), while those of *Lyconus* and *Macruromus*

are unknown. Merlucciids have moderately pedunculate pectorals; *Merluccius* approaches the gadines in pigmentation and sequence of fin formation (caudal first), while macruronines approach the macrourids in pectoral morphology and reduction of caudal fin.

Fig. 140. (A) Macrouridae, 11.2 mm TL, HML uncat., off Newfoundland. (B) *Gadomus* sp., 30+ mm TL, MCZ 58621, 25°48'N, 91°40'W. (C) *Coryphaenoides* sp., 39 mm TL, MCZ 58622, 40°04'N, 68°07'W (pectoral fin damaged). (D) *Coryphaenoides* sp., 30+ mm TL, MCZ 58623, 34°27'N, 71°19'W.

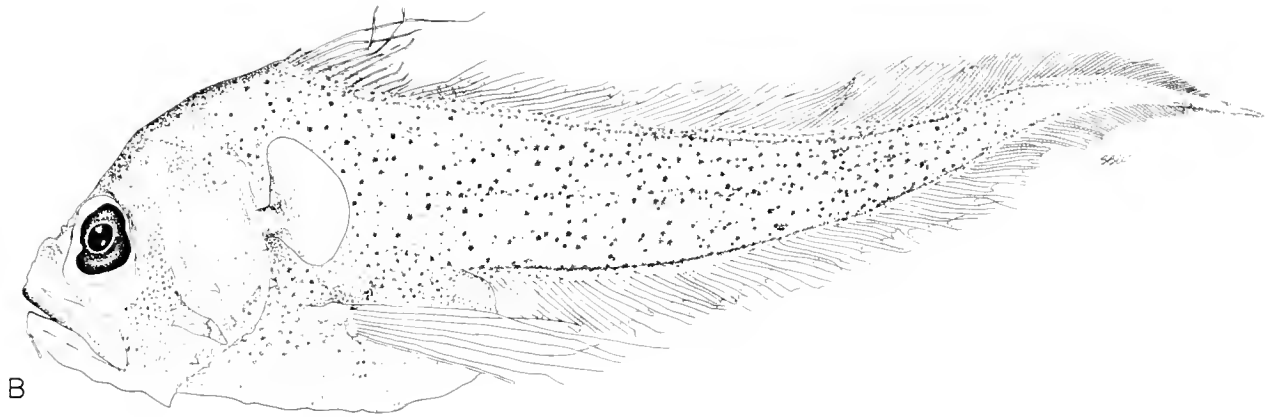
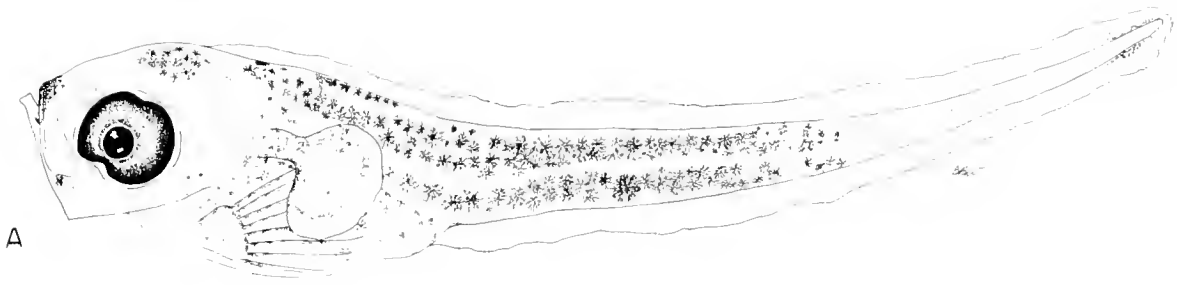

TABLE 75. MERISTIC AND OTHER SELECTED CHARACTERS IN GENERA OF MACROURIDAE. "Number of species" refers to minimum nominal species followed by numbers surveyed for characters. Primary sources of data: Gunther, 1887; Gilbert, 1893; Goode and Bean, 1896; Gilbert, 1905; Gilbert and Burke, 1912; Gilbert and Hubbs, 1916; Gilbert and Thompson, 1916; Koefoed, 1927; Hubbs, 1934; Parr, 1946; Koefoed, 1953; Smith, 1961; Scott, 1962; Iwamoto, 1966; Makushok, 1966; Okamura, 1970b; Hart, 1973; Marshall, 1973; Marshall and Iwamoto, 1973; Iwamoto, 1974; Iwamoto and Stein, 1974; Hubbs and Iwamoto, 1977; Iwamoto, 1978; Merrett, 1978; Iwamoto, 1979; McCann and McKnight, 1980; Trunov, 1981; Merrett et al., 1983.

Genus	Number of species	Retia Mirabilis	Branchio-stegal rays	Precaudal vertebrae	Pelvic rays	First dorsal rays	Pectoral rays	Nature of second spinous ray of first dorsal fin	Longest rays (dorsal, anal, about equal)
Trachyrhynchinae									
<i>Trachyrhynchus</i>	4/3	2	7	14	6-7	9-12	18-26	(ray)	D
Macrouroidinae									
<i>Macrouroides</i> ²	1/1	3	7	—	0	—	22-25	(ray)	D or ≈
<i>Squalogadus</i> ²	1/1	3	7	12-13	5	—	23-26	(ray)	D or ≈
Bathygadinae									
<i>Gadomus</i>	11/9	4	7	11-13	8-9	11-14	13-25	Smooth	D
<i>Bathygadus</i>	14/10	2	7	11-13	7-11	8-13	10-20	Smooth	D
Macrourinae									
<i>Cynomacrus</i> ²	1/1	0	6	—	7-8	—	15-17	Smooth	A
<i>Ondinomacrus</i> ^{1,2}	1/1	2	6	—	7-8	8-10	8-11	Smooth	A
<i>Lepidorhynchus</i>	1/1	9	6	—	8-9	11-13	16-17 (19)	Smooth	—
<i>Mahia</i>	1/1	?	6	—	7	11	17-18	Smooth	A
<i>Coelorhynchus</i>	58/40	4	6	11-12	7	9-14	(13, 14) 15-21 (22)	Smooth	A
<i>Hyomacrus</i>	2/1	2	6	13	8	—	—	Serrate	—
<i>Coryphaenoides</i>	46/24	4	6	11-16	(6) 7-11 (12)	9-14	15-25	Serrate	A
<i>Macrourus</i>	3/2	4	6	16	8-9	10-13	17-21	Serrate	A
<i>Nematourus</i>	4/1	5	6	15	(7) 9-11	10-12	18-21	Serrate	A
<i>Chalinura</i>	8/6	6	6	12-13	8-14	9-12	18-22	Serrate	A
<i>Lionurus</i>	3/2	6	6	11-13 (15)	8-11	10-11	15-20	Serrate or smooth	A
<i>Mesobius</i> ^{1,2}	2/2	2	7	11	6-9	10-12	12-16	Weakly serrate	A
<i>Echinomacrus</i> ²	2/2	0	7	—	9-12	11-13	16-19	Serrate or smooth	A
<i>Hymenocephalus</i>	17/3	2	7	10-11	7-15	10-13 (14)	11-18 (18-22)	Weakly serrate or smooth	A
<i>Cetonurus</i>	2/2	2	7	10	8-10	9-12	16-19	Serrate	A
<i>Paracetonurus</i>	4/3	2	7	11	(5) 6-9	8-11	17-21	Serrate	A
<i>Kumba</i>	1/1	2	7	—	9	11	21	Smooth	A
<i>Parakumba</i>	1/1	?	7	12	10	11	22	Weakly serrate	A
<i>Macrosmia</i>	1/1	2	7	12	11-12	11-13	22	Weakly serrate	A
<i>Mataeocephalus</i>	6/3	2	7	13-14	7-9	10-12	(19) 22-26	Serrate	A
<i>Trachonurus</i>	1/1	2	7	12-13	7	7-11	13-18	Smooth	A
<i>Sphagemacrus</i> ¹	7/2	2	7	11-12	(8) 10-13	12-13	18-22	Serrate	A
<i>Nezumia</i>	44/32	2 (4)	7	13-14	6-17	10-15	13-27	Serrate	A
<i>Pseudonezumia</i>	1/1	?	8	—	6	10	16	Serrate	A
<i>Malacocephalus</i> ¹	4/3	2	7	14	8-10	11-16	16-22	Smooth	A
<i>Ventrifossa</i>	16/10	2	7	10-14	8-11 (13-15)	11-15	18-27	Serrate	A

Juvenile phase known to have prominently-spotted pigment pattern (but see note on *Sphagemacrus* in Table 73).
Includes bathypelagic species

TABLE 75. EXTENDED.

Number of light organs (bulbous or tubular)	Mouth position (terminal, sub-terminal, inferior)	Chin barbel (present or absent)	Position of anus and urogenital opening relative to anal fin origin and pelvic fin bases			Anal fin origin anterior to posterior end of gut cavity?	Anteriormost fin origin D2-A	Distance between dorsal fins		
			A org	Betw	Piv bases			< D1 base	≈ D1 base	> D1 base
0	Inf	Pr	X			No	D2 or ≈	X		
0	Inf	Ab	X			No	D2		Single fin	
0	Inf	Ab	X			No	D2		Single fin	
0	Term	Pr/Ab	X			No	D2	X		
0	Term	Pr/Ab	X			No	D2	X		
0	Term	Ab	X			—	—			
1B	Term	Ab		X		—	A			X
1B	Term	Pr	X			—	—			
1B	Sub-T	Pr		X		Yes	A			X
1B	Inf	Pr	X	or	X	Yes	A (usu.)	X or	X or	X (usu.)
0	Inf	Pr		X		Yes	—			
0	Sub-T, Inf	Pr	X			Yes	A	X or	X or	X
0	Inf	Pr	X			Yes/no	D2	X		
0	Sub-T, Inf	Pr	X			Yes/no	A			X
0	Sub-T	Pr	X			Yes/no	A		X or	X
0	Inf	Pr	X			Yes/no	A			X
1B	Sub-T	Ab	X			Yes	A			X
0	Inf	Pr	X	? X		—	A			X
1T	Sub-T	Pr/Ab	X			No	A			X
0 or 1B	Sub-T	Pr (tiny)	X			Yes	A			X
0	Sub-T, Inf	Pr	X			Yes	A (?)			
1B	Sub-T	Pr (tiny)		X		Yes	A	X		
1B (?)	Sub-T	Pr (tiny)		X		—	A		X	
0	Sub-T	Pr	X			Yes	A		X	
0	Inf	Pr	X or	X		Yes	A		X	
0 or 1B	Sub-T	Pr		X		Yes	A	X		
1B	Sub-T	Pr		X		Yes	A	X		
1B	Sub-T	Pr		X	(X)	Yes	A		X or	X
0	Inf	Pr	X			—	A		X	
1B	Sub-T	Pr		X		Yes	A		X	
1B	Sub-T, Inf	Pr		X	(X)	Yes	A		X or	X

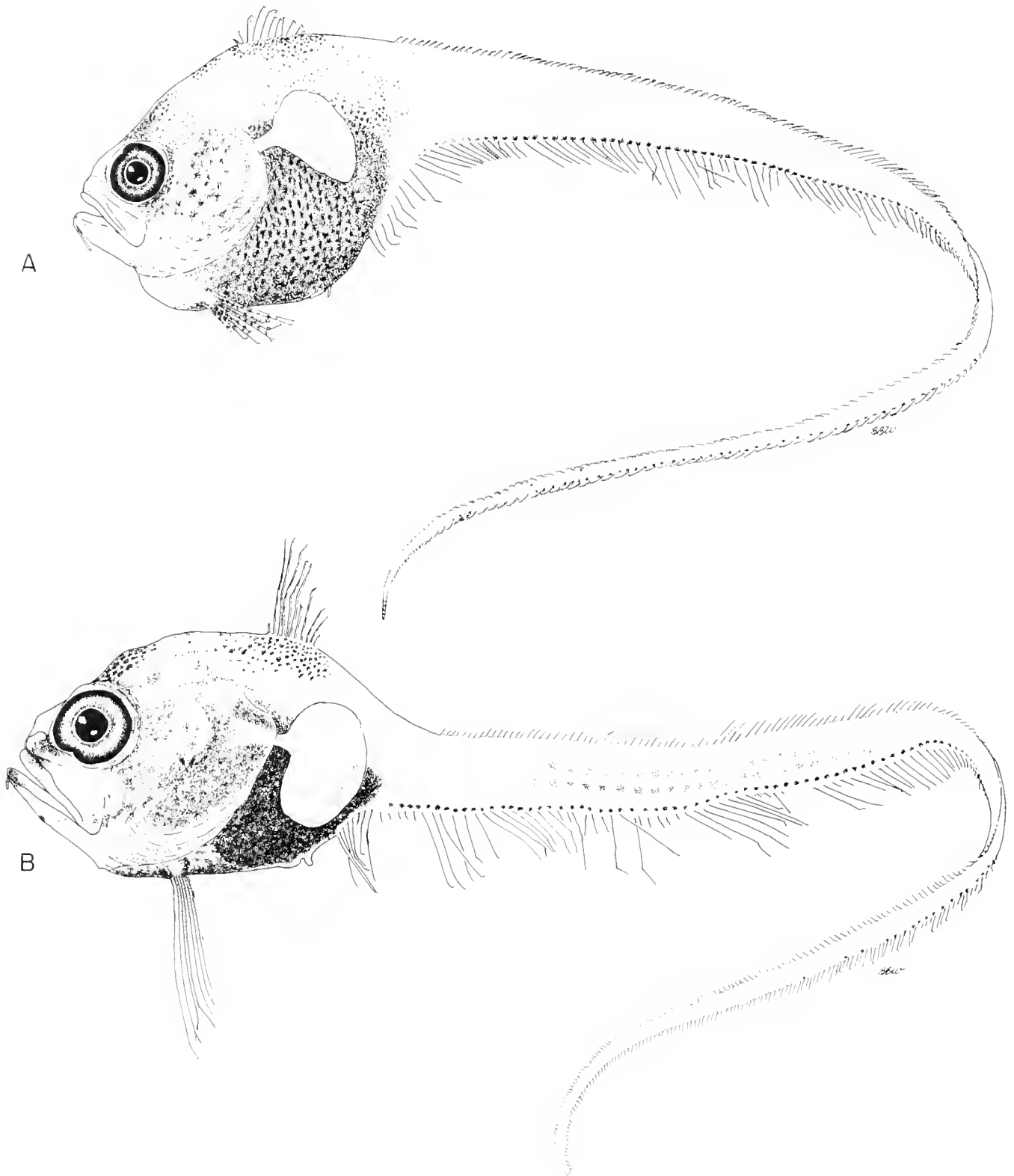

Fig. 141 (A) Macrouridae (Macrourinae), 60 mm TL, HML H6818, 39°52.5'N, 58°54.0'W. (B) Macrouridae (Macrourinae), 15 mm TL, MCZ 58624, 29°55'N, 79°54'W.

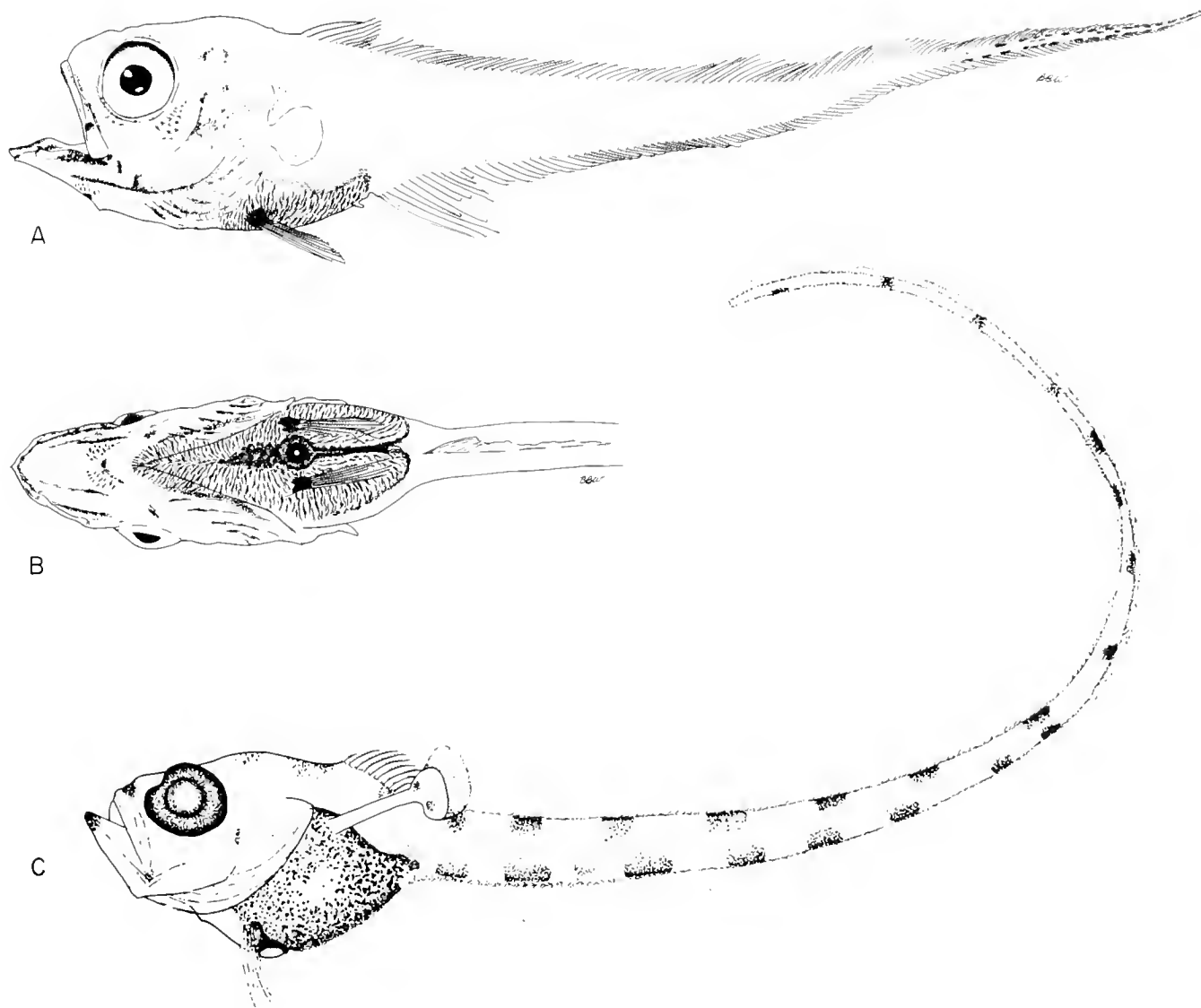

Fig. 142. (A) *Steindachneria argentea*, 24 mm TL, GCRL 01962, 28°45'N, 89°36'W. (B) *Steindachneria argentea*, 24 mm TL, GCRL 01962, ventral view. (C) *Mesobius berryi*, 23.4 mm TL, Hubbs and Iwamoto, 1977.

Gadidae.—The early life history stages of gadids are well known (Table 73) and are reviewed and characterized in this volume by Dunn and Matarese.

SELECTED CHARACTERS

Eggs.—Eggs are undescribed for three gadiform families: Bregmacerotidae, Melanonidae and Steindachneriidae. Efremenko (1983b) recently described muraenolepidid eggs and Markle (1982) summarized information for the remaining families and noted that a relatively small egg (<1 mm) with an oil globule was a widespread and probably primitive character. The oil globule has apparently been lost only in the gadines, a group showing numerous derived states, including relatively large eggs (Markle, 1982).

Except in the gadid, *Brosme*, and macrourids, chorion or-

namentation appears to be restricted to ubiquitous pores seen with scanning electron microscopy (Lonnig and Hagstrom, 1975). In *B. brosme* the chorion pores are many times larger than in other gadiforms and give the egg a pitted appearance (Markle and Frost, MS). In macrourids an elaborate "honey-comb" ornaments the chorion. This ornamentation, like the pores, has an unknown function. The uniqueness of the "honey-comb" (Boehlert, this volume) and its presence in all known macrourine eggs suggests an autapomorphy, at least for the subfamily. Additional information on egg morphology of merlucciids, macrourids, morids and *Steindachneria* could contribute to a discussion of the unsettled status and relationships of the latter.

Transient early life history characters.—After hatching there are at least six characters that can be considered ontogenetically



A

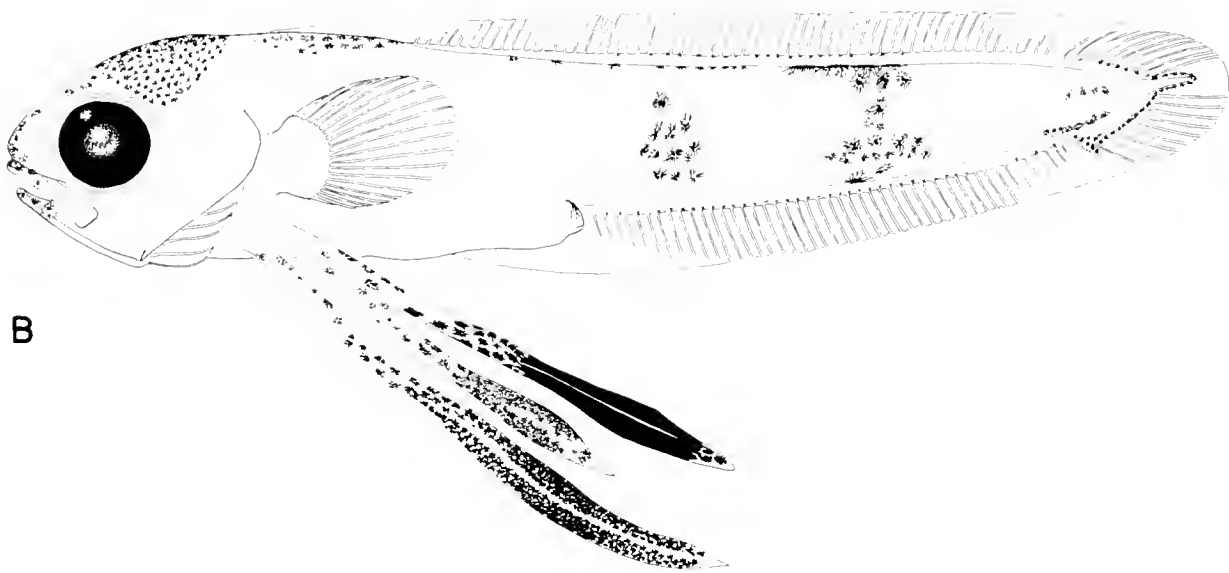

B

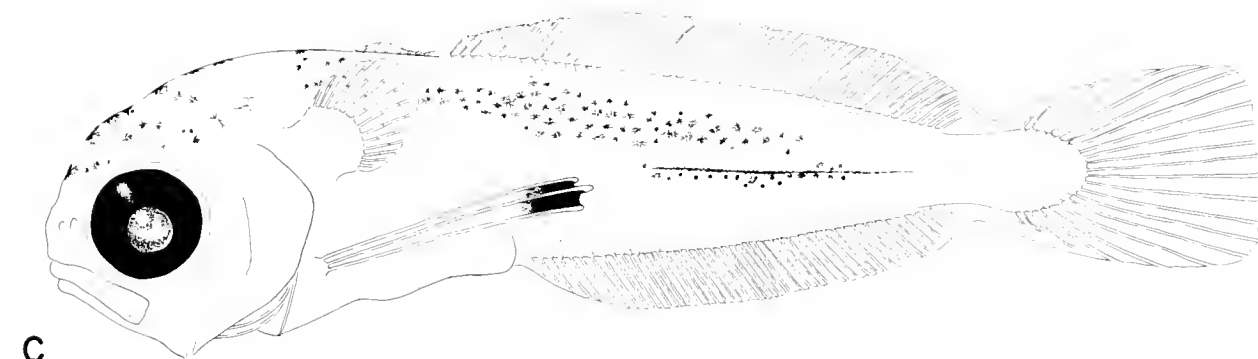

C

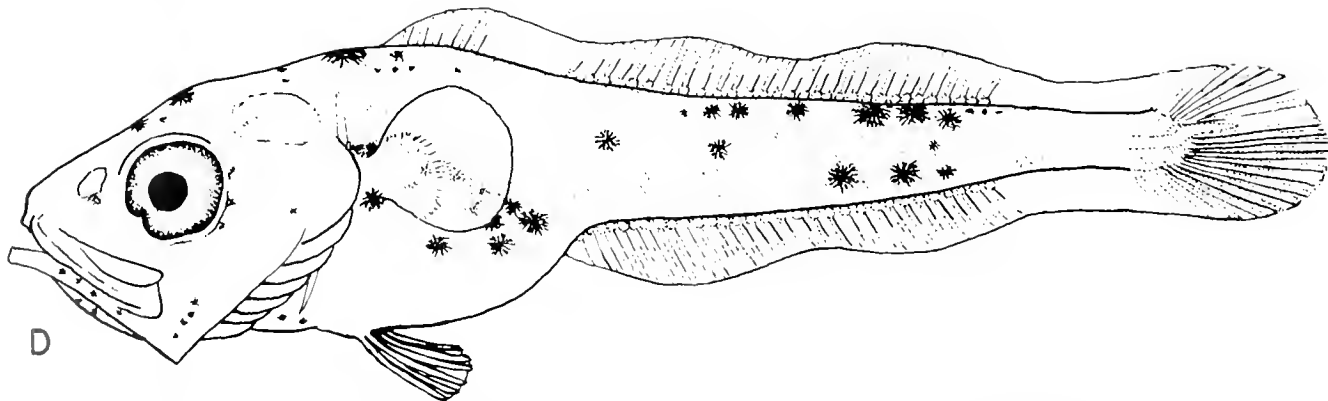

D

Fig. 143. (A) *Gadus morhua*, 11.0 mm, Fahay, 1983. (B) *Brosme brosme*, 14.0 mm, Fahay, 1983. (C) *Urophycis chuss*, 9.5 mm, Fahay, 1983. (D) *Merluccius productus*, 10.1 mm, Ahlstrom and Counts, 1955.

transient: larval pigmentation, lateral maxillary fangs, pterotic spines, pedunculate pectoral fin bases, sequence of developmental events and the presence of a pelagic juvenile stage. Many of these characters are incompletely known for the order and only tentative phylogenetic statements can be made.

Embryonic and larval pigmentation patterns are quite variable. In gadoids there appears to be widespread occurrence of postanal bands, usually one or two, and melanophores at the notochord tip. Similar patterns occur in *Merluccius bilinearis* (Merlucciidae), *Physiculus capensis* (Moridae) and *Coelorhynchus* sp. (Macrouridae). However, even within one subfamily such as the gadines, there are genera without any banding (e.g., *Melanogrammus*) as well as much variation in number of bands (*Pollachius*, *Gadus*). Eye pigmentation at hatching varies depending on development stage at hatching, for example, unpigmented in *Pollachius* and pigmented in *Gadus*. Embryonic and larval pigmentation seems variable in the well studied gadids as well as in other gadiforms so that an evaluation of phylogenetic significance seems premature at this time.

Lateral premaxillary spines are only known in *Muraenolepis* (Fig. 138A) and larval pterotic spines are only known in *Phycis*, *Gaidropsarus* (Demir, 1982; Markle, 1982) and *Ciliata* (Dunn and Matarese, this volume). Both characters appear to be apomorphies, providing phylogenetic information at the generic level at least. The western Atlantic *Phycis*, *P. chesteri*, lacks larval pterotic spines and may, in fact, belong in *Urophycis* (David Methven, pers. comm.).

The lack of developmental series outside the gadoids precludes discussion of many developmental sequence characters. However, it does seem possible to make some tentative statements about the first fin to form rays. On the basis of our examination of a larval series provided by A. W. North of the British Antarctic Survey, *Muraenolepis* does not form pelvic rays first. This contrasts with most gadiforms where the pelvic is the first fin to form (Table 74). Other exceptions seem to be in gadines and merlucciids where the caudal or dorsal and anal fins form before the pelvic. The latter condition may represent a derived character state. However, the tail-less macrourids are precluded from showing this character.

The pectoral fin base is strongly pedunculate (stylopteros) during the larval period in macrourids and steindachneriids, moderately pedunculate in morids and narrow-based (but less pedunculate) in bregmacerotids, *Merluccius* and gadids (Fig. 143A–D). Strong expression of this character is associated with loss of the caudal fin (macrourids, steindachneriids) or delayed caudal fin formation (morids) and may reflect a compensatory response of larvae associated with larval locomotion.

In the life history of most gadiforms there is a benthic or eurybenthic adult phase. In all of these groups (muraenolepidids, morids, most gadids, merlucciids, most macrourids) as well as in pelagic gadiforms there is a prolonged pelagic juvenile stage which, in some cases, includes symbiotic association with jellyfish (Mansueti, 1963). In phycines, for example, this stage is neustonic, includes a pigmentation pattern different from both larval and benthic juveniles, and is characterized by a dense concentration of melanophores on the dorsal surface. In morids, some pelagic juveniles have been described as new genera, such as *Svetovidovia* Cohen, 1973 (= *Gargilius* Koefoed, 1953).

We are not aware of any gadiform that can be shown not to possess a pelagic juvenile. In fact, it appears that life-history neoteny has occurred several times and adults have retained the pelagic habitat (bregmacerotids, melanonids, the gadines *Gad-iculus* and *Micromesistius*, and some macrourids). The pelagic

adult has clearly evolved independently more than once. Even within a single family, Macrouridae, it has apparently happened at least three times and Hubbs and Iwamoto (1977) have called attention to this form of neoteny with the generic name, *Mesobius* ("middle life").

Pelvic fins.—The gadiform pelvic fin shows two major ontogenetic sequences. In the phycines, *Urophycis* and *Phycis*, larvae initially form 3 or 4 rays and ontogenetically reduce or resorb the innermost ray to produce the adult count of 2 or 3 (Markle, 1982). During the course of this study, we have also found ontogenetic pelvic fin ray reduction in the morid *Svetovidovia vitellius*. One transforming specimen, 55 mm SL (MCZ 59773), has two large pelvic fin rays and 2 or 3 very minute remnants of inner pelvic fin rays. Smaller specimens have as many as 11 rays (Table 72). Cohen (1979) has previously suggested that *Lotella maxillaris* (10 pelvic fin rays) may be the young of *Laemonema* (1–3 pelvic fin rays). Gadiforms may be pre-adapted for this type of metamorphosis since even in species with numerous pelvic fin rays, such as the morid *Physiculus*, the external fin ray nerves appear restricted to the outer two rays (Freihofer, 1970: Fig. 12).

In the other, presumed ancestral, ontogenetic sequence, pelvic fin rays increase in number. Variation is seen in this sequence in the speed at which the adult complement is formed. The rays form very quickly in *Merluccius*, somewhat more slowly in *Eleginus*, and over a protracted size range in *Gaidropsarus* (Markle, 1982; Dunn and Vinter, 1984, MS).

In many gadiforms, such as some macrourids, *Merluccius*, many gadids and morids, the pelvic fins also change allometrically. In the *Krohniius* and several other types of macrourid larvae as well as in morids, the pelvics are greatly expanded over their relative size in any known adult. In some phycines the pelvics are not necessarily relatively longer, but are wider and fan-like as opposed to filamentous in adults. This allometry favoring a relatively large, fan-like pelvic in the young would seem to be a device to aid flotation. It is noteworthy, however, that only bregmacerotids among the pelagic gadiforms have retained enlarged pelvic fins as adults.

In addition to elongation, prominent pigmentation of pelvic fins characterizes many genera, including most phycines. The precise extent and location of pigment on the pelvic fin is often an important identifying feature in these larvae. For example, it is absent in *Urophycis regia*, restricted to the tips of the fins in most other *Urophycis* and densely covers the fin membrane in *U. tenuis*, *Enchelyopus*, *Gaidropsarus* and *Raniceps*.

Gadines, as previously mentioned, show a clear departure in the sequence of fin formation. Instead of forming first, pelvic fins form last. In *Merluccius*, whose condition may be an evolutionary precursor to the gadine condition, pelvic fins form second in the sequence after the caudal (Table 74).

Pectoral fins.—As is the case with most teleosts, pectoral fin rays form late, although they may form before the late-forming caudal in morids. As with the pelvic fin, the pectoral fin is often elongate and/or fan-shaped in some morids and macrourids (i.e., *Gadella* and *Hymenocephalus*) but this fin is not prominently pigmented in any member of the order except some species of *Merluccius*.

Dorsal and anal fins.—In the development of all gadiforms described, vertical fins form in their adult positions and there is no evidence of fin base migration. The dorsal fin origin in gad-

TABLE 76. DISTRIBUTION OF CAUDAL RAYS ON SUPPORTING BONES OF THE CAUDAL FIN IN SELECTED SPECIES OF GADIFORMES. "Inferior Hypurals" do not include the parhypural in this listing. See Table 72 for primary sources of data.

Taxa	Epu- rals	Hypu- rals	XY bones	Number of vertebrae associated with caudal fin	Number of rays								Total caudal rays
					Dorsal		Super- ior hypu- ral(s)	Inferior hypu- ral(s)	Ventral				
					(Un- branched)	(Branched)			(Branch- ed)	(Un- branched)			
Muraenolepididae													
<i>Muraenolepis</i> sp.	2	2	See text	See text		2-3		4	2		1-2		8-10
Bregmacerotidae													
<i>Bregmaceros bathymaster</i>	2	2	Present	5-6	(10-12)			8	2		(10-12)		34-36 (?)
Melanonidae													
<i>Melanonus zugmayeri</i>	2	(4) 5 (6)	Absent	13		23-25		6	3		22-25		55-60
Fam. Incertae sedis													
<i>Euchchthys</i> sp.	2	2	X present Y absent	10		17		4	3		17		41
Moridae													
<i>Antimora rostrata</i>	2	5 (6)	Present	8		14		5	4		12		(30) 35
<i>Brosmiculus</i> sp.	2		Present	9		15		6	4		13		38
<i>Eretmophorus kleinenbergi</i>	2	5	Present										26
<i>Gadella</i> sp.	2	5	Present			16		5	4		13		38
<i>Gadella maraldi</i>	2	5	Present										20-24
<i>Laemonema barbatula</i>	2	5	Present	7	(5-6)	8-9	(2-3)	6	3-4	(5-6)	12-15	(6-7)	27-31
<i>Laemonema longipes</i>	2	5	Present										22-25
<i>Lepidion eques</i>	2	5	Present			11-13		6	3		15-17		34-36
<i>Lepidion lepidion</i>	2	5	Present										22
<i>Mora moro</i>	2	5	Present		(6-7)					24-25		(8-9)	
<i>Lotella fernandeziana</i>	2	5	Present	7	(6-8)		(6-7)	6	3-4	(5-6)		(6-7)	34-38
<i>Physiculus nematopus</i>	2	5	Present	4-5	(4-6)		(3-4)	5-6	4	(0-1)		(5-7)	22-26
<i>Physiculus rastrelliger</i>	2	5	Present	5-6	(6-8)		(3-5)	5-6	4	(1-3)		(7-8)	27-32
<i>Sahlota australis</i>	2	5	Present	7		15		6	4		15		40
<i>Tripteryphycis gilchristi</i>	2	5 (6)	Present	5		7		6	4		5		22
<i>Svetovidovia</i>	2	5	Present	7 (?)		(7) 8-9		6	3		(12) 16-18		(28) 30-33
Lotinae													
<i>Brosme brosmie</i>	2	2	Absent	14		19-20		4	3		22-24		45-48
<i>Lota lota</i>	2	2	Absent	13	(4-5)	20-22	(14-15)	4	2	(12-13)	21-25	(4-6)	42-50
<i>Molva molva</i>	2	2	Absent (variable)			22-23		5	3		25		52-53
Phycinae													
<i>Enchelyopus cimbrius</i>	2	2	Present	8-9	(5)	12-15	(9)	(4) 5	2	(6)	13-15	(5)	31-35
<i>Gaidropsarus ensis</i>	2	2	Present			17-20		5	2		18-21		41-46
<i>Gaidropsarus mediterraneus</i>	2	2	Present	8-9		13-15		(4) 5	*		14-15		31-36
<i>Phycis chesteri</i>	2	2	Present	7-8	(6-8)	12-14	(5-6)	6	3	(3-4)	14-17	(6-8)	32-37
<i>Phycis blennoides</i>	2	2	Present		(3)				21			(4)	28
<i>Urophycis regia</i>	2	2	Present	6	(7-8)	11-12	(4-5)	6	3	(2)	13-14	(7-8)	30-32
<i>Urophycis chuss</i>	2	2	Present	7		12-13		6	3		10-11		29-34
<i>Urophycis tenuis</i>	2	2	Present	8	(9)	13-15	(5)	(5) 6	3	(3)	13-14	(9)	33-39
Gadinae													
<i>Arctogadus borisovi</i>	2	2	Absent	15		21-26		4	1		22-25		47-55
<i>Boreogadus saida</i>	2	2	Absent	13-14	(15)	21-25	(8)	4	2 (3)	(6)	21-25	(16)	46-54
<i>Eleginus gracilis</i>	2	2	Absent	15-16		22-25		5	2		23-26		50-56
<i>Gadaculus argenteus</i>					(7-8)				20-21			(7-8)	35-36 (?)

TABLE 76. CONTINUED.

Taxa	Epu- rals	Hypu- rals	XY bones	Number of vertebrae associated with caudal fin	Number of rays								Total caudal rays
					Dorsal		Superi- or hypu- ral(s)	Inferior hypu- ral(s)	Ventral				
					(Un- branched)	(Branched)			(Branch- ed)	(Un- branched)			
<i>Gadus morhua</i>	2	2	Absent	13-14		22-26		4	2		23-27		49-57
<i>Gadus ogac</i>	2	2	Absent	14		21-23		4	2		21-24		46-51
<i>Gadus macrocephalus</i>	2	2	Absent	11-13	(12-13)		(11)	4	2	(9)		(12-13)	51-53
<i>Melanogrammus aeglefinus</i>	2	2	Absent	14	(15-16)	25-27	(11)	5	2	(9)	26-27	(15)	57-60
<i>Microgadus tomcod</i>	2	2	Absent	13-14	(9)	21-22	(12)	4	1	(10)	21-24	(10)	46-50
<i>Microgadus proximus</i>	2	2	Absent	14-15	(11-13)	22-25	(11-13)	(4) 5	2	(9-11)	20-24	(11-12)	49-56
<i>Micromesistius poutassou</i>	2	2	Absent	15		21-22		5	2		23-24		50
<i>Pollachius virens</i>	2	2	Absent	15-16	(15-16)	30-32	(15-16)	5	2	(13-14)	31-33	(16-17)	66-70
<i>Theragra chalcogramma</i>	2	2	Absent	12-13	(12-14)		(9-10)	4	2	(8-9)		(11-13)	
Merlucciidae													
<i>Merluccius albidus</i>	2	2	Present	10	(10)	16	(6)	6	3	(4)	18	(10)	40
<i>Merluccius bilinearis</i>	2	2	Present	9	(8)	13-15	(5-6)	6	(2) 3	(5-6)	15-17	(7-8)	34-37
<i>Merluccius productus</i>	2	2	Present	9-10	(10-11)		(6-7)	6	2-3	(4-6)		(10-11)	42-43
<i>Macruronus novaezelandiae</i>	2	2	See text	2		4?		3	2		2-3?		10-12?

* Included in ventral count.

iforms varies from occipital to slightly behind the pectoral fin tips and is long-based, reaching almost to the caudal fin (and confluent with the caudal in *Muraenolepis* and *Macruronus*). The anal fin originates close behind the anus (except in some macrourids and steindachneriids) and also extends posteriorly to near the caudal fin (confluent with caudal in *Muraenolepis* and *Macruronus*). The caudal peduncle is, as a result, very short, being longest in *Merluccius*. Variations are found in morids (where the dorsal fin may extend farther posteriorly than the anal, accommodating an asymmetrical caudal fin), and in *Steindachneria* and the Macrouridae (where the lack of a caudal fin results in dorsal and anal rays tapering until they meet at the tip of the tail).

Gadiform dorsal and anal fin rays usually form after pelvic fin rays begin (with the exception of the anterior dorsal ray in *Bregmaceros*, which may form very early). Usually, the vertical fins ossify together, so that caudal, dorsal and anal fin rays appear at about the same time. In some genera with one long dorsal fin (or a short first dorsal fin preceding a longer second dorsal) fin rays in the longer fin form from two or more centers of ossification, for example, *Molya* (Schmidt, 1906b) and *Merluccius* (Ahlstrom and Counts, 1955). This may indicate either preadaptation for the multiple dorsal/anal condition or secondary loss of multiple dorsals/anal.

In cases where a long second dorsal fin is preceded by a relatively short first dorsal fin, development of the first is usually delayed and is often the site of the last fin ray formation, as in *Gaidropsarus* (Demir, 1982) and *Urophycis* (Hildebrand and Able, 1938). In gadines, which have three dorsal fins, the first, again, forms last. In Macrouridae and *Merluccius*, however, first dorsal fin rays appear to form much sooner than the second (Merrett, 1978; Ahlstrom and Counts, 1955). In the morids *Physiculus* and *Svetovidovia* the first and second dorsal fins develop together and divide late in development into apparent first and second fins. Thus in the gadiforms, ossification of ver-

tical fin rays is not uniformly anterior to posterior, or vice-versa, or from the middle toward both ends, but instead is variable.

The relationship of dorsal and anal fin rays to centra is an important characteristic in gadiforms (Rosen and Patterson, 1969; Marshall and Cohen, 1973). We believe the primitive state, as exemplified by *Muraenolepis*, involved about three rays per centrum. The major evolutionary trend, as identified by Rosen and Patterson (1969), is for this ratio to change anteriorly where it is replaced by an approximate 2:1 relationship in most families of gadiforms. In phycines, two derived character states are found: a 7:1 relationship in rocklings (Cohen and Russo, 1979; Markle, 1982: fig. 5B) and a 2:1 relationship in hakes (Markle, 1982: fig. 5C).

Caudal fin.—Despite its absence in over a third of all gadiforms, the distinctive caudal skeleton has received an inordinate amount of attention. In the present context it is doubly important, for its presence offers identification as well as phylogenetic information (Markle, 1982; Dunn and Vinter, 1984, MS). Tailed gadiform larvae typically have a symmetrical fin where some "secondary" rays form before some "primary." As used here, "primary" refers to those rays articulating with the superior hypural (hypurals three through five) while rays attached to inferior hypurals (hypurals one and two), parahypurals, epurals, accessory bones (the X and Y bones of some authors), or to elongate neural and haemal spines are referred to as "secondary." Secondary rays also include those originating between neural or haemal spines.

We have summarized the distribution of gadiform caudal fin rays in Table 76. Various authors lump secondary rays together or express them as branched or unbranched. We have included both methods, thus the sum of counts from different sources do not always correspond. Several things are apparent from this table. One involves the utility of using the distribution of caudal rays both in intra- and intergeneric comparisons (Markle, 1982;

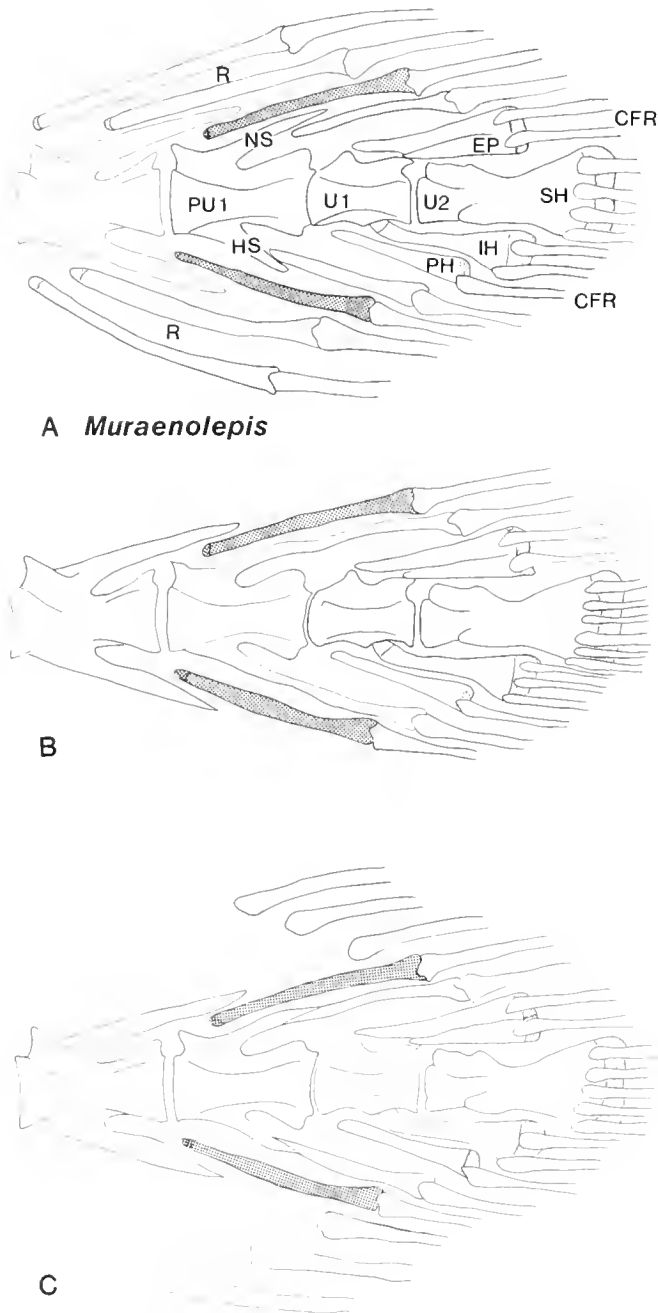

Fig. 144. Hypothesized acquisition of gadoid caudal structure from condition in *Muraenolepis* (see text). X and Y bones shaded. Abbreviations: CFR: caudal fin rays; EP: epurals; HS: haemal spines; IH: inferior hypural; NS: neural spine; PH: parhypural; PU₁: first preural centrum; R: radials; SH: superior hypural; U₁: first ural centrum; U₂: second ural centrum.

Dunn and Vinter, 1984, MS). Primary and total caudal fin ray counts also exhibit some difference in symmetry and patterns of evolutionary change. Morids are the only group of tailed gadiforms that show noticeable asymmetry in superior versus inferior secondary caudal rays (Table 76). Morids and some phycines have relatively low total caudal fin ray counts (20–38) and numerous groups have some genera with six primary caudal

fin rays. Markle (1982) interpreted both of these as primitive states.

The caudal of *Muraenolepis* differs from most other gadiforms¹ in its complete continuity with both dorsal and anal fin rays (Fig. 144A). It is virtually identical to that of the ophidiiform, *Brotula* (Monod, 1968), differing only in number of rays supported by the parhypural (one vs. two). The typical gadoid caudal fin skeleton is easily derived from the condition in *Muraenolepis*, which we identify as the primitive state. The primary requirement is the acquisition of X and Y bones and modified spines of the first preural centrum, both sets of which must have cartilaginous articulating surfaces entering into support of caudal rays. X and Y bones are present in *Muraenolepis* as the penultimate radials of the dorsal and anal fins. If the last radials fuse with the spines of the first preural centrum, both sets of preural caudal bones (with cartilaginous articulating surfaces) are acquired.

A second requirement is an interspace (lacking rays and radials) between the caudal fin and the dorsal and anal fins. This condition could have been satisfied in one of two ways. Rays (and their supporting radials) anterior to the X and Y bones might have been lost, and subsequent changes in caudal ray numbers would then involve the addition of secondary rays lacking radials. A less parsimonious scenario involves the loss of radials (only) anterior to the X and Y bones which leaves a continuous dorsal-caudal-anal fin including some anterior unsupported rays. In this case, further variation in numbers of secondary caudal rays would involve both increases and decreases. The hypothesized ancestral gadoid condition is shown in Fig. 144B. Presumably, this ancestor would have had 16 caudal fin rays (one each on X and Y bones, first preural neural and haemal spines, each epural and parhypural, six on the superior hypural and three on the inferior hypural). This total is close to the lowest known (and presumably most primitive) counts in certain morids (Table 76) and corroborates the suggestion that higher counts in Melanonidae, Gadidae and *Merluccius* are derived states brought about through the acquisition of additional rays lacking radial support (Fig. 144C). In *Brosme* this acquisition has resulted in a secondary elimination of the caudal peduncle and an almost continuous dorsal-caudal-anal fin (Markle, 1982: fig. 7C). The acquisition of rays has apparently occurred asymmetrically in some morids, where ventral secondary rays outnumber dorsal.

Olfactory lobes.—The position of olfactory lobes relative to nasal organs and the forebrain has been used as a systematic character in gadiforms by Svetovidov (1948, 1969) and Marshall (1965). This character develops during ontogeny since the bulbs are close to the forebrain in young of all gadiforms (Rass in Svetovidov, 1948; Marshall, 1965). It reaches the most derived state adjacent to olfactory capsules in “nearly all of the Gadidae,” “most species of Macrouridae,” *Muraenolepis* (Marshall, 1966b) and *Merluccius* (Inada, 1981b). Olfactory lobes are between the forebrain and olfactory capsules in *Bregmaceros* and next to the forebrain in other merlucciids and *Steindachneria* (Marshall, 1966b).

We are not certain how to interpret the available information

¹ The caudal fin of *Macruronus novaezelandiae*, though much reduced in over-all size, is similar to that of *Muraenolepis* in its confluence with dorsal and anal fins.

on this structure since an undescribed ontogenetic sequence is involved. This character is an important part of our current concept of Merlucciidae, thus descriptions of its ontogeny could contribute to a better understanding of this family's interrelationships.

Genital papilla.—A genital papilla develops precociously in most gadiforms. It is most pronounced in morids, macrourids and *Steindachneria* (see figures), but we also could find it in gadids and *Merluccius*.

Mental barbels.—Mental barbels usually develop late in the larval or early in the pelagic juvenile period. They are found in most gadids (being lost in some of the secondarily pelagic forms such as *Pollachius pollachius* and *Micromesistius*), most macrourids, muraenolepidids and morids. Additional fleshy, snout barbels are found in phycine rocklings. The propensity to develop snout and mental barbels seems widespread in gadiforms and can also be found in some ophidiiform fishes; it appears to have a strong ecological component and we are unable to attach phylogenetic significance to its presence or absence.

GADIFORM PHYLOGENY

A framework of interrelationships of the eight gadiform families has developed from among others, Marshall (1966b), Gosline (1968), Rosen and Patterson (1969), Okamura (1970b) and Marshall and Cohen (1973). A consensus on minor as well as some major points does not exist, and we therefore follow a modification of Rosen and Patterson (1969) and Cohen (this volume). In this framework muraenolepidids are the most primitive group, showing no obvious relationships, and are the presumed sister group to all other gadiforms. Based on fossil evidence (Danil'chenko, 1960), bregmacerotids are thought to be related to a group composed of morids and melanonids. These three families are the sister group of macrourids and together form a principal gadiform lineage. *Steindachneria* and merlucciids are sister groups and with gadids form the other principal gadiform lineage.

On the basis of available data, we can identify the following early developmental characters, their derived states, and known distribution in the order. In many cases the "holes" in our data severely reduce the weight of our arguments. (1) Oil globule in egg—lost—gadines; (2) Chorion ornamentation—honey-combed—macrourines; (3) Lateral premaxillary spines—present—muraenolepidids; (4) Pterotic spines—present—some phycines; (5a) Sequence of fin formation—caudal first—gadines and *Merluccius*; (5b) Sequence of fin formation—pelvics last—gadines; (6) Pelvic fin ontogeny—reduction in ray number—phycine hakes and morids; and (7) Larval pectoral fin—pedunculate—macrourids and *Steindachneria*. To this list we can add ontogenetically persistent characters taken in part from Rosen and Patterson (1969), Marshall and Cohen (1973) and Markle (1982). (8) X and Y bones—loss in forms with tails—melanonids, gadines and lotines; (9) Total caudal fin rays—over 50—melanonids, gadines and lotines; (10a) Anterior dorsal fin rays to centra ratio—7:1—phycine rocklings; (10b) Anterior dorsal fin rays to centra ratio—ca. 1:1—gadines, morids?, macrourids and merlucciids; (11) Precaudal vertebrae—counts greater than 20—gadines, lotines, merlucciids and muraenolepidids; (12) Hypurals—fusion into two plates—muraenolepidids, bregmacerotids, gadids and merlucciids; (13) Otophysic connection—present—morids; and (14) Fin differentiation—three dorsals and two anals—gadines, some morids (*Merluccius* and bregmacerotids to a lesser degree).

These characters generally do not support the above hypotheses of relationships. Notable discrepancies and areas for additional investigation are: (1) whether gadids are monophyletic, specifically whether phycines belong in and *Merluccius* belongs out; (2) relationship, if any, of melanonids to gadines; and (3) relationships of *Steindachneria*.

(M.P.F.) NATIONAL MARINE FISHERIES SERVICE, NORTHEAST FISHERIES CENTER, SANDY HOOK LABORATORY, HIGHLANDS, NEW JERSEY 07732; (D.F.M.) HUNTSMAN MARINE LABORATORY, BRANDY COVE, ST. ANDREWS, NEW BRUNSWICK E0G 2X0 CANADA.

Gadidae: Development and Relationships

J. R. DUNN AND A. C. MATARESE

LARVAE of the fishes of the family Gadidae have received a great deal of study through the years and because of the economic value of the family, the larvae are taxonomically as well known as those of most families of teleosts. Svetovidov's (1948) classic work on the systematics of adult gadid fishes is the benchmark of knowledge of the family. He considered 22 genera (including *Merluccius*), examined osteological characters of representatives of all genera, and based his classification scheme mainly on the structure and number of median fins (see also Svetovidov, 1956). Subsequent workers (Mujib, 1967, 1969; Marshall and Cohen, 1973) have extended our understanding

of the relationships of certain members of the family, but a comprehensive study of Gadidae, including early life history stages, has not yet been accomplished. Recently Markle (1982) examined larval and adult representatives of all gadoid families which led him to recognize three gadid subfamilies: Phycinae, Lotinae, and Gadinae.

Our purpose here is to summarize available knowledge of the taxonomy of eggs and larvae of the family Gadidae. We include observations on eggs, larval morphology and pigment patterns, and developmental osteology. Included are illustrations of larvae of representatives of all currently recognized gadid genera

TABLE 77. SUMMARY OF EGG CHARACTERS IN GENERA OF THE FAMILY GADIDAE. All eggs are spherical in shape with a homogeneous yolk.

Taxon	Pelagic/ demersal	Size (mm)	Oil globules			Data source
			Number	Size (mm)	Pigment	
Lotinae						
<i>Brosme</i>	P	1.29–1.51	1	0.23–0.30		Russell (1976), Schmidt (1905b)
<i>Molva</i>	P	0.97–1.13	1	0.28–0.31	yes	Schmidt (1905b)
<i>Lota</i>	D	1.00–1.90	1		yes	Breder and Rosen (1966), Jude (1982b), Morrow (1980), Schmidt (1907a), Snyder (1979)
Phycinae						
<i>Enchelyopus</i>	P	0.66–0.98	multiple to 1	0.13–0.20	yes	Fahay (1983), Hardy (1978a), Russell (1976)
<i>Gaidropsarus</i>	P	0.70–0.85	multiple to 1	0.14–0.16	yes	Dekhnik (1973), Russell (1976)
<i>Phycis</i> ¹	P	0.76–0.79	1			Wenner (1978)
<i>Urophycis</i>	P	0.63–0.97	multiple to 1	0.17–0.20	yes	Fahay (1983), Hardy (1978a)
<i>Cihata</i>	P	0.67–0.98	multiple to 1	0.11–0.18	yes	Russell (1976)
<i>Raniceps</i>	P	0.75–0.91	1	0.14–0.19	yes	Kennedy and Fitzmaurice (1969), Russell (1976)
Gadinae						
<i>Trisopterus</i>	P	0.90–1.22	0			Russell (1976)
<i>Merlangius</i>	P	0.97–1.32	0			Dekhnik (1973), Russell (1976)
<i>Pollachius</i>	P	1.00–1.22	0			Fahay (1983), Fridgeirsson (1978), Russell (1976)
<i>Melanogrammus</i>	P	1.10–1.72	0			Hardy (1978a), Russell (1976)
<i>Gadus</i>	P, D	0.92–1.90	0			Mukhacheva and Zviagina (1960), Russell (1976)
<i>Gadiculus</i>		0.91–0.97 ²				Russell (1976)
<i>Microgadus</i>	D	1.39–1.70	probably 0			Hardy (1978a), this study
<i>Eleginus</i>	D	1.00–1.70	0			Breder and Rosen (1966), Kozlov (1952), Mukhacheva (1957), Mukhacheva and Zviagina (1960)
<i>Boreogadus</i>	P	1.53–1.90	0			Pertseva (1936), Rass (1968), Russell (1976)
<i>Arctogadus</i>	D					Zviagina (1961)
<i>Theragra</i>	P	1.19–1.81	0			Gorbunova (1954), Yusa (1954)
<i>Micromesistius</i>	P	1.04–1.27	0			Lisovenko et al. (1982), Russell (1976), Seaton and Bailey (1971)

¹ Applies to *P. chesterti* only.² Ovarian eggs only

(except *Arctogadus*). Finally, we attempt to evaluate the relationships of the subfamilies of gadid fishes based on early life history and adult characters.

METHODS

We have examined developmental series of varying completeness of representatives of all gadid genera except *Phycis* and *Arctogadus*, of which only juvenile specimens were available to us. Measurements were taken on these series and smaller series were differentially stained (Dingerkus and Uhler, 1977) for study of developmental osteology.

Russell (1976) described eggs and pigment patterns in gadid larvae. Matarese et al. (1981) modified the terminology used by Russell in describing postanal pigment and we use their terminology here.

Our discussion of osteology presented here is limited primarily to features of the pectoral and pelvic girdle, vertebral column, and median and paired fins. Svetovidov (1948) and Mujib (1967, 1969) have described cranial osteology. Matarese et al. (1981) and Markle (1982) have discussed the significance of median fins in gadoid fishes.

CHARACTERISTICS OF ADULT AND EARLY LIFE HISTORY STAGES

Family Gadidae.—Gadid fishes possess four to six pectoral radials; the posttemporal is attached to the skull in adults and possesses a ventral branch of varying length. An anterior process of varying length is present on the coracoid, but a posterior process is lacking. The postcleithrum is variously curved and, in some genera, possesses an expanded distal head. The pelvic

basipterygia have a postero-lateral process of varying length. The first neural spine is attached to the supraoccipital crest in adult fishes; and subsequent anterior neural spines (on vertebrae 2–10) vary in length and are oriented vertically or posteriorly. One or two predorsal bones are present in some genera but are absent in most. One to three dorsal and one or two anal fins are present. When two dorsal fins are present, the first may be separate from the second (interneural bones absent), or continuous (interneural bones present); when three dorsal fins are present the second is always internally continuous with the third; when two anal fins are present, they too are internally continuous. The distance (number of interneural bones) between multiple dorsal and anal fins varies among genera.

The caudal fin has three hypural bones (Matarese et al., 1981) including the parhypural (Markle, 1982), and four to six "primary" caudal fin rays (those articulating with the superior hypural bone [Markle, 1982]). Accessory (x and y) bones are present or absent, two epural bones are present, uroneural bones are absent, two ural centra are present, and the neural and haemal spines on preural centra one are broadly spatulate in most genera. Matarese et al. (1981) did not detect fusion of hypural bones during ontogeny of *Microgadus proximus*, but they hypothesized that hypural 2 represented a fusion of hypurals 2 and 3 and that hypural 3 represented a fusion of hypurals 4–6, because of the presence of three inferior and three superior hypural elements in Moridae (Fitch and Barker, 1972), which is generally considered a more primitive family than Gadidae.

Subfamily Lotinae (Tables 77–82, Figs. 145–146).—Members of the Lotinae are elongate gadid fishes including *Brosme*, *Mol-*

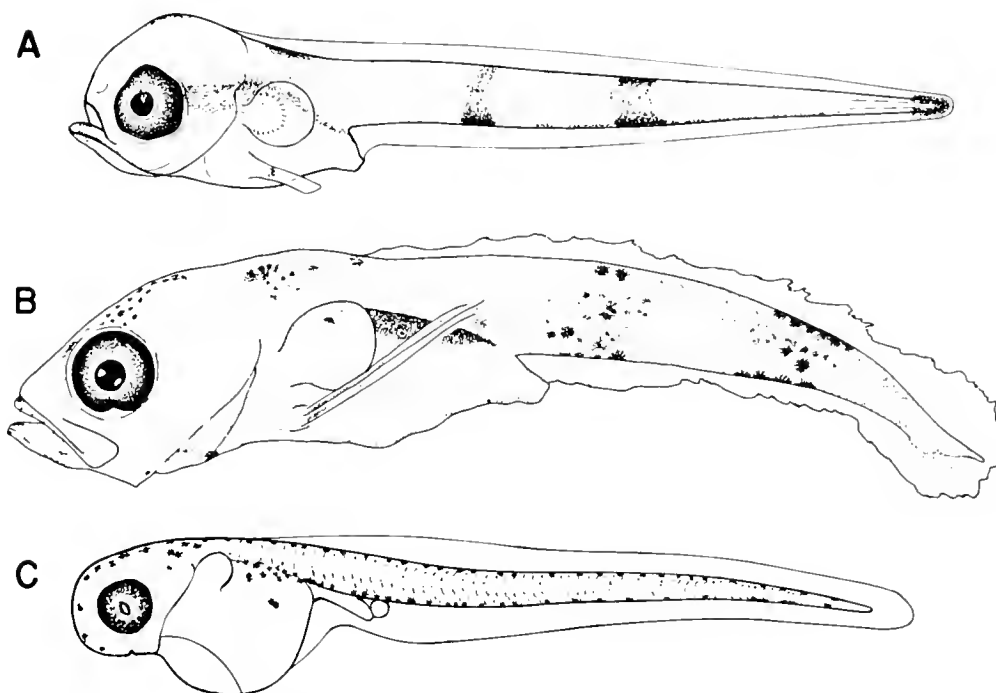

Fig. 145. (A) Preflexion larva of *Brosme brosme*, 5.9 mm SL (Huntsman Mar. Lab., H-16260, stored at NWAFC); (B) Flexion larva of *Molva molva*, 8.2 mm SL (Inst. Sci. Tech. Peches Marit., Nantes, stored at NWAFC); and (C) Preflexion larva of *Lota lota*, 3.7 mm SL (Group Interuniv. Res. Oceanogr., Quebec, stored at NWAFC).

va, and *Lota* (Markle, 1982). *Brosme* is monotypic and occurs on both sides of the North Atlantic Ocean. *Molva*, with three nominal species, occurs in the east and west North Atlantic Ocean (Svetovidov, 1948; Leim and Scott, 1966). *Lota* is monotypic and two subspecies occur in fresh and brackish waters of Europe, northern Asia, and North America (Pivnicka, 1970).

The characteristics of the subfamily, based on Markle (1982) and this study, are egg diameter relatively large (0.97–1.90 mm); oil globule present (0.2–0.3 mm diameter); vertebrae numerous (62–66 total, 20–26 precaudal in specimens examined); pterotic spines absent; pelvic ray formation prior to notochord flexion but acquisition of adult complement delayed; x and y bones usually absent; 4–5 primary caudal fin rays; 45–54 total caudal fin rays; and numerous total dorsal and anal fin rays (77–108D and 59–75A).

Eggs and larvae of lotines are reasonably well known (Tables 77–79). *Brosme* and *Molva* shed planktonic eggs whereas *Lota* deposits nonadhesive, demersal eggs, all with a single oil globule. The chorion of eggs of *Brosme* has deep pits visible by scanning electron microscopy (Markle, pers. comm.¹).

Lotine larvae hatch at moderate sizes (3–4 mm), yolk is absorbed at around 5 mm, and notochord flexion is delayed (9–25 mm). Size at transformation is large and the duration of the pelagic stage is extensive (Table 78). The larvae tend to be slender to moderately slender and taper toward the tail. Pelvic fins are precocious in *Brosme* and *Molva*, but not *Lota*.

Head pigment in larvae is generally limited to the mouth and dorsal area of the head. Gut pigment is sparse, initially located only on the dorsal surface. *Brosme* and *Molva* have pelvic fins

which are pigmented distally. Postanal pigment patterns are similar in *Brosme* and *Molva* (Table 79). *Brosme* larvae have two postanal bars and distinctive pigment above and below the urostyle (Fig. 145A). Although *Molva* does not have a bar pattern initially, the dorsal and ventral pigment eventually coalesce into two postanal pigment bands, the characteristics of which are of taxonomic value in differentiating species in the genus (Fig. 145B). Preflexion larvae (3–7 mm) of *L. lota* (*lacustris*?) in North American waters were reported by Fish (1932) to lack postanal pigment. Snyder (1979), however, reported finding dorsal and ventral postanal pigment in preflexion larvae identified as *L. lota*, as we did in those we examined from James Bay, Canada (Fig. 145C).

Brosme has single dorsal and anal fins with a slight separation between the anal and caudal fins (Markle, 1982). The neural spine on preural centrum one (PU₁) is distally flattened, the haemal spine on this centrum is distally rounded (Table 82), and x/y bones are absent (Fig. 146). *Molva* possesses two dorsal fins with only a slight internal separation. The haemal spine on PU₁ is distally rounded and x/y bones are present or absent (usually absent). *Lota* also possesses two dorsal fins, with only slight internal separation, and a single anal fin. Both the neural and haemal spines on PU₁ are distally flattened and the species usually lacks x/y bones, but a reduced x and/or y bone is sometimes present (Markle, 1982).

Subfamily Phycinae (Tables 77–82, Figs. 147–148).—The subfamily Phycinae was resurrected by Markle (1982) who examined seven species of Northwest Atlantic gadids belonging to four genera: *Enchelyopus*, *Gaidropsarus*, *Phycis*, and *Urophycis*. We include also *Ciliata* and, arbitrarily, *Raniceps* as phycines. *Enchelyopus* and *Raniceps* are each monotypic; the former is found on both sides of the North Atlantic Ocean, the

¹ D. F. Markle, Huntsman Marine Laboratory, St. Andrews, New Brunswick, pers. comm., 25 February 1983.

TABLE 78. SUMMARY OF MORPHOLOGICAL CHARACTERS OF LARVAE OF THE FAMILY GADIDAE. Proportions are expressed as percentages of standard length, when possible.

Taxon	Standard length (mm)					Morphometrics (% SL)				
	Hatching	Flexion	Post-flexion	Pre-juvenile	Juvenile	Eye diameter		Head length		Body depth ¹
						Pre-flexion	Post-flexion	Pre-flexion	Post-flexion	Pre-flexion
Lotinae										
<i>Brosme</i>	4	14–25	25–40	40–60	>60			21 ²		16
<i>Molva</i>	3	9–14	14–20	20–80	>80	9	7	30	24	21
<i>Lota</i>	3	14–19	19–30			8	6			21–25
Phycinae										
<i>Enchelyopus</i>	2	5–7	7–18	18–45	>45	10–15	4–5			
<i>Gaidropsarus</i>	2	5–7	7–12	12–48	>48	11–13	9–13	20–30	20	30
<i>Phycis</i>	?	5–8	8–12	12–30	>30	9		23		
<i>Urophycis</i>	2	4–5	5–	–40	>40					
<i>Ciliata</i>	2	5–8				13	9	28–32	27	25–30
<i>Raniceps</i>	3	7–12				11		27		32
Gadinae										
<i>Trisopterus</i>	3	7–11			>45	8	11	26	30	22
<i>Merlangius</i>	3	9–13	13–23			9	9	28	27	20
<i>Pollachius</i>	3–4	12–16			>50	9		21	26	16
<i>Melanogrammus</i>	3–4	10–16	16–22		>90	10				
<i>Gadus</i>	3–4	10–17	17–25	25–35	>35	5–9	7–10	11–27	22–26	10–18
<i>Gadiculus</i>	?	7–13	13–30	30–40	>40		10		31	
<i>Microgadus</i>	3	8–15	14–28	28–46	>46	8	8	22	32	19
<i>Eleginus</i>	4	11–17	17–24	24–27		8	9	20	26	15
<i>Borcogadus</i>	6	11–17	17–30	30–45	>45	8		18		14
<i>Arctogadus</i>	?						28–31 ³		22–25	16–19
<i>Theragra</i>	3–4	10–17	17–25	25–40	>40		7–8	15	33	
<i>Micromesistius</i>	2	8–13			>32	9	9	29	32	26

¹ At pectoral fin base when possible.² Data between columns indicate no data available for differences in preflexion and flexion larvae.³ Data are % HL.

latter in the eastern North Atlantic, as are the two nominal species of *Ciliata* (Cohen and Russo, 1979). *Gaidropsarus* has about 14 nominal species, 11 in the North Atlantic Ocean and single species off South Africa, New Zealand, and Japan. *Phycis* has three nominal species occurring in both sides of the North Atlantic Ocean. About seven species of *Urophycis* are presently recognized in the western Atlantic Ocean from Canada to South America (Svetovidov, 1948).

Characteristics of phycines according to Markle (1982) and this study include: egg diameter small (0.63–0.98 mm); multiple oil globules that eventually coalesce into a single moderately sized globule (0.11–0.22 mm diameter); vertebrae moderately numerous (45–55 total, 14–17 precaudal); pterotic spines present in some larvae and juveniles of *Gaidropsarus*, *Ciliata*, and *Phycis*; initial pelvic fin ray formation prior to flexion but acquisition of adult complement delayed; x and y bones present (sometimes absent in *Raniceps*); 5–6 primary caudal fin rays and 29–38 total caudal fin rays; and moderate numbers of total dorsal and total anal fin elements [D, 49–73, not including specialized rays (e.g., *Enchelyopus*), and A, 40–57].

Taxonomic problems are prevalent in this group. Specific identification of smaller larvae is not presently possible for certain species of *Gaidropsarus*, *Phycis*, and *Urophycis* (Russell, 1976; Markle, 1982). Adults of some species are easily confused (Musick, 1973; Svetovidov, 1982).

Eggs of *Enchelyopus* and *Ciliata*, some *Urophycis*, as well as those of *Gaidropsarus* that are known, have multiple oil globules in the earliest stages, which coalesce into a single oil globule;

melanistic pigment is present on both the embryo and oil globule (Table 77). In *Phycis*, only ovarian eggs of *P. chesteri* have been described (Wenner, 1978). Multiple oil globules have not been observed in *U. tenuis* (Markle²) nor reported in eggs of *Raniceps raninus*.

Phycine larvae hatch at small sizes (1.5–3.0 mm), yolk is absorbed quickly, notochord flexion occurs at small sizes (about 5–12 mm), size at transformation is variable, and a prejuvenile stage is present in most genera (Table 78). Phycine preflexion larvae tend to be deeper bodied (at the pectoral fin base) than lotines or gadines, but with development they become morphologically diverse. Pelvic fins are precocious and pigmented, although the extent and duration of pigmentation varies among genera. The entire fin is pigmented in *Gaidropsarus*, whereas only the tip is pigmented in some species of *Urophycis*. *Raniceps* is morphologically the most divergent phycine. By 5 mm, the preanal portion of the body is usually high in relation to the postanal region and at a length of about 7.5 mm the larvae are "tadpole shaped."

Although pigmentation is highly variable in phycines, most genera possess head pigment on the dorsal part (sometimes extending to the nape), and on the snout and mouth. In addition, some genera may have pigment near the eye and on the opercular area. Gut pigment is initially located along the dorsal surface, with some genera (e.g., *Enchelyopus*, *Phycis*) developing more pigment over the lateral surface. Postanal pigment is variable,

² D. F. Markle, pers. comm., 5 July 1983.

TABLE 78. EXTENDED.

Morphometrics (% SL)						Data sources
Body depth ¹	Prenatal length		Lateral vent	Precocious pelvic fin	Approximate size at pelvic fin formation	
	Post-flexion	Pre-flexion				
15	35	48	yes	yes	6	Fahay (1983), Russell (1976), this study Russell (1976), Schmidt (1906b), this study
	43	48		yes	5	
		47	yes	no	11	Fish (1932), Jude (1982b), Snyder (1979)
20	60	45	yes	yes	3	Fahay (1983), Hardy (1978a), Russell (1976) Demir (1982), Markle (1982)
		37	yes	yes	<5	
<25	44	50	yes	yes	3-4	Fahay (1983), Hardy (1978a) Russell (1976), this study
			yes	yes	5	
26		50		no	11	Russell (1976), Schmidt (1905a, 1906a), this study
20	48	43		no	9	Russell (1976), this study
		40		no	12	Fahay (1983), Russell (1976), this study
14-20	35-50	47-54		no	9	Fahay (1983), Scott (1982)
28		48		no	13	Mukhacheva and Zviagina (1960), this study
20	41-48	45	yes	no	7-8	Russell (1976), Schmidt (1905a, 1906a), this study
	42	49	yes	no	14	Matarese et al. (1981)
20	38		yes	no	12	Dunn and Vinter (1984)
		42-46		no	13	This study
	30	50	yes	no	14	Zviagina (1961)
23	51	41		no	14	Dunn and Vinter (1984), this study, (T. Nishiyama, pers. comm. July 15, 1982)
				no	11	Russell (1976), Schmidt (1905a), Seaton and Bailey (1971)

both between and within genera (Table 79, Fig. 147A-F). At some size, phycine larvae usually have a single postanal pigment bar located about midtrunk, but *Ciliata* has two bars (which disappear during ontogeny) and *Raniceps* has none. *Phycis* larvae less than 4.3 mm in length are not known, but larger post-flexion larvae have a single midtrunk patch of pigment. The location of the pigment bar varies among species of *Gaidropsarus*. Postanal pigment spots along the ventral body midline occur in *Raniceps* (anteriorly) and in *Ciliata*. Caudal pigment can be present or absent and may be taxonomically significant at the species level.

Phycines have two dorsal fins and one anal fin (Svetovidov, 1948); the first and second dorsal fins are only slightly separated (Table 81). A predorsal bone is present in *Urophycis*, *Phycis chesteri* (two in *P. blennoides*) and *Raniceps*, but is wanting in the other genera. X/Y bones are present (Fig. 148A), or usually present in *Raniceps* (Fig. 148B). Neural and haemal spines on PU₁ are distally flattened except in *Raniceps*, in which those bones are distally rounded. We detected evidence of ontogenetic fusion of the hypural bones in *Raniceps*, as hypurals 2 and 3 are bifurcate distally (Fig. 148), and a sixth hypural bone was found in one larva.

Subfamily Gadinae (Tables 77-82, Figs. 149-151).—This subfamily contains the "true cods." There are approximately 30 nominal species presently assigned to twelve genera. They are found in the North Atlantic, North Pacific and Arctic oceans except for a single species, *Micromesistius australis*, which is distributed in the western South Atlantic Ocean to 60°S (Merrett, 1963; Shust, 1978).

The subfamily Gadinae is characterized as follows [Markle (1982); this study]: egg diameter relatively large (0.9 to 1.9 mm); no oil globule; vertebrae moderately numerous (39-64 total vertebrae, 17-26 precaudal); pterotic spines absent; pelvic fin ray formation at the same time as notochord flexion; x and y bones absent; 4-5 primary caudal fin rays; 46-70 total caudal fin rays; relatively few total dorsal and total anal fin elements (D, 45-67 and A, 35-65).

Eggs of gadines are well known, with eggs of one or more species of each genus described, except for *Gadiculus* and *Arctogadus* (Table 77). Most species shed small, planktonic eggs, but demersal eggs are deposited by a number of species (*Gadus macrocephalus* and both species of *Microgadus*, *Eleginus*, and, presumably, *Arctogadus*). Characteristic pigment develops on late stage embryos which aids in their identification.

Gadine larvae are also well known except for *Arctogadus* (Tables 78, 79). Length at hatching ranges from 2 to 6 mm, yolk absorption (when known) occurs relatively early, notochord flexion occurs from about 7 to 17 mm, and transformation to the juvenile stage occurs at about 25-40 mm. The duration of the pelagic state is moderate to long. Preflexion larvae typically are moderately slender, tapering toward the tail, while flexion larvae tend to be more robust (Table 78).

Head pigment is more diverse and diagnostically more important in this subfamily than in the lotines or phycines. Larvae of most genera have pigment on the dorsal head and on the mouth (usually the dentary). In some genera, the presence (e.g., *Eleginus*) or absence (e.g., *Boreogadus*) of gular and isthmus pigment is important in identification. Absence of ventral gut melanophores in certain size larvae (e.g., *Boreogadus*, *Melano-*

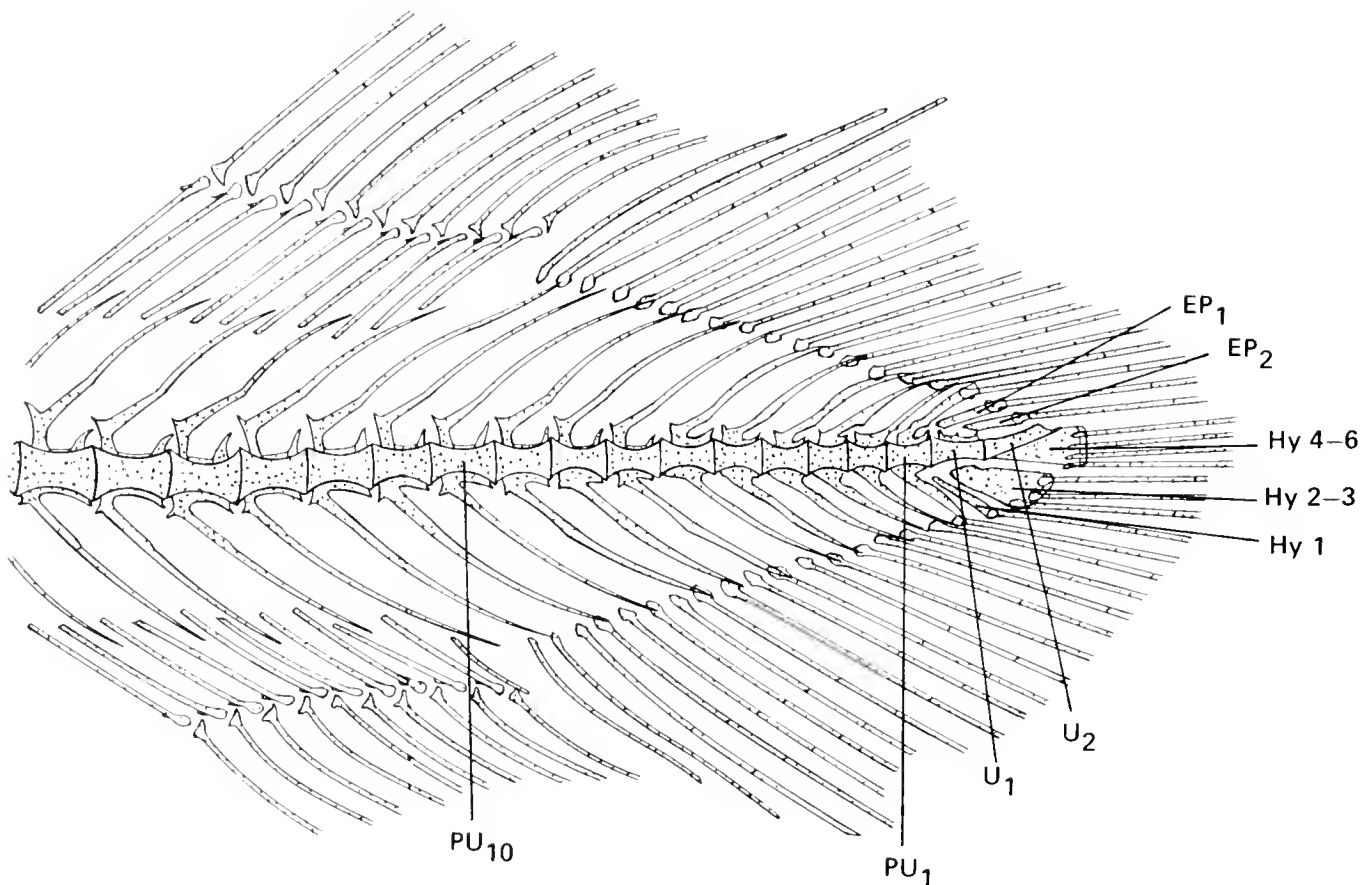

Fig. 146. Caudal fin of *Brosme brosme*, 45.2 mm SL. Hy1 = Hypural bone 1; Hy2-3 = Hypural bones 2 and 3; Hy4-6 = Hypural bones 4, 5, and 6; EP₁ = Epural bone 1; EP₂ = Epural bone 2; U₁ = Ural centrum 1; U₂ = Ural centrum 2; PU₁ = Preural centrum 1; PU₁₀ = Preural centrum 10. (Huntsman Mar. Lab., H-9742, stored at NWAFC).

grammus) or the presence and distribution of such pigment (e.g., *Pollachius virens*, *P. pollachius*) is also of diagnostic value (Russell, 1976; Matarese et al., 1981; Dunn and Vinter, 1984).

Pigment in the postanal region is also diverse and usually of value in discriminating among species (e.g., Russell, 1976). For purposes of discussion here we divide the gadines into three groups based on their postanal pigment patterns: those genera without postanal pigment bars in preflexion larvae, those genera in which individual species may or may not possess such bars, and those genera possessing one or two postanal pigment bars (Table 79).

Merlangius and *Melanogrammus* lack postanal pigment bars (Fig. 149C, D). In *Merlangius*, postanal pigment develops along the dorsal body midline and extends to nearly three-quarters the length of the body. Ventral pigment consists of a row of melanophores from the anus to the caudal fin. Preflexion larvae of *Melanogrammus* lack the dorsal line of pigment, but possess the continuous ventral line.

Within *Trisopterus* and *Pollachius*, some species have one or two postanal pigment bars, whereas others lack such bars [*T. esmarkii*, *T. minutus*, and *P. pollachius* (Russell, 1976)]. In those species possessing postanal bars, *T. luscus* (Fig. 149A) has a single pigment bar, with dorsal and ventral midline pigment extending to about one-half the postanal body (Russell, 1976). *Pollachius virens* (Fig. 149C) has two postanal pigment bars, the

anterior of which is close to the vent. Of those without pigment bars, *T. minutus* and *P. pollachius* possess dorsal and ventral lines of pigment extending to about three-quarters of the body length; caudal peduncle pigment may be present in certain size larvae of the former species, but is normally lacking in the latter.

Gadiculus has one postanal pigment bar located posterior to the midpoint of the postanal region whereas *Micromesistius* has a single bar near the midpoint of this region (Figs. 149F and 150E). The dorsal stripe is slightly longer than the ventral stripe. Mediolateral pigment between the dorsal and ventral bars develops during ontogeny, but the caudal peduncle area is not pigmented. *Gadus* (in those species whose larvae are known), *Microgadus*, *Eleginus*, *Boreogadus*, and *Theragra* have two postanal bars of pigment (not known for *Arctogadus*) as shown in Figs. 149E and 150A-C. In some genera (e.g., *Boreogadus*) the dorsal stripe of each bar is longer than the ventral stripe; in others, the ventral stripe is longer than the dorsal (*Gadus*, *Microgadus*, *Eleginus*, and *Theragra*). The anterior end of the ventral stripe may be near the anus (e.g., *Gadus*), or some distance from it (e.g., *Boreogadus*), and the ventral stripes may be composed of a single row of melanophores on each side of the body midline (e.g., *G. macrocephalus*), a double row on each side of the midline (*E. gracilis*), or on the ventral midline with scattered pigment on each side of the body (*B. saida*). Caudal peduncle pigment may be present or absent.

TABLE 79. SELECTED PIGMENTATION CHARACTERS USEFUL IN IDENTIFYING PREFLEXION AND FLEXION LARVAE OF THE FAMILY GADIDAE.

Taxon	Flexion (mm)	Postanal pigment				Description of pigment	Hypural margin	Pelvic fins	Diagnostic	Data sources
		Bars (any size)	Number of bars	Dorsal stripes continuous	Ventral stripes continuous					
Lotinae										
<i>Brosme</i>	14-25	Yes	2	No	No	Within bars only	Above and below	Yes	Caudal, 2 bars, pelvics	Fahay (1983), Russell (1976)
<i>Molva</i>	9-14	Yes	2	May	No	May occur along dorsal midline, mediolateral within bars	May occur above and below	Yes	Caudal when present, 2 bars, pelvics	Russell (1976), Schmidt (1906b, 1907a)
<i>Lota</i> ¹	14-19	No				Along dorsal and ventral midline, mediolateral	No	No	Lack of pigment in larvae <6 mm, or dorsal/ventral rows	Fish (1932), Hardy (1978a), Jude (1982b), Snyder (1979)
Phycinae										
<i>Enchelyopus</i>	5-7	Yes	1			Bar at mid-trunk	Yes	Yes	Mid-trunk bar, pelvics	Fahay (1983), Hardy (1978a), Russell (1976)
<i>Gadropsarus</i>	5-7	Yes	1			Bar location variable, dorsolateral at bar	May	Yes	Bar location, presence of caudal	Demir (1982), Markle (1982)
<i>Phycis</i>	5-8	No? ²				Several spots along ventral midline	Yes	Yes	Lack of dorsal initially, pelvic	D'Ancona (1933), Fahay (1983), Hardy (1978a), Russell (1976)
<i>Urophycis</i>	4-5	Yes	1			Variable, but mid-trunk patch, mediolateral at bar	May	Yes ³	Postanal pattern, pelvic tips	Fahay (1983), Hardy (1978a)
<i>Cithata</i>	5-8	Yes	2	No	Yes	Bars disappear, ventral midline only	Yes	Yes	Loss of dorsal pigment, pelvics	Russell (1976), this study
<i>Raniceps</i>	7-12	No				Anterior ventral midline, upper body	No	Yes	Upper body pigment, pelvics	Russell (1976), Schmidt (1907b)
Gadinae										
<i>Trisopterus</i>	7-11	Yes/no	1			Variable length dorsal, ventral midline, mediolateral within bar	No	No	Lack of bars (some species) reduced dorsal midline	Russell (1976), Schmidt (1905a, 1906a)
<i>Merlangius</i>	8-13	No				Dorsal (shorter) and ventral midline dorso-ventrolateral	Yes	No	Length of dorsal midline	Russell (1976)
<i>Pollachius</i>	11-16	Yes/no	2	Yes (11 mm)	Yes (14 mm)	Dorsal, and double ventral midline, extends 3/4, some mediolateral	No	No	Unpigmented posterior 1/4 body	Fahay (1983), Fridgerisson (1978), Hardy (1978a), Russell (1976)
<i>Melanogrammus</i>	10-16	No				Small, double ventral midline	Yes	No	Ventral midline, nape	Fahay (1983), Hardy (1978a), Russell (1976)

TABLE 79. CONTINUED.

Taxon	Flexion (mm)	Postanal pigment				Description of pigment	Hypural margin	Pelvic fins	Diagnostic	Data sources
		Bars (any size)	Number of bars	Dorsal stripes continuous	Ventral stripes continuous					
<i>Gadus</i>	10–17	Yes	2	Yes (6 mm)	Yes (6 mm)	Initially posterior stripes longer, mediolateral	May	No	Continuous stripes, ventral gut	Dunn and Vinter (1984), Matarese et al. (1981), Mukhacheva and Zviagina (1960), Schmidt (1906a)
<i>Gadiculus</i>	7–13	Yes	1			Bar posterior to mid-trunk	No	No	Posterior location of bar	Russell (1976), Schmidt (1905a, 1906a)
<i>Microgadus</i>	8–15	Yes	2	Yes (15 mm)	Yes (6 mm)	Bars anterior, mediolateral	Yes	No	Bar location, ventral gut, caudal	Matarese et al. (1981)
<i>Eleginus</i>	11–17	Yes	2	Yes (10 mm)	Yes (7 mm)	Ventral stripes longer, double ventral row each side of midline, mediolateral	No	No	Continuous stripes, mediolateral, ventral gut	Dunn and Vinter (1984)
<i>Boreogadus</i>	11–17	Yes	2	Yes (7 mm)	Yes (10 mm)	Ventral stripe shorter, mediolateral	No	No	Bars, mediolateral	Dunn and Vinter (1984), this study
<i>Arctogadus</i>						Dorsal, ventrolateral margins, mediolateral				Zviagina (1961)
<i>Theragra</i>	10–17	Yes	2	Yes (13 mm)	May	Posterior ventral stripe longer than dorsal, single ventral row each side midline, mediolateral	May	No	Bar location, length	Dunn and Vinter (1984), Gorbunova (1954), Matarese et al. (1981)
<i>Micromesistius</i>	8–13	Yes	1			Bar mid-trunk, dorsal stripe longer, nape	No	No	Bar location, upper body	Lisovenko et al. (1982), Russell (1976), Schmidt (1905a), Weiss (1974)

¹ See text for discussion of pigmentation in *Lota*

² In Phycines, the bar occurs early. Specimens of *Phycis* 3–4 mm not available to us.

³ Pelvic fins not pigmented in *U. regia*

Gadines have three dorsal fins and two anal fins. The distances (number of interneural bones) between dorsal fins 2 and 3 and between anal fins 1 and 2 vary among genera. In all genera, the dorsal and anal fins are separate from the caudal fin. The lower branch of the posttemporal tends to become more elongate than in lotines or phycines (longest in *Arctogadus* and *Micromesistius*), the postcleithrum always has an expanded distal head, and

the posterior process of the basipterygia tends to be short or even lacking. Predorsal bones are absent in Gadinae. The first and second dorsal fins are not usually internally continuous, but the second and third dorsal fins are always internally continuous. The neural and haemal spines on PU₁ are distally flattened in all gadine genera and only three hypural bones (including the parhypural) are present (Table 82, Fig. 151).

Fig. 147. (A) Preflexion larva of *Enchelyopus cimbrius*, 3.7 mm SL (Huntsman Mar. Lab., H-5388, stored at NWAFC); (B) Flexion larva of *Gaidropsarus mediterraneus*, 6.1 mm SL (from Demir, 1982); (C) Flexion larva of *Phycis blennoides*, 4.3 mm SL (from Russell, 1976); (D) Flexion larvae of *Urophycis* sp., 4.2 mm SL (Huntsman Mar. Lab., H-16384, stored at NWAFC); (E) Flexion larva of *Ciliata* sp., 4.4 mm SL (Zool. Mus. Copenhagen, stored at NWAFC); and (F) Preflexion larva of *Raniceps raninus*, 4.7 mm SL (Inst. Sci. Tech. Peches. Marit. Nantes, stored at NWAFC).

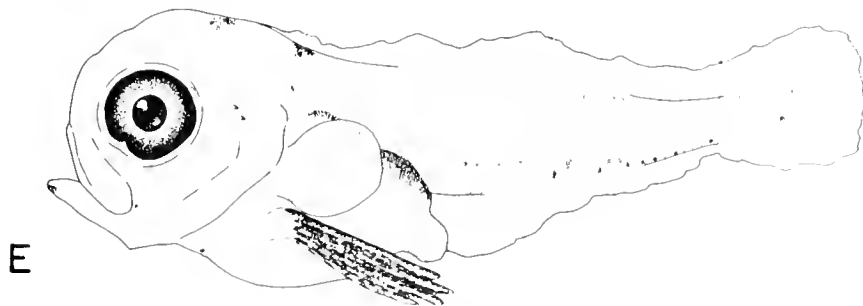
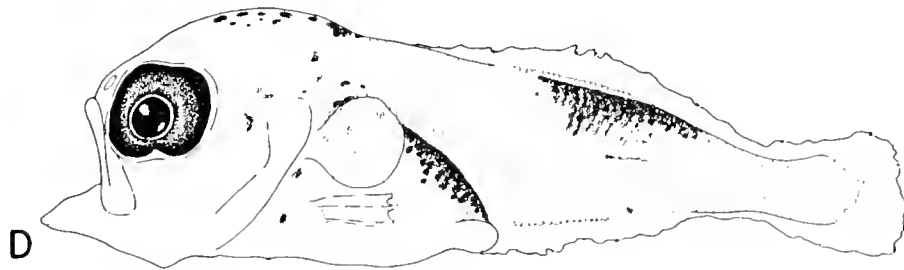
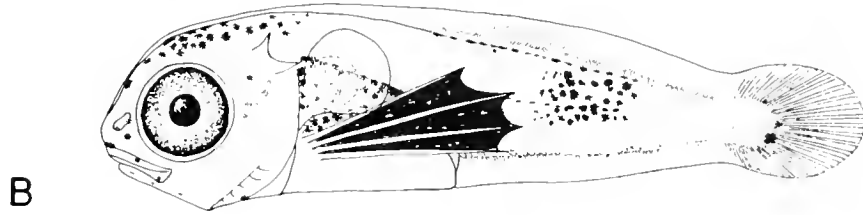
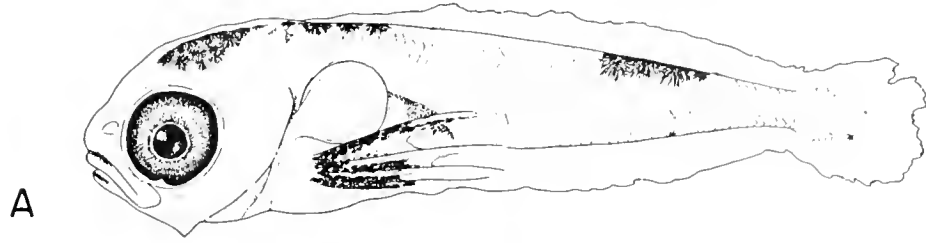

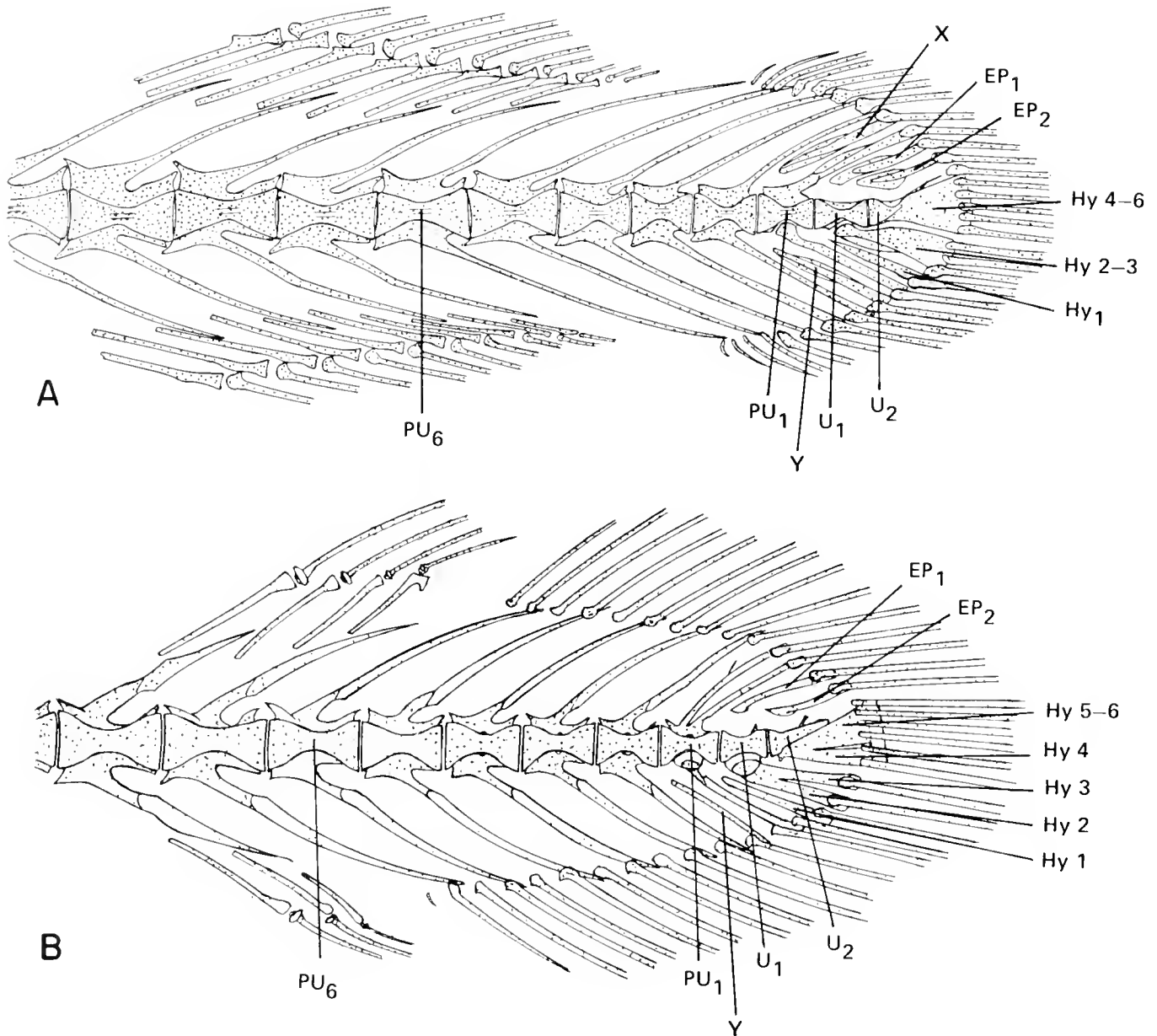

Fig. 148. (A) Caudal fin of *Phycis blennoides*, 82.3 mm SL (British Mus. Nat. Hist. 1976. 7.30.110-119); Hy₁ = Hypural bone 1; Hy₂₋₃ = Hypural bones 2 and 3; Hy₄₋₆ = Hypural bones 4, 5, and 6; EP₁ = Epural bone 1; EP₂ = Epural bone 2; X = x bone, Y = y bone; U₁ = Ural centrum 1; U₂ = Ural centrum 2; PU₁ = Preural centrum 1; PU₆ = Preural centrum 6; (B) Caudal fin of *Raniceps raninus*, 44.4 mm SL (British Mus. Nat. Hist. 1971.2-16.640); symbols as in (A).

Fig. 149. (A) Flexion larva of *Trisopterus luscus*, 7.5 mm SL (Inst. Sci. Tech. Peches Marit., Nantes, stored at NWAFC); (B) Preflexion larva of *Merlangius merlangus*, 5.0 mm SL (Inst. Sci. Tech. Peches Marit., Nantes, stored at NWAFC); (C) Preflexion larva of *Pollachius virens*, 5.9 mm SL (Huntsman Mar. Lab., H-8057, stored at NWAFC); (D) Preflexion larva of *Melanogrammus aeglefinus*, 6.1 mm SL (Huntsman Mar. Lab., H-9473, stored at NWAFC); (E) Preflexion larva of *Gadus macrocephalus*, 4.4 mm SL (from Dunn and Vinter, 1984); and (F) Preflexion larva of *Gadiculus argenteus*, 3.7 mm SL (Zool. Mus. Copenhagen, stored at NWAFC).

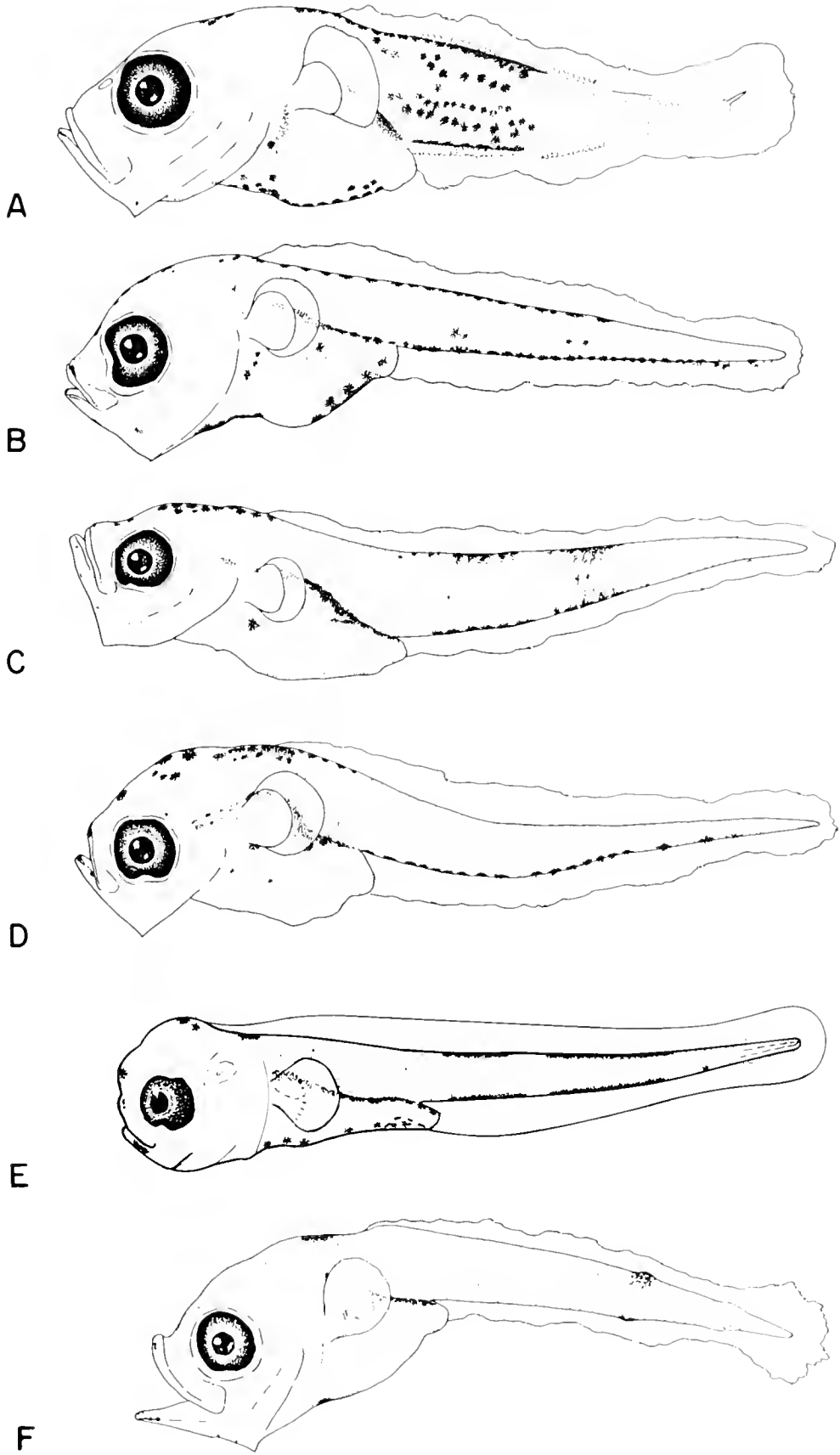

TABLE 80. SUMMARY OF OSTEOLOGICAL CHARACTERS OF THE PECTORAL AND PELVIC GIRDLES, AXIAL SKELETON, AND MEDIAN FINS IN PRE-TRANSFORMATION LARVAE OF REPRESENTATIVES OF THE GENERA OF THE FAMILY GADIDAE.

Taxon	Relative length of lower fork of posttemporal	Shape of postcleithrum	Length of posterior process of basipterygia	Number pre-dorsal bones	Number dorsal fins
Lotinae					
<i>Brosme brosme</i>	Very short, less than $\frac{1}{10}$ length of upper fork	Long, thin, slightly curved, distal head slightly expanded	Long, about $\frac{2}{3}$ length anterior process	0	1
<i>Molva dipterygia</i>	Short, less than $\frac{1}{4}$ length of upper fork	Long, thin, slightly curved, distal head slightly expanded	Moderate, about $\frac{1}{2}$ length anterior process	0	2
<i>Lota lota</i> ¹	Short, less than $\frac{1}{4}$ length of upper fork	Long, thin, slightly curved, distal head wanting	Short, about $\frac{1}{3}$ length anterior process	0	2
Phycinae					
<i>Enchelyopus cimbrius</i>	Short, less than $\frac{1}{3}$ length of upper fork	Moderately long, thin, not curved, no distal head	Very long, about $2 \times$ length anterior process	0	2
<i>Gadropsarus</i> sp.	Short, less than $\frac{1}{4}$ length of upper fork	Long, thin, not curved, no distal head	Long, about $\frac{2}{3}$ length anterior process	0	2
<i>Phycis blennoides</i> ¹	Short, less than $\frac{1}{4}$ length of upper fork	Long, thin, slightly curved, no distal head	Very long, about $1\frac{1}{2} \times$ length anterior process	2	2
<i>Urophycis</i> sp.	Short, less than $\frac{1}{4}$ length of upper fork	Long, thin, curved, no distal head	Very long, about $4 \times$ length anterior process	1	2
<i>Ciliata mustella</i>	Very short, less than $\frac{1}{10}$ length of upper fork	Short, thin, no distal head	Very long, about $1\frac{1}{2} \times$ length anterior process	1	2
<i>Raniceps raninus</i>	Short, less than $\frac{1}{4}$ length of upper fork	Lower bone long, thin, pointed; upper bone short, oblong	Long, about $\frac{3}{4}$ length anterior process	1	2
Gadinae					
<i>Trisopterus luscus</i>	Moderately long, about $\frac{1}{3}$ length of upper fork	Long, thin, slightly curved, slightly expanded head	Absent	0	3
<i>Merlangius merlangus</i>	Moderately long, about $\frac{1}{3}$ length of upper fork	Long, thin, straight, expanded distal head	Very short, less than $\frac{1}{10}$ length anterior process	0	3
<i>Pollachius virens</i>	Moderately long, about $\frac{1}{3}$ length of upper fork	Long, thin, curved, with expanded distal head	Absent	0	3
<i>Melanogrammus aeglefinus</i>	Moderately long, about $\frac{1}{3}$ length of upper fork	Long, thin, slightly curved, slightly expanded distal head	Very short, less than $\frac{1}{10}$ length anterior process	0	3
<i>Gadus macrocephalus</i>	Moderately long, about $\frac{1}{3}$ length of upper fork	Long, thin, strongly curved, expanded distal head	Moderate, about $\frac{1}{2}$ length anterior process	0	3
<i>Gaduculus argenteus</i>	Long, about $\frac{2}{3}$ length of upper fork	Short, relatively wide, pointed distally, slightly expanded head	Short, about $\frac{1}{3}$ length anterior process	0	3
<i>Microgadus proximus</i>	Long, about $\frac{2}{3}$ length of upper fork	Long, straight, recurved distally, with expanded head	Very short, about $\frac{1}{10}$ length anterior process	0	3
<i>Eleginus gracilis</i>	Moderately long, about $\frac{2}{3}$ length of upper fork	Long, straight, recurved distally, with expanded head	Short, about $\frac{1}{4}$ length anterior process	0	3
<i>Boreogadus saida</i>	Long, about $\frac{1}{2}$ length of upper fork	Long, thin, slightly recurved distally, moderately expanded head	Short, about $\frac{1}{4}$ length anterior process	0	3
<i>Arctogadus borisovi</i> ¹	Long, about $\frac{2}{3}$ length of upper fork	Long, thin, straight, expanded head	Short, about $\frac{2}{3}$ length anterior process	0	3
<i>Theragra chalcogramma</i>	Long, about $\frac{2}{3}$ length of upper fork	Long, thin, recurved, expanded distal head	Short, about $\frac{1}{4}$ length anterior process	0	3
<i>Micromesistius poutassou</i>	Long, about $\frac{2}{3}$ length of upper fork	Long, thin, recurved, expanded distal head	Absent	0	3

¹ Juvenile specimens only examined

COMMENTS ON THE SYSTEMATIC RELATIONSHIPS
OF SUBFAMILIES IN THE
FAMILY GADIDAE

Gadoid fishes comprise a complex and rather confusing array of teleosts possessing both relatively primitive and apparently derived character states (Cohen, this volume; Fahay and Markle, this volume). In our analyses of character states we generally follow Markle (1982), Fahay and Markle (this volume) and

Cohen (this volume). For outgroup comparisons, we have examined the osteology of representatives of a limited array (14 families) of gadiform and non-gadiform fishes whose utility is limited because we lack, in many cases, ontogenetic series. We contrast here the characters of the three recognized subfamilies (Markle, 1982) with *Merluccius*, insofar as possible, as the genus is variously considered primitive in the gadid-merlucciid lineage (Danil'chenko, 1947, 1950; Rosen and Patterson, 1969; Cohen,

TABLE 81. SUMMARY OF OSTEOLOGICAL CHARACTERS OF THE MEDIAN FINS IN PRETRANSFORMATION LARVAE OF REPRESENTATIVES OF THE GENERA OF THE FAMILY GADIDAE.

Taxon	Relative distance between dorsal fins one and two	Relative distance between dorsal fins two and three	Relative distance between posteriormost dorsal and caudal fin	Number of anal fins	Relative distance between anal fins one and two
Lotinae					
<i>Brosme brosme</i>	—	—	Close, about 1 inter-neural space	1	—
<i>Molva dipterygia</i>	Very close, about ½ inter-neural space; no inter-neural bones	—	Close, about 1¼ inter-neural spaces	1	—
<i>Lota lota</i> ¹	Very close, about ½ inter-neural space; 1 or 0 interneural bones	—	Close, about 1 inter-neural space	1	—
Phycinae					
<i>Enchelyopus cimbrius</i>	Wide, about 2 inter-neural spaces; no inter-neural bones	—	Close, about 1 inter-neural space	1	—
<i>Gaidropsarus</i> sp.	Very close, about ½ inter-neural space; no inter-neural bones	—	Close, about 1 inter-neural space	1	—
<i>Phycis blennoides</i> ¹	Very close, about ¼ inter-neural space; 1 inter-neural bone	—	Close, about 1 inter-neural space	1	—
<i>Urophycis</i> sp.	Nearly continuous; 1 inter-neural bone	—	Close, about 1 inter-neural space	1	—
<i>Ciliata mustella</i>	Very close, about ½ inter-neural space; 1 inter-neural bone	—	Close, about 1 inter-neural space	1	—
<i>Raniceps raninus</i>	Close, about 1 inter-neural space; 1 reduced interneural bone	—	Close, about 1 inter-neural space	1	—
Gadinae					
<i>Trisopterus luscus</i>	Close, ½–1 interneural space; 0 or 1 inter-neural bones	Very close together, 0–2 interneural bones	Wide, 2–2½ interneural spaces	2	Very close, from 0–2 interneural bones
<i>Merlangius merlangus</i>	Close, usually ½–1 interneural space; 2 inter-neural bones	Close together, 2–4 interneural bones	Wide, 2–2½ interneural spaces	2	Very close, from 0–2 interneural bones
<i>Pollachius virens</i>	Close, about ½ interneural space; no inter-neural bones	Close together, 3–4 interneural bones	Wide, about 2 interneural spaces	2	Close, from 2–3 interneural bones
<i>Melanogrammus aeglefinus</i>	Close, about ½ interneural space; 0–2 interneural bones	Close together, 2–3 interneural bones	Wide, about 2 interneural spaces	2	Close, usually 2 interneural bones
<i>Gadus macrocephalus</i>	Close, about ½ interneural space; 0 or 1 interneural bones	Close together, 2–3 interneural bones	Wide, about 3 interneural spaces	2	Moderately wide, 4 or 5 interneural bones
<i>Gadiculus argenteus</i>	Moderately wide, about 1 interneural space; no interneural bones	Moderately wide, about 5–6 interneural bones	Close, about 1½ interneural spaces	2	Moderately wide, 4 or 5 interneural bones
<i>Microgadus proximus</i>	Close, about ½ interneural space; 0 or 1 interneural bones	Moderately wide, 4–7 interneural bones	Wide, about 3–3½ interneural spaces	2	Moderately wide, about 4 interneural bones
<i>Eleginus gracilis</i>	Moderately wide, about 1½ interneural spaces; 0 or 1 interneural bones	Moderately wide, 5–7 interneural bones	Wide, about 3 interneural spaces	2	Wide, 6 or 7 interneural bones
<i>Boregadus saida</i>	Wide, about 2 interneural spaces; 0 or 1 interneural bones	Wide, 6–7 interneural bones	Wide, about 3 interneural spaces	2	Wide, 5–7 interneural bones
<i>Arctogadus borisovi</i> ¹	Wide, about 2½ interneural spaces; no interneural bones	Wide, 5–8 interneural bones	Wide, about 4 interneural spaces	2	Wide, 5 or 6 interneural bones
<i>Theragra chalcogramma</i>	Moderately wide, about 1½ interneural spaces; 0 or 1 interneural bones	Wide, 7–9 interneural bones	Wide, about 3–3½ interneural spaces	2	Wide, 4–6 interneural bones
<i>Micromesistius poutassou</i>	Wide, about 2 interneural spaces; no interneural bones	Very wide, 20–21 interneural bones	Wide, about 2½ interneural spaces	2	Very close, 1 interneural bone

¹ Juvenile specimens only examined.

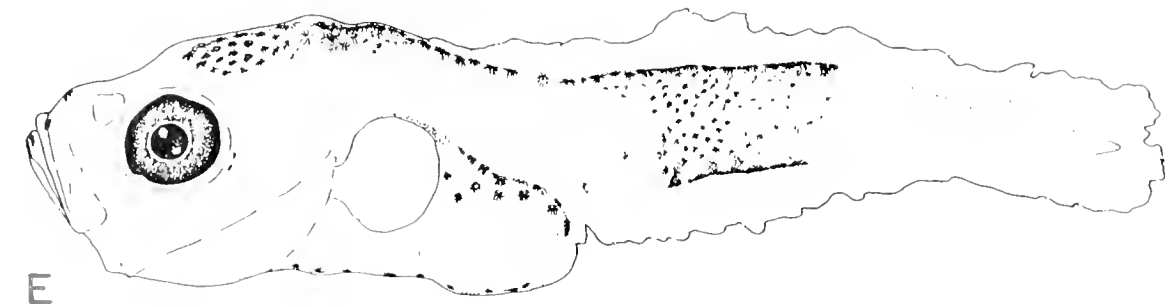
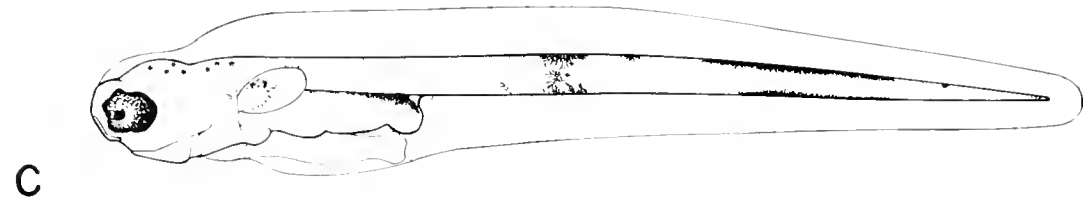
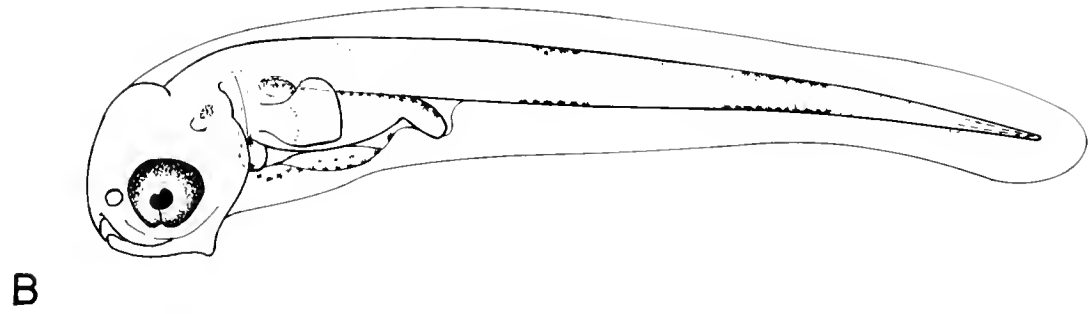
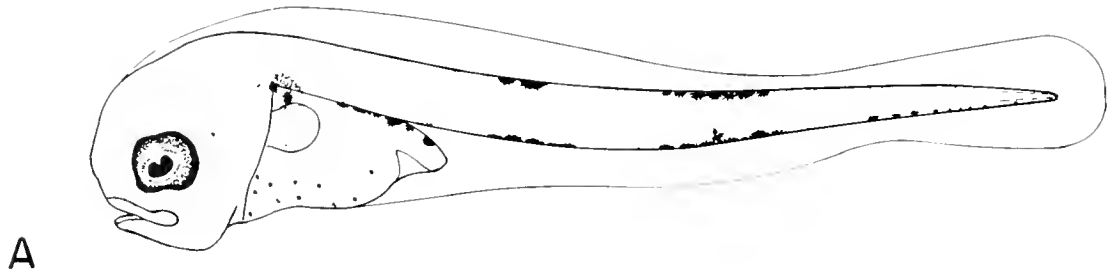

TABLE 82. SUMMARY OF OSTEOLOGICAL CHARACTERS OF THE CAUDAL FIN IN PRETRANSFORMATION LARVAE OF REPRESENTATIVES OF THE GENERA OF THE FAMILY GADIDAE.

Taxon	Relative distance between posterior margin of anal to caudal	Shape neural spine on preural centrum one	Shape haemal spine on preural centrum one	X-Y bones
Lotinae				
<i>Brosme brosme</i>	Very close, about ½ interneural space	Distally flattened	Rounded distally	Absent
<i>Molva dipterygia</i>	Moderate, about 2 interneural spaces	Distally flattened	Rounded distally	Usually absent
<i>Lota lota</i> ¹	Close, about 1 interneural space	Distally flattened	Distal ⅓ slightly flattened	Usually absent
Phycinae				
<i>Enchelyopus cimbrius</i>	Close, about 1 interneural space	Distally flattened	Distally flattened	Present
<i>Gaidropsarus</i> sp.	Close, about 1 interneural space	Distally flattened	Distally flattened	Present
<i>Phycis blennoides</i> ¹	Close, about 1 interneural space	Distally flattened	Distally flattened	Present
<i>Urophycis</i> sp.	Close, about 1 interneural space	Distally flattened	Distally flattened	Present
<i>Ciliata mustella</i>	Close, about 1 interneural space	Distally flattened	Distally flattened	Present
<i>Raniceps ranmus</i>	Close, about 1 interneural space	Distal ⅓ rounded	Distal ⅓ rounded	Usually present
Gadinae				
<i>Trisopterus luscus</i>	Wide, about 2–2½ interneural spaces	Distally flattened	Distally flattened	Absent
<i>Merlangius merlangus</i>	Moderate, about 1½–2 interneural spaces	Distally flattened	Distally flattened	Absent
<i>Pollachius virens</i>	Wide, about 2–2½ interneural spaces	Distally flattened	Distally flattened	Absent
<i>Melanogrammus aeglefinus</i>	Moderate, about 2 interneural spaces	Distally flattened	Distally flattened	Absent
<i>Gadus macrocephalus</i>	Wide, about 3 interneural spaces	Distally flattened	Distally flattened	Absent
<i>Gadculus argenteus</i>	Close, about 1½ interneural spaces	Distally flattened	Distally flattened	Absent
<i>Microgadus proximus</i>	Close, about 1½ interneural spaces	Distally flattened	Distally flattened	Absent
<i>Eleginus gracilis</i>	Wide, about 3 interneural spaces	Distally flattened	Distally flattened	Absent
<i>Boreogadus saida</i>	Wide, about 3 interneural spaces	Distally flattened	Distally flattened	Absent
<i>Arctogadus borisovi</i> ¹	Wide, about 3 interneural spaces	Distally flattened	Distally flattened	Absent
<i>Theragra chalcogramma</i>	Wide, about 3 interneural spaces	Distally flattened	Distally flattened	Absent
<i>Micromesistius poulassou</i>	Moderate, about 2 interneural spaces	Distally flattened	Distally flattened	Absent

¹ Juvenile specimens only examined.

this volume), a basal gadid (Mujib, 1967), a medial gadid related to gadines (Svetovidov, 1948, 1969) or of questionable relationship (Fahay and Markle, this volume). We present here our interpretation of the relationships of subfamilies of gadid fishes.

Egg diameter is largest in lotines and gadines, smallest in phycines (Table 77). A single oil globule is present in lotines; multiple oil globules, which during development coalesce into

one, are found in most phycines (not yet reported to occur in *Raniceps*), and are absent in gadines. *Merluccius* has a moderately sized egg (0.8–1.2 mm) with a single oil globule (Ahlstrom and Counts, 1955; Russell, 1976; Fahay, 1983). Markle (1982) considered small (<1 mm) eggs, possessing an oil globule, the primitive state. We agree, but also consider multiple oil globules, which coalesce into one the most primitive state.

Fig. 150. (A) Preflexion larva of *Microgadus proximus*, 3.6 mm SL (from Matarese et al., 1981); (B) Preflexion larva of *Eleginus gracilis*, 5.0 mm SL (from Dunn and Vinter, 1984); (C) Preflexion larva of *Boreogadus saida*, 6.3 mm SL (from Dunn and Vinter, 1984); (D) Preflexion larva of *Theragra chalcogramma*, 6.2 mm SL (from Matarese et al., 1981); and (E) Flexion larva of *Micromesistius poulassou*, 8.0 mm SL (Zool. Mus. Copenhagen, stored at NWAFC).

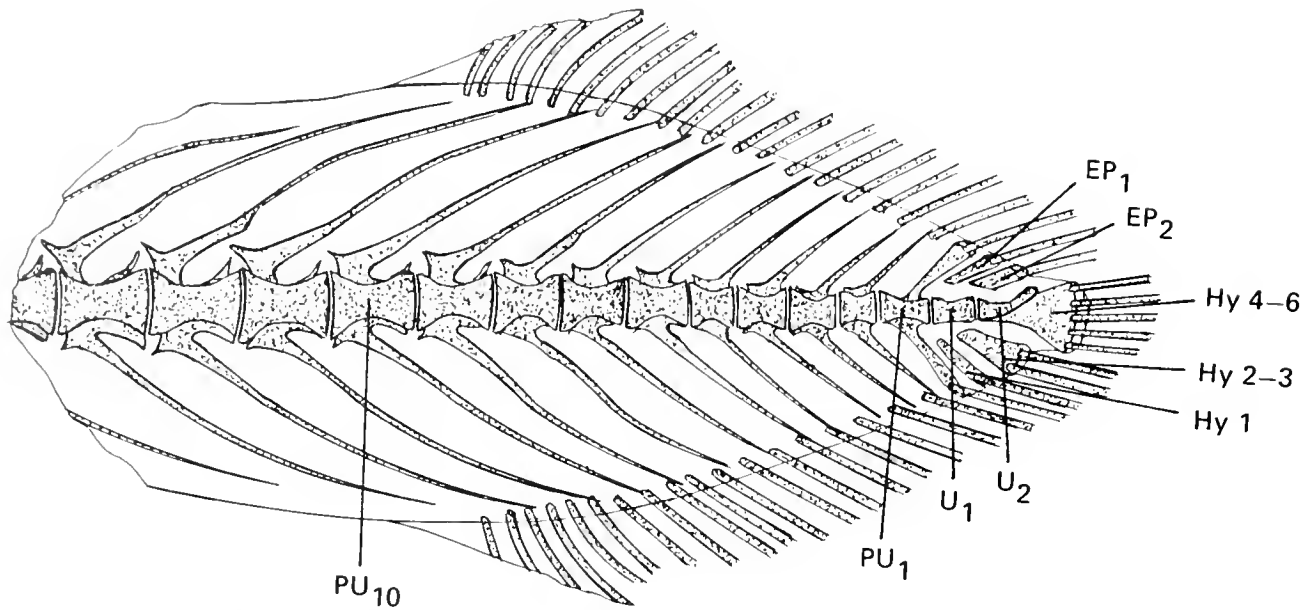

Fig. 151. Caudal fin of *Microgadus proximus*, 41.1 mm SL. Hy1 = Hypural bone 1; Hy2-3 = Hypural bones 2 and 3; Hy4-6 = Hypural bones 4, 5, and 6; EP₁ = Epural bone 1; EP₂ = Epural bone 2; U₁ = Ural centrum 1; U₂ = Ural centrum 2; PU₁ = Preural centrum 1; PU₁₀ = Preural centrum 10 (after Matarese et al., 1981).

Lotinae larvae are relatively elongate and somewhat narrow at the pectoral fin base; the former state is partially due to their numerous vertebrae (Table 78). In contrast, phycines are shorter and stockier in appearance, deep bodied at the pectoral fin base, and morphologically somewhat resemble scorpaeniform larvae. *Raniceps* larvae are morphologically the most divergent, appearing tadpole shaped due to their depth at the pectoral fin base. Gadines are somewhat shorter in appearance, and deeper bodied, than lotines, but morphologically intermediate between phycines and lotines. *Merluccius* larvae are similar to gadines in overall shape (Fig. 143D in Fahay and Markle, this volume).

Length at hatching is smallest in most phycines and somewhat larger in *Raniceps*, lotines, and gadines (Table 78). Notochord flexion occurs at quite small sizes in phycines (except in *Raniceps*), relatively larger sizes in lotines, and intermediate sizes in gadines. A silvery prejuvenile stage is present in phycines (not recorded for *Raniceps*), but a pelagic stage of varying duration (Table 78) is probably present in all gadid larvae (Fahay and Markle, this volume). *Merluccius* hatches at moderate lengths (2.6–3.8 mm; Ahlstrom and Counts, 1955; Russell, 1976; Fahay, 1983), notochord flexion begins at about 9 mm, and transformation begins at 20–25 mm, somewhat similar to gadines. Elongate pelvic fins develop precociously in all lotines (except *Lota*) and phycines, but not in gadines. Pelvic fins in *Merluccius* are shorter than in phycines, but longer than in gadines. Fahay and Markle (this volume) noted similarities in fin development between *Merluccius* and gadines in that the caudal develops first. In gadines, however, the pelvic fins develop last. In *Merluccius*, it is the second fin to develop.

Pigment patterns are shared by *Brosme* and *Molva*, but not *Lota*, whose pigment resembles certain gadines (e.g., *Pollachius pollachius*, *Trisopterus minutus*). Two kinds of pigment patterns have been identified for phycines: either dorsal saddles of pigment in the postanal region (*Enchelyopus cimbrius*, *Gaidropsarus mediterraneus*, *Urophycis chuss*) or a ventral series of melanophores (*Phycis blennoides*, *Ciliata*, and *Raniceps*).

Gadines have either one or two postanal bars or dorsal and ventral lines of pigment. In gadines the pelvic fins lack pigment such as that present in lotines and phycines. In comparison, *Merluccius* has, in certain species (e.g., *M. productus*, Ahlstrom and Counts, 1955), a single postanal band of pigment, but two in *M. albidus* and *M. bilinearis* (Fahay, 1983) and three lateral melanophores (*M. merluccius*, Russell, 1976). Pelvic fins are pigmented in some *Merluccius*.

Lotines have one (*Brosme*) or two (*Molva*, *Lota*) dorsal fins; when two fins are present, they are internally continuous (Markle, 1982). Phycines have two dorsal fins, the first specialized (Cohen and Russo, 1979), and are internally continuous (Markle, 1982). Gadines have three dorsal fins, of which the second and third are always internally continuous. The posterior margins of the dorsal and the anal fins are close to the procurent rays of the caudal fin in lotines and phycines, whereas in gadines these fins are generally some distance from the caudal fin, as is the case in *Merluccius* (Fahay and Markle, this volume).

Certain trends in osteological structures can be noted in the family Gadidae. Transient pterotic spines are present in some phycines (some *Phycis*, *Gaidropsarus*, Markle, 1982) and *Ciliata* (this study), and are lacking (so far as is known) in other phycines, lotines, gadines, and in *Merluccius*. The distribution of branchiostegal rays varies among gadid genera. The seven branchiostegal rays in *Brosme* are carried on the outer surface of the ceratohyal, whereas in *Gadus* and *Lota* (Mujib, 1967, 1969), as well as in *Theragra* (Dunn and Vinter, MS), the three anterior rays are internal and the posterior four are external. *Raniceps* has one branchiostegal ray on the epihyal, a character considered primitive and shared (so far as known) with *Urophycis chuss* and *Merluccius* (Mujib, 1967; Inada, 1981b), whereas gadines have all seven branchiostegal rays on the ceratohyal (this study).

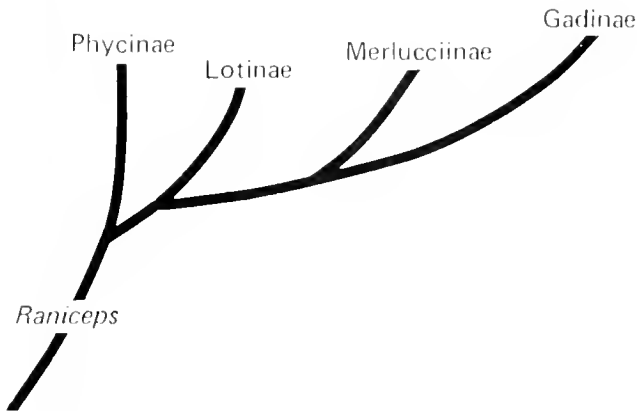

Fig. 152. Proposed relationships of gadid subfamilies.

The ventral branch of the posttemporal is shortest in lotines and phycines (moderately long in *Merluccius*) and longest in gadines. The gadids we examined all have four pectoral radials, except for a single specimen of *Ciliata* with five radials on one side. Phycines lack an expanded distal head on the postcleithra. *Raniceps*, however, has two postcleithra; the upper is oblong in shape, the lower is distally pointed as in phycines. Among the lotines, the distal end of the postcleithrum is slightly expanded in *Brosme* and *Molva* whereas the postcleithrum is distally pointed in *Lota*. In *Merluccius* it is moderately expanded while in gadines, the postcleithrum is considerably expanded at its tip, which we infer is a derived condition. Predorsal bones are present in some, but not all, phycines (*Urophycis*, *Phycis*, and *Raniceps*), but are lacking in lotines, gadines, and *Merluccius*; the loss is considered an advanced state. The posterior process of the basipterygia is quite long in some phycines (and in *Merluccius*), moderately long in lotines, and shortest in gadines, and the latter state is considered derived.

The shape of the neural and haemal spine on PU_1 varies among genera. The neural spine in *Raniceps* is distally rounded (a primitive condition), but this spine is flattened in all other gadids, as it is in *Merluccius*. *Raniceps*, *Brosme*, and *Molva* have a rounded haemal spine on PU_1 , in contrast to the flattened tip on all other gadids (and *Merluccius*). x/y bones are present in all phycines (usually present in *Raniceps*) and *Merluccius*, but are absent (*Brosme*) or usually absent (*Molva*, *Lota*) in lotines (Markle, 1982; this study) and are absent in gadines. All gadids and *Merluccius* (Ahlstrom and Counts, 1955; Inada, 1981b) have three hypural bones (including the parhypural); *Raniceps* alone, among the gadids examined by us, showed evidence of ontogenetic reduction by fusion from six hypural bones to three. As noted by Markle (1982) and Fahay and Markle (this volume), lotines and gadines have four or five primary caudal fin rays, while phycines have five or six such rays. *Merluccius* and *Raniceps* each have six primary rays (Inada, 1981b; this study).

We consider *Raniceps* a basal gadid considering the following characters: eggs small with a single oil globule; larvae tadpole- or liparid-shaped; one branchiostegal ray on the epiphyal; two postcleithra present; a predorsal bone present; the neural and haemal spines on PU_1 distally rounded; six hypural bones which fuse into three during ontogeny; x/y bones usually present; and six primary rays on the superior hypural bone.

We further consider phycines to be a more primitive group than lotines based on the following characters: eggs small, with multiple oil globules which coalesce into one during development; larvae stocky and deep bodied (at the pectoral fin base); elongate and precocious pelvic fins present; postcleithrum without an expanded head; one or more predorsal bones present; elongate pelvic process; and x/y bones present. Until the presence or absence of transient pterotic spines is established in all phycine larvae, the most parsimonious explanation is that their presence represents a derived character state.

Lotines, as presently constituted, appear to us to possess a number of primitive and intermediate characters, as well as some rather specialized traits: eggs moderately large with a single oil globule; larvae elongate, relatively shallow at the pectoral fin base; pelvic fins precocious, elongate and with the posterior process of the basipterygium moderately long; postcleithrum with slightly expanded head; predorsal bones absent; x/y bones usually absent; and three hypural bones present. *Brosme* has both apparently primitive (e.g., all branchiostegal rays carried on the outside surface of the ceratohyal and a rounded haemal spine on PU_1) and derived characters (e.g., x/y bones always lacking); its single dorsal fin was considered primitive by Svetovidov (1948) or derived (within Lotinae, *sensu* Svetovidov, 1948) by Mujib (1969). As noted by Markle (1982), high total dorsal and anal fin ray counts may be primitive for the order Gadiformes.

Gadines seem to us a relatively homogenous group, characterized by reductive (or lost) and apparently derived characters. The former include: eggs without an oil globule; posterior process of the pelvic bone reduced in length or wanting; predorsal and x/y bones absent; and three hypural bones present. The latter characters include: eggs moderate in size; larvae morphologically uniform in appearance; lower branch of posttemporal relatively long; postcleithrum with expanded head; and three dorsal and two anal fins present, with the anal fins and dorsal fins two and three internally continuous.

Our hypothesis of relationships of gadid subfamilies is presented in Figure 152. The relationships of a number of genera, such as *Brosme* and *Raniceps*, and the relationships of *Phycis*, *Gaidropsarus*, and *Ciliata* to other phycines still remain confused. Based on early life history characteristics and osteology, we consider *Merluccius* a gadid related to, but more primitive than, *Gadinae* and, following Svetovidov (1948, 1969), restrict *Merlucciinae* to this genus. The relationship of all nominal gadid subfamilies requires further study.

NORTHWEST AND ALASKA FISHERIES CENTER, 2725 MONTLAKE BOULEVARD EAST, SEATTLE, WASHINGTON 98115.

Bregmacerotidae: Development and Relationships

E. D. HOUDE

THE codlets are small, gadiform fishes of pelagic habit found in neritic and oceanic water of tropical and subtropical seas. The family Bregmacerotidae (Gill, 1872) includes the single genus *Bregmaceros* (Thompson, 1840), in which there are several species. In recent reviews six (Belyanina, 1974) or seven (D'Ancona and Cavinato, 1965) valid species have been recognized. The systematics remain confused, although Belyanina (1974) has partly clarified species relationships. Larvae often are among the ten most common families occurring in both oceanic and coastal ichthyoplankton surveys in subtropical and tropical waters (e.g., Ahlstrom, 1971; Moser et al., 1973; Houde et al., 1979; Loeb, 1979; Richards, 1981). The species are morphologically similar but most have distinctive meristics, from which specific identifications usually are possible. Differences in vertebral number and median fin ray counts serve to distinguish larval to adult stages while pigmentation differences and the size at appearance of the single, first dorsal fin ray serve to identify small larvae. Larval characters, particularly those of the smallest individuals (1.5–3.0 mm SL), often are the best characters for identification purposes. A careful examination of ontogenetic evidence indicates that some species are still undescribed and that misidentified *Bregmaceros* frequently have been reported in the literature. Based on evidence from larval characteristics there may be ten or more valid species in the world oceans.

Species distributions.—Larvae of *Bregmaceros* commonly occur between latitudes 40°S and 40°N (Table 83). D'Ancona and Cavinato (1965) and, more recently, Belyanina (1974), have reviewed distribution data on the known species. Centers of abundance have been observed in the western Indo-Pacific and Indian Oceans (Munro, 1950; D'Ancona and Cavinato, 1965; Kotthaus, 1969; Belyanina, 1974), in the eastern Pacific (Ahlstrom, 1971; Belyanina, 1974) and in the Caribbean Sea and Gulf of Mexico (Belyanina and Lopes, 1974; Milliken, 1975; Belyanina, 1980; Houde, 1981). *Bregmaceros macclellandi* is circumtropical with areas of apparent high abundances in the Caribbean Sea, western Indian Ocean and Indo-Malayan region. It also occurs in the eastern Pacific. *Bregmaceros atlanticus*, including the closely related Pacific Ocean form *B. japonicus* (D'Ancona and Cavinato, 1965) also is circumtropical with an apparent center of abundance in the western Atlantic.¹ The latter sometimes occurs in neritic waters. Several neritic species are known, including *B. nectabanus*, *B. arabicus*, *B. rarisquamosus*, *B. bathymaster*, *B. cantori* (Milliken and Houde, 1984) and the Type A larva described by Houde (1981).

¹ Late larvae and juveniles that I examined from the eastern Pacific appeared to be typical *B. atlanticus* but small larvae, which may have been younger specimens of this species, did not resemble typical *B. atlanticus* from the Atlantic. The eastern Pacific specimens were less pigmented, with a prominent melanophore on the ventral midline, between the anus and the tip of the tail. Specimens were provided by Dr. H. G. Moser, Southwest Fisheries Center, National Marine Fisheries Service, La Jolla, California.

Neritic species vary in the breadth of their distributions. It now seems certain that the Indo-Pacific *B. nectabanus* does not occur in the western Atlantic and its occurrence in the eastern Atlantic Ocean is uncertain. The species *B. cantori*, described by Milliken and Houde (1984), is the most common bregmacerotid in the western Atlantic. It occurs in the Caribbean Sea and Gulf of Mexico (Milliken, 1975; Houde, 1981), in the southwest Atlantic Ocean off Brazil² and along the East Coast of the United States.³ The common bregmacerotid in the Gulf of Cariaco, initially referred to as *B. atlanticus* (Mead, 1963) and subsequently as *B. nectabanus* (Baird et al., 1973, 1974; Belyanina and Lopes, 1974) and that referred to as *B. nectabanus* from the Caribbean Sea and Gulf of Mexico (Belyanina, 1980) is *B. cantori* (Milliken, 1975; Houde, 1981; Milliken and Houde, 1984). *Bregmaceros bathymaster* has been collected only in the eastern Pacific. It is abundant in the Gulf of Panama (D'Ancona and Cavinato, 1965) and in the Gulf of California (Moser et al., 1973). *Bregmaceros rarisquamosus* occurs in the Indian Ocean, Bay of Bengal, Arabian Sea and western Pacific Ocean. It also is present in the Persian Gulf,⁴ where it occurs with *B. nectabanus* and *B. arabicus*. Previously, *B. arabicus* had been reported from the Arabian Sea, Bay of Bengal and East China Sea. Larvae of an undescribed species, *B. Type A*, have been collected in the western North Atlantic (Houde, 1981)⁵.

Bregmacerotids reportedly occur from the surface to depths of approximately 4,000 m, but are most common in the upper 300 m. Larvae generally occur from surface to 600 m depth, neritic species tending to be closer to the surface than oceanic species (D'Ancona and Cavinato, 1965). Some reported catches from great depths may be in error. Adults and subadults of some *Bregmaceros* undertake extensive vertical migrations and one species (*B. cantori*) inhabits anoxic water during a part of the day (Mead, 1963; Wilson, 1972; Baird et al., 1973; Milliken, 1975).

Family characteristics.—Characters defining Bregmacerotidae were summarized briefly by Nelson (1976) and more extensively by D'Ancona and Cavinato (1965) and by Belyanina (1974). Fahay and Markle (this volume) have tabulated meristic data and discussed ontogenetic characters of Gadiformes, including

² I examined specimens of *B. cantori* from coastal waters of Brazil, collected from latitudes of 22°S to 27°S, provided to me by Dr. Y. Matsuura, Instituto Oceanografico, Universidade de Sao Paulo, Brazil.

³ I examined specimens from R/V DOLPHIN cruises, taken from Florida to the Carolinas, provided to me by M. P. Fahay, Sandy Hook Laboratory, National Marine Fisheries Service, Highlands, New Jersey.

⁴ Houde, E. D., J. C. Leak, S. Al-Matar, and C. E. Dowd. 1981. Ichthyoplankton abundance and diversity in the western Arabian Gulf. Kuwait Institute for Scientific Research, Mariculture and Fisheries Department, Final Report, Project MB-16. 3 volumes. (This report was not available for distribution at the time the present paper was written.)

⁵ The Type A larva was present in collections from two R/V ALBATROSS cruises into the Caribbean Sea. I examined larvae provided by Dr. W. J. Richards, Southeast Fisheries Center, National Marine Fisheries Service, Miami, Florida.

Bregmacerotidae. Bregmacerotids are small fishes, the largest species, *B. macclellandi*, rarely exceeding 120 mm SL. They have two dorsal fins, the first a single, elongate ray on the occiput. The second dorsal fin and the anal fin are long with median rays much reduced, giving the fins a divided appearance. The caudal fin is separated from the dorsal and anal fins. Pelvic fins are jugular and consist of 5 (usually)–7 rays, the outer three elongate. The olfactory nerves pass through a broad canal, wider than that in Gadidae. The sacculus is very large. The swimbladder does not contact the auditory capsules. There are a few pyloric caeca. The vomer is toothed. A lateral line is present under the second dorsal fin. Chin barbels are absent.

DEVELOPMENT

Spawning.—Size at maturity is variable but generally <30 mm. In one species, *B. rarisquamosus*, maturity is attained at <15 mm (D'Ancona and Cavinato, 1965). Larvae occur in the tropics and subtropics during all months, indicating protracted spawning, although seasonality is apparent for individual species in some areas.

Eggs.—Eggs are presumed to be pelagic. Excepting a single report, the fertilized eggs and embryos of *Bregmaceros* species have not been described. Pertseva-Ostroumova and Rass (1973) described fertilized eggs, attributable to *B. atlanticus*, as pelagic with smooth chorion, small perivitelline space and homogeneous yolk containing an oil globule. They reported the egg diameter to be 1.1 mm and the oil globule diameter to be 0.20 mm. In my opinion, it is unlikely that *Bregmaceros* eggs are that large because newly-hatched larvae are only 1.5 mm long. Ahlstrom's⁶ unpublished notes give diameters of *B. bathymaster* eggs as 0.84–1.00 mm and indicate that a single oil globule is present.

Ten eggs with well-developed embryos that I examined, identified as *B. bathymaster* by E. H. Ahlstrom, collected in the mouth of the Gulf of California⁷ ranged from 0.88–1.00 mm in diameter (\bar{x} = 0.94 mm) and had a single oil globule 0.22–0.28 mm in diameter (\bar{x} = 0.24 mm). The chorion was smooth, perivitelline space narrow and yolk homogeneous. The oil globule was situated in the posterior part of the yolk mass. Several small melanophores were scattered on the head and dorsal side of the embryo and on the ventral side of the tail.

Larvae.—The larvae are not unusual. Their general morphology is similar to that of other gadiform larvae but bregmacerotids are not likely to be confused with them or with larvae of other tropical-subtropical fishes with which they occur. In bregmacerotids, metamorphosis is gradual and direct.

Newly-hatched larvae are small, approximately 1.5 mm NL, a fact often not appreciated when collecting nets with >333- μ m meshes have been used. The smallest larvae usually have

TABLE 83. GEOGRAPHIC DISTRIBUTION INFORMATION AND SOME MERISTIC DATA OF *BREGMACEROS* ADULTS AND LARVAE \geq 8 mm SL. Numbers in parentheses are the most common counts for a species. For additional meristic data, see Fahay and Markle, this volume.

Species	Distribution*	Myomeres (vertebrae)	Dorsal fin rays	Anal fin rays
<i>B. macclellandi</i>	CTO	52–59 (54–55)	57–65 (58–61)	58–69 (62–66)
<i>B. atlanticus</i>	CTO(N)	50–55 (52–53)	47–56 (50–54)	49–58 (52–55)
(<i>B. japonicus</i> ?)	WPO	56–58	51–60	56–63
<i>B. nectabanus</i>	I, IP, WPN	47–52	42–55 (47–50)	43–55 (50–52)
<i>B. cantori</i>	WAN	45–48	45–48	45–49
<i>B. rarisquamosus</i>	I, IP, WPN	43–48 (43–46)	34–41	36–43
<i>B. bathymaster</i>	EPN	48–51	44–50	45–52
<i>B. arabicus</i>	I, IP, WPN	50–54	50–60 (52–54)	50–63 (56–57)
<i>B. Type A</i>	WAN	44–47	40–44	42–46

* CT = circumtropical; O = oceanic; N = neritic; WP = western Pacific; I = Indian; IP = Indo-Pacific; WA = western Atlantic; EP = eastern Pacific.

not been described, although it is during that stage when specific pigmentation is unique and identification easiest. Small specimens (1.5–3.1 mm NL) of eight species are illustrated (Figs. 153 and 154). Larvae of 3.0–6.0 mm SL may be most difficult to identify because pigment patterns are in transition and fin rays have not developed sufficiently to be diagnostic. At lengths >6.0 mm identification becomes easier, based on pigmentation characteristics (Figs. 155 and 156) and on complete (or nearly complete) counts of median fin rays and myomeres. For larvae >10–11 mm, diagnostic meristics usually are complete and illustrations/descriptions in D'Ancona and Cavinato (1965) and Belyanina (1974) usually will lead to correct identifications. Use of information on larval pigmentation, meristics and size at occipital ray development allow all described species to be identified.

Occipital ray (Table 84).—The size at appearance of the single occipital ray varies among species. It is the first fin ray to develop in *B. macclellandi* and in *B. Type A* (Houde, 1981), appearing when larvae are 2.0–2.5 mm in length. In all other species the ray develops at lengths of 5.0–7.5 mm, usually at approximately 6.5 mm. The occipital ray of *B. macclellandi* is long and delicate, often extending to near the middle of the second dorsal fin in specimens <10 mm, but subsequently declining in relative length. In other species, the occipital ray is shorter, never reaching the second dorsal fin.

Pigmentation (Table 84).—Larvae of the oceanic species *B. macclellandi* and *B. atlanticus* are darkly pigmented. Larvae of the neritic species are lightly pigmented. All have heavy internal pigment over the visceral mass. The most distinctive pigment is present on the smallest larvae (Figs. 153 and 154) and all described species can be identified using pigmentation patterns for larvae of 1.5–3.0 mm SL. The amounts of pigment, and particularly the diagnostic melanophore patterns, tend to be lost or reduced as larvae grow. External pigment tends to migrate internally with growth, the tendency being most apparent in the neritic Indo-Pacific species *B. nectabanus*, *B. arabicus* and *B. rarisquamosus*. At the smallest lengths, the closely related *B. nectabanus* and *B. cantori* have obviously different pigmenta-

⁶ Ahlstrom, E. H. Personal Notes. "Gadiformes." Notes on file at National Marine Fisheries Service, Southwest Fisheries Center, La Jolla, California, USA.

⁷ The eggs, identified as *B. bathymaster*, were provided by Dr. H. G. Moser, Southwest Fisheries Center, National Marine Fisheries Service, La Jolla, California. They were collected on 10 June 1957, Station 145G.40, Cruise 5706-S, near the mouth of the Gulf of California. I could not confirm that the eggs were those of *Bregmaceros*, although embryo myomere numbers were in the reported range for *B. bathymaster*.

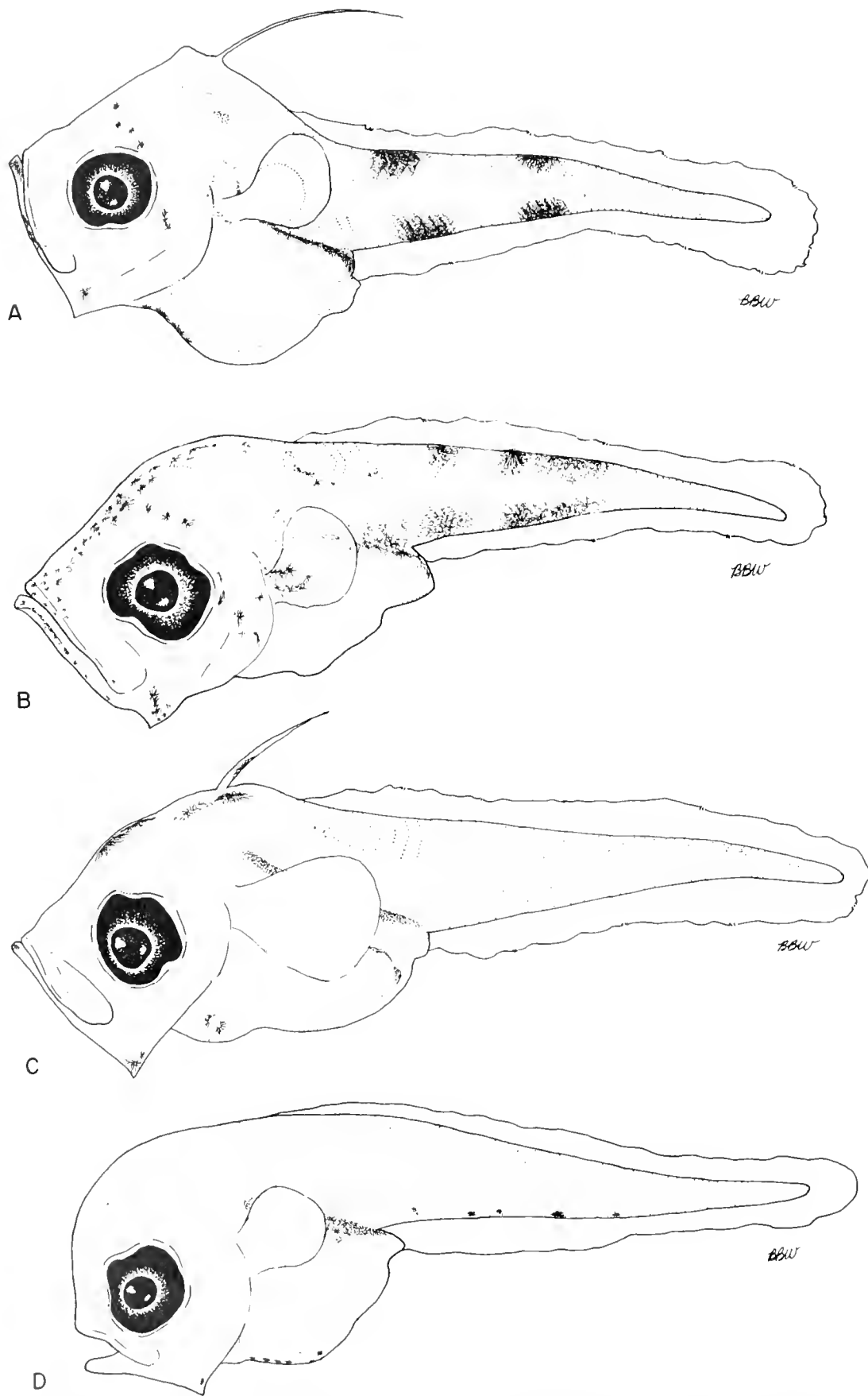

Fig. 153. Larvae of *Bregmaceros* in the length range 2.1 to 3.1 mm NL. (A) *B. maccellelandi*, 3.0 mm, 27°15'N, 084°28'W; (B) *B. atlanticus*, 2.9 mm, 27°00'N, 084°21'W; (C) *B.* Type A, 3.1 mm, 26°00'N, 083°53'W; (D) *B. bathymaster*, 2.1 mm, 22°55'N, 108°40'W.

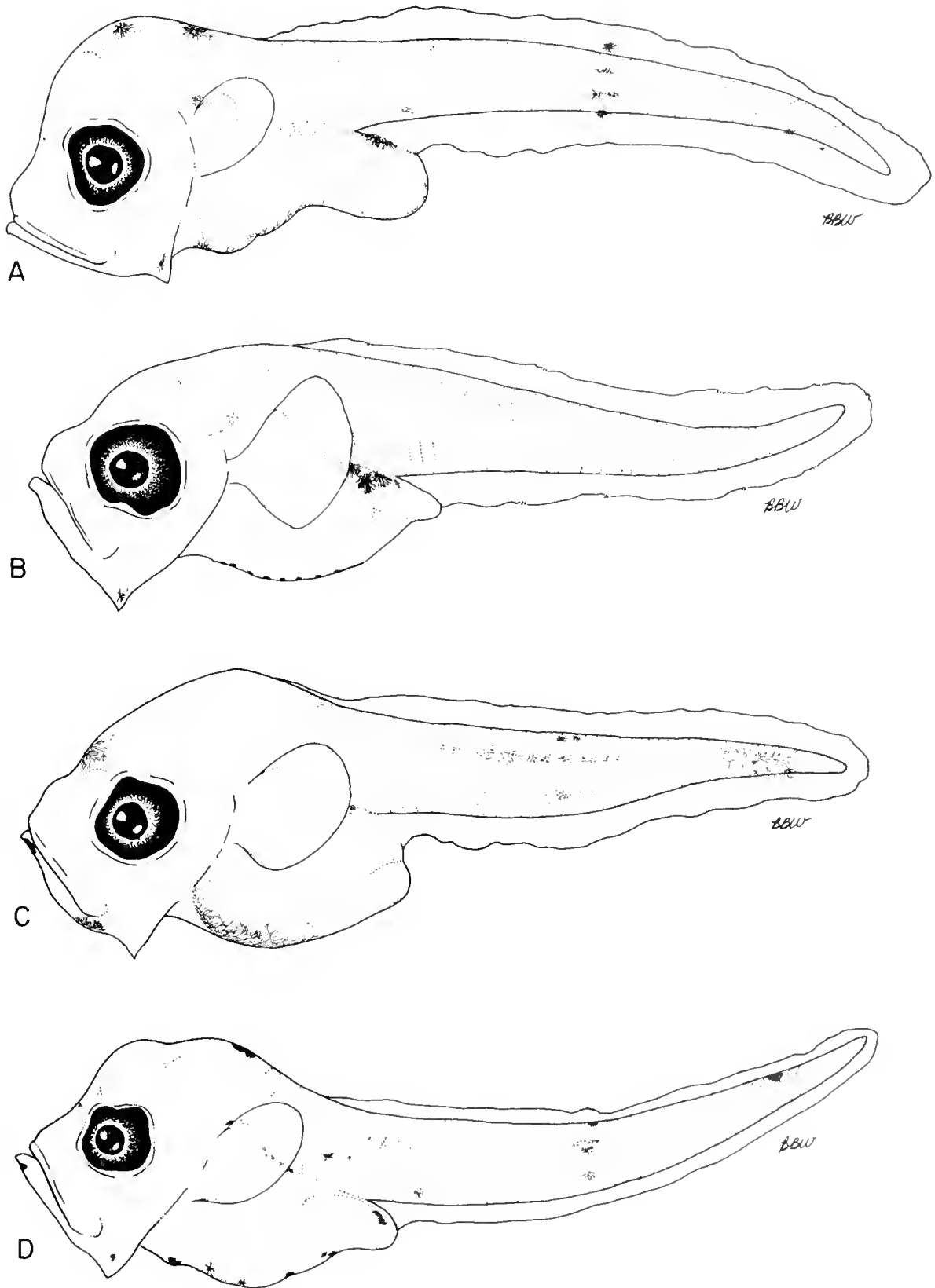

Fig. 154. Larvae of *Bregmaceros* in the length range 2.1 to 3.1 mm NL. (A) *B. nectabanus*, 2.8 mm, 26°18'N, 052°00'E; (B) *B. cantoni*, 2.6 mm; 27°00'N, 084°21'W; (C) *B. arabicus*, 2.5 mm, 29°26'N, 048°00'E; (D) *B. rarisquamosus*, 2.5 mm, 25°52'N, 055°53'E.

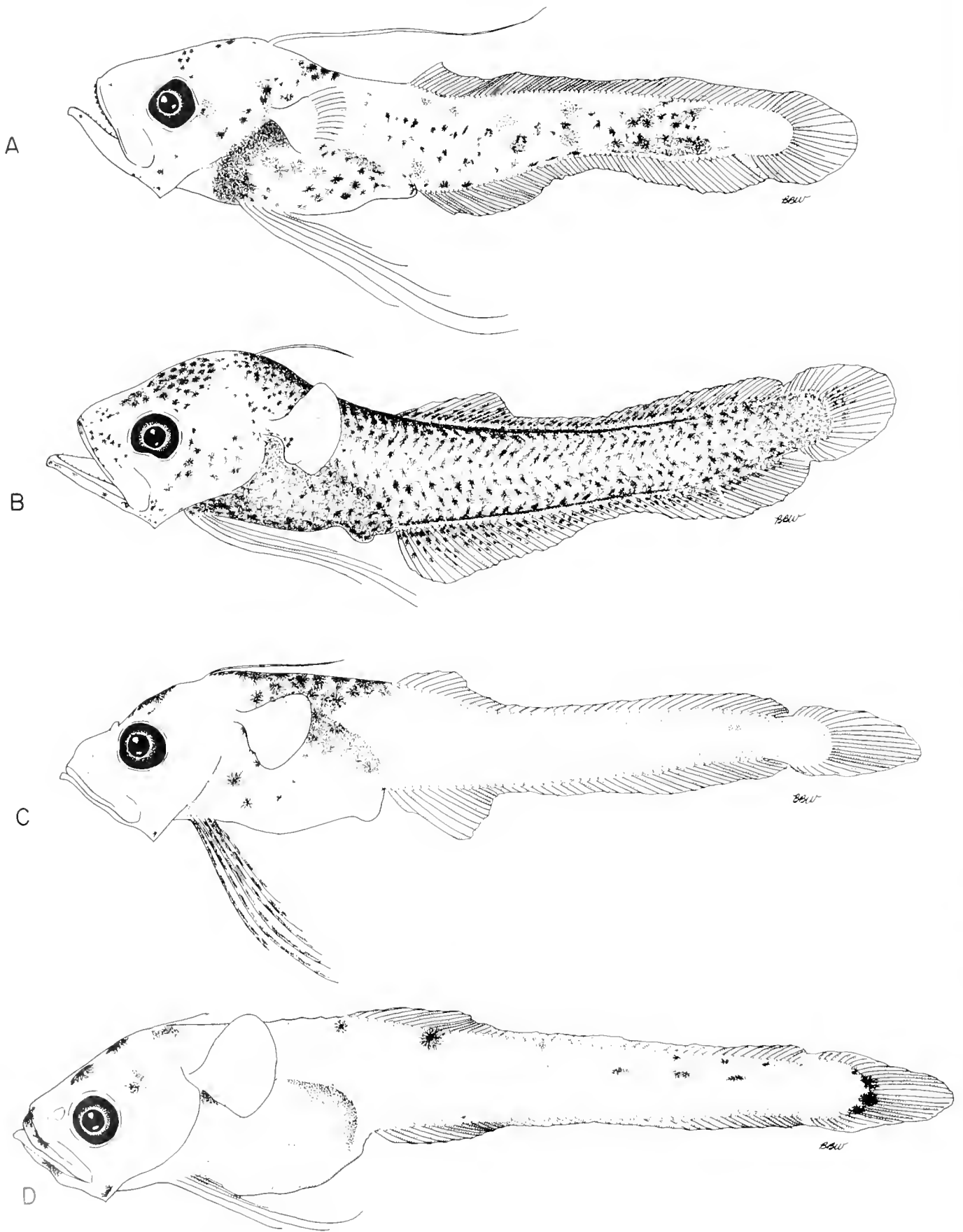

Fig. 155. Larvae of *Bregmaceros* in the length range 7.0 to 10.0 mm SL. (A) *B. macclellandi*, 7.0 mm, 13°00'N, 060°00'W; (B) *B. atlanticus*, 9.0 mm, 24°34'N, 082°56'W; (C) *B. Type A*, 8.5 mm, 27°00'N, 084°22'W; (D) *B. bathymaster*, 9.5 mm, 13°12'N, 091°51'W.

TABLE 84. SIZE AT APPEARANCE OF OCCIPITAL RAY AND PIGMENTATION CHARACTERISTICS OF *BREGMACEROS* LARVAE IN TWO LENGTH RANGES. See Figures 153–156. In addition to pigment described, all *Bregmaceros* larvae have internal pigment on dorsal surface of visceral mass.

Species	Size at appearance of occipital ray (mm SL)	Distinctive pigmentation	
		≤3 mm SL	5–10 mm SL
<i>B. macclellandi</i>	2.0–2.5	Melanophore at angle of jaw and tip of lower jaw; scattered melanophores on head and at base of pectoral fin. A few large, internal stellate melanophores in double row on side of body and tail. Melanophores on ventral surface of visceral mass.	Small, scattered melanophores over surface of head and body but not on posterior part of tail. Several, large, internal stellate melanophores in a double row on side of body and tail.
<i>B. atlanticus</i>	~5.0–5.5	Melanophore at angle of jaw and tip of lower jaw. Scattered melanophores, on head and over midbrain and at base of pectoral fin. Scattered, large internal stellate melanophores on side of body. Diffuse melanophores, some dendritic, on surface of trunk and tail.	Many melanophores over surface of head and body, including dorsal, anal and caudal fins. Larva more or less "completely" pigmented.
<i>B. nectabanus</i>	6.0–7.0	Single melanophores at angle of jaw, over hindbrain, on nape and just anterior to anus. Diffuse melanophores in short, double row on side of tail and also in dorsal and ventral finfolds directly above and below the double row. Melanophore on ventral side of tail, just anterior to notochord tip.	Melanophore at angle of jaw. A few melanophores on tail just anterior to its tip and sometimes one or two melanophores at base of caudal fin. Internal melanophores on side of body, between origins of dorsal and anal fins and also in tail midway between origins of those fins and tip of tail.
<i>B. cantori</i>	6.0–7.0	Melanophore at angle of jaw. A few small melanophores on ventral surface of visceral mass.	Melanophore at angle of jaw. A large melanophore often present over forebrain. Internal pigment visible near otoliths and just anterior to insertion of pectoral fins. Internal pigment sometimes visible along developing vertebral column.
<i>B. rarisquamosus</i>	6.0–7.0	Melanophore at angle of jaw and on lower jaw tip; also over hindbrain. Few scattered melanophores on ventral surface of visceral mass. Diffuse melanophores in three patches on side of tail. Melanophore on dorsal surface of tail just anterior to notochord tip.	Melanophore at angle of jaw. Large, intense group of melanophores in caudal fin. Scattered melanophores on anterior, ventral surface of visceral mass. Some internal melanophores along developing vertebral column in tail, just anterior to its tip.
<i>B. bathymaster</i>	6.5–7.5	Melanophore at angle of jaw and at anus. A few scattered melanophores on ventral surface of visceral mass. A row of 5–7 melanophores on the ventral side of the tail.	Melanophore at angle of jaw and on ramus of lower jaw. Melanophores on snout and on surface over fore- and midbrain. Melanophore at anus and two or more melanophores on dorsum just under base of anterior third of second dorsal fin. Intense group of melanophores in caudal fin. Internal pigment along developing vertebral column in peduncle region.
<i>B. arabicus</i>	6.0–7.0	Melanophore at tip of lower jaw and on ramus of lower jaw (elongate melanophore). Often a few scattered melanophores on ventral surface of visceral mass. Diffuse pigment in three patches on side of tail. Melanophore on side of tail just anterior to notochord tip. Single melanophore over forebrain.	Melanophore at tip of lower jaw and an elongate melanophore on ramus of lower jaw. Several melanophores in base of caudal fin and a few scattered melanophores on tail just anterior to caudal fin.
<i>B. Type A</i>	2.0–2.5	Melanophore at angle of jaw and on tip of lower jaw. Scattered melanophores over hindbrain. Melanophores on occipital ray.	Melanophore at angle of jaw. Scattered melanophores over fore-, mid- and hindbrain and on nape. Melanophores on occipital ray and in pelvic fins. Scattered melanophores on ventral surface of anterior half of visceral mass sometimes present.

tion. The smallest *B. macclellandi* and *B. atlanticus* larvae potentially could be confused, based on pigmentation alone. *Bregmaceros macclellandi* has less external pigment and internal pigment on tail and body is more clearly organized into two rows than that of *B. atlanticus*.

As larvae grow pigmentation becomes less reliable as a means to identify them. Nevertheless, the patterns are distinctive enough to allow tentative identification (Figs. 155 and 156), which can be confirmed by considering meristic characters. Because of identification errors, there are erroneous descriptions of pig-

mentation in the literature. For example, larvae of *B. nectabanus* <10 mm do have a melanophore at the jaw angle, although the review literature indicates that it is absent (D'Ancona and Cavinato, 1965; Belyanina, 1974).

Meristic characters (Table 83).—Except for *B. arabicus*, neritic species have lower myomere, vertebrae and median fin ray counts than do *B. macclellandi* or *B. atlanticus*. The lowest meristics occur in *B. rarisquamosus* and the highest in *B. macclellandi*. The neritic *B. arabicus* has meristics similar to those of *B.*

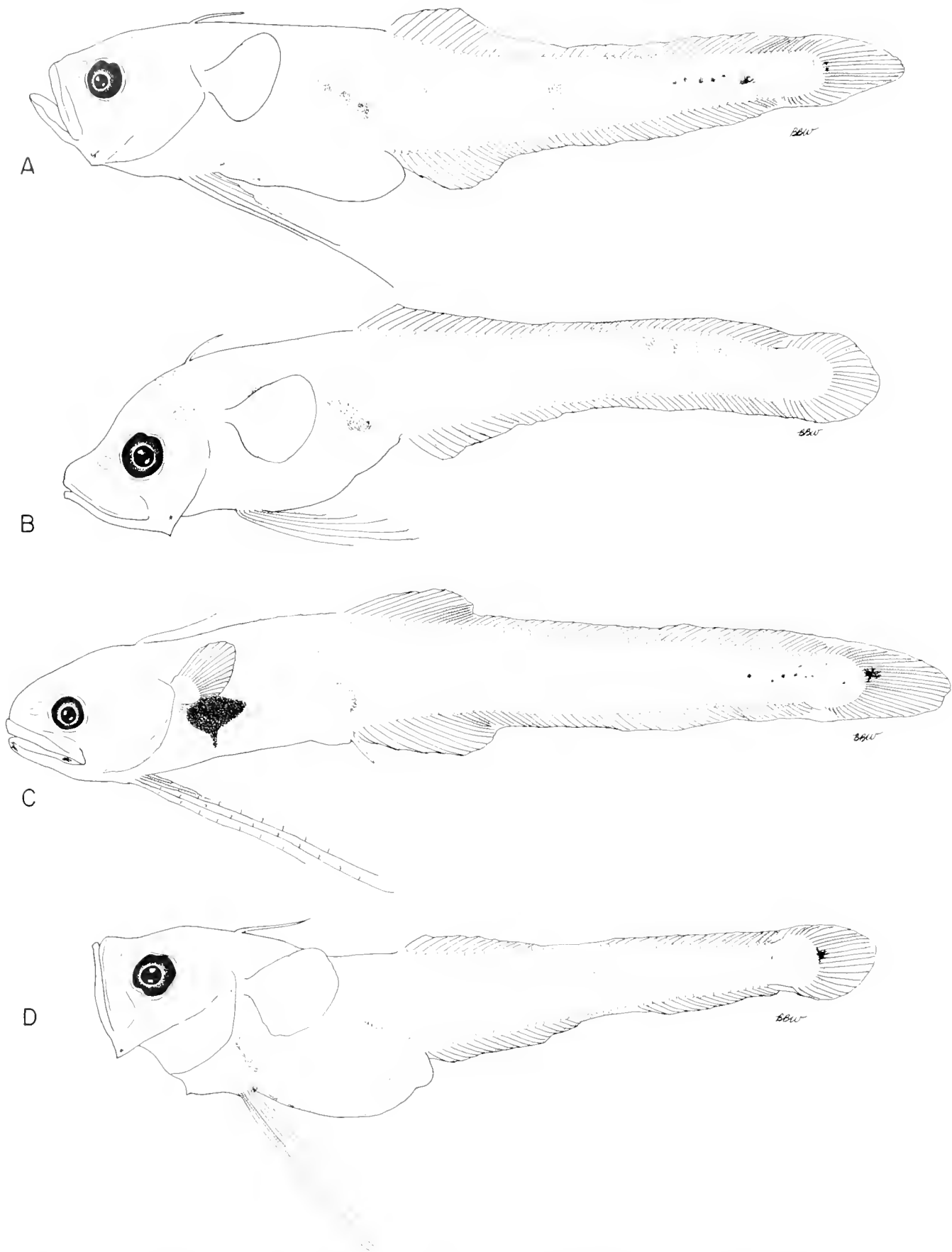

Fig. 156 Larvae of *Bregmaceros* in the length range 7.0 to 10.0 mm SL. (A) *B. nectabanus*, 10.0 mm, 25°28'N, 053°50'E; (B) *B. cantori*, 8.0 mm, 27°15'N, 083°53'W; (C) *B. arabicus*, 8.9 mm, 29°00'N, 048°29'E; (D) *B. rarisquamosus*, 7.0 mm, 27°41'N, 049°45'E.

atlanticus but larvae of the two species are easily separated by pigmentation differences. There is slight overlap in meristics of *B. nectabanus* and *B. cantori*, although *B. cantori* generally has lower counts. The very wide range in dorsal and anal fin ray counts attributed to *B. nectabanus* possibly has resulted from identification errors.

Adult complements of median and of caudal fin rays are present at 7.5–9.5 mm SL. Three or four pelvic fin rays develop early in larvae, most precociously in *B. maccllelandi* and *B. Type A*, just after appearance of the occipital ray. In other species pelvic rays appear at 3.5–4.5 mm length prior to appearance of the occipital ray. As larval development proceeds an additional 2–3 pelvic rays ossify, giving the adult complement of 5–7 rays.

RELATIONSHIPS

Family relationships.—The bregmacerotids are gadiform fishes (Fahay and Markle, this volume) of uncertain affinities and with no obvious close relatives (Cohen, this volume), but generally thought to be most closely related to the Muraenolepidae, Moridae and Melanonidae (Nelson, 1976; Fahay and Markle, this volume). Although affinities are unclear, bregmacerotids are clearly gadiforms. They have high vertebral numbers (Table 83), a long tail and long median fins with numerous rays (Cohen, this volume; Fahay and Markle, this volume). A well-developed caudal fin, separate from the dorsal and anal fins, is present. Accessory (x and y) bones, believed to be a primitive character in Gadiformes, are present in the caudal complex. But the number of hypurals has been reduced to two inferior elements and a platelike superior element, believed to represent fusion of hypural elements 3–5 (Markle, 1982; Cohen, this volume). The caudal fin of bregmacerotids is the most symmetrical in the Gadiformes. Both Ahlstrom⁶ and Markle (1982) have illustrated the caudal skeleton of a *Bregmaceros* sp.; Markle's specimen is undoubtedly *B. maccllelandi*, based on meristics that he gives. The number of principal (branched) caudal rays is 12, among the lowest in gadiform fishes. Procurent (unbranched) rays are numerous, 20–24 in number, equally divided between the dorsal and ventral sides of the caudal complex. One principal ray is associated with each inferior hypural, 8 are associated with the superior hypural plate and one is associated with each epural bone. No uroneural is illustrated by Ahlstrom⁶ but Markle (1982) illustrated one and noted that its presence is unique among gadoid fishes. Six vertebral centra appear to be involved in caudal fin ray support. The first dorsal fin, which consists of a single, elongate ray, is located on the occiput, a unique condition in gadiform fishes. The pelagic, tropical-subtropical distribution of bregmacerotids is unusual among gadiforms.

Species relationships.—The species of *Bregmaceros* are remarkably similar. They have wide geographic distributions with little apparent tendency to differentiate over their ranges of occurrence. Belyanina (1974) discussed the evolution and dispersal of *Bregmaceros*. She believed that the family originated in the Indo-Malayan Archipelago from which it dispersed with little morphological modification. The present-day richness of species in the Archipelago and the adjacent northern Indian Ocean lends credence to that hypothesis. Five species (*B. maccllelandi*, *B. atlanticus*, *B. nectabanus*, *B. rarisquamosus* and *B. arabicus*) presently occur in the proposed area of origin. Three species, (*B. bathymaster*, *B. cantori* and *B. Type A*) do not occur there. The first two of these resemble *B. nectabanus* and may be derived from it. The western Atlantic *B. Type A* is enigmatic

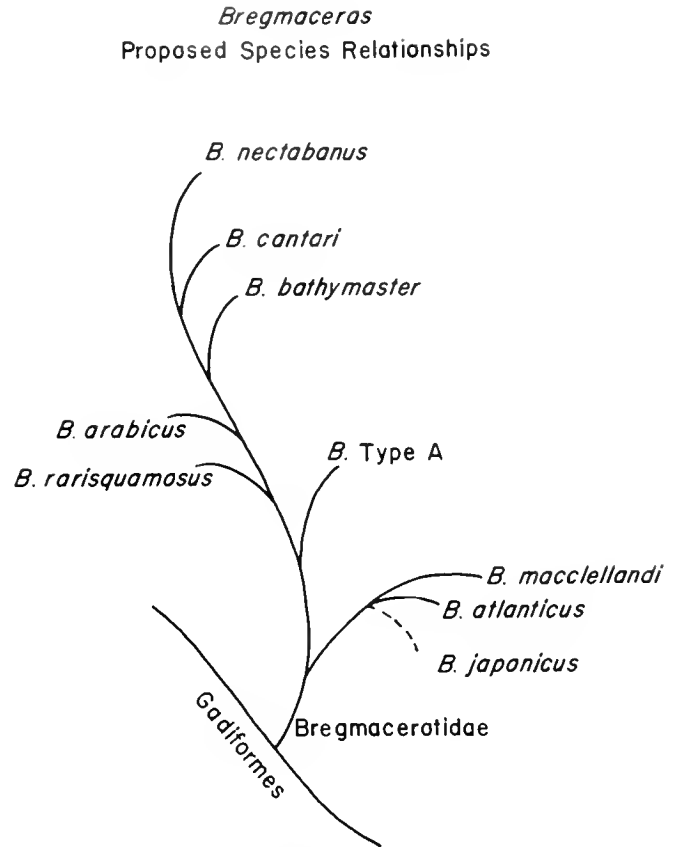

Fig. 157. Proposed species relationships of the Bregmacerotidae. The possible relationships, indicated by the branching points, are based on interpretations of species distributions and on meristic characters and larval pigmentation.

because it differs substantially from all described species. Belyanina (1974, 1980) believed that *B. nectabanus* was the common neritic *Bregmaceros* in the western Atlantic but subsequent research (Milliken, 1975; Houde, 1981; Milliken and Houde, 1984) has demonstrated that the western Atlantic species, *B. cantori*, differs substantially in modal vertebral numbers and median fin ray counts, and also that the larvae differ significantly in pigmentation characteristics.

Based on the species characteristics and known distributions, possible relationships among species are proposed in Fig. 157. Belyanina (1974) believed that the two oceanic species, *B. maccllelandi* and *B. atlanticus*, evolved from neritic species. It seems equally probable that the neritic species evolved from the two circumtropical, oceanic species. *B. maccllelandi* and *B. atlanticus* are very similar. They have relatively high meristic counts and are darkly pigmented. Their larvae are heavily pigmented and tend to be deeper-bodied than larvae of neritic species. The neritic species, except *B. arabicus*, have vertebral numbers and median fin ray counts much lower than those of *B. maccllelandi* and *B. atlanticus*. As larvae the neritic species are relatively thin-bodied and lightly pigmented (Table 84, Figs. 153 and 154).

Bregmaceros nectabanus, *B. arabicus* and *B. rarisquamosus* overlap broadly in their ranges of occurrence, as do *B. maccllelandi* and *B. atlanticus* and, to a lesser extent, *B. cantori* and *B. Type A*. Species frequently are collected together as larvae

in ichthyoplankton surveys. Only *B. bathymaster* appears to live in relative isolation from other species of *Bregmaceros*. In the Indo-Pacific, *B. rarisquamosus* (small-size, early maturation, low meristics) and *B. arabicus* (high meristics) possibly were derived from a *B. nectabanus* stock intermediate in meristic characteristics. The basic *B. nectabanus* stock also may have given rise to *B. bathymaster* and *B. cantori*. Detailed study of eastern Atlantic *B. cantori*-like larvae may help to resolve questions about dispersal and evolution of species.

Bregmaceros Type A is curious. Like *B. maccllelandi*, its larvae develop the occipital ray at <2.5 mm (Table 84). Yet, it bears little resemblance to *B. maccllelandi* in other meristic or pigmentation characters. It has the lowest vertebral and median fin ray counts of any *Bregmaceros* except *B. rarisquamosus* (Table 83). Larvae of Type A generally occur over the deep shelf and slope, occasionally in oceanic waters, and often co-occur with *B. cantori* and *B. atlanticus* (Houde, 1981).

The status of *B. japonicus* is unclear although this form may

be a western Pacific variety or subspecies of *B. atlanticus* (Belyanina, 1974). A recent reexamination of the holotype (Masuda and Ozawa, 1979) indicated that its vertebral and median fin ray counts exceeded or were at the upper extreme of ranges reported for *B. atlanticus* (Table 83). There is a need for critical examination of *B. atlanticus* and *B. japonicus* specimens from the tropical Pacific Ocean. Juveniles and adults that I examined from the eastern, tropical Pacific appeared to be typical *B. atlanticus* but none of the small larvae had typical *B. atlanticus* pigmentation. A moderately heavily-pigmented larva was present in tropical Pacific collections that may be an undescribed species. Its status and its possible relationship to the *B. atlanticus/B. japonicus* systematics problem need to be determined.

UNIVERSITY OF MARYLAND, CENTER FOR ENVIRONMENTAL AND ESTUARINE STUDIES, CHESAPEAKE BIOLOGICAL LABORATORY, SOLOMONS, MARYLAND 20688.

Ophidiiformes: Development and Relationships

D. J. GORDON, D. F. MARKLE AND J. E. OLNEY

THE order Ophidiiformes contains 300–400 species occupying mostly benthic habitats over a broad range of depth and salinity. These are elongate, tapering fishes with or without a caudal fin. The dorsal and anal fins are long, sometimes confluent, without spines and with pterygiophores more numerous than adjacent vertebrae. The pelvic fins, if present, are located far forward and are reduced to one or two rays, sometimes with a small spine.

Cohen and Nielsen (1978) summarized the present understanding of the systematics of ophidiiform fishes, presented keys to the genera, and provided a useful framework on which to base a discussion of the order. The presence or absence of viviparity defines two suborders, Bythitoidei and Ophidioidei. Bythitoidei contains the live-bearing "brotulids" and is divided into two families, Aphyonidae and Bythitidae. The oviparous Ophidioidei contains Ophidiidae and Carapidae. Ophidiidae includes the cusk-eels (Ophidiinae) and the oviparous "brotulids," previously allied with the bythitoids in the family Brotulidae.

Aphyonidae, reviewed by Nielsen (1969), contains 18 species in five genera. These ovoviviparous fishes are benthopelagic and found worldwide. Bythitidae contains over 80 species in 28 genera. Most species of this family occur either in shallow tropical waters, including coral reefs, or in waters of intermediate depths on the continental shelf and slope. Some deeper-dwelling slope species occur at higher latitudes, a few species inhabit abyssal waters and some are found in freshwater. Carapidae contains about 30 species divided into two subfamilies (Pyramodontinae, Carapinae) and six genera, all possessing a vexillifer larva (Olney and Markle, 1979; Markle and Olney, 1980;

Markle et al., 1983). Some species are free-living while others are inquilines within the body cavities of invertebrate hosts (Trott, 1970; Trott, 1981). Ophidiidae, as defined by Cohen and Nielsen (1978), includes oviparous ophidiiform fishes lacking a vexillifer larva and possessing a supramaxillary bone. The family is divided into four subfamilies: Brotulinae, Brotulotaeniinae, Neobythitinae and Ophidiinae. Brotulinae contains one genus (*Brotula*) with at least five species (Cohen and Nielsen, 1978). Adult *Brotula* are benthic and circumtropical on the continental shelf. Brotulotaeniinae contains the single genus *Brotulotaenia* with four midwater, tropical representatives (Cohen, 1974). Neobythitinae is a morphologically diverse group containing 38 genera and over 135 species with worldwide distribution and a wide depth range, but mostly deep sea. Ophidiinae consists of about 60 nominal species with several undescribed forms (Lea, 1980), mostly in shelf waters.

DEVELOPMENT

Knowledge of the early life history of ophidiiform fishes varies considerably among major taxa. Larvae of the live-bearing species are infrequently collected and larvae of deep water forms are even rarer. The incomplete state of knowledge of the taxonomy of bythitoid fishes renders identification of most of their larvae tentative. On the other hand, carapid and ophidiine larvae are common to abundant in tropical plankton. Carapid larvae are relatively well known and have proven to be of systematic value (Olney and Markle, 1979; Markle and Olney, 1980). Though the larvae of only a small percentage of the species of ophidiines are known, these larvae provide useful characters for understanding relationships within the group (Gordon, 1982).

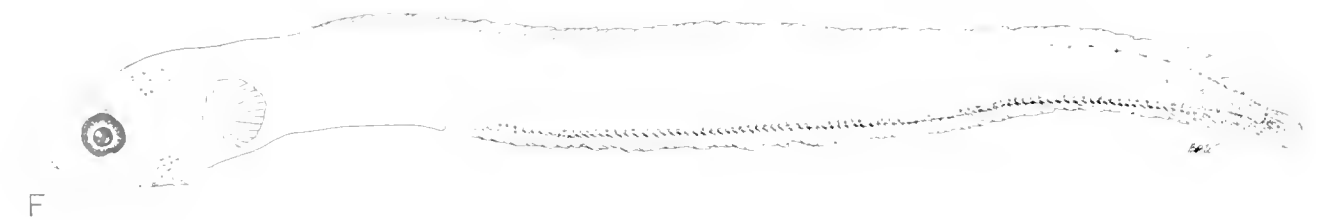
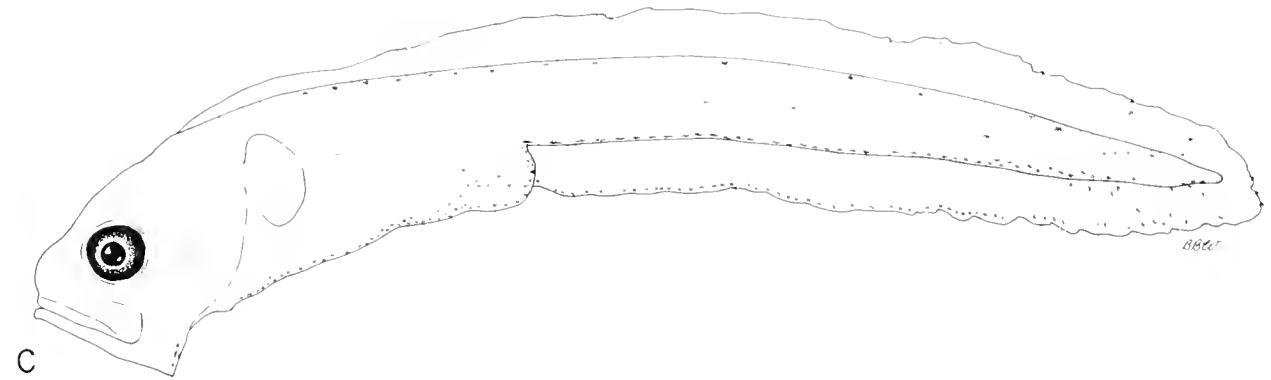
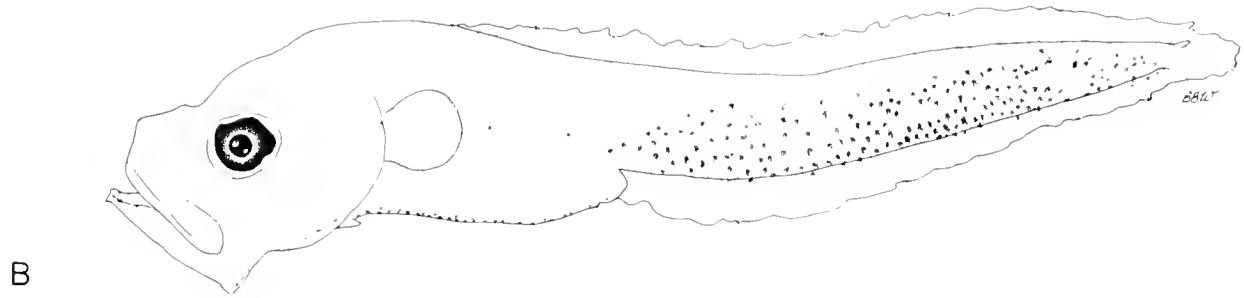

Fig. 158. Larvae of Bythitoidei. (A) Larva of *Brosmophycis marginata*, 12.5 mm NL, NMFS-SWFC, CalCOFI 7207 Ax Sta. 63.52. (B) Unidentified bythitid larva, 21.9 mm SL, HML H 4086, 40°34'N, 66°00'W. (C) Exterilium larva tentatively assigned to Neobythitinae, 29.5 mm SL, MCZ-WHOI, Oceanus 22, JEC 7711, 0°00'N, 37°40'W.

Eggs and embryos.—Ophidiiform eggs are poorly known. The pelagic eggs of *Genypterus capensis* (Ophidiidae) are moderately large, spherical and contain a single oil globule (Brownell, 1979). The few known carapid eggs are pelagic, ellipsoidal, and possess a single oil globule. Early developmental stages may be contained in a mucilaginous raft. Eggs have been described for *Carapus acus* (Emery, 1880; Padoa, 1956j), *Echiodon dentatus*

(Sparta, 1926), *E. drummondii* (Kennedy and Champ, 1971), *E. rendahli* (Robertson, 1975b), and unidentified carapid species from the North Atlantic (Ryder, 1884) and South Africa (Brownell, 1979).

Aphyonid larvae have not been reported from plankton tows but late embryos taken from ovarian tissue were illustrated by Nielsen (1969).



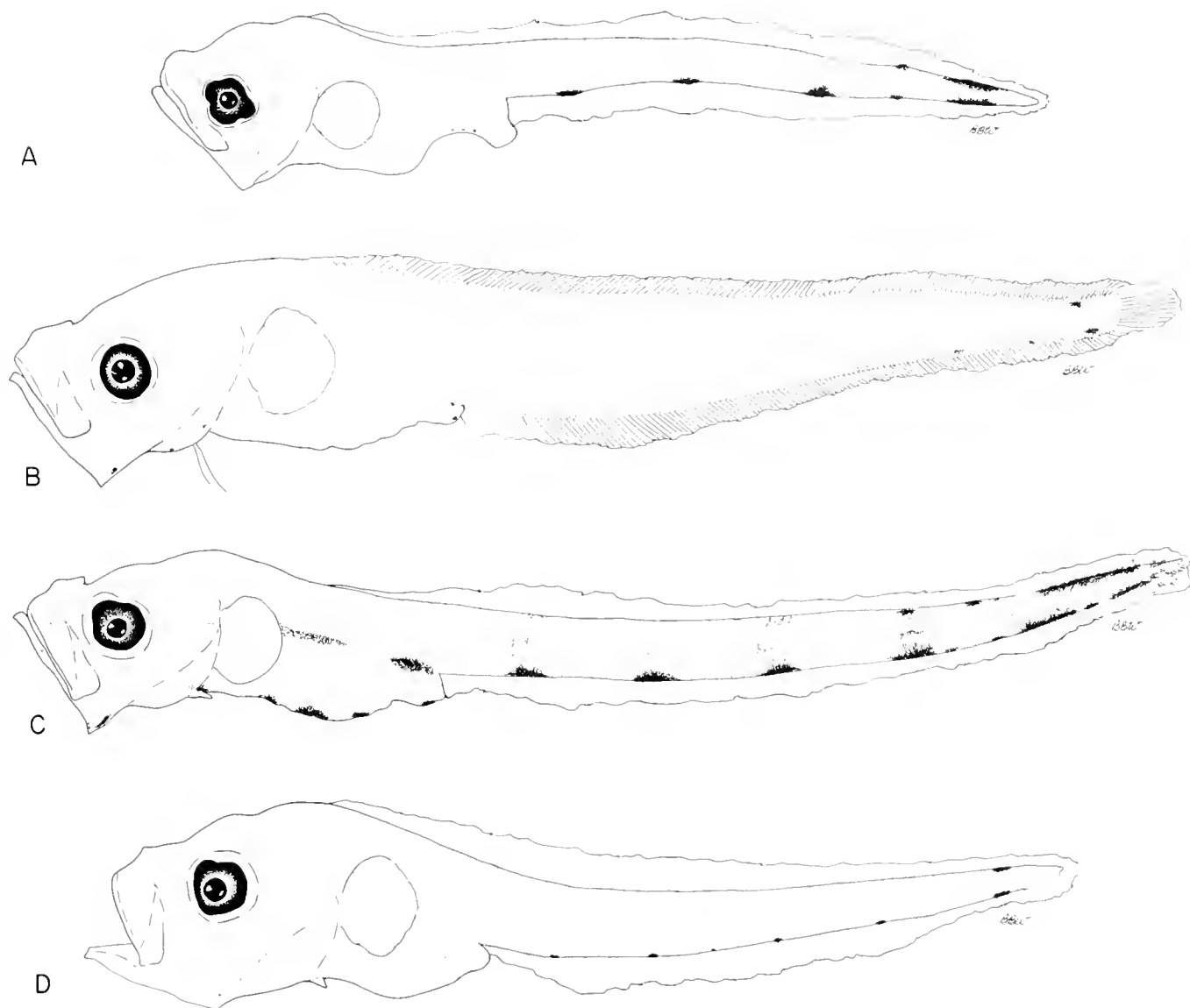

Fig. 160. Larvae of the genus *Lepophidium*. (A) *Lepophidium negropinna*, 5.1 mm NL, NMFS-SWFC, P-28 120.35. (B) *Lepophidium jeannae*, 11 mm SL, UMML, CI 7113 Sta. 62, 26°30'N, 83°00'W. (C) *Lepophidium staurophor*, 12 mm SL, UMML, CI 7113 Sta. 81, 27°00'N, 84°05'W. (D) *Lepophidium* Type 1, 7.8 mm NL, UMML, CI 7114 Sta. 127, 28°15'N, 84°50'W.

Larvae. — The reproductive biology of three bythitid species has been discussed (Wourms and Bayne, 1973; Wourms and Cohen, 1975; Suarez, 1975). Aboussouan (1972a) described a larva attributable to *Oligopus longhursti* and Leis and Rennis (1983) have illustrated a larval *Dinematichthys*. A larva of *Brosmophycis marginata* from the eastern Pacific and an unidentified bythitid from the North Atlantic (Fig. 158) are illustrated here.

Larvae of a number of carapid and ophidiine species have been described, but few larvae of other, generally deeper-dwelling, ophidioid taxa are known. Leis and Rennis (1983) illustrated a larval *Brotula*. Aboussouan (1980) described a large, ribbon-shaped larva which he attributed to *Brotulotaenia*. A specimen of *Spectrunculus grandis* (56 mm SL) is illustrated and discussed by Nielsen and Hureau (1980). Larvae of the neobythi-

Fig. 159. Larvae of tribe Ophidini. (A) *Otophidium omostigmum*, 8.3 mm NL, UMML, CI 7114 Sta. 126, 28°15'N, 84°25'W. (B) *Ophidion* Type 1, 7.6 mm NL, UMML, CI 7308 Sta. 60, 26°31'N, 82°28'W. (C) *Ophidion* Type 2, 7.0 mm NL, UMML, CI 7303 Sta. 94, 27°30'N, 83°29'W. (D) *Ophidion nocomis*, 24 mm SL, NMFS-SEFC, Ore 11 7343 Sta. 160. (E) *Ophidion selenops*, 24 mm SL, UMML, CI 7113 Sta. 95, 27°31'N, 83°46'W. (F) *Parophidion schmidti*, 17 mm SL, MCZ-WHOI, RV Chain 60 RHB 1315, 25°46'N, 79°47'W.

TABLE 85. MERISTIC VARIATION IN WESTERN NORTH ATLANTIC SPECIES OF CUSK-EELS. Sample size is indicated in parentheses below the range.

Species	Vertebrae			Fin rays			Source
	Precaudal	Caudal	Total	Dorsal	Anal	Pectoral	
<i>Otophidium omostigmum</i>	14 (10)	42–44 (10)	56–58 (10)	99–108 (10)	84–87 (10)	16–18 (20)	Gordon, 1982; Böhlke and Robins, 1959
<i>Otophidium dormitator</i>	14, 15 (11)	49–51 (7)	64, 65 (10)	111–117 (14)	94–96 (14)	15–16 (20)	Gordon, 1982; Böhlke and Robins, 1959
<i>Otophidium chickcharney</i>	13 (6)	50–52 (6)	63–65 (6)	111–116 (9)	98–102 (8)	16, 17 (16)	Böhlke and Robins, 1959; original
<i>Parophidion schmidti</i>	15 (1)	52 (1)	67 (1)	115–126 (24)	98–106 (24)	17–19 (25)	Böhlke and Robins, 1959; original
<i>Ophidion selenops</i>	15, 16 (14)	62–65 (14)	77–81 (14)	132–138 (8)	123–129 (8)	15–16 (18)	Gordon, 1982; Robins and Böhlke, 1959
<i>O. nocomis</i>	17 (7)	67–70 (7)	84–87 (7)	144–153 (42)	132–139 (42)	14–17 (74)	Robins and Böhlke, 1959
<i>O. holbrookii</i>	15, 16 (12)	50–53 (12)	66–69 (12)	117–132 (12)	97–109 (12)	19–21	Gordon, 1982
<i>O. beani</i>	15–17 (45)	50–53 (45)	65–69 (45)	111–133 (9)	94–103 (9)	18–21	Gordon, 1982
<i>O. grayi</i>	16 (11)	48–50 (11)	64–66 (11)	131–145 (11)	99–113 (11)	20–23	Gordon, 1982
<i>O. marginatum</i>	15 (4)	53–54 (4)	68–69 (4)	147–158 (4)	118–124 (4)	—	Miller and Jorgenson, 1973
<i>O. welshi</i>	15, 16 (6)	50–52 (6)	67, 68 (6)	128–150 (15)	105–122 (15)	21	Gordon, 1982
<i>O. lagochila</i>	—	—	—	123–125 (3)	103–105 (3)	17–19 (6)	Böhlke and Robins, 1959
<i>Lepophidium graellsii</i>	14–16 (40)	55–57 (39)	69–73 (32)	124–133 (38)	101–109 (37)	20–22	Gordon, 1982
<i>L. marmoratum</i>	14, 15 (31)	55–60 (31)	70–75 (32)	121–136 (30)	103–112 (31)	21–24	Gordon, 1982
<i>L. jeannae</i>	14, 15 (9)	58–60 (9)	73–75 (9)	131–140 (11)	112–117 (11)	20–21 (12)	Gordon, 1982; Robins, 1960
<i>L. staurophor</i>	15 (3)	65–67 (3)	80–82 (3)	140–147 (4)	122–127 (4)	22, 23 (4)	Robins, 1958
<i>L. profundorum</i>	15–17 (14)	58–61 (14)	73–78 (14)	131–140 (14)	110–121 (14)	22–24	Gordon, 1982
<i>L. kallion</i>	15 (1)	59 (1)	74 (1)	133 (1)	108 (1)	23, 24 (4)	Robins, 1959
<i>L. aporrhox</i>	13 (5)	52, 53 (5)	65, 66 (5)	109–114 (7)	96–99 (7)	21–23 (14)	Robins, 1961
<i>L. pheromystax</i>	14, 15 (20)	54–57 (20)	69–72 (20)	125–132 (41)	104–110 (41)	20–22 (86)	Robins, 1960

tine genus *Benthocometes* (*Pteridium*) were illustrated by Padoa (1956i). Exterilium larvae (Fraser and Smith, 1974; Moser, 1981) may be larvae of deep-dwelling neobythitine species (Figure 158C).

Larvae of six ophidiine genera are known. Padoa (1956i) described the larvae of *Parophidion vassali* and *Ophidion barbatum* from the Mediterranean Sea. Aboussouan (1972a) described the larvae of *Ophidion barbatum* from the eastern Atlantic. Brownell (1979) reared early stages of the larvae of *Gerypteris capensis*. Larval stages of *Ophidion marginatum* were illustrated in Scotten et al. (1973) and were reproduced in Fritzsche (1978). Figure 178b in Fritzsche (1978) is probably a stichaeid and not an ophidioid species. Larval stages of *Otophidium omostigmum* (Fig. 159A), *Ophidion selenops* (Fig. 159E), *Lepophidium jeannae* (Fig. 160B) and *Lepophidium staurophor* (Fig. 160C) from the Gulf of Mexico were described by Gordon (1982). Larvae of *Chilara taylora* and *Ophidion scrippsae* were

described by Ambrose et al. (1983). Larvae of *Ophidion nocomis* (Fig. 159D) and *Lepophidium negropinna* (Fig. 160A) are illustrated in this study.

Carapid larvae have been described (or illustrated) for six genera and 12 species: *Carapus acus* (Padoa, 1956j); *C. imberbis* (Aboussouan, 1972a); *C. bermudensis* (Dawson, 1971b; Olney and Markle, 1979); *Echiodon dentatus* (Emery, 1880; Sparta, 1926; Padoa, 1947; Maul, 1976); *E. drummondi* (Ehrenbaum, 1905–1909; Kennedy and Champ, 1971); *Echiodon rendahli* (Robertson, 1975b); *E. dawsoni* (Olney and Markle, 1979); *E. exsilium* (Trott, 1970; Olney and Markle, 1979); *Encheliophis jordani* (Trott, 1970); *Omuxodon margaritiferae* (Govoni et al., 1984); *Snyderidia canina* (Strasburg, 1965; Markle and Olney, 1980); and *Pyramodon ventralis* (Markle and Olney, 1980). In some cases, larval identifications are unsubstantiated and caution should be employed, especially in the older literature. For example, Padoa (1956j) confuses larval *E. dentatus* (plate XLIV,

TABLE 86. MERISTIC VARIATION IN EASTERN NORTH PACIFIC SPECIES OF CUSK-EELS. Sample size is indicated in parentheses below the range.

Species	Vertebrae			Fin rays			Source
	Precaudal	Caudal	Total	Dorsal	Anal	Pectoral	
<i>Otophidium indefatigabile</i>	13-15	45-49	59-64 (17)	106-115 (15)	88-96 (14)	18-19	Lea, 1980
<i>Chilara taylori</i>	18-19	68-72	86-91 (66)	187-229 (50)	150-181 (50)	24-26	Lea, 1980
<i>Ophidion costaricense</i>	14-16	50-54	65-69 (45)	130-153 (44)	107-128 (43)	23-26	Lea, 1980
<i>O. fulvum</i>	13-15	49-55	63-69 (39)	137-160 (34)	112-136 (34)	23-26	Lea, 1980
<i>O. galeoides</i>	14-17	47-49	61-64 (52)	123-143 (42)	97-114 (41)	21-23	Lea, 1980
<i>O. imitator</i>	15-16	55-60	70-76 (20)	135-163 (18)	112-139 (18)	25-28	Lea, 1980
<i>O. iris</i>	16-17	53-56	69-73 (67)	121-148 (65)	98-122 (63)	22-24	Lea, 1980
<i>O. moche</i>	15-16	55-58	71-74 (6)	142-148 (6)	118-126 (6)	24-25	Lea, 1980
<i>O. scrippsae</i>	14-16	50-54	65-69 (102)	124-153 (102)	99-126 (100)	20-23	Lea, 1980
<i>Lepophidium prorates</i>	14-16 (63)	55-58 (59)	70-73 (59)	124-133 (59)	106-113 (60)	21-24 (87)	Robins, 1962
<i>L. pardale</i>	15 (2)	57 (2)	71 (2)	128, 132 (2)	106, 109 (2)	22, 23 (2)	Robins, 1962
<i>L. stigmatistium</i>	14, 15 (2)	55, 56 (2)	70 (2)	125, 130 (2)	103, 109 (2)	19-21 (4)	Robins, 1962
<i>L. microlepis</i>	14-16 (83)	51-62 (83)	66-77 (83)	117-141 (81)	97-121 (82)	21-26 (95)	Robins and Lea, 1978
<i>Cherublemma emmelas</i>	13, 14 (14)	42-44 (14)	55-58 (14)	99-113 (33)	81-93 (32)	24-26 (58)	Robins, 1961
<i>L. negropinna</i>	15, 16 (5)	59-61 (5)	75, 77 (5)	138-148 (12)	116-121 (12)	21-24 (22)	Robins, 1962

Fig. 14; plate XLV, Figs. 3 and 4) with *C. acus* (plate XLV, Fig. 5).

Prejuveniles.—Ophidiine larvae are pelagic, and the development of most species proceeds directly without an abrupt transition period. The larvae of *Ophidion selenops*, however, are extremely elongate and attain a length of 40 mm SL before reduction of intervertebral spaces causes a reduction in total length to about 24 mm (Gordon, 1982). Soon after this transformation the body shape approaches the juvenile form and the larvae become benthic. Elongate larvae identified here as *O. nocomis* have a similar morphology (Fig. 159D). Most ophidiine species probably become benthic at about 25–30 mm SL. *Chilara taylori* and *Parophidion*, however, have extended nektonic prejuvenile stages (Lea, 1980). The prejuvenile stage of *C. taylori* reaches 80 mm SL and was described as *Ophidion novaculum* by Harry (1951).

A specialized prejuvenile stage, known as a tenuis larva, has been described for some *Carapus* species and *Echiodon dawsoni* and is characterized by the absence of a vexillum and an initial lengthening and subsequent reduction in total length (Emery, 1880; Arnold, 1956; Padoa, 1956j; Strasburg, 1961; Hipeau-Jacquotte, 1967; Gustato, 1976; Trott, 1981; Williams and Shipp, 1982). The stage is poorly known and has been reported as an obligate inquiline parasite (Trott, 1981), a free-living benthic form (Trott, 1981), and a pelagic form sometimes attracted to nightlights (Smith et al., 1981).

Meristic characters.—Meristic characters that are observable in ophidiine larvae include myomere number, vertebral formula (precaudal plus caudal vertebrae), dorsal fin ray number and anal fin ray number. Pectoral fin ray number and gill raker development, which are important taxonomically in adults, cannot be considered complete in pelagic larvae. Meristic characters show large variation within species. In many cases, published ranges for these characters are based upon too few specimens to accurately depict the range of variation. In addition, meristic data show broad range overlap between several species and caution should be employed. Positive identification of larvae based solely on meristic characters, however, can be made for some western Atlantic species, including *Ophidion selenops*, *O. nocomis*, *Otophidium omostigmum*, *Oto. dormitator*, *Oto. chickcharney* and *Lepophidium staurophor*. In the eastern Pacific, larvae of *Chilara taylori* and *Otophidium indefatigabile* are identifiable based on meristics. Ranges of meristic characters for western Atlantic ophidiines are given in Table 85 and for eastern Pacific ophidiines in Table 86. Several species of the genera *Ophidion* and *Lepophidium* from the western Atlantic are presently undescribed, and taxonomic questions remain to be resolved (C. R. Robins, pers. comm.).

Development of the ophidiine vertebral column and fins was described by Gordon (1982). Total myomeres in larvae compare closely with total vertebrae in adults. The number of preanal myomeres present prior to coiling of the gut is usually greater than the number of precaudal vertebrae in adults, because the

TABLE 87. MERISTIC VARIATION IN SELECTED SPECIES OF CARAPID FISHES. Abbreviations used are: N—number of specimens examined; D₃₀—number of dorsal rays whose bases lie anterior to 31st vertebra; A₃₀—number of anal rays whose bases lie anterior to 31st vertebra; P₁—pectoral rays; P₂—pelvic rays; PCV—precaudal vertebrae; NVD—number of vertebrae to dorsal origin; NVA—number of vertebrae to anal origin; ARDO—number of anal rays to dorsal origin; NA—not applicable.

Species	N	D ₃₀	A ₃₀	P ₁	P ₂	PCV	NVD	NVA	ARDO
<i>Pyramodon ventralis</i>	10	48–52	46–53	27–29	1	15–18	5–8	6–8	NA
<i>Snyderidia canina</i>	4	49–51	44–46	25	abs	14–15	6–7	9–10	NA
<i>Carapus acus</i>	2	37–39	58		abs	18	11–12	3–4	20–21
<i>Carapus mourlani</i>	3	38	56–57	18	abs	15–16	12–13	2–3	22
<i>Carapus homei</i>	2	33–37	56–60	17–19	abs	16–17	14	3–4	24–26
<i>Carapus parvipinnis</i>	4	35–38	50–53	15–19	abs	16	12–13	4–5	17–19
<i>Echiodon drummondi</i>	6	42–45	47–49	15–17	abs	25–29	8–9	6–8	5–7
<i>Echiodon cryomargarites</i>	24	37–40	46–50	19–21	abs	25–29	11–12	6–8	9–12
<i>Echiodon dawsoni</i>	1	28	39	17–18	abs	22	12	6	12
<i>Onuxodon parvibrachium</i>	4	44–46	44–48	14–15	abs	16–17	6–7	6–8	1–2
<i>Onuxodon margaritiferae</i>	6	46–47	46–50	16	abs	19–22	6–8	5–6	3–4
<i>Encheliophis vermicularis</i>	3	25–26	39–41	abs	abs	21–22	16–18	4–5	18–21
<i>Encheliophis gracilis</i>	4	28–31	45–50	15–17	abs	26–31	16–17	3–7	23–26

gut migrates forward by 2–4 myomeres during formation of the gut coil (Gordon, 1982). By 8–10 mm NL, the haemal arches are closed allowing accurate determination of the vertebral formula in cleared and stained larvae. Rays of the dorsal and anal fins develop from posterior to anterior. Development begins at 7–10 mm NL and is complete by 15–20 mm SL. The adult complement of nine caudal rays and seven branchiostegal rays is present by 10 mm NL in most species. These structures do not appear until 15 to 20 mm SL in the elongate *O. selenops*. The number of pectoral fin rays ranges from 16–28, with sizes at which the first rays appear ranging from 13–20 mm SL. The pectoral fin is complete in some species by 18–20 mm SL.

Traditionally, meristic characters have not been widely used in adult descriptions of carapids (Arnold, 1956) and consequently, some easily observed and useful characters such as pectoral fin ray counts (Cohen and Nielsen, 1978; Olney and Markle, 1979) can not be obtained from the literature. Innovative meristics, partly borrowed from eel systematics (Nielsen and Smith, 1978), are useful aids to identification of larval and adult carapids (Olney and Markle, unpublished data). Table 87 summarizes some of these meristic characters for selected species of carapids.

Morphology.—Except for the larvae of *O. selenops* and *O. no-comis*, known ophidiine larvae show little variation in size, shape and development (Figs. 159, 160). The larvae, which hatch at 2–3 mm NL, are moderately elongate and taper slightly from the head to the end of the notochord. The eyes are round and conspicuous; the mouth is oblique. Larvae become more laterally compressed with growth. In all species examined by Gordon (1982), the gut is straight at hatching and develops a single coil at 5–7 mm NL as a downward loop twists, displacing the more posterior portion of the gut to the right.

Carapid vexillifers (Figs. 161–163) are elongate larvae with a moderately sized head, large eye and nasal rosette, coiled gut,

short preanal length, and tapered body frequently ending in a broken filament, and an elongate larval dorsal fin ray (vexillum) in front of the first adult dorsal fin ray (Olney and Markle, 1979; Govoni et al., 1984). Larvae of *Pyramodon* and *Snyderidia* (Fig. 163) have a somewhat deeper head and trunk, shorter pre-dorsal distance, relatively long anal fin pterygiophores, and more pectoral fin rays than other carapid larvae (Markle and Olney, 1980). Variations in gross morphology in carapine larvae are limited to variation in gut shape and fin ray or vexillum position (Figs. 161, 162; Table 87).

Pigmentation.—Pigmentation of ophidiine larvae is useful for identifying species and species groups though care must be taken since ontogenetic changes occur (Gordon, 1982). Head pigmentation typically consists of two or three melanophores present distally on the suspensorium near the articulation with the lower jaw. Abdominal pigmentation is usually variable within species and consists of melanophores scattered ventral to the gut. Pigmentation on the posterior half of the body is the most useful for taxonomic purposes. All *Lepophidium* larvae have 2–10 large spots placed medially along the base of the anal finfold and 1–2 spots dorsally in the caudal peduncle region. Unlike *Lepophidium*, larvae of *Ophidion*, *Otophidium* and *Chilara* have patterns of small stellate melanophores present laterally on the body. Several species of these genera can be recognized on the basis of postanal pigmentation. Some species have larvae which are very similarly pigmented: *O. selenops* and *O. no-comis*; *O. welshi* and *O. marginatum*. Larvae of other species cannot be distinguished using pigmentation or meristic characters (Gordon, 1982): *Ophidion* Type 1 (Fig. 159B) which represents *O. holbrooki*, *O. beani* and unidentified *Ophidion* species; *Ophidion* Type 2 (Fig. 159C) *O. welshi* and *O. grayi*; and *Lepophidium* Type 1 (Fig. 160D) *L. graellsii* and *L. jeannae*.

Carapid vexillifers are sparsely to moderately pigmented (Figs. 161–163). Red chromatophores have been noted in fresh ma-

Fig. 161. (A) Larva of *Echiodon drummondi*, 76.5 mm TL, ZMUC uncat., DANA St. 8371, 51°29'N, 12°50'W. (B) Larva of *Echiodon rendahli*, 72 mm TL, CSIRO uncat., Warreen Cruise, Sta. 266/39, 36°17'S, 150°25'E. (C) Dorsal fin and vexillar supports of *Echiodon dawsoni*, 4.2 mm HL and 10 mm HL. Abbreviations used are vex—vexillum, fdp—first dorsal pterygiophore. (D) Dorsal fin and vexillar supports of *Echiodon drummondi*, 4.6 mm HL and 24.3 mm HL. Abbreviations as in Fig. 161C.

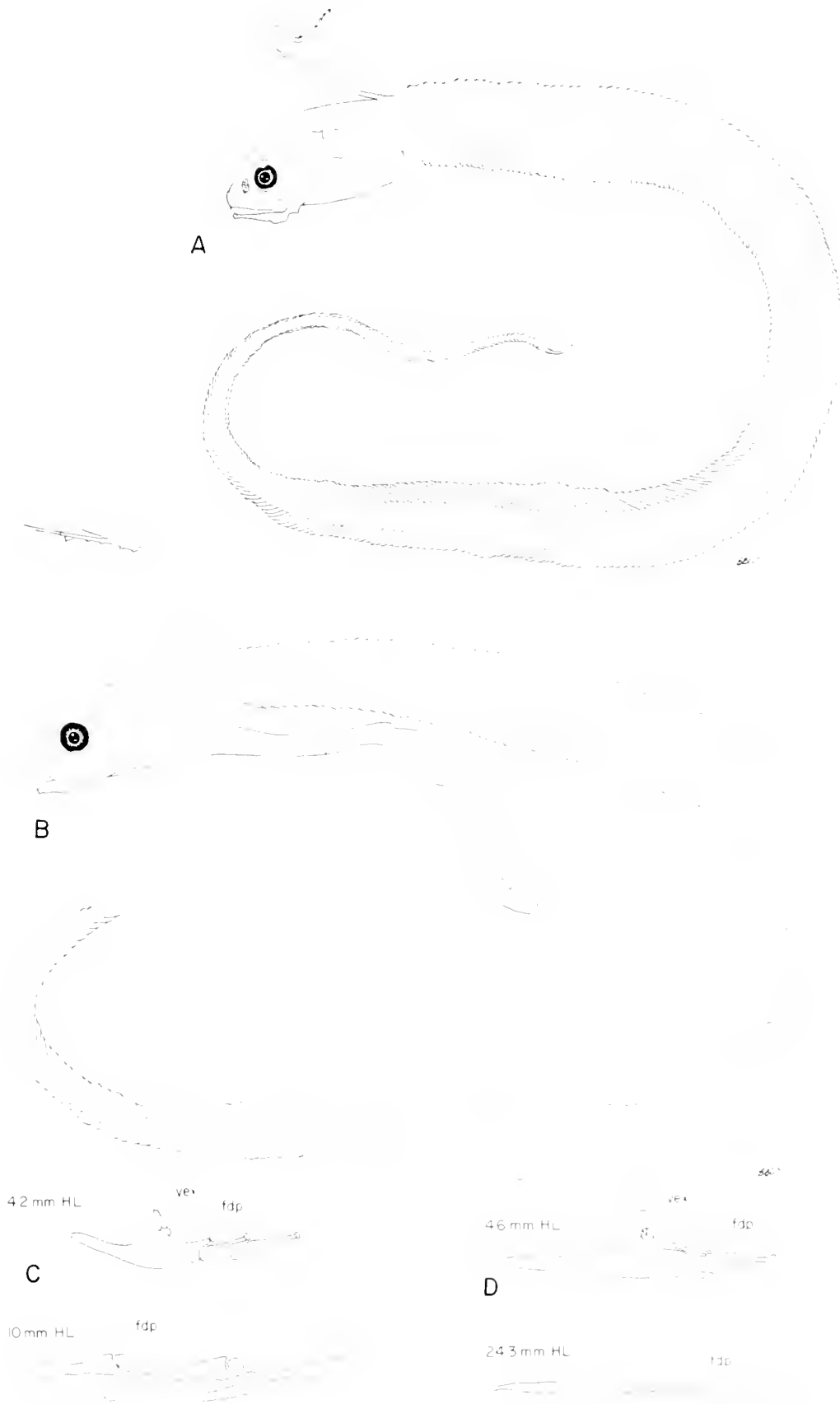

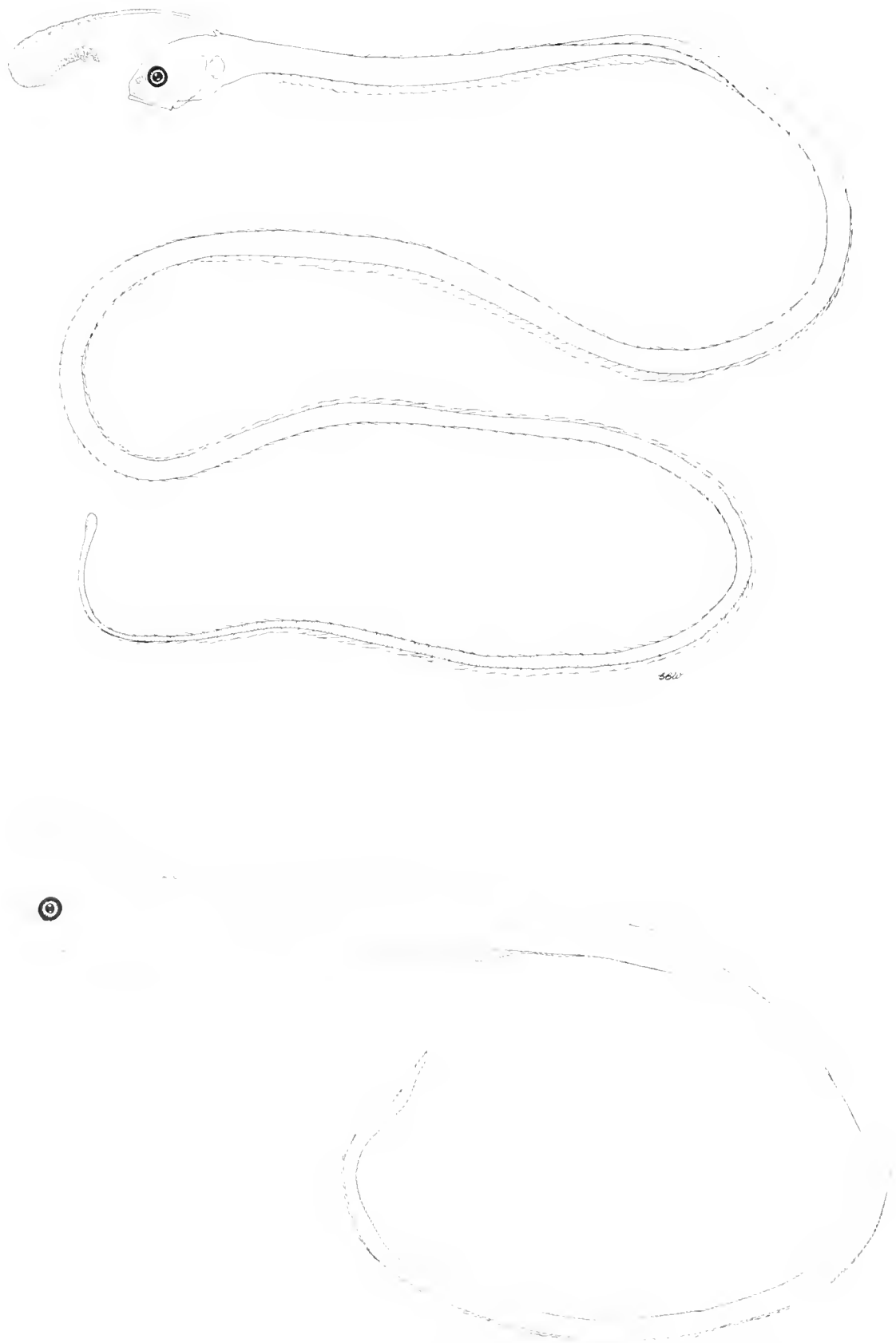

Fig. 162. Larva of *Carapus* sp., (top) uncat., Anton Bruun, 0°14'S, 65°03'E, 27-28 May 1964. Larva of *Onuxodon parvibrachium*, (bottom) ZMUC uncat., Dana St. 3768 XVI, 400 mwo, 1°20'S, 138°42'E, 0315 hrs, 25 July 1929.



Fig. 163. Larva of *Pyramodon ventralis*, (top) uncat., 21°20–30'N, 158°20–30'W, 19 Dec. 1977. Larva of *Snyderidia bothrops*, (bottom) MCZ uncat., RHB 1263, Chain 60, 12°58'N, 73°34'W, 29 May 1966, 0–120 m, IKMT.

terial of *Echiodon dentatus* (Padoa, 1956j) and *E. dawsoni* (Olney and Markle, 1979) but are not normally retained in preserved material. Melanophores are variously present at the symphysis of the lower jaw, on the snout, head, vexillum, swimbladder, trunk, and tail. Preliminary studies (Padoa, 1956j; Robertson, 1975b; Olney and Markle, 1979; Markle and Olney, 1980) indicate that pigmentation may be regionally useful as an aid to identification but seems problematic as an indicator of higher relationships.

Osteology.—The placement of the pelvic fins, which defines the subfamily Ophiidiinae, shows marked ontogenetic change (Gordon, 1982). In early larvae, the cleithra lack the forward extension and the pelvic fins (appearing by about 7 mm NL) are supported in a jugular position. By 20 mm SL, the bony extension of the cleithra develops and begins to elongate anteriorly. The pelvic fins, which are supported at the symphysis, migrate forward and are present in the characteristic mental position in the juveniles. The presence of pelvic fins in the jugular position has occasionally caused the confusion of early larvae with other ophiidioids.

The general structure of the vexillar ray is described by Olney and Markle (1979) and Govoni et al. (1984). External variations of vexilla are in length, ornamentation, pigmentation, and position. Some variation such as length and ornamentation ap-

pears to be an artifact (Govoni et al., 1984). In several species, the vexillar pigmentation and ornamentation are curiously repeated in the caudal filament (Fig. 162). Variation in the supporting proximal radial is seen in its shape, its position relative to the first adult dorsal fin ray and to vertebrae, and in fusion with the proximal radial of the first dorsal fin ray. In addition, the supporting proximal radial may or may not be retained in adults (Fig. 161C, D). Its retention provides a means of identifying the location of the vexillum and can aid in larval identification. Its absorption, however, appears to have occurred independently in several genera. In the pyramodontines (Markle and Olney, 1980) and *Carapus* (Olney and Markle, 1979) there is also an accessory cartilage in front of the second neural spine. Its origin and function are unknown. *Carapus* (and presumably *Encheliophis*) and the pyramodontines also have the most forwardly placed vexilla, usually above or in front of the first anal fin ray. *Carapus* (and presumably *Encheliophis*) differs from the pyramodontines and all other carapids in displacement of the first adult dorsal fin ray far posteriad of the vexillum (Fig. 162).

Modified ribs on the anterior vertebral centra of carapids and ophiidiines are associated with sound production/reception (Rose, 1961; Courtenay and McKittrick, 1970; Courtenay, 1971) and develop in early stages in carapids (Olney and Markle, 1979). In Carapidae, the first two ribs are movable and all subsequent ribs are rigid (Markle et al., 1983). A simple recurved third rib

is found in *Echiodon* and pyramodontines while an expanded third rib is found in *Carapus* (Olney and Markle, 1979; Markle and Olney, 1980; Williams and Shipp, 1982) and *Onuxodon* (Courtenay and McKittrick, 1970). The sexually dimorphic and interspecific differences in swimbladder morphology of ophidiines appear only in juveniles and adults and are not useful in distinguishing larvae.

The visceral cradle, formed from the criss-crossing elongate proximal pterygiophores of the anterior anal fin rays, is a unique specialization of *Pyramodon* (Markle and Olney, 1980). Its presumed precursor, non-crossing elongate proximal pterygiophores, is found in larval *Snyderidia*. The elongate proximal pterygiophores found in pyramodontines are conspicuous in larvae.

The pectoral fin of carapids is a variable structure and potentially useful in the study of relationships as well as for identification. Adults of some species of *Encheliophis* completely lack a pectoral fin while pyramodontines have a well-developed fin with up to 29 rays. Most cleared and stained carapid and ophidiine larvae have an elongate, cartilaginous, ventral process of the coracoid (VPC). In the carapid "exterilium" larvae (Fig. 161B, see also Robertson, 1975b) the development of the VPC has been carried to an extreme. The hanging or trailing gut of this larva is supported by a skeleton of the two VPC's which intertwine with the intestine. Support of a trailing gut by VPC's is not unique since we have also seen it in the ophidioid "exterilium" (Fraser and Smith, 1974; Moser, 1981) and *Symphurus minor* (unpublished data).

The dentition of carapids is useful for adult identification purposes (Arnold, 1956) and enlarged canines as well as the dentary diastema have been used to separate *Carapus* and *Echiodon* larvae (Olney and Markle, 1979).

RELATIONSHIPS

Intra-ordinal relationships.—The classification of Ophidiiformes proposed by Cohen and Nielsen (1978) differs most significantly from earlier classifications in the use of mode of reproduction as a subordinal character. Previous classifications recognized the highly specialized carapids as either one or two families (Carapidae and Pyramodontidae) and, based on the position of the pelvic fins, divided the remaining ophidiiforms into two groups, the ophidiids (ophidiines, pelvics mental) and the brotulids (pelvics absent or jugular).

Relationships within the Bythitoidei remain unclear. The aphyonids share a number of neotenic characters serving to define the family. This may be a polyphyletic group, however, with common character states reflecting convergent trends (Cohen and Nielsen, 1978). Comparisons of embryonic adaptations, such as trophotaeniae (Wourms and Cohen, 1975), may prove useful in resolving systematic problems within Bythitidae. Two subfamilies (Bythitinae and Brosmophycinae) are presently defined on the basis of confluence of anal and dorsal fins with the caudal fin, though neither subfamily has been adequately studied.

Ophidioidei are defined by the presence of oviparity and the anterior nostril (in most genera) well above the upper lip. The relationships of the ophidioid subfamilies are also uncertain and the suborder may be paraphyletic. Carapidae and subfamily Ophidiinae each seem to form natural groupings based upon well-defined synapomorphies. Further study of the neobythitines may reveal several natural groupings (Cohen and Nielsen, 1978). The relationships of Brotulotaeniinae and Brotulinae are unknown.

Two tribes of Ophidiinae can be defined on the basis of squamation and the presence of pyloric caecae. Lepophidiini (imbricate scales; pyloric caecae present) contains three genera: the monotypic *Cherublemma emmelas*, *Genypterus*, and *Lepophidium*. Lea (1980) has proposed the elevation of *Genypterus* to the level of tribe. The Ophidiini (anguilloid squamation; pyloric caeca absent) contains the genera *Ophidion*, *Otophidium*, *Chilara*, *Raneyia* and *Parophidion*. These genera, established on the basis of meristics, morphometrics, swimbladder morphology and squamation, are not well-defined and require further study.

A comparative study of the development of ophidiine larvae of three nominal genera, *Ophidion*, *Otophidium* and *Lepophidium*, suggests that body shape, development of the caudal fin and pigmentation can provide useful taxonomic characters (Gordon, 1982). The body shape and development of *Lepophidium* larvae may represent the primitive state for the subfamily. *Otophidium omostigmum* and most *Ophidion* species retain this morphology, as does *Parophidion* (Fig. 159F; Padoa, 1956j). The morphology and development of *O. selenops* and *O. no-comis*, however, differ markedly from that of other ophidiine larvae. The possession of an elongate larva is a derived character uniting these two species.

Robins and Böhlke (1959) recognized the close relationship between *O. selenops* and *O. no-comis* based upon the shared possession of a well-developed rostral spine, similar to that found in *Lepophidium*, and the tendency for the dorsal fin to originate relatively far back on the body. The larvae of *Chilara taylori* are slightly more elongate than typical ophidiine larvae, but bear no close similarity to the larvae of *O. selenops*.

A character shared by all *Lepophidium* larvae examined by Gordon (1982) is the presence of an elongate cartilaginous epural which ossifies by 15 mm SL. All larvae of the tribe Ophidiini develop a short cartilaginous epural by 10 mm, but the epural never ossifies and is not visible by 15 mm SL. The presence of an epural in the caudal skeleton of the adults is presumably the primitive character state for the subfamily.

The shared pigmentation pattern of *Lepophidium* larvae unites these species. This character may not extend throughout the tribe, however. Brownell (1979) illustrates a *Genypterus* larva (day eight) that has a pigmentation pattern similar to that of *Lepophidium*. Other stages resembled *Ophidion*, however, with stellate melanophores scattered laterally on the body. The possession of similarly pigmented larvae by closely related species in *Ophidion* argues for the validity of pigmentation as a character to show phyletic relationships. The larval pigmentation of *O. selenops* and *O. no-comis* shows only slight differences as does larval pigmentation of *O. welshi* and *O. marginatum*. If the proposed identities of *Ophidion* Type 1 and Type 2 and *Lepophidium* Type 1 are correct (Gordon, 1982), then species which these types represent are presumably closely related.

Adult carapids are morphologically conservative and present some difficulty in identification and elucidation of phylogenetic relationships. Larvae, on the other hand, are reasonably well-known for all genera, fall into fairly distinct morphological groups and provide morphological diversity which is potentially useful in understanding intra-familial relationships (Olney and Markle, 1979; Markle and Olney, 1980). Robins and Nielsen (1970) and Cohen and Nielsen (1978) recognized a single family, Carapidae, consisting of two subfamilies: the Pyramodontinae with two genera, *Pyramodon* and *Snyderidia*; and the Carapinae with four genera, *Carapus*, *Echiodon*, *Encheliophis* and *Onuxodon*. However, Gosline (1960b) and Trott (1981) considered the Pyramodontidae a separate family while Arnold (1956) ignored this

group in his revision of carapids. Williams (1984) in his synopsis considered it as a subfamily. The common possession of a vexillifer larva is the most convincing evidence that the genera of Carapidae are monophyletic, thus we recognize one family.

The genera *Pyramodon* and *Snyderidia* were considered closely related by Robins and Nielsen (1970), and Markle and Olney (1981), on the basis of osteological and larval characters, added further support to this presumed relationship. It now appears that many of the character states of these genera are primitive. The pelvic fins, lost in all other carapids, are obviously a primitive state since they are widely present in all other ophidiiforms. Similarly, the dorsal origin is over or in advance of the anal fin in all non-carapid ophidiiforms as well as in *Pyramodon* and *Snyderidia*. The posterior placements of the first dorsal fin ray or vexillum can therefore be considered advanced states. Thus, the anterior placement of the vexillum relative to first anal ray (a primitive state) in combination with a posteriorly placed first dorsal fin ray (advanced state) appears to define larvae of *Carapus* (Fig. 162) and presumably *Encheliophis*. The genera possess further derived states such as adult inquiline behavior and parasitism (Trott, 1970). In addition, the tenuis stage, unknown in *Pyramodon* and *Snyderidia*, may represent an advanced state, namely retaining larval characters in the early benthic stage.

Larvae of the genus *Echiodon* display a wide variety of morphology especially in gut configuration, vexillum and first dorsal fin ray position and dorsal pterygiophores (Fig. 161; Maul, 1976; Olney and Markle, 1979; Markle et al., 1983). Williams and Shipp (1982) consider *Echiodon* to be composed of two species complexes and the gross morphology of larvae seems to support this contention. In addition, the peculiar gut configuration of *E. rendahli* (Fig. 161B, Robertson 1975b) represents another extreme in morphological variability which suggests the genus (as presently known) is polyphyletic.

Inter-ordinal relationships.—Based upon anatomical similarities shared with the cods, the ophidiiform fishes have been treated as a suborder within Gadiformes (Greenwood et al., 1966; Rosen and Patterson, 1969). These similarities include the development of the levator maxillae superioris and the structure of the caudal skeleton. Freihofer (1963, 1970) presented further evidence for this relationship based upon the pattern of the ramus lateralis accessorius nerve. Alternatively, these similarities may be the result of convergence due to the requirements of bottom feeding behavior (Gosline, 1968; Fraser 1972b; Marshall and Cohen, 1973). Similarities to the perciform fishes in osteology (Gosline, 1968; Regan, 1912b) and biochemistry (Shaklee and Whitt, 1981) point to a perciform origin of the group.

The structure and the development of the ophidiiform caudal skeleton support the hypothesis of a closer relationship to the

gadiform fishes than to the perciform fishes. In *Brotula*, as in gadiforms, two separate ural centra support hypurals. In the Ophidiinae, a single urostyle, which develops from a single cartilaginous structure in the larvae, supports two hypurals. This urostyle is apparently homologous to the two ural centra of *Brotula*. A vestigial neural arch develops on the urostyle, as on the first ural centrum of *Brotula*. Also, the last neural and haemal spines in both *Brotula* and the Ophidiinae are modified. These spines support caudal rays in *Brotula* and share in the support of the last dorsal and anal rays in the Ophidiinae. In the gadiform caudal skeleton, similarly modified spines on the first preural centrum support caudal rays. In both gadiform fishes (Markle, 1982) and ophidiine fishes these spines remain cartilaginous on the distal articular surface.

The ophidiine caudal skeleton differs from perciform skeletons in the development of the hypural elements and last two haemal arches. In ophidiine larvae, only two cartilaginous hypural elements form, whereas five or more hypural elements are typically present in the skeleton of larval perciforms. The last two haemal arches in perciform fishes remain autogenous; these arches fuse to the corresponding centra in the Ophidiinae.

Ophidiiform larvae share other developmental features with gadiform larvae. Larvae of both orders develop coiled guts (except for aphyonid larvae) and larvae of Carapidae and Macrouridae have high vertebral numbers resulting in elongate larvae with reduced or absent caudal fins. Another similarity apparent in the orders is the presence, in larvae of some species, of modified anterior dorsal rays. In Ophidiiformes, this character is present in larval Carapidae. In Gadiformes, somewhat similar structures appear in larvae of *Bregmaceros*, *Enchelyopus* and *Muraenolepis* although comparative studies of the gross and micro-structure of these larval specializations are lacking (Govoni et al., 1984).

Cohen and Nielsen (1978) consider ophidiiform fishes to be too poorly known to resolve questions of phylogeny. Our assessment based on larval data is similar. Further comparative studies focusing on the developmental osteology of such structures as the caudal fin, anterior vertebral column and pectoral girdle, as well as the development of the gut, will allow meaningful interpretation of the significance of these structures to phyletic studies.

(D.J.G.) ROSENSTIEL SCHOOL OF MARINE AND ATMOSPHERIC SCIENCE, UNIVERSITY OF MIAMI, 4600 RICKENBACKER CAUSEWAY, MIAMI, FLORIDA 33149; (D.F.M.) THE HUNTSMAN MARINE LABORATORY, ST. ANDREWS, NEW BRUNSWICK E0G 2X0, CANADA; (J.E.O.) VIRGINIA INSTITUTE OF MARINE SCIENCE, COLLEGE OF WILLIAM AND MARY, GLOUCESTER POINT, VIRGINIA 23062.

Lophiiformes: Development and Relationships

T. W. PIETSCH

THE order Lophiiformes is an assemblage of 18 families, 63 genera, and approximately 282 living species of marine teleosts, the monophyletic origin of which seems certain based on the following synapomorphic features: (1) Spinous dorsal fin primitively of six spines, the anteriormost three of which are cephalic in position and modified to serve as a luring apparatus [involving numerous associated specializations, e.g., a medial depression of the anterior portion of the cranium, loss of the nasal bones (nasal of Rosen and Patterson, 1969 = lateral ethmoid) and supraoccipital lateral-line commissure, and modifications of associated musculature and innervation]; (2) Epitotics separated from parietals and meeting on the midline posterior to the supraoccipital; (3) Gill opening restricted to a small, elongate tubelike opening situated immediately dorsal to, posterior to, or ventral to (rarely partly anterior to) pectoral-fin base; (4) Second ural centrum fused with the first ural and first preural centra to form a single hypural plate (sometimes deeply notched posteriorly) that emanates from a single, complex half-centrum (Rosen and Patterson, 1969:441, text figs. 4E, 60); (5) Pectoral radials narrow and elongate, the ventral-most radial considerably expanded distally; and (6) Eggs spawned in a double, scroll-shaped mucous sheath (Rasquin, 1958).

Within the order there are currently recognized three suborders: the Lophioidei, containing a single family and 25 species of relatively shallow-water, dorso-ventrally flattened forms (Caruso, 1981, 1983; Caruso and Bullis, 1976); the Antennarioidei, with six families and approximately 121 species, nearly all laterally-compressed, shallow-water, benthic forms (Bradbury, 1967; Pietsch, 1981, 1984; Pietsch and Grobecker, in press); and the Ceratioidei, containing about 136, typically globose, meso- and bathypelagic species (Bertelsen, 1951; see also Bertelsen, this volume).

DEVELOPMENT

Little is known about the early life stages of lophiiform fishes, unequal information being available for only the Lophiidae, Antennariidae and most ceratioid families. Eggs are well-known in lophiids (Fulton, 1898; Bowman, 1920; Bigelow and Welsh, 1925) and antennariids (Mosher, 1954; Rasquin, 1958) but unknown in all other lophiiforms. Larvae are adequately described in lophiids (Bowman, 1920; Martin and Drewry, 1978), antennariids (Mosher, 1954; Rasquin, 1958) and most ceratioids (Bertelsen, 1951), but remain undescribed in chaunacids and ogcocephalids despite some available material.

Probably the most striking characteristic of early ontogeny in lophiiforms is the fact that eggs are spawned embedded in a continuous, ribbon-like sheath of gelatinous mucous, often referred to as an "egg-raft" or "veil" (with one known exception, see Pietsch and Grobecker, 1980). Within this mucous veil are found thousands of roughly-hexagonal, liquid-filled chambers arranged in one to several irregular layers, each chamber containing from one to three eggs (see Rasquin, 1958 for further details and figures of the structure of egg rafts). Development is fairly direct, with the larvae in all known groups gradually acquiring adult characters over a size range of approximately 5

mm total length (TL) in antennariids to 65 or 70 mm TL in lophiids. Specialized ontogenetic stages are absent except for the peculiar "scutatus" prejuvenile present in the ontogeny of *Antennarius radiosus* (see below).

Lophiidae

Of the 25 species and four genera of the Lophiidae (Caruso, 1981), early life stages have been described for only three species, all of the genus *Lophius*: *L. americanus* (Martin and Drewry, 1978, and numerous references cited therein), *L. piscatorius* (Tåning, 1923) and *L. budegassa* (Padoa, 1956e). Of these, early ontogeny is best documented in *L. americanus*, a spring or summer spawner, whose egg rafts measure 0.15–1.5 m wide and 6–12 m long. Living eggs are slightly oval, their major axis measuring 1.61–1.94 mm. The outer shell appears smooth and transparent, the yolk homogeneous and amber in coloration. The perivitelline space is narrow. A single, copper, orange or pinkish-colored oil globule is present, having a diameter of approximately 0.40–0.45 mm. Yolk-sac larvae measure 2.5–4.9 mm TL. The larvae, ranging in size from 6.5 to approximately 10.5 mm TL, are prominently pigmented, with early-forming dorsal rays and pectoral and pelvic fins (Fig. 164A). Relative to antennariid larvae, the head is small, somewhat less than 30% of standard length. The gut is unusually short. The dorsal and pelvic rays are unusually elongate. The soft-dorsal and anal fins are last to form. The pectoral fin is typically large and fan-shaped. Fin ray counts are complete by approximately 12 mm TL. Transformation to the prejuvenile stage takes place at a size somewhat greater than approximately 12 mm TL; the juvenile stage is not reached until at least 65 mm TL. In well preserved specimens of some species (i.e., *Lophiodes spilurus*; SIO 59-324, 65.5 mm TL) the epidermal layer of the head and body is greatly distended by transparent, gelatinous connective tissue, giving the larvae an inflated or balloon-like appearance (as described for ceratioid larvae by Bertelsen, 1951:12; see also Bertelsen, this volume). (Largely taken from Martin and Drewry, 1978: 359–366, where the reader will find a full series of figures and more detailed description of early ontogeny.)

Although the significance of variation in larval pigmentation in lophiids is largely unknown, larvae of the American species, *Lophius americanus* Valenciennes, are more easily distinguished from those of the European *L. piscatorius* Linnaeus than are the adults, using characteristic differences in pigmentation (Tåning, 1923; Martin and Drewry, 1978). Tåning (1923), after studying early developmental stages, considered the two species to be distinct at a time when many authors regarded them as synonyms (Martin and Drewry, 1978).

Meristic characters that typify early life stages of lophiids are compared with those of other lophiiforms in Table 88.

Antennariidae

The family Antennariidae consists of 41 species distributed among 12 genera (a modification of Schultz, 1957; Pietsch, 1981, 1984; Pietsch and Grobecker, in press). Of these, early life stages

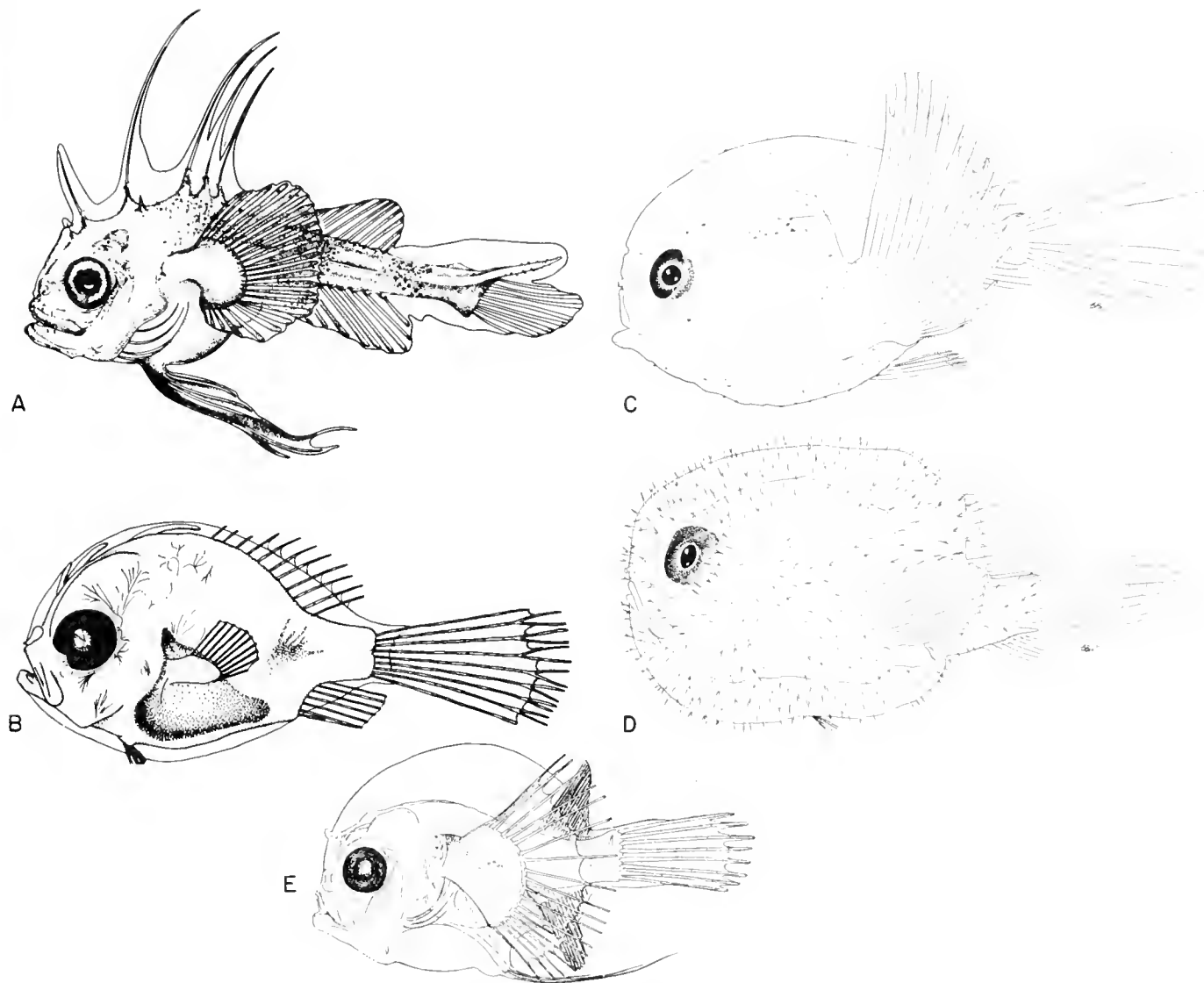

Fig. 164. Representative larvae of lophiiform fishes: (A) *Lophius americanus*, 12 mm TL, taken from Martin and Drewry, 1978:364, fig. 191B; (B) *Histrio histrio*, 5.3 mm TL, taken from Adams, 1960:64, fig. 1B; (C) *Chaunax* sp., 9.8 mm TL, ZMUC P922155, Gulf of Mexico, 22°06'N, 84°58'W; (D) *Ogcocephalus* sp., 10.4 mm TL, SHL D-66-12, P-4, Western North Atlantic, 34°17'N, 76°23.5'W; (E) *Caulophryne jordani*, 9.5 mm TL, ZMUC P92198, taken from Bertelsen, 1951:35, fig. 11B.

have been described in *Antennarius striatus* (*Phrynelox scaber* and *P. nuttingi* of Rasquin, 1958, and *P. scaber* of Martin and Drewry, 1978) and *Histrio histrio* (Martin and Drewry, 1978 and numerous references cited therein), with only brief descriptions of the "scutatus" prejuvenile stage of *A. radiosus* (see below). Of these, *H. histrio* is by far the best known. Spawning occurs year-round except in February and March. Freshly spawned egg rafts measure approximately 25–50 mm wide and 90 mm long. Eggs are initially oval in shape (their major axis measuring 0.62–0.65 mm), but become spherical at the time of the second cleavage. Ova are extremely transparent (Mosher, 1954) and colorless, without oil globules. As development proceeds, the raft unrolls, expanding to a length of 90 cm (Smith, 1907). The membranes remain firm until about the 6–11 myomere stage, but then begin to deteriorate, the raft softening and

expanding to about three times its original dimensions, and finally beginning to sink. Yolk-sac larvae measure 0.88–1.7 mm TL. The larvae, most strikingly characterized by their large head (greater than 45% standard length), range in size from approximately 1.6–7.2 mm TL (Fig. 164B). Pigmentation is conspicuous about the head and midgut. The base of the pelvic fin elongates at about 12 mm TL, at which time the pigmentation of the midgut begins to fade. The sequence of fin formation is as follows: caudal, anal, soft-dorsal, pelvic, pectoral, the dorsal spines being the last to form at approximately 13 mm TL. Prejuveniles range in size from approximately 7.3–20 mm TL. (Taken from Martin and Drewry, 1978:372–384, where the reader will find a full series of figures, and a more detailed description of the early development of *H. histrio*, as well as that of *A. striatus*.)

TABLE 88. MERISTIC VALUES FOR MAJOR TAXA OF THE LOPHIIFORMES.

Character	Lophidae	Antennariidae	Chaunacidae	Ogcocephalidae	Ceratioidei
Dorsal fin	II-III + 0-III + 8-12	III + 10-16	III + 10-12 ¹	II + 1-6 ²	II + 3-22 ²
Anal fin	6-10	6-10	6-7	3-4	3-19
Caudal fin	8	9	8	9	8-10
Pectoral fin	13-28	6-14	11-14	10-15	12-30
Pelvic fin	1 + 5	1 + 5	1 + 4	1 + 5	3-4 ³
Branchiostegal rays	2 + 4	2 + 4	2 + 4	2 + 4	1 + 4, 2 + 4
Vertebrae	19-31	18-23	19	18-21	18-24

¹ Second and third spine embedded beneath skin of head.

² Second spine reduced to a tiny remnant and embedded beneath skin of head.

³ Present only in larvae of the ceratioid family Caulophrynidae.

Meristic characters that typify early life stages of antennariids are compared with those of other lophiiforms in Table 88.

The so-called "scutatus" prejuvenile form, originally described as a new genus and species, *Kanazawaichthys scutatus*, by Schultz (1957), but later found by Hubbs (1958) to be the prejuvenile of *Antennarius radiosus*, remains unique (Fig. 165). The primary morphological features that characterize these early life stages are so drastic (a pair of shield-like, bony extensions of the cranium that reach posteriorly beyond the level of the opercular bones, and an expansion of the anterior margin of the bones of the suspensorium; see Schultz 1957:63, plate 14, fig. A, and Hubbs, 1958) that their appearance in other antennariids of similar sizes, particularly among closely related species (such as *A. ocellatus* and *A. avalonis*), is to be expected. Yet, despite the fact that numerous other species are represented by small specimens, no comparable morphological adaptations have been discovered.

Chaunacidae

The family Chaunacidae contains a single genus and as many as 12 species (J. H. Caruso, pers. comm., 8 June 1983). Aside from the fact that larvae and "young specimens" are often caught bathypelagically (Mead et al., 1964), nothing has been published on their early life stages, despite some available material. The ovaries of members of this family are scrolled like those of other lophiiforms, suggesting the production of epipelagic egg rafts, although neither eggs nor rafts have been reported.

The material of *Chaunax* available to me, 32 specimens in 25 lots (all part of the DANA collections of the Zoological Museum, University of Copenhagen), measured 4.3-10.6 mm TL. Even the smallest of these appear to have reached a prejuvenile stage, with all fin rays formed (including the illicium), and the skin everywhere covered with close-set dermal spinules (Fig. 164C). Pigmentation appears to be absent. In well preserved specimens, the epidermal layer of the head and body is greatly distended by transparent, gelatinous connective tissue. As in antennariids, the head is large, considerably greater than 50% of SL in all specimens examined.

Meristic characters that typify the early life stages of chaunacids are summarized and compared to those of other lophiiforms in Table 88.

Ogcocephalidae

The Ogcocephalidae contains nine genera and approximately 60 species (Bradbury, 1967). Like chaunacids, practically nothing is known about their early life stages. The only published information, aside from a report of the capture of a single, 17.5

mm TL specimen of *Ogcocephalus* sp. by Clark et al. (1969), is a comment by Mead et al. (1964) that larval and postlarval specimens have been caught epipelagically. The scrolled ovaries of members of this family may indicate that egg rafts are produced, but neither eggs nor rafts have been reported.

The larval ogcocephalid material available to me (29 specimens in nine lots, kindly provided by Michael P. Fahay of the Northeast Fisheries Center, Sandy Hook Laboratory, and tentatively identified as *Ogcocephalus* sp.) measured 3.1-18.4 mm TL. In the smallest of these, all fins are fully developed, except for the illicium; a tiny rudiment of this structure is just barely visible in a 4.9 mm TL specimen, but relatively conspicuous in a 5.1 mm TL specimen (the transition to a prejuvenile stage is thus taken to occur at approximately 5.0 mm TL). By a length of 8.6 mm TL the pectoral fins are large and fan-like, the base of the pelvic fin has become elongate, and small, scattered melanophores are present on top of the head, nape of the neck, on the cheek just behind the eye, the pectoral fin base and blade, and on the caudal peduncle (Fig. 164D). At 8.9 mm TL the pigmentation is well developed, and the paired fins are disproportionately large. At 12.4 mm TL dermal spinules are beginning to form in the skin; a lateral, longitudinal cluster of dermal spinules, which will later form the ridge-like, outermost margin of the adult, is just beginning to develop. By 18.4 mm TL the skin is everywhere covered with broad-based dermal spinules, and the lateral ridge is well-developed. At all stages of development, but particularly the prejuvenile stage, the skin is highly inflated, giving the larvae an almost spherical shape. At all stages the head is disproportionately large, considerably greater than 50% of standard length.

Meristic characters that typify the early life stages of ogcocephalids are summarized and compared to those of other lophiiforms in Table 88.

Ceratioid Families

The Ceratioidei contains 11 families, 34 genera and approximately 136 species. Isolated eggs of ceratioids are unknown; ovarian eggs, described in only a few species, are slightly oval, the major axis of the largest of these measuring 0.50-0.75 mm. The larval stages of all of the families and most of the genera have been described (Bertelsen, 1951). Generally speaking, ceratioid larvae are typically small. According to Bertelsen (1951), the smallest known larvae measure 2.0-3.0 mm TL, whereas the largest larvae and smallest metamorphosis stage range from 12-25 mm TL for females, and 10-22 mm TL for males. As in antennariid, chaunacid and ogcocephalid larvae, the head is disproportionately large; as in some lophiids, chaunacids and ogcocephalids, the head and body are enveloped by transparent,

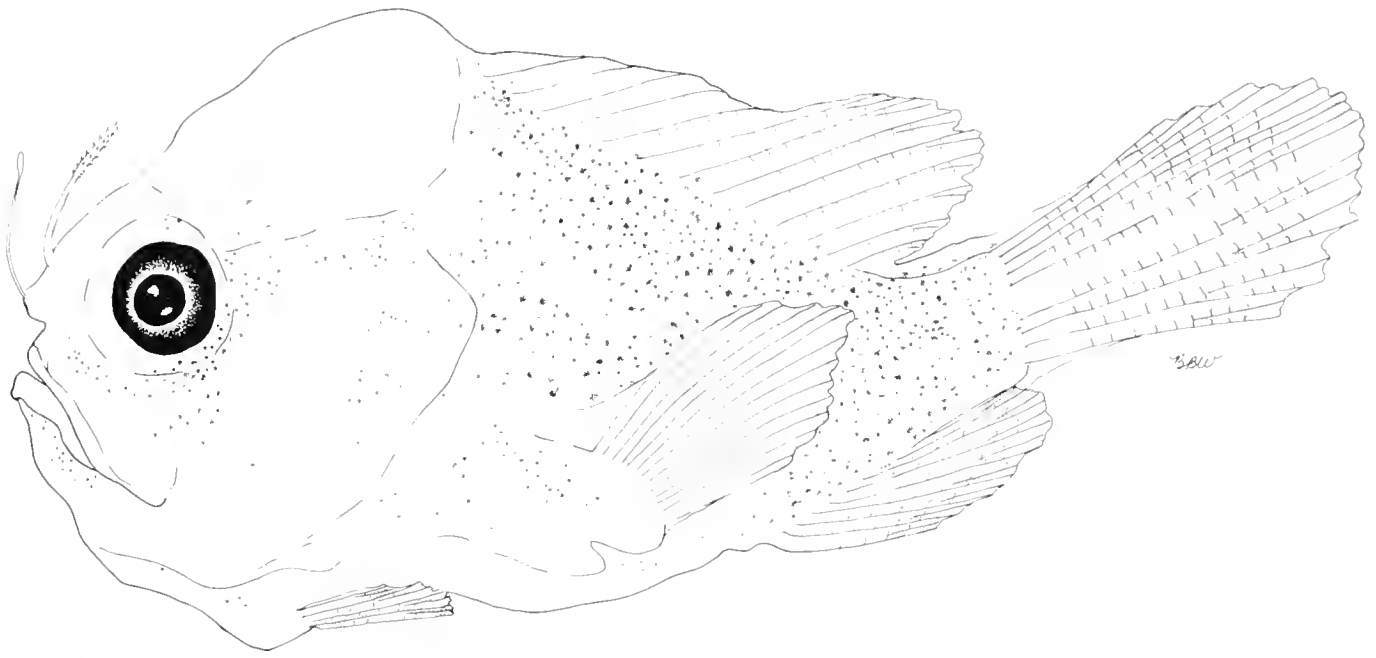

Fig. 165. "Scutatus" prejuvenile of *Antennarius radiosus*, 21.2 mm TL, USNM 251937-F21, North Atlantic, 36°30'N, 74°30'W; drawn by B. Washington.

highly-inflated skin (Fig. 164E; for details see Bertelsen, 1951; Bertelsen, this volume).

Meristic characters that typify the early life stages of ceratioidei are summarized for all eleven families and compared to those of other lophiiforms in Table 88.

Relationships

Since Regan (1912a), three major lophiiform taxa of equal rank have been recognized by nearly all authors. These taxa, together with their currently recognized families (the eleven families of the bathypelagic Ceratioidei excluded; see Bertelsen, this volume), are: Suborder Lophioidei—Family Lophiidae; Suborder Antennarioidei—Families Antennariidae, Tetrabrachiidae, Lophichthyidae, Brachionichthyidae, Chaunacidae, and Ogcocephalidae; Suborder Ceratioidei.

On the basis of adult characters alone, Pietsch (1981:416, fig. 41) attempted to test the validity of Regan's (1912a) three major lophiiform taxa using cladistic methodology, but ran into serious difficulty in attempting to establish monophyly for the Antennarioidei; while a number of synapomorphic features were found to support a sister-group relationship between the four families Antennariidae through Brachionichthyidae, and between the families Chaunacidae and Ogcocephalidae, no convincing synapomorphy was found to link these two larger subgroups.

To date, early life history stages have not been used in formulating hypotheses of relationship among lophiiform fishes; but, several egg and larval characters are shown here to be significant in resolving a number of problems with this group. These characters, along with several previously unidentified adult characters, have been used here to construct a revised cladogram of lophiiform relationships (Fig. 166).

This new cladogram differs significantly from that previously published (Pietsch, 1981: fig. 41). The suborder Antennarioidei

is now restricted to only four families: The Antennariidae, recognized as the primitive sister-group of the Tetrabrachiidae, these two families together forming the primitive sister-group of the Lophichthyidae, and this assemblage of three families forming the primitive sister-group of the Brachionichthyidae. These relationships are supported by a total of seven synapomorphies (most of which were previously described by Pietsch, 1981:413–414) numbered 7 through 13 in Fig. 166: (7) Posteromedial process of vomer emerging from ventral surface as a laterally-compressed, keel-like structure, its ventral margin (as seen in lateral view) strongly convex (Pietsch, 1981:397, figs. 4–6); (8) Postmaxillary process of premaxilla spatulate (Pietsch, 1981:398, figs. 8, 20); (9) Opercle similarly reduced in size (Pietsch, 1981:401, figs. 9, 21); (10) Ectopterygoid triradiate, a dorsal process overlapping the medial surface of the metapterygoid (Pietsch, 1981:400, figs. 9, 21, 22); (11) Proximal end of hypobranchials II and III bifurcated (Pietsch, 1981:407, figs. 11, 28, 29); (12) Interhyal with a medial, posterolaterally directed process that comes into contact with the respective proopercle (Pietsch, 1981:400, fig. 26); and (13) Illicial pterygiophore and pterygiophore of the third dorsal spine with highly compressed, blade-like dorsal expansions (Pietsch, 1981:410, figs. 36, 37).

The present interpretation of lophiiform relationships differs further from any previously proposed hypothesis in considering the Antennarioidei (sensu stricto) to form the primitive sister-group of a much larger group that includes the Chaunacioidei (new suborder), the Ogcocephalioidei (new suborder) and the Ceratioidei. The Ogcocephalioidei is, in turn, recognized as the primitive sister-group of the Ceratioidei (Fig. 166).

Monophyly for a group containing the suborders Antennarioidei, Chaunacioidei, Ogcocephalioidei and Ceratioidei is supported by four, previously unidentified synapomorphies (numbered as they appear in Fig. 166): (14) Eggs and larvae small (at all stages eggs are considerably less than 50% the diameter of

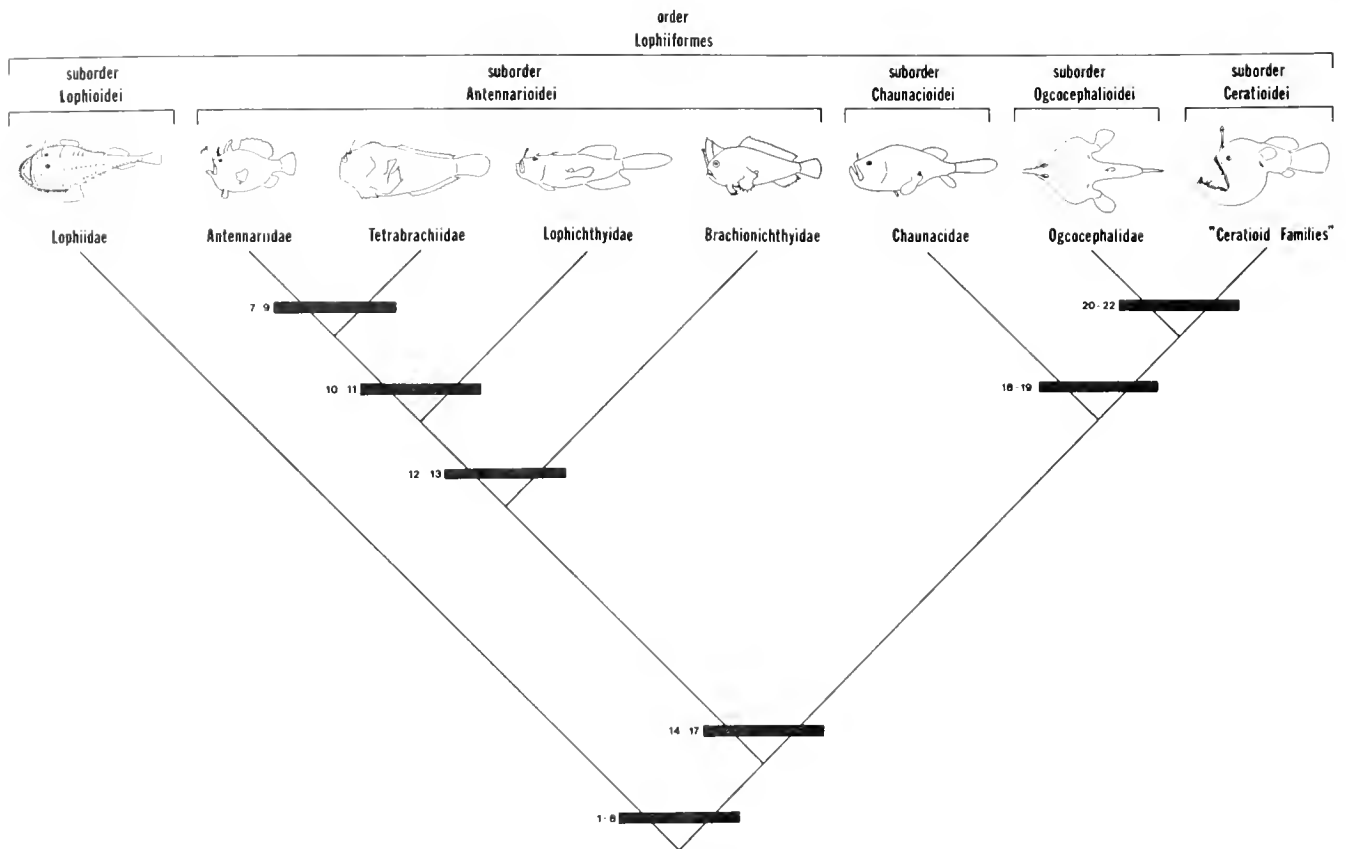

Fig. 166. Cladogram showing proposed phylogenetic relationships of the major subgroups of the Lophiiformes. Black bars and numbers refer to synapomorphic features discussed in the text.

those of lophioids; smallest larvae are certainly less than 50%, and probably less than 30% the size of those of lophioids; size at transformation to the prejuvenile stage is less than 60% that of lophioids); (15) Head of larvae proportionately large relative to body (always greater than 45% of standard length, compared to less than 30% in lophioids); (16) Reduction in the number of dorsal fin spines from a primitive number of six in lophioids to three or less (Pietsch, 1981:409, figs. 36–38); and (17) Loss of pharyngobranchial IV (present and well-toothed in lophioids; Pietsch, 1981:401, figs. 11, 28–32).

Monophyly for a group containing the suborders Chaunacioidei, Ogocephaloidei and Ceratioidei is supported by two synapomorphies: (18) Second dorsal spine reduced and embedded beneath skin of head (Pietsch, 1981:410, figs. 36–38); and (19) Gill filaments of gill arch I absent (but present on proximal end of ceratobranchial I of some ceratioids; Bradbury, 1967:408; Pietsch, 1981:415).

That the Ogocephaloidei is the primitive sister-group of all ceratioid families is supported by three synapomorphies: (20) Second dorsal spine reduced to a small remnant (well developed in the ceratioid family *Diceratiidae*, and in all other lophiiforms; Bertelsen, 1951:17; Pietsch, 1981:410, fig. 38); (21) Third dorsal spine and pterygiophore absent (present in all other lophiiforms; Bertelsen, 1951:17; Bradbury, 1967:401; Pietsch, 1981:410, fig. 38); and (22) Epibranchial I simple, without ligamentous connection to epibranchial II (in batrachoidiforms and all other lophiiforms epibranchial I bears a medial process that is liga-

mentously attached to the proximal tip of epibranchial II; Pietsch, 1981:401, figs. 28–32).

Of the possible cladograms that could be constructed on the basis of the data provided in this study, the one shown in Fig. 166 is by far the most parsimonious. But at the same time, acceptance of this revised hypothesis of relationships of lophiiform fishes requires evolutionary convergence or reversal in three derived character states previously used by me (Pietsch, 1981:415, fig. 41) to support a hypothesis of sister-group relationship between the Chaunacidae and Ogocephalidae: (1) Posteriormost branchiostegal ray exceptionally large (all four posteriormost branchiostegal rays approximately equal in size in batrachoidiforms and all other lophiiforms; Pietsch, 1981, fig. 27); (2) Gill teeth tiny, arranged in a tight cluster at apex of pedicel-like tooth plates (in all other lophiiforms gill teeth, if present, are relatively large, and either single, or associated with a flat, rounded tooth plate; but tiny, and at apex of elongate pedicel-like tooth plates in at least some batrachoidiforms, e.g., *Porichthys*; Pietsch, 1981, figs. 31, 32) and (3) Illicial bone, when retracted, lying within an illicial cavity (an illicial cavity is absent in all other lophiiforms; however, the illicium and esca lie within a shallow groove on the dorsal midline, sometimes enveloped by folds of skin, in the antennariid genus *Histiophryne*; Pietsch, 1981, fig. 39; Pietsch, 1984:40).

The cladistic relationships of the Lophiiformes are summarized in the following revised classification. While the ranking of taxa is not dichotomous (see methods in Pietsch, 1981:388),

inter-nested sets of vertical lines are used to indicate monophyletic units.

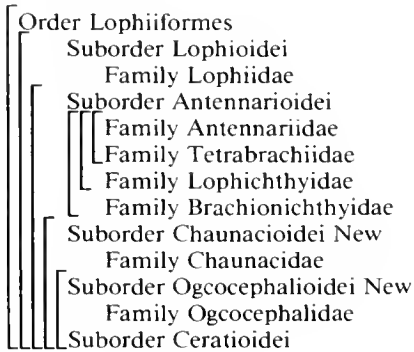

As a final note, the Lophiiformes has traditionally been allied with the Batrachoidiformes, based primarily on osteological characters of the cranium (Regan, 1912a; Gregory, 1933; Rosen and Patterson, 1969). However, this sister-group relationship has yet to be shown conclusively, and I have not been able to assess the significance of early life stages in supporting or refuting this hypothesis.

SCHOOL OF FISHERIES WH-10, COLLEGE OF OCEAN AND FISHERIES SCIENCES, UNIVERSITY OF WASHINGTON, SEATTLE, WASHINGTON 98195.

Ceratioidei: Development and Relationships

E. BERTELSEN

THE Ceratioidei differ most distinctly from all other members of the order Lophiiformes in being meso- and bathypelagic, lacking pelvic fins (except in larval Caulophryniidae) and in having extreme sexual dimorphism. Males are dwarfed and differ from females in lacking an external illicium and having denticular teeth on the tips of the jaws and well-developed eyes and/or olfactory organs. Furthermore, Ceratioidei differ from other Lophiiformes, except the family Ogcocephalidae, in lacking a third cephalic ray and its pterygiophore, and except in the families Caulophryniidae, Neoceratiidae and the gigantactinid genus *Rhynchactis*, females of the suborder differ from all other Lophiiformes in having a bulbous swelling of the tip of the illicium (escal bulb) containing a large globular photophore.

The suborder contains approximately 134 species placed in 34 genera and 11 families (Table 89). The taxonomy is based mainly on studies of the females. Except for the larval stages and the basic meristic and osteological characters shared by the two sexes, descriptions require separate treatment of females and males.

The separation into families is based mainly on osteological characters, of which some of the more important are compared in Table 89. Most of the families form well-defined and mutually very distinct taxa in which the females (especially) possess unique morphological features which separate them from members of all other families.

The separation into genera is based mainly on characters present only in females. Somewhat varying between families, some of the most important of these characters are differences in: (1) shape of skull and other bones of the head including development of its spines; (2) jaw mechanisms, including dentition; (3) illicial apparatus, including basic patterns of escal appendages; and (4) pigmentation of skin and development of dermal spines. Some of the distinguishing osteological characters, especially in shape of opercular bones, are shared with the

males, like the fin ray numbers which in some families show distinct intergeneric differences. The special male structures, such as denticular teeth, show distinct intrageneric differences in full agreement with the separations based on characters of the females.

The species of *Linophryne* have been grouped into subgenera and those of *Himantolophus* (in ms.), *Oneirodes*, and *Gigantactis* into "species-groups" based on shared minor differences in one or more of the characters mentioned above. All intrageneric separations of the females into species are based on differences in pattern and shape of escal appendages, often combined with differences in illicial lengths. In a majority of the recognized species, no other separating characters have been shown. In others, differences in meristic characters (numbers of fin rays and teeth) and minor osteological characters (shape of opercular bones, development and dentition of branchial arches, etc.) have been observed supporting the separation into species. A special opportunity to check the validity of the separations based on escal characters is found in the genus *Linophryne*, in which females have hyoid barbels which in pattern of branching show very distinct differences between species and subgenera (Bertelsen, 1982).

In most cases it has not been possible to separate males into taxa below the level of genera and subgenera. A few males differing from their supposed congeners in special male characters (especially denticular teeth) have been tentatively described as representatives of separate species. Studies of males attached to identified females have not revealed characters of specific order.

DEVELOPMENT

No spawned, fertilized eggs of Ceratioidei have been described (re-examination by Bertelsen, 1980:66, of an egg referred to *Linophryne arborifera* by Beebe, 1932:93, indicated that it represents a diodontid).

TABLE 89. CHARACTERISTICS OF CERATIOIDEI.

X: presumed derived characters O: presumed primitive characters		Caul- ophryni- dae	Neo- cerati- idae	Melano- cetidae	Himantol- ophidae	Dicerati- idae	Oneroi- didae	Thauma- tichthy- idae	Centro- phryni- dae	Cerati- idae	Gigantac- tinidae	Lin- ophryni- idae
Families (11):												
No. of genera (34):		2	1	1	1	2	15	2	1	2	2	5
No. of species (ca. 134):		4	1	4	ca. 15	4	52	6	1	3	19	25
No. Characters shared by sexes:												
1	Dorsal finrays	6-22	11-13	12-17	5-6	5-7	4-8	5-7	6-7	4	3-9	3
2	Anal finrays	5-19	10-13	4	4	4	4-7	4-5	5-6	4	3-7	3
3	Caudal finrays	8	9-10	9	9	9	9	9	9	8-8½	8½	8½
4	Branchiostegal rays	5-6	5-6	6	6	6	6	6	6	6	6	5
5	Pectoral radials	2	3	4	3	3	3	3	4	4	5	3
6	Shape of pelvic bones	X1	X1	O	O	O	O-X1	O	X1	X1	X1-2	X2
7	Head of hyomandibular	O	X	O	O	O	O-X	O	O	O	X	X
8	Parietals	O	O	O	X	O	O	O	O	O	O-X	O
9	Pterosphenoïd	X	O	O	O	O	O-X	O	O	X	X	X
10	Epural	O	X	X	X	X	X	X	X	X	X	O-X
Female characters:												
11	Escal photophore	O	O	X	X	X	X	X	X	X	O-X	X
12	Photophore on 2 nd cephalic ray	O	O	O	O	X	O	O	O	X	O	O
13	Separation of frontals	O	O	X	X	X	X	X	X	O	X	O-X
14	Shape of frontals	O	O	O	O	O	X	X	X	X	X1	X
15	Maxillaries	X1	X1	O	O	O	O	O	O	O	X2	X1-2
16	Maxillomandibular ligament	X	X	O	O	O	O	X	O	O	X	X
17	Branchial teeth	X	X	X	O	X	O-X	X	O	X	X	O-X
18	Quadrate and Articular spine	O	O	O	O	O	O-X	X	O	O	O	O
19	Dermal spines	X	X	O	O	O	O-X	O-X	O	O	O	X
20	Shape of body	O	X	O	O	O	O	X	X	X	X	O
Male characters:												
21	Eyes	O	X1	O	O	O	O	O	X1	X3	X1	X2
22	Olfactory organs	X	O	X	X	X	X	X	X	O	X	X
23	Anterior nostrils	X	O	O	O	O	X	X	X	O	X	X
24	Upper denticular teeth	O	O	X	X	X	X	X	X	X	X	X
25	Dermal spines	X	X	O	O	O	X	O	X	O	O-X	X
26	Parasitic males observed	X	X	O	O	O	X	O	O	X	O	X
Larval characters:												
27	Illicial rudiment	O	O	X	X	X	X	X	X	X	X	X
28	Pelvic fins	O	X	X	X	X	X	X	X	X	X	X
29	Pectoral fins	O	X	X	X	X	X	X	X	X	O	X
30	Shape of body	O	X2	O	O	O	O-X1	O	O	X3	O	X1

(1-2) High numbers of dorsal and anal fin rays possibly a primitive character state; (3) Nine rays presumed primitive, 8½: 9th ray reduced to less than half length of the 8th, (4) Six rays presumed primitive; (5) Three radials, shared with antennarioids, here presumed to be primitive; however, the trend to reduce the number from 4 to 3 in older specimens of centrophryniids and melanocetids might indicate that within ceratioidei four radials are primitive and three a result of secondary reduction, (6) Distally expanded pelvic bones (triradiate in *Himantolophus* and some specimens of the oneroïd genus *Chaenophryne*), presumed primitive; X1: a simple rod, X2: absent, (7) Double head of hyomandibular presumed primitive; X: single head (in oneroïdids in only one of the 15 genera), (8) Parietals absent in all himantolophids, lost in metamorphosed females of the gigantactinid genus *Rhynchactis*; (9) Presence of pterosphenoïd presumed primitive (absent in one of the oneroïd genera), (10) A single epural observed in *Caulophryne* and in the linophrynid genus *Photocorynus*; (11) The absence of escal photophore presumed primitive in *Caulophryniidae*, and possibly in *Neoceratias* while the absence in the gigantactinid genus *Rhynchactis* is presumed to be due to a secondary specialization (cf. text); (12) While the presence of a photophore on 2nd cephalic ray is a derived character state, the presence of this ray may be regarded as primitive; (13) Frontals meeting in the midline presumed primitive (in linophryniids present in *Photocorynus*); (26) Parasitic males observed in *Neoceratias*, both genera of Ceratiidae, one of the two genera of Caulophryniidae, four of the five genera of Linophryniidae, and one of the 15 genera of Oneroididae; (27) Presence of an external illicial rudiment in larval males presumed primitive; (28) Presence of pelvic fins presumed primitive; (29) Enlarged pectoral fins here presumed primitive, and (30) Short, more or less spherical body presumed primitive; X1: moderately elongate; X2: slender; X3: hump-backed.

A cluster of eggs embedded in a mucoid substance hanging out of the greatly expanded genital opening of a sexually parasitized female of *Linophryne arborifera* was observed by Bertelsen (1980:66). This indicates that Ceratioidei expel their eggs in free-floating mucoid egg "rafts" or "veils," as described in species of the other suborders of Lophiiformes (Rasquin, 1958). It is possible that the release of the egg veil of the specimen was caused by the catch, and that the eggs were not completely mature. They were slightly oval, 0.6-0.8 mm in diameter, with smooth, very soft outer membranes that were folded or shrunken in several. The yolk, which contained numerous small oil globules, was opaque and partially surrounded by an irregular perivitelline space.

The observed number of ceratioidei females with apparently nearly mature ovaries is relatively small. In these, the largest eggs have diameters of 0.5-0.75 mm,

Larvae and/or metamorphic stages representing all 11 families and 26 of the 34 recognized genera have been described, the majority by Bertelsen (1951). Identification to species is restricted, however, to those genera, subgenera, or "species-groups" in which only a single species is recognized.

No specialized ontogenetic stage between larvae and juveniles occurs. In most genera, metamorphosis begins at a size of 8-10 mm SL, while in some (*Himantolophidae*, *Thaumatichthys*, *Gigantactinidae*, and *Linophryniidae*), the larvae may reach lengths of 15-25 mm. During metamorphosis, covering a size range somewhat varying between genera, adult characters are gradually acquired. In both sexes, the skin is gradually covered with pigment (except in *Haplophryne*), and in certain genera, skin spines are developed. In females the illicial and escal characters develop, the head and especially the jaws increase in relative size, the larval teeth are replaced, and the growth of eyes and

olfactory organs is retarded. In males the body elongates, larval teeth are lost, the denticular teeth develop, and eyes and/or olfactory organs increase in relative size.

The larvae have been referred to genera, subgenera or species-groups on basis of (1) meristic characters (especially number of dorsal and anal fin rays); (2) osteological characters (especially number of branchiostegal rays and pectoral radials and shape of head of hyandibular, pelvic bones and opercular bones); and (3) pattern of subdermal pigmentation. The pattern is retained under the pigmented skin of post-metamorphic juveniles which have acquired adult characters (Bertelsen, 1951). In most genera the smallest larvae observed are 2.5–3.5 mm. At these stages, in which no distinguishing characters other than pigmentation may be developed, identification is based on comparison with developmental series of older larvae.

Meristic characters.—The 2–3 mm smallest known larvae have an almost straight notochord and almost undifferentiated fins. The fin rays of the unpaired fins are laid down early and the full number is usually present in larvae of 3–4 mm SL of the numerous species where the number of dorsal rays does not exceed 8. The pectoral fin rays are laid down somewhat later than those of the unpaired fins, and the lowermost rays are rarely discernible in specimens of less than about 5–6 mm. Caulophrynidae and the ceratiid genus *Cryptopsaras* have 8 caudal fin rays, all others have 9 (10 in some specimens of *Neoceratias*). The 9th (lowermost) ray is rudimentary or short (less than half the length of the 8th ray) in Linophrynidae, Gigantactinidae, and *Ceratias*.

Except in the three genera in which the number of rays in the anal and/or dorsal fin exceeds 10 (*Caulophryne*, *Neoceratias*, and *Melanocetus*, cf. Table 89), the intraspecific variation of the number of fin rays in these fins is small, rarely more than ± 1 . Significant differences in numbers of dorsal and anal fin rays have been found between species within the genera *Caulophryne*, *Gigantactis*, and *Melanocetus* and between genera in the families Caulophrynidae, Gigantactinidae, and Oneirodidae.

Pectoral fin rays number 12–23 in all ceratioids (except *Ctenochirichthys* with 28–30). As an intraspecific range of variation of 5 to 7 fin rays has been observed, this character may aid identification only in exceptional cases.

All reported vertebral counts of Ceratioidei fall within the range of 19 to 24, the highest number in Neoceratiidae, the lowest in Linophrynidae. The limited number of observations does not permit an evaluation of the diagnostic value of differences within this range.

Morphology.—The head and body of larval Ceratioidei are surrounded by inflated transparent skin. Due to this balloon-like envelope, their shape varies from nearly spherical, with greatest width and depth of body reaching 80–90% SL, to elongated or pear-shaped, with body depth of 40–60% SL.

The inflation of the skin varies with preservation, but generally its greatest development is found in Caulophrynidae (Fig. 167A), Gigantactinidae (Fig. 168A, B), and Himantolophidae (Fig. 169A, B); less pronounced in Neoceratiidae (Fig. 167B), Ceratiidae (Fig. 168C–E) and Oneirodidae (Fig. 170). No distinct change has been observed in the relative development of the inflation during larval life. In larvae of most genera, the relative length of head, measured to base of pectoral peduncle, is about 50% SL. In Oneirodidae and Linophrynidae it is somewhat less (generally about 45%) and is shortest in *Neoceratias*

(35–40%). In the late larval stages of males, the elongation of the body may start before other metamorphic characters have appeared.

In larval Ceratiidae, the vertebral column is more strongly S-shaped than in other families, resulting in a characteristic hump-backed appearance of these larvae (Fig. 168C–E). The larvae of Caulophrynidae (Fig. 167A) and Gigantactinidae (Fig. 168A, B) differ distinctly from those of other Ceratioidei in the size of the pectoral fins, which have lengths of 40% to nearly 60% SL, measured from base of pectoral peduncle. In the other families, this length is generally 20–25% SL and does not exceed 30% SL.

Pigment.—The subdermal pigment occurring in larval Ceratioidei is usually separated into four more or less well-defined main groups: (1) peritoneal; (2) opercular; (3) dorsal; and (4) caudal-peduncular.

In *Neoceratias* (Fig. 167B) and some linophrynids (*Haplophryne*, Fig. 167D), the subgenera of *Linophryne*: *Stephanophryne* (Fig. 167F), and *Rhizophryne* (Fig. 167C), the subdermal pigment forms dorso- and ventrolateral bands along the body.

In all species in which one of these main groups occur, they are generally laid down in the youngest larvae as a few small and scattered melanophores which during larval development gradually increase in size, number, and in area covered.

Additional groups of melanophores occur in some taxa (for instance on base of pectoral peduncle in *Rhynchactis*, Fig. 168B; internally in fin rays of *Pentherichthys*, Fig. 170E; on the posterior angle of lower jaw in *Stephanophryne*, Fig. 167F; and on a swelling of the outer transparent skin in front of the dorsal fin in some *Himantolophus*, Fig. 169B).

Complete lack of pigment is found in *Ceratias* (Fig. 168E), some *Gigantactis*, and the linophrynid genus *Borophryne* (Fig. 167G). Besides in these, peritoneal pigment is absent only in *Neoceratias*. In all others, this group is laid down on the dorsal side of the peritoneum of the youngest larvae and with growth, gradually spreads to its lateral and posterior sides.

Pigmentation of the opercular region varies greatly between taxa. It is absent or weakly developed in most genera, dense and in characteristically different patterns in genera of Oneirodidae (for instance *Oneirodes*, Fig. 170A; *Dolopichthys*, Fig. 170B; *Microlophichthys*, Fig. 170F; *Thaumatichthys*, Fig. 169F; and *Cryptopsaras*, Fig. 168C, D).

Besides in the completely unpigmented larvae mentioned above, dorsal pigment is absent in *Caulophryne*, *Neoceratias*, and all Linophrynidae. In all others it is laid down on the antero-dorsal part of the body. Varying between genera in density and coverage, it spreads from there and may laterally reach and overlap the dorsal part of the peritoneal pigmentation and posteriorly the bases of the dorsal and anal fins, in some becoming confluent with the pigment group of the caudal peduncle.

In occurrence, position and development in relation to larval length, pigmentation on the caudal peduncle shows very distinct differences between genera (cf. for instance Fig. 170) or between subgenera or species-groups (cf. for instance Figs. 167E, F; 169A, B; 170C, D).

Other larval structures.—Pelvic fins.—In contrast to all other Ceratioidei, the larvae of *Caulophryne* have pelvic fins with well-developed fin rays (Fig. 167A). The longest of the 3–4 pelvic fin rays increase in relative length from about 45% SL in the smallest larvae (3 mm) to about 60% SL in the largest (7.5 mm). In the only known free-living stage of a metamorphosed male

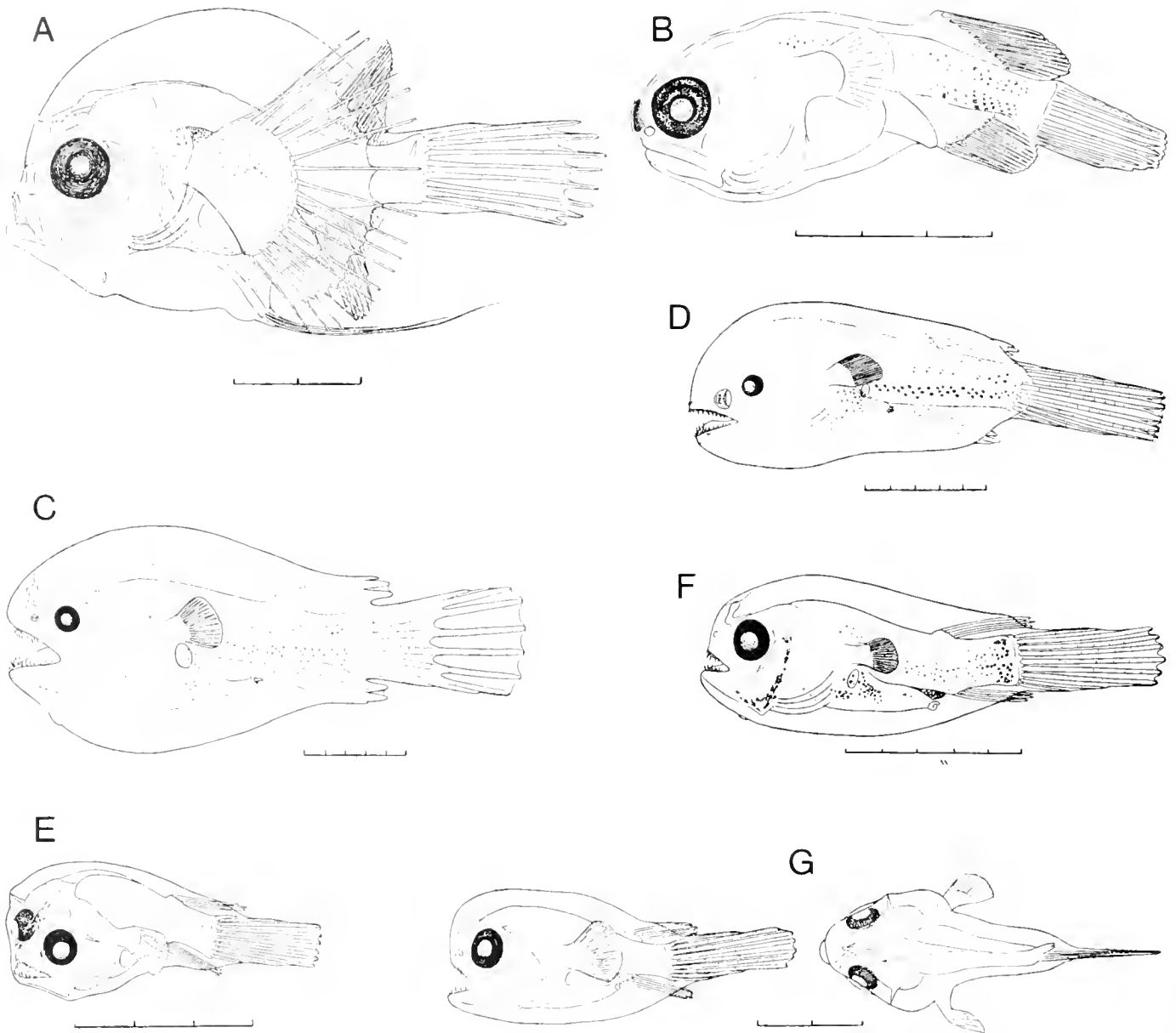

Fig. 167. Ceratioid larvae. (A) Caulophrynidae, *Caulophryne* sp., sex ?, 6.6 mm; (B) Neoceratiidae, *Neoceratias spinifer*, sex ?, 6.3 mm; (C–G) Linophrynidae; (C) *Linophryne* subgen. *Rhizophryne* sp., female, 17.5 mm; (D) *Haplophryne molhis*, metamorphic male, 13.2 mm; (E) *Linophryne* subgen. *Linophryne* sp., male, 3.8 mm; (F) *Linophryne* subgen. *Stephanophryne indica*, female 8.6 mm; (G) *Borophryne apogon*, male, 4.3 mm lateral and dorsal views. (All from Bertelsen, 1951.)

(7.5 mm) this length is reduced to 28% SL, and pelvic fin rays are absent in the two known parasitic males (12–16 mm) as well as in all metamorphosed females (10–109 mm SL).

Illicium, 2nd cephalic ray and caruncles.—In larvae of all families except Caulophrynidae and Neoceratiidae, sexual dimorphism in the development of the illicium is present. In females, the illicium rudiment is club-shaped and protrudes from the head or from the bottom of a groove in its enveloping skin (Fig. 168A, B); in males it is represented only by the tiny subdermal rudiment of the illicial bone. Similarly, the external rudiment of the second cephalic rays of Diceratiidae and Ceratiidae as

well as the caruncles of the latter family are present in the female larvae and absent in the males (Figs. 168C, D; 169E).

Among the 16 known *Caulophryne* and the 11 known *Neoceratias* larvae, no sexual dimorphism has been observed (Bertelsen, 1951). In *Caulophryne*, in which metamorphosed females lack an esca bulb with photophore but have a well-developed illicium, the rudiment protrudes on the dorsal side of the head in the same position as in other ceratioid larvae (Fig. 167A). In *Neoceratias*, in which the illicium is completely absent in the metamorphosed females, all larvae have an elongated cylindrical illicium rudiment (pigmented in larger larvae (Fig. 167B) slightly protruding, in a position unique among

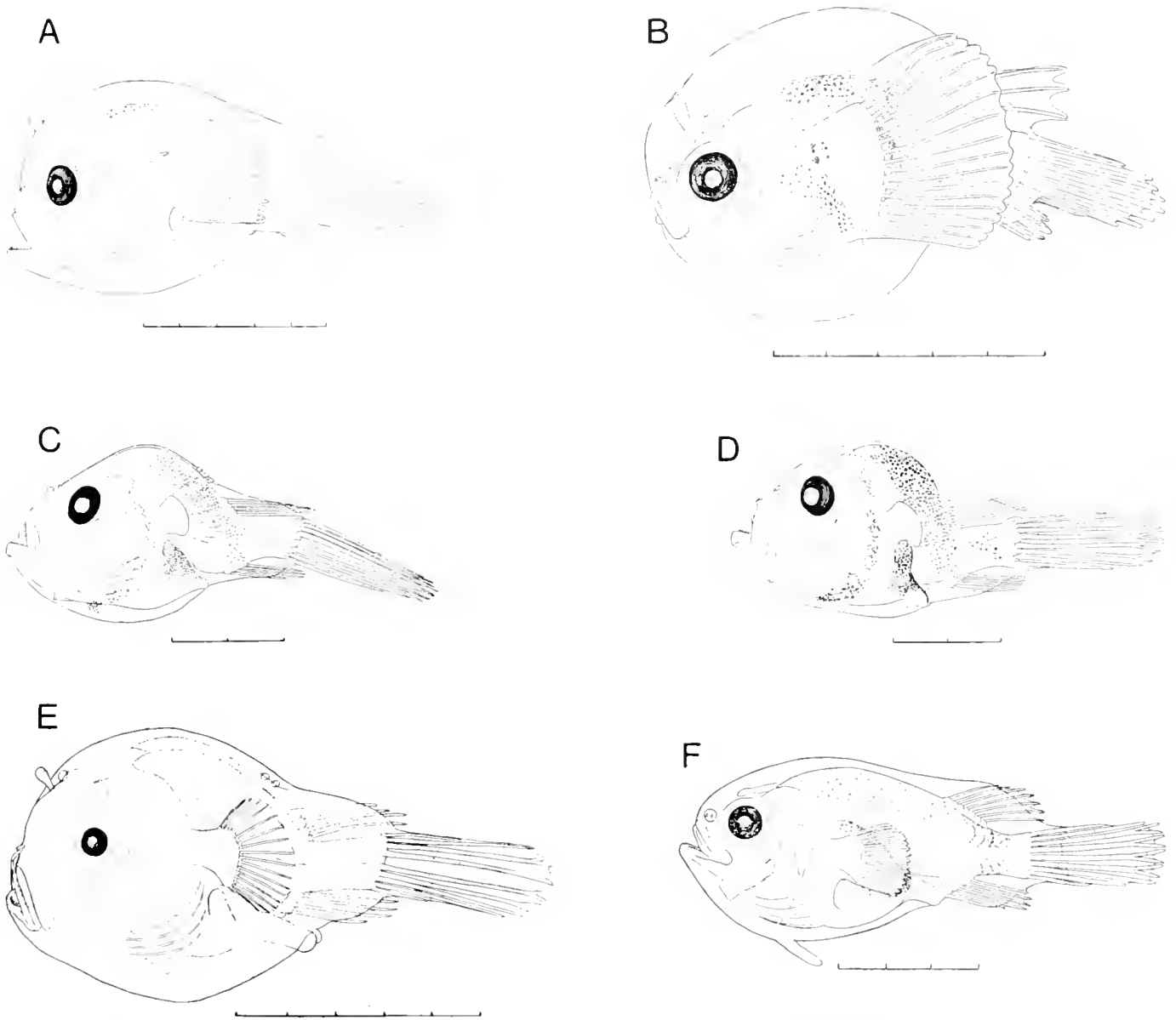

Fig. 168. Ceratioid larvae. (A-B) Gigantactinidae. (A) *Gigantactis* sp., female, 8.5 mm; (B) *Rhynchaetis leptonema*, female, 7.2 mm; (C-E) Ceratiidae; (C) *Cryptopsaras couesi*, female, 5.0 mm; (D) *Cryptopsaras couesi*, male, 5.0 mm; (E) *Ceratias holboelli*, 7.6 mm; (F) Centrophrynidae, *Centrophryne spinulosa*, male, 7.2 mm. (All from Bertelsen, 1951.)

ceratioid larvae, on the tip of the snout, just above the upper jaw.

Barbels.—In *Linophryne*, the only ceratioid genus in which the metamorphosed females have a hyoid barbel, a rudiment of this is present as an opaque, wart-like thickening of the skin in female larvae of more than about 10 mm SL (Fig. 167C).

The larvae of both sexes of the single known species of the family Centrophrynidae differ from all other ceratioid larvae in having a digitiform, hyoid barbel (Fig. 168F). The barbel remains digitiform in the metamorphic males, but after metamorphosis it is in both sexes reduced to a low papilla which gradually disappears in females larger than about 50 mm.

Spines.—Both male and female larvae of the *Linophryne* subgenus *Linophryne* and the linophrynid genus *Borophryne* differ from all other ceratioid larvae in having well-developed, pointed sphenotic spines (Fig. 167E, G). None of the other spines (preopercular, quadrate, articular, etc.) of the head skeleton characteristic of females of different genera is developed before larval metamorphosis.

RELATIONSHIPS

Current principal hypotheses.—That the Ceratioidei represent a monophyletic line appears most clearly from the fact that they all differ from other Lophiiformes in having developed an extreme and unique sexual dimorphism in which the males are

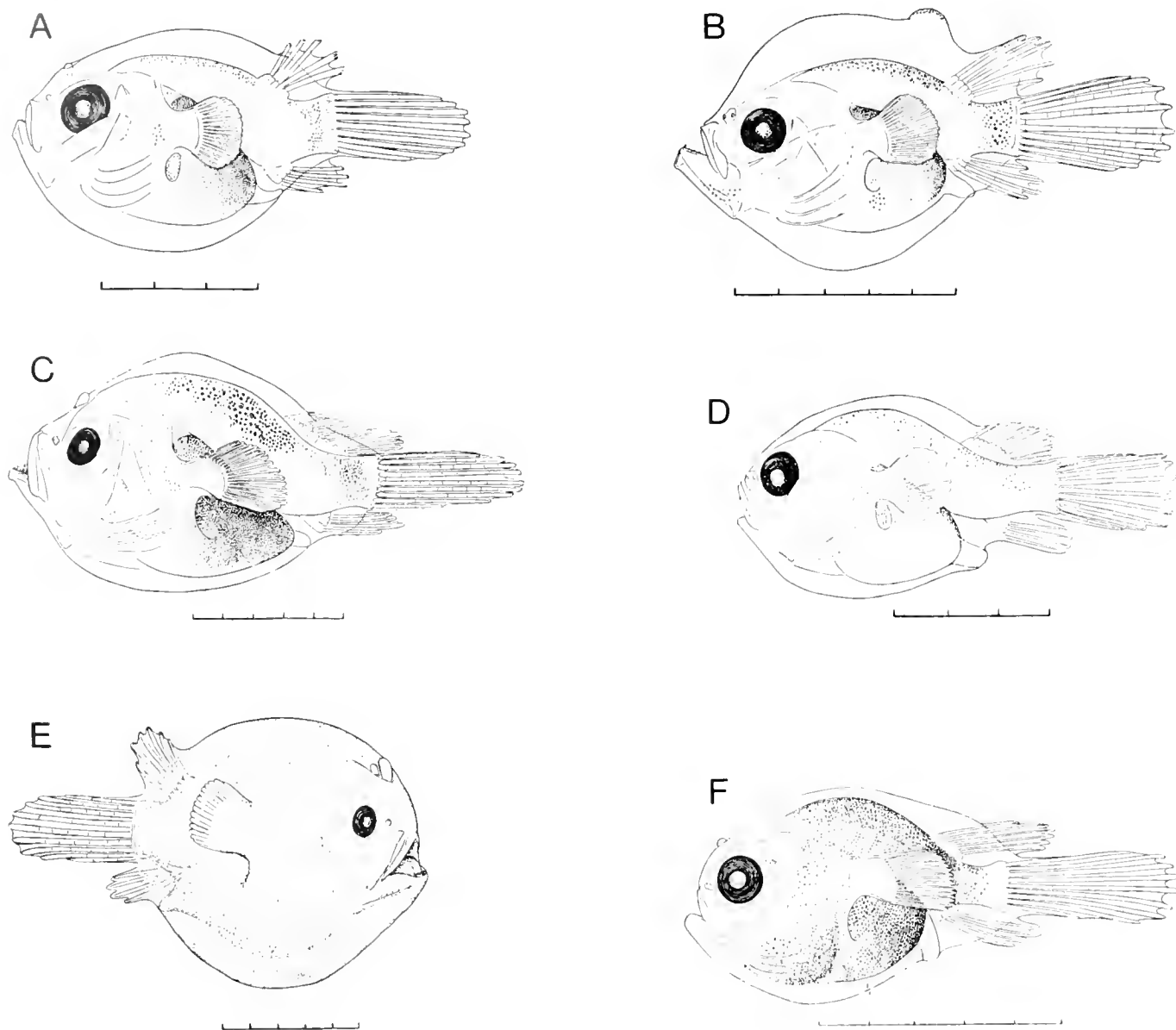

Fig. 169. Ceratioid larvae. (A–B) Himantolophidae. (A) *Himantolophus groenlandicus* gr., female, 6.0 mm; (B) *Himantolophus albinare* gr., male, 7.1 mm; (C–D) Melanocetidae; (C) *Melanocetus ?johnsoni*, female, 12.0 mm; (D) *Melanocetus murrayi*, male, 6.0 mm; (E) Diceratiidae, *Dicerattas* sp., metamorphic female, 10.5 mm; (F) Thaumatchthyidae, *Thaumatchthys* sp., female, 6.4 mm. (All from Bertelsen, 1951.)

dwarfed, lack an external illicium, and are furnished with denticular teeth adapted to attach to the female.

We may assume an ogcocephalid or chaunacid-like ancestral ceratioid which, from the benthic and littoral environment of its ancestors, has invaded the bathypelagic zone of the ocean. Probably this evolution has passed through forms in which the adults were benthic, while the juveniles after metamorphosis continued the pelagic life of the larvae during adolescence as for instance found in the family Chaunacidae and as retained or reestablished in the ceratioid genus *Thaumatchthys*. This move to a new adaptive zone has led to a dimorphism which separates the tasks of the two sexes, the females obtaining ad-

aptations to the bathypelagic conditions of the lophiiform feeding strategy by passive luring, the males being adapted solely to active search for a sexual partner. In both sexes the change from benthic to pelagic life has induced a number of changes of which the most important are: loss of the pelvic fins; a change of the position and development of their limb-like pectoral fins, now used for counteracting gravity during swimming rather than for support and movement on the bottom; and a general trend to reduce their density by reduction of bony structures and by retaining the thick subdermal layer of gelatinous tissue present in the larvae. In the latter character and in the position and shape of the pectoral fins, they may be regarded as neotenic as

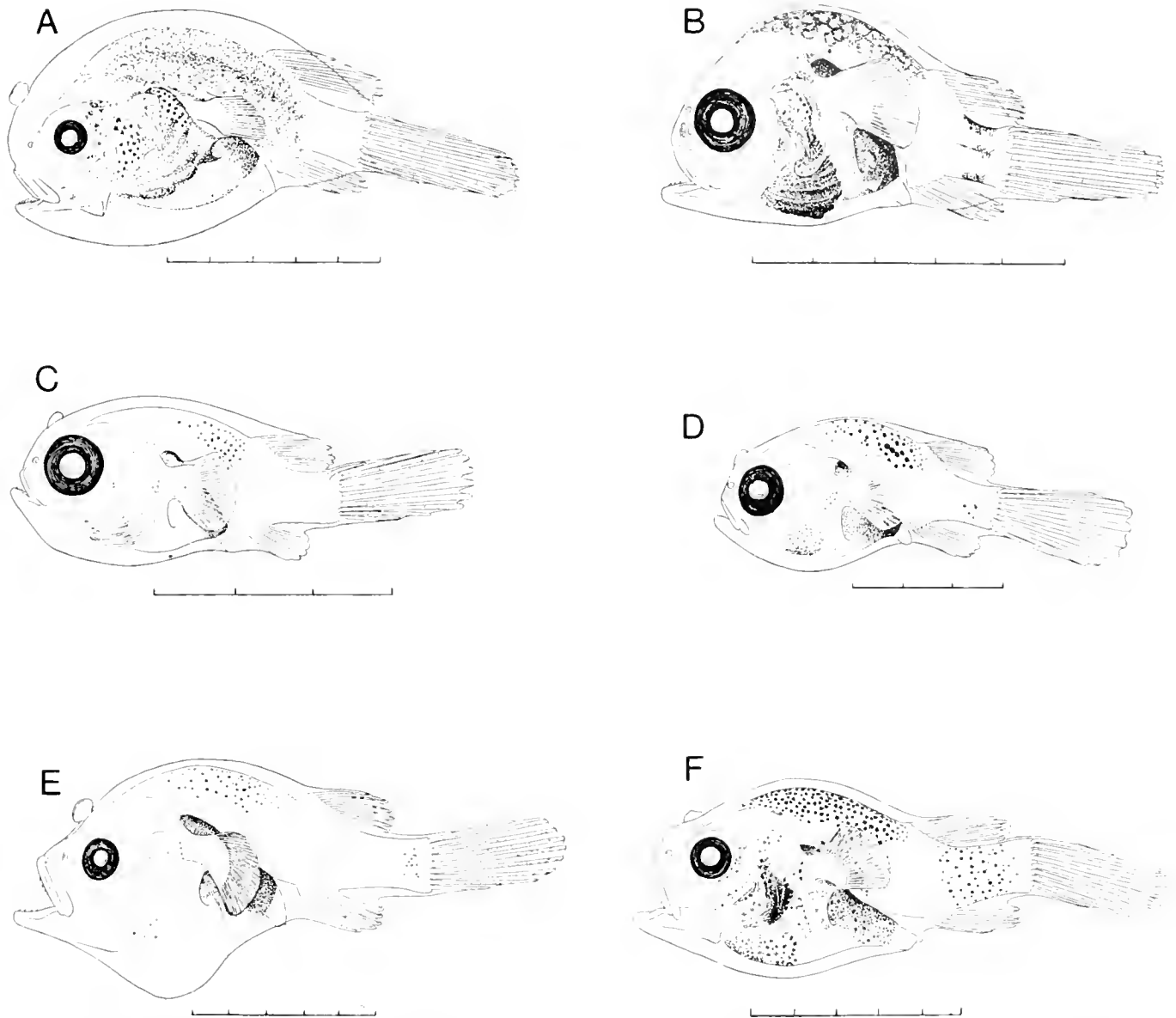

Fig. 170. Ceratioidei larvae. Oneirodidae. (A) *Oneirodes* sp., female, 8 mm; (B) *Dolopichthys* sp., male, 5.4 mm; (C) *Chaenophryne draco* gr., female, 4.0 mm; (D) *Chaenophryne longiceps*, female, 5.5 mm; (E) *Pentherichthys* sp., female, 10.6 mm; (F) *Microlophichthys* ?*microlophus*, female, 9.0 mm. (All from Bertelsen, 1951.)

proposed by Richard Rosenblatt (quoted by Moser, 1981). In females the changed conditions have led to extreme specializations of the luring and feeding mechanisms at the expense of their swimming ability, while in the males this has induced different specializations in their attachment mechanisms and sense organs and a development into more streamlined and efficient swimmers.

The present division of the Ceratioidei into families is based mainly on revisions by Regan (1912a, 1926) and Regan and Trewavas (1932). Some changes have been introduced by Bertelsen (1951) and Pietsch (1972) resulting in the present recognition of the 11 families listed in Table 89.

The phylogenetic relationships between the families of the

Ceratioidei are still uncertain. The main reason for this is that most of the derived osteological characters shared by two or more families are reduction states or loss of parts following the general trend mentioned above and similarities in such characters may in many cases represent convergent developments. At the same time most of the diagnostic family characters which represent new structures or specialization of organs are autapomorphic (and for this reason not included in Table 89). The more conspicuous of these are: an extreme prolongation of dorsal and anal rays of Caulophrynidae; a dense cover of large papillae on snout and chin of female Himantolophidae; a hyoid barbel in larvae and juveniles of both sexes of Centrophrynidae; photophore-bearing, modified dorsal fin rays (caruncles) in fe-

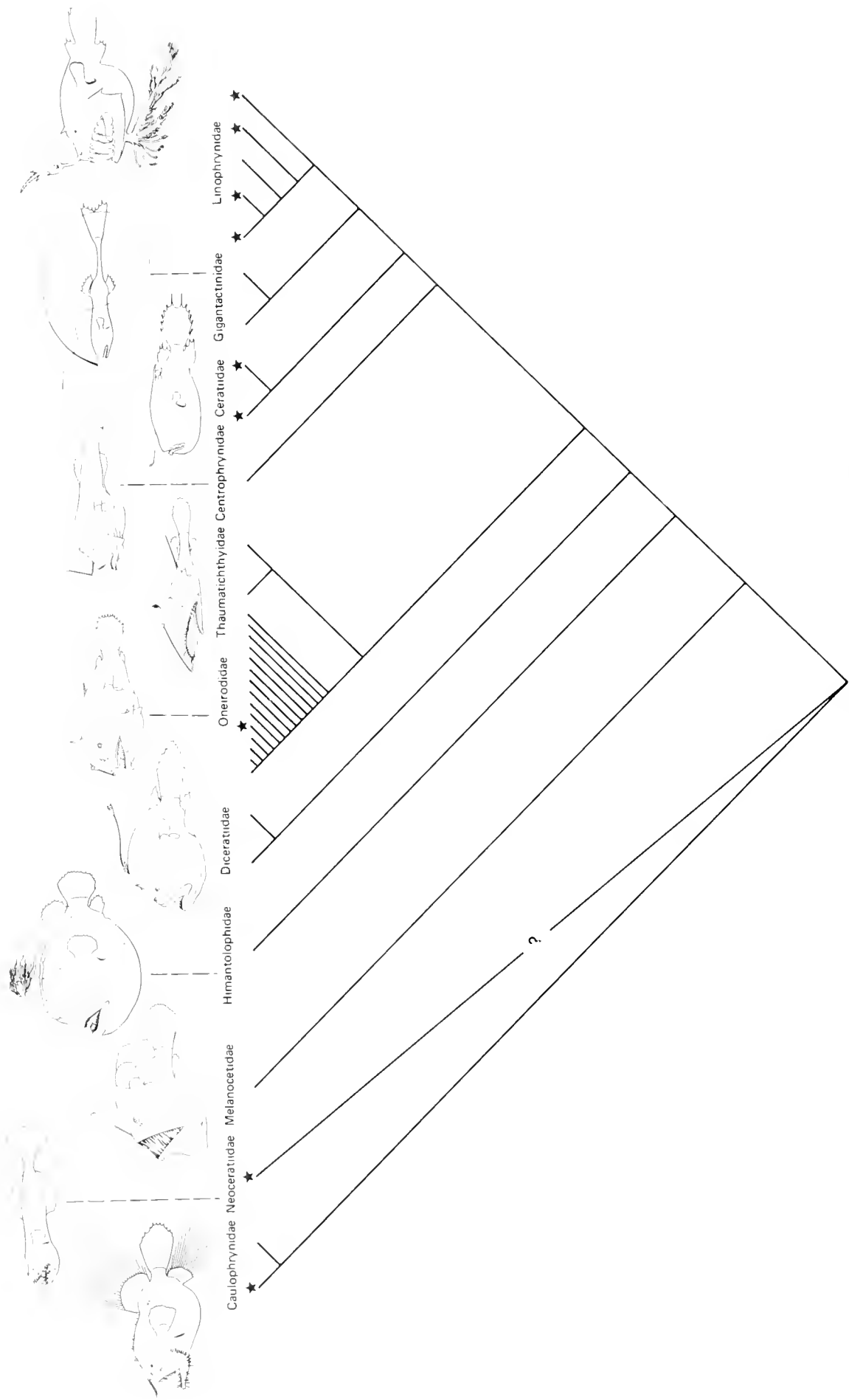

Fig. 171. Schematic illustration of presumed relationships of Ceratioidei. Stars: genera in which parasitic males have been observed.

male Ceratiidae; and very different high specialization of the illicial and jaw mechanisms of female Neoceratiidae, Thaumatiichthyidae and Gigantactinidae.

The interrelationships of the ceratioid families have been discussed by Regan (1912a, 1926), Regan and Trewavas (1932), Bertelsen (1951), and Pietsch (1972, 1979), the latter illustrating with branching diagrams, alternative proposals for phylogenetic relationships of the families. However, no detailed analysis or full discussion of the basis for these proposals has been presented. For this reason the dendrogram shown in Fig. 171 should be regarded only as a very schematic compilation of the expressed views, following most closely Pietsch (1979: fig. 26) with some modifications discussed below.

In accordance with Bertelsen (1951) and Pietsch (1979) it is assumed that sexual parasitism has been established independently in different phylogenetic lineages. The observation of a parasitic male (character 26) in a representative of one of the 15 oneirodid genera (Pietsch, 1976) makes it extremely unlikely that the five families in which such males have been observed represent a monophyletic line. (Furthermore, this observation underlines the possibility that sexual parasitism might be found in other families as well.) It seems that the evolutionary step from the temporary attachment of the male to the female, by means of the denticular teeth present in all ceratioid males (and resulting in a close and protracted contact between the dermis of the pair), to a fusion of their tissues is a less drastic event than it might be supposed and has been established independently in different taxa and possibly even facultative in some, as proposed by Pietsch (1976).

Presence of an esca photophore (no. 11) is presumed to be a synapomorphy separating the other families from Caulophryniidae (and ?Neoceratiidae), a primitive sister-group. This implies that the similarity of some derived character states (nos. 4, 6, 9, 15) to those of one or more of the families Linophryniidae, Gigantactinidae, and Ceratiidae is due to convergence in these bone reductions. The alternative, proposed by Pietsch (1979), that these families were derived from a caulophrynid-like ancestor, would imply that the esca photophore has been evolved independently in two separate lineages. Morphologic and histologic studies of these organs in different families show similarities in such details that this seems extremely unlikely [cf. for instance Brauer, 1908 (*Gigantactis*); O'Day, 1974 (*Oneirodes*); Hansen and Herring, 1977 (*Linophryne*); and Munk and Bertelsen, 1980 (*Chaenophryne*)].

Based on a number of shared derived character states (nos. 6, 7, 15, 20, and presence of teeth externally on the jaws) it has been assumed that Neoceratiidae are closely related to Gigantactinidae. However, they differ considerably in other characters (nos. 5, 9, 13, 14, 21, and 24) and especially in the illicial and jaw mechanisms of the females. While the complete loss of illicium in neoceratiids undoubtedly is a derived character state it remains uncertain whether this family is derived from ancestors with or without esca photophores. As discussed in the following section, some larval characters might indicate the latter possibility. In reference to this the numerous characters shared by the two genera of gigantactinids leaves no doubt that the lack of photophore in *Rhynchactis* is due to secondary reduction (Bertelsen et al., 1981). While none of the highly specialized families Linophryniidae, Gigantactinidae, and Ceratiidae appear closely related, their shared derived character states may indicate a common descent as shown in Figure 171. As pointed out by Pietsch (1972) Centrophryniidae has retained

a number of primitive character states but may be more closely related to Ceratiidae than to any other family, and Thaumatiichthyidae are most probably derived from an oneirodid-like ancestor (Bertelsen and Struhsaker, 1977). The remaining four families Melanocetidae, Himantolophidae, Diceratiidae, and Oneirodidae appear more similar to each other than the more specialized families mentioned above, but as their shared character states are nearly all primitive their interrelationships are uncertain. The position of Melanocetidae in the dendrogram (Fig. 171) is based on the presumption that a reduction of the number of dorsal fin rays to less than 10 is synapomorphic within the following series of families.

Except for the significance of observed sexual parasitism the characters of the males have not been considered in previous discussions of the interrelationships of the ceratioid families. The presence of denticular teeth shared by all families is a derived character state in relation to all other Lophiiformes. The absence of such denticles on the snout observed in caulophryniids and neoceratiids may represent a primitive state within the suborder. In accordance with the classification based on the characters of the females or shared by the sexes, the males are highly but very differently specialized in the families Ceratiidae, Gigantactinidae, and Linophryniidae while the least number of presumed derived character states are found in Melanocetidae, Himantolophidae, and Diceratiidae.

Within the families the inter-generic relationships appear close and relatively simple in the four families divided into two genera. In each of these one of the genera shows more derived character states in reductions and specializations than the other. (*Robia* in Caulophryniidae; *Phrynichthys* in Diceratiidae; *Thaumatiichthys* in Thaumatiichthyidae; *Cryptopsaras* in Ceratiidae and *Rhynchactis* in Gigantactinidae). Among the five genera of the well-defined family Linophryniidae, *Linophryne* appears the most derived (females with photophore carrying barbels). *Borophryne* and *Acentrophryne* seem closely related to this genus (very similar osteology and dentition) while each of the genera *Edriolychnus* and *Photocorynus* appear more isolated; the latter has retained a number of primitive or less derived character states (nos. 10, 13, 15, 17).

In contrast to the other ceratioid families no conspicuous distinctive characters have been found which are common to the large assemblage of genera united in the family Oneirodidae. However, the presence of quadrate and articular spines in most of the genera and shared only with the closely related thaumatiichthyids might be significant and their absence in some genera could be due to secondary reduction. On the basis of osteological characters the evolutionary relationships of 9 of the 15 genera were studied by Pietsch (1974) and notes on some of the others have been added by Bertelsen and Pietsch (1975) and Pietsch (1975). According to these studies *Spiniphryne* appears the most primitive of these genera, having retained well-developed dermal spines, among a number of other primitive character states. Among the most specialized genera are *Lophodolos* (reduction or loss of some elements of the skeleton and enlargements of others) and *Chaenophryne* (lack of sphenotic, quadrate and articular spines, shape of opercular bones and a unique structure of ossifications; Pietsch, 1975).

Contribution of early life history stages.—Apart from meristic and osteological characters shared with adults, the larvae of ceratioid taxa differ from each other only in pigmentation and to some extent in morphology. As the pigment patterns vary

greatly within families only the latter characters may be relevant to the discussion of the relationships of the families.

The assumption by Bertelsen (1951) that the Caulophrynidae are isolated from all other ceratioids was based mainly on three larval characters: (1) presence of pelvic fins; (2) absence of sexual dimorphism in the illicial rudiments; and (3) lack of a distal swelling of these rudiments representing the rudiment of an escal bulb. The two latter character states indicate that the absence of an escal photophore in caulophrynids is not due to a secondary reduction. As expressed by Pietsch (1979) who found a number of additional resemblances between *Caulophryne* and less derived Lophiiformes (lophiids and antennarioids): "That these primitive character states suddenly reappeared in a lineage that arose from an ancestor derived in all, is highly improbable."

The possibility, mentioned above, that the neoceratiids may represent a similar isolated lineage derived from an ancestor without escal photophore, is based on the same larval characters: the absence of sexual dimorphism in their illicial rudiments which lack distal swellings. However, the fact that neoceratiids and caulophrynids share these primitive character states furnishes no information on their relationship. In other larval characters, especially body shape and size of pectoral fins, the two families are extremely different.

The assumption that the absence of escal photophore in the gigantactinid genus *Rhynchaetis* is due to a secondary reduction is confirmed by the presence of a club-shaped illicial rudiment in the female larvae.

Little information on the relationships between the ceratioid families can be obtained from other observed differences in larval morphology. The greatly enlarged pectoral fins present only in gigantactinids and caulophrynids may as assumed by Pietsch (1979) represent a primitive character state which has been retained separately in the two lineages. The most conspicuous derived character states of the larvae are the extreme elongation of the body in neoceratiids, the hump-backed shape of ceratiids, and the barbels of centrophrynids. Being each restricted to a single family they only confirm the distinct separation of these lineages.

Within the families, inter-generic comparisons of larvae are possible only in Gigantactinidae, Linophrynidae, Ceratiidae and

Oneirodidae. Of the remaining seven families, four are monotypic and in each of three, which are divided into two genera, larvae of only one is known. In each of these families very distinct inter-generic differences in larval pigment patterns have been found.

This larval character, retained in juveniles of both sexes, has been one of the main keys to the identification of the free-living metamorphosed males and thus has contributed considerably to the concept of the relationships within the ceratioid families.

The fact that separation of larvae (and males) below generic level has been possible only in those exceptional cases where intra-generic differences above species rank (subgenera, species-groups, etc.) have been observed, underlines that within this suborder the term "genus" indicates a remarkably well-defined and natural group.

However, little information on phylogenetic relationships within the families has been obtained from the study of the larvae. The difficulties in interpreting their character states is well illustrated in the Linophrynidae. Two apparently typical derived larval character states occur in this family: (1) well developed sphenotic spines (within larval Lophiiformes found only in the linophrynid genus *Borophryne* and in one of the three subgenera of *Linophryne*), and (2) a characteristic subdermal pigment pattern (found only in the linophrynid genus *Haplophryne* and in the two subgenera of *Linophryne* lacking larval sphenotic spines). If it is assumed very unlikely that these specializations have evolved independently in different genera of the same family, the only alternative is that apparently primitive character states are in fact due to three secondary reductions: (1) lack of sphenotic spines in two *Linophryne* subgenera; (2) lack of barbels in female *Borophryne*, making this one more subgenus of *Linophryne*; and (3) lack of subdermal pigment in one of the subgenera of *Linophryne* and in *Borophryne*.

Ceratioids are still very incompletely known and future studies on additional characters and as yet unknown forms may bring answers to at least some of the many questions about their phylogenetic relationships.

ZOOLOGICAL MUSEUM, UNIVERSITY OF COPENHAGEN,
COPENHAGEN 2100 Ø, DENMARK.

Atherinomorpha: Introduction

B. B. COLLETTE

THE superorder Atherinomorpha (Greenwood et al., 1966) includes the atherinoids (silversides and phallostethids), cyprinodontoids (killifishes), and beloniforms (halfbeaks and their relatives), first grouped together by Rosen (1964) as the order Atheriniformes. The series Atherinomorpha was redefined by Rosen and Parenti (1981) as including the Atherinoidei (of uncertain rank), Cyprinodontiformes and Beloniformes.

Utilizing 17 apomorph characters, Rosen and Parenti (1981) found 10 synapomorphies uniting the atherinoids, Cyprinodontiformes, and Beloniformes. Two of these involve early life history characters: complete separation of embryonic afferent and efferent circulation by development of the heart in front of, rather than under, the head and the presence of large demersal eggs with long adhesive and short filaments and many lipid

globules that coalesce at the vegetal pole. Four additional synapomorphies between the Cyprinodontiformes and Beloniformes show the atherinoids to be the plesiomorphic sister group of these two orders.

Rosen and Parenti (1981) were unable to find derived characters to unite the atherinoids as a monophyletic group but White et al. (this volume) have discovered two early life history characters which define the Atheriniformes as the plesiomorphic sister group of the Cyprinodontiformes plus Beloniformes.

NATIONAL MARINE FISHERIES SERVICE SYSTEMATICS
LABORATORY, NATIONAL MUSEUM OF NATURAL HISTORY,
WASHINGTON, DISTRICT OF COLUMBIA 20560.

Beloniformes: Development and Relationships

B. B. COLLETTE, G. E. MCGOWEN, N. V. PARIN AND S. MITO

THE Beloniformes (or Synentognathi) is an order of atherinomorphic fishes containing five families, 37 genera, and about 180 species. Species of the Adrianichthyidae inhabit fresh and/or brackish waters. Most species of the other four families are epipelagic marine fishes but several genera of Belonidae and Hemiramphidae are restricted to fresh waters and a few other genera contain estuarine and freshwater as well as marine species.

Two groups have been recognized under various names by a series of authors starting with Schlesinger (1909) and continuing through Regan (1911b), Nichols and Breder (1928), Rosen (1964), and Collette (1966). Each of these groups contains two families, the Scomberesocidae and Belonidae in the first, the Hemiramphidae and Exocoetidae in the second. Recently, Rosen and Parenti (1981) expanded the Beloniformes by adding the Adrianichthyidae to the order as a separate suborder Adrianichthyoidei, the sister group of the Exocoetoidei (containing two superfamilies Scomberesocoidea and Exocoetoidea).

DEVELOPMENT

Eggs

Most beloniform fishes produce large spherical eggs with attaching filaments, characters they share with other atherinomorphic fishes (Rosen and Parenti, 1981). Adrianichthyid eggs are the smallest (1.0–1.5 mm in diameter); followed by exocoetids (generally 1.5–2 mm); Hemiramphidae (typically 1.5–2.5 mm); Scomberesocidae (slightly elliptical, 1.5–2.5 mm); and belonid eggs which are generally the largest (most 3–4 mm) (Table 90). These eggs typically have a homogeneous yolk and a relatively small perivitelline space. According to Kovalevskaya (1982), eggs with long filaments, distributed over the en-

tire sphere of the egg (one filament may be thicker and longer than the others) should be considered primitive. Such eggs are found in the Belonidae, some Hemiramphidae, primitive flying-fishes of the genera *Fodiator* and *Parexocoetus*, and also in many of the highly specialized species of the subfamily Cypselurinae.

Eggs of the Adrianichthyoidei contain numerous small oil globules which coalesce, at least to some extent, during development (Matsui, 1949), as in the Atheriniformes and Cyprinodontiformes (Rosen and Parenti, 1981). Exocoetoid eggs either contain minute, scattered oil globules (Fig. 176C) or lack oil globules (Table 90).

Adrianichthyid eggs have filaments distributed over the entire chorion, a condition we refer to as uniformly spaced. Most of these filaments are short, 0.21–0.35 mm in *Horaichthys setnai* (Kulkarni, 1940), however, on one portion of the chorion they are as long as or longer than the egg diameter (Fig. 172). Pietri (1983) described these two topographically distinct types of filaments from the chorionic surface of *Oryzias latipes* as non-attaching and attaching. Non-attaching filaments showed a regular distribution over the chorion with an interfilament distance of about 65–70 μm , and functioned to maintain the integrity of the egg cluster. Attaching filaments were located at one pole of the egg forming a clump of about 25 filaments that united with those of neighboring eggs to anchor the egg cluster to the gonoduct of the female. In *Oryzias melastigma*, the attaching filaments also anchor the eggs to the female (Job, 1940) or to filamentous algae.

The eggs of most scomberesocids (*Scomberesox*, *Nanichthys* and *Elassichthys*) are pelagic, without long filaments. Eggs of *Scomberesox* (Fig. 173A), however, have short bristles that apparently represent remnants of chorionic filaments (see Boehlert,

TABLE 90. EGGS OF BELONIFORMES FISHES. Much of this information is based entirely on illustrations from the cited references.

Taxon	Diameter (mm)	Oil globule	Filaments			Remarks and sources
			Arrangement	Number	Length (mm)	
Adrianichthyidae						
<i>Horaichthys setnai</i>	1	Numerous coalesce into 15–30	2 types: uniform	Type 1, most numerous	0.21–0.35	Demersal, Kulkarni, 1940
			localized	Type 2, many	>egg dia.	
<i>Oryzias javanicus</i>		Numerous coalesce into 1	2 types			Ahlstrom notes
<i>O. latipes</i>	1.27–1.3	Numerous coalesce into 1	2 types: uniform	Type 1, nonattaching, most numerous		Ahlstrom notes; Matsui, 1949; Pietri, 1983; Hart et al., 1984
			localized	Type 2, attaching, ~25		
<i>O. luzonensis</i>	~1.5	Numerous coalesce into 1	2 types			Ahlstrom notes
<i>O. melastigma</i>	1.0–1.2	30–40 coalesce into 1	2 types: uniform	Type 1, most numerous	<egg dia.	Job, 1940
			localized	Type 2, many	>egg dia.	

TABLE 90. CONTINUED.

Taxon	Diameter (mm)	Oil globule	Filaments			Remarks and sources
			Arrangement	Number	Length (mm)	
Scomberesocidae						
<i>Cololabis saira</i>	1.7 × 1.9 (off round)	No	Polar cluster lateral	12–15 1		Demersal, SWFC, unpublished and original
<i>C. adocetus</i>	~2.5			None		Orton, 1964
<i>Scomberesox saurus</i>	Off round, range of mean diameters = 2.32 × 2.52	No	Uniform or groups	Numerous	Short, rigid	Pelagic, Hardy, 1978a
<i>S. simulans</i>				None		Hubbs and Wisner, 1980
Belonidae						
<i>Ablennes hians</i>	3.0–3.5; mean = 3.16 ripe ovarian	No	Uniformly-spaced tufts	1–6 per tuft; total 37–59 (N = 6)	> egg dia.	Hardy, 1978 and original
<i>Belone belone</i>	3.0–3.5	No	Uniform	60–80	4–18	Demersal, Russell, 1976
<i>Pseudotylosurus microps</i>	1.2–1.4; mean = 1.23					Collette, 1974a and original
<i>Strongylura exilis</i>	2.3–2.8; mean = 2.5 (running ripe)	No	Uniform	18–30	Longer than egg dia.	Original
<i>S. fluviatilis</i>	2.9–3.2; mean = 3.1 (ovarian)					Original
<i>S. hubbsi</i>	2.50–3.14; mean = 2.75 (ovarian)					Collette, 1974c
<i>S. incisa</i>	3.5–4.6; mean = 3.9 (ovarian)					Original
<i>S. krefftii</i>	2.7–4.0; mean = 3.4 (ovarian)					Original
<i>S. marina</i>	3.5–3.6	No	Uniform	Numerous	Variable, but generally < egg diameter	Demersal, Hardy, 1978a
<i>S. notata</i>	3.67–4.18; mean = 3.95		Uniform			Demersal, Breder, 1959
<i>S. strongylura</i>	2.5	No, but one or more clear vesicles project into yolk	Uniform	Numerous 57 in illus.	All long, but 1–2 areas longest	Demersal, Job and Jones, 1938
<i>Tylosurus acus</i>	3.22–4.0		Uniformly-spaced tufts	2–3 per tuft	Longer than egg dia.	Demersal, Hardy, 1978a
<i>T. a. melanotus</i>	3.2–3.5	No	Uniformly-spaced tufts	2–3 per tuft; total @ 100	2–3 × egg dia.	Mito, 1958
<i>T. crocodilus</i>	4.0–4.1	Minute		Numerous	Long	Demersal, Masurkar, 1967
<i>T. punctulatus</i>	3.5–4.3; mean = 3.9					Original
<i>Xenentodon cancella</i>	2.9–3.2	No				Foster, 1973 and original
Hemiramphidae						
<i>Dermogenys pusillus</i>	Viviparous	No				Mohr, 1936a; Brembach, 1976
<i>Euleptorhamphus viridis</i>	1.1 (ovarian)		"Disorderly"		6.0–6.5	Demersal; Parin and Gorbunova, 1964
<i>Hemiramphus far</i>	2.8–3.1			Present		Breder and Rosen, 1966
<i>He. marginatus</i> = <i>He. lutkei</i>	Mean = 2.59	No	8–12 tufts	4–6/tuft	Both > & < egg diameter	Talwar, 1968

TABLE 90. CONTINUED.

Taxon	Diameter (mm)	Oil globule	Filaments			Remarks and sources
			Arrangement	Number	Length (mm)	
<i>Hemirhamphodon</i>	Viviparous					Mohr, 1936c; Brembach, 1976 Sudarsan, 1968b
<i>Hyporhamphus guoyi</i>	2.2-2.6		14-16 tufts	3-4/tuft		
<i>Hy. capensis</i>	~1.6			Present		Smith, 1933b
<i>Hy. intermedius</i>	1.3-1.4	Minute	Bipolar	3-4/tuft, 1 polar	? >25	Uchida et al., 1958
<i>Hy. sajori</i>	2.1-2.3	Minute	Bipolar	4-6/tuft, 1 polar	20-60	Uchida et al., 1958
<i>Hy. unifasciatus</i>	~2.0			Several	>egg diameter	Semibuoyant; Hardy, 1978a Collette, 1982b
<i>Hy. xanthopterus</i>	1.12-1.44; mean = 1.23 (ovarian)					
<i>Melapedalion breve</i>						
<i>Nomorhamphus</i>	Viviparous					Mohr, 1936b; Brembach, 1976
<i>Oxyporhamphus convexus</i>	1.9-2.3		Uniform	Many	0.05-0.06	Pelagic; Kovalevskaya, 1965
<i>O. micropterus</i>	1.8-2.1	No	Uniform	74-120	0.08-0.12	Pelagic; Imai, 1959
					0.07-0.08	Kovalevskaya, 1965
<i>Rhychorhamphus georgii</i>			Bipolar ?	5		Demersal; Koval- evskaya, 1965
<i>R. malabaricus</i>	~1.5					Demersal; Deva- nesen, 1937
<i>Zenarchopterus</i>	Not viviparous					Mohr, 1926; Brembach, 1976
<i>Z. robertsi</i>	3.0-3.5; mean = 3.25 (ovari- an)					Collette, 1982c
Exocoetidae						
<i>Cheilopogon (A.) agoo</i>	1.4-1.6		Uniform	34-66		Demersal, Imai, 1960
<i>Ch. (Ch.) pinnatibarbatus californicus</i>	1.57-1.70; mean = 1.64		Uniform	~60		Hubbs and Kam- pa, 1946
<i>Ch. (Ch.) pinnatibarbatus japonicus</i>	1.9-2.1		Uniform	56-78	~10	Demersal, Imai, 1959
<i>Ch. (Proc.) cyanopterus</i>	1.2 (ovarian, prob. not fully ripe)		Uniform			Gibbs and Staiger, 1970
<i>Ch. (Proc.) katoptron</i>			Uniform	Numerous	0.5-0.55	Pelagic, Kovalev- skaya, 1965
<i>Ch. (Proc.) m- gricans</i>	2.0-2.2		Uniform	Numerous	<egg diameter	Pelagic, Parin and Gorbunova, 1964
	1.8 (maximum ovarian)					Gibbs and Staiger, 1970
<i>Ch. (Proc.) spilopterus</i>	1.79-2.17; mean = 2.02	No	Uniform	12-19 (usually 13)	Long	Demersal, Vijay- araghavan, 1975
<i>Ch. (Pt.) heterurus</i>	1.86	No	Uniform	Numerous	Long	Demersal, Hardy, 1978a
<i>Ch. (Pt.) h. docderleini</i> (type 1)	2.0-2.2		Bipolar	30-86	10	Demersal, Imai, 1959
<i>Ch. (Pt.) h. docderleini</i> (type 2)	1.8-2.2		Uniform	30-48	8-11	Demersal, Imai, 1959
<i>Ch. (Pt.) lutkeni</i>	~1.6			45+		Hubbs and Kam- pa, 1946
<i>Ch. (Pt.) melanurus</i>	1.8-1.9		Uniform			Gibbs and Staiger, 1970

TABLE 90. CONTINUED.

Taxon	Diameter (mm)	Oil globule	Filaments			Remarks and sources
			Arrangement	Number	Length (mm)	
<i>Ch. (Pt.) unicolor</i>	1.5–1.6		Bipolar	10–12 18–20	Short Long	Demersal, Gorbunova and Parin, 1963; Parin and Gorbunova, 1964
<i>Cypselurus (Cy.) naresu</i>	1.8–2.1		Uniform	40–52		Demersal, Imai, 1959
<i>Cy. (Cy.) opisthops hiraii</i>	1.5–1.6		Uniform	55–88	15–21	Demersal, Imai, 1959
<i>Cy. (Poec.) cyanopterus</i>	1.2 (ovarian, prob. not fully ripe)		Uniform			Gibbs and Staiger, 1970
<i>Cy. (Poec.) starksi</i>	1.6		Uniform	40–52		Demersal, Imai, 1959
<i>Exocoetus monocirrhus</i>	2.8–3.3 (ovarian)		None			Pelagic, Kovalevskaya, 1964
<i>E. obtusrostris</i>	2.8–2.9 (ovarian)		None			Pelagic, Breder, 1938
<i>E. volitans</i>	1.7–2.0 2.7–3.0		None None			Pelagic, Bruun, 1935 Kovalevskaya, 1964
<i>Fodiator acutus</i>	1.4–1.7; mean = 1.53 (ovarian)		Uniform	9 (from illustration)	>egg diameter	Demersal, Breder, 1938
<i>Hirundichthys (D.) rondeleti</i>	1.4–1.5			90–100		Demersal, D'Ancona, 1929
			Bipolar	1, many		Kovalevskaya, 1972
<i>H. (H.) affinis</i>	1.6 ± 0.1 (ripe ovarian)	No	Bipolar	? 8–14 mean = 11	Short 40+	Demersal, Evans, 1962
<i>H. (H.) coromandelensis</i>	Mean = 1.87	Minute	Bipolar	1, 3–5 5–12	102.5, 4.6 1.1	Demersal, Vijayaraghavan, 1973
<i>H. (H.) oxycephalus</i>	1.5–1.7		Bipolar	9–18 10–25	4 0.15	Demersal, Imai, 1960
<i>H. (H.) speculiger</i>	1.53–1.87; mean = 1.65 2.05–2.15 (ovarian; after swelling)	Minute	Bipolar	18–20 30	5 0.17–0.18	Demersal, Munro, 1954
			Bipolar	7–10 1	< egg diameter 35–40	Parin and Gorbunova, 1964
<i>Parexocoetus brachypterus brachypterus</i>	1.2–1.5 (ovarian)		Bipolar	6–10 10–18	1.5–2.0 1.5–2.0	Demersal, Imai, 1959
<i>P. mento mento</i>	1.7–1.8		Uniform	20	3.5–8.0	Demersal, Tsukahara and Shiokawa, 1957
<i>Prognichthys brevipinnis</i>			Uniform		Short, less than egg diameter	Kovalevskaya, 1982

this volume). *Cololabis* is the only scomberesocid with filaments, a polar cluster of relatively long filaments plus a single long lateral filament (Fig. 173B). *Cololabis* eggs typically are attached to floating objects such as kelp.

Belonid eggs have filaments (Table 90), typically long, numerous and uniformly spaced over the chorion (Fig. 174A). In at least one species, *Strongylura strongylura*, some filaments are markedly longer than others (Fig. 174B), as in the adrianichthyids. The filaments on eggs of *Tylosaurus acus* are arranged in uniformly distributed tufts containing 2–3 filaments each (Fig. 174C).

Hemiramphids have eggs with attaching filaments (*Rhynchorhamphus*, *Hyporhamphus*, and *Hemiramphus*, Fig. 175A), pelagic eggs with very short uniformly-spaced filaments (*Oxyporhamphus*, Fig. 175B), or are viviparous (*Hemirhamphodon*, *Dermogenys*, *Nomorhamphus*). Filaments were not reported on ovarian eggs of *Dermogenys* by Flegler (1977) and we did not note their presence in *Hemirhamphodon* or *Zenarchopterus* but this needs to be checked more thoroughly. Kovalevskaya (1965) reported that filaments on *Rhynchorhamphus georgii* have a bipolar arrangement; however, this is not clear in her illustration (Fig. 175A). Talwar (1968) and Sudarsan (1968b) reported the

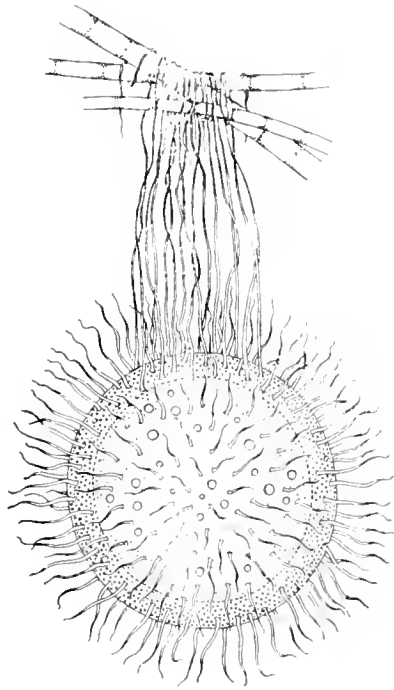

Fig. 172. Adrianichthyidae egg. *Horaichthys setnai*. (From: Kulkarni, 1940.)

filaments of what they called *Hemiramphus marginatus* (Fig. 175C) and *Hyporhamphus quoyi*, respectively, to be grouped in tufts. The filaments in a tuft may be of different lengths (e.g., *He. marginatus*).

Most exocoetids have eggs that are attached with thin thread-like filaments to objects floating in the water column or to seaweed growing near shore. The size and structure of the eggs and the size, nature, and location of the filaments vary among species. The eggs of *Fodiator* and *Prognichthys* have uniformly-spaced filaments (Fig. 176B). Filaments on *Hirundichthys* eggs have a bipolar arrangement. One species, *H. coromandelensis*, has three types of filaments (Vijayaraghavan, 1973), but they are grouped in a bipolar distribution. This type of egg has a single long (103 mm), stout filament arising from the basal pole, which is surrounded by 3–5 medium length ($\bar{x} = 4.6$ mm) filaments. Five to 12 short ($\bar{x} = 1.1$ mm) filaments are located at the distal pole (Fig. 176C). Chorionic filaments in *Parexocoetus*, *Cheilopogon* and *Cypselurus* vary. Some species have uniformly-spaced filaments, whereas others have a bipolar arrangement with the filaments usually longer at one pole than at the other. Unlike all other flying fishes, species of *Exocoetus* have eggs with a smooth membrane, devoid of filaments (Fig. 176A).

Larvae

A relatively long incubation period is typical of the Beloniiformes (Kovalevskaya, 1982). The eggs develop for one to two weeks, and the larvae are well formed and capable of actively capturing food at hatching. Time of development is comparable in pelagic and attaching eggs. Following a pattern similar to that

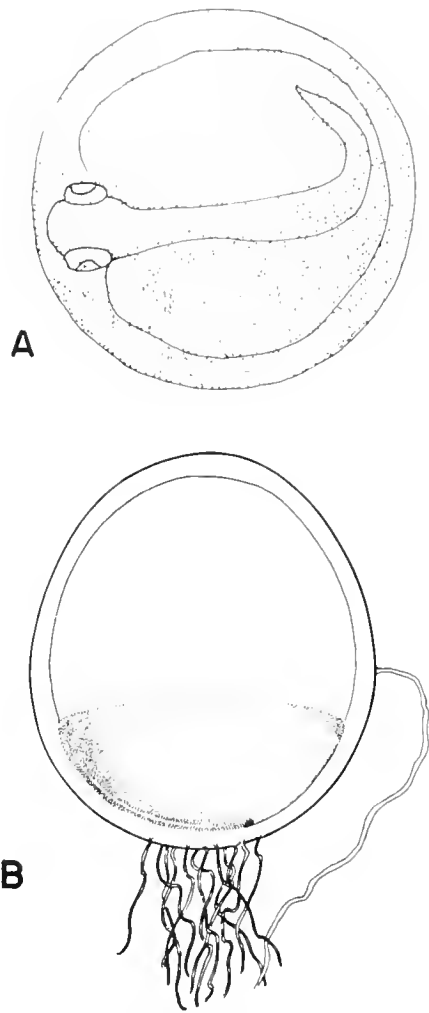

Fig. 173. Scomberesocidae eggs. (A) *Scomberesox saurus*, SWFC Cr. Est 1–4 Sta. Surf. 1; (B) *Cololabis saira*, SWFC CalCOFI. (Original.)

reported for egg size, belonids hatch at the largest sizes (6.8–14.4 mm) followed by hemiramphids (4.8–11 mm), scomberesocids (at least as small as 6.0–8.5 mm), exocoetids (3.5–6.1 mm), and adrianichthyids (3.5–4.5 mm).

Gut length differs between the two suborders. Adrianichthyoid larvae have a short gut, as in Atheriniformes and Cyprinodontiformes, 40–50% of standard length (Fig. 177A). Exocoetoid larvae are generally elongate and have a straight gut extending approximately two-thirds the standard length (Fig. 177B–E, G, and H).

Presence of a preanal finfold appears to be plesiomorphic. Job's (1940) illustration of a yolk-sac adrianichthyoid, *Oryzias melastigma*, shows a preanal finfold (Fig. 177A), but Kulkarni's (1940) illustration of a yolk-sac *Horaichthys setnai* does not. A preanal finfold is present until after formation of all fins in the belonids, hemiramphids and scomberesocids (Fig. 177B–E). The situation in the Exocoetidae is not clear. Most published illustrations of exocoetids do not show a preanal finfold. Ones that



A

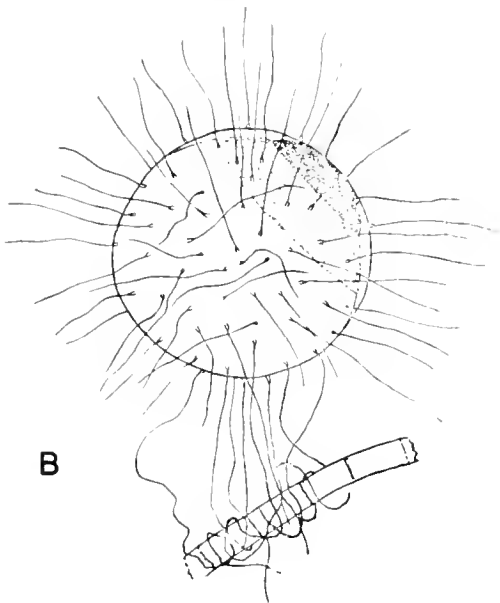

B



C

Fig. 174. Beloniidae eggs. (A) *Strongylura exilis*, LACM 43475-1; (B) *Strongylura strongylura*; (C) *Tylosurus acus*. (From: A. Original. B. Job and Jones, 1938. C. Mito, 1958.)

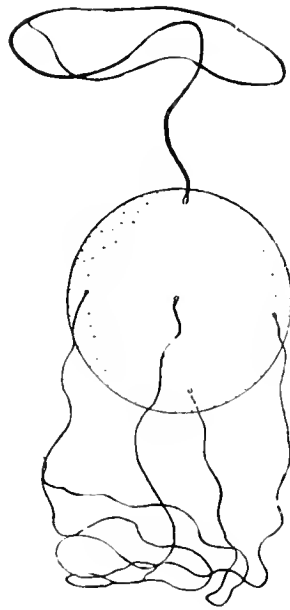

A

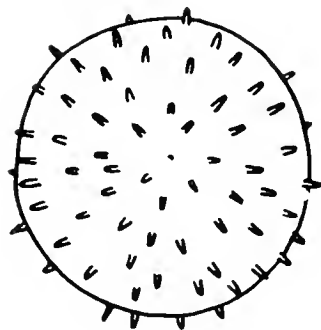

B



C

Fig. 175. Hemiramphidae eggs. (A) *Rhynchorhamphus georgii*; (B) *Oxyporhamphus micropterus*; (C) *Hemiramphus marginatus*. (From: A. Kovalevskaya, 1965. B. Imai, 1959. C. Talwar, 1968.)

do (Evans, 1962—*Hirundichthys affinis*; Vijayaraghavan, 1973—*H. coromandelensis*; Vijayaraghavan, 1975—*Cypselurus spilopterus* and Kovalevskaya, 1965—*Cheilopogon katoptron*) are of embryos or newly hatched larvae and, except for Kovalevskaya (1965), were hatched in the laboratory (Fig. 177H). In these examples the preanal finfold was small and soon lost. We have examined field-collected yolk-sac *Cheilopogon* (presumably *Ch. pinnatibarbatus californicus*) without finding a preanal finfold (Fig. 177G). Perhaps some exocoetids have a preanal finfold, but lose it soon after hatching. If so, most field-collected specimens may have already lost the preanal finfold by the minimum sizes typically illustrated.

Fin formation generally begins during the embryonic stages or soon after hatching. In fact, flexion of the caudal fin precedes hatching in flyingfishes (Ahlstrom and Moser, 1980). In the scomberesocids, belonids and hemiramphids, caudal, dorsal and anal fins generally form first followed by the pectorals and lastly the pelvics. Pectoral and pelvic buds as well as dorsal and anal anlagen are typically present at hatching in exocoetids. Pectoral fins form last in exocoetids, after the pelvic fins.

Belonids, scomberesocids and exocoetids generally hatch with heavy, uniform pigmentation formed or forming over essentially the entire body (Fig. 177B, C, and G). Exceptions are the freshwater needlefish *Xenentodon cancila*, which has 9–10 saddle-shaped dorsal aggregations plus a ventrolateral stripe (Fig. 177D) and some exocoetids of the genera *Paraxocoetus* and *Cheilopogon*, which have patterns somewhat reminiscent of the hemiramphids (compare Fig. 177E and H). This pattern consists of three rows of melanophores on each side of the body, one dorsal, one lateral and one ventral. Two hemiramphids reported to be exceptions to this are *Hyporhamphus quoyi* and *Hemiramphus marginatus*. These species hatch with pigment over the entire body; a pattern reminiscent of most other beloniforms. The pigment pattern in adrianichthyids resembles that in hemiramphids except dorsally where the adrianichthyids have a single middorsal row of melanophores (Fig. 181A), similar to the condition observed in Atheriniformes (see White et al., this volume) rather than the double row typical of most hemiramphids (Fig. 177F).

SPECIALIZED ONTOGENETIC STAGES

During post-embryonic development, beloniform fishes undergo a number of complex changes. Their larvae differ fairly strongly from juveniles and the juveniles are frequently unlike adults. Juveniles of related species frequently differ more from each other than do larvae or adults. In this section, notable ontogenetic changes are described for several character suites in the four families of the Exocoetoidei. Adrianichthyoids lack specialized ontogenetic stages.

Jaws, beaks, and barbels

Scomberesocidae.—Juveniles (20–40 mm SL) have slightly clongate upper and lower jaws but no prominent beaks (Fig. 181B; Hubbs and Wisner, 1980: fig. a). At about 60 mm SL, both upper and lower jaws, but especially the lower jaw, elongate in *Scomberesox* and *Nanichthys*. Elongation continues in both taxa to 100–120 mm SL. Both jaws elongate almost equally in *Scomberesox*; the lower jaw exceeds the upper in

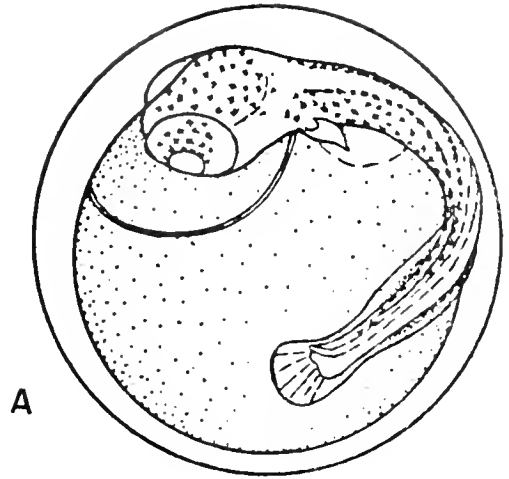

A

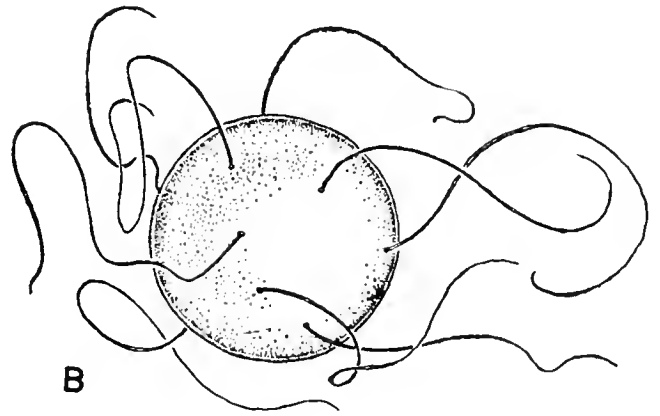

B

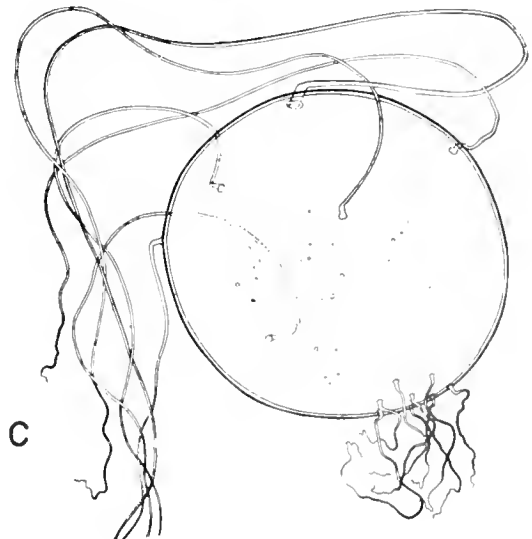

C

Fig. 176. Exocoetidae eggs. (A) *Exocoetus volitans*; (B) *Fodiator acutus pacificus*; (C) *Hirundichthys coromandelensis*. (From: A. Parin and Gorbunova, 1964. B. Breder, 1938. C. Vijayaraghavan, 1973.)

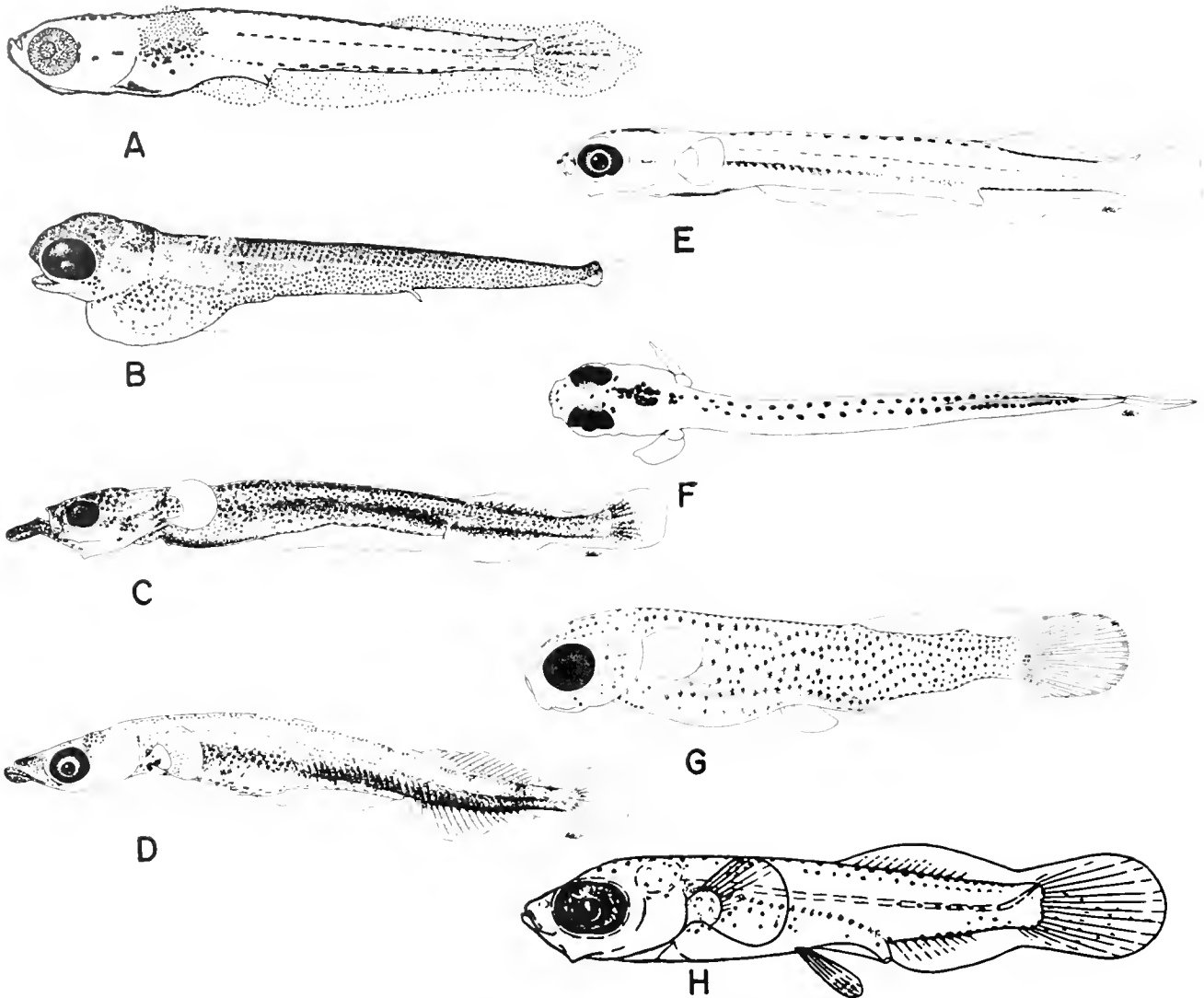

Fig. 177. Beloniform larvae. (A) Adrianichthyidae: *Oryzias melastigma*, 4.3 mm; (B) Scomberesocidae: *Cololabis saira*, SWFC 5009-50.110, 5.1 mm SL; (C-D) Belonidae: (C) *Strongylura exilis*, LACM 42756-5, 8.6 mm SL; (D) *Xenentodon cancila*, 9.6 mm SL ANSP 124230; (E-F) Hemiramphidae: (E-F) *Hyporhamphus rosae*, 5.7 mm SL, LACM 42870-5; (G-H) Exocoetidae: (G) *Cheilopogon pinnatibarbus californicus*, LACM IP77-3, 3.7 mm SL; (H) *Cheilopogon katoptron*, 3.2 mm SL. From: (A) Job, 1940; (B-G) Original; (H) Kovalevskaya, 1965.

Nanichthys. A slight beak develops in *Cololabis*; *Elassichthys* does not develop a distinct beak.

Belonidae.—Most species of Belonidae pass through a “half-beak” stage in which the lower jaw, but not the upper jaw, is greatly elongate. Juveniles of *Belone belone* remain in the half-beak stage for a longer time than other needlefishes. This has led directly to four synonyms of *Belone belone* described as halfbeaks (Collette and Parin, 1970:16–17). Plotting the relative length of the lower jaw extension, as a percentage of head length against body length (Fig. 178), shows that lower jaw extension in *B. belone* may be nearly 150% of head length at 25 mm BL (body length) and decreases to less than 10% by 175 mm BL. *Petalichthys* and *Platybelone* (Fig. 179E) also remain in the halfbeak stage for a long time. The duration of the halfbeak stage varies among species of *Strongylura* (Fig. 179C and F).

Comparative development of *Platybelone* (as *Strongylura longleyi*), *Strongylura marina*, *S. notata*, and two species of *Tylosurus*, (*T. acus* and *T. crocodilus*, Fig. 179G and J) was illustrated by Breder (1932: figs. 7 and 10, plates 1 and 2). *Tylosurus crocodilus* (Fig. 179J) completely lacks a halfbeak stage, upper and lower jaws growing at the same rate from larval to adult stages of development (Breder, 1932: plate 2, fig. 2, as *T. raphidoma*). The South American freshwater genus *Belonion* (maximum size 42 mm body length) is characterized by maturing while still in the halfbeak stage (Fig. 179A–B) and was considered paedomorphic by Collette (1966).

Hemiramphidae.—Adults of four genera of halfbeaks lack the elongate lower jaw that characterizes most members of the family. The lower jaw extends only 1.5–11.0 mm beyond the upper jaw throughout the size range in *Arrhamphus* (Collette, 1974b).

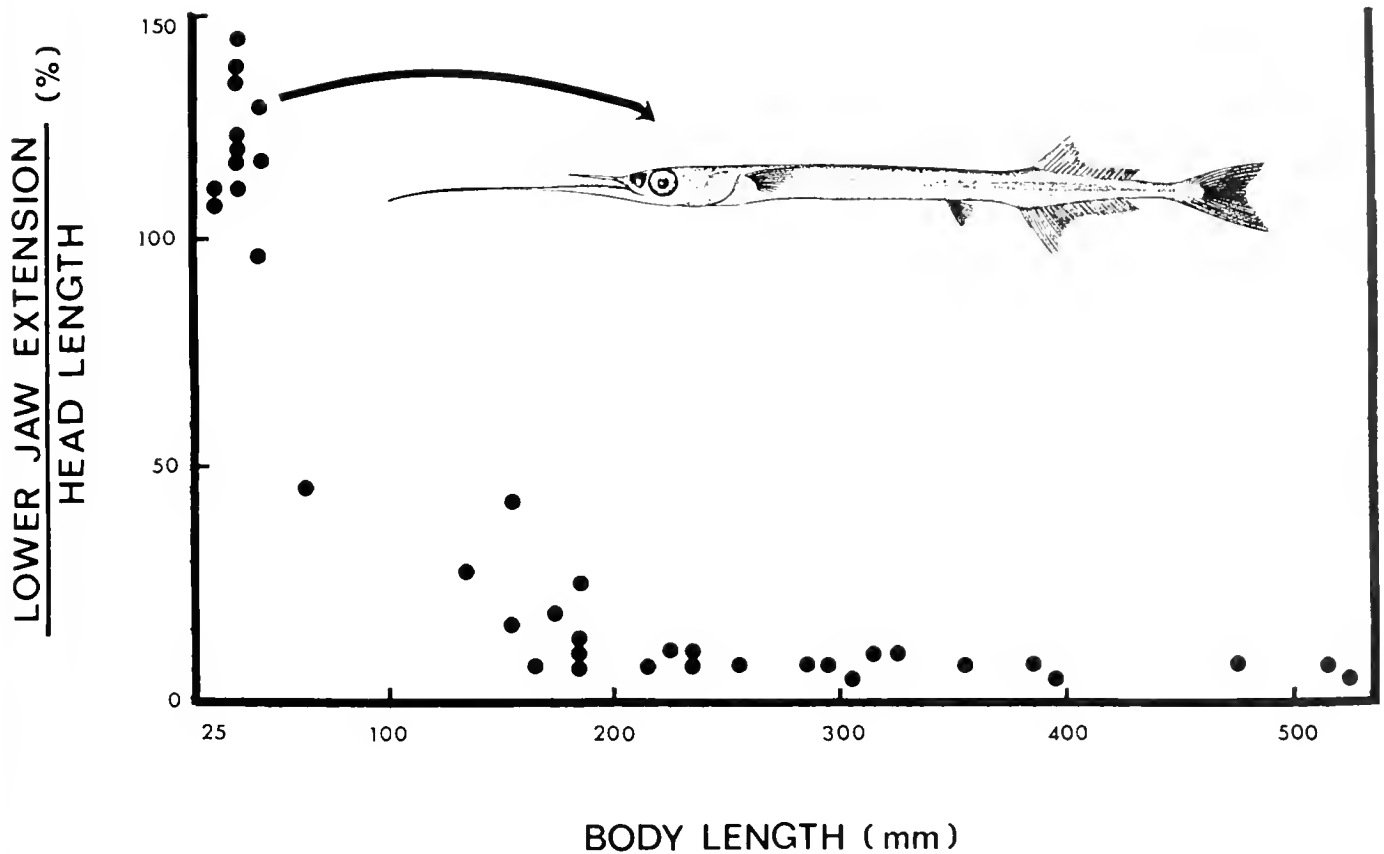

Fig. 178. Relative growth of upper jaw in *Belone belone*. Lower jaw extension as a percent of head length plotted against body length. Inset is of a 43.7 mm BL *B. belone* from Ireland in the "halfbeak" stage. (From: Collette and Parin, 1970.)

The lower jaw is even shorter in *Melapedalion* and virtually absent in adult *Chriodorus* and *Oxyporhamphus*. *Chriodorus* looks superficially more like an atherinid than a halfbeak, hence its specific name of *atherinoides*. Adult *Oxyporhamphus* resemble flyingfishes because of the enlarged pectoral fins. Juveniles of all four genera have a distinct beak. *Arrhamphus*, *Melapedalion*, and *Chriodorus* have always been considered halfbeaks. *Oxyporhamphus* has usually been considered an exocoetid or placed in a separate family.¹ Even with its short beak, *Arrhamphus* varies geographically in beak length; *Arrhamphus s. sclerolepis* of northern Australia has a proportionately shorter lower jaw (up to 20 times in head length) than does *A. sclerolepis krefftii* of southern Queensland and New South Wales (up to 11 times in head length, see Collette, 1974b: fig. 4).

Exocoetidae.—The two most primitive genera of flyingfishes, *Fodiator* and *Parexocoetus*, have an elongate lower jaw (Parin,

¹ Parin (1961), although still recognizing the Oxyporhamphidae as valid, clearly showed that *Oxyporhamphus* is a halfbeak, even though it has a straight margin to the upper jaw instead of triangular as in other halfbeaks. Two developmental characters support placement of *Oxyporhamphus* in the Hemiramphidae: a preanal fin fold is present in larvae (absent or lost soon after hatching in Exocoetidae) and the pelvic fins form last (pectoral fins form last in Exocoetidae).

1961; Kovalevskaya, 1982). This clearly is a beak in juvenile (15–55 mm SL) *Fodiator*, which like several genera of halfbeaks, lose their beaks as they grow larger (Fig. 181C and Breder, 1938: figs. 5 and 6E). A beak is present in *Parexocoetus mento* (Imai, 1959). Small (19–20 mm) *P. brachypterus* have a pair of barbels that are attached to the ventral surface of the beak and obscure it (Fig. 182). Thus, a beak which is absent in advanced flyingfishes, is present in both primitive genera.

Juvenile stages of many exocoetids develop barbels on the lower jaw (Table 91). Barbels range from relatively short to longer than body length (Fig. 181D–I). *Parexocoetus mento* does not develop a barbel nor do species of *Prognichthys* and *Hirundichthys* (Kovalevskaya, 1982). Paired barbels develop in *Parexocoetus brachypterus* and in all species of *Cheilopogon* (Fig. 181D, G–I; Kovalevskaya, 1982). In species of *Cheilopogon* (subgenus *Procypselurus*, *Ch. nigricans* group), the barbels consist of a thick strand with a leathery fold branching off it in the form of a lobe (Parin, 1961; Kovalevskaya, 1982). In small specimens of *Ch. cyanopterus* the barbel may be complex and have 2–3 flaps. Members of *Cheilopogon* (subgenus *Maculocoetus*) have flattened barbels, joined together at the base. These may be large. The barbels of *Cheilopogon* (subgenus *Ptenichthys*) range from short (in *Ch. heterurus doederleini*) to long (in *Ch. unicolor*). The barbels in *Cheilopogon pinnatibarbatu*

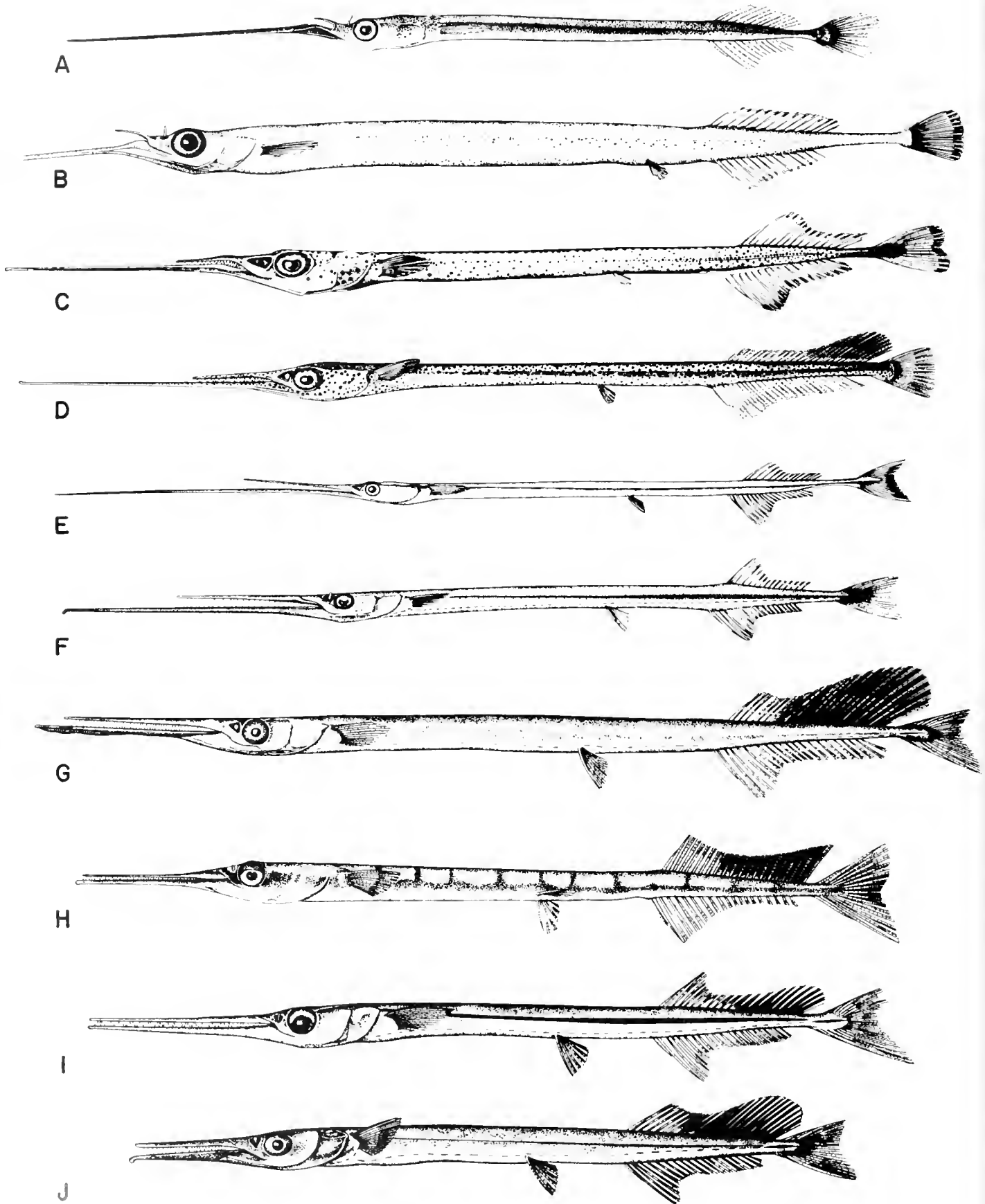

(subgenus *Cheilopogon* s. str.) are flaplike and fringed (Fig. 181I). Kovalevskaya (1982) considered this to result from the fusion of paired barbels and our examination of *Ch. pinnatibarbatus californicus* supports this. The barbel is single in *Cypselurus* (subgenus *Cypselurus* s. str.) and *Exocoetus monocirrhus* (Fig. 181F; Parin, 1961; Kovalevskaya, 1982). Some species of *Cypselurus* (subgenus *Poccilocypselurus*, *Cy. poecilopterus* and *Cy. starksi*) do not develop a barbel, nor do the remaining two species of *Exocoetus*, *E. obtusirostris* and *E. volitans*.

Melanistic dorsal fin lobe

Pelagic members of three families (all except Scomberesocidae) develop prominent melanistic lobes in the dorsal fin. The lobe is in the posterior part of the dorsal fin in the Belonidae and Hemiramphidae but in the middle of the fin in the Exocoetidae so presence of the lobe is not necessarily homologous.

Belonidae.—*Ablennes* and *Tylosurus* are characterized by having a prominent enlarged melanistic lobe in the posterior part of the dorsal fin (Fig. 179D, G–J). Other genera of needlefishes (Fig. 179) lack any trace of this posterior dorsal lobe. Breder (1932: plates 3–5) illustrated the development of this posterior lobe in *T. acus* and *T. crocodilus* and its absence in *Strongylura* and *Platybelone*. Parin (1967) left an Australian species difficult to place in either *Tylosurus* or *Strongylura* in a monotypic genus described by Whitley, *Lhotskia gavaloides*. A juvenile with a well-developed posterior dorsal lobe, captured by Collette, convinces us that it is a species of *Tylosurus* (Fig. 179H). The lobe is apparently sloughed off in *Tylosurus crocodilus* (Breder and Rasquin, 1952), resorbed in *T. acus* (Breder and Rasquin, 1954), and retained in adult *Ablennes*.

Hemiramphidae.—Juveniles of *Hemiramphus* and *Oxypramphus* develop a darkened posterior lobe on the dorsal fin (Fig. 180) similar to that present in two genera of needlefishes, *Ablennes* and *Tylosurus*.

Exocoetidae.—In juveniles of many species of *Cheilopogon*, the middle portion of the dorsal fin develops a melanistic lobe (Fig. 181H). This is reminiscent of the adult stage of *Parexocoetus* and *Fodiaria acutus*.

Body bars

Juveniles of some species in three exocoetoid families (all except Scomberesocidae) have vertical bars on their body.

Belonidae.—Juveniles of two species of *Tylosurus*, *T. gavaloides* (Fig. 179H) and *T. acus* (see Collette and Parin, 1970: fig. 12) and *Ablennes hians* have bars. These bars are retained in adult *Ablennes* as is the posterior dorsal fin lobe.

Hemiramphidae.—The 10 species of the genus *Hemiramphus* all have a series of broad vertical bars on the body (Fig. 180A–E) at some stage of their development. Body bars are retained for different periods of time during development: all body bars are lost before 105 mm SL in *He. lukei* and *He. depauperatus* (Parin et al., 1980: fig. 32), before 120 mm SL in *He. bermudensis* and *He. brasiliensis* (Collette, 1962: fig. 1), but are retained past 175 mm SL in *He. balao*; one blotch is retained throughout life in *He. robustus*, and all are retained in *He. far*.

Pelvic fin pigment

All 10 species of *Hemiramphus* also have pigmented pelvic fins as juveniles (Fig. 183). The patterns of pelvic fin pigmentation divide the genus into two species groups, one with pigmentation concentrated proximally on the fin (*balao* group, Fig. 183, top two rows), the other with pigment absent basally and concentrated distally (*far-brasiliensis* group, Fig. 183, bottom row). Body bars and pelvic fin pigmentation are absent in *Ilyporhamphus*.

Exocoetidae.—In late larval and juvenile stages of many flyingfishes, *Exocoetus*, *Cheilopogon* (at least some species in all subgenera except possibly *Paracypselurus*, for which we lack data), *Cypselurus* (subgenus *Poccilocypselurus*—see Imai, 1959), and *Hirundichthys oxycephalus* (Imai, 1960) transverse stripes develop on the abdomen and sides of the body which disappear (sometimes leaving traces) in adults. The coloration of the larvae and particularly of the juveniles of flyingfishes is diverse, and, as a rule, differs greatly from the coloration of adults. A particularly bright variegated coloration is characteristic of young of neritic species living among algae (Parin, 1961; Kovalevskaya, 1982).

RELATIONSHIPS

Beloniformes

The Beloniformes were defined by 7 characters by Rosen and Parenti (1981:16). Meristic characters for the beloniform genera are summarized in Table 92. A cladogram for the families and higher taxa of the Beloniformes is presented as Fig. 184.

Adrianichthyoidei

Rosen and Parenti (1981) defined the adrianichthyoids by 5 characters. Larval adrianichthyoids also differ from exocoetoids in having a shorter preanal distance, 40–50% of standard length. Rosen and Parenti (1981) included the Horaichthyidae and Oryziidae in the Adrianichthyidae. By this definition the Adrianichthyidae includes four genera, *Adrianichthys*, *Horaichthys*, *Oryzias* and *Xenopocilus* with a total of 11 species (Nelson, 1976). These fishes inhabit fresh and/or brackish waters from India and Japan to the Indo-Australian Archipelago.

Fig. 179. Halfbeak stages of Belonidae, arranged by relative length of upper jaw. (A) *Belonion apodion* Collette; USNM 199540; Brazil, Borba; 29.4 mm BL; (B) *Belonion dibranchodon* Collette; USNM 199463; Venezuela, Río Atabapo; 38.2 mm BL; (C) *Strongylura marina* (Walbaum), USNM 189006; Nicaragua; 23.5 mm BL; (D) *Ablennes hians* (Valenciennes); USNM 188843; Gulf of Honduras; 36.1 mm BL; (E) *Platybelone argalus argalus* (Le Sueur) USNM 198102; 39°28'N, 69°30'W; 96 mm BL; (F) *Strongylura exilis* (Girard); SIO H47-158-23A; Calif., La Jolla; 72.5 mm BL; (G) *Tylosurus acus* (Lacepède); USNM 198402; 38°00'N, 65°25'W; 130 mm BL; (H) *Tylosurus gavaloides* (Castelnau); USNM 226666; Australia, New South Wales; 72.5 mm BL; (I) *T. choram* (Forsskal); USNM 147438; Red Sea; 95.0 mm BL; (J) *T. c. crocodilus* (Peron and Le Sueur); USNM 198407; 37°08'N, 66°14'W; 96.3 mm BL. A–G, I–J drawn by Mildred H. Carrington; H by Keiko Hiratsuka Moore; A–C from Collette (1966: fig. 1).

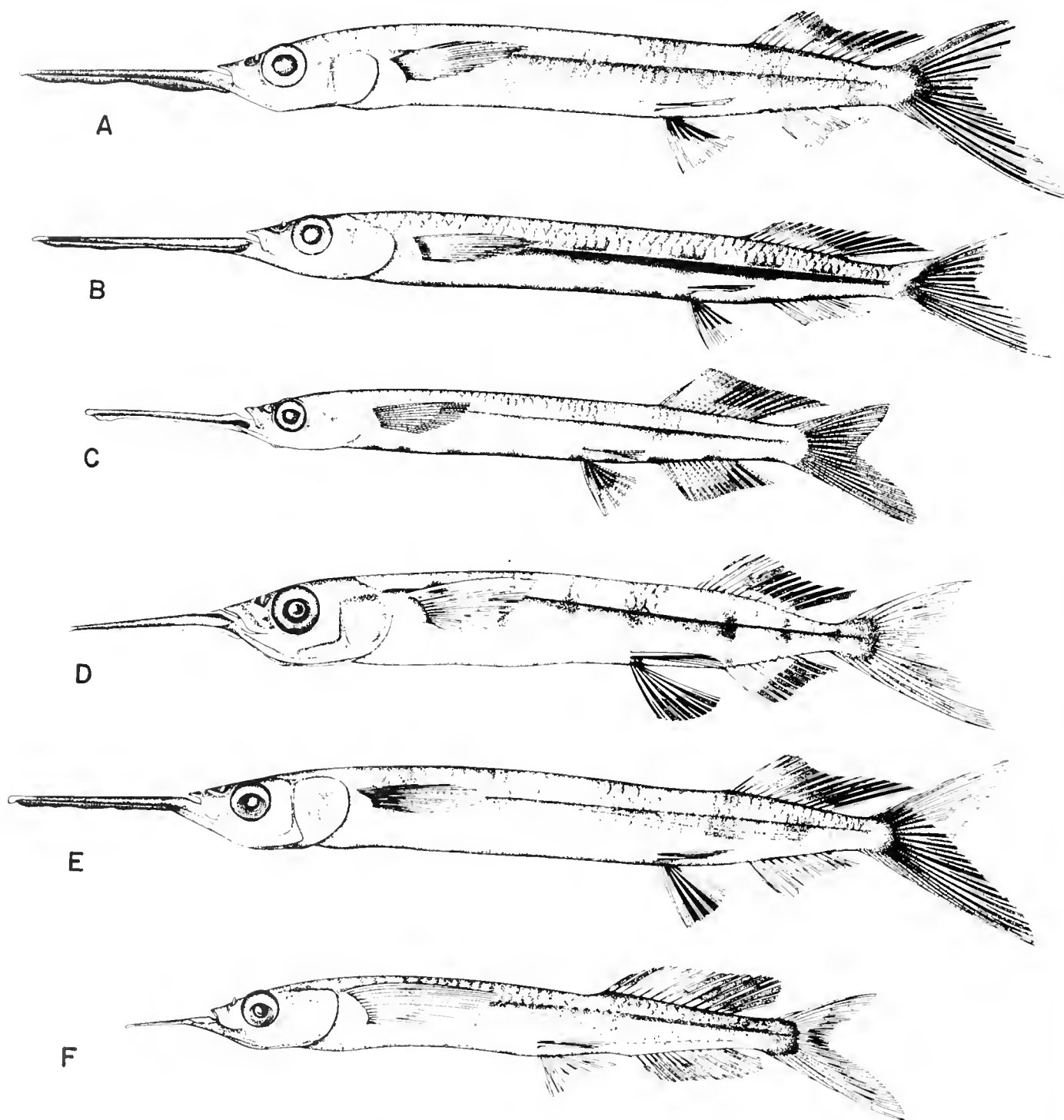

Fig. 180. Juvenile banded stages of five species of *Hemiramphus* and *Oxyporhamphus micropterus*. (A) *Hemiramphus balao* (Le Sueur); USNM 200592; off Cape Hatteras, North Carolina; 53.7 mm SL; (B) *He. saltator* (Gilbert and Starks); SIO 55-247; Gulf of Panama; 49.5 mm SL; (C) *He. depauperatus* Lay and Bennett; Hawaii Inst. Mar. Biol.; Hawaiian Is.; 41.4 mm SL; (D) *He. far* (Forsskål); USNM 148020; Persian Gulf; 47.0 mm SL; (E) *He. brasiliensis* (Linnaeus); USNM 188748; off North Carolina; 50.0 mm SL; (F) *Oxyporhamphus micropterus similis* Bruun; USNM 159032; Gulf of Mexico; 41.2 mm SL. A–B, D–F drawn by Mildred H. Carrington; C by Keiko Hiratsuka Moore.

TABLE 91. LARVAE OF BELONIFORM FISHES. Much of this information is based entirely on illustrations from the cited references.

Taxon	Hatching length (mm)	Beak	Barbel	Sources
Adrianchthyidae		None	None	
<i>Horaichthys setnai</i>	3.5-4.0			Kulkarni, 1940
<i>Oryzias melastigma</i>	4.0-4.5			Job, 1940
Scomberesocidae			None	
<i>Cololabis saira</i>		Slight or none		Hubbs and Wisner, 1980 and original
<i>C. adocetus</i>		None		Hubbs and Wisner, 1980
<i>Scomberesox saurus</i>	6.0-8.5	Present by 15-17 mm		Hardy, 1978a; Fahay, 1983
<i>S. simulans</i>		Present by 40 mm		Hubbs and Wisner, 1980
Belonidae			None	
<i>Abennes hians</i>		Present by 13.9 mm		Mito, 1966
<i>Belone belone</i>	9.0	Present by 18 mm		Russell, 1976
<i>Platybelone argalus</i>		Present by 47 mm		Original
<i>Strongylura marina</i>	9.2-14.4	Present by 14.3 mm		Hardy, 1978a
<i>S. strongylura</i>	6.75	Present by fifth day		Job and Jones, 1938
<i>Tylosurus acus</i>	10.16	Present by 14.1 mm		Hardy, 1978a
<i>T. crocodilus</i>	10.7-12.0	Present by 15.2 mm		Masurekar, 1968
<i>Xenentodon cancila</i>	10.5	Present		Foster, 1973
Hemiramphidae			None	
<i>Dermogenys pusillus</i>	~11			Soong, 1968
<i>Hemiramphus brasiliensis</i>	5-7 SL	Present by 13.0 mm		Hardy, 1978a; Berkeley and Houde, 1978
<i>He. marginatus</i>	5.85			Talwar, 1968
<i>Hemiramphodon pogonognathus</i>	~11			Soong, 1968
<i>Hyporhamphus guoyi</i>	~6.3	Present at hatching		Sudarsan, 1968b
<i>Hy. limbatus</i>		Present by 12.0 mm		Nair, 1952b; Job and Jones, 1938
<i>Hy. intermedius lutkei?</i>	4.8	Present by 10.7 mm		Uchida et al., 1958
<i>Hy. sajori</i>		Present by 12.3 mm		Uchida et al., 1958
<i>Oxyporhamphus convexus</i>		Present by 14.7 mm		Kovalevskaya, 1965
<i>O. micropterus micropterus</i>	7.7	Present by 6-8 mm		Chrapkova-Kovalevskaya, 1963; Kovalevskaya, 1965c
Exocoetidae				
<i>Cheilopogon (A.) agoo</i>	4.5-5.3	None	Pair, short, present by 19.0 mm	Imai, 1960
<i>Ch. (Ch.) pinnatibarbatus californicus</i>	4.1-4.8 mean = 4.45	None	Fan-like, complex with 14 fimbriae	Hubbs and Kampa, 1946
<i>Ch. (Ch.) pinnatibarbatus japonicus</i>	4.6-5.8	None	Fan-like with flaps, present by 20.1 mm	Imai, 1959
<i>Ch. (M.) spilonotopterus</i>		None	Pair, very long, present by 10.4 mm	Imai, 1959
<i>Ch. (M.) spilopterus</i>	4.52	None		Vijayaraghavan, 1975
<i>Ch. (M.) suttoni</i>		None	Pair, flattened and joined at the base	Kovalevskaya, 1982
<i>Ch. (Proc.) cyanopterus</i>		None	Pair, complex on smaller individuals, then long filaments	Breder, 1938; original
<i>Ch. (Proc.) exsilhens</i>	4.5?	None	Pair, medium, present by 14.5 mm	Imai, 1959
<i>Ch. (Proc.) katoptron</i>		None	Short, present by 10.2 mm	Kovalevskaya, 1965
<i>Ch. (Proc.) nigricans</i>		None	Pair, long, complex	Kovalevskaya, 1982
<i>Ch. (Pt.) furcatus</i>		None	Pair, medium length, develop on individuals between 7.7 and 18 mm	Hildebrand and Cable, 1930
<i>Ch. (Pt.) heterurus</i>		None	Pair, present by 19 mm TL	Hardy, 1978a
<i>Ch. (Pt.) h. doederleini</i>	5.2-6.1	None	Pair, short, present by 18.1 mm	Imai, 1959
<i>Ch. (Pt.) unicolor</i>		None	Pair, long, present by 5.8 mm	Gorbunova and Parin, 1963
<i>Cypselurus (Cv.) comatus</i>		None	Single, medium length	Breder, 1938
<i>Cy. (Cv.) narestu</i>		None	Single tape-like, very long with appendages at the base	Imai, 1959

TABLE 91. CONTINUED.

Taxon	Hatching length (mm)	Beak	Barbel	Sources
<i>Cy. (Cy.) opisthops hiraii</i>	4.5–5.1	None	Single, petalous, present by 17.5 mm	Imai, 1959
<i>Cy. (Poec.) poecilopterus</i>		None	Absent	Imai, 1959
<i>Cy. (Poec.) starksi</i>	5.2	None	Absent	Imai, 1959
<i>Exocoetus monocirrhus</i>		None	Single, long, develops on individuals between 16.0 and 18.6 mm	Kovalevskaya, 1964; Imai, 1959
<i>E. obtusirostris</i>		None	Absent	Kovalevskaya, 1964
<i>E. volitans</i>		None	Absent	Kovalevskaya, 1964
<i>Fodiator acutus</i>		Present by 14.6 mm	Absent	Original
<i>Hirundichthys (D.) albimaculatus</i>		None	Absent	Kovalevskaya, 1972
<i>H. (D.) marginatus</i>		None	Absent	Kovalevskaya, 1972
<i>H. (D.) rondeletti</i>		None	Absent	Imai, 1960
<i>H. (H.) affinis</i>		None	Absent	Evans, 1962; Breder, 1938
<i>H. (H.) coromandelensis</i>	3.47–4.23	None	Absent	Vijayaraghavan, 1973; Kovalevskaya, 1972
<i>H. (H.) oxycephalus</i>		None	Absent	Imai, 1960
<i>H. (H.) speculiger</i>		None	Absent	Imai, 1960
<i>Parexocoetus brachypterus brachypterus</i>		Present by 18.1 mm	Pair, short	Imai, 1959
<i>P. mento mento</i>	4.5–5.2	Present by 23.8 mm	Absent	Tsukahara and Shiokawa, 1957; Imai, 1959
<i>Prognichthys gibbifrons</i>		None	Absent	Original
<i>P. scalei</i>		None	Absent	Imai, 1960

Exocoetoidei

Defined by six characters by Rosen and Parenti (1981: 16). We here add two developmental characters: oil droplets in egg minute or absent and preanal distance of larvae increased to about 66% of standard length.

The Exocoetoidei is undoubtedly a monophyletic group. However, various opinions have been expressed as to which group within the suborder is the most primitive. A number of authors have considered the Hemiramphidae to be the most generalized family based largely on the fact that needlefishes and primitive flying fishes (*Fodiator*) pass through an ontogenetic halfbeak stage during development. Parin (1961) and Rosen (1964) supported this viewpoint. On the other hand, Nichols and Breder (1928) and Breder (1932) considered the family Belonidae the most primitive. To resolve the directionality of the "halfbeak" stage (suite four), three additional character suites, each suite consisting of several correlated transformation series, were considered. Apomorphic character states are numbered higher than plesiomorphic states on Fig. 184.

The first suite involves pharyngeal tooth plate fusion, transformation series A–B. State A1 is close opposition of left and right fifth ceratobranchial tooth plates characteristic of more primitive Atherinomorpha and the Adrianichthyoidei. State A2 is the fusion of left and right lower pharyngeal bones into a tooth

plate in the Exocoetoidei. Series B state 1 is when the third upper pharyngeals are separated by a gap. State B2 is when they are joined but not fused in the Exocoetoidea. State B3 is the complete fusion of the third upper pharyngeals into a tooth plate in the Hemiramphidae.

The second suite involves loss of gill arch skeleton bones, transformation series C–D. State C1 is presence of the fourth epibranchial, C2 its loss in the Beloniformes. State D1 is the presence of the fourth upper pharyngeal tooth plates, D2 their loss in the superfamily Exocoetoidea.

The third suite involves reduction in the cephalic lateralis system, transformation series E–F (data from Parin and Astakhov, 1982). The cephalic system is more complete in the Scomberesocoeidea than in the Exocoetoidea, including the presence of a premaxillary canal (E1), an autapomorphy unique among teleosts. The pre-, supra-, and post-orbital system is continuous across the top of the head in state 1. There are short interruptions in the system in state 2 in the Belonidae. The postorbital section is lost in state 3 and secondary bony canals are lost in state 4, both characteristic of the superfamily Exocoetoidea.

We now return to the fourth suite of transformation series and resolve the directionality of the "halfbeak" stage. The fourth suite includes elongation of upper and lower jaws and presence of barbels in juveniles, transformation series G–I. State G1 is

Fig. 181. Late larval and early juvenile stages of beloniform fishes. (A) Adrianichthyidae: *Oryzias melastigma*, 12 mm; (B) Scomberesocidae: *Cololabis adocetus*, SWFC 7205 J-20.145, 25 mm SL; (C–I) Exocoetidae: (C) *Fodiator acutus pacificus*, SWFC FB-62-242, 15.4 mm SL; (D) *Cheilopogon unicolor*, 18.5 mm SL; (E) *Cypselurus comatus*, 25 mm SL; (F) *Exocoetus monocirrhus*, SWFC FB-62-203, 27 mm SL; (G) *Parexocoetus brachypterus*, 43.5 mm SL; (H) *Cheilopogon cyanopterus*, 54 mm SL; (I) *Cheilopogon pinnatubarbatus japonicus*, 80 mm SL. From: (A) Job, 1940; (B, C, and F) Original; (D) Gorbunova and Parin, 1963; (E, G and H) Breder, 1938; (F) Kovalevskaya, 1964; and (I) Abe, 1954.

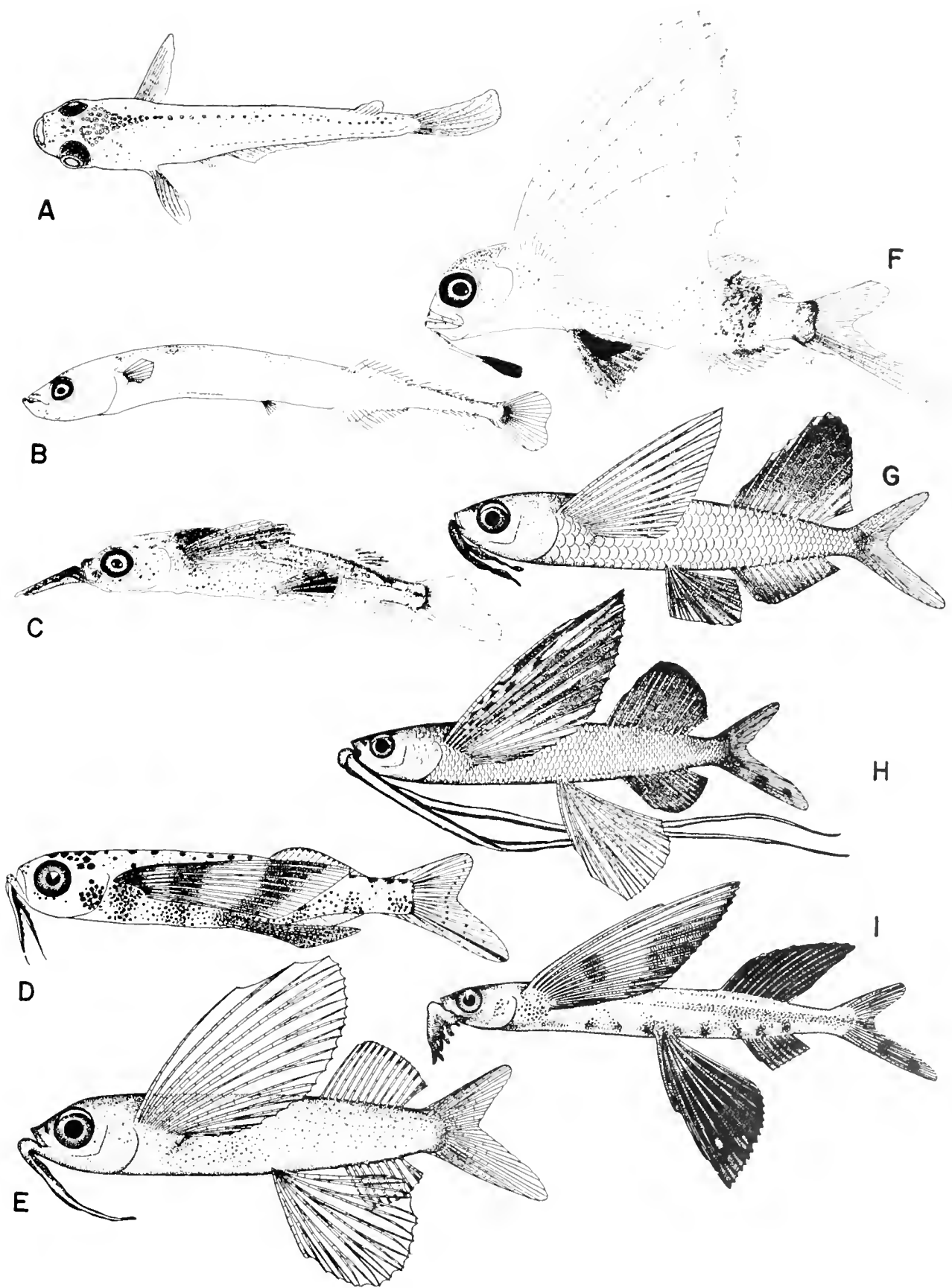

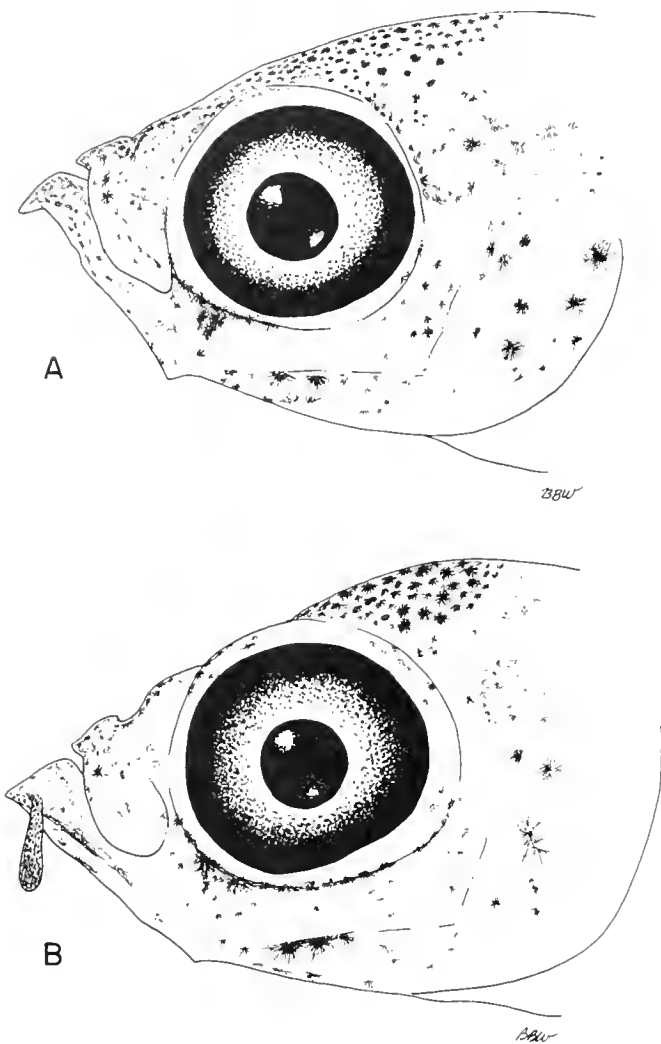

Fig. 182. Exocoetidae, *Parexocoetus brachypterus brachypterus*. (A) 18.1 mm; (B) 19.7 mm.

lower jaw elongate in juveniles and adults, G2 elongate only in juveniles, and G3 never elongate, even in juveniles. Presence of an elongate lower jaw is considered a synapomorphy of the suborder Exocoetoidei because it is present in the most generalized members of each of the four families. This is supported ontogenetically by its presence in juveniles and loss in adults of four genera of Hemiramphidae and in the two least derived subfamilies of Exocoetidae.

Transformation series H involves elongation of the upper jaw. It is most parsimonious to hypothesize the elongation of the upper jaw as a synapomorphy (H2) of the superfamily Scomberesocoidea. Thus, the absence of an elongate upper jaw is plesiomorphous (H1) in the Exocoetoidea.

Transformation series I is the development of barbels in juveniles of advanced flyingfishes. State I1 is the absence of barbels. If we consider barbels in flyingfishes to be derived from the pair of cutaneous lappets on the lower jaw of needlefishes, hallbeaks, and primitive flyingfishes, the most generalized state

of this character is the presence of two separate barbels, I2 (Fig. 185). This supposition is supported ontogenetically by two juvenile *Parexocoetus brachypterus brachypterus*. The smaller one (Fig. 182A, 18.1 mm) has a short beak from the ventral surface of which a pair of small barbels develop in the larger one (Fig. 182B, 19.7 mm). Fusion into a single barbel (I3) and secondary loss of the barbels (I4) are more derived states. Loss of the barbels has apparently occurred independently in the three most advanced subfamilies of the Exocoetidae.

Scomberesocoidea

The superfamily is defined by two derived characters: presence of a premaxillary canal, unique among teleosts; and upper jaw at least slightly elongate. Other diagnostic characters include: third pair of upper pharyngeal bones separate, fourth upper pharyngeal bone usually present, scales on body small. The Scomberesocoidea differ from the Exocoetoidea in four characters of the acoustico-lateralis system (Parin and Astakhov, 1982). The cephalic system is more complete in the Scomberesocoidea than in the Exocoetoidea.

Scomberesocidae

Defined by one derived character: dorsal and anal fins followed by a series of finlets. Other diagnostic characters include: upper and lower jaws only slightly elongate, teeth small; pectoral branch of lateral line absent, posttemporal simple. There are four more differences in the acoustico-lateralis system between the Scomberesocidae and the Belonidae (Parin and Astakhov, 1982).

Four monotypic genera were recognized by Hubbs and Wisner (1980): *Scomberesox* and its dwarf derivative *Nanichthys*, and *Cololabis* and its dwarf derivative *Elassichthys*. All sauries are marine holopepelagic fishes. *Scomberesox* reaches the largest size, 450 mm SL, *Nanichthys* reaches 126 mm; *Cololabis* reaches 350–400 mm, *Elassichthys* only 68 mm. The two dwarf taxa differ convergently from *Scomberesox* and *Cololabis* in losing one ovary and the swimbladder and in having fewer vertebrae, branchiostegal rays, pectoral fin rays, and gill rakers. Rather than recognizing four monotypic genera, we recognize two evolutionary lines in the family by considering *Nanichthys* as a synonym of *Scomberesox* and *Elassichthys* a synonym of *Cololabis* as previously suggested by Parin (1968).

Belonidae

Defined by one derived reductive character: interruptions in the cephalic lateralis system. Other diagnostic characters include: no finlets following dorsal and anal fins; both upper and lower jaws usually elongate and studded with relatively large sharp teeth; pectoral branch of lateral line present; posttemporal forked.

The Belonidae contain 10 genera and 32 species (Collette, 1966, 1974a, 1982a). Four genera are monotypic: the southern African *Petalichthys*, the worldwide *Ablennes* and *Platybelone*, and the Asian freshwater *Xenentodon*. *Belone* contains two eastern Atlantic species. Three genera are restricted to freshwaters of South America: *Pseudotylorus* (two species), *Potamorhaphis* (three), and *Belonion* (two). *Tylorus* contains five species of strictly marine species; *Strongylura* 14 species, some marine, some estuarine, and three strictly freshwater.

The genera *Belone* and *Petalichthys* appear to be most gen-



Fig. 183. Ventral view of pelvic fins of three species of *Hemiramphus* showing development and loss of pigmentation. Top row: *He. balao*: 34.6, 44.3, 75.0, 117, 146, and 163 mm SL. Middle row: *He. saltator*: 22.0, 23.5, 34.4, 66.0, 105, and 224 mm SL. Bottom row: *He. far.*: 21.5, 45.0, 62.8, 96.0, 116, and 224 mm SL.

TABLE 92. NUMBER OF DORSAL, ANAL, AND PECTORAL FIN RAYS, VERTEBRAE AND GILL RAKERS ON THE FIRST GILL ARCH IN THE GENERA OF BELONIFORMES.

Family and genus	No. of spp	D	A	P ₁	Vertebrae			GR
					Precaud	Caud	Total	
Adriamichthyidae								
<i>Adriamichthys</i>	1	17	25	16				
<i>Horachthys</i>	1	6-7	22-32					
<i>Oryzias</i>	7	6-9	17-25	11-15			29-32	13
<i>Xenopoecilus</i>	2	11-13	21-27	11-13				
Belonidae								
<i>Belone</i>	2	16-20	19-23	11-14	48-54	25-30	75-84	27-52
<i>Petalichthys</i>	1	16-19	21-23	10-12	46-47	26-27	72-74	27-35
<i>Platybelone</i>	1	11-17	15-21	10-13	39-48	23-29	62-76	7-14
<i>Tylosurus</i>	5	18-27	17-25	11-15	41-65	23-33	67-96	0
<i>Ablennes</i>	1	22-26	24-29	11-15	51-63	30-37	82-97	0
<i>Strongylura</i>	14	12-23	12-27	9-13	34-57	19-34	53-90	0
<i>Xenentodon</i>	1	14-19	14-19	10-12	35-40	21-25	57-62	0
<i>Pseudotylosurus</i>	2	13-16	14-19	8-11	42-47	25-28	67-73	0
<i>Potamorhaphis</i>	3	27-43	24-39	6-8	35-42	28-44	64-85	0
<i>Belomion</i>	2	11-14	12-15	5-6	32-37	19-23	52-59	0
Scomberesocidae								
<i>Scomberesox</i>	1	15-18	17-21	12-15	39-43	24-28	64-70	34-51
<i>Namchthys</i>	1	14-16	17-20	10-11	35-38	22-26	58-62	19-26
<i>Cololabis</i>	1	14-18	18-21	12-15	37-40	24-29	62-69	32-42
<i>Elassichthys</i>	1	14-18	16-21	8-11	32-35	21-24	54-59	15-21
Hemiramphidae								
<i>Arrhamphus</i>	1	13-16	14-17	12-14	28-32	16-19	18-25	45-50
<i>Chriodorus</i>	1	15-18	15-17	12-14	31-33	18-19	49-51	20-24
<i>Melapedahon</i>	1	15-17	14-16	12-13	33-35	17-18	51-52	25-31
<i>Hemiramphus</i>	10	11-15	9-14	10-13	30-41	16-19	50-59	25-48
<i>Rhynchorhamphus</i>	4	13-17	12-16	10-12	37-40	16-19	54-59	47-78
<i>Hyporhamphus (Hyporhamphus)</i>	23	12-17	13-17	10-13	28-37	16-20	45-55	20-53
<i>Hyporhamphus (Reporhamphus)</i>	11	13-18	13-19	10-13	31-42	15-20	49-61	26-47
<i>Oxyporhamphus</i>	2	12-15	13-17	11-13	30-33	17-19	47-50	26-36
<i>Euleptorhamphus</i>	2	20-25	20-25	7-9	44-46	26-29	70-75	24-35
<i>Zenarchopterus</i>	17	10-16	8-14	7-11	25-36	11-18	38-51	11-18
<i>Dermogenys</i>	3	8-12	14-17	9-13	21-24	16-17	38-40	11-14
<i>Hemirhamphodon</i>	3	14-23	8-9	8-9	24-26	14-16	38-41	11-16
<i>Nomorhamphus</i>	2	12-13	13-17	11-13	21-24	17-19	40-42	0
Exocoetidae								
<i>Fodiator</i>	1	9-11	10-12	13-14	25-26	14-16	39-41	29-33
<i>Parexocoetus</i>	2	9-13	10-14	12-14	21-25	14-16	36-40	23-32
<i>Exocoetus</i>	3	13-15	12-15	14-17	24-27	16-20	42-44	23-35
<i>Cypselurus</i>	11	10-14	7-10	13-17	28-20	13-15	39-48	17-24
<i>Cheilopogon</i>	18	9-16	7-12	13-17	25-30	12-16	41-51	19-28
<i>Proganchthys</i>	4	10-13	8-10	14-19	26-34	12-17	43-45	21-28
<i>Hirundichthys</i>	8	9-13	9-13	15-20	26-31	14-19	42-47	23-32

eralized (Collette and Berry, 1965; Parin, 1967), having well-developed gill rakers, large scales, comparatively weak canine teeth and other generalized characters. *Belone* also is characterized by the most completely developed cranial lateralis system (Parin and Astakhov, 1982). Of the other genera, the greatest number of primitive characters are found in *Platybelone*, characterized at the same time by several specialized features (in particular, the well-developed cutaneous lateral keel on the caudal peduncle). The remaining three genera of marine needlefishes (*Strongylura*, *Ablennes*, and *Tylosurus*) are more advanced but their relationships have been interpreted differently by Collette and Berry (1965), Parin (1967), and Astakhov (1980). The freshwater genera of needlefishes, in the opinion of all au-

thors, have been derived from the genus *Strongylura* or its ancestor and are secondary freshwater fishes.

Exocoetoidea

The superfamily is defined by one derived character and three losses: third pair of upper pharyngeal bones united into a plate; fourth upper pharyngeal bone lost; postorbital section and secondary bony canals of cephalic lateralis system lost. Other diagnostic characters include: scales on body large, lower jaw frequently elongate but upper jaw never significantly elongate; and premaxillary canal absent.

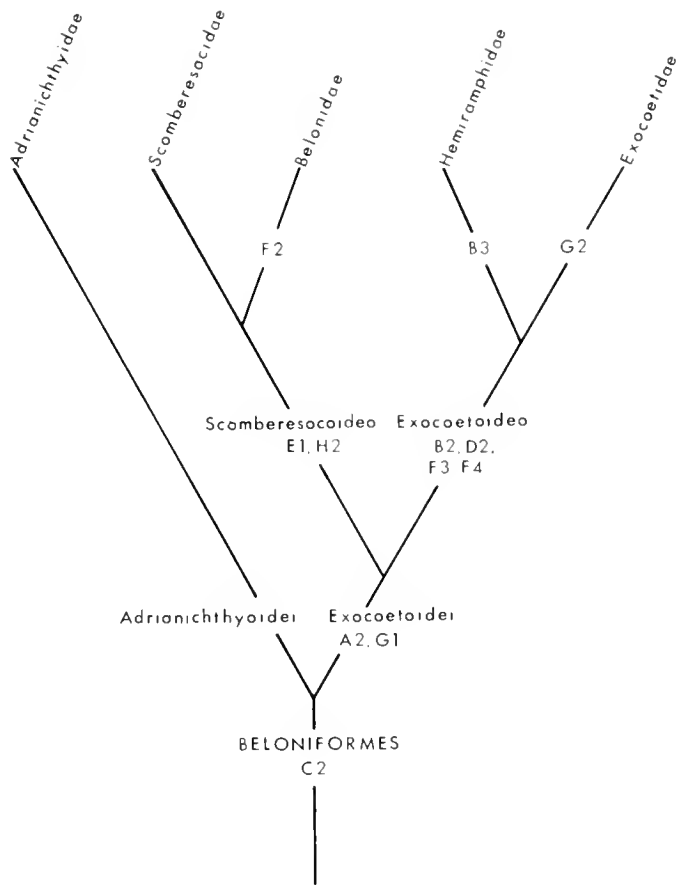

Fig. 184. Cladogram of the Beloniformes. See text for explanation of character transformation series A–H.

Hemiramphidae

Defined by one derived character: third pair of upper pharyngeal bones ankylosed into a plate. Other diagnostic characters include: pectoral fins short or moderately long; premaxillae pointed anteriorly, forming a triangular upper jaw (except in *Oxyporhamphus*); lower jaw elongate in juveniles of all genera, adults of most genera; parapophyses forked; swimbladder not extending into haemal canal.

The Hemiramphidae contains 12 genera and at least 80 species (Parin et al., 1980). Four genera, the first three monotypic (*Arhamphus*, *Chriodoris*, *Melapedalion*, and *Oxyporhamphus*) have very short or no beaks. *Euleptorhamphus* and *Oxyporhamphus* contain two offshore species each. *Zenarchopterus*, *Dermogenys*, *Hemiramphodon*, and *Nomorhamphus* contain about 25 sexually dimorphic Indo-West Pacific estuarine or freshwater species. Three of these genera (*Dermogenys*, *Hemiramphodon*, and *Nomorhamphus*) are viviparous and have the anal fin of the male modified into what Brembach (1976) has termed an andropodium. *Hemiramphus* (with 10 species) is a world wide marine genus. *Rhynchorhamphus* (with 4 species) has fimbriate nasal papillae and is confined to Indo-West Pacific

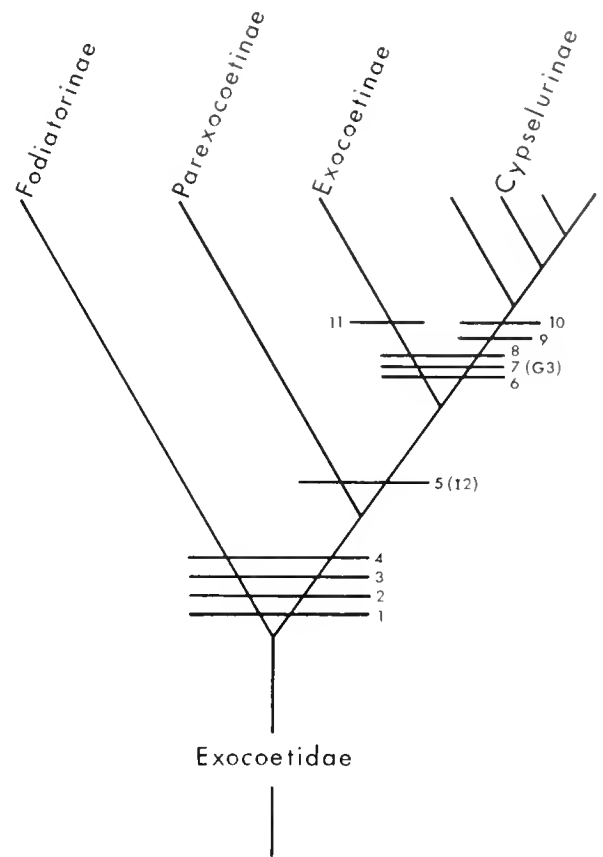

Fig. 185. Cladogram of the Exocoetidae. 1. Swimbladder extends into haemal canal. 2. Pectoral fins enlarged. 3. Lower jaw not elongate in adults. 4. Loss of preanal finfold. 5. Barbels present in juveniles (I2). 6. Pectoral lateral line branch lost. 7. Beak lost in juvenile (G3). 8. Pectoral fins greatly enlarged. 9. Swimbladder extends far into haemal canal. 10. Pelvic fins enlarged. 11. Egg filaments lost.

marine waters. *Hyporhamphus*, the most speciose genus, includes two subgenera, *Hyporhamphus* with 23 species, *Reporhamphus* with 11 species. Some of these are marine, some estuarine, and some freshwater. All genera are characterized by particular lateral line characters (Parin and Astakhov, 1982).

Exocoetidae

Defined by one derived morphological character and three derived early life history characters: swimbladder extending into haemal canal; lower jaw of adults not elongate; preanal finfold reduced or lost; and pectoral fins form last. Other diagnostic characters include: third pair of upper pharyngeal bones coalescent, the plate readily separating into its left and right components; pectoral fins long; premaxillae with straight anterior margin; parapophyses simple, not forked.

The family Exocoetidae contains 7 genera and about 50–55 species (Parin, 1961) which have been placed in four subfamilies (Bruun, 1935; Parin, 1961; Fig. 185): Fodiatorinae containing

only *Fodiator acutus* (with two subspecies; reaching 195 mm SL); Parexocoetinae with two species of *Parexocoetus* (reaching 140 mm SL); Exocoetinae with three species of *Exocoetus* (reaching 200 mm SL); and Cypselurinae with four genera—*Prognichthys* (4 species; reaching 190 mm SL), *Cypselurus* sensu stricto (11 species; reaching 260 mm SL), *Cheilopogon* (not differentiated from *Cypselurus* by some authors; 18 species; contains the largest species of flyingfishes, some reaching 380 mm SL), and *Hirundichthys* (8 species; reaching 190 mm SL; includes the more specialized subgenus *Danichthys* which was recognized as a genus by Bruun and others). All are strictly marine, mostly in tropical and subtropical waters.

Similarities in the skeletal structure (Parin, 1961) and lateralis system (Parin and Astakhov, 1982) between *Exocoetus* and the Cypselurinae (*Cheilopogon*, *Cypselurus*, *Prognichthys*, and *Hirundichthys*) indicate that differentiation of *Exocoetus* from the main stem took place significantly later than separation of the primitive short-winged flyingfishes (*Fodiator* and *Parexocoetus*). There is particular interest in the interrelationships within the subfamily Cypselurinae. One problem concerns whether *Cypselurus* should be accepted in the wide sense (Bruun, 1935; Staiger, 1965; Gibbs and Staiger, 1970) or divided into two genera, *Cypselurus* and *Cheilopogon* (Parin, 1961). The diagnostic differences between these two genera are not simple. Therefore, Parin herein presents the following definition: "lower jaw usually a little shorter than the upper; at least some jaw teeth tricuspid; juveniles with a single chin barbel or without barbels" in *Cypselurus*, and "lower jaw a little longer than upper, teeth mostly unicuspid or with smaller supplementary cusps laterally; juveniles with two barbels which may be fused into a napkin-like appendage" in *Cheilopogon*. Each genus contains groups of species, several of which were distinguished by Bruun (1935) or Parin (1961) at the level of subgenera.

The similarities and differences between species groups are most noticeable in the juvenile stages and form the basis of the systematics of the Cypselurinae worked out by Parin (1961). If we consider barbels in flyingfishes to be derived from the pair of cutaneous lappets on the lower jaw of needlefishes, halfbeaks, and primitive flyingfishes, the most generalized state of this character is the presence of two separate barbels. Their derivatives are fusion into a single appendage or complete loss. In the speciose genus *Cheilopogon*, according to the classification of Parin (1961), the juvenile stages of most intrageneric groupings—the subgenera *Procypselurus* (composed of the *Ch. nigricans* and *Ch. cyanopterus* groups), *Maculocoetus*, and *Abeichthys*—are characterized by a pair of barbels, sometimes joined at their bases, and presence of an enlarged melanistic dorsal fin ("Parexocoetus stage"). In juveniles of the subgenus *Cheilopo-*

gon, the dorsal fin is greatly enlarged, but the barbels are fused into a fringed appendage. In the subgenus *Ptenichthys*, paired barbels remain but the "Parexocoetus stage" is lost (present only in *Ch. longibarbus*, which, apparently should be removed from this subgenus). The subgenus *Paracypselurus* is somewhat intermediate between *Cheilopogon* and *Cypselurus*. Juveniles have paired barbels and an enlarged dorsal fin, but adults are closer to *Cypselurus* in structure of the jaw and other characters (except absence of tricuspid teeth).

SUMMARY

There is a considerable amount of information available on the early life stages of beloniform fishes. Specialized structures such as egg filaments, barbels, beaks, and melanistic dorsal fin lobes have systematic value. It is pleisiomorphic for the eggs of beloniform fishes to have chorionic filaments (Rosen and Parenti, 1981). One or more loss events presumably gave rise to the apomorphic condition, an absence of chorionic filaments, seen in the dwarf sauries (*Cololabis adocetus* and *Scomberesox simulans*) and in the flyingfishes of the genus *Exocoetus*. The development of a beak during some life stage is a derived feature that occurs in all belonids, scomberesocids (except *C. adocetus*) and hemiramphids, and the two most primitive exocoetid genera (*Fodiator* and *Parexocoetus*). It is never found in the adrianichthyids. Presence of a beak is a synapomorphy for the Exocoetoidei and supports Rosen and Parenti's (1981) division of the Beloniformes into two suborders, the Adrianichthyoidei (no beak) and the Exocoetoidei (beak). A second character that supports this is relative length of the gut at hatching, 40–50% standard length in Adrianichthyoidei and approximately 66% in the Exocoetoidei. The superfamily Scomberesocoidea differs from the Exocoetoidea in having a premaxillary lateral line canal and in having the upper jaw at least slightly elongate.

(B.B.C.) NATIONAL MARINE FISHERIES SERVICE SYSTEMATICS LABORATORY, NATIONAL MUSEUM OF NATURAL HISTORY, WASHINGTON, DISTRICT OF COLUMBIA 20560; (G.E.M.) SECTION OF ICHTHYOLOGY, LOS ANGELES COUNTY MUSEUM OF NATURAL HISTORY, 900 EXPOSITION BOULEVARD, LOS ANGELES, CALIFORNIA 90007; (N.V.P.) P.P. SHIRSHOV INSTITUTE OF OCEANOLOGY, ACADEMY OF SCIENCES OF THE U.S.S.R., KRASIKOVA STREET 22, MOSCOW 117218, U.S.S.R.; (S.M.) RESEARCH DIVISION, FISHERIES AGENCY, MINISTRY OF AGRICULTURE, FORESTRY AND FISHERIES, GOVERNMENT OF JAPAN, 2-1, 1-CHOME, KASUMIGASEKI, CHIYODA-KU, TOKYO, JAPAN.

Atheriniformes: Development and Relationships

B. N. WHITE, R. J. LAVENBERG AND G. E. MCGOWEN

IN the latest statement on the evolutionary relationships of the atherinomorph fishes (Rosen and Parenti, 1981), monophyly could not be established for the Atherinoidei. No derived characters could be offered to unite the constituent families (Atherinidae, Bedotiidae, Isonidae, Melanotaeniidae, Phallostethidae, and Telmatherinidae) and the group term Atherinoidei was dropped in favor of a listing convention placing them in Division I of a general classification of the series Atherinomorpha. In this report, two synapomorphic character states are described that suggest that the Division I fishes are indeed a monophyletic group and the group name Atheriniformes is resurrected for this assemblage. This new order is defined by a derived larval pigmentation pattern and a reduction in preanal length that persists from hatching through early flexion. Except for this modification, the classification and familial designations of Rosen and Parenti (1981) are accepted here.

DEVELOPMENT

Eggs

Information on atheriniform egg morphology is assembled in Table 93. The smallest atheriniform egg known, that of *Atherion elymus*, measures 0.55–0.58 mm in diameter (Nakamura, 1936). The largest eggs average approximately 2.3 mm in diameter and are found in the genus *Atherina* (Marion, 1894a; Kanidzev, 1961). Numerous oil globules are found in the yolk of most species. Usually, the globules aggregate at the vegetal pole and may coalesce into a single droplet that comes to lie near the heart. In *Bedotia geayi*, the globules form an equatorial ring two hours after fertilization and reach the vegetal pole by the blastula stage (N. R. Foster, Fish. Wildl. Serv., Michigan, pers. comm.). At fertilization, there may be as few as one oil globule, in *Chirostoma bartoni* (de Buen, 1940), or as many as 115, in *Leuresthes tenuis* (David, 1939).

Although absent in *Leuresthes*, *Atherion*, and *Bedotia*, chorionic filaments are found on the eggs of most species. The eggs can be bound together in a mass by these filaments or attached singly to a substratum. There is only one filament on the eggs of *Eurystole eriarcha*, *Menidia extensa*, and *Telmatherina ladigesii* but most species have more. The filaments can be scattered over the surface of the egg, as in *Atherinops* and *Atherinopsis*, or gathered together in a tuft as in *Atherina*, *Membras*, *Odontesthes*, *Melanotaenia*, *Menidia menidia* and *Menidia beryllina*. In *Menidia beryllina*, one filament is much enlarged; being longer and thicker than the others making up the tuft (Hildebrand, 1922). Until more information is available, it will be difficult to assess the phylogenetic significance of this variation in the size, number and placement of the chorionic filaments. No pattern is readily apparent. In some cases, not all of the species assigned to a genus have the chorionic filaments arranged in the same way. In both *Menidia* and *Austromenidia* there are species in which the filaments are collected in a tuft and species in which they are randomly scattered. Two egg types may occur in *Atherinops affinis*. There are approximately 6 fil-

aments attached at one end to the chorion (Crabtree, pers. comm.) (Fig. 186A) or 40–78 looped filaments attached by both ends to the egg surface (Curless, 1979). This unusual occurrence of two egg types in *Atherinops* may support the contention that there is more than one species in the genus (Hubbs, 1918).

The remarkable ovarian egg of *Eurystole eriarcha* is unlike that known for any other atheriniform species. It averages 1.7 mm in diameter and is pigmented, with a brownish band swirling over its surface (Fig. 186B). Arising from the pigmented portion of the chorion are numerous small anchor-shaped pedicels. Each egg has one major filament arising from the side of one of these unusually shaped pedicels (Fig. 187 upper). Some eggs appear to have a small number of finer filaments similarly attached to some of the other pedicels, but the majority of these chorionic projections do not have attached filaments. Each filament can become entangled in the pedicels of its own and neighboring eggs (Fig. 186B). The pedicels and small depressions that serve as bases of attachment are unpigmented.

The vitelline circulatory system of all atheriniform species examined is simple, unbranched and looping. This pattern is common within the Atherinomorpha. However, the vitelline circulatory system of the cyprinodontoids is characterized by a complex branching pattern.

Larvae

Morphologically, the larvae of the atheriniform fishes are much less variable than the eggs. Development is direct and the known larvae are similar in appearance (Fig. 188). Pectoral fin buds appear in embryos. Throughout the Atheriniformes the preanal finfold regresses as the origin of the dorsal finfold comes to be more posteriorly placed. After hatching, fin rays develop in the caudal fin ventral to the upturned tip of the vertebral column. Next, the pectoral, anal and second dorsal fins become rayed and then the pelvic fin buds develop. Finally, spines appear in the first dorsal and anal fins. The gut is short; with the preanal length averaging one-third the body length (NL or SL) from hatching through the time of flexion. In all atheriniform larvae known, except *Odontesthes debueni*, preanal length is less than 40% of body length at flexion. Preanal length in *Odontesthes debueni* is 45% of body length (Fig. 188A). All known atheriniform larvae are similarly pigmented. Melanophores occur on the top of the head and dorsally and laterally on the gut. Typically, a single row of melanophores occurs mid-laterally along the body, as well as on the dorsal and ventral margins.

Within the Atheriniformes, the total number of vertebrae ranges between 21 and 60, with the typical number of precaudal vertebrae being 22–23 (Ahlstrom notes; Rosen and Parenti, 1981). Meristic data are compiled for 89 atheriniform species and subspecies in Table 94.

Information is available on the early life history of a variety of atheriniform species. The larvae of *Atherinomorus insularium* (Miller et al., 1979), *Iso hawaiiensis* (Miller et al., 1979), *Odontesthes regia* (Fischer, 1963) and *Menidia menidia* (Hildebrand, 1922) follow the normal mode of atheriniform development

TABLE 93. EGG CHARACTERISTICS OF THE ATHERINIFORMES.

Taxon	Diameter (mm)	Oil globules	Vitelline circulation	Filaments	Sources
Atherinidae					
<i>Atherina boyeri</i>	1.72–1.76	Coalesce and move towards heart	Unbranched, looping	—	Sparta, 1942b
<i>Atherina hepsetus</i>	2.0–2.5	Coalesce and move towards heart	Unbranched, looping	Tuft	Marion, 1894a; Breder and Rosen, 1966
<i>Atherina mochon pontica</i>	2.3	Coalesce and move towards heart	Unbranched, looping	—	Kanidev, 1961
<i>Atherina presbyter</i>	1.85–1.95	—	—	Numerous	Miller, 1961
<i>Atherinops affinis</i>					
Channel Islands and Mainland	1.62	—	—	40–78 attached at both ends to the chorion	Curless, 1979
Mainland California		—	—	~6 attached at one end to the chorion	Crabtree, pers. comm.
<i>Atherinopsis californiensis</i>	2.0–2.5	Numerous		~12	Clark, 1929
<i>Atheron elymus</i>	0.55–0.58	Several large (0.16 mm) and small		Absent	Nakamura, 1936
<i>Austromenidia incisa</i>	1.7–2.15	Numerous, small		Present, scattered	de Ciechomski, 1972
<i>Austromenidia regia</i>	1.8–2.15	>50, coalesce into 1	Unbranched, looping	Tuft of 5–10	Fischer, 1963
<i>Chrostoma bartoni</i>	1.0–1.1	1; or several coalesce into 1	Unbranched, looping	Tuft	de Buen, 1940
<i>Eurystole eriarcha</i>	—	—	—	1 attached to one of numerous anchors	This study
<i>Leuresthes tenuis</i>	1.5–1.6	25–115 that coalesce	Unbranched, looping	Absent	David, 1939
<i>Membras vagrans</i>	0.8–1.1	12 that coalesce	Unbranched, looping	Tuft	Kuntz, 1916
<i>Menidia beryllina</i>	0.75	7–10 that coalesce	Unbranched, looping	Tuft	Hildebrand, 1922
<i>Menidia extensa</i>	0.6	—	—	1	Davis and Louder, 1969
<i>Menidia menidia</i>	1.25	7–10 that coalesce	Unbranched, looping	Tuft	Hildebrand, 1922
<i>Menidia notata</i>	2.1	Several of differing size	—	Tuft of 4	Ryder, 1883
<i>Odontesthes bonariensis</i>	~1.0	Several that coalesce	—	~10	Minoprio, 1944
<i>Odontesthes debueni</i>	1.65–1.86	10–20 globules that coalesce	Unbranched, looping	Tuft of 6–9	Fischer, 1963
Telmatherinidae					
<i>Telmatherina ladigesi</i>	—	—	—	1	Breder and Rosen, 1966
Bedotidae					
<i>Bedotia geayi</i>	~2.0	Numerous	Unbranched, looping	Absent	Neal R. Foster, pers. comm.
Phallostethidae					
<i>Gulaphallus mirabilis</i>	1	70–80 do not coalesce	—	8 scattered	Villadolid and Manacop, 1934
<i>Gulaphallus falctifer</i>	1.0–1.1	10–15 large; numerous small, do not coalesce	—	Many in a tuft	Manacop, 1936
Melanotaeniidae					
<i>Melanotaenia maccullochi</i>	1	Numerous, cluster but do not coalesce	—	Tuft	Neal R. Foster, pers. comm.
<i>Pseudomugil signata</i>	1.5	Numerous	Unbranched, looping	—	Neal R. Foster, pers. comm.
<i>Pseudomugil signifer</i>	1.6	—	—	—	Breder and Rosen, 1966

with some minor exceptions. The larva of *I. hawaiiensis* (Fig. 188B) has a deeper body than any other known atheriniform larva and *A. insularum* (Fig. 188C) lacks the ventral melanophore series typical of the order. The ventral melanophore series is also absent in *Odontesthes regia* (Fischer, 1963) which has only sparse midlateral pigment at hatching.

In *Menidia*, dorsal pigmentation can be sparse or even lacking (Hildebrand, 1922). In *M. menidia*, it has been reported that a double row of dorsal melanophores occurs in older larvae (ca. 11 mm) (Lippson and Moran, 1974). However, in a smaller flexion specimen (8 mm), we found a double row of melanophores in the area of the dorsal fin, but only a single row anterior to the fin. The dorsal melanophore row is interrupted by the dorsal fin in other atheriniform larvae as well. This pattern also occurs in the melanotaeniid genus, *Pseudomugil* (Foster, pers. comm.). It is not unusual for single melanophores to be divided by a developing fin in other fishes and it is assumed here that the more complex distribution of dorsal pigment in *Menidia* and *Pseudomugil* is a variation on the simpler pattern seen in *Atherinomorus*, *Iso*, *Odontesthes* and most other atheriniform larvae. In *Melanotaenia*, a single dorsal row develops. The larval morphology of *Melanotaenia* and *Pseudomugil* closely resembles that of the other atheriniform fishes (Foster, pers. comm.).

Larval *Dentatherina merceri* differ from all other known atheriniform larvae but resemble larval *Oryzias* in having a double row of melanophores on the nape. The melanophores on the dorsal surface of the trunk are unpaired except where they are interrupted by the developing dorsal fins. The larva of *Bedotia geayi* (Fig. 188D) has the single dorsal melanophore row and short gut typical of the Atheriniformes. Interestingly, the ventral pigment series of *Bedotia* is paired, with a row of melanophores flanking both sides of the anal finfold (Foster, pers. comm.).

The early life history stages of phallostethid fishes follow closely the atheriniform pattern. In both *Gulaphallus mirabilis* (Villadolid and Manacop, 1934) and *G. falcifer* (Manacop, 1936) the preanal length is short and a median series of melanophores develops middorsally. The exact disposition of the dorsal melanophores has not been described nor can it be assessed from published illustrations.

Relationships

Two ontogenetic character states suggest that the atheriniform fishes are a monophyletic group comprising an order, the Atheriniformes, of equal standing with the Beloniformes and Cyprinodontiformes. First, the preanal length of all known atheriniform flexion larvae, except *Odontesthes debueni*, is short; being approximately one-third of body length. Preanal length is variable in the other two atherinomorph orders but the preanal lengths of few, if any, beloniform or cyprinodontiform species are this short between hatching and early flexion. The Percomorpha is thought to be the sister group of the Atherinomorpha (Rosen and Parenti, 1981). In almost all primitive percomorpha, preanal length exceeds that of the Atheriniformes through flexion and approaches as much as 50–70% of body length (Ahlgren and Moser, 1976). The same can be said of the paracanthopterygian, myctophiform and aulopiform fishes (sensu Rosen, 1973, 1982). Preanal length is reduced in gadid fishes (Dunn, this volume), but the short gut typical of the cods is always looped and therefore is considered here to be nonhomologous with the condition seen in the atheriniforms. Outgroup comparison thus suggests that the reduced larval preanal length can

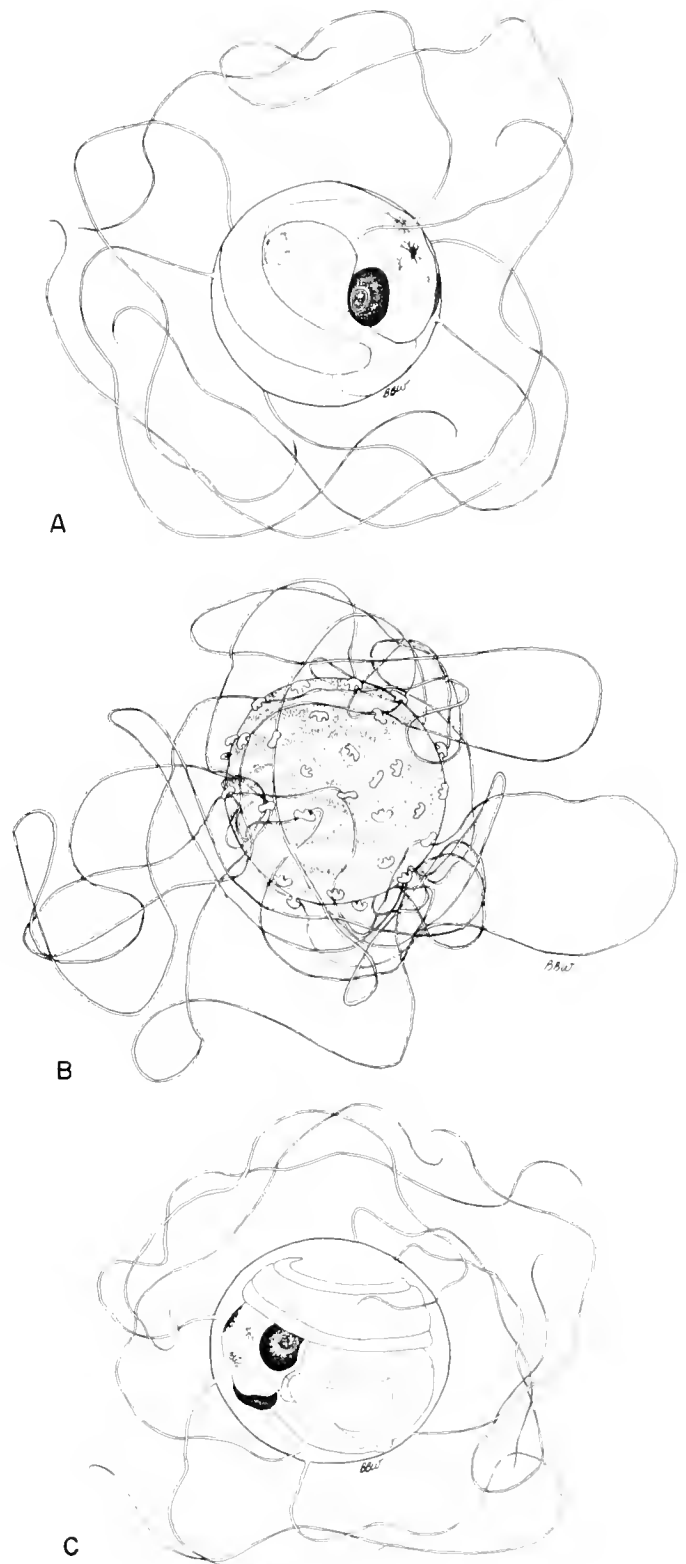

Fig. 186. (A) Atheriniform eggs. Mature egg, *Atherinops affinis*, Santa Catalina Island, California, LACM field no. IP-77-43; (B) Ovarian egg, *Eurystole eriarcha*, LACM 31784-5; and (C) *Atherinopsis californiensis*, egg, LACM 43446-1.

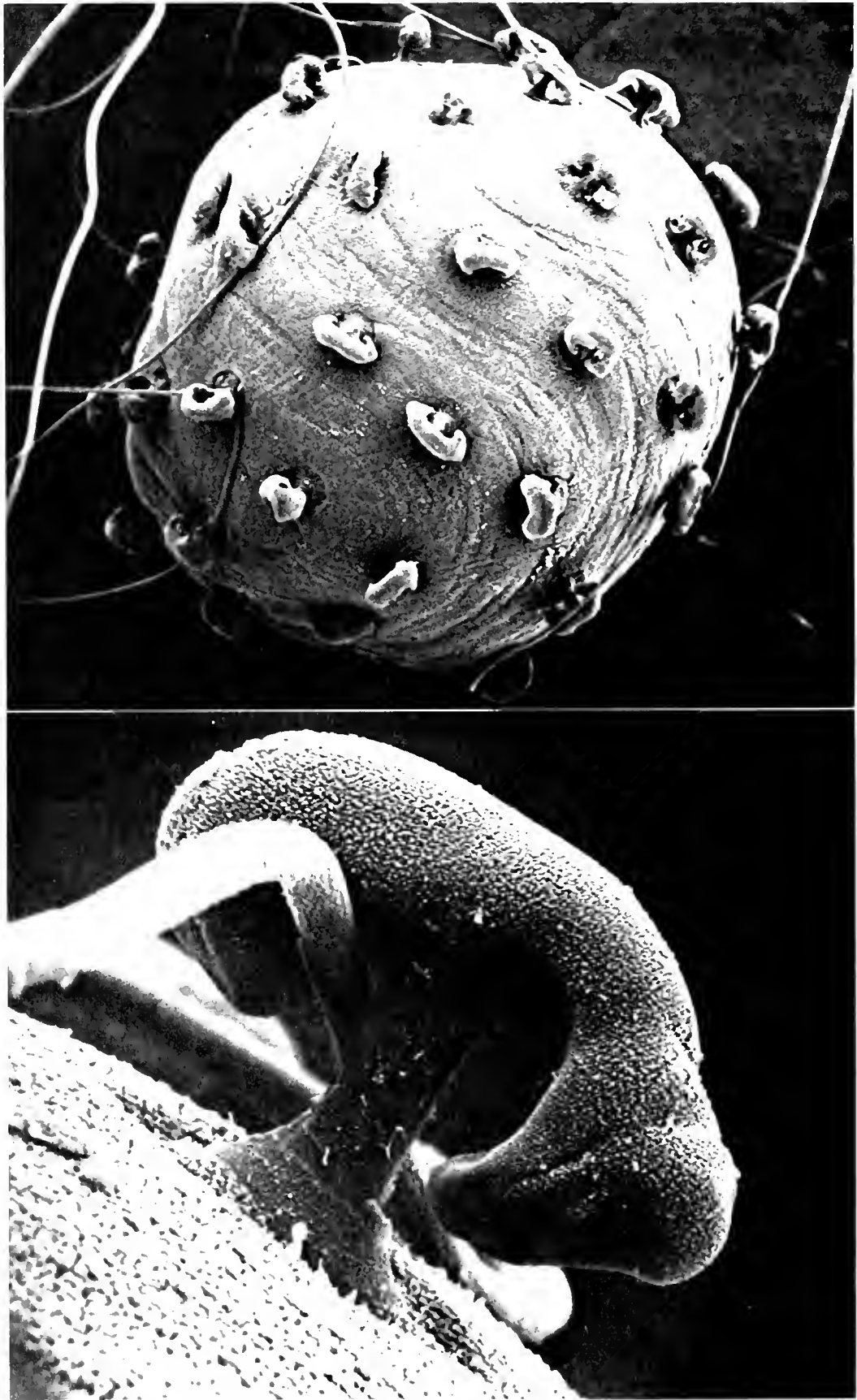

Fig. 187. Ovarian egg, *Eurystole eriarcha* LACM 31784-5. (upper) 100 \times ; (lower) 1,000 \times .

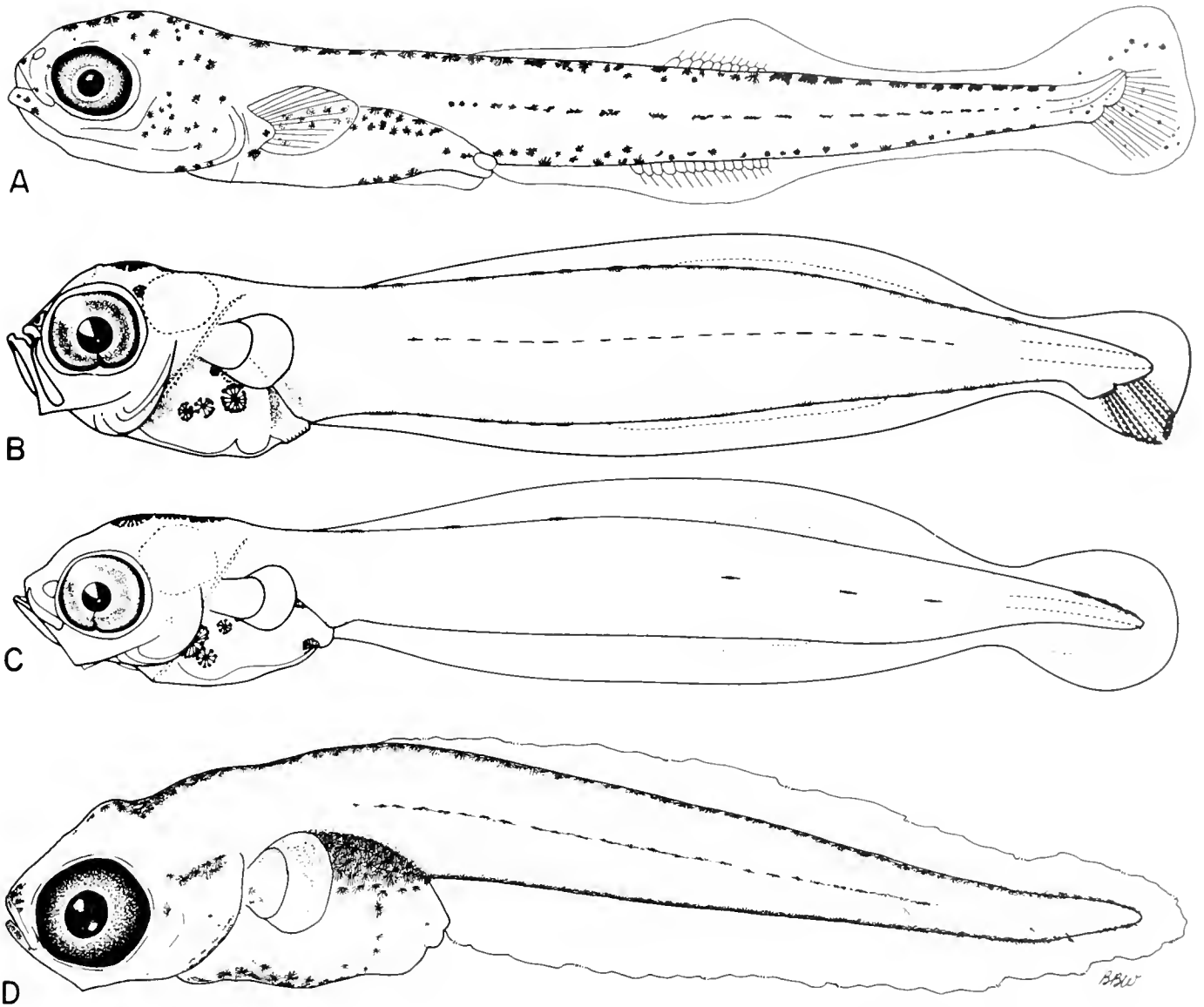

Fig. 188. (A) Atheriniform larvae, *Odontesthes debueni*; 10.2 mm SL, from Fischer, (1963); (B) *Iso hawauensis*; 6.2 mm SL, from Miller et al., (1979); (C) *Atherinomorus insularum*; 5.4 mm SL, from Miller et al., (1979); and (D) *Bedotia geayi*; 5.3 mm SL, LACM uncatalogued.

be used as a synapomorphous character state to define the Atheriniformes.

The second ontogenetic character state suggesting that the atheriniform fishes comprise a monophyletic group relates to larval pigmentation and may contribute to their cladistic diagnosis. In all atheriniform larvae a single row of melanophores develops on the dorsal margin (Fig. 189A). This situation contrasts with the Beloniformes and Cyprinodontiformes, where no consistent larval pigmentation pattern is evident (Hardy, 1978a). What is known of larval halfbeaks suggests that when a dorsal pigment series occurs it is always composed of at least a double row of melanophores (Fig. 189B).

While it is typical for cyprinodontiform larvae to develop dorsal, lateral and ventral pigment series (Foster, 1967), no consistent pattern is evident. In *Fundulus*, the middorsal me-

lanophores are arranged in a paired series (Hardy, 1978a). In *Cyprinodon variegatus* obscure blotches of pigment occur on the body (Hardy, 1978a). Melanophores are evenly distributed over the larva of *Lucania parva* (Hardy, 1978a). The larva of *Epiplatys sexfasciatus* has melanophores randomly distributed over its dorsal surface (Scheel, 1968). In the Atherinomorpha, only the adrianchthyoid fishes have larvae with dorsal melanophores arranged in a single row (Kulkarni, 1940; Job, 1940). This resemblance to the Atheriniformes is considered to be convergent because, given the internal relationships of the Atherinomorpha (Rosen and Parenti, 1981), it is more parsimonious to assume that a single dorsal melanophore row evolved independently in the Atheriniformes and Adrianchthyoidei because only two evolutionary events are involved. However, if this pigment pattern is viewed as a sympleisomorphy, it is necessary to invoke

TABLE 94. MERISTICS OF SELECTED ATHERINIFORM SPECIES. Only total fin elements are reported because of confusion in the literature as to the proper definition of spines and rays and the inconsistencies in published descriptions that resulted from this confusion.

	Fin rays				Vert.	Gill rakers	Reference
	D1	D2	A	Pect.			
Atherinidae							
<i>Allanetta mugiloides</i>	5-7	8-11	9-12	13-15	34-37	14-17	Ivantsoff, 1978
<i>Atherina boyeri</i>	6-9	11-14	12-16	15-17	42-46	17-24	Ivantsoff, 1978
<i>Atherina hepsetus</i>	7-9	10-13	11-14	17-19	52-55	25-28	Ivantsoff, 1978
<i>Atherina presbyter</i>	7-9	11-15	15-19	14-17	45-52	19-24	Ivantsoff, 1978
<i>Atherinason esox</i>	5-9	10-15	11-15	12-14	45-48	18-24	Ivantsoff, 1978
<i>Atherinason hepsetoides</i>	5-10	10-14	12-15	13-16	43-48	15-20	Ivantsoff, 1978
<i>Atherinomorus capricornensis</i>	3-7	10-11	13-16	15-18	42-44	20-24	Ivantsoff, 1978
<i>Atherinomorus endrachtensis</i>	4-6	9-11	12-15	13-17	35-39	18-22	Ivantsoff, 1978
<i>Atherinomorus ogilbyi</i>	4-7	9-12	12-17	16-19	37-42	22-28	Ivantsoff, 1978
<i>Atherinomorus pinquus</i>	4-7	9-12	13-16	15-19	38-43	18-25	Ivantsoff, 1978
<i>Atherinops affinis</i>	3-7	10-14	9-14	12-15	43-49	14-27	White, unpub.
<i>Atherinopsis californiensis</i>	4-9	10-15	20-29	14-17	46-53	18-44	White, unpub.
<i>Atherinosoma elongata</i>	4-8	9-13	9-15	12-16	37-43	12-16	Ivantsoff, 1978
<i>Atherinosoma microstoma</i>	5-9	9-12	9-14	12-16	37-42	12-15	Ivantsoff, 1978
<i>Atherinosoma presbyteroides</i>	6-8	10-14	11-16	12-14	41-48	15-20	Ivantsoff, 1978
<i>Atherion clymus</i>	3-5	9-14	14-16	12-15	38-42	10-14	Ivantsoff, 1978
<i>Atherion maccullochi</i>	3-5	10-13	15-19	12-14	43-46	10-16	Ivantsoff, 1978
<i>Colpichthys regis</i>	5-8	10-13	20-24	13-16	44-48	16-19	White, unpub.
<i>Craterocephalus cuneiceps</i>	4-6	6-9	7-9	12-15	31-34	10-13	Ivantsoff, 1978
<i>Craterocephalus dalhousiensis</i>	4-6	6-8	8-10	13-15	30-32	8-9	Ivantsoff, 1978
<i>Craterocephalus eyresii</i>	3-6	7-9	7-11	12-14	32-41	10-13	Ivantsoff, 1978
<i>Craterocephalus honoriae</i>	5-6	8-9	10-13	13-15	35-38	12-15	Ivantsoff, 1978
<i>Craterocephalus lacustris</i>	5-8	8-10	9-11	13-17	35-39	10-13	Ivantsoff, 1978
<i>Craterocephalus marjoriae</i>	5-7	7-9	7-10	12-16	29-34	10-12	Ivantsoff, 1978
<i>Craterocephalus nouhuysi</i>	6-8	9-11	10-12	13-17	37-38	7-9	Ivantsoff, 1978
<i>Craterocephalus pauciradiatus</i>	4-6	7-9	8-11	12-14	30-35	10-13	Ivantsoff, 1978
<i>Craterocephalus randi</i>	5-8	8-10	8-12	13-15	34-39	7-11	Ivantsoff, 1978
<i>C. stercummuscarum fulvus</i>	4-8	7-11	8-11	13-16	31-36	10-13	Ivantsoff, 1978
<i>C. stercummuscarum stercummuscarum</i>	5-8	6-9	8-10	12-15	35-38	9-12	Ivantsoff, 1978
<i>Hypoatherina barnesi</i>	5-7	9-12	13-15	13-16	41-42	15-18	Ivantsoff, 1978
<i>Hypoatherina ovalaua</i>	4-7	9-11	10-13	16-18	38-40	22-25	Ivantsoff, 1978
<i>Hypoatherina temminckii</i>	5-7	9-11	12-15	17-20	38-44	21-25	Ivantsoff, 1978
<i>Hypoatherina tropicalis</i>	5-8	9-12	12-15	16-19	40-47	18-22	Ivantsoff, 1978
<i>Hypoatherina valenciensis</i>	4-7	9-11	13-14	15-17	39-42	20-25	Ivantsoff, 1978
<i>Leuresthes tenuis</i>	4-7	9-13	20-24	13-16	47-50	20-29	White, unpub.
<i>Stenatherina panatela</i>	6-7	9-10	10-13	17-19	21-24	40-45	Ivantsoff, 1978
Bedotiidae							
<i>Bedotia geayi</i>	4-5	10-13	15-18	12			Pellegrin, 1907, 1914
<i>Bedotia longianalis</i>	5	14	20	12			Pellegrin, 1914
<i>Bedotia madagascariensis</i>	5	12	19				Regan, 1903a
Isonidae							
<i>Iso hawaiiensis</i>	4-5	17	23-25	12-13	35-38		Miller et al., 1979
Melanotaeniidae							
<i>Cairnsichthys rhombosomoides</i>	5-6	14	19-21		36-37	10-12	Allen, 1980
<i>Chilatherina campsi</i>	4-8	13-17	21-25			13-14	Munro, 1967
<i>Chilatherina crassispinosa</i>	4-5	9-13	21-25			14	Munro, 1967
<i>Chilatherina lorentzi</i>	4-7	13-18	24-31			15	Munro, 1967
<i>Chilatherina sentanensis</i>	4-5	10-15	23-26			13-15	Munro, 1967
<i>Glossolepis incisus</i>	5-6	10-11	21-24			32	Munro, 1967
<i>Glossolepis multisquamata</i>	4-5	9-12	18-22			16-19	Munro, 1967
<i>Glossolepis pseudoincisus</i>	5-6	11-13	19-23	13-14		26-30	Allen and Cross, 1980
<i>Iriatherina werneri</i>	6-9	8	11-13		32-33	11-13	Allen, 1980
<i>Melanotaenia affinis</i>	4-5	15-19	21-25			13-17	Munro, 1967
<i>Melanotaenia ajamaruensis</i>	4-6	16-20	22-28	13-15		14-15	Allen and Cross, 1980
<i>Melanotaenia boesemani</i>	4-6	11-15	18-24	13-16		14-15	Allen and Cross, 1980
<i>Melanotaenia fluviatilis</i>	5-7	13-14	19-21	13-15			Scott et al., 1980
<i>Melanotaenia goldiei</i>	5-6	12-16	21-25			14-16	Munro, 1967
<i>Melanotaenia japonensis</i>	4-5	16-18	27-29	13		13-14	Allen and Cross, 1980
<i>Melanotaenia lacustris</i>	4-5	12-14	19-20			14	Munro, 1967
<i>Melanotaenia nigrans</i>	4-7	10-14	18-22			13-15	Munro, 1967
<i>Melanotaenia ogilbyi</i>	5-7	10-12	18-19			12	Munro, 1967

TABLE 94. CONTINUED.

	Fin rays				Vert	Gill rakers	Reference
	D1	D2	A	Pect			
<i>Melanotaenia oktediensis</i>	5-6	19-20	25-27	14-15		15	Allen and Cross, 1980
<i>Melanotaenia praecox</i>	4-6	11-15	18-21			11-12	Munro, 1967
<i>Melanotaenia sexlineata</i>	5-7	10-13	17-18			12	Munro, 1967
<i>Melanotaenia splendida australis</i>	5-7	11-12	20-22	13-16		16	Taylor, 1964
<i>Melanotaenia s. rubrostriata</i>	5-7	10-14	18-23			14-16	Munro, 1967
<i>Melanotaenia trifasciata</i>	4-6	11-13	19-22	16-20			Taylor, 1964
<i>Melanotaenia vanheurmi</i>	4-7	19-22	24-27			14	Munro, 1967
<i>Popondetta furcatus</i>	5-8	10-12	17-21		32	8-10	Allen, 1980
<i>Pseudomugil gertrudae</i>	4-5	6-7	10-12	10-11			Taylor, 1964
<i>Pseudomugil tenellus</i>	4-5	6-7	9-10	12-13		9	Taylor, 1964
<i>Rhadinocentrus ornatus</i>	3-5	11-15	19-23		35	11-12	Allen, 1980
Phallostethidae							
<i>Ceratostethus bicornis</i>	1-2	5-6	14-16	11			Herre, 1942
<i>Gulaphallus eximius</i>	2	7	16-18	9			Herre, 1942
<i>Gulaphallus mirabilis</i>	2	7-8	15-19	9		12-13	Herre, 1942
<i>Manacopus falcifer</i>	1-2	7	16-17	9-10			Herre, 1942
<i>Mirophallus bikolanus</i>		6-7	14-16	13		12	Herre, 1942
<i>Neostethus amaricola</i>	1-2	5-7	13-18	9			Herre, 1942
<i>Neostethus borneensis</i>	1-2	5	14-15	9			Herre, 1942
<i>Neostethus coronensis</i>	1-2	5-6	11-14	10		10-11	Herre, 1942
<i>Neostethus lankestri</i>	1	5-6	15-16	10			Herre, 1942
<i>Neostethus panayensis</i>	1	6-8	14-15	11		15	Herre, 1942
<i>Neostethus siamensis</i>	2	6	16	12			Herre, 1942
<i>Neostethus villadoludi</i>	2	5	14-16	9		15	Herre, 1942
<i>Neostethus zamboanga</i>	1-2	5-6	15-17	9		12	Herre, 1942
<i>Phallostethus dunckeri</i>		8-10	26-28				Regan, 1913c
<i>Phenacostethus smithi</i>	6	14	10		35		Roberts, 1971
<i>Phenacostethus posthon</i>	5	14	9		36		Roberts, 1971
<i>Plectrostethus palawanensis</i>	2	5	14-16				Herre, 1942
<i>Solenophallus ctenophorus</i>	2	5-7		10-11		13	Herre, 1942
<i>Solenophallus thessa</i>	8-10	19-23	12-13			16	Herre, 1942
Telmatherinidae							
<i>Telmatherma celebensis</i>	6-7	11-12	13-15	16	32		Boulenger, 1897

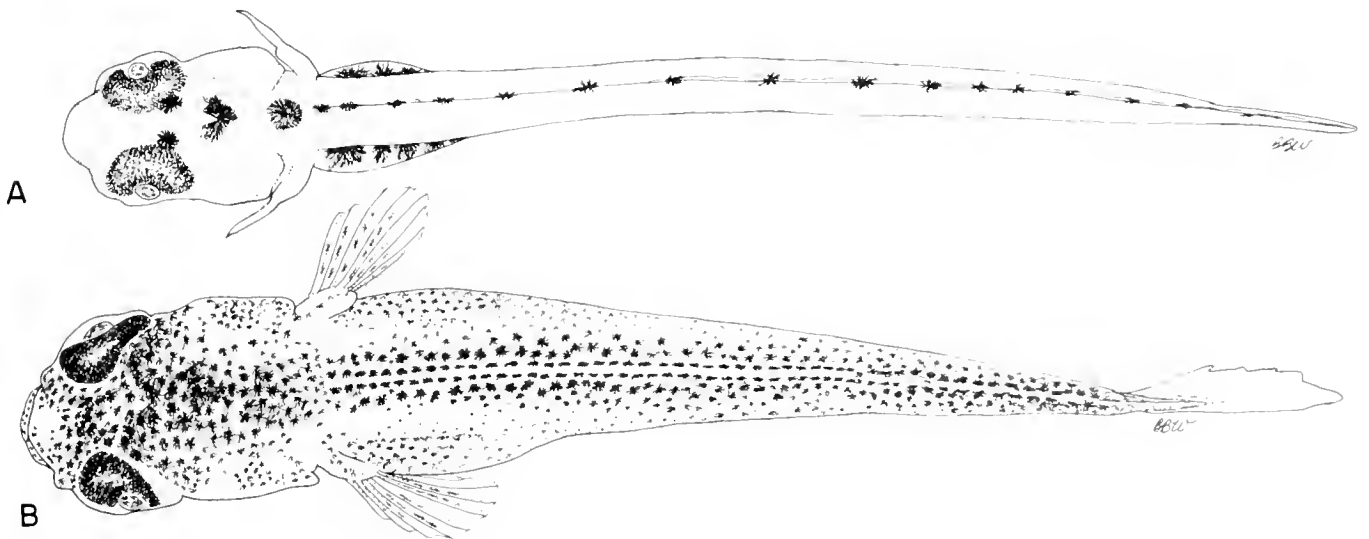

Fig. 189. Dorsal pigment series in atherinomorph larvae. (A) *Atherinops affinis*; 6.7 mm SL, LACM field no. 42841-3; and (B) *Dermogenys pusillus*; 7.7 mm SL, LACM 43448-1.

TABLE 95. DERIVED DEVELOPMENTAL CHARACTER STATES IN THE ATHERINOMORPHA.

	Atherini- formes	Beloni- formes	Cyprino- donti- formes
Egg large, demersal with chorionic filaments and lipid globules coalescing at vegetal pole	X	X	X
Separation of embryonic afferent and efferent circulations by development of heart in front of the head	X	X	X
Formation of spermatogonia near the tunica albuginea	X	X	X
Gut length less than 40% of flexion length	X		
Single row of melanophores on dorsal surface	X		
Fin rays present at hatching		X	X

the development of a single dorsal melanophore row in the common ancestor of the Atherinomorpha and separate loss events in the Exocoetoidei and Cyprinodontiformes.

¹ After this paper went to press, a report on the relationships of the phallostethid fishes appeared in which Parenti (1984) questions our conclusions on atheriniform monophyly. The evidence she presents suggests another phylogenetic interpretation but at the present time neither hypothesis can definitely be rejected.

Aspects of the variable reproductive behavior of the atheriniform fishes might be useful in determining relationships within the order. The habit shared by *Leuresthes tenuis* and *L. sardina* of spawning on the beach in synchrony with the lunar cycle (Thompson and Thompson, 1919; Clark, 1925; Walker, 1952) is a synapomorphy identifying the two grunion species as each other's closest relative. Another lunar spawner, *Menidia menidia* deposits its eggs in detrital mats and on the stems and exposed roots of the cordgrass plant *Spartina alterniflora* (Moore, 1980; Middaugh et al., 1981). *Telmatherina ladigesii* deposit their eggs over a period of several days, attaching them singly and in a widely spaced pattern to aquatic vegetation. In the Phallostethidae, fertilization is internal and the eggs are attached to a substratum by their adhesive filaments. There is much variation in the reproductive behavior of atheriniform fishes and investigation of their breeding habits might secure information bearing on their systematic relationships.

Table 95 summarizes the derived ontogenetic characters that bear on atheriniform relationships. There is still much that is unknown about the early life history of the atheriniform fishes and it is reasonable to hope that future investigation, particularly of their reproductive habits and egg morphology, will contribute to the elucidation of their evolutionary relationships.¹

SECTION OF FISHES, NATURAL HISTORY MUSEUM, LOS ANGELES, CALIFORNIA 90007.

Cyprinodontiformes: Development

K. W. ABLE

THE approximately 800 members of the Cyprinodontiformes (killifishes) are small to medium-sized fishes (8–300 mm SL) that live in shallow fresh and brackish water. They are nearly worldwide in their distribution in temperate and tropical areas (Parenti, 1981). Cyprinodontiformes is considered to be monophyletic based on several adult osteological characters and the long embryonic development time (Parenti, 1981). I here follow the most recent and extensive revision of the group by Parenti (1981) in which she rearranges them into two suborders: Aplocheiloidei with 2 families (Aplocheilidae and Rivulidae) and Cyprinodontoidei with 7 families (Profundulidae, Fundulidae, Valenciidae, Anablepidae, Poeciliidae, Goodeidae, Cyprinodontidae). See Nelson (1976) and Parenti (1981, Table 3) for prior classification schemes. Comments on portions of Parenti's reclassification can be found in Klee (1982) and Foster (1982).

Reproduction and development within the group is exceptionally varied, with oviparity, ovoviviparity, viviparity (including functional states of each) and functional hermaphroditism represented. In addition, viviparity may have evolved independently at least four times within the order (Parenti, 1981). Among the viviparous forms occur a vast array of schedules and morphological modifications for internal development such as the trophotaeniae of the goodeids and the intra- and extra-follicular gestation and superfetation in some poeciliids. Development reportedly is long, from four days to more than one

year (Scheel, 1962) in some of the "annual" killifishes. The rivulid, *Rivulus marmoratus*, is unique among fishes, and vertebrates in general, in that it is a functional hermaphrodite with internal fertilization (Harrington, 1961). Published early life history descriptions are listed in Table 96.

Eggs

The eggs of some Cyprinodontiformes are among the smallest known for fishes. Scrimshaw (1946) recorded fertilized eggs of the poeciliid *Heterandria formosa*, in which development is internal, to average 0.30 mm and Roberts (1970) recorded "ripe" eggs of another poeciliid, *Fluviphylax*, as 0.1 mm (not substantiated). The eggs of other cyprinodontiforms are larger (Table 97) with the largest that of *Fundulus majalis* at 2.0–3.0 mm. Egg size varies within some species (i.e., the cyprinodontid *Aphanius anatoliae*, Grimm, 1979a, b) and judging from the data in Table 97, may vary in other species as well. Other authors have noted differences in the egg size of cyprinodontids of the genus *Cyprinodon* and considered them to be environmental (Soltz and Hirschfield, 1981) or genetic (Garrett, 1982). Fecundity is correlated with egg size in the aplocheilid *Nothobranchius* (Bailey, 1972) and with female size in poeciliids (see Thibault and Schultz, 1978). Fecundity also varies between females and populations in the oviparous goodeid, *Crenichthys baileyi* (Espinoso, 1968). Superfetation occurs in several poeciliid genera

(Turner, 1937; Scrimshaw, 1945; Turner 1940a; Thibault and Schultz, 1978).

The eggs of all cyprinodontiforms contain conspicuous oil droplets (Foster, 1967) (Table 97) including the viviparous poeciliids such as *Gambusia affinis* (Kuntz, 1914a). Within the Fundulidae the size and number of oil droplets is extreme; *Lucania parva* has 8–12 large droplets (Fig. 190C) and *Fundulus* n. sp. from Bermuda has up to approximately 350 with a mean of 181 droplets per egg (Fig. 190F, and Able et al., in prep.). Subspecific variation in the fundulid *F. heteroclitus* is pronounced and population means range from 10 to 180 droplets (Morin and Able, 1983).

These droplets probably provide nutrition late in embryonic development (Smith, 1957; Lentz and Trinkhaus, 1967; Blaxter, 1969a; Terner, 1979). The chemical composition of lipids in the oil droplets has been determined by Bailey (1973). The oil droplets are clumped together at ovulation but disperse after fertilization. Individual oil droplets are retained in the yolk sac after hatching in several *Fundulus* species, *L. parva* (see Hardy, 1978a), *R. marmoratus* (McMillan, 1979) and postflexion *G. affinis* (Ryder, 1885). The eggs of all known oviparous and ovoviviparous cyprinodontiforms have a small perivitelline space and are spherical (except in *Nothobranchius* in which the egg is oval, Scheel, 1968).

The chorion is variable in thickness and surface structure (Table 97). In most of the oviparous and ovoviviparous forms the chorion is multilayered and thick, whereas in many viviparous forms it is considerably reduced (see Flegler, 1977). Detailed studies of the chorion microstructure are available for the fundulid *F. heteroclitus* (Kuchnow and Scott, 1977) and the rivulid *Cynolebias bellottii* (Sterba and Muller, 1962; Muller and Sterba, 1963). The chorion of all oviparous and ovoviviparous forms have adornments of some type on the surface. Instances where they have been reported as lacking (*F. heteroclitus*, *F. parvipinnis*, Foster, 1967; *F. majalis*, Hardy, 1978a) are incorrect. Often the chorion is covered with filaments either uniformly arranged or clustered together to form tufts (Fig. 190, 191; Table 97). The filaments can vary in diameter and density between species (Fig. 190 and 191) and subspecies (Dumont and Brummett, 1980; Morin and Able, 1983). Differences in these structures in *F. heteroclitus* appear to be correlated with spawning site preference (Able, 1984). *Fundulus majalis* has microfilaments on the large filaments and on the chorion surface (Fig. 191A, B). Some species have other structures ("punctae" of Foster, 1967) which appear as small spherical knobs on the surface of the chorion, occasionally with filaments originating from them (Fig. 190D, E; 191D, E). In other species the surface of the chorion may be sculptured (Table 97). *Fundulus luciae* has numerous circular pits in the chorion surface (Fig. 190D, E). The distribution of chorionic modifications (filaments, microfilaments, pits, knobs) within the Cyprinodontiformes is incompletely known and thus it is difficult to assess their phylogenetic significance. Several species of fundulids studied possess punctae or knobs (Table 97; Figs. 190, 191) while these are lacking in the cyprinodontids (see Fig. 190A, B) thus supporting the separation of these groups by Parenti (1981).

The presence of chorionic filaments in the Cyprinodontiformes is a synapomorphy shared with the Atheriniformes and Beloniformes as discussed in this volume and constitutes one of the synapomorphies serving to unite the Atherinomorphs. Further studies of egg morphology in the oviparous forms will

TABLE 96. PUBLISHED DESCRIPTIONS OF CYPRINODONTIFORM EARLY LIFE HISTORY STAGES LISTED BY FAMILY AND GENUS.

Family and genus	Sources
Suborder Aplocheiloidei	
Aplocheilidae	
<i>Fundulopanchax</i>	Peters, 1963
<i>Nothobranchius</i>	Peters, 1963 Zahradka and Frank, 1976
Rivulidae	
<i>Rivulus</i>	McMillan, 1979
Suborder Cyprinodontoidei	
Profundulidae	
None	
Fundulidae	
<i>Plancterus</i>	Koster, 1948
<i>Fundulus</i>	Ryder, 1885 Kuntz, 1914a, 1916 Fish, 1932 Armstrong and Child, 1965 Foster, 1967, 1974 Byrne, 1978 Hardy, 1978a Jones and Tabery, 1980
<i>Lucania</i>	Kuntz, 1916 Foster, 1967, 1974 Hardy, 1978a
<i>Leptolucania</i>	Foster, 1967
<i>Adinia</i>	Foster, 1967 Koenig and Livingston, 1976
Valenciidae	
None	
Goodeidae	
<i>Crenichthys</i>	Kopec, 1949
Cyprinodontidae	
<i>Cubanichthys</i>	Troemner, 1932, 1941
<i>Cyprinodon</i>	Kuntz, 1916 Foster, 1974 Hardy, 1978a Mettee and Beekham, 1978 Foster, 1967
<i>Jordanella</i>	
Anablepidae	
<i>Anableps</i>	Turner, 1940c
<i>Jenynsia</i>	Turner, 1940d
Poeciliidae	
<i>Gambusia</i>	Ryder, 1885 Kuntz, 1914a
<i>Xiphophorus</i>	Tavolga, 1949

probably provide useful insights into the phylogeny of this abundant and diverse group.

Embryonic development

Embryonic development within the Cyprinodontiformes is almost as variable in duration and number of physiological and morphological modifications as in all other fishes combined. The incubation time may be as short as 4–8 days in *C. variegatus* and *Jordanella floridae* (see Foster, 1967; Hardy, 1978a) to possibly longer than a year in some of the "annual" species. Parenti (1981) considers this annual habit to have developed more than once within the Cyprinodontiformes. This is sup-

TABLE 97. SUMMARY OF EGG CHARACTERISTICS OF CYPRINODONTIFORM FISHES.

Species	Egg diameter (mm)	Oil globules	Chorion surface	Source(s)
Suborder Aplocheiloidei				
Family Rivulidae				
<i>Cynolebias bellotti</i>	ca. 2.0	?	?	Breder and Rosen, 1966
<i>Cynolebias ladigesii</i>	?	present	anchorlike filaments	Peters, 1963
<i>Cynolebias whitei</i>	ca. 1.0	?	prickles	Breder and Rosen, 1966
<i>Cynolebias melanotaenia</i>	?	present, large	palm like stems	Scheel, 1962
<i>Procatopus nototaenia</i>	1.0	?	filaments	Scheel, 1961
Family Aplocheilidae				
<i>Fundulopanchax amieti</i>	?	?	filaments	Carr, 1982
<i>Fundulopanchax arnoldi</i>	?	?	hexagonal pattern	Peters, 1963
<i>Aplocheilus blocki</i>	1.3	?	3 long filaments	Jones, 1937
<i>Aplocheilus lineatus</i>	2.0	?	?	Job, 1940
<i>Epiplatys chaperi</i>	?	present, large	filaments in tuft	Peters, 1963
<i>Epiplatys senegalensis</i>	1.0	?	?	Breder and Rosen, 1966
<i>Nothobranchius guentheri</i>	?	present, large	filaments	Peters, 1963
<i>Nothobranchius korthausae</i>	0.9–1.1	present, large	filaments	Zahradka and Frank, 1976
Suborder Cyprinodontoidei				
Family Fundulidae				
<i>Plancterus kansae</i>	2.3–2.4	?	filaments, punctae	Foster, 1967
<i>Fundulus chrysotus</i>	2.0–2.1	?	filaments, punctae	Foster, 1967
<i>F. cingulatus</i>	1.5–1.6	?	filaments, sculpturing	Foster, 1967
<i>F. confluentus</i>	1.6–1.8	10–15, medium	filaments, punctae	Harrington, 1959; Foster, 1967; Hardy, 1978
<i>F. diaphanus</i>	1.7–2.4	10–15, medium and 40–80, small	filaments, punctae	Foster, 1967; Wang and Kernehan, 1979
<i>F. heterooclitus</i>	1.5–2.5	10–180	filaments, variable	Hardy, 1978a; Morin and Able, 1983
<i>F. luciae</i>	1.7–2.2	5–58	filaments, punctae	Hardy, 1978a
<i>F. majalis</i>	2.0–3.0	50	absent ? and present	Ryder, 1885; Nichols and Breder, 1927; Hardy, 1978a; Wang and Kernehan, 1979
<i>F. notatus</i>	ca. 1.8	many, medium also single	filaments in tuft and punctae	Foster, 1967; Jude, 1982a
<i>F. nottii</i>	2.2–2.3	numerous	filaments	Foster, 1967
<i>F. olivaceus</i>	ca. 1.8	many, medium	filaments in tuft and punctae	Foster, 1967
<i>F. parvipinnis</i>	2.8	present	filaments	Ritter and Bailey, 1908; Hubbs, 1965
<i>F. similis</i>	2.6–2.9	?	?	Foster, 1967; Martin and Finucane, 1969
<i>Lucania gooderi</i>	1.3	10–12, medium	filaments in tuft	Foster, 1967
<i>Lucania parva</i>	1.0–1.3	10–12 (0.3–0.4 mm)	filaments in tuft	Kuntz, 1916; Foster, 1967; Hardy, 1978a
<i>Leptolucania ommata</i>	1.0–1.1	?	filaments in tuft, sculpturing	Foster, 1967
<i>Adina xenica</i>	1.5–2.2	many, small	filaments	Foster, 1967; Koenig and Livingston, 1976; Hastings and Yerger, 1971
Family Poeciliidae				
<i>Gambusia affinis</i>	1.6–2.1	present	absent	Hardy, 1978a
<i>Poecilia reticulata</i>	1.7	?	?	Thibault and Schultz, 1978
<i>Poecihopis lucida</i>	1.4	?	?	Thibault and Schultz, 1978
<i>P. monacha</i>	2.0	?	?	Thibault and Schultz, 1978
<i>P. prolifica</i>	1.0	?	?	Thibault and Schultz, 1978
<i>P. turneri</i>	1.0	?	?	Thibault and Schultz, 1978
<i>Tomeurus gracilis</i>	?	?	many, long filaments	Breder and Rosen, 1966
Family Goodeidae				
<i>Cremichthys baileyi</i>	1.9–2.0	?	?	Kopec, 1949; Brill, 1981
Family Valenciidae				
<i>Valencia hispanica</i>	2.5–2.6	?	?	Rachow, 1924; Villwock, 1960

TABLE 97. CONTINUED.

Species	Egg diameter (mm)	Oil globules	Chorion surface	Source(s)
Family Cyprinodontidae				
<i>Cubanichthys cubensis</i>	ca. 1.0	?	present	Mayer, 1933
<i>Cubanichthys pengelleyi</i>	1.2-1.4	few	filaments in tuft	Foster, 1969
<i>Aphanius fasciatus</i>	?	?	filaments	Breder and Rosen, 1966
<i>Aphanius mento</i>	1.4-1.5	ca. 6, medium	filaments	Mazza, 1902
<i>Cyprinodon macularius</i>	ca. 2.0	?	?	Constantz, 1981
<i>Cyprinodon nevadensis</i>	1.3-1.4	?	?	Constantz, 1981
<i>Cyprinodon variegatus</i>	1.1-1.7	one large many minute	filaments	Foster, 1967; Fanara, 1964; Wickler, 1959
<i>Floridichthys carpio</i>	1.4	?	1-2 filaments, long	Kaill, 1967
<i>Jordanella floridae</i>	1.3-1.4	?	filaments	Henzelmenn, 1930; Foster, 1967; Kaill, 1967
<i>Jordanella pulchra</i>	1.0	?	?	Cassel, 1981

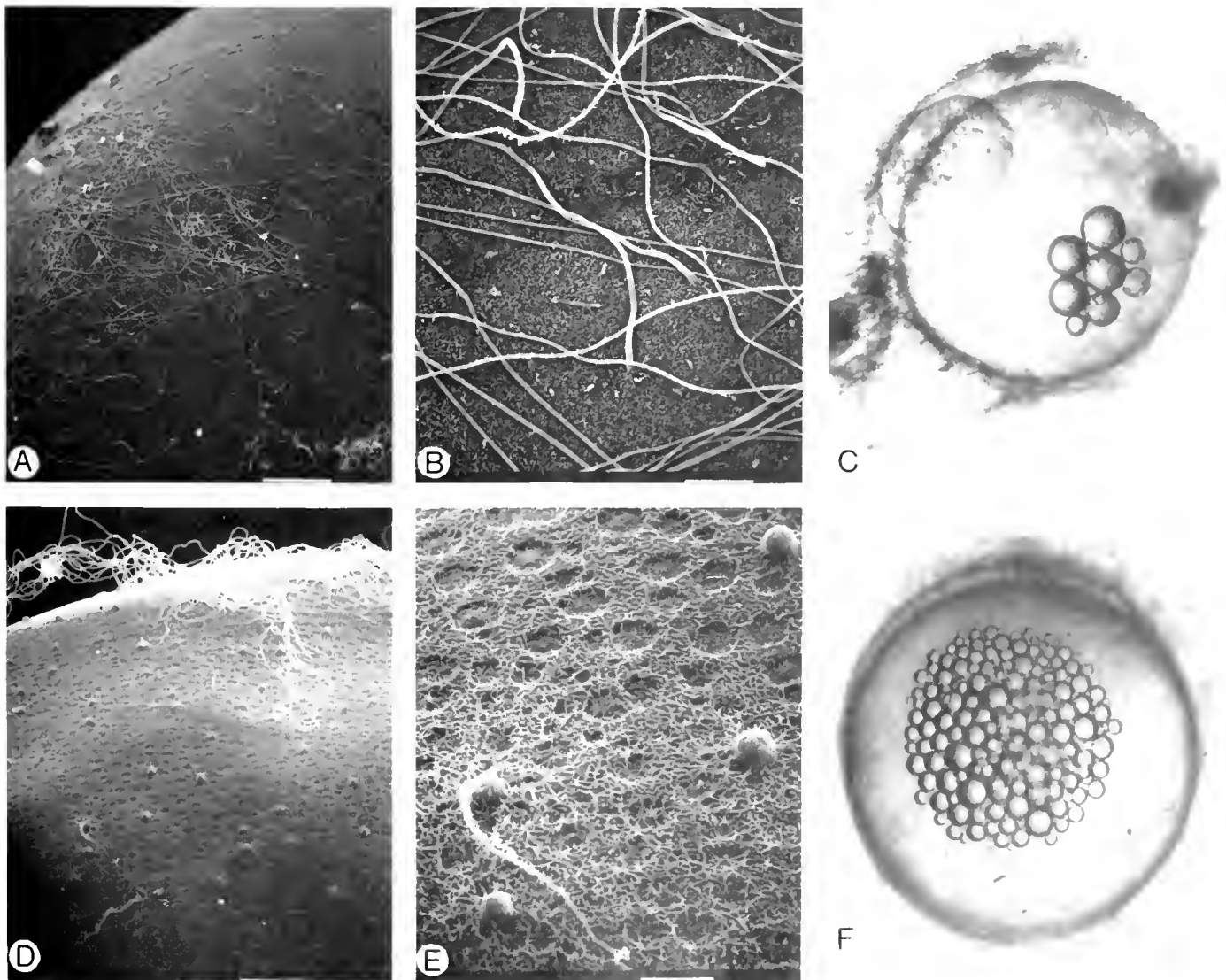

Fig. 190. Scanning electron micrographs of the chorion surface of the cyprinodontid *Cyprinodon alvarezii* (A, B) and the fundulid *Fundulus luciae* (D, E). Oil droplets are shown for the fundulids *Lucania parva* (C) and *Fundulus n. sp.* from Bermuda (F).

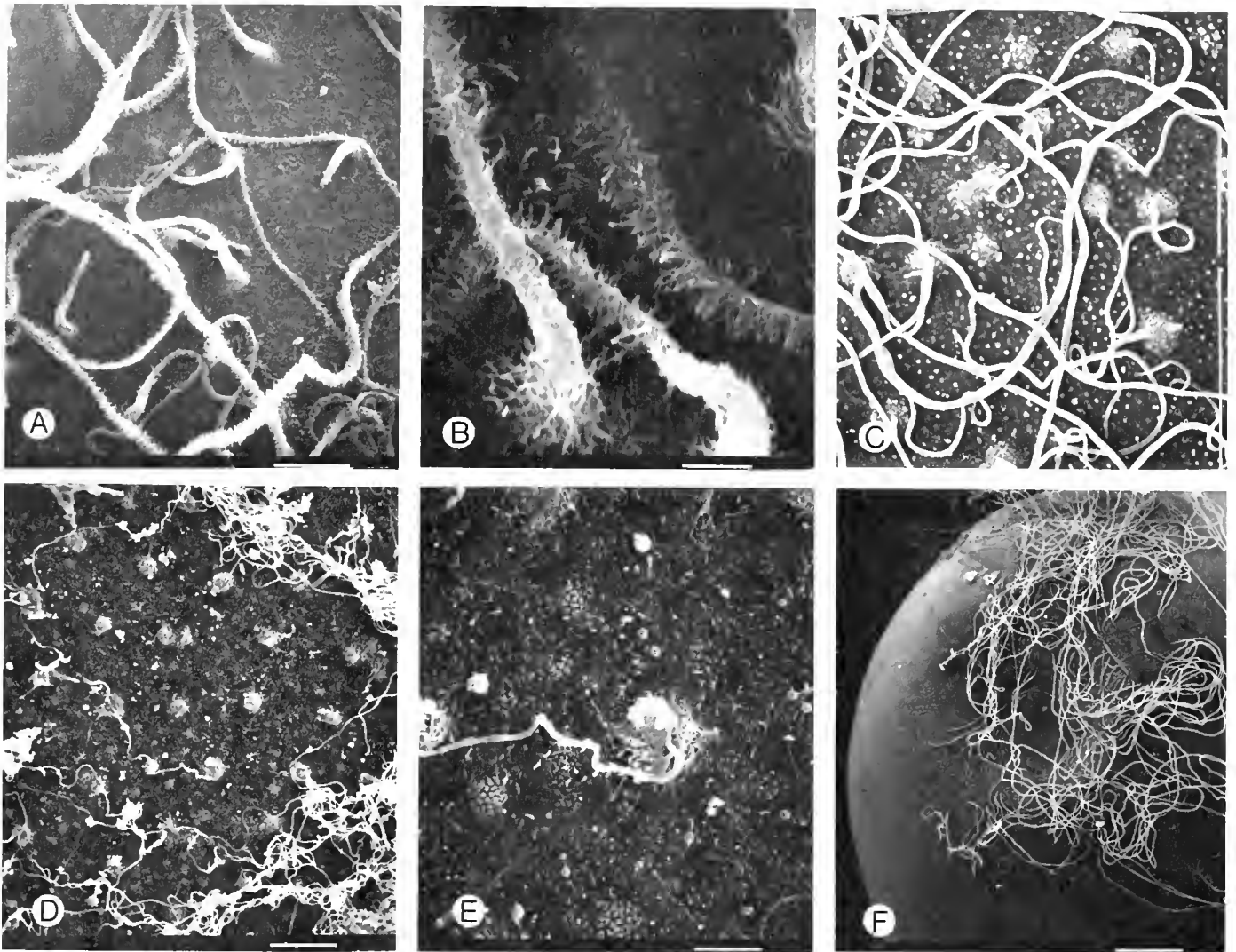

Fig. 191. Scanning electron micrographs of the chorial surface of the fundulids *F. majalis* (A, B), *Fundulus* n. sp. from Bermuda (C), the rivulid *Rivulus marmoratus* (D, E) and the profundulid *Profundulus punctatus* (F).

ported by an apparent difference in the manner in which hatching is delayed. *Fundulus confluentus* can hatch after three months of "latency" or postponement of hatching (Harrington, 1959; Harrington and Haeger, 1958) while the embryos continue to grow and utilize yolk reserves. Delayed hatching is probably typical for many North American fundulids, as seen in *F. heteroclitus* (Taylor et al., 1977) and *Adinia xemca* (Koenig and Livingston, 1976). The incubation period is known to be influenced by temperature (see Gabriel, 1944) and dissolved oxygen (DiMichele and Taylor, 1980). During diapause, which occurs in the annual killifishes (Wourms, 1972a, b, c) hatching may be delayed for up to six months in nature and possibly longer than a year under extreme conditions. During this time growth does not occur, cardiac activity ceases and the yolk is not depleted. The length of the incubation period may be controlled by temperature, photoperiod, desiccation and oxygen tension cues (see Matias, 1982).

The embryonic development of several aplocheilids (*Aplocheilichthys*), a rivulid (*Rivulus*) and two fundulids (*Adinia* and *F.*

heteroclitus) has been described in detail (Table 96). Some authors have placed special systematic significance on the pattern of vitelline circulation of the embryo in cyprinodontiforms (Foster, 1967; Hubbs and Burnside, 1972) and other atherinomorphs (White et al., this volume). The viviparous poeciliids, anablepids, jenynsiids (placed in the Anablepidae by Parenti, 1981) and goodeids have a variety of modifications for receiving nourishment during development (reviewed by Wourms, 1981). The phylogenetic significance of independent development of viviparity in several cyprinodontiform lineages is discussed in detail by Parenti (1981).

Larvae

The larvae of oviparous cyprinodontiforms are incompletely known (Table 96) despite the fact that many of them are avidly bred by aquarium hobbyists. All of those known lack the preanal finfold characteristic of the beloniforms (except exocoetids) (Collette et al., this volume) and have a longer preanal length than the atheriniforms (White et al., this volume). In all cy-

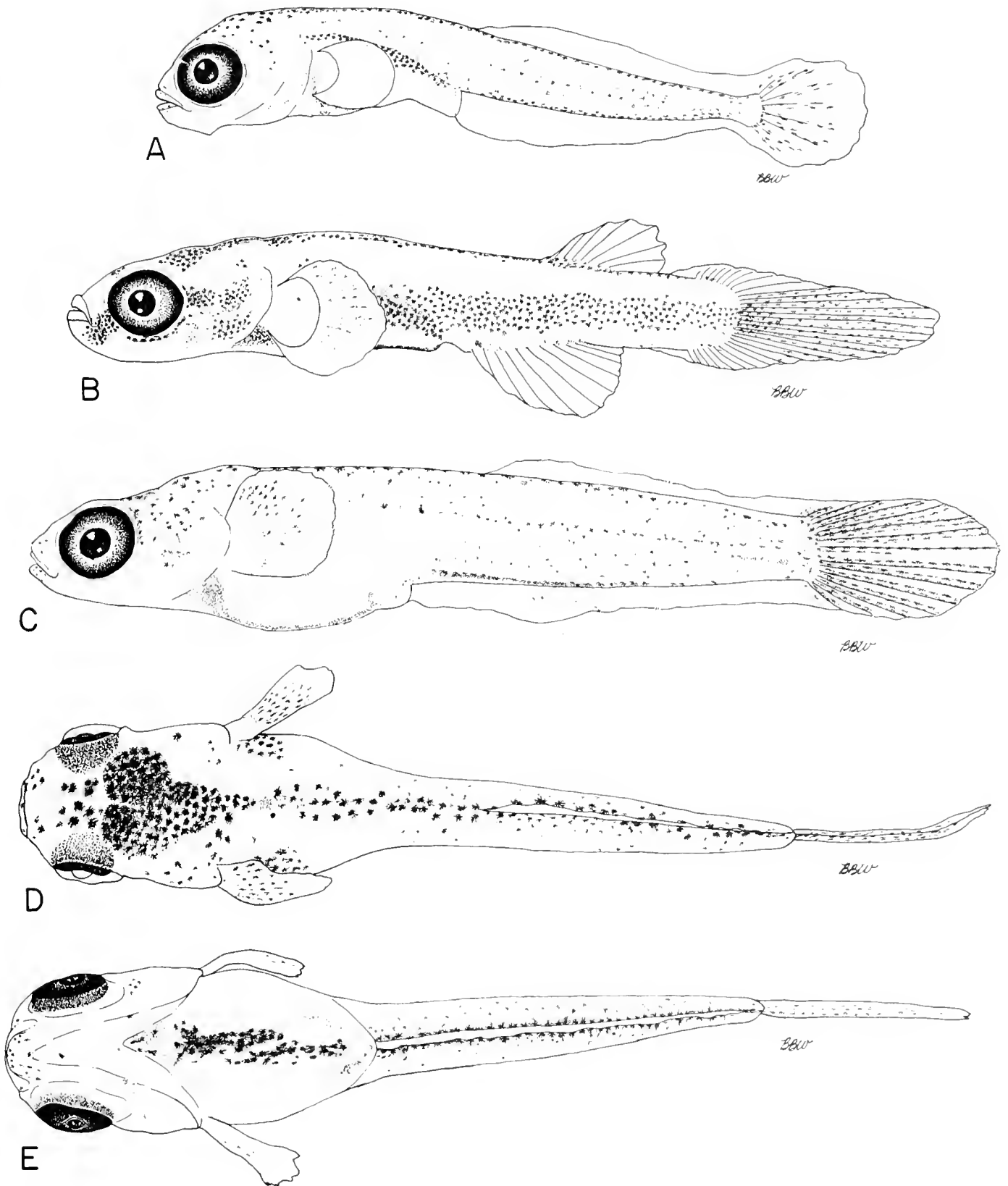

Fig. 192. Larvae of (A) the aplocheilid *Nothobranchius eggersi*, 3.1 mm SL, (B) the rivulid *Rivulus marmoratus*, 4.6 mm SL; and (C-E) the fundulid *Fundulus* n. sp. from Bermuda, 6.0 mm SL.

prinodontiforms that have been studied the caudal fin rays form first (Fig. 192) and often this occurs before hatching (Foster, 1967).

Within the oviparous cyprinodontoid killifishes the presence and location of melanophores as well as the relative location of the dorsal finfold may be useful systematic characters (Foster, 1968). In most fundulid larvae the dorsal finfold originates posterior to the origin of the anal finfold (Foster, 1967; Fig. 192) with the possible exception of *Lucania parva* (see Hardy, 1978a). In the cyprinodontids studied however, the dorsal finfold originates anterior to the anal finfold (Foster, 1967). The larvae of most fundulids, the aplocheilid, *Nothobranchius eggersi* and the rivulid, *R. marmoratus* also possess three rows or stripes of melanophores (middorsal, midlateral and midventral) on the body (Fig. 192). This characteristic is shared by the beloniform *Oryzias latipes* and some atheriniforms (Martin and Drewry, 1978) and suggests that this character may be synplesiomorphic within the Atherinomorpha. In cyprinodontids these rows of melanophores are lacking and the existing melanophores are scattered evenly over the body or appear as saddle-shaped groups of melanophores on the dorsolateral surface of the body (see Foster, 1967; Hardy, 1978a).

Summary

The early life history of cyprinodontiforms appears to offer many possibilities for elaborating on their phylogeny. Several authors (Rosen and Parenti, 1981; Collette et al., this volume; White et al., this volume) have pointed out the usefulness of early life history characters in defining the monophyletic nature of the Atherinomorpha and the orders within. Although studies of the early life history of the Cyprinodontiformes are not as far along, they may offer more potential for several reasons. First, Foster (1967, 1968) has already pointed out the value of early life history characters in resolving the phylogeny of the group. Second, based on this review, both egg morphology and larval characters vary within the group and thus seem to offer real promise for assessing relationships. Third, many killifishes are easily maintained and will reproduce in aquaria so that study material should be easily obtainable, especially given their popularity in the aquarium trade.

BIOLOGICAL SCIENCES AND CENTER FOR COASTAL AND ENVIRONMENTAL STUDIES, DOOLITTLE HALL, RUTGERS UNIVERSITY, NEW BRUNSWICK, NEW JERSEY 08903.

Lampriformes: Development and Relationships

J. E. OLNEY

THE order Lampriformes (=Lampridiformes, see Robins et al., 1980) is composed of approximately 21 species (Table 98) of pelagic, marine fishes with worldwide distribution excluding polar seas. Highly evolved and extremely divergent in form and lifestyle, these species occupy meso- and epipelagic habitats and have attained a remarkable degree of specialization, of which the most notable examples are: the pectoral musculature of *Lampris* (Rosenblatt and Johnson, 1976); the unique feeding mechanism of *Stylephorus* (Pietsch, 1978a); the ribbon-like body form, specialized integument and rotating eye of the trachipterids (Walters, 1963; Haedrick, 1974; Oelschläger, 1976a); the "horn" of *Eumecichthys* (Fitch, 1966; Oelschläger, 1979); and the cephalopod-like ink gland of the lophotids and *Radiicephalus* (Walters and Fitch, 1960; Fitch and Lavenberg, 1968; Harrison and Palmer, 1968; Saldanha and Pereira, 1977; and others). By far the most impressive species of the group is the oarfish, *Regalecus glesne*, which attains lengths of over 8m, possesses a crimson dorsal fin and cockscomb-like anteriormost dorsal rays and is the probable basis for many historical sightings of sea monsters (Fitch and Lavenberg, 1968).

Regan (1907, 1924) first suggested a relationship between *Lophotus*, *Eumecichthys*, *Lampris*, *Velifer* and *Stylephorus*, all on the basis of the common possession of peculiar characteristics of the protractile mouth and assigned these genera to a new order, the Allotriognathi (from the Greek, meaning "strange jaw"). Presently, the order consists of 12 genera (*Velifer*, *Me-*

tavelifer, *Lampris*, *Zu*, *Desmodema*, *Trachipterus*, *Radiicephalus*, *Lophotus*, *Eumecichthys*, *Stylephorus*, *Regalecus* and *Agrostichthys*) comprising seven families (Table 98).

Two conflicting proposals exist for the allocation of these fishes and nomenclatural inconsistencies persist. Oelschläger (1976a, b, 1978a, b, 1979; also see Palmer, 1973) retains Regan's (1907) ordinal designation and defines two suborders of the Allotriognathi: the Bathysomi, deep-bodied fishes with symmetrical caudal fins, well developed skeletons and musculature (represented by *Lampris* and the veliferids); and the Taeniosomi, elongate fishes with asymmetrical caudal fins, weak skeletons and musculature (represented by *Trachipterus*, *Regalecus* and remaining genera). In contrast, Greenwood et al. (1966) recognize four suborders of the Lampriformes: Lampridoidei, Veliferoidei, Trachipteroidei and Stylephoroidei. At lower taxonomic levels, Heemstra (in press) considers *Lophotus* to be monotypic while Briggs (1952) and Oelschläger (1979) recognize two species (Table 98). In addition, a number of nominal species exist within the genera *Regalecus*, *Trachipterus* and *Lampris*. Recently, Heemstra (in press) and Heemstra and Kannemeyer (in press) have treated South African Lampriformes, describing a new *Zu* species and providing synonymies of several trachipterids. In general, the systematic status of lampriform fishes is in question and the nomenclature lacks stability owing, in part, to the rarity of examples in systematic collections and the fragile nature of these fishes.

TABLE 98. RECORDED MERISTICS OF ADULT LAMPRIFORM FISHES. Total element counts are reported without reference to ray or spine designation of original source. Abbreviations used are: ABS—absent; PRE—precaudal vertebrae; CAUD—caudal vertebrae; TV—total vertebrae; DORS—dorsal fin rays; ANAL—anal fin rays; PECT—pectoral fin rays; PELV—pelvic fin rays; CAUD—caudal fin rays.

	PRE	CAUD	TV	DORS	ANAL	PECT	PELV	CAUD	References
Veliferidae									
<i>Velifer hypselopterus</i>	16	17-18	33-34	34-36	25-26	15-16	7-8	36	Heemstra (in press); Regan (1970); Walters (1960)
<i>Metavelifer multiradiatus</i>	16	17-18	33-34	41-45	33-36	15-16	9	36	Heemstra (in press); Stephenson (1977); Walters (1960)
Lampridae									
<i>Lampris guttatus</i>	21	25	46	48-52	33-42	21-24	13-17	30-32	Herald (1939); McKenzie and Tibbo (1963), Regan (1907a)
<i>L. immaculatus</i>	—	—	43	52-56	35-38	23-24	12-14	—	Parin and Kukuyev (1983)
Trachipteridae									
<i>Zu cristatus</i>	22-24	39	62-69	120-150	ABS	10-12	3-7	8-12 + 1-5	Fitch (1964); Heemstra and Kannemeyer (in press); Palmer (1961); Walters and Fitch (1960, 1964)
<i>Z. elongatus</i>	29-31	—	84-87	142-147	ABS	11-12	7	12 + 5	Heemstra and Kannemeyer (in press)
<i>Desmodema polystictum</i>	18-20	—	71-74	120-124	ABS	12-14	ABS	7-10	Rosenblatt and Butler (1977)
<i>D. lorum</i>	21-25	—	106-111	197	ABS	12-14	ABS	4-7	Rosenblatt and Butler (1977)
<i>Trachipterus fukuzaki</i>	25-28	—	69-72	153-174	ABS	11-13	5	7-9 + 6-7	Fitch (1964, 1967); Walters and Fitch (1964)
<i>T. altivelis</i>	35-40	—	90-94	165-184	ABS	10-11	6-7	7-8 + 6	Fitch (1964)
<i>T. trachipterus</i>	35-39	—	84-96	145-185	ABS	9-11	5	8 + 5	Heemstra and Kannemeyer (in press); Palmer (1961)
<i>T. arcticus</i>	—	—	99-102	150-190	ABS	9-11	5-6	8 + 5-6	Palmer (1961)
<i>T. ishikawae</i>	—	—	73	133-168	ABS	13	—	—	Heemstra and Kannemeyer (in press); Nishimura (1964); Smith (1956a)
<i>T. jacksonensis</i>	31-34	—	81-83	166-173	ABS	13-14	—	—	Heemstra and Kannemeyer (in press)
Raducephalidae									
<i>Raducephalus elongatus</i>	36-39	77-79	114-121	152-160	6-7	9-10	9	4 + 7	Harrison and Palmer (1968); Heemstra and Kannemeyer (in press); Karrer (1976)
Lophotidae									
<i>Lophotus lacepedei</i>	—	—	124-153	206-263	12-20	14-17	5	16-17	Heemstra (in press); Saldanha and Pereira (1977)
<i>L. capellei</i>	—	—	—	238	18	14-16	6	17	Briggs (1952); Goin and Erdman (1951)
<i>Eumecichthys fiski</i>	56	101	151-200	310-392	5-9	13-15	2-3	12-13	Abe (1954); Fitch (1966); Heemstra (in press); Walters and Fitch (1960)
Stylephoridae									
<i>Stylephorus chordatus</i>	—	—	50	115-122	16-17	10-11	—	5-6 + 2	Pietsch (1978a); Regan (1924)
Regalecidae									
<i>Regalecus glesne</i>	—	—	143-151	260-412	ABS	12-13	1	3-4	Heemstra (in press); Trunov (1982); Walters and Fitch (1960)
<i>Agrostichthys parkeri</i>	—	—	170	400	ABS	8-11	1	2	Heemstra (in press); Trunov (1982); Walters and Fitch (1960)

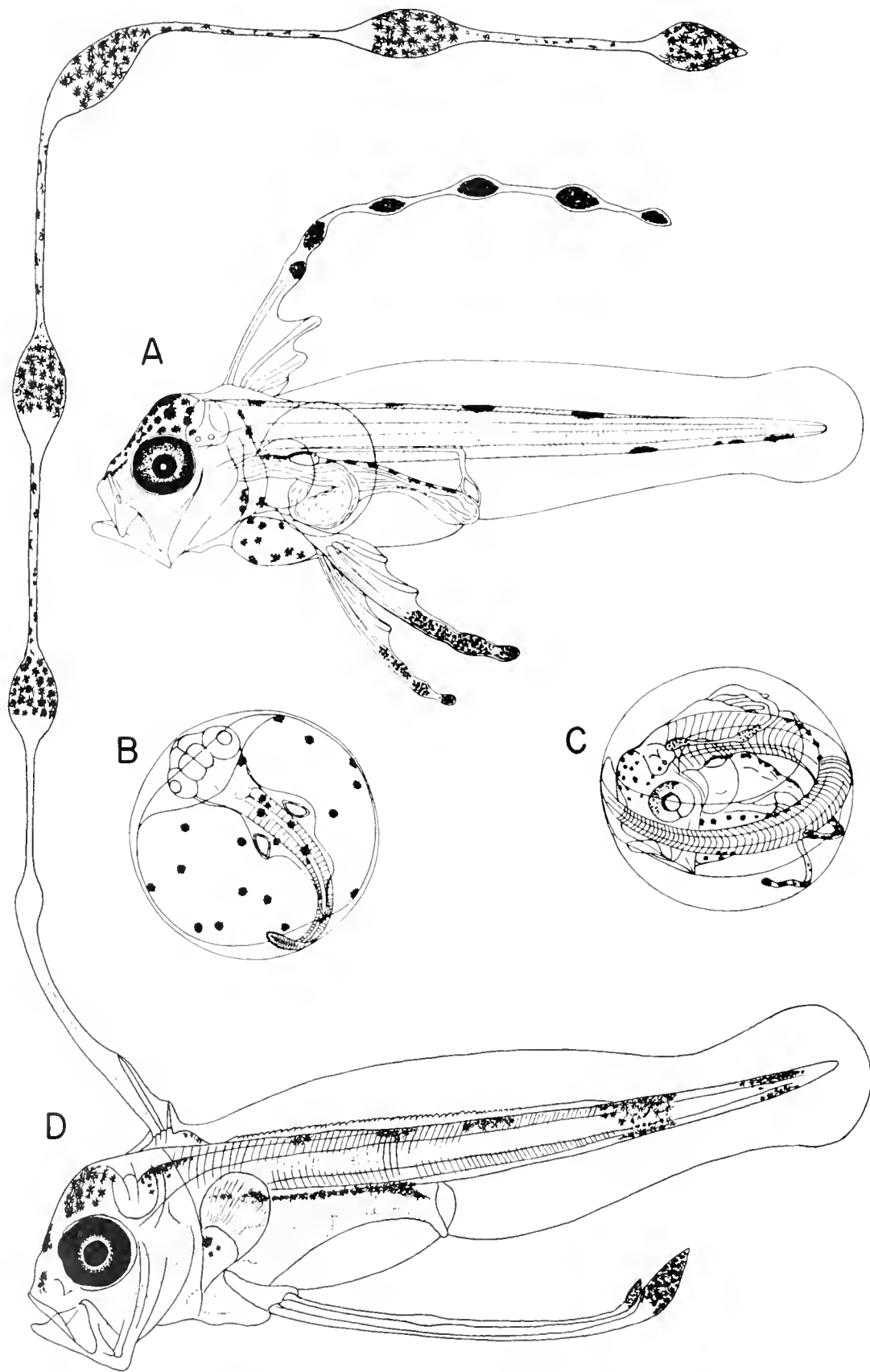

Fig. 193. Eggs and larva (A-C) of *Trachipterus* sp. (larva, 7.6 mm NL) after Mito (1961b). (D) Larva of *Lophotus* sp. (12.1 mm NL) after Sanzo (1940).

DEVELOPMENT

Walters and Fitch (1960), Breder and Rosen (1966), Palmer (1973), Nielsen (1973) and Moser (1981) have summarized the state of knowledge of the early life history of lampriform fishes. Eggs and larvae of the Veliferidae, Radiicephalidae and Stylephoridae are unknown, although Karrer (1976) has mentioned ripe ovarian eggs of *Radiicephalus elongatus*. Harrison and Palmer (1968) presented meristic and morphometric data on a 154 mm SL *R. elongatus* termed a postlarva and Regan (1924) figured a 26 mm SL larval *Stylephorus chordatus*. Little data on young stages of the Lampridae are available. Ehrenbaum (1905–1909) and Gudger (1930) presumed pelagic eggs based on ovarian examination; Gudger (1930), D'Ancona (1933b) and Oelschläger (1976b) figured juvenile stages of *Lampris guttatus*; and Parin and Kukuyev (1983) illustrated a young specimen of *L. immaculatus*. Within the Lophotidae, larvae of *Eumecichthys* are unknown while Fitch (1966) reported on ovarian eggs in *E. fiski* and Parin and Pokhilpkaya (1968) figured juvenile stages. Sanzo (1939b, 1940) and Sparta (1954) have described eggs and early larvae of a species of *Lophotus* considered by Oelschläger (1979) to be *L. lacepedei*. Eggs and larvae of trachipterid and regalecid fishes have received considerable attention although early life history stages of *Agrostichthys* and *Desmodema* are unknown. Eggs and early larvae of *Zu cristatus* were described by Sanzo (1918), Sparta (1933) and Olney and Naplin (1980). Eggs and larvae of *Trachipterus*, probably representing several species, were described by Emery (1879), Lo Bianco (1908a), Jacino (1909), Ehrenbaum (1905–1909), Sparta (1933), Mito (1961b) and Sardou (1966). Eggs and larval stages of *Regalecus* were figured and described by Sanzo (1925), Sparta (1933) and Robertson (1975a). In summary, published information on the development of eggs and larvae of four of the 12 lampriform genera is available. In the following discussion, these published data as well as additional material are utilized to summarize the important characteristics of eggs, larvae and young of lampriform fishes and provide illustrations of larvae of four additional genera.

Egg and embryonic morphology.—Data on morphology and development of lampriform eggs are incomplete (Table 99) but indicate that eggs are large (1.7–4.0 mm egg diameter, range excludes measurements of ovarian eggs; see Table 99), spherical, pelagic, often brightly colored (generally in amber, pink or red hues) and possess thick, resilient chorions. Up to three weeks may be required in incubation (18–20 days for *R. glesne*, Sparta, 1933). As a result, eggs are distinctive and easily recognized in plankton collections (Fig. 193B, C) especially in advanced stages of development (Orton, 1955a; Olney and Naplin, 1980). Sanzo (1940) reported both homogeneous (*Lophotus*) and segmented yolks (*Zu* and *Regalecus*) but recent observations indicate homogeneous yolks in all known forms (Robertson, 1975a; Olney, unpublished data). Egg diameters, presence or absence of oil droplets, chorionic ornamentation and microstructure may delimit some species (Table 99). Scanning electron micrographs of cross-sections of the chorions of *Zu cristatus* and an unidentified trachipterid species (Fig. 194) indicate variability in chorion thickness and layering which may be of systematic value. In general, however, confirmed identification of lampriform eggs requires late stages with advanced embryos (Olney and Naplin, 1980).

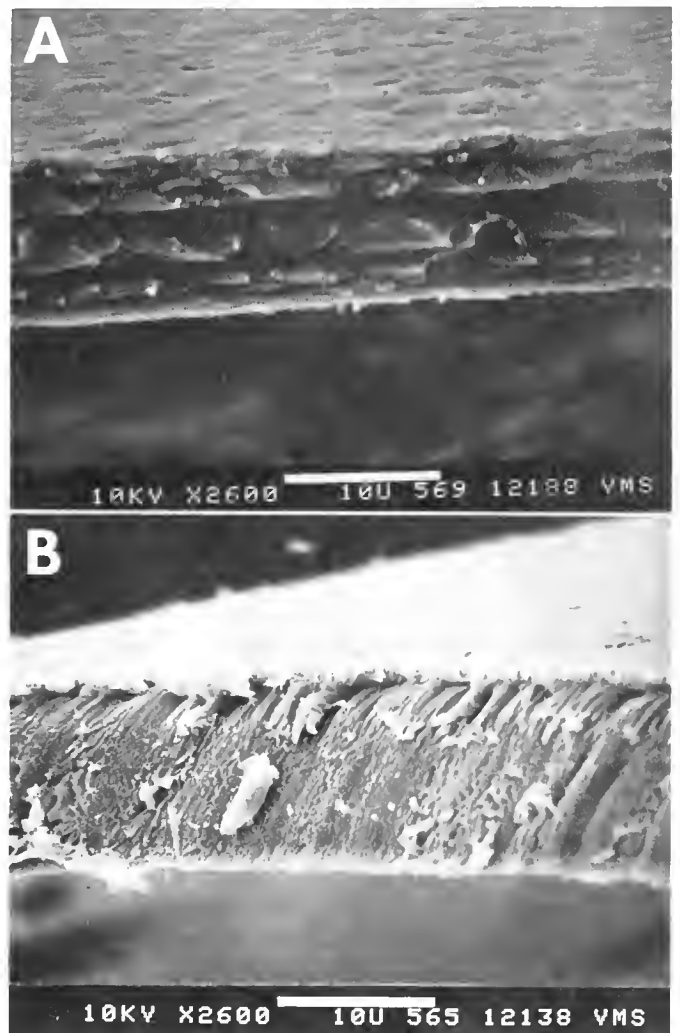

Fig. 194. Scanning electron micrographs of chorionic microstructure in lampriform eggs. (A) trachipterid, chorion thickness 11.04 μm . (B) *Zu cristatus*, chorion thickness 13.3 μm .

Lampriform embryos exhibit precocious development. In *Trachipterus*, *Zu*, *Lophotus* and *Regalecus*, anterior dorsal rays, pelvic rays, distinctive pigment and total myomeres are apparent and distinguish these forms (Sparta, 1933; Mito, 1961b; Sanzo, 1940; Olney and Naplin, 1980). Some disparity exists, however, in descriptions of late embryos. Sparta (1933) depicts late embryonic *R. glesne* with anterior elements reduced but the fourth elongate while Robertson (1975a) figures *R. glesne* embryos off New Zealand with an elongate first element followed by three reduced rays.

Larval morphology.—At hatching, larvae of lampriform fishes possess a number of distinctive characteristics including: well developed, protrusible jaws; differentiated guts with an open lumen and little or no yolk material; elongate anterior dorsal elements which insert between the posterior eye margin and the shoulder and are usually ornamented with broad, spatulate and

TABLE 99. SOME CHARACTERISTICS OF EGGS OF LAMPRIFORM FISHES.

Species	Egg diameter (mm)	Descriptive features	Reference
<i>L. guttatus</i>	—	Ovarian; thick chorion with amber tint	This study
<i>Z. cristatus</i>	2.17–2.27	Thick chorion with amber tint; oil globule absent	Sanzo, 1918; Olney and Naplin, 1980
<i>Trachipterus</i> sp.	1.78	Yolk with scattered melanophores	Mito, 1961b
<i>T. trachipterus</i>	2.9–3.2	Thick chorion; oil globule absent; yolk scattered melanophores	Sparta, 1933
<i>R. glesne</i>	2.4–2.5	Numerous, scattered oil globules; yolk with scattered melanophores	Sanzo, 1925
<i>R. glesne</i>	3.25–4.05	Chorion with pink tint	Robertson, 1975a
<i>Lophotus</i> sp.	2.48–2.64	Oil globules absent; chorion ornamented with small spines	Sanzo, 1940
<i>E. fiski</i>	1.5–2.0	Ovarian; transparent	Fitch, 1966

highly pigmented serial swellings; stout, well developed pelvic elements often with fleshy sheaths and highly pigmented terminal swellings; and snout to vent lengths approximately 40–60% NL (Figs. 193, 195). Larvae of *Metavelifer* and *Lampris* are slender at small sizes but *Lampris* larvae (and presumably veliferids) rapidly increase in body depth (Fig. 196). By 10.6 mm SL (Fig. 197), larval *Lampris* have assumed the characteristic adult, deep-bodied form. Larvae of the remaining genera are also slender at hatching but become rapidly elongate with growth. In these taxa, gut length may vary during ontogeny, increasing to 80–90% SL in *Lophotus*, *Eumecichthys* and *Regalecus*. Gut length at transformation distinguishes these genera from *Zu*, *Trachipterus*, *Desmodema* and *Radiicephalus*.

Anterior dorsal rays are supported by a fleshy base in early larval stages (Figs. 193, 195) and by modified radials first appearing as cartilage. The fleshy base and associated radials supporting these rays are sometimes damaged in capture and torn away from the cranium. This artifactual condition is occasionally referenced in older literature as a "nuchal lobe" (Hubbs, 1925:475) and "nuchal pennant" (Walters and Fitch, 1960:442–443). In larval trachipterid, lophotid and regalecid fishes, the first two dorsal elements are supported by elongate, stout radials, the second of which serially supports succeeding radials of varying number (Table 100). These elements interdigitate in interneural spaces and pterygiophore interdigitation patterns vary at the generic level (Rosenblatt and Butler, 1977; Table 100). *Lampris* and *Metavelifer* possess a predorsal element which interdigitates in the first neural space. These genera (and presumably *Velifer*) are unique in the possession of this character (Table 100). In addition, the morphology of the anterior modified radials varies with ontogeny. The rostrum or "horn" of *Eumecichthys* elongates during growth to twice its original length (Par-

TABLE 100. PATTERNS OF PTERYGIOPHORE INTERDIGITATION IN ANTERIOR INTERNEURAL SPACES OF YOUNG LAMPRIFORM FISHES. Within interneural spaces, P indicates a predorsal element and numerals indicate numbers of pterygiophores.

Species	Interneural space			
	1	2	3	4
<i>Z. cristatus</i>	1	7–9	1	2
<i>Trachipterus</i> sp.	1	8–9	1	2
<i>R. glesne</i>	1	11	2	2
<i>Desmodema</i> spp.	7	2		
<i>R. elongatus</i>	1	13–14	1–2	1–2
<i>M. multiradiatus</i>	P + 1	1	1	1
<i>L. guttatus</i>	P + 1	1	1	1

in and Pokhil'skaya, 1968). Oelschlager (1976a) considers the lophotid "horn" to be supported by modifications of the frontals and the supraoccipital (termed the "fronto-occipital carina"), however these highly modified dorsal rays are likely supported by dorsal fin radials which may fuse to cranial bones in adults. In *Desmodema*, anterior dorsal rays are elongate in juveniles but lost at transition (Rosenblatt and Butler, 1977). Presumably, pterygiophores supporting these rays and interdigitating anterior to the first neural spine (Table 100) are retained in adults.

Development of pelvic fin elements is precocious in all known larval Lampriformes (Figs. 193, 195–200) and characterized by reduction of ray number, length or both in some genera. In *S. chordatus* (Figs. 199 and 200), a single elongate pelvic element in early larvae becomes increasingly long and stout with development, persisting until around 70 mm SL. Adult *S. chordatus* (Regan, 1924; Table 98) lack a pelvic fin. A similar developmental sequence may occur in *Desmodema* which loses pelvic elements by 173 mm SL (Rosenblatt and Butler, 1977) and in *R. elongatus* (Harrison and Palmer, 1968). In *Regalecus* and *Agrostichthys* (Oelschlager, 1978a) the pelvic fin is retained as a persistent larval floatation device that also serves in locomotion and taste perception.

The pectoral fin is the last to complete differentiation in larval lampriformes. In our material, pectoral rays are incompletely developed at 18.4 mm SL in *R. elongatus* (Fig. 198); 21.4 mm SL in *S. chordatus* (Fig. 200); and 29 mm SL in *Trachipterus* sp. Pectoral development is most rapid in *L. guttatus* which possesses adult counts by 10.6 mm SL (Fig. 197). Adults of this species possess a strongly developed, lunate pectoral (Rosenblatt and Johnson, 1976) which may also be important in locomotion of larvae. Pectoral morphology and insertion vary considerably among lampriform genera and are of systematic value, although no comprehensive treatment exists.

Among lampriform genera, caudal morphology exhibits the greatest potential for taxonomic and systematic evaluation. Rosenblatt and Butler (1977) have demonstrated the utility of this character in distinguishing juvenile and adults of *Trachipterus* and *Desmodema* and the details of caudal morphology (Table 98 and see Gosline, 1961; Hulley and Rau, 1969; Oelschlager, 1974; Patterson, 1968; Pietsch, 1978a; and Rosen, 1973 for illustrations of caudal skeletons in various lampriform genera) clearly delimit all other taxa, with the possible exception of *Agrostichthys* (Oelschlager, 1978b). Differentiation of caudal elements occurs early in development, rendering caudal morphology an important larval identification criterion. Although full developmental series are not available for most forms, the

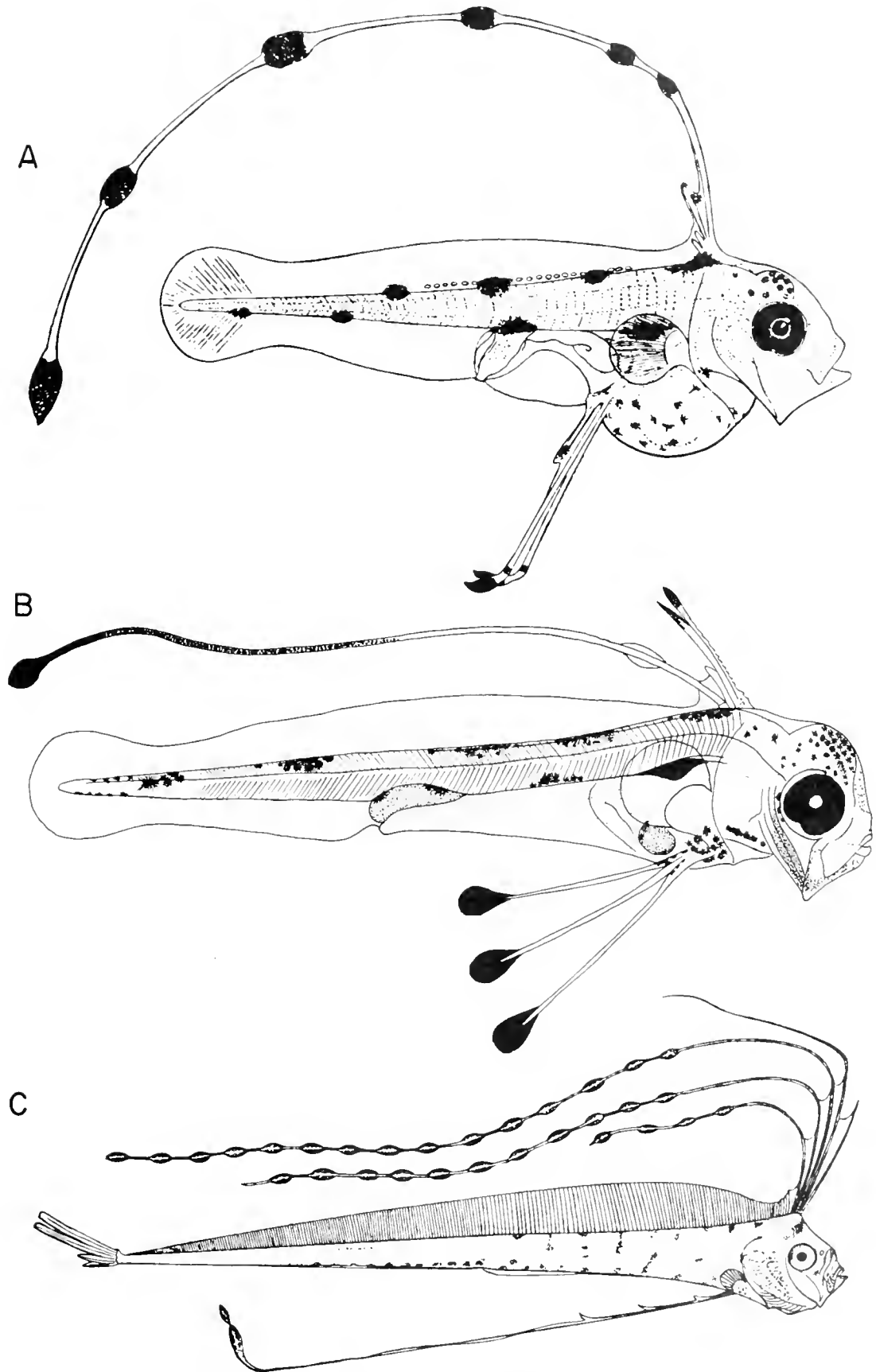

Fig. 195. Larvae of *Zu cristatus*. (A) 6.5 mm NL and *Regalecus glesne*; (B) 5.4 mm; (C) 45.8 mm SL, all after Sparta 1933.

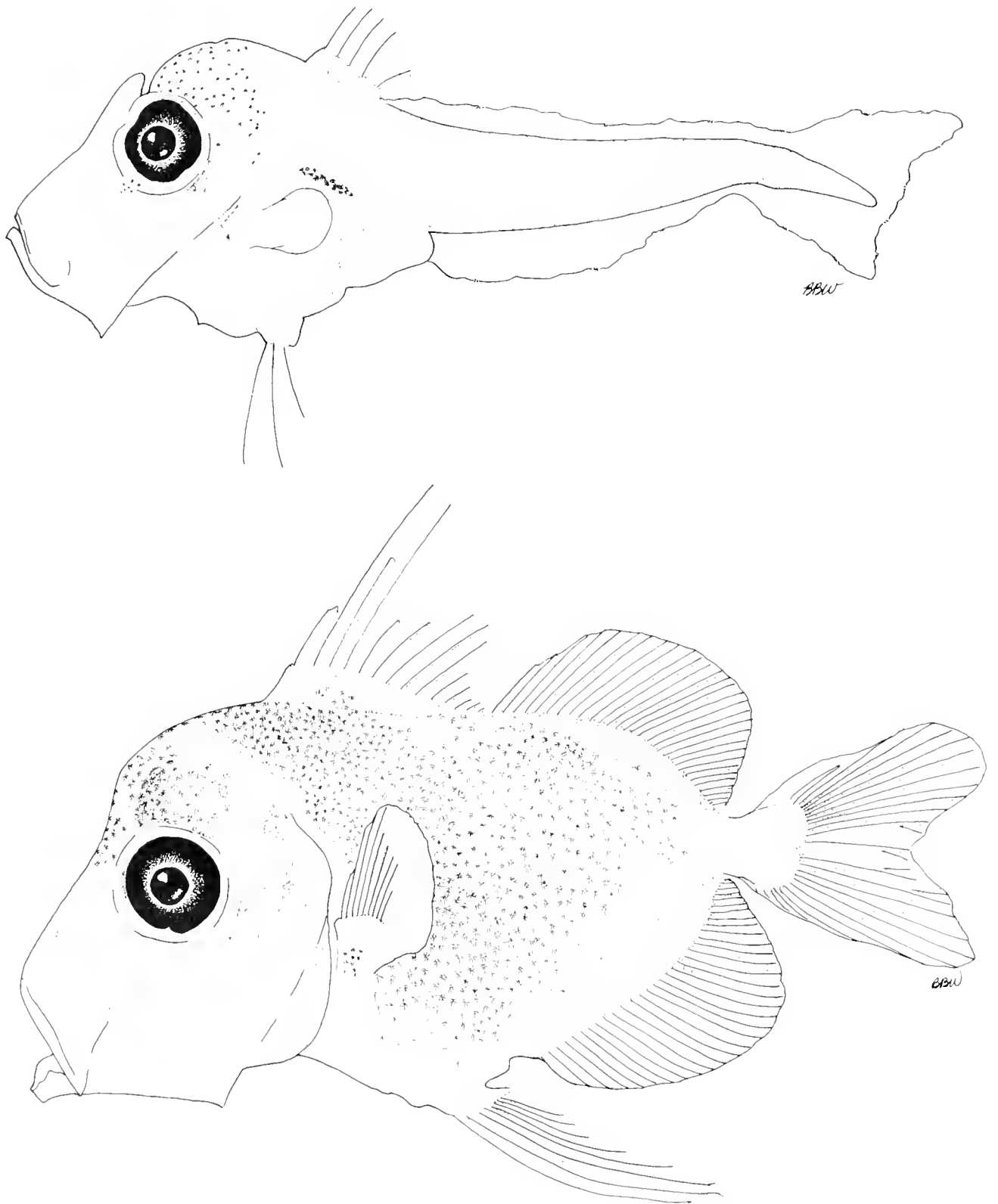

Fig. 196. Larvae of *Lampris guttatus*. (Upper) 4.7 mm NL, MCZ 58990; (Lower) 8.6 mm SL, MCZ 58989.

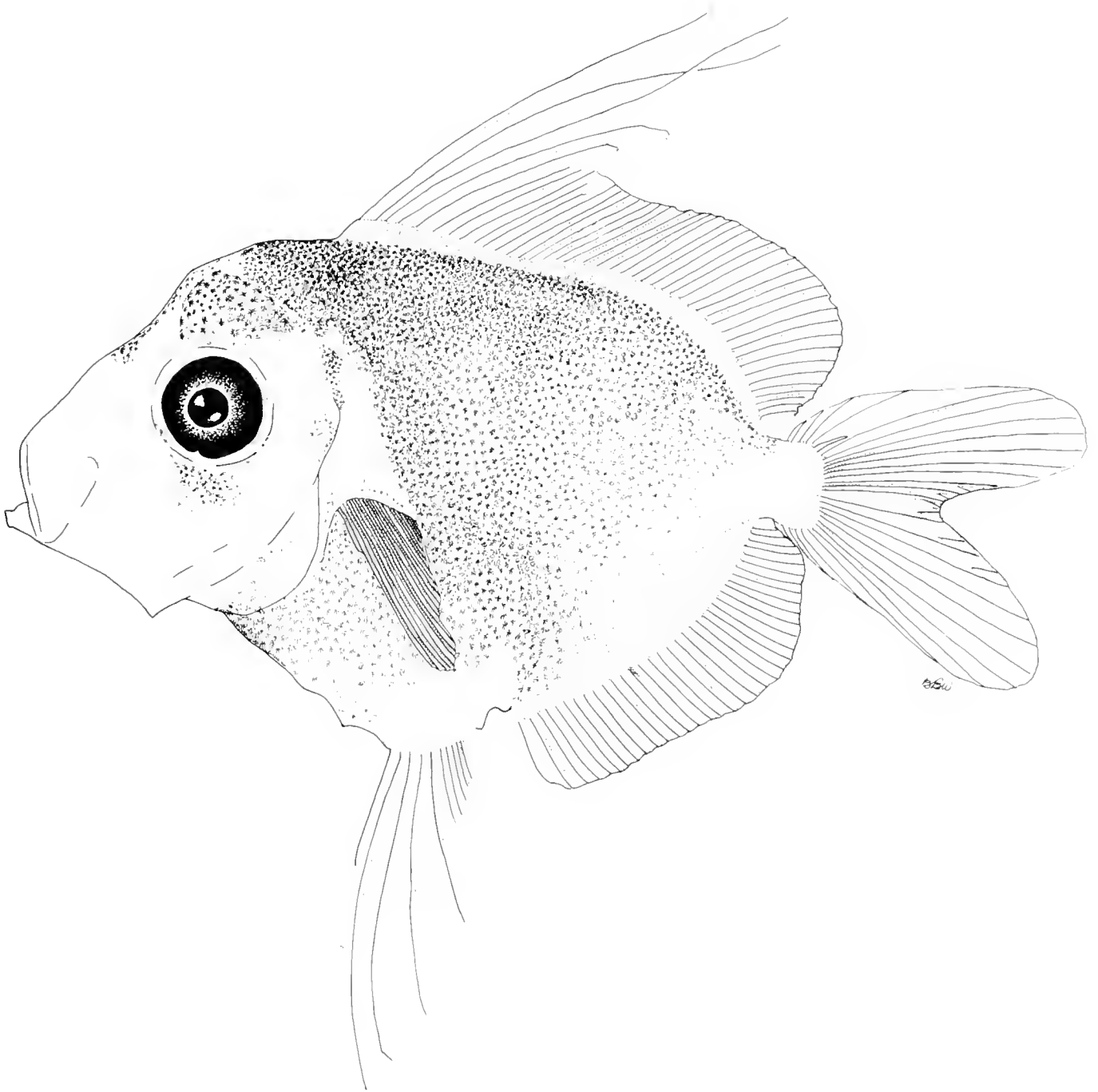

Fig. 197. Larva of *Lampris guttatus* 10.6 mm SL, MCZ 58991.

caudal is complete (or nearly so) by 8.6 mm SL in *L. guttatus* and 12–20 mm SL in *R. elongatus*, *S. chordatus*, *Zu cristatus*, *Trachipterus* spp. and *R. glesne*.

The highly protrusible jaws of lampriform fishes develop precociously and jaw structures vary from the long, tubular mouth of *S. chordatus* (Figs. 199 and 200; Pietsch 1978a) to only moderately specialized in *Velifer*. All lampriform genera possess premaxillae with long ascending processes which fit within the

nasal and ethmoid regions and slide forward during jaw protraction. Larval lampriforms, especially *Stylephorus* (Figs. 199 and 200), are easily recognized by this feature although these upper jaw specializations may not be unique to lampriform genera (Rosen, 1973). In trachipterid, radiicephalid and regalacid fishes, the premaxilla has a high, broad ascending process which is often conspicuous in capture-damaged larvae.

Lampriforms are highly pigmented in all life history stages

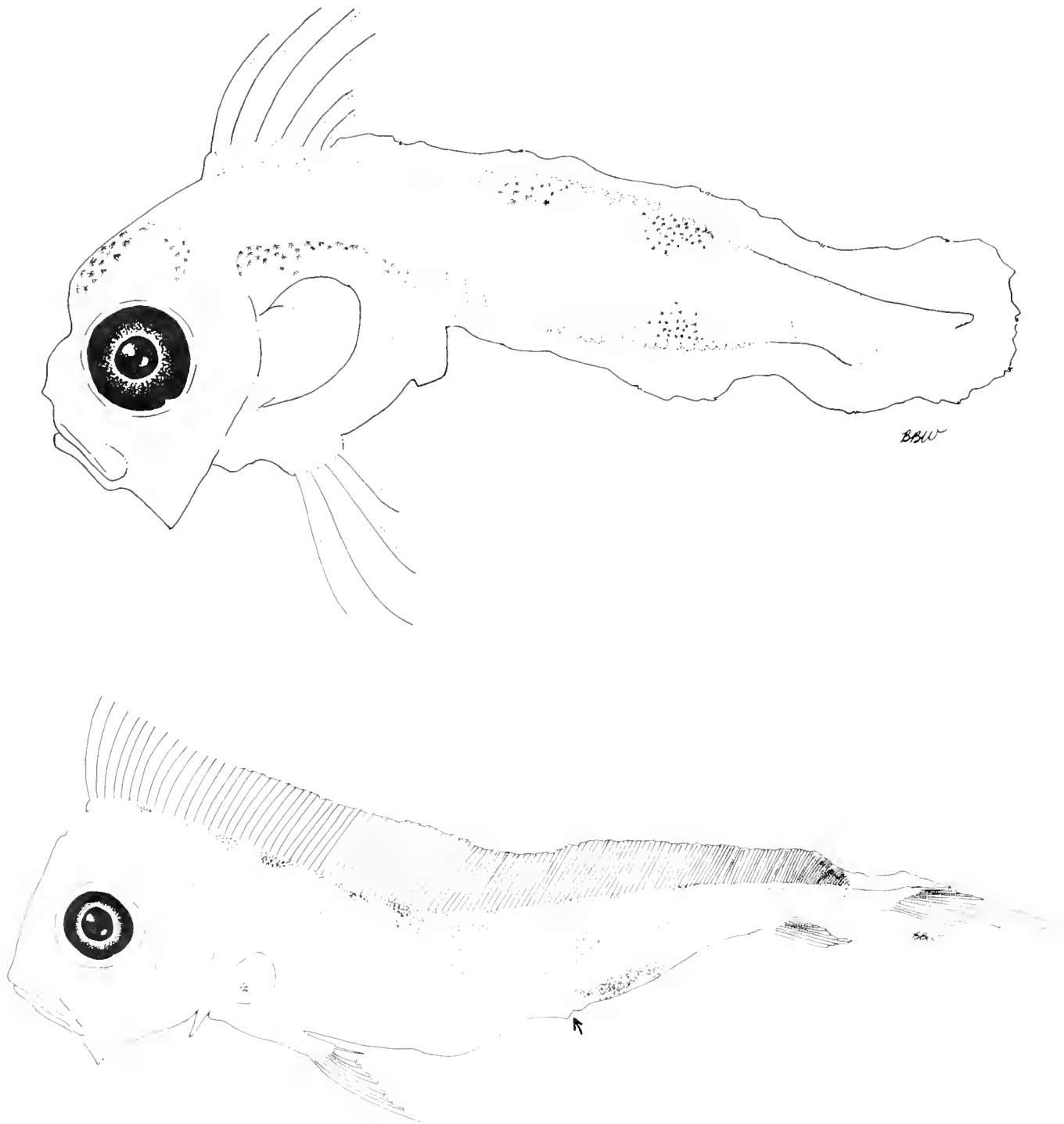

Fig. 198. Larvae of *Metavelifer multiradiatus*, (Upper) 5.7 mm NL, MCZ 59717; and *Radicephalus elongatus*, (Lower) 18.4 mm SL, ZMUC uncatalogued. The vent is indicated by an arrow. The posterior portion of the ink gland is seen as a concentration of melanophores along the ventral margin just posterior to the vent.

and larval pigment, especially in the form of melanophores present laterally and along the dorsal and ventral margins, is useful in identification of some genera (Figs. 193, 195–200). Melanophores, concentrated on spatulate swellings in elongated

dorsal and pelvic rays help to distinguish larval lampriforms although care should be taken since elongate, sometimes pigmented appendages are found in the larvae of a number of unrelated taxa (Govoni et al., 1984). Among these taxa, how-

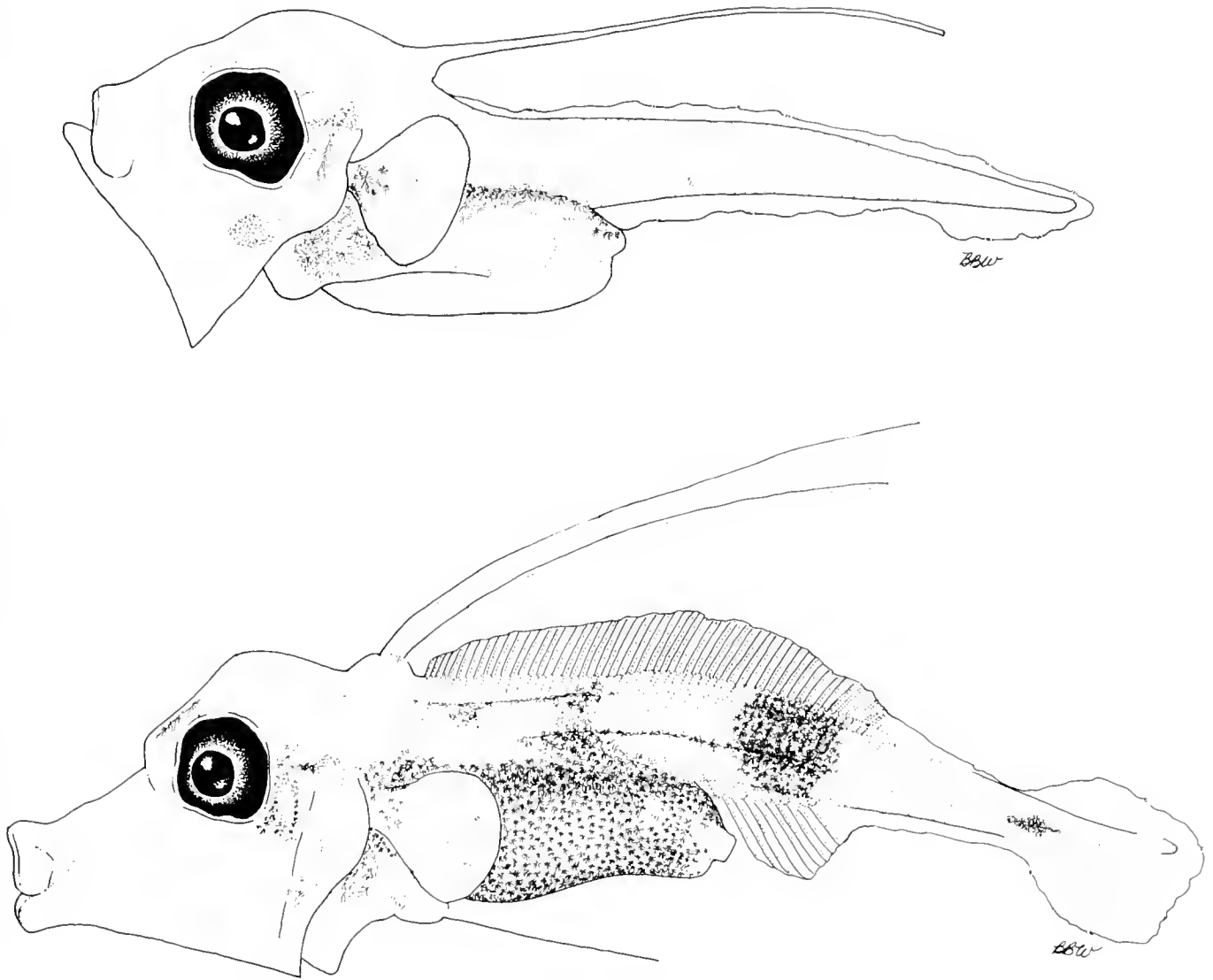

Fig. 199. Larvae of *Stylephorus chordatus*. (Upper) 3.8 mm NL, MCZ 59718; (Lower) 7.6 mm SL, MCZ 59719.

ever, only lophiiform, bothid, zeid and serranid larvae have elongate dorsal and pelvic elements.

Specialized ink glands filled with dark brown fluid are characteristic of lophotid and radiicephalid fishes, and are conspicuous in larval *R. elongatus* (Fig. 198), young *Lophotus* (Fig. 201) and presumably *Eumecichthys* (Walters and Fitch, 1960; Harrison and Palmer, 1968). Although this unpaired, internal structure is not considered a larval specialization, its early appearance in larval *R. elongatus* and juvenile *Lophotus* suggests that the ink gland may be functional in young fishes.

Development from larval to juvenile stages is gradual in *Lampris* (Figs. 196 and 197; Oeschlager, 1976b) but ontogenetic variability is marked and abrupt in trachipterid genera and *Stylephorus chordatus*. This rapid transition from prejuvenile to juvenile morphology has been termed metamorphosis in *Desmodema* (Rosenblatt and Butler, 1977) and *Trachipterus* (Hubbs, 1925). In *D. polystictum*, metamorphosis is characterized by changes in ventral profile, elongation of caudal vertebrae, in-

crease in eye size, eruption of mandibular teeth, and loss of spots, pelvic fins and the posterior nostril (Rosenblatt and Butler, 1977). Examination of *S. chordatus* material indicates a similar rapid transition, characterized by the loss of elongate dorsal rays, three ventral caudal rays and stout pelvic elements and by a marked change in eye morphology from a normal, non-telescopic eye to the specialized adult condition (Pietsch, 1978a). Similar metamorphic change may occur in other lampriform taxa, however full developmental series are not available.

Meristics.—Meristic variability is useful in delimiting lampriform taxa (Tables 98, 100). Precaudal, caudal and total vertebral counts distinguish genera and sometimes species (i.e., *D. polystictum* vs *D. lorum*; *T. fukuzaki* vs *T. altivelis*) and total myomere counts can be used to identify early larvae (Olney and Naplin, 1980). Total vertebral/myomere counts of less than 53 characterize *Lampris*, *Stylephorus* and veliferids and are the

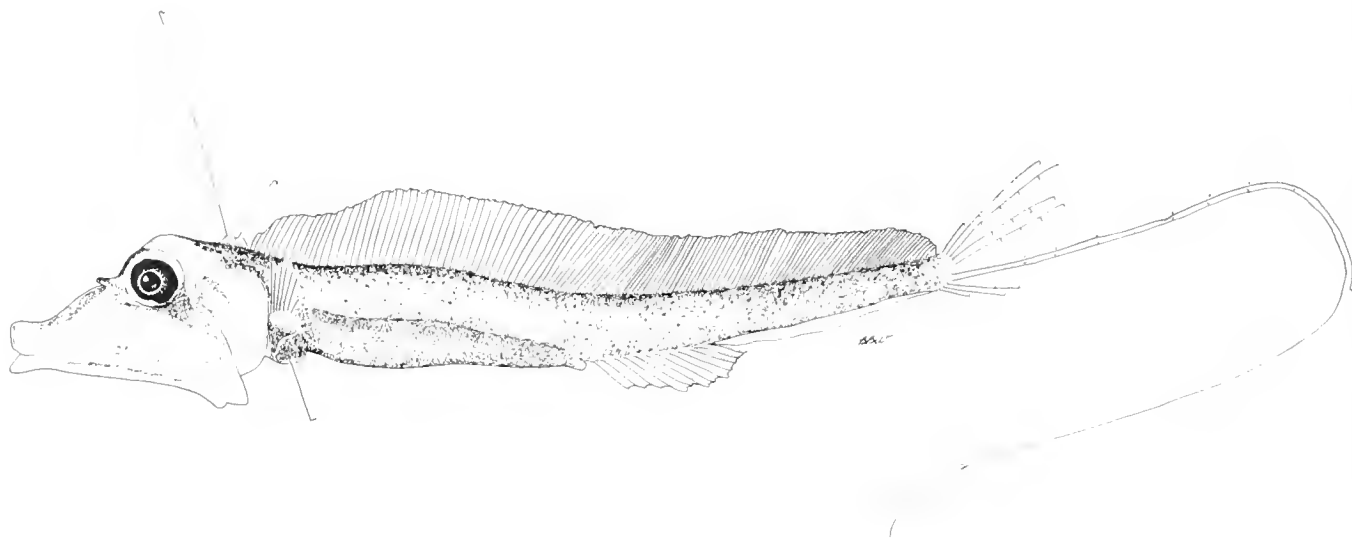

Fig. 200. Larvae of *Stylephorus chordatus* 21.4 mm SL, ZMUC uncataloged.

primary basis for the present identification of larval *L. guttatus* (Figs. 196 and 197), *Metavelifer multiradiatus* (Fig. 198) and *S. chordatus* (Figs. 199 and 200). Total vertebral/myomere counts range from 62–200 (Table 98) in trachipterid, radiicephalid, lophotid and regalecid fishes, but care should be taken since these elongate forms are often damaged in capture and the posteriormost myomeres are difficult to discern in larvae.

Rays of median fins are either stout, unsegmented, spine-like elements or typical soft rays. Previous researchers have been inconsistent in their treatment of these elements as spines or rays and ontogenetic variability likely exists. For these reasons, total element counts are reported without reference to spine or ray designation (Table 98). Furthermore, because of the lack of developmental series in collections, few data exist on the sequence of development of these and other fin elements. As a result, dorsal element counts delimit the genera of veliferid fishes for example (Table 98), but are not developed in a 5.7 mm NL Hawaiian specimen (Fig. 198). Identification of this specimen (Fig. 198) as *M. multiradiatus* is based on distributional records (Walters, 1960; Heemstra, in press). In larval *L. guttatus* (Fig. 196; identification based on distributional records of Parin and Kukuyev, 1983), total dorsal elements are developed by 8.6 mm SL but counts indicate some overlap with veliferid species (Table 98). In the elongate forms, dorsal element counts are less valid identification criteria since complete differentiation of elements occurs late in development (approximately 44 mm SL in *Lophotus lacepedei*, HML 6851; 83 mm SL in *Eumecichthys fiski*, MCZ 42264).

The absence of the anal fin characterizes adult trachipterid and regalecid fishes (Table 98), but its absence in early larvae cannot be considered diagnostic. In genera possessing an anal fin, differentiation of elements is evident in our material at 18 mm SL in *R. elongatus* (Fig. 198); 7.5 mm NL in *S. chordatus* (Fig. 199); 33.5 mm SL in *E. fiski*; 5.7 mm NL in *M. multiradiatus* (Fig. 198); and 8.6 mm SL in *L. guttatus* (Fig. 196). Size at first differentiation of anal elements of *Lophotus* spp. is unknown but total element counts can serve to delimit young *Raducephalus* and *Lophotus* (Table 98; compare Figs. 198, 201).

Larvae of these two forms can be easily confused due to the common possession of the distinctive ink gland (Figs. 198, 201).

Total number of pectoral rays overlap considerably among lampriform fishes and are of limited diagnostic value (Table 98). Total pelvic elements are of potential use in identification but ontogenetic variability is great and care should be taken until descriptions of full transformation series are available. Total caudal elements are diagnostic among some lampriform genera (Table 98), and, as previously discussed, details of caudal morphology are important larval identification criteria.

RELATIONSHIPS

Our present knowledge of the egg and larval taxonomy of lampriform fishes is inadequate to the task of fully understanding phylogenetic relationships. Although larval stages have been described for 8 of 12 genera (those of *Agrostichthys*, *Desmodema*, *Velifer* and *Eumecichthys* remain unknown), full developmental series and detailed studies of developmental osteology and morphology are lacking. Among those taxa for which some ontogenetic data are available, selected characters may elucidate relationships within the Lampriformes and between this group and other teleostean fishes. These are: (1) *Egg morphology*. The distinctive eggs of lampriforms (Table 99, Figs. 193, 194) are likely specializations for epipelagic incubation (Breder, 1962) and, if considered a derived condition, tend to support the conclusion of a common ancestry for the group. Complicating this interpretation is the lack of data on egg morphology in all lampriform genera (Table 99) as well as the common possession of somewhat similar (although probably independently evolved) egg morphology in other fishes (Orton, 1955a); (2) *Precocious embryonic development*. At hatching, all known lampriform larvae possess fully developed, protrusible jaws; functional, differentiated guts; and pigmented eyes. This complement of precociously developed features shared by lampriform taxa may be a specialization for early, successful feeding in the low prey densities of the epipelagic habitat. To my knowledge, only exocoetoid fishes exhibit similar development; (3) *Elongate anterior dorsal elements*. All known lampriform larvae



Fig. 201. Photomicrograph of the posteriormost portion of the ink gland in young *Lophotus lacepedei* (HML 6851, 45 mm SL). Ink gland is seen as the dark, tubular body overlying the hindgut and vent. The vent is indicated by an arrow.

possess elongate anterior dorsal elements which are ornamented with spatulate, pigmented swellings in some genera. As with other fishes with ornamented larval appendages (Govoni et al., 1984), variation in ornamentation may be due to capture damage. As a result, the absence of elaborate ornamentation in early larvae of *L. guttatus* (Fig. 196), *M. multiradiatus* (Fig. 198) and *S. chordatus* (Figs. 199 and 200) could be artifactual; (4) *Pelvic fin elements*. Precocious appearance of ventral fin elements which are stout, elongate and supported by well developed pelvic bones is observed in all known lampriform larvae (Figs. 193, 195–200). Variation among genera occurs in element number and fate at metamorphosis. In *Velifer* and *Lampris*, pelvic elements are numerous and well developed in adults. In remaining genera, reductive trends are evident and only regalecids retain strongly developed and specialized pelvic fins (Oelschlager, 1978a); (5) *Minute spines on dorsal elements*. Small, laterally projecting spines are conspicuous in some young lampriform fishes and have been reported in juveniles by Walters and Fitch (1960: 443), Rosenblatt and Butler (1977:844), and Heemstra and Kennemeyer (in press). In our material, these minute spines are conspicuous in larval *Zu*, *Trachipterus*, *Regalecus*, *Lophotus* and *Radiicephalus* as well as juvenile specimens of *Desmodema* and *Eumecichthys*. Larval *Lampris*, *Metavelifer* and *Stylephorus* lack these characters; (6) *Multiple pterygiophores interdigitate in first two interneural spaces*. In all our lampriform material, only *L. guttatus* and *M. multiradiatus* have fewer than seven pterygiophores which interdigitate in interneural spaces 1 and 2 (Table 100). In addition, only *Lampris* and *Metavelifer* (and presumably *Velifer*) possess a single predorsal element. Interdigitation sequences in *Velifer*, *Lophotus*, *Eumecichthys*, *Stylephorus* and *Agrostichthys* are unknown; and (7) *Metamorpho-*

sis. The absence of abrupt ontogenetic transition delimits *Lampris* (and presumably veliferids) from other lampriform genera.

The distribution of ontogenetic characters 1–7 among lampriform genera may be instructive when considering suggestions by previous authors of evolutionary trends within the order. The indication of monophyly by Regan (1907, 1924) and the adoption of this hypothesis by Greenwood et al. (1966) and Oelschlager (1976a) is supported by the common possession of characters 1–4 among all known lampriform larvae. Rigorous testing of this hypothesis utilizing ontogenetic data, however, must await a more complete knowledge of egg and larval development among Lampriformes and between these fishes and other groups. Rosen (1973) suggested that relationships among trachichthyoids, berycids, zeoids and lampriforms seem plausible. Ontogenetic characters (1–4) which appear to unite the diverse lampriform genera are variously present, absent or unknown in trachichthyoid, berycid and zeoid fishes and present no clear picture of inter-relationships. Larvae of *Diretmus* and *Diretmoides* (Post and Quero, 1981) lack these characters and are distinguished by pronounced occipital and preopercular spines. *Polymixia* sp. (10.0 mm SL; MCZ 58964) lack characters 2 and 3 (eggs of *Polymixia* are unknown) but possess well developed ventral fins. These fins may not be present at hatching, however. Juvenile *Cyttus traversi* (James, 1976b) possess elongate, ornamented and pigmented pelvic and anterior dorsal elements, although the sequence of development of these structures is unknown. The rhomboidal body shape, symmetrical caudal and jaw structure of *C. traversi* resemble deep-bodied lampriform genera.

Rosen and Patterson (1969), Rosen (1973) and Oelschlager (1974, 1976a, 1978a, b, 1979) have examined osteological and functional aspects of adult lampriform morphology and commented on relationships. Recent fishes are represented by a series of highly modified forms of which *Velifer* is believed to be the least specialized. Veliferids are considered to be more closely related to *Lampris* than to any other genus on the basis of similar body form, caudal morphology, meristics and the possession of a predorsal element. No apomorphic character serves as a criterion for monophyly in the Veliferidae (Oelschlager, 1976a). Ontogenetic characters 5–7, however, may be useful in defining relationships between the two series of families [Oelschlager's (1976a) Bathysomi and Taeniosomi] within the order.

Among the elongate genera, *Agrostichthys* is considered most closely related to *Regalecus* (Oelschlager, 1978a, b). *Desmodema* and *Zu* represent an apomorphic sister group of *Trachipterus*, considered the most primitive trachipterid genus (Rosenblatt and Butler, 1977). *Radiicephalus* appears to be the least specialized among all elongate lampriforms although it shares several specialized features (ink sac, caudal filament) in common with lophotids and *Stylephorus* (Harrison and Palmer, 1968).

VIRGINIA INSTITUTE OF MARINE SCIENCE, COLLEGE OF WILLIAM AND MARY, GLOUCESTER POINT, VIRGINIA 23062.

Mirapinnatoidei: Development and Relationships

E. BERTELSEN AND N. B. MARSHALL

FISHES of the Mirapinnatoidei are soft-rayed, scaleless, oceanic teleosts with elongated body, jugular pelvic fins of 4–10 rays, a single dorsal fin opposed to the anal fin with origin behind mid-standard length, pectorals lateral, caudal fin with 10 + 9 principal rays, cleft of mouth oblique to subvertical, premaxillae excluding maxillae from gape, jaws no more than slightly protrusible, branchiostegal rays 3–5 on epihyal, 4 on ceratohyal, swimbladder, functional only in larvae, with two posterior retia mirabilia that supply an anterior gas gland. An isolated phylogenetic lineage of uncertain systematic position but apparently most closely related to the Megalomycterioidei and the Cetomimoidei.

DEVELOPMENT

These fishes were originally placed in two families by Bertelsen and Marshall (1956): (1) Mirapinnidae, with a single genus and species *Mirapinna esau* (Fig. 202) based on a single subadult female 39.5 mm SL caught at the surface off the Azores and (2) Eutaeniophoridae, with two genera *Eutaeniophorus* and *Parataeniophorus* (Figs. 202 and 203) both known only in larval and metamorphosis stages less than 55 mm SL that are epipelagic in tropical and subtropical parts of all oceans.

Examination of more recent material indicates that these fishes are better regarded as members of a single family, Mirapinnidae, containing the above mentioned 3 genera. Adults probably are mesopelagic. The genera and species are distinguished by meristic and morphometric characters as well as differently developed dermal structures (Table 101). Hair-like outgrowths of the epidermis are found all over the head, body and fins of *Mirapinna esau*. The longest hairs measure from about 1.0 to 1.5 mm in length and bear stalked glandular cells. The skin of *Eutaeniophorus* and *Parataeniophorus* is densely covered with minute papillae less than about 0.05 mm in length (Bertelsen and Marshall, in preparation). Skin of the caudal fin of *Eutaeniophorus* and *Parataeniophorus* is prolonged into a ribbon-like streamer reaching lengths of 200–300% SL. Upper and lower lobes of the caudal fin overlap in *Mirapinna*.

Specimens.—Including a number of unpublished records the material of Mirapinnatoidei known to us consists of: One *Mirapinna esau*, the holotype, a 39.5 mm juvenile female; about 100 *Eutaeniophorus festivus* 8.0–53 mm; two *Eutaeniophorus* n. sp. (in preparation) 12 and 16 mm; 32 *Parataeniophorus gulosus* 8–35 mm; 3 *Parataeniophorus brevis* 13.5, 29 and 46 mm; 2 *Parataeniophorus* n. sp. (in preparation) 9 and 11 mm; about 40 unidentified small larvae (most probably *E. festivus*) 5–12 mm. Eggs of Mirapinnatoidei are unknown and no larval *Mirapinna* has been recorded; [according to our reexamination a specimen of about 16 mm referred to this species by Fourmanoir, (1971b) is a *Parataeniophorus* sp.]. All the specimens have small immature gonads. A light brown pigmentation of the skin appears at a larval length of about 20 mm and some of the 35–53 mm largest specimens are dark brown and are considered post-metamorphic juveniles. However the transfor-

mation from larval to juvenile appearance is quite gradual without any distinct specialized metamorphic stage.

The youngest *Eutaeniophorus* larva described (6.5 mm SL) has remains of a yolk sac, nearly unpigmented eyes, no rudiment of pelvic fins, continuous embryonic fins without trace of fin rays and, except for a ventral series of melanophores, the body is completely unpigmented (Bertelsen and Marshall, 1958). Full numbers of rays of the unpaired fins may be detected at 8–9 mm SL. Rudiments of pelvic fins are present at 6–7 mm SL, the number of rays discernable at about 10 mm SL. Pectoral fin rays are not well differentiated until lengths of about 20 mm SL. The caudal streamer, characteristic of *Eutaeniophorus* and *Parataeniophorus*, is present as a short rudiment in the 5–6 mm youngest larvae; it increases with increasing SL. It is broken in most specimens of more than about 10 mm. The greatest lengths observed are 86% SL in a *Parataeniophorus brevis* of 22.6 mm, about 200% SL in two specimens of *Eutaeniophorus* of 12–15.5 mm SL (unpublished data), and no less than 300% in an *E. festivus* of 35 mm (Fig. 203).

All *Eutaeniophorus* larvae are very slender with body depth less than 10% SL except for the largest specimens. Body depth in *Parataeniophorus* species is less than 15% SL. Predorsal lengths (snout to first dorsal finray) in these genera is 69 to 77% SL (cf. Table 101).

All larvae have a fine peppering of melanophores on head and body, slightly increasing in density with increasing SL, with no distinct grouping except for a slight increase in density towards the tail, on the dorsal part of the peritoneum, and along

TABLE 101. CHARACTERISTICS OF MIRAPINNATOIDEI.

	<i>Mirapinna</i>	<i>Parataeniophorus</i>		<i>Eutaeniophorus</i>
	<i>esau</i>	<i>brevis</i>	<i>gulosus</i>	<i>festivus</i>
Texture of skin	Hairs	Minute papillae		
Caudal streamer	Absent	Present		
Length in % SL:				
Head	27	10–17	12	10–13
Predorsal	61	71–72	69	70–77
Longest pectoral finray	14	3–9	7	4–7
Longest pelvic finray	40	15–25	16–39 ¹	12–19 ²
No. of finrays:				
Pectoral	13	ca. 16–18	19–20	20–24
Pelvic	8	8–9	9–10	4–5
Dorsal	16	15–20	28–33	16–20
Anal	14	14–17	23–29	15–18
No. of vertebrae:				
Predorsal	22	21–27	28	31–36
Under dorsal fin	10	8–11	13	8–11
In caudal peduncle	16	10	8	7–8
Total	48	42–46	49	47–55

¹ Shorter in specimens less than 15 mm.

² Shorter in specimens less than 25 mm.

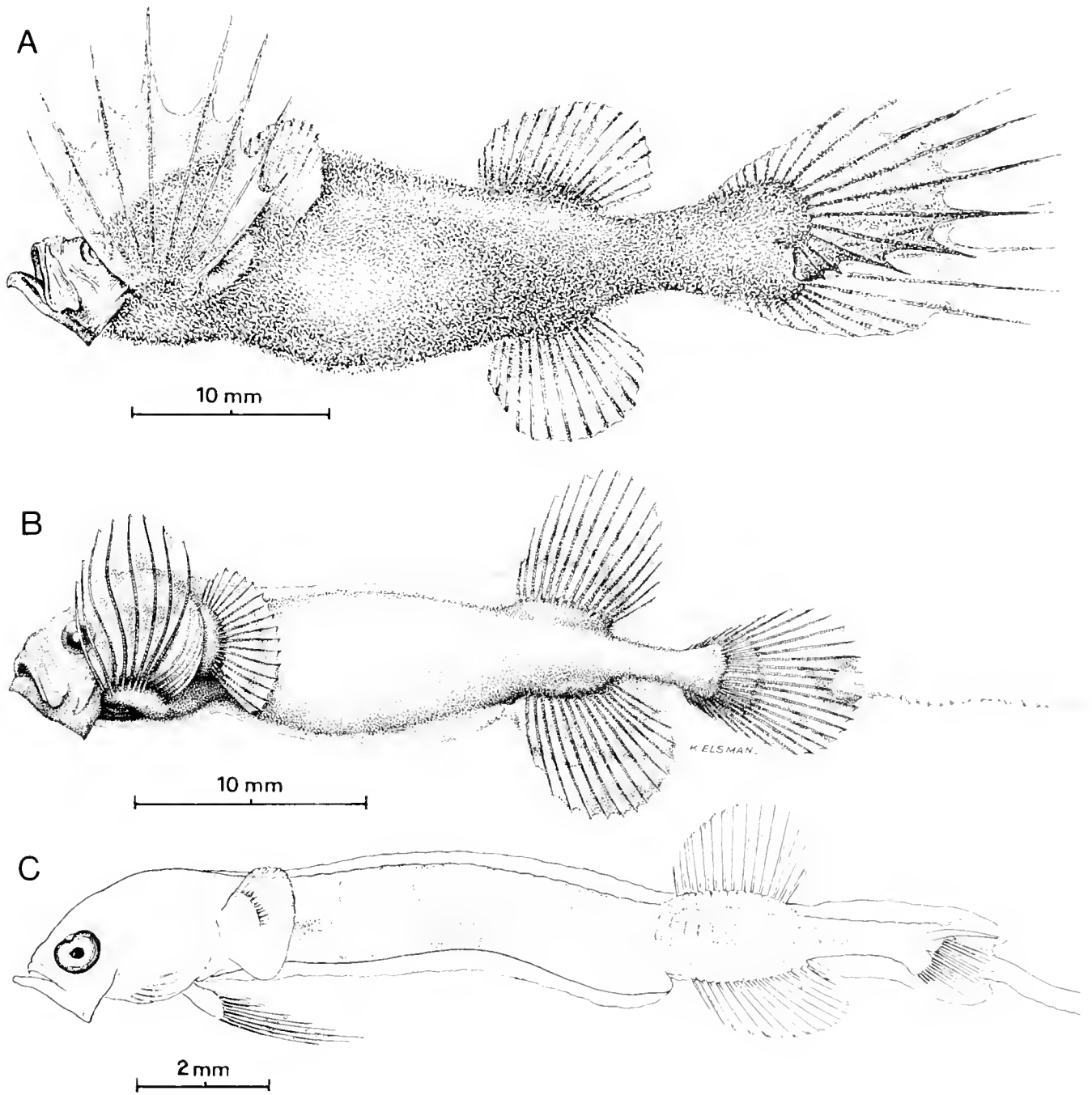

Fig. 202. (A) *Mirapinna esau*, holotype, 39.5 mm SL; (B) *Parataeniophorus brevis*, 29 mm SL; and (C) *Parataeniophorus brevis*, holotype, 13.5 mm SL. A and C from Bertelsen and Marshall (1956), B drawn by Kai L. Elsmann.

the myosepta. Density of pigment is greater on the caudal streamer and the caudal fin rays at the base; the fully developed streamer has a median longitudinal band of pigment and a nearly black ventral border. The two species of *Parataeniophorus* differ in pigmentation from *Eutaeniophorus festivus* in having a distal patch of pigment on each pelvic fin. No other distinguishing characters in pigmentation have been found.

RELATIONSHIPS

Reference to Bertelsen and Marshall (1956), Myers and Freyhofer (1966) and Goodyear (1970) shows that both the mirapinnatoid and megalomycteroid fishes have the following common features: (1) they are small, elongated fishes with a relatively small head and mouth; (2) the suspensoria are inclined forwards and there is a single supramaxilla in the upper jaw; (3) they have

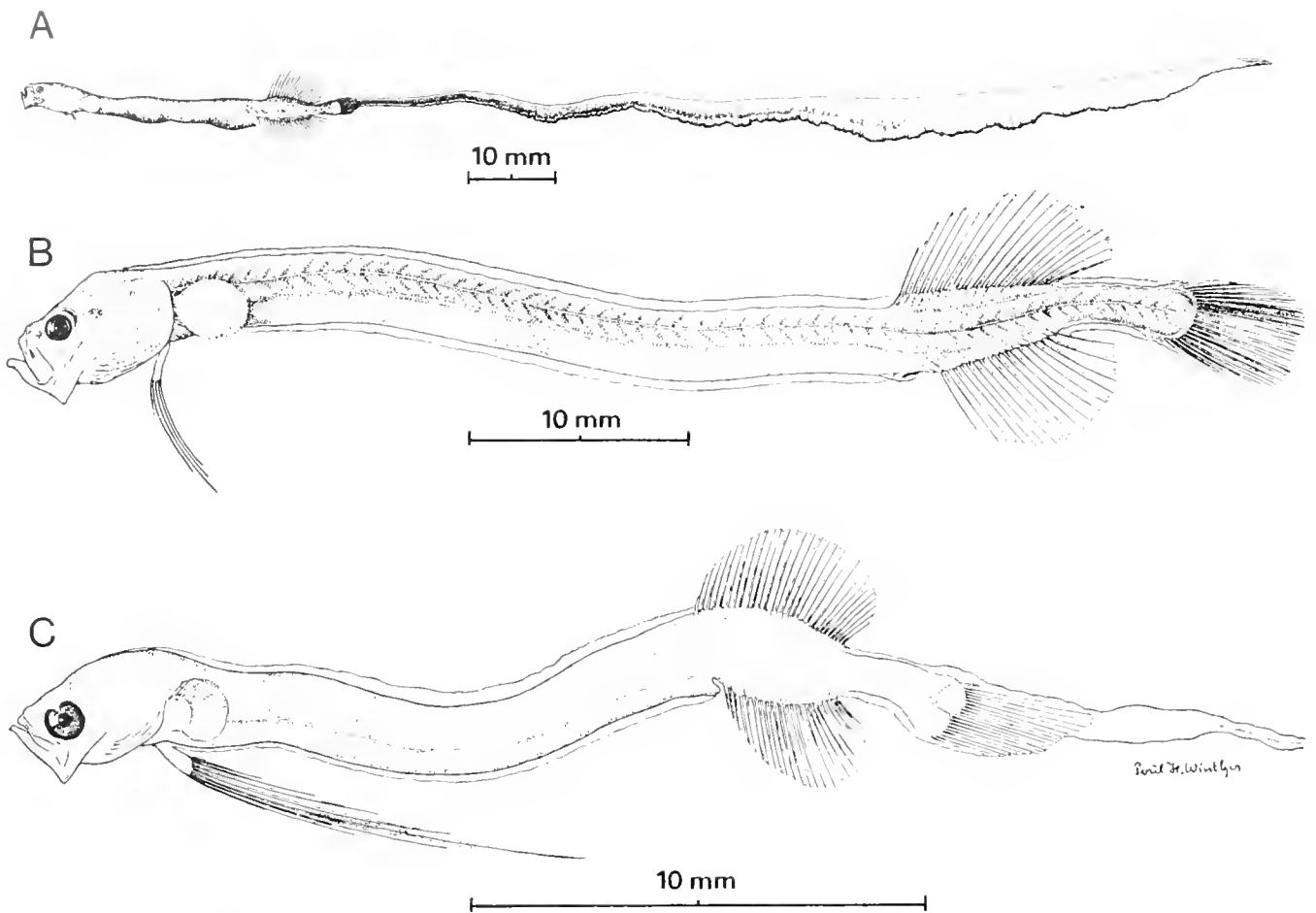

Fig. 203. (A) *Eutaeniophorus festivus*, paratype, 35 mm SL, with complete caudal streamer, 106 mm in length; (B) *Eutaeniophorus festivus*, holotype, 53 mm SL; and (C) *Parataeniophorus gulosus*, paratype, 21 mm SL. All from Bertelsen and Marshall (1956).

soft rays, which are unbranched [except in the caudal fin of megalomycteroids? Myers and Freihofers (1966) drawing of *Megalomycter teevani* shows the complete caudal rays ending in actinotrichia, and they state that the dorsal and anal rays are unsegmented]; (4) the dorsal and anal fins are opposed and inserted on the posterior half of the body; (5) the pectorals are laterally set and have numerous rays (D.15–33, A.14–29 in the mirapinnatoids; D.15–26, A.14–20 in the megalomycteroids); (6) the pelvic fins are inserted below or before the base of the pectorals, but are reduced or absent in the megalomycteroids, whereas the pelvics of the mirapinnatoids are well developed; (7) the numbers of branchiostegal rays (on the epihyal and ceratohyal) are 3–5 + 4–5; (8) the vertebrae number 41–54 (45–48 in the megalomycteroids).

The main differences between the two groups concern the skin (papillate or “hairy” in the mirapinnatoids, scaled in the megalomycteroids), olfactory organs (very large in the latter, small in the former) [Goodyear’s (1970) specimen was a ripe male but Myers and Freihofers (1966) did not determine the sex of their specimens. It is possible that the females have yet to be found and are microsmatic]. The gape markedly oblique in the mirapinnatoids, somewhat oblique or horizontal in the megalomycteroids.

The mirapinnatoids resemble the cetomimoids in having soft rays, a scaleless skin, opposed dorsal and anal rays on the posterior part of the body and the same numbers and arrangement of branchiostegal rays (mirapinnatoids 3–5 + 4, cetomimoids 3–4 + 4–5). There is also a marked resemblance between the swimbladder of *Barbourisia*, which regresses after a presumed functional stage in the early life history, and the swimbladder of the mirapinnatoids (see Bertelsen and Marshall, 1956). In both there are two posterior retia mirabilia that run forward to an anterior gas gland.

One main difference between these two suborders concerns the head, which whether relatively large or small in the cetomimoids, bears long jaws with a more or less horizontal gape. This contrasts strongly with the relatively short, upturned jaws of the mirapinnatoids. (Even so, it may well be that the fishes of these suborders and the megalomycteroids feed largely on copepods.) Secondly, in the two cetomimoids that have pelvic fins (*Rondeletia* and *Barbourisia*) these are abdominal in position whereas those of the mirapinnatoids are jugal.

Beside the similarities considered above, the mirapinnatoids, megalomycteroids and cetomimoids resemble each other in the disposition of the red muscle component of their axial muscles. Down the entire length of their myotomes red muscle fibres

cover at least the main "V" of each element, and such an arrangement seems to be unusual in teleosts. Similar wide red muscle coverage of the myotomes is found also in the stomiatooids and giganturooids (Marshall, unpublished) and apparently also in male ceratioid angler-fishes (Marshall, 1971). Other groups will probably prove to have this kind of red muscle arrangement but the most usual condition in teleosts is a narrow concentration of red muscle on either side of the horizontal septum down the entire length of the fish. However, in alepisauroids the vertical extent of red muscle expands towards the tail, where it may cover most of the myotomes (Marshall, 1971; Johnson, 1982).
 The above treatment of adult characters indicates that the mirapinnatooids are most closely related to the megalomycteroids. Next to the latter they are most nearly allied to the ceto-

mimoids. As will be seen from the title of this paper, we have followed Greenwood et al. (1966) in placing all three suborders in the order Cetomimiformes away from the Acanthopterygii. Whether they can be gathered into a larger ordinal grouping, as in the Lampridiformes (Rosen and Patterson, 1969) or in the Beryciformes (Rosen, 1973), is a matter for further comparative studies (see also Zehren, 1979). Nothing is known of larval megalomycteroids and cetomimoids. Larval forms of other groups seem to have no affinities to larval mirapinnatooids.

(E.B.) ZOOLOGICAL MUSEUM, UNIVERSITY OF COPENHAGEN, COPENHAGEN 2100 Ø, DENMARK. (N.B.M.) 6 PARK LANE, SAFFRON-WALDEN, ESSEX, ENGLAND.

Beryciformes: Development and Relationships

M. J. KEENE AND K. A. TIGHE

IN the classification of Greenwood et al. (1966), the order Beryciformes was divided into 3 suborders; the Stephanoberycoidei with 3 families, the Polymixioidei with 1 family and the Berycoidei with 8 families. Rosen and Patterson (1969) removed the Polymixiidae from the Beryciformes, assigned it to a new order, the Polymixiiformes and placed this order in the

Paracanthopterygii. Rosen and Patterson (1969) also moved the Cetomimidae, Barbourisiidae and Rondeletiidae to the Beryciformes in the suborder Cetomimoidei. Woods and Sonoda (1973) considered the order Berycomorphi to contain the families Polymixiidae, Diretmidae, Monocentridae, Anomalopidae, Trachichthyidae, Holocentridae, Berycidae, Sorosichthyidae, and

TABLE 102. MERISTIC RANGES, OSTEOLOGICAL CHARACTERS, NUMBER OF GENERA, AND NUMBER OF SPECIES FOR FAMILIES IN THE ORDER BERYCIFORMES. All data are from Woods and Sonoda (1973), Ebeling and Weed (1973) or Zehren (1979) unless noted.

	Pelvic	Dorsal	Anal	Principle caudal rays	Pectoral	Branchiostegals	Vertebrae	Osteological characters			Number of genera	Number of species
								Orbitosphenoid	Subocular shelf	Supra-maxillary		
Berycidae	1, 7 or 1, 10-12	IV-VII, 13-18	IV, 12-30	16-17	13-18	7-9	24	Present	Present	2	2	ca. 10
Anoplogasteridae	1, 6	0, 17-19	0, 8-9	17	14-16	8	28	Present	Present	1	1	1
Diretmidae	1, 6	0, 17-19	0, 18-24	17	16-20	7-9	27-31	Present	Present	1	2	3
Sorosichthyidae ¹	1, 5	X, 8	II, 8	16 or 17	13	7	?	?	?	?	1	1
Trachichthyidae	1, 6	IV-VIII, 12-18	II-III, 8-12	17	14-20	8	26-29	Present	Present	2	5	ca. 14
Anomalopidae	0, 6-7	II-IV, 14-19	II, 10-13	19	16	7 or 8	25-30	Present	Present	1 or 2	3	4
Monocentridae	1, 2-3	IV-VII, 11-12	0, 10-12	19	14	8	27	Present	Present	1	1	2
Hispidoberycidae ²	1, 6	IV-V, 10	III, 9	17	12	8	34	Present	Absent	1	1	1
Holocentridae	1, 5-8	X-XIII, 11-16	IV, 9-16	17	14-17	7-8	26-27	Present	Present	2	9	ca. 70
Gibberichthyidae	0, 5-6	V-VIII, 8-9	IV-V, 7-9	17	13-15	8	28-31	Absent	Absent	1	1	2
Stephanoberycidae	0, 5	0-III, 11-14	0-III, 10-13	19	11-18	7-8	30-33	Absent	Absent	1	3	3
Melamphaidae	1, 6-9	I-III, 9-18	I, 7-10	17	14-17		24-31	Absent	Absent	0 or 1	5	ca. 30
Rondeletiidae	0, 5-6	0, 13-16	0, 13-15	17	9-10	8	24-27	Absent	Absent	1	1	2
Barbourisiidae	0, 6	0, 21-22	0, 16-18	17	14	8	ca. 42	Absent?	Absent?	1	1	1
Cetomimidae	Absent	14-ca. 30	13-ca. 30	11-19	16-20	8-10	51-52	Absent?	Absent?	1	5	10
Paradiretmidae ³	1, 5	X-XI?, 15?	III, 13	ca. 13	16	?	?	?	?	?	1	1

¹ Whitley, 1945
² Kotlyar, 1981
³ Whitley, 1946

TABLE 103. REFERENCES GIVING DESCRIPTIONS AND/OR FIGURES OF EARLY LIFE HISTORY STAGES OF THE ORDER BERYCIFORMES.

Family	Eggs	Larvae	Pre-juveniles juveniles
Holocentridae	—	McKenney, 1959 Jones and Kumaran, 1962 Aboussouan, 1966b	McKenney, 1959 Jones and Kumaran, 1962 Greenfield, 1965 Randall et al., 1982
Melamphaidae	—	Ebeling, 1962 Ebeling and Weed, 1963, 1973 Pertseva-Ostrou- mova and Rass, 1973 Moser, unpub- lished	—
Diretmidae	—	Post, 1976 Post and Quero, 1981	—
Anoplogasteridae	—	—	Parr, 1933
Trachichthyidae	—	Ahlstrom (notes) Crossland, 1981	Parr, 1933 Johnson, 1970
Gibberichthyidae	—	—	Robins and de Sylva, 1965 Thorp, 1969 de Sylva and Eschmeyer, 1977
Berycidae	—	—	—
Anomalopidae	—	—	—
Monocentridae	—	—	—
Sorosichthyidae	—	—	—
Paradiretmidae	—	—	—
Hispidoberycidae	—	—	—
Stephanoberycidae	—	—	—
Barbourisiidae	—	—	—
Rondelettiidae	—	—	—
Cetomimidae	—	—	—

Anoplogasteridae, while Ebeling and Weed (1973) considered the order Xenoberyces to contain the families Melamphaidae, Gibberichthyidae, and Stephanoberycidae. Both pairs of authors gave diagnostic characters, and compared and contrasted their orders. Zehren (1979), after studying the comparative osteology and phylogeny of the beryciform families of Greenwood et al. (1966), also concluded that the Polymixiidae did not belong in the Beryciformes. Nelson (1976) included the families Sorosichthyidae and Paradiretmidae in the suborder Berycoidei but did not treat them further. Kotlyar (1981) described a new species of beryciform which he felt deserved status as a new family, the Hispidoberycidae. He tentatively aligned his new family within the Berycoidei. The Beryciformes are presently defined on the basis of several primitive characters such as the presence of an orbitosphenoid and subocular shelf (in most forms) and a high number of pelvic and caudal rays as well as

several derived characters such as the presence of dorsal, anal and pelvic spines, and the presence of spinous procurrent caudal fin rays. However, none of the characters is unique to the order and the monophyly of the order is still in question. Meristics, osteological characters, and the number of genera and species in each beryciform family are shown in Table 102.

Although the systematics of the Acanthopterygii is in a state of flux, the order Beryciformes presently contains 3 suborders; the Stephanoberycoidei with 3 families, the Berycoidei with 10 families, and the Cetomimoidei with 3 families.

The Beryciformes are considered by Greenwood et al. (1966) to be the basal stock from which some of the more advanced acanthopterygians have evolved. Beryciformes are marine and occur in all oceans. Some species are semibenthic inhabiting coral reefs, rocky shores, and shelf or slope waters (Woods and Sonoda, 1973) while others are epipelagic, mesopelagic, bathypelagic, or bathybenthic (Ebeling and Weed, 1973).

DEVELOPMENT

There is no published information on early life history stages for the Monocentridae, Anomalopidae, Berycidae, Sorosichthyidae, Paradiretmidae, Hispidoberycidae, Stephanoberycidae, Barbourisiidae, Rondelettiidae, and Cetomimidae (Table 103). Although information is lacking on the eggs of the Beryciformes, there is some on other early life history stages of the Holocentridae, Melamphaidae, Anoplogasteridae, Diretmidae, Trachichthyidae and Gibberichthyidae.

The Holocentridae contains two subfamilies, the Holocentrinae and the Myripristinae. Prejuveniles and early life history stage series are known for at least one species in each subfamily. McKenney (1959) gave a detailed description of the early life history of *Holocentrus vexillarius* based on specimens less than 2.0 mm to adults, while both Aboussouan (1966b) and Jones and Kumaran (1962) figure and discuss larvae of *Holocentrus* sp. less than 5.0 mm SL. Jones and Kumaran (1962) also figure and describe larval stages ranging from 2.7 to 6.7 mm, for *Myripristis nurdjan* [specific identification questioned by Greenfield (1965)]. McKenney (1959) figured the prejuvenile or rhynchichthys stage of *Holocentrus vexillarius* while Jones and Kumaran (1962), Greenfield (1965), and Randall et al. (1982) figure the rhynchichthys stage for several myripristine species. The following characterization of holocentrid development is based on the data of McKenney (1959) and Jones and Kumaran (1962).

Holocentrid larvae are characterized by a relatively large head with well-developed preopercular, rostral, and median cranial spines. Pigmentation is extensive on the peritoneum and there is a ventral line of melanophores in the postanal region. The long preopercular spines develop first and are well developed at 1.8 mm TL (Fig. 204A). At 2.2 mm the posteriorly directed cranial spine is rapidly forming and by 2.8 mm the rostral spine is apparent. The 5.0 mm *H. vexillarius* and 4.7 mm *Myripristis* sp. (Fig. 204B, C) both exhibit strong rostral, median cranial, preopercular and opercular spination that develops into the head armor found in the rhynchichthys stage (Fig. 204D, E). There

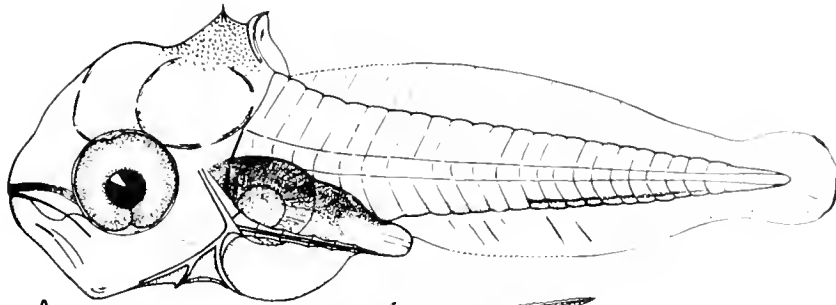

A

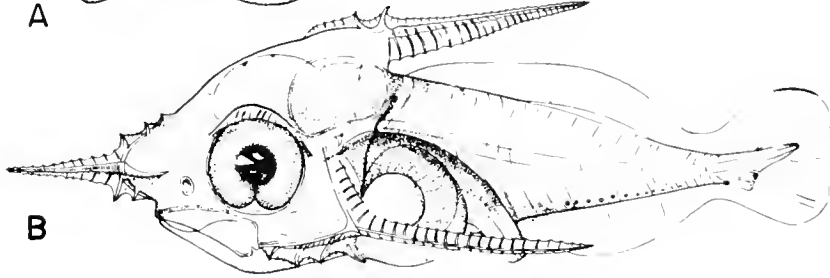

B

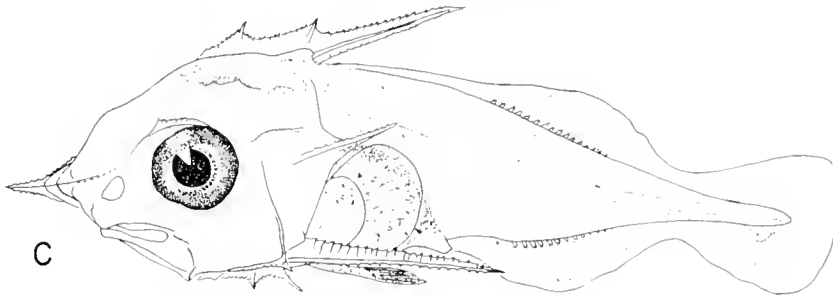

C

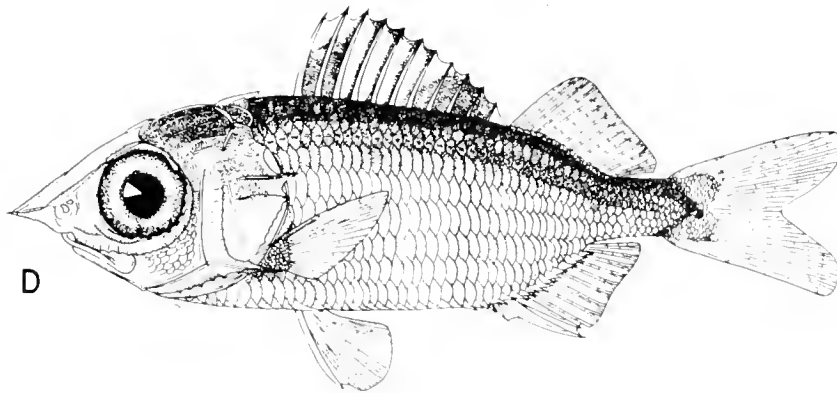

D

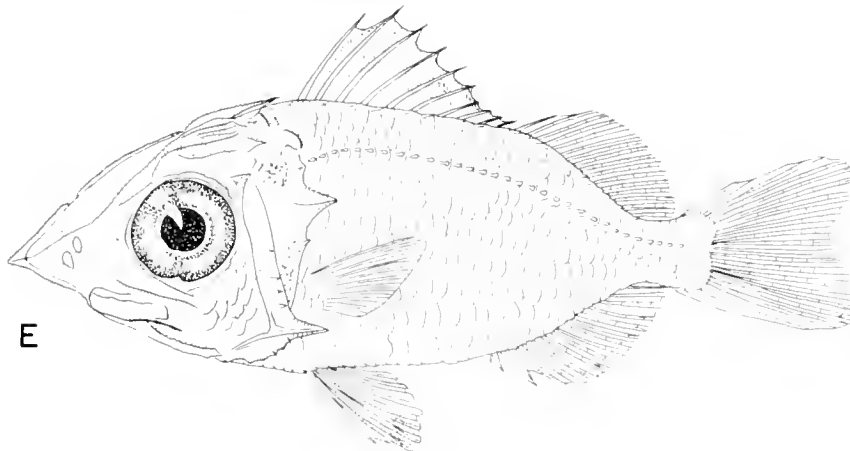

E

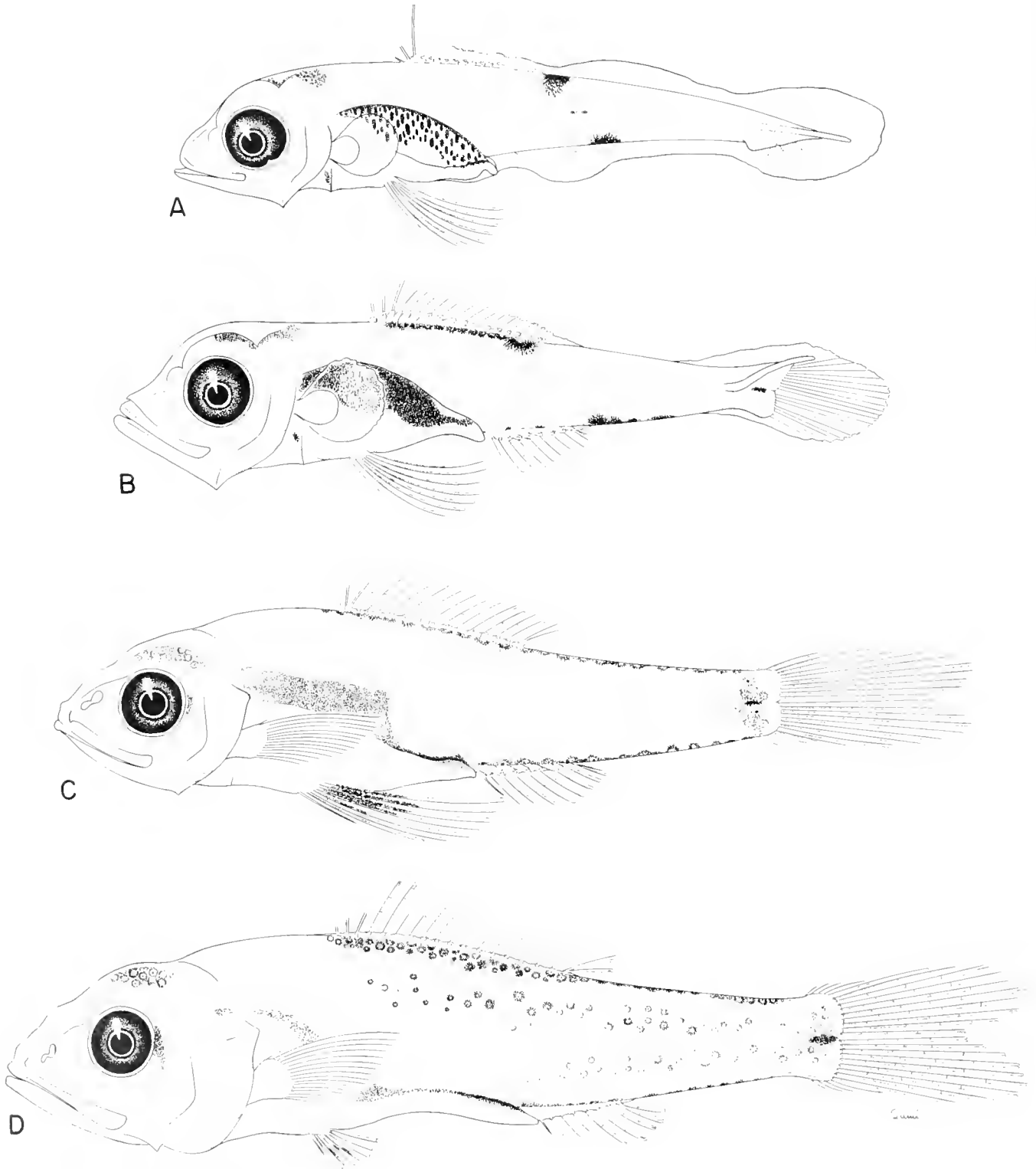

Fig. 205. Larval series of *Melamphaes lugubris* (A) 5.3 mm NL, (B) 6.2 mm SL, (C) 10.4 mm SL and (D) 15.2 mm SL (source: Southwest Fisheries Center, CalCOFI, original, illustrated by B. Y. Sumida).

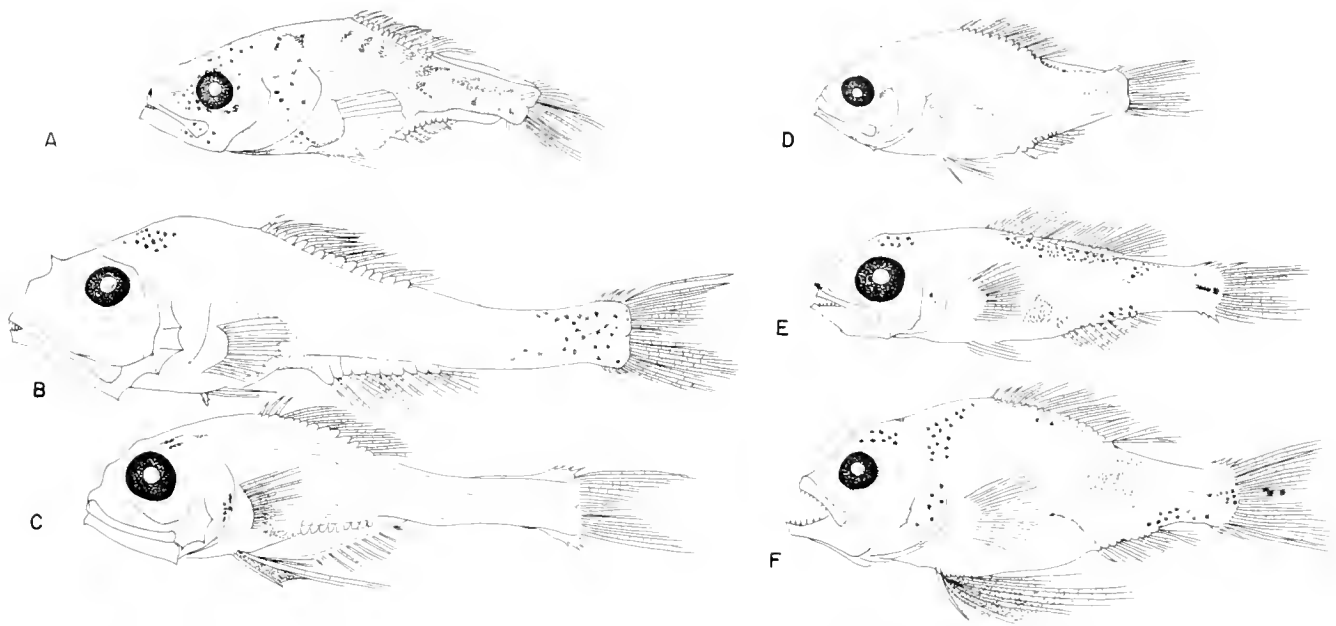

Fig. 206. (A) Postflexion larva of *Scopelogadus bispinosus*, 8.0 mm SL; (B) Postflexion larva of *Poromitra* sp., 13.5 mm SL; (C) Postflexion larva of *Poromitra megalops*, 10.0 mm SL; (D) Postflexion larva of *Scopeloberyx* sp., 6.5 mm SL; (E) Postflexion larva of *Melamphaes lugubris*, 8.3 mm SL; (F) Postflexion larva of *Melamphaes typhlops*, 9.4 mm SL (source: Ebeling, 1962).

are minor differences in the spine patterns of the two species illustrated, and the *Holocentrus* spination is somewhat more developed. All of these spines are lost as the fish develops into a juvenile in the Myripristinae, while the Holocentrinae retain only large preopercular spines.

A considerable amount is known about at least some of the early life history stages of all melamphaid genera except *Sio*. Notes from Moser and Ahlstrom, and an examination of melamphaid larval specimens from the Southwest Fisheries Center (SWFC), allow the following conclusions to be made about early melamphaid larvae 2–10 mm for *Poromitra*, *Melamphaes*, *Scopelogadus*, and *Scopeloberyx*. Specimens in this range tend to have a relatively more elongate and slender body shape than later larval stages. The pelvics develop rapidly followed closely by the pectoral fins. The pelvic fin origin is more anterior than in later stages, and the pelvic rays are quite long, fragile and darkly pigmented. This condition persists longer and is more striking in some species such as *M. typhlops* than in others. In early larvae of *Melamphaes*, *Scopelogadus*, and *Scopeloberyx*, two pigment spots occur near the posterior end of the dorsal and anal fin anlagen (Fig. 205A). These pigment spots spread both anteriorly and posteriorly during growth to form longitudinal rows of pigment along the dorsal and ventral surfaces of the body (Fig. 205B). In some species, these areas of initial pigmentation spread laterally to form a band of pigment between the dorsal and anal fin bases in later larval stages. Additional pigmentation occurs on the cranium and peritoneum in all four genera, and in the form of a spot at the posterior end of the caudal peduncle in at least *Melamphaes* and some *Poromitra*. In these early stages, the second or third dorsal fin ray tends to be much longer than the others, extending to the region of the caudal peduncle. This elongate ray is known to occur in *Melamphaes*, *Scopeloberyx*, and *Scopelogadus*. Usually damaged,

this elongate ray is not evident after 5–10 mm but, even in adults, the second or third dorsal ray (spine) is the largest. By 5–10 to 20 mm SL melamphaid larvae exhibit body shapes and other characters such as meristics and preopercular spination that allow them to be separated into genera (Ebeling, 1962; Fig. 206A–F). Development is gradual and direct; there are no known prejuvenile stages. Additional larvae were illustrated and are published here without further comment (Fig. 207).

Early life history stages are known for all three species contained in the two genera of the Diretmidae. Post (1976) discusses the systematics and early life history of two of these species, and Post and Quero (1981) in their familial revision, describe a new genus and species, give the early life history of all three species, and provide a key for the identification of juveniles. The larvae of all three species are relatively elongate at 4–5 mm sizes but rapidly develop a relatively deeper body. All three species also possess a short stout spine over each eye, a longer cranial spine directed posteriodorsad on each side of the head, and a long preopercular spine directed posteroventrad (Fig. 208A). The head spine configuration is quite similar to that of *A. cornuta*, described below, and is gradually lost during growth.

The monotypic Anoplogasteridae contains the highly specialized mesopelagic predator *Anoplogaster cornuta*. Specimens over about 100 mm SL are jet black with large fangs while specimens less than 80 mm SL are metallic grey with black pigmentation developing along the ventral midline, do not have such large teeth, and exhibit a pattern of head spination not found in larger individuals (Woods and Sonoda, 1973). USNM collections contain many individuals from 4.5 mm TL larvae to adults, upon which the following characterization of the early life history stages is based.

A 4.5 mm preflexion larva has the caudal fin elements de-

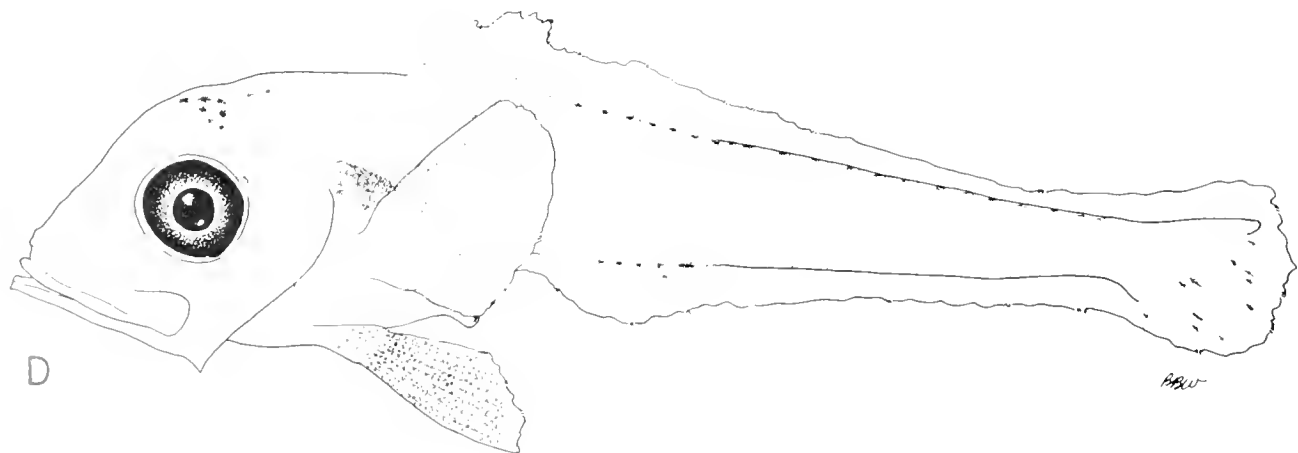
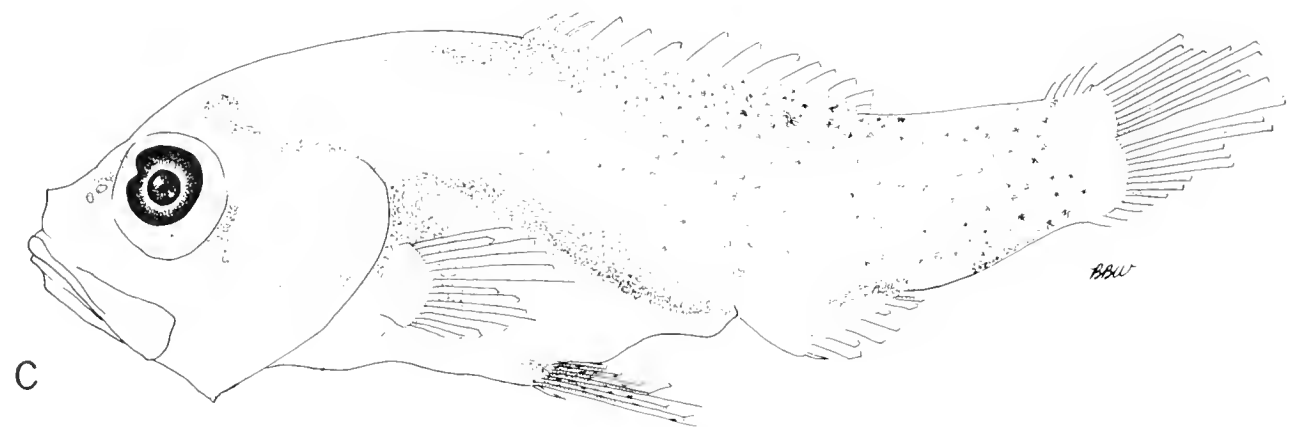
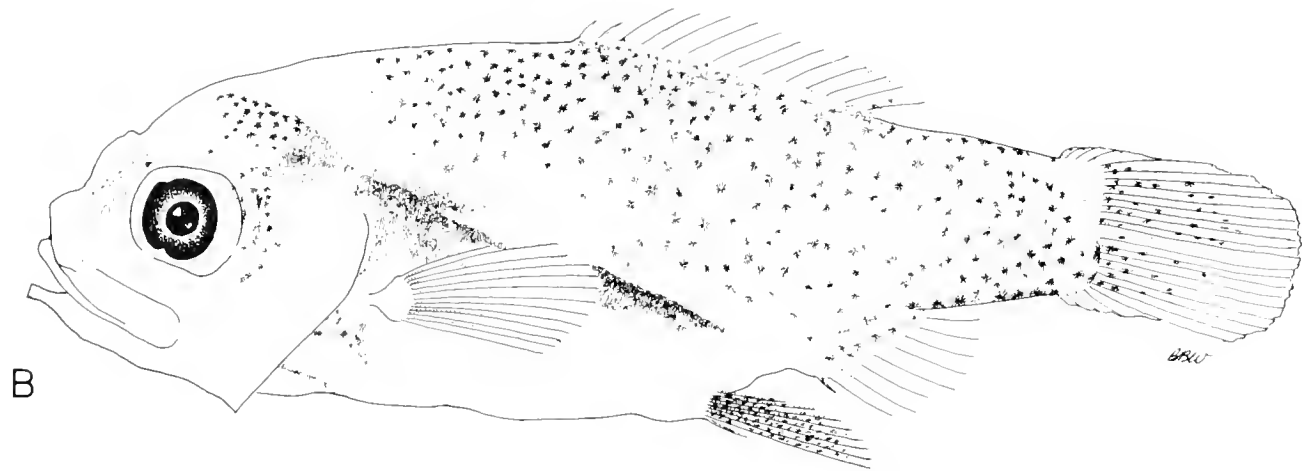
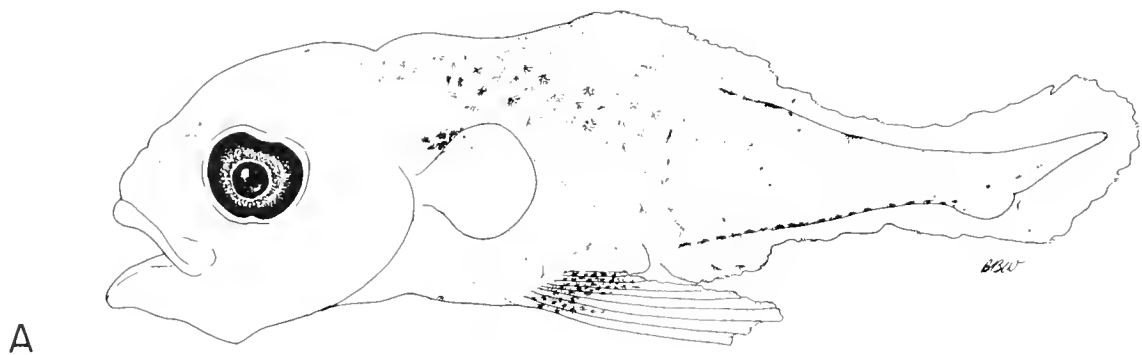

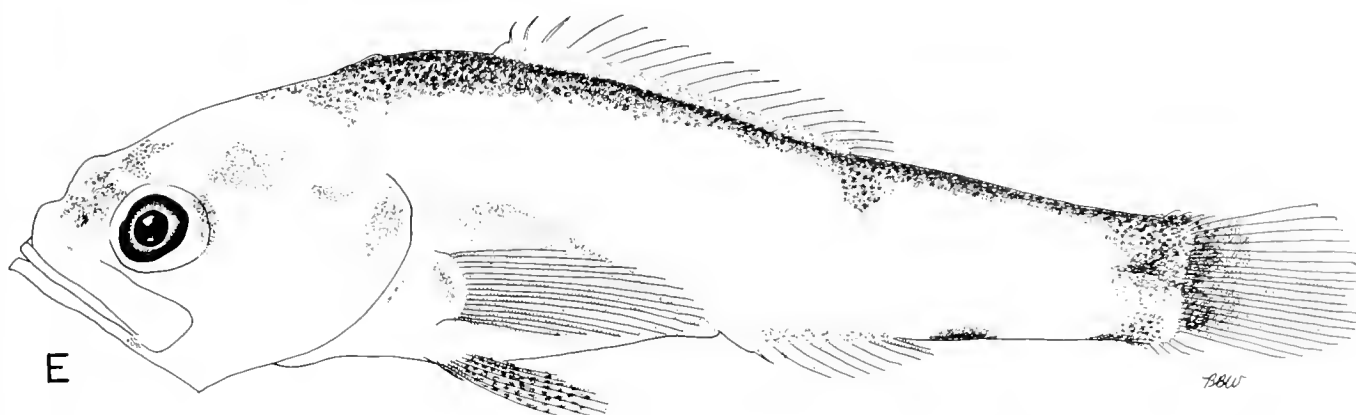

Fig. 207. (A) Preflexion larva of *Scopeloberyx* sp., 4.4 mm TL; (B) Postflexion larva of *Scopeloberyx opisthopterus*, 9.1 mm SL; (C) Postflexion larva of *Scopeloberyx robustus*, 13.0 mm SL; (D) Preflexion larva of *Poromitra crassiceps* complex, 7.9 mm SL; (E) Postflexion larva of *Melanphaes leprus*, 19.5 mm SL; all drawn by B. Washington.

veloping. The dorsal, anal and pectoral fins are already developed, while pelvic fin buds are present. The pattern of head spination described below is already well formed. A 6.0 mm postflexion specimen (Fig. 208B) has all fins completely developed except for the pelvics and procurrent caudal elements. There is pigmentation on the head, lateral surface of the body and caudal peduncle, while the abdominal area is pale with scattered melanophores. A small pigmented area occurs on the pectoral bases. A serrate frontal ridge bordering the anterior of each eye terminates in a short stout supraocular spine. Ridges continuing posteriodorsad on the cranium terminate in long serrate spines probably arising from the parietals. The preopercles end in strong serrate spines directed posteroventrad. By 9.0 mm SL, the pelvics have become well-developed and the head spination is still strong. A small dense patch of melanophores occurs on the ventral surface of the body just anterior to the origin of the pelvic fins. With increasing growth (28 mm SL), this pigmentation darkens and expands, extending forward in a continuous band to the tip of the isthmus. Additional pigmentation occurs at the origin of the pelvic fins, around the vent, just posterior to the anal fin on the caudal peduncle, and in a transverse bar on the abdomen midway between the pelvic origin and the vent. The increase in dark pigmentation and the reduction in cranial and preopercular spines in larger juveniles is described by Woods and Sonoda (1973).

Crossland (1981) illustrated a trachichthyid larva, probably of *Optivus elongatus*, taken off northeastern New Zealand (Fig. 208C). Larger larvae of the same species had the skin on the dorsal surface of the head and body covered with tiny spines. Ahlstrom (notes) sketched early *Trachichthys mento* larvae that are fairly deep-bodied at 3.5 to 4.5 mm, with the pectoral fin showing precocious development. A dark spiny pigmented band extending from the region of the anal to the dorsal occurs in 3.5 mm TL specimens. This spination covers areas on both sides of the dorsal fin, parts of the head, thoracic region and jaws. In a preflexion 6.4 mm specimen, the fin rays are mostly developed, and the body is stockier, approaching the shape of the adult and is covered with minute spines. The holotype of *Korogaster nanus* Parr 1933, synonymized by Woods and Sonoda (1973) in *Holoplostethus*, is 19 mm long (Fig. 208D), possesses unbranched

rays in the pectoral, pelvic and caudal fins, and has dermal papillae and small spines all over its body. This specimen and the second specimen of *Korsogaster* reported by Johnson (1970) (Fig. 208E) are juveniles of the family Trachichthyidae.

The most striking early life history of any beryciform is exhibited by the prejuvenile kasidoron stage of gibberichthyids (Figs. 209, 210). This stage is characterized by a long trailing pelvic appendage which is part of a modified third pelvic ray and is present in specimens from at least 7.5 to 21 mm TL. It is lost by 30 mm SL (de Sylva and Eschmeyer, 1977). During early growth, this trailing appendage becomes more ornate and resembles the trailing tentacles of siphonophores or Sargassum weed at about 15 mm SL. Up until about at least 20 mm, the prejuveniles inhabit epipelagic waters but by 30 mm individuals have lost the pelvic appendage and taken up a mesopelagic to upper bathypelagic existence. The anterior dorsal and anal fin elements are soft rays during the kasidoron stage, but develop into strong fin spines in the adult. There is also a marked development of bony head ridges in the adults, that is not found in the stages 20 mm and smaller (de Sylva and Eschmeyer, 1977).

RELATIONSHIPS

Rosen and Patterson (1969) and Rosen (1973) emphasized the futility of the present classification of the Beryciformes and the rest of the Acanthopterygii, because it relies on grouping of primitive characters to express relationships. Realizing this, Zehren (1979) did a phylogenetic analysis of the Beryciformes to attempt to determine whether or not the order is monophyletic (Fig. 211).

Besides supporting Rosen and Patterson's removal of the Polymixiidae from the Beryciformes, Zehren's analysis superficially suggests that the remaining ten families form a monophyletic group. However, he cautions that since none of the derived character states that he uses is unique to the ten families, their monophyly is uncertain.

Zehren's results and discussion suggest that the Holocentridae do not appear to be closely related to the other nine families studied. Woods and Sonoda (1973) felt that the Holocentridae were very different from the other Beryciformes and Rosen (1973)

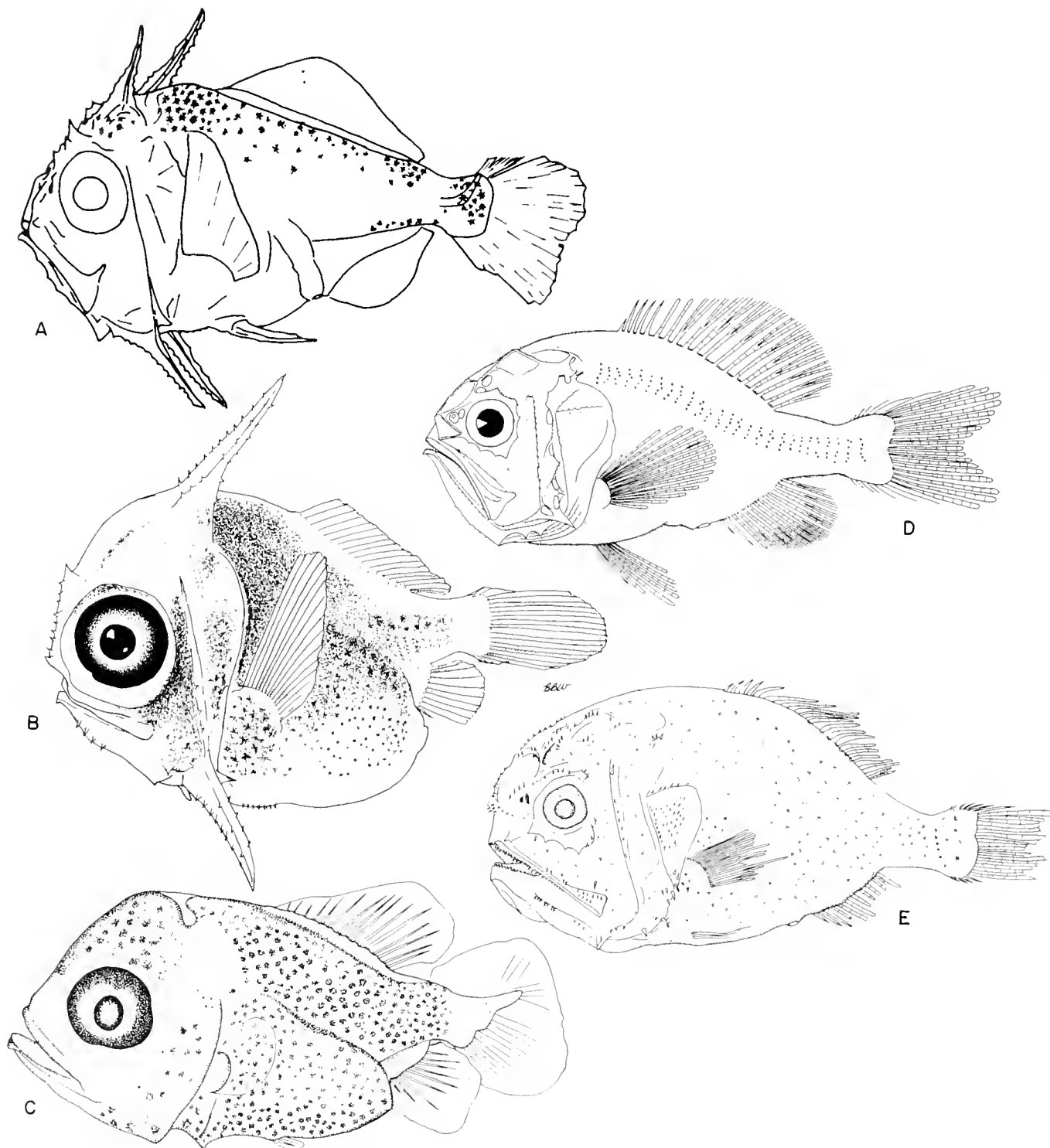

Fig. 208. (A) Postflexion larva of *Doretmus argenteus*, ca. 6 mm SL (source: Post, 1976); (B) Postflexion larva of *Anoplogaster cornuta*, 6.0 mm SL (USNM 244902) drawn by B. Washington; (C) Flexion larva of *Optivusus elongatus* ? 5.3 mm NL (source: Crossland, 1981); (D) Unidentified trachichthyid juvenile, 19.0 mm SL (source: Parr, 1933); (E) Unidentified trachichthyid juvenile, 21.5 mm SL (source: Johnson, 1970).

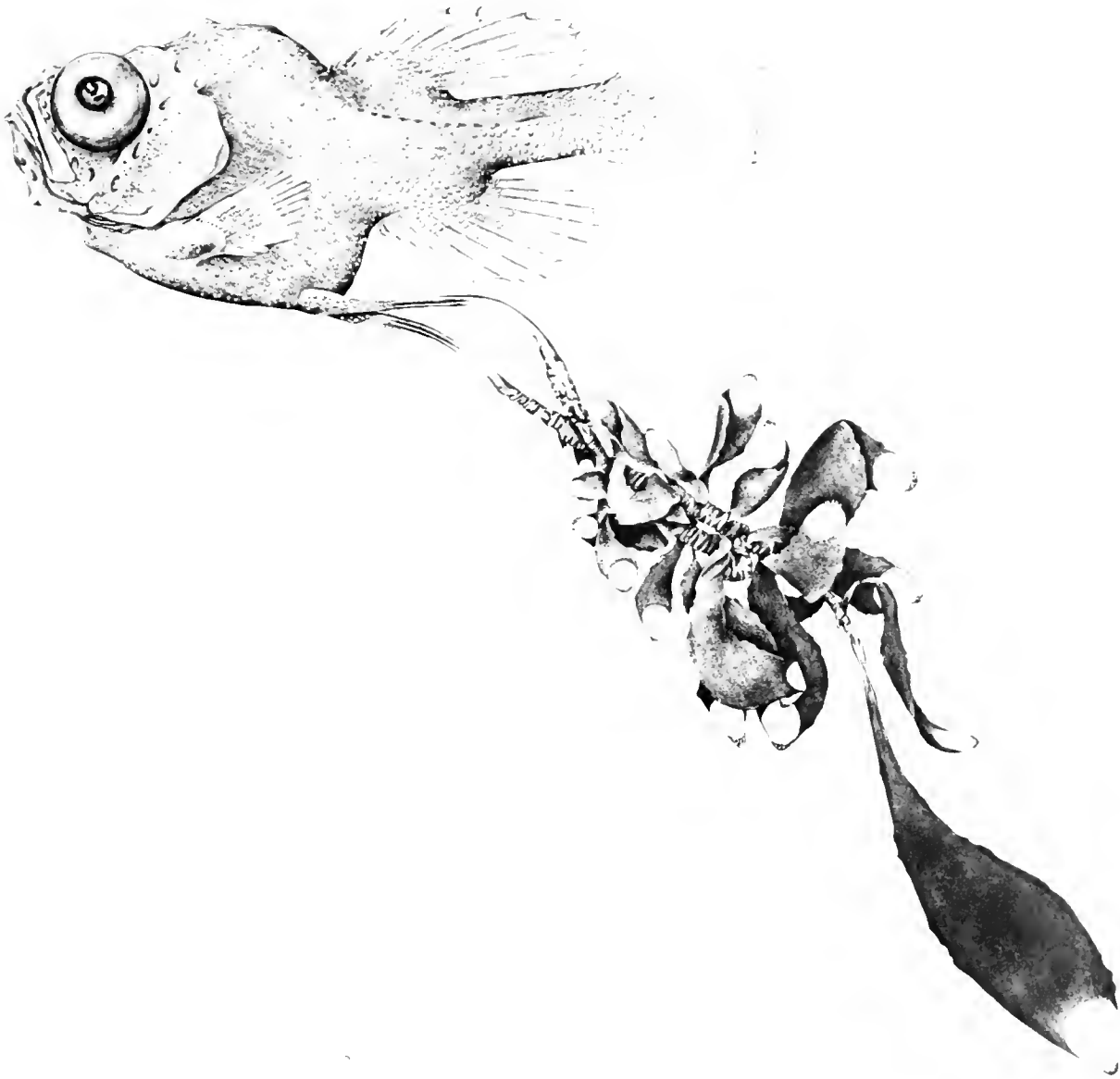

Fig. 209. Kasidoron prejuvenile of *Gibberichthys pumilus*, 15.3 mm SL (source: de Sylva and Eschmeyer, 1977).

considered the holocentrids to be a distinct major subgroup within the order. Rosen (pers. comm. to Zehren) believes that the Holocentridae should be placed within the Perciformes.

Another result of Zehren's study is that the Berycidae appear to be the primitive sister group to the other eight families and should be placed in their own suborder, the Berycoidei. The Trachichthyidae, Diretmidae, Anoplogasteridae, Anomalopidae and Monocentridae are closely related and should be placed in the suborder Trachichthyoidei, as suggested by Parr (1933). The Gibberichthyidae, Stephanoberycidae and Melamphaidae also appear closely related and form the suborder Stephanoberycoidi.

Despite the efforts of Rosen and Zehren, there are still prob-

lems with beryciform classification. Only adult characters have presently been used, but early life history data is pertinent in two instances. In the cladogram, a common ancestry is suggested for the Diretmidae, Anoplogasteridae, Trachichthyidae, Anomalopidae and Monocentridae with no character state to separate them. The larval head spine pattern in the Diretmidae and Anoplogasteridae is similar and distinctive, and may help to resolve the cladogram. *Gibberichthys* with its kasidoron stage may appear to be vastly different from the Melamphaidae, but the occurrence of very long branched pelvics in larval *Poromitra* suggest a possible relationship (de Sylva and Eschmeyer, 1977).

In summary, further phylogenetic studies of the order Beryciformes are needed in order to determine if the order is mono-

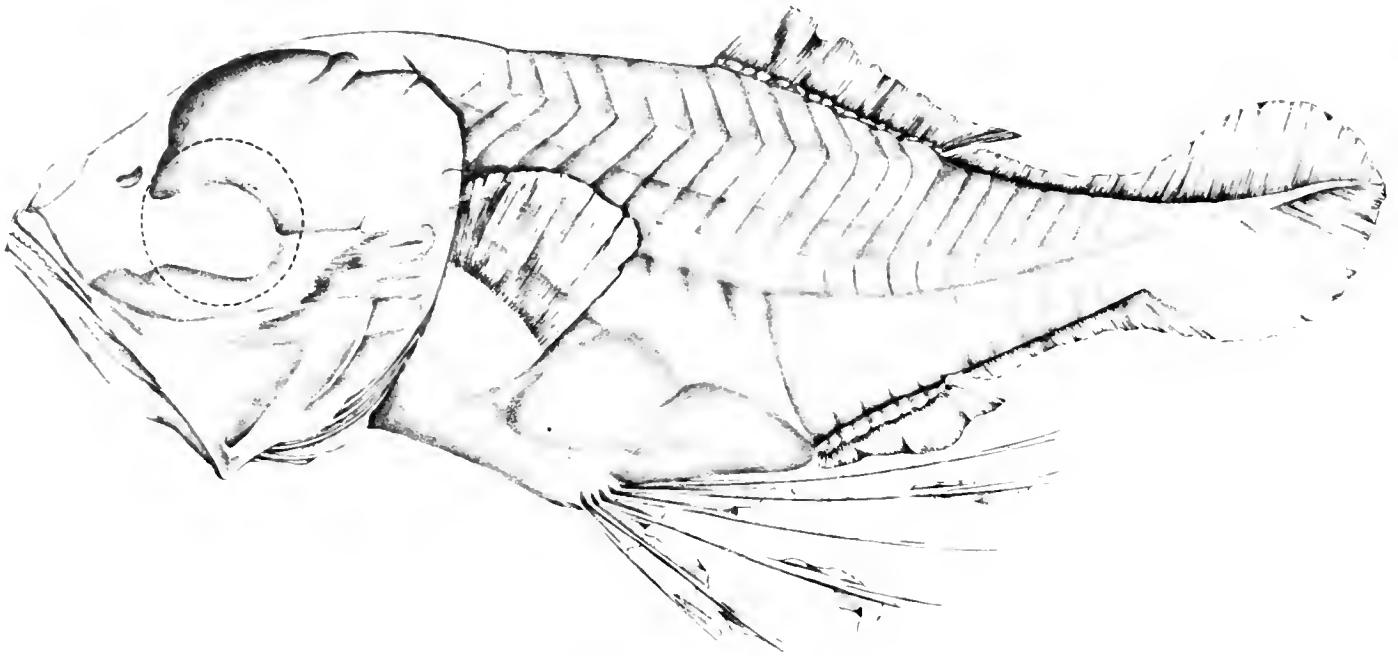

Fig. 210. Kasidoron larva of *Gibberichthys pumilus*, 6.2 mm NL, DANA Sta. 3543 (source: de Sylva, pers. comm.).

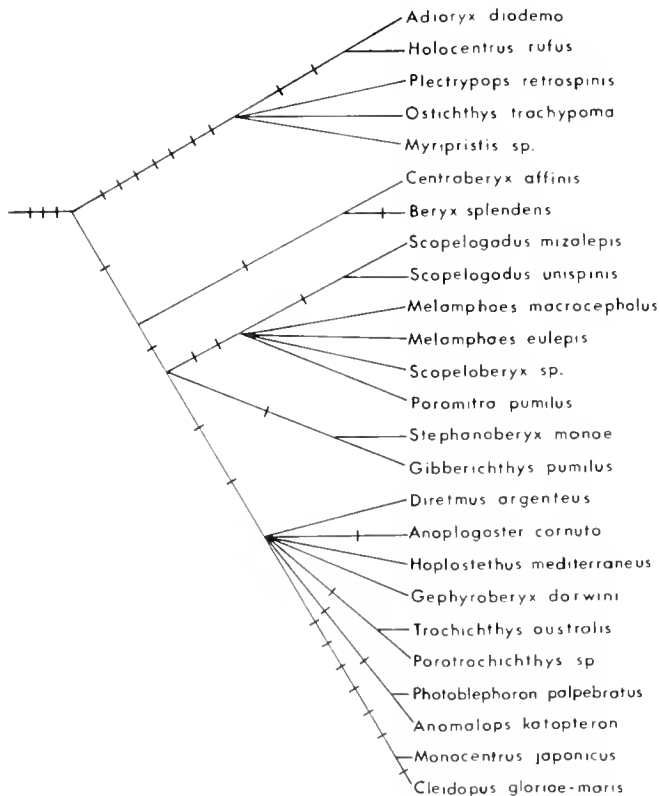

Fig. 211. Cladogram showing the relationships of the beryciform families studied by Zehren (1979).

phyletic, to determine the relationships between the various suborders, and to determine the relationships of the Beryciformes to other orders of fishes. Inclusion of early life history characters in these studies would be useful. However, the lack of early life history data for ten of the beryciform families may prove a stumbling block in these efforts.

DIVISION OF FISHES, NATIONAL MUSEUM OF NATURAL HISTORY,
SMITHSONIAN INSTITUTION, WASHINGTON, DISTRICT OF
COLUMBIA 20560.

Zeiformes: Development and Relationships

K. A. TIGHE AND M. J. KEENE

THE order Zeiformes is diagnosed by a series of derived characters that are not unique to the order (Heemstra, 1980): presence of dorsal spines in most forms; presence of anal and pelvic spines in most forms; reduced number of pelvic and caudal rays; absence of orbitosphenoid; absence of subocular shelf; gills $3\frac{1}{2}$ (no slit behind last hemibranch); mouth more or less protrusible; no supramaxilla. Other characteristics of the order as presented by Heemstra (1980) are primitive characters that shed little information on the relationships of the order. The literature on Zeiformes is scattered and inadequate. Only the family Zeidae has been examined on a world-wide basis (Bray, 1983). Information on most species is descriptive, with little known about ranges, life history stages, abundance, ecology, and relationships. Zeiformes are marine and various species occur in the tropical and temperate parts of all oceans in coastal, benthic, epipelagic, mesopelagic, bathypelagic, and bathybenthic waters (Wheeler et al., 1973). Families are distinguished by presence of vertically elongate or small or no scales, relative body depth, relative mouth size, degree of development of anal and pelvic fin spine(s), number of lateral lines, and morphology of the eye-jaw region. Generic and specific designations are based mainly on morphometric, meristic, specialized scale, and color characters (Heemstra, 1980).

The order Zeiformes is presently placed in superorder Acanthopterygii, near the Beryciformes and other groups that have not attained the perciform level of structural organization. Greenwood et al. (1966) included the Parazenidae, Grammicolepididae, Zeniontidae, Oreosomatidae, Zeidae, Caproidae, and Macruricyttidae in the Zeiformes. Heemstra (1980) revised the Zeidae of South Africa and gives a key to all the zeiform families above except the Caproidae which he, like earlier workers (Rosen, 1973), feels is only superficially similar to zeiforms and therefore should not be included in the order. He also provides diagnoses for the order and four of the remaining families. *Parazen pacificus*, not reported from South Africa, is described by Mead (1957). Keys to South African zeids and grammicolepidids are given by Heemstra (1980), along with a key to adult oreosomatids of the southern Atlantic and Indian Oceans supplied to him by Karrer and Eschmeyer. Meristic ranges, number of species, and number of genera for the six families presently in the Zeiformes are given in Table 104.

DEVELOPMENT

Early life history information on most zeiform species is nonexistent (Table 105). There is some information on prejuvenile stages (specialized ontogenetic stages between larvae and juveniles) for Oreosomatidae and Grammicolepididae, but none on earlier stages. Early life history data for *Zeus faber* from egg through juvenile is quite extensive, but such information is incomplete or nonexistent for other zeid species. For the Caproidae, larvae of *Antigonia capros* and *A. rubescens* are known, as are all the early stages of *Capros aper*. Nothing is known for the Parazenidae and Zeniontidae.

Eggs are known for two species of zeids. They are spherical,

have a single oil droplet, nonsegmented yolk, and a smooth chorion. Eggs of *Zeus faber* range from 1.8–2.1 mm in diameter with an oil droplet diameter of .32–.40 mm (Sanzo, 1956; Dekhnik, 1973; Robertson, 1975a). Those of *Zenopsis nebulosus* are 2.0–2.25 mm with a droplet of .275–.375 mm (Robertson, 1975a). Eggs of *Capros aper* are about 1.0 mm in diameter, spherical, and have a smooth chorion, unsegmented yolk and a single oil droplet (Arbault and Boutin, 1968a; Sanzo, 1956). Eggs of all other species of zeiform fishes are unknown.

Newly hatched larvae of *Zeus faber* were described by Sanzo (1931b). Pigmentation is extensive over body, head and yolk sac with the pigmentation extending to the margin of the dorsal finfold and also on the base of the anal finfold for most of its length (Fig. 212A). Only the tip of the caudal region is unpigmented. The pectoral and pelvic fin buds are present upon hatching. Preflexion larvae retain the extensive body pigmentation, rapidly become deep-bodied, and show a precocious development of the pelvic fins (Fig. 212B). Postflexion larvae have almost all fin elements developed (Fig. 212C) and are rapidly assuming the characters of the adult.

Larval stages are known for both genera in the family Caproidae. Newly hatched larvae of *Capros aper* (Fig. 212D) have large stellate melanophores on the dorsal, lateral and ventral surface of the body with a few melanophores on the head and associated with the oil globule. Preflexion larvae (Fig. 212E) become very deep-bodied with an increase in head size. Pigmentation densely covers the entire body except for the caudal region. A medial serrated ridge occurs on the cranium and other paired serrate ridges develop along the lower jaw and in the supraocular region. Numerous preopercular spines also develop during this stage. Minute spines associated with the developing scales cover the entire body (Fage, 1918). Transformation to the juvenile is gradual and completed by a size of 15–20 mm SL.

Larvae of *Antigonia* were described by Uchida (1936) and Nakahara (1962). The larvae are relatively deep-bodied with pigmentation on the peritoneum and head. The median serrate cranial spine, serrate preopercular spines, and serrate ridges on the frontal, mandibular and preopercular regions are characteristic of both *A. rubescens* and *A. capros* (Fig. 213A, B), but are totally lost before reaching juvenile sizes of 25 mm. There are several differences between the larvae of the two species but the most obvious is the presence of a vertically directed spine in the occipital region of *A. rubescens*.

At least some grammicolepidids exhibit striking proportional changes during growth. Smaller *Grammicolepis brachiusculus* are very deep-bodied relative to larger ones based on an examination of specimens 70 to 400 mm SL (Quero, 1979). Young *Xenolepidichthys dalgleishi* also have a relatively deeper body than larger specimens (Myers, 1937) and possess long filamentous extensions on some of the dorsal spines and on the first anal spine (Smith, 1949; Fig. 279). These shorten greatly with growth as shown by Myers' (1937) 71 mm SL specimen.

Oreosomatid adults have mainly overlapping cycloid or cte-

TABLE 104. MERISTIC RANGES, NUMBER OF GENERA, AND NUMBER OF SPECIES FOR THE FAMILIES PLACED IN THE ZEIFORMES BY GREENWOOD ET AL. (1966). All data are from Heemstra (1980) unless noted.

	Pelvic	Dorsal	Anal	Branched caudal rays	Branchiostegals	Vertebrae	Pectoral	Number of genera	Number of species
Grammicolepididae	1, 6	V–VII, 27–34	II, 27–35	13	7	37–46	13–16 ⁸	3	5
Zeidae ¹	0–I, 6–10	VII–X, 22–37	I–IV, 20–39	11	7	29–42	11–14, 17–18	6	13
Oreosomatidae ²	1, 5–6	V–VIII, 29–35	II–IV, 27–34	11	7 (3 genera) ⁶	35–43	17–22	4 (5?)	10
Zeniontidae	1, 5–6	VI–VII, 25–29	0–II, 23–32	11	7–8	25–27	17 ⁹	3?	4?
Parazenidae ³	0, 7	VIII, 26–30	I, 31–33	9	7	34	15–16	1	1
Caproidae ⁴	1, 5	VII–X, 26–37	III, 23–34	10	5–6	21–23 ⁷	1, 11–14	2	6
Macrurocyttidae ⁵	1, 3	V, 27	22	?	ca. 5	?	15	1	1

¹ Bray, 1983² Karrer and Eschmeyer, Ms.³ Mead, 1957.⁴ Berry, 1959a.⁵ Fowler, 1934⁶ McAllister, 1968.⁷ Rosen, 1973.⁸ Myers, 1937.⁹ Quero, 1978

noid scales while the pelagic prejuveniles are oval in outline and possess a leathery skin with distinct hardened cones or scaley knobs laterally and ventrally (Myers, 1960; Eschmeyer et al., 1983). This stage is exhibited by Abe and Kaji's (1972) specimen of *Oreosoma atlanticum* (Fig. 213C). Karrer and Eschmeyer (in press) report prejuveniles of *Pseudocyttus* as large as 100 mm and suggest that metamorphosis can be delayed. In one species, the transformation is incomplete and the species remains in the midwater prejuvenile habitat and becomes mature there.

In the Zeidae, only *Cyttus traversi* is presently known to have a prejuvenile stage. This stage has a relatively much deeper body than the adult, and bears long filamentous extensions with numerous appendages from the dorsal spines and pelvic spine and rays (James, 1976b; fig. 1). The prejuvenile stage occurs near

the surface in coastal waters (James, 1976b) while specimens greater than about 100 mm have been caught near the bottom at depths from 200 to 800 meters (Heemstra, 1980).

Macrurocyttus acanthopodus was described by Fowler (1934) and was placed in the order Zeiformes by Greenwood et al. (1966). Its small size, elongate pelvic spine, and stout dorsal spine (Fig. 213D) array suggest that this may be a juvenile or prejuvenile form, perhaps of the Zeniontidae as suggested by Heemstra (1980).

RELATIONSHIPS

The present classification of the Zeiformes is based only on characters of the adults. Heemstra (1980) includes five families in the Zeiformes but speculates that the Grammicolepididae

TABLE 105. REFERENCES GIVING DESCRIPTIONS AND/OR ILLUSTRATIONS OF EGGS, LARVAE AND PREJUVENILES OF THE ORDER ZEIFORMES.

Family	Eggs	Larvae	Pre-juveniles
Grammicolepididae	—	—	Smith, 1949
Zeidae	Sanzo, 1931b Sanzo, 1956 Dekhnik, 1973 Robertson, 1975a	Ehrenbaum, 1905–1909 Schmidt, 1908 Sanzo, 1931b Sanzo, 1956 Banarescu, 1964 Crossland, 1982	James, 1976b
Caproidae	Cunningham, 1889 Holt, 1897, 1899 Sanzo, 1956 Arbault and Boutin, 1968a	Holt, 1897, 1899 Helford, 1910 Clark, 1914 Fage, 1918 Sanzo, 1956 Uchida, 1936 Nakahara, 1962	—
Oreosomatidae	—	—	Cuvier, 1829 Abe, 1957 Kobayashi et al., 1968 Abe and Kaji, 1972
Zeniontidae	—	—	—
Parazenidae	—	—	—
Macrurocyttidae	—	—	Fowler, 1934

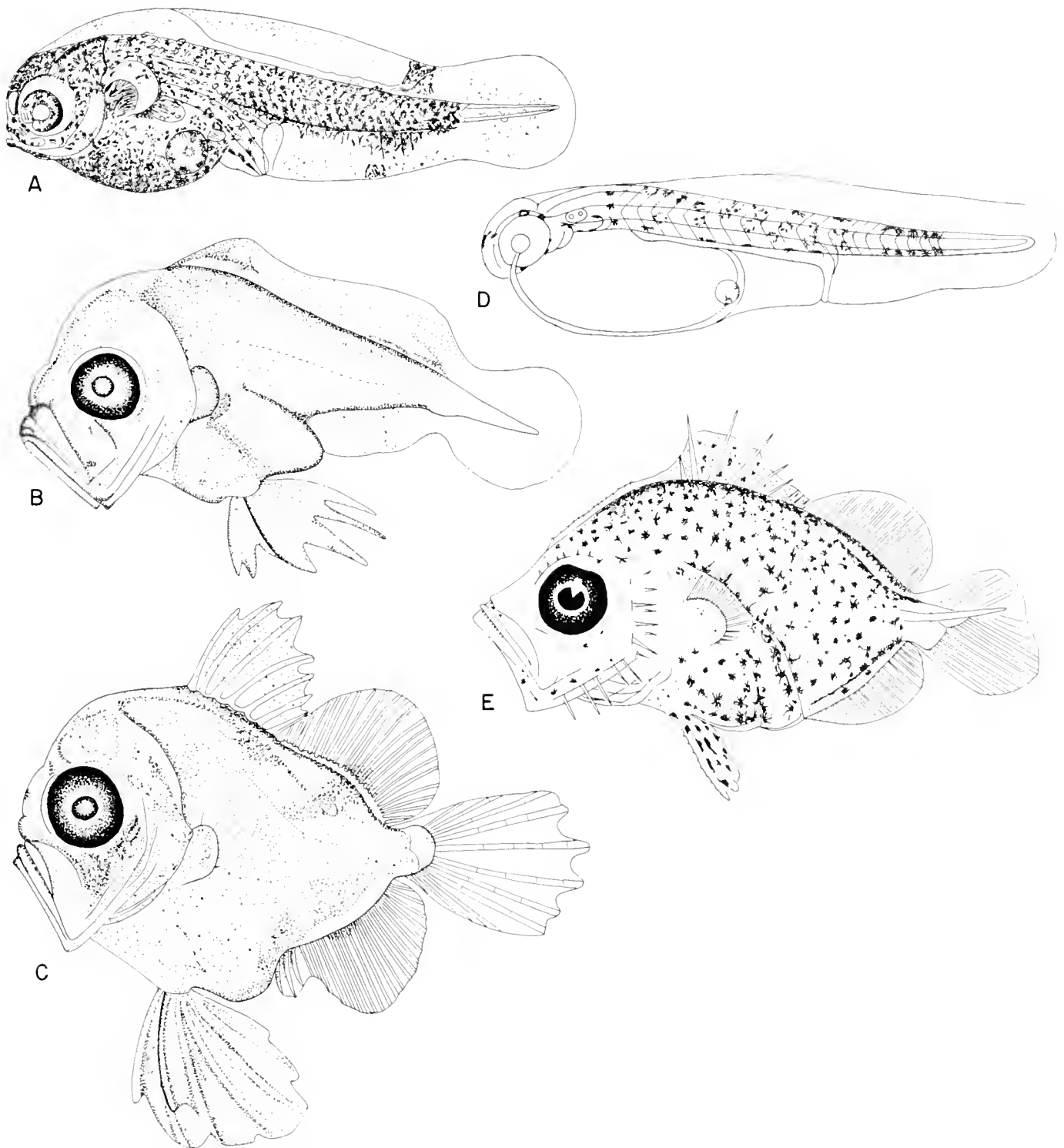

Fig. 212. Zeiform larvae. (A) Yolk-sac larva of *Zeus faber*, 4.3 mm NL (source: Sanzo, 1931b); (B) Preflexion larva of *Zeus faber*, 4.3 mm NL (source: Crossland, 1982); (C) Postflexion larva of *Zeus faber*, 7.2 mm SL (source: Crossland, 1982); (D) Yolk-sac larva of *Capros aper*, 2.9 mm NL (source: Sanzo, 1956); and (E) Preflexion larva of *Capros aper*, 5.0 mm NL (source: Sanzo, 1956).

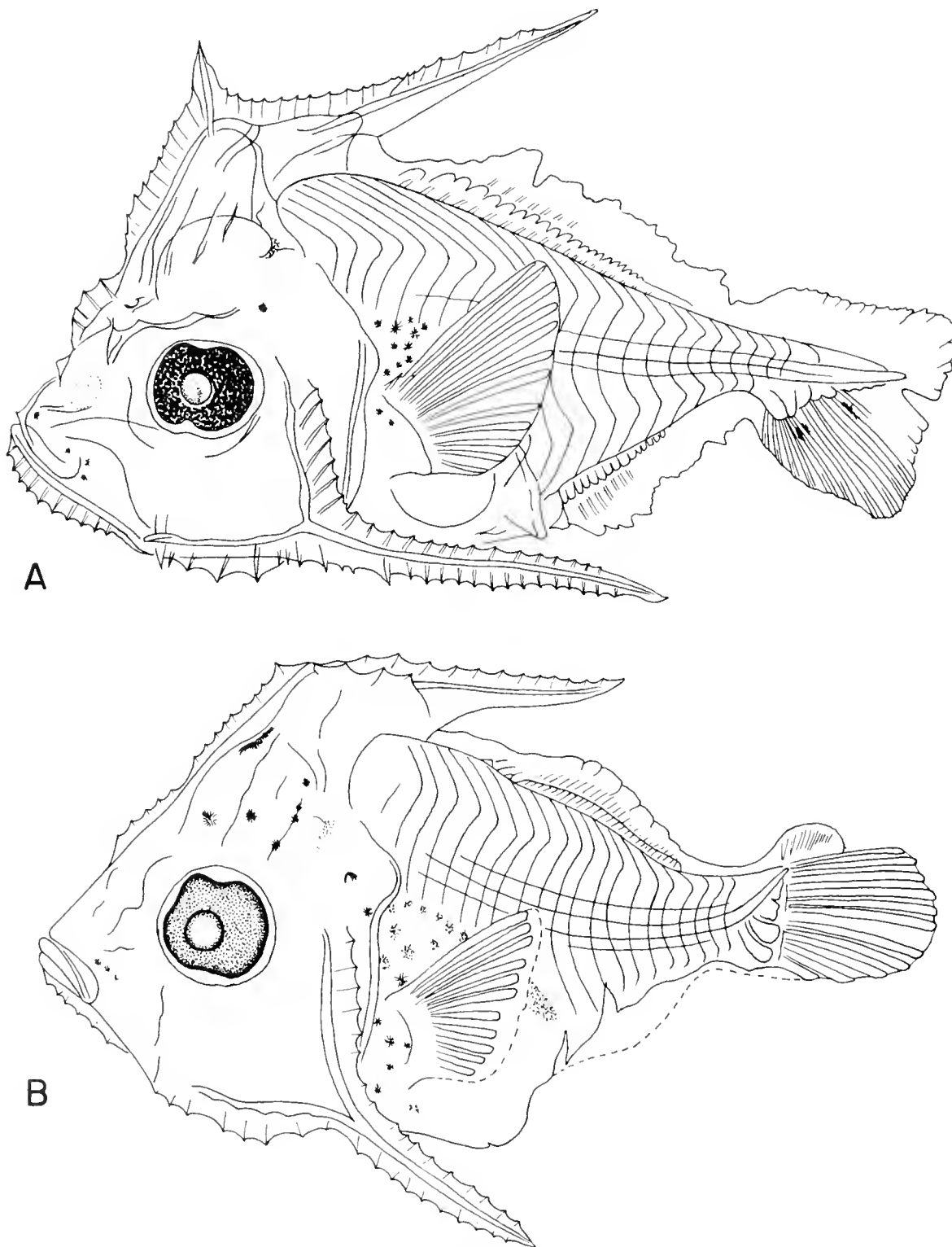
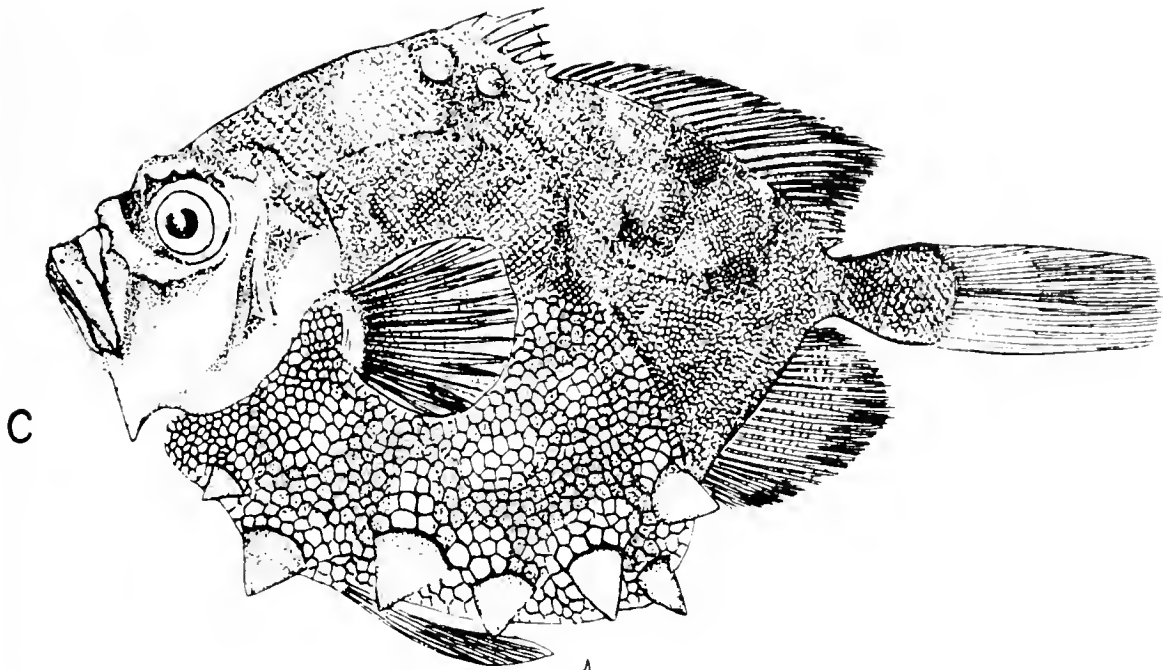
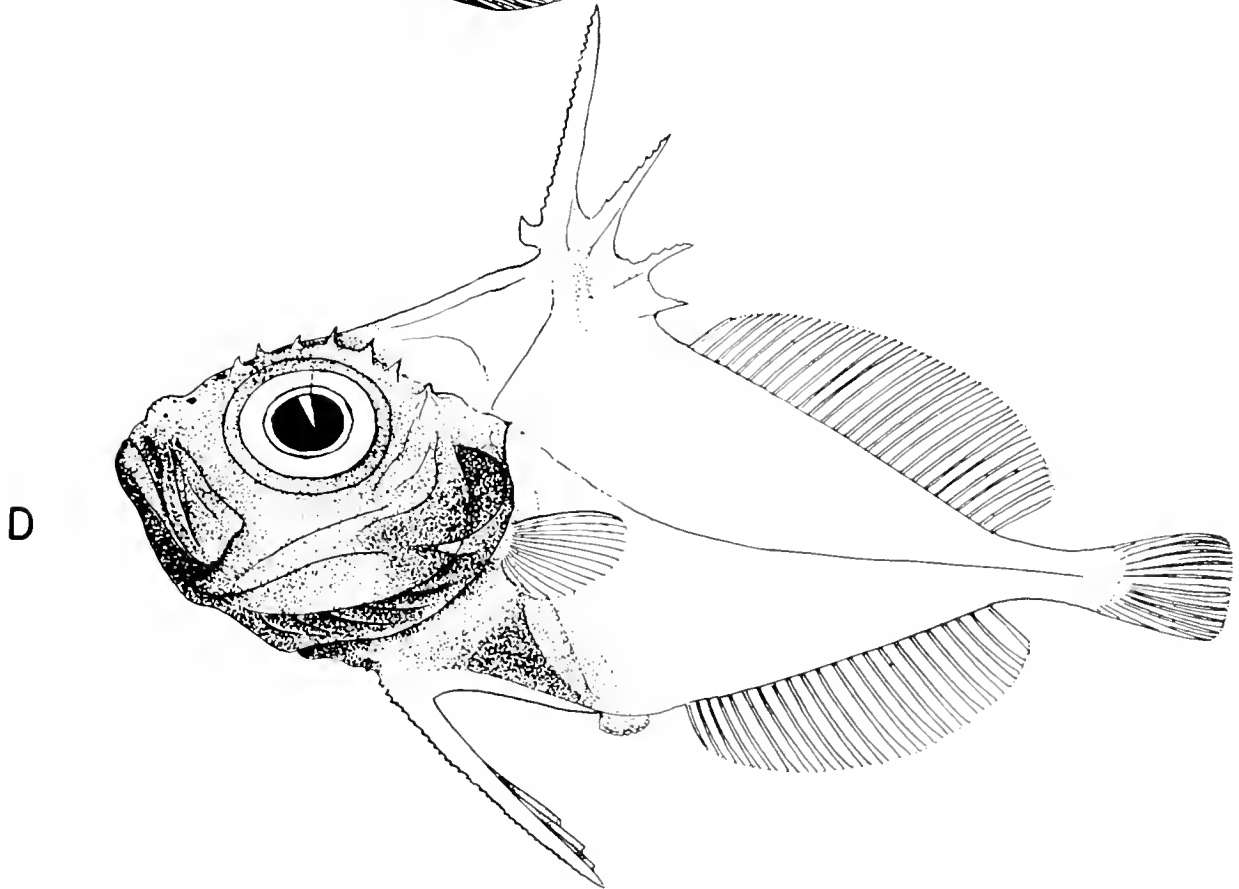

Fig. 213. Zeiform larvae. (A) Preflexion larva of *Antigonia rubescens*, 4.5 mm TL (source: Uchida, 1936); (B) Postflexion larva of *Antigonia capros*, 4.75 mm TL (source: Nakahara, 1962); (C) Prejuvenile of *Oreosoma atlanticum*, 61 mm SL (source: Abe and Kaji, 1972); and (D) Holotype of *Macrurocyttus acanthopodus* Fowler 1934, 43 mm SL (source: Fowler, 1934).



C



D

may prove to be incorrectly placed there because they differ considerably in the configuration of their jaw elements, scales, number of vertebrae, and have a higher number of caudal rays. Heemstra's decision to exclude the Caproidae from the Zei-

formes is supported by evidence from Rosen (1973), who discusses some similarity between zeoids and caproids but states that the pelvic count of 1 spine and 5 rays, 3 anal spines, and the reduced vertebral number 21-23 are a combination of char-

acters found among percoids. The possession of normal abdominal parapophyses, lack of ventral ridge scales or bucklers, and a percoid type of caudal skeleton suggest to Rosen that caproids appear to fit the present definition of a perciform while other zeoids do not.

These findings support the movement of the Caproidae higher in Acanthopterygian classification. The very different larvae of the two caproid genera suggest that a thorough reexamination of the osteology of adult representatives of these genera could be necessary before the family is placed somewhere else.

There has been no phylogenetic systematic study of the order Zeiformes. Inclusion of early life history characters would probably be useful in such a study, but these are unknown for most members of the order.

ADDENDUM: After this paper went to press, Rosen (1984) published a phylogenetic analysis of the families (except Macruricytidae) herein included in the order Zeiformes which resulted in a drastic change in the systematic placement of this

group. Rosen has suggested that the Zeiformes do not represent a monophyletic lineage, but are best included within the Tetraodontiformes with which they are united by seven synapomorphies. Within Rosen's classification, the Caproidae are the sister group to the rest of the Tetraodontiformes. In addition, the rest of the zeiform families are united with the plectognath fishes by four synapomorphies while the plectognath families are monophyletic on the basis of six synapomorphies. Evidence from early life history characters supporting this classification is very limited due to the lack of knowledge of the early life history of most of these fishes, but the similarity in morphology and pigmentation between newly hatched *Zeus faber* larvae and tetraodontid larvae does provide some support for Rosen's hypothesis.

DIVISION OF FISHES, NATIONAL MUSEUM OF NATURAL HISTORY,
SMITHSONIAN INSTITUTION, WASHINGTON, DISTRICT OF
COLUMBIA 20560.

Gasterosteiformes: Development and Relationships

R. A. FRITZSCHE

THE actinopterygian fish order Gasterosteiformes contains a diverse assemblage of specialized fishes. There are about 220 species arranged into 10 or 11 families (Fritzsche, 1982). Historically this group has been divided into two or three orders, under such names as Lophobranchii, Thoracostei, Solenichthyes, Catostomi, Hemibranchii, Hypostomides, Gasterosteiformes, Syngnathiformes, and Pegasiformes (Boulenger, 1904; Berg, 1940; and Starks, 1902). Pietsch (1978b) presented information which suggests that Pegasiformes are intermediate between the Gasterosteiformes and Syngnathiformes. Pegasids are intermediate in (1) snout development and in the condition of the nasal bones; (2) retention of the parietals; (3) retention of three circumorbital bones; (4) presence of a dorsal strut joining the ceratohyal and epihyal; (5) reduction in number of elements of the branchial arches; (6) the presence of two pairs of pleural ribs; and (7) retention of support for a spinous dorsal fin (Pietsch, 1978b). He proposed a tentative classification uniting all three groups into the single order Gasterosteiformes. This order is characterized by (1) branchiostegal rays reduced to 1–5; (2) absence of supramaxillary, orbitosphenoid, and basisphenoid; (3) postcleithrum reduced to single bone or absent; (4) pelvic girdle never attached directly to cleithra; (5) rather small mouth, often at end of more or less tubular snout; and (6) armor of dermal plates covers most members (Fritzsche, 1982). Pegasids form the primitive sister-group of the Solenostomidae and Syngnathidae. These families share a number of derived character states including (1) feeding mechanism; (2) metapterygoid absent; (3) hyoid apparatus short, bearing elongate, filamentous branchiostegal rays; (4) gill opening restricted to a small hole on the dorsolateral surface behind head; (5) gill filaments tufted or lobe-like; (6) articular processes of mobile vertebral centra absent; (7) posttemporal co-ossified with cranium; (8) postcleithrum absent; and (9) head and trunk encased by bony plates, tail encircled by bony rings (Pietsch, 1978b). The Pegasidae, Solenostomidae and Syngnathidae form the primitive sister-group of the Macrorhamphosidae, Centriscidae,

Aulostomidae, and Fistulariidae and the resulting classification is as follows:

Order Gasterosteiformes
Suborder Gasterosteoidae
Superfamily Aulorhynchoidea
Family Aulorhynchidae

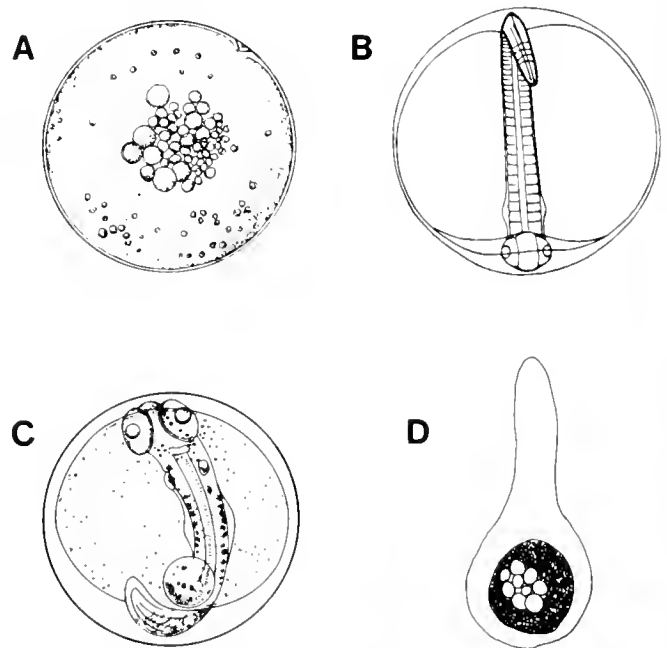

Fig. 214. Eggs of some gasterosteiforms: (A) *Gasterosteus aculeatus* (from Kuntz and Radcliffe, 1917); (B) *Fistularia petimba* (from Mito, 1961a); (C) *Macrorhamphosus scolopax* (from Hardy, 1978a, after Sparta, 1936); (D) *Hippocampus erectus* (from Hardy, 1978a).

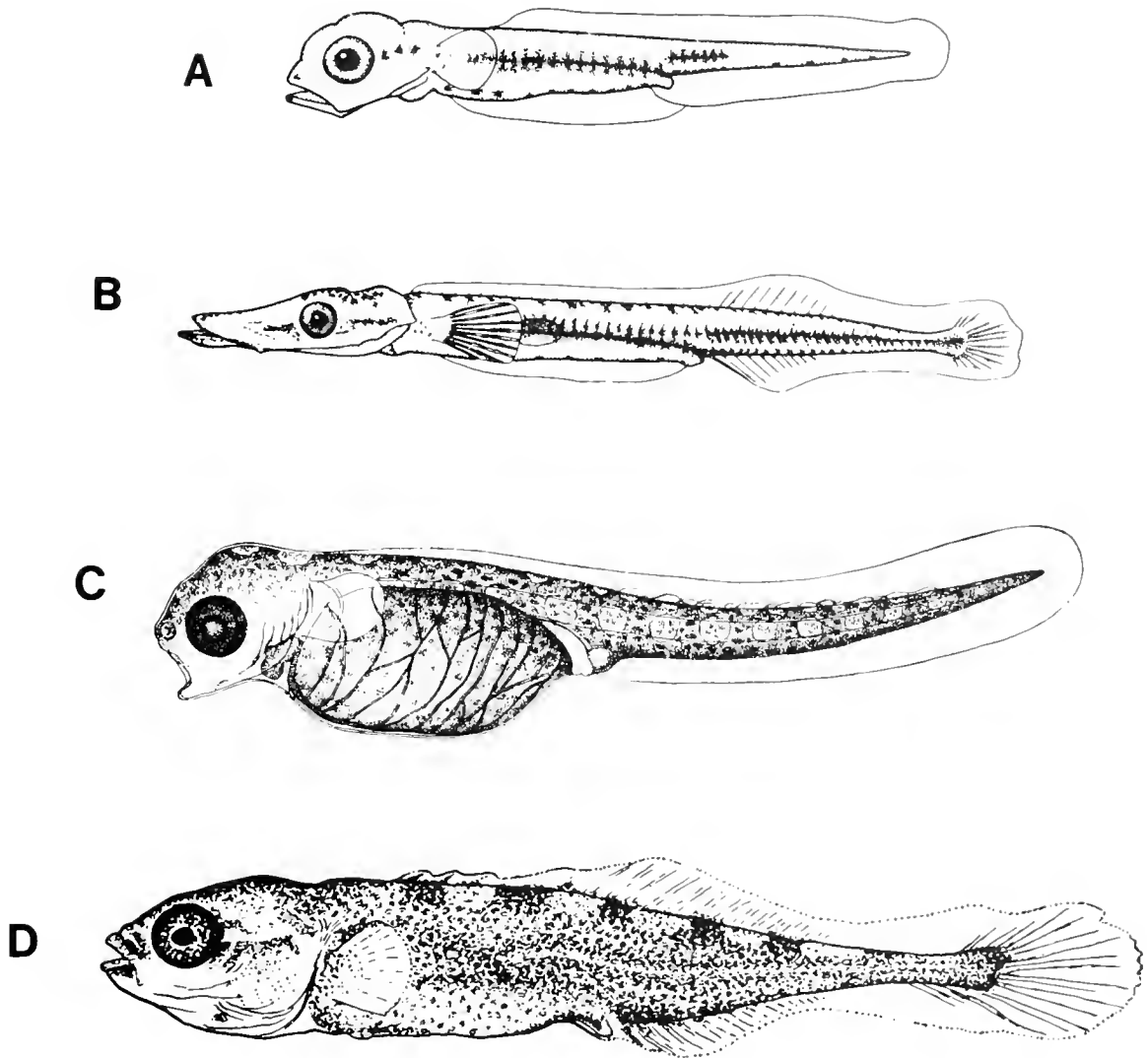

Fig. 215. Larvae of some gasterosteoids. (A, B) *Aulorhynchus flavidus*, 8 mm TL and 23 mm TL (from Marliave, 1976); (C) *Apeltes quadracus*, 6.0 mm TL (from Ryder, 1887); (D) *Apeltes quadracus*, 10.5 mm TL (from Hardy, 1978a).

Family Hypoptychidae
 Superfamily Gasterosteoidea
 Family Gasterosteidae
 Suborder Syngnathoidei
 Infraorder Syngnatha
 Superfamily Pegasoidea
 Family Pegasidae
 Superfamily Syngnathoidea
 Family Solenostomidae
 Family Syngnathidae
 Infraorder Macrorhamphosa
 Superfamily Macrorhamphosoidea
 Family Macrorhamphosidae
 Family Centriscidae
 Superfamily Aulostomoidea
 Family Aulostomidae
 Family Fistulariidae

The taxonomy within this order is poorly understood. The lack of agreement regarding relationships within the *Gasterosteus aculeatus* complex (Bell, 1976) and whether or not *Macrorhamphosus* contains only one species (Ehrich, 1976) are two examples. Recent studies, such as that of Fritzsche (1980), have shown that many species of syngnathids are morphologically plastic. This plasticity has been the cause of a proliferation of species and subspecies descriptions in the literature. The process of sorting out the nominal species still continues for most taxa included in Gasterosteiformes.

Gasterosteiformes are found in freshwater, estuarine, and marine habitats through tropical and temperate regions. Most species are relatively small and cryptically colored. They have no real fishery importance and usually are thought of as interesting aquarium fishes or simply curiosities, e.g. the seahorse. Since commercial importance is lacking, there is very little literature dealing with the early life histories of these fishes except for

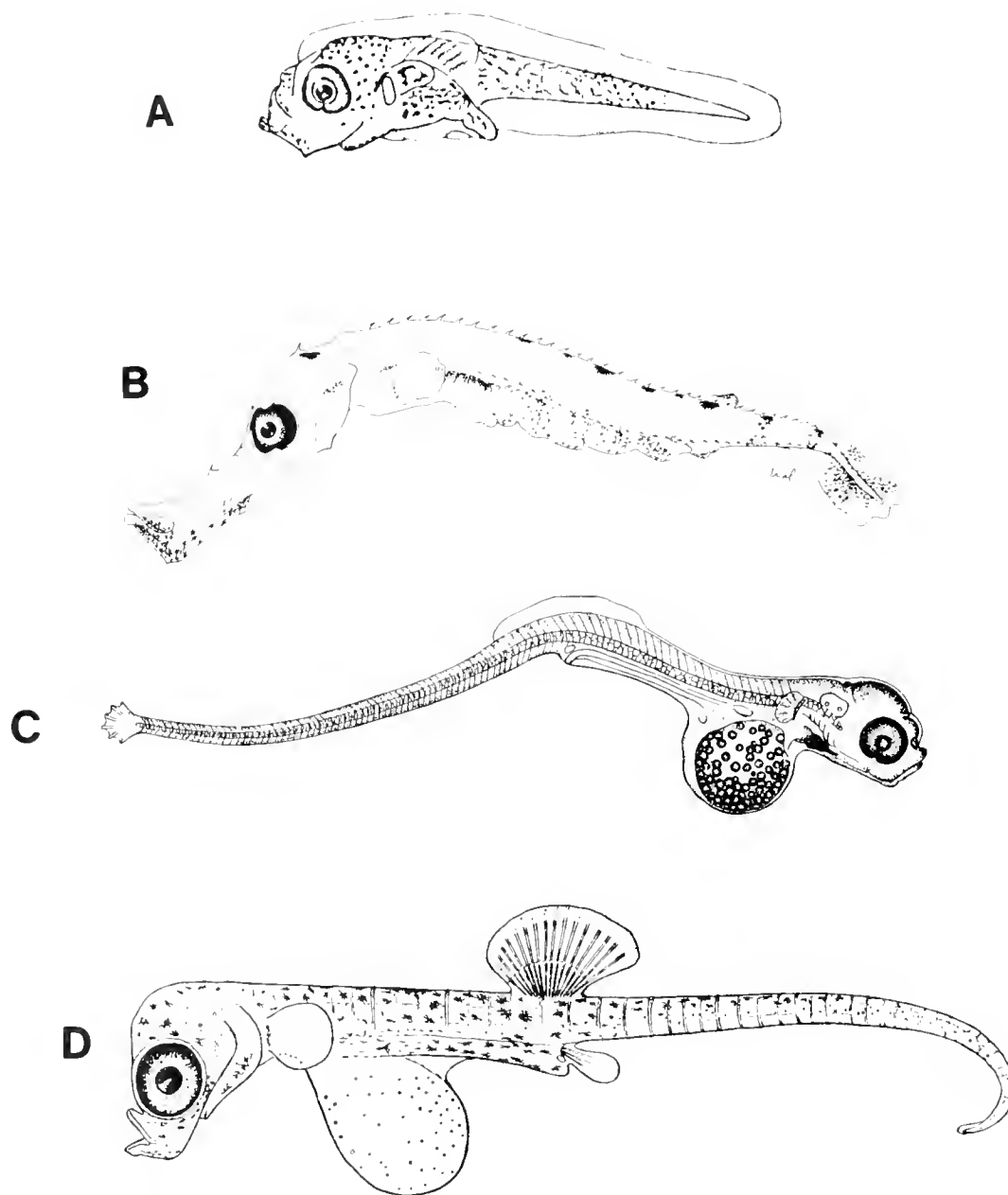

Fig. 216. Larvae of some pegasoids and syngnathoids. (A) Pegasidae, 2.4 mm (from Leis and Rennis, 1983); (B) *Solenostomus* sp., 5.1 mm NL (original illustration by Wayne A. Laroche); (C) *Syngnathus fuscus*, ca. 3.5 mm TL (from Ryder, 1887); (D) *Hippocampus japonicus*, ca. 6 mm TL (from Nakamura, 1937).

anecdotal accounts or descriptions of chance collections of eggs or young.

DEVELOPMENT

There are published descriptions of the eggs of *Aulorhynchus* (Limbaugh, 1962; Ida, 1976), *Hypoptychus* (Ishigaki, 1957; Ida, 1976), gasterosteids (notably Kuntz and Radcliffe, 1917; Vrat, 1949; Swarup, 1958), *Solenostomus* (Padmanabhan, 1961), *Macrorhamphosus* (Sparta, 1936), and *Fistularia* (Delsman, 1921; Mito, 1961a; Watson and Leis, 1974). There are few descriptions of the eggs of syngnathids due to the unique male

brooding habits of this group, however, Hudson and Hardy (1975) provided a good description of *Hippocampus erectus* eggs. Most accounts simply include the number and size of eggs in the male's pouch (e.g., Fritzsche, 1980). Gudger (1905) provided a fairly extensive treatment of the embryology of *Syngnathus floridae*.

Larvae (usually just one or two and not a series) have been described, for *Aulorhynchus* (Limbaugh, 1962; Marliave, 1976), gasterosteids (Kuntz and Radcliffe, 1917; Vrat, 1949; Swarup, 1958), pegasids (Jones and Pantulu, 1958; Jones and Kumaran, 1967; Leis and Rennis, 1983), *Solenostomus* (Padmanabhan,

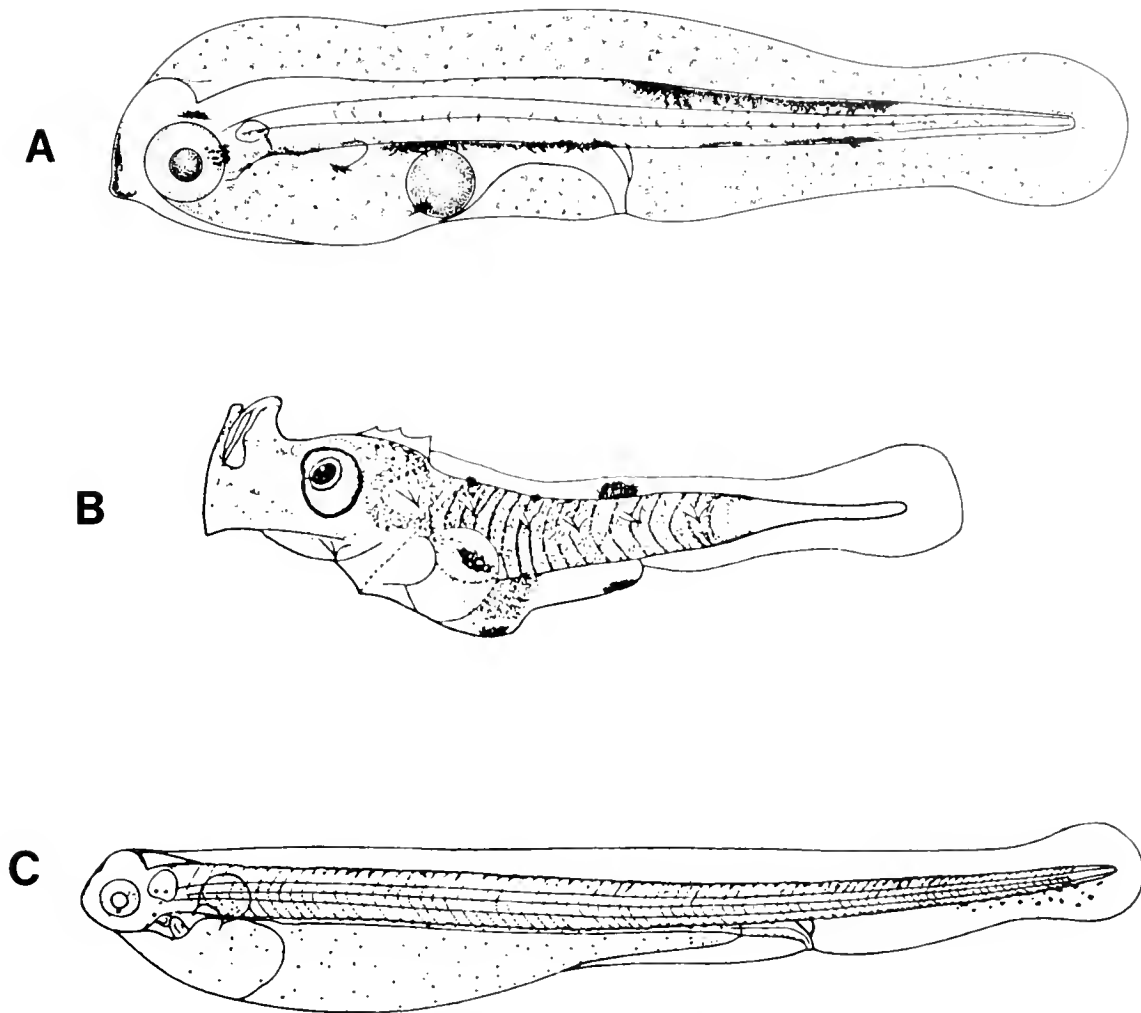

Fig. 217. Larvae of some macrorhamphosoids and some aulostomoids. (A) *Macrorhamphosus scolopax*, 3.0 mm TL (from Hardy, 1978a, after Sparta, 1936); (B) Centriscidae, 2.7 mm (from Leis and Rennis, 1983); (C) *Fistularia petumba*, 7.08 mm (from Mito, 1961a).

1961), syngnathids (most notably D'Ancona, 1933c; Nakamura, 1937; Takai and Mizokami, 1959; James, 1970; Russell, 1976; Dawson et al., 1979), macrorhamphosids (D'Ancona, 1933d; Sparta, 1936; Mohr, 1937), centriscids (Mohr, 1937; Leis and

Rennis, 1983) and *Fistularia* (Jungersen, 1910; Delsman, 1921; Mito, 1961a; Leis and Rennis, 1983). Larvae have not been described for *Hypoptychus* and *Aulostomus*.

Osteological development has not been studied for most gas-

TABLE 106. MERISTIC CHARACTERS FOR FAMILIES OF THE GASTEROSTEIFORMES (ADAPTED FROM PIETSCH, 1978B).

Character	Aulorhynchidae	Hypoptychidae	Gasterosteidae	Pegasidae	Solenostomidae	Syngnathidae	Macrorhamphosidae	Centriscidae	Aulostomidae	Fistulariidae
Circumorbital bones	3	2	3	3	0	2-3	1	1 (+2?)	1 (0?)	0
Branchiostegal rays	4	4	3-4	5	1 (bifid)	1-3	4-5	3-5	4	5
Vertebrae	52-56	55	28-42	19-22	33	37-77+	24	20	59-64	76-87
Elongate anterior vertebrae	0	0	0	6	3	3	5	5-6	4	4
Pleural ribs (pairs)	0-22	?	9-16	2	0	0	0	0	0	0
Dorsal-fin rays	XXIV-XXVI + 9-10	20	III-XXVI + 6-14	5	V + 18-23	0-60	IV-VII + 9-11	III + 10-12	VIII-XIII + 21-26	14-20
Anal-fin rays	1 + 9-10	20	1 + 6-12	5	16-23	0-6	19-20	11-12	22-27	14-19
Caudal-fin rays	13	13	11-12	8	16	0-11	23	11	20	22-24
Pectoral-fin rays	10-11	9	9-23	10-18	18-27	0-23	15	10-12	15-16	13-18
Pelvic-fin rays	1 + 4	0	1 + 0-2	1 + 2-3	1 + 6	0	1 + 4	1 + 4	6	5-6

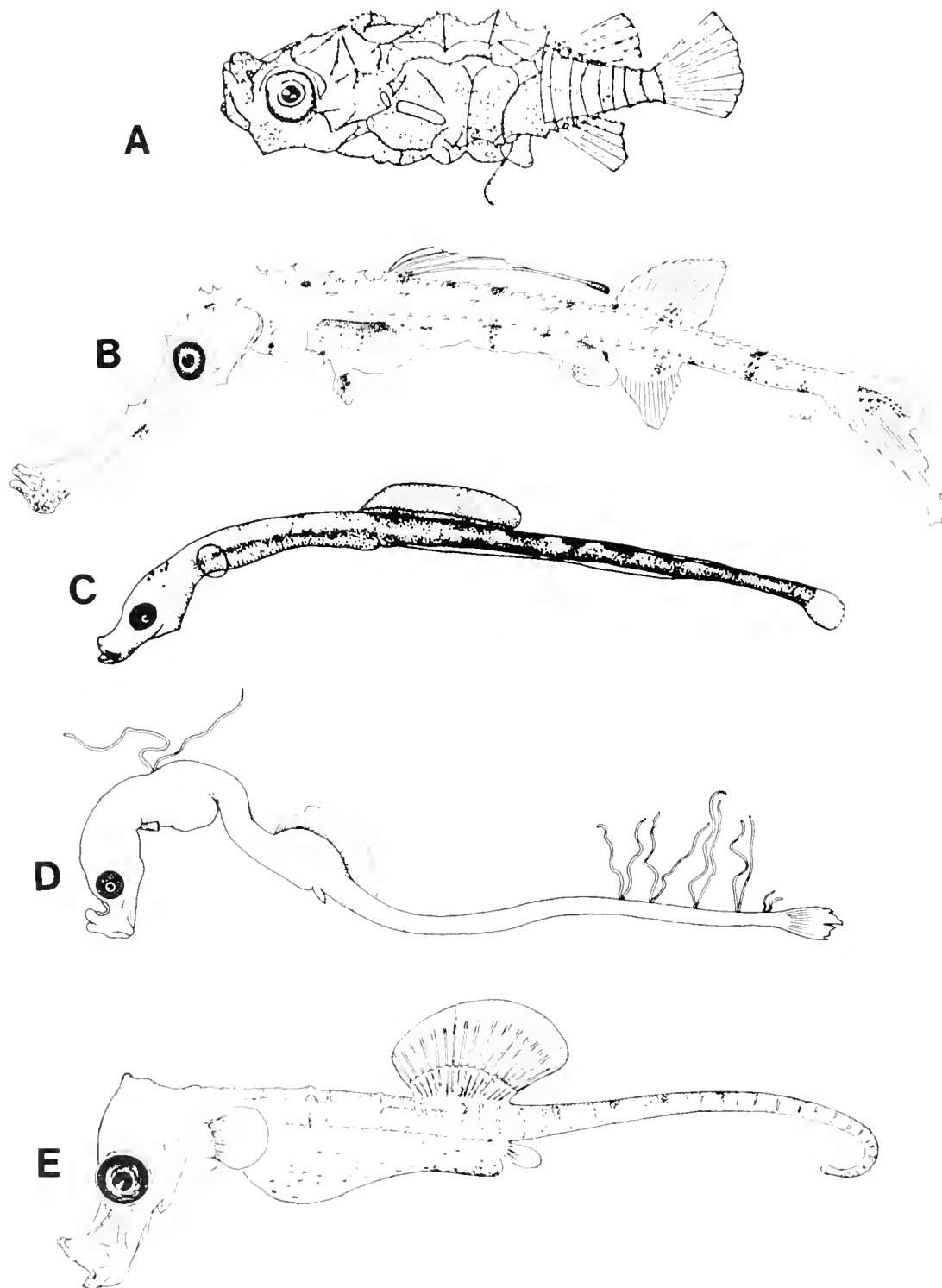

Fig. 218. Larvae of some pegasoids and syngnathoids. (A) *Eurypegasis papilio*, 7.0 mm (from Leis and Rennis, 1983); (B) *Solenostomus* sp., 11.5 mm SL (original illustration by Wayne A. Laroche); (C) *Syngnathus schlegelii*, size unknown (from Chyung, 1977); (D) *Yozia bicoarctata*, ca. 10–11 mm SL (from Dawson et al., 1979); (E) *Hippocampus japonicus*, ca. 6.5 mm TL (from Nakamura, 1937).

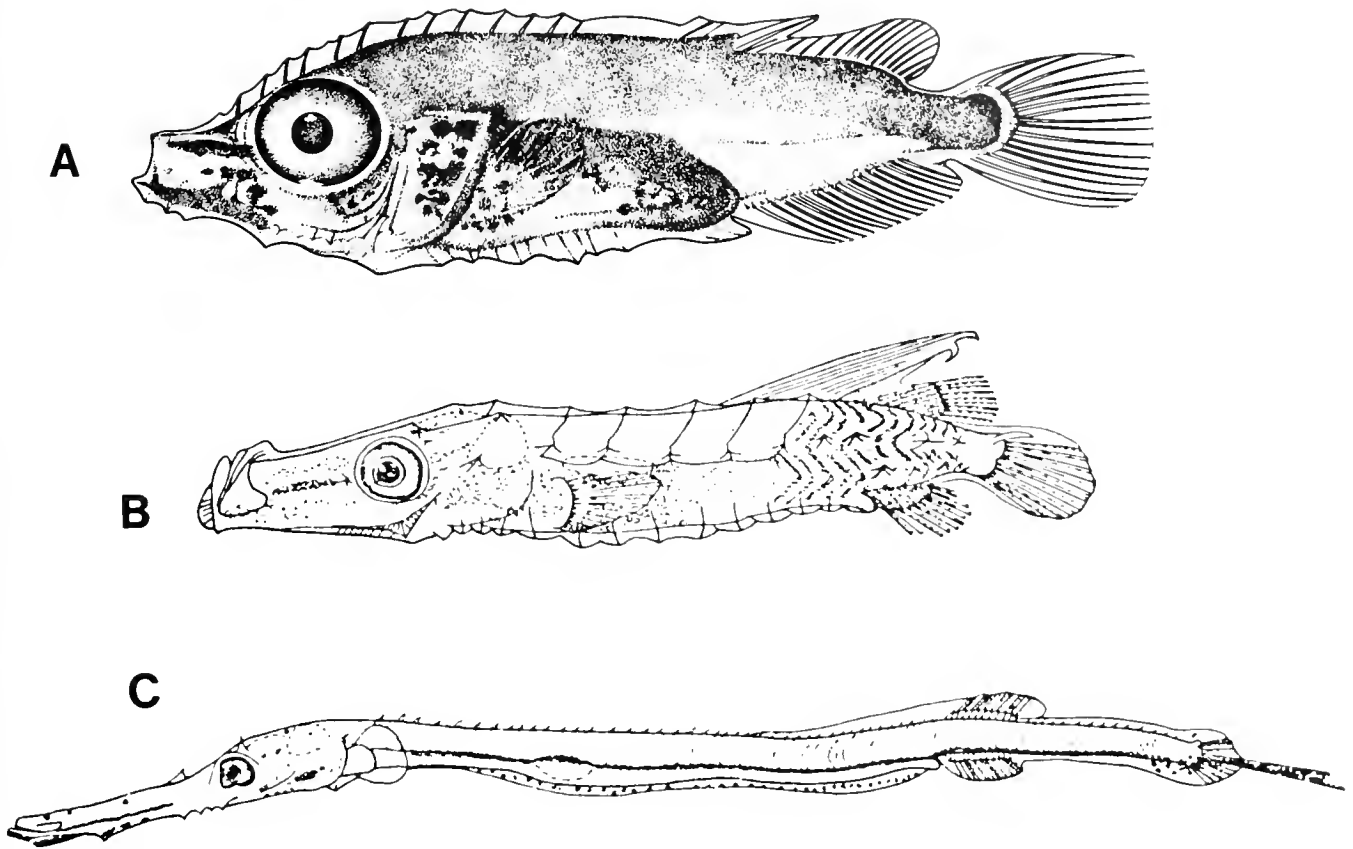

Fig. 219. Larvae of some macrorhamphosoids and aulostomoids. (A) *Macrorhamphosus scolopax*, 9.0 mm TL (from Hardy, 1978a, after D'Ancona, 1933d); (B) *Aeoliscus strigatus*, 7.9 mm (from Leis and Rennis, 1983); (C) *Fistularia petimba*, 15.6 mm (from Leis and Rennis, 1983).

terosteiforms. Kindred (1921) presented a classic study on the chondrocranium of *Syngnathus fuscus*. Padmanabhan (1961) published information on the development of jaws in *Solenostomus cyanopterus*. Development of the bony rings on the body of *Syngnathus typhle* was studied in detail by Czolowska (1962).

Considering the diversity of habitats and spawning behaviors found within the group, it is difficult to identify a character or suite of characters that typifies all members of this order. Some gasterosteiforms spawn in open water and produce buoyant eggs (e.g., *Fistularia*, Watson and Leis, 1974); others such as the sticklebacks and tubesnouts (Gasterosteidae and Aulorhynchidae) construct nests out of vegetation for receipt of the eggs; while others such as the seahorses, pipefishes, and ghost pipefishes (Syngnathidae and Solenostomidae) brood the eggs within specialized structures located on one of the parents. Syngnathids have a most unusual adaptation in having a specialized patch or pouch (marsupium) developed on the males for receipt and incubation of eggs. Those groups containing species that broadcast spawn or have nests produce larvae that go through the typical developmental pattern of pelagic larvae. Those that brood eggs, such as the more advanced syngnathids, may retain the eggs and developing larvae until the young have reached a juvenile stage of development.

In general, eggs of most gasterosteiforms are spherical, however, those of *Hippocampus* have been described as being dis-

tinctly pear-shaped (Hudson and Hardy, 1975) or ellipsoidal (Nakamura, 1937) (Fig. 214). The eggs typically have numerous oil droplets in the yolk (Gudger, 1905; Kuntz and Radcliffe, 1917). However, those of *Fistularia* lack oil droplets (Watson and Leis, 1974), and *Macrorhamphosus* has a single oil globule (Lo Bianco, 1909; Fage, 1918). The perivitelline space is narrow in *Solenostomus* (Padmanabhan, 1961), gasterosteids (Hardy, 1978), and *Fistularia* (Mito, 1961a), while it is relatively wide in *Hippocampus* (Hardy, 1978a). The yolk is not segmented and is typically yellow in syngnathids (James, 1970), rose-violet in *Macrorhamphosus* (Hardy, 1978a), and clear in *Fistularia* (Mito, 1961a). The chorion is typically smooth, however, small attachment threads have been reported for some gasterosteids (Hardy, 1978a). Most gasterosteiforms have eggs about 1.0 mm in diameter except that *Solenostomus* eggs are about 0.6 mm (Padmanabhan, 1961) and *Hippocampus* eggs may approach 4.0 mm in one dimension (Hardy, 1978a).

Larvae of most gasterosteiforms (except gasterosteids) have a very distinctive, elongate snout bearing a small upturned mouth which reflects a trenchant character of the adults (Figs. 215–219). Meristic characters are quite variable in this order (Table 106). Myomere counts range from a low of 19 in pegasids to 87 in *Fistularia* (Leis and Rennis, 1983). Fin ray meristics are equally variable and some groups lack one or all of the fins (Table 106). Syngnathids, for example, may have 0 to 60 dorsal

fin rays. Size at hatching has not been well documented for gasterosteiforms. Gasterosteids and *Solenostomus* may hatch at 3.0 mm TL (Padmanabhan, 1961; Hardy, 1978a), while *Aulorhynchus* hatch at 5.5–8.0 mm TL (Marliave, 1976). Presence of bony plates rather than scales is the rule in this order. These plates are typically present and easily seen by the time notochord flexion is complete (Figs. 218 and 219). Several groups develop small spinules in the skin on the body early in development. *Macrorhamphosus* develops spinules at about 6 mm TL (Sparta, 1936). All species of *Fistularia* go through a so-called "villosa stage" (Lütken, 1880) during which they are covered with small spinules (Fig. 219C). Pigmentation of species for which larvae have been described varies from very heavy pigmentation in Gasterosteidae and Macrorhamphosidae to rather light pigmentation in Syngnathidae and Fistulariidae. The young of several species of syngnathids have conspicuous dark bars (D'Ancona, 1933c; Takai and Mizokami, 1959; and Fritzsche, 1980) (Fig. 218C). Dawson et al. (1979) reported the presence of elongate dermal appendages in young of the syngnathid genus *Yozia* (Fig. 218D). They believed that these appendages have a buoyant function for aid in distribution of the pelagic young.

RELATIONSHIPS

Besides the hypothesis of relationships proposed by Pietsch (1978b), there are several other recent hypotheses. Greenwood, et al. (1966) proposed the following classification scheme:

- Order Gasterosteiformes
 - Suborder Gasterosteioidei
 - Family Gasterosteidae
 - Family Aulorhynchidae
 - Family Indostomidae
 - Suborder Aulostomoidei
 - Family Aulostomidae
 - Family Fistulariidae
 - Family Macrorhamphosidae
 - Family Centriscidae
 - Suborder Syngnathoidei
 - Family Solenostomidae
 - Family Syngnathidae
- Order Pegasiformes
 - Family Pegasidae

The family Indostomidae has at various times been thought to be related to the gasterosteiforms (Bolin, 1936b; Berg, 1940). But, Pietsch (1978b) has pointed out that the specific relationship of this family must await further investigation. I have, therefore, not included this monotypic family (*Indostomus paradoxus*) in this account.

Banister (1967) proposed a classification based on his osteological studies as follows:

- Order Aulorhynchiformes
 - Family Aulorhynchidae
 - Family Gasterosteidae
- Order Aulostomiformes
 - Suborder Aulostomoidei
 - Family Aulostomidae
 - Family Fistulariidae
 - Family Solenostomidae
 - Family Syngnathidae
 - Suborder Centriscioidei
 - Family Macrorhamphosidae
 - Family Centriscidae

His scheme differs little from previous ideas except in use of new ordinal names (to reduce confusion?) and inclusion of the closely related macrorhamphosids and centriscids in their own suborder. Characters of his Centriscioidei are (1) separate metapterygoid present and anterior end of quadrate normal; (2) nasals large and elongated; (3) five or more modified anterior vertebrae; (4) supraethmoid contributes little to dorsum of snout; (5) post-temporal pyramidal; (6) caudal fin skeleton uniform, with single large hypural plate; (7) vertebral number low (about 20); (8) no sign of reduction in pharyngeal skeleton; and (9) interneurons for vertebrae five and six absent. Banister's (1967) hypothesis of relationships has not been published.

Nelson (1976) proposed a classification that was similar to that of Greenwood et al. (1966) except that the families Gasterosteidae and Aulorhynchidae were recognized as forming the order Gasterosteiformes while the remainder of the families were placed in Syngnathiformes. This separation was done pending clarification of relationships and establishment of monophyly. As noted earlier, Pietsch (1978b) was able to link the two groups based on the intermediate nature of the pegasids.

Ida (1976) demonstrated that the monotypic *Hypoptichus dybowskii* Steindachner resembled gasterosteids and aulorhynchids in osteology, mode of life, and reproduction. He, therefore, removed this species from the Perciformes and placed it close to the Gasterosteidae and Aulorhynchidae in the suborder Gasterosteioidei of his order Syngnathiformes.

Early life history stages have contributed little to the development of the above hypotheses of relationships. Pietsch (1978b) showed that snout structure of *Pegasus* and *Macrorhamphosus* is very much alike at small sizes even though it is quite different in adults. Ida (1976) used egg morphology as one of the characters supporting his placement of the Hypoptichidae close to the Gasterosteidae.

Considering the paucity of developmental descriptions for species of the Gasterosteiformes, it is difficult to test existing hypotheses of relationships using developmental characters. However, it is interesting to note the sequence of fin formation seems to support the close relationship of the Gasterosteidae and Aulorhynchidae. *Aulorhynchus* forms the pectoral fins first, followed by the caudal, second dorsal and anal fins (Marliave, 1976). The gasterosteid *Apeltes* follows the same sequence (Hardy, 1978a). *Gasterosteus* forms the pectoral fins after the anal fin (Hardy, 1978a). Few developmental sequences are known for the other gasterosteiforms. Those that are available show that for the pegasids, macrorhamphosids and syngnathids the sequence begins with the development of the dorsal fin followed by the anal, caudal and pectoral. It may well be that the sequence of fin formation will provide evidence for the retention of the Gasterosteidae and Aulorhynchidae in their own order or suborder. Additionally *Macrorhamphosus*, *Aeoliscus* and *Fistularia* develop a dorsal finfold that extends on to the head which might be given as evidence in support of Pietsch's (1978b) infraorder Macrorhamphosa. However, pegasids also have this anteriorly placed finfold (Leis and Rennis, 1983). This coupled with the low myomere numbers for pegasids and macrorhamphosids may indicate that these two groups should be placed closer together than is presently indicated in Pietsch's treatment. This question must remain unresolved pending further descriptive and comparative work on gasterosteiform larvae.

Studies of the relationships of Gasterosteiformes to other taxa have been dominated by unsupported hypotheses. Gosline (1971) proposed that the "origin for both gasterosteoids and synga-

thoids (sic) suggest one or two origins in the percopsiform—beryciform area.” The mixture of advanced and primitive characters shown by gasterosteiforms suggested to Banister (1967) evolution “from a primitive myctophoid type of fish . . . towards an acanthopterygian grade.” McAllister (1968) suggested “the Gasterosteiformes are derivable from the Perciformes” and “. . . the Syngnathiformes from the subperciforms, such as Beryciformes and Zeiformes.” In fact he suggests that *Antigonia* or *Capromimus* would appear to be close to the ancestors of the Syngnathiformes. None of these authors presented evidence for support of their ideas. Examination of the description of *Antigonia* larvae by Nakahara (1962) shows that this fish bears little resemblance to the early stages of described gasterosteiforms. Larval *Antigonia* are characterized by well-developed, serrated

preopercular and cranial spines. These spines are never seen in gasterosteiform larvae. However, the description of the larvae of *Capros aper* (Russell, 1976) indicates that the most characteristic feature of them is the occurrence of small spines all over the body surface. Additionally the larvae of *C. aper* are darkly pigmented. These two characteristics are also found in some gasterosteiform larvae, e.g., *Macrorhamphosus*. It is therefore tempting to use these characters in support of McAllister’s hypothesis, however we will have to wait for further information on both gasterosteiforms and zeiforms before we can support or refute this hypothesis.

DEPARTMENT OF FISHERIES, HUMBOLDT STATE UNIVERSITY, ARCATA, CALIFORNIA 95521.

Scorpaeniformes: Development

B. B. WASHINGTON, H. G. MOSER, W. A. LAROCHE AND W. J. RICHARDS

THE Scorpaeniformes are the fourth largest order of fishes encompassing about 20 families (depending on classification used), 250 genera and over 1,000 species. Representatives of the order are widely distributed from tropical to arctic and antarctic waters. Most scorpaeniforms are benthic or epibenthic with representatives ranging from freshwater to the deep ocean.

The morphologically diverse “mail-cheeked fishes” are named for the bony suborbital stay which extends posteriorly from the third infraorbital to the preopercle. The suborbital stay is the only known character that defines the order; however, some workers have suggested that the stay evolved independently in several lineages and may not indicate monophyly (Matsubara, 1943; Quast, 1965; Poss, 1975). The classification of the scorpaeniforms is controversial, not only in terms of monophyly but also at the subordinal and familial levels. Discussion of the taxonomic status and current hypotheses of relationships is presented in Scorpaeniformes: Relationships (this volume).

Modes of reproduction vary widely within the scorpaeniforms. Many families spawn individual pelagic eggs (Anoplomatidae, Congiopodidae, Hoplichthyidae and Triglidae), while others spawn demersal clusters of adhesive eggs (Agonidae, Cottidae, Cyclopteridae and Hexagrammidae). Where known, most scorpaenids produce pelagic egg masses enclosed in a gelatinous matrix. Notable exceptions include the scorpaenid genus *Sebastes* and the comephorids of Lake Baikal which give birth to live young.

Larvae of only about 20% of scorpaeniform genera and approximately 10% of the species are known. Because of the wide diversity of form, we are not able to characterize a typical scorpaeniform larva. Early life stages of many scorpaeniforms are characterized by strong head spination as depicted in the generalized scorpaenid larva *Sebastes* (Fig. 220). However, the expression of head spination is variable within the order with elaborations and losses in many groups.

For the purposes of this paper, we consider the Scorpaeniformes to be monophyletic and utilize the broad suborders Scor-

paenoidei and Cottoidei as a framework for presentation and discussion. Because of the order’s morphological diversity and the lack of an agreed upon classification, discussion of larval taxonomy is focused upon each family. The scorpaeniform family Cyclopteridae is presented in the subsequent article in this volume.

SCORPAENOIDEI

Eggs

Eggs are known for seven of the scorpaenoid families recognized in Washington et al. (this volume), however, they are known only for a few species (Table 107). Most scorpaenoid families are oviparous and spawn pelagic eggs; however, reproductive modes are varied in the Scorpaenidae. In the scorpaenid subfamilies Scorpaeninae, Pteroinae, and Sebastolobinae the eggs are extruded in bilobed gelatinous egg masses which float at the surface. The eggs are slightly elliptical and have homogeneous yolk, a narrow perivitelline space, and a smooth chorion. A single oil globule is present in *Pterois* (0.16–0.17 mm) and *Sebastolobus* (0.18–0.20 mm); *Scorpaena* lacks an oil globule. In the choridaetyline genus *Inimicus*, eggs are extruded singly, are spherical, and lack an oil globule (Table 107). Members of the scorpaenid subfamily Sebastinae are viviparous and give birth to large broods of young which are comparable in stage of development to first-feeding larvae of oviparous scorpaenids. The eggs are retained in the lumen of the ovary after ovulation, range between 0.75 and 1.9 mm, have homogeneous yolk, a narrow perivitelline space, smooth chorion, and one to many oil globules. For the other families for which eggs are known, the eggs are pelagic with none to multiple oil globules (Table 107).

Larvae

At least one larval stage is known for 64 of the more than 600 species of scorpaenoids and for 20 of the 100+ genera. Major reviews of larval scorpaenoids include Sparta (1956b)

TABLE 107. SUMMARY OF EGGS AND LARVAL SIZE CHARACTERISTICS OF THE SCORPAENIFORMES BASED ON AVAILABLE LITERATURE (EXCLUDING CYCLOPTERIDAE).

Family/subfamily species	Type of egg pelagic (P), demersal (D) or viviparous (V)	Egg size (mm)	Number of oil globules	Largest oil globule size (mm)	Body length (mm) at			References
					Hatching	Flexion	Transformation	
SCORPAENOIDEI								
Scorpaenidae								
Sebastinae ¹								
<i>Sebastes capensis</i>	V	—	—	—	3.8	6.2–7.0	ca. 20	Moser et al., 1977
<i>S. fasciatus</i>	V	—	—	—	ca. 5.8	8.5–10.0	—	Moser et al., 1977; Fahay, 1983
<i>S. marinus</i>	V	1.5	—	—	6.7–7.2	8.5–11.8	ca. 24	Moser et al., 1977; Tåning, 1961
<i>S. viviparous</i>	V	—	—	—	5.4–5.8	7.8–10.6	—	Tåning, 1961
<i>S. hubbsi</i>	V	—	—	—	ca. 4.4	ca. 6	—	Uchida et al., 1958
<i>S. inermis</i>	V	—	—	—	4.5	ca. 7	ca. 18	Harada, 1962
<i>S. longispinis</i>	V	1.36	1	—	5.8–6.1	6.4–7.1	—	Takai and Fukunaga, 1971
<i>S. marmoratus</i>	V	0.75–0.95	1	0.2	ca. 4.5	ca. 8	ca. 17	Tsukahara, 1962
<i>S. nigricans</i>	V	1.6	many to 1	—	6.9–7.0	—	ca. 10	Fujita, 1957b, 1959
<i>S. oblongus</i>	V	1.56–1.60	many	—	7.2–7.5	ca. 8.5	12–14	Fujita, 1958
<i>S. pachycephalus</i>	V	1.5–1.9	many	—	6.0–7.0	ca. 8	>13	Shiokawa and Tsukahara, 1961
<i>S. schlegeli</i>	V	—	—	—	ca. 6.1	—	—	Sasaki, 1974
<i>S. steindachneri</i>	V	—	—	—	ca. 4.8	—	—	Sasaki, 1974
<i>S. taczanowskii</i>	V	—	—	—	ca. 5.4	—	—	Sasaki, 1974
<i>S. constellatus</i>	V	—	—	—	4.0–5.0	<7.1	—	Moser and Butler, in press
<i>S. cortezi</i>	V	—	—	—	4.1	7.0–8.3	ca. 17	Moser et al., 1977
<i>S. crameri</i>	V	—	—	—	ca. 5.7	8.0–9.3	16–21	Westrheim, 1975; Richardson and Laroche, 1979
<i>S. dallii</i>	V	—	—	—	5.0	6.2–8.0	<20	Moser and Butler, 1981
<i>S. entomelas</i>	V	—	—	—	4.5–4.6	9.9–12.9	21.7–30.6	Laroche and Richardson, 1981; Moser and Butler, in press
<i>S. flavidus</i>	V	—	—	—	4.5	—	23.6–26.7	DeLacy et al., 1964; Laroche and Richardson, 1980
<i>S. helvomaculatus</i>	V	—	—	—	4.1	7.7–8.0	12.0–18.6	Richardson and Laroche, 1979; Westrheim, 1975
<i>S. jordani</i>	V	—	—	—	5.4	8.0–10.0	27–30	Moser et al., 1977
<i>S. levis</i>	V	—	—	—	5.0	7.6–10.4	ca. 19	Moser et al., 1977
<i>S. macdonaldi</i>	V	—	—	—	4.0–5.0	7.7–9.0	ca. 15	Moser et al., 1977
<i>S. melanops</i>	V	—	—	—	—	—	23.2–30.6	Laroche and Richardson, 1980
<i>S. melanostomus</i>	V	—	—	—	4.5	6.2–7.2	ca. 16	Moser and Ahlstrom, 1978
<i>S. ovalis</i>	V	—	—	—	4.9–5.1	ca. 6.8	—	Moser and Butler, in press
<i>S. paucispinis</i>	V	1.0	1	ca. 0.20	4.6	7.2–9.7	15	Moser et al., 1977
<i>S. pinniger</i>	V	—	—	—	4.0	ca. 7.8	12.8–18.4	Waldron, 1968; Richardson and Laroche, 1979
<i>S. rufus</i>	V	—	—	—	4.6–4.8	6.1–7.6	—	Moser and Butler, in press
<i>S. zacentrus</i>	V	—	—	—	ca. 4.3	7.4–8.5	13.7–19.6	Laroche and Richardson, 1981; Westrheim, 1975
<i>Sebastes</i> Type A	V	—	—	—	4.2	7.0–7.6	—	Moser et al., 1977
<i>Helicolenis dactylopterus</i>	V	—	—	—	2.2	6.0–7.9	>19	Graham, 1939; Sparta, 1956b; Tåning, 1961; Moser et al., 1977; Fahay, 1983
Scorpaeninae								
<i>Pontinus</i> Type A	—	—	—	—	<2.3	4.1–4.6	ca. 15	Moser et al., 1977
<i>Pontinus</i> Type B	—	—	—	—	—	<5.0–5.5	ca. 10	Moser et al., 1977

TABLE 107. CONTINUED.

Family subfamily species	Type of egg pelagic (P), demersal (D) or viviparous (V)	Egg size (mm)	Number of oil globules	Largest oil globule size (mm)	Body length (mm) at			References
					Hatching	Flexion	Transformation	
<i>Scorpaena guttata</i>	P	1.22– 1.29 × 1.16– 1.19	0	—	1.9–2.0	4.5–5.7	>13	David, 1939; Orton, 1955d; Moser et al., 1977
<i>S. notata</i>	P	0.76 × 0.88	0	—	<2.7	ca. 6.0	—	Sparta, 1956b
<i>S. porcus</i>	P	0.84 × 0.92	0	—	1.72	ca. 6.7	ca. 12	Sparta, 1956b
<i>S. scrofa</i>	P	0.68 × 0.88	0	—	<2.8	ca. 6.0	ca. 17	Sparta, 1956b
<i>Scorpaena</i> Type A	—	—	—	—	ca. 2.0	4.0–5.5	>12	Moser et al., 1977
<i>Scorpaenodes xyris</i>	—	—	—	—	1.8	4.0–5.4	11–14	Moser et al., 1977
Pteroinae								
<i>Pterois lunulata</i>	P	0.81–0.83	1	0.16–0.17	1.52–1.58	—	—	Mito and Uchida, 1958; Mito, 1963
<i>Dendrochirus brachypterus</i>	P	—	0	—	ca. 1.1	—	—	Fishelson, 1975
Sebastolobinae								
<i>Sebastolobus alascanus</i>	P	1.2–1.4	1	0.18–0.20	ca. 2.6	6.0–7.3	14–20	Pearcy, 1962; Moser, 1974; Moser et al., 1977
<i>S. altivelis</i>	P	1.2–1.4	1	0.18–0.20	ca. 2.6	6.0–7.3	14–20	Moser et al., 1977
Setarchinae								
<i>Ectreposebastes imus</i>	—	—	—	—	<2.8	ca. 5.5	ca. 28	Moser et al., 1977
Choridactylinae								
<i>Inimicus japonicus</i>	P	1.31–1.43	0	—	3.18–3.27	6.4–8.2	ca. 10.4	Fujita and Nakahara, 1955; Mito, 1963; Sha et al., 1981
Minoinae								
<i>Minous</i> sp. (?)	—	—	—	—	ca. 1.8	3.7–5.9	>9.0	Leis and Rennis, 1983
Triglidae								
<i>Chelidonichthys cuculus</i>	P	1.45–1.65	1	—	—	—	—	Padoa, 1956e
<i>C. gurnardus</i>	P	1.45–1.5	1	0.19–0.33	3.2	9.0	17.0	Padoa, 1956e
<i>C. kumu</i>	P	1.20–1.27	1	0.25–0.27	3.12–3.26	—	—	Uchida et al., 1958
<i>C. lastoviza</i>	P	1.29–1.33	1	0.24	—	—	—	Padoa, 1956e
<i>C. lucerna</i>	P	1.25–1.36	1	0.26–0.28	3.2	9.0	17.0	Padoa, 1956e
<i>C. obscurus</i>	P	—	—	—	—	—	—	Padoa, 1956e
<i>Lepidotrigla alata</i>	P	1.22–1.25	1	0.25	2.78–2.92	—	—	Mito, 1963
<i>L. aspera</i>	P	1.16	1	0.21–0.22	3.2	7.0	19.0	Padoa, 1956e
<i>L. japonica</i>	P	1.20–1.40	1	0.25–0.26	—	—	—	Mito, 1963
<i>L. microptera</i>	P	1.26–1.31	1	0.25–0.28	—	—	—	Mito, 1963
<i>Prionotus carolinus</i>	P	0.94–1.15	10–25	—	2.6–2.8	—	8.6	Fritzsche, 1978; Fahay, 1983
<i>P. evolans</i>	P	—	—	—	—	6.3	8.7	Fahay, 1983
Peristediidae								
<i>Peristedion</i>	P	1.7	—	—	—	<11.5	15.0	Padoa, 1956e; Breder and Rosen, 1966
Congiopodidae								
<i>Congiopodus leucopaecilus</i> ²	P	1.9–2.2	0	NA	—	—	—	Robertson, 1974, 1975a
<i>C. spinifer</i> ²	P	1.82	0	NA	5–6	—	>12.4	Brownell, 1979; Gilchrist, 1904; Gilchrist and Hunter, 1919; Robertson, 1975a
<i>C. torvus</i> ²	P?	1.7–1.8	0	NA	—	—	—	Gilchrist, 1904
Platycephalidae								
<i>Platycephalus indicus</i> ²	P	0.88–1.2	1	0.19–0.25	1.78–2.3	7.3	13	Ueno and Fujita, 1958; Chang et al., 1980
<i>Platycephalidae</i> spp.	—	—	—	—	~2.1	3.9–5.2	—	Leis and Rennis, 1983

TABLE 107. CONTINUED.

Family/subfamily species	Type of egg pelagic (P), demersal (D) or viviparous (V)	Egg size (mm)	Number of oil globules	Largest oil globule size (mm)	Body length (mm) at			References
					Hatching	Flexion	Transformation	
Hoplichthyidae								
<i>Hoplichthys haswelli</i> ²	P	0.85–0.90	1	0.15	—	—	—	Robertson, 1975a
<i>Hoplichthys</i> sp. ²	—	—	—	—	—	≥8	—	Okiyama (unpubl. MS)
Dactylopteridae								
<i>Dactylopterus volitans</i>	P	~0.8	1	0.14	1.8	<7	ca. 16	Fritzsche, 1978; Sanzo, 1933c; Padoa, 1956e
<i>Daicocus petersoni</i>	—	—	—	—	—	4.3	ca. 10	Senta, 1958
<i>Dactyloptena</i> sp.	—	—	—	—	—	3.9–6.5	ca. 10	Leis and Rennis, 1983
COTTOIDEI								
Agonidae								
<i>Agonomalus mozinoi</i>	D	~1.0	—	—	5.5	—	—	Marliave, 1978
<i>Agonopsis chiloensis</i> ²	—	—	—	—	—	—	—	de Ciechomski, 1981
<i>Agonus cataphractus</i>	D	1.7–2.2	Several co-alesce	0.7–0.75	6.3–8.0	—	~14 mm	Russell, 1976; Ehrenbaum, 1904; McIntosh and Prince, 1890
<i>A. decagonus</i> ²	—	—	—	—	—	—	—	Ehrenbaum, 1905–1909
<i>Aspidophoroides monopterygius</i> ²	—	—	—	—	—	—	—	Dannevig, 1919; Bigelow and Schroeder, 1953
<i>A. oltriki</i> ²	—	—	—	—	—	—	—	Dunbar, 1947
<i>Bothragonus swani</i>	D	2	—	—	7.5	~10–12	>16	Marliave, 1975
<i>Pallasina barbata</i> ²	—	—	—	—	—	—	—	Marliave, 1975
<i>Xeneretmus latifrons</i> ²	—	—	—	—	~7	~10	—	Marliave, 1975
Anoplopomatidae								
<i>Anoplopoma fimbria</i>	P	2.0–2.1	—	—	<8.8	11–14	>33	Ahlstrom and Stevens, 1976; Hart, 1973; Kobayashi, 1957
Comephoridae								
<i>Comephorus baicalensis</i>	V	N/A	—	—	9.4	—	>48	Chernyayev, 1975
<i>C. dybowskii</i>	V	N/A	—	—	8.2	~13	~21	Chernyayev, 1971
Cottidae								
<i>Artedius creaseri</i>	—	—	—	—	~3.5	5.7–7.9	13–14	Washington, 1981
<i>A. fenestralis</i>	—	—	—	—	3.5–3.8	5.9–6.8	12–13	Washington, 1981; Marliave, 1975
<i>A. harringtoni</i>	—	—	—	—	~3.0	5.2–6.4	12–14	Washington, 1981
<i>A. lateralis</i>	D	1.07	1	0.22	3.9–4.5	5.0–6.3	9.5–10.5	Washington, 1981; Marliave, 1975; Budd, 1940
<i>A. meanyi</i>	—	—	—	—	~3	6.3–9.4	15–20	Washington, 1981
<i>Ascelichthys rhodorus</i>	D	1.7–2.0	—	—	6.0	8.8–9.0	12–15	Matarese and Marliave, 1982
<i>Blepsias cirrhosus</i> ²	—	—	—	—	—	≤11	—	Marliave, 1975; Richardson, 1981a
<i>Chitonotus pugetensis</i> ²	D	1.02–1.05	1 large 5–8 small	0.3	2.9–3.0	—	>16	Misitano, 1980; Richardson and Washington, 1980
<i>Clinocottus acuticeps</i>	D	1.0–1.2	—	—	3.1–3.3	5.5–7.3	12.6–15.0	Washington, 1981; Washington, pers. obs.
<i>C. analis</i> ²	D	1.2–1.3	several large	0.18	4.2–4.5	—	—	Budd, 1940; Washington, 1981
<i>C. embryum</i>	—	—	—	—	~4.0	6.4–9.6	13–14	Washington, 1981
<i>C. globiceps</i>	D	1.5–2.0	—	—	5.1–5.4	6.2–8.1	12.9–13.5	Washington, 1981
<i>C. recalvus</i>	D	1.25–1.35	—	—	4.6–4.7	—	9–11	Morris, 1951
<i>Cottus asper</i>	D	—	—	—	5.5–6.3	~7.0	—	Stein, 1972; Richardson and Washington, 1980
<i>C. bairdi</i>	D	1–3	1	—	6.3–6.9	—	9–10	Heufelder, 1982
<i>C. carolinae</i>	D	2.6–3.3	—	—	6.86	—	9.5–10	Wallus and Granneman, 1979
<i>C. cognatus</i>	D	2–3	—	—	5.7–6.3	—	8–11	Wallus and Granneman, 1979
<i>C. nozawae</i>	D	3.1–3.5	—	—	10.5	—	—	Watanabe, 1976
<i>C. reinii</i> ²	D	2.0–2.6	1	—	—	—	—	Watanabe, 1976

TABLE 107. CONTINUED.

Family subfamily species	Type of egg pelagic (P), demersal (D) or viviparous (V)	Egg size (mm)	Number of oil globules	Largest oil globule size (mm)	Body length (mm) at			References
					Hatching	Flexion	Transformation	
<i>C. ricei</i> ²	D	—	—	—	7–8	—	—	Heufelder, 1982
<i>Enophrys bison</i>	D	1.7–1.8	1	0.36	4.9–5.2	5.2–7.0	7.6–7.8	Misitano, 1978; Richardson and Washington, 1980
<i>E. bubalis (Taurulus)</i>	D	1.5–1.8	several	—	5.5–5.8	—	12	Russell, 1976
<i>E. lilljeborgi (Taurulus)</i> ²	D	2.0	1	0.38	~4.0	—	—	Russell, 1976
<i>Gymnocanthus herzensteini</i>	D	1.6–1.7	few	—	5.6–6.1	—	—	Kyushin, 1970
<i>G. ventralis</i> ²	—	—	—	—	—	—	—	Ehrenbaum, 1905–1909
<i>Hemilepidotus gilberti</i> ²	—	—	—	—	—	—	—	Hattori, 1964
<i>H. hemilepidous</i>	D	1.5–1.6	1	0.31–0.56	~5–6	~9.1	>19–23	Richardson and Washington, 1980
<i>H. jordani</i>	—	—	—	—	—	—	—	Gorbunova, 1964a ⁶
<i>H. spinosus</i>	—	—	—	—	~5	7.6–10.1	19	Richardson and Washington, 1980
<i>H. zapus</i>	—	—	—	—	—	7–12	—	Matarese and Vinter (in prep.)
<i>Hemitripterus americanus</i>	D	4	1 large	0.8	10–14	~14.5	>18.8	Fahay, 1983; Fuiman, 1976
<i>H. villosus</i>	D	—	—	—	10.9–11.6	≤14.4	~20	Okiyama and Sando, 1976
<i>Icelus bicornis</i> ²	—	—	—	—	—	—	—	Russell, 1976; Ehrenbaum, 1905–1909
<i>Leptocottus armatus</i> ²	D	1.4–1.5	present	—	3.9–4.8	~8	15–20	Richardson and Washington, 1980; Jones, 1962
<i>Myoxocephalus aenaeus</i>	D	1.5–1.7	2+	0.2	4.7–6.3	6.8	—	Fahay, 1983; Lund and Marcy, 1975
<i>M. octodecimspinosus</i>	D	1.9–2.3	1 or more	diameter varies	6.3–7.3	9–11	~15	Fahay, 1983; Colton and Marak, 1969
<i>M. quadricornus</i>	D	1.5–2.2 ³	—	—	~8	ca. 10.5+	—	Khan and Faber, 1974
<i>M. scorpius</i>	D	1.8–2.5	several	0.4–0.5	7.4–8.6	9–15	17–20	Russell, 1976; Ehrenbaum, 1905–1909; McIntosh and Masterman, 1897
<i>M. thompsoni</i> ²	—	—	—	—	8–10	—	—	Heufelder, 1982
<i>Nautichthys oculo fasciatus</i>	D	2–2.5	—	—	9	~9–11	~26	Richardson and Washington, 1980; Marliave, 1975
<i>Oligocottus maculosus</i>	D	1.3–1.5	1 large many small	—	4.2–4.5	7.2–7.6	7.5–10	Washington, 1981; Stein, 1973
<i>O. snyderi</i>	D	1.2–1.3	—	—	4.47	6.2–8.4	11–13	Washington, 1981; Stein, 1972
<i>Orthonopias triacis</i> ²	D	0.9–1.0	1 large 2 small	—	2.9–3.8	—	—	Bolin, 1941
<i>Paricelhnus hopliticus</i> ²	—	—	—	—	<5.6	—	~25	Richardson and Washington, 1980
<i>Pseudoblennius cottoides</i> ²	D	2.0–2.2	—	—	12.5	—	—	Watanabe, 1976
<i>Radulmus asprellus</i>	—	—	—	—	≤4.7	7.2–10.9	≥15	Richardson and Washington, 1980
<i>R. boleoides</i> ²	—	—	—	—	—	~8.7	—	Richardson and Washington, 1980
<i>Rhamphocottus richardsoni</i>	D	2.5–2.8	—	—	6–7	8.4	~14–15	Richardson and Washington, 1980; Marliave, 1975; Blackburn, 1973
<i>Scorpaenichthys marmoratus</i>	D	1.4–1.9	1 large several small	0.27	5.8–6.0	7.5–8.7	14–15 ⁴	Richardson and Washington, 1980; O'Connell, 1953
<i>Triglops murrayi</i> ²	—	—	—	—	7–8	12	—	Fahay, 1983
<i>T. pingelii</i> ²	D	2.0	many	—	—	—	—	Bigelow and Schroeder, 1953; Rass, 1949
Cottocomephoridae								
<i>Abyssocottus bergianus</i> ²	D	3.2–3.3 ³	—	—	—	—	—	Taliev, 1955
<i>A. godlewskii</i> ²	D	2.8–3.0 ³	—	—	~5	—	—	Taliev, 1955
<i>A. korotneffi</i> ²	D	~4.5 ³	—	—	—	—	—	Taliev, 1955

TABLE 107. CONTINUED.

Family-subfamily species	Type of egg pelagic (P), demersal (D) or viviparous (V)	Egg size (mm)	Number of oil globules	Largest oil globule size (mm)	Body length (mm) at			References
					Hatching	Flexion	Transformation	
<i>A. pallidus</i> ²	D	2.6–2.8 ³	—	—	~6	—	~16	Taliev, 1955
<i>Asprocottus gibbosus</i> ²	D	3.3–3.4 ³	—	—	—	—	—	Taliev, 1955
<i>A. herzensteini</i> ²	D	3.0–3.2 ³	—	—	—	—	≥9	Taliev, 1955
<i>A. megalops</i> ²	D	3.5–3.7 ³	—	—	—	—	—	Taliev, 1955
<i>Batrachocottus baicalensis</i>	D	~3.0	3–10 small	—	10.0	N/A	~16	Chernyayev, 1981
<i>B. multiradiatus</i> ²		~4.0	—	—	~6.0	—	—	Taliev, 1955
<i>B. nikolskii</i> ²	D	2.9–3.1	—	—	—	—	—	Taliev, 1955
<i>B. uschkanii</i> ²	—	—	—	—	—	—	—	Taliev, 1955
<i>Cottinella boulengeri</i> ²	D	2.8 ³	—	—	—	—	—	Taliev, 1955
<i>Cottocomephorus grewingki</i>	D	1.2–1.8	—	—	~6.8–7.0	—	~19	Taliev, 1955
<i>C. inermis</i> ²	D	1.5–1.7	—	—	—	—	—	Taliev, 1955
<i>Paracottus kessleri</i>	D	1.0–1.45	1 large	0.3	5.2–5.4	~6.2	~20	Chernyayev, 1978
<i>P. kneri</i>	D	2.0–2.3	—	—	6.8–7.1	—	>10.8	Taliev, 1955
<i>Procottus jettelesi</i> ²	D	2.5–3.3	—	—	—	—	—	Taliev, 1955
Hexagrammidae								
<i>Hexagrammos agrammys</i>	D	2.02–2.07	many coalesce to 1	—	8.15–8.61	~11	≤40–48	Fukuhara, 1971
<i>H. decagrammus</i>	D	—	—	—	ca. 8	15–18	~30 ⁴	Kendall and Vinter, 1984
<i>H. lagocephalus</i>	D	2.0–2.6	many	—	~8–9	12–15	ca. 29	Kendall and Vinter, 1984; Gorbunova, 1964b (as <i>H. decagrammas</i>)
<i>H. octagrammus</i>	D	1.75–2.10	many	0.8	6–7	~12–15	~30 ⁴	Gorbunova, 1964b
<i>H. otakii</i>	D	2.3–2.7	many	—	6.5–7.0	~11	—	Gorbunova, 1964b; Yusa, 1960c
<i>H. stelleri</i>	D	—	—	—	~7–9	~12–15	~30 ⁴	Kendall and Vinter, 1984
<i>Ophiodon elongatus</i>	D	2.9–3.2	1	—	~9.0	11–15	~30 ⁴	Kendall and Vinter, 1984
<i>Pleurogrammus monoptyerygius</i>	D	2.1–2.8	many	1.38–1.4	10–11	~14–19	~30 ⁴	Yusa, 1967; Gorbunova, 1964b
<i>Oxylebius pictus</i>	D	—	—	—	4–5	7–9	~45	Kendall and Vinter, 1984; DeMartini, 1976
<i>Zaniolepis</i> sp.	—	—	—	—	~2.5	~6	?15	Kendall and Vinter, 1984
Normanichthyidae								
<i>Normanichthys crockeri</i>	—	—	—	—	<4.4	7–9	>16	Balbontin and Perez, 1980
Psychrolutidae								
<i>Dasycottus setiger</i> ²	—	—	—	—	—	~10	—	Richardson, 1981a
<i>Gilbertidia sigalutes</i> ²	D	2.3	—	—	—	~13–15	~23	Marliave, 1975
<i>Malacocottus</i> sp.	—	—	—	—	—	~7–9.8	≤24	Richardson, 1981a
<i>Psychrolutes paradoxus</i> ²	—	—	—	—	—	~10.5	~13–14	Marliave, 1975

¹ Ovarian or newborn larvae of 30 species of *Sebastes* not listed here are described in Efremenko and Lisovenko (1970), Westheim (1975), and Moser et al. (1977).

² Incomplete description with illustration.

³ Ripe ovarian egg diameter.

⁴ Pelagic juvenile stage.

⁵ Hatch at advanced postflexion stage.

⁶ Confusion exists regarding correct identification [Matarese and Vinter (in prep.)].

and Moser et al. (1977) on scorpaenids and Sparta (1956b) and Richards (in prep.) on triglids and peristediids.

Scorpaenidae (Figs. 220–223).—This is the largest and most diverse scorpaenoid family with about 44 genera and more than 350 species. The classification and relationships of the family are in controversy (Washington et al., this volume) and we follow their subfamily groupings.

Sebastinae.—Barsukov (1981) includes 3 genera and 114 species in this temperate and boreal group. *Sebastes* with about 106

species accounts for almost 1/3 of the species in the order. At least a single larval stage is known for 62 species of *Sebastes* and flexion or postflexion stages have been described for about 32 of these (Table 107). Larval stages have been described for one of the 6 species of *Helicolenus* and are unknown for the two species of *Hozukius*.

In *Sebastes* most of the yolk is utilized before hatching while the eggs lie freely within the ovary. Hatching precedes extrusion and newborn larvae range from 3.8 to 7.5 mm in length among the various species and have functional eyes, jaws, and pectoral fins. The finfold is slightly inflated and has minute cell-like

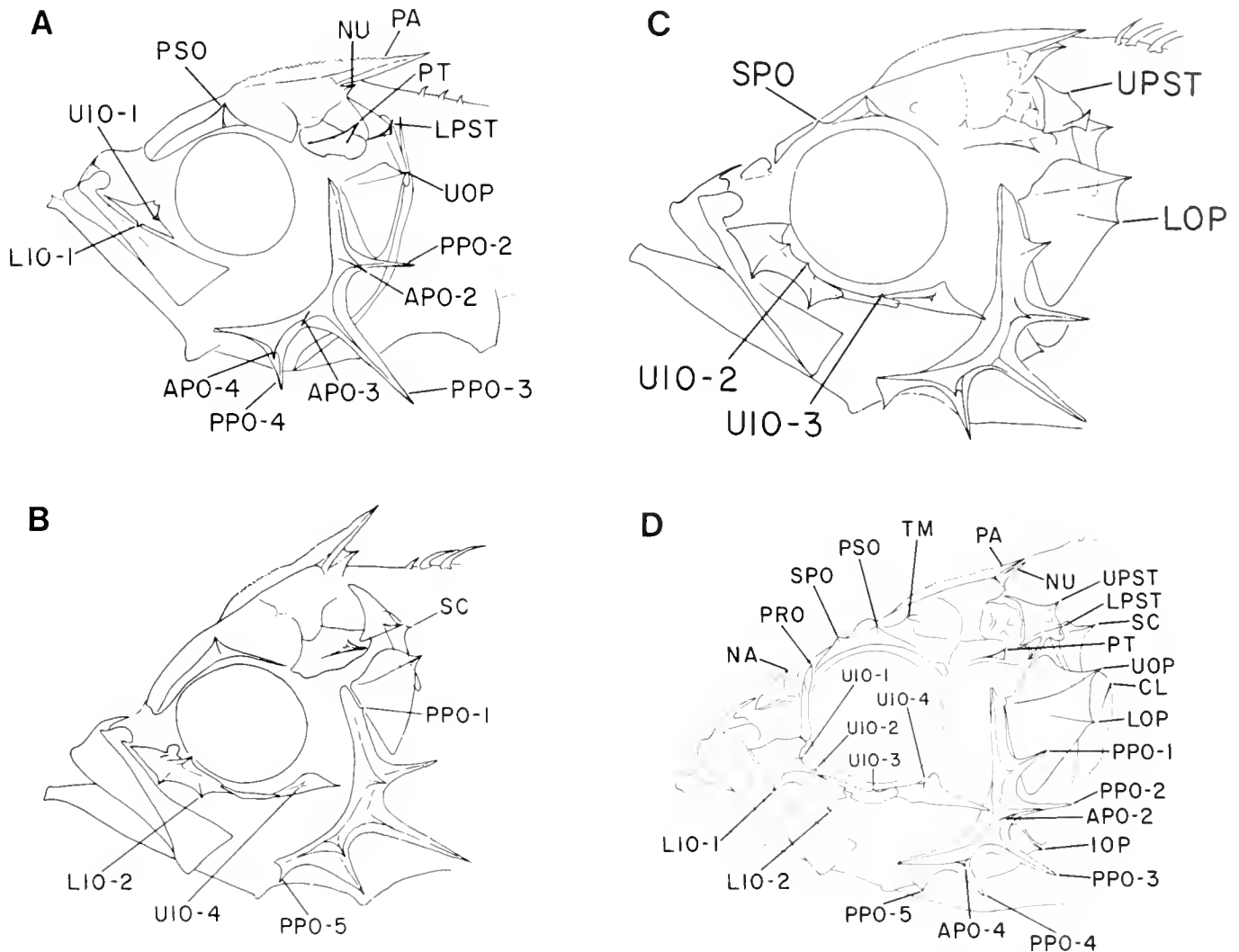

Fig. 220. Head spines in 6.2 mm (A), 8.2 mm (B), 10.0 mm (C) and 16.0 mm (D) stained larvae of *Sebastes melanostomus*. Abbreviations of head spines: APO-2, 2nd anterior preopercular; APO-3, 3rd anterior preopercular; APO-4, 4th anterior preopercular; CL, cleithral; IOP, interopercular; LIO-1, 1st lower infraorbital; LIO-2, 2nd lower infraorbital; LOP, lower opercular; LPST, lower posttemporal; NA, nasal; NU, nuchal; PA, parietal; PPO-1, 1st posterior preopercular; PPO-2, 2nd posterior preopercular; PPO-3, 3rd posterior preopercular; PPO-4, 4th posterior preopercular; PPO-5, 5th posterior preopercular; PRO, preocular; PSO, postocular; PT, pterotic; SC, supracleithral; SPO, supraocular; TM, tympanic; UIO-1, 1st upper infraorbital; UIO-2, 2nd upper infraorbital; UIO-3, 3rd upper infraorbital; UIO-4, 4th upper infraorbital; UOP, upper opercular; UPST, upper posttemporal. From Moser and Ahlstrom, 1978.

structures concentrated along the dorsal and ventral margins. Notochord flexion occurs at about 6–12 mm and transformation at 15–25 mm (Table 107). Many species have a distinct pelagic juvenile stage which can reach almost 60 mm body length.

Preflexion larvae have a slender body (body depth 13–23% of body length) and compact gut; snout–anus distance increases from about 40–50% of body length to over 60% in some species during the larval period. The caudal and pectoral fins begin forming first, followed by the pelvics and then the dorsal and anal fins. The pectoral fins range from short and rounded to elongate and fan-shaped, reaching almost 50% of body length in *S. levis* (Fig. 221). The pectoral fin base is shallow (typically 7–13% of body length) in comparison with other subfamilies. Ossification of skeletal elements begins early in the larval period

and proceeds rapidly as in other scorpaenoids; vertebral ossification follows the pattern of other scorpaeniforms, with the neural arches ossifying before the centra (Moser, 1972).

Pigmentation in newborn larvae consists of a melanistic sheath over the gut and a postanal series along the ventral midline. Some species also have a dorsal midline series which may develop gradually. Pigment increases with development, appearing on the head (above brain, on jaws and opercular region), fins, and caudal peduncle. Often the pectoral fins (both base and blade) have diagnostic pigment patterns. Several of the western Pacific species are heavily pigmented with the head and body covered by a sheath of melanophores (Fig. 221).

Head spines are a prominent feature of all *Sebastes* larvae. Pterotics, parietals (usually serrated), and preopercular spines

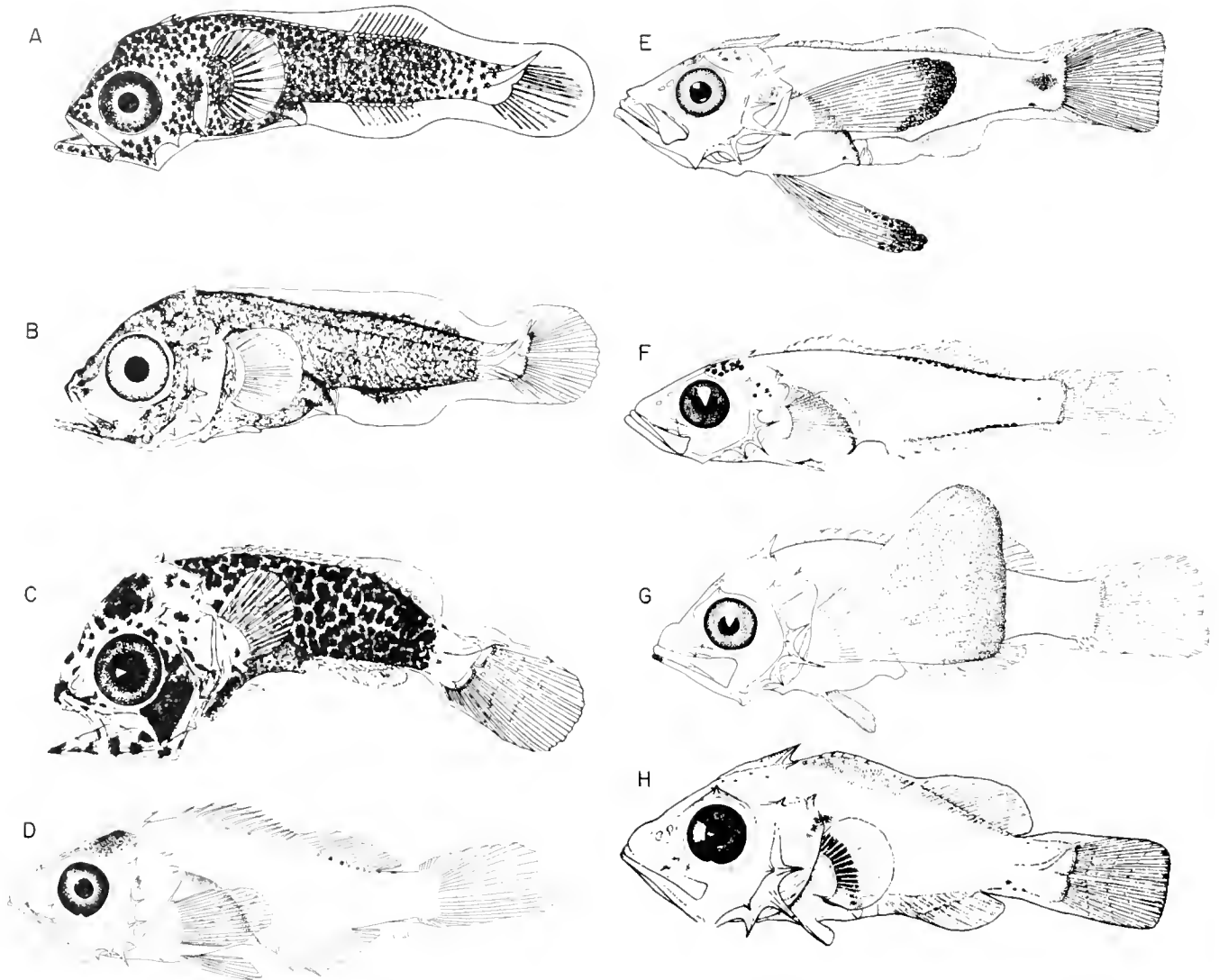

Fig. 221. Larvae of Scorpaenidae. (A) *Sebastes oblongus*, 8.5 mm TL (from Fujita, 1958); (B) *S. longispinis*, 7.1 mm TL (from Takai and Fukunaga, 1971); (C) *S. hubbsi*, 6.0 mm TL (from Uchida et al., 1958); (D) *S. zacentrus*, 12.7 mm SL (from Laroche and Richardson, 1981); (E) *S. paucispinis*, 10.5 mm SL (from Moser et al., 1977); (F) *S. jordani*, 15.5 mm SL (ibid.); (G) *S. levis*, 10.4 mm SL (ibid.); (H) *Helicolenus dactylopterus*, 10.0 mm (from Täning, 1961).

form during the preflexion period in most species, and other spines appear gradually thereafter (Fig. 220). Although there is variation in larval spine complements (Moser and Ahlstrom, 1978; Moser and Butler, 1981; Richardson and Laroche, 1979; Laroche and Richardson, 1980, 1981), it is apparent that 1) the adult head spine complement develops during the larval period and 2) certain spines develop during the larval period but are not present in adults. Of the latter, the most prominent are the pterotic, anterior preoperculars, lower posttemporal, and upper infraorbitals.¹ The fact that these spines do occur in adults of other subfamilies is of possible phylogenetic significance (Moser and Ahlstrom, 1978).

Helicolenus is viviparous, the fertilized eggs developing in a gelatinous matrix within the ovary (Graham, 1939; Krefft, 1961). Larvae of *H. dactylopterus* have been described; hatching and birth occur at a smaller size (2.2 mm) than in *Sebastes*, although sizes at notochord flexion and transformation are similar (Table 107). Larvae are moderately deep-bodied (Fig. 221); body depth averages 29%, 33%, and 49% of body length for preflexion, flexion and postflexion stages. Head and gut shape are similar to that of *Sebastes*. The pectoral fin is moderate in size and rounded; the base is slightly deeper than in most species of *Sebastes*. Sequence of fin formation is similar to that of *Sebastes*. A mass of spongy tissue develops anteriorly in the dorsal finfold in preflexion larvae and persists through most of the larval period; the structure is apparently unique. The early pigment pattern consists of a dorsolateral gut sheath, melanophores above the brain, on the lower jaw, in a short median ventral series just

¹ Upper infraorbitals are present in adults of a few species of *Sebastes*.

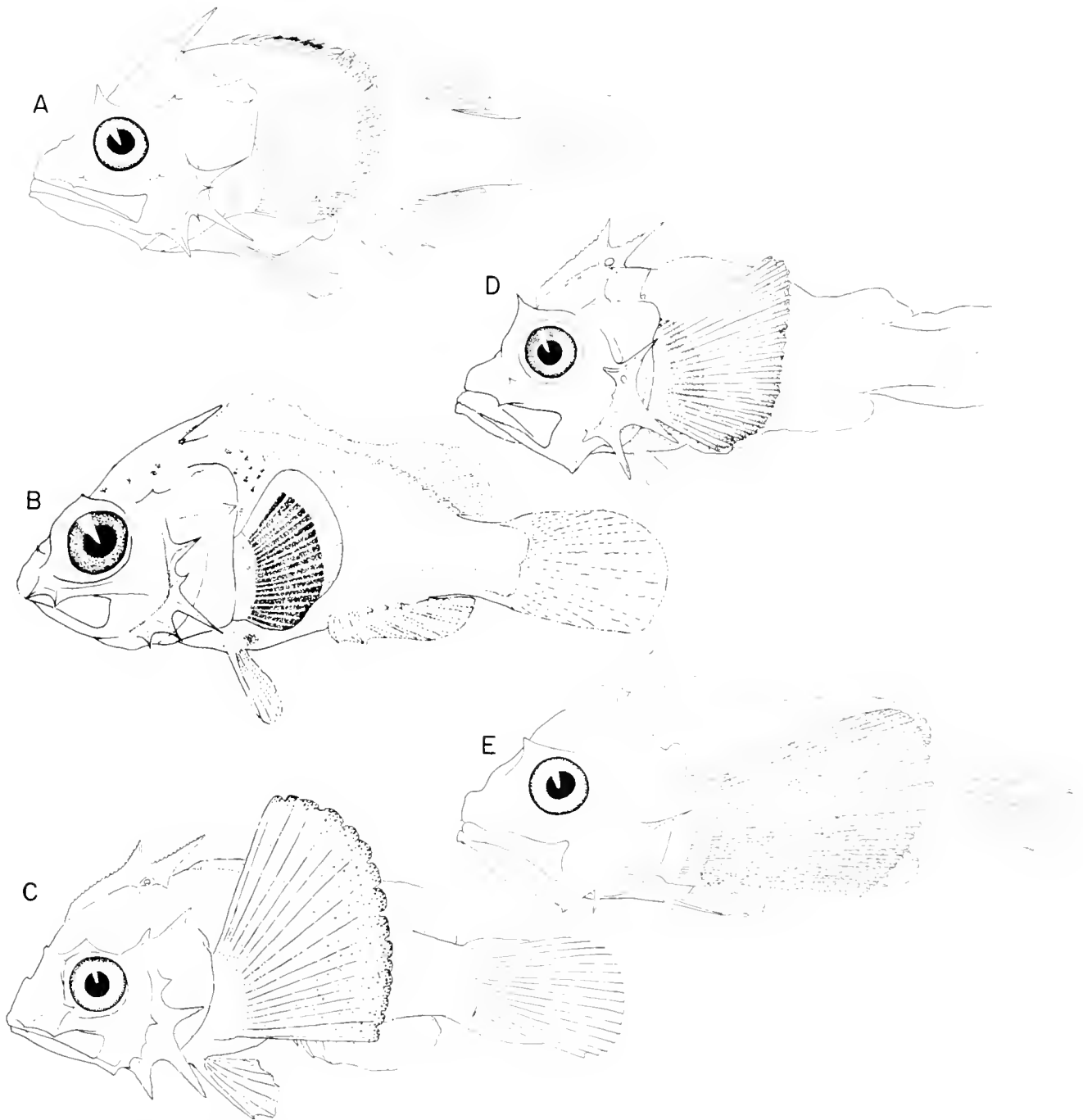

Fig. 222. Larvae of Scorpaenidae. (A) *Pontinus* Type A, 8.0 mm SL (from Moser et al., 1977); (B) *Scorpaena* Type A, 8.0 mm SL (ibid.); (C) *Scorpaenodes xyris*, 6.2 mm SL (ibid.); (D) *Sebastolobus* sp. 7.7 mm SL (ibid.); (E) *Ectreprosebastes imus*, 6.7 mm SL (ibid.).

anterior to the caudal fin, and on the distal and proximal regions of the pectoral fin blade (Fig. 221). Head spine formation is similar to that of *Sebastes* species which have full larval complements, except that spines are lacking on the 2nd infraorbital bone and the cleithrum.

Scorpaeninae.—Larval stages are known for only 3 of the 15 genera in this subfamily; a total of 8 species (or generic types)

out of about 150 have been described (Table 107; see Sparta, 1956b and Moser et al., 1977, for major reviews). Hatching occurs at about 2.0 mm or less; newly-hatched larvae have a large elliptical yolk sac, unpigmented eyes, pectoral fin buds, and lack a mouth. The finfold is inflated and, along with the body skin, forms a balloon-like envelope that is attached principally at the snout and pectoral regions (Orton, 1955d). Cell-like granulations cover the entire envelope but are concentrated

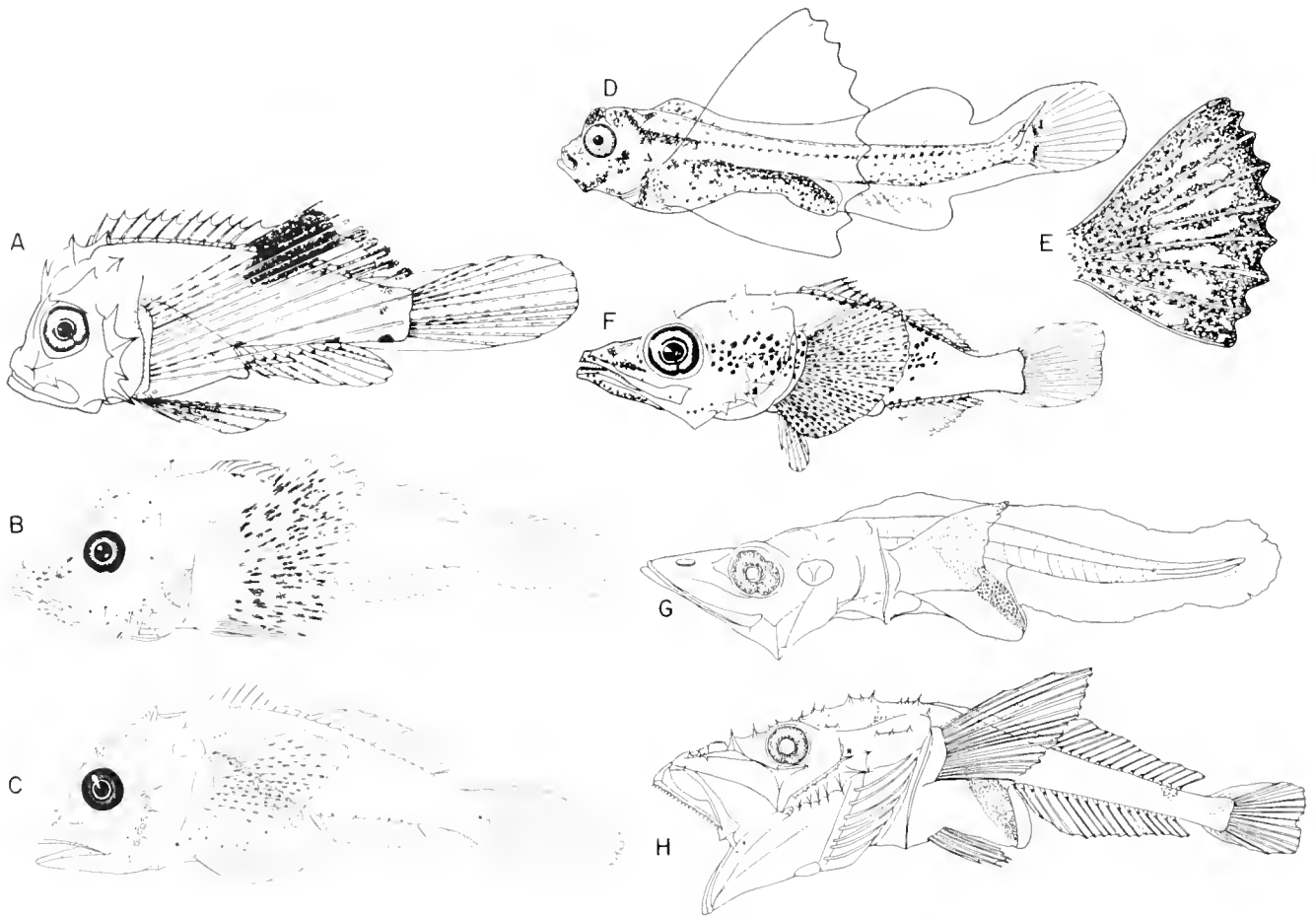

Fig. 223. Larvae of Minoine (A), Triglidae (B, C), Congiopodidae (D, E), Platycephalidae (F), Hoplichthyidae (G, H). (A) *Minous* sp.?, 6.4 mm SL (from Leis and Rennis, 1983); (B) *Prionotus* sp., 6.4 mm SL (original); (C) *Prionotus stephanophrys*, 8.8 mm SL (CalCOFI 7510 sta. 117.70); (D) *Congiopodus spinifer*, 10.8 mm SL (from Brownell, 1979); (E) Detail of pectoral fin of *Congiopodus spinifer* (ibid.); (F) Platycephalidae, unidentified, 6.2 mm SL (from Leis and Rennis, 1983); (G) *Hoplichthys* sp., 7.1 mm SL (original, courtesy M. Okiyama); (H) *Hoplichthys* sp. 17.2 mm SL (ibid.).

at the median edges of the finfold. Flexion occurs at a small size (4–6 mm) as does transformation (10–17 mm). Larvae are relatively deep-bodied during preflexion and flexion and more so during postflexion, when body depth averages 38–40% of body length for the genera listed in Table 107. The gut is compact and the head becomes massive. Snout–anus length increases from 46–50% of body length in preflexion larvae to 61–67% in postflexion larvae. The snout has a steep profile (Fig. 222).

The pectoral fins are well developed and deep-based; fin base depth is 13–15% of body length in preflexion larvae and 14–18% in flexion and postflexion larvae. They are fan-shaped and enlarged in *Scorpaenodes*; fin length attains 41% of body length during the postflexion stage. They are smaller but distinctively shaped in *Scorpaena* (fan-shaped with scalloped margin) and *Pontinus* (slightly wing-shaped). Ossification of fin rays, as well

as skeletal elements, occurs in early larvae (4–5 mm). The caudal, pectoral, and pelvic rays begin ossifying almost simultaneously, followed immediately by the dorsal and anal fins.

Preflexion larvae have a postanal ventral midline series of melanophores ranging in number from 2–7 in *Scorpaena guttata* to 12–18 in *Scorpaenodes xyris*. The most prominent pigment is on the pectoral fins; typical patterns are a concentration at the distal margin (*Scorpaenodes*, some *Pontinus*, some *Scorpaena* spp.), a solid covering over most of the fin (some *Scorpaena* spp.), or a diagonal bar (some *Pontinus* spp.). A melanistic sheath develops over the dorsal surface of the gut and gas bladder in most species of *Scorpaena*, whereas in *Scorpaenodes* and *Pontinus* only the gas bladder is pigmented. Other pigment in *Scorpaena* forms at the cleithral juncture and above the brain (Fig. 222).

Fig. 224. Larvae of the *Oxylebus* scorpaeniform group (A, B) and the hexagrammid group (C–F) of Washington and Richardson (MS) (see Washington et al., this volume). (A) *Oxylebus pictus*, 8.5 mm SL (from Kendall and Vinter, 1984); (B) *Zaniolepis* sp., 7.7 mm SL (ibid.); (C) *Hexagrammos octogrammus*, 15.2 mm SL (ibid.); (D) *Pleurogrammus monoptygius*, 20.5 mm SL (ibid.); (E) *Ophiodon elongatus*, 15.4 mm SL (ibid.); (F) *Anoplopoma fimbria*, 13.8 mm SL (Ahlstrom and Stevens, 1976).

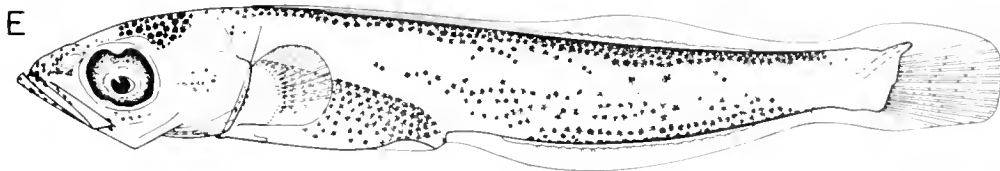
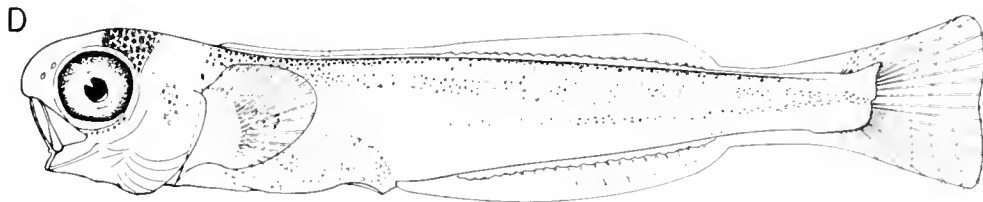
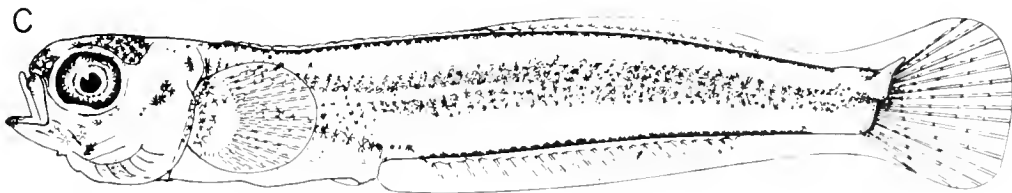
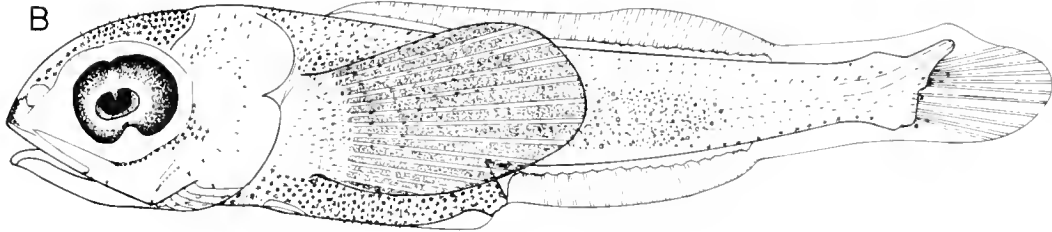
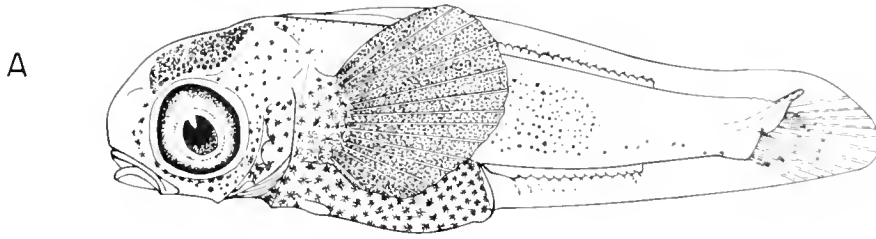

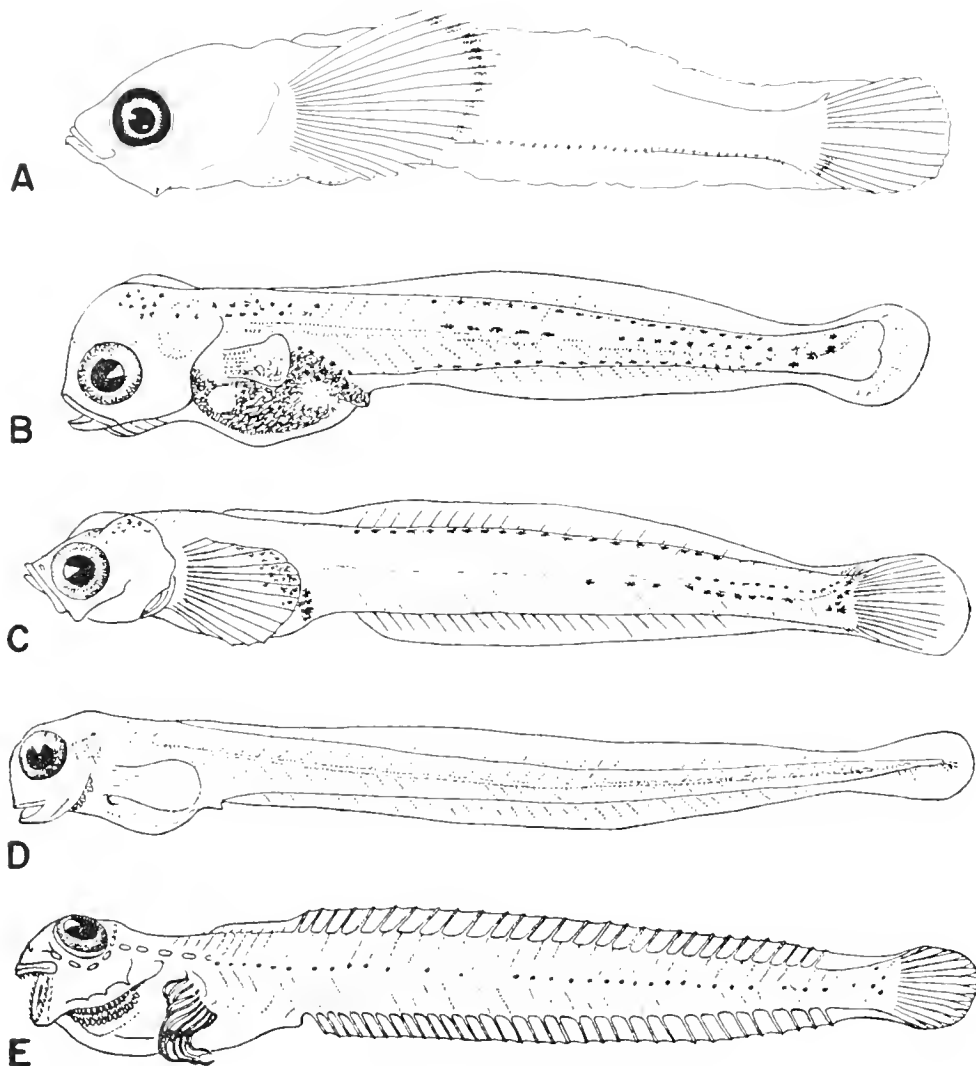

Fig. 225. Larvae of Normanichthyidae (A), Cottocomephoridae (B, C), Comephoridae (D, E). (A) *Normanichthys crockeri*, 8.5 mm SL (original); (B) *Cottocomephorus grewingki*, 7.4 mm (from Taliev, 1955); (C) *Cottocomephorus inermis*, 11.2 mm (ibid.); (D) *Comephorus baicalensis*, 6.9 mm (ibid.); (E) *Comephorus baicalensis*, 21.3 mm (ibid.).

Cranial spine development is similar to that in sebastines. The pterotic, parietal, postocular (supraocular crest), posterior preoperculars (2nd, 3rd, and 4th) anterior preoperculars (2nd and 4th) and lower posttemporal develop during the preflexion period. The lower infraorbital (1st), upper infraorbitals (1st and 4th), posterior preoperculars (1st and 5th), nuchal, supraclithral, cleithral, upper opercular, and lower opercular spines appear during postflexion. Late in the postflexion stage the lower infraorbital (2nd), nasal, preocular, and supraocular spines appear. Spines which do not develop in scorpaenine larvae but are present in adults of most genera are the upper infraorbitals (2nd and 3rd), upper posttemporal, tympanic, and sphenotic. In *Scorpaenodes* the nuchal spine develops during the preflexion period and exceeds the parietal spine in length, giving the parietal ridge a bifurcate appearance. In other scorpaenines and all other scorpaenids except *Sebastolobus*, the nuchal develops late and is excluded from the parietal ridge.

Pteroinae.—Early preflexion larvae have been described for *Pterois lunulata* and *Dendrochirus brachypterus* (Table 107). Newly-hatched larvae are small (1.1–1.6 mm) and similar in morphology to those of Scorpaeninae. The pectoral fins are large and fan-shaped with pigment at the distal margin. Postanal pigment in *Pterois* consists of ventral and dorsal midline series. In *Dendrochirus* this pigment coalesces to form a band.

Sebastolobinae.—Life history series have been described for *Sebastolobus alascanus* and *S. altivelis* (Moser, 1974). Larvae are 2.6 mm at hatching, 6.0–7.3 mm at notochord flexion, and 14–20 mm at transformation. The distinctive pelagic juveniles (up to 56 mm in *S. altivelis*) have a prolonged midwater existence before settling to the deep shelf and slope habitat of the adults. Larval morphology is similar to that of scorpaenines. The pectoral fins are large, deep-based, and fan-shaped (Fig. 222); their rays are the first to ossify, followed by the caudal rays and then

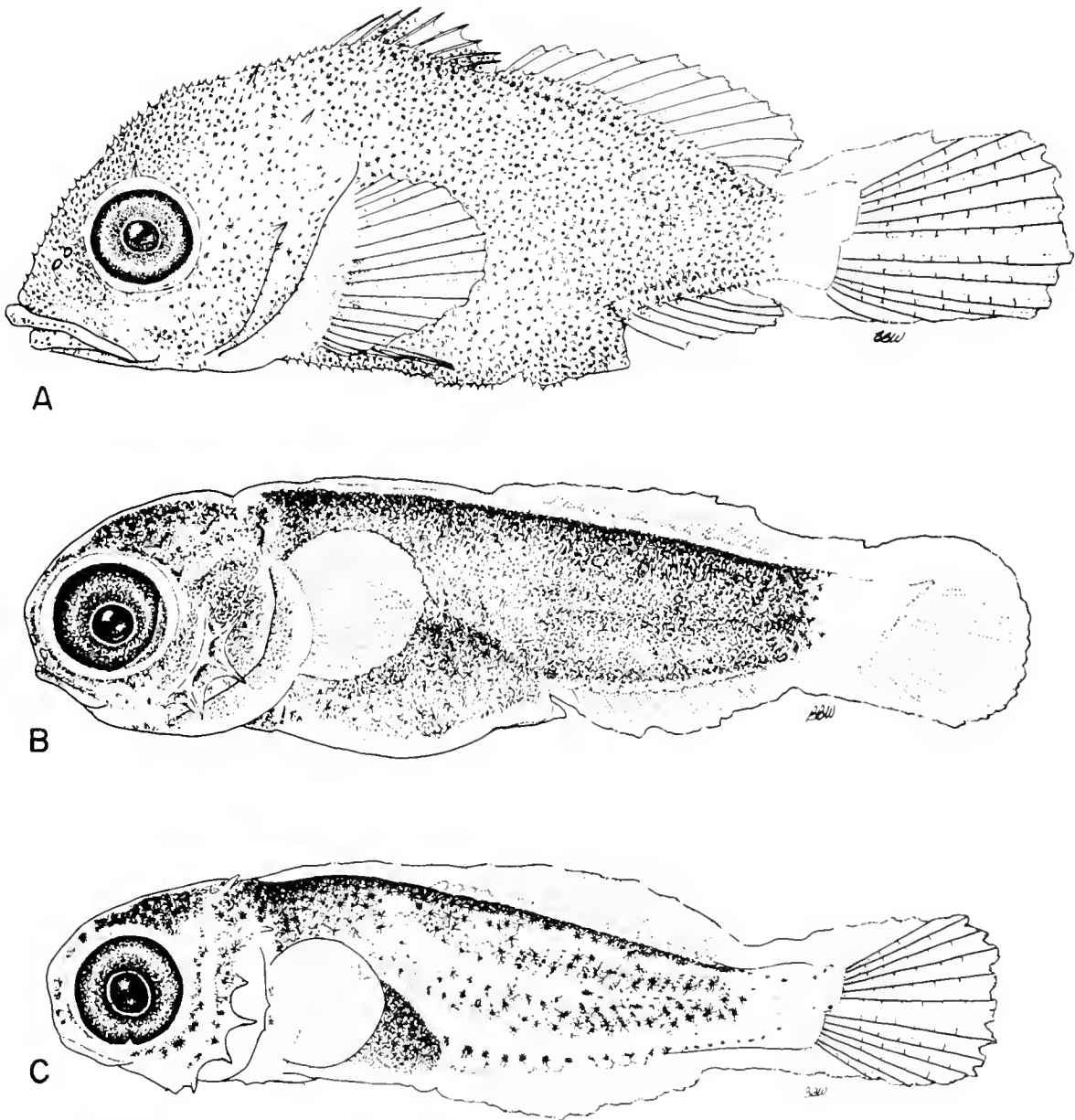
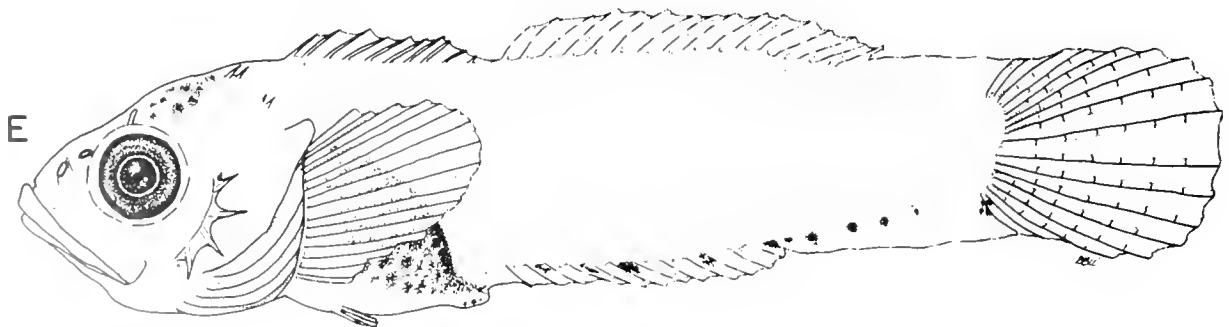
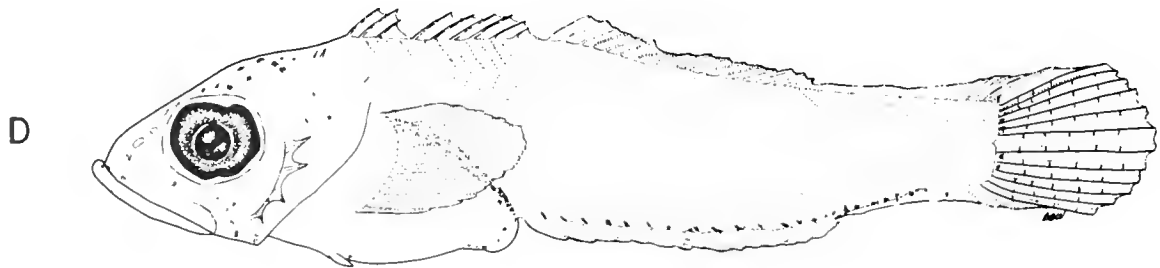
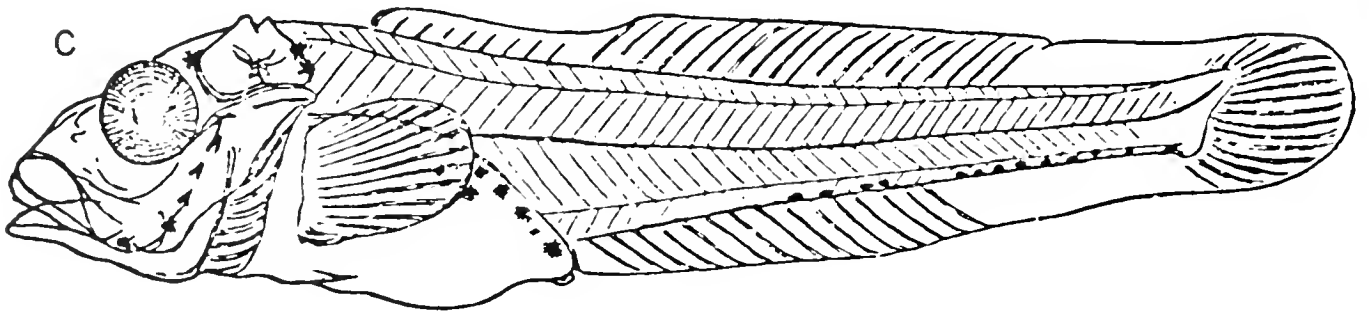
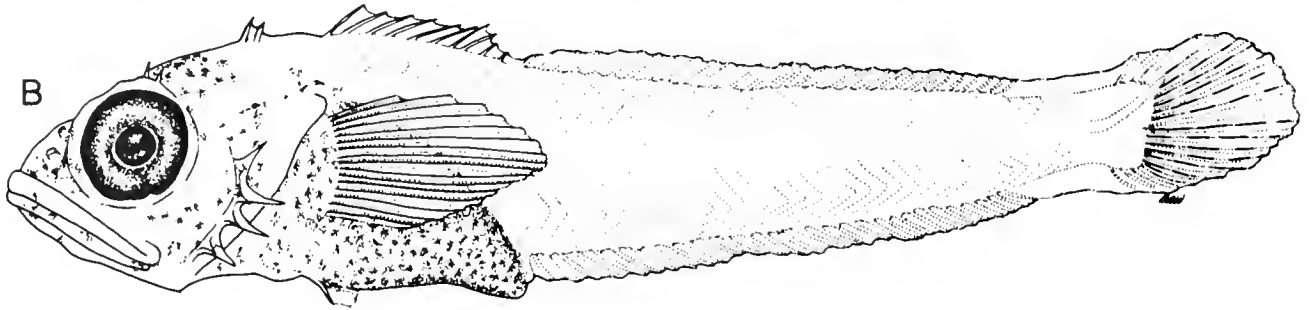
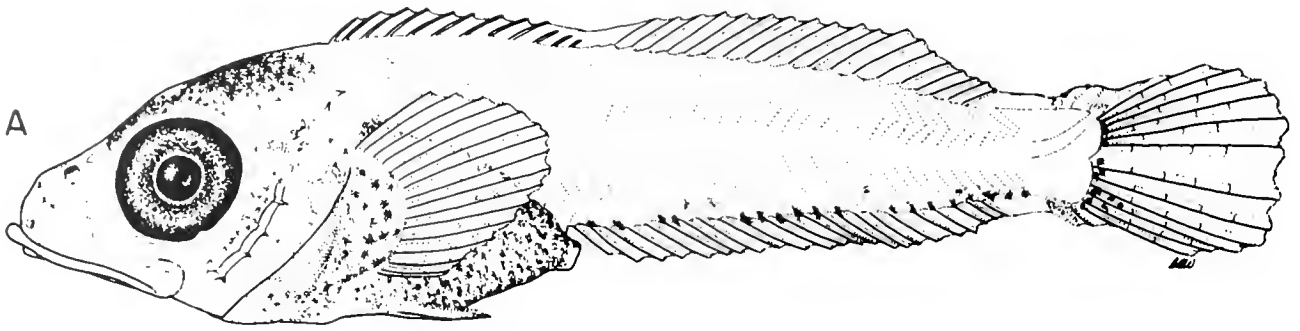

Fig. 226. Larvae of the *Rhamphocottus* group (A) and the *Scorpaenichthys* group (B, C) of cottids of Washington and Richardson (MS) (see Washington et al., this volume). (A) *Rhamphocottus richardsoni*, 10.6 mm SL (from Richardson and Washington, 1980); (B) *Scorpaenichthys marmoratus*, 8.7 mm SL (ibid.); (C) *Hemilepidotus spinosus*, 11.0 mm SL (ibid.).

those of the other fins. The pectoral fins are pigmented at the distal margin; other pigment includes a sheath over the gut and melanophores above the brain. Head spination is highly developed (Fig. 222); the sequence of development is similar to that of scorpaenines. In addition to the spine complement of scorpaenines, *Sebastolobus* larvae develop the 2nd and 3rd upper infraorbital spines and the 1st anterior preopercular spine.

Setarchinae. — Larvae are known for *Ectreposebastes imus* (Moser et al., 1977). Hatching and notochord flexion occur at a small size as in the scorpaenines; however, postflexion larvae attain a large size (Table 107). Larvae have the deepest body of known

scorpaenids; body depth reaches 55% of body length in late postflexion stage. The gut is compact with an elongate terminal section; snout–anus distance averages 53% of body length in preflexion larvae and 76% in postflexion. The pectoral fins are deep-based, fan-shaped, and large, extending to the caudal peduncle (Fig. 222). Fin base depth and fin length reach 22% and 57% of the body length respectively. The pigment pattern consists of a postanal ventral series of 11–14 melanophores (not present after 4.0 mm), a blotch above the gas bladder, and an almost solid sheath over the pectoral fin, which recedes distally with development. Head spine development is similar to that of scorpaenines.



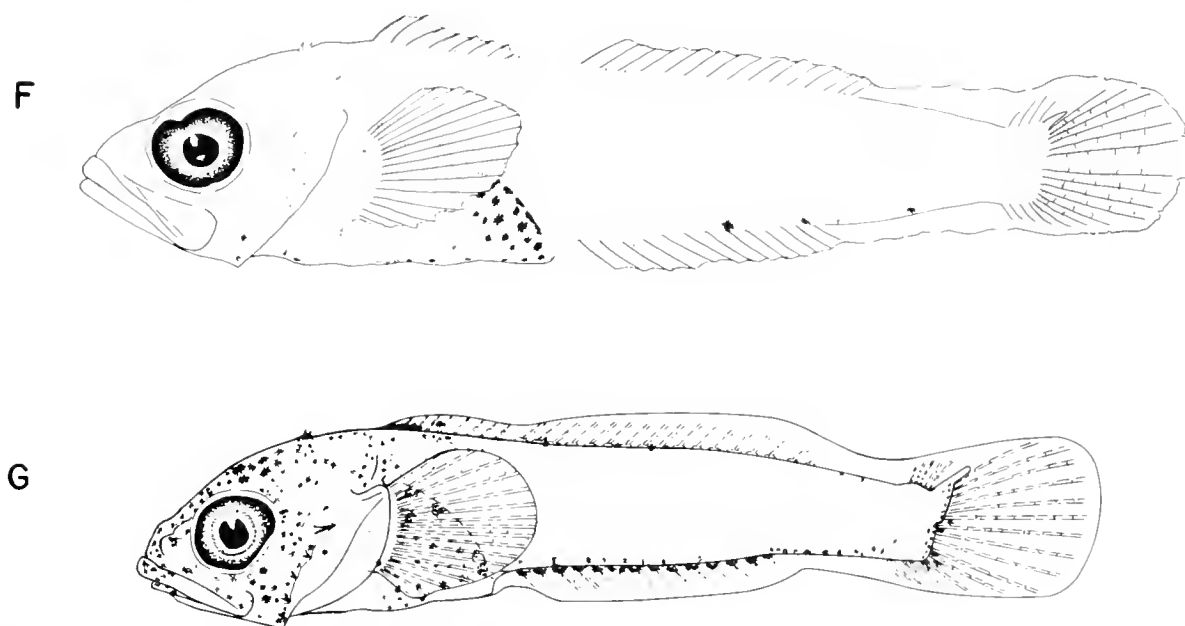

Fig. 227. Larvae of the *Myoxocephalus* group of cottids of Washington and Richardson (MS) (see Washington et al., this volume). (A) *Paricelinus hopliticus*, 13.8 mm SL (from Richardson and Washington, 1980); (B) *Triglops* sp., 15.4 mm SL (ibid.); (C) *Icelus bicornis*, 25 mm (from Ehrenbaum, 1905–1909); (D) *Chitonotus pugetensis*, 11.5 mm SL (from Richardson and Washington, 1980); (E) *Artedius meanyi*, 13.8 mm SL (ibid., as *Icelinus* sp.); (F) *Icelinus* sp., 11.9 mm SL (original); (G) *Ascelichthys rhodorus*, 11.0 mm SL (from Matarese and Marliave, 1982).

Choridactylinae.—The developmental stages of *Inimicus japonicus* have been described by Fujita and Nakahara (1955) and Sha et al. (1981). Larvae are 3.2 mm at hatching, 6.4–8.2 mm at flexion and about 10 mm at transformation. Yolk-sac larvae are similar to those of Scorpaeninae. Larvae are relatively slender and blunt-headed, with a compact short gut (Fig. 223). The pectoral fins are large and fan-shaped, with a scalloped margin; they develop a series of large blotches distally. One to several large postanal melanistic blotches form on the postanal ventral midline and the gas bladder region is pigmented. Sha et al. (1981) show the larvae to be heavily xanthic.

Minoinae.—Leis and Rennis (1983) described a larval series tentatively identified as *Minous* sp. It is generally similar in morphology and pigmentation to *Inimicus*; however, the pectoral fin is relatively larger and has a different pigment pattern.

Triglidae (Fig. 223).—Eggs are only known for 3 of the 8 genera of triglids. The new world genus *Prionotus* has multiple oil globules whereas single oil globules are known for *Chelidonichthys* and *Lepidotrigla*. Larvae are poorly known with complete series having been described for 4 species in 3 genera (Table 107). There are approximately 90 species in this family and many are very difficult to identify as adults. The genus *Lepidotrigla* has 40+ species and is poorly known in many areas. Diagnostic features include the depressed profile of the head and large pectoral fins of which the lowest three rays become detached during transformation. Meristics are very similar to platycephalids and caution is advised. However, most triglids have fewer pectoral rays than most scorpaenoids. *Prionotus*, including *Bellator*, has 13 to 15 plus 3 free rays; *Trigla*, *Chelidonichthys*, *Lepidotrigla*, and *Uradia* have 11 plus 3 free rays; and *Pterygotrigla* and *Parapterygotrigla* have 11 to 13 plus 3.

Peristediidae.—ELH information has been published only for *Peristedion cataphractum* of the eastern Atlantic (Table 107). Larvae and transforming juveniles have elongated upper pectoral rays and strong head spination (see plate 40 in Padoa, 1956e). This family is often combined with the Triglidae, but differs in many characters such as the presence of barbels, 2 rather than 3 free pectoral rays, and the body is encased in bony scutes rather than scales. Three genera (*Heminodus*, *Paraheminodus* and *Gargariscus*) have jaw teeth and two genera (*Peristedion* and *Satyrichthys*) lack jaw teeth. There are about 25 species found in the tropics of all oceans in deep water (>200 m).

Congiopodidae (Fig. 223).—Eggs are known for only 1 (*Congiopodus*) of the 4 genera of Congiopodidae (Brownell, 1978; Gilchrist, 1904; Robertson, 1974). The pelagic eggs are relatively large (1.7–2.18 mm) and spherical, with a narrow perivitelline space and no oil globules. The egg surface is covered with striations. Early life history stages have been illustrated for one species, *Congiopodus spinifer* (Brownell, 1979; Gilchrist and Hunter, 1919). Robertson (1975a), illustrated a well-developed embryo of *C. leucopaecilus*. Larvae hatch at about 5 to 6 mm NL and are elongate with long guts reaching 50% SL. The pectoral fins are extremely large and fan-shaped. Melanistic pigment is present on the head, nape and on the dorsal and ventral surface of the gut. Two large blotches of pigment on the dorsal and ventral midlines form a band midway between the vent and tail tip. The large pectoral fins have a distal band of pigment which gradually expands over the entire fin with development. Larvae develop large postocular and parietal spines. The presence of preopercular spines can not be determined from the description by Brownell (1975).

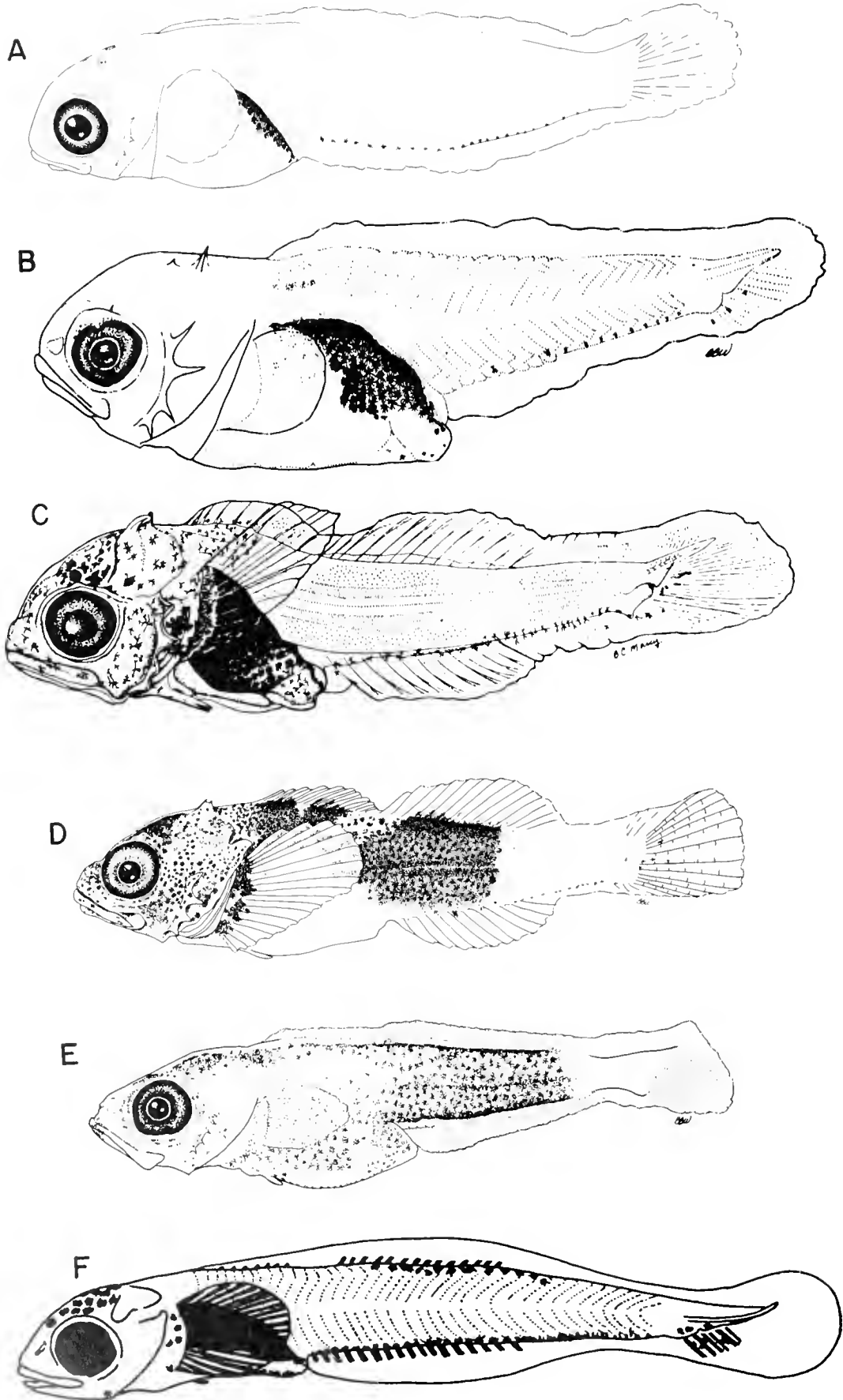

Platycephalidae (Fig. 223).—Platycephalids spawn small spherical eggs (<1 mm) with a single oil globule (Chang et al., 1980; Uchida et al., 1958). Larvae have been described and illustrated for *Platycephalus indicus* (Ueno and Fujita, 1958) and for a series of larvae incorporating seven unidentified species (Leis and Rennis, 1983). Newly-hatched platycephalids are relatively small (1.7–2.3 mm) and slender-bodied, with unformed mouths, unpigmented eyes, and large yolk sacs. By the time of yolk absorption larvae have large heads and deep bodies which taper toward the tail. The gut is quite long reaching $\frac{2}{3}$ SL during development. The pointed snout becomes distinctively long and flattened. Pigmentation is usually present on the head, jaws, ventral surface of the gut and along the postanal ventral midline. Pigment may also be present on the dorsolateral surface of the tail and pectoral fin. Larvae develop 4 to 9 preopercular spines. Other head spines include: supraocular, supracleithral, parietal and pterotic. Unlike most other scorpaeniforms, head spines persist and become more pronounced in juveniles. Fin development proceeds as follows: pectoral, caudal, dorsal, anal and pelvic.

Hoplichthyidae (Fig. 223).—The pelagic eggs of *Hoplichthys haswelli* are described by Robertson (1975a) as small and spherical with a smooth surface. A single oil globule is present. Descriptions of hoplichthyid larvae have not been published; however, based on Okiyama (in prep.) larvae are quite similar to platycephalids. Preflexion larvae (3.2 mm) are elongate with large heads and pointed snouts. The gut is moderately long (>50% SL) and the early-developing pectoral fins are large and fan-shaped. The snout becomes increasingly long and depressed during development. Pigmentation is limited to the gut, distal tip of the pectoral fin and a band on the ventral finfold midway between the vent and notochord tip. Numerous clusters of small spines develop in the supraocular, parietal and pterotic regions. Seven spines form on the posterior margin of the preopercle with smaller spines at their base. As in platycephalids, head spines persist in juveniles.

Dactylopteridae (Fig. 233).—The pelagic eggs are small (0.8 mm) and slightly ovoid with a single oil globule. The egg surface is smooth and unsculptured. Larvae hatch at about 1.8 mm and undergo flexion of the notochord between 3.9–6.5 mm. Transformation to the juvenile form occurs at about 9 mm. Larvae are moderately deep-bodied with a distinctively blunt snout and small mouth. The gut is long, reaching about 75% SL in postflexion larvae. Pigmentation occurs over the head, gut, along the postanal ventral midline and around notochord tip. Pigmentation increases dramatically over most of the body in postflexion larvae. The distinctive head armature is quite different from all known scorpaeniform larvae and is present in larvae as small as 2.3 mm NL. A small supraoccipital spine is present only during the larval period. The extremely long posttemporal and preopercular spine extend posteriorly to the middle of the anal fin in larvae by about 6.5 mm and persist in juveniles and adults.

COTTOIDEI

Eggs

Eggs are known from representatives of six of the nine cottoid families recognized here (Table 107). Where known, most cottoids spawn demersal, adhesive eggs which often form clusters found under rocks. Eggs are frequently brightly colored, e.g., red, blue, green, yellow. The eggs of *Anoplopoma fimbria* are pelagic. The Comephoridae of Lake Baikal are reported to be viviparous.

Most eggs are spherical and average 1–2 mm in diameter, although eggs as large as 4 mm have been reported in the cottid *Hemitripterus* and some of the cottocomephorids. A single large oil globule, frequently accompanied by several small ones, occurs in many species. The surface of the eggs is often covered by a tough adhesive membrane, and may be smooth as in *Anoplopoma* and *Myoxocephalus aeneus* (Fahay, 1983) or covered by tiny, radiating canals as in *Artemius lateralis* and *Clinocottus analis* (Budd, 1940).

Larvae

At least one larval stage is known for 88 of the 329+ species and for 46 of the 104 genera of cottoids. Major overviews of larval cottoid taxonomy include: Richardson and Washington (1980) on cottids; Kendall and Vinter (1984) on hexagrammids; Taliev (1955) and Chernyayev (1971, 1975, 1978, 1981) on comephorids and cottocomephorids; and, forthcoming Laroche (in prep.) on agonids.

Larval cottoids exhibit a broad diversity of form. Size at hatching varies from 2 to 12 mm. Planktonic life may be quite brief, several weeks in many cottoids, or may be extended up to a year with a special pelagic juvenile stage as in the hexagrammids.

Cottoid larvae exhibit such a diversity of form and development that it is impossible to characterize a generalized "cottoid" larva.

Hexagrammidae (Fig. 224).—Larvae are known for 10 of the 11 species of the hexagrammid genera *Hexagrammos*, *Pleurogrammus*, and *Ophiodon*. Major works presenting descriptions and illustrations include Kendall and Vinter (1984) and Gorbunova (1964b). Hexagrammids hatch at a relatively large size (6–11 mm NL). Development is gradual from hatching to the juvenile stage with a prolonged epipelagic prejuvenile period (~30–50 mm SL). Larvae have elongate, slender bodies with large eyes. Larval *Hexagrammos* and *Pleurogrammus* have blunt heads, while *Ophiodon* larvae have pointed snouts and large terminal mouths.

Larvae are heavily pigmented especially dorsally. Melanophores are scattered over the head, gut and usually on the dorsal and ventral midlines. The extent of postanal, ventral midline and lateral pigmentation is useful in specific identification.

Fin formation proceeds in the following sequence: caudal, pectoral, second dorsal and anal, first dorsal and pelvic. Larvae exhibit delayed ossification. Vertebral ossification in hexagram-

Fig. 228. Larvae of the *Myoxocephalus* cottid group of Washington and Richardson (MS) (see Washington et al., this volume). (A) *Orthonopias triacis*, 7.0 mm SL (original); (B) *Enophrys bison*, 7.0 mm SL (from Richardson and Washington, 1980); (C) *Myoxocephalus aeneus*, 7.0 mm SL (from Lund and Macey, 1975); (D) *Myoxocephalus polyacanthocephalus*, 12.0 mm SL (from Richardson, 1981a); (E) *Radulinus asprellus*, 10.9 mm SL (from Richardson and Washington, 1980); (F) *Gymnocanthus tricuspis*, 13.0 mm (from Khan, 1972).

mids (and *Anoplopoma*) is similar to that in Scorpaenoidei with the neural and hemal arches ossifying before the associated vertebral centra. Vertebral counts are notably high (47–63). Head spines are absent in larval *Hexagrammos* and *Pleurogrammus* and extremely reduced in *Ophiodon*, with late-stage larvae developing 4 tiny preopercular spines.

Anoplopomatidae (Fig. 224, Table 107).—Larvae of only *Anoplopoma* have been described and illustrated by Kobayashi (1957) and Ahlstrom and Stevens (1976). Early development of *Anoplopoma* is similar to that of the hexagrammids. Larvae hatch at a large size (~9 mm NL) and development is gradual without great changes in form.

Larvae are slender and elongate with pointed snouts and long guts. The distinctive pectoral fins with heavy distal pigmentation are exceptionally large reaching nearly 33% SL late in the larval period. Larvae are heavily pigmented with melanophores over most of the head, gut and lateral surface of the body.

As in hexagrammid larvae, ossification is delayed with the neural and hemal arches ossifying before the associated vertebral centra. Vertebral counts (61–66) are distinctively high. Pectoral fin development is precocious. Head and preopercular spines are absent.

Oxylebius-Zaniolepis (Fig. 224).—*Oxylebius* and *Zaniolepis* are sometimes included in the Hexagrammidae, but are herein treated separately because of the distinctiveness of their larvae from hexagrammids (Washington and Richardson, MS; Kendall and Vinter, 1984). Larvae of *Oxylebius pictus* and *Zaniolepis* sp. are illustrated and described by Kendall and Vinter (1984). Larvae hatch at a small size (2.5–5 mm NL), undergo notochord flexion between 6 and 9 mm NL, and transform to a benthic juvenile at about 15 mm SL.

Oxylebius and *Zaniolepis* are relatively short and deep-bodied with large, bulging guts and rounded snouts. Pectoral fins develop early and are distinctively large and fan-shaped. Pigmentation is heavy over the anterior half of the body in preflexion larvae and increases over the postanal lateral body with development. *Zaniolepis* possesses characteristic snout pigment which is absent in *Oxylebius*. The pectoral fins of both species are densely pigmented.

Head spination is well-developed with preopercular (5 spines in *Oxylebius*; 6–7 in *Zaniolepis*), posttemporal and supracleithral spines present. *Zaniolepis* larvae develop distinctive pricklescales over most of the body by about 7 mm.

Normanichthyidae (Fig. 225).—Larvae of the monotypic *Normanichthys crockeri* are illustrated and described by Balbontin and Perez (1980). Hatching occurs at a small size (4.4 mm NL) and flexion of the notochord occurs at 7 to 9 mm. Development from hatching to the juvenile stage is gradual without great change.

Larvae are elongate and slender with short, coiled guts and distinctive large pectoral fins. Pigmentation is restricted to the

pectoral fins and the ventral midline extending from the isthmus to the tail. In small larvae several large melanophores are present on the dorsal midline.

Distinctive features of larval development include: the absence of head and preopercular spines, delayed ossification, early development of the pectoral fin, and presence of only 5 branchiostegal rays.

Comephoridae (Fig. 225).—The endemic comephorids of Lake Baikal in Russia are reported to be viviparous (Chernyayev, 1971, 1975) and are born at a relatively large size (8.2–9.4 mm) but are not well developed. Flexion of the notochord occurs at about 8.2 to 13 mm. Larvae develop very slowly with transformation occurring 3 or 4 months after birth.

Larvae are extremely slender and elongate with small heads and very short coiled guts. Comephorids are quite different from other cottoids morphologically and are blennioid in appearance. Pigmentation is usually limited to the gut and sometimes in a series along the postanal lateral midline. Four small preopercular spines develop in late-stage larvae; other head spines are absent.

Cottocomephoridae (Fig. 225).—Larvae of seven genera of Lake Baikal cottocomephorids have been described and illustrated (Chernyayev, 1971, 1975, 1978, 1981; Taliev, 1955). Larvae hatch at about 5 to 10 mm, and range from forms with large yolk sacs and no fin development (e.g., *Paracottus*) to well developed, postflexion forms with fins well developed (e.g., *Batrachocottus*). Size at transformation varies from 9 to 20 mm. Larvae are slender with moderately short guts and rounded snouts, somewhat similar to freshwater cottids (*Cottus*) in form. Pigmentation is variable with melanistic pigmentation usually present on the head, nape, gut and variously on the dorsal and ventral midline. Melanophores are frequently present in a row along the lateral midline near the tail tip.

Larvae develop 4 small preopercular spines accompanied by two spiny projections from an inner preopercular shelf. Other head spines are lacking.

Cottidae (Figs. 226–231).—The taxonomic status of the family Cottidae is controversial with the number of recognized families ranging from 1 to 17 (see Washington and Richardson, MS). To minimize confusion, and because there is no generally agreed upon classification of this “family,” we use the generic groupings identified by Washington and Richardson (MS) for our discussion of early life history information. Larvae are known for 28 of the 70+ cottid genera. A general overview of larval cottid taxonomy is presented in Richardson and Washington (1980), Richardson (1981a), Washington (1981) and Fahay (1983).

Rhamphocottus (Fig. 226).—Larvae of this distinctive, monotypic species hatch at a relatively large size (6–7 mm NL). Notochord flexion occurs at 7 to 8 mm and transformation to a

Fig. 229. Larvae of the *Artedius* Part A group (A–C) and the *Cottus* group of cottids of Washington and Richardson (MS) (see Washington et al., this volume). (A) *Artedius fenestratis*, 9.9 mm SL (from Richardson and Washington, 1980, as *Artedius* Type 2); (B) *Chnocottus acuticeps*, 10.4 mm SL (from Washington, in prep.); (C) *Oligocottus snyderi*, 10.2 mm SL (from Washington, 1981); (D) *Leptocottus armatus*, 8.1 mm SL (from Richardson and Washington, 1980); (E) *Cottus asper*, 8.2 mm SL (ibid.).

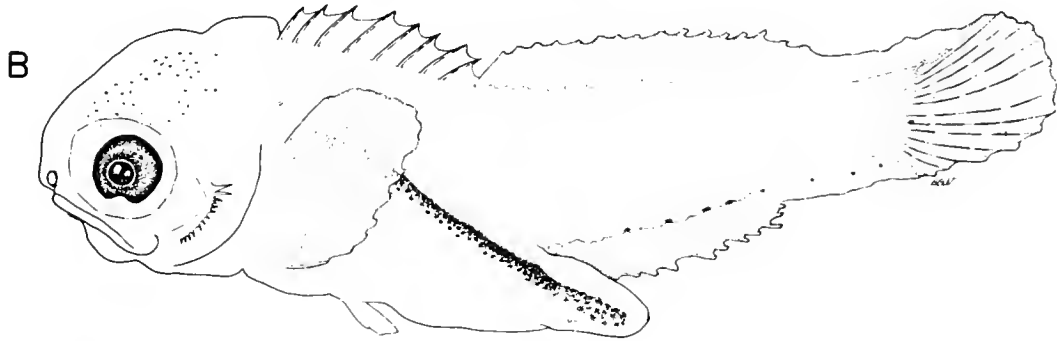

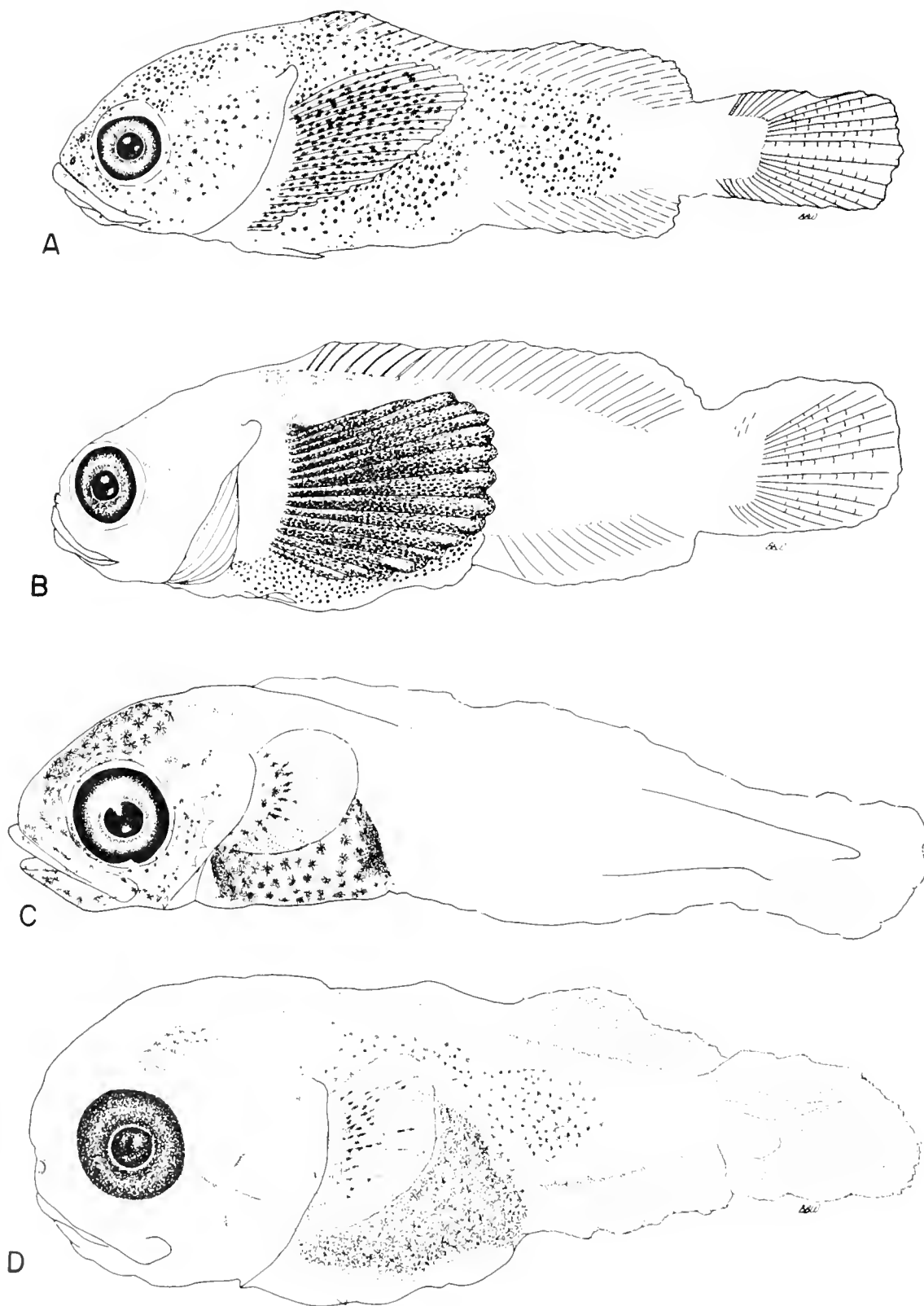

Fig. 230. Larvae of the *Psychrolutes* group (A, B) and the *Malacocottus* group (C, D) of cottids of Washington and Richardson (MS) (see Washington et al., this volume). (A) *Psychrolutes paradoxus*, 13.0 mm SL (from Richardson, 1981a); (B) *Gilbertidia sigalutes*, 13.0 mm SL (ibid.); (C) *Dasycottus setiger*, 10.3 mm SL (original); (D) *Malacocottus zonurus*, 9.8 mm SL (original).

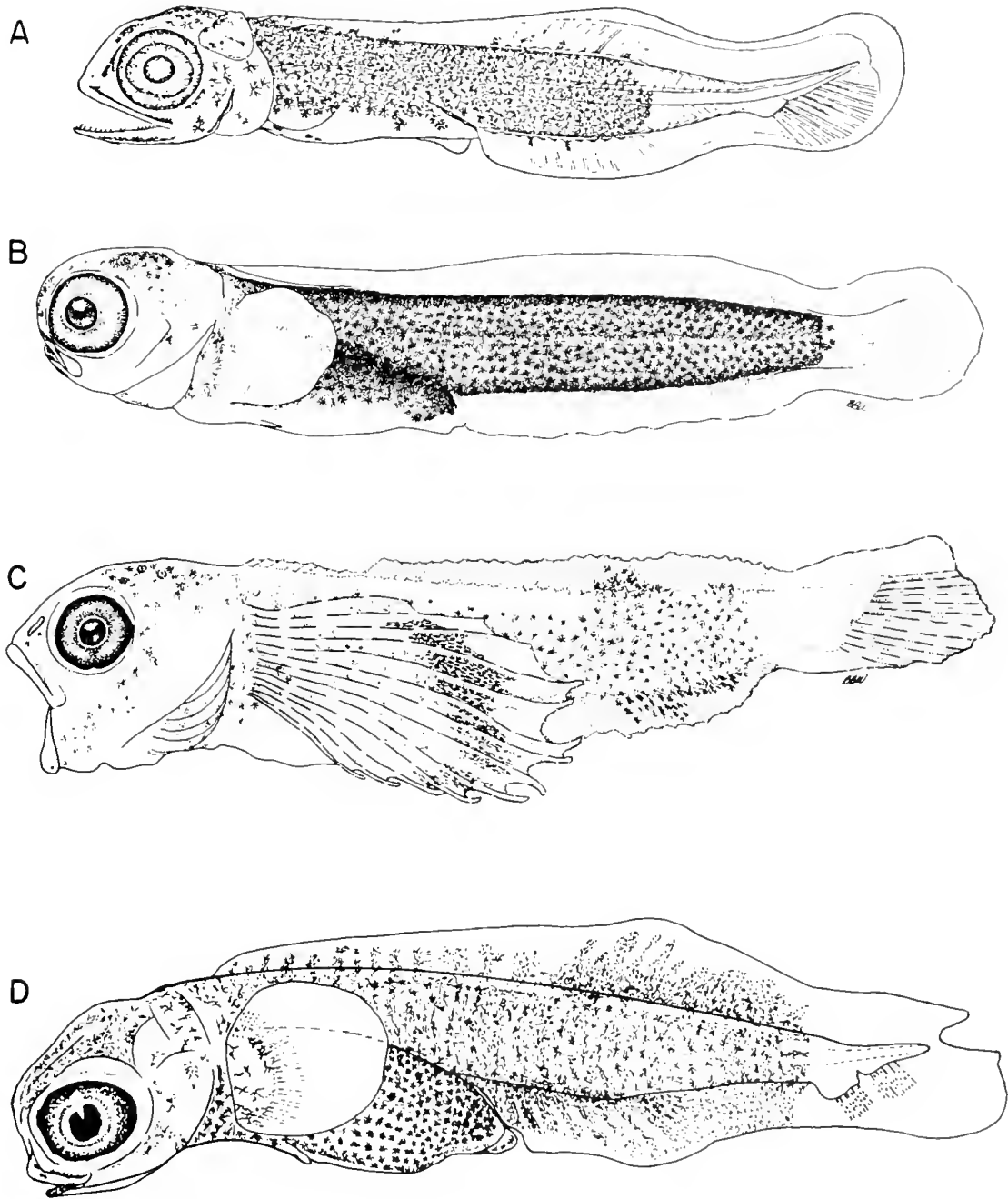

Fig. 231. Larvae of the *Hemitripteris* group (A–C) of cottids of Washington and Richardson (MS) (see Washington et al., this volume) and Agonidae. (A) *Hemitripteris villosus*, ca. 15.5 mm SL (from Kyushin, 1968); (B) *Blepsias currhosus*, 11.0 mm SL (from Richardson, 1981a); (C) *Nautichthys oculo-fasciatus*, 11.7 mm SL (from Richardson and Washington, 1980); (D) *Agonomalus* or *Hypsagonus* sp., 8.2 mm SL (original, courtesy B. Vinter).

benthic juvenile occurs at about 14 to 15 mm SL. *Rhamphocottus* larvae are extremely deep-bodied with a very long snout-anus length.

Larvae are uniformly covered with melanophores except for the caudal peduncle and ventral surface of the gut. *Rhamphocottus* develop small pricklescales over most of the body by 9 or 10 mm. Larvae develop only one preopercular spine in con-

trast to the usual four possessed by most cottid larvae. Parietal, nuchal, supracleithral, posttemporal and postocular spines occur during the larval period.

Hemilepidotus-Scorpaenichthys (Fig. 226).—Larvae of this group hatch at 4 to 6 mm NL. Transformation to the neustonic or pelagic juvenile phase occurs at about 13 to 20 mm. Larvae are

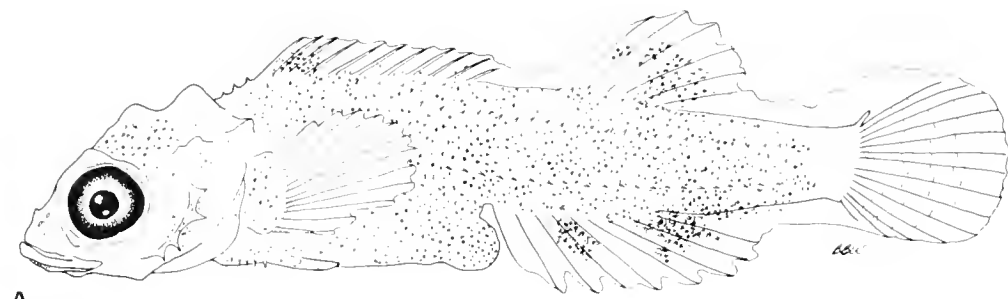

A

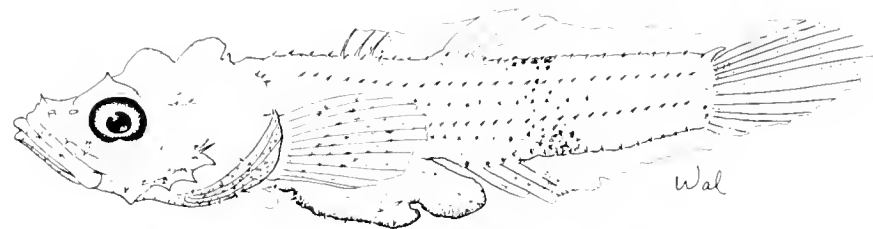

B

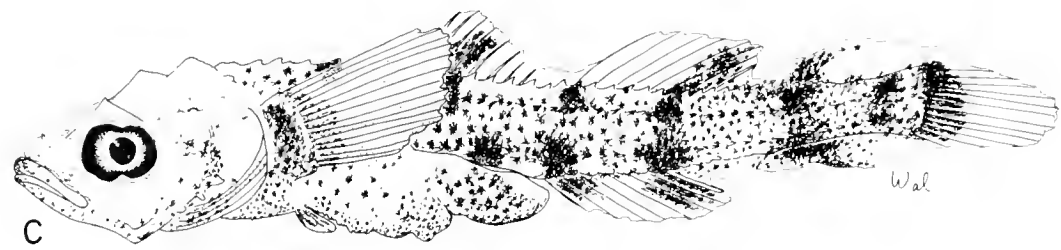

C

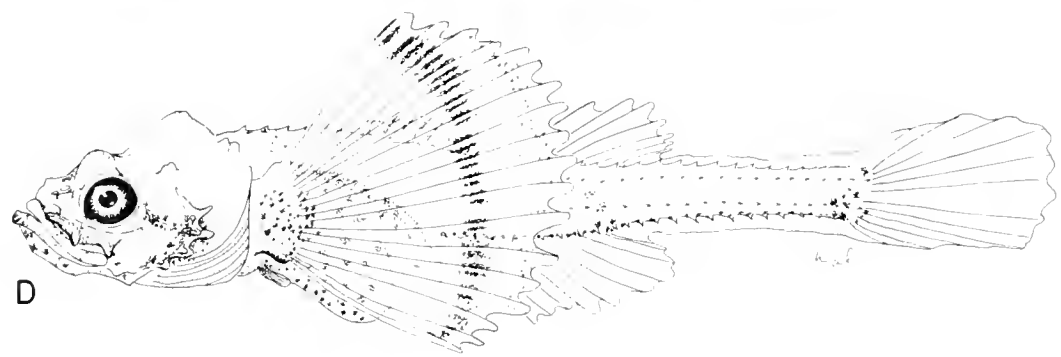

D

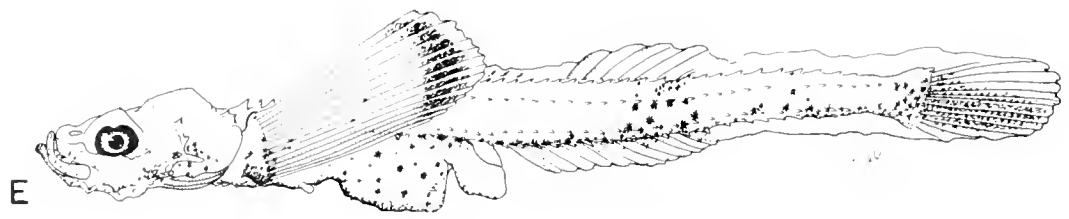

E



F

Fig. 232. Larvae of Agonidae (all original). (A) *Hypsagonus quadricornis*, 11.5 mm SL; (B) *Bothragonus swani*, 6.3 mm SL; (C) *Xeneretmus latifrons*, 9.6 mm SL; (D) *Stellerina xyosterna*, 10.2 mm SL; (E) *Ocella verrucosa*, 10.1 mm SL; (F) *Aspidophoroides monopterygius*, 14.3 mm SL.

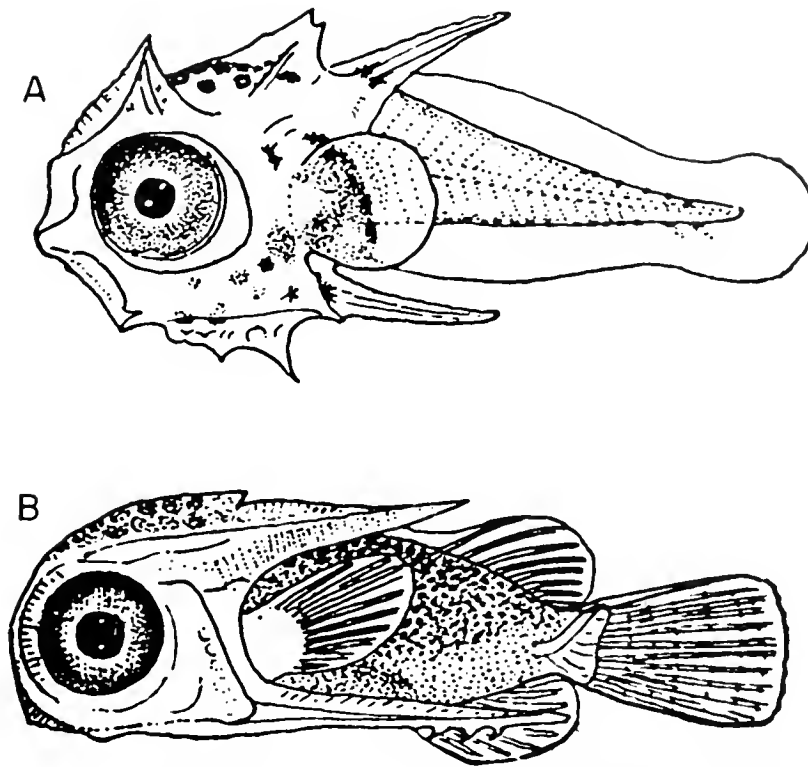

Fig. 233. Larvae of Dactylopteridae. (A) *Dactylopterus voltans*, 2.4 mm (from Padoa, 1956e); (B) *Dactylopterus voltans*, 7.5 mm (ibid.).

long and slender at hatching with moderately long guts (44 to 60%) and rounded snouts. They become increasingly deep-bodied with development.

Larvae are relatively heavily pigmented with melanophores over the head and gut. *Scorpaenichthys* larvae have dense pigment covering the body except for the caudal peduncle while *Hemilepidotus* spp. have postanal pigment concentrated on the dorsal and ventral body midlines. Lateral melanophores develop above and below the notochord in *Hemilepidotus*.

Hemilepidotus and *Scorpaenichthys* larvae develop four prominent preopercular spines. *Hemilepidotus* possess numerous head spines while *Scorpaenichthys* develop bony bumps in corresponding areas. Larvae of this group develop unique pitted dermal bones on the head. In addition, the uppermost pectoral radial is tiny and fuses to the scapula in larval *Scorpaenichthys* and nearly so in *Hemilepidotus*.

Myoxocephalus group (Figs. 227 and 228).—This is the least well-defined and most diverse cottid group containing 13 genera. Where known, size at hatching varies from 2.9 to 10 mm. Transformation to the benthic juvenile stage varies from 7.6 to 20 mm.

Members of this group are generally slender-bodied with pointed snouts; however, *Enophrys* is stout-bodied, and *Orthonopias* has a blunt, rounded snout.

Pigmentation is variable. Heavy pigment on the dorsal surface of the gut, on the nape and along postanal ventral midline is characteristic of many members of this group. Several genera possess heavy melanistic pigmentation on the lateral body surface (e.g. *Radulimus*, some *Myoxocephalus*). Head pigment may be present.

Larvae of this group develop four preopercular spines and a

distinctive bony preopercular shelf. Parietal, nuchal, supra-cleithral, posttemporal and occasionally, postocular spines develop in late-stage larvae.

Artedius group (Fig. 229, Table 107).—This group contains 3 genera, *Artedius* (in part), *Clinocottus* and *Oligocottus* and the larvae have been described by Washington (1981). Larvae hatch at 3 to 5 mm and transform to benthic juveniles at approximately 10 to 13 mm. Larvae are stubby-bodied with a slightly humped appearance at the nape. Snouts are rounded and guts trail distinctively below the ventral body midline. Several species of *Artedius* develop dorsal gut diverticula while *Clinocottus acuticeps* develops long hindgut diverticula.

Larvae are relatively lightly pigmented and characterized by pigment on the nape, over the gut and along the postanal ventral midline. Head pigment is present in some species.

Larvae develop a unique preopercular spine pattern with 6 to 24 spines. Parietal and supra-cleithral spines are variable in this group and may form in clusters, individually or not at all.

Leptocottus group (Fig. 229).—This group includes the genera *Leptocottus* and *Cottus*. Hatching occurs at 4 to 5 mm and transformation ranges from 8 to 12 mm. Larvae are relatively slender-bodied with rounded snouts and moderately short guts. Pigmentation is usually light with melanophores on the nape, over the gut and widely spaced along the postanal ventral midline. Head pigment may be present.

Where known, these larvae develop four weak preopercular spines; however, other head spines are lacking.

Psychrolutes group (Fig. 230).—This group includes two genera *Psychrolutes* and *Gilbertidia*. Larvae hatch at a relatively large

size, about 6 to 7 mm. They transform and settle from the plankton at about 18 to 20 mm SL. Larvae are generally tadpole shaped with large rounded heads tapering toward the tail. Larvae possess an outer layer of loose flabby skin.

Melanistic pigment occurs on the head, nape, gut and characteristically on the pectoral fins. Postanal ventral midline melanophores are absent; however, pigment is added laterally with development.

Head and preopercular spines are absent.

Malacocottus group (Fig. 230).—This group includes *Malacocottus* and *Dasycottus*. Size at hatching is not known. Larvae of this group are similar to those of the *Psychrolutes* group with large, blunt heads tapering to the tail. An outer bubble or layer of skin is present in both genera and is particularly pronounced in *Malacocottus*.

Pigmentation is present on the head, nape and over the entire gut. Pigment occurs laterally on the anterior third of the tail in *Malacocottus* larvae. As in the *Psychrolutes* group, the pectoral fins are characteristically pigmented.

Larvae develop four preopercular spines with a fifth accessory spine present in *Malacocottus*.

Hemitripteris group (Fig. 231).—This group includes the genera: *Hemitripteris*, *Blepsias* and *Nautichthys*. Hatching occurs at a relatively large size, 7 to 13 mm NL. Newly-hatched larvae have elongate, slender bodies which become deeper with development. *Nautichthys* larvae have distinctively long, pigmented pectoral fins.

Pigmentation is relatively heavy with melanophores covering the head, dorsal surface of the gut and over the lateral body surface except for the caudal peduncle. *Nautichthys* and *Hemitripteris* larvae possess distinctive pigment bands extending onto the dorsal and ventral finfolds that are not found in other cottid larvae.

Larvae develop four prominent preopercular spines and a strong frontoparietal spiny ridge. This group is characterized by

delayed ossification in the larval period and a unique "honey-comb" pattern of ossification on the head. *Hemitripteris* larvae develop large bony prickles, similar to the prickle-scales found in agonids.

Agonidae (Figs. 231 and 232).—At least one early life history stage of 9 of the 49 nominal species is known. Agonids hatch at 5.5 to 8.0 mm NL. Development is a gradual transformation to the juvenile form attained at 20 to 30 mm.

Agonid larvae are generally long and slender with relatively long guts. Extremes of form range from short stout genera such as *Agonomalus* and *Bothragonus* to the extremely attenuated forms such as *Ocella* and *Aspidophoroides*. Larvae have distinctively large, fan-shaped pectoral fins.

Pigmentation varies in the family. Melanistic pigment may be present on the head, nape, scattered over the gut and frequently in bands on the postanal lateral surface of the body. The pectoral fins are distinctively pigmented often with distal bands of melanistic pigment. In some species (e.g. *Agonomalus*, *Hypsagonus*) pigmentation extends onto the dorsal and ventral finfolds.

Larvae are characterized by spiny heads with large frontoparietal spiny ridges, postocular spines, and usually four large preopercular spines. Tiny rows of spines form in small larvae and help distinguish agonid larvae. These rows correspond to the plates (scales) of adults.

(B.B.W.) GULF COAST RESEARCH LABORATORY, EAST BEACH DRIVE, OCEAN SPRINGS, MISSISSIPPI 39564; (W.A.L.) SCHOOL OF NATURAL RESOURCES, DEPARTMENT OF FISHERIES, HUMBOLDT STATE UNIVERSITY, ARCATA, CALIFORNIA 95521; (H.G.M.) NATIONAL MARINE FISHERIES SERVICE, SOUTHWEST FISHERIES CENTER, POST OFFICE BOX 271, LA JOLLA, CALIFORNIA 92038; (W.J.R.) NATIONAL MARINE FISHERIES SERVICE, SOUTHEAST FISHERIES CENTER, 75 VIRGINIA BEACH DRIVE, MIAMI, FLORIDA 33149.

Cyclopteridae: Development

K. W. ABLE, D. F. MARKLE AND M. P. FAHAY

THE scorpaeniform family Cyclopteridae is composed of two subfamilies (Nelson, 1976), the Cyclopterinae (lumpfishes) with 7 nominal genera and 28 species, and the Liparidinae (snailfishes) with 18 nominal genera and 150+ species (Table 108). Some authors have considered the subfamilies as separate families (Gill, 1891; Garman, 1892; Jordan and Evermann, 1896–1900; Regan, 1929; Burke, 1930; Matsubara, 1955; Ueno, 1970), while others have treated them together (Boulenger, 1910; Berg, 1940; Greenwood et al., 1966). We follow Nelson (1976) without prejudice; both groups appear distinct yet are clearly sister taxa. The most compelling synapomorphy is a ventral sucking disk (secondarily lost in some liparidines) formed from pelvic fin rays. The cyclopterid disk differs structurally from

analogous structures in Gobiesociformes and Gobiidae (see for example, Briggs, 1955; Ueno, 1970). Certain osteological (Ueno, 1970) and meristic differences (Table 108) between the subfamilies are marked. The lumpfishes have two dorsal fins (the first dorsal may be embedded in the skin and not externally visible in some genera) with few total elements (4–8 spines and 8–12 rays), few anal rays (6–13) and vertebrae (23–29). The snailfishes have a single dorsal fin with numerous elements (28–82), and more anal rays (24–76) and vertebrae (38–86) (Table 108).

Representatives of the Liparidinae have been collected in all oceans from the Arctic to the Antarctic. They are found from intertidal depths to greater than 7 km (Andriashev, 1954; 1975). However, their distribution over shallow continental shelves is

TABLE 108. NOMINAL CYCLOPTERID GENERA, NUMBER OF SPECIES, AND RANGE OF MFRISTIC CHARACTERS FOR EACH. Based primarily on data from Burke (1930), Schmidt (1950), Ueno (1970), Andriashev (1975), Andriashev and Neelov (1976), Stein (1978), and Kido (1983). Dorsal fin counts are given as dorsal spines and dorsal rays for Cyclopterinae.

Genus	No. of species	Fin rays				Pyloric caecae	Vertebrae
		Dorsal	Anal	Pectoral	Caudal		
Cyclopterinae							
<i>Aptocycclus</i> De La Pylaie	1	V, 8-11	6-9	19-22	9-11	15-43	27-29
<i>Cyclopsis</i> Popov	1	VI, 11-12	10	23-24	10-11	9	?
<i>Cyclopteropsis</i> Soldatov and Popov	8	VI-VII, 10-12	9-13	25-28	9-11	9-10	25-26
<i>Cyclopterus</i> Linnaeus	1	VI-VIII, 9-11	9-10	19-20	11-12	36-79	28-29
<i>Eumicrotremus</i> Gill	14	V-VIII, 9-13	9-13	19-29	9-12	8-12	26-29
<i>Lethotremus</i> Gilbert	2	VI-VII, 8-11	7-10	20-23	10-11	4	23-24
<i>Pelagocycclus</i> Lindberg and Legeza	1	IV-V, 9-10	8-9	19-21	10	?	?
Liparidinae							
<i>Acantholiparis</i> Gilbert and Burke	2	45-52	38-47	20-26	8-10	0-6	50-54
<i>Careproctus</i> Kroyer	47+	40-67	32-60	17-37	6-12	0-60	47-71
<i>Crystalias</i> Jordan and Snyder	1	56	53	31	10	71	?
<i>Crystallichthys</i> Jordan and Gilbert	2	48-53	42-44	30-35	10-12	36-40	?
<i>Elassodiscus</i> Gilbert and Burke	2	49-68	45-60	27-32	8-9	ca. 14-16	60
<i>Gemoliparis</i> Andriashev and Neelov	1	53	49	19	6	7	62
<i>Gyrinichthys</i> Gilbert	1	—	—	25	14	—	?
<i>Liparis</i> Scopoli	50-60	28-49	24-45	28-41	10-12	10-90	38-53
<i>Lipariscus</i> Gilbert	1	50-52	47-49	13-15	4	ca. 6	?
<i>Nectoliparis</i> Gilbert and Burke	1	50-55	45-50	19-25	6	6-9	?
<i>Notoliparis</i> Andriashev	3	41-57	38-53	31	10	—	50-65
<i>Odontoliparis</i> Stein	1	51	46	17	6	7	59
<i>Osteodiscus</i> Stein	1	47-52	40-44	20-25	6-7	0	51-56
<i>Paraliparis</i> Collett	27+	48-82	42-76	14-39	3-8	5-41	57-86
<i>Polypera</i> Burke	3	37-44	31-34	33-37	—	200-300	?
<i>Rhinoliparis</i> Gilbert	2	ca. 68	ca. 60	20-23	1-3	7-12	?
<i>Rhodichthys</i> Collett	1	56-60	54-57	16-17	10	?	ca. 65
<i>Temnocora</i> Burke	1	45-48	39	33-37	—	20	?

limited to the cooler waters of the arctic, antarctic and temperate regions with the possible exception of *L. fishelsoni* from the Red Sea (Smith, 1968). The Cyclopterinae are more restricted in their distribution, occurring exclusively in the northern hemisphere's boreal and arctic waters (Ueno, 1970) where they are usually limited to continental shelves. Although most cyclopterids are benthic the cyclopterine *Pelagocycclus vittazi* (Lindberg and Legeza, 1955) and the liparidines *Nectoliparis pelagicus* and *Lipariscus nanus* (Stein, 1978) are pelagic. *Liparis fabricii* is considered cryopelagic in the high Arctic (Tsinovsky and Mel'nikov, 1980). The cyclopterine *Cyclopterus lumpus* is benthic during the reproductive season and pelagic at other times (Thorsteinsson, 1981; Able, in prep.).

DEVELOPMENT

The available information on early life history stages is inadequate to allow confident generalizations about the biology or systematics for most members of the family. This is due to rarity of material (adults and especially larvae) and the incomplete understanding of cyclopterid taxonomy.

Eggs

Cyclopterid eggs are moderate to large (0.8 to 8.0 mm), demersal and adhesive (Table 109). Variation in fecundity is generally related to female length (Stein, 1980a; Lisovenko and Svetlov, 1981; Matarese and Borton, in prep.) but appears to be a complex function of egg diameter as well (Table 109). Much of the available information on cyclopterid eggs, summarized

in Table 109, is based on observations of ovarian eggs or otherwise incomplete descriptions. It is possible, for example, that one or more oil globules may be characteristic of all cyclopterid eggs. Sculpturing of the chorion surface has been reported for *Liparis montagui* (McIntosh and Prince, 1890), *L. tanakae* (Aoyama, 1959) and *L. atlanticus* (Detwyler, 1963). Pores in the chorion have been reported for *Cyclopterus lumpus* and *L. montagui* (McIntosh and Prince, 1890). We have found that sculpturing of the chorion occurs in *L. liparis* (Fig. 234A, B, C) and *Paraliparis calidus* and possibly *Eumicrotremus orbis* (Fig. 234D, E, F). Pores in the chorion are quite numerous in *L. liparis* (Fig. 234B, C). Pits are present on some portions of the egg surface of *E. orbis* (Fig. 234D, E, F).

Incubation is moderately long (5 to 10 weeks) in the few reported cases (Russell, 1976; Andriashev, 1954; Matarese and Borton, in prep.). The combination of relatively large eggs and long incubation times results in an advanced state of development at hatching for some members of each subfamily. In these instances fin rays and disk are formed and notochord flexion is underway prior to hatching (Fig. 235A, Table 110). Hatching at an advanced state of development is characteristic for all deep-water Liparidinae that have been relatively well studied (Andriashev et al., 1977; Stein, 1978). Hatching may be cued to wind induced temperature changes for some inshore *Liparis* (Frank and Leggett, 1983).

Some form of parental protection, either egg hiding, paternal guarding, or both may also be characteristic (Table 109). Some Pacific *Careproctus* deposit eggs within the gill cavities of lith-

TABLE 109. SUMMARY OF EGG CHARACTERISTICS OF CYCLOPTERIDAE.

Species	Egg or maximum ovarian egg diameter (mm)	Oil globule(s)	Clutch count or ripe egg fecundity	Paternal care or egg deposition sites	Source(s)
Cyclopterinae					
<i>Aptocyclus ventricosus</i>	2.3–2.4	present	3,800	paternal guarding	Kyushin, 1975; Schmidt, 1950; Kobayashi, 1962
<i>Cyclopsis tentacularis</i>	2.0	?	1,540	?	Lindberg and Legeza, 1955
<i>Cyclopteropsis macalpinii</i>	5.0	?	60–70	paternal guarding, hidden (mollusc shells)	Parr, 1926
<i>Cyclopterus lumpus</i>	2.2–2.7	present	15,000–200,000	paternal guarding	Zhitenev, 1970; Russell, 1976; Andriashev, 1954
<i>Eumicrotremus birulai</i>	3.9–4.0	present	1,230	hidden (mollusc shells)	Honma, 1956; Ueno, 1970
<i>Eumicrotremus derjugini</i>	4.0–5.0	?	?	?	Andriashev, 1954
<i>Eumicrotremus orbis</i>	2.2	present	325–477	paternal guarding	Matarese and Borton, MS
<i>Eumicrotremus soldatori</i>	3.1	?	4,049	?	Ueno, 1970
<i>Eumicrotremus spinosus</i>	3.2–4.5	?	?	paternal guarding, hidden (mollusc shells)	Andriashev, 1954
<i>Lethotremus awae</i>	1.4	?	232	?	Ueno, 1970
Liparidinae					
<i>Acantholiparis opercularis</i>	4.8	?	1–6	?	Stein, 1980a
<i>Careproctus</i> sp.	5.0	?	?	hidden (lithodid crab gill cavity)	Hunter, 1969; Vinogradov, 1950
<i>Careproctus</i> sp.	3.0–3.5	?	100	hidden (lithodid crab gill cavity)	Anderson and Cailliet, 1974
<i>Careproctus falklandica</i>	?	?	?	hidden (lithodid crab gill cavity)	Balbontin et al., 1979
<i>Careproctus longifilis</i>	7.1	?	16	?	Stein, 1980a
<i>Careproctus melanurus</i>	4.2	?	534	hidden (lithodid crab gill cavity)	Peden and Corbett, 1973
<i>Careproctus microstomus</i>	7.6	present	15	?	Stein, 1980a
<i>Careproctus oregonensis</i>	5.6	?	3–5	?	Stein, 1980a
<i>Careproctus ovigerum</i>	7.8	?	756	?	Stein, 1980a
<i>Careproctus rastrinoides</i>	4.5	?	?	?	Schmidt, 1950
<i>Careproctus remhardti</i>	4.5	?	300	?	Collett, 1905; Andriashev, 1954
<i>Careproctus sinensis</i>	5.0	?	?	hidden (lithodid crab gill cavity)	Rass, 1950
<i>Liparis atlanticus</i>	0.8–1.4	present	1,400–3,000	paternal guarding, hidden (algae)	Detwyler, 1963
<i>Liparis fabricii</i>	2.1–2.7	?	485–735	?	Andriashev, 1954
<i>Liparis fucensis</i>	1.0	?	?	paternal guarding, hidden (mollusc shell, tubeworms)	DeMartini, 1978; Marliave, 1976
<i>Liparis inquilinus</i>	1.0–1.3	present	231–563	hidden (hydroids)	Able and Musick, 1976
<i>Liparis liparis</i>	1.4–1.7	present	?	hidden (hydroids)	Russell, 1976
<i>Liparis montagui</i>	1.0–1.2	present	700	hidden (red algae)	Russell, 1976; Andriashev, 1954
<i>Liparis pulchellus</i>	1.5	?	941–996	?	Johnson, 1969
<i>Liparis tanakae</i>	1.7–1.8	present	?	hidden (sea weed)	Aoyama, 1959
<i>Notoliparis kermadecensis</i>	8.0	?	16	?	Neilsen, 1964
<i>Osteodiscus cascadae</i>	5.3	?	1–5	?	Stein, 1980a
<i>Paraliparis bathybius</i>	4.5	?	422–434	?	Collett, 1905; Andriashev, 1954
<i>Paraliparis calidus</i>	2.6–2.9?	?	?	?	Wenner, 1979
<i>Paraliparis copei</i>	2.0	?	45–86	?	Wenner, 1979
<i>Paraliparis deam</i>	2.0	?	?	?	Hart, 1973
<i>Paraliparis garmani</i>	3.5	?	190–317	oral brooding?/ paternal guarding?	Wenner, 1979; Stein, 1980a
<i>Paraliparis gracilis</i>	2.6–2.9	?	?	?	Marshall, 1953
<i>Paraliparis latifrons</i>	4.5	?	2–8	?	Stein, 1980a
<i>Paraliparis megalopus</i>	4.3	?	32	?	Stein, 1980a
<i>Paraliparis mento</i>	2.5	?	101	?	Stein, 1980a
<i>Paraliparis rosaceus</i>	3.6	?	1,277	?	Stein, 1980a
<i>Rhinoliparis barbulfifer</i>	2.5	?	?	?	Schmidt, 1950
<i>Rhodichthys regina</i>	3.2–4.0	?	70	?	Johnsen, 1921

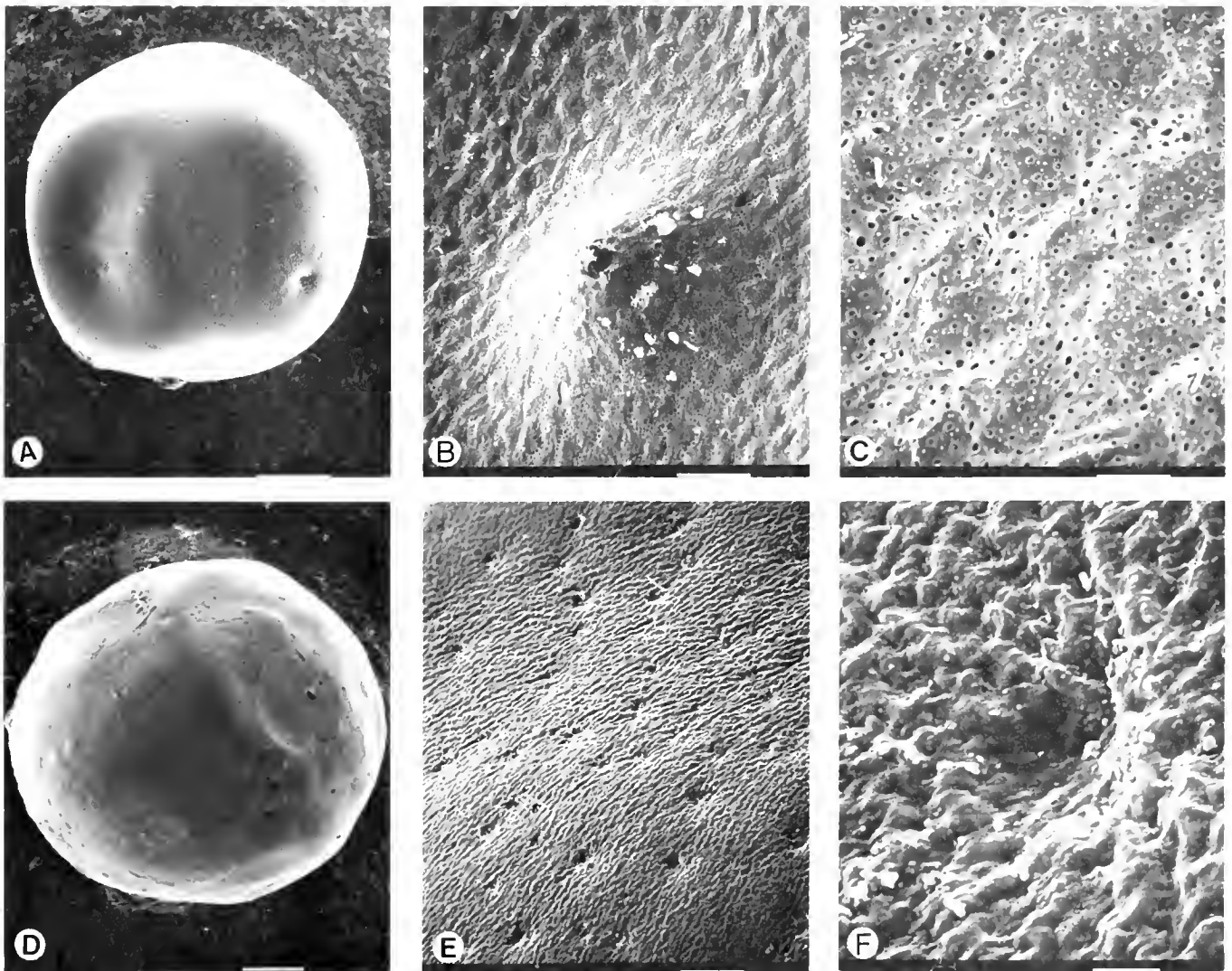

Fig. 234. Scanning electron micrographs of *Liparis liparis* egg (A, B, C, Zoologisch Museum Amsterdam 114.522, North Sea) and *Eumicrotremus orbis* egg (D, E, F) from the study by Matarese and Borton (in prep.). The depression in A and B is the micropyle. Scale bar equals 200 μ (A), 19 μ (B), 4.9 μ (C), 280 μ (D), 28 μ (E), 3.3 μ (F).

oid crabs; a site which may provide both protection and water circulation.

Larvae

In the Cyclopterinae development has only been described for 4 of 7 nominal genera and 4 species (Table 110). Other partial descriptions are for *Aptoicyclus ventricosus* (Kobayashi, 1962) and *Eumicrotremus spinosus* (Ehrenbaum, 1905–1909; Koefoed, 1909). In the Liparidinae, larvae of 3 of 18 nominal genera and 10 species have been described (Table 110). Besides those listed, partial descriptions have been published for *Careproctus georgianus* (Efremenko, 1983a), *Careproctus falklandica* and *Careproctus* sp. (Balbontin et al., 1979) and several *Liparis*: *L. atlanticus* (Detwyler, 1963), *L. fabricii* (Ehrenbaum, 1905–1909; Koefoed, 1909; Johansen, 1912; Dunbar, 1947), *L. fuscensis* (Marliave, 1976), *L. liparis* (Ehrenbaum 1904, 1905–

1909; Ehrenbaum and Strodman, 1904; Fage, 1918), *L. montagu* (McIntosh and Prince, 1890; McIntosh and Mastermann, 1897; Ehrenbaum and Strodman, 1904; Ehrenbaum, 1905–1909; Fage, 1918; Arbault and Boutin, 1968b), *L. tanakae* (Aoyama, 1959; Kim et al., 1981), and *L. tunicatus* (Johansen, 1912).

Morphological characters.—Cyclopterid larvae typically have flaccid skin enveloping the entire body, a short bulbous head usually without spines, large eyes, and a trilobed lower lip. The sucking disk forms early in development and may be present at hatching in some forms (Fig. 235–238). The preanal length is short and the gut is coiled. Cyclopterines may have both dorsal fins at hatching (Fig. 235B), typically have larger disks at hatching, and usually have more pigmentation at hatching (Fig. 235–238) than liparidine larvae. Some cyclopterine larvae develop dermal spines that become pronounced tubercles in adults (Ueno, 1970). In many liparidine larvae the medial surface of the pec-

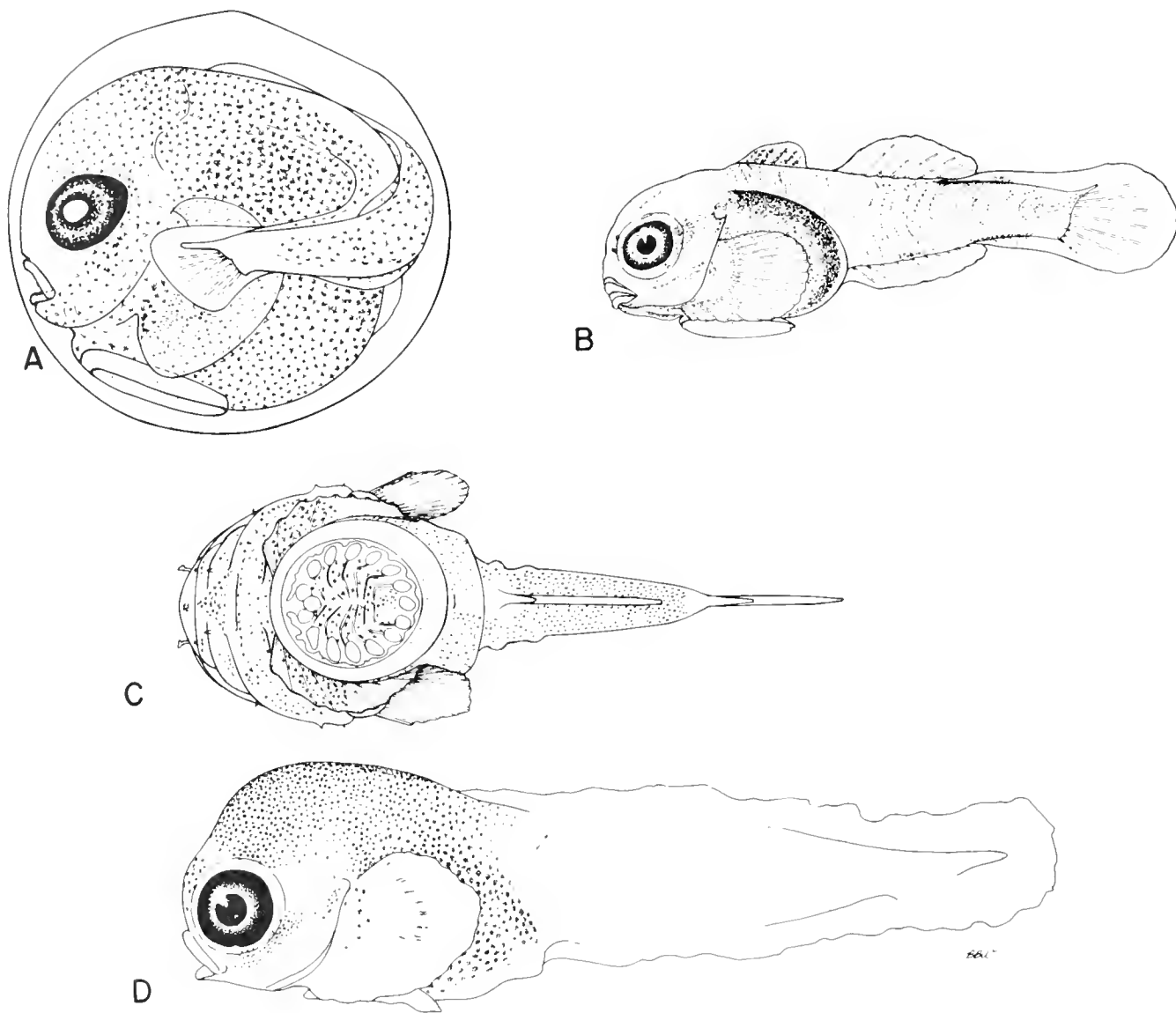

Fig. 235. Egg (A) and larvae (B—4.5 mm SL, C—6.3 mm SL, ventral view) of *Eumicrotremus orbis* from Matarese and Borton (in prep.) and larvae of *Cyclopterus lumpus* (D—5.0 mm SL, Damariscotta River, Maine, HML H-24029).

toral fin has numerous melanophores (Fig. 237) and during development the fin may become bilobed (Fig. 238). The gill opening decreases in size during development.

Disk size varies within each subfamily and may be related to habitat. Pelagic forms such as the cyclopterine *Pelagocychus vitazi* and the liparidine *L. fabricii* (Fig. 237) have small or greatly reduced disks. Some pelagic forms, such as *Nectoliparis pelagicus* and *Lipariscus nanus* lack disks entirely.

The arrangement of the cranium may offer useful insights into cyclopterid phylogeny. Svetovidov (1948) noted that the cranial cavity extends into the interorbital space in *Liparis* but only reaches the hind margin of the orbit in *Cyclopterus*. Our material indicates that this character state changes ontogenetically in *Cyclopterus* with the earliest stages showing the liparidine state.

Able and McAllister (1980) suggested that tooth shape exhibits polarity, with trilobed teeth with equal lobes representing the primitive condition, trilobed teeth with a larger central lobe an intermediate condition, and simple teeth the derived condition. The ontogeny of teeth in *Liparis* supports this statement. All *Liparis* examined to date possess trilobed teeth early in development. With continued growth the oldest teeth may become simple, as in *L. fabricii* (Able and McAllister, 1980).

Caudal morphology and ontogeny show variation that may prove useful for identification and phylogenetic studies. Within liparidines caudal elements vary. For example, Stein (1978) noted a lack of epurals in *Careproctus longifilis*, whose caudal structure he considered typical of deepwater eastern Pacific liparidines he examined, while we note the typical presence of

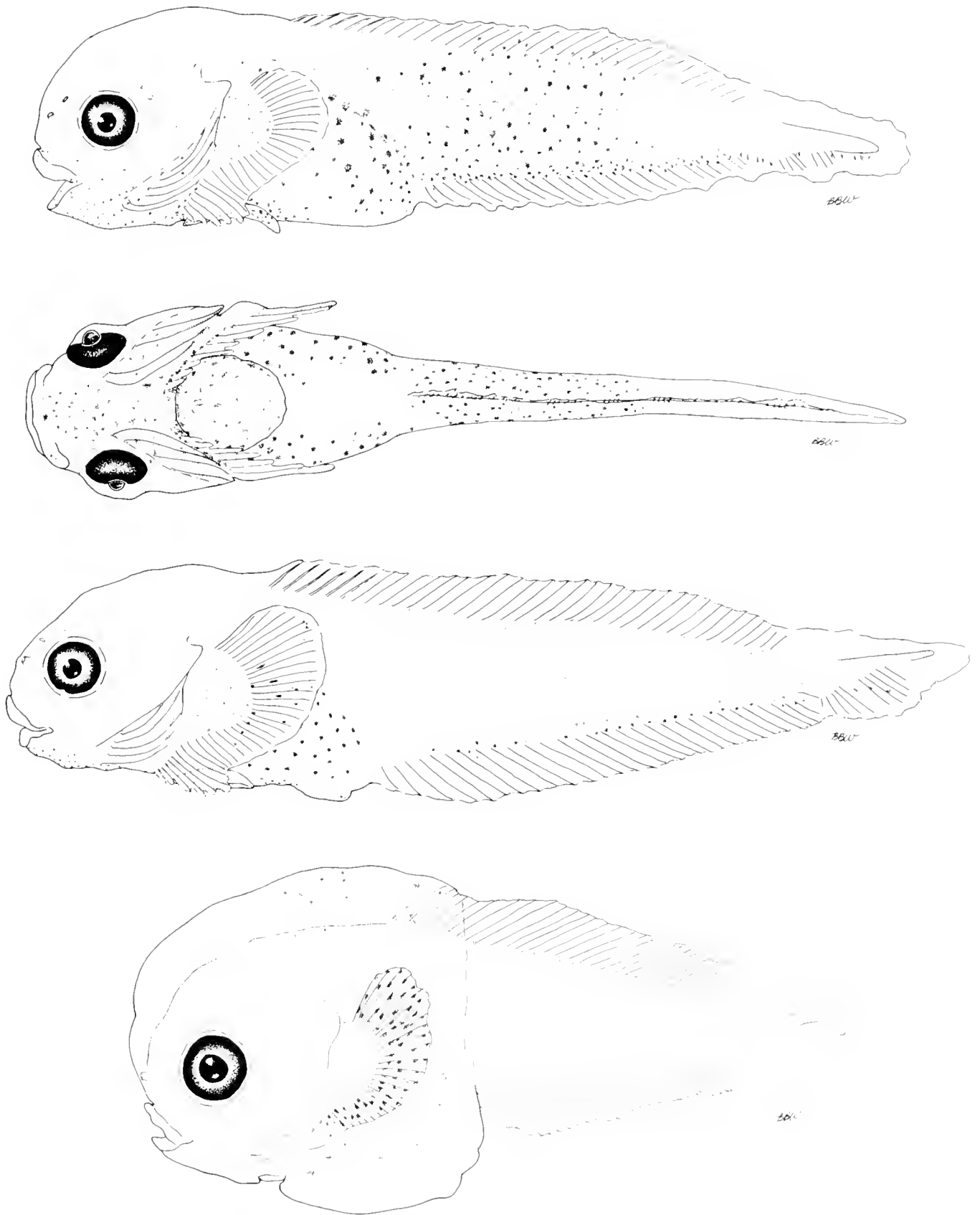

Fig. 236. Larvae of *Liparis* (from top to bottom). *Liparis atlanticus* (7.9 mm NL, 47°37'N, 62°02'W, HML H-2140); ventral view of above; *L. cohem* (13.6 mm NL, Damariscotta River, Maine, HML H-24030); and an unidentified cyclopterid (5.8 mm, CALCOFI 6401 Sta. 70.52).

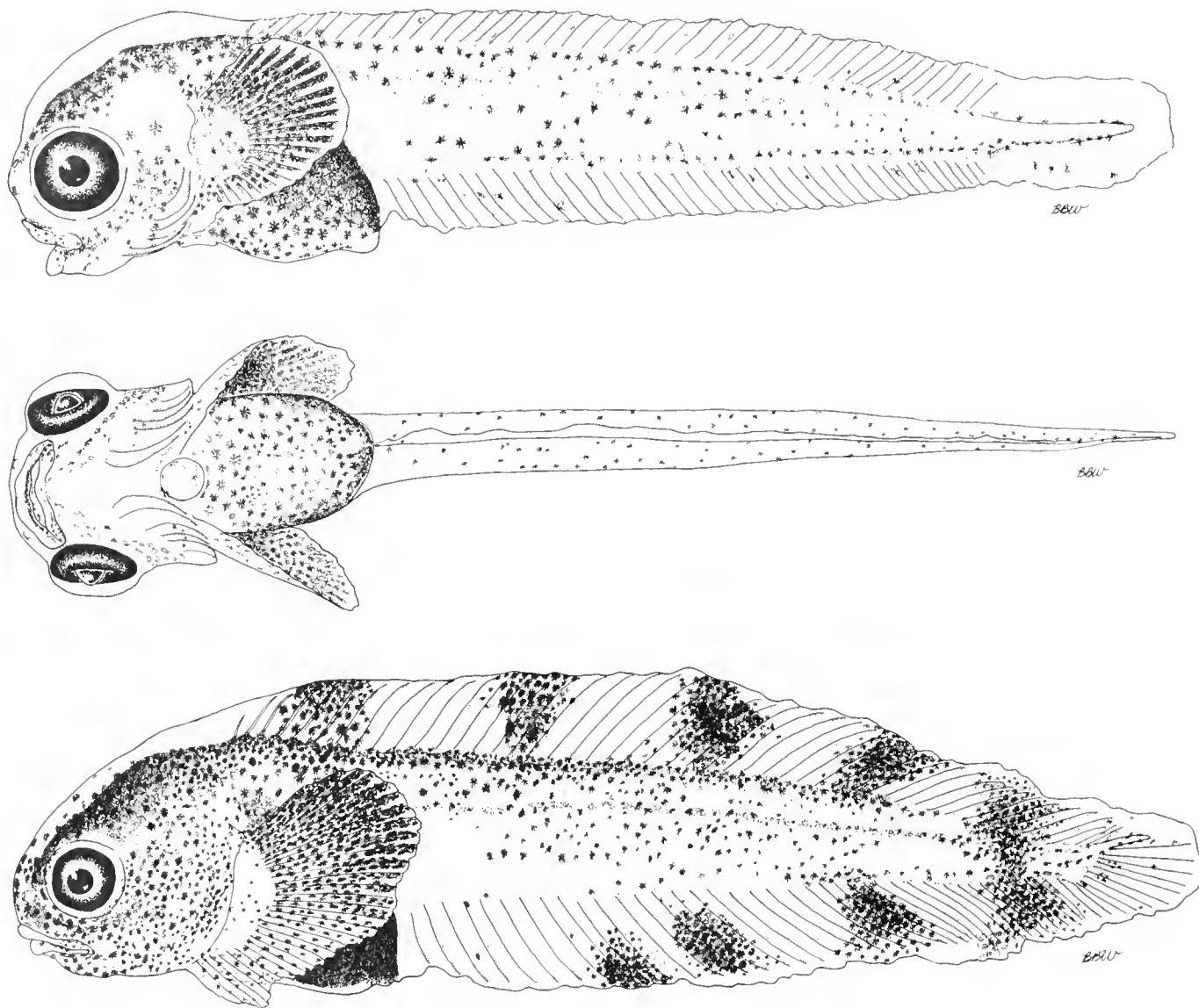

Fig. 237. *Liparis fabricii* larvae (from top to bottom): 16.7 mm NL, NZ 4, 74°06'N, 81°30'W, NMC 83-1135; ventral view of above; 32.8 mm NL, NZ 292, 74°27'N, 82°03'W, NMC 83-1136, from Arctic Canada.

two epurals in some western North Atlantic *Liparis* (Fig. 239) from shallow water. Caudal development also varies. In *Cyclopterus* (Fig. 239), *Eumicrotremus* (Matarese and Borton, in prep.), and deepwater southern hemisphere liparidines (Andriashev et al., 1977) the notochord is resorbed and flexion is complete at hatching. In western Atlantic *Liparis*, especially *L. fabricii*, notochord resorption and flexion are delayed as late as 50 mm SL (Fig. 237, Table 110).

Body proportions are also useful taxonomic characters for

larval identification. Within *Liparis*, larval *L. fabricii* are separable from other western North Atlantic *Liparis* by a relatively shorter head length, smaller eye diameter, shallower body depth and shorter preanal distance. The disk size relative to eye length has also proven effective in distinguishing between all species of western North Atlantic *Liparis* (Able et al., MS). The size of the gill opening is difficult to measure consistently but it decreases as development proceeds in *Liparis*, suggesting that a reduced gill opening is a derived character state.

Fig. 238. Larvae of *Careproctus* and *Paraliparis* (from top to bottom). *Careproctus reinhardti*, with yolk sac, 12.6 mm SL, Chaleur Bay, Gulf of St. Lawrence, Canada, HML H-24031; ventral view of above; *Paraliparis copei*, 24.0 mm SL, St. Lawrence River estuary, Canada, HML H-24032; and *P. calidus* 12.9 mm SL, St. Lawrence River estuary, Canada, HML H-24033; ventral view of above.

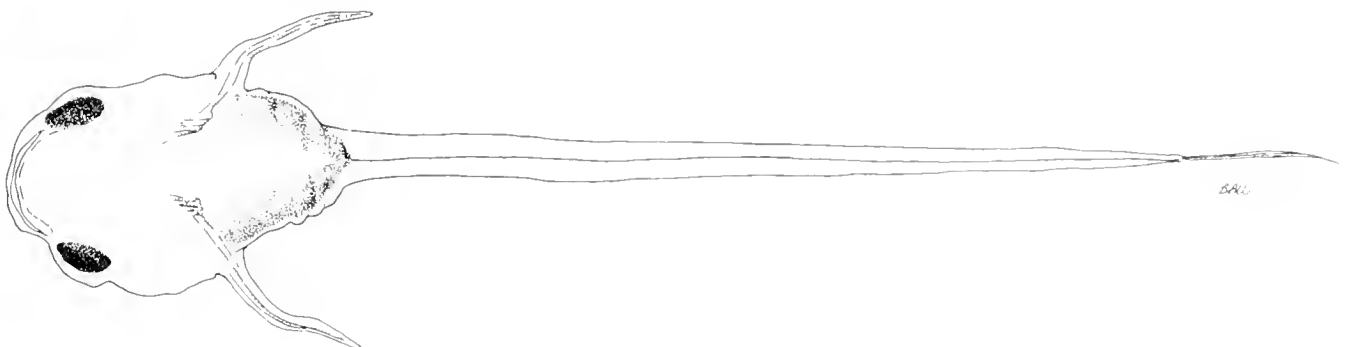
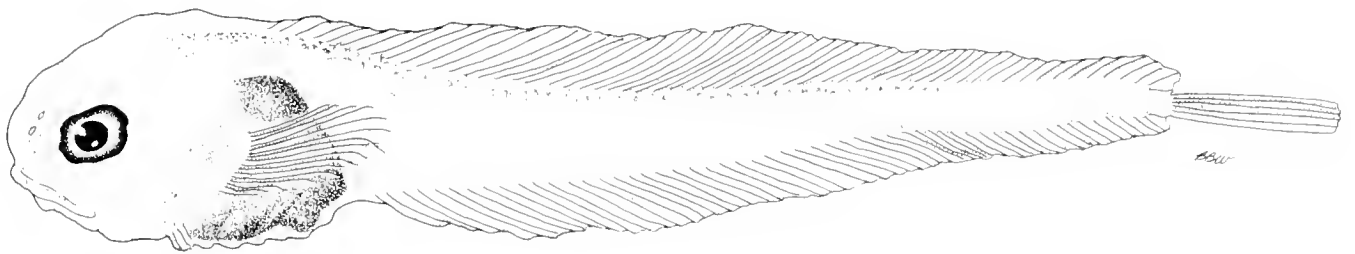
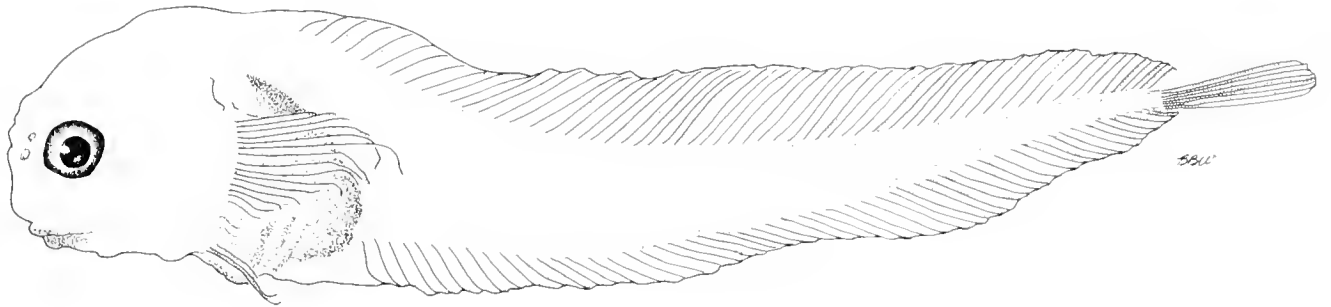
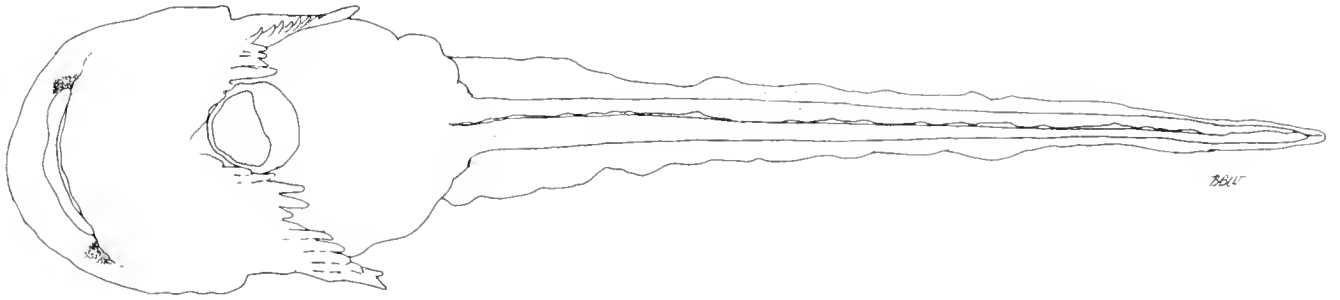
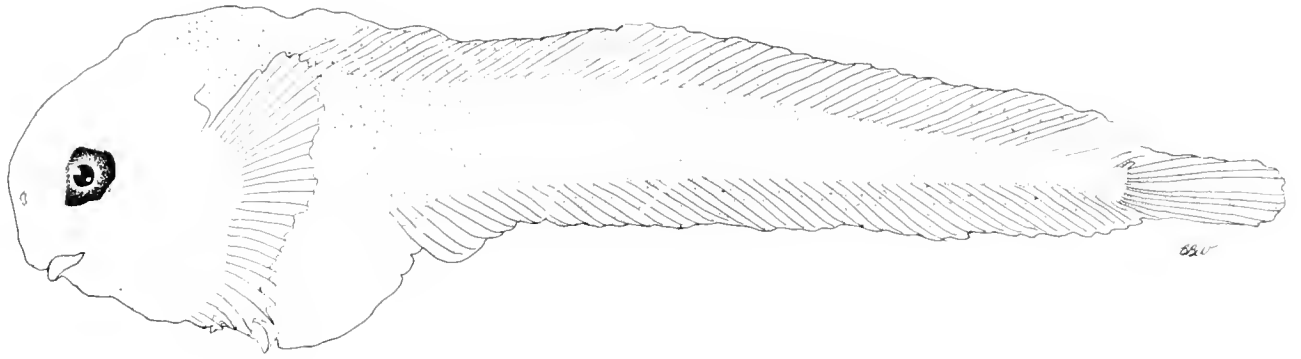

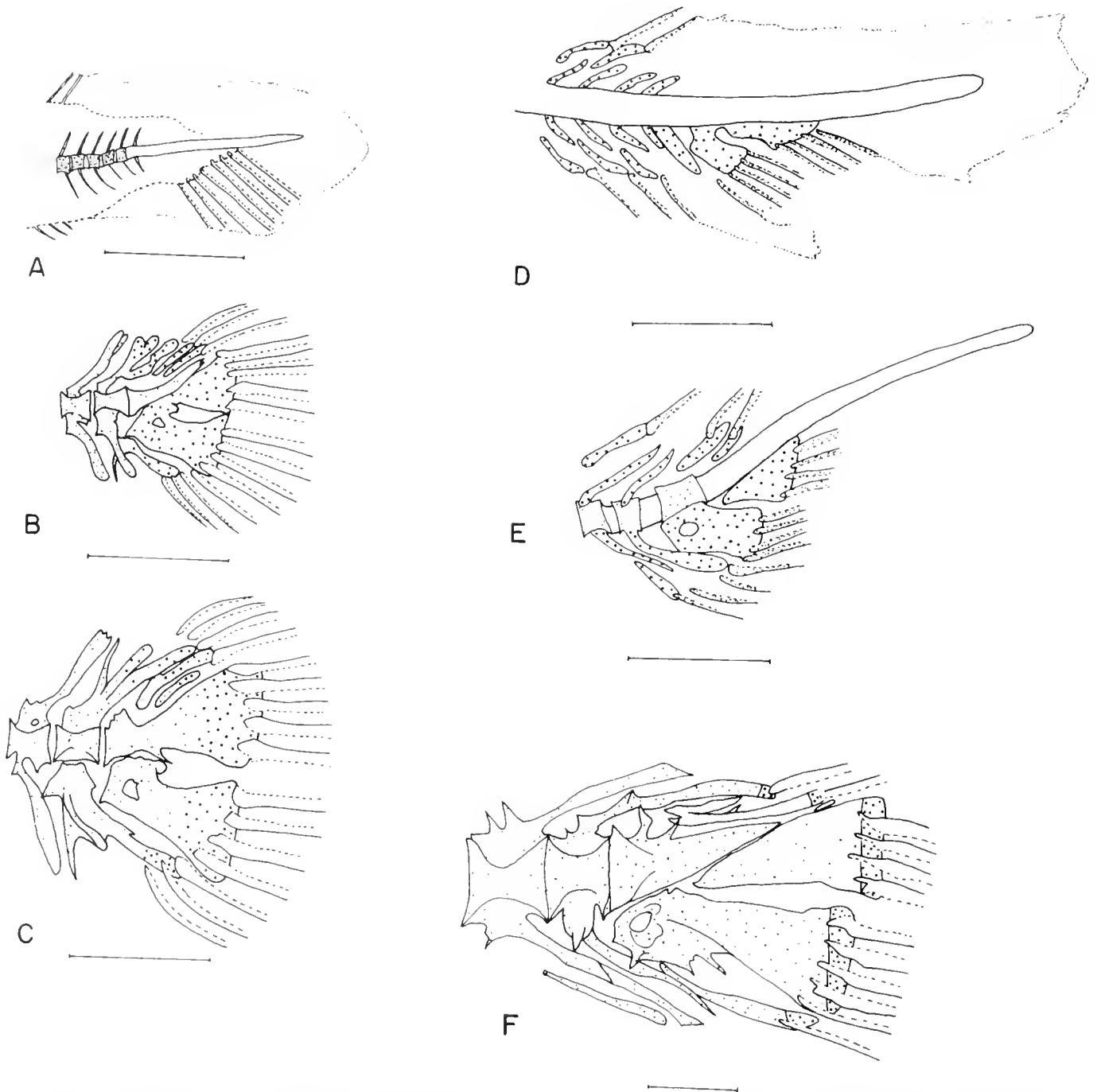

Fig. 239. Caudal development of *Cyclopterus lumpus* (A) 6.0 mm NL, (B) 12.5 mm SL, (C) 18.0 mm SL, HML H-3093, 43°12'N, 66°00'W; and *Liparis fabricii* (D) ca. 20 mm NL, 72°30.4'N, 76°46.2'W, NMC 83-1137; (E) ca. 34 mm NL, 74°27'N, 82°03'W, NMC 83-1138; (F) ca. 145 mm SL, 70°07'15"N, 60°44'15"W, NMC 83-1139). Scale bars equal one mm.

The arrangement and degree of adherence of the soft flaccid skin of cyclopterid larvae may be of taxonomic value. In *Cyclopterus* and all western North Atlantic forms examined (Able et al., MS) the skin conforms loosely to the entire surface of the body. In an unidentified cyclopterid from the eastern Pacific the skin forms a distinct bubble over the anterior portion of the body and then adheres tightly over the posterior portion (Fig. 236).

Pigment.—Cyclopterines are usually more heavily pigmented at hatching (Kyushin, 1975; Matarese and Borton, in prep.: Fig. 235) than liparidines (Figs. 236, 238). An exception is *L. fabricii* (Fig. 237) which has well-developed pigment. Throughout development, all *Liparis* we examined from the western North Atlantic possess melanophores on the medial surface of the pectoral fin, on the abdomen, and a line of melanophores at the base of the anal finfold and fin. The abdominal melanophores

TABLE 110. ONTOGENY OF CHARACTER DEVELOPMENT FOR CYCLOPTERIDS BASED ON AVAILABLE LITERATURE. Stage of development at hatching indicated by pre (preflexion), and flex (flexion). X indicates event takes place before hatching.

Species	Source	Stage at hatching	Length (mm) at development of character					
			Hatching	Disk formation	Flexion	Nostril splitting	Postflexion	Demersal phase
Cyclopterinae								
<i>Aptocyclus ventricosus</i>	Kyushin, 1975	flex	6.5–7.0 TL	X	X	X	?	at hatching
<i>Cyclopteropsis macalpinii</i>	Parr, 1926	flex	?	X	X	?	?	?
<i>Cyclopterus lumpus</i>	Fritzsche, 1978	flex	4.0–7.4 TL	X	X	?	8.0–10.0 TL?	?
<i>Eumicrotremus orbis</i>	Matarese and Borton, in prep.	flex	4.5–4.7 SL	X	X	X	55 SL	at hatching
Liparidinae								
<i>Careproctus melanurus(?)</i>	Peden and Corbett, 1973	flex?	?	X	X	—	—	—
<i>Careproctus reinhardtii</i>	Able et al., MS	flex	ca. 9.8 NL	X	X	—	17.2–21.1 SL	at hatching?
<i>Liparis atlanticus</i>	Able et al., MS	pre	ca. 3.1 NL	3.3 NL	5.8–6.9 NL	5.4–6.3 NL	12.1–17.1 SL	?
<i>Liparis inquilinus</i>	Able et al., MS	pre	ca. 3.4 NL	3.7–6.0 NL	8.1–8.5 NL	5.1–9.4 NL	14.9–19.0 SL	14 TL
<i>Liparis coheni</i>	Able et al., MS	pre	ca. 5 NL	ca. 5.0 NL	8.5–9.3 NL	7.8–9.6 NL	19.9–20.7 SL	29–36 TL
<i>Liparis gibbus</i>	Able et al., MS	pre	4.8 NL	7.4 NL	7.4–10.3 NL	12.7–15.4 NL	20.0–41.7 SL	?
<i>Liparis fabricii</i>	Able et al., MS	pre	ca. 8 NL	8.6–11.5 NL	11.9–13.4 NL	14.1–17.2 NL	48.2–52.1 SL	?
<i>Liparis tunicatus</i>	Able et al., MS	pre	?	?	?	?	20.8–27.0 SL	?
<i>Paraliparis calidus</i>	Able et al., MS	flex?	?	—	X?	—	18.6–20.7 SL	at hatching?
<i>Paraliparis copei</i>	Able et al., MS	flex?	?	—	X?	—	ca. 18.0 SL	at hatching?

are variable, with some species lacking melanophores on the ventral surface behind the disk (Fig. 236) while in *L. fabricii* they are prominent (Fig. 237). A second row of melanophores occurs on the edge of the anal finfold in preflexion *L. fucensis* (Marliave, 1976). The early appearance of melanophores on the lateral surface of the tail prior to beginning of notochord flexion is diagnostic for *L. atlanticus* (Fig. 236) among western North Atlantic *Liparis* with the exception of *L. fabricii*. *Liparis fabricii*, unlike other *Liparis* examined, has numerous, stellate melanophores over most of the body and these become increasingly numerous with development (Fig. 237). By late flexion the peritoneum is completely black, the pectoral fins and head are very dark, and oblique patches of melanophores are apparent on the dorsal and anal fins (Fig. 237). All of these patterns are unique to this species and suggest that it may be relatively isolated within the genus. Generally, pigmentation patterns should be used with caution since geographical variation does occur, as for *L. gibbus* (Able et al., MS).

Ontogenetic schedule.—On the basis of current information, it appears that certain developmental landmarks are useful for distinguishing between groups of cyclopterids and may, in some instances, reflect relationships. The degree of development at hatching is variable both between and within subfamilies (Table 110). All cyclopterines studied hatch late in development, at relatively large sizes, when many developmental characters are nearly complete (see Fig. 235). Embryonic development is more

variable within the liparidines (Table 110); some *Careproctus*, *Paraliparis* (Fig. 238) and other deepwater forms from the southern hemisphere (Marshall, 1953; Andriashev et al., 1977) apparently hatch late in development, at large sizes while shallow water *Liparis* studied to date hatch as preflexion larvae (Able et al., MS).

Within *Liparis*, the development of several characters occurs over a wide size range (Table 110). For example, in *L. atlanticus* and *L. inquilinus* hatching, disk formation, nostril splitting, flexion and postflexion and assumption of demersal habitat occur at relatively small sizes, while in *L. fabricii* all of these events are delayed until larger sizes. Other species (*L. coheni*, *L. gibbus*) are intermediate. *Liparis fabricii*, which shows the most delayed development, may remain pelagic throughout its life (Able and McAllister, 1980; Tsinovsky and Mel'nikov, 1980). While some of this variation may be explained by the variation in egg size it can not account for the great differences observed. We suggest that delayed development is associated with delayed assumption of the demersal habitat and that this represents neoteny.

(K.W.A.) BIOLOGICAL SCIENCES AND CENTER FOR COASTAL AND ENVIRONMENTAL STUDIES, RUTGERS UNIVERSITY, NEW BRUNSWICK, NEW JERSEY 08903; (D.F.M.) HUNTSMAN MARINE LABORATORY, ST. ANDREWS, NEW BRUNSWICK E0G 2X0, CANADA; (M.P.F.) NATIONAL MARINE FISHERIES SERVICE, NORTHEAST FISHERIES CENTER, SANDY HOOK LABORATORY, HIGHLANDS, NEW JERSEY 07732.

Scorpaeniformes: Relationships

B. B. WASHINGTON, W. N. ESCHMEYER AND K. M. HOWE

THE order Scorpaeniformes is a large, morphologically diverse group containing about 20 families (depending on classification used), 250 genera, and over 1,000 species. The order is defined by the presence of a suborbital stay, a posterior extension of the third infraorbital bone which in nearly all species is firmly attached to the preopercle. Infraorbital bones for many scorpaeniform groups were discussed most recently by Poss (1975). Many workers have suggested that the stay may have evolved independently (Matsubara, 1943; Quast, 1965; Greenwood et al., 1966; Poss, 1975; and Nelson, 1976).

RELATIONSHIPS

The higher classification of the Scorpaeniformes remains controversial and uncertain, both in terms of monophyly and in the definition of families and their relationships. Confusion exists not only at the subordinal levels, but also at lower taxonomic levels. For example, between 1 and 17 families of cottids have been recognized by previous workers.

Two workers presented hypotheses of relationships within the Scorpaeniformes. Matsubara (1943), in a detailed study of Japanese scorpaenoids based on osteological and anatomical characters, briefly treated relationships of scorpaenoids to other scorpaeniforms. His graphic presentation of relationships is shown in Figure 240. Several lineages are recognizable: 1) the Hexagrammidae, Anoplopomatidae, and "generalized" scorpaenids; 2) Peristediidae, Triglidae, and Dactylopteridae; 3) "specialized" scorpaenids, Bembridae, Platycephalidae, and Hoplichthyidae; 4) Cottidae and Agonidae; and, 5) Cyclopteridae and Liparididae. In 1955, Matsubara refined his hypothesis of relationships and presented a classification with categories equivalent to three suborders, several superfamilies and included families as follows:

- Cottida
 - Cottina
 - Scorpaenicae
 - Scorpaenidae, Synanceiidae, Congiopodidae
 - Hexagrammicae
 - Anoplopomatidae, Hexagrammidae
 - Platycephalicae
 - Parabembridae, Bembridae, Platycephalidae, Hoplichthyidae
 - Cotticae
 - Cottidae, Psychrolutidae
 - Agonicae
 - Agonidae, Aspidophoridae
 - Triglicae
 - Triglidae, Peristediidae
 - Dactylopterina
 - Cephalacanthidae
 - Cyclopteridae
 - Cyclopteridae, Liparididae

Quast (1965) presented a notably different hypothesis of re-

lationships of the scorpaeniforms. His work was based on characters which were useful in comparisons with the hexagrammids and included many characters taken from the earlier works of Gill (1888), Regan (1913a) and Berg (1940). Quast proposed that the Scorpaeniformes included three basic lineages: 1) the cottid-hexagrammid (including the Cyclopteridae and Agonidae); 2) the anoplopomatid; and, 3) the scorpaenoid (including all other families). Quast (1965) did not incorporate his recommended revisions in his formal synopsis of scorpaeniforms because he believed that the cottoids and anoplopomatids were still in need of intensive study.

Several studies of particular character complexes have also contributed to understanding of relationships within the order. Freihofer (1963), in a study of patterns of the ramus lateralis accessorius and associated nerves in teleosts, found three patterns of nerves in scorpaeniforms which suggested three groups: 1) the Scorpaenidae and Synanceiidae; 2) the Hexagrammidae, Cottidae, and Liparididae; and, 3) the Anoplopomatidae. These groupings seem to support Quast's hypothesis of relationships but many families were not examined by Freihofer. Hallacher (1974) provided a summary of gasbladder muscles in the scorpionfish genus *Sebastes* and included observations on other scorpaeniforms. Matsubara (1943) treated this feature for Japanese scorpaenoids. Hallacher recognized four states of the extrinsic muscle in scorpaeniforms. His characters were based on the connections, or lack of connections, of this muscle between the cranium, pectoral girdle, vertebral column, and the gasbladder. His observations partially supported Matsubara's hypothesis of scorpaeniform lineages.

Scorpaeniform fishes have been considered as pre-perciforms or as perciform derivatives but their relationship to other fishes remains uncertain. Many workers have argued that the Scorpaeniformes evolved from a "generalized" perciform ancestor because of striking similarities in general body form, and anatomical and osteological characters of generalized scorpaenids and perciforms (Gill, 1888; Regan, 1913a; Taranets, 1941; Matsubara, 1943; Gregory, 1959; Quast, 1965; Gosline, 1971; Lauder and Liem, 1983). Others (Greenwood et al., 1966; Nelson, 1976) have tentatively placed the Scorpaeniformes as a distinct pre-perciform group of the Acanthopterygians.

As previously mentioned, several authors have suggested that the Scorpaeniformes may be polyphyletic and hence, derived from several groups. Greenwood et al. (1966) noted that some scorpaeniforms share similarities of the parietals and cheek muscles with cods, while others share similarities with toadfishes, and still others with perciforms. Freihofer (1970), on the basis of nerve evidence, suggested that gobiesocids were related to cottoids, especially liparidids. Although several authors have suggested that the suborbital stay may have evolved more than once in the Scorpaeniformes, little consideration has been given to the hypothesis that other groups of fishes may have lost the suborbital stay. Within the Scorpaeniformes, several groups show a reduction or loss of the suborbital stay. Groups which have lost the circumorbital bones, and possibly a suborbital stay (e.g. gobiesocids, callionymids, lophiiforms

and gobioids) should not be excluded from consideration of relationships to some scorpaeniform groups.

In summary, the limits of the order, suborders, families and distribution of families in the suborders are the subject of considerable disagreement among current workers. These problems will not be resolved without a worldwide revision of the order. At this point, we assume that the order is monophyletic. For the purposes of summarizing information on this order, we treat two broad suborders: the Scorpaenoidei and the Cottoidei. We consider these groups as a convenient way to discuss disagreements in classification of specific groups and hypotheses of relationships; we do not propose that they are monophyletic groups.

Suborder Scorpaenoidei

For this paper, we recognize the Scorpaenoidei to include the following families: Scorpaenidae (broad sense of Matsubara, 1943), Triglidae, Peristediidae, Bembridae, Platycephalidae, Hoplichthyidae, and Dactylopteridae. Some of these families have been assigned to separate suborders or superfamilies and the dactylopterids have often been placed in a separate order (Quast, 1965; Nelson, 1976; Lauder and Liem, 1983).

Meristic features and approximate number of species for included groups are provided in Table 111. Data have been drawn from many sources and may not be complete for some genera or may omit extremes found in abnormal individuals.

Matsubara's work (1943) is the most thorough study of scorpaenoids to date. His hypothesis of relationships (Figure 240) is based on a wide variety of characters including those of the infraorbital bones, suspensorium, hyoid apparatus, cranium, pectoral girdle and gasbladder. Matsubara included 14 subfamilies in his family Scorpaenidae. He recognized three large generic groups or lineages within the scorpaenoids which he labeled: *Sebastes*-stem, *Scorpaena*-stem and *Cocotropus*-stem. His *Sebastes*-stem contains two subfamilies, the Sebastinae and Neosebastinae which were viewed as the most primitive or "generalized" of the scorpaenoids. His second group, the *Scorpaena*-stem, includes five subfamilies: Scorpaeninae, Pteroinae, Setarchinae, Sebastolobinae, and Plectrogeninae. The third group, the *Cocotropus*-stem, includes six subfamilies: Apistinae, Congiopinae, Aploactinae, Minoinae, Pelorinae, and Erosinae. The latter two groups were considered "specialized" or derived relative to the *Sebastes*-stem. Other workers (Greenwood et al., 1966; Nelson, 1976; Poss and Eschmeyer, 1978) have departed from Matsubara's classification of the Scorpaenidae by elevating some subfamilies of Matsubara to family status. In addition, the Congiopodidae [but not Matsubara's Congiopinae (sic)] has been recognized as a separate family in a monotypic suborder by Greenwood et al. (1966) and Nelson (1976) and as a superfamily by Quast (1965). Other scorpaenoid groups not treated by Matsubara (1943) have been given separate status within the Scorpaenoidei by the aforementioned workers, and include the Caracanthidae and Pataecidae. In his later work on fish hierarchy, Matsubara (1955) recognized three families of scorpaenoids which basically correspond to his earlier three "stem" groups.

We basically follow the phylogenetic hypotheses of Matsubara (1943, 1955) in presenting general trends in relationships within the suborder. The following discussion highlights groups where problems or disagreements about relationships are persistent. A phylogenetic approach based on information presented here would result in family and subfamily lines being interpreted quite differently. However, we believe presentation of a new

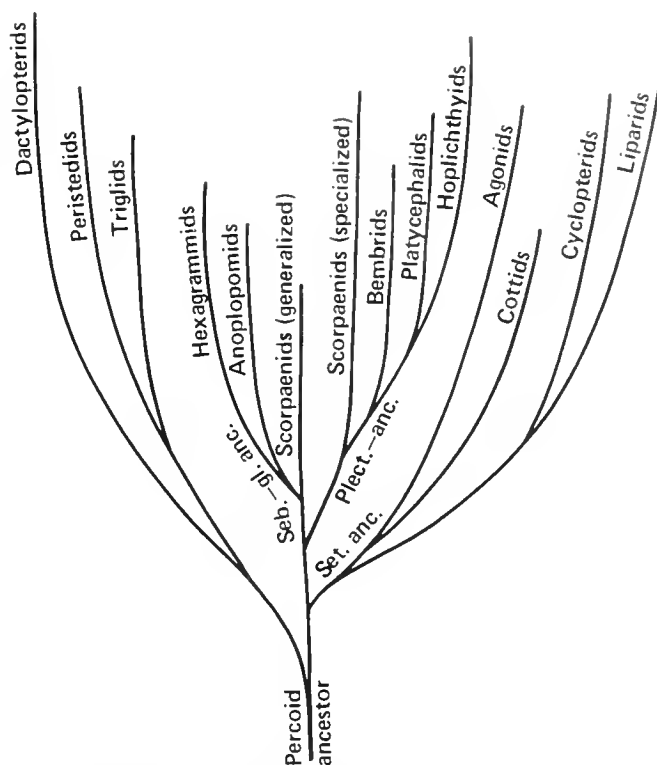

Fig. 240. Schematic representation of scorpaeniform relationships from Matsubara (1943).

classification is premature; a thorough study of the scorpaenoids is required on a worldwide basis.

The Sebastinae is currently considered to be the most primitive or generalized group of scorpaenoids because of the incomplete suborbital stay in *Sebastes*, weak head spination, and general body plan similar to the percoids (Matsubara, 1943 and others). Matsubara (1943) proposed that *Sebastes* was the most generalized genus within the subfamily with a transition series to *Helicolenus*. Eschmeyer and Hureau (1971) and Barsukov (1973) believed that Matsubara's transition series is reversed with *Helicolenus* the most generalized genus and *Sebastes* being a relatively derived form.

The subfamily Scorpaeninae with its 150 genera is considered a "catch-basket" subfamily, and there is no certainty that it is monophyletic.

Matsubara (1943) noted that the Setarchinae lack a basisphenoid as do cottoids and that the second and third actinosts intervened between the hypercoracoid and hypocoracoid. He concluded from these observations that the Setarchinae and cottoids shared a common ancestor. However, Eschmeyer and Collette (1966) disagree. In their review of the Setarchinae, a small basisphenoid, connected only by cartilage, was found in cleared and stained specimens; they stated that Matsubara's conclusion was untenable.

Matsubara (1943) suggested that the genus *Sebastolobus* was closely related to the genus *Plectrogenium* (subfamily Plectrogeninae) because of their shared lack of gasbladders, notched pectoral fins and prominent rows of spines along the sides of their head. He further noted (1943:160): that "*Plectrogenium*

TABLE III. MERISTIC FEATURES FOR SUBORDER SCORPAENOIDEI. Parentheses show rarer counts; abnormal specimens not included.

Taxon	[Genera] Species	Dorsal fin rays			Anal fin rays		Pectoral rays	Pelvic rays	Vertebrae
		Spines	Soft rays	Total	Spines	Soft rays			
Scorpaenidae									
Sebastinae									
<i>Helicolenus</i>	12	(11) 12 (13)	11-14	23-26	3	5-6	(17) 18-20	1 + 5	25
<i>Hozukius</i>	2	12	11-12	23-24	3	6	18	1 + 5	(25) 26
<i>Sebastiscus</i>	4	(11) 12 (13)	11-13	22-25	3	(4) 5 (6)	17-19	1 + 5	25 (26)
<i>Sebastes</i>	110	(12) 13-16	11-17	24-30	3	5-10	15-21	1 + 5	(25) 26-31
Scorpaeninae	[15] 150	12-13	8-10	21-23	3	5	14-21	1 + 5	24
Sebastolobinae									
<i>Adelosebastes</i>	1	13	13	26	3	5	21	1 + 5	26
<i>Trachyscorpia</i>	2	12-13	8-9	20-22	3	5	20-24	1 + 5	25-26
<i>Sebastolobus</i>	2	15-17	8-10	23-27	3	(4) 5 (6)	20-24	1 + 5	27-30
Plectrogeninae	[1] 2	12	(6) 7	(18) 19	3	5	20-24	1 + 5	26
Pteroinae	[5] 17	12-13	9-12	22-24	2-3	5-9	13-21	1 + 5	24
Setarchinae	[3] 5	(11) 12 (13)	9-10 (11)	21-23	2-3	5-6 (7)	19-25	1 + 5	24
Neosebastinae	[2] 12	13	(6) 7-8 (9)	19-22	3	(5) 6	19-23	1 + 5	25-26
Apistinae									
<i>Apistus</i>	1-2	14-16	8-10	23-25	3	6-8	10-12 + 1	1 + 5	(25) 26
<i>Cheroscorpaena</i>	1	13	7-9	20-22	3	6-7	9 + 3	1 + 5	26
Minomae	[1] 10	8-11 (12)	(8) 9-14	19-24	2	7-11	11 + 1	1 + 5	(24) 25-27
Choridactylinae									
<i>Choridactylus</i>	2	12-15	8-9 (10)	21-23 (24)	2	8-10	9 + 3	1 + 5	26-28
<i>Inimicus</i>	8	15-18	(5) 6-9	23-26 (27)	2	8-13	10 + 2	1 + 5	27-30
Synanceiinae									
<i>Synanceia</i>	4-5	(12) 13-14 (15)	4-7	18-20	3	4 (5)*-6 (7)*	11-19	1 + 4-5	24
<i>Erosa</i>	1	14	5-6	19-20	3	5-6	14-16	1 + 4	(24) 25 (26)
<i>Dampierosa</i>	1	12 (?13)	(8) 9	21	2	6	12	1 + 4	—
<i>Pseudosynanceia</i>	1	(15) 16-17	4*-6*	19*-21*	3	7*-8*	14-15 (16)	1 + 3	26-27
<i>Leptosynanceia</i>	1	16	5*	21	3-4	5*-6*	13-15	1 + 4	28
<i>Trachicephalus</i>	1	(11) 12 (13)	12*-14*	24*-26*	2	12*-14*	14-15	1 + 5	(28) 29 (30)
Tetrarogidae¹									
<i>Ablabys</i>	3	15-17	7-11	23-27	3	5-9	11-13	1 + 5	26-28
<i>Centropogon</i>	3	15-16	7-9	23-24	(2) 3	5 (6)	13-15	1 + 5	26-27
<i>Cocotropsis</i>	1	14-16	5-6	19-22	3	(3) 4 (5)	11	1 + 3	25-27
<i>Cottapistus</i>	1	13-15	5-7	18-21	3	5-6	(13) 14 (15)	1 + 4	(24) 25
<i>Glyptauchen</i>	1	16-18	6-7	23-25	3	5	13-15	1 + 5	26-28
<i>Gymnapistes</i>	1	13-14	7-9	20-22	3	5-6	11-12	1 + 5	27-29
<i>Liocrannum</i>	1	13-14	6-9	20-22	3	5-6	13-15	1 + 4	24-25
<i>Neocentropogon</i>	4	13-15	7-8	20-22	3	5-7	13-16	1 + 5	25
<i>Notestes</i>	1	14-16	8-10	22-25	3	5	11-14	1 + 5	27-28
<i>Ocosia</i>	6	14-17	7-9	23-24	3	5	12-13	1 + 5	26-30
<i>Paracentropogon</i>	2-4	13-15	6-8	20-22	3	(3) 4 (5)	9-12	1 + 4	25-27
<i>Richardsonichthys</i>	1	12-13	5-8	18-20	3	(5) 6-7	14-16	1 + 5	24-25
<i>Snyderina</i>	2	12-14	10-11	22-24	3	5-6	13-15	1 + 5	24-28
<i>Tetraroge</i>	2	13 (14)	6-9	20-22	3	(4) 5 (6)	11-12	1 + 5	24-26
<i>Vespicula</i>	ca. 5	3 + 8-13	3-8	18-21	3	3-5	10-14	1 + 5	24-26
Paetaecidae¹									
<i>Aetapcus</i>	3	19-22	11-13	30-34	7-9	4-5	8	0	35-37
<i>Neopataecus</i>	1	19-23	7-10	29-31	5-7	3-4	8	0	34-37
<i>Pataecus</i>	1	22-25	14-17	38-40	9-11	4-7	8	0	41-44
Gnathanacanthidae¹									
<i>Gnathanacanthus</i>	1	11-13	9-11	20-23	3	8-9	10-12	1 + 5	28-30
Congiopodidae¹									
<i>Alertichthys</i>	1	14-16	10-13	26-27	2	7-9	9	1 + 5	30-31
<i>Congiopodus</i>	4?	16-20	11-14	28-33	0-2	7-10	(8) 9	1 + 5	36-38
<i>Perryena</i>	1	14-15	8-9	23-24	3	5-6	12	1 + 5	28
<i>Zanchlorynchus</i>	1	7-9	12-14	19-22	0	8-10	8-9	1 + 5	36
Aploactinidae²									
<i>Acanthosphex</i>	1+	11-13	7-11	19-22	1 (2)	6-8	9-10	1 + 2	24-26
<i>Adventor</i>	1	3 + 10	7-9	21-23	1	8-10	12-14	1 + 2	27 (28)
<i>Aploactis</i>	1	12-15	11-15	24-28	1-3	10-12	11-14	1 + 2	28-30
<i>Aploactisoma</i>	1	13-15	12-16	26-29	1	9-13	10-11	1 + 2	30-33
<i>Bathyploactis</i>	2	14-15	7-9	21-23	3-4	5-9	10-12	1 + 2	25-28
<i>Cocotropus</i>	10	12-15	7-12	19-24	1-2	6-9	11-14	1 + 3	25-28

TABLE III. CONTINUED.

Taxon	[General] Species	Dorsal fin rays			Anal fin rays		Pectoral rays	Pelvic rays	Vertebrae
		Spines	Soft rays	Total	Spines	Soft rays			
<i>Erisphex</i>	3+	10-12 (13)	9-16	21-28	1 (2)	9-15	11-15	1 + (1) 2	27-31
<i>Eschmeyer</i> ***	1	8	13	21	3	8	19-20	1 + 3	24
<i>Kanekoma</i>	3	11-13	7-10	20-22	1 (2)	7-9	13-16	1 + (1) 2	25-26
<i>Neaploactis</i>	1	4 + 7 + 1	9-10	21-22	1 (2)	7-9	12	1 + 3	26
<i>Paraploactis</i>	7	12-15	8-11	22-24	1 (2)	7-10	13-15	1 + 3	26-28
<i>Peristrominous</i>	1	12-13	10-11	22-24	0-2	7-10	14-15	1 + 3	26-27
<i>Prosoproctus</i>	1	12	8	20	2	7	13	1 + 3	26
<i>Ptarmus</i>	2	13-16	7-10	21-23	2	4-7	9-10	1 + 2	25-30
<i>Sthenopus</i>	1	3 + 9	8-10	20-22	1	7-9	14-15	1 + 2	26
<i>Xenaploactis</i>	3	3 + 9-10	8-9	21-22	1	9-10	14-15	1 + 3	27-28
Caracanthidae	[1] 4	6-8	11-14	18-23	2	11	12-15	1 + 2-3	24
Triglidae	[ca. 10] 80	7-11	10-19	18-26	0-1	11-18	11-16 + 3	1 + 5	34-38
Peristediidae	[3] 40	7-9	16-23	24-31	0	16-23	+2	1 + 5	
Bembridae									
<i>Parabembras</i>	1	9; 11-12	8-9	18; 20	3	5	21	1 + 5	26
<i>Bembradon</i>	1	6	14	20	0	14*-15*	23	1 + 5	
<i>Bembras</i>	1	10-11	12	21	0	14*-15*		1 + 5	
<i>Bembradium</i>	1	8-9	12	20-21	0	10*-11*	24-27	1 + 5	26
Platycephalidae	[18] 60	6-9 (10)	11-15	18-23	0-1	10-14	16-22	1 + 5	27
Hoplichthyidae	[1] 10	5-6	14-16	19-21	0	16-18	13-14 + 3-4	1 + 3-5	26
Dactylopteridae									
<i>Dactylopterus</i>	1	7	8	15	0	6*	34-37	1 + 4	22
<i>Dactyloptena</i>	6	7*-8**	8 (9)	15 (16)	0	6 (7)*	28-35	1 + 4	22

* Last ray single (usual condition is a double ray).

** 1 + 0 + V + I or I + 1 + V + I = 7-8 spines

*** Placement uncertain

¹ Data supplied by Poss

² From Poss (1982)

nanum is closely related to the bembrids," and that "it is very probable, therefore, that the platycephalids, bembrids and hoplichthyids arose from an ancestor not very unlike the scorpaenid, *Plectrogenium nanum*." Matsubara and Ochiai (1955) present additional characters which support this view. Other characters observed by one of us (WNE) which support this conclusion include, "similar caudal skeletons and scales" [comparison of bembrid *Parabembras curtis* (SU 49456, cleared and stained) and *Plectrogenium*]. At present, this available evidence suggests that the scorpaenid subfamilies Sebastolobinae and Plectrogeninae and the families Bembridae, Platycephalidae and Hoplichthyidae may form a monophyletic assemblage.

Another scorpaenid subfamily, the Apistinae, also has questionable relationships within the family. Matsubara (1943) placed *Apistus* at the base of his *Cocotropus* stem which led to a number of specialized scorpaenid groups. However, the Apistinae have a "unique", bilobed gasbladder with an intrinsic muscle, unlike other scorpaenids (Matsubara, 1943; Hallacher, 1974). The triglids and peristediids possess a similar gasbladder. Other characters which appear to unite the Apistinae, Triglidae, and Peristediidae include elongate pectoral fin rays, 1 to 3 lower free pectoral fin rays (1 in *Apistus*, 3 in *Cheroscorpaena*, 3 in triglids, and 2 in peristediids) and shape and expansion of the head bones (especially the infraorbital bones). These characters suggest that the scaled, less bony-headed Apistinae may be the primitive sister group of the Triglidae and Peristediidae. This would involve the independent development of a moveable, preorbital bone with long spine in the Apistinae. If, in fact, the Apistinae forms part of a monophyletic assemblage with the triglids and peristediids, a change in classification would be warranted.

Matsubara (1943) recognized five Japanese genera within his subfamily Congiopinae (sic) which more recently have been placed in the tentative scorpaenid subfamily, Tetraroginae (Poss and Eschmeyer, 1975; see also Smith, 1958b). The presently recognized Congiopodidae is considered to contain 7 to 9 species, all of which are confined to the Southern Hemisphere (Moreland, 1960; Hureau, 1971). Moreland (1960:241) stated: "the Congiopodidae show relationship with the Scorpaenidae, particularly with *Snyderina* and *Ocosia* from Japan [studied by Matsubara (1943)], and are clearly derived from a scorpaenid stock of perhaps Indo-Pacific origin."

We tentatively include the Dactylopteridae in our discussion of the Scorpaenoidei, however relationships of these fishes remain uncertain. They have been variously placed in their own order (Regan, 1913a; Berg, 1940; Greenwood et al., 1966; Lauder and Liem, 1983) and as a suborder of the Scorpaeniformes (Gill, 1888; Nelson, 1976). Many workers have noted that the dactylopterids differ markedly from scorpaeniformes in a number of osteological characters such as: 1) nasals fused into a median plate; 2) very large extrascapulars; and, 3) mesethmoid and intercalary absent.

Matsubara (1943) suggested that despite these notable differences, the dactylopterids possess the characteristic suborbital arrangement of bones of the generalized scorpaenids and triglids. Accordingly, Matsubara (1943) placed them near the triglids and peristediids, evolving from a generalized scorpaenid ancestor. One of us (WNE) has noted that the gasbladders of the triglids and dactylopterids appear to be similar, with anterior and posterior lobes and very large intrinsic muscles (see Evans, 1973, for information on triglids). In dactylopterids the gas-

TABLE 112. MERISTIC FEATURES FOR SUBORDER COTTOIDEI. Dashes [—] indicate data not available.

Genera	No. of species	Dorsal fin		Anal fin		Pectoral fin	Pelvic fin	Vertebrae	References
		Spines	Rays	Spines	Rays				
Agonidae									
<i>Agonomalus</i>	4	8-10	5-8	0	11-12	11-12	I, 2	—	Howe ¹
<i>Agonopsis</i>	3	6-11	6-9	0	7-12	12-15	I, 2	39-42	Howe ¹
<i>Agonus</i>	7	5-11	5-14	0	5-17	13-19	I, 2	36	Howe ¹
<i>Anoplagonus</i>	2	0	4-6	0	4-5	8-12	I, 2	41-45	Howe ¹
<i>Aspidophoroides</i>	3	0	4-7	0	4-7	9-16	I, 2	38-40	Howe ¹
<i>BathYGONUS</i>	4	5-8	5-8	0	5-9	14-16	I, 2	40-46	Howe ¹
<i>Bothragonus</i>	2	2-5	4-6	0	4-6	10-12	I, 2	31-38	Howe ¹
<i>Brachyopsis</i>	2	7-9	7-9	0	10-14	14-15	I, 2	—	Freeman, 1951
<i>Hypsagonus</i>	2	7-11	5-7	0	9-11	12-14	I, 2	36	Howe ¹
<i>Ocella</i>	6	7-13	6-9	0	7-18	14-18	I, 2	33-39	Howe ¹
<i>Odontopyxis</i>	1	3-6	5-7	0	5-7	12-15	I, 2	37-42	Howe ¹
<i>Pallasina</i>	3	5-9	6-9	0	9-14	10-13	I, 2	45-47	Howe ¹
<i>Percis</i>	2	5-7	5-9	0	7-9	11-12	I, 2	42	Howe ¹
<i>Sarritor</i>	2	6-9	5-8	0	6-8	13-17	I, 2	—	Howe ¹
<i>Stellerina</i>	1	6-8	5-8	0	7-9	16-19	I, 2	34-37	Howe ¹
<i>Tulesina</i>	2	19-21	7-10	0	25-28	15-16	I, 2	—	Freeman, 1951
<i>Veneretmus</i>	4	5-9	6-9	0	5-9	12-17	I, 2	39-43	Howe ¹
Anoploomatidae									
<i>Anoplopoma</i>	1	17-30	16-21	III	15-19	—	I, 5	61-66	Richardson and Washington, 1980; Andriashev, 1954; Miller and Lea, 1972; Howe ¹
<i>Erilepis</i>	1	12-14	16-20	III	11-14	16-19	I, 5	45-46	Andriashev, 1955a
Comephoridae									
<i>Comephorus</i>	2	6-9	28-34	0	27-36	10-15	—	48-50	Taliev, 1955
Cottidae									
<i>Aleichthys</i>	1	9-10	14-17	0	13-16	15-16	I, 2-3	33-36	Watanabe, 1960
<i>Antipodocottus</i>	2	8	14-15	0	11-12	18-19	I, 2	—	Nelson, 1975
* <i>Archaulus</i>	1	9-10	28-29	0	22-23	16	I, 3	—	Howe ¹
<i>Archistes</i>	1	10	23	0	18	15-16	I, 3	—	Jordan and Gilbert, 1899
<i>Argyrocottus</i>	1	8-9	14-19	0	11-16	13-14	I, 2-3	35-36	Watanabe, 1960
* <i>Artdiellchthys</i>	1	7-9	12-13	0	9-11	21-23	I, 3	—	Howe ¹
* <i>Artdiellina</i>	1	—	—	—	—	—	—	—	—
<i>Artdielliscus</i>	1	—	—	—	—	—	—	—	—
<i>Artdiellus</i>	15	6-9	11-14	0	10-14	20-24	I, 3	28-30	Howe ¹ ; Leim and Scott, 1966
<i>Artdius</i>	7	7-10	12-18	0	9-14	13-17	I, 2-3	30-35	Howe and Richardson, 1978; Washington, 1981
<i>Ascelchthys</i>	1	7-10	17-19	0	13-16	16-18	0	33-36	Howe and Richardson, 1978
<i>Asemichthys</i>	1	9-11	14-16	0	15-16	16-18	I, 3	33-35	Howe and Richardson, 1978
<i>Astrocottus</i>	2	7-10	12-14	0	10-12	15-17	I, 2-4	28-29	Watanabe, 1960, 1976
<i>Bero</i>	1	9-10	15-16	0	13-15	15-16	I, 2	32-35	Watanabe, 1960
<i>Blepsias</i>	2	6-10	20-26	0	18-22	11-17	I, 3	37-39	Howe and Richardson, 1978; Watanabe, 1960
<i>Chitonotus</i>	1	8-11	14-17	0	14-17	16-18	I, 2-3	35-36	Howe and Richardson, 1978
<i>Chinocottus</i>	5	7-10	13-17	0	9-14	12-15	I, 3	31-35	Howe and Richardson, 1978; Washington, 1981
<i>Cottusculus</i>	3	7-10	11-15	0	9-15	19-22	I, 3	24-29	Watanabe, 1960
<i>Cottus</i>	35±	4-10	14-23	0	10-18	10-19	I, 2-5	31-39	Howe ²
* <i>Crossias</i>	1	8-10	17-20	0	10-16	14-16	I, 3	—	Soldatov and Lindberg, 1930; Watanabe, 1960
* <i>Daruma</i>	1	8-10	13	0	12	16	I, 2	—	Watanabe, 1960
* <i>Enophrys</i>	6	7-9	9-14	0	6-13	15-19	I, 3-4	29-33	Sandercock and Wilmovsky, 1968; Howe and Richardson, 1978
<i>Furcina</i>	2	8-11	15-20	0	13-18	13-15	I, 2	32-37	Watanabe, 1960
<i>Gymnocanthus</i>	6	9-12	13-18	0	14-20	15-21	I, 3	33-40	Howe and Richardson, 1978; Leim and Scott, 1966; Watanabe, 1960; Wilson, 1973
<i>Hemulepidotus</i>	6	8-11	18-20	0	13-16	14-17	I, 4	35-37	Howe and Richardson, 1978
<i>Hemuripierus</i>	3	11-19	11-14	0	12-15	18-22	I, 3	37-41	Howe and Richardson, 1978; Leim and Scott, 1966
<i>Icelinus</i>	9	8-12	12-18	0	10-17	15-19	I, 2	33-39	Howe and Richardson, 1978; Yabe et al. 1980; Peden, 1981
* <i>Icelus</i>	13	7-10	17-24	0	13-20	17-20	I, 3	37-44	Howe ¹
<i>Jordana</i>	1	17-18	15-18	0	22-24	13-15	I, 4-5	46-48	Howe and Richardson, 1978

TABLE 112. CONTINUED.

Genera	No. of species	Dorsal fin		Anal fin		Pectoral fin	Pelvic fin	Vertebrae	References
		Spines	Rays	Spines	Rays				
<i>Leiocottus</i>	1	9-10	16-17	0	15-20	18	1, 3	35-36	Howe and Richardson, 1978
<i>Leptocottus</i>	1	6-8	15-20	0	15-20	17-20	1, 4	35-39	Howe and Richardson, 1978
<i>Megalocottus</i>	2	8-10	12-15	0	11-13	16-18	1, 3	—	Howe ¹ ; Soldatov and Lindberg, 1930
<i>Mesocottus</i>	1	8-9	14-15	0	10-12	—	1, 3-4	—	Soldatov and Lindberg, 1930
<i>Microcottus</i>	1	7-9	12-14	0	10-12	14-17	1, 3	32-34	Howe ¹
<i>Myoxocephalus</i>	18	8-12	10-20	0	8-16	14-19	1, 3	34-46	Howe ² ; Andriashev, 1954
<i>Nautichthys</i>	3	7-10	19-30	0	14-21	13-17	1, 3	35-41	Peden, 1970
<i>Ocynectes</i>	2	9-13	12-17	0	6-11	13-15	1, 2	29-31	Watanabe, 1960
<i>Oligocottus</i>	4	7-10	15-20	0	9-15	12-15	1, 3	33-37	Washington, 1981; Howe and Richardson, 1978
<i>Orthonopias</i>	1	8-9	15-18	0	12-15	13-15	1, 3	33-35	Howe and Richardson, 1978
<i>Parcelinus</i>	1	12-13	19-20	0	23-24	14-15	1, 5	42	Howe and Richardson, 1978
<i>Phallocottus</i>	1	10-12	22-24	0	22-25	14-16	1, 3	—	Howe ¹
<i>Porocottus</i>	6	8-10	13-18	0	11-18	13-19	1, 3	34-38	Howe ¹ ; Andriashev, 1954; Watanabe, 1960
<i>Pseudoblennius</i>	6	8-11	15-21	0	12-18	13-16	1, 2	32-38	Watanabe, 1960
<i>Radulinopsis</i>	2	9-10	14-15	0	14-15	16-17	1, 3	—	Soldatov and Lindberg, 1930
<i>Radulinus</i>	5	8-11	20-23	0	21-25	17-20	1, 3	38-40	Howe and Richardson, 1978
<i>Rhamphocottus</i>	1	7-9	12-14	0	6-8	14-16	1, 3-4	26-28	Howe and Richardson, 1978
<i>Ricuzenius</i>	2	8-11	14-20	0	10-19	15-19	1, 2-3	28-32	Watanabe, 1960, 1976; Jordan and Starks, 1904
<i>Scorpaenichthys</i>	1	8-12	15-19	0	11-14	14-16	1, 4-5	35-37	Howe and Richardson, 1978
<i>Sigmistes</i>	2	8-10	19-26	0	14-20	13-15	1, 3	34-36	Howe and Richardson, 1978
<i>Stelgistrum</i>	2	8-9	17-19	0	12-14	14-16	1, 3	36	Howe ¹
<i>Sternias</i>	1	10-11	22-24	0	22-24	16-18	1, 3	44-46	Howe and Richardson, 1978
<i>Silegicottus</i>	1	9	19	0	17	18	1, 3	—	Howe and Richardson, 1978
<i>Silengis</i>	3	7-11	13-16	0	11-15	11-20	1, 2	29-35	Watanabe, 1960
<i>Synchurus</i>	1	8-10	19-21	0	18-21	21-24	1, 3	38-39	Howe and Richardson, 1978
* <i>Taurocottus</i>	2	11	15-16	0	12-13	19	1, 3	—	Howe ¹ ; Taranetz, 1935
<i>Thecopterus</i>	1	10	14	0	11	20	1, 2	—	Howe ¹
<i>Thyriscus</i>	1	10	21	0	17	15	1, 3	38-39	Howe ¹
<i>Trachydermus</i>	1	8	18-19	0	16-17	16-17	1, 4	34-36	Watanabe, 1960
<i>Triglops</i>	9	9-13	20-32	0	19-32	15-24	1, 3	44-54	Howe ¹ ; Andriashev, 1954; Watanabe, 1960; Leim and Scott, 1966
<i>Velltor</i>	1	10	18-20	0	17-20	13-15	1, 2	36-39	Watanabe, 1960
<i>Zesticeilus</i>	1-2	5-7	10-13	0	8-11	19-21	1, 2-3	25-26	Howe and Richardson, 1978
Cottocomphoridae									
<i>Asprocottus</i>	5	5-8	12-17	0	11-16	13-17	1, 3-4	30-34	Taliev, 1955
<i>Abyssocottus</i>	5	3-7	10-16	0	8-15	12-18	1, 2-3	31-34	Taliev, 1955
<i>Batrachocottus</i>	4	5-8	14-19	0	10-15	14-19	1, 3	32-37	Taliev, 1955
<i>Cottunella</i>	2	5-7	13-17	0	11-13	15-17	1, 3	33-34	Taliev, 1955
<i>Cottocomphorus</i>	2	7-10	17-21	0	19-22	17-21	1, 4	37-42	Taliev, 1955
<i>Metacottus</i>	1	7	19	0	13	16	1, 3	—	Taliev, 1955
<i>Paracottus</i>	4	6-9	15-20	0	12-22	16-19	1, 4	33-39	Taliev, 1955
<i>Procottus</i>	1	6-10	18-21	0	12-16	16-19	1, 3	35-37	Taliev, 1955
Erenuniidae									
<i>Ereunias</i>	1	9-11	12-15	0	11-13	14-15	0	36-39	Yabe, 1981; Watanabe, 1960, 1976
<i>Marukawickthys</i>	1	10	12-15	0	11-12	15	1, 4	34-39	Yabe, 1981; Watanabe, 1960, 1976
Hexagrammidae									
<i>Hexagrammos</i>	6	16-25	18-26	0-1**	19-26	17-21	1, 5	47-57	Kendall and Vinter, 1984; Washington and Richardson, MS
<i>Ophiodon</i>	1	25-28	19-21	3**	21-25	16-18	1, 5	56-59	Kendall and Vinter, 1984; Washington and Richardson, MS
<i>Pleurogrammus</i>	1	21-24	24-30	0-1**	23-28	23-28	1, 5	58-63	Kendall and Vinter, 1984; Washington and Richardson, MS
<i>Oxylebius</i>	1	15-17	13-16	3-4**	14-17	14-17	1, 5	36-40	Kendall and Vinter, 1984; Washington and Richardson, MS
<i>Zamolepis</i>	2	21-22	11-12	3**	18-20	14	1, 5	40-43	Kendall and Vinter, 1984; Washington and Richardson, MS
Normanichthyidae									
<i>Normanichthys</i>	1	10-11	11-12	0	14-15	17-19	1, 5	36-37	Balbontin and Perez, 1980

TABLE 112. CONTINUED.

Genera	No. of species	Dorsal fin		Anal fin		Pectoral fin	Pelvic fin	Vertebrae	References
		Spines	Rays	Spines	Rays				
Psychrolutidae									
<i>Cottunculus</i>	4	6-9	13-17	0	10-14	17-23	1, 2-3	28-29	Howe ² ; Nelson, 1982
<i>Dasycottus</i>	1-2	8-11	13-16	0	12-16	22-26	1, 3	34-35	Howe and Richardson, 1978; Nelson, 1982
<i>Ebinamia</i>	5	6-8	15-18	0	11-14	17-24	1, 3	—	Nelson, 1982
<i>Eurymen</i>	1	8	21-23	0	15-17	25-26	1, 3	38	Howe and Richardson, 1978
* <i>Malacocottus</i>	4 (?)	8-10	12-15	0	9-13	19-23	1, 3	30-33	Howe and Richardson, 1978; Nelson, 1982
<i>Neophrinichthys</i>	2	7-12	14-18	0	11-14	23-26	1, 3	31-34	Nelson, 1977
<i>Psychrolutes</i>	6	6-12	13-20	0	12-15	15-26	1, 3	33-35	Nelson, 1982; Stein and Bond, 1978

* Taxonomic status is not agreed upon by current workers

** No. of anal spines recognized varies among workers.

¹ Howe, K. Compilation of meristic data from published and unpublished sources, available from Northwest and Alaska Fisheries Center, NOAA-NMFS, Seattle, WA.

² Howe, K., unpublished data

bladder is huge, occupying much of the body cavity with anterior lobes reaching near the rear of the cranium. A more thorough study of these gasbladders is needed. Dactylopterids, in relation to triglids, have: 1) a hinged bony connection with the preopercle; 2) much heavier and more elaborate ossification of the cranium; 3) first three vertebrae elongate and modified; and, 4) reduced opercular and gill openings. Given the extreme osteological modifications of these fishes, a current working hypothesis (WNE) is that the Apistinae, triglids, peristediids and dactylopterids share a common ancestry. However, more information is needed before any formal changes are proposed.

Suborder Cottoidei

We include the following families in this group: Hexagrammidae, Zaniolepididae, Anoplopomatidae, Cottidae (broad sense), Agonidae, Cyclopteridae, and Liparididae. The limits of these families and subfamilies are not well-defined and there is considerable lack of understanding among workers in defining both family limits and those of higher categories (see Washington and Richardson, MS for review). We treat these diverse groups together in order to facilitate discussion of past classifications, not because we believe they necessarily form a monophyletic assemblage.

Meristic features and approximate number of species for included groups are provided in Table 112. Data have been compiled from many sources and may not be complete for some groups and may omit extremes found in abnormal individuals.

Matsubara (1955), in a thorough treatment of Japanese species, recognized: 1) a superfamily "Hexagrammiceae" (including Anoplopomatidae and Hexagrammidae); 2) a superfamily "Cotticeae" (including Cottidae with subfamilies and Psychrolutidae); and, 3) a superfamily "Agoniceae" (including Agonidae and Aspidophoridae). He placed the cyclopterids and liparidids in a larger division, Cyclopterina.

Quast (1965), in a treatment which focused on relationships of hexagrammid fishes, followed Regan (1913a) and Berg (1940) in recognizing a superfamily Hexagrammoidae and a superfamily Cottoideae. He separated the Cottoideae from the Hexagrammoidae on the basis of four characters: 1) lack of a basisphenoid; 2) dentigerous upper pharyngeals restricted to one or two pairs; 3) pleural ribs absent or developed on only a few posterior abdominal vertebrae; and, 4) pectoral interradial foramina small or absent. However, Quast proposed that the hexagrammids

and cottoids form a single evolutionary lineage within the Scorpaeniformes and that the Anoplopomatidae are significantly distinct from both the hexagrammid-cottid lineage and the scorpaenid lineage to warrant separate superfamily status. He further suggested that the zaniolepidids are intermediate between the hexagrammids and cottoids.

Other workers (Greenwood et al., 1966; Nelson, 1976) have placed the hexagrammids, anoplopomatids, and zaniolepidids together in the suborder Hexagrammoidei, and the cottoids (broad sense of Washington and Richardson, MS), agonids, and cyclopterids in the suborder Cottoidei. Hallacher (1974) found a cranioclavical (gasbladder) muscle present in the zaniolepidids, cottoids (broad sense), agonids, and cyclopterids. In contrast, *Hexagrammos* was found to have the scorpaenoid condition.

In the following discussion, we present information about recent studies which have helped resolve relationships within cottoid subgroups and outline groups where problems remain.

The systematic status of the Hexagrammidae is the subject of disagreement at the specific through family levels. Quast (1965) and Nelson (1976) include four genera in the Hexagrammidae—*Oxylebius*, *Ophiodon*, *Hexagrammos* (including *Agrammus*), and *Pleurogrammus*. Quast considered *Oxylebius* to be the most primitive genus because of low numbers of meristic elements and the "lack of specializations." *Hexagrammos* and *Pleurogrammus* were considered to be closely related, relatively specialized genera because of the reduction in head spination, dorsal and anal fin spines, etc.

Quast (1965) and Nelson (1976) included the two species of the genus *Zaniolepis* in the family Zaniolepididae. Other workers (Rutenberg, 1962) have included *Zaniolepis* in the family Hexagrammidae, while others (Hart, 1973) have combined *Zaniolepis* and *Oxylebius* in the family Zaniolepididae.

The Anoplopomatidae contains two monotypic genera, *Anoplopoma* and *Erilepis* (Quast, 1965; Nelson, 1976), however some workers have placed *Erilepis* in its own family, the Erilepididae.

Those families that traditionally have been placed in or near the Cottidae are not clearly defined. Previous workers have proposed between 1 and 17 families of "cottids." Greenwood et al. (1966) and Nelson (1976) recognize 7 cottid families: Cottidae, Icelidae, Cottocomephoridae, Comephoridae, Cottunculidae, Psychrolutidae and Normanichthyidae. Other workers have chosen to combine these 7 families in the single family

Cottidae, until further study can define the phylogenetic relationships or monophyletic nature of these groups (Howe and Richardson, 1978; Washington and Richardson, MS).

Yabe (1981) recognized the family Ereuniidae for the Japanese "cottid" genera *Ereunias* and *Marukawichthys*. He used derived characters such as free pectoral fin rays and associated pectoral girdle modifications to define the family. Yabe concluded that the genus *Icelus* belonged in the Cottidae. Previous workers (Matsubara, 1936; Berg, 1940; Nelson, 1976) have placed *Marukawichthys* and *Ereunias* in the family Icelidae with members of the genus *Icelus*.

Nelson (1982) has revised the 'family' Psychrolutidae which includes two subfamilies (Psychrolutinae and Cottunculinae). Nelson could not define the family as monophyletic on the basis of unique, derived characters and stated that the question of whether to include the psychrolutids in the Cottidae was subjective at this time. He rejected a close affinity between the psychrolutids and liparidids as suggested by early workers.

The families Comephoridae and Cottocomephoridae are endemic to the Lake Baikal basin (U.S.S.R.). Berg (1940) recognized each as separate families within the superfamily Cottoidae. Taliev (1955), after detailed study of the two groups, suggested that they had originated from cottid ancestors and cited as evidence their similarities to two cottid genera, *Mesocottus* and *Trachydermus*. Both Taliev (1955) and Kozhov (1963) placed the cottocomephorids in the Cottidae while the viviparous comephorids were recognized as a separate family.

The family Agonidae has been reviewed only by Freeman (1951) who suggested that the agonids were most closely related to the cottids. The family is distinct in having fused, bony plates covering the body.

Normanichthys crockeri, the sole member of the Normanichthyidae, occurs off the coasts of Peru and Chile. Its relationships are obscure. Norman (1938b) considered it to be a primitive cottid, while others (Berg, 1940; Quast, 1965) have placed it in its own family, in the superfamily Cottoidae. In addition to a different body plan, the suborbital stay of *Normanichthys* is quite distinct from other scorpaeniform fishes (Poss, 1975). Its relationships to cottoids have yet to be established.

RELATIONSHIPS BASED ON LARVAL CHARACTERS

Larvae of only about 20% of the scorpaeniform genera are known, and only recently have larvae been used in systematic studies (see Richardson, 1981a; Washington, 1981; Kendall and Vinter, 1984; Washington and Richardson, MS). The most extensive information dealing with systematic characters of scorpaeniform larvae is presented in a recent study by Washington and Richardson (MS). This work dealt with over 100 osteological characters of larval and juvenile cottids and their allies. About half of the 70 characters used in their analysis were restricted to the larval period. In general, larval characters were most useful in defining groups below the subordinal level.

Larvae of many scorpaenoid families are not yet known. Characters such as head and preopercular spination and pectoral fin length and pigmentation may be useful in future systematic analyses; however, at present, larvae of too few taxa are known to suggest relationships within the suborder Scorpaenoidei.

The results of Washington and Richardson's (MS) study, agree with those of past studies which propose that a scorpaenid-like stock was ancestral to the Scorpaeniformes and was derived

from a "generalized" perciform. Larvae of the scorpaenid genera *Sebastes*, *Sebastolobus*, and *Scorpaena* possess some characters which are but slight modifications of those possessed by some generalized percoids. In contrast, other scorpaeniform larvae examined possessed considerable modifications of these characters. These generalized scorpaenid characters include among others: presence of predorsal bones; large, fused first anal pterygiophore with three, stout anal spines; pleural ribs on abdominal vertebrae; epipleurals attached to pleural ribs; hypurals 1 + 2 partially fused; hypurals 3 + 4 partially fused; presence of a fifth hypural and parhypural; all hypural elements autogenous and a specialized neural spine on preural centrum 2. Without the suborbital stay, larvae of a scorpaenid such as *Sebastes* could easily be mistaken for those of a generalized percoid. We consider these character states to represent the plesiomorphic condition in the Scorpaeniformes.

Washington and Richardson's study focused in detail on cottoid and hexagrammoid fishes where larvae of many taxa are fairly well known. They found that the hexagrammoids exhibit many character complexes which are derived relative to the scorpaenids. These include: 1) reduced anal spines and first anal pterygiophore; 2) the pleural and epipleural ribs inserted together on the vertebral parapophyses; and, 3) the pectoral radials broadened and anvil-shaped, but with distinct foramina between them. None of these characters is unique to the larval period.

Within the taxa traditionally assigned to the Hexagrammoidei (Nelson, 1976), two monophyletic groups are recognized by Washington and Richardson (MS). The first includes the hexagrammid genera *Hexagrammos*, *Pleurogrammus*, and *Ophiodon* and the anoplopomatid genus *Anoplopoma*. This group is defined by seven autapomorphies: 1) reduced head spination; 2) prolonged chondrification; 3) a unique (within Scorpaeniformes) sequence of ossification of the vertebral centra; 4) paired first dorsal fin elements; 5) five preural centra involved in caudal fin support; 6) anterior insertion of principal caudal rays; and, 7) a high number of vertebrae and ribs. The first four characters are restricted to the larval period.

In contrast, larvae of the second group, *Oxylebius* and *Zaniolepis*, do not possess any of the synapomorphies of the first group. They do share one derived character—an unfused neural arch and spine of the first vertebral centrum. The arms of the first neural "arch" and spine remain unfused for a brief time during larval development, a unique condition among known scorpaeniform larvae. Other larval characters support the separation of these groups, but we are cautious in the interpretation of these characters. They include: 1) large versus small size at hatching; 2) neustonic versus planktonic larvae; and 3) long, slender versus deep body shape.

Washington and Richardson (MS) concluded that the first group of hexagrammoids is very distinctive and differs from all other scorpaeniforms so far examined, particularly in the mode of ossification of the vertebral column and in the number of preural centra involved in the caudal fin support. Because of the uniqueness of these characters, Washington and Richardson (MS) suggest that members of this hexagrammoid group probably comprise a separate lineage within the order, distinct from *Oxylebius* and *Zaniolepis* and the other cottoids. The second group, *Oxylebius* and *Zaniolepis*, is distinctive but appears to be closer in many characters to the scorpaenids than to other hexagrammoids.

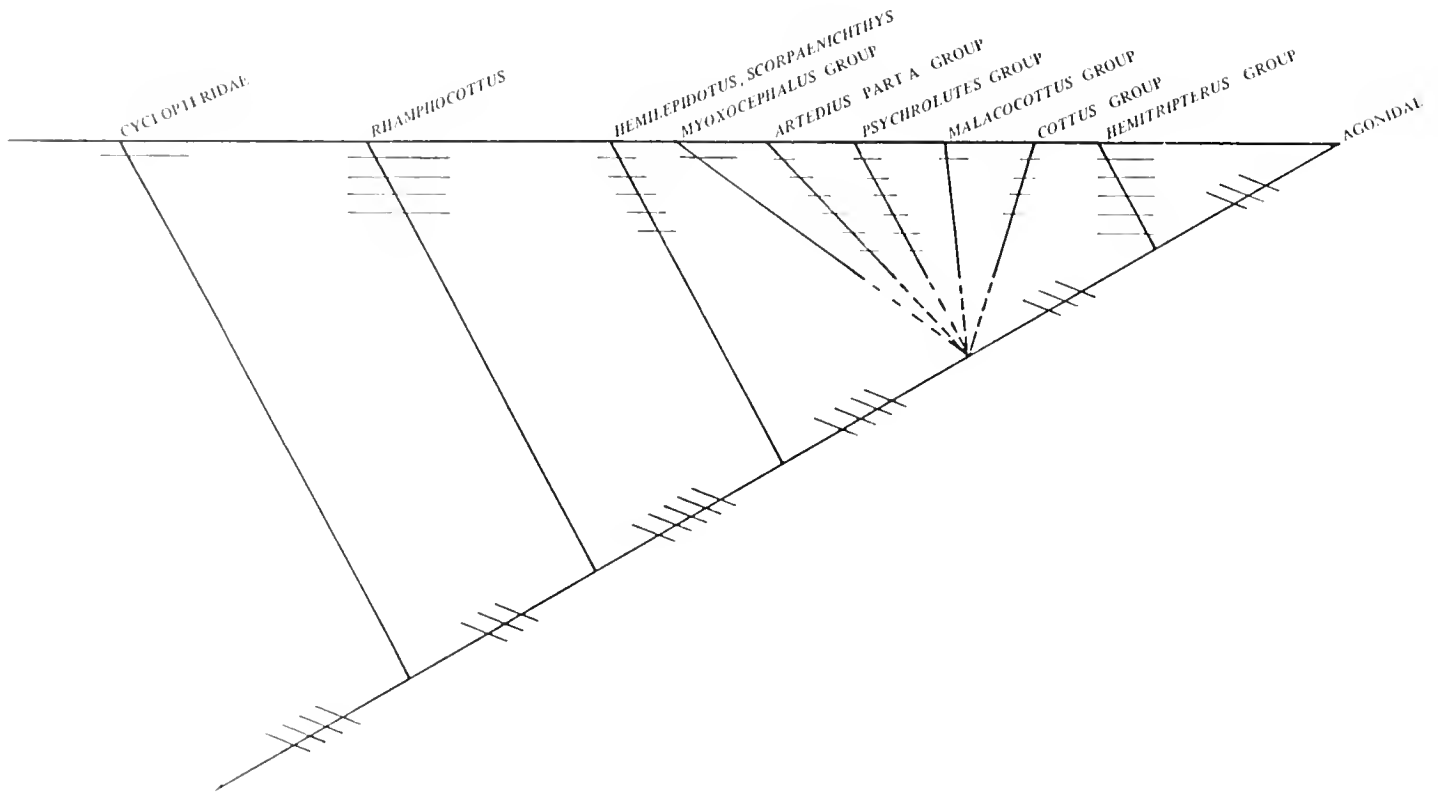

Fig. 241. Hypothesis of cottoid relationships modified from Washington and Richardson (MS).

Washington and Richardson's (MS) hypothesis of relationships among the other cottoids studied is shown in Fig. 241. Characters observed in the cottoid families, Cottidae (broad sense of Washington and Richardson, MS), Agonidae, and Cyclopteridae, are derived relative to both the scorpaenids and hexagrammids. The cottids, agonids, and cyclopterids share four apomorphic characters, none of which is restricted to the larval period. These include: 1) pleural ribs absent or restricted to the posterior three abdominal vertebrae; 2) epipleurals independent or sessile; 3) small first anal pterygiophore; and, 4) no anal spines.

The cyclopterids (including liparidids) appear to be a distinct family defined by a modified ventral sucking disc and are the sister group of the cottids and agonids. (See Able, Markle and Fahay, this volume, for discussion of cyclopterid relationships).

The cottids and agonids share three derived characters: 1) the first anal pterygiophore is simple; 2) there are no supernumerary anal elements; and 3) the haemal spine of preural centrum 2 is enlarged. Again, none of these characters is unique to the larval period.

Among the 28 genera of cottids examined, Washington and Richardson (MS) recognized eight monophyletic groups which are defined by one or more apomorphic characters. *Rhamphocottus*, a monotypic genus, is characterized by four distinctive autapomorphies, two of which are larval characters. *Rhamphocottus* larvae possess a unique body shape with an extremely long snout to anus length (>60% SL) and deep body shape (29–40% SL). *Rhamphocottus* larvae also possess only one preopercular spine. Other workers have also found *Rhamphocottus* to

deviate from other cottids and have placed it in its own family (Gill, 1888; Johnson, 1918; Jordan, 1923; Bolin, 1934; Taranets, 1941).

Hemilepidotus and *Scorpaenichthys* form another cottid group and are defined by five autapomorphies, three of which are unique to the larval period. First, members of both genera develop heavy, pitted dermal bone on the cranium which forms early in larval development. As the bone develops, ossification proceeds unevenly with small pockets of bone apparently resorbed forming pitted areas, while surrounding areas are thickened. Second, larvae develop broad supraocular bony shelves which project laterally over the orbit. Third, the dorsalmost radial of the pectoral fin is reduced in size and becomes fused or nearly fused to the scapula during larval development.

These three characters are not present in any other cottids examined. Although both *Scorpaenichthys* and *Hemilepidotus* have been postulated as "primitive" cottids by workers studying adults, they have not previously been considered closely related to each other.

The remaining cottids and agonids share four additional derived characters: 1) neural spine of PU 2 elongate; 2) neural spine of first vertebra absent; 3) upper and lower hypural plates fused to each other and fused to the urostyle; and, 4) the first neural arch is unfused, rather it forms in a broad U-shape. The last character is a larval feature found only in these taxa.

Five additional generic groups are defined by one to six autapomorphies. Although these five groups contain the majority of cottid genera, no synapomorphies were found which united these groups and yet separated them from the agonids. The

Myoxocephalus group includes 13 genera defined by the unique larval character of a bony shelf on the anterior portion of the preopercle. The *Artedius* group includes *Clinocottus*, *Oligocottus*, and *Artedius* Group A (see Washington, 1981). This group is defined by six autapomorphic characters including three unique larval features: 1) multiple preopercular spines; 2) enlargement and expansion of the anterior neural arches; and, 3) first three neural arches unfused. The *Psychrolutes* group includes *Gilbertidia* and *Psychrolutes* and is defined by six apomorphic characters. Only one, the absence of head and preopercular spines, is unique to the larval period. The *Malacocottus* group includes *Dasycottus* and *Malacocottus* and is defined by heavy, bony arches on the cranium which form late in larval development. Members of the last two groups were recently combined in the family Psychrolutidae (Nelson, 1982) and correspond to his subfamilies Psychrolutinae and Cottunculinae, respectively. The *Cottus* group, including *Cottus* and *Leptocottus*, is defined by four autapomorphies, two of which are larval characteristics: the first proximal dorsal pterygiophore is simple and slender in contrast to all other cottid larvae and the parhypural is absent in larvae of these genera. Further, larvae of these genera exhibit a delay in ossification of the cranium and reduced head spination.

The last two cottoid groups are: the *Hemitripterus* group including the "cottids" *Hemitripterus*, *Nautichthys*, and *Blepsias*, and the agonids. These share three derived characters: 1) modified prickles-scales; 2) a knobby fronto-parietal ridge; and, 3)

broad plate-like epurals. The first two characters are unique larval features of this group.

These characters provide evidence that the *Hemitripterus* group, traditionally placed in the Cottidae, may be the sister group of the Agonidae. Several agonid genera, such as *Hypsagonus* and *Agonomelas* are very similar to members of the *Hemitripterus* group both as larvae and adults. In addition, larvae of these genera share several apparently derived characters. However, the agonids, including *Hypsagonus* and *Agonomelas* share several autapomorphies unique to the agonids including one or two plate-like epurals, and extreme modifications of the pectoral girdle.

The implications of these findings are that the agonids are derived from the cottids and according to cladistic methodology should be relegated to a sub-unit of the Cottidae. However, Washington and Richardson (MS) do not propose any formal changes in the cottids and agonids at this time. Larvae of only about a third of the cottid genera have been studied. In addition, the family or families of cottids have not been clearly defined on the basis of derived characters, and until such time, we cannot hope to fully understand the cottid-agonid interrelationships.

(B.B.W., K.M.H.) GULF COAST RESEARCH LABORATORY, EAST BEACH DRIVE, OCEAN SPRINGS, MISSISSIPPI 39564; (W.N.E.) DEPARTMENT OF ICHTHYOLOGY, CALIFORNIA ACADEMY OF SCIENCES, GOLDEN GATE PARK, SAN FRANCISCO, CALIFORNIA 94118.

Tetraodontoidei: Development

J. M. LEIS

THE tetraodontoid fishes (Gymnodontes) are a diverse suborder of one large and three small families and about 150 recent species (Winterbottom, 1974a; Tyler, 1980). The four families (Table 113) are largely tropical, but many species are temperate. Most species are marine and bottom-associated in shallow waters, but the Molidae is entirely pelagic and both the Diodontidae and Tetraodontidae have fully pelagic species. The Tetraodontidae also includes a number of fully freshwater species. Many tetraodontoids have a pelagic, often oceanic, juvenile stage.

DEVELOPMENT

Development of tetraodontoid fishes is not particularly well-known. Previous reviews of the early development of the group are by Breder and Clark (1947), Tortonese (1956) and Martin and Drewry (1978). Early development of triodontids is entirely unknown, and, overall, information is available for only 36 species. The information available for particular species of these 36 is often scanty. However, for the Molidae, information is available for all three species. Complete (i.e., egg to juvenile) information is available for about 10 species (Table 114). In the following sections, I assume that the few taxa for which infor-

mation is available are representative (these taxa and the developmental stages concerned are listed in Table 114). The following sections should be read in conjunction with Table 114; citations listed in Table 114 are not repeated in the text. In parentheses after the family heading I give the number of species for which some information is available.

On the basis of early life history characters, the tetraodontoid fishes are a more coherent group than the balistoid fishes.

TABLE 113. MERISTIC CHARACTERS OF TETRAODONTOID FISHES PRINCIPALLY AFTER TYLER (1980). N is the approximate number of recent species largely after Nelson (1976). Pelvic fins are lacking in this suborder.

Family	N	D	A	P ₁	C	Verte-brac
Triodontidae	1	0-11, 11	10	15-16	12	20
Tetraodontidae	130	7-34	7-27	12-20	11	16-30
Diodontidae	15	10-18	10-18	18-25	9-10	18-23
Molidae	3	15-20	14-18	7-13	12-26*	16-18

* Not a true caudal fin, but a clavus or pseudocaudal

TABLE 114. TETRAODONTOID TAXA FOR WHICH INFORMATION IS AVAILABLE ON EGG AND LARVAL STAGES. YS—yolk-sac stage; pre—preflexion stage; flex—flexion stage; post—postflexion stage; U—unstated; dem—demersal; pel—pelagic; PS—examined for the present study. Numbers in parentheses after each genus refer to the number of species represented. A blank means no information available on that stage.

	Eggs			Larvae developmental stage				References
	Type	Size (mm)	Oil droplets	YS	Pre	Flex	Post	
Tetraodontidae								
<i>Canthigaster</i> (>1)	dem	0.68–0.72	cluster	x			x	Fujita, 1962; Stroud et al., MS; PS
<i>Carnioetraodon</i> (1)	U	0.78	U					Breder and Rosen, 1966
<i>Chelonodon</i> (1)	dem	U	U					Breder and Rosen, 1966
<i>Chonerhinos</i> (5)	U	1.1–2.3	U					Roberts, 1982a
<i>Fugu</i> (7)	dem	0.85–1.32	cluster	x	x	x	x	Uchida et al., 1958; Mito, 1966; Masuda et al., 1975; Fujita, 1962
<i>Lagocephalus</i> (1)	dem	0.61–0.70	cluster	x	x	x	x	Uchida et al., 1958; Fujita, 1962, 1966
<i>Sphoeroides</i> (1)	dem	0.85–0.91	cluster	x	x		x	Welsh and Breder, 1921
<i>Tetraodon</i> (1)	dem	1.0	U					Breder and Rosen, 1966
<i>Torquigener</i> (2)	dem?	0.94	U	x	x		x	Munro, 1945
Unidentified (7)				x	x	x	x	Miller et al., 1979; Leis and Rennis, 1983; PS
Diodontidae								
<i>Allomycteris</i>	pel	2.0–2.2	20–25					Robertson, 1975a
<i>Chilomycteris</i> (3)	pel	U–1.8	U			x	x	Evermann and Kendall, 1898; Breder, 1927; Nichols and Breder, 1927; Fowler, 1945; Breder and Clark, 1947; Heck and Weinstein, 1978; Moyer, pers. comm.; Fujita, 1962; PS
<i>Diodon</i> (3)	pel	1.62–2.1	cluster	x	x	x	x	Sanzo, 1930d ¹ ; Mito, 1966; Leis, 1978; Sakamoto and Suzuki, 1978; Fujita, 1962; PS
<i>Tragulichthys</i> (1)					x		x	PS
Molidae?								
<i>Masturus</i> (1)	pel	1.8	cluster		x	x	x	Schmidt, 1921; Martin and Drewry, 1978
<i>Mola</i> (1)					x	x	x	Martin and Drewry, 1978
<i>Ranzania</i> (1)	pel	1.42–1.68	cluster	x	x	x	x	Schmidt, 1921; Leis, 1977

¹ Misidentified as *Crayracion* sp. (Tetraodontidae)

² No caudal fin forms; pre, flex and post in this case refer to clavus formation, not notochord flexion

Eggs.—Tetraodontoid fishes are oviparous. Pelagic and demersal eggs are known; the chorion is smooth; clusters of oil droplets are present; eggs range in size from large (2.1 mm) to small (0.6 mm) and are spherical; incubation times are long and range from 3 to 20 days; development at hatching varies; the perivitelline space is narrow; the yolk is unsegmented; and embryos may be heavily pigmented. Parental care of eggs is present only in some tetraodontids.

Larvae.—All tetraodontoid larvae are pelagic. Development in most tetraodontids is direct; in molids and diodontids specialized ontogenetic stages may exist. There are few larval specializations except in the Molidae, and development is usually completed at a small size. There is often an apparently unspecialized pelagic juvenile stage, which may be very large at settlement. Larvae are enclosed in a more or less inflated vesicular sac. Larvae are deep and wide in head and trunk, and the tail is comparatively small and compressed. The head is large and rounded and the gut is coiled and massive. The eye is particularly large. The specialized adult scales form directly (i.e., do not pass through an unspecialized spinule stage). In molids specialized larval spines are formed. The pectoral fin is the first to form, and the caudal fin is last. Except for the tail of molids, structures are not formed and subsequently lost—they never form. The specialized dentition develops during the larval stage directly, without any intervening generalized teeth. However, diodontids and tetraodontids may have small, raised points

along the cutting edges of their beak-like teeth. Meristic characters are summarized in Table 113 [see Tyler (1980) for further information]. The number of vertebrae is low (16–30), as is the number of caudal fin rays (0–12). Pelvic fins are lacking and except for some triodontids, the fins lack spines. Larvae are heavily pigmented. The few larval specializations which do occur are the vesicular dermal sac of all species and the huge dermal spines of molids.

Only two groups have specialized ontogenetic stages between larvae and juveniles. In the Diodontidae, some Atlantic species of *Chilomycteris* (sensu lato) have a postflexion stage (“*Lyo-sphaera*”) that lacks dermal spines, but has fleshy protuberances in the locations the spines will occupy and other enlarged protuberances unassociated with spines (Evermann and Kendall, 1898; Breder, 1927; Heck and Weinstein, 1978). In the Molidae, *Mola* and *Masturus* have a deep-bodied, compressed stage (“*Molacanthus*”) that has reduced larval spines, and a distinctly non-adult shape (Martin and Drewry, 1978).

Family Accounts

Triodontidae.—Nothing is known of triodontid eggs or larvae.

Tetraodontidae.—Tetraodontid eggs are demersal, small to medium-sized, have multiple oil droplets (Table 114) and hatch in 3–20 days. The very large ovarian eggs of *Chonerhinos* (Table 114), a highly specialized freshwater genus (Tyler, 1980; Roberts, 1982a), are here regarded as a specialization for freshwater

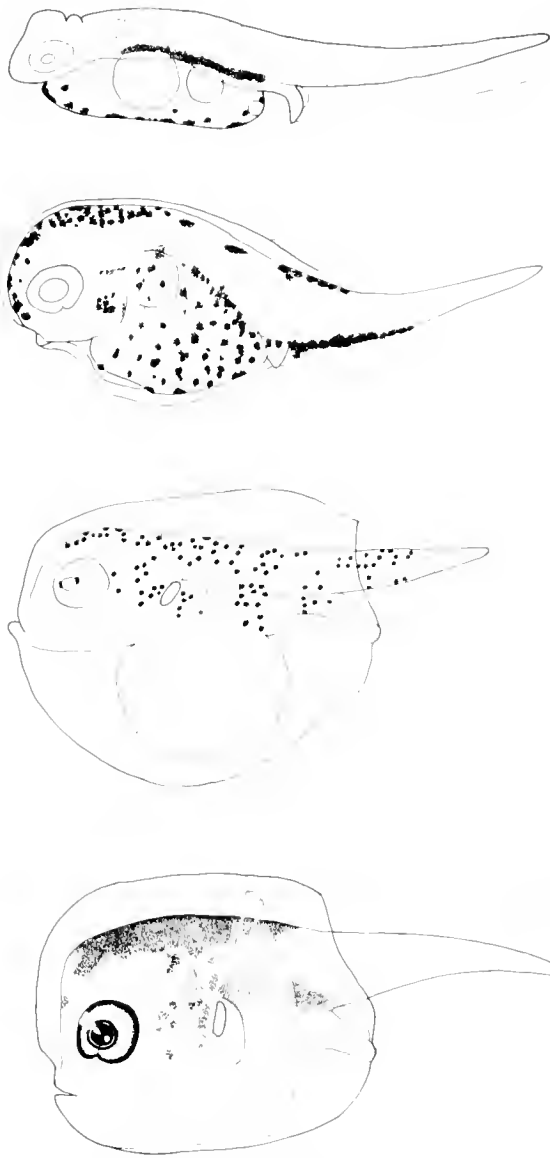

Fig. 242. Tetraodontoid yolk-sac larvae. All specimens are enclosed in a more or less well-developed vesicular dermal sac. The vesicles are omitted in the drawings. From top to bottom: *Lagocephalus lunaris* (Tetraodontidae) 1.7 mm (1.9 mm TL) (after Fujita, 1966); *Fugu pardalis* (Tetraodontidae) 2.6 mm (2.84 mm TL) (after Uchida et al., 1958); *Diodon (hystrix?)* (Diodontidae) 2.6 mm (after Leis, 1978); and *Ranzania laevis* (Molidae) 1.8 mm (after Leis, 1977).

conditions [freshwater species commonly have larger eggs than their marine confamilials (Roberts, pers. comm.)]. The chorion is adhesive. Parental care of eggs is known, but not universal. Development of larvae at hatching varies with species: jaws totally unformed to partially formed; the eye ranges from unpigmented to completely pigmented; the pectoral bud may be present or absent; a moderately developed vesicular dermal sac encloses head and trunk; much yolk remains; and pigment ranges from moderate to heavy (Fig. 242). If the often huge yolk sac is ignored, larvae are initially cylindrical, but become progressively deeper and wider-bodied with growth (Fig. 243). Larvae

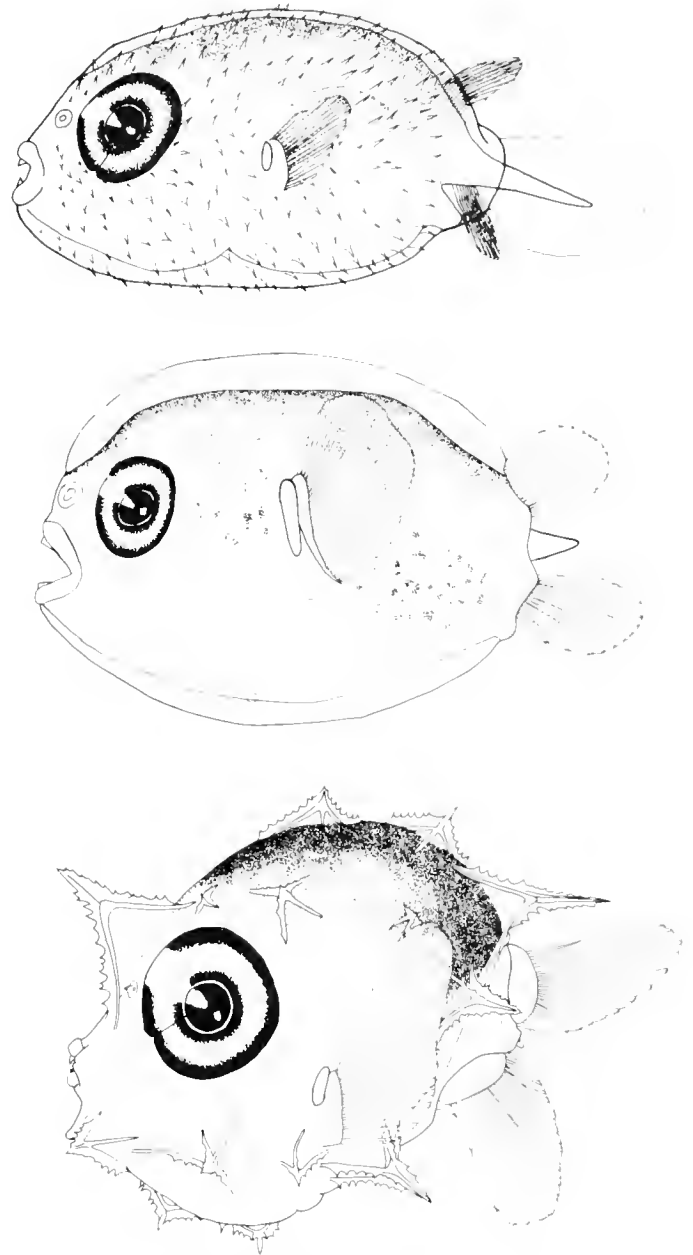

Fig. 243. Tetraodontoid larvae. From top to bottom: Unidentified tetraodontid larva (possibly *Canthigaster*), 3.6 mm, from the Great Barrier Reef. Note small spines in skin; *Tragulichthys jaculiferus* (Diodontidae), 4.2 mm, from the Great Barrier Reef (small circles in the dermal sac represent incipient spines and are ossified); and *Ranzania laevis* (Molidae), 3.9 mm (after Leis, 1977).

remain deeper than broad until they acquire the ability to inflate. Until mid-preflexion stage the body remains relatively fusiform with a well-developed tail (relative to other tetraodontoids and ostraciids). The moderately-developed vesicular sac often disappears during the preflexion stage, but may be retained in some species until after flexion. This sac does not correspond to the inflatable belly found in this family. The gill opening closes to a pore shortly after the yolk is absorbed, but the membranes are thin and transparent and thus easily missed. Sequence of fin

formation is: $P_1-D = A-C^1$. The long notochord tip persists for a time following flexion. The vesicles of the dermal sac are said to be the source of the small dermal ossifications (Welsh and Breder, 1921). The dermal ossifications (=scales) develop directly into small, often embedded, spines. The dermal spines seem to first appear on the belly, usually in the preflexion stage. Depending on species, the spines may appear on the rest of the body shortly thereafter, slowly and gradually, or not at all. Pigment is initially heavy over the gut, brain and yolk sac, and usually spreads to cover much of the head and trunk before flexion. Welsh and Breder (1921) and Munro (1945) report the presence of a single opercular spine in preflexion larvae of *Spherooides maculatus* and *Torquigener pleurogramma*, respectively. None of the larvae examined for the present study has such a spine, but these two species have not been examined.

Diodontidae.—Diodontid eggs are pelagic, large, have multiple oil droplets (Table 114) and hatch in 3 to 5 days. Larvae are moderately to well developed at hatching, but development varies between species and possibly between populations of the same species: jaws range from totally unformed to formed and apparently functional; eyes are partially to fully pigmented; the gill opening is reduced to a pore; moderate to heavy pigment (including yellow, red and orange) is present; much yolk remains; and a well-developed, inflated, vesicular dermal sac encloses head and trunk (Fig. 242). Larvae are deep-bodied and broader than deep (Fig. 243). At hatching or very shortly thereafter, diodontid larvae are extremely rotund with head and trunk a single ball-like unit. The tail is small and becomes relatively smaller still with age. It becomes nearly vestigial during flexion, but thereafter starts to increase in size. Body shape changes little during development. The fins form $P_1-D = A-C$. The mouth is large compared with other tetraodontiform larvae. Shortly before flexion, lens-like thickenings form in the dermal sac, and (depending on species) small swellings or elongate papillae form over these. The large spines (=scales) subsequently form inside these structures without an intermediate stage. In most species, spines are present around the time flexion is completed, but in *Chilomycterus antennatus* and *C. schoepfi* (but not *C. affinis* or *C. orbicularis*) there is a specialized pelagic stage which lacks

spines and may have some of the elongate papillae enormously enlarged (the genus *Lyosphaera* was described from such a stage). The spines in the "*Lyosphaera*" stage form after settlement. Nostrils of diodontids form in a conventional manner. Only following development of a short tentacle with two openings do the split nasal flaps of *Dicotylichthys* or the open reticulated nasal cups of *Chilomycterus affinis* form during the late juvenile stage. Pigment is moderate to heavy and in preflexion larvae much heavier dorsally than ventrally. Following flexion, there is a tendency for the belly to become more heavily pigmented than the dorsum.

Molidae.—Molid eggs are pelagic, large, have multiple oil droplets (Table 114), and hatch in 7 to 8 days. Larvae are developmentally very advanced at hatching with: jaws formed; eyes pigmented; gill opening reduced to a pore; a well-developed vesicular dermal sac enclosing head and trunk; the cleithrum and several pectoral fin rays ossified; a dorsal fin anlage; heavy pigment; and an unknown amount of yolk (Fig. 242). The body is deep (Fig. 243) and wide but not as wide as deep. At hatching molid larvae are extremely rotund with head and trunk a single ball-like unit. The compressed tail becomes progressively smaller. With growth and body spine development the body eventually becomes more compressed and a ventral keel forms. The fins form $P_1-D = A-Clavus$. The P_1 forms very early and becomes large. The tail of young larvae is normal, but soon begins to atrophy, and a true caudal fin never forms. Notochord flexion does not take place, so the clavus is not homologous with the caudal fin. Shortly after hatching, the huge spines which characterize molid larvae begin to form. These reach a maximum size at about the time the clavus is formed. As the massive spines decrease in size, small spines form elsewhere, particularly on the ventral keel. Also, small ossifications within the skin begin to form, and these eventually make up the carapace-like skin covering. *Mola* and *Masturus* pass through a fairly long ontogenetic stage between larvae and juveniles which is characterized by retention of reduced massive spines, a deep, compressed body with a ventral keel and a shape quite unlike the adult (the genus *Molacanthus* was described from such a stage). *Ranzania*, in contrast, loses its spines relatively quickly and directly assumes the adult shape. Larvae are heavily pigmented over the gut and on the dorsal surfaces.

¹ Sequence of ossification of first element in each fin, except that the symbol for caudal fin (C) refers to completion of notochord flexion. Fin preceding dash forms prior to fin following dash.

DEPARTMENT OF ICHTHYOLOGY, THE AUSTRALIAN MUSEUM, P.O. BOX A285, SYDNEY, 2000, AUSTRALIA.

Balistoidei: Development

A. ABOUSSOUAN AND J. M. LEIS

THE tetraodontiform suborder Balistoidei (Sclerodermi) is a small group of six families with about 175 recent species of great morphological diversity (Tyler, 1968, 1980; Winterbottom, 1974a; Matsuura, 1979). The suborder is generally agreed to consist of the six families (Table 115) considered here (Tyler,

1980). However, Winterbottom (1974a) has suggested that the triacanthodids and triacanthids could be removed to a suborder distinct from all other tetraodontiform fishes. The group is largely tropical and marine, but some species range well into the temperate zones, particularly in Australia. Most species are bot-

TABLE 115. RANGE OF MERISTIC CHARACTERS OF BALISTOIDS. Mostly after Tyler, 1980; see this and Matsuura, 1979 for further information.

	Triacanthodidae	Triacanthidae	Balistidae	Monacanthidae	Aracantidae	Ostraciidae
Number of species (after Nelson, 1976)	19	7	35	90	12	15
Dorsal spines	6	4 or 6	3	1 or 2	0	0
Second dorsal rays	12-18	19-26	23-35	22-50	9-12	9-11
Anal rays	11-17	13-22	19-31	20-62	9-11	8-11
Pectoral rays	12-15	12-16	12-17	8-16	10-13	9-13
Caudal rays	6 + 6	6 + 6	6 + 6	6 + 6	5 + 5-6	5 + 5
Pelvic spines	1	1	0	0	0	0
Pelvic rays	0-2	0-1	0	0	0	0
Ventral scales	absent	absent	present	absent or present	absent	absent
Vertebrae	8 + 12 = 20	8 + 12 = 20	7 + 10-12 = 17-19	6-8 + 11-23 = 19-31	9-10 + 8-9 = 18	9 + 9-10 = 18-19
Caudal fin bones						
Epurial	1	1	1	1	0	0
Uroneural	2	1	1?	0	0	0
Hypural	3 to 5	3	3	2 or 3	2	2
Smallest hypural (5th)	present	present	present	absent or present	absent	absent
Parhypural	1	1	1	1	0	0
Vertebrae before the first second dorsal pterygiophore	8	4-5	5	4-7	5-6	6-8
Vertebrae behind the last anal pterygiophore	5-6	7	4-5	4-6	4-6	4-6

tom-associated in shallow to moderate depths, but many triacanthodids live in deep (>500 m) water. Most species have a pelagic, often oceanic, juvenile stage, and a few are pelagic throughout their lives.

DEVELOPMENT

Development of balistoid fishes is not well known. Previous reviews of the early development of the group are by Breder and Clark (1947), Tortonese (1956), and Martin and Drewry (1978). The early development of aracanids is entirely unknown, and, overall information is available for only 30 species. Often the information available for a species is scanty. Complete (i.e., egg to juvenile) information is available for only four or five species (Table 116). This narrow data base makes generalizations about development somewhat suspect. However, we assume that the few taxa for which information is available are representative.

Few generalizations can be made about development of balistoid fishes, but this is not surprising in view of the diversity of the adults. A reference to development in juveniles, which usually differ little from adults, is given at the end of each section. We make no attempt to review the literature on juvenile development.

Eggs (Table 116).—Balistoid fishes are oviparous. Pelagic and demersal eggs are known: the chorion is usually smooth, but may have limited sculpturing; oil droplets are usually present; eggs range in size from small (0.5 mm) to large (2.0 mm) and are approximately spherical; incubation times range from one to four days; development at hatching varies widely; the perivitelline space is narrow; the yolk is unsegmented; and considerable pigment may develop on the embryo. Parental care of eggs ranges from non-existent (pelagic eggs) to considerable (Balistidae).

Larvae.—All balistoid larvae are pelagic. Development is generally direct (i.e., no specialized ontogenetic stages between larvae and juveniles), with few larval specializations, and is completed at a small size (Figs. 244-251). There is often an apparently unspecialized pelagic juvenile stage which may grow to a significant fraction of the adult size. Larvae tend to be deep-bodied, and many are also wide-bodied. The head is large and the gut coiled and massive. The mouth is small. The head is usually rounded, at least in preflexion larvae. The head and body of young ostraciid larvae are enclosed in an inflated dermal sac which has numerous vesicles (or tubercles) embedded in its outer surface. Except in ostraciids, the specialized adult scales pass through an unspecialized spinule stage. The caudal fin is usually the last fin to form. The reduction in structures, notably fins, which characterizes the balistoid fishes is not a case of development followed by loss—these structures never develop. The specialized dentition develops during the larval stage directly, without any intervening generalized or larval teeth. Meristic characters are summarized in Table 115 (see Tyler, 1980 for further information). The number of vertebrae and caudal fin rays is low, pelvic fins are reduced or lacking, anal fins lack spines, and dorsal spines, if present, are few (Table 115). Larvae are generally moderately to heavily pigmented.

The few larval morphological specializations which do occur are either developments of the often very specialized scales (or their precursors) of the adults or delicate skin flaps, filaments and tendrils. These are discussed under the appropriate family section. There are no specialized ontogenetic stages between larvae and juveniles.

A shorthand notation will be used to designate the sequence of fin formation. By formation, we mean ossification of the first element, with the exception of the caudal fin where completion of flexion is meant. However, except for some monacanthids

TABLE 116. BALISTOID TAXA FOR WHICH INFORMATION IS AVAILABLE ON EGG AND LARVAL STAGES. YS—yolk-sac stage; pre—preflexion stage; flex—flexion stage; post—postflexion stage; U—unstated; dem—demersal; pel—pelagic. Numbers in parentheses after each genus refer to the number of species represented. A blank means no information available.

	Eggs			Larvae developmental stage				References
	Type	Size (mm)	Oil droplets	YS	Pre	Flex	Post	
Triacanthodidae								
<i>Atrophacanthus</i> (1)					X	X	X	Fraser-Brunner, 1950; Tyler, 1968; present study
<i>Macrorhamphosodes</i> ? (1)							X	
Triacanthidae								
<i>Triacanthus</i> (1)	pel	0.78	0	X	X		X	Ohsima and Nakamura, 1941; Gopinath, 1946
Unidentified (1)					X	X	X	
Balistidae								
<i>Balistes</i> (2)	dem	U	1	X	X	X	X	Sanzo, 1939b ¹ ; Garnaud, 1960; Aboussouan, 1966; Lythgoe and Lythgoe, 1975; Matsuura and Katsuragawa, 1981
<i>Balistapus</i> (1)	dem	0.55	0? ²	X				
<i>Canthidermis</i> (1–2?)	dem	U	U		X	X	X	Lobel and Johannes, 1980
<i>Odomus</i> (1)	dem	U	U					Nellis, 1980; Watson and Walker, pers. comm.; present study
<i>Pseudobalistes</i> (3)	dem	0.55–0.60	0? ²					
<i>Sufflamen</i> (3)	dem	0.51–0.56	1 & U	X			X	Fricke, 1980
<i>Xanthichthys</i> (1)					X			Masuda et al., 1975; Fricke, 1980; Lobel and Johannes, 1980; Matsuura, 1982
Unidentified (>1)					X	X	X	
Monacanthidae								
<i>Alutera</i> (2)	dem	U	U		X	X	X	Clark, 1950; Suzuki et al., 1980; present study
<i>Amanses</i> (1)					X			
<i>Anacanthus</i> (1)				X	X		X	Present study
<i>Brachaluteres</i> (1)					X	X	X	Leis and Rennis (1983, figure 72); present study
<i>Cantherines</i> (1)					X			
<i>Monacanthus</i> (1)					X	X		Present study
<i>Navodon</i> (1)					X		X	Uchida et al., 1958; Kobayashi and Abe, 1962; Mito, 1966
<i>Parika</i> (1)	pel ³	0.65–0.74 ³	1 ³		X	X		
<i>Pseudalutaris</i> (1)					X		X	Regan, 1916; Robertson, 1975a; Crossland, 1981
<i>Rudarius</i> (1)	dem	0.52	2		X		X	
<i>Stephanolepis</i> (3)	dem	0.61–0.70	cluster	X	X	X	X	Fujita, 1955; Uchida et al., 1958; Kobayashi and Abe, 1962; Mito, 1966; Masuda et al., 1975; Suzuki et al., 1980
Unidentified (>10)					X	X	X	Ryder, 1887; Hildebrand and Cable, 1930; Fujita, 1955; Uchida et al., 1958; Mito, 1966; Aboussouan, 1966
								Leis and Rennis, 1983; Watson and Walker, pers. comm.; present study
Ostraciidae								
<i>Acanthostracion</i> (1)	pel	1.4–1.6	1	X	X		X	Breder and Clark, 1947; Palko and Richards, 1969; present study
<i>Lactoria</i> (2)	pel	1.6–1.9	cluster	X	X		X	
<i>Ostracion</i> (2)	pel	1.6–1.9	cluster	X	X		X	Watson and Leis, 1974; Moyer, 1979; Leis and Moyer, MS; present study
<i>Tetrosomus</i> (1)							X	Watson and Leis, 1974; Leis and Rennis, 1983; Leis and Moyer, MS; present study
Unidentified (6)	pel	1.4–2.0	cluster	X	X			
<i>Rhmesomus</i> (1)					X			Present study
								Delsman, 1930d ⁴ ; Sanzo, 1930d ⁵ ; Mito, 1962c, 1966; present study
								Present study

Notes

¹ Two specimens (1.86 and 2.48 mm) from a supposed series of *Dactylopterus volitans* appear to be *Balistes capricus*, and one has the preopercular cluster of spinules. A 4 mm specimen identified as *B. capricus* is also illustrated.

Lobel and Johannes (1980) describe the eggs as "without visible inclusions," but their photograph of a newly hatched *B. undulatus* seems to show an oil drop in the yolk sac.

² Eggs identified as *Novodon* [sic] *convexirostris* (*Parika scaber*) were described by Robertson (1975a) and Crossland (1981), however there is reason to question this identification. Robertson (*in litt.* Nov. 1982) notes the identification and classification as pelagic of this egg was "based on a small sample of ripe [unfertilized] eggs from a female leatherjacket and a conforming type in the Otago Harbour plankton at that time," and that no eggs were reared. We feel the eggs described by Robertson and Crossland are not monacanthids.

³ Misidentified as *Tetraodon* sp.

⁴ Misidentified as *Tetraodon honkemu*.



Fig. 244. Scanning electron micrograph of the sculptured chorion of an unidentified Hawaiian ostraciid egg. The micropyle is the hole in the center. The width of the field of bumps is ca. 0.5 mm.

where the posterior rays of dorsal and anal fins are slow to form, ossification of all elements of the fin could serve as an equally good definition. The fins will be indicated by standard notation (D—dorsal, Dsp—dorsal spine, etc.). The order of the letters corresponds to the order of formation. An equal sign between two letters indicates the fins form simultaneously, a dash indicates the fins do not form simultaneously.

Triacanthodidae

The eggs of triacanthodids are unknown, although there is a dubious report of pelagic eggs (Nikol'skii, 1961). The body of preflexion and flexion larvae (Fig. 247) is moderately to very deep, moderately wide in head and trunk, and compressed in tail. The body becomes more compressed and elongate with growth, but may remain very deep until well after flexion. The gill opening is closed to a pore in the smallest available specimens (late preflexion). There is no dermal sac. The fins form $D = A = P_1 - C - P_2 = Dsp$. The Dsp anlage and P_2 buds do not form until after flexion. Although no early postflexion larvae are available, late flexion larvae have a notochord with a long posterior portion that probably indicates that the notochord has an extended tip for awhile following flexion. Dermal spinules first form in preflexion larvae, and appear first on side of head (cheek, operculum, over otic vesicle) and laterally on two small regions of the gut (ventral to P_1 base and just anterior to anus). The spinules are unspecialized, and fully cover the body of postflexion larvae. The available larvae of *Atrophacanthus* are

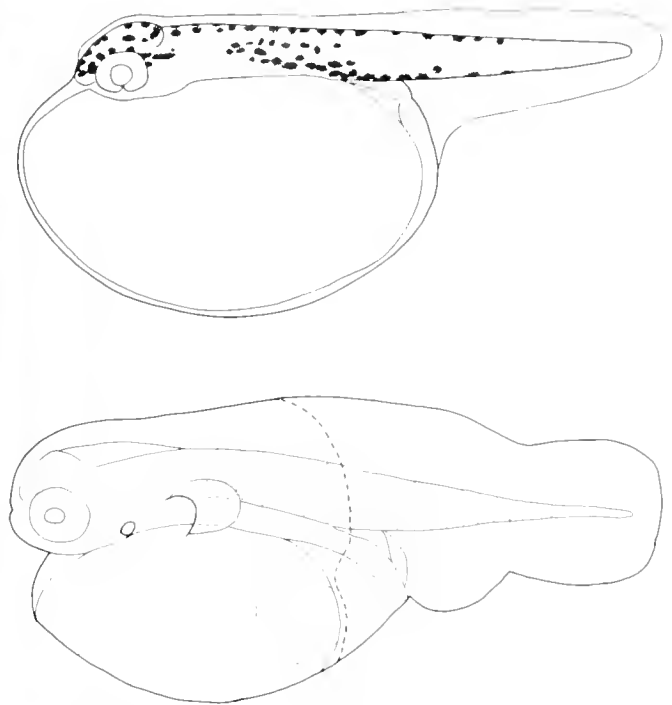

Fig. 245. Triacanthid and ostraciid yolk-sac larvae from top to bottom: *Tracanthus biaculeatus*, 1.3 mm (1.4 mm TL) after Ohsima and Nakamura, 1941; and *Acanthostracion quadricornis*, 2.6 mm reared larva from Florida. Specimen is fully enclosed in a vesicular sac which is most inflated over head and trunk. The vesicles are omitted in the drawing. Specimen is unpigmented, but is probably bleached.

unpigmented, but their poor condition implies they could be faded. The *Macrorhamphosodes* (?) larva is moderately and uniformly pigmented with small melanophores.

The specimen identified as *Tracanthodes* sp. by Weber (1913) appears to be a trichiurid (Scombroidei), not a triacanthodid.

Tyler (1968) describes juvenile development of several triacanthodid species.

Triacanthidae

Triacanthid eggs lack oil droplets and chorion sculpture, are pelagic, small, and hatch in about 22 hours (Table 116). Development at hatching is not advanced (Fig. 245); no jaws or pectoral fins are present, the eye is unpigmented and much yolk remains. The body is cylindrical at hatching and becomes much deeper with growth (Fig. 247) and, especially following flexion, very compressed. The gill opening closes to a pore prior to flexion. There is no dermal sac. The fins form $D = A = P_1 - P_2 = Dsp - C$. The notochord has an extended tip following flexion. The D and P_2 spines become relatively elongate. Dermal spinules first form in preflexion larvae and appear first on the sides of the head (cheek, operculum, over otic vesicle), and laterally on the posterior portion of the gut. The spinules are unspecialized (except for some terete ones on the fin spines), and fully cover the body shortly after flexion. Pigment is heavy on brain and gut, and a single ventral tail melanophore is present. Following yolk exhaustion, pigment spreads over most of the body in a blotchy pattern.

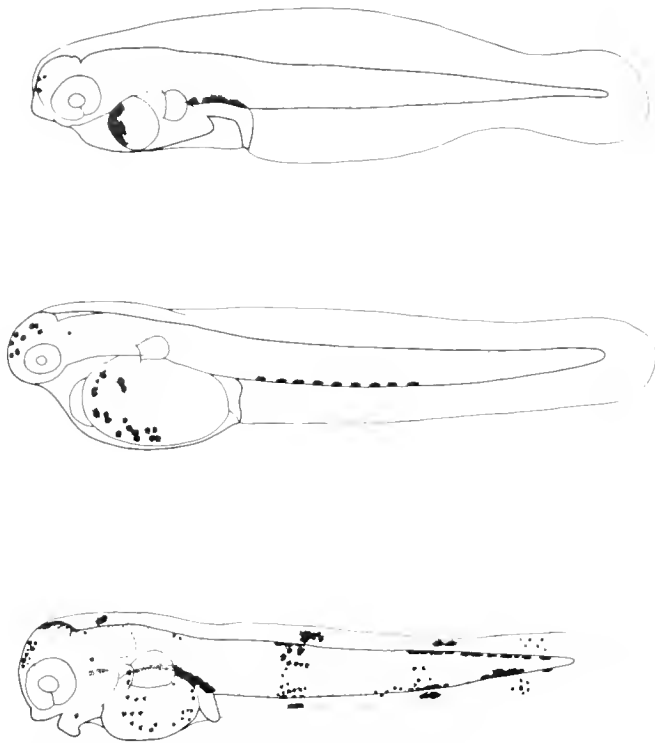

Fig. 246. Balistid and monacanthid yolk-sac larvae from top to bottom: *Sufflamen chrysopterus*, 1.7 mm reared larva from the Great Barrier Reef (24 hours after hatching); *Stephanolepis cirrifer*, 1.9 mm (2.1 mm TL) after Fujita, 1955; and *Anacanthus barbatus*, 2.4 mm larva from a Great Barrier Reef plankton sample (age unknown). Note anlage of dorsal fin spine in occipital region. Mouth is not fully formed. Fragmented oil droplets are present in the yolk sac, but are not illustrated.

The descriptions of larvae identified as *Triacanthus brevirostris* by Kuthalingam (1959b) do not resemble triacanthid larvae in morphology, sequence of development, or size. One can only conclude the larvae are misidentified and the drawings inaccurate. The eggs identified by Kuthalingam (1959b) as *Triacanthus brevirostris* are probably those of an atheriniform fish.

Tyler (1968) describes juvenile development of several triacanthid species.

Balistidae

Balistid eggs are demersal, small, lack chorion ornamentation (but are adhesive), have a single oil droplet (Table 116), and hatch in one to two days. Eggs are laid in clusters in shallow nests on sand or rubble bottoms and are guarded by the adult. Development of larvae at hatching is not advanced: no jaws are present, the eye is unpigmented, minimal body pigment is present and much yolk remains (Fig. 246). Larvae have a cylindrical, slightly compressed body at hatching. The body quickly becomes deeper and then moderately rotund in the trunk (Figs. 248 and 249). The tail remains compressed. About the time fins start to form, the larva starts to become compressed and this increases thereafter. In newly hatched larvae, a slightly inflated area is present surrounding the trunk (Fig. 246), but it contains no vesicles, and soon disappears. The gill opening closes to a pore just prior to flexion. The fins form Dsp-D = A = P₁-C.

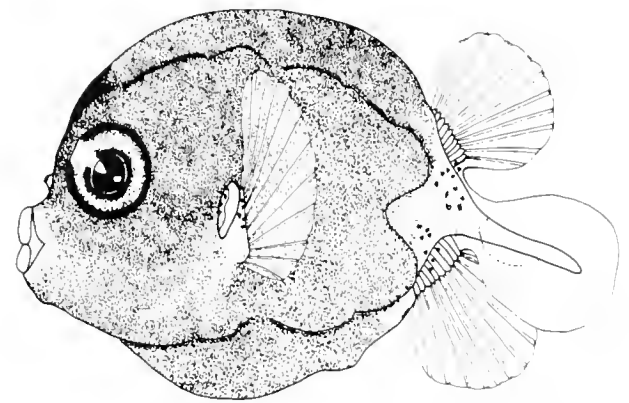
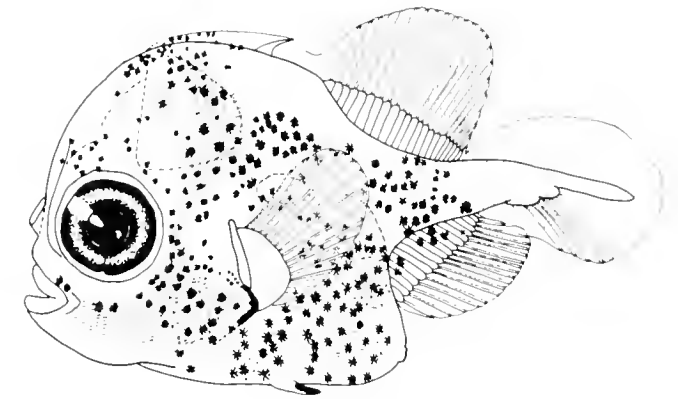
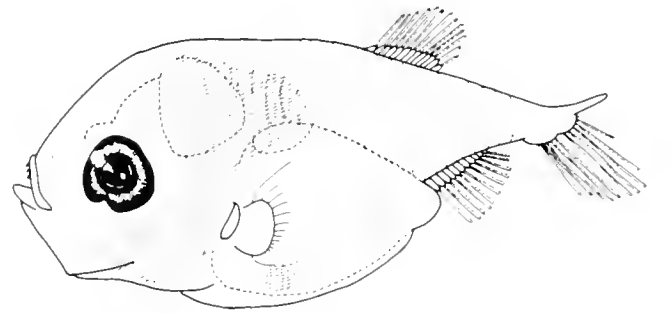

Fig. 247. Late preflexion larvae of three balistoid families. Small ticks on upper and middle specimens indicate position of dermal spinules. From top to bottom: *Atrophacanthus japonicus* (Triacanthodidae), composite drawing of three damaged larvae (2.6–2.7 mm) from a Dana Station in the Philippines; unidentified triacanthid, 3.5 mm, from the Great Barrier Reef, note small dorsal spine and pelvic fin bud; and *Acanthostracion quadricornis* (Ostraciidae), 3.3 mm, reared larva from Florida. The dermal plates are not yet formed, but ridges on the body are evident.

The first dorsal spine becomes large and heavily armed with barbs before flexion. This ornamentation varies between species and is useful in identification. The notochord has an extended tip for a short while following flexion. Dermal ossifications first

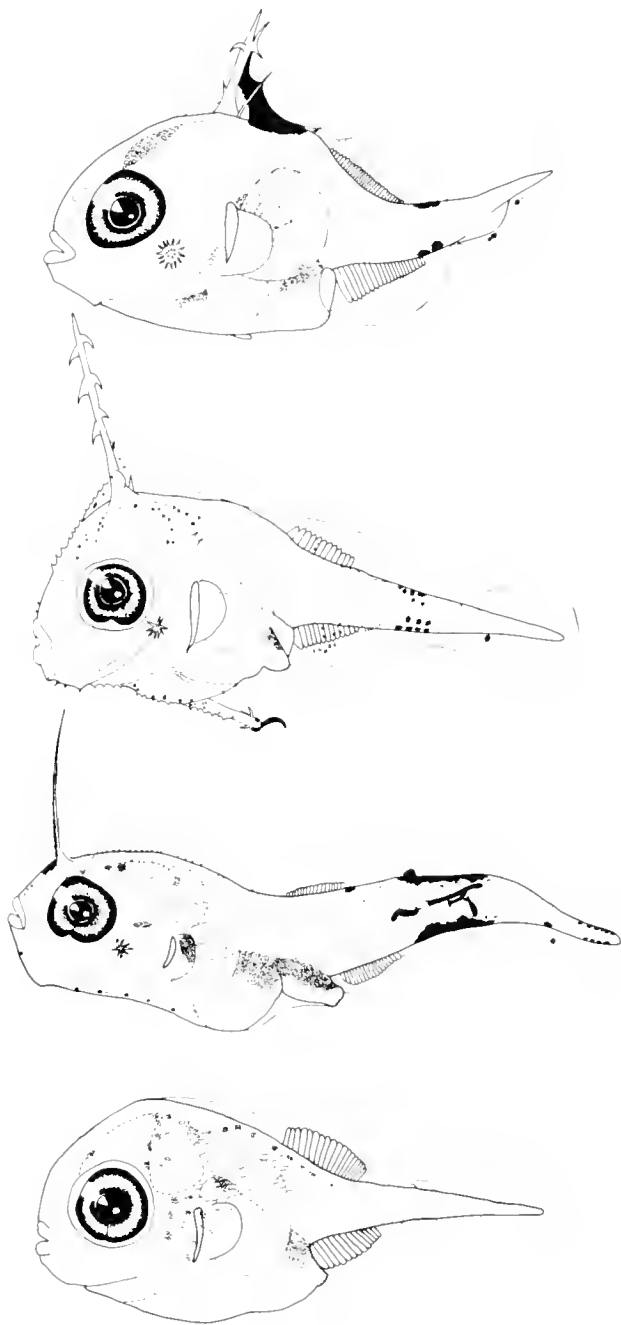

Fig. 248. Late to mid preflexion larvae of two balistoid families. Small ticks indicate position of dermal spinules. From top to bottom: *Canthidermis sufflamen* (Balistidae), 3.5 mm, from Puerto Rico, note small pelvic bud and preopercular cluster of spinules; unidentified Morph A monacanthid, 3.6 mm, from the Great Barrier Reef, note pigmented filament at terminus of pelvic bone and preopercular cluster of spinules; *Pseudalutaris nasicornis* (Morph B monacanthid), 4.3 mm, from the Great Barrier Reef, note pigmented fleshy tendrils laterally on tail and preopercular cluster of spinules; unidentified Morph C monacanthid, 3.0 mm from the Great Barrier Reef. Dermal spinules in this species are longer than in the other illustrated species. Dorsal spine is just beginning to form (not yet ossified).

TABLE 117. CHARACTERS THAT DIFFER BETWEEN THE TWO LARVAL MONACANTHID MORPHS.

Character	Morph	Morph
	AB (Figs. 246 and 248)	C (Fig. 248)
Body shape	Deep to elongate; becoming angular with growth. Compressed.	Deep; becoming deeper with growth, but remaining rounded. Somewhat rotund early, becoming compressed.
Cluster of spinules on preoperculum	Small to large	Absent
Sequence of fin formation	Dsp-D = A-P ₁ - or = C	D = A = C-P ₁ -Dsp
Dorsal fin spine	Early-forming, armed or unarmed, lightly to moderately pigmented	Late-forming, lightly pigmented
Tail pigment in preflexion larvae	Present. Ventral or dorsal series or blotches.	None
Identified taxa included	<i>Alutera</i> , <i>Amanses</i> , <i>Anacanthus</i> , <i>Cantherines</i> , <i>Monacanthus</i> , <i>Navodon</i> , <i>Parika</i> , <i>Pseudalutaris</i> , <i>Stephanolepis</i>	<i>Brachaluteres</i> , <i>Rudarius</i> (the morph C larvae illustrated by Leis and Rennis (1983, Fig. 72) are <i>Brachaluteres</i>)

appear in the form of a small cluster of relatively long spinules on the preoperculum (larval specialization). This cluster appears within a few days of hatching and persists until just prior to flexion. Shortly before the cluster disappears, dermal spinules appear in three areas: laterally on the cheek ventral to the cluster; over the otic vesicle; and laterally on the gut from below the pectoral base to near the anus. These unspecialized spinules rapidly spread to cover the body by mid-flexion. They do not transform into the specialized scales of the adults until well into the pelagic juvenile stage. A pigmented filament (larval specialization) often develops at the terminus of the pelvic bones (see discussion of such structures under Monacanthidae). Pigment is heavy on the brain and gut, and preflexion larvae have a series of melanophores on the ventral midline of the tail. Blotches or bands may form on the tail. The spiny dorsal fin is heavily pigmented and this pigment spreads laterally over the trunk.

Berry and Baldwin (1966) describe juvenile development of several balistid species.

Monacanthidae

Monacanthid eggs are demersal (we tentatively conclude that pelagic eggs were wrongly attributed to *Parika scaber*—see Table 116), adhesive, small, have several oil droplets, and hatch in about 2 days. Eggs are attached to vegetation, and there is no record of parental care. Development at hatching is not advanced: jaws are absent or only partially formed, the eye is unpigmented, and much yolk remains (Fig. 246). Newly-hatched larvae are cylindrical and somewhat compressed. Morphological and developmental diversity among monacanthid larvae is high,

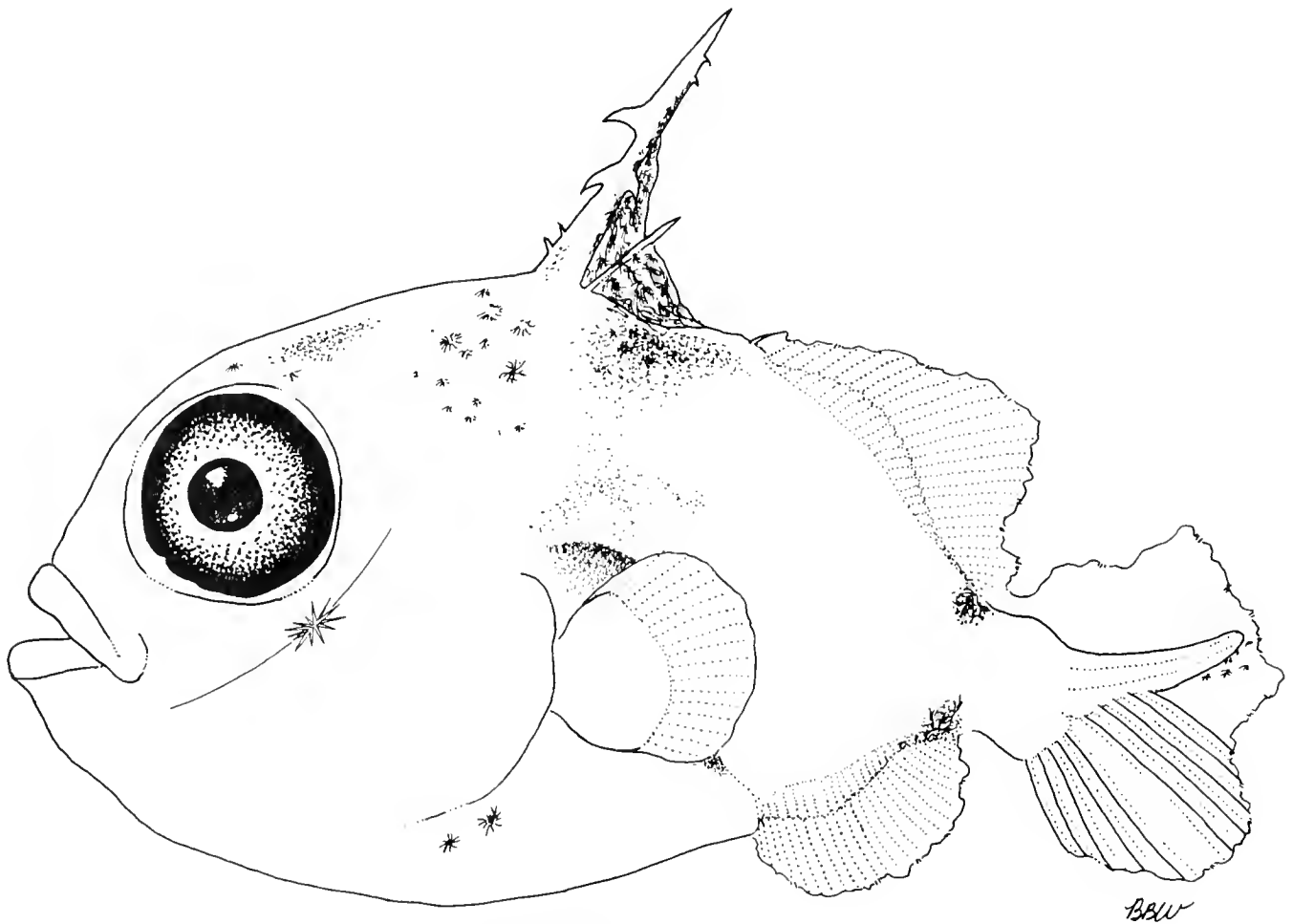

Fig. 249. Balistid preflexion larva *Xantichthys ringens* 3.87 mm, ASF101, western Atlantic.

particularly in comparison with other tetraodontiform families. Leis and Rennis (1983) considered that three distinct morphs were present among larval monacanthids. However, our studies of additional taxa indicate that Morphs A and B of Leis and Rennis (1983) are merely extremes (Fig. 248), and that no clear division can be made between A and B. For example, while Leis and Rennis (1983) utilized seven characters to separate the two morphs, larvae of *Ahutera* sp. (Fig. 250) have three 'A' characters, three 'B' characters, and are intermediate for the seventh. Morph C of Leis and Rennis (1983) (Fig. 248) is distinct from the combined Morph AB (Table 117). Rapid changes in body proportions may take place in many species. Morph AB larvae are compressed and become more so with growth, while Morph C larvae are moderately broad in gut and head, but become compressed with growth. The gill opening closes to a pore late in the preflexion stage, and the position of the pore relative to the eye varies with species. The dorsal spines form at a very early stage in Morph AB larvae, but are the last fin elements to form in Morph C larvae. In some species, the first spine becomes heavily armed by the mid-preflexion stage. The pelvis may form either early and be prominent by the mid-preflexion stage or very late and may never become externally visible, depending on species. The sequence of fin development is morph-dependent (Table 117). There is no dermal sac. The notochord tip is

long and persists for a time following flexion. If present (Morph AB), the small cluster of spinules on the preoperculum (a larval specialization) forms very early and is lost before flexion. Depending on species, dermal spinules may first appear laterally on the gut and head, or on the forehead and along the ventral midline near the cleithral symphysis. Dermal spinules cover the body prior to flexion or shortly thereafter. Pigment is heavy on the brain and over the gut, but on the tail, it varies with species.

Several species temporarily develop small, pigmented flaps or filaments (a larval specialization) on different portions of the body. *Ahutera* sp. (Fig. 250) develops an elongate flap which originates on the operculum near the preopercular spinule cluster; *Pseudahutera nasicornis* (Fig. 248) develops several, elongate tendrils laterally on the tail; and many species develop a filament at the terminus of the pelvic bones (Fig. 248). The latter possibly represents a pelvic fin bud that atrophies.

The description of *Stephanolepis hispidus* by Hildebrand and Cable (1930) seems to be based on more than one monacanthid species (Martin and Drewry, 1978). Berry and Voegelé (1961) describe the juvenile development of several monacanthid species.

Hildebrand and Cable (1930) state that the pelvis of *Stephanolepis hispidus* possibly forms through coalescence of two separate fin buds. In the material available to us (Table 116),

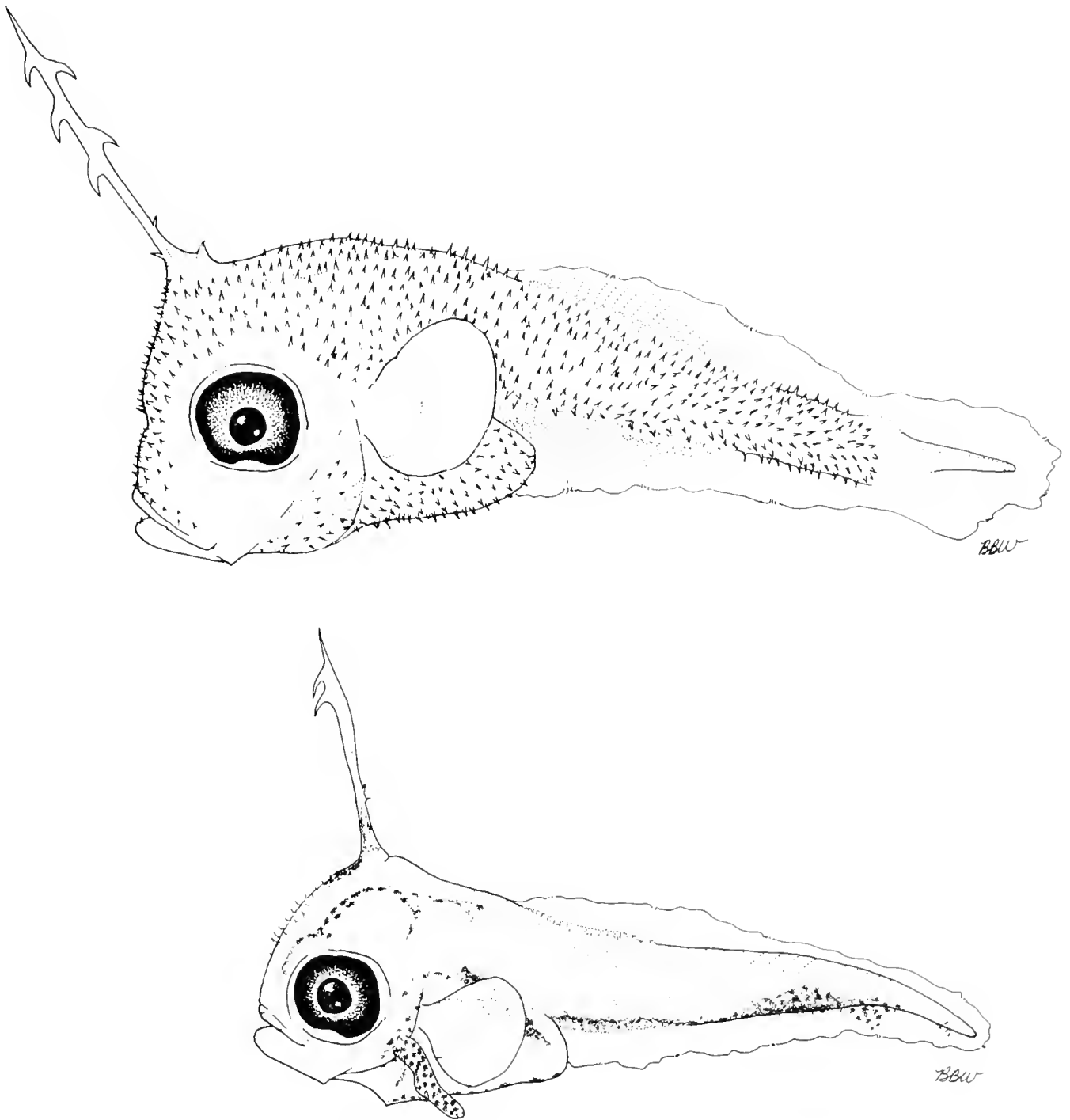

Fig. 250. Monacanthid preflexion larvae. (upper) *Amanses pullus* 3.99 mm SL, Y-92; (lower) *Alutera* sp. 2.76 mm SL, ASF-94 western Atlantic (preopercular cluster of spinules not seen in these specimens).

the pelvis forms from a single unpaired anlage located just posterior to the cleithral symphysis. The terminal encasing scales form first as unspecialized spinules, and at the same time a pair of pelvic elements begins to ossify. The pelvis then fuses beginning from its base (e.g., in a 2.35 mm specimen, the pelvis is roughly 'Y'-shaped and fused along about 75% of its length).

The "two ventral fins" observed by Hildebrand and Cable (1930) are probably dermal flaps similar to those of *Alutera* sp.

Development of the preopercular cluster of spinules, aside from Leis and Rennis (1983), has been described in published works only for *Balistes caprisacus* (Sanzo, 1939b; Matsuura and Katsuragawa, 1981) and *Parika scaber* (Crossland, 1981), al-

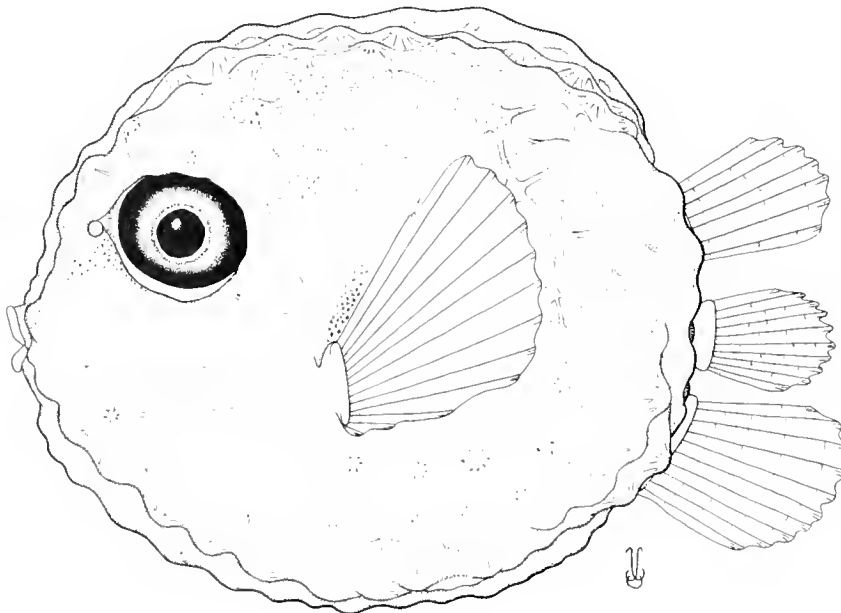
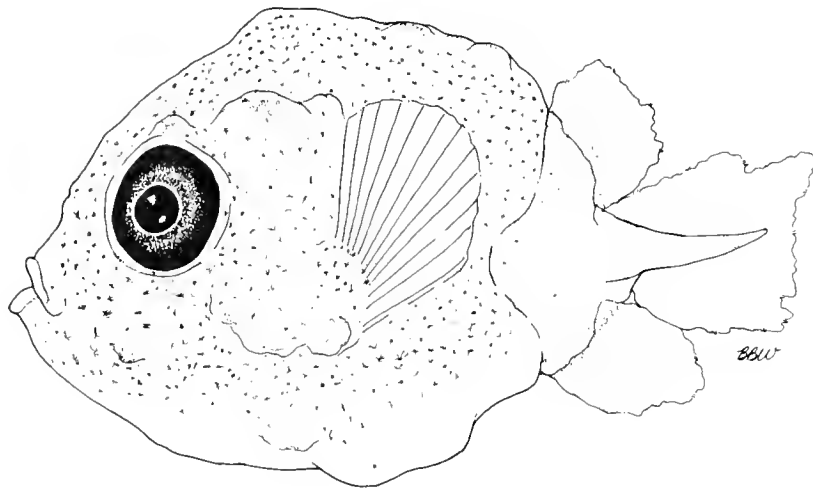
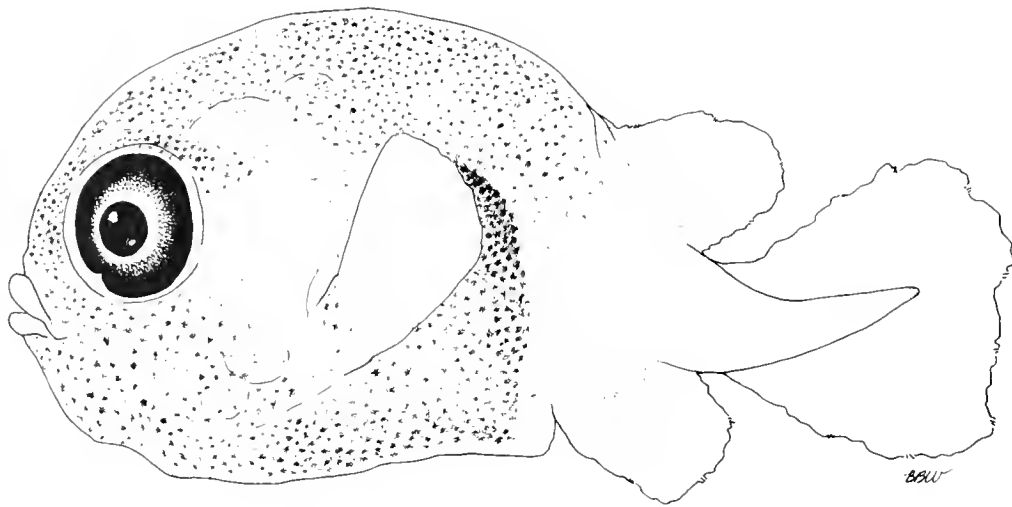

Fig. 251. Ostraciid larvae from top to bottom: *Rhinesomus triqueter* 2.85 mm SL, ASF-37, western Atlantic; *Lactophrys quadricornis* 2.53 mm SL, and 6.0 mm SL ASF94, western Atlantic (exhalant gill openings not shown).

though in the latter it is illustrated as a serrate preopercular border. However, this structure is present in all balistids and Morph AB monacanthids examined for the present study, and because it is an inconspicuous structure it is most likely that it is present in previously described taxa and has been overlooked (see Fig. 250).

Aracaniidae

Nothing is known of aracaniid eggs or larvae.

Ostraciidae

Ostraciid eggs are pelagic, large, slightly ovoid, have one or more oil droplets (Table 116) and hatch in two to four days. There is some chorion ornamentation surrounding the micropyle. In Indo-Pacific species (Ostraciinae) this consists of a partially raised field of small bumps surrounding a small pore-like depression containing the micropyle (Fig. 244). In the single Atlantic species examined (Lactophrysinae), only the pore-like depression is present. Development of larvae at hatching is relatively advanced, but there is some interspecific variation in how advanced: jaws are totally unformed to formed and apparently functional, the eye is unpigmented to partially pigmented, dorsal and anal fin Anlagen may be present. Moderate pigment is present, much yolk remains, the gill opening is restricted to a pore, and an inflated vesicular dermal sac encloses head and trunk (Fig. 244). The dermal sac disappears before flexion. The larvae are deep-bodied and the tail is compressed (Fig. 247). Depending on species, the body may be moderately (*Rhinesomus*) to very wide (*Ostracion*) (Fig. 251); the lactophrysine species examined were more narrow-bodied than the ostraciine species. Larvae tend to become wider with growth, but never become as wide as deep. At hatching, ostraciine larvae

are rotund with head and trunk a single ball-like unit, and they have a small tail. Lactophrysine larvae attain this condition within a few days of hatching. The tail progressively becomes relatively smaller with age until after flexion, and the ball-like shape of the body is retained. The notochord tip is small. The lips have an unusual flared structure. The fins form $P_1-D = A-C$. The dermal ossifications do not pass through a spinule stage, but form directly starting as thickenings in the dermal sac which ossify and grow out from their centers. These eventually coalesce into the mosaic-like armoured carapace characteristic of adults. The individual carapace units that eventually produce spines and other ornamentation tend to be larger and with more relief than other carapace units. The ossifications become visible well before flexion, and larvae are fully armoured by the end of flexion. Pigment is moderate to heavy and generally uniform on head and trunk, with the tail often unpigmented.

Le Danois (1961) describes the juvenile development of several ostraciid species.

Chorion ornamentation of ostraciid eggs previously has been reported only for Hawaiian taxa (Watson and Leis, 1974; Leis, 1977, 1978), however it is present in all ostraciid eggs examined in the present study (Fig. 244), albeit reduced to a pore in *Acanthostracion quadricornis* (Table 116). The ornamentation is subtle and confined to a small portion of the chorion, and we feel it is probably present in all taxa, but has been overlooked in previous descriptions.

(A.A.) STATION MARINE D'ENDOUME ET CENTRE D'OCEANOGRAPHIE, RUE BATTERIE DES LIONS, 13007, MARSEILLE, FRANCE; (J.M.L.) DEPARTMENT OF ICHTHYOLOGY, THE AUSTRALIAN MUSEUM, P.O. BOX A285, SYDNEY, N.S.W., 2000, AUSTRALIA.

Tetraodontiformes: Relationships

J. M. LEIS

IN this contribution I construct a phylogeny of tetraodontiform fishes based on early life history (ELH) characters and contrast this with phylogenies based on adult characteristics. The ELH characters of tetraodontiform fishes are summarized in the preceding two contributions (Aboussouan and Leis, and Leis, this volume). Although in many cases there is little information available, I have assumed that which is available is representative, and that new information will not change the conclusions herein. This is unlikely, and for this reason, the present treatment must be viewed with caution.

Inter-ordinal Relationships

The tetraodontiform fishes are usually presumed to have been derived from perciform ancestors, with the Acanthuroidei being the popular choice for closest relative (Tyler, 1980; Winterbottom, 1974a; Lauder and Liem, 1983). However, D. E. Rosen in an unpublished study (pers. comm.) presents evidence supporting a relationship between zeiform and tetraodontiform fishes (see also Winterbottom, 1974a).

There is little in the early life history of tetraodontiform fishes to indicate they are the sister group of the acanthuroid fishes. The few ELH characters acanthuroids and tetraodontiforms share (small mouth, gas bladder present, relatively few myomeres, large head, oviparity, spherical eggs with unsegmented yolk) are very widespread in the perciform fishes, and the larvae are not even generally similar (see Leis and Rennis, 1983). Certain character states (e.g., scale development) are shared by the acanthuroid fishes and some groups of tetraodontiform fishes. This situation could be interpreted as indicating a relationship between acanthuroids and tetraodontiforms, whereupon the character state involved would be viewed as primitive for the Tetraodontiformes as a whole. Therefore, the presence of an alternate character state in some tetraodontiform families would be viewed as a derived condition. This type of interpretation, while probably realistic, is avoided here as it is fraught with opportunities for circular reasoning.

Too little is known of ELH characters in zeiform fishes (Tighe and Kcene, this volume) to enable a proper evaluation of the

Zeiformes as a potential sister group to the tetraodontiform fishes. However, at least *Zeus* and *Capros* have a long notochord tip; *Capros* has early-forming spinule-like scales; and *Capros* and *Zeus* (but not *Antigonia*) larvae are generally similar to some balistoid larvae in body shape and pigmentation. Thus, based on scanty ELH information, there are some suggestions of support for Rosen's proposal of a zeiform-tetraodontiform relationship.

Present knowledge of ELH characters does not help much in determining the inter-ordinal relationships of the tetraodontiform fishes. This is partially because there are no unique, derived ELH characters shared by all tetraodontiform fishes (see below). In addition the ELH characters which are shared between tetraodontiforms and either acanthuroids or zeiforms (above) are shared with other groups as well, thus lessening the value of these characters in determining relationships: e.g., similar body shape, pigment, reduced number of vertebrae, early-forming spinule-like scales, and elongate notochord tip are found in various combinations in priacanthids, pomacanthids, callionymids and lophiiform fishes (Leis and Rennis, 1983, and relevant chapters in this volume).

Therefore, one must rely on ideas of inter-ordinal relationships based on adults. For the purposes of this analysis, the Acanthuroidei and the Zeiformes are considered as alternative sister groups for the Tetraodontiformes.

Order Tetraodontiformes

There are relatively few ELH characters which apply to the Tetraodontiformes as a whole, and fewer still which could be considered derived. The only characters which might be considered derived are the late formation of the caudal fin and the various early-forming scale specializations, and both are found in a few other percoid and non-percoid groups. The dermal sac and some other derived characters are probably derived within the order and are of no use in characterizing the order as a whole. Other tetraodontiform characters which are wide-spread among other fishes are: small mouth, gas bladder present, relatively few myomeres and fin rays, large head, no bones of the head with spines, oviparity, basically spherical eggs with unsegmented yolk, and transformation to an unspecialized pelagic juvenile at a small size. Therefore, I could find no uniquely derived ELH characters shared by all members of the order.

Some features of the adults can be considered pedomorphic: large head, lack of certain structures that simply never form (Fraser-Brunner, 1950), delayed ossification of some bones.

Intra-ordinal relationships

As noted above, the Acanthuroidei (consisting of the families Acanthuridae, Zanclidae and Siganidae) and the Zeiformes (including Caproidae after Rosen, pers. comm.) will be considered as alternative sister groups to the Tetraodontiformes. Therefore, characteristics shared with the early life history stages of the Acanthuroidei, and particularly the Acanthuridae (or alternatively with the Zeiformes) will be considered primitive. Characteristics of acanthuroid larvae are summarized in Leis and Rennis (1983) and Leis and Richards (this volume). Characteristics of zeiform larvae are summarized in Russell (1976) and Tighe and Keene (this volume).

Two tetraodontiform families cannot be included for lack of information (Araucanidae and Triodontidae) and these are not considered further. I don't know how seriously these omissions might bias the results. It is assumed the egg characteristics of

the triacanthodids (which are unknown) are the same as those of the triacanthids.

Perhaps surprisingly, the acanthuroid and zeiform character states differ for only three of the characters used in the following analysis. For these three, the difference lies in my inability to assign polarity to the character if the zeiforms were chosen as the outgroup. Thus, it makes no difference to the shape of the resulting phylogeny (but does weaken two of the branch points) if the Zeiformes rather than the Acanthuroidei is chosen as outgroup.

A discussion of the characters used follows (Table 118): (1) Egg type—Acanthurids (and zeiforms) have pelagic eggs, although siganids have demersal eggs. The demersal eggs of tetraodontiform fishes and siganids have no adaptations for being demersal other than stickiness or a mucous mass, and seem relatively unspecialized for being demersal. A pelagic egg is considered primitive. (2) Egg size—Acanthuroid eggs are small (<1 mm), so eggs larger than 1.4 mm are considered derived. However, zeiform eggs are medium to large (0.95–2.0 mm), so if zeiform fishes are accepted as the outgroup, polarity of this character cannot be determined. (3) Oil droplets in eggs—Acanthuroid eggs (and zeiform eggs) have one or more oil droplets in the yolk. Lack of oil droplets in eggs is considered derived. (4) Egg shape—An egg that is not spherical is considered derived because acanthuroid eggs (and zeiform eggs) are spherical. (5) Chorion sculpture—Sculpturing on the chorion is considered derived because acanthuroid eggs (and zeiform eggs) are unsculptured. (6) Incubation period—Acanthuroid eggs hatch in about two days or less, and an incubation time longer than this is considered derived. Because incubation period is temperature-dependent, it is possible that some of the differences noted here are artifacts of the different temperatures at which the eggs were reared. However, insofar as it has been possible to compare different taxa reared at similar temperatures, the differences in incubation period noted here seem valid. Incubation times of zeiform eggs are poorly known, but may be up to 13 days for *Zeus*. Therefore, if zeiform fishes are accepted as the outgroup, polarity of this character cannot be determined. (7) Parental care of eggs—There is no parental care of eggs by fishes with pelagic eggs including zeiforms and acanthuroids. Siganids lay demersal eggs but no parental care has been reported. Therefore, lack of parental care is considered primitive. (8) Body shape—Acanthuroid (and zeiform) larvae tend to be cylindrical to somewhat compressed at hatching and to be compressed by the time flexion is complete, although they may pass through an early preflexion stage which is more rotund. This developmental pattern is considered primitive. Some tetraodontiform larvae are extremely rotund throughout development, but this is largely due to a greatly inflated dermal sac (see character 10). (9) Head and gut development—All balistoid fishes but ostraciids hatch with a cylindrical to compressed body. All of these but monacanthid Morph AB become deeper-bodied and wider in head and gut by the middle of the preflexion stage and then become compressed by flexion. Morph AB monacanthids never become broad in head and gut. Due to the widespread occurrence of the wide body development mode in the suborder, it is considered primitive. (10) Vesicular dermal sac—Some tetraodontiform larvae have the head and trunk enclosed in a vesicular dermal sac, a condition not found in acanthuroids or zeiforms (a very weakly-developed dermal sac without vesicles similar to the one of yolk-sac balistids is found in acanthuroids). This sac and its subdermal space seem to be the source of many of the dermal

TABLE 118. EARLY LIFE HISTORY CHARACTERISTICS OF THE TETRAODONTIFORM FISHES. (P) indicates primitive, and (D) derived. (?) indicates assumed. (s) indicates that character is secondarily in state given. (—) indicates not applicable for family. See text for discussion of characteristics. (*) indicates character for which polarity cannot be established if the Zeiformes is considered the sister group of the Tetraodontiformes.

Character	Taxon								
	Triacantho- tidae	Triacanthi- dae	Balisti- dae	Mona- canthidae A B	Mona- canthidae C	Ostraciidae	Tetra- odontidae	Diodonti- dae	Molidae
1. Egg type	P?	P	D	D	D	P	D	P	P
*2. Egg size	P?	P	P	P	P	D	P	D	D
3. Oil droplets	D?	D	P	P	P	P	P	P	P
4. Egg shape	P?	P	P	P	P	D	P	P	P
5. Chorion sculpture	P?	P	P	P	P?	D	P	P	P
*6. Incubation period	P?	P	P	P	P?	D	D	D	D
7. Parental care of eggs	P?	P	D	P	P?	P	P-D	P	P
8. Body shape	P	P	P	P	P	D	D	D	D
9. Head and gut development	P	P	P	D	P	—	—	—	—
10a. Vesicular dermal sac	P	P	P	P	P	D	D	D	D
10b. Dermal sac inflation	—	—	—	—	—	D	P	D	D
11a. Opercular pore A	P?	P	P	P	P	D	D	D	D
11b. Opercular pore B	—	—	—	—	—	D	P	D	D
12. Scale development	P	P	P	P	P	D	D	D	D
13. Very large spines	P	P	P	P	P	P	P	P	D
14. Preopercular cluster	P	P	D	D	Ps	P	P	P	P
15. Long notochord tip	P	P	P	P	P	P	D	D	D
16. Dorsal spine development	D	D	P	P	Ds	—	—	—	—
17a. Dorsal spines A	P	P	D	D	D	D	D	D	D
17b. Dorsal spines B	P	P	P	D	D	—	—	—	—
17c. Dorsal spines C	P	P	P	P	P	D	D	D	D
18. Dsp, P ₂ sp formation	D	P	P	P	P	—	—	—	—
19. Pelvic fin	P	P	D	D	D	D	D	D	D
20. Pelvis	P	P	P	P	P	D	D	D	D
*21a. Caudal fin rays (≤11)	P	P	P	P	P	D	D	D	D
21b. Caudal fin rays (≤10)	P	P	P	P	P	D	P	D	D
21c. Caudal fin rays (none)	P	P	P	P	P	P	P	P	D
22. Pectoral development	P	P	P	P	P	D	D	D	D
23. Body width	P	P	P	P	P	P	P	D	P

specializations of the Tetraodontiformes. A dermal sac is considered derived (10a). A strongly inflated dermal sac (with a large subdermal space) linking head and trunk in a ball-like unit is considered a further derivation from the presence of a sac (10b). (11) Restriction of gill opening to a pore—In perciforms with restricted gill openings (no zeiform fishes have restricted gill openings), the opercles are fully open in early larvae and gradually close to a pore. The assumed-primitive condition in Tetraodontiformes is for closure to a pore to occur after some rays of the median fins have ossified (11a) because this is closest to the perciform condition. Having the opening closed to a pore at hatching is considered derived from closure at the end of the yolk-sac stage (11b). (12) Scale development—The specialized scales of adult tetraodontiform fishes form in two ways: directly or by first passing through a relatively unspecialized spinule stage. The intermediate spinule stage is considered primitive because it is present in acanthurids and at least *Capros* in the zeiforms. In acanthurids small spine-like scales change into triangular scales arrayed in vertical rows, and these spine-like scales form first on the lower gut and laterally on the head, in the same place they first form in most tetraodontiform fishes which have them. In *Capros* small spinules form prior to flexion and eventually cover the whole body before differentiating into scales. (13) Very large dermal spines (larval specialization)—The very large, fixed spines with conical or pyramidal bases of molids are unique and are considered derived. (14) Preopercular spinule cluster (larval specialization)—This cluster of spinules

is unique to balistids and most monacanthids and is considered a derived character. (15) Long notochord tip—The notochord may extend well past the caudal fin anlage, and if so, following flexion it will protrude dorsal and parallel to the caudal rays (to about ½ their length) for a time. This condition was initially considered derived because it is absent in acanthuroid fishes. However, in the Tetraodontiformes the long notochord tip is absent only in taxa in which the tail becomes greatly reduced (i.e., Diodontidae, Ostraciidae, Molidae). Therefore, it seems better to regard the long notochord tip as a primitive character within the order, but a character derived after the supposed split from the acanthuroid fishes. The absence of this structure within the order is thus derived. Zeiform larvae (*Zeus*, *Capros*) have an elongate notochord tip very similar to that of balistoid fishes, so this is considered the primitive condition. (16) Dorsal fin spine development sequence—Dorsal fin spine development prior to dorsal fin soft ray development is considered primitive because this is the condition in acanthuroids and zeiforms. (17) Dorsal fin spines—Acanthuroid fishes have 4 to 14 dorsal fin spines, and zeiform fishes 5 to 10. Therefore, in the tetraodontiform fishes, the most primitive character state is the greatest number of spines (i.e., 4–6 of triacanthodids and triacanthids). The intermediate derived condition is a reduction in this number to three spines (17a). From the intermediate condition are derived one or two spines (17b) and no spines (17c). (18) Initial formation of fin spines—The presence of dorsal fin spine anlage and pelvic fin buds prior to flexion in fishes that have late-

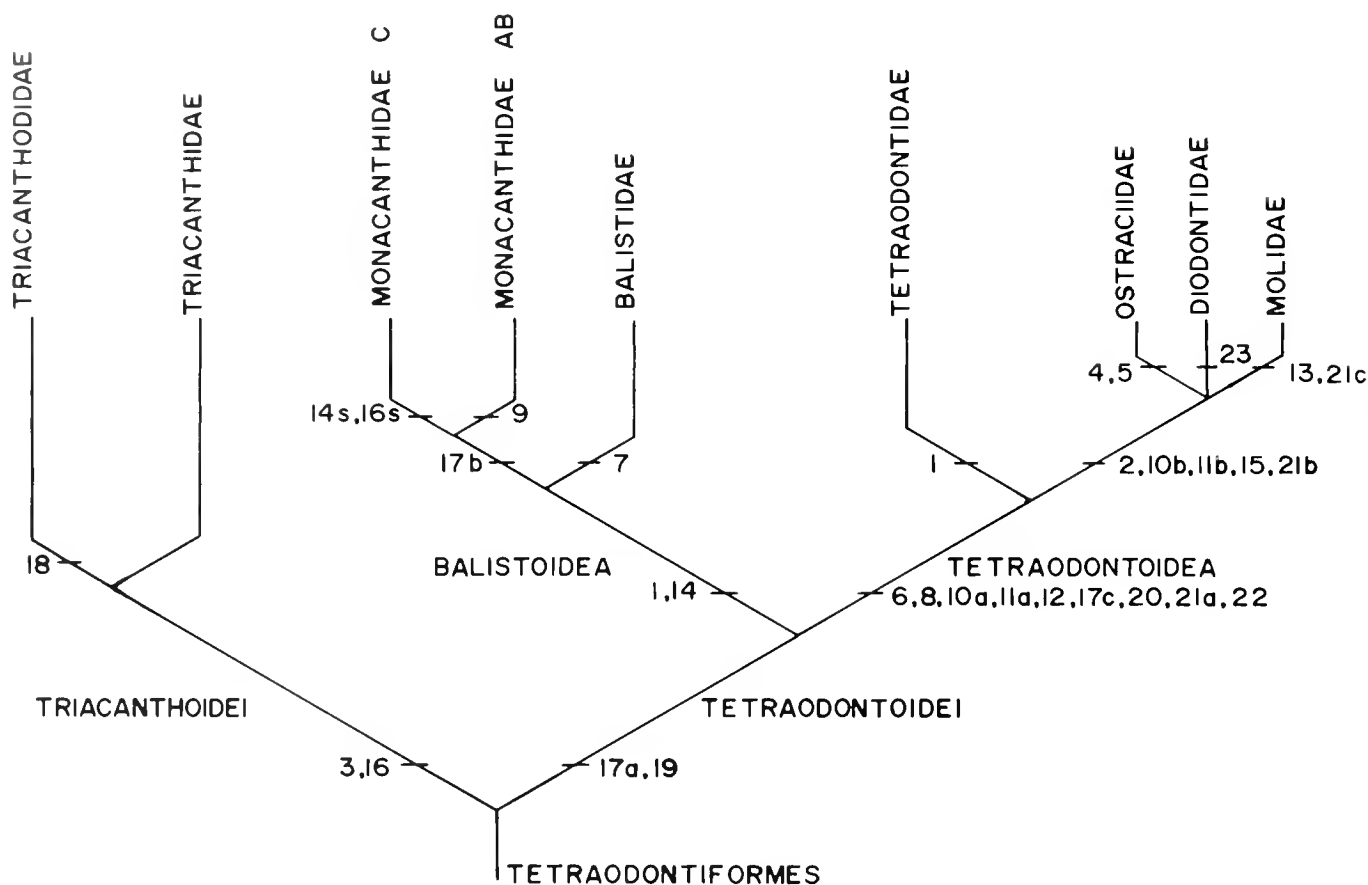

Fig. 252. Phylogeny of tetraodontiform fishes based on early life history characters (excluding Aracaniidae and Triodontidae for which no information is available). Numbers refer to characters (see text) and are located on the branch which possesses the derived state. Characters 2, 6 and 21a would be deleted if the Zeiformes is accepted as the sister group of the Tetraodontiformes. Note that character 1 occurs in two places indicating conflict with the accepted classification.

forming dorsal spines (character 16) is considered primitive because it is closer to the presumed ancestral (i.e., acanthuroid and zeiform) condition of early-forming dorsal and pelvic spines than is late formation of the anlage. (19) Pelvic fin—Acanthuroid (and zeiform) fishes have a pelvic fin formula of at least I, 3. Presence of a pelvic fin is primitive, and its absence is derived. (20) Pelvis—The pelvis is present in acanthuroid (and zeiform) fishes, and its absence is considered derived. (21) Caudal fin rays—Acanthuroids have 16–17 principal caudal fin rays. The maximum number (i.e., 12) in tetraodontiform fishes is considered primitive. The intermediate derived condition is ≤ 11 rays (21a). The next most advanced condition is ≤ 10 rays (21b), and the most advanced condition is the complete absence of the caudal fin (21c). Zeiform fishes have 11–15 principal caudal fin rays, so if zeiforms are accepted as the outgroup, polarity of 21a cannot be determined, while 21b and 21c would not change. (22) Pectoral fin development—The pectoral fin in acanthuroid (and probably zeiform) fishes develops after or simultaneously with the dorsal and anal fin soft rays, and this is considered primitive. (23) Body width—The condition of body width $>$ body depth found in the Diodontidae is unique in the Tetraodontiformes and is considered derived.

PHYLOGENETIC ANALYSIS

Relationships within the Tetraodontiformes based on ELH characters are presented in Fig. 252. In the following section, I

will contrast the present phylogeny with three phylogenies based on adult characters (Fig. 253): myology (Winterbottom, 1974a), external and internal characters (Tyler, 1980) and osteology (Rosen, pers. comm.). Lauder and Liem's (1983) review of interrelationships of tetraodontiform fishes depends heavily on Winterbottom's (1974a) work and, for my purposes here, is identical to his phylogeny. Therefore, Lauder and Liem's (1983) phylogeny will not be considered separately. The ELH-based phylogeny exactly matches none of the three adult-based schemes, but is closest to Rosen's (pers. comm.), differing only in placement of the Tetraodontidae. Two cautions should be kept in mind: 1) Rosen's (pers. comm.) study is primarily concerned with inter-ordinal relationships, and the portion dealing with intra-ordinal relationships of the Tetraodontiformes is based on relatively few characters; and 2) the present phylogeny has limitations flowing from exclusion of two families and many subfamilial taxa due to lack of information.

There is most agreement between the four phylogenies in the question of the relationship of the triacanthodids (Figs. 252, 253). The present phylogeny and those of Winterbottom (1974a) and Rosen (pers. comm.) agree in the erection of the suborder Triacanthoidei as the sister group to all other tetraodontiform fishes. Tyler (1980) includes the triacanthodids in the balistoid line, but this is a result of philosophy of classification more than anything else (Tyler, pers. comm.).

The four phylogenies are evenly divided on the question of

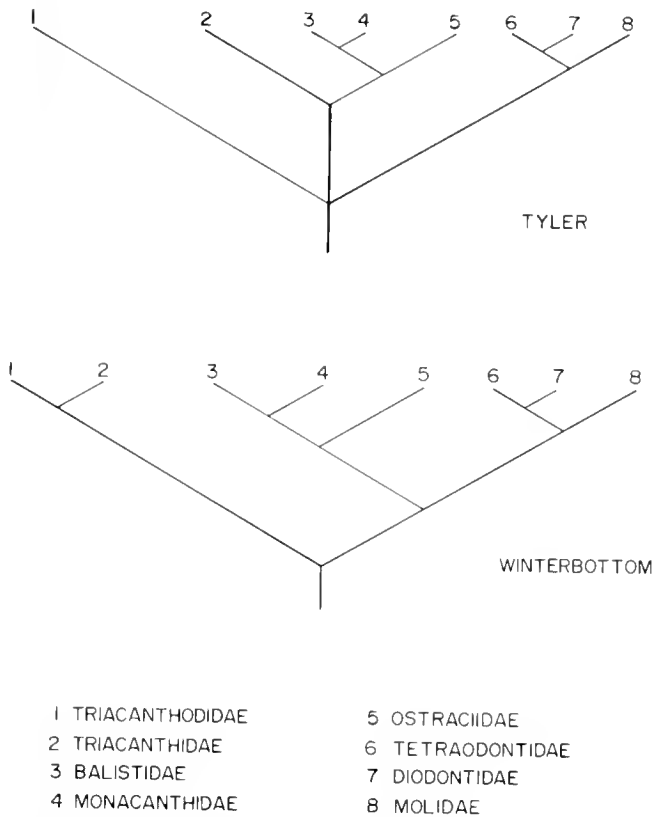

Fig. 253. The two published adult-based phylogenies of tetraodontiform fishes which were tested by the ELH-based phylogeny. These phylogenies were modified by omitting the two families which could not be included in the ELH-based phylogeny. After Tyler (1980) and Winterbottom (1974a). Numbers refer to the families listed at bottom. Rosen's unpublished phylogeny is not shown.

ostraciid relationships (Figs. 252, 253), indicating that further study is required. Winterbottom (1974a) and Tyler (1980) place the ostraciids with the balistoids, a view reinforced by a recent reassessment of their data (Winterbottom and Tyler, 1983). The present phylogeny and Rosen's (pers. comm.), however, place the ostraciids with the tetraodontoids. A relationship between ostraciids and tetraodontoids was suggested by Sakamoto and Suzuki (1978) based on general similarity of larvae.

The three adult-based phylogenies regard the tetraodontids as the sister group of the diodontids (Fig. 253). This differs significantly from the ELH-based phylogeny (Fig. 252) which regards the tetraodontids as the sister group of all other tetraodontoids (including ostraciids). The trichotomy between these "other tetraodontoids" in Fig. 252 cannot be resolved at present. Further study is indicated.

The balistoids (Monacanthidae-Balistidae) branch off in a convincing manner, but not without problems. The phylogeny as depicted in Fig. 252 requires that demersal eggs (1) be independently derived in balistoids and tetraodontids. Although this is quite possible, it brings into question the validity of using demersal eggs as a derived character to define the Balistoidea. Morph C monacanthids lack the preopercular spine cluster (14)

which characterises all other balistoids. I conclude that this is a secondary loss and that the delayed development of the dorsal fin spine in Morph C is independently derived (thus not indicating a relationship with triacanthoids).

All phylogenies agree on the close relationship of monacanthids and balistids. Indeed, in the present study (Fig. 252), they were separated by only two ELH characters, (17b) loss of a fin spine, and (7) parental care of eggs, about which there is little information and which is variable in tetraodontids. Although the present phylogeny is nominally consistent with Matsuura's (1979) phylogeny, Winterbottom (1974a) considered monacanthids and balistids to be subfamilies, and the ELH-based phylogeny presented here has done little to clarify this conflict.

There is some indication from ELH characters of divergences within families, but the amount that can be said is severely limited by the small number of taxa for which ELH characters are known. The diodontids seem very conservative but some species of *Chilomycterus* have a specialized ontogenetic stage between larvae and juveniles ("*Lyosphaera*"): this supports removal of these species to a separate genus (study in progress). Within the ostraciids, the two subfamilies are separated by degree of chorion ornamentation, and to a lesser degree by development at hatching. The specialized "*Molacanthus*" stage separates *Mola* and *Masturus* from *Ranzania* in the Molidae. Balistids seem very conservative in development. Tetraodontids vary greatly in development at hatching, parental care of eggs, and perhaps in a number of other characters. Too few taxa are known within the triacanthoids and triacanthids for any statements to be made here. Monacanthids have the most variation in ELH characters within the order, some of which has already been referred to (Aboussouan and Leis, this volume). There seems to be a great deal of potential in the use of ELH characters for phylogenetic studies in the Monacanthidae, but first, developmental series for more species and genera must be established.

I have attempted to use ELH characters independently as a test of phylogenies based on adult characters. Where the two types of phylogenies support each other, confidence in the phylogeny is increased. Where differences appear, further study, or re-interpretation of existing data is called for to resolve the differences.

In conclusion, the present classification should be viewed with caution because there are relatively few taxa for which early life history information is available. Monophyly of the tetraodontiform fishes could not be established using ELH characters. The present ELH-based phylogeny and those of Winterbottom (1974) and Rosen (pers. comm.) agree in the creation of a separate suborder for triacanthoid fishes; Tyler (1980) disagrees with this placement. Tyler (1980) and Winterbottom (1974a) agree in placing the Ostraciidae in the Balistoidea, in contrast to inclusion of the Ostraciidae within the Tetraodontoidea as proposed here and by Rosen (pers. comm.). My placement of the Tetraodontidae is in conflict with previous phylogenies based on adult characters. In other areas, the ELH-based phylogeny is in agreement with the three adult-based phylogenies. The different placements of the Tetraodontidae and in particular the Ostraciidae in the present classification warrant further investigation of tetraodontiform interrelationships.

DEPARTMENT OF ICHTHYOLOGY, THE AUSTRALIAN MUSEUM, P.O. BOX A285, SYDNEY, N.S.W., 2000, AUSTRALIA.

Percoidei: Development and Relationships

G. D. JOHNSON

AS the largest and most diverse of the perciform suborders, the Percoidei exemplifies the inadequacies that characterize perciform classification. Regan (1913b) defined the Percoidei "by the absence of the special peculiarities which characterize the other suborders of the Percomorphi [=Perciformes]," and seventy years of research in systematic ichthyology have failed to produce a more meaningful definition. In the absence of even a single shared specialization uniting the percoids, the monophyly of this great assemblage of fishes is doubtful. In spite of our inability to adequately define the Percoidei, or because of it, half of the approximately 145 families of perciform fishes are usually referred to this suborder. Greenwood et al. (1966) listed 71 percoid families in their "highly tentative" familial classification of the Perciformes, and Nelson (1976) stated that the Percoidei contains 72 families, 595 genera and about 3,935 species.

Percoids are best represented in the nearshore marine environment and form a significant component of the reef-associated fish fauna of tropical and subtropical seas. A few groups are primarily epipelagic or mesopelagic. Association with brackish water occurs in many nearshore marine families, some of which have one or more exclusively freshwater members, but only four families are primarily restricted to freshwaters, the north temperate Percidae and Centrarchidae, the south temperate Percichthyidae (with one brackish water species) and the tropical Nandidae.

In a practical sense, the suborder Percoidei serves the Perciformes in much the same capacity as the Serranidae once served the Percoidei itself, as a convenient repository for those "generalized" perciform families that cannot obviously be placed elsewhere. I have treated the percoids in a similar sense here, one of practicality and convenience. I do not intend to imply or formulate hypotheses about the monophyly of the Percoidei or to consider their intrarelationships as a whole. My major objectives are to provide some preliminary documentation of the variability of a number of character complexes among adults and larvae of those fishes we now call percoids, to suggest what I believe to be promising avenues of future research and to offer some specific examples illustrating the utility of larval morphology in elucidating percoid phylogeny.

CLASSIFICATION

As here defined (Table 119) the Percoidei includes 80 families and 12 *incertae sedis* genera, making it by far the largest and most diverse suborder of teleostean fishes. The overall limits of the suborder are only slightly modified from Greenwood et al. (1966). The Pomacentridae, Embiotocidae and Cichlidae are excluded because of their recent placement in the Labroidei by Kaufman and Liem (1982). The suborder Acanthuroidea is treated separately in this volume, but a recent hypothesis (Mok and Shen, 1983), with which I concur, based on additional evidence, suggests a close relationship between acanthuroids and the Scatophagidae. The affinities of the questionably monophyletic Nandidae remain unresolved (Lauder and Liem, 1983), and although the nandidae are provisionally included in my list

of percoid families, they were not considered in the larval and adult tables. The genus *Elassoma*, formerly a member of the family Centrarchidae, is excluded from the Percoidei, for reasons discussed below. The monophyly of the suborder Trachinoidei, as defined by Greenwood et al. (1966) is suspect, and the affinities of families such as the Mugiloididae, Percophidae, Chiasmodontidae and others may lie with the percoids. However, these families are treated elsewhere in this volume, and of the "trachinoids," only the Opistognathidae are here included as percoids.

Although the overall limits of the Percoidei are similarly perceived in my classification and that of Greenwood et al. (1966), substantive discrepancies result from differences in concepts of family limits. For example, my Serranidae (Johnson, 1983) includes the Pseudogrammidae and Grammistidae of Greenwood et al. (1966), *Leptobrama* is treated as a monotypic family separate from the Pempherididae (Tominaga, 1965), epigonids are treated as a separate family, etc. The high percentage of monotypic families that has historically characterized percoid classification is a disturbing but unavoidable problem that can only be remedied with a better understanding of percoid intrarelationships. In my classification (Table 119), 26 of the 80 families are monotypic and 12 genera, which lack family names, are retained *incertae sedis*. Families and *incertae sedis* genera are arranged alphabetically for easy reference and to avoid any inference of affinity based on sequence. The classification of Springer (1982) was followed for most families treated by him and otherwise that of Nelson (1976). Below, I discuss differences between my classification and that of Springer (1982) or that of Nelson (1976), and present some new information about familial relationships. Early life history information contributed substantially to some of these modifications.

Acropomatidae and *Symphysanodon*.—The "oceanic percichthyids" of Gosline (1966) do not share the defining characteristics of the Percichthyidae (see below), and are treated here as a separate family, including the following genera—*Acropoma*, *Apogonops*, *Doederleinia* (= *Rhomboserranus*), *Malakichthys*, *Neoscombrops*, *Synagrops* and *Verilus*. I know of no synapomorphy that unites the acropomatids, and further work will be necessary to test their monophyly. Larvae of four genera are known. Those of *Acropoma* (Fig. 254C), *Doederleinia* (Fig. 254D) and *Malakichthys* are quite similar, but those of *Synagrops* (Fig. 254B) differ in pigmentation, body form, and the presence of more extensive head spination. Although the larvae of *Symphysanodon* (Fig. 254A) are unique in their possession of horn-like frontal spines, they are otherwise remarkably similar to those of *Synagrops* (Fig. 254B), suggesting that these two genera may be closely related.

Callanthiidae and Grammatidae.—Springer (1982) noted that "there is little evidence to unite" the five genera he included in the family Grammatidae. I concur with this and treat two of these genera, *Callanthias* and *Grammatonotus* as a distinct family, the Callanthiidae (currently under revision in collaboration

with W. D. Anderson). Callanthiids share a flat nasal organ without laminae, a lateral line that runs along the base of the dorsal fin, ending near its terminus or continuing along the dorsolateral margin of the caudal peduncle, and a midlateral row of modified scales that bear a series of pits and/or grooves. The larvae of these two genera appear dissimilar (Fig. 255E, F), but specimens of *Grammatonotus* smaller than 13 mm are unknown. *Stigmatonotus* (based on a small, now lost specimen) was reported to have three opercular spines, and probably represents a larval or juvenile anthiine serranid. The family Grammatidae, as considered here, contains only *Gramma* and *Lipogramma*.

Carangidae, Coryphaenidae, Echeneididae, Rachycentridae and Nematistiidae.—See discussion on utility of larval morphology.

Coracinae, Drepanidae and Ephippidae.—The family Ephippidae, as defined here, contains the following genera: *Chaetodipterus*, *Ephippus*, *Parapsettus*, *Platax*, *Proteracanthus*, *Rhinoprenes* and *Tripterodon*. Ephippids exhibit considerable diversity in several features that are more commonly conservative among percoids, such as scale morphology and the structure and arrangement of median fin supports and predorsal bones. Nonetheless, monophyly of the family is supported by shared specializations of the gill arches that include reduction or absence of the basihyal, absence of the interarcual cartilage, a relatively large first pharyngobranchial and, most notably, a peculiar comblike series of large blunt rakers loosely associated with the anterior margin of the broadened first epibranchial. Springer (1982; pers. comm.), following some previous authors (Jordan, 1923; Golvan, 1965) included *Parapsettus* in the Scorpididae. *Rhinoprenes* was previously treated as a monotypic family, possibly related to the Scatophagidae (Munro, 1967), and *Proteracanthus* as a girellid (Norman, 1966). Although *Drepane* may be related to the ephippids, it does not share the branchial specializations described above, and lacking further evidence of a direct relationship, I treat it separately. Based on other features of the gill arches a close relationship between *Drepane* and *Coracinus* seems likely. In both genera the basihyal is embedded in thick connective tissue and is tightly bound along the anteroventrally sloping median junction of the hypohyals. In addition, an unusual moveable articulation between the hypohyals and the anterior ceratohyal allows for dorsoventral rotation of the ceratohyal. Pending further investigation of the possible affinities of these two genera, I retain them as monotypic families. Larval morphology could provide important information in resolving the relationships among the five ephippid genera, *Drepane* and *Coracinus*, but to date, only the larvae of *Chaetodipterus* have been described (Fig. 256G).

Elassoma.—In an extensive comparison of the acoustico-lateralis system of the Centrarchidae, Branson and Moore (1962) placed the pygmy sunfishes, genus *Elassoma*, in a separate family, based on over 20 "major characteristics." These include numerous reductions in the laterosensory system (e.g., absence of a lateral-line canal on the body, absence of all infraorbitals except the lacrimal, absence of the mandibular and angular lateralis canals, etc.), presence of numerous free neuromasts of a distinctive form, rudimentary olfactory organ, gill membranes broadly united across the isthmus, rounded caudal fin, and cycloid scales. To these, I add the following reductive features of *Elassoma*, not shared by the Centrarchidae: basisphenoid absent; endopterygoid absent; ectopterygoid absent or fused to

TABLE 119. LIST OF THE FAMILIES AND *INCLUTAE* GENERA OF THE SUBORDER PERCOIDEI. * Families with a single genus.

Acanthochnidae	Emmelichthyidae	Nematistiidae*
Acropomatidae	Enoplosidae*	Nemipteridae
Ambassidae	Ephippidae	<i>Neoscorpis</i>
Aplodactylidae	Epigonidae	Opistognathidae
Apogonidae	Gerreidae	Oplegnathidae*
Arripidae*	Giganthiidae*	Ostracoberycidae*
Banjosiidae*	Girellidae	Parascorpididae*
Bathylucpidae*	Glaucosomatidae*	Pempheridae
Bramidae	Grammatidae	Pentacerotidae
Caesionidae	Haemulidae	Percichthyidae
<i>Caesiocorpsis</i>	<i>Hapalogenys</i>	Percidae
Callanthiidae	<i>Hemilutjanus</i>	Plesiopidae
Carangidae	<i>Howella</i>	Pomacanthidae
Caristiidae*	Inermiidae	Pomatomidae*
Centrarchidae	Kuhliidae*	<i>Polyprion</i>
Centrarchidae	Kyphosidae	Priacanthidae
Centrogenysidae*	Lactariidae*	Pseudochromidae
Centropomidae	<i>Lateolabrax</i>	Rachycentridae*
Cepolidae	Latrididae	Scatophagidae
Chaetodontidae	Leiognathidae	Sciaenidae
Cheilodactylidae	Leptobramidae*	Scombroptidae*
Chironemidae	Lethrinidae	Scorpididae
Cirrhitidae	Lobotidae*	Serranidae
Congrogadidae	Lutjanidae	Sillaginidae
Coracinae*	Malacanthidae	<i>Simperca</i>
Coryphaenidae*	Menidae*	Sparidae
<i>Datnioides</i>	Microcanthidae	<i>Stereolepis</i>
Dinolestidae*	Monodactylidae*	<i>Symphysanodon</i>
<i>Dinoperca</i>	Moronidae	Teraponidae
Drepanidae*	Mullidae	Toxotidae*
Echeneididae	Nandidae	

palatine; palatine with a single notch-like articulation with ethmoid cartilage; predorsals usually absent, a single bone present in some (vs. 3–7 in centrarchids); branchiostegals 5 (vs. 6–7); principal caudal rays 6–7 + 7–8 (vs. 9 + 8); hypurals 1–2 and 3–4–5 fused.

Branson and Moore (1962) concluded that "either the elassomids diverged from the centrarchid stock early in the history of the group or they have entirely different affinities." Subsequent classifications (Greenwood et al., 1966; Nelson, 1976) have continued to treat *Elassoma* as a subfamily of the Centrarchidae, presumably accepting the conclusion of Eaton (1953, 1956) that *Elassoma* is a neotenous centrarchid, with most of its distinctive features having arisen through paedomorphosis. Weitzman and Fink (1983) attributed similar reductions in the laterosensory system of small characids to paedomorphosis and suggested that these characters may be quite labile. These and other osteological reductions similar to those of *Elassoma* are found in other small fishes such as gobioids (Springer, 1983) and cyprinodontoids (Parenti, 1981), but I know of no such extreme examples among small percoids.

That the reductive specializations of *Elassoma* actually represent character states of earlier developmental stages of centrarchids has never been clearly demonstrated or even adequately investigated, and comparative studies of the osteological development of these fishes would be necessary to answer this question. However, a crucial point, that seems to have been overlooked, is the absence of any other evidence suggesting a close relationship between *Elassoma* and the Centrarchidae. Although I know of no morphological specialization that defines the family, all centrarchids exhibit a similar mode of nest-build-

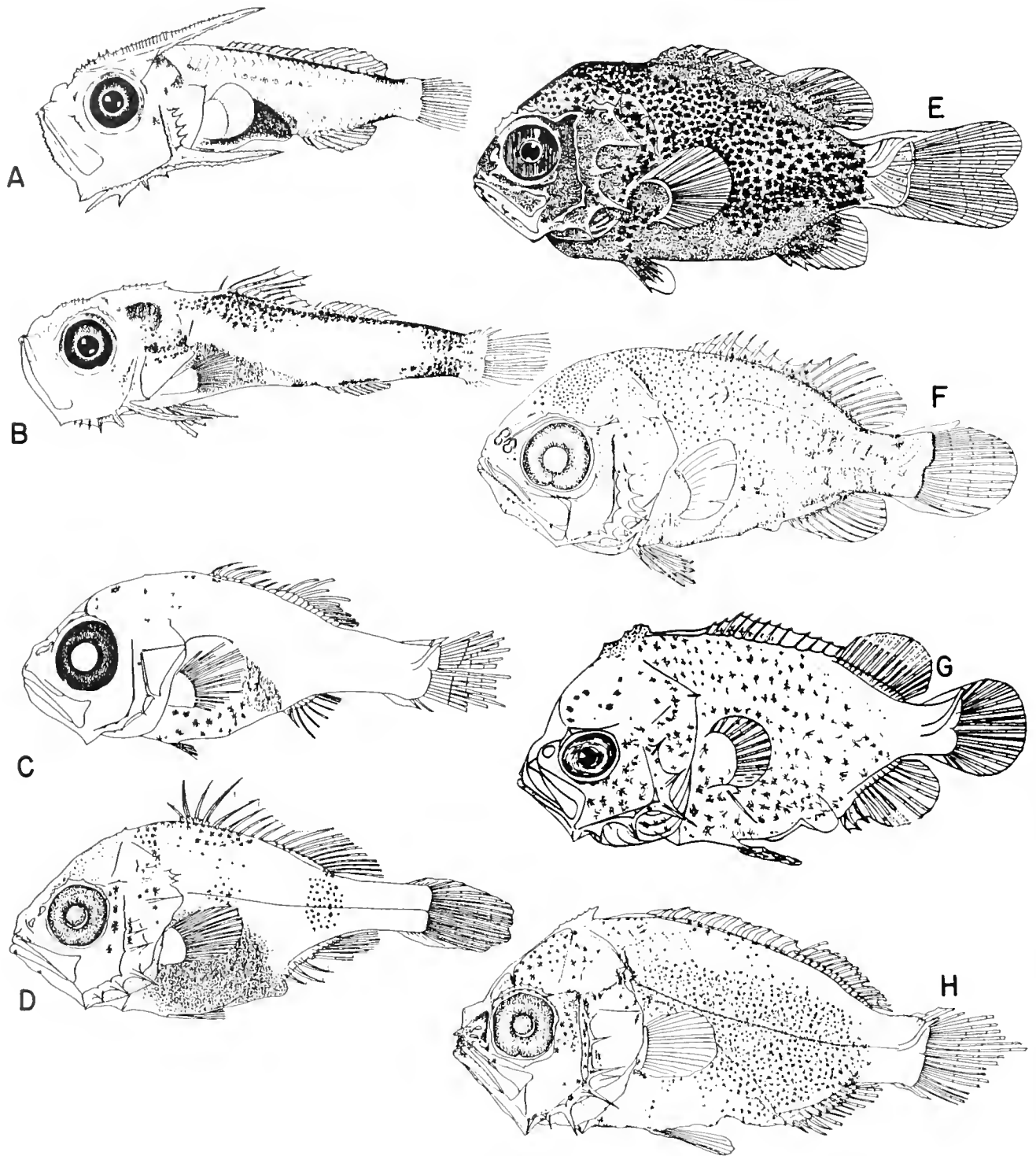

Fig. 254. (A) *Symphysanodon* sp., 5.1 mm SL; (B) Acropomatidae—*Synagrops* sp., 8.5 mm SL; (C) Acropomatidae—*Acropoma japonicum*, 6.0 mm SL, from Y. Konishi (unpubl.); (D) Acropomatidae—*Doederleinia berycoides*, 8.0 mm SL, from Okiyama (1982b); (E) *Polyprion americanus*, 12.2 mm TL, from Sparta (1939a); (F) *Stereolepis doederleini*, 7.2 mm SL, from Okiyama (1982b); (G) Lobotidae—*Lobotes surinamensis*, 6.0 mm TL, from Uchida et al. (1958); (H) *Hapalogenys* sp., 7.3 mm SL, from Okiyama (1982b).

ing and parental-care behavior, and this behavioral "synapomorphy" is not shared by *Elassoma* (Breder and Rosen, 1966; M. F. Mettee, pers. comm.). Consequently, though *Elassoma* may be a product of pedomorphosis, I see no reason to limit

the search for its origins to the Centrarchidae. Quite the contrary, I believe the affinities of *Elassoma* will be shown to lie outside the Percoidae and, perhaps, outside the Perciformes.

My preliminary findings indicate that *Elassoma* possesses a

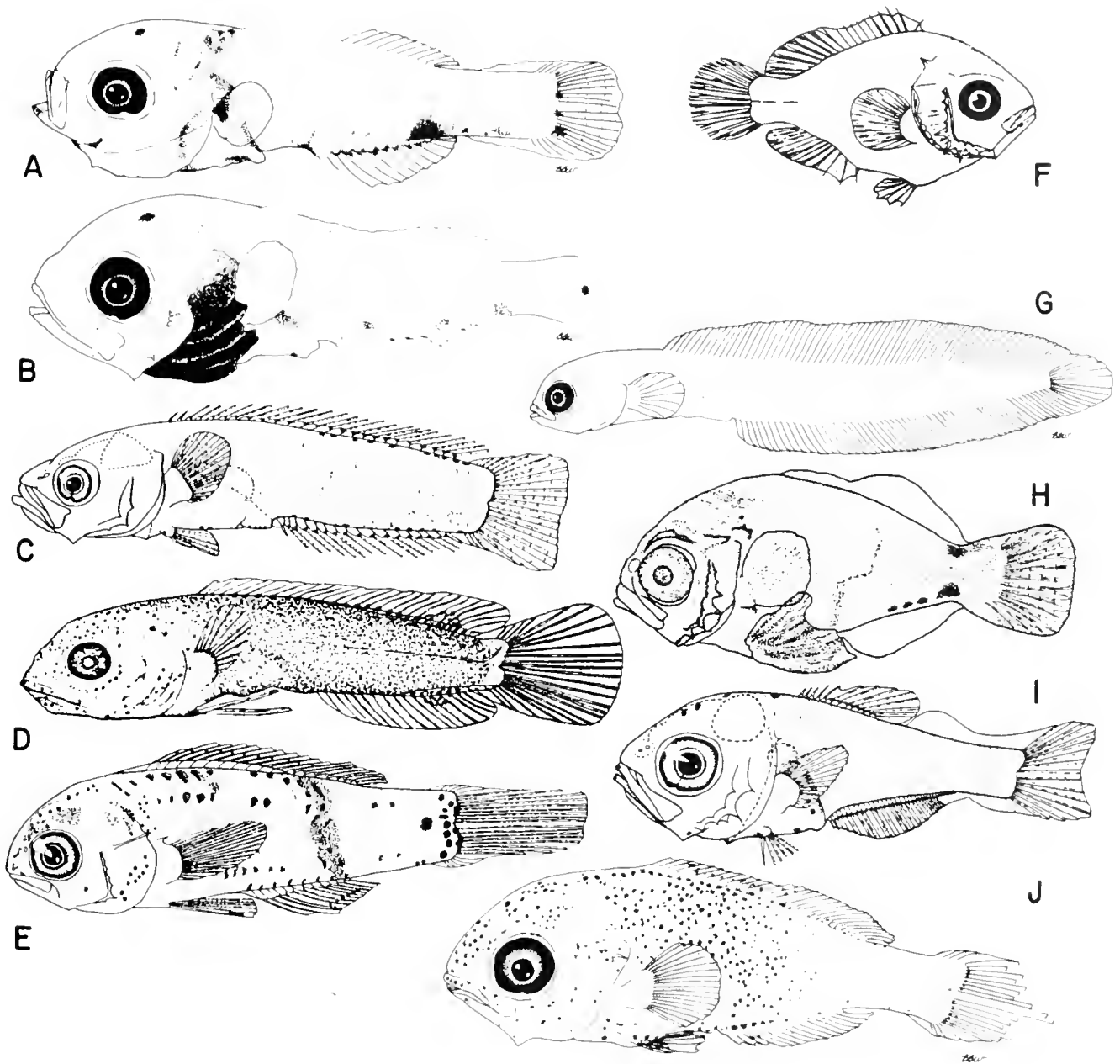

Fig. 255. (A) Ambassisidae—*Velambassis jacksonensis*, 5.5 mm SL; (B) Opistognathidae—*Opistognathus* sp., 6 mm SL; (C) Pseudochromidae, 8.1 mm SL, from Leis and Rennis (1983); (D) Acanthoclinidae—*Acanthoclinus trilineatus*, 10.0 mm, from Crossland (1982); (E) Callanthiidae—*Grammatonotus laysanus*, 13.7 mm SL, from Leis and Rennis (1983); (F) Callanthiidae—*Callanthus peloritanus*, 8 mm TL, from Fage (1918); (G) Congrogadidae—*Congrogadus subducens*, 11.8 mm SL; (H) Monodactylidae—*Monodactylus sebae*, 5.2 mm SL, from Akatsu et al. (1977); (I) Pempheridae—*Pempheris* sp., 5.5 mm SL, from Leis and Rennis (1983); (J) Oplegnathidae—*Oplegnathus fasciatus*, 7.5 mm SL.

number of salient features (not mentioned above) that cast doubt on its affinities with the Percoidae. The second preural centrum bears a full neural spine, and there are no autogenous haemal spines. Strong parapophyses begin on the first centrum, and pleural ribs may begin on the first, second or third vertebra. The first neural arch is fused to its respective centrum. The pelvic fin is inserted well behind the pectoral fin base and the pelvic girdle does not contact the cleithra. The first pharyngobranchial and interarcual cartilage are absent and what is apparently the uncinat process of the first epibranchial articulates

directly with the second pharyngobranchial. The fourth pharyngobranchial, usually cartilaginous in percoids, is absent. The proximal base of the medial half of the uppermost pectoral ray does not extend laterally to form a process for articulation with the scapular condyle (also true of at least some cyprinodontoids and gobioids). Finally, the ossified portion of the ethmoid consists of two, closely applied, disc-like bones, a condition listed as one of the defining characteristics of the Atherinomorpha by Rosen (1964) and Rosen and Parenti (1981). (They did not discuss the distribution of this character among other groups,

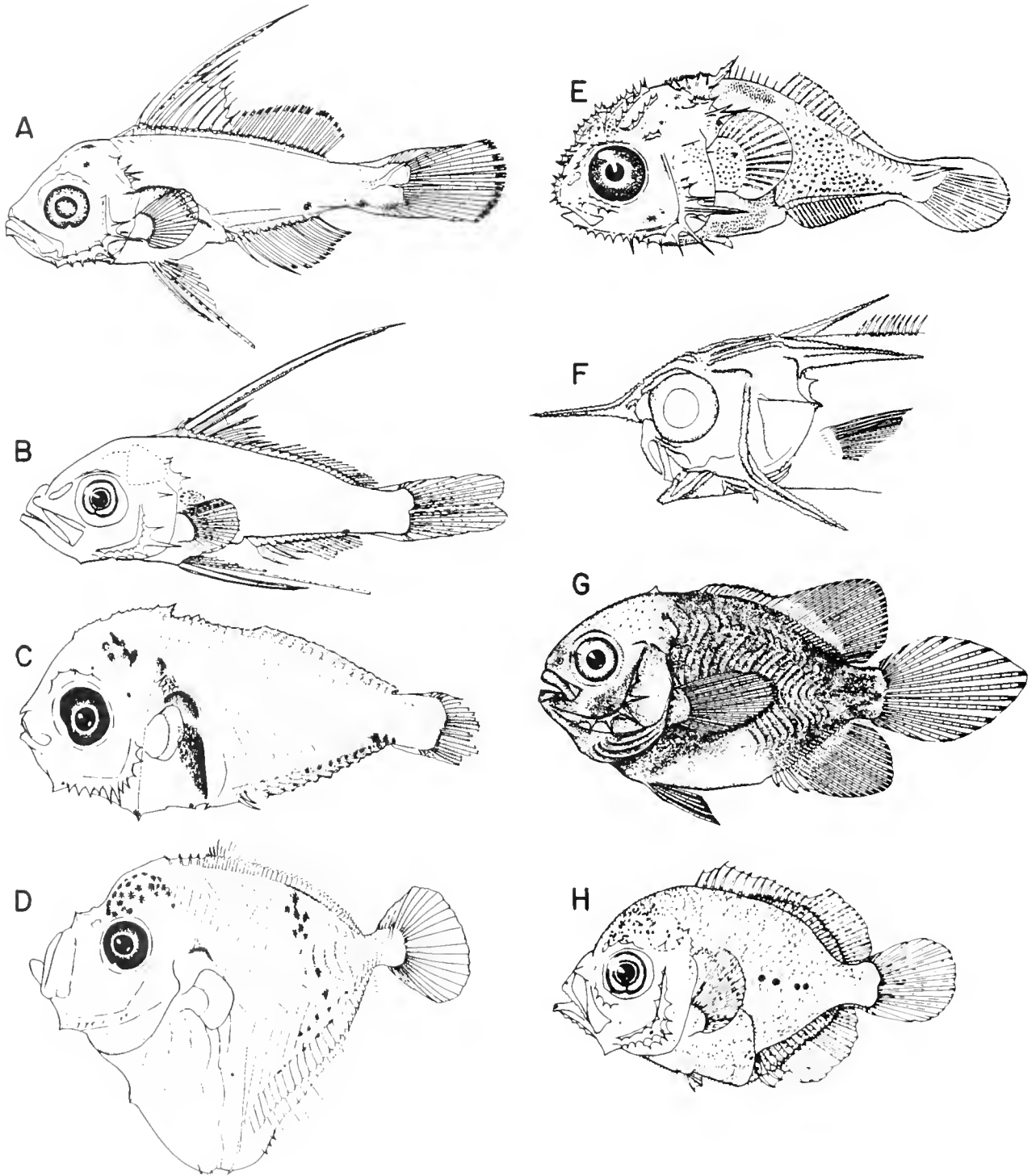

Fig. 256. (A) Lutjanidae—*Lutjanus campechanus*, 7.3 mm SL, from Collins et al. (1980); (B) Caesionidae—*Caesio* sp. or *Gymnocaesio* sp., 7.8 mm SL, from Leis and Rennis (1983); (C) Leiognathidae—unidentified, 4.8 mm SL; (D) Menidae—*Mene maculata*, 4.6 mm SL; (E) Malacanthidae—*Caulolatilus princeps*, 6.0 mm SL, from Moser (1981); (F) Malacanthidae—*Hoplolatilus fronticinctus* (head only), 15 mm SL, from Dooley (1978); (G) Ephippidae—*Chaetodipterus faber*, 9 mm, from Hildebrand and Cable (1938); (H) Pomacanthidae—*Centropyge* sp., 4.4 mm SL, from Leis and Rennis (1983).

but I have observed a similar condition in the gobiid *Dormitator*.)

Elassoma seems to exhibit a confusing mosaic of character states variously shared with atherinomorphs, cyprinodontoids, percopsiforms, perciforms, and gobioids. Resolution of the evolutionary affinities of this genus could be important to our understanding of acanthomorph interrelationships, and I intend to examine this problem more fully.

Epigonidae.—Fraser (1972a) treated *Epigonus*, *Florenciella* and *Rosenblattia* as a subfamily (Epigoninae) of the Apogonidae, but I find no evidence to suggest that these genera are closely related to other apogonids. They are primitive with respect to apogonids in possessing two pairs of uroneurals and a procurrent spur (Johnson, 1975), but specialized in several features listed below. Moreover, the two anal spines of epigonines and apogonids, usually cited as evidence of their close relationship, are not homologous (see discussion on median fins). The Epigonidae are here recognized as a distinct family, including *Brinkmanella*, *Sphyraenops* and Fraser's epigonines. These five genera share the following specializations: rostral cartilage greatly enlarged, ascending processes of premaxillaries reduced or absent; premaxillary articular cartilages enlarged; endopterygoids large, metapterygoids notably reduced; infraorbitals more than six. The larvae of *Sphyraenops* (Fig. 257A) resemble those of *Epigonus* (Fig. 257B) but differ in possessing well-developed head spination.

Girellidae, Kyphosidae, Microcanthidae, Neoscorpis, Parascorpididae and Scorpidae.—Springer (1982; pers. comm.), following Jordan (1923) and Golvan (1965), included microcanthids, *Neoscorpis*, *Parascorpis* and scorpidids in the family Scorpidae, but no convincing evidence for uniting them has been presented, and they are treated separately here. The Scorpidae is here restricted to *Scorpius*, *Medialuna*, *Labracoglossa* and *Bathystethus*. The latter two genera were treated as a separate family, Labracoglossidae, by Springer. Scorpids share similar meristic and osteological features (not derived) and comparable scale morphology. An unusual small slip of muscle extends from the basioccipital to the first vertebra in *Scorpius* and *Labracoglossa*, but its presence has not been confirmed in the other two genera. The larvae of *Scorpius* and *Bathystethus* are undescribed but those of *Labracoglossa* (Fig. 258A) and *Medialuna* (Fig. 258B) share a similar body form, generalized head spination, late fin development and pigment pattern with larvae of the Girellidae (Fig. 258C). Girellids are specialized in several osteological features with respect to the Scorpidae (see Table 120) and have a unique adductor mandibulae in which A_2 inserts on the lateral surface of the dentary (Johnson and Fritzsche, in prep.). The distinctive larval form shared by scorpids and girellids suggests that they may be sister groups. Convincing evidence supporting a close relationship between the Scorpidae and the Microcanthidae (*Microcanthus*, *Atypichthys* and *Neatypus*) or the Kyphosidae (*Kyphosus*, *Sectator* and *Hermosilla*) is lacking. Furthermore, the larvae of the latter two families (Figs. 259G, J) do not possess the salient features of scorpidid or girellid larvae, but more closely resemble those of the Teraponidae (Fig. 259H). The larvae of *Neoscorpis* and *Parascorpis* are unknown, and available anatomical information is insufficient to clarify the systematic position of these two genera.

Malacanthidae.—See discussion on utility of larval morphology.

Moronidae (*Morone* and *Dicentrarchus*), *Lateolabrax* and *Siniperca*.—Gosline (1966) included the Moronidae (using the name *Roccus*), *Lateolabrax* and *Siniperca* (= *Coreoperca*) in his "estuarine and freshwater percichthyids." I treat these separately, because I lack evidence of their affinities with the Percichthyidae, with one another, or with any other percoid group. It is interesting to note that the Moronidae share one of the two synapomorphies of the Centropomidae described by Greenwood (1976)—the lateral line extends almost to the posterior margin of the caudal fin. In addition, moronids have an auxiliary row of lateral line scales on the caudal fin above and below the main row, as does the centropomid *Lates*. Although both of these conditions occur elsewhere in generalized percoids (e.g., *Neoscorpis*, some species of *Lutjanus*, and the percoid subfamily Luciopercinae) and may actually be primitive for the Percoidei (Springer, 1983), the possibility of a moronid-centropomid relationship seems plausible and should probably be investigated further. Unfortunately, as is typical of most fresh or brackish water spawners, the larvae of these groups (Fig. 260) exhibit relatively direct development and consequently offer little phylogenetic information.

Percichthyidae.—The Percichthyidae of Gosline (1966) represents a polyphyletic assemblage defined on the basis of shared primitive features. I am unable to find synapomorphies that support recognition of the assemblage as a monophyletic group. I restrict the Percichthyidae to the following genera, which occur only in freshwaters of Australia and South America: *Percalates* (brackish water), *Plectroplites*, *Macquaria*, *Maccullochella*, *Percichthys*, *Percilia*, *Bostockia*, *Gadopsis*, *Nannoperca*, *Edelia*, and *Nannatherina*. The monophyly of the family is supported by a series of nested synapomorphies, only a few of which are mentioned here. The scales of most of these genera are similar and unlike those of the excluded genera in having the posterior field filled with simple, only slightly amputated (see McCully, 1970), needle-like ctenii (those of *Bostockia*, *Gadopsis* and *Nannatherina* are secondarily cycloid). The three most generalized genera, *Percalates*, *Plectroplites*, and *Macquaria* are very similar biochemically [MacDonald (1978) synonymized them on this basis], and the latter two share two morphological specializations with *Maccullochella*, *Percichthys*, *Percilia*, *Bostockia* and *Gadopsis*: enlarged sensory pores on the dentary and a separate inner division of adductor mandibulae section A_1 . The three most derived genera, *Nannoperca*, *Edelia* and *Nannatherina* (heretofore treated as kuhliids) share with *Bostockia* a similar vertebral number (29–33), a distinctive asymmetrical nasal rosette, and a number of reductive specializations (absences of the subocular shelf, procurrent spur, and supracleithral sensory canal, reduced numbers of procurrent caudal rays, dorsal spines, branchiostegals and trisegmental pterygiophores, and an interrupted or absent lateral line). Systematic placement of the enigmatic *Gadopsis* has proved problematic, even in recent years. It has generally been treated as a monotypic family and variously assigned to the Percoidei (Greenwood et al., 1966), Ophidiioidei (Gosline, 1968), Perciformes with proposed affinities to the Trachinoidei and Blennioidei (Rosen and Patterson, 1969) or a separate order Gadopsiformes (Scott, 1962). The percoid affinities of *Gadopsis* are manifest in the anatomy of the dorsal gill arches, caudal skeleton and median fin supports. Its affinities with the Percichthyidae are indicated by a number of features shared with some percichthyid genera, including the configuration of the adductor mandibulae noted above. *Gadopsis* shares

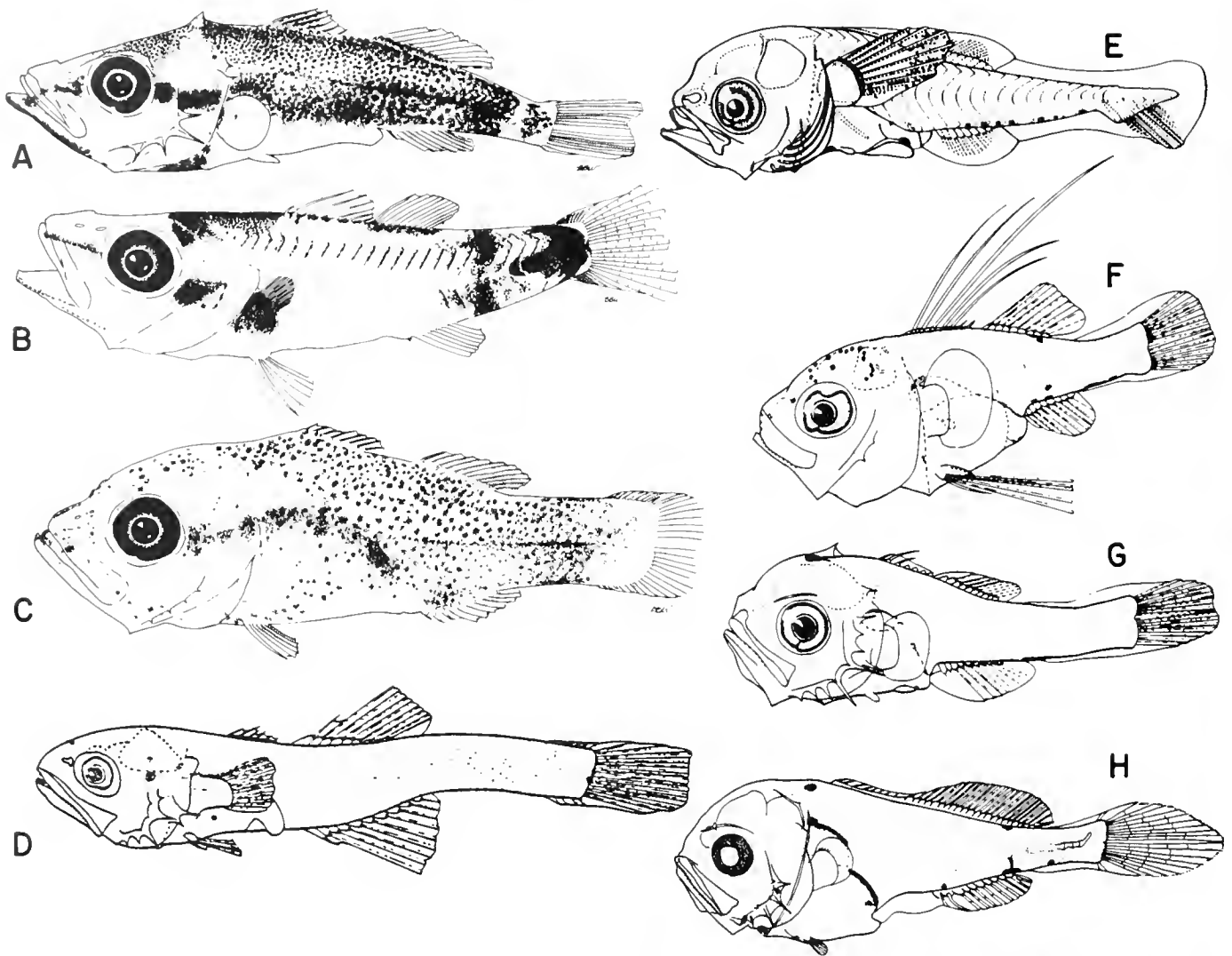

Fig. 257. (A) Epigonidae—*Sphyraenops bairdianus*, 6.8 mm SL; (B) Epigonidae—*Epigonus* sp., 14.0 mm SL; (C) *Howella* sp., 6.0 mm SL; (D) Apogonidae—*Pseudamia* sp. or *Pseudamiops* sp., 8.7 mm SL, from Leis and Rennis (1983); (E) Apogonidae—*Foa brachygramma*, 4.2 mm SL, from Miller et al. (1979); (F) Apogonidae—unidentified, 4.2 mm SL, from Leis and Rennis (1983); (G) Apogonidae—unidentified, 5.0 mm SL, from Leis and Rennis (1983); (H) Sciaenidae—*Stellifer lanceolatus*, 6.2 mm SL, from Powles (1980).

the asymmetrical nasal rosette of *Bostockia*, *Nannoperca*, *Edelia* and *Nannatherina* and all reductive specializations of those genera noted above, except the reduced lateral line and branchiostegal number. Specializations shared with *Bostockia* alone include a tubular anterior nostril placed near the margin of the lip and absences of the basisphenoid, medial tabular, and third epural. Based on this evidence, *Gadopsis* appears to be most closely related to *Bostockia*, however it bears a strong superficial resemblance to *Macullochella* and shares the premaxillary frenum of that genus.

ADULT MORPHOLOGY

The scope of morphological diversity exhibited within the Percoidei surpasses that of all other perciform suborders. Although many percoids have a generalized bass-like or perch-like physiognomy, extremes of adult body form range from deep

bodied, compressed or "slabsided" fishes, such as the ehippidids, chaetodontids and menids to extremely elongate forms like the cepolids and the eel-like congrogadids. Add to this the exceptional variability in fin conformation, ornamentation of head bones, squamation, jaw configuration, and internal osteological features, and the suborder Percoidei presents an impressive heterogeneous array of forms. Lack of progress in elucidating percoid phylogeny is largely attributable to this somewhat overwhelming diversity and the ostensible convergence (particularly in reductive traits) that seems to have characterized percoid evolution. To date, no familial phylogeny, cladistic or otherwise, has been proposed for the suborder. The limits and monophyly of many of the component families are not clearly defined and the affinities of numerous genera remain unresolved. Superficial knowledge of basic percoid anatomy and an inadequate understanding of character distribution and vari-

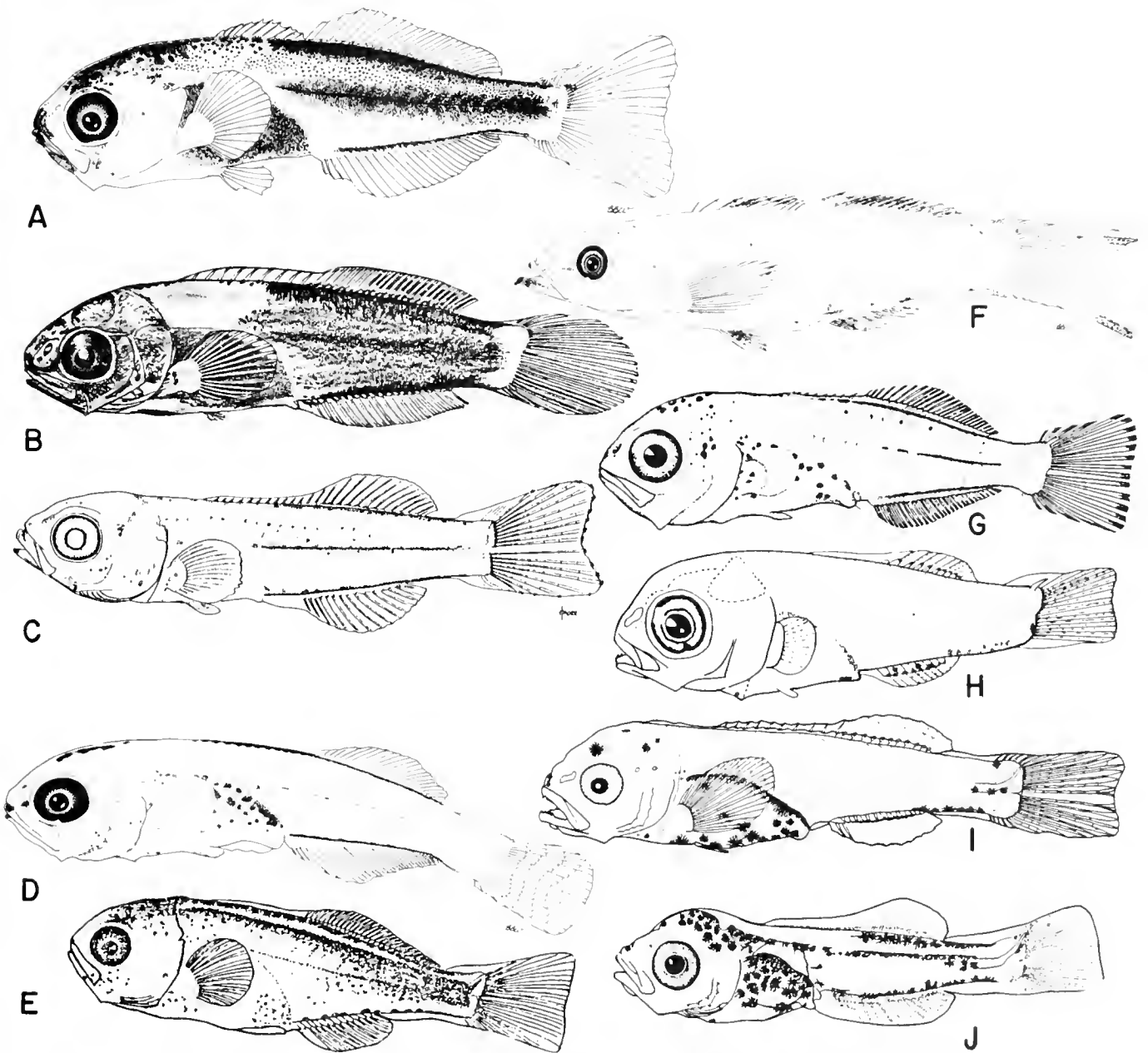
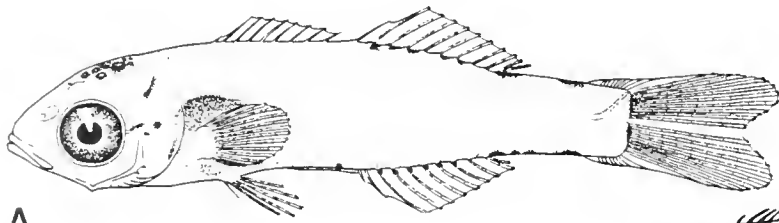

Fig. 258. (A) Scorpididae—*Labracoglossa argentiventris*, 9.9 mm SL; (B) Scorpididae—*Medialuna californiensis*, 10.1 mm SL; (C) Girellidae—*Girella nigricans*, 10.9 mm SL; (D) Leptobramidae—*Leptobrama mulleri*, 7.2 mm SL; (E) Cheilodactylidae—*Palunolepis brachydactylus*, 8.3 mm SL; (F) Cirrhitidae—*Amblycirrhitus pinos*, 13.2 mm SL; (G) Pomatomidae—*Pomatomus saltatrix*, 7.3 mm TL, from Pearson (1941); (H) Nemipteridae—unidentified, 5.1 mm SL, from Leis and Rennis (1983); (I) Sparidae—*Acanthopagrus cuvieri*, 8 mm SL, from Hussain et al. (1981); (J) Centracanthidae—*Pterosmaris axillaris*, 7.7 mm SL, from Brownell (1979).

ability, basic to cladistic outgroup comparison, have seemingly inhibited, or at least hindered, meaningful comparative studies within the Percoidei.

Because the group is so large, these problems will necessarily continue to plague studies of percoid relationships. Outgroup comparisons based on a single family are speculative without evidence for a sister group relationship, and broader surveys of each character are frequently impractical if not impossible. One

approach that can gradually alleviate this problem is the cumulative tabulation of characters and character states. Comparative tables document the distribution of morphological features throughout the suborder and the variability of these features within families, and they accordingly offer the most complete foundation for outgroup comparison. Furthermore, they provide information about the plasticity of various complexes, allow identification of characters most frequently subject to con-



A

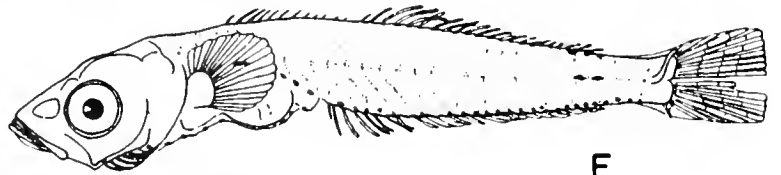

F

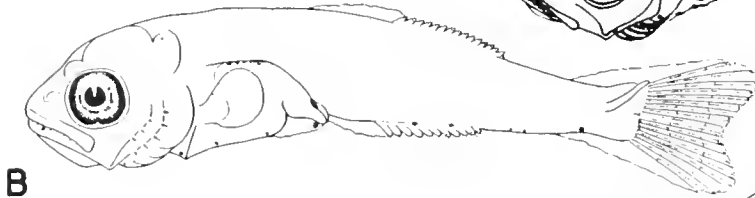

B

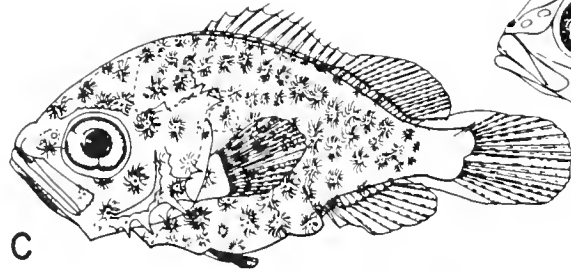

C

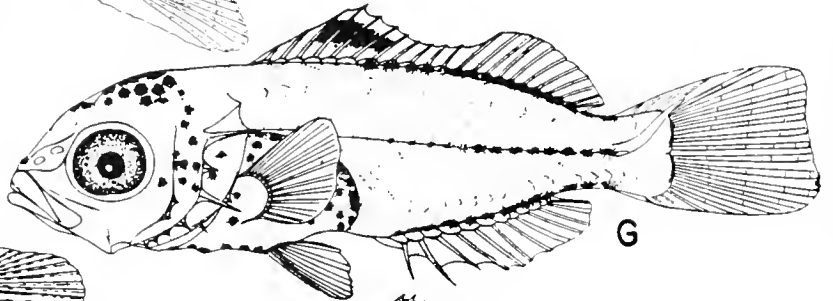

G

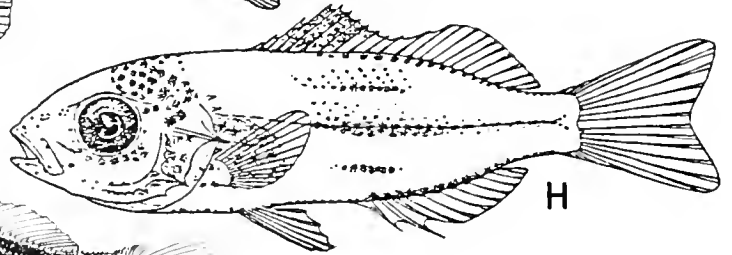

H

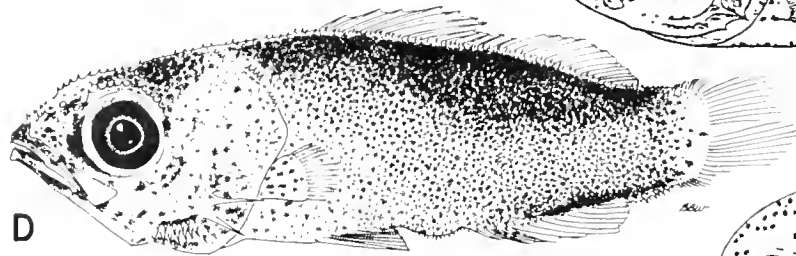

D

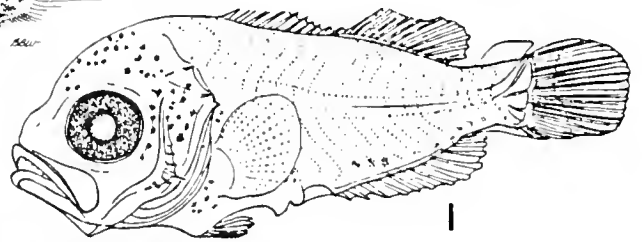

I

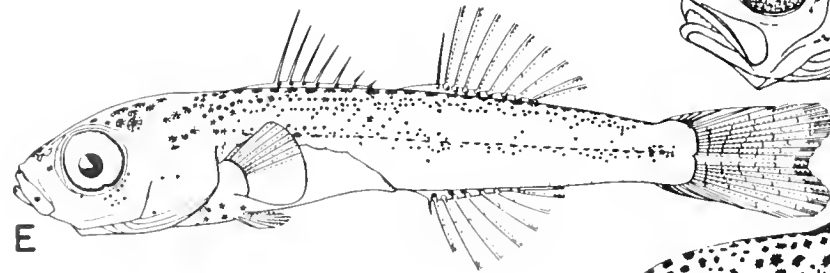

E

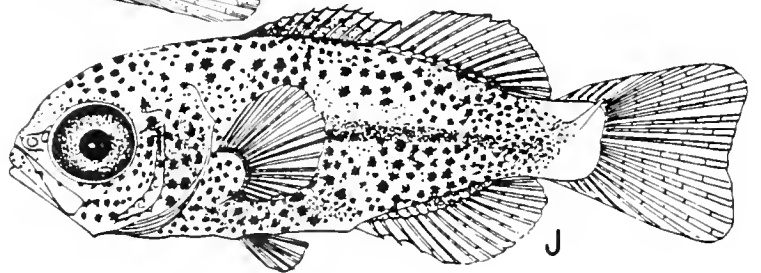

J

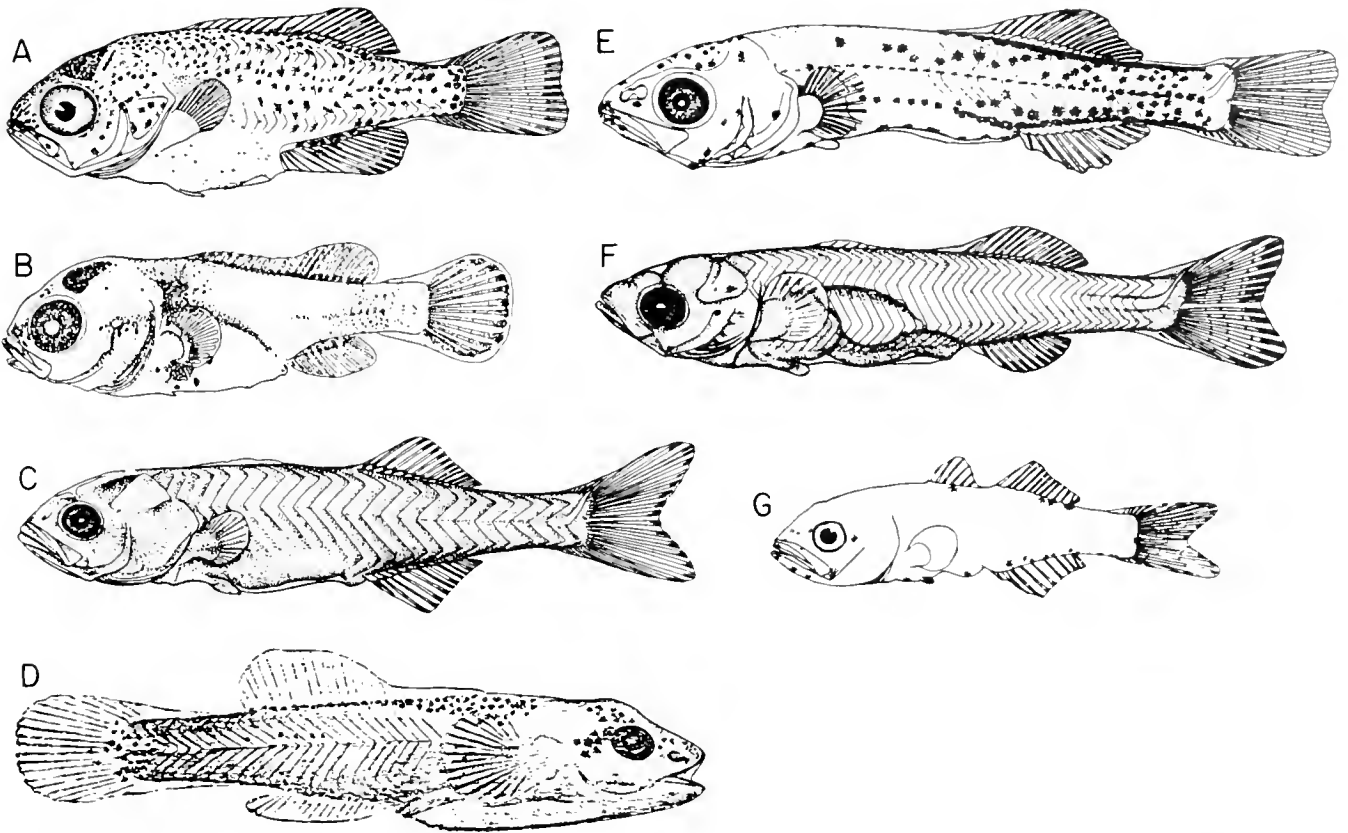

Fig. 260. (A) Centrarchidae—*Ambloplites rupestris*, 10.5 mm TL, from Fish (1932); (B) *Siniperca* (= *Coreoperca*) *kawamebari*, 9.0 mm TL, from Imai and Nakahara (1957); (C) Percidae—*Perca flavescens*, 14.2 mm TL, from Mansueti (1964); (D) Percichthyidae—*Maccullochella macquariensis*, size unknown, from Dakin and Kesteven (1938); (E) *Lateolabrax japonicus*, 13.7 mm TL, from Mito (1957b); (F) Moronidae—*Morone americana*, 13.2 mm TL, from Mansueti (1964); (G) Centropomidae—*Centropomus undecimalis*, 6.3 mm SL, from Lau and Shafland (1982).

vergence and convincingly document the uniqueness of derived features. With this in mind, I have compiled information about selected morphological features of adults (Table 120) and larvae (Table 121) for each percoid family or *incertae sedis* genus. This information was compiled from the literature (particularly the meristic data) and from my own examination of cleared and stained specimens and radiographs. Data for a few groups were compiled by experts working on those groups. For many families, I examined at least one representative of each genus, but obviously this was not always possible and only in a few of the smaller families were all species examined. As a consequence, this data will not reflect the full range of variability for every family but should represent a reasonably close approximation. Most features considered in Table 120 are discussed below.

Fins.—The primitive perciform complement of one spine and five rays (I, 5) in the pelvic fin is the most consistent feature of

percoid fins. A single spine is always present and fewer than five soft rays are found only in the Acanthoclinidae (I, 2), Congrogadidae (I, 2–4 or absent), Plesiopidae (I, 4), Pseudochromidae (I, 3–5) and the percichthyid *Gadopsis* (I, 1).

The primitive and most common number of principal caudal fin rays (branched rays + 2) is 9 + 8. Where reductions occur (in 18 families) they usually involve one fewer principal ray dorsally and/or ventrally and are frequently consistent within families, e.g., 8 + 7 in Cheilodactylidae, Chironemidae, Cirrhitidae, Latrididae and Mullidae, and 8 + 8 in Acanthoclinidae, Priacanthidae, and Scatophagidae. The most extreme reduction (4–6 branched + 4–8 branched) is seen in the Congrogadidae. The only apparent increases, 10 + 9 found in some grammatids and plesiopids, do not result from an increased number of rays articulating with the hypurals, but from branching of the outermost hypural-associated rays. Numbers of procurent or secondary caudal rays dorsally and ventrally

Fig. 259. (A) Gerreidae—*Eucinostomus* sp., 8.7 mm SL; (B) Haemulidae—*Xenistius californiensis*, 6.5 mm SL; (C) Haemulidae—*Pseudopristipoma nigra*, 5.8 mm SL, from Leis and Rennis (1983); (D) Haemulidae—*Conodon nobilis*, 9.8 mm SL; (E) Mullidae, 8.2 mm SL, from Miller et al. (1979); (F) Sillaginidae—*Sillago sihama*, 9.0 mm TL, from Uchida et al. (1958); (G) Microcanthidae—*Microcanthus strigatus*, 7.1 mm TL, from Uchida et al. (1958); (H) Teraponidae—*Therapon theraps*, 9.5 mm, from Zvjagina (1965b); (I) Emmelichthyidae—*Erythrocles schlegeli*, 6.9 mm TL, from Nakahara (1962); (J) Kyphosidae—*Kyphosus cinerascens*, 9.8 mm TL, from Uchida et al. (1958).

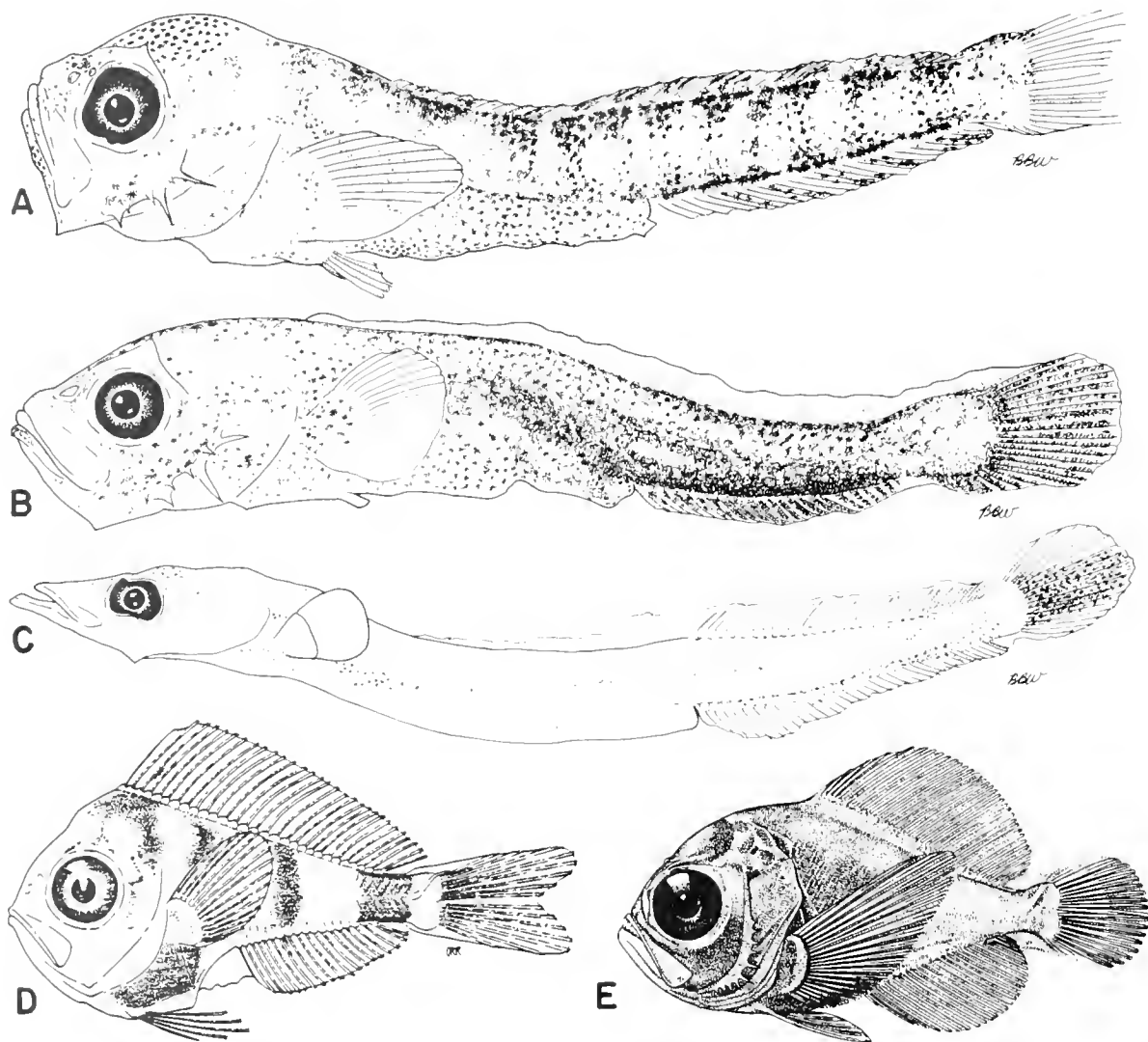

Fig. 261. (A) Coryphaenidae—*Coryphaena hippurus*, 8.5 mm SL; (B) Rachycentridae—*Rachycentron canadum*, 9.0 mm SL; (C) Echeineidae—*Echeineis* sp., 8.8 mm SL; (D) Caristiidae—*Caristiis* sp., 10.1 mm SL; (E) Bramidae—*Brama dussumieri*, 6.5 mm SL, from Mead (1972).

range from 0 in the Congrogadidae to 19 in the Sillaginidae, the most common numbers being 8–14.

One of the most variable aspects of percoid physiognomy is the form and composition of the dorsal fin. Even the most consistent feature, the presence of spines, does not characterize all percoids. Absence of dorsal spines in six percoid families appears to have originated by at least two different mechanisms. In *Bathychupea*, it is obvious that the spines have been lost because the spinous pterygiophores are still present and the soft rays occupy a position posterior to them. In *Coryphaena*, how-

ever, Potthoff (1980) showed that although the anteriormost 3–4 pterygiophores bear soft rays, they are of the type that normally support spines. This suggests that the absence of spines in *Coryphaena* is the result of transformation, rather than loss, of pre-existing elements. Absence of spines in the Bramidae, Caristiidae, some cepolids and some congrogadids is also probably the result of transformation.

Spines are present anteriorly in the dorsal fin of all other percoids, ranging from I in some malacanthids and pseudochromids to XXI in some acanthoclinids. Dorsal soft rays range

Fig. 262. (A) Chaetodontidae—unidentified, 10 mm, from Burgess (1978); (B) Chaetodontidae—*Forcipiger longirostris*, 17 mm TL, from Kendall and Goldsborough (1911); (C) Chaetodontidae—*Chelmon* sp. or *Coradion* sp., 6.5 mm SL, from Leis and Rennis (1983); (D) Scatophagidae—*Scatophagus argus*, 10 mm SL from Weber and de Beaufort (1936); (E) Scombroptidae—*Scombrops boops*, 6.2 mm SL, from Uchida et al. (1958); (F) Lethrinidae—*Lethrinus nematacanthus*, 6.1 mm SL, from K. Mori (unpubl.); (G) Cepolidae—*Acanthocepola* sp., 9.7 mm SL, from Okiyama (1982b); (H) Priacanthidae—unidentified, 4.6 mm SL, from Leis and Rennis (1983); (I) Priacanthidae—*Priacanthus* sp., 10.9 mm SL, from Leis and Rennis (1983); (J) Pentacerotidae—*Pseudopentaceros richardsoni*, 15 mm SL.

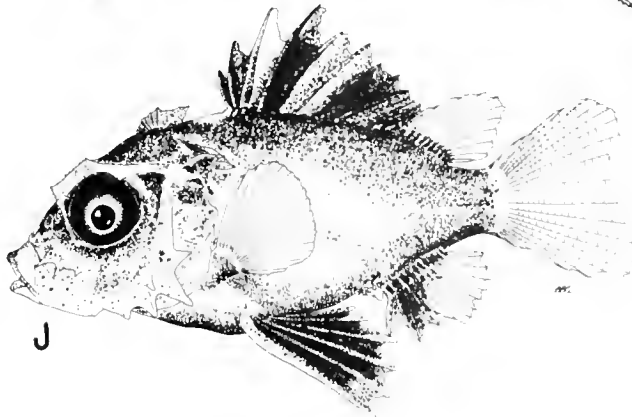
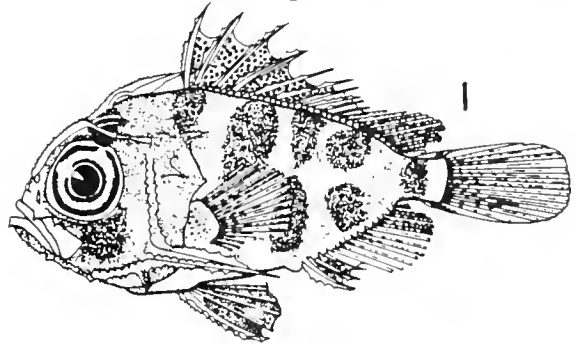
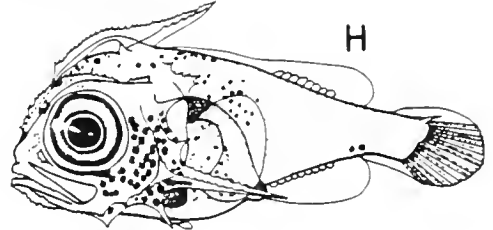
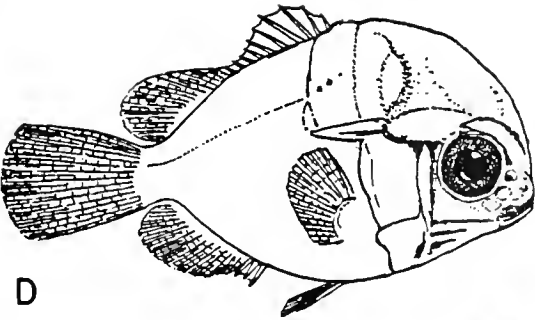
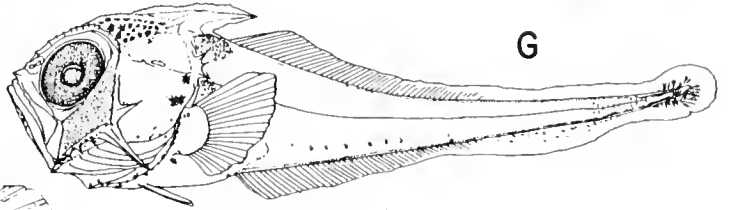
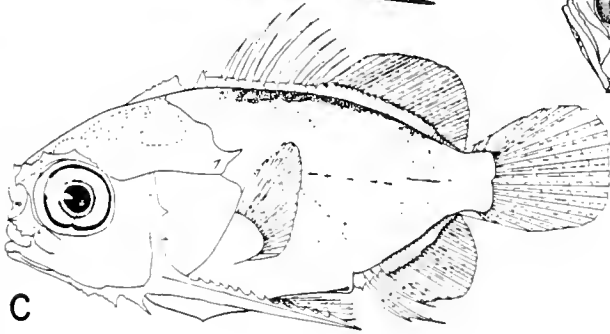
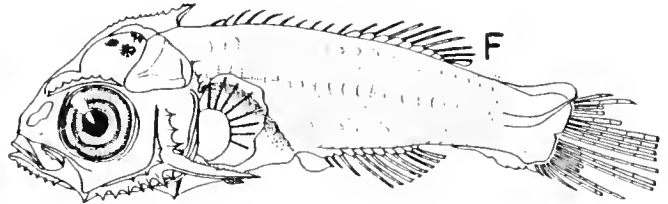
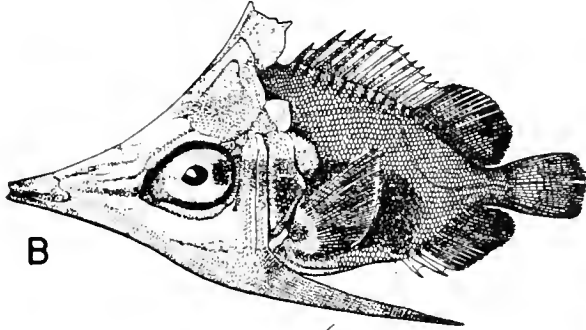
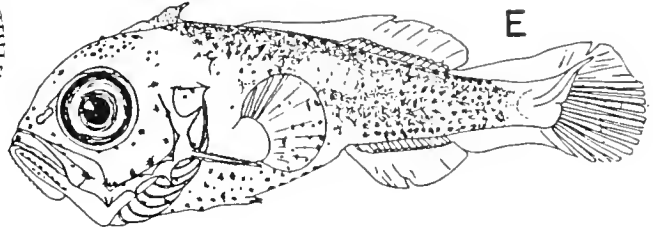
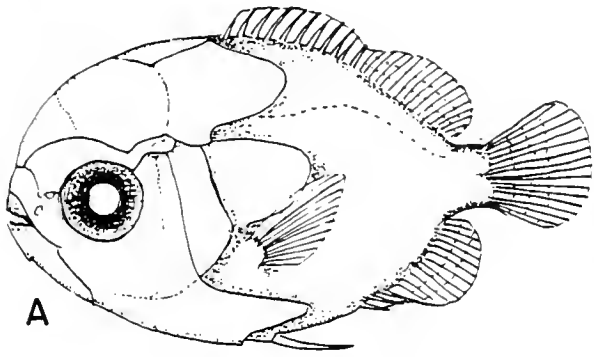

TABLE 120. SELECTED MORPHOLOGICAL FEATURES OF ADULT PERCOIDEI. Abbreviations and definitions: SS—supernumerary (non-serial) spines (or soft rays) on first anal pterygiophore (see Johnson, 1980); D—dorsal fin; A—anal fin; Triseg. pteryg.—pterygiophores with proximal, medial and distal radials separate; Stay—separate bony element posterior to ultimate pterygiophore in D and A; Predorsal formulae—based on Ahlstrom et al. (1976); P—pterygiophore with no supernumerary spines or soft rays; H—hypurals; E—epurals; U—uroneurals; Ah—autogenous haemal spines; pH—parhypural; UR—urostyle; Proc spur—procurent spur (see Johnson, 1975); PU3 cart—radial cartilage anterior to neural and haemal spines of third preural centrum; BR—branchiostegals; IAC—interarcual cartilage; Cy—cycloid; Ct—ctenoid, ctenii free from posterior margin; Ct—ctenoid, ctenii continuous with posterior margin; and br—branched caudal fin rays. With the exception of (SS), parentheses enclose features known to characterize only some members of a group.

	Vertebrae	Dorsal fin		TrISEG. PTERYG. D Stay A	Pelvic fin	Predorsal formulae	CAUDAL FIN Principal	
		Anal fin (SS)					Procurent	
Acanthoclinidae	10 + 18 11 + 17 11 + 18 12 + 18 13 + 16	<u>XVIII-XXI, 3-4</u> <u>VIII-XI, 4 (1-2)</u>		$\frac{0}{0} +$	1, 2	0/0/1/1+1/	$\frac{8+8}{3-4+3-4}$	
Acropomatidae	10 + 15	VII-X-I, 8-10 or <u>IX-X, 10</u> <u>II-III, 7-9 (2)</u>		$\frac{1-6}{1-4} +$	1, 5	/0+0/0+2/1+1/ 0/0/0+2/1/ 0/0/0+2/1+1/	$\frac{9+8}{9-13+9-13}$	
Ambassidae	10 + 14	<u>VII-I, 8-11</u> <u>III, 7-10 (2)</u>		$\frac{0}{0} -$	1, 5	0/0/0+1/1/ 0/0/1+1/1/	$\frac{9+8}{7-11+7-10}$	
Aplodactylidae	15 + 20 16 + 19	<u>XIV-XXI, 16-21</u> <u>III, 6-9 (2)</u>		$\frac{0}{0} +$	1, 5	0/0+0/2+1/1/ 0/0+0/2/1+1/	$\frac{8-9+7}{12-14+12-13}$	
Apogonidae	10 + 14 10 + 15	<u>VI-VIII-1, 8-14</u> <u>II, 8-18 (1)</u>		$\frac{3-11}{3-8} +$	1, 5	various: 0/0/0+2 or 1/ to ///2 or 1/	$\frac{9+8}{6-10+5-10}$	
Arripidae	10 + 15	<u>IX, 13-19</u> <u>III, 9-10 (2)</u>		$\frac{5}{1} +$	1, 5	0/0/0+2/1+1/	$\frac{9+8}{7+6}$	
Banjosidae	11 + 14	<u>X, 12</u> <u>III, 7</u>		$\frac{9}{5} +$	1, 5	0/0+2/1/1/	$\frac{9+8}{6+5}$	
Bathyclupeidae	9 + 22 10 + 21	<u>9</u> <u>I, 26-27 (0)</u>		$\frac{0}{0} +$	1, 5	0/0/0//P+P/P/P/P+P/P/P/P/1/	$\frac{9+8}{9+8}$	
Bramidae								
Braminae	T:36-47	<u>30-38</u> <u>21-30 (2-3)</u>		$\frac{0}{0} +$	1, 5	0/0/0/P/P/1+1/ 0/0/0/P/1/	$\frac{9+8}{7-8+7-8}$	
Pteraclinae	T:45-54	<u>46-57</u> <u>39-50 (?)</u>		$\frac{1-2}{1-2} +$	1, 5	1+1+1+1, etc./1/1/	$\frac{9+8}{5+5}$	
Caesionidae	10 + 14	<u>IX-XV, 9-21</u> <u>III, 9-13 (2)</u>		$\frac{2-4}{2-4} +$	1, 5	0/0/0+2/1+1/ /0+0/2/1+1/	$\frac{9+8}{7-10+5-10}$	
<i>Caesiocorpsis</i>	10 + 15	<u>XI, 20-21</u> <u>III, 18-20 (2)</u>		$\frac{6-8}{6-8} +$	1, 5	0/0+0/2/1	$\frac{9+8}{9-11+8-10}$	
Callanthudae	10 + 14	<u>X-XI, 8-12</u> <u>III, 9-12 (2)</u>		$\frac{1}{1} +$	1, 5	0/0/2/1+1/	$\frac{8-9+7-8}{5-9+5-9}$	
Carangidae	10 + 14 10 + 15 10 + 16 10 + 17 11 + 13 11 + 14	<u>IV-VIII-1, 17-44</u> <u>1-II-I, 15-39 (1-2)</u>		$\frac{0-3}{0-2} -$	1, 5	see section on Carangidae	$\frac{9+8}{8-14+8-12}$	
Caristiidae	T: 35-40	<u>32-40</u> <u>18-21 (1)</u>		$\frac{0}{0} ?$	1, 5	1+1+1+1+1+1/1/1/ 1+1+1+1/1/1/	$\frac{9+8}{7-8+7-8}$	
Centracanthidae	10 + 14	<u>XI-XIII, 9-11</u> <u>III, 9 (2)</u>		$\frac{1-4}{1-4} +$	1, 5	0/0+0/2+1/1/ 0/0/0+2/1/	$\frac{9+8}{9-10+8-10}$	
Centrarchidae	11-14 + 15-19 T: 28-32	<u>V-XIII, 9-16</u> <u>II-VIII, 8-19 (2-3)</u>		$\frac{3-6}{3-6} +$	1, 5	3-7 predorsals 1-3 sup. spines	$\frac{9+8}{5-10+5-9}$	
Centrogenysidae	11 + 14	<u>XIII-XIV, 9-11</u> <u>III, 5 (2)</u>		$\frac{0}{0} +$	1, 5	0/0+2/1/1/	$\frac{7+7}{5+5}$	

TABLE 120. EXTENDED.

CAUDAL SKELETON H/E/U/Ah H Fusions	Proc spur PU3 cart.	BR	IAC	Scales
$\frac{3}{3}/\frac{0}{0}$ pH-1-2; 3-4-UR	-- +	6	+	Ct or Cy
$\frac{5}{3}/\frac{2}{2}$ —	++ +	7	+	Ct or Cy
$\frac{3}{2}/\frac{1}{1}$ 1-2; 3-4	-- +	6	+	Cy
$\frac{5}{3}/\frac{1}{2}$ —	-- ?	6	?	Cy
$\frac{2-5}{2-3}/\frac{0-1}{0-2}$ various	-- +	7	+	Ct or Cy
$\frac{5}{3}/\frac{2}{2}$ —	+ +	7	+	Ct
$\frac{5}{3}/\frac{2}{2}$ —	++ ?	7	+	Ct
$\frac{5}{3}/\frac{2}{2}$ —	++ +	7	+	Cy
$\frac{5}{3}/\frac{2}{2}$ —	+ +	7	+	Ct'
$\frac{5}{3}/\frac{2}{2}$ —	+ +	7-8	+	Ct'
$\frac{3}{3}$ or $\frac{5}{3}/\frac{2}{2}$ (1-2; 3-4)	-- ?	7	+	Ct
$\frac{5}{3}/\frac{2}{2}$ —	++ ?	7	+	Ct
$\frac{3}{2}-\frac{3}{1}/\frac{1}{1}$ 1-2; 3-4	-- +	6	+	Ct
$\frac{2-3}{2}-\frac{3}{1}-\frac{2}{2}$ 1-2; 3-4-(5)	-- —	7-9	+	Cy
$\frac{5}{3}/\frac{?}{2}$ —	-- ?	7	+	Cy
$\frac{3}{3}/\frac{2}{2}$ 1-2; 3-4	-- ?	6	+	Ct
$\frac{5}{3}/\frac{1-2}{2}$ —	-- +	6-7	+	Ct
$\frac{4}{3}/\frac{1}{2}$ 1-2	-- ?	7	+	Ct

from as few as 3 in some acanthoelinids to 89 in some cepolids. Within families, the range of dorsal fin ray counts may be relatively restricted as in the Lutjanidae (X-XII, 10-17) or quite broad, as in the Sciaenidae (VII-XV-1, 17-46).

In most percoids the spinous and soft portions of the dorsal fin are continuous, but gradual shortening of the posteriormost spines results in a variously developed cleft or apparent separation. Where this cleft is present, the ultimate spine is notably longer than the penultimate and is considered to form the first element of the soft dorsal portion of the fin. Some groups (e.g., Pseudochromidae, Grammatidae, Plesiopidae, Priacanthidae, Cepolidae) do not develop this cleft. Others, such as the Acropomatidae, Ambassidae, Apogonidae, Emmelichthyidae, Enoplosidae and Epigonidae have such a well-developed cleft that the spinous and soft portions of the fin appear completely separate. Pterygiophores usually continue beneath the resultant gap and may even bear minute spines. The Mullidae and Echeiidae are exceptional in having no pterygiophores below this gap. Extreme separation of the spinous and soft dorsal fins occurs only in the Echeiidae, where the spinous dorsal fin has been modified as an attachment disc and has moved far forward to cover the flattened cranium.

The anal fin of percoids is less variable in form and composition than the dorsal fin. The most common, and apparently primitive condition is three anal spines. The first anal pterygiophore is larger than the succeeding pterygiophore and bears the first two spines in supernumerary (non-serial) association and the third in serial association (see Johnson, 1980). Scatophagids and some chaetodontids and pomacanthids have four spines, the first two supernumerary. Centrarchids have from two to eight spines, pentaceroctids from two to six and gerreids from three to five, all with the first two supernumerary. The only other percoids characterized by more than three anal spines (eight to eleven) are the Acanthoelinidae, where one or two may be supernumerary. Several groups have fewer than three anal spines, and, as in the dorsal fin, it is important to understand the nature of this reduction. Apogonids, for example, have only two spines and only one of these is supernumerary, suggesting that the anteriormost spine was lost. The mesopelagic epigonines (*sensu* Fraser, 1972a) have usually been treated as a subfamily of the Apogonidae, for they also have only two anal spines. The epigonine anal spines, however, are both supernumerary (as are those of the Sciaenidae), suggesting that the usually spinous third (serial) element has not transformed into a spine. Hence, the two anal spine conditions of epigonines and apogonids are not homologous. In bathylupeids, the single anal spine is serially associated with the first pterygiophore, suggesting that the first two spines have been lost. Only a few groups, Bramidae, Caristiidae, Congrogadidae, Coryphaenidae and some cepolids and grammistine serranids, lack anal spines. The presence of 1-3 supernumerary elements on the first pterygiophore in all these groups indicates transformation rather than loss of the pre-existing spines. Anal soft rays range in number from 4 in the Acanthoelinidae to 101 in the Cepolidae and, with some exception, the range of variability within families is comparable (frequently within two or three rays) to that of the dorsal soft rays.

Predorsal bones.—In most percoids, one to three strut-like bones precede the anteriormost pterygiophores of the dorsal fin. It has been proposed (Smith and Bailey, 1961), but never conclusively demonstrated, that these predorsal bones were derived from true pterygiophores that once bore spines or rays, but Fraser

TABLE 120. CONTINUED.

	Vertebrae	Dorsal fin	TRINEG PTERYG. D - A	Pelvic fin	Predorsal formulae	CAUDAL FIN Principal
		Anal fin (SS)	D - A			Precurrent
Centropomidae	10 + 14 11 + 14	VII-VIII, 8-13 III, 6-9 (2)	0-5 0-4 +	1, 5	0/0/0 + 2/1 + 1/ 0/0/0 + 1/1 + 1/	9 + 8 8-12 + 7-11
Cepolidae						
Cepolinae	12 + 44-66 14 + 55 16 + 53	0-III, 65-89 0-I, 62-101	0 0 +	1, 5	//2/1/	6-7 + 6 1-2 + 1-2
Owstoniinae	11 + 17 13 + 16 14 + 16	III-IV, 21-27 1-II, 14-19	0 0 +	1, 5	//2/1/	8 + 7 3-4 + 3-4
Chaetodontidae	10 + 14 11 + 13	VI-XVI, 15-30 III-V, 14-23 (2)	0 - 0 - (+)	1, 5	0/0 + 2/1/ 0/2/1/1/	9 + 8 2-4 + 2-3
Cheilodactylidae	14 + 21	XIV-XXII, 15-39 III, 6-19 (2)	0 0 +	1, 5	0 + 0/2 + 1 + 1/1/ 0 + 0/2 + 1/1 + 1/	8 + 7 9-11 + 8-10
Chronemidae	13 + 20 14 + 19	XIV-XVI, 15-21 III, 6-8 (2)	0 0 +	1, 5	0/0/2 + 1/1/	8 + 7 13-16 + 10-12
Cirrhitidae	10 + 16	X, 11-17 III, 5-7 (2)	0 0 +	1, 5	0/0 + 0/2/1 + 1/ 0/0/0 + 2/1 + 1/	8 + 7 9-14 + 10-13
Congrogadidae	12-19 + 34-64	0-II, 33-76 28-63	0 - 0 -	1, 2-4 or absent	0/0/0/P + 1 0/0//P + 1 0/0//P + P ///P + P/	4-6 br + 4-8 br 0-4 + 0-3
Coracinidae	10 + 15	X, 18-23 III, 13-14 (2)	10 6 +	1, 5	0/0/0 + 2/1 + 1/	9 + 8 9 + 8
Coryphaenidae	13-15 + 17-19 T:30-34	52-66 23-31 (2)	0 - 0 -	1, 5	1-3 + 1 + 1 + 1, etc./1/1/	9 + 8 10-14 + 10-14
<i>Datnioides</i>	10 + 14	XII, 15 III, 9 (2)	5 1 +	1, 5	0/0/0 + 2/1/	9 + 8 6 + 7
Dinolestidae	10 + 17	VIII-1, 18-19 I, 26-27 (1)	0-1 0-1 +	1, 5	0/0/0 + 1/1 + 1/ 0/0/0/1 + 1/	9 + 8 11 + 11
<i>Dinoperca</i>	10 + 16	XI, 17-19 III, 11-13 (2)	4 3 +	1, 5	0/0/0 + 2 + 1/1/	9 + 8 13 + 12
Drepanidae	10 + 14	XIII-IX, 19-22 III, 17-19 (2)	0 (+) 0 -	1, 5	0/0 + 0/2/1 + 1/	9 + 8 5 + 4
Echeneididae	12-18 + 14-22 T:26-40	IX-XXVIII-17-42 II, 14-36 (1)	0 - 0 -	1, 5	absent; D ₁ on head	9 + 8 8-13 + 7-13
Emmelichthyidae	10 + 14	XI-XIV, 9-12 III, 9-11 (2)	6-8 6-8 +	1, 5	0/0/0 + 2/1/	9 + 8 7-8 + 7-8
Enoplosidae	10 + 16	VIII-1, 14-15 III, 14-15 (2)	1-7 4-8 +	1, 5	0/0/0 + 2/1 + 1/	9 + 8 5-6 + 5-6
Ephippidae	10 + 14	V-IX, 18-40 III, 15-28 (2)	0 (11*) 0 (11*) - (+) *Ephippus	1, 5	0/0 + 0/2/1 + 1/ 0 + 0 + 0//2/1 + 1/ 0 + 0/2/1 + 1/ 0/0/0 + 1/1/ 0 + 0/0/P/1	9 + 8 3-7 + 3-6
Epigonidae	10 + 15 11 + 14	VII-VIII-1, 7-10 1-III, 7-9 (1-2)	0-1 0-1 +	1, 5	0/0/0 + 2/1 + 1/ /0 + 0/0 + 2/1 + 1/ /0 + 0/0 + 1/1/	9 + 8 9-10 + 7-10
Gerreidae	10 + 14	IX-X, 9-17 III-V, 13-17 (2)	0-2 0-2 +	1, 5	0/0/0 + 2/1 + 1/	9 + 8 9-11 + 9-10

TABLE 120. CONTINUED. EXTENDED.

CAUDAL SKELETON H/E/U/Ah H Fusions	Proc spur PU3 cart.	BR	IAC	Scales
<u>5/2-3/1-2/2</u> —	++ +	7	+	Ct
<u>2-4/1-2/1/2?</u> (1-2; 3-4; 5 absent)	-- ?	6	+	Cy
<u>3-4/3/1/2</u> (1-2; 3-4)	-- —	6	+	Cy
<u>5/3/2/2</u> —	-- —	6	+	Ct
<u>5/2-3/1/2</u> —	-- —	3-6	—	Cy
<u>5/3/1/2</u> —	-- ?	6	—	Cy
<u>5/3/2/2</u> —	-- +	6	r or —	Cy
<u>2/0-2/0/0-1</u> pH--1-2; 3-4-UR	-- —	6	—	Cy
<u>5/3/2/2</u> —	++ ?	6	+	Ct
<u>3/1/1/2</u> 1-2; 3-4	-- —	7	+	Cy
<u>5/3/2/2</u> —	++ +	6	+	Ct
<u>5/3/2/2</u> —	++ ?	7	+	Cy
<u>5/3/2/2</u> —	++ —	7	+	Ct
<u>5/2-3/2/2</u> —	++ +	6	+	Cy
<u>5/2/1/1-2/</u> —	- + (-) —	8-11	—	Cy
<u>5/3/2/2</u> —	++ ?	7	r or —	Ct
<u>5/3/2/2</u> —	++ ?	7	+	Cy
<u>4-5/3/2/2</u> (2-3)	++ (- -)* (+) * <i>Rhinoprenes</i>	6	—	Ct or Cy
<u>5/3/2/2</u> —	++ +	7	+	Ct or Ct
<u>3 or 5/3/2/2</u> (1-2; 3-4)	++ +	6	+	Ct

(1972a) argued that the first three predorsal elements of percoids may represent supraneurals. Ahlstrom et al. (1976) recognized the importance and utility of considering patterns of predorsal bones in early life history studies, and further developmental studies could resolve the origin of these elements.

The most common and presumably primitive number of predorsal bones in percoids is three; Table 120 shows that over half of 91 percoid groups (families and *incertae sedis* genera) have three predorsal bones exclusively, with three predorsals occurring in at least some members of 66 groups. The first dorsal pterygiophore inserts in the third interneural space in at least some members of 69 groups, bears two supernumerary spines in some members of 69 groups and exhibits both conditions in 57 groups. Therefore, the most common and ostensibly primitive predorsal formulae (using that defined by Ahlstrom et al., 1976) for the Percoidei are 0/0/0+2/ and 0/0+0/2/. The 0/0/1 pattern, considered by Smith and Bailey (1961) to be primitive for percoids occurs in only six families, frequently in the more derived members. Furthermore, Fraser (1972a) noted that derivation of the 0/0/0+2/ or 0/0+0/2/ patterns from the 0/0/1 pattern by backward shift of the first dorsal spine, hypothesized by Smith and Bailey (1961), is untenable and inconsistent with pterygiophore interdigitation. On the other hand, the 0/0/0+2/ pattern could be easily derived by a posterior shift of the first dorsal spine in the 0/0/1+1/ pattern that characterizes many beryciforms, including holocentrids and diretids. This latter pattern is found among percoids only in some ambassids.

Departures from the primitive predorsal pattern have apparently arisen independently in many families. In anterior shifts of the dorsal fin origin a compound first pterygiophore with two supernumerary spines is frequently retained, but it is invariably absent in posterior shifts. A possible conclusion is that forward shifts result from anterior displacement of the pterygiophores, whereas posterior shifts result only from loss of spines. Reductions in numbers of predorsal bones to fewer than three are almost certainly the result of simple losses as opposed to transformations, even when these reductions are accompanied, as they are occasionally (e.g., Chaetodontidae, Scatophagidae, Pentacerotidae, Priacanthidae), by a forward shift of the dorsal fin origin. Transformations of pre-existing predorsal bones to spinous pterygiophores would require the unlikely addition of *de novo* spines and distal radials, and modification of musculature. More than three "predorsal bones" are found in at least some members of 13 percoid groups, with a corresponding posterior shift of the dorsal fin origin. The additional elements are usually distinguishable from the anterior three ("true") predorsals. In *Bathyclupea*, Braminae, some carangids, Congrogadidae, *Mene*, *Neoscorpis*, *Platax*, some pempheridids and Toxotidae, these additional spineless elements (designated P in Table 120) resemble pterygiophores, may have separate distal elements, and often articulate with succeeding similar elements or with the anterior-most spine-bearing pterygiophore. In *Bathyclupea* and Toxotidae, they are also separated from the true predorsals by one interneural space. In the remaining groups with more than three "predorsals" (some percichthyids and centrarchids, *Brinkmanella* and *Leptobrama*), the additional elements are not morphologically distinguishable from the anterior three, but, as in the other groups, the dorsal fin originates posterior to the third interneural space (except in *Brinkmanella*), and it seems likely that these elements were also derived from pre-existing pterygiophores. Studies of the sequence of development of predorsal

TABLE 120. CONTINUED.

	Vertebrae	Dorsal fin		TRISEG PTERYG. D A Stay	Pelvic fin	Predorsal formulae	CAUDAL FIN
		Anal fin (SS)	Principal				Procurent
Gigantiidae	10 + 15	<u>IX, 13</u> III, 8 (2)	$\frac{11}{6} +$	1, 5	0/0/2/1+1/	$\frac{9+8}{10+9}$	
Girellidae	11 + 16 11 + 17 14 + 20	<u>XII-XVI, 11-17</u> III, 10-13 (2)	$\frac{0-1}{0-1} +$	1, 5	0/0+0/2/1+1/ 0/0/2/1+1/	$\frac{9+8}{9-14+8-12}$	
Glaucosomatidae	10 + 15	<u>VIII, 11</u> III, 9 (2)	$\frac{10}{7} +$	1, 5	0/0/0+2/1+1/	$\frac{9+8}{7-8+7-8}$	
Grammatidae	10 + 15 10 + 17 10 + 18	<u>XII-XIV, 8-10</u> III, 7-11 (2)	$\frac{0}{0} +$	1, 5	0/0/0+2/1+1/ 0/0/0+1/1+1/	$\frac{8-10+7-9}{2-8+2-7}$	
Hacmulidae	10 + 16 11 + 16	<u>IX-XIV, 11-26</u> III, 6-13 (2)	$\frac{0}{0} +$	1, 5	0/0/0+2/1/ 0/0+0/2+1/1/ 0/0+0/2/1/	$\frac{9+8}{9-14+8-13}$	
Haplogeny	10 + 14	<u>XI-XIV, 14-19</u> III, 9-13 (2)	$\frac{0}{0} +$	1, 5	0/0+0/2/1+1/	$\frac{9+8}{6+5-6}$	
Hemuljanus	10 + 15	<u>X, 10-11</u> III, 9 (2)	$\frac{6}{6} +$	1, 5	0/0/0+2/1+1/	$\frac{9+8}{11+10}$	
Howella	10 + 16	<u>VIII-1, 9</u> III, 7 (2)	$\frac{0}{0} +$	1, 5	0/0/0+2/1+1/	$\frac{9+8}{9-10+9-10}$	
Inermiidae	12 + 14 13 + 13	<u>X-II or XVII, 9-10</u> III, 8-10 (2)	$\frac{0}{0} +$	1, 5	/0/0+2/1/ /0+0/0+2/1/	$\frac{9+8}{10-12+10-12}$	
Kuhliidae	10 + 15	<u>X, 9-12</u> III, 9-13 (2)	$\frac{4-7}{5-8} +$	1, 5	0/0/0+2/1+1/ 0/0/0+2/1/	$\frac{9+8}{11-13+10-12}$	
Kyphosidae	10 + 15 10 + 16	<u>X-XII, 11-15</u> III, 10-16 (2)	$\frac{1-7}{3-5} +$	1, 5	0/0/0+2/1/	$\frac{9+8}{8-10+8-10}$	
Lactariidae	10 + 14	<u>VII-VIII-1, 20-22</u> III, 25-28 (2)	$\frac{3-5}{2-3} +$	1, 5	0/0/0+2/1+1/	$\frac{9+8}{9+8}$	
Lateolabrax	17 + 18	<u>XII-XIV, 12-16</u> III, 7-10 (2)	$\frac{6}{3} +$	1, 5	0/0/0+1/1+1/	$\frac{9+8}{13+12-13}$	
Latrididae	14 + 21	<u>XIV-XXIII, 23-40</u> III, 18-35 (2)	$\frac{0}{0} +$	1, 5	0/0+2/1+1/1/ 0+0/2/1+1/1/	$\frac{8+7}{14+12}$	
Leiognathidae	10 + 14	<u>VIII, 15-16</u> III, 14 (2)	$\frac{15-16}{13} +$	1, 5	0/1/1/1/	$\frac{9+8}{9-10+7-9}$	
Leptobramidae	10 + 14	<u>IV, 16-18</u> III, 26-30 (2)	$\frac{0}{0} +$	1, 5	0/0/0/0//P/P/P/P/P/1/1+1+1/	$\frac{9+8}{6-8+7}$	
Lethrinidae	10 + 14	<u>X, 9-11</u> III, 8-10 (2)	$\frac{2-3}{2-3} +$	1, 5	0/0+0/2+1/1/	$\frac{9+8}{7-9+7-9}$	
Lobotidae	11 + 13 12 + 12	<u>XII, 15-16</u> III, 11 (2)	$\frac{0}{0} +$	1, 5	0/0/0+2/1+1/	$\frac{9+8}{3-5+3-5}$	
Lutjanidae	10 + 14	<u>X-XII, 10-17</u> III, 7-11 (2)	$\frac{1-7}{1-7} +$	1, 5	0/0/0+2/1+1/ 0/0+0/2/1+1/	$\frac{9+8}{8-13+8-13}$	
Malacanthidae	10 + 14 11 + 14 11 + 16	<u>I-X, 14-60</u> I-II, 11-55 (1-2)	$\frac{2-17}{2-14} +$	1, 5	0/0/2/1+1/ /0+0/2/1+1/ //2+1+1+1+1/1+1+1/	$\frac{9+8}{10-13+9-13}$	
Menidae	10 + 14	<u>IV, 38-42</u> III, 28-32 (2)	$\frac{0}{0} +$	1, 5	0/0+0/P/1/	$\frac{9+8}{4+3-4}$	
Microcanthidae	10 + 15	<u>X-XI, 16-22</u> III, 13-19 (2)	$\frac{10-16}{10-15} +$	1, 5	0/0+0/2/1+1/	$\frac{9+8}{7-10+7-10}$	
Monodactylidae	10 + 14 10 + 15	<u>VII-IX, 26-36</u> III, 27-37 (2)	$\frac{0-2}{0-1} +$	1, 5	0/0/0+1/1+1/	$\frac{9+8}{6+5-6}$	
Moronidae	11 + 14 12 + 13	<u>VIII-X-1, 10-13</u> III, 9-12 (2)	$\frac{2-4}{2-4} +$	1, 5	0/0/0+2/1+1/ 0/0/0+2/1/ 0/0/0/2+1/	$\frac{9+8}{10-13+9-13}$	

TABLE 120. CONTINUED. EXTENDED.

CAUDAL SKELETON H/E/U/Ah H Fusions	Proc spur PU3 cart.	BR	IAC	Scales
<u>5/3/1/2</u> —	— — ?	7	+	Ct
<u>5/3/1/2</u> —	—(r) — +	6	+	Ct
<u>5/3/2/2</u> —	+ + —	7	+	Ct
<u>2-3/3/0/2</u> 1-2; 3-4-UR 5 absent	— — +	6	+	Ct
<u>5/3/2/2</u> —	+ + ?	7	+	Ct
<u>5/3/2/2</u> —	— — ?	7	+	Ct
<u>5/3/2/2</u> —	+ + ?	7	+	Ct
<u>5/3/2/2</u> —	— — +	7	+	Ct
<u>3/3/2/2</u> 1-2; 3-4	+ + ?	7	+	Ct
<u>5/3/2/2</u> —	+ + +	6	+	Ct
<u>5/3/2/2</u> —	+ + +	7	+	Ct
<u>3/3/2/2</u> 1-2; 3-4	+ + +	7	+	Cy
<u>5/3/2/2</u> —	+ + +	7	+	Ct
<u>4/3/1/2</u> 3-4	— — ?	6	?	Cy
<u>3/3/1/2</u> 1-2; 3-4	— — —	5	—	Cy
<u>4/3/2/2</u> 3-4	+ + ?	6	+	Ct
<u>5/3/2/2</u> —	— — ?	6	+	Ct
<u>5/3/2/2</u> —	+ — —	6	+	Ct
<u>3 or 5/3/2/2</u> (1-2; 3-4)	— — —	7	+	Ct
<u>5/3/2/1-2</u> —	— — +	6	+	Ct
<u>2/3/0/0/</u> 1-2-3-4-UR	— — —	7	+	Cy
<u>5/3/2/2</u> —	+ + (+)	7	+	Ct
<u>2-5/3/2/2</u> (1-2; 2-3; 3-4)	+ — +	7	+	Ct
<u>5/3/2/2</u> —	+ + +	7	+	Ct

bones in relation to the development of the dorsal fin may prove useful in determining the homologies of these additional elements as well as the first three predorsals.

Caudal skeleton.—The primitive percoid caudal skeleton consists of one parhypural with a well-developed hypurapophysis, five hypurals, two pairs of uroneurals, three epurals, one ural centrum, a low neural crest on PU2 and autogenous haemal spines on PU2 and PU3. This configuration is found in at least some members of 54 percoid groups.

The most common reductions involve fusion of hypurals one and two and hypurals three and four and loss of the posterior uroneural pair. Loss of one epural occurs in only 14 groups, and epurals are completely lacking only in some congrogadids. More extreme reductions, including various combinations of fusions of the hypurals with the parhypural and/or urostyle, loss or fusion of the anterior uroneural pair and fusion of the autogenous haemal spines, occur in only a few groups: Acanthoclinidae, some apogonids, Congrogadidae, Grammatidae, Menidae, Mullidae, Opstognathidae, Plesiopidae, and Pseudochromidae.

The second preural centrum bears a full neural spine in only two groups, Echeneididae and Nandidae, except for occasional anomalous specimens. This full neural spine must be secondarily derived in the echeneidids because these fishes are unquestionably closely related to other percoids that bear the usual reduced neural crest on PU2 (see discussion on utility of larval morphology). Unfortunately, evidence for the origin of this *de novo* spine in echeneidids is lacking. Although it may represent a captured first epural (there are only two in echeneidids), it is attached and of full length at its earliest appearance in ontogeny. Another possibility is that the second preural centrum of other percoids has been lost in echeneidids, so that the last centrum bearing a full neural spine actually corresponds to PU3. However, presence of the usual autogenous haemal spines on both PU2 and PU3 in echeneidids refutes this hypothesis. The significance of a full neural spine on PU2 in the Nandidae is unclear, since the affinities of this family with the Percoidei remain problematic.

The presence of a procurrent spur and of radial cartilages anterior to the neural and haemal spines of PU3 are probably primitive features (Johnson, 1975, 1983). The procurrent spur is developed to some extent in 50 percoid groups, all but ten of which have a primitive caudal complex. Reductions among these ten groups usually involve only simple hypural fusion. The procurrent spur is never present in groups with fewer than 9 + 8 principal rays. Third preural radial cartilages are found in 45 of 66 groups examined for them, about half of which have primitive caudal complexes.

Vertebral number.—Vertebral number ranges from 23 to about 78 in percoids. Gosline (1968, 1971) noted that the "basal number" of vertebrae in percoids is 24–25 (10 + 14–15), and this number characterizes 45 of the 91 groups treated in Table 120; 63 groups have 24–27 vertebrae. Twenty-two groups have vertebral counts greater than thirty, but only five have more than 40 vertebrae. Only priacanthids and scatophagids have fewer than 24 (10 + 13).

Gill arches.—Primitively, percoid gill arches contain the following elements: one basihyal, four basibranchials (the fourth cartilaginous), three pairs of hypobranchials, five pairs of ceratobranchials, four pairs of epibranchials, four pairs of

TABLE 120. CONTINUED.

	Vertebrae	Dorsal fin	TRISEG. PTERYG D - Stay A	Pelvic fin	Predorsal formulae	CAUDAL FIN
		Anal fin (SS)				Principal
Mullidae	10 + 14	$\frac{\text{VII-VIII}-1, 8-9}{\text{I-II}, 5-8 (0-1)}$	$\frac{0}{0} +$	1, 5	0/0/0+2/1+1/ 0/0/0+1/1+1/ 0/0/2/1+1/	$\frac{8+7}{8-10+8-10}$
Nematistiidae	10 + 14	$\frac{\text{IX}, 26-29}{\text{III}, 16-17 (2)}$	$\frac{1}{1} +$	1, 5	0+0+0//2/1/	$\frac{9+8}{9-10+8-9}$
Nemipteridae	10 + 14	$\frac{\text{X}, 9-10}{\text{III}, 7-8 (2)}$	$\frac{1}{1} +$	1, 5	0/0/2+1/1/	$\frac{9+8}{8-11+8-11}$
<i>Neoscorpis</i>	10 + 15	$\frac{\text{VI-VIII}, 20-22}{\text{III}, 23-26 (2)}$	$\frac{14}{11} +$	1, 5	0/0/0+P/P/P+1/	$\frac{9+8}{9+8}$
Opistognathidae	10 + 15-21 11 + 16-23 12 + 18-19 13 + 18-20	$\frac{\text{X-XII}, 11-22}{\text{II-III}, 10-20 (1-2)}$	$\frac{0}{0} +$	1, 5	/0+0/1/1+1/ /0/1/1+1/ //1/1+1/	$\frac{6-7+6-7}{3-8+3-7}$
Oplegnathidae	10 + 15	$\frac{\text{XI-XII}, 11-22}{\text{III}, 11-18 (2)}$	$\frac{11}{8} +$	1, 5	0/0+0/2/1+1/ 0/0/2/1+1/	$\frac{9+8}{9+8}$
Ostracoberyidae	10 + 15 10 + 16	$\frac{\text{IX}, 8-10}{\text{III}, 7-8 (2)}$	$\frac{4-7}{4} +$	1, 5	0/0/0+2/1+1/	$\frac{9+8}{10-12+10-11}$
Parascorpididae	12 + 15	$\frac{\text{XI-XII}, 14-17}{\text{III}, 13-15 (2)}$	$\frac{13}{11} +$	1, 5	0/0+0/2+1/1/	$\frac{9+8}{11+9}$
Pempheridae	10 + 15	$\frac{\text{IV-VII}, 7-12}{\text{III}, 17-45 (2)}$	$\frac{0}{0} +$	1, 5	0/0/0+1/1+1/ 0/0/0+1/1/ 0/0/0+P/1+1	$\frac{9+8}{3-7+3-7}$
Pentacerotidae	12 + 12 12 + 13 13 + 11 13 + 12 13 + 13 13 + 14	$\frac{\text{IV-XV}, 8-29}{\text{II-VI}, 6-17 (?-2)}$	$\frac{0}{0} +$	1, 5	0/0+2/1/ 0/0/2/1+1/	$\frac{9+8}{3-7+3-6}$
Percichthyidae	10-15 + 15-23 T:25-36	$\frac{\text{VII-XI}, 8-18}{\text{III}, 7-13 (2)}$	$\frac{0-16}{0-15} +$	1, 5	variable: 0-5 predorsals 0-2 sup. spines	$\frac{9+8}{5-16+5-14}$
<i>Gadops</i>	21 + 26	$\frac{\text{X-XII}, 25-28}{\text{III}, 17-19 (2)}$	$\frac{0}{0} -$	1, 1	//0/0/1/1/	$\frac{9+8}{5+5}$
Percidae	T:31-50	$\frac{\text{V-IXX}-0-\text{III}, 7-24}{\text{I-II}, 4-15 (1-2)}$	$\frac{0}{0} + (-)$	1, 5	0/1/1/1/ /1/1/1/ ///1/1/ ////1/1/	$\frac{8-9+7-8}{10-15+8-13}$
Plesiopidae	10 + 15 10 + 16 12 + 25	$\frac{\text{IX-XV}, 7-21}{\text{III}, 8-23 (2)}$	$\frac{6-16}{6-19} +$	1, 4	0/0/0+2/1+1/ 0/0/2/1+1/ 0/0/0+1/1+1/ 0/0/1/1+1/	$\frac{9-10+8-9}{3-10+3-9}$
Pomacanthidae	10 + 14	$\frac{\text{IX-XV}, 15-33}{\text{III-IV}, 14-25 (2)}$	$\frac{0}{0} +$	1, 5	0/0/2/1+1/ 0//2/1+1/	$\frac{9+8}{4+3-4}$
Pomotomidae	11 + 15	$\frac{\text{VII-IX}, 23-28}{\text{III}, 22-28 (2)}$	$\frac{2-3}{3} +$	1, 5	0/0/0+1/1+1/	$\frac{9+8}{9-10+8-9}$
<i>Polyprion</i>	13 + 14	$\frac{\text{XI-XII}, 11-13}{\text{III}, 8-10 (2)}$	$\frac{8-10}{5-6} +$	1, 5	0/0/0+2/1+1/	$\frac{9+8}{8-9+7-8}$
Priacanthidae	10 + 13	$\frac{\text{X}, 11-15}{\text{III}, 9-16 (2)}$	$\frac{0-1}{0-1} +$	1, 5	0+2/1/1/1/ 2/1/1/1/	$\frac{8+8}{4-6+4-6}$
Pseudochromidae	10-13 + 16-25 T:26-35	$\frac{\text{I-III}, 21-37}{\text{I-III}, 13-30}$	$\frac{0-\text{many}}{0-\text{many}} +$	1, 3-5	0/0/0+2/1+1/ 0/0/0+1/1+1/ 0/0/2/1+1/ 0/0/1/1+1/	$\frac{7-9+7-8}{5-7+5-7}$

TABLE 120. CONTINUED. EXTENDED.

CAUDAL SKELETON H/E/U/Ab H Fusions	Proc spur PU3 cart.	BR	IAC	Scales
<u>3/2/1-2/2</u> 1-2; 3-4-UR	- - ?	4	-	Ct
<u>3/3/2/2</u> 1-2; 3-4	- - -	7	+	Cy
<u>5/3/2/2</u> -	- - +	6	r or -	Ct
<u>5/3/2/2</u> -	+ + -	6	+	Ct
<u>2-3/3/0/1</u> pH-1-2; 3-4-UR; (5 absent)	- - +	6	+	Cy
<u>5/3/2/2</u> -	+ + ?	7	+	Ct
<u>5/3/2/2</u> -	+ + +	7	+	Ct'
<u>5/3/2/2</u> -	+ + ?	7	+	Ct
<u>3 or 5/3/1-2/0-2</u> (1-2; 3-4)	- (+) + +	7	+	Ct or Cy
<u>5/3/1/2</u> -	+ -(+) +	7	+	Ct
<u>?/2-3/1-2/2</u> ?	+ + (- -) + (-)	5-7	+	Ct or Cy
<u>5/2/1/2</u> -	- - -	7	+	Cy
<u>5/3/1/2</u> -	- - + (-)	5-8	+	Ct
<u>3/3/0-2/1</u> 1-2-(pH); 3-4-UR	- - +	6	+ or -	Ct
<u>5/3/2/2</u> -	- - +	6	+	Ct'
<u>5/3/2/2</u> -	+ + -	7	+	Cy
<u>5/3/2/2</u> -	+ + ?	7	+	Ct
<u>5/3/2/2</u> -	- - -	6	-	Ct'
<u>3/2-3/0/0-1/</u> (pH)-1-2; 3-4-UR	- - +	6	-	Ct

pharyngobranchials, and an interarcual cartilage between the uncinete process of epibranchial 1 and pharyngobranchial 2. The first pharyngobranchial is rod-like and serves to suspend the dorsal gill arches from the neurocranium. The fourth pharyngobranchial is reduced and cartilaginous, but consistently bears a well-developed dermal tooth plate, as do the second and third pharyngobranchials and the fifth ceratobranchials. Small tooth-plates on the second and third epibranchials are variously present or absent.

Reductive departures from the primitive branchial complex are few and involve only the basihyal, first pharyngobranchial or interarcual cartilage. The basihyal is reduced or absent in ephippidids. Pseudochromids lack a first pharyngobranchial (Springer et al., 1977). Of 88 percoid groups examined for it, only 13 lack a well-developed interarcual cartilage and at least three of these (Cirrhitidae, Emmelichthyidae and Nemipteridae) may have a vestigial element. The remaining eleven groups completely lack the interarcual cartilage, but most have an uncinete process with the cartilaginous tip separated by a decided gap from the second pharyngobranchial and frequently pointing away from it. This condition differs from the primitive state (as represented in most beryciforms) wherein the uncinete process of the first epibranchial directly contacts that of the second pharyngobranchial, and suggests that these percoids have secondarily lost the interarcual cartilage. A condition resembling that of the beryciforms was observed among percoids only in some anthiine serranids, where it must be secondary. In eche-neidids the uncinete process of the first epibranchial also articulates directly with that of the second, but there is a concomitant extreme reduction of the main arm of the first epibranchial not seen in beryciforms. Again this condition must be derived if the relationships of the eche-neidids are as postulated here (see discussion on utility of larval morphology).

Scales.—The unpublished work of McCully (1961) on comparative anatomy of serranid scales provides an excellent illustration of the wealth of information available in the scales of percoid fishes that has largely been ignored in systematic studies. More recent work on ctenoid scales of other groups (DeLamater and Courtenay, 1973a, b, 1974; Hughes, 1981) using scanning electron microscopy also demonstrates the systematic value of ctenoid scales. Details of the scale morphology of most percoids are unknown. On a gross level, three basic scale types (Ct, Ct' and Cy in Table 120) are found among percoids. Although beryciforms and some myctophids are said to have ctenoid scales, these scales (Ct') differ from the type possessed by most percoids and other perciforms (Ct). In beryciforms and myctophids the "ctenii" are continuous spinous projections from the lateral surface and posterior margin of the scale. A few percoids (Bramidae, Epigonidae, *Howella*, Pomacanthidae, Priacanthidae, Ostracoberycidae and Scatophagidae) possess similar scales that may represent retention of the plesiomorphic beryciform condition, or may have been secondarily derived. In the "true" ctenoid scale that characterizes most percoids (59 groups), the ctenii are separate bony plates, or scalelets (McCully, 1961, 1970), that are continually added in the posterior field as the scale grows. In most groups the posterior field becomes filled with remnants of old ctenii, the tips of which are amputated (or, more likely, resorbed), as each new row of ctenii is added. In a few groups, however (e.g., anthiine serranids and callanthiids), only a primary and secondary row of marginal ctenii are evident. This second variation of "true" ctenoid scale also characterizes

TABLE 120. CONTINUED.

	Vertebrae	Dorsal fin	TRISEG PTERYG	Pelvic fin	Predorsal formulae	CAUDAL FIN
		Anal fin (SS)	D — A			Stay
						Procurent
Rachycentridae	11 + 14	VII-IX, 26-34 I-II, 22-28 (1)	0 0	-	1, 5	/I + 1/1/1/ 15-16 + 12-14
Scatophagidae	10 + 13	XI-XII, 16-18 IV, 14-16 (2)	0 0	+	1, 5	0/0 + 2/1/1/ 4-6 + 4-5
Sciaenidae	10-15 + 12-18 T:24-29	VII-XV-I, 17-46 I-II, 5-23 (1-2)	0 0	+	1, 5	0/0/0 + 2/1 + 1/ //2 + 1 + 1 + 1, etc./ 9 + 8 7-10 + 6-9
Scombroptidae	10 + 16	VIII-IX-I, 12-13 II, 11-12 (1)	5 4	+	1, 5	0/0/0 + 2/1 + 1/ 9 + 8 11 + 10
Scorpididae	10 + 15 10 + 16	IX-X, 22-28 III, 17-28 (2)	7-18 9-22	+	1, 5	0/0/0 + 2/1 + 1/ 11-13 + 10-12
Serranidae	10 + 14 11 + 13 10 + 15 10 + 16 11 + 15 10 + 18	VI-XII, 9-24 or II-IV, 20-29 II-III, 6-22 (2) or 13-17 (1)	0-24 0-19	+	1, 5	0/0/0 + 2/1 + 1/ 0/0 + 0/2/1 + 1/ 0/0/2/1 + 1/ 0 + 0/2/1/1/ 0/0/1/1 + 1/ 0/0/P/1 + 1/ //1/1 + 1/ 8-9 + 7-8 3-12 + 3-10
Sillaginidae	14-20 + 19-27 T:33-44	X-XIII-I, 16-27 II, 14-26	0 0	+	1, 5	0/0/0/1 + 1/ 0/0/0/1/ 0//0/1/1 + 1/ 9 + 8 17-19 + 14-19
<i>Siniperca</i>	12 + 16 13 + 15 13 + 18	XI-XV, 10-17 III, 7-13 (2)	7-10 4-6	+	1, 5	0/0/0 + 2/1 + 1/ 0/0/0/2/1 + 1/ 9 + 8 6-12 + 6-12
Sparidae	10 + 14	X-XIII, 10-15 III, 7-14 (2)	1-4 1-4	+	1, 5	0/0 + 0/2 + 1/1/ 9 + 8 7-11 + 7-11
<i>Stereolepis</i>	12 + 14	XI-XII, 9-10 III, 7-9 (2)	6-8 3-6	+	1, 5	0/0 + 0/2/1 + 1/ 0/0/0 + 2/1 + 1/ 9 + 8 10-11 + 8-9
<i>Symphysanodon</i>	10 + 15	IX, 10 III, 7-8 (2)	2-3 2-3	+	1, 5	0/0/0 + 2 + 1/1/ 9 + 8 12-14 + 12-14
Teraponidae	10 + 15 10 + 16 10 + 17 11 + 14 11 + 16	XI-XIV, 8-14 III, 7-12 (2)	0 0	+	1, 5	0/0 + 0/2/1 + 1/ 0/0 + 0/1/1 + 1/ 0 + 0/0 + 2/1/1/ 9 + 8 9-10 + 5-8
Toxotidae	10 + 14	IV-VI, 11-14 III, 15-18 (2)	0 (+) 0	-	1, 5	0/0/0//P/P/1/ 0/0/0//P/1/ 0/0//P/P/1/ 9 + 8 4-5 + 4-5

Aphredoderus, gobies and some flatfishes, and the mechanism of growth of the posterior field is not understood. As shown by the authors mentioned above, there is extensive diversity in configuration and processes of formation of marginal and sub-marginal ctenii, and this diversity undoubtedly holds useful phylogenetic information.

The third major scale type found among percoids is the cycloid scale (Cy in Table 120), characteristic of most groups below the Percomorpha. Although the cycloid scales of some percoids may represent a plesiomorphic state, they are clearly secondary in a number of families where they occur only in some members (acanthoelinids, acropomatids, apogonids, ephippidids, pempheridids, percichthyids, sciaenids and serranids). Cycloid scales also characterize all members of two groups of percoid families,

each of which probably comprises a monophyletic lineage. The cirrhitoid fishes (Aplodaetlylidae, Cheilodaetlylidae, Chironemidae, Cirrhitidae, and Latrididae) have large cycloid scales of similar morphology, and the carangoid fishes (Carangidae, Coryphaenidae, Nematistiidae, Rachycentridae and Echeneididae) have very small adherent cycloid scales. Cycloid scales characterize five other families of moderate size, Ambassidae, Cepolidae, Congrogadidae, Leiognathidae and Opistognathidae. Otherwise, cycloid scales are restricted to a few monotypic families and *incertae sedis* genera (Bathyclupeidae, Caristiidae, Dinolestidae, Drepanidae, Enoplosidae, Laetariidae, Menidae, Pomatomidae, Scombroptidae and *Siniperca*). The widespread occurrence of true ctenoid scales in the Percoidae, including most of the less specialized forms, and the distribution of cycloid

TABLE 120. CONTINUED. EXTENDED.

CAUDAL SKELETON H/E/U/Ah H Fusions	Proc spur PU3 cart.	BR	IAC	Scales
<u>5/3/2/2</u> —	— + —	7	+	Cy
<u>5/3/1/2</u> —	— —	6	—	Ct'
<u>5/3/2/2</u> —	+ + (— —) ?	7	+	Ct or Cy
<u>5/3/2/2</u> —	+ + +	7	+	Cy
3 or 5/3/2/2 (1-2; 3-4)	+ + (+)	7	+	Ct
3 or 5/3/1/2 (1-2; 3-4)	— — —	6-7	+ (—)	Ct or Cy
<u>5/2-3/1-2/2</u> —	+ + +	6	+	Ct
<u>4-5/3/1/2</u> (3-4)	r(—) + —	7	+	Cy
3 or 5/3/2/2 (1-2; 3-4)	— — +	6	+	Ct
<u>5/3/2/2</u> —	+ + ?	7	+	Ct
<u>5/3/2/2</u> —	— + +	7	+	Ct
<u>5/3/2/2</u> —	+ + +	6	+	Ct
<u>5/3/0-1/2</u> —	+ — +	7	+	Ct

scales just described, suggests that cycloid scales in most percoids have been secondarily acquired.

DEVELOPMENT

Eggs

Most percoids have buoyant, spherical eggs about 1mm in diameter, with a single oil globule. The total size range is about .5 to 4.6 mm, but eggs larger than 2 mm are found only in a few freshwater-associated groups, Centrarchidae, Moronidae, Percichthyidae, Percidae, *Siniperca* and Teraponidae, and in the marine Echeneididae (Table 121). Multiple oil globules occur in some centrarchids, percichthyids and sciaenids, and in *Hapalogenys*, moronids and *Polyprion*, but they are generally

fully coalesced by hatching. Most members of the three primary freshwater families, Centrarchidae, Percichthyidae and Percidae have demersal eggs as do some members of the Ambassidae and Teraponidae, however only six families of exclusively marine percoids are known to possess non-buoyant eggs. The Acanthoelinidae, Congrogadidae, Plesiopidae and Pseudochromidae have specialized demersal eggs with adhesive threads that bind them together in attached, sheet-like (Plesiopidae) or free, spherical (Acanthoelinidae and Pseudochromidae) masses that are guarded by the male. These eggs also have numerous small oil globules that gradually coalesce with a single, much larger globule. The possibility that these four families are closely related has remained unresolved (Böhlke, 1960a; Springer et al., 1977), but the similar egg morphology and parental care shared by them may represent synapomorphies not heretofore considered. The other two marine families with adhesive demersal eggs, Apogonidae and Opistognathidae are oral brooders, and oral brooding has also been reported for the plesiopid *Assessor* (Allen and Kuiter, 1976).

Larvae

Diversity of general body form and morphological specialization among the larvae of percoid fishes is extensive, and, as with the adults, no single feature shared by larval percoids characterizes the suborder. Representative postflexion larvae of 62 percoid groups are illustrated in Figs. 254-262. Larval serranids and carangids were excluded from these figures because they are illustrated elsewhere in this volume. I was unable to obtain specimens or illustrations of larvae of the remaining 30 groups and most are probably unknown, or at least undescribed. Of these, 19 are monotypic.

Larval body form ranges from elongate to deep-bodied, by the criteria of Leis and Rennis (1983), and frequently, but not always, reflects adult body form. Thus, some of the most deep-bodied percoid larvae are found among the Chaetodontidae, Pomacanthidae, Menidae, Bramidae, and Caristiidae, whereas the elongate Congrogadidae and Cepolidae have elongate larvae. On the other hand, the moderately elongate larvae of groups like the Girellidae or the Cirrhitidae are not particularly reflective of the adult body form, nor are the deeper-bodied larvae of the Emmelichthyidae.

In Table 121, selected aspects of known larvae of percoid families and *incertae sedis* genera are given. This table should prove a useful guide to identification of postflexion larval percoids at the family level, particularly when used in conjunction with the meristic data in Table 120 and the illustrations in Figs. 254-262. Features included in Table 121 are discussed below.

Fin development. — Formation of median fin rays occurs at very small sizes in most percoids. Flexion may begin as early as 2.5-3 mm and is complete in most groups by 4-5 mm, at which time the full complement of principal caudal rays is present. Dorsal and anal fin rays begin to form during or shortly after flexion and are usually complete, including spinous rays, by 5-8 mm. Size at flexion and completion of full median fin ray complements is relatively consistent within families, the range usually not varying more than 2 mm. Groups characterized by notably later flexion (6-18 mm) include the Caristiidae, Centrarchidae, Centrarchidae, Cheilodactylidae, Girellidae, *Latolabrax*, *Morone*, Percichthyidae, Percidae, *Polyprion*, Scorpididae, Sillaginidae, and *Siniperca*. These groups also exhibit somewhat delayed dorsal and anal fin ray completion (7-18 mm). Among marine percoids, the most extreme delay in com-

TABLE 121. SELECTED EARLY LIFE HISTORY FEATURES OF PERCOIDEI. Parentheses enclose features known to characterize only some members of a group. Head spination abbreviations—Supraoccipital: S1—small peak-like crest; S2—S1 with serrations; S3—large vaulted spine-like crest with serrations; S4—low serrated median ridge; S5—entire surface rugose. Frontal: F1—entire surface rugose; F2—one or more parallel or converging serrated ridges; F3—serrated supraorbital ridges; F4—single spine on supraorbital ridge; F5—large posteriorly projecting serrated spine. Preopercle: P1—posterior margin with moderate to large simple spines; P2—P1 plus lateral ridge with one or more small simple spines; P3—P2 with spine at angle notably elongate; P4—P3 with marginal spines serrate; P5—posterior margin and sometimes lateral ridge with very small spines or serrations. Other bones with simple spines, serrations or serrated ridges: Op—opercle; Sb—subopercle; Io—interopercle; Ta—tabular; Pt—posttemporal; Scl—supracleithrum; Cl—cleithrum; La—lacrima; Co—circumorbitals; Na—nasal; Mx—maxillary shaft; D—dentary; Br—branchiostegals; Pe—pterotic; Pa—parietal; Sp—sphenotic. Sequence of completion of fin rays: A. D₂-A-D₁-P₂-P₁; B. D₁-P₂-D₂-A-P₁; C. P₁-P₂-D₂-A-D₁; D. P₁-D₂-A-D₁-P₂; E. A-D₂-P₂-P₁-D₁; F. P₂-D₂-A-D₁-P₁. Egg type: P—pelagic, buoyant; D—demersal; A—adhesive; M—egg mass; O—oral brooder.

Taxon	Text figures	Egg type	Size (mm)					Sequence of fin completion	Head spination	Other specializations
			Egg	Hatch	Flex	D & A rays complete	First scales			
Acanthoelinidae	255D	D, A, M	~1.4	~4.7	5-6	?	?	A	P5	None
Acropomatidae	254A-D	P	?	?	~4	~5	12-15	A	(S1), (S4), (F2), F3, (P4), (P5), Op, Sb, Io, Pt, Scl, (Pcl), (Co), (D), (Pe)	(D and P ₂ spines serrate)
Ambassidae	255A	(D, A) (P)	.7-.8	1.8	~3.5	5.5-6	9-10	A	P5	None
Apogonidae	257D-G	D, A, M, O	<1	2.5-3	3-4	4-6	12 or >	A (B)	(S1), (S5), (F1), (P2), (P3), (P5), (Op), (Sb), (Pt) (...?)	(Elongate D spines and P ₂ rays)
Bramidae	261E	P	?	~3	4-7	6-10	7-10	C (D)	(F1), P1, Op, Sb, Io	Spinous scales (large P ₁ and P ₂)
Callanthiidae	255E-F	P	?	?	5	7	7-14	A	P2, Op, Sb, Io, Pt	None
Carangidae	—	P	.7-1.3	1-3.5	~3-5	~6-10	~7-14	A (D)	(S1), (F3), (F4), P3, (P4), Pt, Scl, (Pe)	(Elongate D spines and P ₂ rays)
Caristiidae	261D	P	1.1-1.3	2.3-2.9	~7	~8	?	A	P5	None
Centracanthidae	258J	P	1.1-1.3	2.3-2.9	6-7	8-9	?	A	P5	None
Centropomidae	260G	P	.7	1.4-1.5	3.6-3.8	~7	~14	A	P5	None
Centrarchidae	260A	D, A	.8-2.8	2.2-5.5	6-9	~7-13	~14-18	A	None	None
Cepolidae	262G	P	.7	<3	8-9	7-9	?	A	S3, F1, F3, P4, Scl, D	None
Chaetodontidae	262A-C	P	.7-.9	1.5-2.0	4-5	5-8	7-11	A (B)	All exposed head bones thick and ru- gose. Pt and Scl ex- panded poste- riorly. P expanded to cover cheek and with broad flat spine poste- riorly.	(P ₂ spine long and serrate) (Ant. D spines long and ru- gose)
Cheilodactylidae	258E	P	.9-1	2.9-3.3	7-8	10-12	~10	A	None	Postlarvae deep, com- pressed, sil- very to 70- 90 mm
Cirrhitidae	258F	P	?	?	~4	~8	10 or <	A	P5	Chin barbel
Congrogadidae	255G	D, A, M	?	?	?	?	?	?	None	None
Coryphaenidae	261A	P	~1.6	~4	6.5-7.5	D 13-24 A 8-11	~25-30	E	F4, P2, Pt	Minute epithe- lial "prick- les" by ~6 mm; "swollen" pterotics
Echeneididae	261C	P	1.4-2.6	4.7-7.5	5-9	D 12-30 A 6-12	~15-30	E	None	Large hook- like teeth on dentary
Emmelichthyidae	259I	P	?	?	?	?	?	A	P1, Op, Io, Pt, Scl	None

TABLE 121. CONTINUED.

Taxon	Text figures	Egg type	Size (mm)					Sequence of fin completion	Head spination	Other specializations
			Egg	Hatch	Flex	D & A rays complete	First scales			
Ephippididae										
<i>Chaetodipterus</i>	256G	P	~1	~2.5	~4	~5	~8-9	A	S1, F3, P2, Op, Io, Ta, Pt	Spinous scales to ~15 mm
Epigonidae										
<i>Epigonus</i>	257B	P	?	?	?	?	?	?	None	None
<i>Sphyraenops</i>	257A	P	?	?	?	?	~12	?	S1, S5, F1, F3, P3, Op, Pt, Pe	None
Gerreidae	259A	P	.6-.75	~1.4	3.5-4.4	~6	>15	A	P5, (Scl)	None
Girellidae	258C	P	~1	~2.3	~6	11-13	~15-16	A	P5, Scl	None
Haemulidae	259B-D	P	.8-1.0	1.7-2.8	3.9-5.4	6-8 (earlier in in <i>P. nigra</i>)	~13 (much earlier in <i>Conodon</i>)	A	(F3), (P1), (P5), (Op), Sb, Io, (Pt), Scl, Pe (also F2, Pcl, La, Co, Na, D in <i>Conodon</i>)	None (spinous scales in <i>Conodon</i>)
<i>Hapalogenys</i>	254H	P	1.2	~3	~4.5	~5-6	>10	F	S3, S5, F1, F3, P2, Op, Sb, Io, Pt, Scl, La, Pe	P ₂ precocious, large
<i>Howella</i>	257C	P	?	?	~3.5	~4.5	?	A	P5, Op, Io, Pt, Cl	None
Kyphosidae	259J	P	~1	2.4-2.9	3.8-5.5	6-7	~7	A	P5, Op, Sb, Io, Scl, Pcl	Spinous scales
<i>Latcolabrax</i>	260E	P	1.3-1.4	4.4-4.6	~9	~15	>15	A	P5	None
Leiognathidae	256C	P	.6	1.4	~4	~5	?	?	S3, F3, P4, Pt, Scl	Ant. D spines serrate
Leptobramidae	258D	?	?	?	?	>8	>9	?	None	None
Lethrinidae	262F	P	.7-.8	1.3-1.7	4.4-5.2	5.5-7.0	8	A	S3, F3, P4, Op, Sb, Io, Ta, Pt, Scl, Pcl, La, Co, Mx, D, Pe	Spinous scales
Lobotidae	254G	P	~1	?	<6	<6	~8	?	S3, S5, F1, F4, P2, Op, Sb, Io, Pt, Scl	P ₂ large (precocious?)
Lutjanidae (including Caesionidae)	256A-B	P	~.5-.8	1.7-2.2	4.2-5.3	5-6	~12-14	B	F3, (P2), (P3), (P4), Op, Io, Pt, Scl, Pcl	(2nd dorsal spine and P ₂ spine and soft rays elongate) (anterior D, A, and P ₂ spines serrate)
Malacanthidae	256E-F	P	1.2	2.2-2.6	4-6	5-8	3-4	A	F2, F3, P4, Op, Sb, Io, Ta, Pt, Scl, La, Na, D, Pe, Pa	Spinous scales to ~30 mm or >; fused nasals
Menidae	256D	?	?	?	<4.5	<4.5	?	?	None	None
Microcanthidae	259G	P	?	?	~4	5-6	~15	A	P2, Op, Sb, Io, Pt, Scl	None
Monodactylidae	255H	P	.6-.7	1.8	3.5-4.0	5-6	9-10	F	F3, P2, Op, Io, Pt, Scl	P ₂ large, precocious
Moronidae	260F	(P) (D, A)	.7-4.6	1.7-3.7	7-9	10-13	16-25	A	P5	None
Mullidae	259E	P	.6-.9	1.6-3.4	3.5-4.5	~7	~12-13	A	None	Silvery, pelagic postlarvae to ~40-60 mm
Nemipteridae	258H	P	.7-.8	1.5-1.6	~4	6-8	~11	A	None	None
Opistognathidae	255B	D, A, M, O	?	?	~5.5	~7	?	A	P5, Io	None
Oplegnathidae	255J	P	.9	2.3	~5	~7	~12	A	P5, Op, Io, Scl	None
Pempheridae	255I	P	?	?	3.6-4.3	~6	?	F	P5, Io, Scl	P ₂ precocious
Pentacerotidae	262J	P	?	?	?	?	~12	?	S3, S5, F1, F3, F4, P4, Op, Pt, Cl, La, Pe	P ₂ spines serrate; spinous scales
Percichthyidae	260D	(P) (D, A)	1.2-4.2	3.1-9.0	7-9	9-13	10-20	D	None	None

TABLE 121. CONTINUED.

Taxon	Text figures	Egg type	Size (mm)					Sequence of fin completion	Head spination	Other specializations
			Egg	Hatch	Flex	D & A rays complete	First scales			
Percidae	260C	(P) (D, A) (M)	.7-2.8	4.7-8.7	7-15	9-18	13-24	A (D)	(P5)	None
Plesiopidae	—	D, A, M, (O)	~.9 × .6	2.8-2.9	?	?	?	?	?	?
<i>Polyprion</i>	254E	P	1.6	3.7	~7	~9	?	A	S2, F3, P2, Op, Sb, Io, Pt, Scl	None
Pomacanthidae	256H	P	.7-.9	1.5-1.8	3.4-4.3	4-5	2.5-2.8	A	F3, P2, Sb, Io, Ta, Pt, Scl, La, Co, Na, D	Spinous scales to 17-19 mm
Pomatomidae	258G	P	.8-1.2	2-2.5	5-6	~7	~12	A	P5	None
Priacanthidae	262H-1	P	?	?	4-5	~7	~6	A	S3, F2, F3, P4, Op, Sb, Io, Ta, Pt, Scl, La, Co, Na, D, Br	D ₁ , A, P ₂ spines and soft rays serrate; spinous scales to ~20 mm
Pseudochromidae	255C	D, A, M	?	3-4	4.4-5.8	~8	12-13	A	P5	None
Rachycentridae	261B	P	1.2-1.4	?	~7	D 16-18 A 9-10	30-35	E	F4, P2, Pt	Minute epithelial prickles by ~6 mm "swollen" pteriotics
Scatophagidae	262D	P	?	~3	~4	~4-5	~4	D	Most exposed head bones thick and rugose; P and Pt expanded posteriorly; Pt with posterior spatulate "spine"; Pe swollen and with separate rugose "shield"	Spinous scales
Sciaenidae	257H	P	.7-1.3	1.5-2.5	3.0-4.6	~5-9	14-20	A (B)	(S4), (F3), (P2), P5, Pt, Scl, Io	None
Scombroptidae	262E	P	?	?	?	>6	?	A	S2, F3, P4, Op, Sb, Io, Pt	None
Scorpididae	258A-B	P	?	?	~6	9-10	9-11	A	P2, Op, Sb, Io, Scl	None
Serranidae										
Serraninae	—	P	.8-1.0	~2.2	4.3-5	~6	~11-12	A (B)	P2, Op, Sb, Io, Pt, Scl	None
Anthiinae	—	P	.6-.8	1.2-1.4	3.5-5	4.6-5.5	~6->10	B (A)	(S1), (S2), (F1), (F2), (F3), (F4), (P3), (P4), Op, Sb, Io, (Ta), Pt, Scl, (La), (Co), (D), (Pe), (Pa)	(D ₁ , A and P ₂ spines serrate) (ant D spines and P ₂ rays elongate)
Epinephelinae										
Epinephelini	—	P	.7-1.0	1.4-2.4	~4-5	~6	>15	B	(F1), F3, P4, Op, Sb, Io, Pt, Scl	D ₁ , A and P ₂ spines serrate; second D ₁ spine and P ₂ spines elongate
Grammistini	—	P	~1	<2.9	3.3-4.6	~6	?	P ₁ , D ₁ , D ₂ , A, P ₂	P2, Op, Sb, Io	Ant D spines flexible, elongate, pigmented; P ₁ large, precocious

TABLE 121. CONTINUED.

Taxon	Text figures	Egg type	Size (mm)					First scales	Sequence of fin completion	Head spination	Other specializations
			Egg	Hatch	Flex	D & A rays complete					
Liopropomini	—	P	~1	?	?	~6	?	D ₁ , D ₂ , A, P ₁ , P ₂	(F4), P2, Op, (1o)	Ant D spines flexible, elongate, ornamented	
Sillaginidae	259F	P	.6-.7	1.3	~6	~9	?	A	P5, Pt	None	
<i>Siniperca</i>	260B	D, A	~2	~5	~10	~11	?	A	P5	None	
Sparidae	258I	P	.8-1.2	2.0-2.7	4-7	6-11	8-20	A	P5, 1o, Pt, Scl (also S2, F3, P2, in <i>Pagrus</i>)	None (spinous scales in <i>Pagrus</i>)	
<i>Stereolepis</i>	254F	P	?	?	?	<7	>10	?	F3, P2, Sb, 1o, Pt, Scl, Pe	None	
<i>Symphysanodon</i>	254A	P	?	?	3.5-4.0	~4.5	~13-14	A	F2, F5, P4, Pt, Scl, Ta, La, Co, D, Pe	None	
Teraponidae	259H	(P) (D)	.7-2.8	1.7-3.7	~4-8	~7-11	14-18	A	P5, Op, Sb, 1o, Scl, Cl, Pel	None	

pletion of dorsal fin rays (12-30 mm) occurs in the elongate larvae of *Coryphaena*, *Rachycentron* and the Echeneidae.

The most commonly observed sequence of fin completion (pattern A in Table 121) is that described for *Morone* by Fritzsche and Johnson (1980) and for *Anisotremus* by Potthoff et al. (1984). Soft rays of the dorsal and anal fins begin to form during or just prior to flexion. Fin rays appear first near the future middle of these fins and are added in an anterior and posterior direction. Full complements of dorsal and anal soft rays are usually achieved at about the same time as the full principal caudal fin ray complement. The spinous dorsal fin is completed next (usually from posterior to anterior) followed by the pelvic and pectoral fins.

Precocious development of the anterior portion of the spinous dorsal and the pelvic fins, pattern B, is usually associated with ornamentation and/or elongation of the spines. It characterizes all larvae of lutjanids and epinepheline serranids, and a few apogonids, chaetodontids and sciaenids. In liopropomine serranids, the anterior portion of the spinous dorsal is precocious, but the pelvic fins develop last. Precocious development of pectoral and pelvic fins, pattern C, is unique to some members of the Bramidae. Pattern D, precocious pectorals only, is found in seatophagids, some bramids, and interestingly, is also shared by the freshwater Percichthyidae and some Percidae. The pectoral fin and anterior portion of the spinous dorsal are precocious in the serranid tribe Grammistini. In pattern E, the full anal fin ray complement tends to be complete prior to that of the dorsal, and the spinous dorsal is the last fin to be completed. This pattern is unique to the echeneoid fishes (*Coryphaenidae*, *Rachycentridae* and *Echeneidae*). Pattern F, in which only the pelvis are precocious, is found in *Hapalogenys*, *Monodactylidae* and *Pempheridae*.

Scales.—Most percoids begin to develop scales well after completion of fins near the end of the larval period, frequently after settling. In several families (e.g., *Chaetodontidae*, *Cheilodactylidae*, *Cirrhitidae*, and *Scorpididae*) unspecialized scales first appear at or slightly before completion of the median fins and are thus present during the late larval stages. Larvae of a few groups are characterized by early development of specialized

spinous scales that eventually transform into the typical adult ctenoid scale. In the ephippidid *Chaetodipterus*, the haemulid *Conodon*, malacanthids, pomacanthids and scatophagids these consist of small, roughly circular, non-imbriate bony plates from the center of which one to several spines project outward at right angles. Larvae of the Bramidae, *Kyphosidae*, *Pentaceroptidae*, *Priacanthidae*, some anthiin serranids, the sparid *Pagrus* and the sparoid family *Lethrinidae* possess spinous scales in which one or more spines project outward at less than right angles from the posterior field or margin of imbricate plates that more closely resemble scales of the adults. Among non-percoid fishes, spinous larval scales occur in trachichthyids, chiasmodontids, acanthurids, *Xiphias*, *Antigonia* and some pleuronectiforms, tetraodontiforms, scorpaeniforms and gasterosteiforms. The function of specialized larval scales is unknown, but it seems likely that they provide some defense against small biting predators, parasites and/or nematocysts.

Head spination.—The simple to elaborate spinous ornamentation of various bones of the head in larvae of many percoid fishes is an area ripe for future detailed investigations. Nowhere is the potential utility of larval morphology in phylogenetic studies more evident, for it is in this feature that larval percoids frequently exhibit far more complexity and diversity than adults. Although more work is needed to determine if patterns of head spination will prove useful in studies of interfamilial relationships, there can be no doubt that the diversity of these patterns within some well-defined families or subfamilies (e.g., anthiin serranids, chaetodontids, priacanthids, malacanthids, pomacanthids, haemulids, etc.) offer critical information for intra-familial phylogenetic analyses.

Extensive head spination appears to have arisen independently numerous times within the Percoidei. Nevertheless, an ordered progression of increasing complexity is evident in the sequence in which ornamentation is added to various bones. Most families are characterized by a single level of complexity, but some are more diverse. In the larvae of several unrelated families (e.g., *Cheilodactylidae*, *Echeneidae*, *Menidae*, *Mullidae*, *Percichthyidae*) head spines are completely lacking. A

somewhat larger, equally heterogeneous assemblage of percoid groups (including the Ambassidae, Centranchidae, Centropomidae, Cirrhitidae, Moronidae, Percidae, Pomatomidae and Pseudochromidae) has minimal head spination, consisting of only a few small spines along the posterior, and usually lateral, margins of the preopercle. In most instances, these spines are so small and isolated that it is difficult to imagine that they serve any useful function.

The most common pattern of head spination among larval percoids is one in which, in addition to small to moderate preopercular spines, small spines may also occur on other bones of the opercular series (interopercle, subopercle and opercle) and on various bones of the pectoral series (cleithrum, postcleithrum, supracleithrum, posttemporal and tabulars). This pattern occurs in many of the more generalized families that have usually been considered "basal" percoids, including the Acropomatidae, Gerreidae, Girellidae, Haemulidae, Kyphosidae, Sciaenidae, Scorpionidae, Sparidae and Teraponidae, and it must be primitive for at least some large subgroup of percoid families.

Two additional levels of complexity in this artificial hierarchy involve modifications of cranial bones (frontal and supraoccipital) in addition to opercular and pectoral series spination. Modifications of the frontal bones occur only in those larvae with opercular and pectoral series spination and encompass several types of ornamentation. Frontal surface rugosity is found in a few apogonids, bramids and serranids as well as in *Acanthocephala*, *Lobotes*, *Hapalogenys*, *Pseudopenaceros* and *Sphyracnops*. Johnson and Keener (1984) noted this condition in larval *Alphistes*, but it was not previously considered in descriptions of percoid larvae. With closer examination, cranial rugosity will undoubtedly be detected in larvae of other percoid and non-percoid groups. It probably offers an efficient way to strengthen the neurocranium during early development. Frontal spines or serrations are most frequently borne along the supraorbital ridge. *Coryphaena*, *Rachycentron*, *Lobotes*, and some carangids have one large, broad-based supraorbital spine, but the more common condition is a series of supraorbital spines or serrations. These are found in lutjanids, malacanthids, monodactylids, pomacanthids, *Stereolepis*, some acropomatids, carangids, haemulids, sciaenids, and serranids as well as in most groups with supraoccipital modifications. More elaborate ornamentation, consisting of a series of parallel serrated ridges on the dorsal surface of the frontals, characterizes larval malacanthids, priacanthids, *Synagrops* and some anthiine serranids.

The most extreme example of frontal spination is seen in *Symphysanodon* (Fig. 254A). A longitudinal serrated crest above the supraorbital ridge on each frontal bone continues posteriorly as a long, spike-like serrated spine extending to about the middle of the spinous dorsal fin. The only other example of large paired cranial spines among larval perciforms is found in istiophorids, where the spines originate from the pterotics. This "horned" effect occurs elsewhere in larvae of many scorpaeniform groups (e.g., Scorpaenidae and Triglidae) and in the beryciforms, *Diretmus* and *Anoplogaster*, but in these groups the large paired spines are parietal in origin. With the exception of occasional minute spines or small ridges, larvae of perciform fishes never develop parietal ornamentation, and it is tempting to speculate that the presence of variously developed parietal spines among larvae of many scorpaeniform groups offers support for the often questioned monophyly of the Scorpaeniformes. In any case, this uncommon feature should be examined in future considerations of higher relationships among acanthopterygian fishes. The

monophyly of the Beryciformes has recently been questioned (Zehren, 1979), and it is interesting to note that although *Diretmus*, *Anoplogaster* and at least some trachichthyoids share larval parietal spines with scorpaeniforms, holocentrids lack them, instead possessing frontal, supraoccipital and preopercular spination similar to that seen in more elaborately ornamented larval percoids.

Modifications of the supraoccipital, representing the last category of complexity in head spination, occur in those larvae which also have opercular series, pectoral series and frontal ornamentation. Simple forms of supraoccipital ornamentation include a small peak-like median crest (*Chaetodipterus*, *Pagrus*, *Polyprius*, *Sphyracnops*, and some acropomatids, apogonids, carangids and anthiine serranids) or a serrated, ridge-like crest (*Synagrops*, some sciaenids and anthiine serranids). The more extreme form is a large, vaulted, variously serrate spine-like crest that projects beyond the posterior margin of the cranium and is well-developed in preflexion larvae soon after hatching. This type of crest characterizes larval cepolids, *Hapalogenys*, leiognathids, lethrinids, (lobotids?), pentacerotids, priacanthids and *Scombrops*. To my knowledge, it occurs elsewhere only in the larvae of holocentrid beryciforms and the caproid *Antigonia*.

The so called "tholichthys" larvae of the Chaetodontidae and Scatophagidae (Fig. 262A–D) perhaps represent the ultimate in head bone modification among larval percoids. The cranial bones and many of the other exposed bones of the head are thickened and rugose, effecting an armor-like protective covering. In chaetodontids the posttemporal and supracleithrum are rugose and expanded posteriorly as large laminar plates. The preopercle is similarly expanded anteriorly and posteriorly and at its angle bears a broad, flattened or serrated, terete spine. In scatophagids the preopercle is rugose and expanded, but, unlike chaetodontids, the supracleithrum is unmodified. The posttemporal is rugose, its dorsal portion is somewhat expanded, and its ventral half extends posteriorly as a very blunt, thick, spine-like projection. Also notable is a large, thick, rugose protuberance covering the pterotic. Although not identical, the larvae of chaetodontids and scatophagids share a unique physiognomy, the details of which should be investigated in relation to possible close affinity of these two families.

Spination on circumorbital, nasal, premaxillary and maxillary bones is generally found only in those larval percoids with cranial ornamentation, and it is almost exclusively in these larvae that other specializations, such as elongate serrate fin spines and spinous scales occur. In addition, opercular and pectoral series spination is usually more extensive and almost always includes an elongate and/or serrate spine at the angle of the preopercle.

In summary, there seem to have been some common evolutionary constraints on the order in which morphological complexity and specialization of larval percoids has progressed, but a simple direct relationship between this ordered progression and phylogenetic affinity among families is not apparent. In fact, the assemblages of taxa that characterize the various levels of complexity discussed above are quite diverse and not compatible with what little we do understand about percoid affinities based on adult morphology. Furthermore, it is clear that elaborately ornamented larvae have arisen independently several times within monophyletic groups otherwise characterized by larvae with only generalized opercular and preopercular spination. Examples include the haemulid *Conodon*, the sparoid family Lethrinidae and the serranid subfamily Anthiinae. Resolution of the phylogenetic significance of intricate patterns of

head spination among larval percoids will entail more precise study than has characterized much previous work. Determination of homology will require detailed information about location, conformation and processes of development of head spines prior to considering the question of compatibility with adult characters.

Utility of Larval Morphology in Phylogenetic Studies

The preceding two decades have seen notable advances in our understanding of the evolutionary relationships of teleost fishes; however, as noted above, progress in elucidating the phylogeny of the Percoidei has not kept pace. Many families are poorly delineated and hypotheses about inter- and intrafamilial relationships are few. Lack of progress is chiefly attributable to the size and diversity of the Percoidei, the adaptive malleability and convergence that have characterized percoid evolution and the paucity of conspicuous morphological specializations that can be readily identified as true synapomorphies. With few exceptions (Burgess, 1974; Dooley, 1978; Kendall, 1979; Johnson, 1983), previous studies of percoid phylogeny and classification have failed to consider early life history stages, even though it is obvious that the prodigious variety of larval form and specialization among percoids offers a rich suite of additional characters.

Within many families there is a complexity of larval morphology or diversity of larval form that suggests excellent potential for the application of larval characters in elucidating generic interrelationships. Particularly promising families in this regard include the Acropomatidae, Apogonidae, Bramidae, Carangidae, Cepolidae, Chaetodontidae, Haemulidae, Lutjanidae, Malacanthidae, Pentacerotidae, Pomacanthidae, Priacanthidae, Sciaenidae, and Serranidae. The intricate bony ornamentation of the larvae of anthiine serranids, for instance, is considerably more complex than that of the adults, and preliminary studies of details of larval head spination and scale development among New World genera indicate that the current generic classification, based exclusively on adult morphology, should be reexamined (Carole Baldwin, Abstracts of 1983 ASIH Annual Meeting). Larvae of groups like the apogonids and carangids exhibit a less complex morphology, but the wide range of form and specialization should prove useful in phylogenetic analyses.

Larval morphology will undoubtedly also prove useful in considerations of higher relationships among percoids. At the family level, a rather simplistic approach is to consider that larvae offer independent tests of hypotheses of monophyly. In other words, do the larvae of each percoid family share one or more derived features that corroborate the monophyly of that family as currently defined on the basis of adult morphology? The answer to this question appears to be yes for many groups, but problems stem from an inadequate understanding of character polarity and the fact that, for most families, larvae of many genera and most species remain undescribed. Nonetheless, this is a useful concept, and the validity and power of such a test will increase as we gain more knowledge of the larvae of various percoid groups.

Consider, for example, the bearing of larval morphology on several hypotheses of relationship resulting from the recent redefinition of Schultz's (1945) Emmelichthyidae, a polyphyletic assemblage of planktivorous fishes. Heemstra and Randall (1977) transferred *Dipterygonotus* to the Caesionidae and Johnson (1980) hypothesized that caesionids are lutjanoid fishes most

closely related to the lutjanid subfamily Lutjaninae. Caesionids are quite distinctive in body form and upper jaw configuration, but share with the lutjanines a number of osteological features and a specialized adductor mandibulae (similar to that of most carangids) in which a separate division of A_1 originates on the subocular shelf. Subsequent descriptions of larval lutjanines and caesionids (see Table 122) show that they share a distinctive body form, pattern of head spination, precocious first dorsal and pelvic fins with elongate spines and soft rays, and sparse pigmentation (Fig. 256A, B). The hypothesized sister group relationship is thus corroborated by larval morphology.

The Centranchidae were also removed from the Emmelichthyidae and hypothesized to be most closely related to the Sparidae (Heemstra and Randall, 1977; Johnson, 1980) based on adult morphology. Although the larvae of these two groups share no obvious specializations, they are quite similar (Fig. 258I, J), and are distinguishable from those of the Emmelichthyidae (Fig. 259I) and the other reassigned groups. *Labracoglossa*, placed in a separate family by Heemstra and Randall (1977) is here placed in the family Scorpididae (see section on classification), and the larval form corroborates this placement (Fig. 258A, B). The larvae of inermiids, *Inermia* and *Emmelichthyops*, also removed from the Emmelichthyidae, remain undescribed, but their identification can provide a test of the hypothesis that they are most closely related to the Haemulidae (Johnson, 1980).

These examples and those that follow demonstrate that early life history stages offer important information that can be used to test previous phylogenetic hypotheses or incorporated with adult characters into new phylogenetic analyses. Additional examples are mentioned in the discussion of familial classification. Where the larvae are known, failure to consider their morphology in studies of percoid phylogeny seems hardly justifiable, and may inhibit progress or lead to false conclusions. This point is well-illustrated in the two examples discussed below, in which details of larval morphology provide critical evidence in support of new or previously rejected phylogenetic hypotheses.

The families Branchiostegidae (=Latilidae) and Malacanthidae have been variously united and separated in past classifications. In the most recent revision, Dooley (1978) concluded that "the branchiostegids and malacanthids have few characters in common that might be used to justify their consolidation into a single family" and noted that they "could as easily be aligned with several other percoid families as with each other." He suggested that the malacanthids are possibly "a branch of the labrid-scarid lineage, while the branchiostegids show closer affinities to the serranid-percid line of perciform evolution." In contrast, Robins et al. (1980) recognized a close affinity between the two groups by treating them as subfamilies of the Malacanthidae. Marino and Dooley (1982) took issue with this classification and stated that there are "several more myological (differences) why the families are distinct." Actually, Marino and Dooley listed only one myological difference, the absence of adductor mandibulae section A_{3b} . This difference and the other 13 listed by Dooley (1978, Table 1), including body depth, body shape, and skull contour, have little relevance to the phylogenetic affinity of these two groups. As for features common to the malacanthids and branchiostegids, Dooley found only three: dorsal and anal fins relatively long and continuous, a single opercular spine, and "grossly similar larval stages." Dooley correctly noted that the first two of these are not particularly meaningful because they are fairly common percoid features, but he

TABLE 122. REFERENCES TO LARVAL PERCOIDEI.

Taxon	Eggs	Yolk-sac	Preflexion	Postflexion
Acanthoclinidae	Jillett, 1968	Jillett, 1968	Jillett, 1968	Crossland, 1981 Crossland, 1982 Jillett, 1968
Acropomatidae	—	—	—	Fourmanoir, 1976 Okiyama, 1982b
Ambassidae	Breder and Rosen, 1966 Eng, 1969 Nair, 1958	Eng, 1969	—	Nair, 1952b Gopinath, 1946 Nair, 1958
Apogonidae	Breder and Rosen, 1966 Leis and Rennis, 1983 Allen, 1975b Bertolini, 1933a	Leis and Rennis, 1983 Miller et al., 1979 Allen, 1975b Bertolini, 1933a	Leis and Rennis, 1983 Miller et al., 1979 Allen, 1975b De Gaetani, 1937	Leis and Rennis, 1983 Miller et al., 1979 Allen, 1975b Fourmanoir, 1976 Okiyama, 1982b Bertolini, 1933a Fahay, 1975 Whitley, 1926 Vatanachi, 1972 De Gaetani, 1937
Bramidae	—	Johnson, 1978 Mead, 1972	Johnson, 1978 Mead, 1972	Johnson, 1978 Mead, 1972 Fahay, 1983
Caesionidae	—	—	—	Leis and Rennis, 1983
Callanthiidae	—	—	Leis and Rennis, 1983 Bertolini, 1933b Fage, 1918	Leis and Rennis, 1983 Fourmanoir, 1976 Bertolini, 1933b Fage, 1918
Carangidae	Laroche et al., this volume			
Caristiidae	—	—	—	Belyanina, 1982b
Centracanthidae	Brownell, 1979 Thomopoulos, 1954 Aboussouan, 1964 Montalenti, 1933 Sanzo, 1939c	Brownell, 1979 Sanzo, 1939c	Brownell, 1979 Sanzo, 1939c	Brownell, 1979 Fage, 1918 Montalenti, 1933
Centrarchidae	Numerous references, see Breder and Rosen, 1966; Hardy, 1978b; and Auer, 1982			
Centropomidae	Lau and Shafland, 1982	Lau and Shafland, 1982	Lau and Shafland, 1982	Lau and Shafland, 1982
Cepolidae	Breder and Rosen, 1966 Russell, 1976 Holt, 1891 Montalenti, 1937b	—	Russell, 1976 Fage, 1918 Montalenti, 1937b Okiyama, 1982b	Russell, 1976 Fourmanoir, 1976 Clark, 1920 Fage, 1918 Montalenti, 1937 Fourmanoir, 1973
Chaetodontidae	Leis and Rennis, 1983 Burgess, 1978 Suzuki et al., 1980	Leis and Rennis, 1983 Suzuki et al., 1980	Leis and Rennis, 1983 Suzuki et al., 1980	Leis and Rennis, 1983 Burgess, 1978 Fourmanoir, 1976 Kendall and Goldsborough, 1911 Burgess, 1974
Cheilodactylidae	Brownell, 1979 Mito, 1963 Robertson, 1978 Gilchrist and Hunter, 1919 Barnard, 1927	Brownell, 1979 Robertson, 1978	Brownell, 1979 Gilchrist and Hunter, 1919 Hattori, 1964	Brownell, 1979 Dudnik, 1977 Vooren, 1972 Tong and Saito, 1977 Nielsen, 1963a Hattori, 1964
Cirrhitidae	—	—	Leis and Rennis, 1983	Leis and Rennis, 1983 Fourmanoir, 1973 Fourmanoir, 1971a
Congrogadidae	—	—	—	Whitley, 1926
Coracinae	—	—	—	Smith, 1938
Coryphaenidae	Johnson, 1978 Miller et al., 1979 Mito, 1960	Johnson, 1978 Miller et al., 1979 Mito, 1960	Johnson, 1978 Miller et al., 1979 Mito, 1960 Potthoff, 1980	Johnson, 1978 Miller et al., 1979 Gibbs and Collette, 1959 Aboussouan, 1969 Potthoff, 1980

TABLE 122. CONTINUED.

Taxon	Eggs	Yolk-sac	Preflexion	Postflexion
Echeneididae	John, 1950 Sanzo, 1930a Martin and Drewry, 1978 Sanzo, 1928 Akazaki et al., 1976	John, 1950 Sanzo, 1930a Martin and Drewry, 1978 Sanzo, 1928 Akazaki et al., 1976	John, 1950 Martin and Drewry, 1978 Sanzo, 1928 Akazaki et al., 1976	Gudger, 1926 Gudger, 1928 Akazaki et al., 1976
Emmelichthyidae	—	—	—	Nakahara, 1962
Ehippididae	Breder and Rosen, 1966 Johnson, 1978 Ryder, 1887	Johnson, 1978 Ryder, 1887	Johnson, 1978 Hildebrand and Cable, 1938 Fahay, 1983	Johnson, 1978 Hildebrand and Cable, 1938 Fahay, 1983
Epigonidae	—	—	—	Mayer, 1972
Gerreidae	Leis and Rennis, 1983 Rass, 1972	Leis and Rennis, 1983	Leis and Rennis, 1983	Leis and Rennis, 1983 Nair, 1952b Uchida et al., 1958
Girellidae	Breder and Rosen, 1966 Uchida et al., 1958 Mito, 1957a	Uchida et al., 1958 Mito, 1957a	Uchida et al., 1958 Mito, 1957a	Kobayashi and Igarashi, 1961 Munro, 1945 Uchida et al., 1958
Haemulidae	Breder and Rosen, 1966 Leis and Rennis, 1983 Johnson, 1978 Mito, 1966 Podosinnikov, 1977 Saksena and Richards, 1975 Hildebrand and Cable, 1930 Fahay, 1983	Leis and Rennis, 1983 Johnson, 1978 Mito, 1966 Podosinnikov, 1977 Saksena and Richards, 1975 Hildebrand and Cable, 1930 Fahay, 1983	Leis and Rennis, 1983 Johnson, 1978 Saksena and Richards, 1975 Hildebrand and Cable, 1930 Fahay, 1983	Leis and Rennis, 1983 Johnson, 1978 Saksena and Richards, 1975 Hildebrand and Cable, 1930 Nellen, 1973b Fahay, 1983 Heemstra, 1974
<i>Haplogenyis</i>	Suzuki et al., 1983	Suzuki et al., 1983	Suzuki et al., 1983	Okiyama, 1982b Suzuki et al., 1983
<i>Howella</i>	—	—	Gonzales, 1946	Gonzales, 1946
Kyphosidae	Leis and Rennis, 1983 Miller et al., 1979 Watson and Leis, 1974	Leis and Rennis, 1983 Miller et al., 1979	Leis and Rennis, 1983 Miller et al., 1979	Leis and Rennis, 1983 Moore, 1962 Johnson, 1978 Uchida et al., 1958 Nair, 1952b
Lactariidae	Breder and Rosen, 1966 Chacko, 1944	—	—	Nair, 1952b
<i>Lateolabrax</i>	Breder and Rosen, 1966 Mito, 1957b Uchida et al., 1958	Mito, 1957b Uchida et al., 1958	Mito, 1957b Uchida et al., 1958	Okiyama, 1982b Mito, 1957b Uchida et al., 1958
Leiognathidae	Breder and Rosen, 1966 Fujita, 1960	Fujita, 1960	Fujita, 1960	Nair, 1952b Vatanachi, 1972 Gopinath, 1946
Lethrinidae	Leis and Rennis, 1983 Suzuki and Hioki, 1978 Renzhai and Suifen, 1980a Mito, 1956a	Leis and Rennis, 1983 Suzuki and Hioki, 1978 Renzhai and Suifen, 1980a Mito, 1956a	Leis and Rennis, 1983	Leis and Rennis, 1983
Lobotidae	Hardy, 1978b Gudger, 1931	—	Hardy, 1978b Uchida et al., 1958	Hardy, 1978b Okiyama, 1982b Uchida et al., 1958
Lutjanidae	Leis and Rennis, 1983 Suzuki and Hioki, 1979b Rabalais et al., 1980 Stark, 1971 Mori, 1984	Leis and Rennis, 1983 Suzuki and Hioki, 1979b Rabalais et al., 1980 Mori, 1984	Leis and Rennis, 1983 Richards and Saksena, 1980 Collins et al., 1980 Laroche, 1977 Mori, 1984	Leis and Rennis, 1983 Fourmanoir, 1976 Okiyama, 1982b Richards and Saksena, 1980 Collins et al., 1980 Fahay, 1975 Heemstra, 1974 Vatanachi, 1972 Stark, 1971 Musiy and Sergiyenko, 1977 Laroche, 1977; Mori, 1984
Malacanthidae	Breder and Rosen, 1966 Fischer, 1958	Fischer, 1958a Fahay, 1983	Fischer, 1958a Okiyama, 1964	Fourmanoir, 1970, 1976 Dooley, 1978

TABLE 122. CONTINUED.

Taxon	Eggs	Yolk-sac	Preflexion	Postflexion
	Fahay, 1983		Fahay, 1983	Moser, 1981 Okiyama, 1964 Okiyama, 1982b Fahay, 1983 Berry, 1958 Hubbs, 1958
Microcanthidae	—	—	Leis and Rennis, 1983 Uchida et al., 1958	Leis and Rennis, 1983 Uchida et al., 1958
Monodactylidae	Akatsu et al., 1977	Akatsu et al., 1977	Akatsu et al., 1977	Akatsu et al., 1977 Ogasawara et al., 1978
Moronidae	Breder and Rosen, 1966 Hardy, 1978b Mansueti, 1964 Ryder, 1887 Ryder, 1887 Mansueti, 1958 Pearson, 1938 Pearson, 1938	Hardy, 1978b Mansueti, 1964 Ryder, 1887 Mansueti, 1958 Pearson, 1938 Doroshev, 1970	Hardy, 1978b Mansueti, 1964 Ryder, 1887 Mansueti, 1958 Pearson, 1938 Doroshev, 1970 Fritzsche and Johnson, 1980	Hardy, 1978b Mansueti, 1964 Mansueti, 1958 Pearson, 1938 Doroshev, 1970 Okiyama, 1982b Fritzsche and Johnson, 1980
Mullidae	Breder and Rosen, 1966 Leis and Rennis, 1983 Russell, 1976 Miller et al., 1979 Marinaro, 1971 Raffaële, 1888 Heincke and Ehrenbaum, 1900	Leis and Rennis, 1983 Russell, 1976 Marinaro, 1971 Raffaële, 1888 Heincke and Ehrenbaum, 1900	Leis and Rennis, 1983 Russell, 1976 Miller et al., 1979 Heincke and Ehrenbaum, 1900 Montalenti, 1937 Uchida et al., 1958 Lo Bianco, 1908b	Leis and Rennis, 1983 Johnson, 1978 Russell, 1976 Miller et al., 1979 Uchida et al., 1958 Vatanachi, 1972 M. C. Caldwell, 1962 Lo Bianco, 1908b
Nemipteridae	Leis and Rennis, 1983 Aoyama and Sotogaki, 1955 Renzhai and Suifen, 1980b	Leis and Rennis, 1983 Aoyama and Sotogaki, 1955 Renzhai and Suifen, 1980b	Leis and Rennis, 1983	Leis and Rennis, 1983
Opistognathidae	—	—	—	Vatanachi, 1972
Oplegnathidae	Breder and Rosen, 1966 Mito, 1956b Uchida et al., 1958	Fukuhara and Ito, 1978 Mito, 1956b Uchida et al., 1958	Fukuhara and Ito, 1978 Uchida et al., 1958	Fukuhara and Ito, 1978 Fuskusho, 1975
Pempheridae	Leis and Rennis, 1983	Leis and Rennis, 1983	Leis and Rennis, 1983	Leis and Rennis, 1983
Pentacerotidae	—	—	—	Zama et al., 1977 Hardy, 1982
Percichthyidae	Breder and Rosen, 1966 Dakin and Kesteven, 1938 Llewellyn, 1974 Lake, 1967 Jackson, 1978 Fuster de Plaza and Plaza, 1955	Dakin and Kesteven, 1938 Llewellyn, 1974 Lake, 1967 Jackson, 1978	Dakin and Kesteven, 1938 Llewellyn, 1974 Lake, 1967 Jackson, 1978	Dakin and Kesteven, 1938 Lake, 1967 Jackson, 1978
Percidae	Numerous references, see Breder and Rosen, 1966; Hardy, 1978b; and Auer, 1982			
Plesiopodae	Breder and Rosen, 1966 Mito, 1955	Mito, 1955	—	—
<i>Polyprion</i>	Hardy, 1978b Sparta, 1939a Thomson and Anderton, 1921	Hardy, 1978b Sparta, 1939a	Hardy, 1978b Sparta, 1939a	Hardy, 1978b Sparta, 1939a Bertolini, 1933b
Pomacanthidae	Leis and Rennis, 1983 Suzuki et al., 1979 Fujita and Mito, 1960	Leis and Rennis, 1983 Suzuki et al., 1979 Fujita and Mito, 1960	Leis and Rennis, 1983 Burgess, 1974	Leis and Rennis, 1983 Burgess, 1978 Fourmanoir, 1976 Burgess, 1974
Pomatomidae	Hardy, 1978b Deuel et al., 1966 Dekhnik, 1973 Salekhova, 1959 Sparta, 1962 Fahay, 1983	Hardy, 1978b Deuel et al., 1966 Dekhnik, 1973 Salekhova, 1959 Sparta, 1962 Fahay, 1983	Hardy, 1978b Deuel et al., 1966 Dekhnik, 1973 Salekhova, 1959 Sparta, 1962 Norcross et al., 1974 Pearson, 1941 Fahay, 1983	Hardy, 1978b Dekhnik, 1973 Salekhova, 1959 Norcross et al., 1974 Pearson, 1941 Silverman, 1975

TABLE 122. CONTINUED.

Taxon	Eggs	Yolk-sac	Prefixion	Postflexion
Priacanthidae	Leis and Rennis, 1983 Suzuki et al., 1980	—	Leis and Rennis, 1983 Hardy, 1978b D. K. Caldwell, 1962 Aboussouan, 1969	Leis and Rennis, 1983 Hardy, 1978b D. K. Caldwell, 1962 Fourmanoir, 1976 Okiyama, 1982b
Pseudochromidae	Leis and Rennis, 1983 Lubbock, 1975	Leis and Rennis, 1983 Lubbock, 1975	Leis and Rennis, 1983	Leis and Rennis, 1983
Rachycentridae	Hardy, 1978b	—	—	Hardy, 1978b Dawson, 1971a
Scatophagidae	—	Weber and de Beaufort, 1936	—	Nair, 1952b Weber and de Beaufort, 1936
Sciaenidae	Numerous references, see Breder and Rosen, 1966; Hardy, 1978b; and Auer, 1982	—	Hattori, 1964	Hattori, 1964
Scorpididae	—	—	—	—
Serranidae	Kendall, this volume	—	—	—
Sillaginidae	Breder and Rosen, 1966 Ueno and Fujita, 1954 Uchida et al., 1958	Ueno and Fujita, 1954 Uchida et al., 1958	Munro, 1945 Uchida et al., 1958	Okiyama, 1982b Munro, 1945 Uchida et al., 1958 Gopinath, 1946
<i>Simiperca</i>	Imai and Nakahara, 1957 Chyung, 1977	Imai and Nakahara, 1957 Chyung, 1977	Imai and Nakahara, 1957 Chyung, 1977	Okiyama, 1982b Imai and Nakahara, 1957 Chyung, 1977
Sparidae	Breder and Rosen, 1966 Johnson, 1978 Russell, 1976 Ranzi, 1933 Rathbun, 1893 Cardeilhac, 1976 Kuntz and Radcliffe, 1917 Houde and Potthoff, 1976 Uchida et al., 1958 Fahay, 1983 Hussain et al., 1981	Johnson, 1978 Russell, 1976 Ranzi, 1933 Kuntz and Radcliffe, 1917 Houde and Potthoff, 1976 Uchida et al., 1958 Fahay, 1983 Kohno et al., 1983 Hussain et al., 1981	Johnson, 1978 Russell, 1976 Ranzi, 1933 Hildebrand and Cable, 1930 Kuntz and Radcliffe, 1917 Houde and Potthoff, 1976 Fahay, 1983 Kohno et al., 1983 Hussain et al., 1981	Johnson, 1978 Russell, 1976 Ranzi, 1933 Hildebrand and Cable, 1930 Kuntz and Radcliffe, 1917 Okiyama, 1982b Munro, 1945 Houde and Potthoff, 1976 Uchida et al., 1958 Fahay, 1983 Kohno et al., 1983 Hussain et al., 1981
<i>Stereolepis</i>	—	—	—	Okiyama, 1982b
<i>Symphysanodon</i>	—	—	—	Fourmanoir, 1973
Terapontidae	Breder and Rosen, 1966 Llewellyn, 1973 Zvjagina, 1965b Lake, 1967	Llewellyn, 1973 Lake, 1967	Llewellyn, 1973 Zvjagina, 1965b Lake, 1967	Llewellyn, 1973 Nair, 1952b Munro, 1945 Zvjagina, 1965b Lake, 1967 Vatanachi, 1972

incorrectly dismissed the significance of the larvae, which, as Okiyama (1982b) pointed out, are remarkably similar and distinctive among the percoids. I believe the larval morphology of these two groups offers conclusive evidence for a sister-group relationship between them, including a synapomorphy unique among percoids, and perhaps all teleosts.

Larval malacanthids and branchiostegids (Fig. 256E, F), are among the most elaborately ornamented in the Percoidei. They share early developing spinous scales, a series of serrate ridges on the frontals, and have very similar configurations of spines and serrate ridges on many of the exposed bones of the head. The most distinctive feature is a median rostral bony structure, forming a blunt, serrate-ridged projection in *Caulolatilus*, *Lopholatilus* and *Branchiostegus*, a smooth anchor-shaped projection in *Malacanthus* and a long spike-like spine with serrate ridges in *Hoplolatilus*. Dooley (1978) stated that larvae with similar rostra and head spination occur among holocentrids, lutjanids, serranids and istiophorids and that the similarity "could

be considered as convergence or perhaps a relict characteristic carried over from a common beryciform ancestor." In fact, the larvae of these groups are quite different morphologically, and misconceptions about their similarity apparently result from superficial considerations that have often characterized earlier larval descriptions. Neither larval lutjanids nor serranids have rostral projections or (with the exception of some anthiini serranids) particularly elaborate head spination. The rostral projection of istiophorids is a premaxillary beak or bill, supported internally by a fixed, horizontally-oriented rostral cartilage and is structurally homologous to that of larval *Xiphias* and scombrids (except Scombrini). Although the spinous rostrum of holocentrids bears a strong resemblance to that of *Hoplolatilus*, it is an entirely different structure, formed by enlargement of the supraethmoid and supported by a greatly enlarged ethmoid cartilage. The median rostral projection of malacanthids and branchiostegids has been described as an ethmoid spine (Okiyama, 1964, 1982b), but it actually originates from a modification of

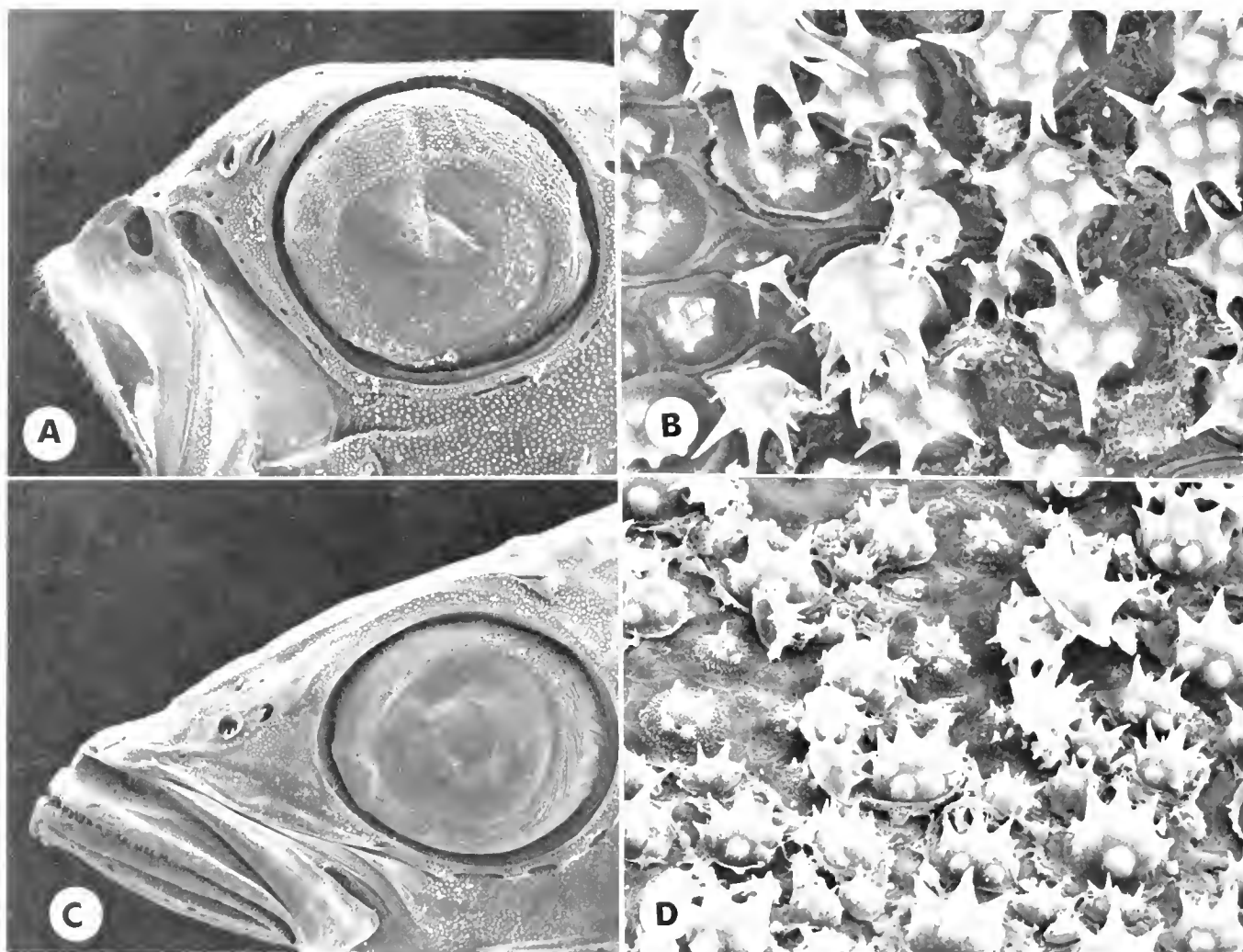

Fig. 263. Scanning electromicrographs of epithelium of juvenile dolphins and cobia at various magnifications. (A) *Coryphaena hippurus*, 28 mm SL, 15 \times ; (B) *C. hippurus*, 28 mm SL, 360 \times ; (C) *Rachycentron canadum*, 30 mm SL, 15 \times ; and (D) *R. canadum*, 80 mm SL, 360 \times .

the nasal bones. The nasal bones first appear as separate structures, but prior to or during flexion, they become fused anteriorly by a median bony bridge. This modified nasal structure then develops the various ornamentations that characterize malacanthid and branchiostegid larvae. At transformation, the bony bridge begins to fragment and is eventually entirely resorbed, so that the nasal bones once again become completely separate. I know of no other example in fishes of transient ontogenetic fusion of nasal bones. This unique synapomorphy, in conjunction with the other shared larval specializations, cogently supports the hypothesis that malacanthids and branchiostegids are sister groups. Classification of the two lineages of tilefishes as subfamilies of the Malacanthidae seems an appropriate way to express this relationship.

The evolutionary relationships of the dolphins, Coryphaenidae, have remained uncertain, but the family has usually been placed close to the Carangidae as have the Echeneididae and the monotypic Rachycentridae. Examination of the larvae of these groups during this investigation and subsequent considerations of adult morphology have led to further resolution of the interrelationships of these families (Johnson, Abstracts of 1983 ASIH Annual Meeting). This final example provides the

most convincing illustration of the importance of larval characters to studies of phylogeny among percoids. Consequently I discuss it in considerable detail.

Freihofer (1978) noted that the Nematistiidae, Carangidae, Coryphaenidae, Rachycentridae and Echeneididae share a unique specialization in the lateralis system on the snout—an anterior extension of the nasal canal consisting of one (Nematistiidae) or two prenasal canal units, with one (Nematistiidae and Carangidae) or both (remaining three families) surrounded by tubular ossifications. In addition, they share small, adherent cycloid scales. Based on two presumed synapomorphies, then, these five families constitute a monophyletic group, hereafter referred to as the carangoids.

Three synapomorphies unite the Carangidae, Coryphaenidae, Rachycentridae and Echeneididae as a monophyletic group. These four families lack the bony stay (Potthoff, 1975) posterior to the ultimate dorsal and anal pterygiophores found in almost all other percoids (see Table 120), have two prenasal canal units and have a lamellar expansion along the anterior margin of the coracoid. *Nematistius*, placed in separate family by Rosenblatt and Bell (1976), is apparently the sister group of these four families (see cladogram, Fig. 276, in Smith-Vaniz, this volume).

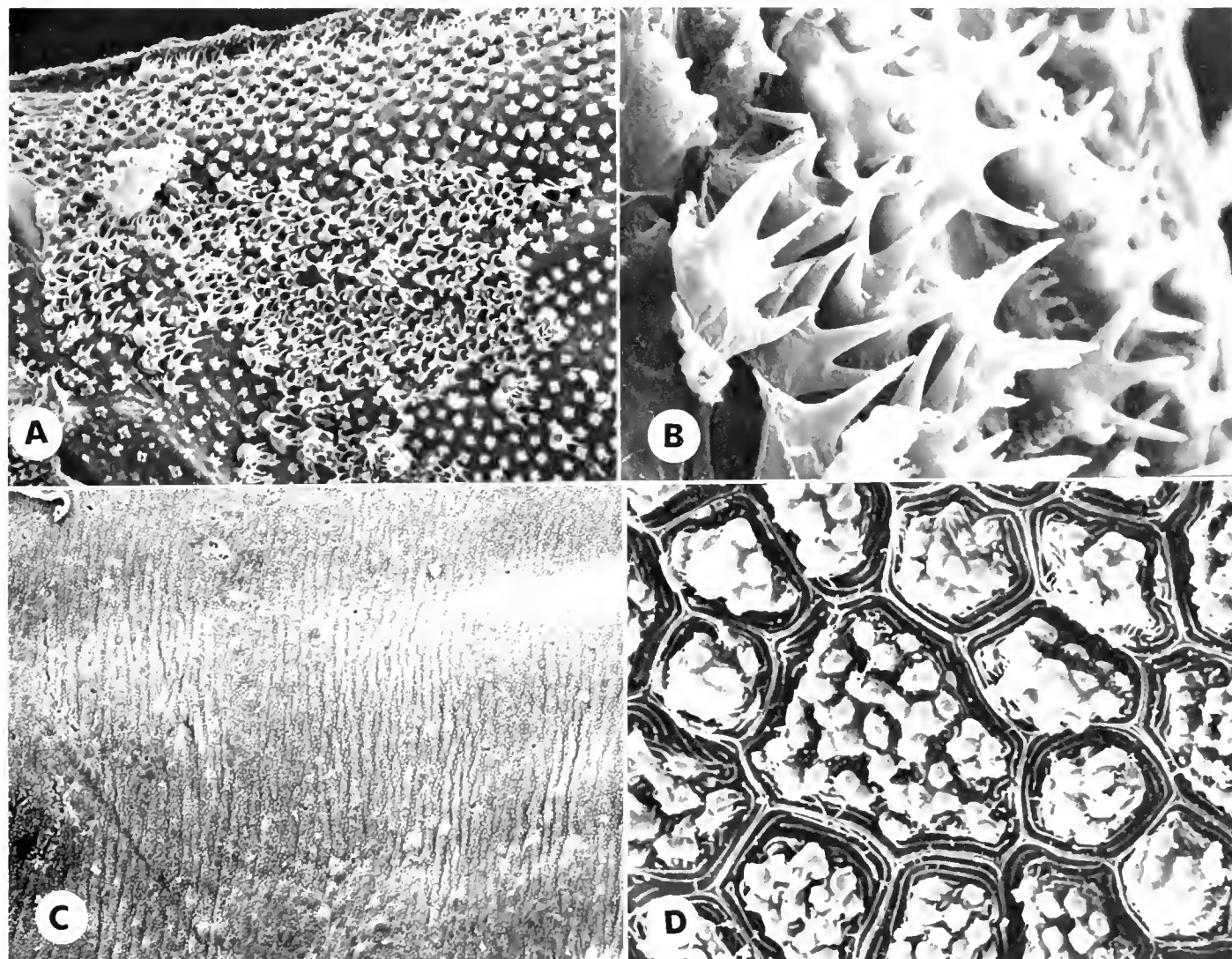

Fig. 264. Scanning electromicrographs of epithelium of larval dolphin and amberjack at various magnifications. (A) *Coryphaena hippurus*, 17.0 mm SL, 55 \times ; (B) *C. hippurus*, 17.0 mm SL, 400 \times ; (C) *Seriola* sp., 11.2 mm SL, 55 \times ; and (D) *S.* sp., 11.2 mm SL, 2,000 \times .

it has a well developed bony stay, a single, partly ossified prenasal canal unit and an unmodified coracoid.

Within the carangoids, the Coryphaenidae, Rachycentridae and Echeneididae form a monophyletic group, here referred to as the echeneoids. Adult echeneoids are specialized with respect to the Carangidae in the following features: absence of predorsal bones; anterior shift of the first dorsal pterygiophore forward of the third interneural space; presence of several anal pterygiophores anterior to the first haemal spine (vs. one in carangids and most other percoids); loss of the so-called beryciform foramen in the anterior ceratohyal; and tubular ossifications surrounding both prenasal canal units. Larval echeneoids are also specialized with respect to carangids (larvae of *Nematistius* are unknown). Whereas larval carangids are moderate to deep-bodied, hatch at small sizes (1–3.5 mm) and complete dorsal fin and anal fin rays in conjunction with or soon after flexion, echeneoid larvae (Fig. 261A–C) are very elongate, hatch at large sizes and complete dorsal fin rays at two to three times the size at flexion (see Table 121). Larval morphology thereby corroborates the hypothesized monophyly of the echeneoids.

Although a sister-group relationship between the Coryphaenidae and either the Rachycentridae or the Echeneididae has not been previously proposed, it has often been suggested that *Rachycentron* and the echeneids are sister groups. This hypothesis was based on general external similarity including the remarkable resemblance in body form, color pattern and caudal fin shape between juveniles of *Rachycentron* and *Echeneis naurerates* (Böhlke and Chaplin, 1968). Because the juvenile features of *Rachycentron* are shared by only one species of echeneidid, they do not provide evidence for a sister-group relationship between the Rachycentridae and the Echeneididae, nor does a detailed osteological comparison of the two groups. The echeneidids are highly modified in almost every aspect of their osteology compared to both *Rachycentron* and *Coryphaena*, and with two exceptions (absence of a median cranial crest and fusion of the prenasal ossifications), the only specializations shared by both *Rachycentron* and the echeneidids are also shared by *Coryphaena*. The following are autapomorphies of the Echeneididae: spinous dorsal fin modified as an attachment disc covering the dorsal surface of the cranium; first neural arch fused

to its centrum, spine absent; endopterygoid absent; quadrate with a lateral shelf; palatine and upper jaw bones distinctively modified; postcleithra absent; supracleithrum extremely reduced; medial tabular bones absent; posttemporal modified in shape and angle of articulation with supracleithrum; pelvic girdle broad and short, with two distinct anterior processes; caudal skeleton with a full neural spine on the second preural centrum; branchial skeleton with main arm of first epibranchial reduced to a nubbin, uncinat process enlarged and articulating directly with second pharyngobranchial, and interarcual cartilage absent. None of these extreme modifications (those of the caudal and branchial skeletons being unique among percoids) are even foreshadowed in the skeleton of *Rachycentron*, which is instead remarkably similar to that of *Coryphaena*, except in the anterior portion of the dorsal fin and the neurocranium.

In *Coryphaena*, the dorsal fin is elaborated anteriorly and extended into the first interneural space (second in *Rachycentron*) and there is an extreme supraoccipito-frontal crest on the neurocranium. The dorsal fin modification is autapomorphic for *Coryphaena*, but the median cranial crest is probably primitive for echeeneids since it is variously developed in all carangids and well-developed in *Nematistius*. The absence of this crest in *Rachycentron*, associated with a slight flattening of the neurocranium, is the only specialization shared with the Echeeneidae. Here again, however, there is little similarity between the slightly flattened neurocranium of *Rachycentron* and the extremely flattened and restructured neurocranium of the echeeneids, in which, for instance, the supraethmoid and vomer have become flat plates and the orbit is completely occluded by enlargement and anterior extension of the pterospheneids. This extreme restructuring of most cranial bones is evident even in larval echeeneids at the earliest development of the neurocranium, whereas the neurocrania of *Rachycentron* and *Coryphaena* exhibit a generalized development similar to that of carangids. Prior to development of the median crest in *Coryphaena* (> 100 mm), the neurocrania of cobia and dolphin differ mainly in relative depth. Echeeneids also have an exceptionally modified adductor mandibulae in which A_1 is absent and A_2 and A_{∞} are distinctively subdivided. *Coryphaena* and *Rachycentron* share a relatively generalized adductor mandibulae, specialized with respect to the primitive carangids (see section on Carangidae) in having A_1 somewhat reduced and inserting narrowly on the maxillo-mandibular ligament.

The pronounced similarities between *Coryphaena* and *Rachycentron* in the adductor mandibulae and most osteological features merely serve to reiterate the lack of evidence for the frequently proposed sister-group relationship between *Rachycentron* and the echeeneids. Further comparison with character states throughout the Carangidae will be required to define these adult similarities as primitive or derived features. The most compelling evidence for a sister-group relationship between *Coryphaena* and *Rachycentron* is found in the morphology of their larvae. As noted above all echeeneid larvae have a similar body form and pattern of development, but the elongate, flattened head of larval echeeneids lacks ornamentation. In contrast, larval dolphin and cobia share identical patterns of head spination: a small posttemporal spine; several spines on the posterior and lateral margin of the preopercle, including one enlarged spine on either side of its angle; and a very large, posterolaterally directed spine on the supraorbital ridge of each frontal bone. Another obvious feature is the presence of laterally swollen pterotics, previously described in *Coryphaena* as blunt

sphenotic spines (Gibbs and Collette, 1959). This specific pattern of head spines is distinctive, but similar features occur in various combinations among carangid larvae, and it is premature to interpret this configuration as synapomorphic for *Coryphaena* and *Rachycentron* until detailed comparisons with carangids have been made.

A specialization clearly unique to the larvae of dolphin and cobia, however, is a modified epithelial cuticle in which are borne minute crown-shaped spicules (Figs. 263A–D, 264A, B). The cuticle itself is composed of large, multinucleate "cells," 40–100 μ in diameter, that appear to continually produce and slough-off the thorny spicules. Each epithelial "cell" produces one spicule, so that these extraordinary structures cover all exposed body surfaces, excluding the pupil of the eye, giving the integument a bristly appearance under magnification (Fig. 264A). They first appear at about 8mm and are present in some individuals as large as 100 mm. Further histological work and electron microscopy will be necessary to determine the composition of the spicules, which may be keratinous. It is clear, however, that they are neither bony nor cartilaginous. Their function is unknown, but as with spinous scales, it seems likely that they are defensive.

The surface and cellular composition of the epithelium of larval echeeneids appear normal, but some modification of the larval epithelium may actually be a primitive feature of carangoids. In larvae of trachinotine and naucratine carangids examined thus far (*Trachinotus*, *Naucrates*, *Seriola*) the epithelial cells are of normal size (~8–12 μ), but their surfaces bear clusters of bump-like structures, seemingly the result of keratinization (Fig. 264C, D). Absence of these modified epithelial cells in larvae of carangine carangids is parsimoniously interpreted as secondary (see Laroche et al., this volume). Their presence in the larvae of *Nematistius* (currently unknown) would corroborate the hypothesis that modified larval epithelium is primitive for carangoids and thus also for echeeneids, suggesting that it has been lost in carangines and echeeneids.

The multinucleate epithelial cells and enlarged, thorny spicules of larval *Coryphaena* and *Rachycentron* represent a complex, shared specialization, unique among percoids. The phylogenetic significance of this synapomorphy is lessened only by the unlikely possibility that loss of a modified epithelium in echeeneids occurred after development of multinucleate cells and spicules. Available evidence strongly points to a *Coryphaena-Rachycentron* sister-group relationship, and it should be clear that further investigations testing this hypothesis must integrate larval, adult and developmental characters.

In conclusion, the study of early life history stages of fishes has traditionally been treated as a discipline somewhat removed from the mainstream of systematic ichthyology. As a result, larval morphology has rarely been incorporated into studies of evolutionary relationships of fishes. It is evident that the larvae of percid fishes exhibit a prodigious array of complexity and diversity that offers exceptional potential applicability to phylogenetic studies. Recognition and application of this potential will be an important step in understanding the complex evolutionary history of the Percoidei.

SOUTH CAROLINA WILDLIFE AND MARINE RESOURCES DEPARTMENT, POST OFFICE BOX 12559, CHARLESTON, SOUTH CAROLINA 29412. PRESENT ADDRESS: FISH DIVISION, NATIONAL MUSEUM OF NATURAL HISTORY, WASHINGTON, DISTRICT OF COLUMBIA 20560.

Serranidae: Development and Relationships

A. W. KENDALL, JR.

THE percoid family Serranidae is defined by the presence of three spines on the opercle (Gosline, 1966) and three reductive specializations (absence of the posterior uroneural, procurrent spur, and third preural radial cartilage) that separate it from the Percichthyidae (Johnson, 1983). These are primarily tropical to temperate marine fishes that vary in size from <10 cm to >300 cm. It is a speciose family with nearly 400 species (Nelson, 1976) that has had a history of being hard to characterize and subdivide. The serranids are continuing objects of taxonomic studies from the species to subfamily levels and several new species are described each year, primarily anthiines whose deep-water reef habitat has made collecting difficult. As presently understood (Johnson, 1983), the family is composed of 3 subfamilies (Serraninae, Anthiinae, and Epinephelinae), although Katayama (1960) recognized 15 subfamilies. Various authors have included other groups (e.g., *Callanthias*) in the Serranidae, and others have raised parts of the family to familial status (e.g., Anthiinae and Grammistinae). Such problems will probably not be resolved without a worldwide revision of the family, which is not forthcoming.

DEVELOPMENT

The eggs of all but a few serranids are unknown. Often, Wilson's (1891) classic work on the development of *Centropristis striata* eggs has been cited as the example of teleost embryology in texts (e.g., Nelsen, 1953). Serranid eggs described to date are typical of the majority of pelagic marine teleost eggs: they are spherical, about 1 mm in diameter, have a single oil globule, a narrow perivitelline space, and a smooth egg envelope. Several species of *Epinephelus* (e.g., Guitart Manday and Juarez Fernandez, 1966; Hussain and Higuchi, 1980), *Paralabrax* (Butler et al., 1982), and several anthiines (e.g., Suzuki et al., 1974, 1978) have been reared. There seems to be a difference in oil globule placement in yolk-sac larvae among the subfamilies (Fig. 265). Larvae of representatives of all the subfamilies, most of the tribes, and about a third of the genera of serranids have been described. Serranid larvae fall into one of four types, which correspond to two of the subfamilies and two of the tribes within the Epinephelinae. These larval types can be characterized based on the taxa for which larvae are known as follows (based on Kendall, 1979).

Serraninae.—Body proportions show rather direct development. There are no elongate spines in the opercular region, rather a series of blunt points. The fin spines are thin and only slightly elongated in some. Most larval pigment consists of melanophores in characteristic positions along the ventral midline.

Anthiinae.—These deep-bodied larvae have produced spines on several bones in the opercular region, some of which may be serrated. There is a tendency to develop armature on the head, and the interopercular has a characteristic long posteriorly directed spine that is overlaid by an even larger, similar spine on the preopercular. The pelvic and some dorsal fin spines are strong, serrate in some, and not very elongate. Pigment consists

mainly of large blotches and dashes in characteristic positions on the trunk.

Epinephelini.—Known larvae of members of this tribe are all quite similar and generally difficult to assign to a genus on the basis of larval characters. These are among the most spectacular of fish larvae, with stout, elongate, serrate, and pigmented dorsal and pelvic fin spines. Usually the second dorsal spine is much longer than the others and it, as well as the pelvic spines, are as long as the body. The dorsal spine is often "locked" in an upright position—presumably possible because of a unique pte-

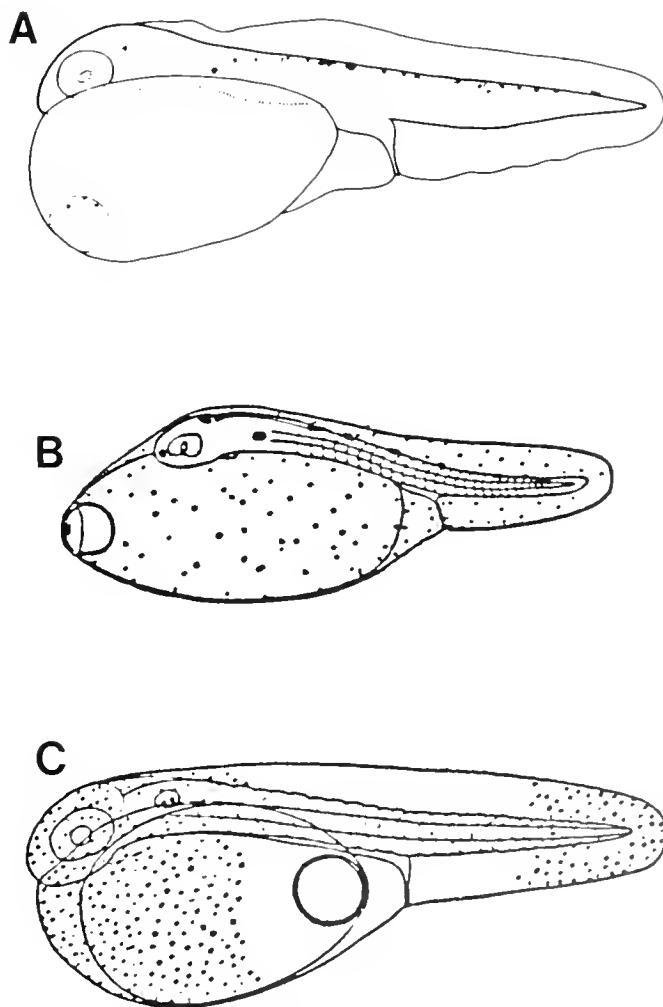

Fig. 265. Newly hatched yolk-sac larvae of serranids: (A) Serraninae: *Paralabrax clathratus*, from Butler et al. (1982); (B) Anthiinae: *Sacura margaritacea*, from Suzuki et al. (1974); and (C) Epinephelinae: *Epinephelus akaara*, from Ukawa et al. (1966).

TABLE 123. SERRANID TAXA (SUBFAMILIES THROUGH SUBGENERA). Their general distribution and references to early life history (ELH) descriptions. A-A: Atlanto-American, I-P: Indopacific. Stages described: E (eggs), Y (yolk-sac larvae), L (larvae—yolk-sac through post flexion), Pr (preflexion larvae), F (flexion larvae), Po (postflexion larvae), T (transforming larvae) and J (juveniles).

Subfamily tribe	Genus subgenus	Distribution		ELH descriptions	
		A-A	I-P		
Serraninae	<i>Acanthistius</i>		+		
	<i>Centropristus</i>	+		Ryder (1888)—E-Y, Wilson (1891)—E-Y, Hoff (1970)—E-Y, Kendall (1972)—Pr-J, Kendall (1977, 1979)—Pr-Po	
	<i>Chelidoperca</i>		+		
	<i>Cratinus</i>	+			
	<i>Diplectrum</i>	+		Kendall (1977, 1979)—Pr-Po	
	<i>Dules</i>	+			
	<i>Hypoplectrus</i>	+		Kendall (1977, 1979)—Pr-Po	
	<i>Paralabrax</i>	+		Kendall (1977, 1979)—Pr-Po, Butler et al. (1982)—E-J	
	<i>Schultzea</i>	+			
	<i>Serraniculus</i>	+		Kendall (1977, 1979)—Pr-Po	
	<i>Serranus</i>	+		Raffaele (1888)—E-Y, Fage (1918)—Pr-J, Roule and Angel (1930)—L, Bertolini (1933b)—E-J, Vodyanitsky and Kazanova (1954)—E-Po, Aboussouan (1972b)—Pr-Po, Kendall (1977, 1979)—Pr-Po	
	<i>Serranus</i>				
	<i>Paracentropristus</i>				
	Anthiinae	<i>Anthias</i>	+	+	Roule and Angel (1930)—Pr-T, Sparta (1932)—Pr-T, Bertolini (1933b)—Pr-J, Aboussouan (1972b)—Pr-Po, Fourmanoir (1976)—Po, Kendall (1977, 1979)—Pr-Po, Suzuki et al. (in press), Leis and Rennis (1983)—Pr-T
<i>Microlabrichthys</i>					
<i>Nemanthias</i>					
<i>Pseudanthias</i>					
<i>Caestoperca</i>			+	Fourmanoir (1976)—Po	
<i>Caprodon</i>		+	+		
<i>Dactylanthias</i>			+		
<i>Ellerkeldia</i>			+		
<i>Franzia</i>			+	Suzuki et al. (1978)—E-Y	
<i>Giganthias</i>			+		
<i>Hemanthias</i>		+		Kendall (1977, 1979)—Pr-Po	
<i>Holanthias</i>		+	+		
<i>Luzonichthys</i>			+	Fourmanoir (1976)—T	
<i>Ocyanthias</i>			+		
<i>Odontanthias</i>			+		
<i>Plectranthias</i> ^s		+	+	Kendall (1977, 1979)—Po	
<i>Pronotogrammus</i>		+		Kendall (1977, 1979)—Pr-Po	
<i>Sacura</i>			+	Suzuki et al. (1974)—E-Pr, Fourmanoir (1976)—Po	
<i>Selenanthias</i>			+	Fourmanoir (1973)—T	
<i>Serranocirrhitus</i>			+		
<i>Tosana</i>		+			
<i>Tosanoidea</i>		+			
Epinephelinae ^b	Nipponini	<i>Nippon</i>		+	
		Epinephelini	<i>Anyperodon</i>		+
		<i>Cromileptes</i>		+	
		<i>Epinephelus</i> ^c	+	+	Raffaele (1888)—E, Fage (1918)—Po, Bertolini (1933b)—F, Sparta (1935)—E-T, Fowler (1944)—T, Vodyanitsky and Kazanova (1954)—E-Po, Guitart Manday and Juarez Fernandez (1966)—E-Y, Ukawa et al. (1966)—E-Pr, Mito et al. (1967)—Pr-J, Presley (1970)—F-Po, Smith (1971)—Po, Aboussouan (1972b)—Pr-Po, Fourmanoir (1976)—L, Chen et al. (1977)—E, Kendall (1977, 1979)—Po, Hussain and Higuchi (1980)—Y-J
		<i>Alphestes</i>			Johnson and Ashe (1984)—Po-J, Leis and Rennis (1983)—Pr-Po
		<i>Cephalopholis</i>			
		<i>Dermatolepis</i>			
		<i>Epinephelus</i>			
		<i>Promicrops</i>			
		<i>Gonioplectrus</i>	+		Kendall and Fahay (1979)—Po, Johnson and Ashe (1984)—Po
		<i>Gracilia</i>		+	
		<i>Mycteroperca</i>	+		Kendall (1977, 1979)—Pr-J, Johnson and Ashe (1984)—Po-T
		<i>Paranthias</i>	+	+	Kendall (1977, 1979)—Po, Johnson and Ashe (1984)—Po-T
		<i>Plectropomus</i>		+	
		<i>Trisotropis</i>		+	
		<i>Variola</i>		+	
	Diploprionini	<i>Aulacocephalus</i>		+	
	<i>Belonoperca</i>		+		
	<i>Diploprion</i>		+	Hubbs and Chu (1934)—T	
Liopropomini	<i>Jebochikta</i>	+			
	<i>Liopropoma</i>	+	+	Kotthaus (1970)—L, Fourmanoir (1971a)—Po, Fourmanoir (1976)—Po, Kendall (1977, 1979)—Pr-Po	

TABLE 123. CONTINUED.

Subfamily tribe	Genus subgenus	Distribution		ELH descriptions
		A-A	I-P	
Grammistini	<i>Pikea</i>	+		
	<i>Rainfordia</i>		+	
	<i>Aporops</i>		+	Fourmanoir (1976)—Po
	<i>Grammistes</i>		+	Fourmanoir (1976)—T
	<i>Grammistops</i>		+	
	<i>Pogonoperca</i>		+	
	<i>Pseudogramma</i>	+	+	Kendall (1977, 1979)—Pr-Po, Leis and Rennis (1983)—Pr-Po
	<i>Rypticus</i>	+	+	Aboussouan (1972b)—Po, Kendall (1977, 1979)—Po
	<i>Suttonia</i>		+	

* Randall (1980) includes in *Plectranthias*: *Sayanora*, *Isobuna*, *Xenanthias*, *Pteranthias*, *Zalanthias*, *Serranops*, *Pelontrius*, and *Zacallanthias*.

^b Subdivisions follow Johnson (1983).

^c Tortorise (1973) states that Bertolini (1933b) and Sparta (1935) described *Mycteroperca rubra* larvae as *Ephinephelus alexandrinus* and that this mistake has been continued in more recent literature.

rygiophore arrangement (Johnson, 1983). The first and third dorsal spines and the anal spines are also stout and may bear serrations. The spine at the angle of the preopercular is elongate and serrate; there are two smaller spines dorsal and ventral to the one at the angle, and these may also bear serrations. There is a serrate spine on the supracleithrum. The body is "kite-shaped"; pigment lines the body cavity and there is a large, conspicuous spot on the caudal peduncle that migrates from the ventral midline to a midlateral position during flexion.

Grammistini-Liopropomini.—The body is roughly tubular with a deep caudal peduncle. Among the bones in the opercular series the preopercular is armed with about five elongated, simple spines. One or two dorsal fin spines become quite elongate, and are thin and flexible with pigmented membranous sheaths around them. Bodies of the larvae are practically devoid of pigment throughout development.

The following is a summary of the current status of the systematics and knowledge of larval morphology of each of the subfamilies of serranids (Table 123).

Serraninae

There has been no revision of this primarily Atlanto-American subfamily, and little work on relationships among species in the various genera (Bortone, 1977). These are considered the least specialized of the serranids and are mainly united by shared possession of basal percoid characters rather than unique specializations, which would allow a definitive statement about monophyly. They possess the four serranid specializations as mentioned by Johnson (1983), are hermaphroditic or secondarily gonochoristic (see Kendall, 1977), have a common pre-dorsal bone pattern (0/0/0/2), and a fairly coherent larval morphology (Fig. 266).

The larvae of *Schultzea*, *Dules*, *Acanthistius*, and *Cratinus* are unknown. The following summary of what is known of the larval morphology of the rest of the serranines is based primarily on Kendall (1977, 1979). The only more recent contributions to serranine larval knowledge are the descriptions of *Paralabrax* (Butler et al., 1982).

Centropristis.—Only one larval type is known, although four species are named. The eggs and yolk-sac larvae have been described from reared specimens. Development is typical of serranines with small simple spines on the preopercular. The first and second dorsal fins develop at about the same rate; there

are no elongate or armed fin spines. Most pigment is in blotches in characteristic serranine positions. The body gradually assumes the adult shape.

Paralabrax.—Butler et al. (1982) reared from eggs and described development of the three species found off California. These larvae vary from the general serranine pattern of development, primarily in having pigmented membranes of the pectoral, pelvic, first dorsal, and anal fins variously developed among the species. Pigment is also variously present on the body ventral to the first dorsal fin.

Serraniculus.—Larvae of the only species (*S. pumilio*) are deeper bodied and have more lateral pigment than other serranines. The flank pigment is composed of three series of dashes (one along the midlateral septum and one along the base of the dorsal and anal fins) and superficial small spots over much of the trunk. The ventral midline spots are small and rather uniform in size. The first dorsal fin develops concurrently with the second dorsal, and the spines are no longer than the rays.

Diplectrum.—Two distinct types of larvae with the meristic characters of this genus were found in both Atlantic and Pacific material. One type (Type 1) closely follows the serranine pattern of development, the main difference being in the early development of the spinous dorsal and pelvic fins. The ventral midline pigment spots seem more uniform in size than in other genera, and there is pigment on some of the fin membranes. Larvae of the other type (Type 2) are quite different from other serranine larvae in that the pectoral and pelvic fins develop early and are enlarged and pigmented on their distal thirds. The body is practically devoid of pigment except for two spots on the caudal peduncle—one dorsal and one ventral, and an internal diffuse area of pigment lateral to the anterior part of the anal fin that develops after the fin rays are formed.

Serranus.—Larvae of this genus from both sides of the Atlantic have been described, and reared eggs and yolk-sac larvae were among the first serranids described (Raffaele, 1888). These larvae differ from the serranid pattern of development in having early-forming elongate dorsal spines and a deeper body. In *S. cabrilla* the pelvic spines develop before any other fin rays and they and the third dorsal spine become quite elongate. Some of the smaller ventral melanophores seen in other serranines are absent from *Serranus* larvae, while some of the larger spots are

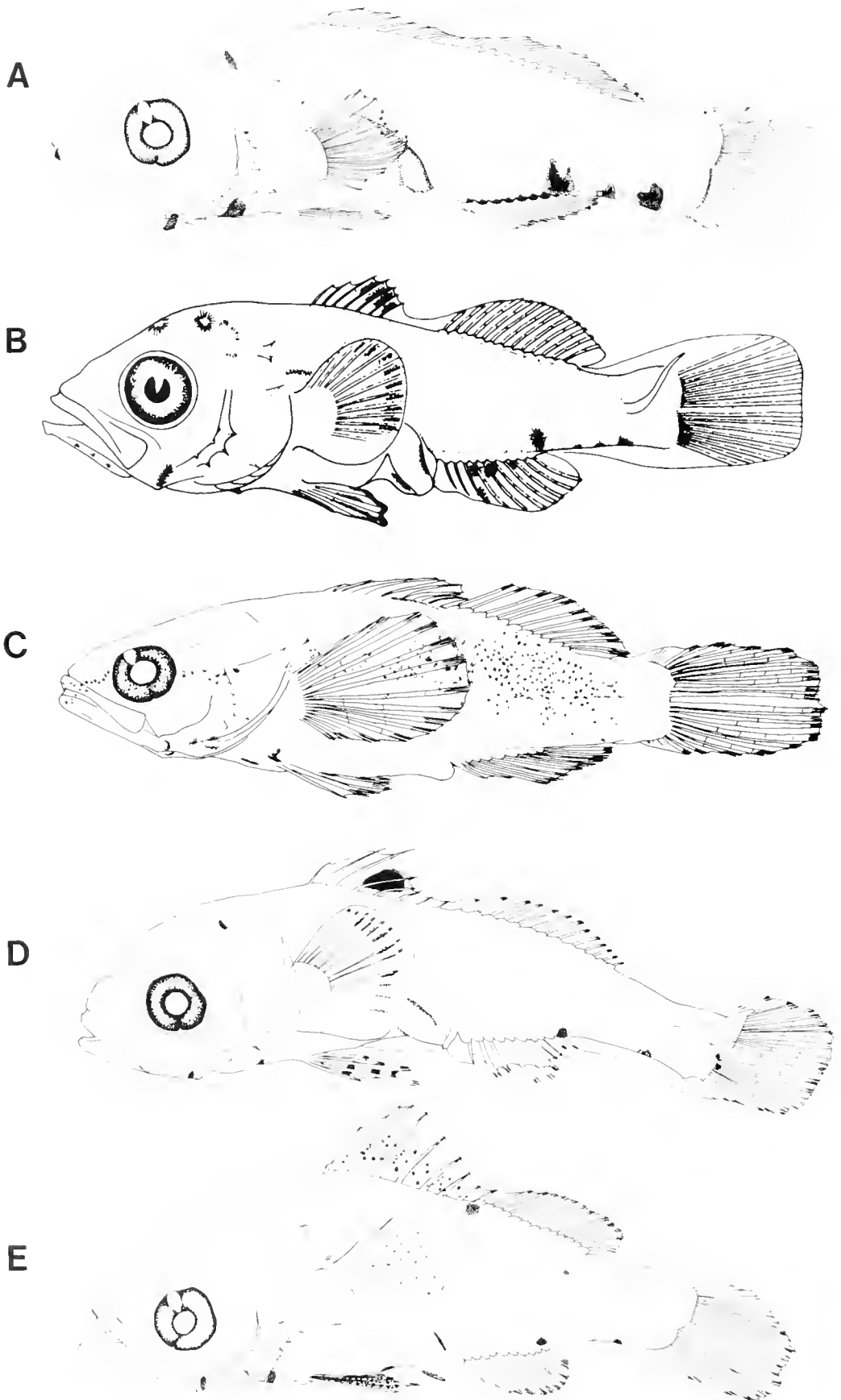

more intense. Pigment develops variously at the base of the dorsal fin and in the membranes of the first dorsal, pelvic, and anal fins. *S. cabrilla* has large opposing spots on the caudal peduncle.

Hypoplectrus.—Reared larvae of this genus are quite different from other serranines. The first dorsal and pelvic fins develop early and are heavily pigmented. The head and fin membranes are fleshier than in other serranines, and these larvae do not possess the characteristic ventral pigment pattern. Rather, there are a few spots ventral to the base of the first dorsal fin, and a few blotches ventrally at the base of the pelvic fins, at the anus, along the base of the anal fin, on the caudal peduncle, and at the base of the middle of the caudal fin.

Anthiinae

This is a cohesive group of fishes that share several specializations in addition to those they hold in common with other serranids. These specializations include large scales, a highly arched lateral line, deep bodies and large heads, mainly 10 + 16 vertebrae, and a predorsal pattern of 0/00/2 or 0/0/2. They are generally small, brightly colored reef fishes. The generic alignments of many species are dubious, and a revision of the group is badly needed. Most recent work, however, has focused on describing new species, faunal studies, and some generic revisions.

Recent and ongoing work (Fitch, 1982; Baldwin, pers. comm.) has brought out several incongruencies in generic assignments of Kendall (1977, 1979). In the following summary of what is known of anthiine larval morphology, generic larval types will be described, with the understanding that some of the variation within these may be due to species that are assigned to the genus incorrectly. Alternate generic placements of species will be noted as appropriate (Table 124). Better definitions of the genera must await a worldwide revision that will include information on early life history stages. Larvae of 10 of the 19 currently recognized anthiine genera are known to some extent (Fig. 267 and Table 123).

Plectranthias (Fig. 267a).—Randall (1980) included eight nominal genera in this genus, but the monophyly of the included species is not resolved (W. D. Anderson, Jr., pers. comm., Jan. 1983). Kendall (1977, 1979) described larvae of the American species (*P. garupellus*) as having an elongate third dorsal spine, opposing caudal peduncle pigment blotches as well as a blotch below the center of the first dorsal fin, and no serrated head or fin armature (rather the characteristic anthiine spines are thin and weakly developed). The larvae showed the least development of anthiine larval characters among American genera.

Anthias (Fig. 267c).—(includes *Pronotogrammus multifasciatus* (see Fitch, 1982)) This is a speciose circumtropical genus that has provisionally been subdivided into three subgenera (Randall and Lubbock, 1981). Larvae of several species from around the world have been described. They share a number of larval char-

TABLE 124. REASSIGNMENT OF SOME ANTHIINE LARVAE. Those of Kendall (1977, 1979) reassigned by Baldwin (pers. comm.) and Kendall, based on work on adults from the eastern Pacific by Fitch (1982) and from the western Atlantic by Anderson and Heemstra (1980) and W. D. Anderson (pers. comm., unpublished data). Letters after most likely species names refer to Baldwin (B) and Kendall (K) who recognized these reassignments.

Kendall, 1977, 1979	Most likely species	Figure no.
<i>Pronotogrammus aureorubens</i>	<i>Hemanthias leptus</i> —B	267f
<i>Pronotogrammus eos</i>	<i>Hemanthias signifer</i> —B	
<i>Anthias gordensis</i>	<i>Pronotogrammus multifasciatus</i> —K	
<i>Anthias</i> sp. Type 2	<i>Holanthias martinicensis</i> —B	267d
<i>Hemanthias peruanus</i>	<i>Pronotogrammus eos</i> —K	

acters, but there are some notable differences among the species. The second or third dorsal spine is elongate and thin (the first may be late forming, so the elongate spine may always be the third); the first few dorsal spines and the pelvic spine are early forming; the elongate dorsal spine has a pigmented sheath; the preopercular and interopercular have long serrate spines; and there are generally two pigment spots ventrally on the caudal peduncle. There is a simple supraoccipital spine in some species and a variable number of spines on a ridge above the eye. Pigment, in addition to that mentioned above, varies among the species and some species become fully scaled during the larval stage. Whether these differences in larval characters can be related to the subgeneric alignment of species must await further larval descriptions. Fitch (1982) synonymized the Pacific *Anthias* (*A. gordensis*), whose larvae Kendall (1977, 1979) described, with *Pronotogrammus multifasciatus*.

Franzia.—Eggs and yolk-sac larvae of *F. squamipinnis* have been described (Suzuki et al., 1978) but later larval stages are unknown.

Caesioperca.—Fourmanoir (1976) illustrated the head and briefly described a transforming specimen thought to belong to this genus. It has a smooth supraoccipital region and no spiny ridge above the eye, but has simple stout spines in the characteristic position on the preopercular and interopercular. The information presented is too brief for further evaluation of anthiine larval characters.

Luzonichthys.—Fourmanoir (1976) illustrated the anterior portion and briefly described two transforming specimens of this genus. These have probably lost some of their larval characters, since the mouth is already subterminal and the body covered with scales. The spines on the preopercular are not especially elongate, but one on the interopercular is pronounced, simple, and stout. Anterior dorsal fin spines appear thin and not produced.

Fig. 266. Examples of serranine larvae: (A) *Centropristis striata*, 8.3 mm, from Kendall (1979); (B) *Paralabrax clathratus*, 7.4 mm, from Butler et al. (1982); (C) *Serraniculus pumilo*, 5.8 mm, from Kendall (1979); (D) *Diplectrum* sp., 6.1 mm, from Kendall (1979); and (E) *Serranus* sp., 5.5 mm, from Kendall (1979).

A



B

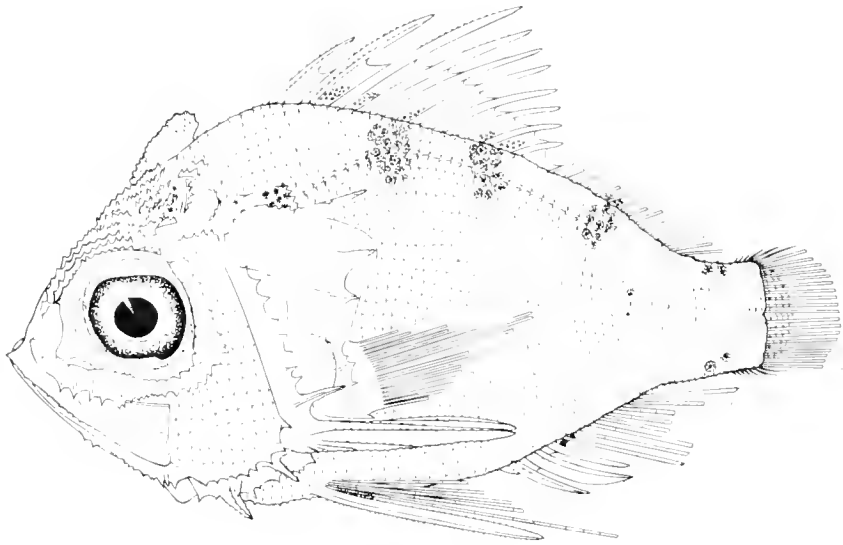

C



D**E****F**

Fig. 267. Examples of anthiine larvae. (A) *Plectranthias garupellus*, 5.5 mm, from Kendall (1979); (B) *Pronotogrammus aurcorubens*, 9.8 mm, original illustration; (C) *Anthias* sp., 5.3 mm, from Kendall (1979); (D) *Holanthias martunicensis*, 8.4 mm, from Kendall (1979), labelled *Anthias* sp. Type 2; (E) *Hemanthias vivanus*, 6.8 mm, from Kendall (1979); and (F) *Hemanthias leptus*, 6.0 mm, from Kendall (1979) labelled *Pronotogrammus aurcorubens*.

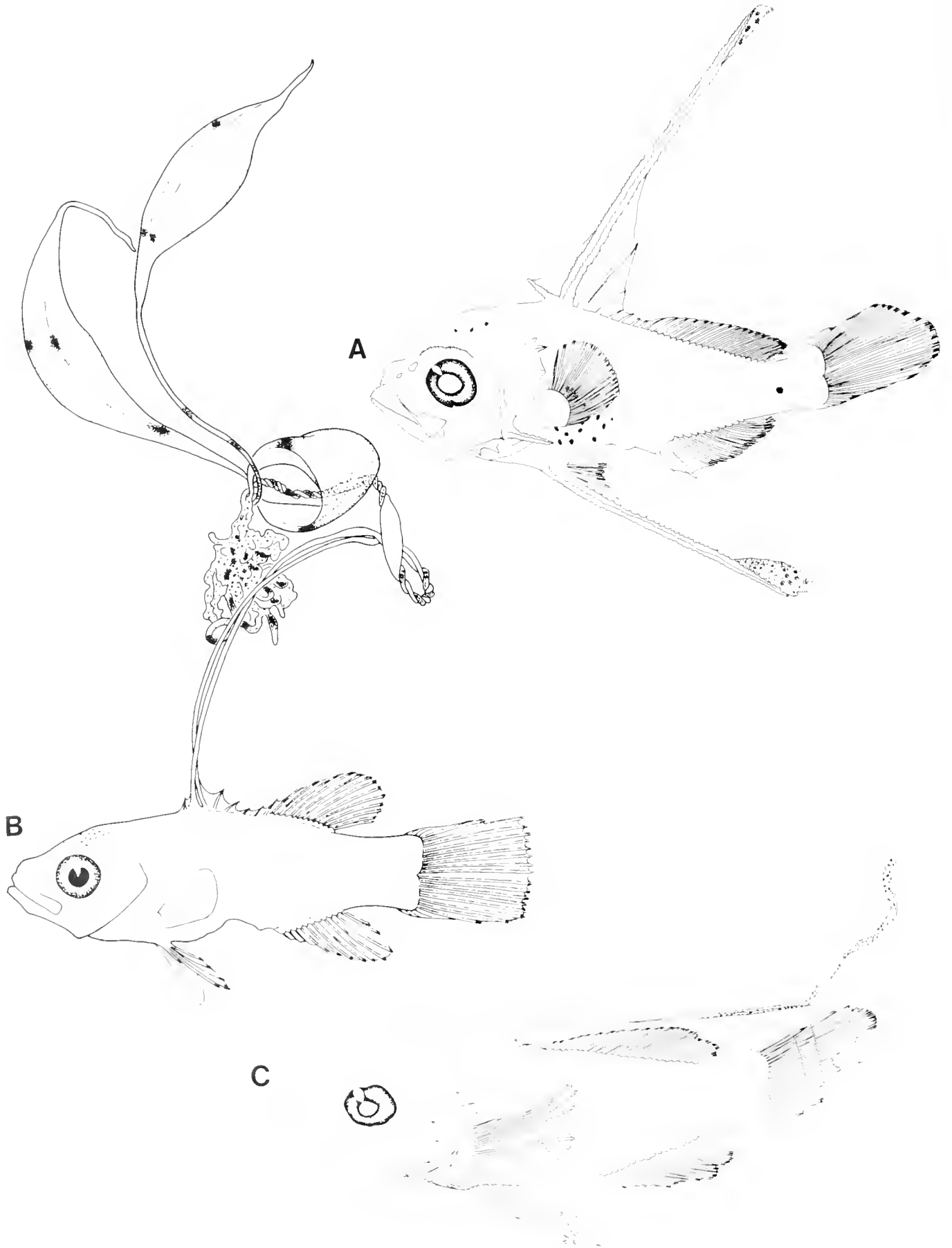

Sacura.—Reared eggs and yolk-sac larvae were described by Suzuki et al. (1974) and a postflexion larva, illustrated and briefly described by Fourmanoir (1976), shows characters of anthiine larval development. The latter specimen has the third dorsal and pelvic spines extremely elongate and with a pigmented sheath; the opercular and interopercular are armed with stout serrate spines, and there is a similar more ventrally-directed spine anterior to these; the anal spines are stout and serrate; there is a serrate ridge above the eye, and a midlateral pigment dash on the caudal peduncle.

Pronotogrammus-Hemanthias.—As presently understood, two species assigned to each of these genera occur in the eastern Pacific (*P. eos*, *P. multifasciatus*, *H. signifer*, and *H. peruanus*, see Fitch (1982)), and there are two *Hemanthias* and one *Pronotogrammus* in the western Atlantic (*H. leptus*, *H. vivanus*, and *P. aureorubens*).

Kendall (1977, 1979) assigned larval types from both oceans to these genera. More recently, Baldwin (pers. comm.) has established alternate generic assignments for some of Kendall's (1977, 1979) types based on more complete meristic data and has assigned a previously undescribed type to *Pronotogrammus aureorubens*. Thus, present generic assignments, do not coincide with the larval types described by Kendall (1977, 1979). In the following, the morphology of the larval types of Kendall (1977, 1979) will be summarized under the species whose larvae are represented by these types.

Hemanthias signifer, *Hemanthias leptus* (Kendall's *Pronotogrammus eos* and *P. aureorubens*) (see Fig. 267f).—These larvae are characterized by serrate, spiny armature in the opercular region, supraoccipital crest simple or absent, first spines of the dorsal fin and the pelvic fin early developing but not becoming elongate or serrate, and midlateral trunk pigment.

Pronotogrammus eos, *Hemanthias vivanus* (Kendall's *Hemanthias peruanus* and *H. vivanus*) (see Fig. 267e).—These larvae develop a complex "cockscorn" ridge on the supraoccipital, a serrate ridge above the eye, some serrate spines on the preopercular and interopercular, some serrate fin spines (in all spiny rayed fins in *H. vivanus*, only in the pelvic of *P. eos*), and spiny scales.

Pronotogrammus aureorubens (Fig. 267b).—Baldwin (pers. comm.) has found larvae from the western Atlantic that are heavily spined and possess the meristic characters of *P. aureorubens*. These larvae are completely scaled, have serrations on spines of all spinous fins which are also quite stout, and have heavy serrate spines in the opercular region. The dorsal aspect of the head is covered with spinous ridges including a complex cockscorn spine on the supraoccipital. There are four blotches of pigment dorsally on the body: two ventral to the first dorsal fin, one ventral to the second dorsal fin, and one on the caudal peduncle.

Holanthias (Fig. 267d).—Kendall (1977, 1979) illustrated and briefly mentioned an anthiine larva he called *Anthias* sp. Type 2 which has been shown to be *Holanthias martinicensis* (Bal-

win, pers. comm.). These larvae are deep-bodied with large heads and mouths. They develop serrate spines in the opercular region, and a simple supraoccipital spine in post-flexion larvae. They have several spines above the eye and develop scales during the larval stage. They have some pigment in the membrane of the first dorsal fin as well as a line on the body ventral to the second dorsal fin. Baldwin (pers. comm.) has pointed out the similarities between *Holanthias martinicensis* larvae and those Kendall (1977, 1979) described as *Anthias gordensis*, including the early appearance of scales, not noted by Kendall (1977, 1979).

Selenanthias.—A transforming specimen illustrated and briefly described by Fourmanoir (1973) is deep-bodied but has no elongate fin spines. It appears to be fully scaled and has stout, possibly serrate preopercular and interopercular spines.

Epinephelinae

Johnson (1983) has dealt with the systematics of several genera that had been thought variously related to each other. These are mainly genera in the epinepheline-grammistine lineage of Kendall (1976). On the basis of several characters, Johnson proposed that these genera form a monophyletic lineage (subfamily Epinephelinae) that is composed of five tribes (Niphonini, Epinephelini, Diploprionini, Liopropomini, and Grammistini). Some early life history stages are known for all of the tribes except Niphonini (Fig. 268). The larvae share the elongation of one or two anterior dorsal spines, and the larvae and adults share predorsal bone and pterygiophore arrangements which presumably function to support the larval dorsal spines (Johnson, 1983). In the Epinephelini, the dorsal spines are stout and serrate, whereas in the other three tribes they are extremely elongate, flexible, and some have siphonophore-mimicking pigment and shape.

The following is a summary of what is known of the morphology of early life history stages of fishes in the epinepheline tribes of Johnson (1983).

Niphonini.—*Niphon spinosus*, the sole member of this tribe, has unknown larvae but Johnson (1983) speculated that on the basis of first dorsal pterygiophore morphology and presumed relationships, their third dorsal spine should be elongate.

Epinephelini.—Larvae are known only for those genera occurring in Atlanto-American waters. Several species have been reared and their egg and larval development described (see Table 123).

Epinephelus.—Larvae of species from every ocean belonging to this circumtropical genus are known. Smith (1971) placed the American members of the genus in five subgenera: *Epinephelus*, *Promicrops*, *Cephalopholis*, *Dermatolepis*, and *Alphestus*. These had formerly been considered genera, and members of these occur in other parts of the world. Johnson and Ashe (1984) were able to identify larvae of most species of American *Epinephelus* primarily on the basis of spinelets on the elongate dorsal and pelvic spines. They compared spinelet patterns among members of the subgenera and species groups of Smith (1971) and found

Fig. 268. Examples of epinepheline larvae: (A) Epinephelini: *Paranthias furcifer*, 8.6 mm, from Kendall (1979); (B) Liopropomini: *Liopropoma* sp., 11.0 mm. Collected by G. R. Harbison, 16 May 1981, 6°31.8'S, 150°21.8'E; and (C) Grammistini: *Rypticus* sp., 6.6 mm, from Kendall (1979).

that most share common patterns (e.g., species groups *E. striatus* and *E. adscensionis*), although there are some notable problems (subgenera *Cephalopholis* and *Alphestes*). Thus, in *Epinephelus* there is general concordance between the only distinguishing characters of the larvae (spinelet patterns) and the relationships hypothesized based on a variety of adult characters; but thorough analysis must be done to resolve apparent discrepancies.

Paranthias.—One species (*P. fuscifer*) occurs in American waters of the Atlantic and Pacific Oceans. The larvae have a unique spinelet pattern on the dorsal fin spines, and have internal notochord pigment not found in other epinephelins (Johnson and Ashe, 1984). This genus as an adult is quite distinct ecologically and morphologically.

Mycteroperca.—This American genus with 13 species is distinguished from the other epinepheline genera by several characters, including usually having more anal rays (11–13). The species of *Mycteroperca* cannot be distinguished as larvae, and their spinelet patterns resemble those of several members of *Epinephelus* (e.g., *E. niveatus*, *E. flavolimbatus*, and *E. acanthistius*). However, *Mycteroperca* larvae have a melanophore at the cleithral symphysis, which is not found in any of these species of *Epinephelus* (Johnson and Ashe, 1984).

Gonioplectrus.—Postflexion larvae of the only species, *Gonioplectrus hispanus*, are known (Kendall and Fahay, 1979). The larvae are more robust and have shorter elongate dorsal and pelvic spines than other American epinephelins. Also, these elongate spines are different in cross section and spinelet appearance than those of other epinephelins (Johnson and Keener, 1984).

Diploprionini.—A photograph of a transforming larva, a drawing of a juvenile, and a brief description of the juvenile showed fish with long flexible dorsal spines and rather deep bodies (Hubbs and Chu, 1934). The second and third dorsal spines are extremely produced in the larva, but only the third is in the juvenile. The photograph of the larva does not allow more detailed observation.

Liopropomini.—Larvae of *Liopropoma/Pikea* are known and cannot presently be distinguished on the basis of larval characters (Kendall, 1977, 1979). They were first described as a new genus, *Flageloserranus*, by Kotthaus (1970). *Jeboehlkia* is known from a single, small specimen which shows traits of being a transforming larva (Robins, 1967).

Lioproma/Pikea.—The general body shape is similar to that of the serranines, although the gut is shorter and there is a space between the anus and the origin of the anal fin. The caudal peduncle is both longer and deeper than it is in serranines. The most outstanding developmental feature is the presence, even in small larvae, of two elongate, thin dorsal spines. These develop before other fin rays, reach a length of up to three times the fish length, and become the second and third dorsal spines. These spines are delicate and are broken in many specimens. Kotthaus (1970) described the presence of thick tissue surrounding these spines; the tissue around the second spine has two vane-like swellings on its distal third and the tissue around the third spine is tubular for its entire length. The distal portion of both spines is pigmented with several large melanophores. The

remaining fin rays develop their adult proportions without any pronounced elongations. The ventral fins develop more slowly than those of most other serranids.

Except for the pigment on the elongate dorsal fin spines, most larvae are unpigmented. Some spots develop on the hindbrain surface in larger larvae, probably representing the onset of juvenile pigment.

Jeboehlkia.—The single species (*J. gladifer*) is known only from the holotype, a 40.8 mm female. Characters that indicate that it may not have completed transformation, or may be paedomorphic, include the virtual lack of pigment, the enlarged eye, and the elongate first dorsal spine (see Robins, 1967).

Grammistini.—Fishes in this tribe have been variously grouped as members of families separate from the serranids and as subfamilies of the serranids. Larvae of four of the seven genera placed in this tribe by Johnson (1983) are known. The first or second dorsal spine is elongate and flexible, and the preopercular margin is armed with about five subequal spines in larvae of all four genera.

Grammistes.—A single, 11 mm postflexion larva of *G. sexilineatus* illustrated by Fourmanoir (1976) has an elongate flexible first dorsal spine and five spines on the preopercular margin. It is well developed, rather deep-bodied, and appears to lack pigment except on the pectoral fin which is covered with fine melanophores on its distal third.

Aporops.—The anterior portion of a 12 mm postflexion larva of *Aporops bilinearis* illustrated by Fourmanoir (1976) has the first dorsal spine elongate and flexible and five spines on the preopercular margin. It is well developed and is not as deep-bodied as the aforementioned *Grammistes* larva. No pigment is evident in the illustration.

Pseudogramma.—A developmental series of *P. gregoryi* was described by Kendall (1977, 1979) and Leis and Rennis (1983) illustrated a series of *P. polyacantha*. These larvae have shallow tubular bodies; a greatly elongate, flexible dorsal spine (the first or second); precocious enlarged pectoral fins; a gap between the anus and the anal fin; and a general lack of pigment except on the pectoral fin of small larvae and on the sheath that surrounds the elongate dorsal spine.

Rypticus.—Aboussouan (1972b) illustrated and briefly described two larvae, and Kendall (1977, 1979) compared these with specimens he described from the western Atlantic. These larvae have the first dorsal spine produced, flexible, and surrounded by a pigmented sheath; about five preopercular spines; an enlarged pectoral fin that may be pigmented; rather long rays in the second dorsal, caudal, and anal fins; small, late-developing pelvic fins; a lack of body pigment; and are moderately deep-bodied at the nape.

RELATIONSHIPS

Although known larvae of serranids show a diversity of characters that will probably permit them to be used in definitive studies of relationships within the group, such studies are presently premature (Fig. 269). More characters need to be traced ontogenetically, and larvae of more species, particularly in the Anthiinae and several tribes of Epinephelinae, need to be de-

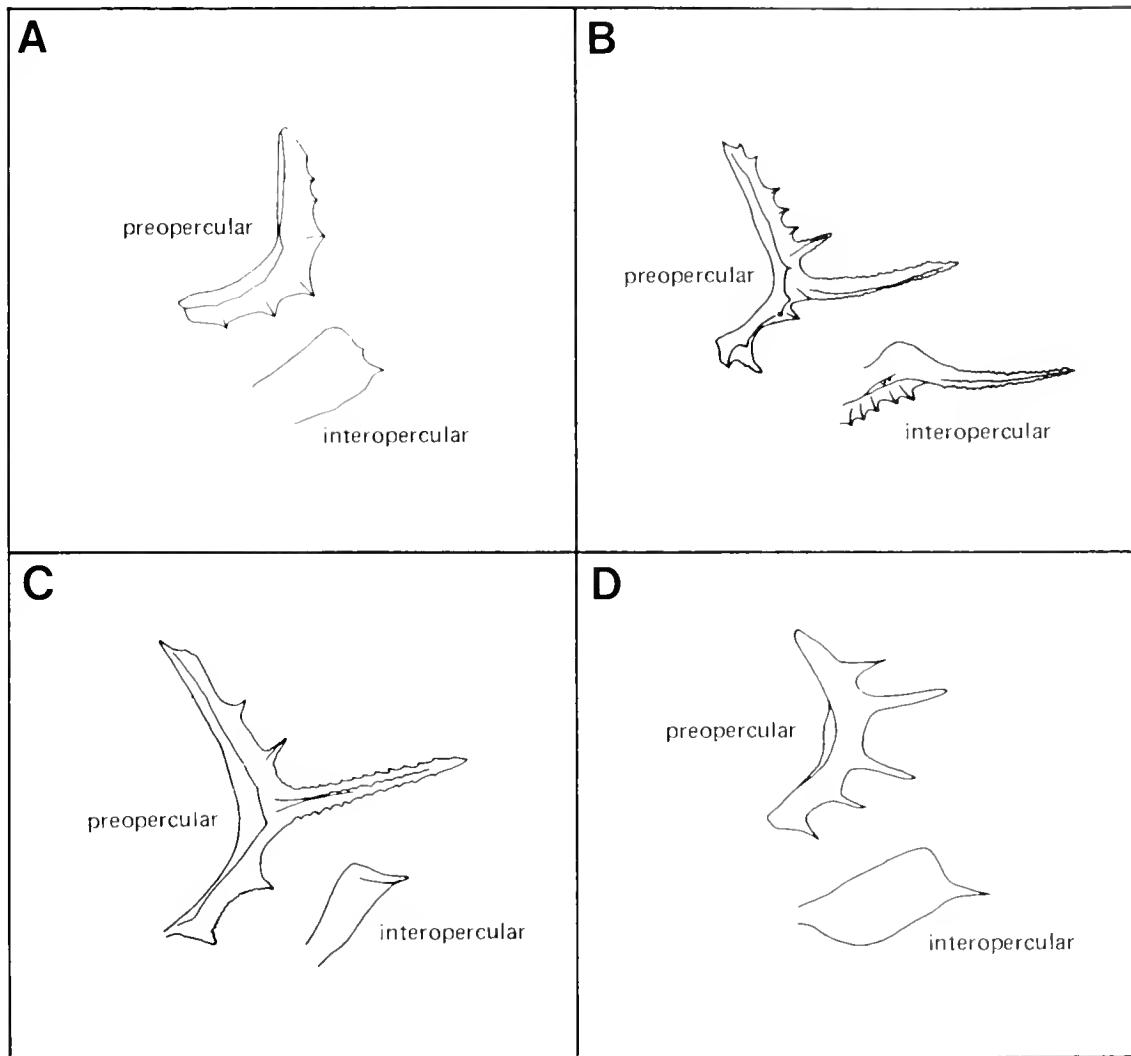

Fig. 269. Representative preopercular and interopercular bones from larval serranids (from Kendall, 1979): (A) Serraninae: *Serranus* sp.; (B) Anthiinae: *Anthias* sp. Type 1; (C) Epinephelinae: Epinephelini, *Epinephelus niveatus*; and (D) Epinephelinae: Grammistini, *Pseudogramma gregoryi*.

scribed. At present, however, some statements can be made concerning serranid systematics from what is known about the larvae.

The serranid subfamilies are clearly distinct as larvae. In fact, it is not possible to characterize the Serranidae based on larval morphology, because no characters unite the subfamilies while separating them from larvae of all other families. Serraninae larvae seem to be the least specialized and are more similar to percid genera thought to represent the basal stock from which serranids arose (e.g., *Morone*, *Lateolabrax*, and *Dicentrarchus*). The serranine genera can be distinguished from each other and ordered in a rough progression of divergence from the supposed ancestral larval form (as exemplified by *Morone*), as follows: *Serraniculus*, *Centropristis-Paralabrax*, *Diplectrum* Type 1, *Serranus* (see Kendall, 1979). Characters that lead to this assessment include pigment, body shape, sequence of dorsal spine-soft ray development, and dorsal fin spine elongation.

Based on larval and other evidence, it appears that two major radiations from the ancestral serranines arose leading to the anthiine and the epinepheline lineages. The anthiines form a fairly cohesive group of fish which are at the same time quite speciose. The generic alignment of many anthiines is unclear and in some cases larval evidence is in conflict with that based on adults. Anthiine larvae, like the adults, share several characters that unite them, yet they are quite diverse and will probably prove to be excellent subjects for phylogenetic investigations. Larvae of only about half of the presently understood anthiine genera are known to any extent, some of them only from one transforming larva. Thus the lack of generic revisions and incomplete knowledge of larval development makes it presently unreasonable to attempt a thorough systematic assessment that would include larvae. Within the group, a progression of increasing spyness and armature is apparent. Among the larvae described to date, armature seems to be added as follows:

elongate preopercular and interopercular spines, serrate preopercular and interopercular spines, stout pelvic and first three dorsal spines, supraoccipital spine, serrate dorsal and pelvic spines, serrate head spines on several bones, and spiny scales developing during the larval stage.

The other major line of divergence from the serranines is the five tribes of the epinephelins. Johnson (1983) pointed out the adult features that characterize this subfamily and the tribes within it, although he did not provide a detailed analysis of the relationships among the tribes. The larvae (representatives of four tribes are known) all have one or two quite elongate dorsal spines. In the Epinephelini, the elongate dorsal spines are stout and serrate; in the other tribes, they are flexible, thin, and in an elaborately pigmented sheath. Thus it appears from the larvae that the Diplopionini, Liopropomini, and Grammistini may form a monophyletic group within the Epinephelinae.

Epinephelini larvae are all quite similar but some genera can be separated by larval characters (*Gonioplectrus*, and *Paranthias*), although larvae are unknown for several genera. *Gonioplectrus* larvae are most similar to anthiine larvae and may represent the most primitive extant epinephelini state. Johnson (1983) suggested that *Nippon* represented the primitive sister

group of all other epinephelins and that its unknown larvae may have an elongate third rather than second dorsal spine. There is less variation in size of the second and third dorsal spines in *Gonioplectrus*, compared to other Epinephelini, which adds credence to the above suggested relationships.

Few larval representatives of the other epinepheline tribes [grammistine lineage of Kendall (1976)] are known and none of them have been studied in detail. Their elongate, pigmented flexible dorsal spines, lack of corresponding elongate pelvic spines, five subequal preopercular spines, and dearth of body pigment unite the known larvae. Larvae of *Diploprion* are rather deep-bodied compared to the more tubular bodies of the other known larvae grammistines. The second and third dorsal spines are produced in members of the Grammistini. In this group of serranids there appear to be larval characters that will be helpful in systematic studies, but larvae of more representatives must be known in more detail before such studies will be meaningful.

NATIONAL MARINE FISHERIES SERVICE, NORTHWEST AND ALASKA
FISHERIES CENTER, 2725 MONTLAKE BOULEVARD EAST,
SEATTLE, WASHINGTON 98112.

Carangidae: Development

W. A. LAROCHE, W. F. SMITH-VANIZ AND S. L. RICHARDSON

THE family Carangidae (jacks, trevallies, and pompano) has traditionally been assigned to the suborder Percoidei, an assemblage of generalized perciform fishes (Lauder and Liem, 1983). The family is notably heterogenous, including species which differ widely in structure and appearance. Phylogenetic relationships within the suborder and even the familial limits of the Carangidae are not clearly established (see Smith-Vaniz, this volume). The family is composed of approximately 140 species and 30 genera (Table 125) many of which remain poorly defined.

Carangids are found world-wide in tropical and warm temperate marine and estuarine waters. Carangids are actively swimming fishes which range from small schooling planktivores to large solitary piscivores (Berry and Smith-Vaniz, 1978). Some species of carangids are known to spawn pelagically offshore, i.e., *Seriola lalandi* = *S. dorsalis* (Baxter, 1960) and *Trachurus symmetricus* (Ahlstrom and Ball, 1954), while others spawn close to shore and near the bottom, i.e., *Caranx ignobilis* (von Westernhagen, 1974) and *Oligoplites saurus* (Aprieto, 1974). The greatest amount of information concerning early life stages exists for species of *Decapterus* and *Trachurus* on which research has focused due to their commercial importance.

DEVELOPMENT

Eggs

Carangids have spherical, pelagic eggs which have a narrow perivitelline space and range in diameter from about 0.7 to 1.3 mm. One to several oil globules are usually present, and egg

envelopes are clear, unsculptured, and lack filaments (Ahlstrom and Ball, 1954; Miller and Sumida, 1974; James, 1976a). The eggs of *Naucrates ductor* have erroneously been reported to be demersal, adhesive, with a fine entangling filament at one pole (Gilchrist, 1918) and attached to sharks and the hulls of ships (Gilchrist, 1918; Shuleikin, 1958). They are actually pelagic, non-adhesive, and without filaments (Barnard, 1926; Sanzo, 1931a; Maksimov, 1969).

Development proceeds in the typical manner of pelagic fish eggs (Ahlstrom and Ball, 1954; Miller and Sumida, 1974). Eggs hatch 24 to 48 hours after spawning at water temperatures between 18 and 30°C (temperature range within which eggs and larvae are most commonly taken).

Carangid eggs are similar in size and appearance to those of many other marine fishes. Thus, identification even to family level may be difficult or frequently impossible using presently known characters.

Larvae

Morphology.—Information is available on at least one developmental stage for 58 of the 140 valid species representing 24 of 30 genera (Table 125). However, even among those taxa for which descriptive information is available, inconsistent quality in descriptive text and coverage of the developmental period make detailed morphological comparisons and identifications based upon these descriptions difficult in many cases. Laroche et al. (MS) have refined developmental terminology for carangids so as to define developmental stages more precisely and thus improve comparability of descriptions between taxa.

TABLE 125. SPECIES AND WORLD DISTRIBUTION LIST FOR THE FAMILY CARANGIDAE. Selected literature references deal with descriptions of larvae and juveniles.

Genus ¹	Species	Author	Ind. ³ Ocean	West Pac.	Cent. ⁴ Pac.	East Pac.	West Atl.	East Atl.	References ⁵
<i>Alectis</i>	<i>alexandrinus</i> (E. Geoffroy St.-Hilaire)		-	-	-	-	-	+	*Aboussouan, 1975
	<i>ciliaris</i> (Bloch)		+	+	+	+	+	+	*Aboussouan, 1968a; *Fowler, 1936; *Ginsburg 1952; *Johnson, 1978
	<i>indicus</i> (Rüppell)		+	+	-	-	-	-	
	<i>djedaba</i> (Forsskål)		+	+	-	-	-	-	*Tsokur, 1977
	<i>melanoptera</i> Swainson		+	+	-	-	-	-	
	<i>sp.</i>		-	+	-	-	-	-	
	<i>vari</i> (Cuvier)		+	+	-	-	-	-	
	<i>atropos</i> (Bloch and Schneider)		+	+	-	-	-	-	
	<i>mate</i> (Cuvier)		+	+	+	-	-	-	*Kuthalingam, 1959a; *Miller and Sumida, 1974; *Miller et al., 1979; Zvyagina and Rass, 1977
	<i>campogramma glaycos</i> (Lacepède)		-	-	-	-	-	+	
	<i>arangoides armatus</i> (Rüppell)		+	+	-	-	-	-	
	<i>bajad</i> (Forsskål)		+	+	-	-	-	-	
	<i>bartholomaei</i> (Cuvier)		-	-	-	-	+	-	*Berry, 1959b; *Johnson 1978; Laroche et al. (in prep.)
	<i>caeruleopinnatus</i> (Rüppell)		+	+	-	-	-	-	
	<i>chrysophrys</i> (Cuvier)		+	+	-	-	-	-	
	<i>dinema</i> Bleeker		+	+	-	-	-	-	
	<i>equula</i> (Temminck and Schlegel)		+	+	+	-	-	-	
	<i>ferdau</i> (Forsskål)		+	+	+	-	-	-	
	<i>fulvoguttatus</i> (Forsskål)		+	+	-	-	-	-	
	<i>gymnostethus</i> (Cuvier)		+	+	-	-	-	-	
	<i>hedlandensis</i> (Whitley)		+	+	-	-	-	-	
	<i>humerosus</i> (McCulloch)		-	+	-	-	-	-	
	<i>malabaricus</i> (Bloch and Schneider)		+	+	-	-	-	-	
	<i>oblongus</i> (Cuvier)		+	+	-	-	-	-	
	<i>orthogrammus</i> Jordan and Gilbert		+	+	+	+	-	-	
	<i>otrynter</i> (Jordan and Gilbert)		-	-	-	+	-	-	
	<i>plagiotaenia</i> Bleeker		+	+	+	-	-	-	
	<i>praeustus</i> (Bennett)		+	+	-	-	-	-	
	<i>ruber</i> (Bloch)		-	-	-	-	+	-	*Berry, 1959b
	<i>talamparoides</i> Bleeker		+	+	-	-	-	-	
	<i>uii</i> (Wakiya)		+	+	-	-	-	-	
	<i>vinctus</i> (Jordan and Gilbert)		-	-	-	+	-	-	
	<i>bucculentus</i> Alleyne and Macleay		-	+	-	-	-	-	
	<i>caballus</i> Günther		-	-	-	+	-	-	
	<i>caninus</i> Günther		-	-	-	+	-	-	
	<i>crysos</i> (Mitchill)		-	-	-	-	+	+	Aboussouan, 1975; Berry, 1959b; Johnson, 1978; Montolio, 1976; McKenney et al., 1958
	<i>hippos</i> (Linnaeus)		-	-	-	-	+	+	Berry, 1959b; Johnson, 1978
	<i>ignobilis</i> (Forsskål)		+	+	+	-	-	-	
	<i>latus</i> Agassiz		-	-	-	-	+	+	Berry, 1959b; Johnson, 1978
	<i>lugubris</i> Poey		+	+	+	+	+	+	
	<i>melampygus</i> Cuvier		+	+	+	+	-	-	
	<i>papuensis</i> Alleyne and Macleay		+	+	+	-	-	-	
	<i>sem</i> Cuvier		+	+	-	-	-	-	
	<i>senegallus</i> Cuvier		-	-	-	-	-	+	Aboussouan, 1975
	<i>sexfasciatus</i> Quoy and Gaimard		+	+	+	+	-	-	Ahlstrom and Sumida (in prep.)
	<i>tulle</i> Cuvier		+	+	-	-	-	-	
	" <i>Caranx</i> " <i>koheru</i> Hector		-	+	-	-	-	-	
	" <i>Caranx</i> " <i>para</i> Cuvier		+	+	-	-	-	-	*Bapat and Prasad, 1952
	" <i>Caranx</i> " <i>rhonchus</i> E. Geoffroy St.-Hilaire		-	-	-	-	-	+	Aboussouan, 1967; Aboussouan, 1975; Conand and Franqueville 1973
	<i>chloroscombrus chrysurus</i> (Linnaeus)		-	-	-	-	+	+	Aboussouan, 1968a; Aboussouan, 1975; Laroche et al. (in prep.)
	<i>chloroscombrus orqueta</i> Jordan and Gilbert		-	-	-	+	-	-	Ahlstrom and Sumida (in prep.)
	<i>decapterus kurroides</i> Bleeker		+	+	-	-	-	-	
	<i>decapterus macarellus</i> (Cuvier)		+	+	+	+	+	+	
	<i>decapterus macrosoma</i> Bleeker		+	+	+	+	-	-	?Delsman, 1926a
	<i>decapterus maruadsi</i> (Temminck and Schlegel)		-	+	-	-	-	-	Shojima, 1962
	<i>decapterus muroadsi</i> (Temminck and Schlegel)		-	+	+	-	-	-	
	<i>decapterus punctatus</i> (Cuvier)		-	-	-	-	+	+	Aboussouan, 1975; Aprieto, 1974; Hildebrand and Cable, 1930; Johnson, 1978; Montolio, 1976

TABLE 125. CONTINUED.

Genus ¹	Species	Author	Ind. ¹ Ocean	West Pac	Cent. ⁴ Pac.	East Pac	West Atl.	East Atl.	References ⁵
<i>Decapterus</i>	<i>russelli</i> (Rüppell)		+	+	-	-	-	-	?*Delsman, 1926a; ?*Tsokur, 1977; Vijayaraghavan, 1958
<i>Decapterus</i>	<i>scombrinus</i> (Valenciennes)		-	+	+	+	-	-	
<i>Decapterus</i>	<i>tabl</i> Berry		+	+	+	-	+	+	
<i>Decapterus</i>	n. sp. "stonebrass scad"		-	-	-	-	-	+	
<i>Elagatis</i>	<i>bipinnulata</i> (Quoy and Gaimard)		+	+	+	+	+	+	Aprieto, 1974; Berry, 1969; Johnson, 1978; Laroche et al. (in prep.); Okiyama, 1970
<i>Gnathanodon</i>	<i>speciosus</i> (Forsskål)		+	+	+	+	-	-	Ahlstrom and Sumida (in prep.); Miller et al., 1979
<i>Hemicaranx</i>	<i>amblyrhynchus</i> (Cuvier)		-	-	-	-	+	-	Hoese and Moore, 1977; Laroche et al. (in prep.)
<i>Hemicaranx</i>	<i>bicolor</i> (Günther)		-	-	-	-	-	+	
<i>Hemicaranx</i>	<i>leucurus</i> (Günther)		-	-	-	+	-	-	
<i>Hemicaranx</i>	<i>zelotes</i> Gilbert		-	-	-	+	-	-	
<i>Lichia</i>	<i>amita</i> (Linnaeus)		+	-	-	-	-	+	Lo Bianco, 1909; Padoa, 1956c
<i>Magalespis</i>	<i>cordyla</i> (Linnaeus)		+	+	-	-	-	-	?Kuthalingam, 1959a
<i>Naucrates</i>	<i>ductor</i> (Linnaeus)		+	+	+	+	+	+	Ahlstrom and Sumida (in prep.); Lütken, 1880; Padoa, 1956c; Pertseva-Ostroumova and Rass, 1973; Roule and Angel, 1930; Sanzo, 1930a, 1931
<i>Oligoplites</i>	<i>altus</i> (Günther)		-	-	-	+	-	-	
<i>Oligoplites</i>	<i>palometa</i> (Cuvier)		-	-	-	-	+	-	
<i>Oligoplites</i>	<i>refulgens</i> Gilbert and Starks		-	-	-	-	+	-	
<i>Oligoplites</i>	<i>saliens</i> (Bloch)		-	-	-	-	+	-	
<i>Oligoplites</i>	<i>saurus</i> (Schneider)		-	-	-	+	+	-	Aprieto, 1974; Johnson, 1978; Laroche et al. (in prep.)
<i>Pantolabus</i> ²	<i>radiatus</i> (Macleay)		-	+	-	-	-	-	
<i>Parastromateus</i>	<i>niger</i> (Bloch)		+	-	-	-	-	+	
<i>Parona</i>	<i>signata</i> (Jenyns)		-	-	-	-	+	-	Phonlor, 1979
<i>Pseudocaranx</i>	<i>chulensis</i> (Guichenot)		-	-	-	+	-	-	
<i>Pseudocaranx</i>	<i>dentex</i> (Bloch and Schneider)		+	+	+	-	+	+	*James, 1976a; *Padoa, 1956c; ?*Schnakenbeck, 1931
<i>Pseudocaranx</i>	<i>wrighti</i> (Whitley)		-	+	-	-	-	-	
<i>Scomberoides</i>	<i>commersonianus</i> Lacepède		+	+	-	-	-	-	
<i>Scomberoides</i>	<i>lysan</i> (Forsskål)		+	+	+	-	-	-	*Premalatha, 1977
<i>Scomberoides</i>	<i>tala</i> (Cuvier)		+	+	-	-	-	-	
<i>Scomberoides</i>	<i>tol</i> (Cuvier)		+	+	-	-	-	-	
<i>Selar</i>	<i>hoops</i> (Cuvier)		+	+	-	-	-	+	
<i>Selar</i>	<i>erumenophthalmus</i> (Bloch)		+	+	+	+	+	+	*Delsman, 1926a; *Miller et al., 1979; Zvyagina and Rass, 1977
<i>Selaroides</i>	<i>leptolepis</i> (Cuvier)		+	+	-	-	-	-	?Bapat, 1955
<i>Selene</i>	<i>brevoortii</i> (Gill)		-	-	-	+	-	-	Ahlstrom and Sumida (in prep.)
<i>Selene</i>	<i>brownii</i> (Agassiz)		-	-	-	-	+	-	Laroche et al. (in prep.)
<i>Selene</i>	<i>dorsalis</i> (Gill)		-	-	-	-	-	+	*Aboussouan, 1975; *Conand and Franqueville, 1973
<i>Selene</i>	<i>oerstedii</i> Lütken		-	-	-	+	-	-	
<i>Selene</i>	<i>peruviana</i> (Guichenot)		-	-	-	+	-	-	Ahlstrom and Sumida (in prep.)
<i>Selene</i>	<i>setapinnis</i> (Mitchill)		-	-	-	-	+	-	*Fowler, 1936; *Ginsburg, 1952; Johnson, 1978; Laroche et al. (in prep.); Lütken, 1880
<i>Selene</i>	<i>vomer</i> (Linnaeus)		-	-	-	-	+	-	Aprieto, 1974; Fowler, 1936; Ginsburg, 1952; Johnson, 1978; Laroche et al. (in prep.); Lütken, 1880
<i>Seriola</i>	<i>carpenteri</i> Mather		-	-	-	-	-	+	
<i>Seriola</i>	<i>dumerli</i> (Risso)		+	+	+	-	+	+	?Hildebrand and Cable, 1930; Johnson, 1978; Laroche et al. (in prep.); Padoa, 1956c; Roule and Angel, 1930; Sanzo, 1930c, 1933b
<i>Seriola</i>	<i>fasciata</i> (Bloch)		-	-	-	-	+	+	Ginsburg, 1952; Johnson, 1978; Laroche et al. (in prep.)
<i>Seriola</i>	<i>hippos</i> Günther		-	+	-	-	-	-	
<i>Seriola</i>	<i>lalandi</i> Valenciennes		+	+	+	+	+	+	Ahlstrom and Sumida (in prep.); ?Brownell, 1979
<i>Seriola</i>	<i>peruana</i> Steindachner		-	-	-	+	-	-	
<i>Seriola</i>	<i>quinqweradiata</i> Temminck and Schlegel		-	+	+	-	-	-	Lütken, 1880; Mitani, 1960; Uchida, Dotsu et al., 1958
<i>Seriola</i>	<i>rivohana</i> Cuvier		+	+	+	+	+	+	*Ginsburg, 1952; Laroche et al. (in prep.)

TABLE 125. CONTINUED.

Genus ¹	Species	Author	Ind. ³ Ocean	West Pac.	Cent. ⁴ Pac.	East Pac.	West Atl.	East Atl.	References ⁵
<i>Seriola</i>	<i>zonata</i> (Mitchill)		-	-	-	-	+	-	Aprieto, 1974; Ginsburg, 1952; Johnson, 1978; Lütken, 1880
<i>Seriolna</i>	<i>nigrofasciata</i> (Rüppell)		+	+	-	-	-	-	
<i>Trachinotus</i>	<i>africanus</i> Smith		+	-	-	-	-	-	
<i>Trachinotus</i>	<i>anak</i> Ogilby		-	+	-	-	-	-	
<i>Trachinotus</i>	<i>baillonii</i> (Lacepède)		+	+	+	-	-	-	
<i>Trachinotus</i>	<i>blochii</i> (Lacepède)		+	+	+	-	-	-	
<i>Trachinotus</i>	<i>carolinus</i> (Linnaeus)		-	-	-	-	+	-	Fields, 1962; Johnson, 1978; Laroche et al. (in prep.)
<i>Trachinotus</i>	<i>cayennensis</i> Cuvier		-	-	-	-	+	-	
<i>Trachinotus</i>	<i>falcatus</i> (Linnaeus)		-	-	-	-	+	-	Fields, 1962; Hildebrand and Schroeder, 1928; Johnson, 1978; Laroche et al. (in prep.)
<i>Trachinotus</i>	<i>goodii</i> Jordan and Evermann		-	-	-	-	+	-	*Fields, 1962; Johnson, 1978; Laroche et al. (in prep.)
<i>Trachinotus</i>	<i>gorceensis</i> Cuvier		-	-	-	-	-	+	Aboussouan, 1975
<i>Trachinotus</i>	<i>kennedyi</i> Steindachner		-	-	-	-	+	-	
<i>Trachinotus</i>	<i>marginatus</i> Cuvier		-	-	-	-	+	-	
<i>Trachinotus</i>	<i>maxillosus</i> Cuvier		-	-	-	-	-	+	
<i>Trachinotus</i>	<i>mookalee</i> Cuvier		+	+	-	-	-	-	
<i>Trachinotus</i>	<i>ovatus</i> (Linnaeus)		-	-	-	-	-	+	*De Gaetani, 1940; *Padoa, 1956c
<i>Trachinotus</i>	<i>pattenensis</i> Cuvier		-	-	-	-	+	-	
<i>Trachinotus</i>	<i>rhodopus</i> Gill		-	-	-	-	+	-	
<i>Trachinotus</i>	<i>russellii</i> Cuvier		+	+	-	-	-	-	
<i>Trachinotus</i>	<i>stilbe</i> (Jordan and MacGregor)		-	-	-	-	+	-	
<i>Trachinotus</i>	<i>teraia</i> Cuvier		-	-	-	-	-	+	
<i>Trachinotus</i>	<i>velox</i> Ogilby		-	+	-	-	-	-	
<i>Trachurus</i>	<i>declivis</i> (Jenyns)		-	+	-	-	-	-	
<i>Trachurus</i>	<i>delagoa</i> Nekrassov		+	-	-	-	-	-	
<i>Trachurus</i>	<i>japonicus</i> (Temminck and Schlegel)		-	+	-	-	-	-	Shojima, 1962; Uchida et al., 1958
<i>Trachurus</i>	<i>indicus</i> Nekrassov		+	-	-	-	-	-	*Tsokur, 1977
<i>Trachurus</i>	<i>lathamii</i> Nichols		-	-	-	-	+	-	*de Ciechowski and Weiss, 1973; Johnson, 1978; Laroche et al. (in prep.)
<i>Trachurus</i>	<i>mediterraneus</i> (Steindachner)		-	-	-	-	-	+	Demir, 1961; Padoa, 1956c; Sanzo, 1932a
<i>Trachurus</i>	<i>murphyi</i> Nichols		-	-	-	-	+	-	Santander and de Castillo, 1971
<i>Trachurus</i>	<i>novaezelandiae</i> Richardson		-	+	-	-	-	-	
<i>Trachurus</i>	<i>picturatus</i> (Bowdich)		-	-	-	-	-	+	Aboussouan, 1975
<i>Trachurus</i>	<i>symmetricus</i> (Ayres)		-	-	-	-	+	-	Ahlstrom and Ball, 1954; Ahlstrom and Sumida (in prep.)
<i>Trachurus</i>	<i>trachurus</i> (Linnaeus)		+	-	-	-	-	+	Aboussouan, 1975; Arbault and Boutin, 1968c; Brownell, 1979; Demir, 1961; Ehrenbaum, 1905-1909; Haigh, 1972b; Kiliachenkova, 1970; King et al., 1977; Letacounoux, 1951; Padoa, 1956c; Russell, 1976; Schnakenbeck, 1931
<i>Trachurus</i>	<i>trecae</i> Cadenat		-	-	-	-	-	+	Aboussouan, 1967; Aboussouan, 1975
<i>Ulua</i>	<i>aurochs</i> (Ogilby)		-	+	-	-	-	-	
<i>Ulua</i>	<i>mentalis</i> Cuvier		+	+	-	-	-	-	
<i>Uraspis</i>	<i>helvola</i> Forster		+	+	+	+	-	+	
<i>Uraspis</i>	<i>secunda</i> Poey		+	+	+	+	+	+	Johnson, 1978
<i>Uraspis</i>	<i>uraspis</i> Günther		+	+	-	-	-	-	

¹ Carangid generic limits are not well established and some taxa here recognized ultimately may be allocated to subgeneric status. *Carangoides* is a poorly defined group that may include several subunits worthy of recognition. The three species assigned to "Carangus" are not closely related and their generic placement is uncertain.

² *Pantolabus* Whitley, 1931 is here recognized as a senior synonym of *Absalom* Whitley, 1937. Recent examination of the syntypes of *Carangus parasitus* Garman (type-species of *Pantolabus*) has revealed that they are conspecific with *C. radiatus* Macleay, type-species of *Absalom*.

³ Species that reach their western distributional limit on the eastern margin of the Indian Ocean (including western Australia) are not tabulated as occurring in the Indian Ocean.

⁴ Species that reach their eastern distributional limit on the western margin of the Pacific Plate (see Springer, 1982) are not tabulated as occurring in the Central Pacific. Easter Island is treated as a component of the central Pacific.

⁵ Asterisk indicates scientific name used in cited reference differs from present allocation, question mark indicates only a provisional identification given in cited reference, or adult taxonomy of group so inadequate at time of publication that specific identification must be treated as suspect.

Development in carangids proceeds relatively directly towards the adult stage. Adult characters are gradually acquired without remarkable, sudden metamorphoses (developmental rate changes) occurring between stages.

Carangid larvae are relatively small and undeveloped at hatching, usually 1.0 to 2.0 mm notochord length (NL), with a relatively large yolk sac. Head size, presence of 24-27 myomeres, and possession of an oil globule at the anterior of the

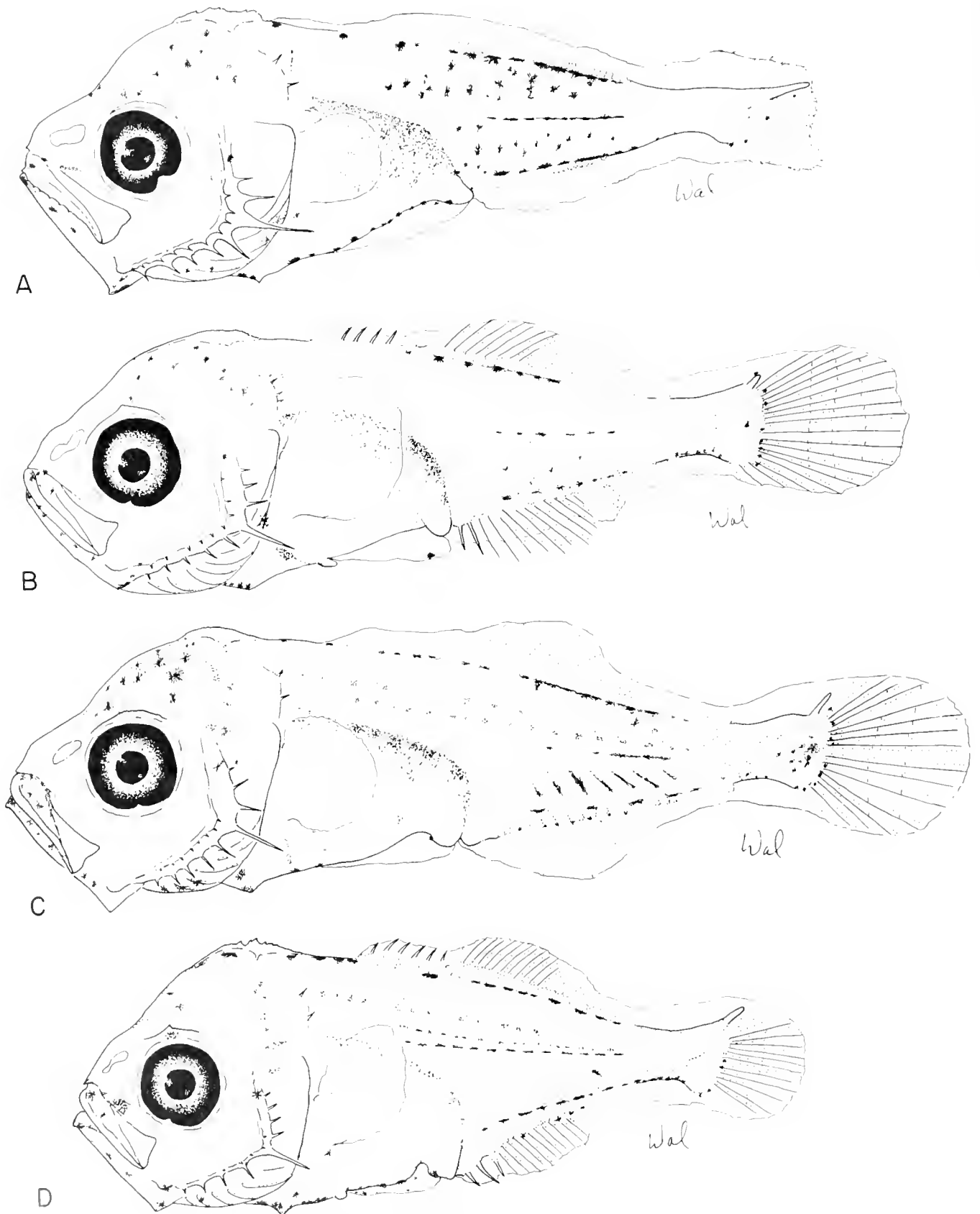

Fig. 270. (A) Flexion larva (5.4 mm) of *Trachurus lathami*; postflexion larvae (5.5, 5.6 mm) of (B) *Decapterus punctatus* and (C) *Selar rumenophthalmus*; and (D) early flexion larva (4.6 mm) of *Chloroscombrus chrysurus*.

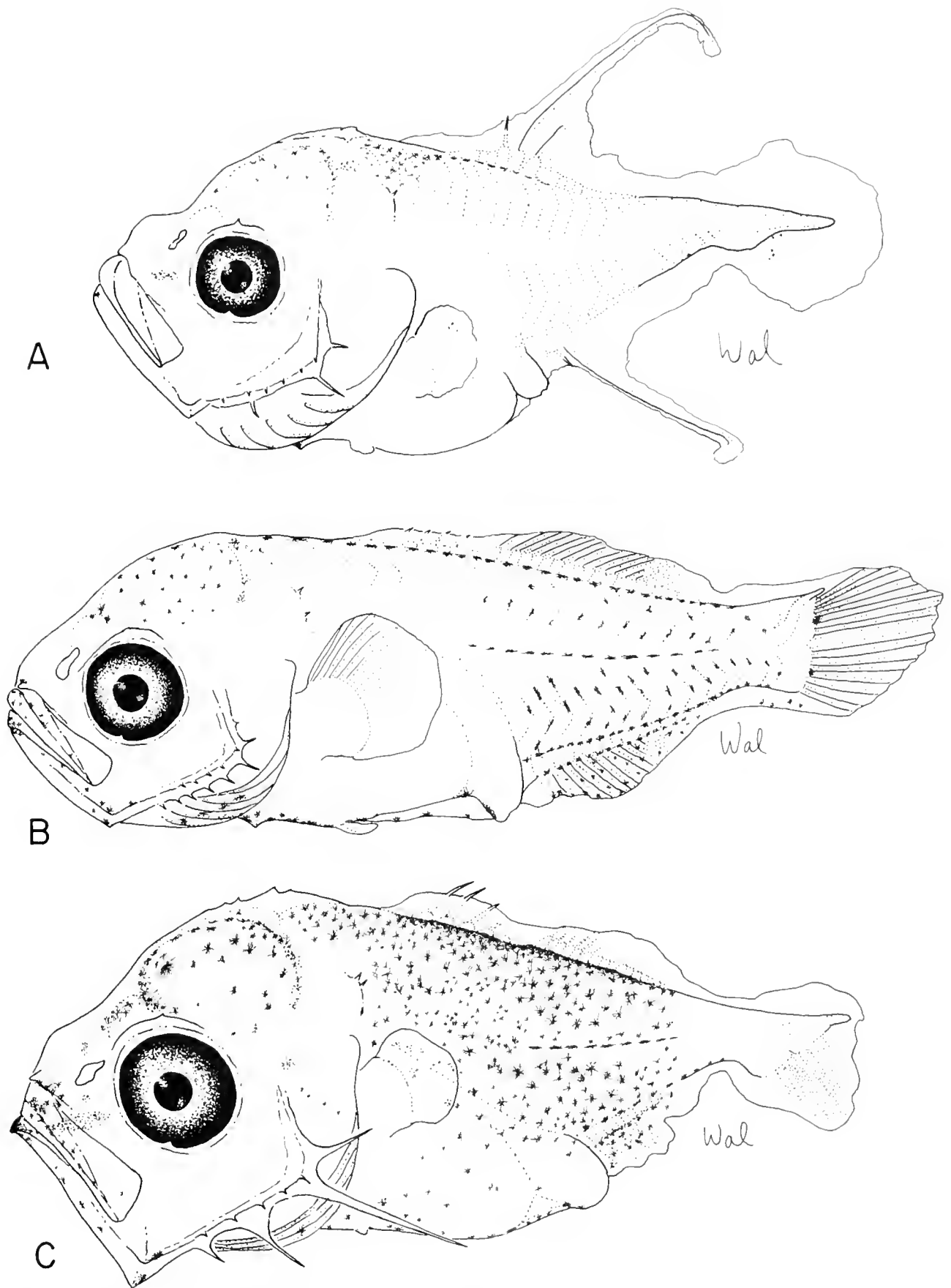

Fig. 271. (A) Early flexion larva (3.1 mm) of *Alectis ciliaris*; (B) postflexion larva (4.9 mm) of *Atule mate*; and (C) flexion larva (4.0 mm) of *Gnathanodon speciosus*.

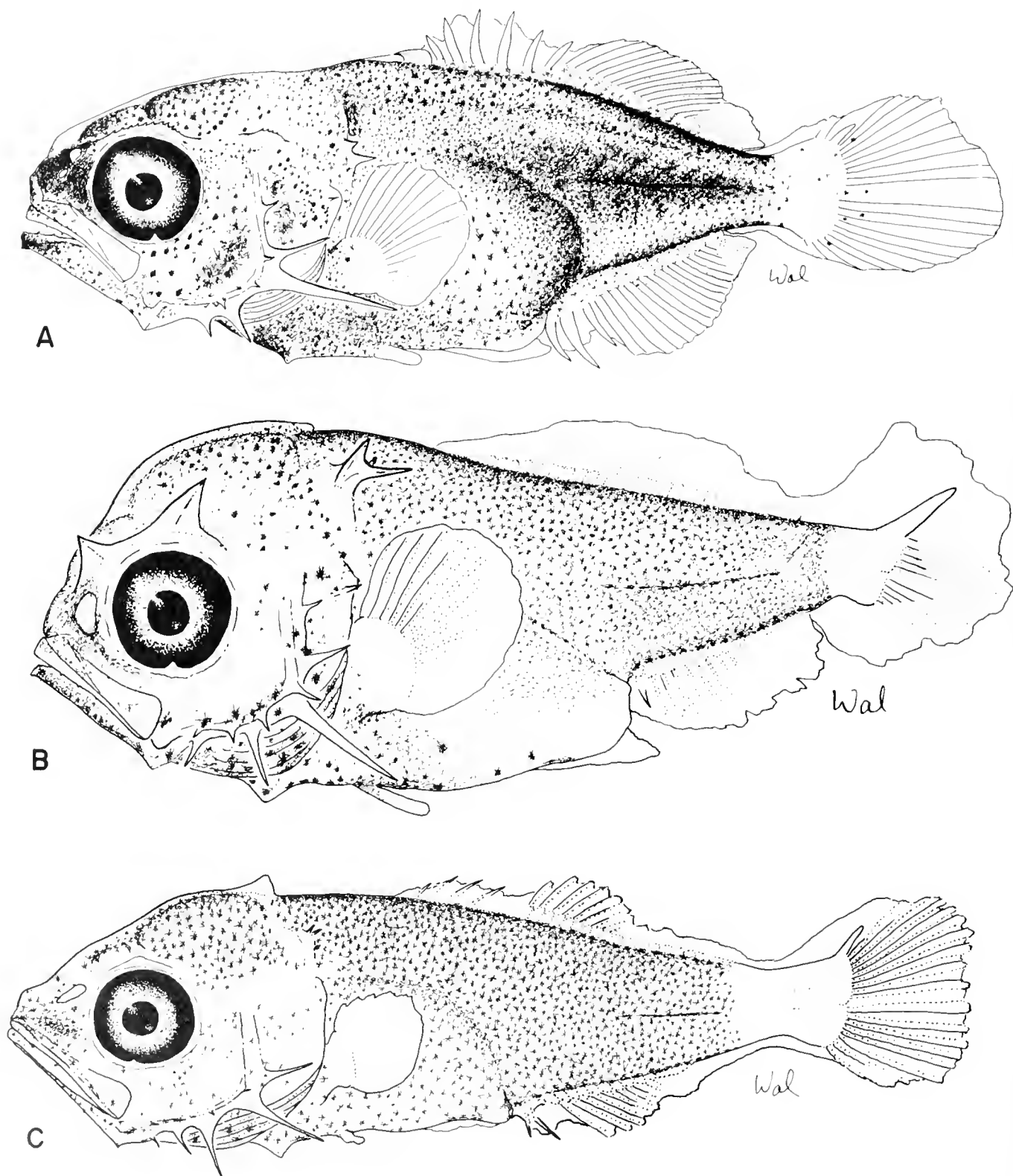

Fig. 272. (A) Postflexion larva (5.9 mm) of *Trachinotus carolinus*; (B) late flexion larva (4.7 mm) of *Naucrates ductor*, and (C) postflexion larva (5.3 mm) of *Scomberoides lysan*.

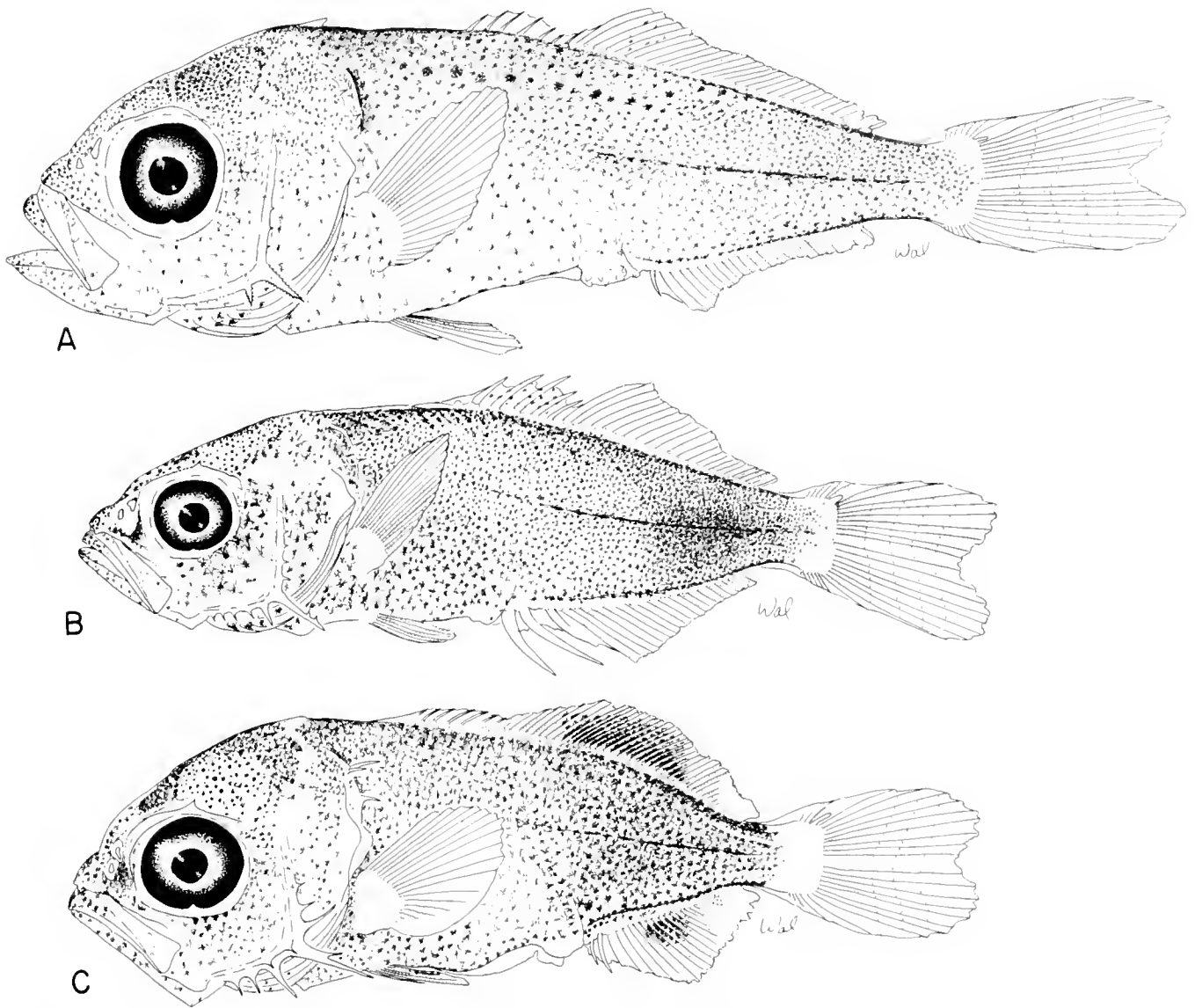

Fig. 273. Late postflexion larvae of (A) *Elagatis bipinnulata* (11.4 mm); (B) *Oligoplites saurus* (8.6 mm) and (C) *Seriola zonata* (9.5 mm).

yolk sac, ventral to the head, are the most outstanding characters of yolk sac larvae. The mouth is not formed, and the gut is undeveloped. Eyes lack melanistic pigmentation; fins are undeveloped; the notochord is straight; and head spines are lacking (Ahlstrom and Ball, 1954; Aprieto, 1974; Miller and Sumida, 1974). The present state of knowledge is not adequate to establish a set of characters which will distinguish pre-fin formation carangid larvae from larvae of all other marine fish families in the world. Newly hatched carangid larvae are difficult to identify even to family due to the paucity of diagnostic morphological characters and multitude of perciform taxa which co-occur and have similar-appearing larvae. Since larvae of many taxa remain unknown, the problem is even more complicated. However, within restricted and well-defined geographic areas it may be possible to define such a character set if the fish fauna is well known (Laroche et al., MS).

Following yolk absorption, larval carangids range from relatively slender forms, i.e., body depth (BD) 20 to 27% SL in *Oligoplites saurus* (Fig. 273B), to relatively deep bodied forms, i.e., BD 32 to 59% SL in *Selene* sp. (Aprieto, 1974) (Fig. 274A). The gut develops as a narrow straight tube on the first day after hatching. A single gut loop is present in larvae 3–4 mm NL, which is about 5 days after hatching in *Atule mate* and *Oligoplites saurus* (Aprieto, 1974; Miller and Sumida, 1974). This pattern seems to be common among other species although lengths at which the gut loops vary slightly. The gut extends to midbody with snout to anus length in preflexion and flexion larvae usually ranging from 46 to 67% SL (Aprieto, 1974; Laroche et al., MS). The head ranges in length from about 24 to 41% SL and is typically about 33% SL.

Head spines form relatively early in development. The first head spine to develop is a preopercular spine at the angle of the

TABLE 126. DISTINGUISHING CHARACTERS USEFUL IN IDENTIFICATION (TO GENUS) OF FLEXION AND POSTFLEXION LARVAE OF CARANGIDAE. Presence of character indicated by "+," absence by "-" and no data by "0." Species and sources on which this table is based are listed in preceding table, except for original observations on *Gnathanodon speciosus*, *Naucrates ductor*, *Parastromateus niger*, and *Scomberoides lysan*. Character definitions follow Laroche et al. (MS). Information in this table should be considered preliminary, awaiting more thorough descriptions.

Genus	Supra-occipital ridge	Angle preopercular spine			Supraocular ridge				Posttemporal and supraclithral spines		Pterotic ridge	Vomer pigment	Dorso-lateral pigment
		Simple	Ser-rated	Spinule(s)	Weak		Prominent		Weak	Prominent			
					Small spine	Ser-rated	Ser-rated	2 or 3 spines					
<i>Alectis</i>	+	+	-	-	+	-	-	-	+	-	-	+	-
<i>Alepes</i>	+	+	-	-	+	-	-	-	+	-	-	+	+
<i>Atropus</i>	0	0	0	0	0	0	0	0	0	0	0	0	0
<i>Atule</i>	-	+	-	-	+	-	-	-	+	-	-	-	+
<i>Campogramma</i>	0	0	0	0	0	0	0	0	0	0	0	0	0
<i>Carangoides</i>	+	+	-	-	+	-	-	-	+	-	-	0	+
<i>Caranx</i>	+	+	-	-	+	-	-	-	+	-	-	±	+
" <i>Caranx</i> "	+	+	-	-	+	-	-	-	+	-	-	-	+
<i>Chloroscombrus</i>	+	+	-	-	+	-	-	-	+	-	-	+	-
<i>Decapterus</i>	+	+	-	-	+	-	-	-	+	-	-	-	-
<i>Elagatis</i>	+	0	+	-	+	-	-	-	+	-	-	+	+
<i>Gnathanodon</i>	+	+	-	-	+	-	-	-	+	-	-	+	+
<i>Hemicaranx</i>	0	0	0	0	+	-	-	-	+	-	-	0	0
<i>Lichia</i>	0	0	0	0	0	0	0	0	0	0	0	0	0
<i>Megalaspis</i>	0	0	0	0	0	0	0	0	0	0	0	0	0
<i>Naucrates</i>	-	+	-	-	-	-	-	+	-	+	-	+	+
<i>Oligoplites</i>	-	-	-	+	+	-	-	-	+	-	-	+	+
<i>Pantolabus</i>	0	0	0	0	0	0	0	0	0	0	0	0	0
<i>Parastromateus</i>	+	+	-	-	-	+	-	-	+	-	+	-	-
<i>Parona</i>	+	+	-	-	-	-	+	-	+	-	-	0	+
<i>Pseudocaranx</i>	0	0	0	0	0	0	0	0	0	0	0	0	0
<i>Scomberoides</i>	+	+	-	-	+	-	-	-	+	-	-	+	+
<i>Selar</i>	+	+	-	-	+	-	-	-	+	-	-	-	+
<i>Selaroides</i>	0	0	0	0	0	0	0	0	0	0	0	0	0
<i>Selene</i>	+	+	-	-	+	-	-	-	+	-	-	+	-
<i>Seriola</i>	-	±	-	±	+	-	-	-	+	-	-	+	+
<i>Seriolina</i>	0	0	0	0	0	0	0	0	0	0	0	0	0
<i>Trachinotus</i>	-	+	-	-	-	+	-	-	-	+	+	+	+
<i>Trachurus</i>	+	+	-	-	+	-	-	-	+	-	-	+	+
<i>Ulua</i>	0	0	0	0	0	0	0	0	0	0	0	0	0
<i>Uraspis</i>	0	0	0	0	+	-	-	-	+	-	-	0	0

posterior margin of the preopercle, usually first appearing in larvae 2.0 to 4.0 mm NL, which coincides with yolk sac absorption.

Carangids develop two series of preopercular spines, one series along the posterior margin of the preopercle and another along the anterior margin, called the "preopercular crest" by Ahlstrom and Ball (1954). Both series have an upper and lower segment (Fig. 270). The number of preopercular spines does not seem to reach a constant number as in larvae of many other fish families. Instead, the number of spines in both series increases through preflexion, flexion, and postflexion stages to a maximum of usually about 9 in the anterior and 11 in the posterior series, then decreases in number during transformation and early juvenile stages. Usually just prior to or during the early juvenile stage, preopercular spines become completely overgrown by tissue and bone. Development of preopercular spines in both the anterior and posterior series proceeds along the margins away from the angle of the preopercle. Conversely, reduction in preopercular spination proceeds toward the angle. When spines are present on either the anterior or posterior margin, a spine is always present at the angle of the margin, and it is always the largest. The size and shape of this spine are particularly useful in distinguishing carangid taxa (Table 126).

For example, *Seriola zonata* and *Oligoplites saurus* (Fig. 273C, 273B) have a preopercular spine with a spinule(s), and *Elagatis bipinnulata* has serrated preopercular spines (Fig. 273A).

A median supraoccipital crest develops on the head during the preflexion stage in many species (Table 126) and persists until late in the transformation stage when it becomes overgrown by tissue and bone. The supraoccipital crest is very useful in distinguishing carangids since there are relatively few marine fish families which have larvae with a crest. The shape of the supraoccipital crest has been used to distinguish carangid larvae of various taxa (Aboussouan, 1975), however, the difficulty in defining shape characters makes them somewhat subjective and of questionable reliability. However, some taxa, i.e., *Elagatis bipinnulata* (Fig. 273A) and *Chloroscombrus chrysurus* (Fig. 270D), have crests which do appear quite distinct from those of other known carangid larvae.

Among other head spines, supraocular spines and serrations develop in many taxa (Table 126). The larger multiple supraocular spines present in *Naucrates ductor* (Fig. 272B) and serrated pterotic ridge in *Trachinotus* spp. (Fig. 272A) are notable. All species develop posttemporal and/or supraclithral spines which vary in number, usually 1-5, and relative size among taxa (Fig. 270-274).

TABLE 126. EXTENDED.

Ventrolateral pigment		Internal melano- phores over dorsal aorta	Lateral midline pigment	Melano- phores on branchi- ostegal mem- brane	In- ternal melano- phores over noto- chord	Dorsal and anal finlet	Melanophores on dorsal body margin		Body pigmentation		Body depth		Dorsal fin spines elongate (form early)	Pelvic fin rays first to develop	Dorsal and anal fin rays elongate (form early)	Number of myomeres (typical)
Scat- tered	Aligned along myosepta						Anti- medial rows	Median row	Dense	Light	Shallow ($\bar{x} < 35\%$ SL)	Deep ($\bar{x} > 35\%$ SL)				
-	-	-	-	-	-	-	+	-	+	-	+	-	-	+	24	
+	-	0	+	+	0	-	0	0	+	-	-	+	-	-	24	
0	0	0	0	0	0	0	0	0	0	0	0	0	0	0	24	
-	+	-	+	+	-	-	+	-	-	+	-	+	-	-	24	
0	0	0	0	0	0	0	0	0	0	0	0	0	0	0	24	
+	-	0	+	+	0	-	0	0	-	+	-	+	-	-	24	
+	±	±	+	±	±	-	±	±	-	+	-	+	-	-	24	
-	+	0	+	-	0	-	0	0	-	+	-	+	-	-	24	
-	+	+	+	+	+	-	-	+	-	+	-	+	-	-	24	
-	-	-	+	-	-	+	+	-	-	+	+	-	-	-	25	
+	-	-	+	+	-	-	+	-	+	-	+	-	-	-	24	
+	-	-	+	+	-	-	+	-	+	-	+	-	-	-	24	
0	0	0	0	0	0	-	0	0	0	0	-	+	-	0	26	
0	0	0	0	0	0	0	0	0	0	0	0	0	0	0	24	
0	0	0	0	0	0	0	0	0	0	0	0	0	0	0	24	
+	-	-	+	+	-	-	±	-	+	-	+	-	-	-	25	
+	-	-	+	+	-	-	±	-	+	-	+	-	-	-	26	
0	0	0	0	0	0	0	0	0	0	0	0	0	0	0	24	
-	-	-	+	+	-	-	0	0	-	+	-	+	-	0	24	
+	-	0	0	0	0	0	0	+	-	+	0	0	-	-	27	
0	0	0	0	0	0	0	0	0	0	0	0	0	0	0	25	
+	-	-	+	+	-	-	±	-	+	-	+	-	-	-	26	
-	+	+	+	+	+	+	+	-	-	+	+	-	-	-	24	
0	0	0	0	0	0	0	0	0	0	0	0	0	0	0	24	
-	-	+	+	-	+	-	+	-	-	+	-	+	+	+	24	
-	-	+	+	0	0	-	±	-	+	-	+	-	-	-	24	
0	0	0	0	0	0	0	0	0	0	0	0	0	0	0	24	
+	-	+	+	+	-	-	±	-	+	-	+	-	-	-	24	
+	-	-	+	-	-	-	-	+	-	+	+	-	-	-	24	
0	0	0	0	0	0	0	0	0	0	0	0	0	0	0	24	
0	0	0	0	0	0	-	0	0	0	0	-	+	-	0	24	

Dorsal, anal, preanal, and caudal finfolds are present at hatching. Yolk-sac larvae rapidly develop the pectoral fin base and finfold. The sequence of fin formation in most species is: caudal, pectoral, anal and soft dorsal, spinous dorsal, and pelvic. Species of *Alectis* (Fig. 271A) and *Selene* (Fig. 274A) are exceptions, developing pelvic and/or dorsal fin elements precociously before the notochord begins to flex. The sequence of fin formation in these taxa is: either pelvic, spinous or soft dorsal followed by caudal, anal, and pectoral (Aprieto, 1974; Laroche et al., MS).

Spinous dorsal, soft dorsal, and anal fins generally develop from anterior to posterior, although the first element in each fin may lag, and the most posterior element in the soft dorsal and anal fins may develop precociously in some species, i.e., *Decapterus* spp. and *Selar crumenophthalmus* (Laroche et al., MS) (Fig. 270B, C). In many species at least some dorsal and anal fin spines ossify from the distal tip proximally (Fig. 271C, 272C) which may be an unusual condition among marine fish larvae and may help characterize the Carangidae. This condition has been noted in a number of species and may occur in most or all species, however, lack of specimens in the critical stage when this condition is recognizable does not yet permit documentation of its occurrence. Pectoral fin elements develop from dorsal

to ventral. The pelvic spine develops before the rays, and ray formation proceeds away from the spine.

The separation of the two anteriormost anal fin spines from the third spine by a distinct gap is an important characteristic of most young carangids once fins have formed. This gap is caused by anterior and posterior extensions of the distal part of the pterygiophores supporting the second (ultimate) and third (penultimate) anal fin spines. This gap, although present, is relatively narrow in *Elagatis bipinnulata* and *Seriolina nigrofasciata*, which differ from other carangids in having only two anal fin spines. The only other family known to have young with a similar gap is the Pomatomidae (Laroche et al., MS).

Development of an "antrorse spine" on the anterodorsal margin of the first dorsal fin pterygiophore (Fig. 272A) is another character that is found in most young carangids following fin development and is shared by only a few other families, i.e., Ephippidae. This "spine" is usually covered with skin but is visible in larvae and juveniles.

Scales begin to develop during the transformation stage. Many species of carangids develop modified scales in the form of scutes along the posterior portion of the lateral line. Ossifying scales are usually first visible along the straight part of the lateral line anterior and adjacent to the caudal peduncle, where scutes form.

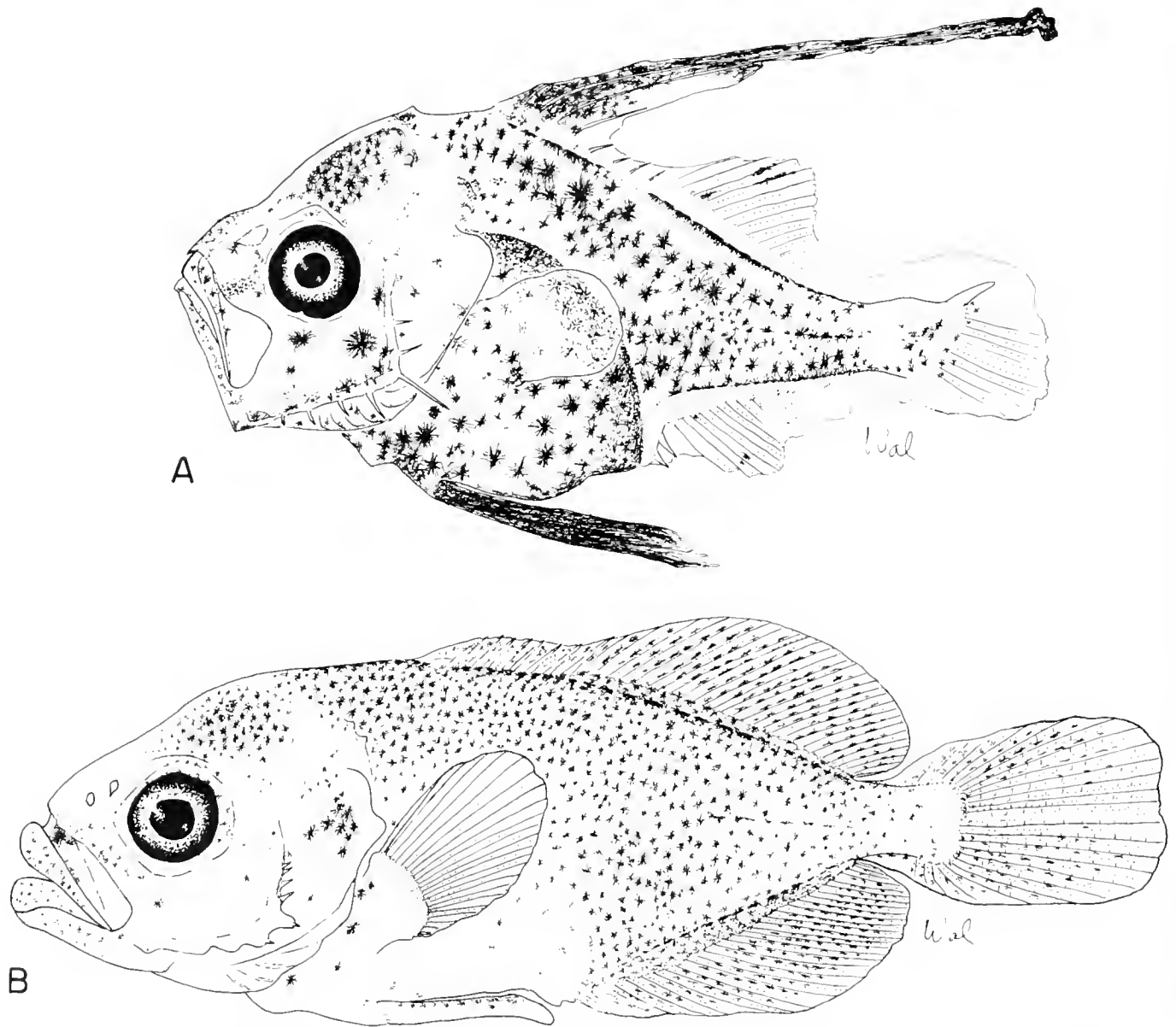

Fig. 274. (A) Early postflexion larva (5.2 mm) of *Selene* sp. and (B) late postflexion larva (9.2 mm) of *Hemecaranx amblyrhynchus*.

Scale development proceeds dorsally, ventrally, and anteriorly from this location. Berry (1960) presented a detailed account of scute development and methodology for making counts.

Osteology.—Developmental osteology has been described for *Trachurus symmetricus* (Ahlstrom and Ball, 1954); *Decapterus punctatus*, *Elagatis bipinnulata*, *Selene vomer*, and *Seriola zonata* (Aprieto, 1974); and *Atule mate* (Miller and Sumida, 1974). The sequence of ossification is the same for all of these species. The cleithrum, premaxilla, and posterior preopercular angle spine are first to ossify in preflexion larvae. Although the cleithrum begins to ossify early, the pectoral and pelvic girdles do not completely ossify until late in the transformation stage. Near the beginning of notochoord flexion, the maxilla, dentary, parasphenoid, supraoccipital, articular, frontal, angular, and bran-

chial arches begin to ossify. However, much of the cranium does not completely ossify until late transformation stage. Teeth form along the anterior margin of the premaxilla as soon as it ossifies. Aprieto (1974) noted that early ossification of bones related to feeding is consistent with need for food following yolk resorption. The first branchial arch begins to ossify first with ossification proceeding from the angle of the arch outward. The other arches ossify similarly in sequence. Gill rakers develop following ossification of the element on which they are attached. The full complement of gill rakers is not attained until late transformation or early juvenile stage. Patches of small teeth form on the upper pharyngeals of the third and fourth gill arches, and the fifth arch has tooth patches along most of its length. Pharyngeal teeth ossify early in the postflexion stage.

Vertebrae begin to ossify next, in the middle of the flexion

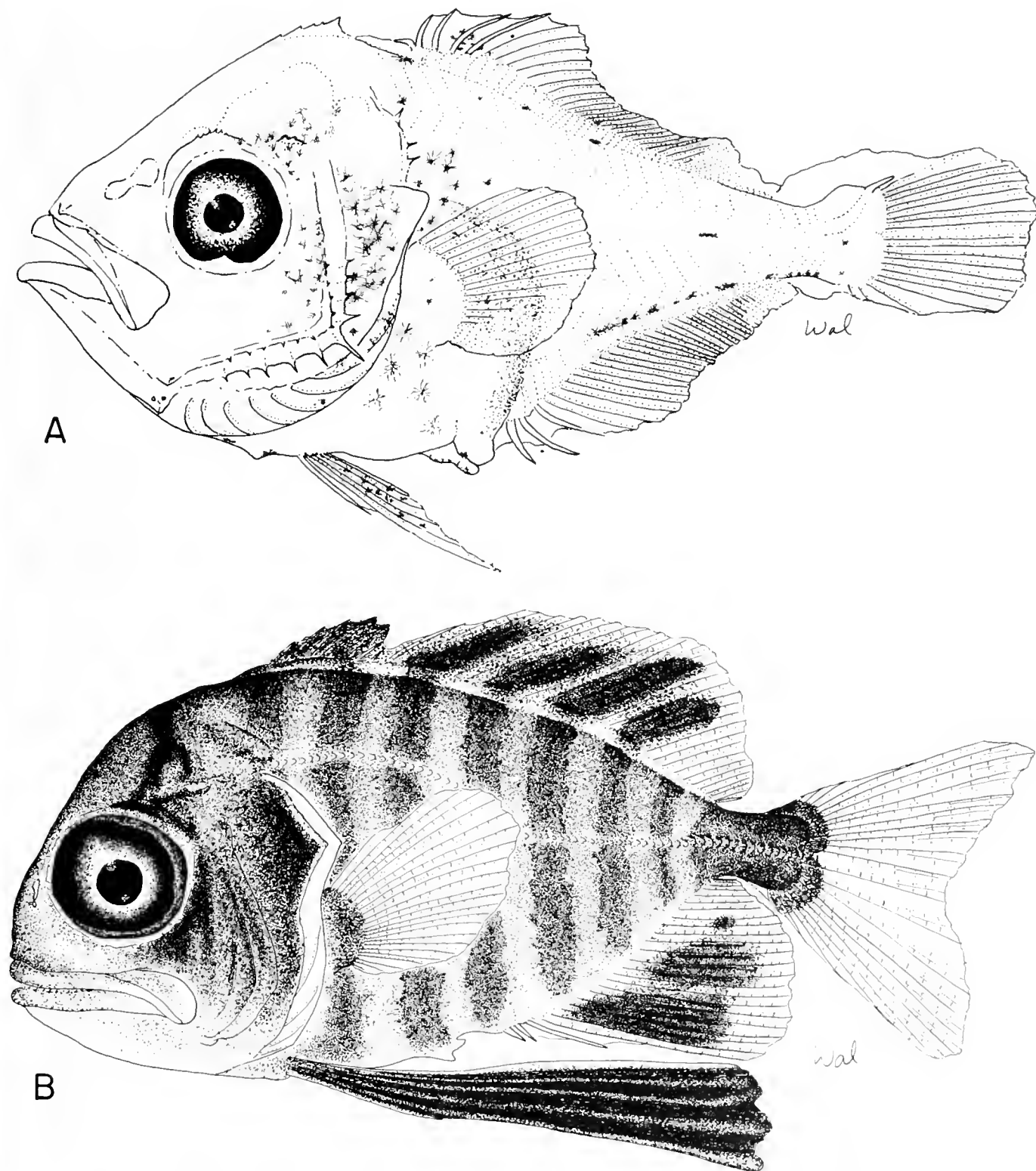

Fig. 275. (A) Postflexion larva (5.5 mm) of *Parastromateus niger* and (B) small juvenile (25.6 mm) of *Uraspis secunda*.

stage (along with the caudal fin rays) in most species, closely followed by neural and haemal spines. Vertebrae, neural, and haemal spines ossify sequentially, anteroposteriorly. Centra ossify from their anterior margin posteriorly. Neural spines of the abdominal vertebrae, and neural and haemal spines of caudal vertebrae begin to ossify before their respective centra. Ribs ossify at about the same time and also develop anteroposteriorly. Pleural ribs ossify before the epipleural ribs. The urostyle begins to ossify before the posteriormost two or three vertebrae during the flexion stage. Ossification proceeds from its anterior base towards its distal tip as it also does in the hypurals.

Pigmentation.—Details concerning the development and variety of pigmentation characters are discussed by Laroche et al. (MS) and are summarized for genera in Table 126. Although many species have not been observed and this table is tentative, it reflects the potential utility of pigmentation characters.

It is not possible to describe a generalized pigmentation pattern that is unique to and diagnostic for all carangid larvae. By the end of the preflexion stage, most species have rows of melanophores along the dorsal and ventral margins of the tail. Melanophores appear on the head over the brain and eventually form a cap of pigmentation. Dorso- and ventrolateral pigmentation may be present or absent depending on the species (Fig. 270A, B). A row of small melanophores develops along the lateral midline at midbody during the preflexion stage and persists into the juvenile stage (Figs. 270–275). When these melanophores are expanded, they appear as a line of pigmentation. This pigmentation along the lateral midline has been referred to as the “lateral line streak” by Ahlstrom and Ball (1954) and Miller and Sumida (1974). The amount and pattern of melanistic pigmentation on the head, body, and fins of carangid larvae is otherwise quite diverse, grading from very light to very dark pigmentation. However, larvae can usually be categorized as either lightly or darkly pigmented (Table 126, Figs. 270–275). Darkly pigmented forms usually have a lightly pigmented caudal peduncle (Figs. 272, 273).

Systematic considerations

Although considerable taxonomic confusion still exists regarding carangids, and developmental stages for most species remain unknown, similarities among larvae of species assigned to the same genus suggest a congruence between adult and larval similarities which may reflect the naturalness of some generic groups. For example, all species of the genus *Selene* for which larvae are known share precocious development of the spinous dorsal, pelvic, and caudal fins, while all species of *Decapterus* for which larvae have been described begin development of a finlet at the posterior of the dorsal and anal fins before more anterior elements begin to develop. Interestingly, *Selar crumenophthalmus* (which lack finlets as adults) larvae also begin development of a fin element at the posterior of the dorsal and anal fins before more anterior elements begin to develop (Fig. 270C). This character may reflect a relationship between *Decapterus* and *Selar*. This type of information is encouraging and may tend to raise confidence in the naturalness of taxonomic groups and in the potential utility of developmental characters for use in systematic studies of carangids.

Developmental information is available for too few species to allow interpretation of character patterns which might reflect phylogenetic relationships within the Carangidae. Of course, investigation of Carangidae's relationship to other groups within Perciformes is a much larger problem and will require that similar information be gathered for other taxa. Careful, comparative developmental studies are needed to supply this critical information and provide the most direct route towards a better understanding of relationships.

(W.A.L.) SCHOOL OF NATURAL RESOURCES, DEPARTMENT OF FISHERIES, HUMBOLDT STATE UNIVERSITY, ARCATA, CALIFORNIA 95521; (W.F.S.-V.) DEPARTMENT OF ICHTHYOLOGY, THE ACADEMY OF NATURAL SCIENCES, 19TH AND THE PARKWAY, LOGAN CIRCLE, PHILADELPHIA, PENNSYLVANIA, 19103; (S.L.R.) GULF COAST RESEARCH LABORATORY, EAST BEACH DRIVE, OCEAN SPRINGS, MISSISSIPPI 39564.

Carangidae: Relationships

W. F. SMITH-VANIZ

DESPITE the great economic importance and broad geographic distribution of the Carangidae, knowledge of their systematics is very inadequate. The few attempts to determine their phylogenetic relationships have been both limited in scope and methodologically flawed. These classifications largely reflect the distribution of characters shared between taxa rather than being based on evolutionarily derived characters. Lack of knowledge of an appropriate out-group for comparison has also limited progress in this area.

In his pioneering study of carangid osteology and relationships, Starks (1911) recognized four subfamilies but stressed the difficulty of establishing intrafamilial relationships. Suzuki (1962) described and illustrated the osteology of 18 genera of carangids.

Unfortunately only Japanese species were considered and, although much useful descriptive information was presented, little progress was made towards attaining a better understanding of carangid phylogeny. Vergara (1972) described the osteology of the Cuban species assigned to *Caranx* and presented a phyletic analysis of their relationships. In a subsequent paper Vergara (1974) expanded his analysis to include all Cuban genera of Carangidae and evaluated the phenetic relationships of Cuban *Caranx*. Smith-Vaniz and Staiger (1973) concentrated their efforts on the Scomberoidini and presented evidence suggesting a sister-group relationship between *Parona* and *Scomberoides* + *Oligoplites*. The detailed comparison and osteological description of *Nematistius* by Rosenblatt and Bell (1976) provided

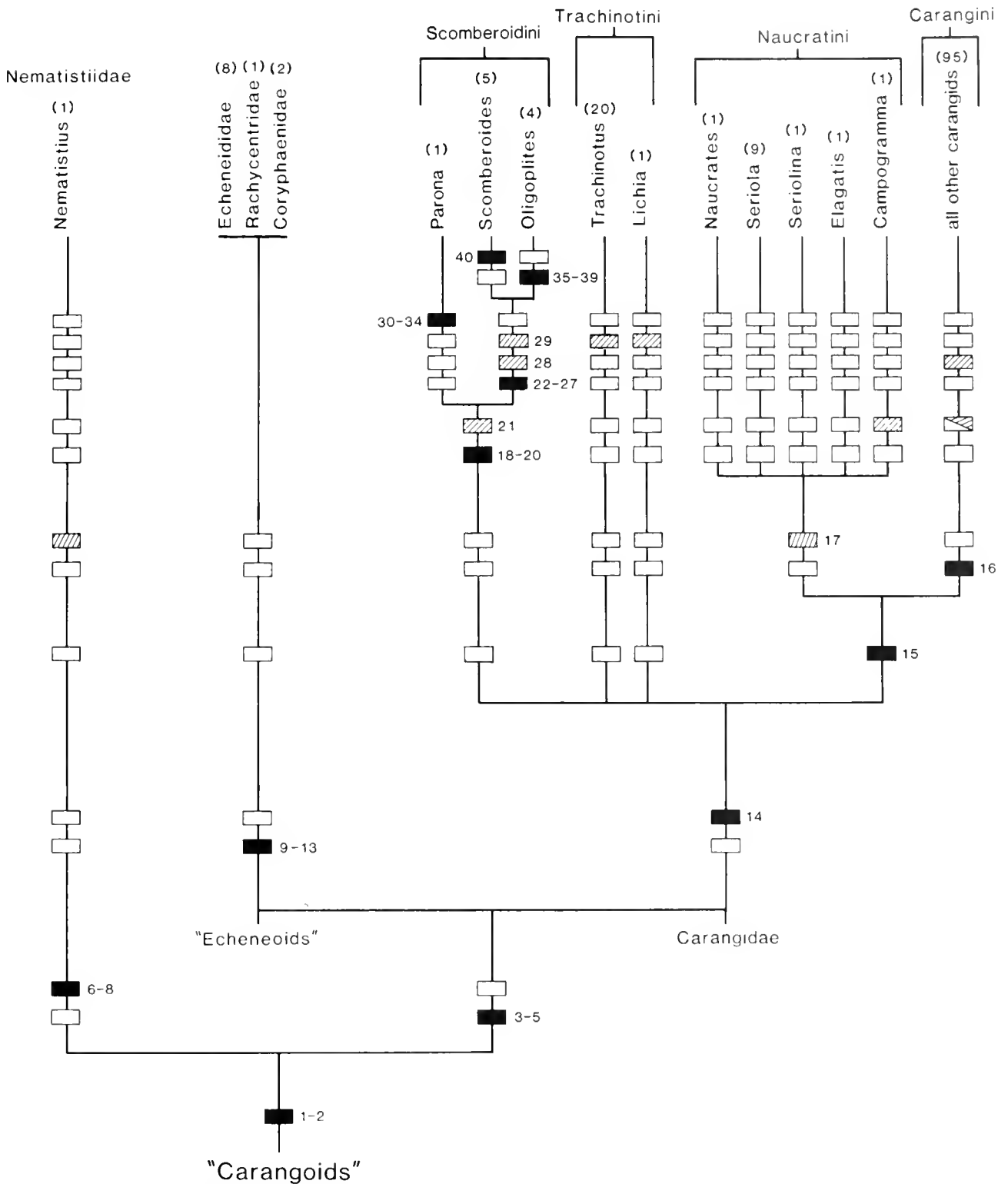

Fig. 276. Hypothesized cladogram of "carangoid" fishes including main groups of Carangidae. Numbers opposite rectangles correspond to characters discussed in text. Numbers in parentheses are estimated total number of species in taxon. Open rectangles are hypothesized to represent plesiomorphic (phylogenetically primitive) character states and solid rectangles derived character states; characters indicated by barred rectangles are hypothesized to have evolved more than once, and acquired independently in each lineage so marked; half-barred rectangles indicate that both the primitive and derived character states occur in some component taxa of the lineage with the derived condition secondarily evolved.

TABLE 127. SELECTED CHARACTERS OF CARANGID GENERA. (Abbreviations: Triseg. = trisegmental; Br. = branchiostegal; P = rayless pterygiophore.)

	No. species	Scutes	1st haemal spine attachment	Caudal peduncle grooves	AM muscle A ₁ div	Triseg radials
Trachinotini						
<i>Trachinotus</i>	(20)	absent	strong	absent	absent	absent
<i>Lichia</i>	(1)	absent	strong	absent	absent	absent
Scomberoidini						
<i>Parona</i>	(1)	absent	strong	absent	absent	absent
<i>Scomberoides</i>	(4)	absent	strong	absent	absent	absent
<i>Oligoplites</i>	(5)	absent	strong	absent	absent	absent
Naucratini						
<i>Seriola</i>	(9)	absent	weak	present	present	present
<i>Seriolina</i>	(1)	absent	weak	present	present	present
<i>Elagatis</i>	(1)	absent	weak	present	present	present
<i>Naucrates</i>	(1)	absent	weak	present	present	present
<i>Campogramma</i>	(1)	absent	weak	present, but rudimentary	present	absent
Carangini						
<i>Alectis</i>	(3)	present	strong	absent	present	absent
<i>Alepes</i>	(4)	present	strong	absent	present	absent
<i>Atropus</i>	(1)	present	strong	absent	present	absent
<i>Atule</i>	(1)	present	strong	absent	present	absent
<i>Carangoides</i>	(22)	present	strong	absent	present	absent
<i>Caranx</i>	(14)	present	strong	absent	present	absent
<i>Chloroscombrus</i>	(2)	present	strong	absent	present	absent
<i>Decapterus</i>	(10)	present	strong	absent	present	absent
<i>Gnathanodon</i>	(1)	present	strong	absent	present	absent
<i>Hemicaranx</i>	(4)	present	strong	absent	present	absent
<i>Megalaspis</i>	(1)	present	strong	absent	present	absent
<i>Pantolabus</i>	(1)	present	strong	absent	present	absent

TABLE 127. EXTENDED.

Br rays	Inferior vertebral foramina	Epural bones	Vertebrae	'Predorsal formulae	Dorsal fin Anal fin
7-8	absent	3	10 + 14	0/0/0+P/1+1/ 0/0/0+P/P+1/	<u>V-VI+1, 17-29</u> II+1, 16-18
8	present	3	10 + 14	0/0/0+1/	<u>VII+1, 19-21</u> II+1, 17-19
9	absent	3	10 + 17	0/0/0+1/	<u>VI+1, 32-38</u> II+1, 34-38
8	absent	2	10 + 16	0/0/0+1/ 0/0/0+P/1/	<u>VI-VII+1, 19-21</u> II+1, 16-20
7	absent	2	10 + 16	0/0/0+P/1+1/ 0/0/0+P/P+1/ 0/0/0+P/P/1/ 0/0/0+P/P+P/1/	<u>IV-VI+1, 18-21</u> II+1, 19-21
7	absent	3	10 + 14 (6) 11 + 13 (2) 11 + 14 (1)	0/0/0+1+1/ 0/0/0+2+1/ 0/0+0/1+1+1/ 0/0/0/0+1/	<u>VII-VIII+1, 22-39</u> II+1, 15-22
7	absent	3	11 + 13	0/0+0/1+1/ 0/0+0/1+1+1/	<u>VII+1, 30-37</u> I+1, 15-18
7	absent	3	10 + 14	0/0/0/1+1/	<u>VI+1, 25-30</u> I+1, 18-20
7	absent	3	10 + 15	0/0/0+1/	<u>IV-V+1, 25-29</u> II+1, 15-17
7	absent	3	10 + 14	0/0+0/1+1/	<u>VI-VII+1, 26-28</u> II+1, 23-25
7	present	2	10 + 14 (2) 10 + 15-16 (1)	0/0+0/1+1/ 0/0+0/P+1/	<u>VI-VII+1, 18-22</u> II+1, 16-20
7	present	2	10 + 14	0/0+0/2+1/	<u>VIII+1, 23-27</u> II+1, 18-23
7	present	2	10 + 14	0/0+0/2+1/	<u>VIII+1, 19-22</u> II+1, 17-18
7	present	2	10 + 14	0/0+0/2+1/	<u>VIII+1, 22-25</u> II+1, 18-21
7	present or absent (1)	2	10 + 14 (21) 10 + 15 (1)	0/0+0/2+1/	<u>VII+1, 18-35</u> II+1, 16-29
7	present	2	10 + 14 (11) 10 + 15 (3)	0/0+0/2+1/	<u>VIII+1, 18-25</u> II+1, 14-21
7	present	2	10 + 14	0/0/0+1+1/ 0/0+0/2+1/	<u>VII-VIII+1, 25-28</u> II+1, 25-28
7	present	2	10 + 14 (9) 10 + 15 (1)	0/0+0/2+1/ 0/0/0/2+1/ -/0/0/2+1/ -/0/0+0+2+1/	<u>VIII+1, 27-37</u> II+1, 22-32
7	present	2	10 + 14	0/0+0/1+1/	<u>VII+1, 18-21</u> II+1, 15-17
7	present	2	10 + 15 (2) 10 + 16 (2)	0/0+0/1+1/ 0/0+0/2+1/	<u>VI-VII+1, 20-25</u> II+1, 20-25
7	present	2	10 + 14	0/0+0/2+1/	<u>VIII+1, 18-20</u> II+1, 16-17
7	present	2	10 + 14	0/0+0/2+1/	<u>VIII+1, 21-23</u> II+1, 18-20

TABLE 127. CONTINUED.

	No. species	Scutes	1st haemal spine attachment	Caudal peduncle grooves	AM muscle A ₁ div.	Trseg. radials
<i>Parastromateus</i>	(1)	present	strong	absent	present	absent
<i>Pseudocaranx</i>	(3)	present	strong	absent	present	absent
<i>Selar</i>	(2)	present	strong	absent	present	absent
<i>Selaroides</i>	(1)	present	strong	absent	present	absent
<i>Selene</i>	(7)	present	strong	absent	present	absent
<i>Trachurus</i>	(12)	present	strong	absent	present	absent
<i>Ulua</i>	(2)	present	strong	absent	present	absent
<i>Uraspis</i>	(3)	present	strong	absent	present	absent

definitive evidence supporting its removal from the Carangidae. Their work is an important contribution towards elucidating carangoid relationships.

Much more effort needs to be focused on obtaining basic data on the biology, ontogeny and systematics of carangids. The data presented in Table 127 and the following discussion are a first step in that direction.

RELATIONSHIPS

Evidence supporting the monophyly of carangoids and several major groups of carangids is discussed below. Refer to G. D. Johnson (this volume) for discussion of interfamilial relationships of the three echeneoid families. The oldest available name for each of the four carangid tribes herein recognized has not been determined but none is proposed as new. No synapomorphies were found to support the inclusion of *Lichia* in the tribe Trachinotini, and its placement is one of convenience in accord with the practice of previous authors and reflects my own subjective bias. Autapomorphies that define *Trachinotus*, *Lichia* and the naucratine genera are not included in the cladogram (Fig. 276) because they are not informative about relationships. These taxa are recognized individually in the figure to make it easier for the reader to determine the character state distributions and the number of species comprising each genus. The Carangini includes approximately 20 genera (Table 127), many not well established, and their osteology poorly known. Until this presumably monophyletic assemblage has been studied in much greater detail no meaningful discussion of relationships will be possible. Several recent authors have considered *Parastromateus* to constitute either a monotypic family or carangid subfamily. Available evidence suggests, however, that it should be assigned to the Carangini.

The following character states are the basis for the hypotheses of carangoid interrelationships inferred in Fig. 276. The presumed derived character state is listed first, followed by discussion of the character in out-groups when necessary.

(1) Freilhofer (1978) made the important observation that in the Nematistiidae, Carangidae, Coryphaenidae, Rachycentridae

and Echeneididae there are one or two tubular ossifications (prenasals) around the anterior extension of the nasal canal. This presumed specialization of the lateralis system is very rare in percoids (also present in the unrelated and highly specialized Toxotidae) and is considered to be a synapomorphy suggesting that these five families constitute a monophyletic group.

(2) The possession of small adherent cycloid scales is a derived character shared by carangoids in contrast to the typically ctenoid scales of most other percoids. Berry (1969) reported that the carangid *Elagatis* has "ctenoid" scales and Zheng (1981) also described the highly modified caudal peduncle scales of *Naucrates* as ctenoid. These scales are not typically "ctenoid" and appear to represent modifications of the carangoid scale-type.

(3) Two separate prenasal canal units, one membranous and one bony (Carangidae) or both bony (echeneoids). In contrast, *Nematistius* has only a single prenasal canal unit.

(4) Loss of the bony stay (Fig. 277) posterior to ultimate dorsal and anal pterygiophores that is present in most other percoids (see Table 127, G. D. Johnson, this volume).

(5) On shoulder girdle, middle part of coracoid with its anterior margin consisting of a lamella of bone broadly extending towards the median cleithral wing (Suzuki, 1962: figs. 36–44). In *Nematistius* the middle and lower parts of the coracoid are rodlike with lamellar bone restricted to its posterior margin (Rosenblatt and Bell, 1976: fig. 8).

(6) Basioccipital with a pair of foramina (Rosenblatt and Bell, 1976: fig. 3) into which anterior processes of the gas bladder extend forward to the region of the inner ear.

(7) Anterior shift of second predorsal bone to the first interneural space and first pterygiophore greatly expanded and plate-like. In carangids, as in most other percoids, the second predorsal bone occupies the second interneural space (predorsals absent in echeneoids), and in both echeneoids and carangids the first dorsal pterygiophore is not greatly expanded.

(8) Spines of first dorsal fin very long and filamentous and only basally connected by interradiial membrane.

(9) Tubular ossifications surrounding both prenasal canal units;

TABLE 127. CONTINUED. EXTENDED.

Br. rays	Inferior vertebral foramina	Epural bones	Vertebrae	¹ Predorsal formulae	<u>Dorsal fin</u> <u>Anal fin</u>
7	present	2	10 + 14	0/0+0/1+1+1/	<u>IV-V, 41-44</u> <u>II+I, 35-39</u>
7	absent	2	10 + 14 (2) 10 + 14-15 (1)	0/0+0/2+1/	<u>VIII+I, 23-28</u> <u>II+I, 20-24</u>
7	present	2	10 + 14	0/0+0/2+1/	<u>VIII+I, 23-27</u> <u>II+I, 19-22</u>
7	present	2	10 + 14	0/0+0/2+1/	<u>VIII+I, 24-26</u> <u>II+I, 21-23</u>
7	present	2	10 + 14	0/0+0/2+1/	<u>VIII+I, 20-24</u> <u>II+I, 16-20</u>
7	present	2	10 + 14	0/0+0/2+1/	<u>VIII+I, 28-36</u> <u>II+I, 24-32</u>
7	present	2	10 + 14	0/0+0/2+1/	<u>VIII+I, 21-22</u> <u>II+I, 17-18</u>
7	present	2	10 + 14	0/0+0/2+1+1/	<u>VIII+I, 24-32</u> <u>II+I, 17-28</u>

¹ Methodology of predorsal formulae after Ahlstrom et al. (1976).

posterior canal unit unossified in carangids and absent in Nematistiidae.

(10) Absence of the so-called beryciform foramen in the anterior ceratohyal.

(11) Absence of predorsal bones.

(12) Several anal pterygiophores anterior to the first haemal spine (versus one in Carangidae, Nematistiidae and most percoids).

(13) Larvae very elongate, with dorsal fin ray development not completed until two or three times size at flexion (G. D. Johnson, this volume). In contrast, larvae of carangids are moderate to deep-bodied and complete dorsal and anal fin development in conjunction with or soon after flexion (Laroche et al., this volume). Larvae of Nematistiidae are unknown.

(14) Posteroventral elongation of first proximal pterygiophore of anal fin resulting in a relatively wide gap (Fig. 278b-e) between the last two anal spines. The carangid genera *Elagatis* and *Seriolina* (Fig. 278c) are exceptional in having only one spine on this pterygiophore so the gap is not as apparent.

(15) Presence of a separate dorsal division (A_1') of the adductor mandibulae muscle originating on the suborbital shelf (Fig. 279). The relative size of the suborbital shelf in carangids is not correlated with the presence or absence of this muscle, which is also lacking in echeneoids, *Nematistius* and most percoids.

(16) Some lateral line scales (at least those on caudal peduncle) modified as thickened scutes.

(17) Caudal-peduncle grooves present dorsally and ventrally; these specialized structures undoubtedly have a hydrodynamic function related to swimming mode. *Campogramma*, which appears to be the most advanced naucratine (judging from the relatively large number of autapomorphic characters that it possesses), is exceptional in having only rudimentary caudal-peduncle grooves (absent in young).

The occurrence of caudal-peduncle grooves on *Nematistius* which shares many plesiomorphic characters, including a similar external morphology, with naucratines is most parsimoniously interpreted as parallelism. These structures are also present on carcharhinid sharks.

(18) Premaxilla non-protractile and in adults dorsal margin of upper lip attached to snout by a broad frenum.

(19) Epiotics broadly united along midline of cranium beneath the supraoccipital.

(20) Total vertebrae 26 or 27 (versus 24 or 25).

(21) Cheeks unscaled.

(22) Spines of dorsal and anal fins with well developed venom glands (Halstead et al., 1972; Sazima and Uieda, 1979).

(23) First proximal pterygiophore of anal fin expanded anterolaterally to form a roof over anal spines (Smith-Vaniz and Staiger, 1973: fig. 15b).

(24) Juveniles with two widely spaced rows of dentary teeth

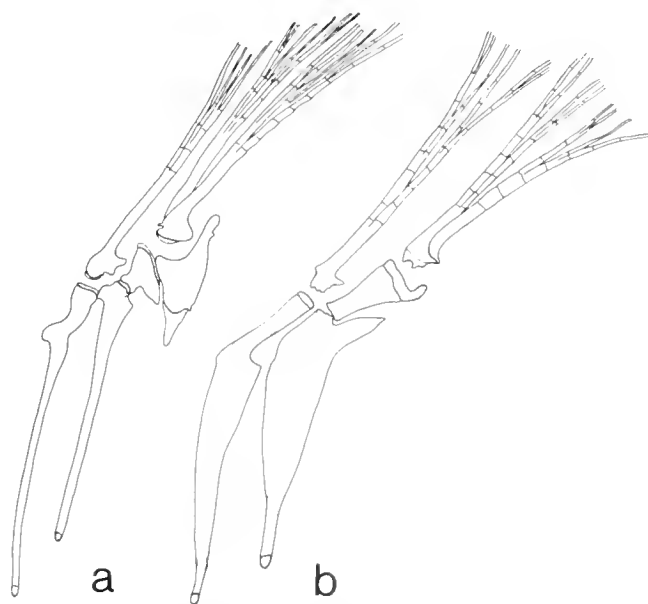

Fig. 277. Terminal pair of dorsal fin rays and associated pterygiophores: (a) *Nematistius pectoralis* (Note presence of large bony stay behind last medial pterygiophore) and (b) *Naucrates ductor*.

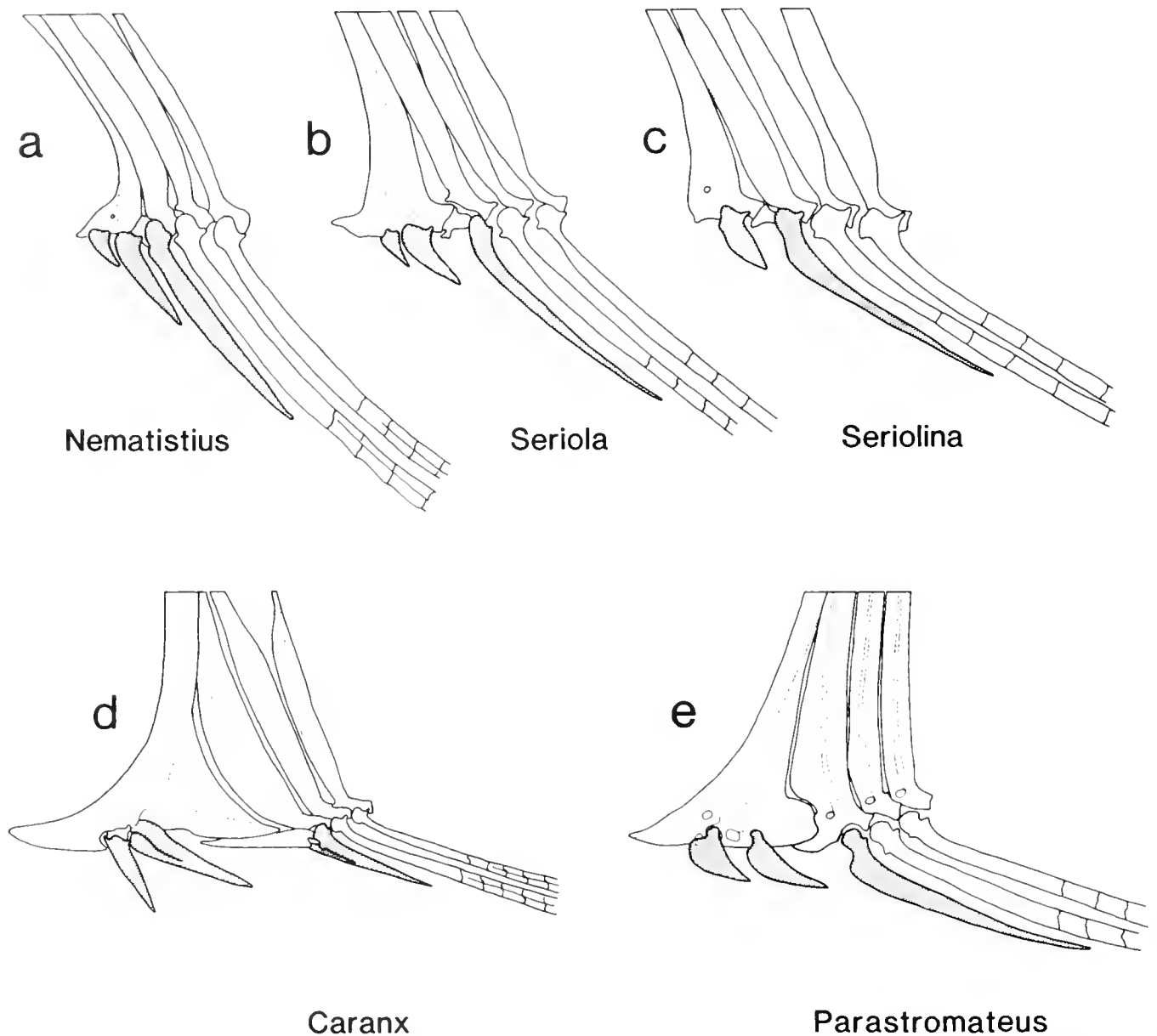

Fig. 278. Anterior pterygiophores and associated spines and rays of anal fin (Note relative spacing between last two spines): (a) *Nematistius pectoralis*; (b) *Seriola zonata*; (c) *Seriolina nigrofasciata*; (d) *Caranx sexfasciatus*; (e) *Parastromateus niger*.

into which the premaxillary teeth fit when the mouth is closed, and the outer series of dentary teeth strongly hooked outward and with spatulate tips. Major (1973) has shown that this dental arrangement facilitates lepidophagous feeding in juvenile *Scomberoides* and, on the basis of stomach content analyses of two species, concluded that at least some *Oligoplites* have similar feeding habits. Carr and Adams (1972) postulated that intentional removal of ectoparasites is also an important activity in juvenile *Oligoplites*. Presumably such unique dentition facilitates both types of specialized trophic ecology.

(25) Interosseous space between coracoid process of dentary and posterodorsal projection of anguloarticular minute or absent.

(26) Pleural ribs on vertebrae 3 through 7 or 8 attached high on centrum and spatulate in cross-section.

(27) Posterior dorsal- and anal-fin rays consisting of semi-detached finlets.

(28) Reduction in number of epurals in caudal fin from 3 to 2.

(29) Supramaxilla minute or absent. It might be argued that the reductive-loss supramaxilla character state is a synapomorphy uniting *Trachinotus* + *Lichia* with the Scomberoidini, in which case the well developed supramaxilla of *Parona* would constitute a reversal. Alternatively, the reductive trend of the supramaxilla in the two taxonomic pairs under consideration might be a simple case of parallelism. In the absence of any other obvious synapomorphy that supports the first hypothesis

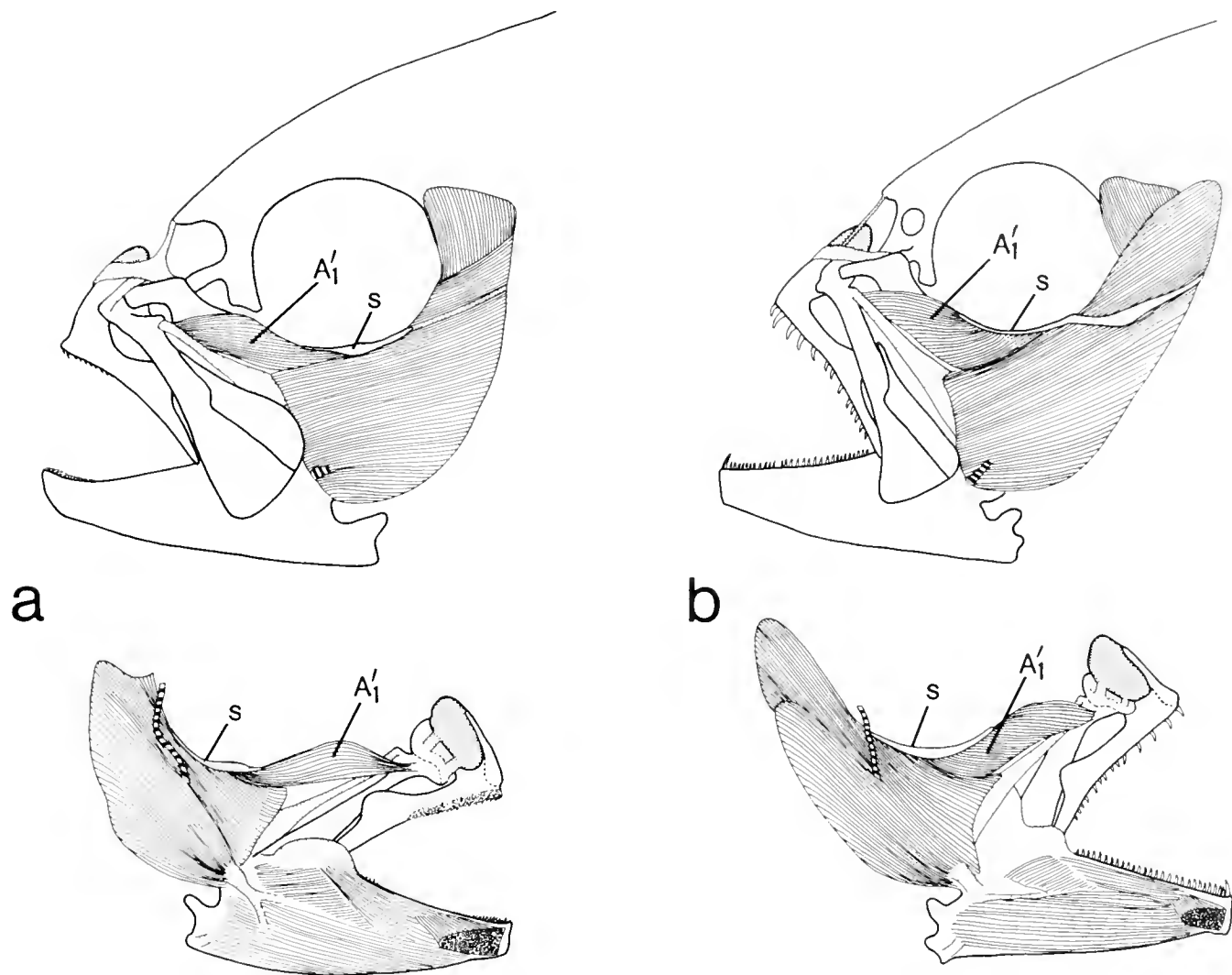

Fig. 279. Adductor mandibulae: (a) *Seriola dumerili*; (b) *Caranx sexfasciatus*. Note the presence of A_1' , a separate dorsal section originating on the suborbital shelf (S).

and because the reversal of a reductive trend is involved, I believe it is more conservative (even though less parsimonious) to retain the unresolved position of *Trachinotus-Lichia* in the cladogram.

(30) Pelvic fins absent at all stages of development.

(31) Increase in number of caudal vertebrae from 16 to 17.

(32) Branchiostegal rays 9 (versus 7 or 8).

(33) Basibranchial dentition consisting of large median tooth plates, presumably derived from fusion of the large paired tooth plates found in *Scomberoides* and *Oligoplites* (Smith-Vaniz and Staiger, 1973; figs. 24b-d).

(34) Lateral line with 5-9 dorsal branches.

(35) Loss of dorsal-fin spines resulting in an increase in the number of rayless pterygiophores (see Table 127).

(36) Loss of mesopterygoid teeth.

(37) Loss of supramaxilla (minute in *Scomberoides*).

(38) Loss of suborbital shelf on third infraorbital bone.

(39) Infraorbitals 2-4 enlarged and extending posteriorly across cheek in adults.

(40) Prominent dark spots or short bars on sides of adults. Unlike many carangids, the juveniles of both *Scomberoides* and *Oligoplites* are unbarred.

Recognition of the family Nematistiidae

The familial placement of *Nematistius* has long been controversial. Some distinguished ichthyologists (Gill, 1863; Jordan and Evermann, 1896-1900; Berg, 1947) placed it in a separate family while others, most recently Robins et al. (1980), assigned it to the Carangidae. On the basis of a detailed osteological comparison, Rosenblatt and Bell (1976) concluded that *Nematistius* should not be classified with the Carangidae. They also commented on the striking similarities between the Nematistiidae and certain primitive carangids, especially naucratine genera. Almost all of the many features shared by these two

taxa are plesiomorphic character states, the one notable exception being caudal-peduncle grooves.

In addition to possessing different character states 3–8 and 14 as listed above, Freihofer (1963) observed that the Carangidae and Nematistiidae differ in the course of the nerves of the ramus lateralis accessorius (RLA) complex; the former having pattern 9 and the latter pattern 10 (reduced). *Nematistius* also differs in having two foramina in the scapula; a typically large one and a smaller more posteriorly positioned foramen (absent in carangids) that also occurs in the Rachycentridae. Like the two RLA nerve patterns, the derived character state for the two scapular foramina conditions has not been determined. Nevertheless, the inclusion of *Nematistius* in the Carangidae would make the family paraphyletic (unless the three echeeneoid families are also included) and impossible to define based on shared derived characters.

Familial position of *Parastromateus*

Several recent authors have followed Apsangikar (1953) or Suzuki (1962) in recognizing *Parastromateus* either as a subfamily of the Carangidae or as the sole representative of the monotypic Formionidae (=Apolectidae or Parastromatidae). All the

characters used to justify the latter classification, with one exception discussed below, have been autapomorphic characters which can provide no information about relationships. That the genus should be assigned to the Carangidae is clearly indicated by the possession of derived character states 3–5 and 14–16 discussed previously.

Haedrich (1971) noted that *Parastromateus* (=Apolectus) is the only fish with a pattern-9 ramus lateralis accessorius nerve system that has a "pons moultoni." In an addendum to his paper it was suggested that retention of the pons is a primitive character state. It should be emphasized that very few carangoids have been examined for the presence of this easily overlooked structure. Until the distribution of this character has been determined for the major lineages of carangoids, its phylogenetic significance can not be evaluated. Similarly, no data have been presented to substantiate assigning *Parastromateus* to its own subfamily within the Carangidae.

DEPARTMENT OF ICHTHOLOGY, THE ACADEMY OF NATURAL SCIENCES, 19TH AND THE PARKWAY, LOGAN CIRCLE, PHILADELPHIA, PENNSYLVANIA 19103.

Mugiloidei: Development and Relationships

D. P. DE SYLVA

MUGILOIDEI is one of three closely related suborders, together with Sphyranoidei and Polynemoidei, in the Perciformes. The suborder is represented by a single family, the Mugilidae. Until recently, the Atherinidae had been considered close relatives of the Mugiloidei. Within the family Mugilidae, classical morphological taxonomic analyses have been applied to regional groupings rather than to the family as a whole (Weber and de Beaufort, 1922; Roxas, 1934; Smith, 1935, 1947; Schultz, 1946; Ishiyama, 1951; Thomson, 1954; Ebeling, 1957, 1961; Lindberg and Legeza, 1969; Ben-Tuvia, 1975). Hence, the systematics of the family are poorly understood.

Mulletts are characterized by thick, streamlined bodies, deeply forked caudal fin, large cycloid or weakly ctenoid scales, and the lack of a lateral line. The mouth is small, the jaws have small teeth or none, and the gill rakers are long and slender, the latter assisting the pharyngeal jaw apparatus to form a filtering apparatus (Lauder and Liem, 1983). They share, with the threadfins and barracudas, the characteristic of having two widely separated dorsal fins. Two subfamilies of mulletts are recognized, the Mugilinae and the Agonostominae (Jordan and Evermann, 1896–1900). The latter have sessile teeth which attach directly to the jaws, a flat preorbital, and only 2 anal spines in the adult. The Mugilinae have flat labial teeth, if any, connected to the jaws by elongated fibers, a ridged and grooved preorbital, and 3 anal spines in the adult.

The Mugilinae occur worldwide except in polar regions, while the Agonostominae are confined to Central America, the west-

ern Indian Ocean, the tropical west Pacific, and the Australian coastline. Mulletts occur in oceans, bays, estuaries, and fresh water. They are uniformly important as food for humans and an important prey in the food web. They seldom exceed 1 meter.

DEVELOPMENT

Many studies exist on the eggs, larvae, and post-larval stages of mulletts in comparison to other families, but only a few are comprehensive, and most deal with a single species (e.g., Anderson, 1957; Dekhnik, 1973; Farrugio, 1977; Kuo et al., 1973; Lai, 1979; Martin and Drewry, 1978; Sanzo, 1936; Tung, 1973; Vialli, 1937; Yang and Kim, 1962; Yashouv and Berner-Samsonov, 1970). However, a general overview of each stage can be summarized.

Eggs are pelagic, spherical, and transparent, with the surface of the egg being smooth and usually without sculpture (Fig. 280). The yolk is unsegmented, the perivitelline space is narrow, and there is one or more oil globules. During development, several oil globules merge with each other, becoming situated on the yolk sac upon hatching. Egg sizes for various species of European and African mugilids range from 0.6 to 1.3 mm and vary greatly in diameter from one geographic area to another. Although most eggs have similar pigmentation, different species have similar, though sometimes overlapping spawning seasons, which may offer a clue in the analysis of phyletic relationships and mugilid evolution.

Larval pigmentation ranges from relatively light to heavy (Fig.

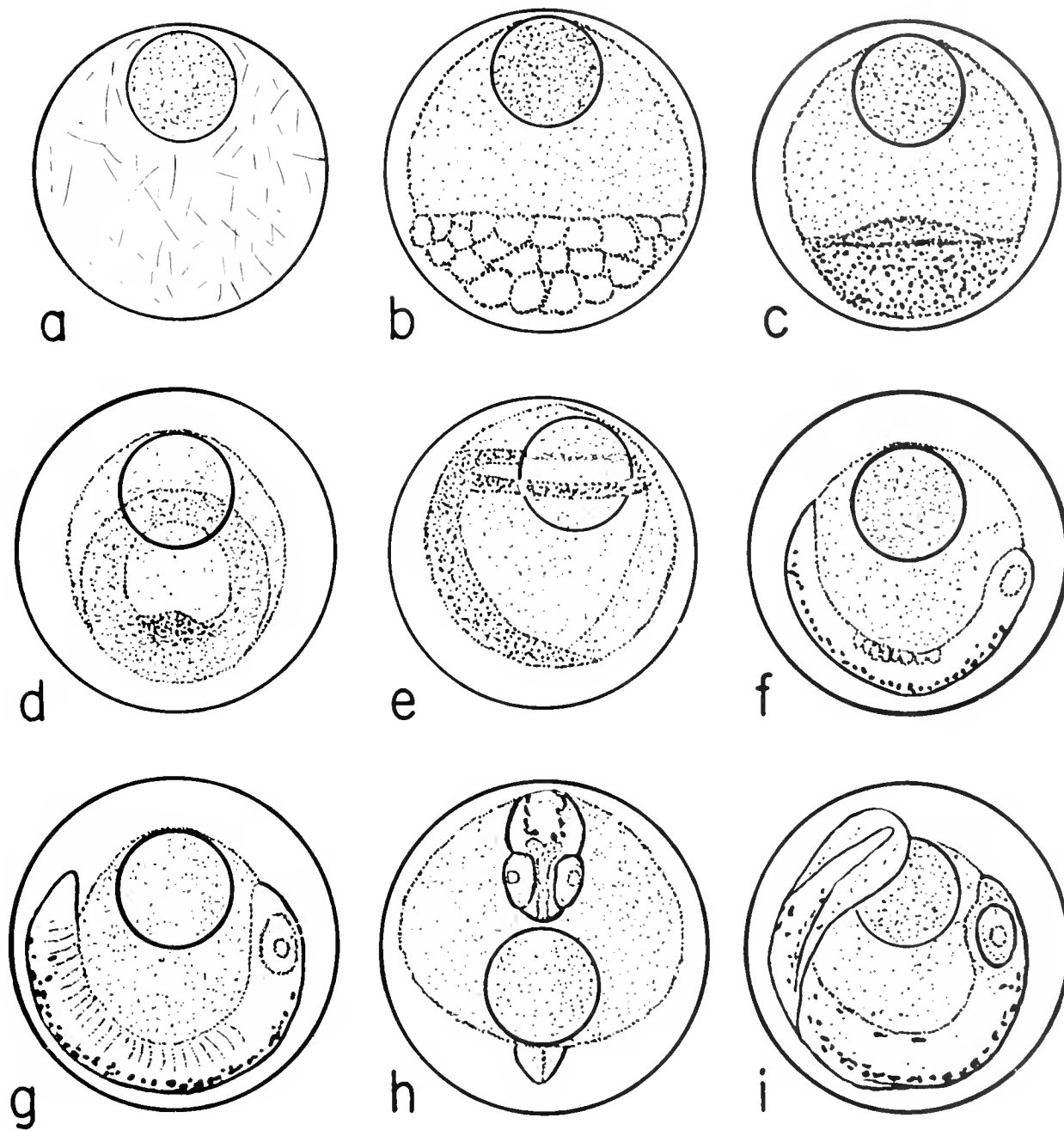

Fig. 280. Various stages of development of eggs of silver mullet, *Mugil curema*: (a) unfertilized eggs; (b) 2 hours after fertilization (32 blastomeres); (c) 4 hours after fertilization (blastodisc well formed, cells small); (d) 8 hours after fertilization (segmentation cavity forming); (e) 12 hours after fertilization (early embryo); (f) 16 hours after fertilization (embryo); (g) 24 hours after fertilization (lateral view of embryo); (h) 24 hours after fertilization (top view of embryo); (i) 32 hours after fertilization (lateral view of embryo) (from Anderson, 1957).

281). All larvae have stellate melanophores on the oil globule, which also occur on the forehead of some species. This feature has not been studied for mugilids on a global basis, but offers possibilities for phyletic analysis.

At hatching, stellate melanophores also occur on the yolk surface and body, with fine spots along the dorsal and ventral profile of the caudal trunk. The caudal rays form first, at 4 mm total length. The second dorsal forms at between 4 and 5.7 mm,

and the first dorsal forms at 5.4 mm. Scales begin to develop at between 8 and 10 mm and are well formed at 11 mm. Pigmentation is strong at from 2 to 5 mm, and the dorsal surface is dark by 5 mm total length. By a length of 8.2 to 10.9 mm they are silvery white to silvery green, and at this size they resemble the adults in body form, there being no distinctive metamorphosis throughout development (Fig. 281).

Identification of later larvae (Fig. 282) is based upon color,

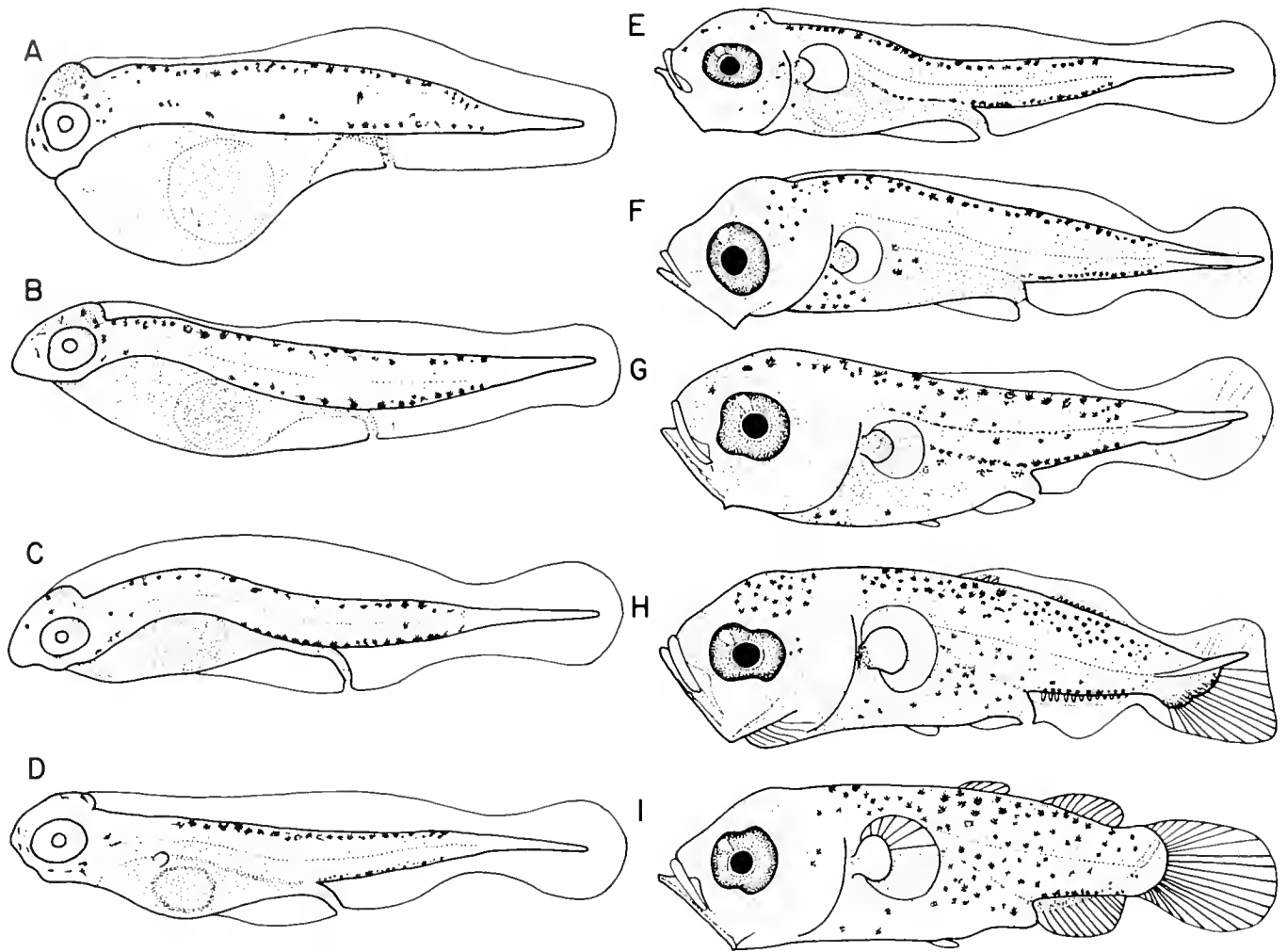

Fig. 281. Larvae of silver mullet, *Mugil curema*. (A) Newly hatched, 1.76 mm; (B) yolk-sac stage, 2.15 mm; (C) yolk-sac stage, 2.47 mm; (D) yolk-sac stage, 2.56 mm; (E) yolk-sac stage, 2.56 mm; (F) 3.7 mm; (G) 4.0 mm; (H) 4.7 mm; (I) 5.3 mm. From Anderson (1957).

pigmentation pattern, number of anal elements, longitudinal scales, transverse scales, scale morphology, pyloric caeca, and gill rakers. The general profiles of the head, lips, and the labial and lingual teeth are also very useful characters (Tung, 1973; Wallace and van der Elst, 1973; Thomson, 1975; Lai, 1979; Zisman, 1982).

RELATIONSHIPS

In some species such as *Mugil cephalus*, as presently understood, which has a worldwide distribution, there is considerable variability in meristic characters and proportional measurements. Additional studies are warranted to determine the real extent of genetic exchange between local subunits (Thomson, 1982).

At the generic and specific levels, mugilid taxonomy has not been resolved. As in the case of *Mugil cephalus*, those species with extensive ranges may be known under different names in various parts of their range.

A variety of external morphology features have been used to identify genera and species of the adult stages, ranging from

dentition (Ebeling, 1957, 1961; Farrugio, 1977) and scales (Thomson, 1982), to eye coloration (Alvarez-Lajonchere, 1975). Internal anatomy is valuable in systematic analysis, including the shape and number of pyloric caeca (Perlmutter et al., 1957; Luther, 1975b), the alimentary tract (Thomson, 1966), intestinal convolution (Hotta, 1955), osteology (Luther, 1975a; Mohsin, 1978; Kobelkowsky and Resendez, 1972; Sunny, 1971; Hotta and Tung, 1972), and otoliths (Morović, 1953).

Phyletic studies within the family have not been undertaken. Thomson's manuscript revision (see Thomson, 1982) recognizes 14 genera and 64 species of the nominal 282 species. Of these, 32 are indeterminate because of inadequate descriptions or missing holotypes. The only published world revision, by Schultz (1946), recognizes 13 genera. Relationships are based upon the adipose eyelid, type of scales, labial characteristics, preorbital shape, and type of habitat. Larval mullets have been studied extensively, but not on a worldwide basis, and no phyletic analysis has been attempted. It is known that in certain species the young stages have 2 anal spines, but larger stages have 3 spines. The younger stages have been referred to as the

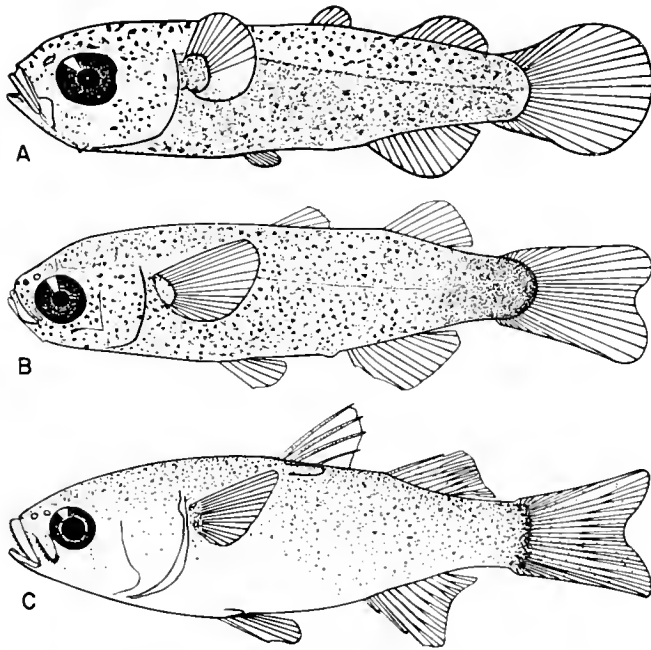

Fig. 282. Postflexion larvae (A, B) and juvenile (C) of silver mullet, *Mugil curema*. (A) 7.0 mm; (B) 14.5 mm; (C) 25.5 mm. From Anderson (1957).

"querimana stage." An analysis of the genera and species possessing this trait has not been undertaken. Biochemical studies on mugilid systematics have been undertaken by Callegarini and Basaglia (1978) and by Autem and Bonhomme (1980) in the Mediterranean, but no studies have been carried out on a worldwide basis.

As stated in the discussions on Sphyraenoidei and Polynemoidei (this volume), they have been closely linked with the Mugiloidei phyletically. Previously, the atherinids had been placed within this assemblage, but Rosen (1964) has clearly shown that the atherinids belong in a separate superorder containing the flyingfishes and livebearers. The Mugiloidei appear more closely related osteologically to the Sphyraenoidei than they are to the Polynemoidei.

A brief history of the higher classification of these groups is reviewed here. The suborder Percosoces had included the Atherinidae, Mugilidae, and Sphyraenidae (Jordan and Evermann, 1868–1900), but Starks (1900) questioned their similarity, though he believed them to be quite close based upon the decided branching of the epiotic crests. Superficially, the mugiloid-sphyraenoid skeleton resembles that of atherinoids, but Hollister (1937) pointed out an important developmental difference between them. In *Atherina*, the lowermost hypural plate develops as a single entity. In *Mugil* and *Sphyraena* this plate forms from two distinct elements. Berg (1940) separated the Mugilidae, with the Sphyraenidae and the Atherinidae, from the Perciformes as the order Mugiliformes because they have abdominal pelvic fins, a relatively primitive character. Rosen (1964) also pointed out the similarities among mugiloids, sphyraenoids, and polynemooids in ossification of the skull, especially the common presence of a subocular shelf, the jaw suspension and feeding mechanism, jaw musculature, and the pharyngobranchial and opercular apparatuses. Further, Rosen stated that "the embryos of mullet (Anderson, 1957) and barracuda (Orton, 1955b) are small and contain a large oil globule A forward-displaced heart is also characteristic of *Oryzias* . . . but not of *Sphyraena* (Orton, 1955b; Shojima et al., 1957), and probably not of *Mugil*."

Removal of the Mugilidae from the suborder Percoidae is supported by studies of blood plasma and plasma proteins (Sul'ya et al., 1960). Plasma proteins of mugilids are less complex than those of any other family considered to be Perciformes, and show relationships to some species of Cypriniformes and Clupeiformes (Gunter et al., 1961). In contrast, plasma proteins of some species of 3 perciform families, the Carangidae, Sciaenidae, and Scombridae, do not differ greatly from those of the Mugilidae. Based on this, the Mugilidae could be regarded either as belonging to the most primitive perciform group or as branching from some early perciform.

The early life history stages do not appear to offer useful hints as to phyletic relations with other taxa, except that the Mugiloidei have 23 myotomes during larval development, a feature shared with the Polynemoidei and Sphyraenoidei.

ROSENSTIEL SCHOOL OF MARINE AND ATMOSPHERIC SCIENCE,
UNIVERSITY OF MIAMI, 4600 RICKENBACKER CAUSEWAY,
MIAMI, FLORIDA 33149.

Sphyraenoidei: Development and Relationships

D. P. DE SYLVA

SPHYRAENIDAE is a closely knit, monogeneric perciform family of the suborder Sphyraenoidei (Gosline, 1971). Schultz (1953) revised the family, which has since been partially modified by Smith (1956b), Williams (1959), and de Sylva (1975) for Indian Ocean species. Six genera, including three new names, were proposed by J. L. B. Smith in his 1956 review of the Indian Ocean species. These have been synonymized by subsequent authors to include the single genus *Sphyraena*, recognized for all living species. Fossil genera have been noted in the Cretaceous and are widespread since the lower Eocene. These are represented by the genera *Sphyraenodus*, *Protosphyraena*, *Prosphyraena*, and *Sphyraena* (see de Sylva, 1963). However, because most fossil generic descriptions are based only upon teeth or dentary fragments, it seems presumptive to attach very great importance to the validation of such genera. In a draft revision of the family, I have recognized the genera named by Smith, as well as other genera previously proposed for other sphyraenids, at the subgeneric level to clarify phyletic relationships on a worldwide basis (Fig. 283; Table 128).

All species are tropical or temperate, and are schooling or solitary predators. They usually live in the littoral zone from the surface to just off the bottom in shelf waters. Several are

epipelagic and are found far from shoal water. They are important food fishes, although one species, *Sphyraena barracuda*, is frequently responsible for ciguatera poisoning (de Sylva, 1963). Maximum size is 180 cm and 48 kg.

There are 20 valid species of the 69 nominal species. Sphyraenids are distinguishable from Polynemidae and Mugilidae by their well-developed fang-like teeth, large mouth, and pointed snout, with the upper jaw not protrusible. Gill rakers may be absent, bristle-like, or limited to one or two at the angle of the gill arch (de Sylva, 1975).

DEVELOPMENT

Eggs of Sphyraenidae have been described for only 3 species, and they are similar in size and pigmentation. Larval stages have been described for 5 (Raffaele, 1888; Barnhart, 1927; Vialli, 1956; Orton, 1955b; Shojima et al., 1957; Marinaro, 1971; Uchida et al., 1958; de Sylva, 1963; Houde, 1972b). Larval stages have been described for 4 of the 20 species, from reasonably complete developmental series (e.g., Figs. 284-287). Osteological development of the neurocranium is described for only 1 species (Gregory, 1933), while the caudal skeleton and urophore complex have been studied for only 3 species (Hol-

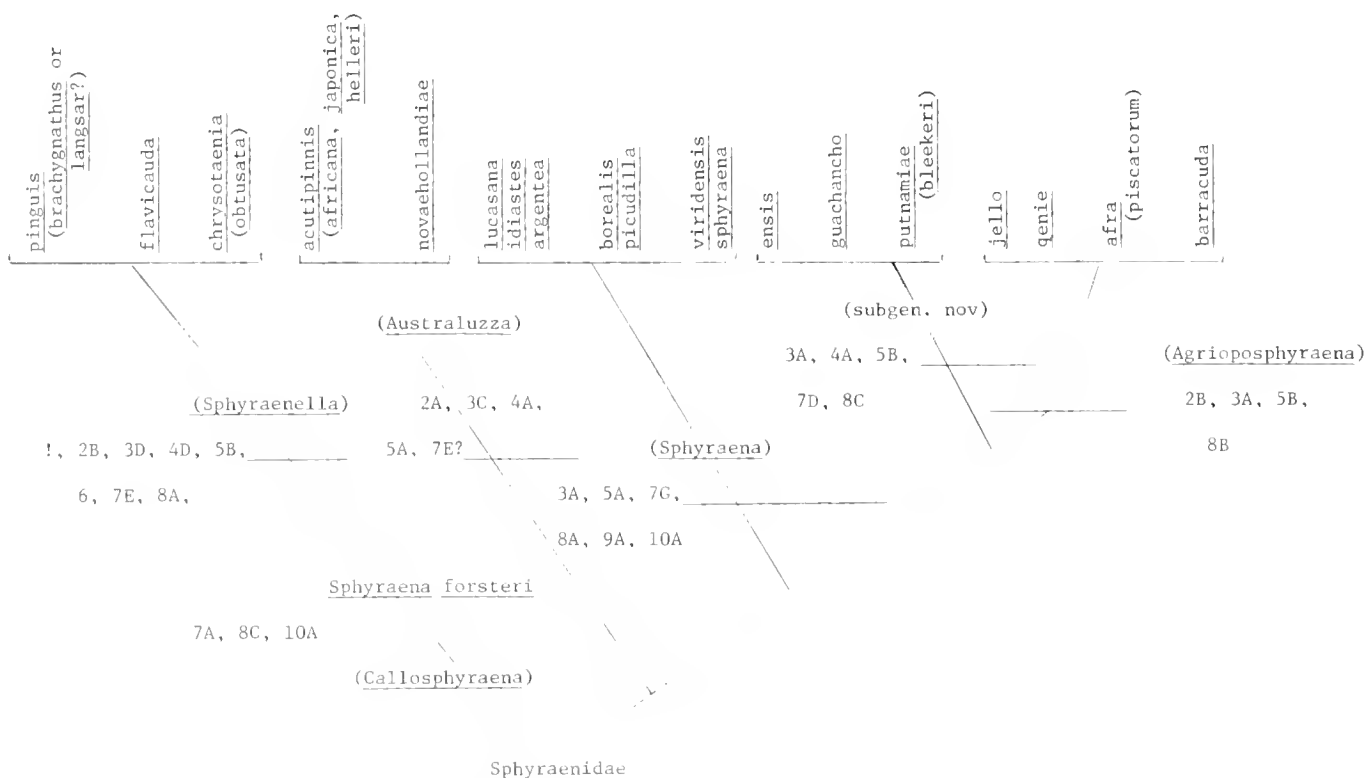

Fig. 283. Diagram of relationships among sphyraenids based on adult and larval characters. Numbers refer to characters listed in Table 128. Labeled horizontal lines cross branches and demonstrate presumed advanced character states.

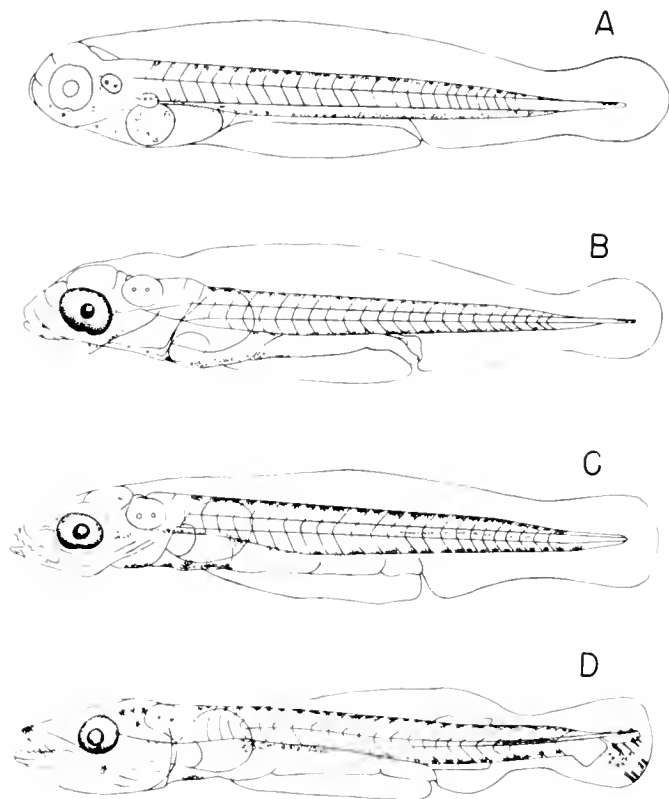

Fig. 284. Developmental stages of *Sphyraena borealis* reared in the laboratory. (A) 3.8 mm; (B) 4.3 mm; (C) 5.3 mm; (D) 7.4 mm (from Houde, 1972b).

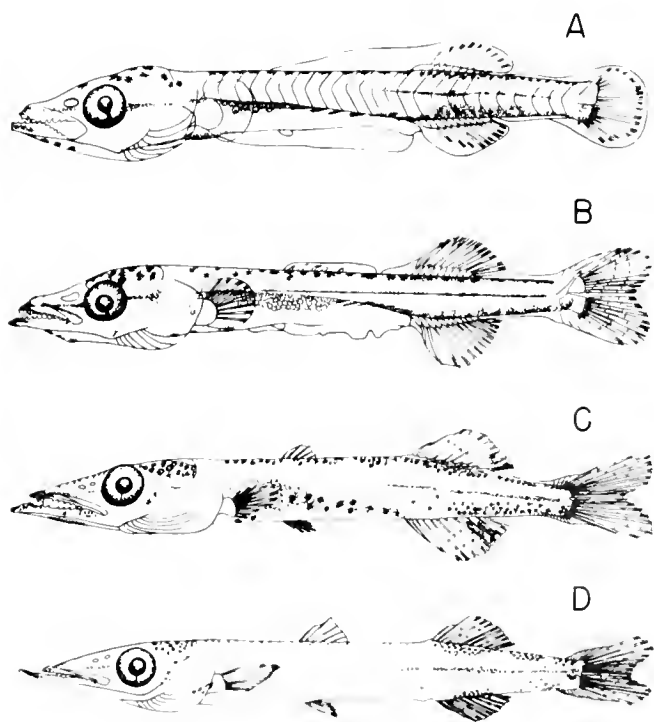

Fig. 285. Developmental stages of *Sphyraena borealis*. Specimens A, B, and C were laboratory reared; specimen D was collected in a plankton net. (A) 9.4 mm SL; (B) 12.3 mm SL; (C) 14.5 mm SL; (D) 21.0 mm SL (from Houde, 1972b).

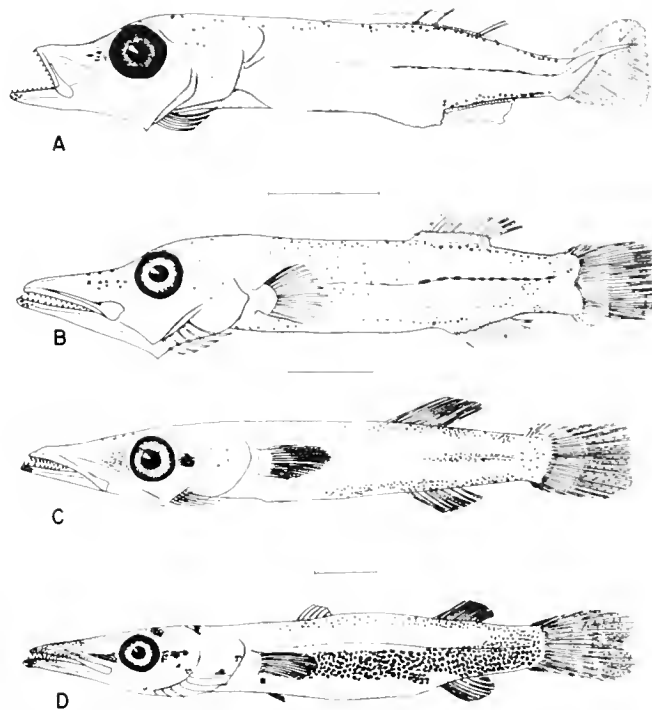

Fig. 286. Drawings showing changes in pigmentation and body form with larval development in *Sphyraena barracuda*. (A) 5.5 mm SL; collected by R/S DANA, Station 1293-V, 17°43'N, 64°56'W, April 17, 1922. (B) 6.6 mm SL; collected by R/S DANA, Station 952, 17°55'N, 64°48'W, May 12, 1921. (C) 8.6 mm SL; collected by R/S DANA, Station 1352-V, 35°42'N, 73°43'W, May 21, 1922. (D) 11.9 mm SL; collected by Donald P. de Sylva, 1 mile southwest of the harbor entrance of North Bimini, Bahamas, June 6, 1956 (from de Sylva, 1963).

lister, 1937; Monod, 1968). Development of *Sphyraena* is direct, with no metamorphosis (Vialli, 1956; de Sylva, 1963; Houde, 1972b).

Meristic characters are not especially valuable in differentiating most adult species of this family. Although little work has been done on larval meristic characters, it would be expected similarly that they would not prove valuable. Anal rays vary from 8 to 9, and the dorsal secondary rays of the caudal fin vary from 9 to 10 in two different subgenera.

Similarly, morphological characteristics do not differ widely in the early life history of the species except that two groups can be broadly identified—those with blunt heads and more fusiform bodies, such as *S. barracuda* (de Sylva, 1963) (Figs. 286, 287) and those with more slender heads and having fleshy tips on the lower jaw and a more slender, tapering body, as in *S. sphyraena* and *S. borealis* (Vialli, 1956; Houde, 1972b) (Figs. 284, 285).

Adult species are distinguished by the shape and angle of the teeth, number of lateral line scales, opercular and preopercular bone configuration, lateral pigment pattern, dorsal fin placement, and kinds of gill rakers.

In *S. barracuda*, adult characters are acquired over a size range of from 5.5 to 213 mm. Pigmentation is acquired gradually from about 5.5 mm to 24 mm, then rapidly above that size.

In *S. barracuda*, the caudal fin forms first followed by the

TABLE 128. CHARACTERISTICS OF SPHYRAENIDAE. (+ = occurs in this species; - = does not occur in this species; 0 = no information.)

Characters	<i>Sphyraena forsteri</i>	<i>S. pingus</i>	<i>S. flavicauda</i>	<i>S. chryso-taenia</i>	<i>S. helleri</i>	<i>S. acuti-pinnis</i>	<i>S. novae-hollandiae</i>	<i>S. lucasana</i>	<i>S. idastes</i>	<i>S. argentea</i>
1. Meristic										
Lat. line scales	112-123	88-92	84-88	85-96	120-128	122-128	130-155	126-137	145	166
2. Maximum length (mm), SL	640	350	320	231	800	434	500	467	530	907
3. Gillrakers										
a. Absent	-	-	-	-	-	-	-	+	+	+
b. Occur as spinules	+	-	-	-	-	-	-	-	-	-
c. One	-	-	-	-	+	+	+	-	-	-
d. Two	-	+	+	+	-	-	-	-	-	-
4. Lower jaw										
a. With fleshy knob	-	-	-	-	+	+	+	+	+	+
b. Without fleshy knob	+	+	+	+	-	-	-	-	-	-
5. Dorsal fin										
a. Above pelvis	-	-	-	-	+	+	+	-	-	-
b. Behind pelvis	+	+	+	+	-	-	-	+	+	+
6. Scales										
a. Cycloid	0	-	-	-	0	+	+	+	+	+
b. Ctenoid	0	+	+	+	0	-	-	-	-	-
7. Adult pigment (lateral)										
a. Axial spot beneath pectoral fin	+	-	-	-	-	-	0	-	-	-
b. Vertical bars	-	-	-	-	-	-	0	+	+	+
c. Vertical bars festooned	-	-	-	-	-	-	0	-	-	-
d. Chevrons angled forward	-	-	-	-	-	-	0	-	-	-
e. Stripes (one or two)	-	+	+	+	+	-	0	-	-	-
f. Inky blotches on lower sides	-	-	-	-	-	-	0	-	-	-
g. No lateral markings	-	-	-	-	-	+	0	-	-	-
8. Teeth										
a. Conical, widely spaced	-	+	+	+	+	+	+	+	+	+
b. Flattened, erect, contiguous	-	-	-	-	-	-	-	-	-	-
c. Flattened, angled backward, contiguous	+	-	-	-	-	-	-	-	-	-
Larval characters										
9. a. L. jaw with fleshy knob	0	0	0	0	0	0	0	0	0	+
b. L. jaw without fleshy knob	0	+	0	0	0	0	0	0	0	-
10. a. Well-marked pigmentation	0	0	0	0	0	0	0	0	0	-
b. Poorly developed pigmentation	0	0	0	0	0	0	0	0	0	-

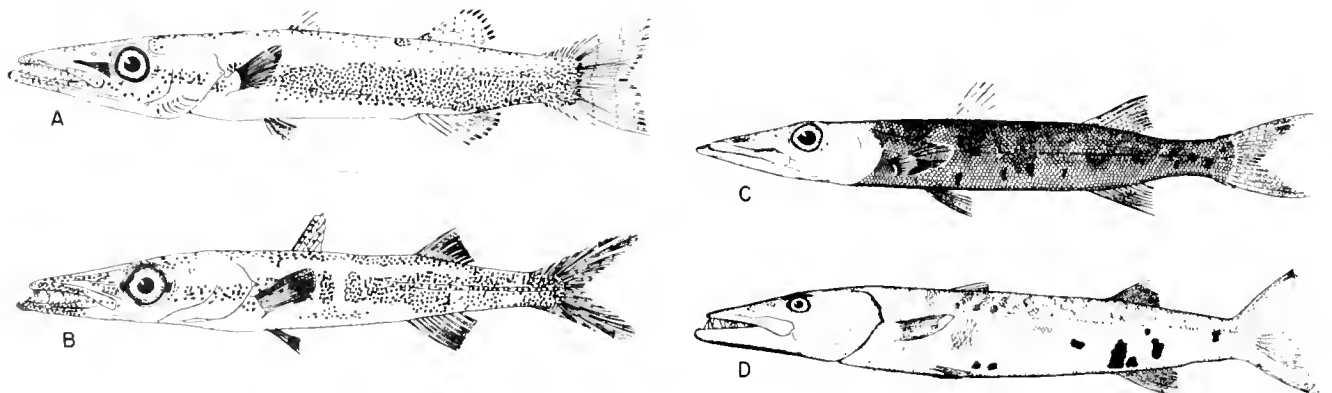

Fig. 287. Drawings showing changes in pigmentation and body form transformations in *Sphyraena barracuda*. (A) 17.2 mm SL; collected by Donald P. de Sylva, 1 mile southwest of the harbor entrance of North Bimini, Bahamas, May 12, 1956. (B) 23.7 mm SL; collected by Donald P. and Doris D. de Sylva, at beach east of Lerner Marine Laboratory, Bimini, Bahamas, July 7, 1956. (C) 213 mm SL; collected by David K. Caldwell, Spanish Harbor Key, Monroe County, Florida, June 7, 1956; University of Florida No. 7072. (D) 790 mm SL; collected by Doris D. de Sylva, north of North Bimini, Bahamas, 25°48'N, 79°17'W, July 18, 1956 (after de Sylva, 1963).

TABLE 128. EXTENDED.

<i>S. borealis</i>	<i>S. picudilla</i>	<i>S. sphyraena</i>	<i>S. viridensis</i>	<i>S. ennis</i>	<i>S. guachancho</i>	<i>S. putnamae</i>	<i>S. jello</i>	<i>S. gene</i>	<i>S. atra</i>	<i>S. barracuda</i>	
115-130	110-120	120-135	137-140	108-116	108-110	129-131	130-140	120-130	122-140	80-90	1
450	400	1,370	540	470	600	873	1,250	1,150	1,720	1,650	2
+	+	+	+	+	+	+	+	+	+	+	} 3
-	-	-	-	-	-	-	-	-	-	-	
-	-	-	-	-	-	-	-	-	-	-	
+	+	+	+	-	-	-	-	-	-	-	} 4
-	-	-	-	+	+	+	+	+	+	+	
-	-	-	-	+	+	+	+	+	+	+	} 5
+	+	+	+	-	-	-	-	-	-	-	
+	+	+	+	+	+	+	+	+	+	+	} 6
-	-	-	-	-	-	-	-	-	-	-	
-	-	-	-	-	-	-	-	-	-	-	} 7
-	-	+	?	-	-	-	-	+	-	+	
-	-	-	-	-	-	-	+	-	-	-	
-	-	-	-	+	+	+	-	-	+	-	
-	-	-	-	-	-	-	-	-	-	+	
+	+	-	-	-	-	-	-	-	-	-	
+	+	+	+	-	-	-	-	-	-	-	} 8
-	-	-	-	-	-	-	+	+	+	+	
-	-	-	-	+	+	+	-	-	-	-	} 10
+	0	+	0	0	0	0	0	0	0	-	
-	0	-	0	0	0	0	0	0	0	+	
+	0	+	0	0	0	0	0	0	0	+	
-	0	-	0	0	0	0	0	0	0	-	

second dorsal fin, and then the pectoral and anal fins (de Sylva, 1963). By 6.6 mm, the second dorsal, anal, and pectoral fins are fully ossified (Fig. 286). By 11.9 mm the first dorsal and pelvic fins have developed. Middorsal and midventral pigmentation is well developed at 9 mm, and is useful in differentiating among larval stages.

Juveniles of most species are unknown, and characters used to separate adult species would be expected to be the most useful, especially pigment patterns.

RELATIONSHIPS

Most sphyraenids in museums have been misidentified. The revision of the family in the Indian Ocean by Williams (1959) has greatly clarified the identification of several important Indo-Pacific species whose identification rests largely upon the pattern of vertical bars or chevrons, festoons (Figs. 288-289), gill raker characteristics, relative eye size, or upon the relative position of the first dorsal fin (de Sylva, 1975). The lack of any analysis of the family based upon osteology, scale morphology (see Bleeker, 1854-1857), or internal anatomy precludes an exhaustive analysis of this family. Electrophoresis and functional enzymic

evolution has related the phylogeny of four eastern Pacific sphyraenids to evolutionary temperatures (Graves and Somero, 1982) and offers much promise for analysis of other fishes. As previously mentioned, fossil sphyraenids are so incompletely described that they shed little light on phyletic affinities.

Because the larvae of only 5 of the 20 species have been described, almost nothing can be deduced about the phylogeny of the family based on larval characters.

Sphyraenids were placed by Starks (1900) in the suborder Percesoces, together with the Mugilidae and the Atherinidae. This is based essentially upon their widely separated dorsal fins, elevated pectoral fins, and the decided branching of the epiotic crests. Hollister (1937) pointed out that while the mugiloid-sphyraenoid skeleton superficially resembles that of atherinoids, there was an important difference in the development of the hypural plates. Rosen (1964) placed the Atherinoidea in a separate order, the Atheriniformes. Greenwood et al. (1966) recognized the Atheriniformes as a superorder, the Atherinomorpha, based upon distinctive habits or morphological peculiarities, and placed in the superorder Acanthopterygii the suborders Mugiloidei, Sphyraenoidei, and Polynemoidei.

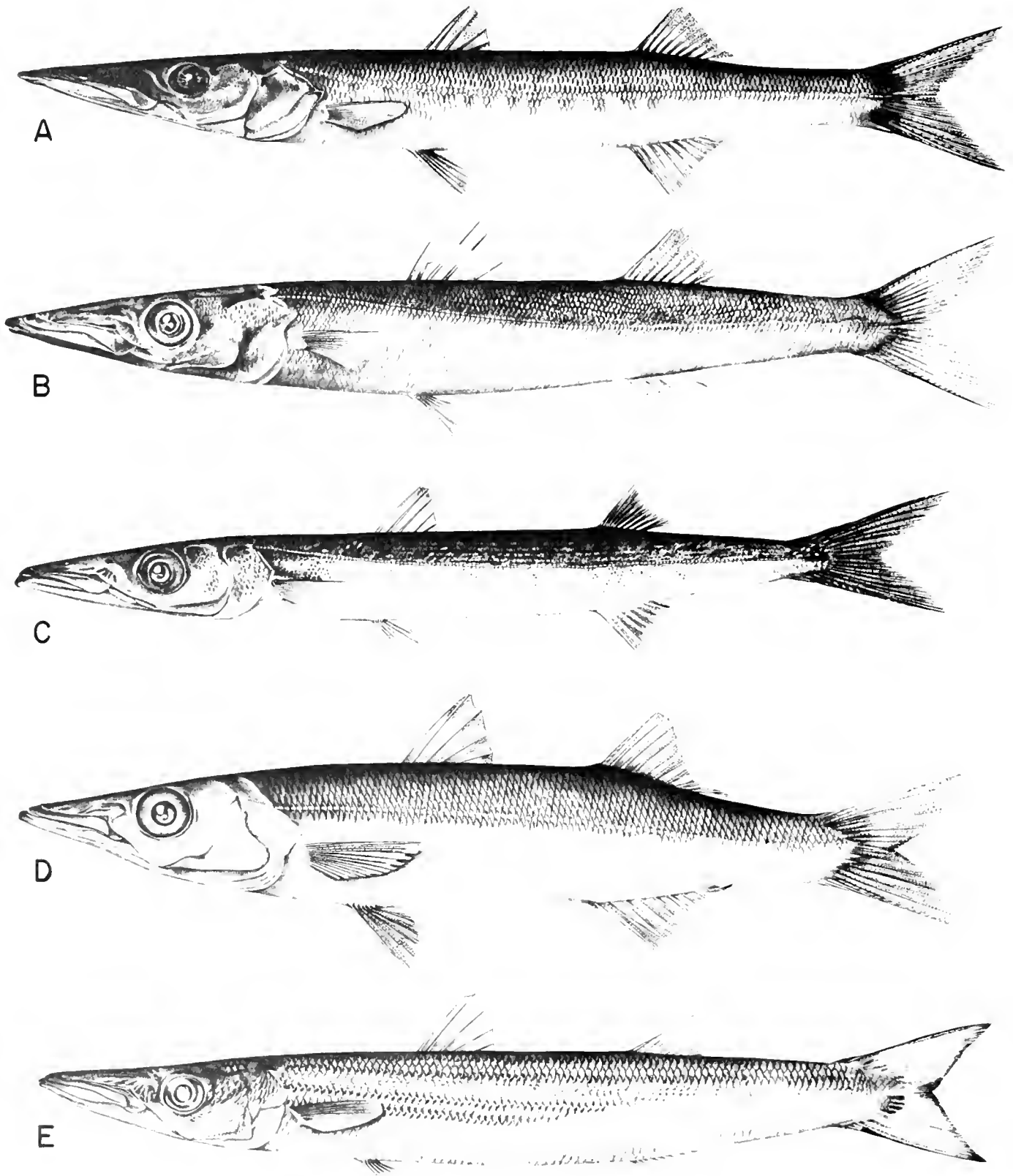

Fig. 288. Variation in lateral pigmentation in various species of *Sphyraena*. (A) *Sphyraena idiaestes*, 21 cm, Galápagos Islands; (B) *Sphyraena acutipinnis*, 27 cm, Hong Kong; (C) *Sphyraena novaehollandiae*, 43 cm, Kapingamarangi, Caroline Islands; (D) *Sphyraena chrysotaenia*, 18 cm, South Africa; and (E) *Sphyraena flavicauda*, 33 cm, Strait of Jubal, Red Sea. (All drawn by J. I. Godfrey.)

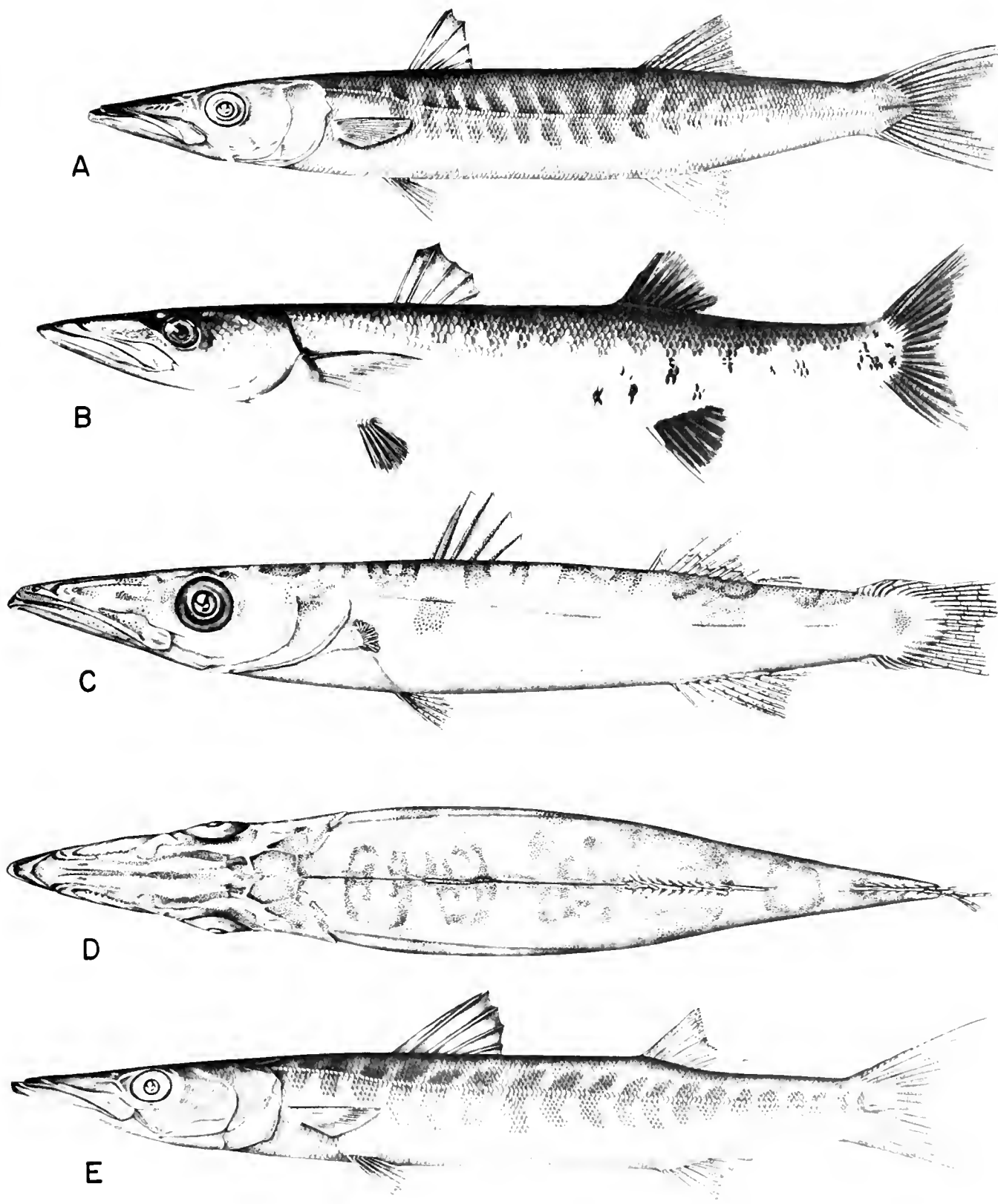

Fig. 289. Variation in pigmentation in various species of *Sphyraena*. (A) *Sphyraena gene*, 29 cm, Makassar, Indonesia; (B) *Sphyraena barracuda*, 63 cm, Biscayne Bay, Miami, Florida; (C) *Sphyraena forsteri*, 5.9 cm, Indonesia, lateral view; (D) *Sphyraena forsteri*, 5.9 cm, Indonesia, dorsal view; and (E) *Sphyraena putnami*, 45.7 cm, Mahé, Seychelles Islands. (All drawn by J. I. Godfrey.)

No other close relatives of the Sphyraenidae have been disclosed, although it has been postulated that the Australian sea pike, family Dinolestidae, is an early offshoot. However, Fraser (1971) critically compared the internal anatomy of the two families and concluded that their apparent similarity is a result of convergent evolution.

Larval characters of the Sphyraenidae do not show any obvious similarity to either the Mugilidae or the Polynemidae. There are only two illustrated accounts of larval Polynemidae (Aboussouan, 1966d; Kowtal, 1972), neither of which discusses familial relationships. Superficially, polynemid larvae resemble

the phyletically distant Sciaenidae. Nor do the Mugilidae resemble the Sphyraenidae in the larval stages. Undoubtedly there are similarities in the larval development of the hypural complex in the Mugilidae and Sphyraenidae, but I am unaware of any published material on this. The question of whether the polynemids should be grouped within the Mugiloidei and Sphyraenoidei is still unresolved.

ROSENSTIEL SCHOOL OF MARINE AND ATMOSPHERIC SCIENCE,
UNIVERSITY OF MIAMI, 4600 RICKENBACKER CAUSEWAY,
MIAMI, FLORIDA 33149.

Polynemoidei: Development and Relationships

D. P. DE SYLVA

POLYNEMIDAE is the only family of the suborder Polynemoidei, containing 37 species, most of which are Indo-Pacific. Seven genera have been recognized: *Galeoides* Günther, *Filimamus* Myers, *Pentanemus* Günther, *Polynemus* Linnaeus, *Polydactylus* Lacepède, *Polistonemus* Gill, and *Eleutheronemus* Bleeker (see Norman, 1930). This is a shallow-water group dwelling on sand or mud bottoms, frequently in turbid water. Most are common in tropical brackish environments, and some species enter rivers. They are important commercial fishes, especially in the Indo-Pacific, where some species reach 2 meters.

The threadfins resemble mullets (Mugilidae), but the snout is pointed and overhangs the large mouth, and the eyes are rather large (Fig. 290). The feature distinguishing them from their close relatives, the barracudas and the mullets, is seen in their 4 to 7 pectoral rays which are detached from the rest of the pectoral fin. Polynemids also differ from mugilids by having a lateral line, absent in mugilids, which extends onto the caudal fin. Polynemids are distinguished from sphyraenids by the absence of fang-like chopping teeth and the rather blunt, terminal mouth characteristic of the Mugilidae. With the mullets and the barracudas they share the characteristic of 2 widely separated dorsal fins. The maxillary attachment, shape of the preopercle, length and number of pectoral filaments, tooth development, and development of the lower lip are important taxonomic characters.

DEVELOPMENT

Little is known about the eggs and larvae of the Polynemidae in comparison to the Mugilidae. Eggs have been obtained through artificial fertilization of *Polydactylus sexfilis* in Hawaiian aquaculture ponds (Morris and Kanayama, 1964–1969; Lowell, 1971; Rao, 1977), but illustrations of the egg and larval stages have not been published. Larval stages of the Indian species *Eleutheronema tetradactylum* from India show developmental stages from egg to 5.5 mm (Sarojini and Malhotra, 1952; Kowtal, 1972). The small egg, which averages 0.76 mm, has a large oil globule. In the smallest larva described (3.8 mm), caudal fin development has started. Some rays appear in the caudal fin at 4.7 mm, and melanophores occur on the maxillary symphysis and upper side of the pectoral fin bud. A related African species, *Galeoides polydactylus* from Sénégal, shows little development of the dorsal fin at 2.7 mm (Aboussouan, 1966d). The head is

relatively large, with a very large eye, and 23 myotomes can be seen (Fig. 291); they resemble sciaenids. Pigmentation is weak, in contrast to the Mugilidae, except for some melanophores on the opercle, anal fin base, and gut. By 4.3 to 4.4 mm, the two dorsal fins and their rays have formed. At the largest size described, 7.6 mm, pigmentation occurs around the opercular series and posterior trunk, the pectoral filaments are forming, and the mouth is distinctly inferior. No special larval characters occur in this group, and development is direct and without any peculiar metamorphosis.

RELATIONSHIPS

No modern phyletic analysis has been undertaken to delineate the relationships among the 7 genera. The only revision of the family is by Gill (1862). The characters which separate them from one another are the extent of maxillary attachment, shape of the preopercle, length and number of pectoral filaments, and development of the teeth and lower lip. Except for the number of pectoral filaments, those characters at best offer weakly qualitative differences useful in identifying species rather than genera.

Early life history stages shed little light on relationships among members of the Polynemidae. Of the 37 species, larval stages have been illustrated for only 2 species. Osteological studies on the axial skeleton have been carried out on 6 species, based

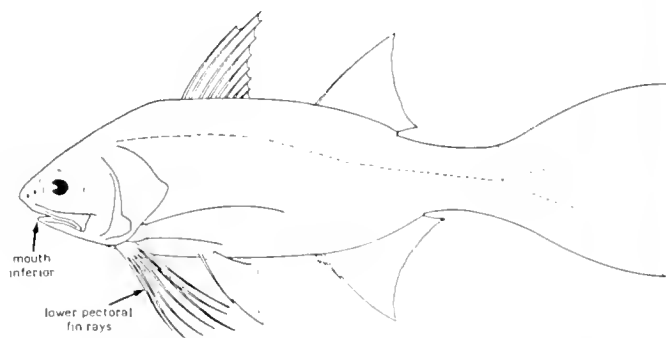

Fig. 290. Major features of the family Polynemidae (from Allen, 1981).

TABLE 129. COMPARISON OF MERISTIC CHARACTERS OF *Mugil* AND *Agonostomus* (MUGILIDAE), *Polydactylus* (POLYNEMIDAE), AND *Sphyraena* (SPHYRAENIDAE) FROM THE WESTERN ATLANTIC OCEAN (DATA FROM MILLER AND JORGENSEN, 1973).

No. of elements	<i>Mugil</i>	<i>Agonostomus</i>	<i>Polydactylus</i>	<i>Sphyraena</i>
Vertebrae	24	25	24	24
Precaudal	12	12	10	12
Caudal	12	13	14	12
First count dorsal fin	5	5	8-9	6
Second dorsal fin	7-8	8	10-12	9
Anal fin	3, 8-9	2, 10	3, 12-13	2, 9
Total caudal elements	28-29	32-34	41-43	35
Dorsal secondary	7	9-10	12-13	9-10
Dorsal primary	7	7	9	9
Ventral primary	7	7	8	8
Ventral secondary	7-8	9-10	12-13	9

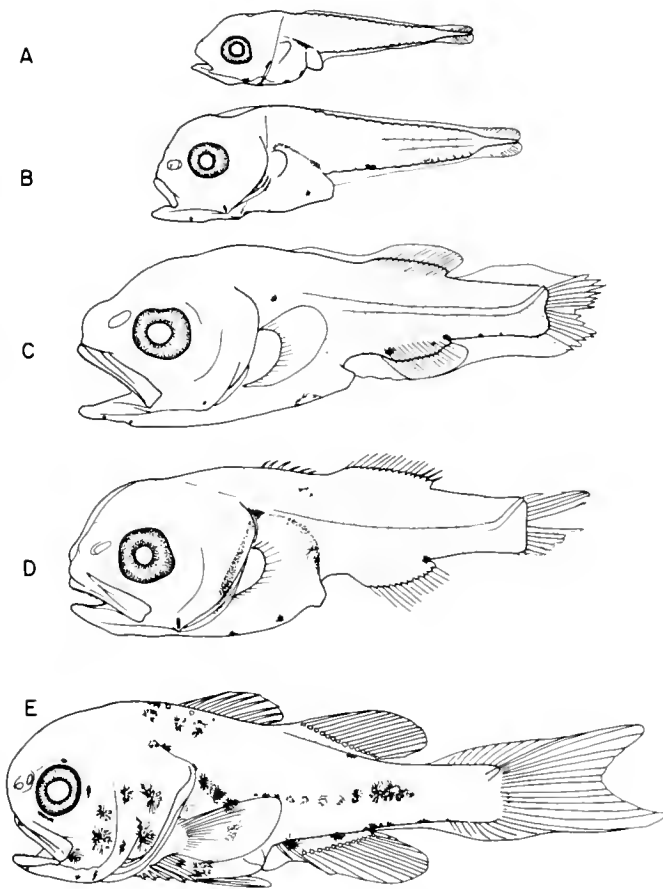

Fig. 291. Larvae of the polynemoid, *Galeoides polydactylus*. (A) 2.75 mm; (B) 3.13 mm; (C) 4.3 mm; (D) 4.4 mm; (E) 7.6 mm. From Abousouan (1966d).

upon adult specimens (Marathe and Bal, 1958). No studies of the external or internal anatomy have been undertaken on any polynemid.

The suborder Percosoces was established by Starks (1900) to show the close relationships among the families Atherinidae, Mugilidae, and Sphyraenidae. To this group Tate Regan (1929) added the Polynemidae, based upon the well-developed cranial crests, the position of the exoccipitals and basioccipitals, the alisphenoid juncture, the poor development of the parapophyses, and the 24 vertebrae shared with the Sphyraenidae. Based upon extensive osteological evidence, Gosline (1962) concluded that the Polynemidae, Sphyraenidae, Atherinidae, and Phallostethoidei are more closely related to one another than to other fish groups, and placed them in a separate order, Mugiliformes. He did, however, show that the Polynemidae, Sphyraenidae, and Mugilidae were more closely related to each other based on the similar number of vertebrae, the postcleithral strut, and the possession of nonadhesive eggs, than to the Atherinidae and Phallostethoidei. The pelvic morphology of the polynemids and sphyraenids is so primitive as to suggest that these groups could not have arisen from any advanced percoid groups, and that they must be derived from a very low level of percoid.

Gosline (1971) removed the Phallostethoidei from the suborder Mugiloidei (the old Mugiliformes), but concluded that the superfamily Atherinoideae belonged in this suborder together with the superfamilies Polynemoidae, Sphyraenoideae, and Mugiloideae. However, Rosen (1964) had removed the atherinoids from the percococine group and had established them as part of a new, separate order, the Atheriniformes, a practice followed widely today. Thus, the Polynemoidei, Sphyraenoidei, and Mugiloidei have no relatives closer to them than they are to each other. These are presently recognized as separate suborders within the order Perciformes.

There is no salient feature in the early life history which relates the Polynemoidei to other taxa. The development of the eggs and larvae of Polynemoidei, Mugiloidei, and Sphyraenoidei seem to follow approximately the same pattern, and all have pelagic eggs. However, a major departure of the Polynemoidei from the other two is that one species, *Polydactylus sexfilis*, is a protandrous hermaphrodite. It matures first as a male at a fork length of about 20 to 29 cm, and then transforms into the female at between 30 and 40 cm following a hermaphroditic stage (Santerre and May, 1977). As far as is known, none of the Mugiloidei or the Sphyraenoidei is ever hermaphroditic.

Comparisons of meristic characters offer some noteworthy data (Table 129). The vertebral count of the Polynemoidei is $10 + 14 = 24$; the other two suborders have a count of $12 + 12 = 24$. The number of dorsal and anal elements of the Mugiloidei and Sphyraenoidei resemble each other more closely than they do the Polynemoidei. The vertebral formula, as well as the number of dorsal and anal elements, are more closely related to the Gerreidae. In fact, the habits of the Polynemoidei closely resemble those of the Gerreidae. To my knowledge, there is nothing published on the early life history of the Gerreidae which might disclose any similarities to the Polynemidae.

The Polynemoidei (i.e., *Polydactylus*) have a higher number of first dorsal, second dorsal, anal, and caudal elements than the other groups (Table 129). However, a comparison on a worldwide basis is required before such an analysis can reveal phyletic relationships.

ROSENSTIEL SCHOOL OF MARINE AND ATMOSPHERIC SCIENCE,
UNIVERSITY OF MIAMI, 4600 RICKENBACKER CAUSEWAY,
MIAMI, FLORIDA 33149.

Labroidei: Development and Relationships

W. J. RICHARDS AND J. M. LEIS

THE most recent concept of this group concludes that the Pomacentridae, Cichlidae, Embiotocidae, and Labridae comprise a monophyletic assemblage (Kaufman and Liem, 1982). Kaufman and Liem (1982) include the Odacidae and Scaridae in the expanded family Labridae. For present purposes, we employ the traditional view of three separate families. Pomacentridae is a large primarily marine family of about 23 genera and 230 species found in the tropics and warm temperate waters of the world's oceans (Allen, 1975a). Cichlidae is a fresh and brackish water family found in the Americas, Africa including Madagascar, coastal western Mediterranean, and the coastal areas of India. It is a large family comprised of about 85 genera and perhaps 700 species making it the second largest perciform family (Stiassny, 1981). Embiotocidae is found only in the North Pacific with 2 species around Japan and Korea, 18 off the west coast of the U.S., and 1 confined to freshwater of California (Tarp, 1952). Labridae is a tropical and warm temperate marine family of about 58 genera and about 400 species (Russell, 1980). Odacidae is a temperate marine group of 4 genera and 12 species confined to New Zealand and southern Australia (M. F. Gomon and J. R. Paxton, pers. comm.). Scaridae is a tropical marine family of about 12 genera and 70 species (Schultz, 1958). Table 130 summarizes meristic characters of labroid fishes.

DEVELOPMENT

The family Embiotocidae is a small family of viviparous species that has several unusual morphological specializations during development as reviewed by Wourms (1981). During gestation, the vertical fins hypertrophy and develop spatulate extensions, and the alimentary canal hypertrophies, especially the hind gut. All these specializations appear due to viviparity and are not treated further here.

Cichlidae, so far as known, all undertake elaborate parental care (Breder and Rosen, 1966). The eggs are slightly elliptical or irregularly shaped. The eggs are also adhesive except for those which are orally incubated. There is a vast literature on reproductive behavior most of which describes spawning behavior and parental care, but there is little descriptive information on larvae since many species transform directly from yolk sac to juvenile (Balon, 1981b; Noakes and Balon, 1982). Balon (1959) described the young of *Cichlasoma cyanoguttatum*. The larvae

of laboratory reared *Cichlasoma octofasciatum* are depicted in Fig. 292. The larvae of *Pterophyllum* have an adhesive disk on the head for attachment to substrate and several stages are depicted in photographs in Innes (1956). The *Cichlasoma* larvae (Fig. 292) have unusual structures on the head though they were not observed to be used as holdfast organs (A. W. Kendall, pers. comm.). Larvae of *Symphysodon* cling to the mucus of the parent and actually derive nourishment from it (Breder and Rosen, 1966). Balon (1977) thoroughly describes the development of *Labeotropheus*, a mouth brooder which has direct development.

Pomacentridae have demersal eggs with an adhesive pedestal; the male guards and incubates them. Few species have been studied from an early life history perspective (Table 131). Most have pelagic larvae, but at least one species (*Acanthochromis polyacantha*) broods and protects the young in a manner similar to cichlids (Robertson, 1973). Larval development is direct with few larval specializations and no specialized stages between larvae and juveniles. The sequence of fin formation is variable. All fins may be formed as early as 3 mm, but depending on species, settlement may not occur until 18 mm. The gut is coiled at hatching. The larvae are very similar to percoids and may be easily confused with numerous families (Leis and Rennis, 1983). In general they have a short, coiled, triangular gut, an inconspicuous gas bladder which is covered by melanophores, and weak preopercular spination (Fig. 293).

Some early life history information is available on about one-half of the labrid genera (Table 130). The vast majority of labrids spawn small (0.5–1.1 mm) pelagic eggs, but three northeast Atlantic genera have adhesive, demersal eggs with parental care (Table 131). Demersal labrid eggs are small (<1 mm) and adhesive, but do not have an adhesive pedestal. Labrid eggs usually have a smooth chorion and a single oil globule. Newly hatched larvae have the yolk sac protruding anteriorly in front of the head with the oil globule (if present) at the anteriormost position. The larvae are generally elongate and laterally compressed with a deep caudal peduncle, but some species are deep-bodied (Fig. 294). The gut is rugose and is initially straight; coiling may be delayed until after flexion in some species. The head is compressed and almost always lacks spines. Scales do not form prior to settlement. In tropical forms the eye may be round, ovoid,

TABLE 130. SOME MERISTIC CHARACTERS OF LABROID FISHES. N is the approximate number of recent species largely after Nelson (1976). Other data from Gunther, 1862; Boulenger, 1915; Tarp, 1952; Miller and Jorgensen, 1973; Russell, 1980; Leis and Rennis, 1983; Sanchez, 1981; and J. R. Paxton, pers. comm.

	N	D	A	P ₁	P ₂	Vertebrae
Cichlidae	700	IX–XXV, 3–31	III–XIII, 6–28	—	I, 5	24–39
Embiotocidae	23	VII–XVIII, 9–28	III–IV, 13–35	17–29	I, 5	31–42
Labridae	400	VIII–XX, 5–15	III–V, 6–14	11–21	I, 5	23–40
Odacidae	11	XIV–XXVI, 9–23	II–III, 8–14	11–18	0, 0 or I, 4	31–54
Pomacentridae	230	VIII–XVII, 10–18	II, 10–18	14–22	I, 5	26
Scaridae	70	IX, 10	III, 8–9	13–17	I, 5	26

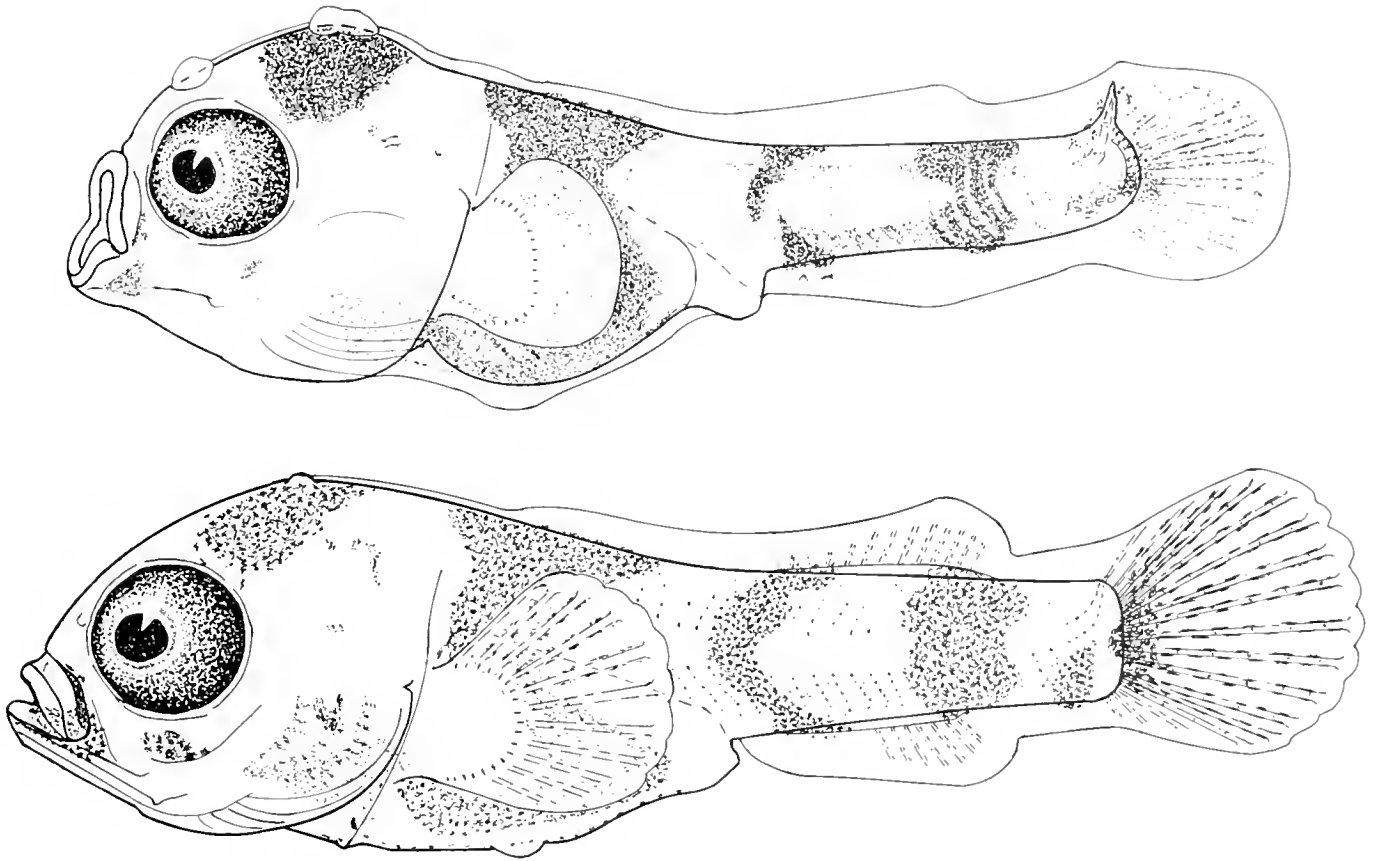

Fig. 292. Larva of (upper) *Cichlasoma octofasciatum*, 5.4 mm SL, laboratory reared, 4 days after hatching, drawn by B. Vinter and (lower) 5.9 mm SL, laboratory reared, 10 days after hatching, drawn by B. Vinter.

squarish, or narrow and have choroid tissue associated with it. Larvae of temperate species tend to have heavy melanistic pigment while tropical forms have few melanophores although erythrophores may be abundant. Meristic characters are very

useful for identifying these larvae. Development is direct, with only the non-round eyes (some with choroid tissue) and elongate fin rays of some species, and perhaps the reduced melanistic pigment of tropical taxa representing larval specializations. Most

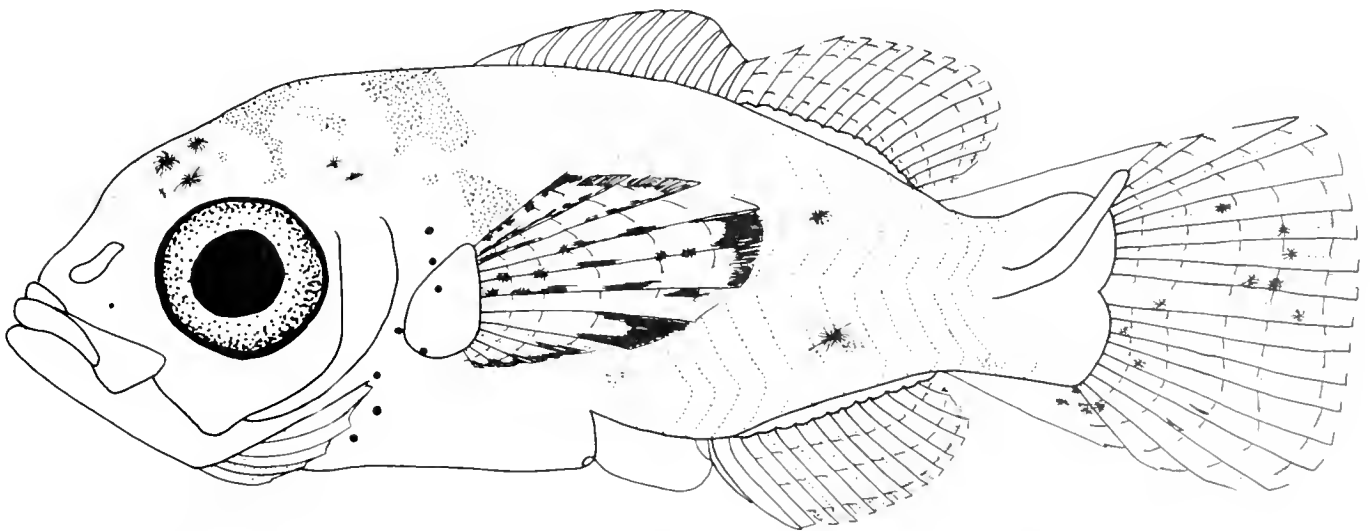

Fig. 293. Larva of *Microspathodon chrysurus* 3.7 mm SL from specimen reared in the laboratory. From MS by Poithoff et al., drawn by J. C. Javech.

TABLE 131. LABROID TAXA FOR WHICH INFORMATION IS AVAILABLE ON EGG AND LARVAL STAGES. References dealing with spawning which do not describe eggs or larva are omitted. YS—yolk-sac stage; pre—preflexion stage; flex—flexion stage; post—postflexion stage; D—demersal, P—pelagic.

Family/genus	Number of species	Egg type	Larvae—developmental stage				References
			YS	Pre	Flex	Post	
Pomacentridae							
<i>Abudefduf</i>	4	D	X	X	X	X	Shaw, 1955; Mito, 1966; Miller et al., 1979; Ré, 1980; Leis and Rennis, 1983
<i>Acanthochromis</i>	1	D		Parental care of larvae			Robertson, 1973
<i>Amphiprion</i>	3	D	X	X	X	X	Delsman, 1930c; Allen, 1972; Vatanachi, 1972; Leis and Rennis, 1983
<i>Chromis</i>	3	D	X	X	X	X	Fage, 1918; Padoa, 1956d; Fujita, 1957a; Turner and Ebert, 1962; Ahlstrom, 1965; Leis and Rennis, 1983
<i>Microspathodon</i>	1	D	X	X	X	X	Potthoff et al., MS
<i>Pomacentrus</i>	1	D		X	X	X	Leis and Rennis, 1983
<i>Stegastes</i>	1	D		X			Miller et al., 1979
Unidentified	Several		X	X	X	X	Nellen, 1973b; Leis and Rennis, 1983
Labridae							
<i>Bodianus</i>	1					X	Richards, 1984
<i>Centrolabrus</i>	1	D				X	Sparta, 1956a; Russell, 1976
<i>Cheilinus</i>	1					X	Leis and Rennis, 1983
<i>Choerodon</i>	1					X	Leis and Rennis, 1983
<i>Cirrhilabrus</i>	1	P	X				Suzuki et al., 1981
<i>Coris</i>	2	P	X	X	X	X	Fage, 1918; Sparta, 1956a; Fourmanoir, 1976
<i>Ctenolabrus</i>	1	P	X	X	X	X	Russell, 1976
<i>Hahchoeres</i>	4	P	X	X		X	Mito, 1962b; Fourmanoir, 1976; Richards, 1984
<i>Imistius</i>	1					X	Masuda and Tanaka, 1962
<i>Labroides</i>	1	P	X				Suzuki et al., 1981
<i>Labrus</i>	2	D	X	X	X	X	Sparta, 1956a; Russell, 1976
<i>Lachnolaimus</i>	1	P	X	X	X	X	Colin, 1982; Kelley, pers. comm.
<i>Novaculichthys</i>	1					X	Vatanachi, 1972
<i>Oxyjulis</i>	1	P					Bolin, 1930; Orton, 1953a
<i>Pseudocheilinus</i>	1					X	Fourmanoir, 1976
<i>Pseudolabrus</i>	3	P	X	X		X	Mito, 1962b; Robertson, 1975a; Crossland, 1981
<i>Pteragogus</i>	1	P	X				Mito, 1962b
<i>Semicossyphus</i>	1	P	X				Orton, 1953a
<i>Stethojulis</i>	2	P	X		X	X	Mito, 1962b; Nellen, 1973b
<i>Symphodus</i>	6	D	X	X			Sparta, 1956a; Russell, 1976
<i>Tautoga</i>	1	P	X	X		X	Kuntz and Radcliffe, 1917
<i>Tautogolabrus</i>	1	P	X	X		X	Kuntz and Radcliffe, 1917
<i>Thalassoma</i>	4	P	X	X		X	Kubo, 1939; Sparta, 1956a; Leis, 1983; Richards, 1984
<i>Xyrichtys</i>	3	P		X		X	Sparta, 1956a; Leis and Rennis, 1983; Richards, 1984
Unidentified	Several	P	X	X	X	X	Kamiya, 1925; Mito, 1962b; Dekhnik et al., 1966; Fourmanoir, 1976; Miller et al., 1979; Crossland, 1982; Leis and Rennis, 1983
Scaridae							
<i>Calotomus</i>	2	P-round	X			X	Kamiya, 1925; Leis and Rennis, 1983
<i>Nicholsina(?)</i>	1					X	Regan, 1916; Aboussouan, 1969
<i>Scarus</i>	4	P-spindle	X				Winn and Bardach, 1960; Mito, 1962b
<i>Sparisoma</i>	5	P-round	X	X			Sparta, 1956a; Winn and Bardach, 1960; Randall and Randall, 1963
Unidentified	Several	P-spindle		X	X	X	Watson and Leis, 1974; Leis and Rennis, 1983; Richards, 1984
Odacidae							
<i>Neoodax</i>	1					X	Regan, 1916
<i>Odax</i>	1	P		X		X	Robertson, 1975a; Crossland, 1982 (as unidentified larva 1)

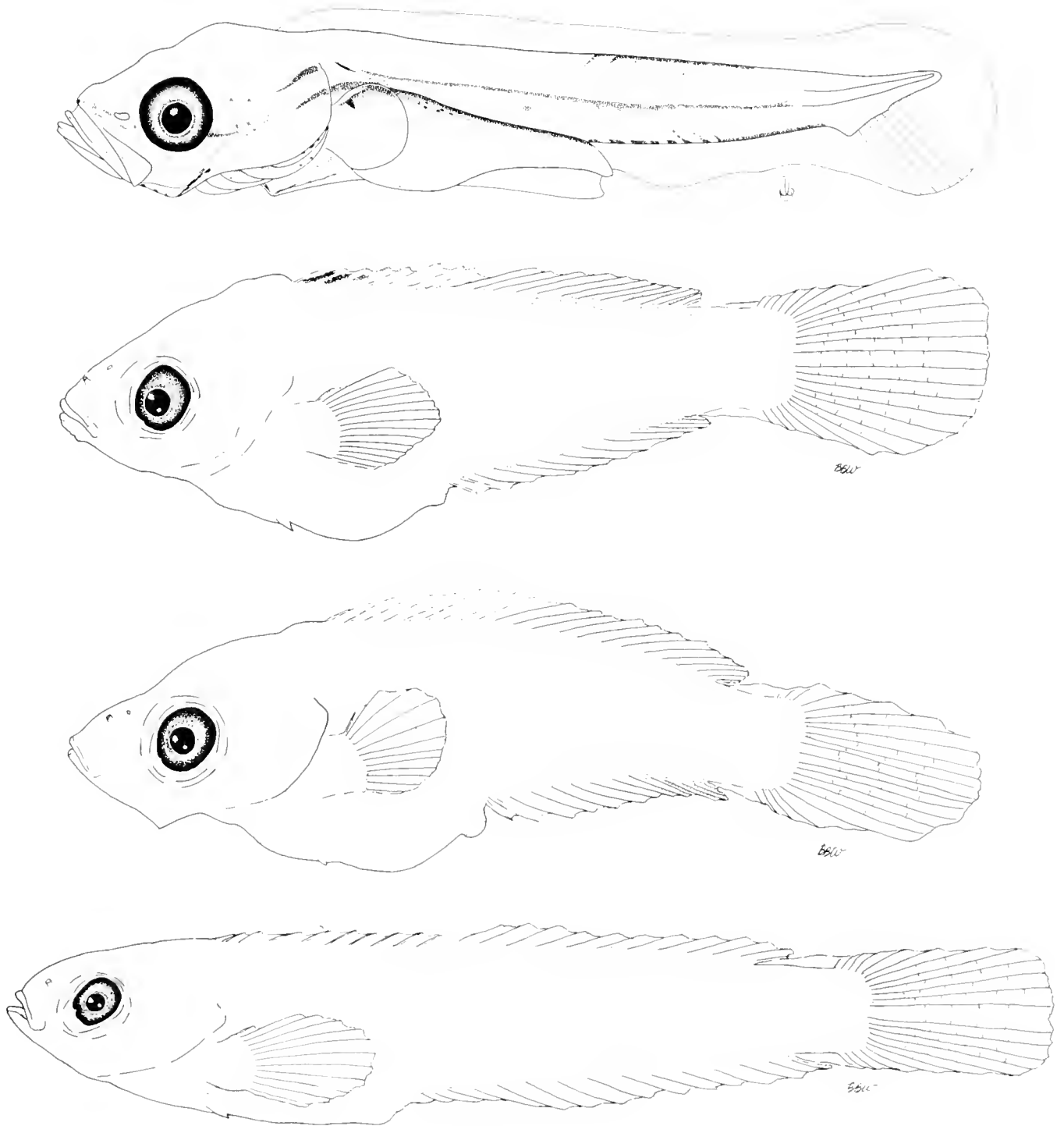

Fig. 294. Labrid larvae from top to bottom: *Lachnolaimus maximus*, 5.0 mm SL, from specimen reared in the laboratory (from MS by Kelley) (drawn by J. C. Javech); *Thalassoma bifasciatum* 8.2 mm SL collected on R/V OREGON II cruise 7239, station 10, 18°00'N latitude, 059°59'W longitude, July 14, 1972 (drawn by B. Washington); *Xyrichtys* sp. (deep body form), 5.0 mm SL, collected on R V OREGON II cruise 7239, station 149, 23°29'N latitude, 079°13'W longitude, August 7, 1972. [Note narrow eyes. Freshly caught specimens have red pigment (erythrophones) on the head, trunk, and tail] (drawn by B. Washington); and *Xyrichtys* sp. (narrow body form), 10.5 mm SL, collected on R V OREGON II cruise 7239, station 149, 23°29'N latitude, 079°13'W longitude, August 7, 1972. Note narrow eyes. Freshly caught specimens have red pigment (erythrophones) on the head, trunk, and tail (drawn by B. Washington).

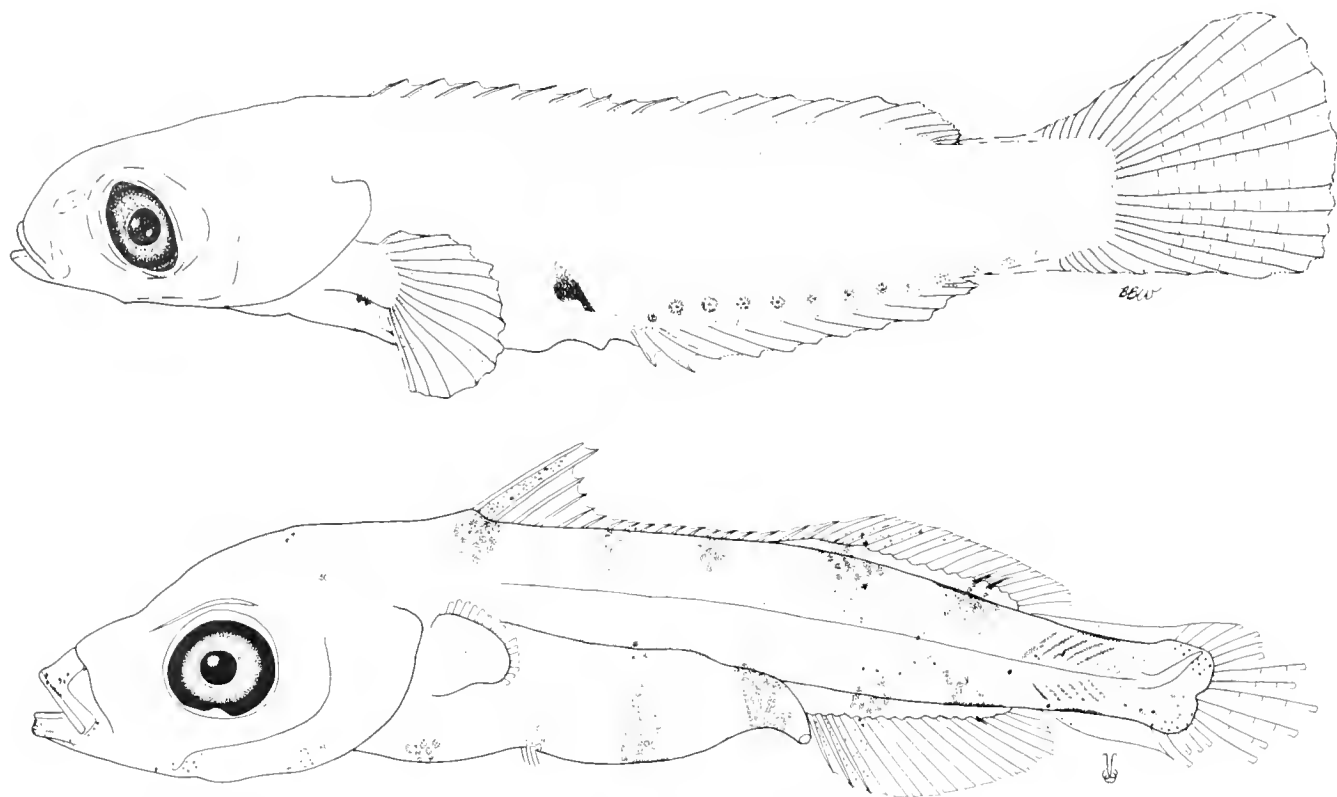

Fig. 295. Larva (upper) of an unidentified scarid, 9.3 mm SL, collected on R/V OREGON II cruise 7239, station 54, 18°58'N latitude, 080°09'W longitude, July 30, 1972; [meristic characters for Atlantic scarids and the labrid *Doratonotus megalepis* are identical] (drawn by B. Washington); and larva (lower) of *Odax pullus*, 12.2 mm SL, from New Zealand (drawn by J. C. Javech).

labrid larvae settle out at less than 15 mm, but some may remain pelagic until 25 mm.

Scarids spawn pelagic eggs: the subfamily Scarinae appears to spawn spindle-shaped eggs, and the subfamily Sparisomatinae to spawn spherical eggs (Table 131). Morphologically, scarid larvae are similar to many labrids: they are elongate and compressed; have an initially straight, rugose gut that later coils; lack head spines; have squarish to narrow eyes; and usually develop choroid tissue (Fig. 295). Scarid larvae differ most strikingly from labrid larvae in melanistic pigment. Scarid larvae consistently have melanophores over the posterior gut and have a ventral series of melanophores on the tail. Melanophores in the cardiac region and dorsally on the caudal peduncle are commonly found in scarids. Melanophores in these regions are either absent or limited to one or two melanophores in tropical labrids. The ventral series of melanophores on the tail of some scarid larvae resembles a set of developing photophores (a histological study is warranted). This ventral pigment plus the narrow eyes and choroid tissue (particularly of sparisomatines) give some scarid larvae a gonostomatid or myctophid appearance, resulting in some identification problems. Scarines seem to settle out at 10 mm or less, while *Calatomus* (a sparisomatine) may remain pelagic until 15 mm.

Little is known of the early life history of odacids, but they spawn pelagic eggs (Table 131), and their larvae are generally similar to elongate labrids with high numbers of myomeres (Table 131). Only three larvae of two species have been described, so it is difficult to generalize, but these are elongate,

compressed, have unlooped guts, no head spines, and round eyes. One species has very elongate, early-forming, anterior spines in the dorsal fin, and a pigment pattern of blotches along the body margins (Fig. 295). The other species is unpigmented and lacks elongate fin elements.

RELATIONSHIPS

Kaufman and Liem (1982) include in the Labroidae the Pomacentridae, Cichlidae, Embiotocidae, Labridae, Odacidae, and Scaridae and further include the Odacidae and Scaridae in the Labridae. They consider the Pomacentridae to be the primitive sister group of all the other labroids, the cichlids the primitive sister group of embiotocids and labrids, and embiotocids the primitive sister group of the labrids.

Labroids are characterized by (1) united or fused fifth ceratobranchials resulting in the formation of one functional unit, (2) a true diarthrosis between upper pharyngeal jaws and the basicranium without an intervening part of the transversus dorsalis anterior muscle, and (3) the presence of an undivided sphincter oesophagi muscle forming a continuous sheet (Kaufman and Liem, 1982).

Kaufman and Liem's (1982) arrangement and composition of the Labroidae receives only limited support from ELH characters. The monophyly of the Labroidae cannot be established from early life history characters. Pomacentrid and cichlid larvae are morphologically and developmentally nearly indistinguishable from many percoid larvae (e.g., mullids, gerreids, sparids), while the labrids, scarids, and odacids are quite dif-

ferent. A cursory study indicates larvae of these latter families share at least four derived characters: almost total lack of head spination; a long, rugose, straight gut which loops relatively late in development; compressed, elongate body; and a reduction in principal caudal ray number from the typical percoid complement of 9 + 8. The "percoid" larval type of the pomacentrids and cichlids might be a primitive character state, but there are no derived characters which unite their larvae with the labrid type of larvae. At least gut development and head spination of the labrids are shared with the pseudochromids, which are generally very similar to some labrid larvae which settle at small sizes (Leis and Rennis, 1983). This may be the result of convergence, but a labrid/pseudochromid relationship should be investigated as an alternative to Kaufman and Liem's (1982) proposed phylogeny.

If Kaufman and Liem (1982) are correct in proposing the pomacentrids as the primitive sister group of the other labroids, then either parental care of hatched young evolved independently in the pomacentrid *Acanthochromis* and the cichlids (viviparity in embiotocids might be a derivation of parental care of eggs and hatched larvae, but this remains to be shown), or was present in a pre-pomacentrid common ancestor and was secondarily lost in all labroids but the cichlids and *Acanthochromis*. Similarly, either demersal eggs and parental care of them evolved independently in some labrids, pomacentrids, and cichlids, or were present in a pre-pomacentrid common ancestor and secondarily lost in most labrids and all scarids and odocids. Therefore, neither demersal eggs nor parental care of hatched young offer much support to Kaufman and Liem's (1982) phylogeny.

ELH characters may be useful in studying the intrafamilial relationships of labroid fishes. Larval labrids are very diverse in development and morphology, and this may prove useful in elucidating labrid interrelationships. Within the labrids, demersal eggs and parental care of eggs are unique to some members of the tribe Labrini. Egg shape and larval morphology support the subfamilial divisions within the Scaridae. Too little is known of pomacentrid and cichlid development to say if ELH characters might be useful in elucidating intrafamilial relationships.

In conclusion, ELH characters support Kaufman and Liem's (1982) labroid phylogeny only in the close relationship of the labrids, scarids, and odocids. In spite of the similarities uniting the three families, there are enough differences between their known larvae to lead us to suggest the labrids, scarids, and odocids should not be combined into one family at this time. M. F. Gomon (pers. comm.) argues that the alternative to combining the three families into one is splitting the group into as many as five smaller families. While we do not advocate this course, the great larval diversity found within the group could provide evidence supporting this alternative. However, ELH information for more genera of labrids, scarids, and odocids must be gathered before firm statements can be made.

(W.J.R.) NATIONAL MARINE FISHERIES SERVICE, SOUTHEAST FISHERIES CENTER, 75 VIRGINIA BEACH DRIVE, MIAMI, FLORIDA 33149; (J.M.L.) THE AUSTRALIAN MUSEUM, 6-8 COLLEGE STREET, SYDNEY 2000, AUSTRALIA.

Acanthuroidei: Development and Relationships

J. M. LEIS AND W. J. RICHARDS

THE acanthuroid fishes are marine, tropical and, except for the pelagic Luvaridae, are associated with coral reefs. The suborder consists of about 110 species distributed among four families: Acanthuridae (Randall, 1955a), Luvaridae (Roule, 1924; Tyler, Nakamura and Collette, MS in prep.), Siganidae (Woodland, 1983), and Zanclidae (we follow Randall, 1981, and consider the Zanclidae distinct from the Acanthuridae). Apparently, all species have a specialized pelagic stage between larvae and juveniles, often referred to as an acronurus larval stage (we prefer to restrict this term to its original usage in the

Acanthuridae). This specialized pelagic stage has provided the basis for the description for many supposedly new species and genera, and has been used as evidence for uniting the group (e.g., Lauder and Liem, 1983). The siganids are usually considered the most generalized (=primitive) family of the suborder, and the zanelids are considered closely related to if not included in the acanthurids (Tyler, 1970). *Luvarus* has recently been shown to be closely related to the acanthurids (Tyler, Nakamura and Collette, MS in prep.). The chaetodontids have been suggested as the percoid group from which acanthuroids were derived

TABLE 132. MERISTIC CHARACTERS OF ACANTHUROID FISHES. N is the number of recent species, principally after Nelson, 1976. Note that in the Luvaridae there is a progressive loss of fin rays from the larval stage (adult counts in parentheses). Maximum larval counts are followed by adult counts in parentheses. (Data from Randall, 1955b, c; Smith, 1966a; Weber and de Beaufort, 1936; Gregory and Conrad, 1943; and Leis and Rennis, 1983).

	N	D	A	P ₁	P ₂	C	Vertebrae
Acanthuridae	85	IV-IX, 19-33	II-IV, 18-32	14-19	1, 3-1, 5	16	22-23
Siganidae	23	XII-XIV, 9-11	VII, 9-10	14-21	1, 3, 1	17	23
Zanclidae	1	VII, 38-42	III, 31-35	18-19	1, 5	16	22
Luvaridae	1	II, 24 (12-13)	18 (13-14)	17-20	1, 4 (0)	16	23

TABLE 133. ACANTHUROID TAXA FOR WHICH INFORMATION IS AVAILABLE ON EGG AND LARVAL STAGES. YS—yolk-sac; pre—preflexion; flex—flexion stage; post—postflexion stage; D—demersal; P—pelagic.

Genus	Number of species	Egg type	Larvae—developmental stage				References
			YS	Pre	Flex	Post	
Acanthuridae							
<i>Acanthurus</i>	5	P	X	X		X	Lütken, 1880; Breder, 1927; Whitley and Colefax, 1938; Randall, 1956, 1961; Aboussouan, 1965; Burgess, 1965
<i>Ctenochaetus</i>	2	P				X	Randall, 1955c
<i>Naso</i>	2			X	X	X	Fourmanoir, 1976; Leis and Rennis, 1983
<i>Zebrasoma</i>	2			X		X	Randall, 1955b; Aboussouan, 1966a
Unidentified	Several	P		X	X	X	Dekhnik et al., 1966 (Fig. 37-1, misidentified as Balistidae); Randall, 1955c; Nellen, 1973b; Watson and Leis, 1974
Luvaridae							
<i>Luvarus</i>	1				X	X	Roule, 1924; Roule and Angel, 1930; Blache, 1964
Siganidae							
<i>Siganus</i>	6	D	X	X	X	X	Fujita and Ueno, 1954; Uchida et al., 1958; Mito, 1966; Popper et al., 1973; May et al., 1974; von Westernhagen and Rosenthal, 1975, 1976; Bryan and Madrisau, 1977; Leis and Rennis, 1983
Zanclidae							
<i>Zanclus</i>	1					X	Strasburg, 1962

(Tyler, 1970). Table 132 summarizes meristic characters of the suborder, and Table 133 reviews current state of knowledge of its early life history.

DEVELOPMENT

Siganids have small (<1 mm) demersal eggs with oil droplets (Table 133). No parental care has been recorded. Larvae hatch in a poorly developed condition. Moderately long preopercular spines and serrate ridges form on the head, and the first fin elements to form—the pelvic spine and second dorsal spine—form very early (Fig. 296). The body does not become very deep, and although the pelvic and dorsal spines are elongate and serrate, they do not exceed three times the eye diameter. No scales form prior to settlement, but the pelagic stage may grow to 30 mm and is very silvery in life, particularly over the gut. Early larvae, in particular, are very percoid in appearance. Pigment in preflexion larvae is limited to dorsal and pelvic fin membranes, gut, and a ventral series on the tail. Older larvae are more heavily pigmented.

Acanthurids have small (<1 mm) pelagic eggs with a single oil droplet (Table 133). Larvae hatch in a poorly developed condition, but very soon develop serrate ridges on the head (but no elongate preopercular spines form). The first fin elements to form (the pelvic spine and second dorsal spine) do so very early, and these are quickly followed by the second anal spine (Fig.

296). These fin spines are serrate, and at least one exceeds three times the diameter of the eye. The head and trunk become remarkably deepened. This is accentuated by the elongate pelvic, dorsal, and anal spines at the opposite edges of the deepest point of the body: the body becomes distinctly kite-shaped. Small, triangular scales arrayed in vertical rows begin to form shortly after flexion. The pelagic stage may reach 60 mm and is very silvery in life around the gut. Preflexion larvae are lightly pigmented in specific patterns. Late larval stages may acquire aspects of the juvenile pigment pattern. The caudal peduncle armature forms late in the larval period. In *Naso* the spines form from existing scales (i.e., they pass through an unspecialized scale stage). In *Acanthurus* it forms directly without the unspecialized scale stage.

Nothing is known of luvarid or zanclid eggs or preflexion larvae (Table 133). *Luvarus* larvae apparently have early-forming pelvic and anterior dorsal fin spines. They also have early-forming scales, serrations on the head, but lack elongate preopercular spines (Fig. 297). The dorsal and pelvic spines of *Luvarus* are more than three times the diameter of the eye. *Luvarus* larvae are deep-bodied, but not as kite-shaped as acanthurids, and have a more square-shaped head. With growth, the spines of the fins, and many of the soft rays are lost, and the body becomes more fusiform. Late *Zanclus* larvae are very similar to acanthurid larvae (Fig. 297) and are scaled similarly,

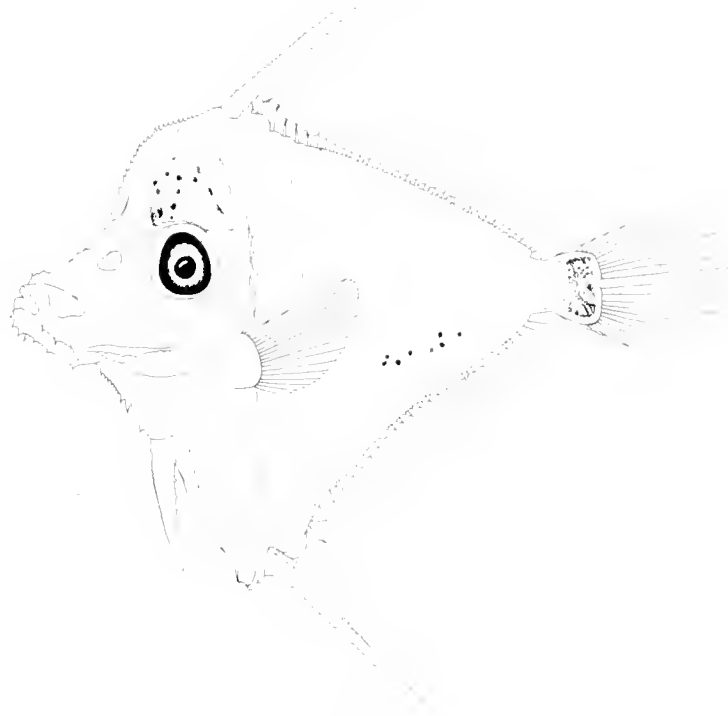
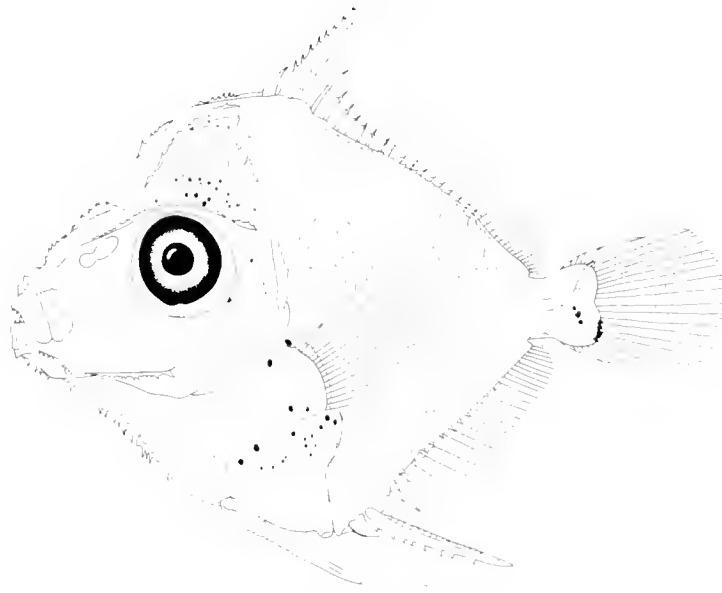



Fig. 297. Larvae of (upper) *Luvarus imperialis*, 6.8 mm TL, modified after Fahay (1983); and (lower) *Zanclus canescens*, 16 mm SL, modified after Strasburg (1962).

but only the third dorsal spine is elongate (the unknown smaller larvae may have elongate spines in other fins).

RELATIONSHIPS

Acanthuroids share the following, probably derived characters (we assume acanthuroids have a percoid ancestry): long pelagic period; early-forming, elongate dorsal and pelvic spines; serrate fin spines; moderately to very deep, compressed body;

serrate ridges on the head; silvery gut; 22–23 vertebrae; and 16–17 principal caudal rays. This is strong evidence for the monophyly of the group.

Tyler (1970) notes that acanthuroids have been considered as chaetodontid derivatives. We find no support for this view among ELH characters. Chaetodontids and pomacanthids do have large, specialized pelagic stages, but these differ greatly from acanthuroids (Leis and Rennis, 1983) and resemble ca-

rangids at early stages. Leiognathid larvae are similar to siganid larvae in many respects (head spination, fin spine development, silvery gut—see G. D. Johnson, this volume and Leis and Goldman, 1983), and we suggest the leiognathids should be evaluated as a potential primitive sister group of the acanthuroids. There is little evidence from ELH characters to support the notion that the acanthuroid fishes are the primitive sister group of the tetraodontiform fishes (Leis, this volume).

Intra-ordinal relationships of acanthuroid fishes as suggested by ELH characters fully support those based on adult characters. The siganids are distinguished from the other acanthuroids by the following derived characters: demersal egg, two spines in pelvic fin, and seven spines in the anal fin. Larvae of acanthurids, luvarids, and zancrids have the following derived characters: no elongate preopercular spines; kite-shaped body; elongate snout; extremely elongate dorsal and pelvic spines; early-forming spe-

cialized scales; and reduced number of dorsal fin spines. Thus the siganids appear to be the primitive sister group of the other acanthuroids. Interrelationships of the acanthurids, zancrids, and luvarids cannot be clarified given the current knowledge of zancrid and luvarid ELH characters. Larval zancrids have an extremely elongate dorsal spine and a retrose preorbital spine. Acanthurids have caudal peduncle armature, and luvarids have ontogenetic reduction in fin elements, no anal spines, and a very squared head. None of these specializations are shared by any two of the families, so they shed no light on interrelationships.

(J.M.L.) THE AUSTRALIAN MUSEUM, 6-8 COLLEGE STREET, SYDNEY 2000, AUSTRALIA; (W.J.R.) NATIONAL MARINE FISHERIES SERVICE, SOUTHEAST FISHERIES CENTER, 75 VIRGINIA BEACH DRIVE, MIAMI, FLORIDA 33149.

Blennioidei: Introduction

R. H. ROSENBLATT

THE modern concept of the perciform suborder Blennioidei dates from the paper of Regan (1912b), who defined and delimited the group as "Percomorphous Teleosts with the pelvic fins jugular or mental, each of a spine and four soft rays or still further reduced, with the dorsal and anal rays typically corresponding in number to the vertebrae, each basal bone attached to its own neural or haemal spine (rays more numerous in Ophidiiformes) with well developed wings of the parasphenoid ascending in front of the prootics, and with all or most of the ribs inserted on strong parapophyses."

As Regan himself indicated this definition encompasses a heterogeneous group, and his series "Ophidiiformes" has now been removed from the Perciformes. Subsequent to Regan several widely differing classifications have been proposed, with groups often being added or removed without comment. Jordan (1923) proposed the most radical arrangement. He placed in the order Jugulares almost all spiny rayed fishes with advanced pelvic fins. Jordan's Jugulares was divided by him into 12 series, comparable to suborders, and no less than 62 families. Jordan, in his magisterial fashion, provided an outline classification, without substantiation by characters.

Berg in his 1940 classification rationalized the classification of the Blennioidei. He restricted the suborder mainly to Regan's series "Blenniiformes" and "Cliniiformes," and redistributed the remainder of the Jugulares, either to the Percoidei or to the suborders Ophidioidae (equivalent to Regan's series Ophidiiformes), Ammodytoidei, or Callionymoidei. Some indication of relationships is perhaps implicit in Berg's placement of portions of Jugulares *auctororum* immediately preceding the Blennioidei.

Although a number of works on various blennioid groups have appeared (see particularly Hubbs, 1952; Makushok, 1958, and the papers of V. Springer) the only subsequent attempt to characterize and deal with the group as a whole is that of Gosline (1968). The classification given by Nelson (1976) differs from

that of Gosline as well as the outline classification of Greenwood et al. (1966). The discussion of larval forms given here mostly accords with Nelson's Blennioidei as a convenience, regardless of the eventual disposition of the taxa. The only major departure from the arrangement of Nelson is that the family Zoarcidae is treated here, although Nelson included it in the Gadiformes (see Anderson, this volume).

The reasons for the varying treatment of these fishes are not difficult to find. The unraveling of phyletic lines within the Perciformes is made difficult by the sheer number of species and genera. One is faced with the choice of mining a narrow vein for nuggets of knowledge which lie isolated, or engaging in a strip mining operation which reveals broad patterns at the expense of ignoring contradictory details. In other terms, insufficient knowledge of morphological variation within the Perciformes precludes at this time either identification of unequivocal synapomorphies or the determination of polarity of a number of characters within almost any presumed lineage.

A number of features taken to characterize, if not to define, the Blennioidei may be the product of convergent or parallel evolution, correlated with the assumption of benthic life.

As pointed out by Gosline (1968) the blennioids, as compared with percoids, have less deep bodies, with a short trunk and a relatively attenuated caudal region. The dorsal and anal are long and low, terminating near the caudal, and the pectoral and usually the caudal fins are rounded. There is an exact correspondence in number between dorsal and posterior anal soft-rays and vertebrae supporting them. The pelvic fins are inserted in advance of the pectoral fins, and the number of rays is generally reduced; the spine often rudimentary or splint-like, and the soft-rays three or fewer.

The deep, relatively compact body of a generalized perciform is that of a fish which hovers, probably near the substrate, but which makes rapid bursts either in feeding or predator avoidance, or both. The body shape is adapted for slow swimming,

alternating with bursts of acceleration. There is a general but far from universal trend for bottom dwelling fishes to become elongate; the eel-like body is widely distributed taxonomically. Bottom-living fishes often use crevices for shelter and forage in interstices, and may burrow. Elongation of the body accompanied by an increase in the number of vertebrae produces the flexibility necessary for these activities. The elongate body form requires either anguilliform swimming or undulation of the median fins. In either case the role of the caudal fin is reduced. The pectorals are used in short darts or lunges, and their fan shape is associated with accelerating a large amount of water per thrust. This function is important even in relatively elongate forms in accelerating the head in feeding strikes, and pectorals are reduced or lost in only a few lineages.

The pelvics of bottom living forms no longer have a hydrodynamic function as brakes or rudders. Instead they may function as props which hold the head off the bottom (as in the Cottidae and Gobiidae as well). A reduction in the number of rays is also seen in the Cottidae.

That morphological features are functional does not mean that their joint possession cannot be taken to demonstrate common ancestry. However, it does indicate caution. The only one of Gosline's characters for the Blennioidei that is not clearly functional is the 1:1 relationship of median fin rays and vertebrae. However, the reduction in the number of fin rays per segment to one is the culmination of a functional trend begun in the Paleozoic, and we cannot yet be sure that it happened but once.

Although Gosline regarded his classification as owing more to that of Jordan than Regan, his main characters of pelvic position and median fin ray arrangement are exactly those given by Regan in his diagnosis. Gosline's concept of the Blennioidei and its superfamilies, although not completely accepted (see Nelson, 1976), has not been superseded, except that his Congrogadoideae is no longer included; the Congrogadidae is now placed in the Percoidea (Winterbottom, 1982) and the Peronedysidae has been synonymized with the Clinidae (George and Springer, 1980).

According to Gosline the Blennioidei (without the Congrogadoideae) may be divided into four superfamilies. The first of these, the Notothenioidae, is clearly the most heterogeneous. In addition to the Antarctic and sub-Antarctic families (Bovichthyidae, Nototheniidae, Harpagiferidae, Bathydraconidae and Channichthyidae) usually placed in this group (Berg, 1940), the tropical Mugiloididae (=Paraperceidae) Trichonotidae and Chei-

marrhichthyidae were included although they do not share with them the specialized features of a single nostril and a loss of one pectoral actinost. There appears to be no reason to regard the two groups of families as closely related.

The Trachinoideae was said to be comprised of the Trachinidae, Leptoscopidae, Uranoscopidae and Dactyloscopidae. All are adapted for lying buried in the substrate, and it is likely that their structural similarities are related to this habit. The Dactyloscopidae has recently been placed in the Blennioideae (George and Springer, 1982).

The superfamily Blennioideae was regarded as composed by the families Tripterygiidae, Clinidae, Chaenopsidae, and Blennioideae. Subsequently the subfamily Labrisominae of the family Clinidae was raised to family status and the Dactyloscopidae transferred from the Trachinoidei (George and Springer, 1980). Within the Blennioidei, the superfamily may be characterized by the combination of two nostrils on each side, pelvic soft-rays four or fewer, prootic excluded from orbital rim (that is, ascending wing of paraspheroid meets frontal), and basisphenoid present.

The remaining superfamily, the Zoarceoidae, was regarded as composed of 11 families, some poorly understood. Anderson (1983, this volume) recognized 8 families in the group: Bathymasteridae, Stichaeidae, Pholididae, Anarhichadidae, Ptilichthyidae, Zaproridae, Scytalinidae and Zoarcidae. Although composed of forms differing greatly in morphology, the superfamily may be diagnosed as blennioids with a single nostril on either side of the head, prootic excluded from rim of orbit, and basisphenoid absent. There is no merit in the removal of the Zoarcidae to the Gadiformes (see also Anderson, this volume).

It should be clear from the foregoing that no satisfactory definition of the Blennioidei has as yet been framed. Perhaps lines of relationships would best be recognized by restricting the Blennioidei to the Blennioideae and Zoarceoidae of Gosline, and returning his other two superfamilies to the Percoidei. It appears that ontogeny and larval characters have as yet little to contribute to questions of suprafamilial and subordinal relationships between and among these fishes.

Perhaps it is fitting to end with a quote from Jordan (1923), addressing issues such as this: "I may repeat a warning as old as science itself: that we must not expect a degree of accuracy which the subject in question does not permit."

SCRIPPS INSTITUTION OF OCEANOGRAPHY, UNIVERSITY OF CALIFORNIA, SAN DIEGO, LA JOLLA, CALIFORNIA 92093.

Schindlerioidei: Development and Relationships

W. WATSON, E. G. STEVENS AND A. C. MATARESE

THIS suborder contains a single paedomorphic family composed of two species of the genus *Schindleria*. Both species inhabit neritic surface waters of the subtropical and tropical Indian and Pacific Oceans (Bruun, 1940; Schindler, 1932; R. J. Lavenberg, pers. comm.). Their early life histories are known

from the work of Watson and Leis (1974), Miller et al. (1979), and Ozawa and Matsui (1979). Classification of Schindlerioidei is speculative, and its placement here by Nelson (1976) follows Gosline (1971), who tentatively considered this taxon a percoid derivative, possibly related to Ammodytoidei.

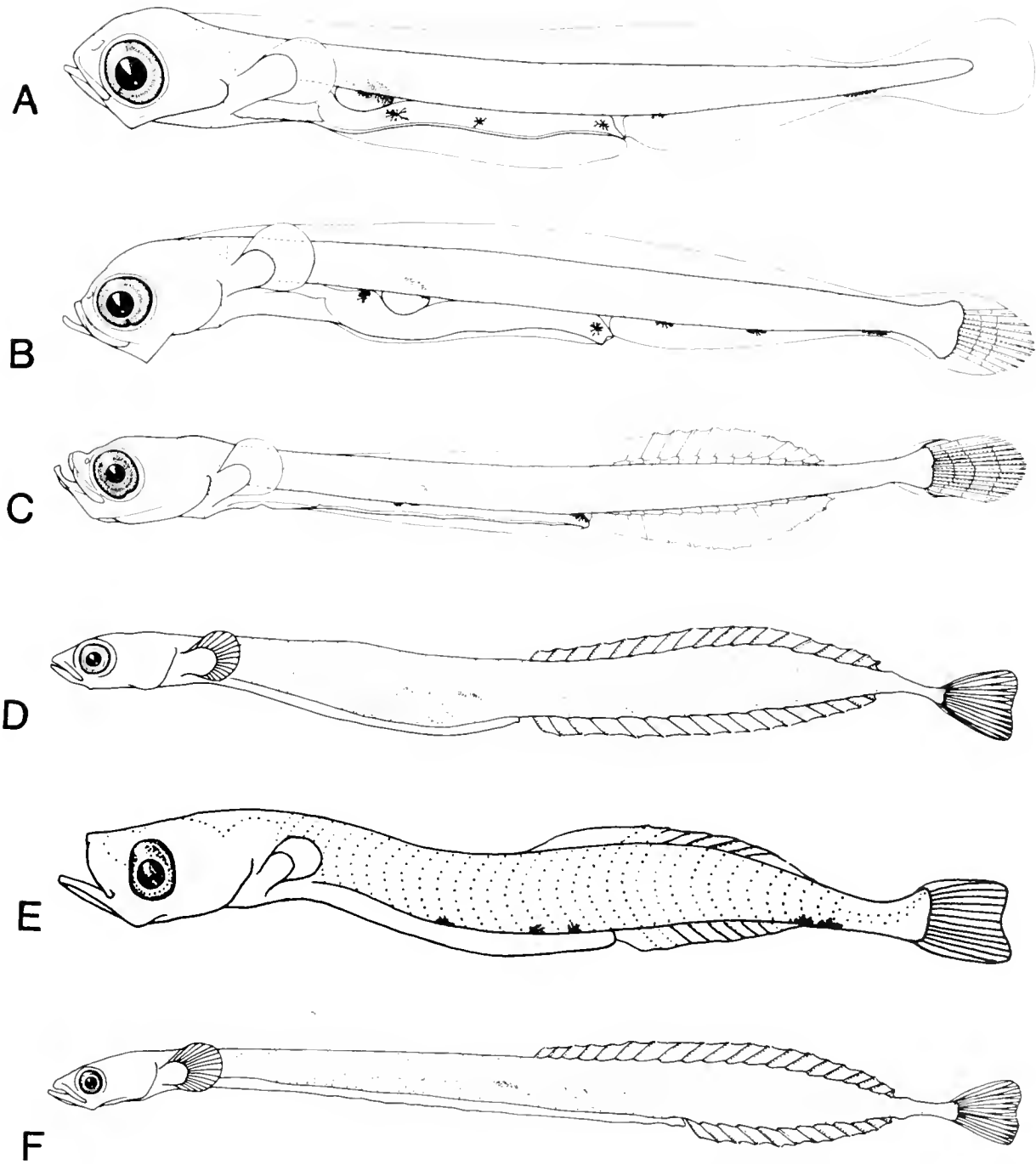

Fig. 298. Lateral views of: (A) *Schindleria pietschmanni* larva, 2.7 mm; (B) *S. pietschmanni* larva, 3.5 mm (redrawn from Miller et al., 1979); (C) *S. pietschmanni* larva, 4.7 mm (from Miller et al., 1979); (D) *S. pietschmanni* adult female, 15.1 mm (redrawn from Jones and Kumaran, 1964); (E) *S. praematura* larva, 3.6 mm (from Ozawa and Matsui, 1979); and (F) *S. praematura* adult female, 20.1 mm (redrawn from Jones and Kumaran, 1964).

DEVELOPMENT

Eggs

Although ovarian eggs are well-known for both species (Jones and Kumaran, 1964; Sardou, 1974), the mode of spawning is unknown. Watson and Leis (1974) reported planktonic *Schind-*

leria sp. eggs which they suggested were either pelagic or perhaps demersal eggs extruded in the net. The largest ovarian eggs lack oil droplets and are irregular in shape, 0.35–0.40 mm in diameter (*S. praematura*), or oval, 0.30 × 0.65 mm (*S. pietschmanni*). Hydrated, planktonic eggs of *Schindleria* sp. are oval,

0.50 × 1.30 mm, contain no droplets, and have an unsculptured chorion with a cap-like structure at one end. Incubation time is not known.

Larvae

Morphology.—Larval size and degree of development at hatching are unknown. However, *S. pietschmanni* at 1.9 mm NL has a rather large yolk sac (containing an apparently segmented yolk) in addition to pigmented eyes and an open, presumably functional, mouth. Notochord flexion occurs after 2.7 mm but before 3.5 mm NL in *S. pietschmanni*, and before 4.3 mm in *S. praematura*. Development to the essentially larval mature form is gradual. The juvenile stage may be taken to begin with completion of the dorsal and anal fins and the acquisition of the principal caudal rays (ca. 4–5 mm), and the adult stage to begin when the male genital papilla or the ovaries of the female become discernable (longer than ca. 9 mm SL). The distinctive schindleriid terminal section at the rear of the vertebral column does not become apparent until the late larval or early juvenile period.

Aside from fin development, morphology changes little during larval development. The swim bladder moves posteriorly from myomeres 6–8 to myomeres 14–15 in *S. pietschmanni*; a similar migration presumably occurs in *S. praematura* (e.g., Sardou, 1974). Preanal length is greater in *S. praematura* than in *S. pietschmanni*.

Pigmentation.—Schindleriids are lightly pigmented throughout development (e.g., Miller et al., 1979; Ozawa and Matsui, 1979). During the larval and early juvenile period, *S. pietschmanni* has one to four pairs of melanophores along the sides of the gut (usually two or three pairs), one to four melanophores along the ventral midline of the tail (usually two or three), and pigment on the posterior dorsal surface of the swim bladder. The posterior tail melanophore is typically more elongate than the others (Fig. 298). All but the swim bladder pigment is lost during the

juvenile stage. Larval pigmentation of *S. praematura*, as shown by Ozawa and Matsui (1979), and juvenile pigment, shown by Sardou (1974), are very similar to that of *S. pietschmanni*. Like *S. pietschmanni*, *S. praematura* retains only the posterior swim bladder pigment in the adult stage (Fig. 298).

Meristics.—Meristics for *Schindleria* are: Vertebrae 15–25 + 12–21 = 33–44; D 15–22; A 10–14; P 15–17; and C 13 prin. A combination of caudal vertebrae and anal fin ray counts usually will distinguish the two species.

The caudal fin rays are the first to develop, followed by the dorsal and anal fin rays (forming simultaneously). Pectoral fin rays are the last to ossify. Pelvic fins never form.

RELATIONSHIPS

Early life history characters, to the extent that they are presently known, do little to clarify the phylogenetic position of the Schindlerioidei. For example, Gosline (1963b, 1971) speculated that Schindlerioidei might be derived from an ammodytoid ancestor; however, while both suborders share some characters (e.g., an elongate larval form with preanal length just over 50% body length), they differ in other important ways (e.g., late development of pectoral fin rays in schindleriids and early development in ammodytoids). Knowledge of spawning and early development might aid in ascertaining schindleriid relationships although at present this group seems destined to remain an enigma.

(W.W.) MARINE ECOLOGICAL CONSULTANTS, 531 ENCINITAS BOULEVARD, SUITE 110, ENCINITAS, CALIFORNIA 92024; (E. G.S.) NATIONAL MARINE FISHERIES SERVICE, SOUTHWEST FISHERIES CENTER, PO BOX 271, LA JOLLA, CALIFORNIA 92038; (A.C.M.) NATIONAL MARINE FISHERIES SERVICE, NORTHWEST AND ALASKA FISHERIES CENTER, 2725 MONTLAKE BOULEVARD EAST, SEATTLE, WASHINGTON 98112.

Trachinoidea: Development and Relationships

W. WATSON, A. C. MATARESE AND E. G. STEVENS

THE blennioid infraorder Trachinoidea, as used here, contains about 140 species in 11 families of morphologically quite diverse, but generally small, primarily shallow-living temperate and tropical marine demersal or burrowing fishes (Chiasmodontidae is bathypelagic; Cheimarrichthyidae inhabits fresh water). These families have not always been considered as closely related (e.g., Gosline, 1968, 1971), but we follow Nelson (1976) in considering them together here. Nelson (1976) originally placed 16 families in the Trachinoidea, but subsequently synonymized the Limnichthyidae with Creediidae (Nelson, 1978). Springer (1978) removed Oxudercidae to the Gobiidae. Three other families are treated elsewhere in this volume: Bathymasteridae and Dactyloscopidae with the Blennioidea (Matarese et al., this volume) and Opistognathidae with the Percoidei (G. D. Johnson).

In this brief review, we summarize the present state of knowl-

edge of the early life histories of trachinoid fishes and attempt to determine whether such information contributes to our understanding of their phylogenetic relationships. Unfortunately, early life histories, mostly incomplete, are known for only a small number of species (Table 134). This paucity of early life history data makes generalizations about development tenuous at best, but for purposes of this paper the known taxa are considered representative.

DEVELOPMENT

Eggs

Eggs are unknown for the Percophidae, Trichonotidae, and Leptoscopidae. Only ovarian eggs have been described for the

TABLE 134. SUMMARY OF EARLY LIFE HISTORY INFORMATION AVAILABLE FOR TRACHINOID FISHES.

Family	Number of genera	Approximate number of species	Distribution	Descriptions		Illustrations		Early life history source
				Genera	Species	Genera	Species	
Trichodontidae	2	2	North Pacific	1	1	1	1	Breder and Rosen, 1966; Marliave, 1981
Champsodontidae	1	10	Indo-Pacific	1	1	1	1	Mito, 1962d, 1966
Chiasmodontidae	4	23	Worldwide (temperate and tropical, marine)	1	1	1	1	Ahlstrom, pers. comm.; Lavenberg, pers. comm.
Percophididae	6	17	Atlantic, Indo-Pacific	1	1	1	1	Crossland, 1982
Mugiloididae	3	36	Atlantic, Indian, Pacific (subtropical and tropical)	1	5	1	4	Leis and Rennis, 1983; Mito, 1966; Robertson, 1973, 1975a; Watson, unpubl.
Trichonotidae	2	5	Indo-Pacific	1	2	1	1	Leis and Rennis, 1983
Cheimarrhichthyidae	1	1	New Zealand (freshwater)	0	0	0	0	McDowall, 1973c
Creediidae	7	14	Indo-Pacific	2	2	2	3	Leis, 1982; Leis and Rennis, 1983; Regan, 1916; Watson and Leis, 1974
Trachinidae	1	4-5	Eastern Atlantic, Mediterranean	1	4	1	2	Breder and Rosen, 1966; Dekhnik, 1973; Ehrenbaum, 1905-1909; Marinaro, 1971; Padoa, 1956g; Russell, 1976; Schnakenbeck, 1928; Vodyanitsky and Kazanova, 1954
Uranoscopidae	8	25	Atlantic, Indian, Pacific (shallow temperate and tropical)	3	4	2	3	Dekhnik, 1973; Fritzsche, 1978; Mito, 1966; Robertson, 1974
Leptoscopidae	2	3	Australia, New Zealand (marine)	0	0	0	0	

Cheimarrhichthyidae (McDowall, 1973c). Six of the seven remaining families spawn small to moderate (0.70-2.45 mm diameter), spherical, single pelagic eggs (Table 135). McDowall (1973c) suggested a pelagic spawning mode for Cheimarrhichthyidae as well, unusual for the suggested riparian spawning habitat but consistent with the close relationship, or identity, of Cheimarrhichthyidae with Mugiloididae. All pelagic eggs have oil droplets (most have only one, 0.16-0.26 mm in diameter) and all except some Uranoscopidae have smooth, unsculptured chorions. Incubation periods range from 2 to 6 days and larvae are not well developed at hatching (Trachinidae are somewhat better developed, with pigmented eyes and pelvic buds).

Demersal egg masses (750-1,000 eggs) are produced only by the Trichodontidae (Table 135). These eggs are large (3.52 mm in diameter), slightly flattened, with an unsculptured chorion and no oil droplet. Incubation is estimated at about one year (Marliave, 1981) and larvae are well developed at hatching.

Larvae

Larval stages are unknown for the Cheimarrhichthyidae and Leptoscopidae. The described trachinoid larvae display only a few unifying characteristics: (1) all are pelagic, hatching at ca. 2-15 mm (Table 136); (2) they pass through no specialized stages (except the gargaropteron juvenile stage of the chiasmodontid genus *Kali*); and (3) they metamorphose gradually to the demersal juvenile stage at a small to moderate size (ca. 10-60 mm).

Morphology.—Morphology is quite variable; however, larvae are either relatively long and slender (Fig. 299: Trichodontidae, Chiasmodontidae, Percophididae, Trichonotidae, Creediidae) or rather robust (Fig. 300: Champsodontidae, Mugiloididae,

Trachinidae, Uranoscopidae). All the robust larvae and one of the slender types (Trichodontidae) have somewhat rounded heads with relatively short snouts. Preanal length in both types usually is not more than 50% of standard length (60% or more in Creediidae and Trichonotidae) and changes little during development. Head and body spination are extremely variable. Preopercular spination is known for six families: Trichodontidae, Chiasmodontidae, Champsodontidae, Mugiloididae, Creediidae, and Trachinidae. Champsodontid larvae develop a serrate crest on the snout and head during the postflexion period, and chiasmodontid larvae (except *Kali*: R. J. Lavenberg, pers. comm.) develop small body spicules (Fig. 299) just before or during notochord flexion.

Pigmentation.—Pigmentation of trachinoid larvae is quite variable, from nearly absent to quite intense (Table 137). Larval champsodontids, mugiloidids, trichonotids, and creediids remain lightly pigmented throughout development, while larval trichodontids, chiasmodontids, trachinids, and uranoscopids may become rather heavily pigmented. Pigmentation usually increases with increasing larval size; trichonotids and creediids change little in pigmentation with growth.

Head.—Eyes are pigmented at hatching for the demersally-spawned Trichodontidae, and for two of the six families with pelagic eggs (Table 137). Pigmentation is present at hatching, or subsequently develops, over the brain in five families. The degree of pigmentation of other areas of the head is variable.

Gut.—Pigmentation typically is present dorsally over the gut and swim bladder throughout larval development (absent only in creediids and postflexion trichonotids). Other gut pigment is variable.

TABLE 135. CHARACTERISTICS OF TRACHINOID EGGS.

Family	Pelagic (P) or demersal (D)	Single or mass	Egg diameter (mm)	Oil droplets number: size range (mm)	Attachments or ornamentation	Pigmentation	Incubation period	Source
Trichodontidae	D	Mass 750–1,000 eggs	3.52	0	None	Amber	2 mo.–1 yr.	Breder and Rosen, 1966; Marliave, 1981
Champsodontidae	P	Single	1.09–1.19	1: 0.17–0.22	None	Melanophores on embryo and oil droplet		McDowell, 1973c; Mito, 1966
Chiasmodontidae	P	Single	1.08–1.14	1: 0.26	None	Chorion rose to amber		Ahlstrom, pers. comm.
Percophididae	Unknown							
Mugiloididae	P	Single	0.77–1.25	1: 0.16–0.25	None	Melanophores on embryo and oil droplet	5–6 days	Mito, 1966; Robertson, 1973, 1975a
Trichonotidae	Unknown							
Cheimarrhichthyidae	P (assumed)	Single (ovarian)						McDowell, 1973c
Creediidae	P	Single	0.70–1.10	400–600 in 8–12 clusters; coalesce to 3–8: 0.05–0.10	None	Melanophores on embryo	2 days	Leis, 1982; Watson and Leis, 1974
Trachinidae	P	Single	0.94–1.37	1–30, coalesce: 0.19–0.25	None		4–5 days	Breder and Rosen, 1966; Dekhnik, 1973; Marinaro, 1971; Padoa, 1956g; Russell, 1976
Uranoscopidae	P	Single	1.52–2.45	3–27: 0.02–0.15	Polygonal network on chorion in <i>Uranoscopus</i>	Melanophores on yolk and embryo		Dekhnik, 1973; Fritzsche, 1978; Mito, 1966; Robertson, 1975a
Leptoscopidae	Unknown							

Trunk and tail.—Most trachinoid larvae display some degree of pigmentation along the ventral margin of the tail (absent in some mugiloidids and preflexion trachinids). Pigmentation (typically rather light) occurs along the dorsal margin of the trunk and tail at some time during larval development in many trachinoids. Internal pigment may develop above and below the vertebral column (e.g., Trichodontidae).

Hypural margin.—Hypural pigment typically is light or absent although its presence as a bar is diagnostic for the Trichodontidae.

Fins.—Fins typically are unpigmented in trachinoid larvae, although for some groups fin pigmentation can be diagnostic (e.g., the caudal and posterior dorsal and anal fin pigment of Trich-

TABLE 136. SIZE (MM SL) OF TRACHINOID LARVAE AT SELECTED DEVELOPMENTAL STAGES.

Family	Hatching	Notochord flexion	Prejuvenile or specialized stages	Juvenile
Trichodontidae	14.5	Before hatching	None	32–60
Champsodontidae	3.4–3.7	4.6–5.0	None	9.6–10.7
Chiasmodontidae	ca. 4	Before ca. 9	ca. 45	ca. 12–45
Percophididae		<16.0		
Mugiloididae	2.2–3.0	3.7–4.8	None	10.0 to ≥ 12.6
Trichonotidae		5.2–6.3	None	>18.8
Cheimarrhichthyidae				≤ 25
Creediidae	2.6–3.5	7.0–10.2	None	>11.0, ≤ 29.2
Trachinidae	3.2	5.0–10.0	None	13–15
Uranoscopidae	≥ 2.5 –4.38		None	≥ 23
Leptoscopidae	No information			

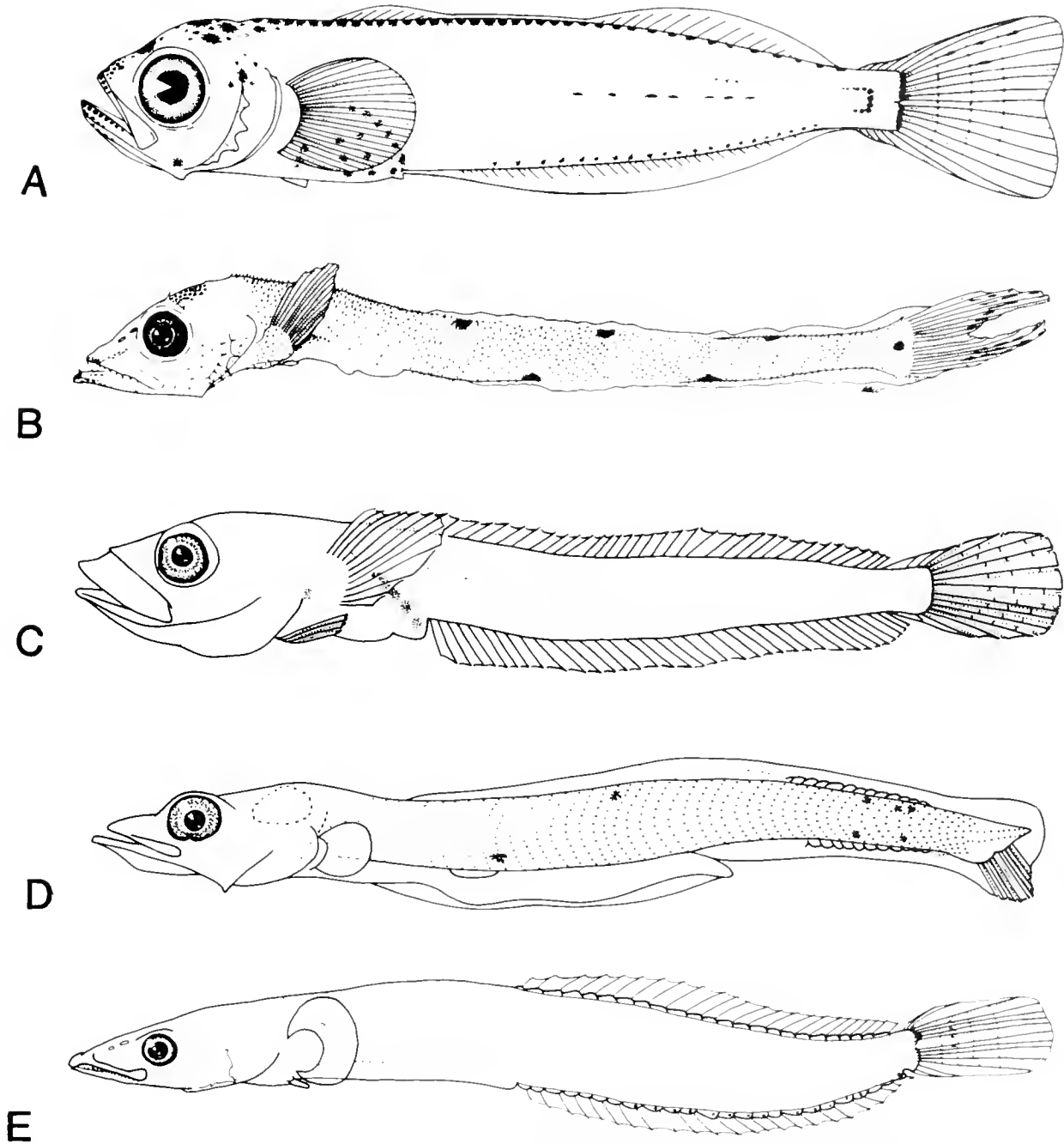

Fig. 299. (A) Trichodontidae: *Trichodon trichodon*, 13.0 mm, from Marliave (1981); (B) Chiasmodontidae: *Pseudoscopus* sp., 14.0 mm, CalCOFI station 5710-5-130.80 (approximately 24°49'N, 116°49'W); (C) Percophididae: *Hemerochetes* sp., 16.0 mm, redrawn from Crossland (1982); (D) Trichonotidae: *Trichonotus* sp., 5.9 mm, from Leis and Rennis (1983); and (E) Creediidae: *Limnichthys donaldsoni*, 11.0 mm, from Leis (1982).

onotidae or the early developing heavily pigmented pelvic fins of trachinids).

Meristic characters.—Vertebral and fin ray counts are summarized in Table 138. The sequence of fin ray formation, incompletely described for most families, appears to be quite variable except that the caudal fin is first to begin ossification of rays in all but the trachinids (the caudal is second in this family, fol-

lowing the pelvic fins). Dorsal and anal fin rays are second to form in four families (Mugiloididae, Trichonotidae, Creediidae, Uranoscopidae), while pectoral fin rays are second in two (Trichodontidae and Chiasmodontidae) and pelvic fin rays in one (Champsodontidae).

Special structures.—Special structures are generally lacking in trachinoid larvae. Only the elongate opercular appendage of

TABLE 137. SUMMARY OF PIGMENTATION (MELANIN ONLY) OF LARVAL TRACHINOID FISHES. Key: +, present; 0, absent; †, increasing with development; ‡, decreasing with development; 0→+, initially unpigmented, becoming pigmented with development; An, anterior; Po, posterior.

Family	Eye at hatching	Head						Gut				Trunk and tail	
		Bran	Jaws	Snout	Opercle	Isthmus	Nape	Anterior	Dorsal	Ventral	Lateral	Pre-flexion	Flexion
Trichodontidae	+	+†	+	+	0	0	0→+	0	0	0	+		+
Champsodontidae	+	+	0	+†	0	0	0→+	0	+	0→+	+	+	+
Chiasmodontidae	0	+	+	0	0	0→+	0	0	+	0	0	+	+
Percophididae		0	0	0	+	0	0	0	+	0	0		
Mugiloididae	0	0, or +‡, or +†	0	0, or +†	0	0	0	0, or +	+†	0, or +	0→+	0, or +	+
Trichonotidae	0	0	0	0	0	0	0	0	+‡	0	0	+ Po	+ Po
Cheimarrhichthyidae ¹													
Creediidae	0	0	0	0	0	0	0	0	0	+	0	+ Po	+ Po
Trachinidae	+	0, or +†	0, or +†	0, or +†	0→+†	0	0, or +	0	+	0	0→+†	0, or +	+
Uranoscopidae	0	+†	0→+	+†	0→+	0→+	0→+	+	+†	0→+† or +†	0→+† or +†	+†, or +†	+†, or +†
Leptoscopidae ¹													

¹ Larvae unknown

TABLE 138. SELECTED MERISTICS OF TRACHINOID FISHES.

Family	Dorsal fin	Anal fin	Pectoral fin	Pelvic fin	Primary caudal fin rays	Vertebrate	Source
Trichodontidae	X–XVI + 0–1, 13–19	1, 27–31	21–23	1, 5	12–15	12–15 + 34–40 = 47–50	Marliave, 1981; NWAFC, unpubl.
Champsodontidae	V + 1, 18–22	1, 17–20	9–13	1, 5		10 + 19–22 = 29–32	de Beaufort and Chapman, 1951; Matsubara et al., 1964; Mito, 1962
Chiasmodontidae	VI–XIII + 18–28	0–1, 17–28	10–15	1, 5	17	33–44	Johnson and Cohen, 1974; Lavenberg, pers. comm.; Norman, 1929
Percophididae	0–IX + 14–31	0–I, 15–42	20–28	1, 5	15	8–9 + 19–21 = 27–30	Ginsburg, 1955; Iwamoto and Staiger, 1976; Miller and Jorgenson, 1973
Mugiloididae	IV–VII, 19–28	1, 16–26	15–22	1, 5	14–15	10–16 + 18–22 = 28–38	Cantwell, 1964
Trichonotidae	III–VII, 40–46	36–40	12–14	1, 5	13	15 + 40 = 55	Leis and Rennis, 1983; Masuda et al., 1975
Cheimarrhichthyidae	IV–VI, 18–21	1–II, 14–16	14–18	1, 5	12–15	12 + 20–21 = 32–33	McDowall, 1973c
Creediidae	18–40	25–40	11–17	None, or 1, 3–5	10	37–59	Leis and Rennis, 1983; Smith, 1961
Trachinidae	V–VII + 21–32	25–36	15	1, 5	14	11–12 + 23–31 = 34–43	Padoa, 1956g; Russell, 1976
Uranoscopidae	0–V + 12–19	0–I, 12–19	13–24	1, 5	11–14	9–12 + 14–17 = 25–29	Berry and Anderson, 1961; Fritzsche, 1978; Marshall, 1965; Miller and Jorgenson, 1973; Mito, 1966; Scott et al., 1974; Smith, 1961; Wade, 1946
Leptoscopidae	34–35	37		1, 5		10+	Gosline, 1968; Scott et al., 1974

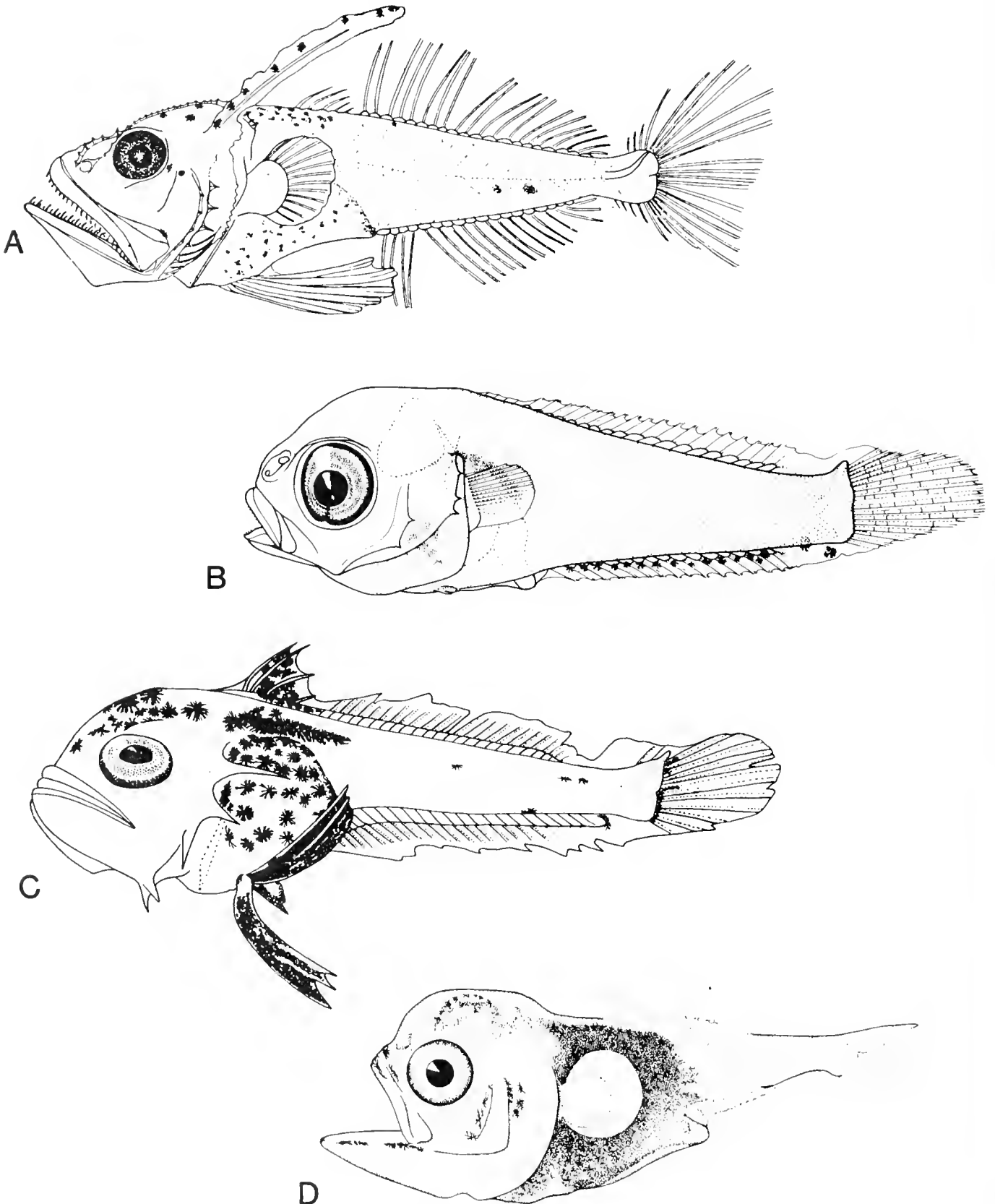

Fig. 300. (A) Champsodontidae: *Champsodon snyderi*, 9.6 mm, from Mito (1962a); (B) Mugiloididae: *Parapercis schauinslandi*, 5.3 mm, Kahe Point, Oahu, Hawaii (approximately 21°16'N, 158°5'W); (C) Trachinidae: *Trachinus vipera*, 7.5 mm, redrawn from Schnakenbeck (1928); and (D) Uranoscopidae: *Astroscopus guttatus*, 4.9 mm, from Pearson (1941).

mode (Tables 135 and 139) typical of the marine percoids, one shares with the other Blennioidei the condition of spawning non-pelagic egg masses. Among the pelagic spawners, four retain the percoid-like condition of early hatching of poorly-differentiated larvae; two share with the demersal spawners the condition of a relatively long incubation and hatching of well developed larvae with pigmented eyes.

The larvae of four families are moderately deep-bodied, a character shared with the majority of percoids. Each of these families (except Trachinidae) contains at least some species with myomeres numbering in the mid-to-upper twenties: typical percoid counts. Five trachinoid families resemble blennioids in having elongate larvae, usually with more than 30 myomeres.

All trachinoid larvae (except some Trachinidae) follow the typical perciform pattern of beginning caudal fin ossification first; larvae of five families follow the percoid pattern of beginning ossification of dorsal and anal fin rays before pectoral and pelvic fin rays. Four families share with the other blennioids the early acquisition of pectoral and/or pelvic fin rays. All trachinoid families share with the other blennioids the jugular placement of pelvic fins, but only one family (not all species) also shares the blennioid condition of fewer than five pelvic fin rays.

Larval pigmentation and preopercular spination of the Trachinoidea (Table 139) are difficult to assess, since both range from absent to highly developed in both the Percoidae and Blennioidei. The distribution of these characters is listed in Table 139 to aid in determining relationships among the Trachinoidea.

Based solely on early life history characters (Table 139), the Uranoscopidae and Mugiloididae (including Cheimarrichthyidae?) appear to be the most percoid-like members of the Trachinoidea, while Trichodontidae are most like the other Blennioidei. Two points become clear in considering the contribution of early life history to the understanding of trachinoid phylogeny: (1) the Trachinoidea is a very diverse, probably polyphyletic, group; and (2) much more early life history data are needed before any substantial contribution can be made to the understanding of this group.

(W.W.) MARINE ECOLOGICAL CONSULTANTS, 531 ENCINITAS BOULEVARD, SUITE 110, ENCINITAS, CALIFORNIA 92024; (A.C.M.) NATIONAL MARINE FISHERIES SERVICE, NORTHWEST AND ALASKA FISHERIES CENTER, 2725 MONTLAKE BOULEVARD EAST, SEATTLE, WASHINGTON 98112; (E.G.S.) NATIONAL MARINE FISHERIES SERVICE, SOUTHWEST FISHERIES CENTER, PO BOX 271, LA JOLLA, CALIFORNIA 92038.

Notothenioidea: Development and Relationships

E. G. STEVENS, W. WATSON AND A. C. MATARESE

NOTO THENIOIDEA comprises 5 families with 35 genera and about 100 species (Table 140). These families are endemic to the Antarctic and Subantarctic regions (DeWitt, 1971; Norman, 1938a; Wyanski and Targett, 1981). Adults, ranging from 100 to 900 mm SL, occupy several habitats from the surface to several hundred meters depth and are often associated with continental and island slopes and shelves. Some species are adapted for living close to the undersurface of ice.

Discussions of the systematic position of notothenioids are found in Gosline (1968) and Norman (1938a), who consider them Perciformes or perciform relatives on the basis of the adult cranial osteology; the jugular position of the pelvic fins, which have one spine and five rays; and the caudal fin ray number, usually 14. Both note the reduced number of pectoral radials found in Notothenioidea. Gosline (1968) unites the notothenioids with trachinoids and blennioids using characters such as the one to one ratio of vertebrae to dorsal and anal fin

rays, more than 25 vertebrae, and fewer than 15 branched caudal rays. Gosline (1968), Norman (1938a), and other recent workers (i.e., Andersen and Hureau, 1979) separate Nototheniidae and Harpagiferidae making a total of five families (this classification is used here), whereas Nelson (1976) follows Berg (1940) and

TABLE 141. NOTOTHENIOIDEA: EGG DIAMETER (MM) AND LARVAL SIZE AT SELECTED DEVELOPMENTAL STAGES (MM SL).

Family	Egg diameter	Hatching	Notochord flexion	Juvenile
Bovichthyidae	Unknown	Unknown	Unknown	ca. 25
Nototheniidae	1.2-4.0	6-14	9-20	25-60
Harpagiferidae	2.4-3.0	7-13	ca. 9-13	35-38
Bathydraconidae	1.5-3.0	Unknown	18-24	24-34+
Channichthyidae	2.8-4.5	ca. 14	18-42	50-60+

TABLE 140. NOTOTHENIOIDEA: GENERAL SUMMARY AND EARLY LIFE HISTORY INFORMATION.

Family	Number of genera	Approximate number of species	Distribution	Early life history		
				Descriptions		Illustrations
				Genera	Species	Species
Bovichthyidae	3	12	Antarctic, Subantarctic	0	0	0
Nototheniidae	8	50	Antarctic, Subantarctic	5	16	12
Harpagiferidae	5	15	Antarctic, Subantarctic	2	4	3
Bathydraconidae	10	14	Antarctic	7	8	6
Channichthyidae	11	17	Antarctic	8	8	7

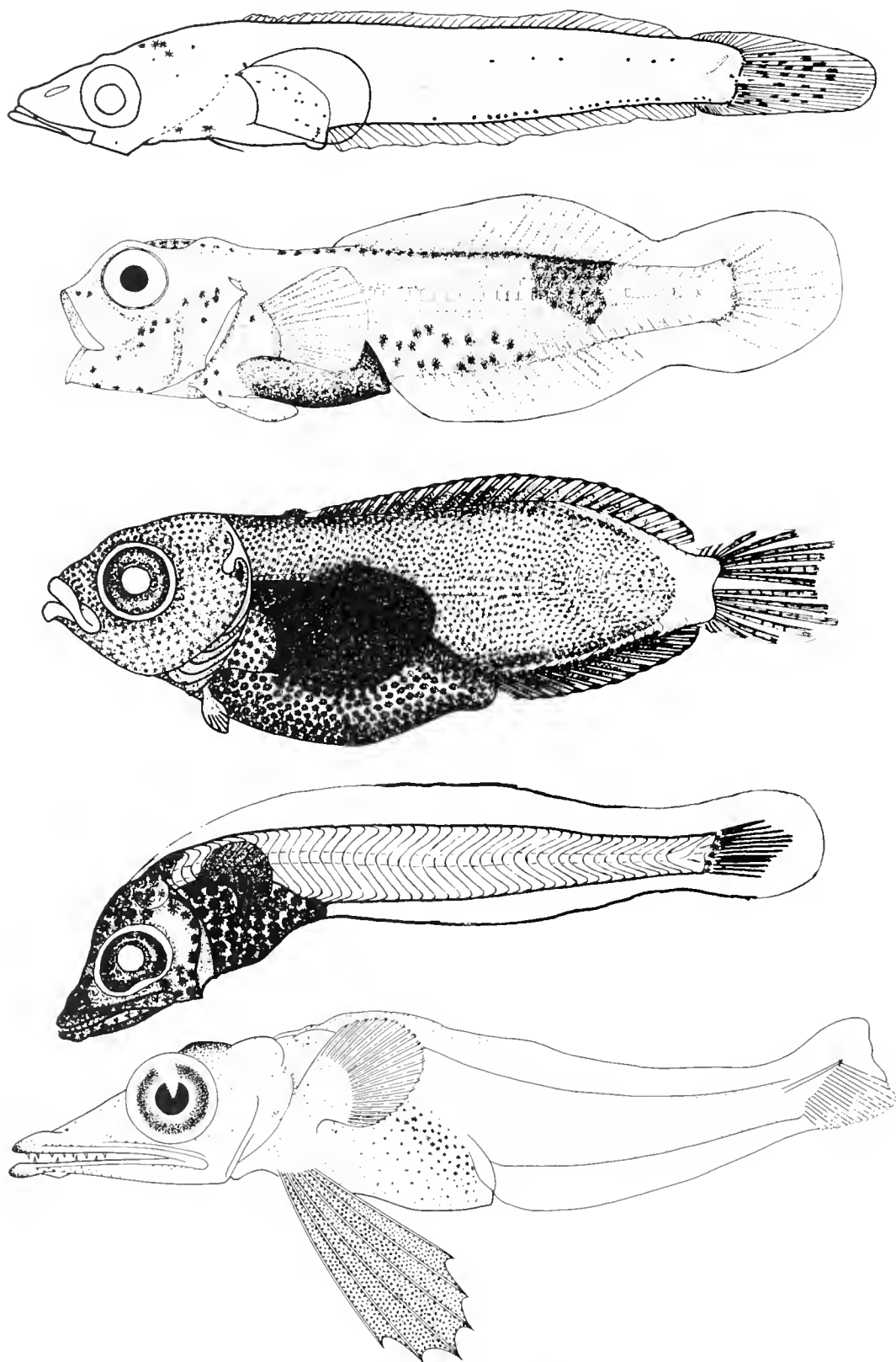

Fig. 301. Notothenioid larvae (from top to bottom): Nototheniidae: *Patagonotothen larseni*, 35 mm, from North and White (1982); Harpagiferidae: *Harpagifer bispinis*, 18.2 mm, from Everson (1968); Harpagiferidae: *Artedidraco murus*, 24.0 mm, from Efremenko (1983); Bathylacridae: *Psilodraco breviceps*, 16.9 mm, from Efremenko (1983); and Channichthyidae: *Pagetopsis macropterus*, 19 mm, redrawn by H. Orr from Regan (1916).

Greenwood et al. (1966) in placing Harpagiferinae as a subfamily of Nototheniidae (Table 140).

DEVELOPMENT

The first work on the early life history of these fishes was undertaken with material collected on the polar expeditions of the early 20th century. Regan (1916) illustrated larvae of seven notothenioid species. Additional early life history data were sparse until the Antarctic expeditions of the second half of the century. In the last 30 years efforts have been directed toward understanding the biology, ecology, population dynamics, and physiological adaptations of these fish. In these investigations some early life history data have been acquired. Larvae of 36 species have been described (Table 140). The most comprehensive summaries are the key in North and White (1982), the papers of Yefremenko (1979b, c) and the atlas of Efremenko (1983a).¹ No early life history data are available for the family Bovichthyidae except for a brief description of the behavior and an illustration of a 25 mm prejuvenile of *Bovichthys variegatus* (Robertson and Mito, 1979).

Eggs

Eggs of four notothenioid families have been described including some known only from studies of ovaries (Table 141). Eggs are moderate to large (1.2–4.5 mm diameter) with large yolks, no oil globules, and small perivitelline spaces (Marshall, 1953; Andriashev, 1965; Dearborn, 1965). In one species, *Notothenia (Trematomus) bernacchii*, eggs are bright yellow to deep brown. Most species are demersal spawners; nesting behavior has been observed in *N. bernacchii* (Moreno, 1980) and *Harpagifer bispinis* (Daniels, 1978). However, *Notothenia microlepidota* eggs have been reported from plankton collections (Robertson, 1975a). The demersal eggs are sticky, clinging to substrate or algae. One species, *N. neglecta*, reared in the laboratory from artificially fertilized eggs, has an incubation time of 103–150 days and hatches with a well-developed, heavily pigmented body, black eyes, and a large yolk sac (White et al., 1982). Daniels (1978) reports an incubation time of 14 to 18 weeks for *H. bispinis*.

Larvae

Morphology.—The described larvae of 36 species display some morphological similarity (snout–anus length), and some diversity (snout length and body shape). Preflexion larvae, ca. 6–18 mm SL, are elongate with large pectoral fins and moderate to wide finfolds. Channichthyid larvae have well developed pelvic fins at this stage and more elongate snouts than larvae of other notothenioids. Some species have large yolk sacs which persist after notochord flexion has begun. Preanal lengths range from slightly under to slightly over 50% of body length.

During flexion and postflexion stages most larvae maintain their elongate shape (Fig. 301). However the larvae of the harpagiferid genera *Artedidraco* and *Pogonophryne* become very robust (North and White, 1982; Efremenko, 1983a). Notochord flexion occurs between 9 and 42 mm with larval Harpagiferidae and Nototheniidae flexing at the shortest lengths, Channichthyidae at the longest, and Bathydraconidae at intermediate lengths (Table 141). Size at transformation to the juvenile stage also spans a wide range with *Harpagifer bispinis* settling at 18.3 mm

(Everson, 1968) and pelagic larvae of other species reaching 24–60 mm (de Ciechowski and Weiss, 1976; North and White, 1982; Yefremenko, 1979b, c).

Larvae of all species develop pelvic fins. Channichthyid larvae retain their elongate snouts and develop teeth and preopercular and rostral spines not reported for other notothenioids (Fig. 301).

Pigmentation.—Pigment patterns of all known larvae are highly specific and are useful identification criteria. The amount and location of pigment varies within families and the amount usually increases with development. A few species have general body pigment, but most exhibit patterns in one or more of the following areas: dorsal body margin, ventral body margin, body midline, peritoneum, gut, and along the myosepta. The occipital and parietal areas typically are pigmented; many species have snout, opercular, and jaw pigment as well. The paired fins are usually pigmented. Pigment is found at the base of the caudal fin in most species, associated with the posterior margin of the hypural elements or the bases of the caudal rays.

Meristics.—Meristics are from counts given for adults by Regan (1913d, 1916), Norman (1937, 1938a), Nybelin (1947, 1951), Andriashev (1959), and DeWitt (1970) (Table 142). Vertebral counts are especially useful diagnostic features within and between families. The dorsal, anal, pectoral, and vertebral counts have been the most significant characters linking larvae to adults (Yefremenko, 1979b, c). The sequence of fin formation is the same in Nototheniidae, Harpagiferidae, and Bathydraconidae with pectoral and caudal fins forming first, followed by pelvics, with dorsal and anal last to ossify. In Channichthyidae the pelvics are precocious and are present in yolk-sac larvae.

RELATIONSHIPS

Knowledge of the early life history of Notothenioidea has not contributed to understanding relationships between Blennioidei and other perciform suborders, but does offer some clues to relationships within the suborder. The lengthy ovarian egg development (Dearborn, 1965; Everson, 1970) is probably related to the cold environment. In other aspects of spawning, i.e., nesting behavior, long incubation time, and laying of demersal adhesive eggs, this infraorder resembles other cold-water blennioids. The well developed state of newly hatched larvae and the sequence of fin development as well as the general lack of specialized larval structures are also blennioid features. Further study of developmental characters, such as the sequence of ossification, might contribute to better understanding of the relationships among the Blennioidei. Superficial morphological and meristic resemblances exist among notothenioid larvae and those of other blennioid species, for example, the notothenioid *Patagonotothen larseni* (Fig. 301), the trachinoid *Trichodon trichodon* (see Trachinoidea, this volume) and the blennioid *Heterostichus rostratus* (see Blennioidea, this volume). As relationships among the blennioids become better known, their relationship with other perciforms might become clearer.

(E.G.S.) NATIONAL MARINE FISHERIES SERVICE, SOUTHWEST FISHERIES CENTER, PO BOX 271, LA JOLLA, CALIFORNIA 92038; (W.W.) MARINE ECOLOGICAL CONSULTANTS, 531 ENCINITAS BOULEVARD, ENCINITAS, CALIFORNIA 92024; (A.C.M.) NATIONAL MARINE FISHERIES SERVICE, NORTHWEST AND ALASKA FISHERIES CENTER, 2725 MONTLAKE BOULEVARD EAST, SEATTLE, WASHINGTON 98112.

¹ Efremenko and Yefremenko are alternative transliterations of the name of the same author.

Blennioidea: Development and Relationships

A. C. MATARESE, W. WATSON AND E. G. STEVENS

THE Blennioidea is composed of 16 families with about 182 genera and 759 species (Table 143). The families discussed here are those included in the infraorder Blennioidea by Nelson (1976), as amended by the current literature. For convenience we divide the infraorder into a tropical and a northern group. The tropical group is similar to Gosline's (1968) superfamily Blennioidea except for the following: 1) Ophiclinidae and Peronedysidae are synonymized with the Clinidae (George and Springer, 1980); 2) Dactyloscopidae is included (George and Springer, 1980); and 3) Congrogadidae is excluded (Winterbottom, 1982¹). The northern group is similar to Gosline's (1968) superfamily Zoarceoidae except that we include the Bathymasteridae (Anderson, 1984). The Zoarcidae is treated separately (Anderson, this volume).

The majority of species (80%) belong to four tropical families: Tripterygiidae, Clinidae, Labrisomidae, and Blenniidae. Of the northern forms, only the family Stichaeidae represents a significant percentage (8%) of the species. Tropical Blennioidea inhabit primarily the Indo-West Pacific south to Australia, while northern fishes inhabit the North Atlantic and North Pacific (Table 143). Occasionally, representatives of mainly tropical families occur in boreal waters (e.g., Clinidae and Blenniidae), and members of northern families may occur in the subtropics. Some dactyloscopids inhabit fresh water. Four families are monotypic and three of these are endemic to the northeast Pacific.

As a group most of the 16 families in Blennioidea are not well understood, probably due to their lack of commercial importance, small size and cryptic habits. In general, the tropical and more speciose families (e.g., Blenniidae) are better known than the northern families. Monotypic families are quite poorly known. Although sparse and incomplete, some early life history information is available for 11 of the 16 families (Table 143). In most cases, however, the data on few species may not be representative of the family. Among the families in the infraorder, the Blenniidae has the greatest number of species (22) described; but with about 319 species in the family, this amounts to fewer than 10%. Morphology, pigment, and meristics of larvae in the infraorder are diverse (Figs. 302, 303).

DEVELOPMENT

Eggs

Fishes in this infraorder spawn demersal eggs (Table 144), except for some clinids. Clinids of the tribe Ophiclinini are ovoviviparous (George and Springer, 1980), while those of the tribe Clinini are viviparous (Penrith, 1969; Hoese, 1976).

Most blennioid eggs are spherical to somewhat flattened, possess one to several oil droplets, are attached to one another (and often to a substrate) by filaments or other adhesions, and have

a smooth unsculptured chorion. Sizes range from among the smallest of fish eggs (Blenniidae, 0.50 mm) to among the largest (Anarhichadidae, 8.0 mm). Incubation periods range from 6 to 70 days. Eggs are unknown for four families: Xenocephalidae, Ptilichthyidae, Zaproridae, and Scytalinidae.

Parental care is common among most families; e.g., in stichaeids, males or females may guard egg masses (Shiogaki and Dotsu, 1972a; Shiogaki, 1981, 1982). In an extreme example of parental care, male dactyloscopids incubate eggs in ball-like clusters carried beneath the pectoral fins (Dawson, 1982).

Larvae

Morphological characters.—Blennioidea larvae hatch at sizes ranging from as small as 2.0 mm (Blenniidae) to as large as 17.0 mm (Anarhichadidae) (Table 145). Larvae of the northernmost families hatch at more than twice the size of larvae of the more tropical families (i.e., averaging ca. 11.5 mm versus ca. 4.5 mm). Size at which notochord flexion is complete is also variable, but tropical larvae are usually fully flexed by ca. 10.0 mm whereas northern larvae do not complete flexion until ca. 20.0 mm. At least three families have larvae with an extended pelagic existence: Blenniidae, Cryptacanthodidae, and Zaproridae. Members of the blennioid tribe, Salariini, have the only well-documented, prejuvenile pelagic stage (Miller et al., 1979; Leis and Rennis, 1983). This has been termed the "ophiblennius" stage and usually occurs between 4.6 and 26.0 mm (Fig. 302). At least two families, Cryptacanthodidae (Shiogaki, 1982) and Zaproridae (Haryu and Nishiyama, 1981), have heavily pigmented larvae and prejuveniles that are extensively collected in surface nets suggesting an extended pelagic existence (Fig. 303C, G). Most blennioid larvae do not undergo a marked metamorphosis. Transformation is usually complete in tropical forms by 26.0 mm, but may begin as early as 10.0 mm in some families (Tripterygiidae and Blenniidae). Larvae in the more northern families transform at a slightly larger size, ca. 30.0–40.0 mm, although *Ptilichthys* transforms at ca. 114.0 mm.

Among the tropical families, larval Tripterygiidae, Clinidae, and Labrisomidae share many similar morphological features. They are moderately elongate, have a preanal length about 50% BL (slightly less in labrisomids), possess a large swimbladder, and usually lack preopercular spines (Figs. 302A, B, C, D). Heads are small, sometimes rounded, with a short snout. Mouths extend just beyond the anterior eye margin. In tripterygiid and clinid larvae, the gut is initially straight but coils during flexion.

The blenniids include many larval forms with diverse morphological features. According to Leis and Rennis (1983), however, larvae are more similar within tribes than between tribes. Most species are moderately elongate (Nemophini includes both slender and robust forms), becoming either more slender (Nemophini) or more robust (Salariini) with development. Heads are short, rounded, and broad becoming more elongate with development (except Salariini larvae in which the snout elongates early in the preflexion stage). The gut is short to moderate (usually < 50% BL), and eventually coiled if not so initially. Larval preopercular spination may be elaborate: spines can be numer-

¹ Winterbottom, R. 1982. The perciform fish family Congrogadidae—biogeography and evidence for monophyly. *Amer. Soc. Ich. Herp.*, oral paper, 62nd annual meeting.

TABLE 143. GENERAL SUMMARY AND EARLY LIFE HISTORY (ELH) INFORMATION IN BLENNIOIDEA.

Taxon	Number of genera	Approx number of species	Primary Distribution	Early life history			Primary early life history sources
				Number of genera	Number of species	Number of species illustrated	
Blennioidea							
Dactyloscopidae	6	20	Atlantic, Pacific (tropical)	1	1		Dawson 1982
Xenocephalidae	1	1	New Ireland, New Guinea	0	0		
Notograptidae	2	3	Australia	0	0		
Tripterygiidae	18-19	75-95	Atlantic, Pacific, Indian (tropical)	5	6	7	Graham, 1939; Leis and Rennis, 1983; Miller et al., 1979; Ruck, 1973a, 1980; Shioyaki and Dotsu, 1973; Watson, unpubl.; Wirtz, 1978
Clinidae	26	85	Atlantic, Pacific, Australia	4	5	14	Barnhart, 1932; Padoa, 1956h; Shioyaki and Dotsu, 1972b; Sparta, 1948; Stevens, unpubl.; Watson, unpubl.
Chaenopsidae	10	55	Atlantic, Pacific (tropical)	0	0		Böhlke, 1957; Stephens et al., 1966
Labrisomidae	14	100	New World (tropical)	2	3	3	Breder, 1939; Breder, 1941; Springer, 1958; Watson, unpubl.
Blenniidae	53	289-319	Indo-Pacific	17	22	27	Cipria, 1934, 1936; Dotsu, 1982; Dotsu and Moriuchi, 1980; Dotsu and Oota, 1973; Dutt and Rao, 1960; Eggert, 1932; Fishelson, 1963, 1976; Fives, 1970a; Ford, 1922; Fritzsche, 1978; Hildebrand and Cable, 1938; Lebour, 1927; Leis and Rennis, 1983; Lippson and Moran, 1974; Miller et al., 1979; Mito, 1954; Munro, 1955; Peters, 1981; Qasim, 1956; Rao, 1970; Russell, 1976; Stevens and Moser, 1982; Thomson and Bennett, 1953; Watson, 1974, unpubl.; Wickler, 1957
Bathymasteridae	3	7	North Pacific	2	3	1	Breder and Rosen, 1966; Fitch and Lavenberg, 1975; Matarese, unpubl.
Stichaeidae	37	54	North Atlantic, Pacific	14	18	15	Breder and Rosen, 1966; Faber, 1976; Hart, 1973; Marliave, 1975; Matarese, unpubl.; Peppar, 1965; Rass, 1949; Russell, 1976; Shioyaki, 1981; Shioyaki, 1983; Shioyaki and Dotsu, 1972a; Tokuya and Amaoka, 1980; Wourms and Evans, 1974
Cryptacanthodidae	3	4	North Atlantic, Pacific	3	3	2	Hart, 1973; Matarese, unpubl., Shioyaki, 1982
Pholidae	4	13	North Atlantic, Pacific	3	5	3	Breder and Rosen, 1966; Marliave, 1975; Rass, 1949; Sawyer, 1967; Tokuya and Amaoka, 1980
Anarhichadidae	2	6	North Atlantic, Pacific	2	3	2	Andriyashev, 1954; Barsukov, 1959; Breder, 1941; Kobayashi, 1961a; Marliave, 1975; Rass, 1949
Ptilichthyidae	1	1	Northeast Pacific	1	1	1	Kobayashi, 1961b; Richardson and Denhart, 1975
Zaproridae	1	1	Northeast Pacific	1	1	1	Chapman and Townsend, 1938; Haryu and Nishiyama, 1981
Scytalinidae	1	1	Northeast Pacific	0	0		

ous or large (Blenniini and Omobranchini) or completely lacking (Nemophini). Teeth develop early in most species; these become large (Nemophini) or hooked (Saliariini) (Fig. 302E). Cirri may develop at the end of the larval period. Members of the Saliariini have elongate pectoral fins (Fig. 302F).

Larvae of the northern families have an elongate body shape,

but they range from moderately elongate (Zaproridae) to extremely long and thin (Ptilichthyidae) (Fig. 303). Heads are small, and initially pointed or rounded but become more pointed with development. Most species have a short to moderate snout. Preanal length is highly variable. Generally, preanal length is at least 50% BL, but it ranges from short (<50% BL in pre-

TABLE 144. SUMMARY OF EGG CHARACTERS IN BLENNIOIDEA. Blanks indicate data are unavailable.

Taxon	Egg type ¹	Single or mass	Egg diameter (mm)	Number of oil globules	Attachment processes or ornamentation	Pigmentation	Incubation (days)	Primary sources
Blennioidea								
Dactyloscopidae	D							Dawson, 1982
Xenoccephalidae								
Notograptidae								
Tripterygiidae	D	Mass	0.90-1.40	Few to numerous	Filaments at one pole or everywhere	Embryo, yolk with "pigment spheres"	16-22	Graham, 1939; Miller et al., 1979; Ruck, 1973a; Ruck, 1980; Shioyaki and Dotsu, 1973
Clinidae	D ²		0.96-1.7	Several	Filaments		12-40	Barnhart, 1932; Padoa, 1956h; Shioyaki and Dotsu, 1972b; Sparta, 1948; Stevens, unpubl.
Chaenopsidae	D							Stephens et al., 1966
Labrisomidae	D	Mass	1.15-1.33	1-6	Attach to each other, strands	Embryo, yolk	10	Breder, 1939
Blenniidae	D	Mass	0.58-1.6 × 0.4-0.96	0-several	Adhesive disk or pedestal	Embryo, yolk	6-61 ³	Cipria, 1934, 1936; Dotsu, 1982; Dotsu and Moriuchi, 1980; Dotsu and Oota, 1973; Dutt and Rao, 1960; Egger, 1932; Fishelson 1963, 1976; Fritzsche, 1978; Hildebrand and Cable, 1938; Lebour, 1927; Mito, 1954; Munro, 1955; Peters, 1981; Qasim, 1956; Rao, 1970; Stevens and Moser, 1982; Thomson and Bennett, 1953; Watson, unpubl.; Wickler, 1957
Bathymasteridae	D	Mass	0.99-1.1	1	Non-adhesive mass		13-15	Breder and Rosen, 1966; Fitch and Lavenberg, 1975; Matarese, unpubl.
Stichaeidae	D	Mass	1.37-2.5	1	Adhesive		21	Breder and Rosen, 1966; Hart, 1973; Marliave, 1975; Matarese, unpubl.; Peppar, 1965; Shioyaki, 1983; Wourms and Evans, 1974
Cryptacanthodidae	D		1.8					Hart, 1973
Pholidae	D	Mass	1.4-3.0	1	Adhesive		42-70	Breder and Rosen, 1966; Marliave, 1975; Matarese, unpubl.; Sawyer, 1967
Anarhichadidae	D	Loose or clumps	4.0-8.0	1				Barsukov, 1959; Breder and Rosen, 1966; Matarese, unpubl.
Ptilichthyidae								
Zaproridae								
Seytaliniidae								

¹ D = demersal.² Ophichini-ovoviparous George and Springer (1980) Chini-viviparous (Penrith, 1969, Hoese 1976)³ Usually 7-14 days

TABLE 145. SUMMARY OF LARVAL SIZE AT SELECTED DEVELOPMENTAL STAGES IN BLENNIOIDEA (MM SL). Blanks indicate data are unavailable.

Taxon	Hatching	Notochord flexion	Special prejuvenile	Juvenile
Blennioidea				
Dactyloscopidae				
Xenocephalidae				
Notograptidae				
Tripterygiidae	2.7–6.1	4.8–<9.4	None	≥11.0
Clinidae	5.5–6.7	by 11.4–14.3	None	>16–25
Chaenopsidae				>16–17
Labrisomidae	4.1	4.9–6.9	None	>19–25
Blenniidae	2.0–5.4	3.6–10.75	4.6–26.0 Salariini	6.4–26.0
Bathymasteridae	5.5–6.0	<10.0	None	ca. 40.0
Stichaeidae	6.5–12.5 (8–9.5)	12.0–20.0 (13–15)	None	>25.0
Cryptacanthodidae	10.0–11.0	<18.0	Neustonic	ca. 30.0
Pholidae	10.0–12.5	ca. 19.0–30.0	None	>30.0
Anarhichadidae	17.0–18.0	<20.0	None	ca. 40.0
Ptilichthyidae	<20.0		None	ca. 114.0
Zaproridae	<12.0	<17.0	Neustonic	
Scytalinidae				

flexion Stichaeidae) to very long (Pholidae) (Fig. 303B, D). The family Anarhichadidae includes one genus with a long, thin bodied larva (*Anarrhichthys*) and another with only a moderately elongate larva (*Anarhichas*) (Fig. 303E). The monotypic family Ptilichthyidae has a unique larval form—it is highly elongate with a small head and extended postanal body (Fig. 303F).

Pigmentation characters.—Pigmentation is typically sparse for most families within this infraorder, and tends to be added subcutaneously with development. However, four families [Zaproridae, Anarhichadidae, Cryptacanthodidae, and some Nemophini (Blenniidae)] have larvae with dense body pigment that is not typical of the Blennioidea (Figs. 303C, E, and G). Important pigment areas are along the ventral body midline and in the gut area (Table 146).

Head.—Eyes are pigmented prior to hatching in all known groups. Pigment is generally absent or light during notochord flexion but usually increases dorsally, over the brain, by the time flexion occurs. Additionally, postflexion larvae may have pigment on the snout, mouth, and in the opercular area.

Gut.—Preflexion larvae in most species have peritoneal and some dorsolateral pigment. In families that have a gas bladder (e.g., Tripterygiidae, Labrisomidae, and Blenniidae), pigment is present on its dorsal surface (Fig. 302A, D). Ventral pigment may or may not be present. During notochord flexion, pigment increases on the lateral gut surface, and becomes subcutaneous in postflexion larvae.

Trunk and tail.—This is the most important pigment area for

TABLE 146. SUMMARY OF SOME PIGMENTATION CHARACTERS IN LARVAE OF BLENNIOIDEA. Key: D, dorsal; A, anal; P, pectoral; V, ventral; C, caudal; +, present; O, absent; An, anterior; Po, posterior;], increasing;], decreasing; -, with development; and O → +, unpigmented initially, becoming pigmented with development.

Taxon	Eye at hatching	Head						Gut				
		Brain	Jaw	Snout	Opercle	Isthmus	Nape	Anterior	Dorsal	Ventral	Lateral	
Tripterygiidae	+	+	O	O	O	O	O	O	+	O, +Po	O	
Clinidae	+	O	O	O	O	O	O → +	O	+	+Po	O	
Chaenopsidae		O	O	O	O	O	O	O	O	O	O	
Labrisomidae		O	O	O	O	O	O	O	+	+	O	
Blenniidae	+	O, + →]	O	O	O	O	O	O	+]	O → +]	+ →]	
Bathymasteridae	+	O → +	O	O	O	+	O	O	+	+	O	
Stichaeidae	+	O, +	O, +	O	O	+	O	O	+ →]	+	O	
Cryptacanthodidae	+	+]	+	+	+]	O → +	+	O	+ →]	O	O	
Pholidae	+	O →]	O	O	O	+	O	O	+	+	O	
Anarhichadidae	+	+]	+	+	+]	+	O → +	O	+]	O → +	+ →]	
Ptilichthyidae		+	+	O	O	+	O	+	+	+	O → +An	
Zaproridae	+	+]	+	+	+]	+	+	O	+	O	+]	

identifying specific groups within this infraorder. Except for the densely pigmented families listed above, pigment along the dorsal body midline is rare in preflexion larvae. With development, pigment may increase along the dorsal midline or on the nape. Initially, lateral pigment is either absent or consists of a few spots internally along the notochord. After notochord flexion, internal and external pigment can increase ventrolaterally, or above and below the notochord (Stichaeidae, Bathymasteridae, and Pholidae). Typically, a series of ventral midline melanophores occurs in preflexion larvae. Although these melanophores may be absent in some families (Chaenopsidae, some Tripterygiidae), a number of families have larvae with up to 50 melanophores here (e.g., Blenniidae). The number, size, and shape of these melanophores can be very important when identifying groups. These spots may change shape with development (becoming y-shaped in Tripterygiidae and some Blenniidae), decrease in number (some Blenniidae and Stichaeidae), or become subcutaneous (Stichaeidae).

Fins.—With the exception of zaprorids and some blenniids, fins are rarely pigmented in preflexion larvae. After notochord flexion pigment develops on the various fins of blenniids, anarhichadids, and ptilichthyids (Table 146).

Hypural margin.—Pigment in the caudal area is usually lacking in preflexion larvae, and in postflexion larvae its presence is limited to a few families (Table 146).

Meristic characters.—The number of dorsal fins varies from one to three and in most families some combination of spines and rays is present, with spines predominating. Tripterygiids, clinids, and labrisomids may have up to three dorsal fins, the first two composed of spines. The total number of dorsal elements is highly variable but in some groups (stichaeids, anarhichadids, and ptilichthyids) well over 100 elements are present. The anal fin in most groups may include 1–2 spines. Stichaeids may have up to 5 anal spines. Information on the caudal fin is incomplete. In addition, from data available in the literature, principal rays and branched rays are not consistently distinguished. Most groups

have between 9 and 15 (usually about 12–13) principal caudal fin rays and about 25–30 total caudal fin rays. All possess a pectoral fin with as few as 3 (labrisomids and clinids) or as many as 25 (zaprorids) fin rays. Pelvic fins can be present or absent. The northern families, except some stichaeids and pholids, lack pelvic fins. Tropical families usually possess thoracic pelvic fins with 1 spine and fewer than 5 rays (mostly 2–3 soft rays).

Vertebral counts are unknown for many blennioids or are based on few specimens. The number of vertebrae is highly variable within some families (e.g., stichaeids, blenniids, anarhichadids). In general, tropical families have a lower vertebral count than do northern families.

The order of fin ray development is highly variable in the Blennioidea. Information available on this is also inadequate, since in most studies reviewed here larvae have not been cleared and stained to determine the onset of ossification. In the tropical families where notochord flexion occurs as early as 3.6 mm, fin ray development may begin as early as 2.5 mm. Caudal fin rays develop first in clinid and labrisomid larvae, followed by the remaining fin rays soon after notochord flexion is complete. Typically, pectoral fin rays develop first in blenniid larvae (Blenniini and Salariini). In Ombranchini larvae (Blenniidae), the pectoral fin rays and caudal fin rays develop simultaneously. Among the northern families, data are insufficient to allow any generalizations. Fin rays begin forming at 9–15 mm in stichaeid larvae (usually caudal fin rays first) but may not be complete until larvae are 30 mm (Fig. 303B). Zaprorid and cryptacanthodid larvae begin caudal ray development about the time notochord flexion occurs. Fin ray development in ptilichthyid larvae begins with the dorsals and second anal at 40 mm.

RELATIONSHIPS

Although the scope of the available egg and larval data within the Blennioidea is limited, early life history characters reviewed here do not support the cohesiveness of this group. Due to a lack of unifying characters, the infraorder Blennioidea, as presently arranged, probably does not form a monophyletic group. Early life history characters appear to be more useful in clarifying relationships between families or within families rather than

TABLE 146. EXTENDED.

Trunk								
Dorsal margin	Dorso-lateral	Medio-lateral	Ventro-lateral	Ventral margin	Internal notochord	Hypural margin	Fin base	Diagnostic
+Po	○ → +	○	○	+	○	○	P	Anus, ventral midline
+ →	○ → +	+	○	+	+	○	○	Gut, ventral midline
○	○	○	○	○	○	○	○	Lack of pigment
○, +Po	○	○	○	+	○	○	○	Swimbladder, ventral midline
○ → + An	○ → +	○ → +	○ → ○, +	+ →	+	○ → ○, +	○ → PV	Gut, ventral midline
○ → +	○	○	○ → +	+	+	○, +	○	Urostyle or lateral cross-checking
○ → +	○	+ →	○ → +	+ →	+	○ → ○, +	○	Gut, anus, ventral midline
+	+	+	+	+	-	○	○	Dense body
○ → ○, +	○	+	○	+	+	○ → ○, +	○	Gut, ventral midline
+	+	+	+	+	+	○	○ → DA	Dense body, fins
+	○	○	○	+	○	○	AP ○ - C	Gut, dorsal and ventral margin, caudal fin
+	+	+	+	+	-	+	AP → D	Dense body

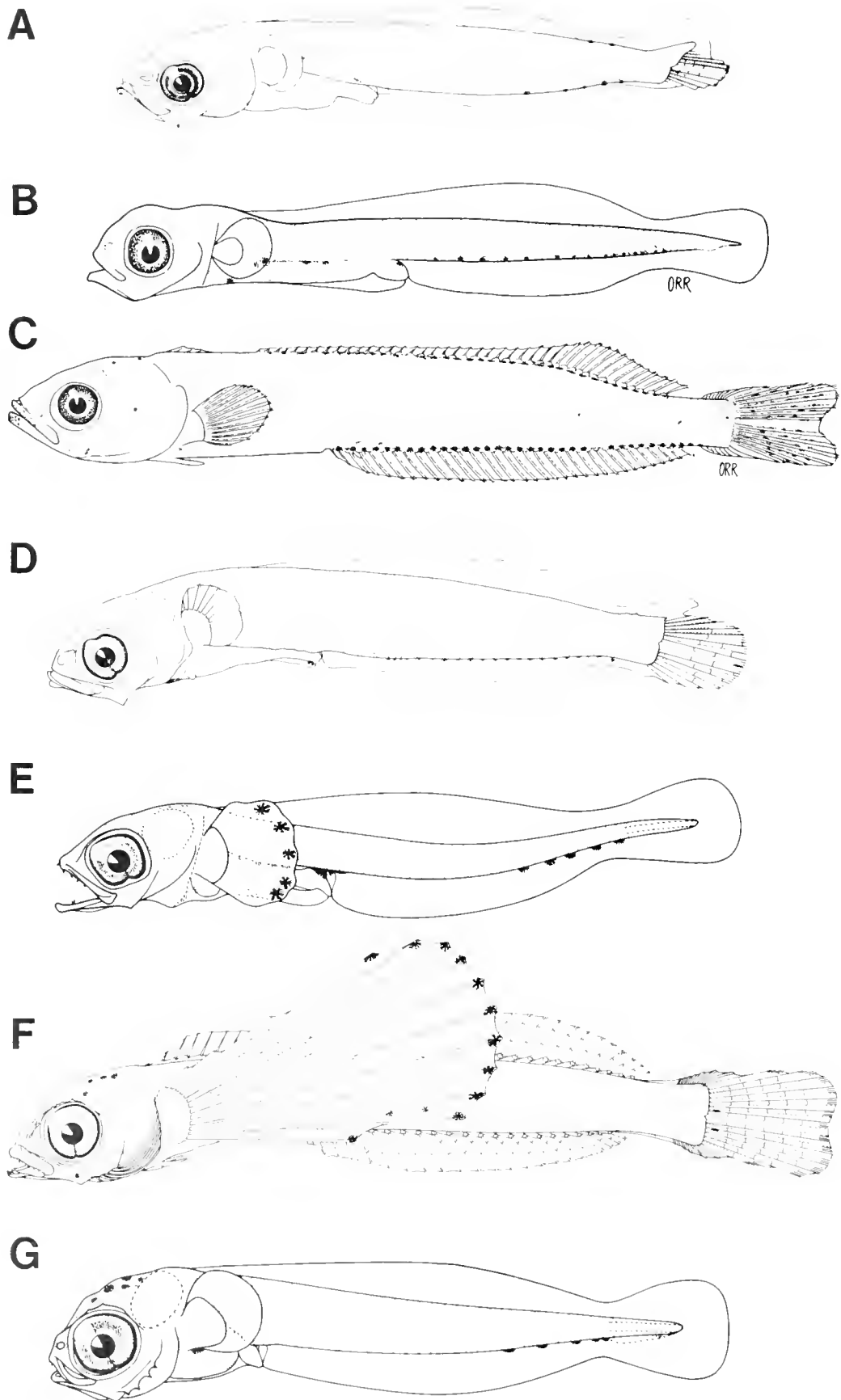

Fig. 302 Blennioidea larvae (tropical forms): (A) *Enneapterygius atriceps* (Tripterygiidae), 5.8 mm (from Miller et al., 1979 described as *Tripterygion atriceps*); (B-C) *Heterostichus rostratus* (Clinidae), 6.5 mm, 21.2 mm; (D) *Parachmus integrifinnis* (Labrisomidae), 7.2 mm; (E-F) *Istiblennius zebra* (Blenniidae), 3.3 mm, 11.0 mm (from Miller et al., 1979); (G) *Enchelyurus brunneohis* (Blenniidae), 3.2 mm (from Miller et al., 1979).

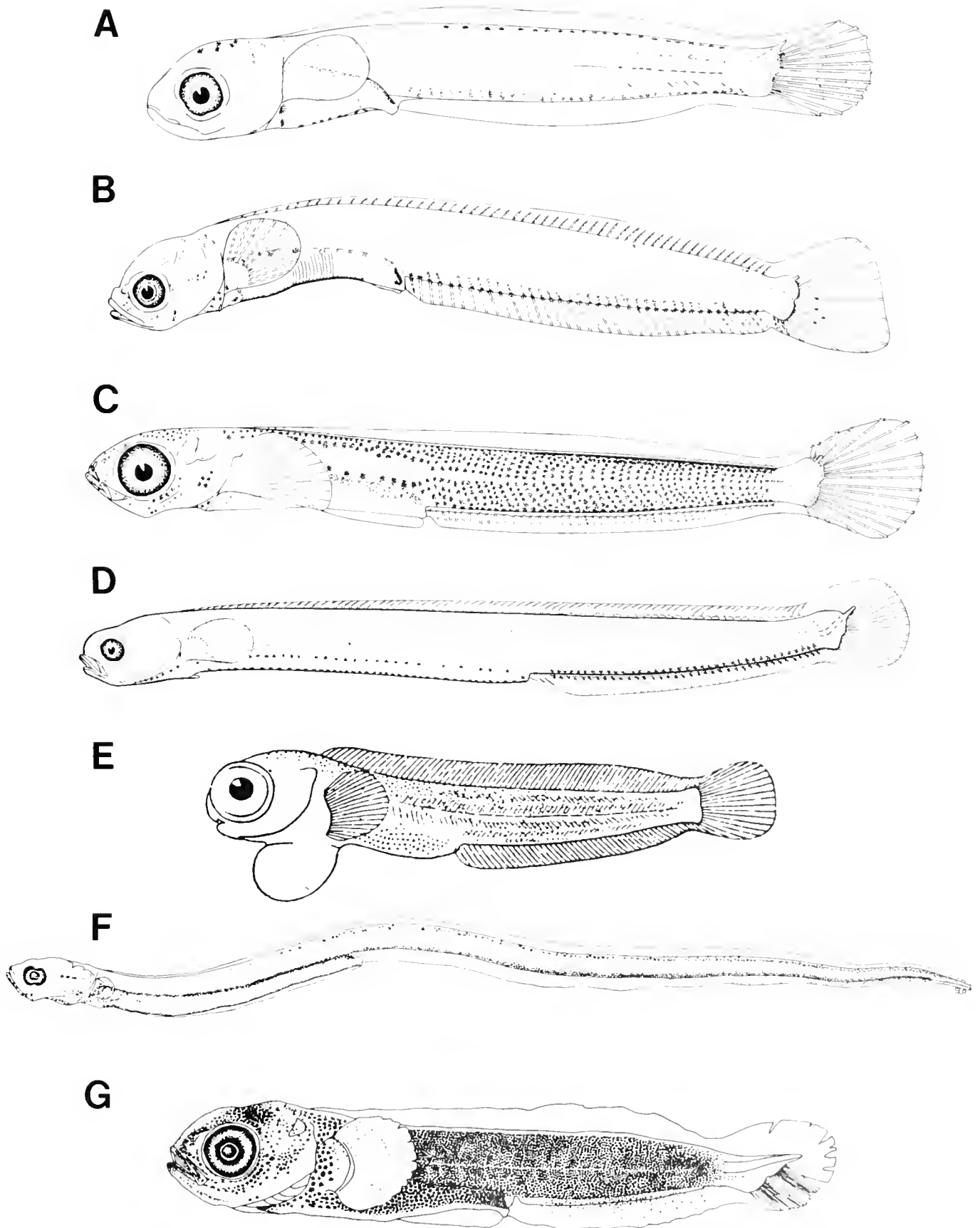

Fig. 303. Blennioidea larvae (northern forms): (A) *Ronqulus jordam* (Bathymasteridae), 10.4 mm; (B) *Anoplarchus purpurescens* (Stichaeidae), 12.0 mm; (C) *Lyconectes aleutensis* (Cryptacanthodidae), 16.0 mm; (D) *Pholis* sp. (Pholidae), 23.0 mm; (E) *Anarhichas lupus lupus* (Anarhichadidae), 24.5 mm (from Barsukov, 1959); (F) *Ptilichthys goodeti* (Ptilichthyidae), 24.7 mm (from Richardson and Dehart, 1975); (G) *Zaprora silenus* (Zaproridae), 16.0 mm (from Haryu and Nishiyama, 1981).

TABLE 147. SUMMARY OF SELECTED MERISTICS IN BLENNOIDEA. Blanks indicate data are unavailable.

Taxon	Fins					
	Dorsal		Anal		Pectoral	Pelvic
	Spines	Rays	Spines	Rays		
Blennioidea						
Dactyloscopidae	0-VII + V-XVIII	14-36	II	22-41	12-16	1, 3
Xenocephalidae	—	7	—	10	21	5
Notograptiidae						1
Tripterygiidae	III-VII + X-XXIV	7-15	0-II	14-30	10-19	1, 2-3
Clinidae	III + XXIV-LXXXIV	1-14	II	14-62	3-18	1, 2-3
Chaenopsidae	XVII-XXXIII	10-34	II	18-38	12-14	1, 3
Labrisomidae	III + I-IV + XX-LII	7-14	I-II	15-28	3-17	0-1, 0-3
Blenniidae	III-XVII	9-119	II	10-119	10-18	1, 2-4
Bathymasteridae	II	39-49	I-II	27-36	17-21	1, 5
Stichaeidae	XXII-CXXI	0-43	I-V	24-95	8-21	Absent or 1, 1-5
Cryptacanthodidae	LX-LXXVII	—	II	45-50	11-15	Absent
Pholidae	LXXIV-CCL	—	I-II	29-53	10-16	Absent or 1, 0-1
Anarhichadidae	LXX-CCL	—	0-1	42-233	18-23	Absent
Ptilichthyidae	LXXXIII-XC	115-148	—	179-196	13	Absent
Zaproridae	LIV-LVII	—	—	24-30	20-25	Absent
Scytalinidae		41-51	—	41-51	8	Absent

between Blennioidei infraorders, e.g., the similarity between labrisomid and clinid larvae and the differences between larvae in the various blenniid tribes.

Many of the families in Blennioidea include a large number of intertidal forms and many of the similarities (e.g., demersal eggs, parental care, and advanced state of newly hatched larvae) may be related to environmental conditions rather than to a close phylogenetic relationship. Additional study on the complete life history of these fishes is needed to identify unifying characters, if any exist. Studies at the family level will improve

our knowledge of this unsatisfactorily defined group and facilitate outgroup comparisons.

(A.C.M.) NATIONAL MARINE FISHERIES SERVICE, NORTHWEST AND ALASKA FISHERIES CENTER, 2725 MONTLAKE BOULEVARD EAST, SEATTLE, WASHINGTON 98112; (W.W.) MARINE ECOLOGICAL CONSULTANTS, 531 ENCINITAS BOULEVARD, SUITE 110, ENCINITAS, CALIFORNIA 92024; (E.G.S.) NATIONAL MARINE FISHERIES SERVICE, SOUTHWEST FISHERIES CENTER, PO BOX 271, LA JOLLA, CALIFORNIA 92038.

TABLE 147. EXTENDED.

Fins		Vertebrae		Primary sources
Principal caudal	Precaudal	Caudal	Total	
9-11	11-14	25-41		Böhlke and Caldwell, 1961; Böhlke and Chaplin, 1968; Dawson, 1974a, 1975, 1976, 1982; Kanazawa, 1952; Miller and Briggs, 1962; Myers and Wade, 1946; Munro, 1967; Nelson, 1976; Nelson, 1976
13-15	10-13	20-30	40-50	Bath, 1973; Leis and Rennis, 1983; Rosenblatt, 1959, 1960; Wheeler and Dunn, 1975
10-15	13-35	25-63		Böhlke, 1960b; George and Springer, 1980; Hoese, 1976; C. Hubbs, 1952, 1953a; Penrith, 1969; Scott, 1955, 1962, 1966, 1967; Shen, 1971; Springer, 1955, 1970, Stevens and Springer, 1974
13, 19-23			39-57	Böhlke, 1957; Greenfield, 1972; Johnson and Greenfield, 1976; Robins and Randall, 1965; Rosenblatt and Stevens, 1978; Smith-Vaniz and Palacio, 1974; Stephens, 1963, 1970; Stephens et al., 1966
10-14	10-14	20-33		Böhlke and Robins, 1974; Böhlke and Springer, 1961, 1975; C. Hubbs, 1952, 1953b; Rosenblatt and Parr, 1969; Rosenblatt and Taylor, 1971; Smith, 1957; Springer, 1954, 1955, 1958, 1959; Springer and Gomon, 1975b
10-15	9-16	19-119	28-135	Bath, 1976, 1978; Smith-Vaniz, 1975, 1976; Smith-Vaniz and Springer, 1971; Springer, 1967, 1968, 1971, 1972a, 1972b, 1976; Springer and Gomon, 1975a; Springer and Smith-Vaniz, 1972; Springer and Spreitzer, 1978; Stephens, 1970
14	14-16	35-39	49-54	NWAFIC, unpubl.
3-8 + 3-9	14-43	29-72	46-113	Makushok, 1958; NWAFIC, unpubl.; Shiogaki, 1980, 1981
13-15, 14	24-27	47-51	72-78	NWAFIC, unpubl.; Shiogaki, 1982
6-7 + 6-7			80-107	Makushok, 1958; NWAFIC, unpubl.
7-8 + 19-26	24-39	46-214	72-250	Barsukov, 1959; Makushok, 1958; NWAFIC, unpubl.
	53-59	170-181	227-240	Makushok, 1958
30-31	24-26		61-62	Chapman and Townsend, 1938; NWAFIC, unpubl. NWAFIC, unpubl.

Ammodytoidei: Development and Relationships

E. G. STEVENS, A. C. MATARESE AND W. WATSON

THE suborder Ammodytoidei consists of one family, Ammodytidae, with 5 genera and about 18 species. These are small (less than 100–350 mm SL), elongate fish occurring in the littoral and neritic waters of the Atlantic, Indian, Pacific, and Arctic Oceans. Adults form schools but also bury themselves in the sand. They are commercially valuable in the North Sea and off Japan.

The systematic position of Ammodytoidei, reviewed by Duncker and Mohr (1939), is unresolved, although the suborder is considered a perciform derivative by Berg (1940), Greenwood et al. (1966), and Gosline (1971). A second family, Hypoptychidae, has been included in this suborder by these authors and by Robins and Böhlke (1970), but was removed to the suborder Gasterosteoidae by Ida (1976), who considered it a prepercomorph family on the basis of jaw and caudal osteology, egg size, and reproductive behavior (see Fritzsche, this volume).

DEVELOPMENT

The ammodytid genera, *Gymnammodytes*, *Hyperoplus*, and *Ammodytes* (11 species) are temperate and boreal; *Bleekeria* and *Embolichthys* (7 species) are more tropical in distribution. The confused nomenclature of the North Atlantic species was clarified by the synonymies in Reay (1970) and Russell (1976), where summaries of early life history data were also given. Other larval descriptions were given by Fage (1918) for *Gymnammodytes*; by Altukhov (1978), Kobayashi (1961c), Norcross et

al. (1961), Richards (1965), Scott (1972), and Senta (1965) for *Ammodytes*; and by Macer (1967) for North Atlantic species. To date, eggs of 6 species and larvae of 9 species of these genera have been described. No early life history data are available for the tropical genera.

Eggs

Eggs of the six species that have been described are demersal and adhesive, forming clumps on sandy substrates in shallow water. Eggs, probably loosened by tidal currents, have been collected in plankton nets (Williams et al. 1964; Senta, 1965). Russell (1976) summarized studies made on eggs resulting from artificial fertilization. Incubation time ranges from 2.0 to 12.5 weeks. Eggs are irregularly shaped, but generally spherical, from 0.67 to 1.23 mm in diameter, with a single yellow oil globule, 0.17 to 0.42 mm. Embryos develop specific dorsal and ventral pigment, pigmented eyes, a moderate finfold, and pectoral buds prior to hatching at about 3.6 mm.

Larvae

Morphology.—Larvae of Ammodytidae typically are elongate, with rounded snouts which become pointed with age, and pre-anal length slightly more than 50% body length (Fig. 304). Newly hatched larvae range from 3.0 to 4.6 mm body length. In newly hatched and preflexion larvae the anus does not extend to the edge of the moderately wide finfold but opens to the side. Notochord flexion occurs at 10 to 12 mm body length in most

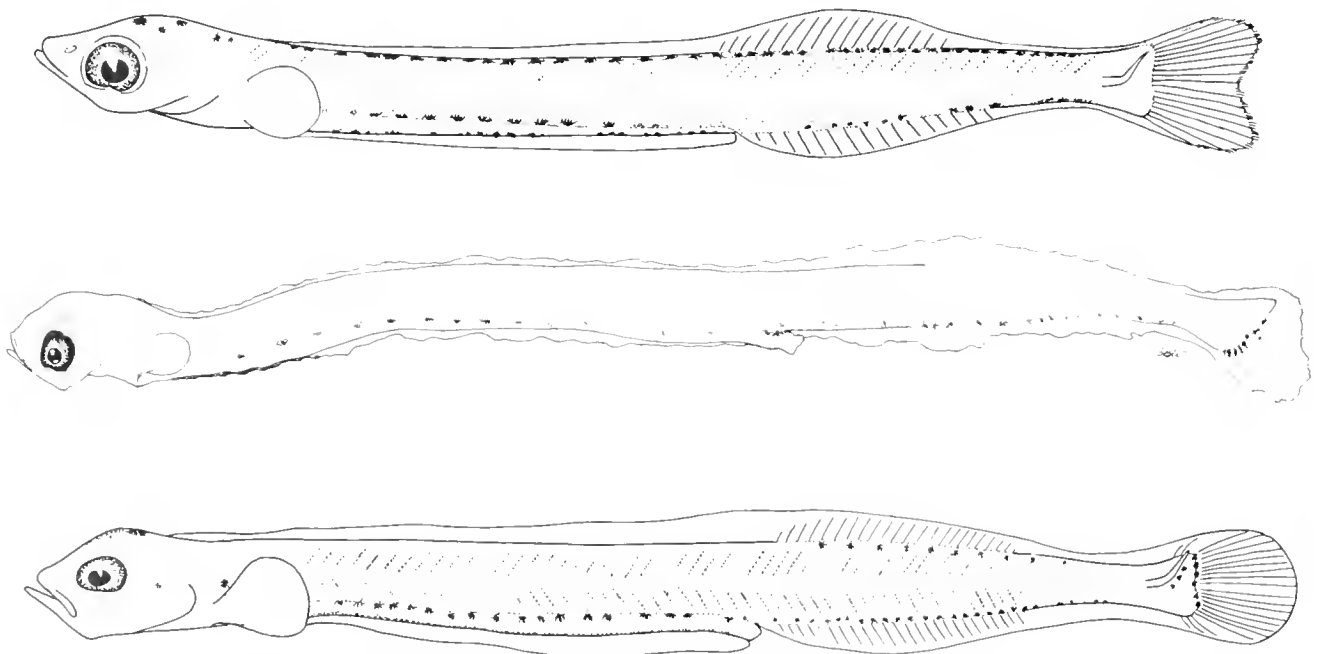

Fig. 304. Larvae of: (upper) *Hyperoplus lanceolatus*, 16 mm, redrawn by H. Orr from Einarsson (1951); (middle) *Ammodytes hexapterus*, 16 mm; and (lower) *Ammodytes marinus*, 16 mm, redrawn by H. Orr from Einarsson (1951).

TABLE 148. SELECTED PIGMENT CHARACTERS OF AMMODYTIDAE LARVAE. 0 = absent, + = present, ↑ = increasing with development, ↓ = decreasing with development, po = posterior, an = anterior.

Species	Stage	Body length (mm)	Head				Ventral gut	Dorsal midline	Caudal	Fin-fold	Sources
			Jaws	Snout	Brain	Nape					
<i>Gymnammodytes semisquamatus</i>	preflexion	4.8	0	0	0	0	+	0	0	+	Cameron, 1959
	flexion	7.0	0	0	0	+	+	near tail	+	+	Macer, 1967
	postflexion	11.8–38.0	0	+	+, 0	+	↑	↑	+	+	
<i>G. cicerellus</i>	preflexion	7.0	0	0	0	+	0	+	+	0	Fage, 1918
	postflexion	11.0–25.0	0	0	+	+	0	↓	+		
<i>Hyperoplus lanceolatus</i>	flexion	6.0	0	0	+	+	+	po 1/3	0	0	Einarsson, 1951
	postflexion	11.0–25.0	0, +	0, +	+	+	↑	+	↓		Macer, 1967
<i>H. immaculatus</i>	preflexion	5.5–9.0	0	0	0↓	0	an	po 1/4	0	0	Macer, 1967
	flexion	13.0	0	0	+	0	an	↑	+	0	
	postflexion	26.0	+	+	+	0	an	+	+		
<i>Ammodytes tobianus</i>	preflexion	4.0–5.0	0	0	0	+	an	0	0	0	Einarsson, 1955
	flexion	7.5–12.0	0	0	+	+, 0	an	near tail	0	0	Macer, 1967
	postflexion	16.0–27.0	0	0	+, 0	+, 0	0	↓	0↓		
<i>A. marinus</i> <i>dubius</i> <i>americanus</i>	preflexion	4.5–6.0	0	0	0	0	an	0	+	0	Einarsson, 1951
	flexion	7.5–11.0	0	0	+	0	an	po 1/4	+	0	Macer, 1967
	postflexion	19.0–33.0	0	0↓	+	0	+	↓	+		
<i>A. hexapterus</i>	preflexion	7.0–8.0	0	0	0	0	an	0	0	0	Kobayashi, 1961c
	flexion	11.0–13.0	0	+, 0	0	0	an	0	+	0	NWAFIC, unpubl.
	postflexion	16.0–31.0	0↓	+	0↓	0	an	0↓	+		

species, and transformation to juveniles occurs at about 40 mm. The caudal fin is the first to ossify, followed by the pectorals, then the dorsal and anal. The median fin rays form in the posterior part of the body, and ossification proceeds forward. During larval development the body thickens somewhat, but maintains its elongate shape. All adult Ammodytidae have protrusible upper jaws, but *Gymnammodytes semisquamatus* is the only species in which this character is reported in larvae as small as 9 mm (Cameron, 1959). Postflexion larvae of *Hyperoplus* develop vomerine teeth which persist in the adult, while *Gymnammodytes* postflexion larvae develop both vomerine and premaxillary teeth which disappear at about transformation. During the larval period *Gymnammodytes*, *Hyperoplus*, and *Ammodytes* are pelagic. Juveniles and adults are both pelagic and benthic.

Pigment.—Pigment can be a useful diagnostic feature among the larvae of Ammodytidae, especially the location and development of melanophores on the ventral gut margin, the dorsal body margin, and the caudal area, i.e., the tip of the notochord and the edge of hypural elements. These pigment characters are summarized in Table 148. All species have a row of melanophores dorsally on the gut, beginning at or just posterior to the cleithrum, and a postanal row on the ventral body margin from the anus to the tail. The dorsal gut pigment becomes obscured with growth. Specific variations in pigment patterns can be seen in the 16 mm specimens illustrated in Fig. 304. At this length, dorsal midline pigment forms a complete row in *H. lanceolatus*, but occurs only on the posterior quarter in *A. hexapterus* and *A. marinus*; and ventral gut pigment extends the length of the gut in *H. lanceolatus* and *A. marinus* but is found only on the anterior ventral gut of *A. hexapterus*. Pigment patterns of *A. marinus*, *A. dubius* and *A. americanus* are nearly identical (Macer, 1976) although Richards (1982) has noted differences in the ranges of melanophore numbers, especially on the anterior ventral gut (stomach) and dorsal midline (supradorsal). Pigment

appears variously on the head, increasing with age in all species reported. The only reported decrease in pigmentation is on the dorsal and ventral margins of *G. cicerellus* (Fage, 1918). *G. semisquamatus* has pigment on the ventral finfold margin, the only ammodytid species for which finfold pigment has been noted (Cameron, 1959).

Meristics.—Fin ray and vertebral counts for the family Ammodytidae are: Vert 54–78; D 40–69; A 14–36; Pec. 10–16; Pel. 0–1.5; and C 15–17 prin., 13 branched. In all genera the number of precaudal vertebrae exceeds the number of caudal. Robins and Böhlke (1970) report 9+8 principal caudal rays for *Embolichthys sarissa*, but all other ammodytid species, including *E. mitsukurii*, have 8 + 7. *Embolichthys* is the only genus with pelvic fins, which are thoracic. The caudal fin is the first to form, followed by the pectorals, dorsal, and anal. Posterior rays of the median fins form first and development proceeds forward. Fin formation is completed by 30 to 40 mm body length.

RELATIONSHIPS

Although early life history data of the suborder Ammodytoidei do little to clarify its phylogenetic position, larval pigment patterns and myomere-vertebrae counts are useful in separating sympatric species (Macer, 1967). General characters, such as the well developed state of newly hatched larvae and the sequences of fin development, are shared with other perciform derivatives and relatives, but essentially the problem of the systematic position of ammodytids is not yet resolved.

(A.C.M.) NATIONAL MARINE FISHERIES SERVICE, NORTHWEST AND ALASKA FISHERIES CENTER, 2725 MONTLAKE BOULEVARD EAST, SEATTLE, WASHINGTON 98112; (E.G.S.) NATIONAL MARINE FISHERIES SERVICE, SOUTHWEST FISHERIES CENTER, PO BOX 271, LA JOLLA, CALIFORNIA 92038; (W.W.) MARINE ECOLOGICAL CONSULTANTS, 531 ENCINITAS BOULEVARD, SUITE 110, ENCINITAS, CALIFORNIA 92024.

Icosteoidae: Development and Relationships

A. C. MATARESE, E. G. STEVENS AND W. WATSON

THE suborder, Icosteoidae, consists of one family, Icosteidae, with a monotypic species *Icosteus aenigmaticus* (Nelson, 1976). Adults inhabit the epi- and bathypelagic areas of the North Pacific Ocean from southern California to Japan. Adults may exceed 2 m in length and have dark flaccid bodies; a characteristic implied in the common name of the species, ragfish (Hart, 1973).

The systematic position of this group and its designation as an order or suborder is not well established. Greenwood et al. (1966) consider it a suborder of Perciformes while Gosline (1971) elevates it to an order, Icosteiformes, a probable perciform derivative.

DEVELOPMENT

The only early life history data previously published is a brief description of the egg (Allen, 1968). *Icosteus aenigmaticus* eggs are commonly collected in ichthyoplankton surveys off the Pacific coast of North America [California Cooperative Oceanic Fisheries Investigations (CalCOFI) and Northwest and Alaska Fisheries Center (NWAFC)], but larvae (mostly preflexion) are infrequently found and a complete size series from hatching to transformation is not presently available. Larvae may move offshore or into deeper waters. The first published description and illustration of the larvae from pre- to postflexion stages are provided here, based on National Marine Fisheries Service (NMFS) collections. Although *I. aenigmaticus* juveniles undergo a marked transformation to the adult stage, little information is available concerning this change (Hart, 1973).

Eggs

The pelagic egg of *I. aenigmaticus* ranges in diameter from 2.8 to 3.1 mm (Fig. 305). A large, sometimes irregular, oil globule with a diameter of 0.42 to 0.60 mm is present. The oil globule usually decreases in size with development. The chorion is smooth, sometimes amber or rose colored. Early stage egg yolks are frequently opaque, although later stages have a clear, unsegmented yolk. During the middle stage of development, embryos have pigment along the dorsal body as well as on the yolk and oil globule. Late stage embryos have functional mouths, pectoral buds, and very wide finfolds. Scattered pigment occurs on the eyes, snout, jaws, and dorsal head. The dorsal surface of the gut is pigmented. Along the dorsal and anal finfolds, three or four clusters of melanophores appear at each distal edge. Melanophores also appear above and below the tail in the caudal finfold. An irregular double row of melanophores extends the length of the dorsal body margin. A few mediolateral spots appear anteriorly. Occasionally, pigment occurs along the ventral body margin.

Larvae

Morphology.—Newly hatched larvae of *I. aenigmaticus* are 6.5 mm NL; yolk material may persist until larvae are 10 mm. Flexion begins at about 11 mm and is complete at about 17 mm SL. The size at transformation is not known, but fin de-

velopment is almost complete by 28 mm. The body, surrounded by a wide finfold, is very soft. Preflexion larvae have small heads with rounded snouts and long tapering bodies (Fig. 306). Dorsal and ventral finfolds are wider than the body. During flexion the body thickens and becomes more robust, especially anteriorly. Postflexion larvae have a robust head and gut and a tapering trunk (Fig. 306). Preanal length is less than 50% body length. A series of preopercular spines appears during late flexion.

Pigment.—Newly hatched larvae of *I. aenigmaticus* display essentially the same eye, head, gut, body, and finfold pigment as the embryos. With increasing size the head and gut usually become increasingly covered with discrete spots. Dorsal body margin pigment is present throughout larval development, while the amount of lateral and ventral body margin pigment varies and is relatively sparse. The characteristic embryonic caudal pigment persists in the developing larvae, becoming less prominent but remaining as scattered melanophores on the hypural margin and fin ray bases. In general, postflexion larvae are less pigmented except on the head. Pelvic and pectoral fin bases and pelvic rays acquire melanophores during postflexion.

Meristics.—*Icosteus aenigmaticus* larvae have the following vertebral and fin ray counts: Vert. 66–68; D 55; A 39; Pec. 21; Pel. 1,4; and C 9 + 8 = 17 (NWAFC files). These counts conform

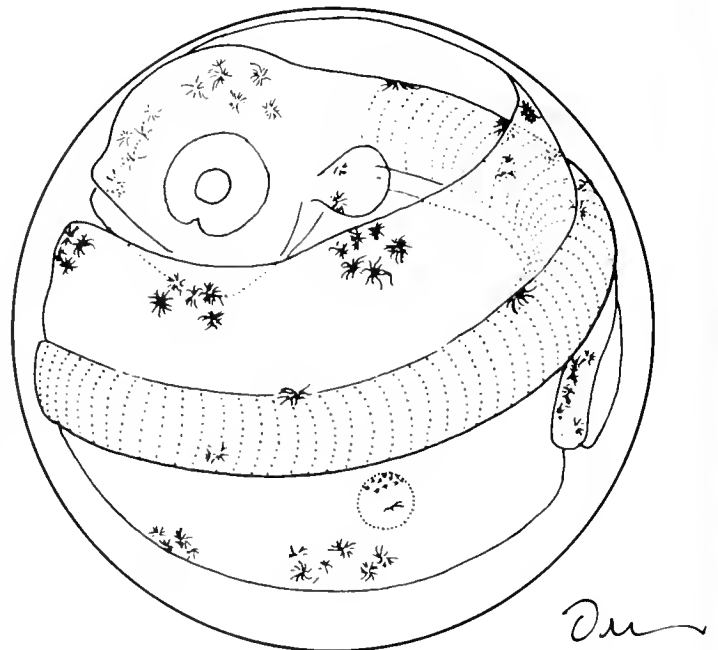

Fig. 305. Egg of *Icosteus aenigmaticus*: 2.8 mm, drawn by H. Orr.

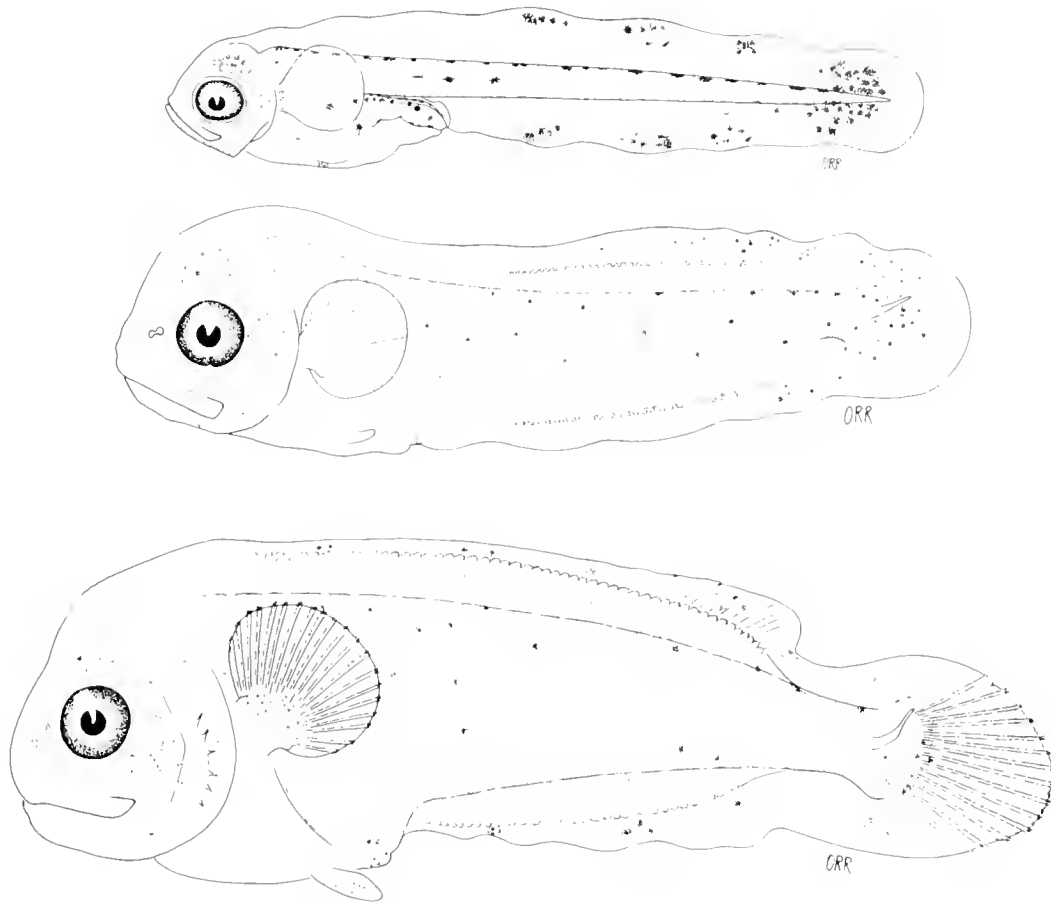

Fig. 306. Larvae of *Icosteus aenigmaticus* from top to bottom: 9.5 mm SL; 10.2 mm; and 28.5 mm SL, drawn by H. Orr.

to those for the adults except adults lack a pelvic fin (Abe, 1954; Miller and Lea, 1972; Hart, 1973). The caudal fin contains the pereiiform number of principal rays, 17, with 6–9 procurrent rays on each side. Pectoral fin blades are present at hatching and rays form during flexion. Pelvic fin rays begin development during flexion and are complete in postflexion larvae. At what size the pelvic fins disappear is not known. The last fin rays to form are the dorsal and anal, with their anlagen appearing in the middle of the posterior half of the finfolds at about mid-flexion. Formation of these fins proceeds forward and toward the body margin (Fig. 306). The largest larva available, 28.5 mm, has the complete fin ray complement.

RELATIONSHIPS

The foregoing brief description of the eggs and larvae of *I. aenigmaticus* provides some additional information toward the understanding of the life history of this unique but poorly understood fish. Characters discussed here (e.g., sequence of fin for-

mation and meristics) help support its position among perciform relatives. Sequence of fin formation and reduced number of pelvic fin rays are blennioid-like characters, and 17 principal caudal fin rays are the typical percoid number. Eggs, larvae, and early juveniles superficially resemble stromateoid fishes but additional data are needed before a precise relationship can be determined. To understand this family more fully, we need information regarding the critical juvenile phase as well as a complete osteological examination from preflexion larvae to adults.

(A.C.M.) NATIONAL MARINE FISHERIES SERVICE, NORTHWEST AND ALASKA FISHERIES CENTER, 2725 MONTLAKE BOULEVARD EAST, SEATTLE, WASHINGTON 98112; (E.G.S.) NATIONAL MARINE FISHERIES SERVICE, SOUTHWEST FISHERIES CENTER, PO BOX 271, LA JOLLA, CALIFORNIA 92038; (W.W.) MARINE ECOLOGICAL CONSULTANTS, 531 ENCINITAS BOULEVARD, SUITE 110, ENCINITAS, CALIFORNIA 92024.

Zoarcidae: Development and Relationships

M. E. ANDERSON

THE eelpouts, Zoarcidae, comprise a monophyletic group of about 200 valid species of marine fishes in 44 genera (Table 149; Anderson, 1984). About 20 additional undescribed species are known to me from collections around the world. Most zoarcids live on the bottom in deep water in boreal seas, but 11 are known from intertidal areas, especially in temperate South America. Twenty-two species are known from tropical-subtropical areas and all of them live in deep water (640–5,320 m).

Fourteen species are known from both shallow and deep waters of Antarctica and subantarctic regions. Two deep-living genera, *Lycodapus* and *Melanostigma*, are coastal or thalassobathyal, deep-pelagic forms that seem to occur in greatest numbers where their zooplankton prey concentrate (Belman and Anderson, 1979; Anderson, 1981). Thus the family is stenothermic and adapted to very low temperatures (mostly below about 8° C).

TABLE 149. DISTRIBUTION, ECOLOGY AND SELECTED MERISTICS OF ZOARCIDAE.

Genus	No. of species	Distribution	Ecology	D
<i>Aiakas</i>	1	SW Atlantic	Benthic; slope	88–89
<i>Andriashevina</i>	1	NW Pacific	Benthic; slope	144
<i>Austrolycichthys</i>	4	E trop. Pacific; W trop. Atlantic; Antarctica	Benthic; slope	0–II, 87–104
<i>Bilabria</i>	1	NW Pacific	Benthic; shelf	110
<i>Bothrocarina</i>	8–9	NW Pacific to Peru	Benthic; slope	108–125
<i>Bothrocarina</i>	2	NW Pacific	Benthic; shelf-slope	1, 106
<i>Crossostomus</i>	2	SW Atlantic	Benthic; shelf	96–108
<i>Dadyanos</i>	1	SW Atlantic	Benthic; shelf	104–116
<i>Davidjordania</i>	4	NW Pacific	Benthic; shelf	85–118
<i>Derepodichthys</i>	1	NE Pacific	Benthic; slope	110–116
<i>Exechodontes</i>	1	W trop. Atlantic	Benthic; slope	80–86
<i>Gymnelopsis</i>	4	NW Pacific	Benthic; shelf-slope	1, 79–112
<i>Gymnelus</i>	5	N Pacific, Arctic	Benthic; shelf	1, 76–101
<i>Hadropareia</i>	1	NW Pacific	Benthic; shelf	106–113
<i>Hadropogonichthys</i>	1	NW Pacific	Benthic; slope	126–128
<i>Iluocoetes</i>	2	SE Pacific-SW Atlantic	Benthic; shelf	84–98
<i>Krusensterniella</i>	4	NW Pacific	Benthic; shelf	XLV–LVII, II–XXVI, 37–64
<i>Lycenchelys</i>	40–41	Worldwide, except Indo-Pac.	Benthic; slope-abyss	0–I, 94–132
<i>Lycodapus</i>	13	NW Pacific to subantarctic	Deep pelagic	70–98
<i>Lycodes</i>	46–51	Boreal seas; South Africa	Benthic; shelf-abyss	85–120
<i>Lycodichthys</i>	2	Antarctica	Benthic; slope	I–II, 83–89
<i>Lycodonus</i>	4	N and S Atlantic	Benthic; slope	98–112
<i>Lycogrammoides</i>	1	NW Pacific	Pelagic ?	62
<i>Lyonema</i>	1	NE Pacific	Benthic; shelf-slope	100–107
<i>Lyczoarces</i>	1	NW Pacific	Benthic; shelf	II, 62–67
<i>Macrozoarces</i>	1	NW Atlantic	Benthic; shelf	92–103, XVI–XXIV, 16–30
<i>Maynea</i>	1	SW Atlantic-SE Pacific	Benthic; shelf	119–127
<i>Melanostigma</i>	7	Worldwide	Deep pelagic	76–95
<i>Nalbantichthys</i>	1	N Pacific	Benthic; slope	143–152
<i>Notolycodes</i>	1	SW Atlantic	Benthic; slope	85–88
<i>Oidiphorus</i>	1	SW Atlantic	Benthic; slope	56–61
<i>Ophthalmolycus</i>	3	Chile to Antarctica	Benthic; slope	0–I, 87–103
<i>Pachycara</i>	9	Worldwide	Benthic; slope-abyss	0–I, 95–113
<i>Phucocoetes</i>	1	SW Atlantic-SE Pacific	Benthic; shelf	101–107
<i>Piedrabuenia</i>	1	SW Atlantic	Benthic; slope	108–113
<i>Pogonolycus</i>	1	SW Atlantic	Benthic; shelf	86–88
<i>Puzanovia</i>	1	NW Pacific	Benthic; slope	135–147
<i>Taranetzella</i>	1	N Pacific	Benthic; slope-abyss	84–89
<i>Zoarces</i>	3	NE Atlantic; NW Pacific	Benthic; shelf	72–94, 0–XIX, 14–27
Genus A.	1	Coast of California	Benthic; shelf-slope	97–107
Genus B.	1	Scotia Sea	Benthic; slope	—
Genus C.	1	Bering Sea	Benthic; slope	—
Genus D.	1	SW Atlantic	Benthic; slope	77–83
Genus E.	2	SW Atlantic	Benthic; slope	92–96

DEVELOPMENT

As far as known, almost all eelpouts are oviparous, laying relatively few, large eggs. The exception is the genus *Zoarces*, which is viviparous. There are three species of *Zoarces*, the common European eelpout, *Z. viviparus* (Linnaeus), and two little known, northwestern Pacific species, *Z. gillii* Jordan and Starks and *Z. elongatus* Kner. Viviparity in the European eelpout has been known since the Middle Ages (Schonevelde, 1624), but of the two Pacific species, females with embryos are known only in *Z. gillii* (Anderson, 1984).

Among benthic, oviparous species, nest building with parental guardianship is probably common. Nesting has been directly observed in *Macrozoarces americanus* (Olsen and Merriman, 1946), *Gymnelus viridis* (Emery, 1973), *Lycodes pacificus* (Levings, 1969) and *Phucocoetes latitans* and *Iluocoetes effusus* (Gosztonyi, 1977). Probably most, if not all, the other South

American intertidal zoarcids discussed by Gosztonyi also build and guard nest sites. Pelagic spawning occurs in *Lycodapus* and *Melanostigma*. Markle and Wenner (1979) found *Melanostigma atlanticum* may utilize the sea bottom as a concentration interface for group spawning. Bottom trawl-caught ripe individuals had parasite loads more typical of deep-demersal fishes in the western North Atlantic. However, Anderson (1981) reported *Lycodapus mandibularis* to have a parasite fauna similar to other midwater fishes in Monterey Bay, California. Early juveniles were caught in midwater at all depths inhabited by adults. This suggests *L. mandibularis* does not shoal near the bottom for spawning.

Eggs

Spawned zoarcid eggs have been described from field observations for only seven species (Table 150). Egg descriptions are

TABLE 149. EXTENDED.

Fin rays			Vertebrae		Sources
A	P	C	Precaudal	Caudal	
67-69	18-19	10	26	65-66	This report; Gosztonyi (1977)
123	Absent	—	22	125	Fedorov and Neyelov (1978)
70-89	15-19	9-10	20-25	72-87	This report
93-94	15-16	10	23	95-96	This report; Lindberg and Krasnyukova (1975)
92-109	13-17	0-13	18-24	93-108	This report
95	10-11	11	19	94	This report
68-78	16-17	10	28-32	67-76	This report; Gosztonyi (1977)
89-95	16-17	10	21-24	84-93	This report; Gosztonyi (1977)
68-90	12-17	10	20-23	77-97	This report; Lindberg and Krasnyukova (1975)
94-101	10-11	8-9	22-26	92-98	Anderson and Hubbs (1981)
73-79	13-15	10	19-21	72-78	This report; DeWitt (1977)
73-97	9-12	5-8	16-23	73-95	Anderson (1982)
69-85	9-14	9-12	17-26	65-84	Anderson (1982)
86-92	13-15	7-8	24-28	83-89	This report
112-114	19	11	23-24	109-110	Fedorov (1982)
65-82	15-19	7-9	19-24	62-79	This report; Gosztonyi (1977)
71-103	11-12	5-7	19-25	80-97	This report; Lindberg and Krasnyukova (1975)
80-112	13-21	9-13	20-30	77-118	This report; Andriashev (1955b)
58-86	5-9	8-12	13-19	59-85	Peden and Anderson (1978, 1981)
67-92	14-24	10-12	19-26	65-104	This report
66-75	15-17	11	23-24	68-70	This report; DeWitt (1962a)
83-93	14-17	7-9	21-25	85-105	This report
52	9	8	14	53	This report
90-96	15-17	12	20-21	86-93	This report; Gotshall (1971)
49-54	13-15	13-15	15-17	50-55	This report; Toyoshima (1981)
103-125	17-20	9-10	25-28	105-118	This report
95-103	14-16	7	29-30	89-98	This report; Gosztonyi (1977)
62-80	6-9	8-10	18-23	62-81	This report; Parin (1977)
121-127	6	7-10	25	119-125	Schultz (1967)
69-72	18-21	11	23-26	66-69	This report; Gosztonyi (1977)
45-54	16-19	7-9	15-17	43-50	This report; Gosztonyi (1977)
69-87	14-18	10	22-23	72-88	This report
77-97	14-19	10-12	25-32	74-91	This report
78-85	14-16	10	24-27	75-83	This report; Gosztonyi (1977)
98-104	17-18	8	24-25	95-101	This report; Gosztonyi (1977)
72-74	17	9	20	71-73	This report; Gosztonyi (1977)
115-128	9-12	9-12	22-24	110-125	Fedorov (1975); Amaoka et al. (1977)
71-76	15	8	20	69-74	This report; Andriashev (1952)
64-90	16-21	9-11	21-26	80-106	This report; Schmidt (1917)
83-93	13-14	10	27-28	79-84	This report; Cailliet and Lea (1977)
—	—	—	—	—	Torno et al. (1977)
—	—	—	—	—	Bond and Stein (in prep.)
64-69	17-19	9-10	19-21	66-73	This report
68-73	9-14	7	24-27	67-75	This report

TABLE 150. DATA ON THE EGGS AND LARVAE OF ZOARCIDAE KNOWN TO DATE.

Species	Eggs				Larvae		
	Size range, mm	Oil globule	Incubation (months)	Hatch size, mm	Description	Illustration	Sources
<i>Gymnelus viridis</i>	3.2–4.6*	—	—	~20–25	X	X	Rass (1949)
<i>Macrozoarces americanus</i>	~6.0–7.0	—	2.5–3.5	28–31	X	X	White (1939); Olsen and Merriman (1946)
<i>Zoarces viviparus</i>	2.8–3.2*	—	4	32–40	X	X	Soin (1968); Altukhov (1979)
" <i>Maynea</i> " <i>californica</i>	4.0–5.3*	—	—	—	—	—	Kliever (1976)
<i>Melanostigma atlanticum</i>	~3.0–3.8*	—	—	—	—	—	Markle and Wenner (1979)
<i>Lycodes pacificus</i>	5.0*	—	—	—	—	—	Levings (1969)
<i>Lycodes palearis</i>	6.0–7.0	Multiple	—	—	—	—	Slipp and DeLacy (1952)
<i>Lycodes pallidus</i>	—	—	—	~10–12	—	—	Altukhov (1979)
<i>Derepodichthys alepidotus</i>	~2.1–2.4*	—	—	—	—	—	Anderson and Hubbs (1981)
<i>Bothrocara hollandi</i>	9.2	—	—	35–36	X	X	Okiyama (1982a)
<i>Bothrocara</i> sp.	7.0	1 (1.6 mm)	—	—	X (embryos)	X (embryos)	Kendall et al. (1983)
<i>Lycodapus mandibularis</i>	1.7–1.9*	1	—	~15–17	—	—	Anderson (1981)
<i>Austrolycus laticinctus</i>	7.5–8.4*	—	—	~17	—	—	Gosztonyi (1977)
<i>Dadyanos instgnis</i>	5.0	—	—	—	—	—	Gosztonyi (1977)
<i>Phucoetes latitans</i>	4.5	—	—	20	—	—	Gosztonyi (1977)
<i>Iluocoetes effusus</i>	5.0–5.5	—	2	—	—	—	Gosztonyi (1977)

* Maximum ovarian diameters.

generally cursory (except that of Kendall et al., 1983). In general, zoarcid eggs are large (about 4–9 mm, except in some diminutive species), spherical and usually with a single oil globule that may have coalesced from a few smaller globules. Spawmed eggs are orange-yellow or purple with a somewhat darker orange or yellow oil globule (Anderson, 1981; Kendall et al., 1983) and have a narrow perivitelline space. Benthic egg masses are held together by a sticky, gelatinous mass that is not especially thickened. Incubation times are known for only three species. Eggs "hatch" in the ovary of *Zoarces viviparus* after two months and embryos develop for another two months therein (Fig. 307). Embryos develop a dense vitelline vascular network that aids in yolk resorption, respiration and assimilation of nutrients from the mother's ovarian fluid (Soin, 1968). Olsen and Merriman (1946) found that eggs of southern populations of *Macrozoarces americanus* had an average incubation time of 2.5 months, whereas eggs of northern populations took about 3.5 months to hatch. Gosztonyi (1977) observed the eggs of *Iluocoetes effusus* (as *I. elongatus*) from the Patagonian intertidal to require two months to hatch during the austral autumn.

Larvae

As with observations on eggs, zoarcid "larvae" are not well known, if this stage is developed at all. Although a few early stages have been collected during ichthyoplankton surveys (Rass, 1949; Mattson and Wing, 1978; Altukhov, 1979), they are notably absent in collections of other surveys where adults are abundant, such as the Bering Sea (Musienko, 1963; Waldron and Vinter, 1978) and off Oregon (Richardson and Percy, 1977). This is probably due to their short planktonic time. Early life history stages of only five zoarcid species have been illustrated (Kendall et al., 1983) and all these are reproduced here (Figs. 307, 308).

Females of *Lycodapus mandibularis*, *Gymnelus viridis* and

"*Maynea*" *californica*¹ are known to spawn larger eggs at increasingly larger adult sizes, thus zoarcid hatching sizes vary. In large eelpouts, like *Macrozoarces* and *Zoarces*, young hatch at about 30–40 mm, but diminutive species, like *Melanostigma* and *Derepodichthys* are probably only about 10 mm at hatching. At hatching, the yolk sac is rapidly taken into the gut. White (1939) reported "the complete external disappearance of the yolk" to occur in about 20 seconds in *Macrozoarces americanus* that were stimulated to hatch in a pan of cold sea water. I have observed a similarly rapid internalization of the yolk in larvae of the liparidid *Careproctus* sp. (Anderson and Cailliet, 1974). Perhaps rapid yolk uptake is typical of fishes with a protracted developmental period.

Newly hatched zoarcids strongly resemble adults. The major differences are the larger eyes and more rounded snout in the young (Fig. 308). At the free-swimming, yolk-ingestion stage, all fin rays have formed. The stage and direction of fin formation in embryos is unknown in Zoarcidae. Most of the cephalic lateral pores were formed in larvae of *Bothrocara hollandi* (as *Allolepis hollandi*) noted by Okiyama (1982a). Post-hatching *Macrozoarces* that I examined for this study had not developed all their lateral pores, a case similar to that of *Gymnelus* spp. (Anderson, 1982). These planktonic young *Macrozoarces* had absorbed their yolk and measured 33.8–36.0 mm SL. The young fish were generally well ossified, except central regions of the neurocranium and suspensorium. Jaw and pharyngeal teeth were developed and a few had eaten copepods. In the smallest specimen, the pectoral actinosts, scapula and coracoid were a fused mass of cartilage, but these were separated and ossified in just slightly larger specimens. Vertebrae were square in shape (rect-

¹ This species properly belongs in an unnamed, monotypic genus (Anderson, 1984).

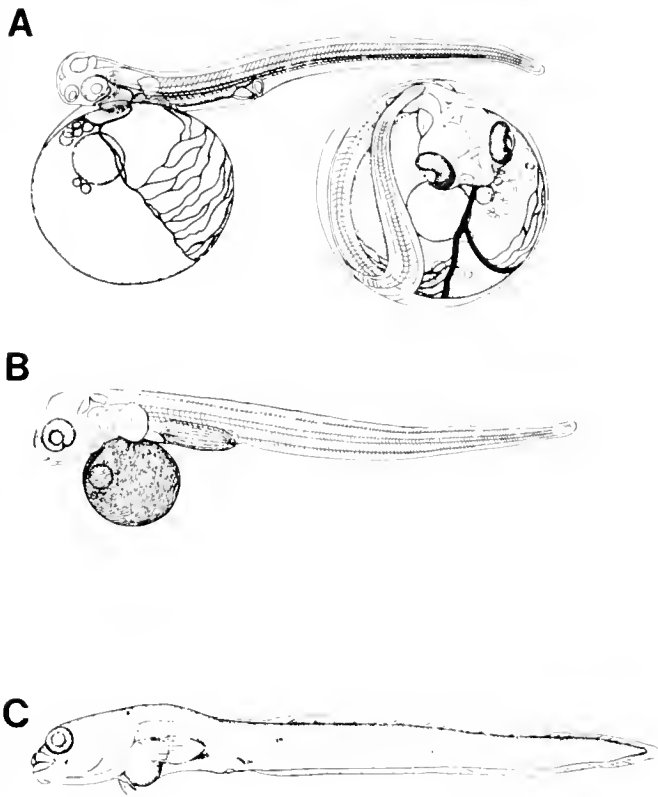

Fig. 307. *Zoarces viviparus*. (A) egg and newly hatched embryo; (B) developing embryo from mother's ovary; and (C) newly emerged young; all from Soin (1968).

angular in adults) and all neural arches were fused, as in adults. In the caudal skeleton, all fin rays and pterygiophores were present, as in adults, but the neural arches of the first ural and first preural centra were poorly developed, with some sections free of the urostyle. Typical of many zoarcids, the caudal of *Macrozoarces* has two epural, four upper hypural and 3–4 lower hypural fin rays.

There are no specialized larval pigment patterns. The larvae of *Gymnehus viridis* and *Bothrocara hollandi* appear to be monotone, as are most adults (Rass, 1949; Okiyama, 1982a). The larva of *Macrozoarces* illustrated by White (1939) and those examined by me bore the typical criss-cross pigment pattern of older stages.

Meristic characters of *Macrozoarces* early juveniles examined fit within the range reported for adults (Table 150). However, Soin (1968) and Kendall et al. (1983) showed that developing embryos of *Zoarces viviparus* and *Bothrocara* sp. had myomere counts well below that of adult populations. Although large sample sizes of most zoarcid genera are lacking for satisfactory statistical analysis of meristic characters, the important thing to note is that myomere addition seems to be a slow process in zoarcids and that the full adult complement may not be reached until embryos are very close to hatching. Alternatively, zoarcid embryos and larvae may have differentiated myomeres with the adult counts, but their small size and tight packing, particularly near the tail tip, may make it difficult to observe them with a conventional light microscope.

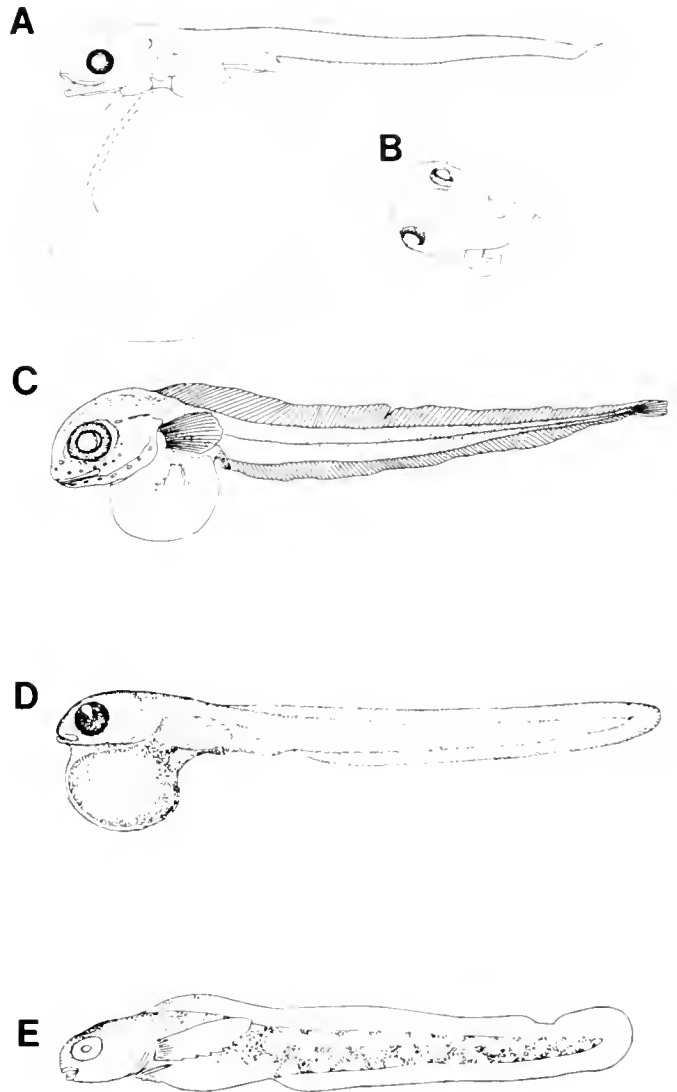

Fig. 308. Early stages of Zoarcidae. (A, B) *Bothrocara* sp., after Kendall et al. (1983); (C) *Bothrocara hollandi*, after Okiyama (1982a); (D) *Gymnehus viridis*, after Rass (1949); and (E) *Macrozoarces americanus*, after White (1939).

RELATIONSHIPS

The relationships of the zoarcids to other living fishes has been confused in the literature. Greenwood et al. (1966) and Rosen and Patterson (1969) allied the zoarcids to the gadiform-ophidiiform lineages. Two of the four characters they used to suggest this relationship, the presence of a basisphenoid bone and free second ural centrum, both illustrated by Yarbber (1965), were shown to be erroneous by Anderson and Hubbs (1981). Anderson (1984) suggested zoarcid relationships are within Gosline's (1968) Blennioidei, especially his superfamily Zoarceoidea. Eight of Gosline's 11 zoarceoid families were recognized by Anderson (1984), with Lycodapodidae and Derepodichthyidae synonymized under Zoarcidae and Stichacidae expanded to include Cryptacanthodidae and Neozoarcinae (see Makushok, 1961; Peden and Anderson, 1978; Anderson and Hubbs, 1981).

A definitive phylogenetic reconstruction of zoarceoid relationships is not presently possible without a more thorough knowledge of the anatomy of other fishes that have been traditionally allied with them. Preliminary phylogenetic inferences were made by Anderson (1984), who also discussed relationships among zoarcid genera. It should be noted, however, that a search for more characters is still in progress. Makushok (1958) and Springer (1968) suggested zoarceoid, or "northern blennioid" relationships were not close to the "tropical blennioids," a fact that my own research supports. However, for the convenience of the reader, information on the early life history stages of zoarceoids, excluding Zoarcidae, is given by Matarese et al. (this volume) under Blennioidea, following Nelson (1976).

Since there is a dearth of knowledge on early stages and since the youngest specimens known of any zoarcid so closely resemble adults, no early life history characters have helped in elucidating systematic relationships within Zoarcidae, or the zoar-

cids to their allies. All the zoarceoids are characterized by precocious early stages (see Matarese et al., this volume), but the utility of these forms in phylogeny remains untested. Within Zoarcidae, it is interesting to note that the development of cephalic lateralis pores in the primitive *Gymnelus viridis*, *Melanostigma pammelas*, and *Macrozoarces americanus* takes place over a much longer growth period (up to 50–60 mm) than in the more derived *Bothrocara* (Okiyama, 1982a) or in youngest stages 1 studied of *Lycenchelys* (32 mm), *Lycodapus* (20 mm), or *Lycodes* (38 mm). The value of this information awaits more complete data on early life history stages of all zoarceids.

VIRGINIA INSTITUTE OF MARINE SCIENCE, COLLEGE OF WILLIAM AND MARY, GLOUCESTER POINT, VIRGINIA 23062. PRESENT ADDRESS: DEPARTMENT OF ICHTHYOLOGY, CALIFORNIA ACADEMY OF SCIENCES, GOLDEN GATE PARK, SAN FRANCISCO, CALIFORNIA 94118.

Gobioidei: Development

D. RUPLE

GOBIOIDS are one of the most speciose groups of fishes, comprised of approximately 2,000 species or ten percent of the total number of teleosts in the world (Cohen, pers. comm.). Various workers have recognized from two to seven major families of gobioids, based on adult characters. For present purposes I will recognize seven families¹ Eleotridae, Gobiidae, Rhyacichthyidae, Kraemeriidae, Gobioididae, Trypauchenidae, and Microdesmidae after Nelson (1976).

DEVELOPMENT

Larvae are known for less than 5% of gobioid species. Eggs and larvae are best known from Japanese waters (e.g., Dotsu, 1954, 1957, 1958, 1979; Dotsu and Fujita, 1959; Dotsu and Mito, 1955, 1963; Dotsu and Shiogaki, 1971; Kobayashi et al., 1973; Shiogaki and Dotsu, 1971c, 1972c), in the northeastern Atlantic and Mediterranean Sea area (e.g., Petersen, 1917, 1919; Fage, 1918; Lebour, 1919; Sparta, 1934; plus summaries in Padoa, 1956f; and Russell, 1976), and less so in American waters (e.g., Hildebrand and Cable, 1938; Perlmutter, 1939; Pearson, 1941; and Ruple, in prep.). Most of these descriptive works deal with the gobiids, although larvae are known for representatives of all families except Rhyacichthyidae and Kraemeriidae.

Larvae of gobioids are fairly distinctive from other teleosts, but considerable variation does occur within the suborder. The diversity of characters found in eggs and larvae will be discussed in the following section. This information was compiled from published literature and the examination of gobioid larvae.

Eggs

Eggs are known for eleotrids, gobiids, gobioidids, and microdesmids (Table 151). Eggs of eleotrids and gobiids are generally ellipsoid and adhesive, many of which have filamentous strands. Eggs range in size from as small as 0.40×0.32 mm in *Eleotris oxycephala* (Eleotridae; Dotsu and Fujita, 1959) and 0.45×0.20 mm in *Evorthodus lyricus* (Gobiidae; Foster and Fuiman, MS in prep.) to 3.8×1.3 mm in *Percottus glehni* (Gobiidae; Kryzhanovsky et al., 1951) and 5.5×0.9 mm in *Acanthogobius flavimanus* (Gobiidae; Dotsu and Mito, 1955). *Taenioides rubicundus* (Gobioididae) eggs are demersal, adhesive and measure approximately 1.3×0.70 mm (Dotsu, 1957) while *Gunnellichthys* (Microdesmidae) eggs are spherical (Smith, 1958a).

Known gobioid eggs usually contain numerous small oil droplets within the yolk. Newly hatched larvae range from 1.7 mm in *Asterropteryx semipunctatus* (Eleotridae; Dotsu and Mito, 1963) to 7.0 mm in *Chaenogobius castanea* (Gobiidae; Dotsu, 1954).

Larvae

Gross morphology.—Body shape of gobioids is generally slightly elongate and slender, with body depth usually nearly uniform rather than sharply tapering (Figs. 309–311). Gobioidid and microdesmid larvae are moderately elongate and slender (Fig. 311), while most eleotrids and trypauchenids are only slightly elongate and slender (Fig. 311). Microdesmids have the most elongate body shape of any known gobioid larvae. Body form within the gobiids exhibits the greatest variety, ranging from fairly short and stout (Gobiidae Larva 1, Fig. 309) to moderately elongate and slender *Luciogobius elongatus* (Fig. 309). These characteristic body shapes are usually retained from the larval through adult stages.

¹ Hoese (this volume) includes Gobioididae and Trypauchenidae in the Gobiidae subfamily Amblyopinae and recognizes Xenisthmidae as a distinct family. Eleotridae is changed to Eleotrididae.

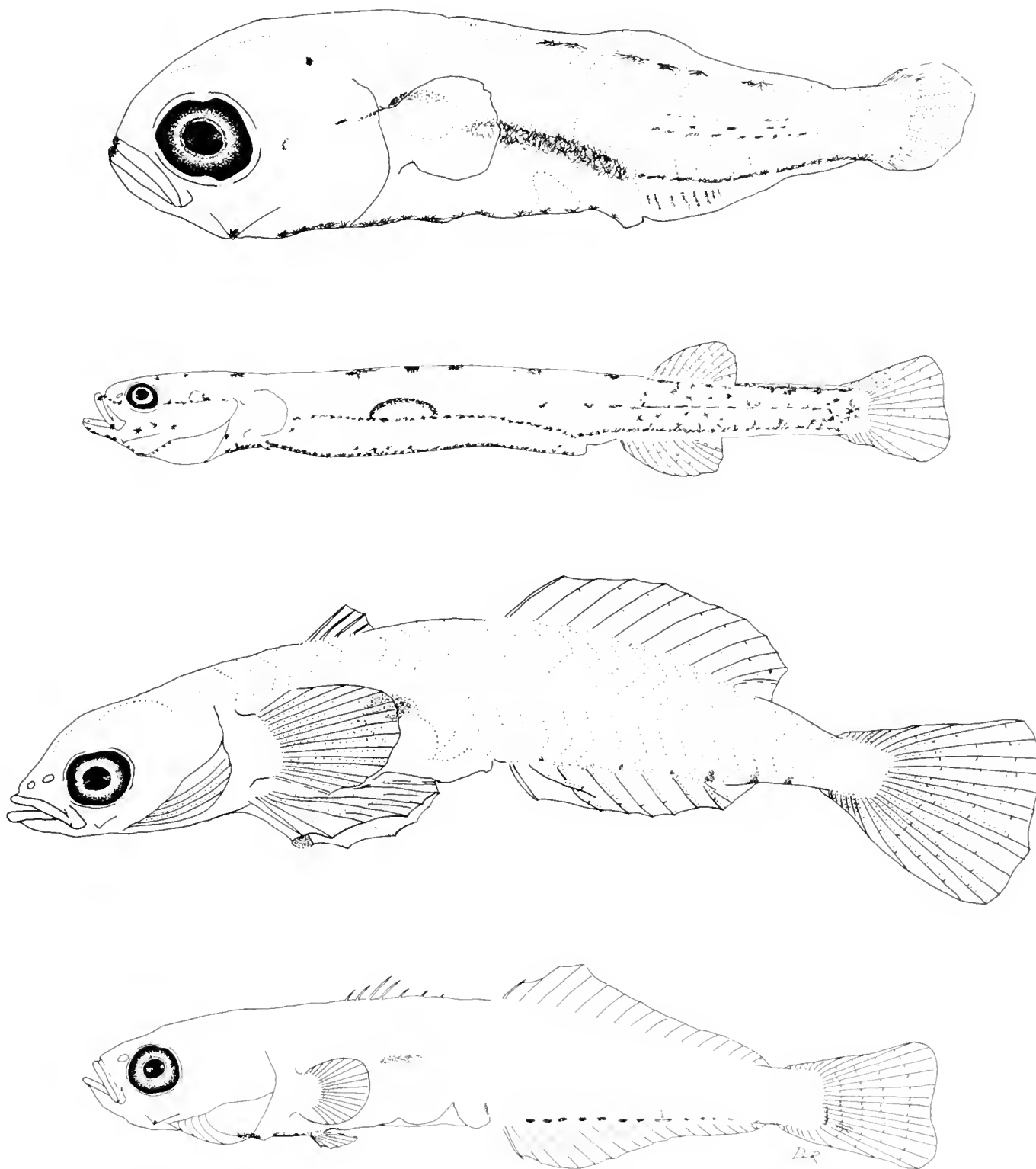

Fig. 309. Larval gobiids from top to bottom: Gobiidae Larva 1, 3.0 mm NL [AMS (Australian Museum Sydney): JML82-1-2-2]; *Luciogobius elongatus*, 12.0 mm SL (redrawn from Shiogaki and Dotsu 1972c); Gobiidae Larva 2, 6.0 mm SL (AMS:JML 16-10-7); and *Microgobius thalassinus*, 8.4 mm SL [GCRL (Gulf Coast Research Laboratory): 02035].

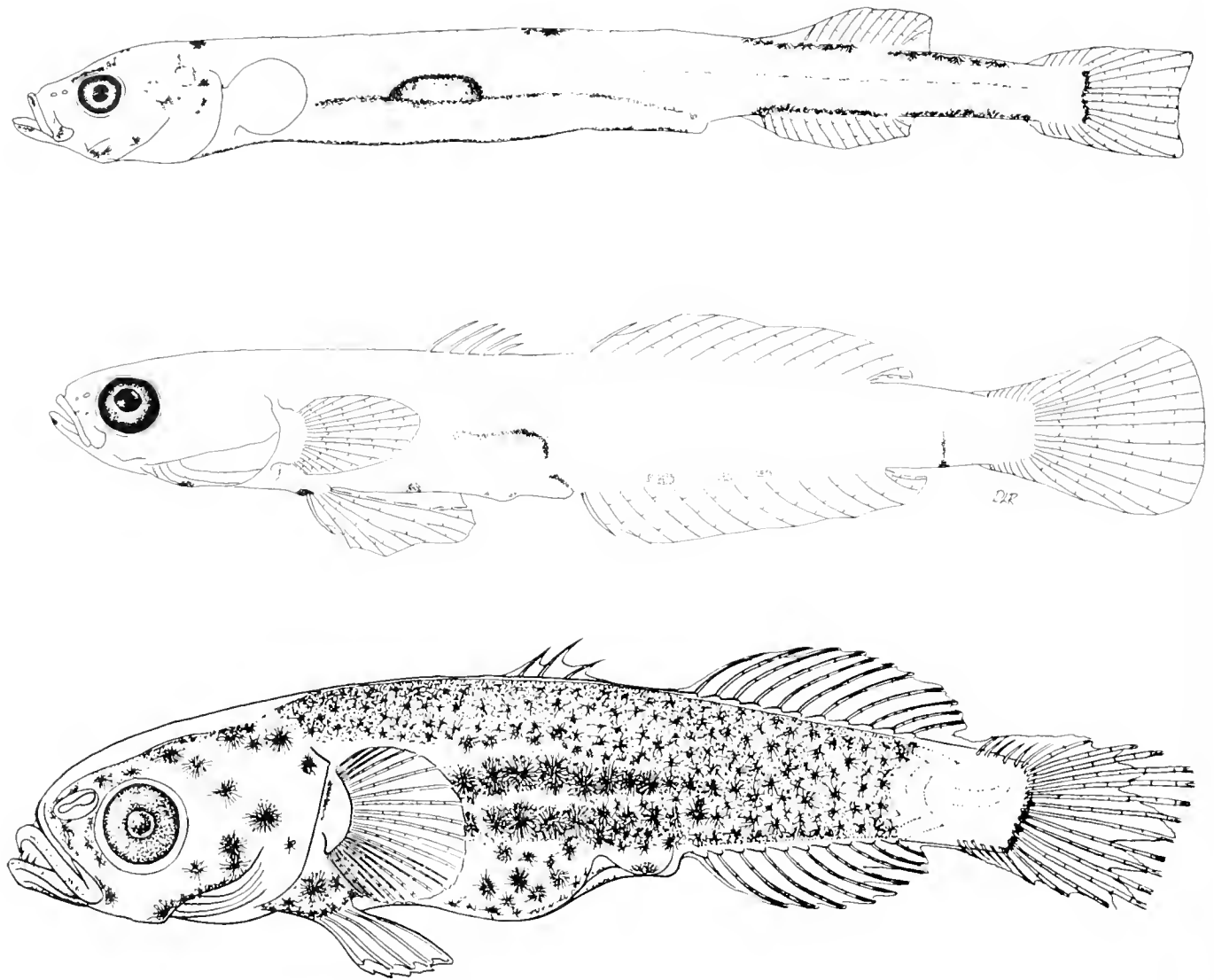

Fig. 310. Larvae of gobiids from top to bottom: *Expedio parvulus*, 12.0 mm SL (redrawn from Shioyaki and Dotsu 1971e); *Astrabe lactisella*, 11.1 mm SL (from Dotsu and Shioyaki 1971); *Gobionellus beleosoma*, 8.6 mm SL. (GCRL:02038).

The gut is generally straight and extends to about midbody or just beyond ($\sim 50\%$ to 65% SL) in most gobioids (Figs. 309–311), although in many species the gut is slightly looped just anterior to the vent as in *Microgobius thalassinus* (Fig. 309). In the trypauchenid, *Trypauchen microlepis* (Fig. 311), the gut is considerably shorter ($\sim 39\%$ SL) than in other gobioids.

A prominent feature of gobioid larvae is a large gas bladder, usually situated slightly anterior of midbody (Fig. 309). The gas bladder is located just posterior to the pectoral fin in *Trypauchen microlepis* (Fig. 311) and is smaller and less pronounced than in most other gobioids. In small larval microdesmids (≤ 4.0 mm) the gas bladder is located at about mid-gut, while in larger larvae it is found about midbody, near the posterior portion of the gut (Fig. 311). The prominent gas bladder in larvae usually disappears by the juvenile stage, but is retained in the adults of some species such as *Gobiosoma atronasum* (Colin, 1975).

Eyes of known gobioid larvae are basically round or slightly

ovoid in shape. The elongate gobioids such as the microdesmids and gobioidids have small eyes ($< 20\%$ HL) while most eleotrids and gobiids have somewhat larger eyes ($> 20\%$ HL).

The head is of moderate length ($\sim 16\%$ to 34% SL), generally slightly rounded and gently sloping. The shape of the head changes drastically in many species as they transform into juveniles. In microdesmids such as *Microdesmus longipinnis* and *Gunnellichthys* sp. the lower jaw becomes hooked and protruding during the later pelagic larval stages (Fig. 311).

The lengths of dorsal and anal fin bases vary considerably and are useful in the separation of gobioid larvae at various taxonomic levels. The lengths of the fin bases are related to the number of elements and/or the spacing between the individual elements, which varies considerably. Trypauchenids, microdesmids, and some gobioidids, all have long dorsal and anal fin bases (Fig. 311). Some eleotrids (*Eleotris pisonis* and *Erotelis smaragdus*) and various gobiids (*Rhinogobius similis*, *Yono-*

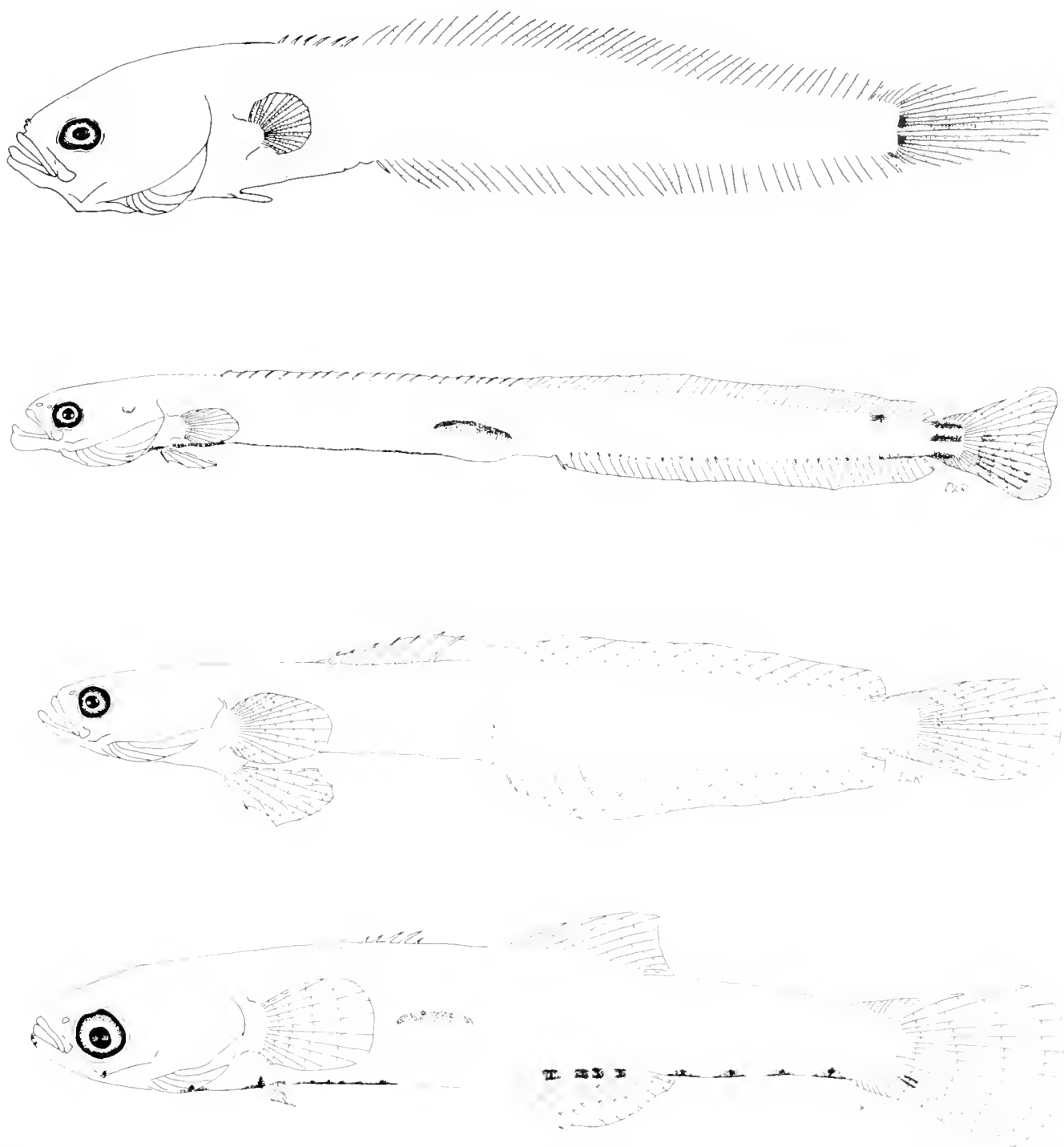

Fig. 311. Larvae of gobioids from top to bottom: *Trypauchen microlepis* (Family Trypauchenidae) 8.0 mm SL (ASMS:CFIT 2-11-78); *Microdesmus longipinnis* (Family Microdesmidae) 19.2 mm SL (GCRL:02036); *Gobioides broussoneti* (Family Gobioididae), 15.0 mm SL (GCRL:02037); and *Dormitator maculatus* (Family Eleotridae) 8.1 mm SL (GCRL:02039).

gobius boreus, and *Luciogobius elongatus*; Fig. 309) have short fin bases, with few closely spaced elements.

Gobioids transform from larvae to juveniles over a wide size range. The gobiids *Gobiosoma bosci* and *G. robustum* begin transformation at ~7.0 mm, while some microdesmids main-

tain a pelagic larval existence until they reach lengths of ~25–35 mm.

Meristics and fin development.—Sequence of development, number of elements, and size at which various fins develop are

TABLE 151. CHARACTERS USEFUL FOR THE SEPARATION OF GOBIOID LARVAE TO THE FAMILY LEVEL. Characters present at least during postflexion stage.

	Larvae						
	Eggs General	Body shape	Gut length	Eye shape	Continuous or separated dorsals	Dorsal and anal fin base length	Last fin to form and develop full complement of elements
Eleotridae	Most ellipsoid and adhesive	Slightly elongate and slender	Midbody to slightly beyond	Round	Separated	Short to long	First dorsal
Gobiidae	Most ellipsoid and adhesive	Short and stout to slightly elongate and slender	Most to about midbody or slightly beyond	Round to slightly ovoid	Most are separated	Short to long	Pelvic
Rhyacichthyidae ¹ Kraemeriidae ¹					Separated Continuous	Short Long	
Gobioididae	Demersal and adhesive	Moderately elongate and slender	Midbody to slightly beyond	Round	Continuous	Long	Pelvic
Trypauchenidae		Slightly elongate and slender	1/3 body length to slightly beyond	Slightly ovoid	Continuous	Long	Pelvic
Microdesmidae	Spherical	Moderately elongate and slender	Midbody to slightly beyond	Round	Continuous	Long	Pelvic

¹ Larvae unknown, character states projected from adult conditions.

useful in distinguishing gobioid larvae at all levels. The sequence of fin development is similar in most gobioids, although it varies somewhat in eleotrids and gobioidids. Numbers of fin rays and spines vary greatly among the gobioids and are particularly useful in distinguishing gobioids at the family and species levels (Hoese²). Degree of fin development at different sizes is helpful in separating certain species of larvae, particularly if complete developmental series are available.

Median finfolds and pectoral fins are present at hatching or develop in early larvae of all known gobioids. The pelvic fin is the last fin to form, usually beginning during the flexion or postflexion stages.

The caudal fin is the first fin to form differentiated rays, beginning during the flexion stage. Gobioids usually have 17 segmented principal caudal rays and numerous secondary rays that are usually all differentiated by the postflexion or transforming stages.

The second dorsal and anal fins are next to develop in eleotrids, gobioids, and microdesmids. The anterior and middle elements are first to form and development generally proceeds posteriorly. It is difficult to distinguish the dorsal spines from rays in the continuous dorsal fin of microdesmids during the larval stages, but they are usually shorter than the rays. The first element of the anal fin and the first element of the second dorsal fin initially develop as rays, but later transform into spines in most eleotrids and gobioids. The presence of a continuous (*Microdesmus longipinnis*, Fig. 311) or separated (Gobiidae Larva 2, Fig. 309) dorsal fin is useful in family diagnosis of gobioids. This character varies considerably from the continuous dorsal

in microdesmids, gobioidids, and trypauchenids to the widely separated fins of the gobiid *Periophthalmus cantonensis* (Kobayashi et al., 1973).

The first dorsal and pectoral fins are usually next to complete development in microdesmids and gobioids, while the full complement of first dorsal spines is last to form in eleotrids. While complete developmental series of eleotrids are sparse, it appears that the posteriormost first dorsal spines form after the full complement of pectoral and pelvic fin elements are present (e.g., *Dormitator maculatus*, *Eleotris pisonis*, and *Erotelis smaragdus*). In the gobioidid, *Taenoides cirratus* (9.3 mm), Dotsu (1958) depicts the pectoral fin to be the last fin to obtain its full complement of elements. First dorsal spines range from 2 or 3 in some gobioids (e.g., *Claringer cosmurus*) to 28 in some microdesmids (e.g., *Microdesmus longipinnis*). The gobiid *Luciogobius elongatus* (Fig. 309) lacks a first dorsal fin entirely (Shiogaki and Dotsu, 1972c). Pectoral fin rays range from 3 to 26.

In known gobioids, trypauchenids, and microdesmids the pelvic fin is last to form and complete development. Development of the pelvic fins in gobioids varies greatly between families and within certain families such as the gobioids. Some gobioids have strongly united pelvics that form a cup-shaped disc (Fig. 309) at a very early age, while adult *Rhyacichthys aspro* (Rhyacichthyidae) have widely separated pelvics. Eleotrids, trypauchenids, microdesmids, kraemeriids, and gobioidids usually have separated or weakly united pelvics. Pelvic fins in gobioids range from strongly united, forming a disc to weakly connected at the base to totally separated (usually in species with reduced pelvics; Fig. 309). The size at which pelvics develop is an important character in the separation of some gobiid genera and species. One pelvic spine and 2–5 rays occur in gobioids. *Expedito parvulus* (Gobiidae) lacks pelvic fins entirely (Fig. 310).

² Hoese (this volume) provides a meristic table for gobioid families.

TABLE 151. EXTENDED.

Larvae			
Pelvic fin condition	Gas bladder pigment	General body pigment	Prominent ventral pigment
Separated	Dorsal surface	Moderate	Present
United to separated	Dorsal surface or dorsal and posterior surface	Sparse to heavy	Usually present
Separated Usually separated	Dorsal and posterior surface or lacking	Sparse	Absent
Usually weakly united	Lacking	Sparse	Absent
Separated	Dorsal surface	Moderate	Present

Various other meristic characters are useful in the separation of gobioid fishes. Branchiostegal rays number from 5 to 6. Myomeres/vertebrae range from 25 in *Eviota infidata* (Eleotridae) to 76 in some of the microdesmids.

Pigmentation.—Pigmentation on the gas bladder and along the ventral surface of the body are considered to be characteristic of most gobioid larvae. Melanistic pigmentation in gobioid larvae varies considerably, from the heavily pigmented gobiid *As-trabe lactisella* (Fig. 310) to the sparsely pigmented gobioidids (Fig. 311) and trypauchenids. Larval gobiids, eleotrids, and microdesmids generally have a moderate amount of pigmentation. Pigmentation patterns are especially useful in separating larvae at the generic and specific levels.

Trypauchenid larvae, *Ctenotrypauchen microcephalus* and *Trypauchen microlepis* (Fig. 311) generally lack pigmentation except for two spots of pigment along the anterior portion of the caudal fin, while the gobioidids *Taenioides cirratus* and *Gobioides broussonneti* totally lack pigmentation except for a pigmented gas bladder in *Gobioides broussonneti* (Fig. 311).

Pigmentation on the gas bladder is a prominent feature of most known gobioids. The most common condition is pigment on the dorsal surface, as in *Microgobius thalassinus* (Fig. 309) and appears in most known gobioids. Dorsal and posterior gas bladder pigment is known only in *Gobionellus* species and *Gobioides broussonneti* (Figs. 310, 311). *Trypauchen microlepis* (Fig. 311), *Ctenotrypauchen microcephalus*, and *Taenioides cirratus* are the only known gobioid species which lack gas bladder pigmentation entirely during their early development.

The most pronounced pigmentation occurring in many eleotrids, gobiids, and microdesmids is that found along the ventral

surface of the body, in the region of the gut and anal fin base. Along the anal fin base, this pigmentation often occurs on internal as well as external surfaces.

Pigmentation is often found in eleotrids, gobiids, and microdesmids on the caudal peduncle, along the dorsal surface of the body, on the otic capsule, on the tip of the lower jaw, along the mid-lateral posterior portion of the body, and on various fins. While pigmentation often appears very similar, the subtle variations are frequently useful in the separation of larval gobioids.

Contribution of larvae to systematics

Gobioid larvae have not been previously examined in terms of contributing to the understanding of systematic relationships, but I believe they will be of great use in the future. A preliminary phenetic overview of gobioids based on characters available in larvae (representing less than 5% of the total number of gobioid species), presents some interesting groupings. Known larvae from three eleotrid genera; *Erotelis*, *Eleotris*, and *Dormitator* seem to form a cohesive group. Shared characters include: gross body and head shape, short dorsal and anal fin bases, separated pelvics, gut length (~55% to 57% SL), dorsal gas bladder and ventral pigmentation, late development of the first dorsal fin, and separation of the two dorsal fins. Microdesmid larvae from the genera *Microdesmus*, *Cerdale*, and *Gunnellichthys*, likewise, all appear quite similar to each other, based on the following: gross body and head shape, connected dorsal fins, long dorsal and anal fin base, high vertebrae number, reduced pelvic and pectoral fins, gas bladder and dorsal and ventral body pigmentation.

While the above mentioned eleotrid and microdesmid groups appear fairly cohesive as well as distinct from other gobioids, the family Gobiidae seem to be in some respects a catch-all group. Currently, many diverse types of gobies are included within the family Gobiidae (some 250 genera and well over 1,000 species). It is possible that larvae may present us with additional characters that may help to better define the group. The use of only adult characters has led many workers to debate the rank of many taxa, for example Nelson's (1976) families Trypauchenidae and Gobioididae have been relegated to subfamilial status within the Gobiidae (Hoese, this volume) or lower by other workers. Although the use of larval characters alone will not define gobioid families they may allow a better understanding of relationships. Known larvae of Trypauchenidae and Gobioididae exhibit characters that are distinctive or unique to these taxa. *Trypauchen microlepis* has the shortest and most acutely looped gut of any gobioid and is one of only three species that lack gas bladder pigmentation (others are a trypauchenid and a gobioidid). Pectorals are also more reduced than in other gobioids. The long continuous dorsal fin and long anal fin base are not shared among most gobioids. *Gobioides broussonneti* also has a long continuous dorsal fin and long anal fin base. It is one of only two known gobioid genera with dorsal and posterior gas bladder pigment (the other being the gobiid genus *Gobionellus*), and is one of the most sparsely pigmented gobioids known.

More descriptive work needs to be completed on the taxonomic level of both adults and larvae before the full value of ontogenetic characters in gobioid systematics can be adequately assessed.

GULF COAST RESEARCH LABORATORY, EAST BEACH DRIVE, OCEAN SPRINGS, MISSISSIPPI 39564.

Gobioidei: Relationships

D. F. HOESE

APPROXIMATELY 500 genera and 2,000 species of gobioid fishes have been named. Currently, about 270 genera are recognized, and it is estimated that the group contains between 1,500 and 2,000 species. About 50 families, subfamilies, and tribes have been named. Gobioid fishes are distributed throughout much of the tropical, subtropical and temperate regions of the world, occurring in a variety of habitats in fresh, brackish, and coastal marine waters to depths of about 220 meters on the continental shelf. Of the six extant families recognized here, three (Eleotrididae, Gobiidae, and Microdesmidae) are world-wide, and three (Xenisthmididae, Rhyacichthyidae, and Kraemariidae) are restricted to the Indo-Pacific. Most species of gobioid fishes are benthic, but some are pelagic, many are burrowers, and many live in burrows constructed by other organisms.

Much of the early history of the classification of gobioid fishes has been summarized by Iljin (1930), Koumans (1931), and Miller (1973). Early classifications, based on external features were provided by Günther (1861), Bleeker (1874), Jordan (1923), and Berg (1940). Sanzo (1911) published the first extensive study of the lateralis-system pores and papillae, characters which have come into wide usage in the last 20 years at the generic and specific levels. Regan (1911c) presented the first classification based largely on osteological characters. He established the family Psammichthyidae (=Kraemariidae), and provisionally placed it with the gobioids, a placement which was not accepted until relatively recently. The study of Regan was largely confined to the cranial osteology, pectoral girdle, and vertebral numbers. Gosline (1955) examined the osteology of a few representatives of the major groups of gobioid fishes, and gave evidence for the placement of microdesmids and kraemariids among the gobioids. Takagi (1950, 1953) contributed to the classification based on examination of scales and the glossohyal, and later (1966) published an extensive paper on the distribution of the group. Akihito (1963, 1967) studied the scapula in a number of species, and later (1969) presented one of the most detailed studies of the higher classification of gobioid fishes, dealing with major osteological features of 71 genera and 85 species, but did not present a classification. Miller (1973) described the osteology of *Rhyacichthys*, and presented a largely new classification of the group. Birdsong (1975) presented information on the primitive character states for several osteological characters and indicated presumed trends for each character. He also criticized the classification of Miller and recommended a return to the traditional classification.

Dawson (1974b) characterized the Microdesmidae and (1973) summarized distributional information on Indo-Pacific species. Rofen (1958) reviewed the Kraemariidae. Matsubara and Iwai (1959) described the osteology of *Kraemaria sexradiata*. Obrheleva (1961) described a new family of gobioid fishes (Pirskeniidae) from Oligo-miocene fossil material from Europe.

Few studies have been carried out on the relationships of the suborder to other fishes. Most early workers considered the group related to perciform or scorpaeniform fishes. McAllister

(1968) and Freihofer (1970) suggested a relationship with the Paracanthopterygii. Other workers have accepted a perciform derivation (Miller, 1973; Springer, 1983; Gosline, 1955), although Gosline (1971) suggested that the group might eventually be regarded as a distinct order based on the structure of the suspensorium and the caudal skeleton. No sister group has been postulated.

Gobioid fishes are characterized by the following features: no parietals; a pelvic intereleithral cartilage; interhyal displaced away from the dorsal end of the symplectic; a gap between symplectic and preoperculum; no orbitosphenoid or basisphenoid; lacrimal typically present, extending over maxilla, but not forming lower margin of orbit; only one other suborbital rarely present; fourth basibranchial cartilaginous; penultimate vertebra with a short expanded neural spine and an elongate expanded hemal fused to centra; caudal skeleton with one to three epurals, a small free parhypural, an enlarged lower hypural plate articulating with and sometimes fused with urostyle, an enlarged upper hypural plate fused to urostyle, and a small free upper hypural; procurrent caudal rays articulate with cartilaginous plates; lateral line usually absent on body, canals often developed on head, suborbital canal and mandibular canal usually absent; first spine or ray, when spine absent, associated with proximal elements of two pterygiophores (median element of first pterygiophore of second dorsal fin rarely present); last two rays of second dorsal and anal fins closely spaced and articulating with a single pterygiophore in each fin. Meristics are given in Table 152.

The following groups are recognized:

Rhyacichthyidae.—The monotypic family Rhyacichthyidae is the most primitive gobioid fish in the following features: branchiostegals 6; mesopterygoid and dorsal posteleithrum present; lateral line present on body; an anterior sclerotic; lacrimal and one additional suborbital present; 3 epurals; interhyal adjacent to dorsal end of symplectic; 3 posttemporals; infraorbital and mandibular head canals present; scales with multiple rows of ctenii. Its specializations are related to adaptations to fast flowing rocky streams and include: thickened muscular pelvic fins, small mouth, placed ventrally and anteriorly.

Eleotrididae.—The eleotridids, largely confined to freshwater and estuarine environments, are currently definable on the basis of the following primitive features: branchiostegal rays 6; pelvic fins widely separate, pelvic girdle with a short post-pelvic process, extending well beyond last pelvic ray, pelvic rays in line with pelvic spine; mesopterygoid and dorsal posteleithrum generally present; interorbital normally broad; caudal peduncle long, generally longer than second dorsal base; palatine normally more or less L-shaped, with a short ethmoid process, articulating medially with lateral ethmoid; scapula normally completely ossified; anterior sclerotic, suborbital (other than lacrimal), posttemporals, and median element of first pterygiophore of second dorsal fin usually absent; first basibranchial cartilaginous, ba-

TABLE 152. SELECTED MERISTICS FOR GOBIOID FAMILIES AND SUBFAMILIES.

Group	Branchiostegal rays	D1	D2	A	P1	P2	Epurals	Segmented caudal rays	Vertebrae
Rhyacichthyidae	6	VII	1, 8-9	1, 8-9	21-22	1, 5	3	17	12 + 16 = 28
Eleotrididae	6	III-X	1, 6-17	1, 6-13	13-21	1, 5	1-2	15-17	10-18 + 11-19 = 24-36
Xenisthmidae	6	0-VI	0-I, 9-32	1, 9-25	17-21	0-1, 1-5	1-2	15-17	10-18 + 16-28 = 26-46
Microdesmidae									
Microdesminae	5	XX-XXVIII	26-66	23-61	10-15	1, 2-4	1	15-17	42-76
Oxymetopontinae	5	VI	1, 9-37	1, 9-36	15-26	1, 4-5	1	17	10-11 + 15-16 = 26
Gobiidae									
Oxudercinae	5	V-VIII	0-1, 10-30	0-1, 10-30	10-21	1, 5	2	17	10 + 16 = 26
Amblyopinae	5	VI-VIII	16-50	0-1, 14-50	13-21	1, 5	1-2	17	10 + 16-26 = 26-36
Sicydiinae	5	VI	1, 9-11	1, 9-11	15-23	1, 5	1	17	10 + 16 = 26
Gobiinae	5	0-X	0-1, 5-19	0-1, 5-19	11-25	1, 4-5	1-2	13, 16-17	10-16 + 14-21 = 25-36
Kraemariidae	5	IV-V	13-19	1, 11-15	3-10	1, 5	1	11	10-14 + 16-17 = 26-31

sibranchials 2 and 3 present; pterospheonoid present, coronomeckelian bone present; pterygiophores of two dorsal fins normally continuous, without an interneural gap. One group (*Leptophilypnus* and *Gobiomorphus* and relatives) are specialized in having an interneural gap (an interneural space without a pterygiophore) between the two dorsal fins. Members of the group also have often lost several eleotridid primitive features, such as the mesopterygoid and dorsal postcleithrum. Some are specialized in having an unossified scapula and a single epural. Other eleotridids consistently have 2 epurals and a well ossified scapula. The group includes about 40 genera and the following named taxa: Butinae, Belobranchinae, Gobiomoridae, Hypseleotrinini, Milycingidae, Ophiocarinae, and Philypni. Whether any of these are recognizable must await further study.

Xenisthmidae.—This coral reef group, restricted to the Indo-Pacific, is treated extensively by Springer (1983) and is distinctive in the following specializations: lower lip with a free ventral margin; ascending process of premaxilla absent or rudimentary; rostral ossified and functionally replacing ascending process of premaxilla; first basibranchial ossified; basibranchials 2-4 absent; no pterospheonoid or coronomeckelian bone; interneural gap present between two dorsal fins. The two genera studied lack the dorsal postcleithrum and the mesopterygoid. The group includes 4 genera.

Microdesmidae.—The group possesses the following primitive features: maxilla more or less L-shaped, with a very short inner process articulating medially with lateral ethmoid; usually separate pelvic fins, without an interspinal membrane. The group is uniquely specialized in having a very long posterior pelvic process. Other specializations include the strongly compressed head and body, with lateral eyes; 5 branchiostegal rays; one epural; dorsal postcleithrum and mesopterygoid absent. Trends in the group include reduction of pelvic rays, the tendency for the scales to become nonimbricate, and the development of a very long-based second dorsal fin. Two subfamilies are recognized here, but further studies may show both to be distinct families.

Microdesminae.—The specializations include: maxilla with a long strut-like anterior projection; body very elongate, with a single dorsal fin attached to or reaching near caudal fin; dentary

with a long ventral process at anterior tip. The worldwide group includes 5 genera and the following named taxa: Cerdalidae, Gunnellichthyidae, and Paragobioideidae.

Ptereleotrinae.—The specializations include: mouth almost vertical; articular process of premaxilla absent or fused with ascending process; a single pterygiophore precedes the first hemal spine. The worldwide group includes 6 genera (2 undescribed) and the following named taxa: Nemateleotrinae, Pogonoculinae, Oxymetopontinae. In addition both subfamilies of microdesmids contain several specializations sometimes found in Gobiidae, such as the interlocking of the anterior preopercular process with the dorsal end of the symplectic and the expanded dorsal flange of the sphenotic reaching to the supraoccipital.

Gobiidae.—In some genera primitive features are found, such as the ventral postcleithrum, 2 epurals, and separate head canals between the eyes. Specializations include: pelvic fins usually connected to form a cup-shaped disc, often separate in coral reef genera, but interspinal membrane usually present; pelvic spine displaced forward and ventrally, not in line with rays; mesopterygoid and dorsal postcleithrum absent; palatine normally T-shaped, but L-shaped in some specialized genera; ethmoid process of palatine extends across front of lateral ethmoid, articulating with proximal base of lateral ethmoid or more commonly with median ethmoid; maxilla generally without an anterior process; median ethmoid displaced ventrally; an interneural gap present between two dorsal fins (except in *Trypauchen* and relatives). There may be one or two dorsal fins, and most genera have 17 segmented caudal rays, rarely 13 or 16. Several subfamilies have been recognized. Four are recognized here, but further studies may considerably expand the number.

Oxudercinae.—Tongue fused to floor of mouth; a single pterygiophore precedes first hemal arch; teeth flattened; second dorsal fin usually long based; eyes displaced forward and upward; 2 epurals, lateral process of sphenotic large and not in contact with eye. The group occurs in mud and mangrove areas in all tropical areas, except the New World. The group contains about 10 genera and the following named taxa: Apocrypteidae, Boleophthalminae, Periophthalmidae.

Amblyopinae.—Tongue fused to floor of mouth; 2 or 3 pterygiophores precede first hemal spine; a single dorsal fin reaching

to near or fused with caudal; eyes rudimentary and placed forward in orbit; lateral process of symplectic large; 2 epurals. The worldwide group occurs in estuaries or off river mouths, and includes about 10 genera and the following named taxa: Gobioididae, Taenioididae, Trypauchenidae.

Sicydiinae.—Tongue fused to floor of mouth or free only at tip, highly modified jaw suspension; thickened and highly branched pelvic rays and fleshy pads at tips of pelvic spines. The worldwide group occurs in freshwater and includes about 5 or more genera and the following included taxa: Sicydiaphiinae (in part).

Gobiinae.—The worldwide group includes about 200 genera and is not easily definable. The group includes the following named higher taxa: Aphyinae, Austrolethopinae, Benthophilinae, Brachygobii, Calleleotrinae, Chaeturichthyi, Croilinae, Crystallogobiinae, Doliichthyidae, Gobiodontinae, Gobiosomini, Gymnogobiini, Latrunculini, Lebetinae, Leioterinae, Luciogobiinae, Platygobii, Rhinogobiinae, Trienophorichthyini, Tridentigeriinae, Valencienninae.

Kraemariidae (= *Psammichthyidae*).—The family agrees in most features with the Gobiidae, being specialized in having a large amount of cartilage in the skeleton and 3 pectoral radials. The group is restricted to the Indo-Pacific and includes 2 genera.

RELATIONSHIPS

Most workers have generally agreed that the Rhyacichthyidae and Eleotrididae represent the most primitive gobioid fishes characterized by 6 branchiostegal rays, a mesopterygoid, and dorsal postcleithrum. In addition other primitive features, not found in gobiids are sometimes present, such as an anterior sclerotic, lower suborbital (other than lacrimal), and extrascapulae. Most other features generally retain a primitive nature in eleotridids, such as 2 epurals, ossified scapula, head canals, when present, separate between eyes, and a ventral postcleithrum. Gobiids, microdesmids, and kraemariids have 5 branchiostegal rays and lack a mesopterygoid and dorsal postcleithrum (with over two thirds of the genera examined). These differences in organizational grades have led some workers to suggest that the advanced gobiid level of organization may be polyphyletic (Springer, 1983).

The primary innovate character defining the gobiid fishes is the development of a pelvic cup-shaped disc, formed by membranes connecting the inner pelvic rays and two pelvic spines (interspinal membrane or frenum); with the forward and ventral rotation of the pelvic spines on the pelvic girdle. It has been shown that reef gobiids often have secondarily separate pelvic fins (Hoese, 1971), although most species retain a rudiment of the interspinal membrane and the typical gobiid pelvic spine orientation. Consequently, the question of whether gobiid fishes are monophyletic depends in part on whether the disc has evolved independently in various gobiid groups. Studies of other gobiid specializations, although incomplete, have not indicated that gobiids are polyphyletic. For example Regan (1911c) first noted that the eleotridids have an L-shaped palatine and gobiids a T-shaped palatine. In eleotridids the ethmoid process of the palatine is short and articulates directly with the middle of the lateral ethmoid, while in gobiids the ethmoid process is typically long, extending across to the median ethmoid, which is displaced ventrally. Similarly in gobiids there is an interneural gap be-

tween the two dorsal fins (a space between two neural arches without a pterygiophore). Primitively in eleotridids, the pterygiophores of the two dorsal fins are continuous, without a gap. From the relationship between the pterygiophores of the second dorsal and the anal fins, it appears that the gap in gobiids forms from a posterior shift of the second dorsal fin. The interneural gap also occurs in *Rhyacichthys* and *Xenisthmus*, and several eleotridid genera from New Guinea, Australia, and New Zealand (*Gobiomorphus*, *Philypnodon*, *Grahamichthys*, and two new genera) and the Central American genus *Leptophilypnus*. Structural comparisons indicate that *Rhyacichthys* probably obtained the gap by loss of a dorsal spine or forward shift of the posterior dorsal spines. It is currently unknown whether the Xenisthmidae and the *Gobiomorphus*-*Leptophilypnus* group are convergent with gobiids or represent sister groups. Both groups sometimes lose primitive eleotridid features such as the mesopterygoid and dorsal postcleithrum. In general body form the *Gobiomorphus*-*Leptophilypnus* group most closely approach the gobiid body form expected of an ancestral gobiid. Although currently placed with the eleotridids further studies are underway to determine the relationships of the genera in the group.

The microdesmids also represent a gobiid level of organization, in lacking several primitive features, but their relationships to other gobioid fishes are unclear. The group is characterized primarily by the unique specialization of having an elongate posterior pelvic process. The two subfamilies have other specializations in common and show similar trends, with the Ptereleotrinae representing the primitive sister group. The microdesmids retain a primitive palatine-ethmoid articulation, and the posterior pelvic process probably represents an elongation of the short posterior pelvic process of eleotridids. Microdesmids share with gobiids the loss of the anterior branchiostegal ray. The strong compression of the head may have led independently to the loss of the anterior branchiostegal ray. Unfortunately no immediate sister group is known, although on the basis of the interneural gap, the Xenisthmidae represent a possible group. Although the inner rays of the two pelvic fins are sometimes connected in microdesmines, no species is known with an interspinal membrane. The microdesmines have presumably secondarily lost the interneural gap. A similar situation occurs in the gobiid *Trypauchen*, where a single long-based dorsal fin is present.

The kraemariids appear closest to gobiids. Whether the group will remain a family is uncertain, since the group shows some similarity to the gobiid *Parkraemaria*.

Since no immediate sister group has been postulated for gobioid fishes, relationships of the more primitive groups are unclear. Miller (1973) and Springer (1983) have recognized only two gobioid families, Rhyacichthyidae and Gobiidae. Springer (1983) has suggested that the Rhyacichthyidae represents the primitive sister group of all gobioid fishes. It is clear that *Rhyacichthys* is more primitive than any other known gobioid (although arguably only marginally more primitive than some eleotridid genera, such as *Micropercops*), and at the same time specialized. However, eleotridids do not show obvious innovative specializations in relation to *Rhyacichthys*, but show loss of some primitive features. Until a proposed phylogeny of primitive genera becomes available, the eleotridids can only be regarded as a primitive stock, which gave rise to one or more lines leading to the families recognized here. While most eleotridid genera may well have evolved before the xenisthmid-micro-

desmid-gobiid line (or lines) evolved, some genera, such as the *Gobiomorphus-Leptophilypnus* group, may have evolved from a common ancestor of the line (or lines).

Irrespective of the number of families, or subfamilies of gobioid fishes recognized, there is no obvious evidence to combine the 40 eleotridid genera with any particular gobioid group. It is

clear that the interrelationships of this large group will not be fully clarified in the near future.

THE AUSTRALIAN MUSEUM, 6-8 COLLEGE STREET, SYDNEY 2000, AUSTRALIA.

Scombroidei: Development and Relationships

B. B. COLLETTE, T. POTTHOFF, W. J. RICHARDS, S. UEYANAGI,
J. L. RUSSO AND Y. NISHIKAWA

THE Scombroidei is a suborder of the Perciformes containing 6 families, 44 genera, and nearly 100 species. All species are marine although at least one (*Scomberomorus sinensis*) moves fairly long distances into fresh water. Most species are pelagic, some epipelagic and some bathypelagic.

The first modern definition of the scombroid fishes as the suborder Scombroidei was by Regan (1909). He clearly separated the scombroids from such percoid families as the Carangidae, Rachycentridae, Coryphaenidae, Bramidae, and Menidae. Within the Scombroidei, Regan recognized four divisions: I. Trichiuriformes (Gempylidae and Trichiuridae); II. Scombriformes (Scombridae); III. Luvariformes (Luvaridae); and IV. Xiphiiformes (Istiophoridae, Xiphiidae, and three families known only as fossils). Regan's Scombroidei was defined by three primary characters: premaxillae beak-like, gill membranes free from the isthmus, and epiotics separated by the supraoccipital. To include *Luvarus* in the Scombroidei, reversals must be postulated in these three characters. The relationships of *Luvarus* lie with the Acanthuroidei (Regan, 1902; Leis and Richards, this volume; Tyler et al., MS) and will not be considered here. Recent workers have usually recognized a suborder Scombroidei that is essentially the same as that of Regan (1909) including the Luvaridae (e.g., Greenwood et al., 1966) or have placed the billfishes (Istiophoridae and Xiphiidae), along with the Luvaridae, in a separate suborder, the Xiphioidei (Gosline, 1968; Potthoff et al., 1980), or have removed *Xiphias* from the group and placed it in its own suborder, Xiphioidei (Potthoff and Kelley, 1982).

Scombroidei

Perciform fishes with epiotics separated by the supraoccipital, gill membranes free from the isthmus, premaxillae beak-like, upper jaw nonprotrusile (except in *Scombrolabrax*), predorsal bones lost (except for a small one in *Ruvettus*, *Thyrsites*, and *Tongaichthys* and three well-developed ones in *Gasterochisma*), second epibranchial extending over the top of the third infra-pharyngobranchial (except in *Gasterochisma*), vertebrae 24 or more, interorbital commissure of the supraorbital canals widely incomplete or absent (Regan, 1909; Gosline, 1968; G. D. Johnson, pers. comm.).

Six families are recognized: Scombrabracoidei (monotypic; Potthoff et al., 1980); Gempylidae (15 genera, 16 species; Matsubara and Iwai, 1952, 1958; Russo, 1983); Trichiuridae (9 genera, about 20 species; Parin and Bekker, 1972); Xiphiidae

(monotypic); Istiophoridae (3 genera, about 11 species; Nakamura et al., 1968; Morrow and Harbo, 1969; Nakamura, 1974); and Scombridae (15 genera, 49 species; Collette, 1979, 1983).

Fig. 312 is a Wagner Tree based on 40 characters considered significant in assessing scombroid relationships (see Appendix) generated by the computer program (WAGNER 78) written by J. S. Farris (following Farris, 1970; Farris et al., 1970). The tree is rooted at *Scombrolabrax* which is considered as the most primitive scombroid and was used as the outgroup for comparison with the other scombroid fishes. Numbers show where a character changes from a plesiomorphous (*Scombrolabrax* condition) to a derived-apomorphous state. The gempylids were grouped together on this cladogram because data were not available on all the characters. The unresolved areas have been resolved in a separate study by Russo (1983) and are discussed in the section on the Gempylidae. The cladogram shows several synapomorphies of the billfishes and the Scombridae: pharyngeal tooth plate stay (character 3; G. D. Johnson, pers. comm.), pair of small lateral keels at the base of the caudal fin (character 12), caudal fin rays covering hypural plate (character 14), etc. Billfishes show many character reversals and independent acquisitions. Within the Scombridae, most groups seem well-defined.

Scombrabracoidei

From its original description by Roule (1922), *Scombrolabrax heterolepis* has been considered as related to gempylid fishes (Grey, 1960; Gosline, 1968; Potthoff et al., 1980). In most instances wherein *Scombrolabrax* differs from the gempylids it differs in the direction of the percoids: upper jaw protrusile, some opercular bones spinous or serrate, pelvic girdle relatively strong and attached to the cleithra, no fusion in the caudal skeleton, one fewer vertebra (17 + 13 = 30) than in any other scombroid (except the billfishes) and procurrent spur present but reduced (Gosline, 1968; Johnson, 1975; Potthoff et al., 1980). The stay on the pharyngobranchial of the fourth gill arch that is present in the Scombridae, Xiphiidae, and Istiophoridae is absent as in the Gempylidae and Trichiuridae (Potthoff et al., 1980). Roule (1922) originally placed *Scombrolabrax* in a separate suborder. Bond and Uyeno (1981) also recognized a suborder Scombrabracoidei because of the unique specialization in adults of the 5th through 12th vertebrae which are expanded to form thin-walled bullae with wide ventral openings which accommodate delicate bubble-like evaginations of the gas blad-

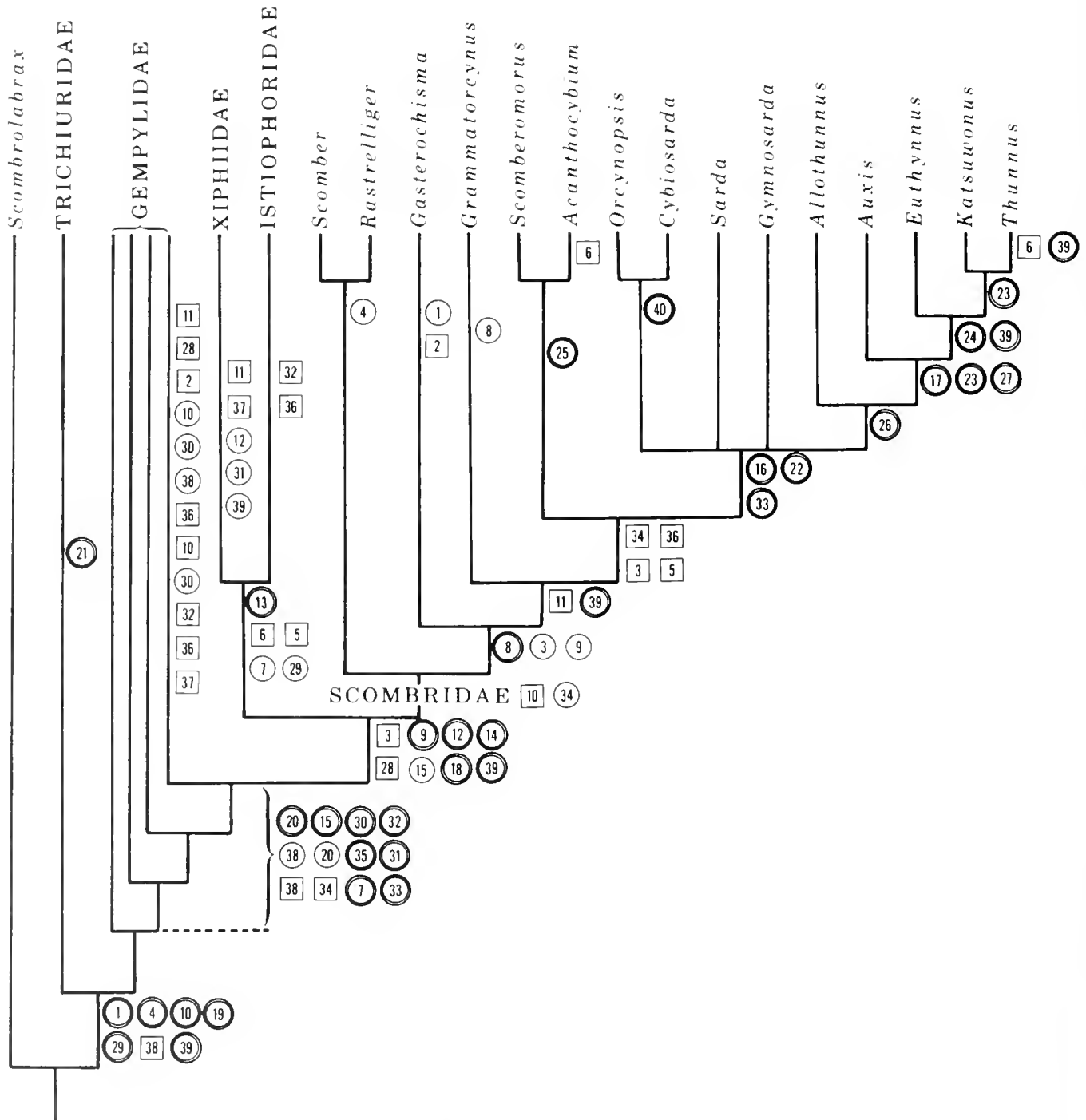

Fig. 312. Wagner tree of scombroid fishes based on 40 characters (Appendix). Numbers are inserted where a character changes from a plesiomorphous (*Scombrlabrax* condition) to an apomorphous state. Numbers in dark circles show no homoplasy, those in light circles show reversals in character state, and those in squares show independent acquisitions.

der. The presence of this autapomorphy is not sufficient reason to place *Scombrlabrax* in a monotypic suborder. Taxa should be grouped based on shared specializations.

Development

Scombrlabrax heterolepis (Fig. 313).—Larval development was described by Potthoff et al. (1980). Early larvae from 3–4

mm NL resemble the scombrid *Thunnus* in pigmentation, but *Scombrlabrax* can be distinguished from *Thunnus* in having only 30 myomeres as opposed to 39 myomeres in *Thunnus*. Larger larvae acquire characteristic melanophores on the lower jaw ramus and on the caudal peduncle.

Scombrlabrax shares characters with the Gempylidae and the most primitive scombrid tribe Scombrini (*Scomber*, *Ras-*

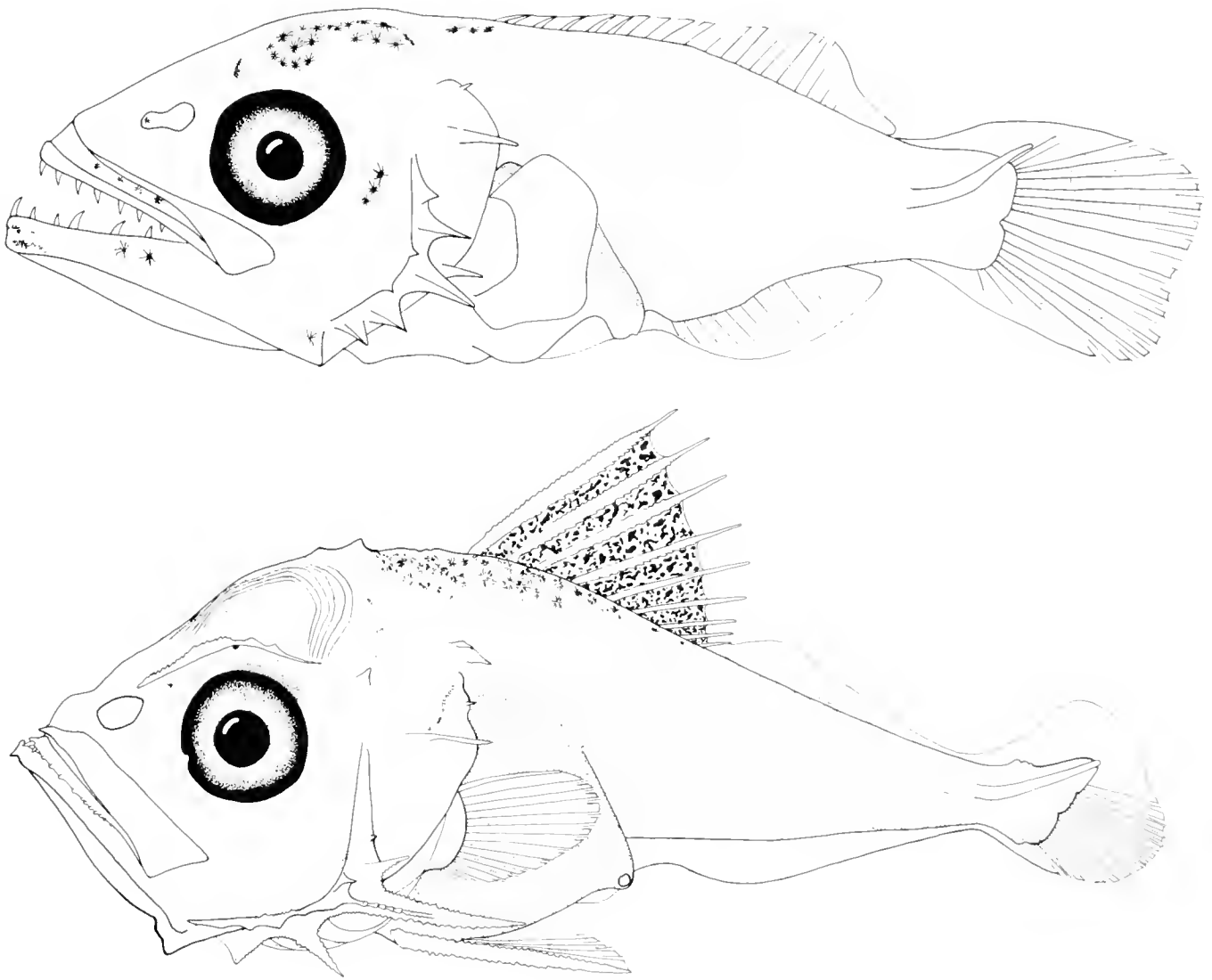

Fig. 313. Lateral views of scombroid larvae. (upper) *Scombrobrax heterolepis*, 5.0 mm SL, from Potthoff et al. (1980); (lower) *Lepidocybium flavobrunneum* 5.0 mm SL, western Atlantic, ATLANTIS II, Cr. 59, Sta. RHB2083, Nov. 26, 1970, drawn by J. Javech.

trelliger) (Table 153). Many of these shared characters are plesiomorphous and so are not useful in constructing a classification.

Gempylidae

Body oblong or elongate, compressed; maxilla exposed; strong anterior canine teeth present; base of spinous dorsal fin longer than soft dorsal; three anal spines except *Rexea* and *Nealotus*, with two spines; pelvic fins 1,5 or reduced to only a spine; caudal fin present; vertebrae 32–58 (Tables 154 and 155); anterior pre-caudal vertebrae without parapophyses, with sessile ribs; posterior pre-caudal vertebrae with ribs attached at the extremities of closed haemal arches (Regan, 1909). The family currently includes 16 species in 15 genera (Parin and Bekker, 1972; Nakamura and Fuji, 1983; Russo, 1983).

Russo (1983) divided the Gempylidae into six monophyletic groups (Fig. 314) based on osteological characters. Three groups are monotypic: *Lepidocybium*, *Ruvettus*, and *Thyrstites*. The *Epinnula* group consists of four genera above character 7: *Epinnula*, *Neoepinnula*, *Tongaichthys*, and *Thyrstites*.

The *Nealotus* group is composed of three genera above character 2: *Nealotus*, *Promethichthys*, and *Rexea*. The *Gempylus* group contains five genera above character 3: *Thyrstoides*, *Nesiarchus*, *Gempylus*, *Diplospinus*, and *Paradiplospinus*. *Diplospinus* and *Paradiplospinus* should probably be combined under *Diplospinus*.

Development

The family Gempylidae is characterized by the following larval and adult characters when compared to the family Scombridae: known gempylid larvae (except *Thyrstites* with smooth spines) have serrate dorsal, anal and pelvic fin spines, scombrid larvae have smooth spines (Table 153). Gempylids initially develop 3 epurals (ontogenetic fusion in *Diplospinus*), scombrids develop 2 epurals. Gempylids develop 2 uroneurals (we were unable to confirm this on all gempylid genera), scombrids develop one uroneural. In gempylids the first dorsal pterygiophore inserts in the second interneural space; in scombrids it inserts in the third space. Most gempylids, except *Ruvettus* and *Neo-*

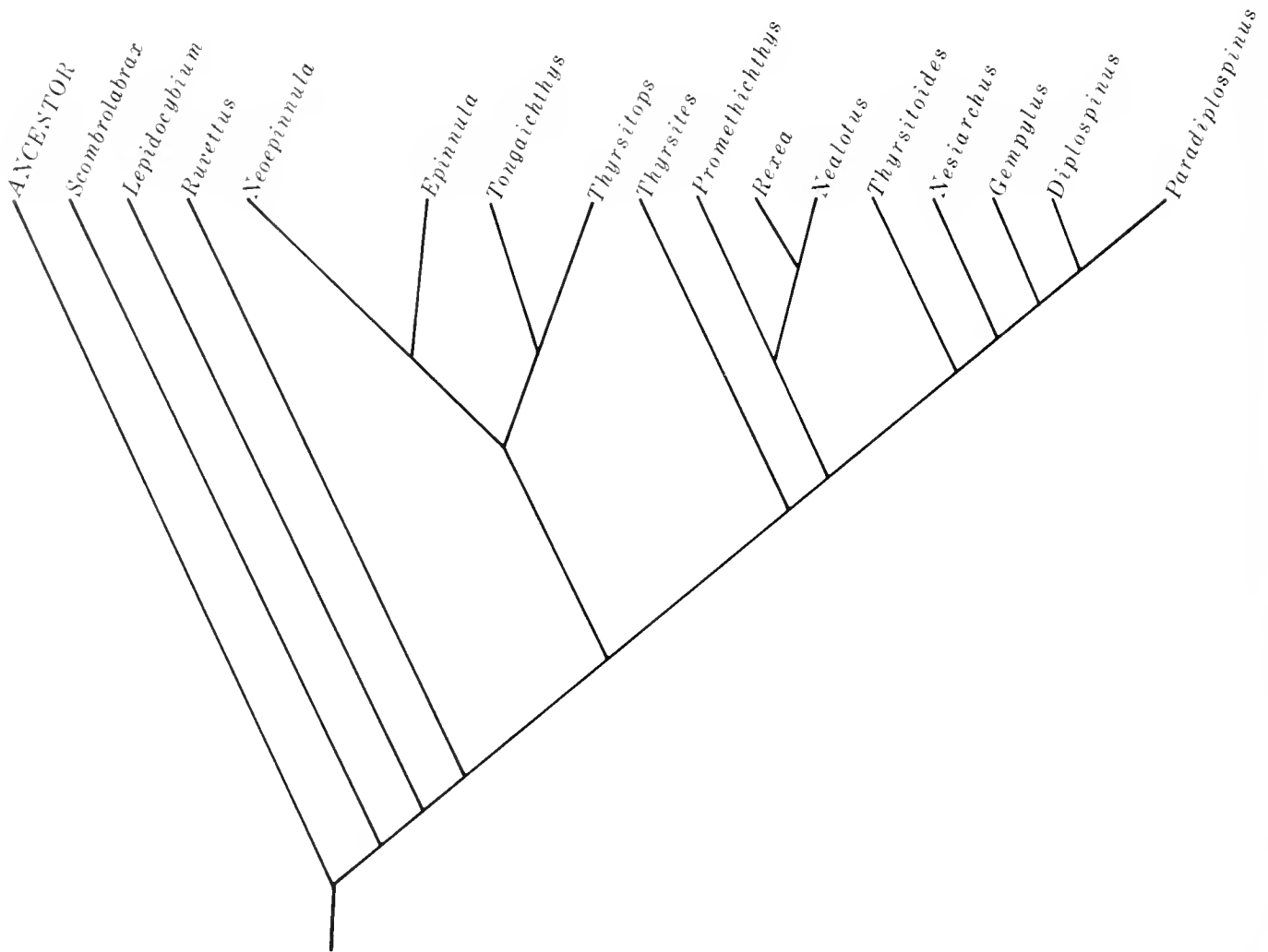

Fig. 314. Most parsimonious cladogram of relationships of genera in the Gempylidae (from Russo, 1983: fig. 47).

pinnula, have more precaudal and fewer caudal vertebrae; in most scombrids the reverse is true (Table 154). In the gempylids 3 centra support caudal rays; in scombrids (except Scombrini and *Grammatorcynus*) 4 or 5 centra support the caudal rays.

Lepidocybium flavobrunneum (Fig. 313).—*Lepidocybium* larvae, caught in the Indian Ocean, have been described by Nishikawa (1982). The description agrees with the Atlantic Ocean and Gulf of Mexico larvae from the MCZ collection examined by Potthoff, except for the vertebral count which Nishikawa reported to be $16 + 15 = 31$. The MCZ specimens had $17 + 15 = 32$ vertebrae. *Lepidocybium* larvae and juveniles can be distinguished from other scombrid and gempylid species by meristics (Tables 154, 155, and 156), pigmentation and shape. First dorsal fin spine count is the lowest for all gempylids and

scombrids. The first dorsal fin is intensely pigmented in larvae of *Lepidocybium* and the individual spines have serrations. The height and pigmentation of the fin is similar in larvae of *Thunnus* and *Euthynnus*, but the fin spines are smooth in these two scombrid genera. *Neopinnula* has a considerably higher first dorsal fin, also with serrate fin spines and also intensely pigmented. The low total vertebral count of 32 in *Lepidocybium* is similar in *Scombrolabrax*, *Scomber*, *Rastrelliger* and *Thyrsitops* and the count is the same in *Ruvettus*, *Epinnula* and *Neopinnula*. The small projection on top of the head of *Lepidocybium* larvae as shown in Fig. 313 is also present in larvae of *Scomberomorus* and *Sarda*. Cranial rugosities (striations) observed in *Lepidocybium* larvae seem to be unique to this genus. A very stout and long serrate preopercular spine is present in *Lepidocybium* larvae. The overall intense gut pigmentation

Fig. 315. Lateral views of gempylid larvae from top to bottom: *Neopinnula orientalis*, 5.5 mm NL, Gulf of Mexico, Flower Garden 81-12, Sta. 379, Nov. 8, 1981, drawn by J. Javech; *Epinnula magistralis*, 6.3 mm NL, modified after Gorbunova (1982); *Thyrsitops lepidopoides*, 5.5 mm NL, drawn from a specimen from Sato's (1983) study by J. Javech.

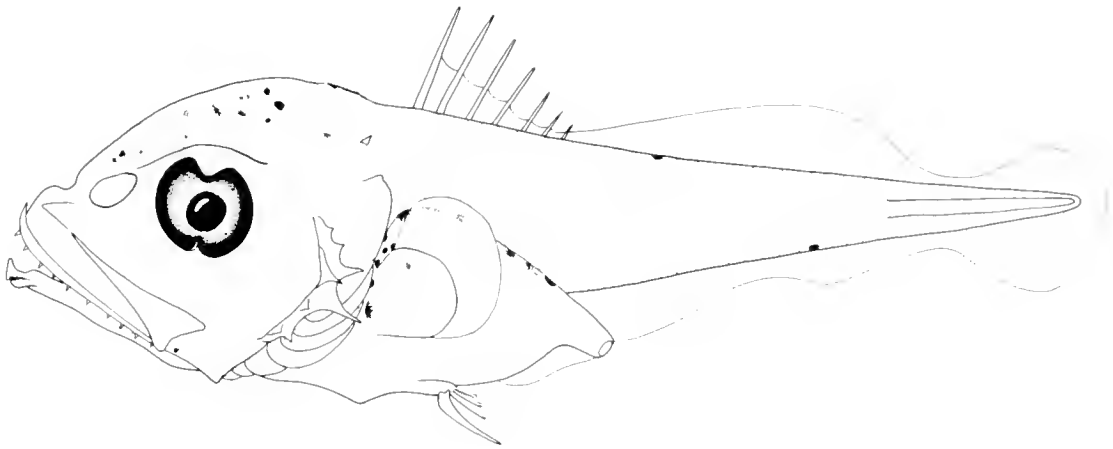
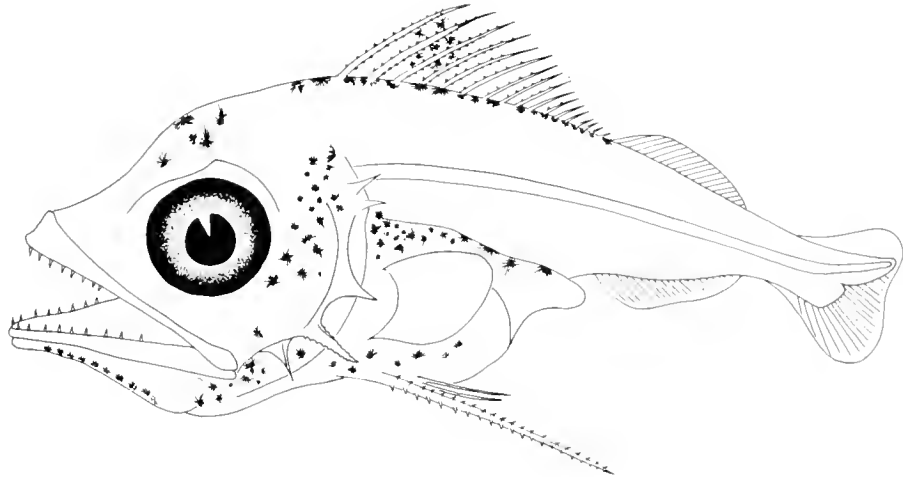
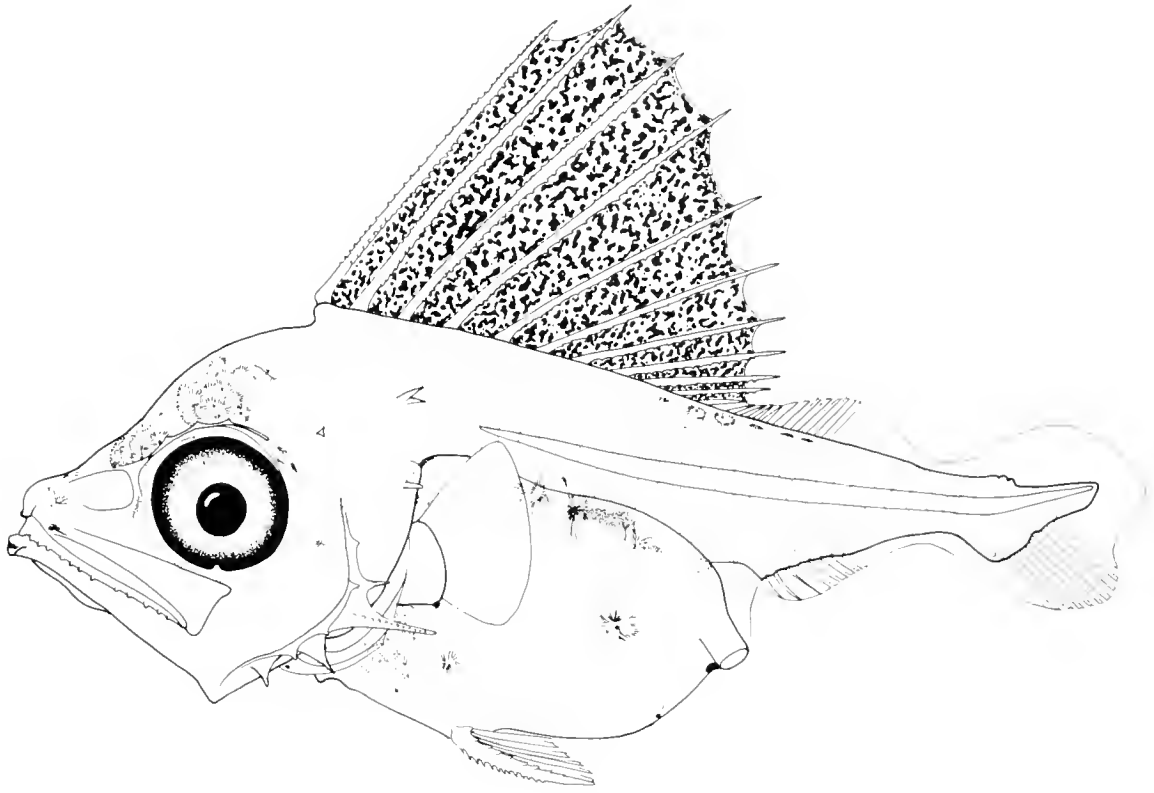

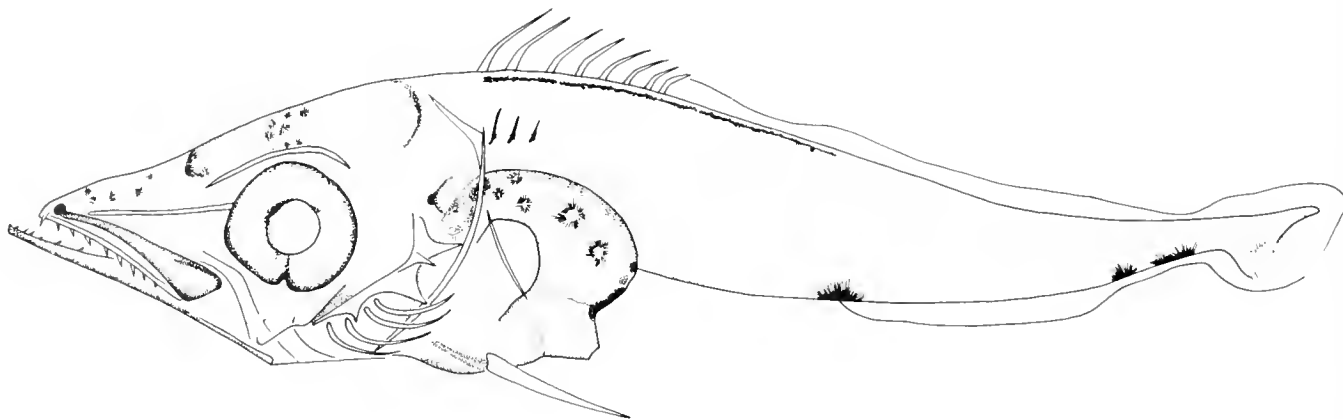

Fig. 316. Lateral view of the gempylid larva *Thyrsites atun* 6.0 mm NL, modified after Haigh (1972a).

in *Lepidocybium* is probably unique among scombrid and gempylid larvae. In all known scombrid and gempylid larvae the gut is intensely pigmented only dorsad with little lateral and ventral pigmentation.

Lepidocybium has more affinities to the Gempylidae than to the Scomberomorini. With the Gempylidae it shares caudal skeletal characters such as 2 uroneurals and 3 epurals; scombrids have 1 uroneural and 2 epurals. Larval *Lepidocybium* have serrate pelvic and first dorsal and anal fin spines, which also are present in known gempylid larvae, except *Thyrsitops*. The first dorsal pterygiophore in *Lepidocybium*, as in all gempylids, inserts in the second interneural space in Atlantic specimens, but in Pacific *Lepidocybium* the first dorsal pterygiophore is found in the third interneural space; in all scombrids the first dorsal pterygiophore inserts in the 3rd space.

Ruvettus pretiosus.—The larvae of *Ruvettus* are not known. This lack of knowledge is surprising, because *Ruvettus* is caught as by-catch in the tuna longline fishery (Nakamura, 1977). The smallest *Ruvettus* known to us is 209 mm SL and has the features of adults.

Epinnula magistralis (Fig. 315).—The larvae of *Epinnula* are not well known. Gorbunova (1982) reported the capture of 3 larvae from the Gulf of Mexico and one larva from the Straits of Yucatan. In larval *Epinnula*, the first dorsal fin is not as high and not as intensely pigmented as in *Neoepinnula* and the first dorsal fin is inserted more anteriorly in *Neoepinnula* than in *Epinnula*. In *Epinnula* the preopercular spine is shorter than in *Neoepinnula*. We believe that the 17.8 mm specimen figured in Belyanina (1982b) is a specimen of *Epinnula* not *Neoepinnula* because of the more posterior first dorsal fin insertion.

Neoepinnula orientalis (Fig. 315).—*Neoepinnula* larvae have been described by Nishikawa and Nakamura (1978) and one 7.3 mm specimen was figured by Gorbunova (1982). Belyanina's (1982b) figure of a 17.8 mm *Neoepinnula* probably is an *Epin-*

nula as mentioned above. The larvae of *Neoepinnula* are very distinctive. They have a very high and intensely pigmented first dorsal fin which inserts anteriorly almost on top of the head. This causes the anteriormost first dorsal pterygiophores to insert slanted in a posterior direction; no other gempylid or scombrid larva has such a first dorsal fin.

Tongaichthys robustus.—The larvae of this recently described genus and species are unknown (Nakamura and Fuji, 1983).

Thyrsitops lepidopoides (Fig. 315).—The larvae of *Thyrsitops* were recently described by Sato (1983). These are the only known gempylid larvae which lack serrations on the fin spines. We believe that the count of XVI–XXII first dorsal fin spines for *Thyrsitops* given in Parin and Bekker's (1972) Table 4 is a misprint and should be XVI–XVII.

Thyrsites atun (Fig. 316).—Haigh (1972a) described the larvae of *Thyrsites* captured in plankton tows. Pigmentation is distinctive with 2 to 3 dark pigment blotches on the ventral tail margin unlike any other known gempylid, but similar to the trichiurid *Benthodesmus*. Haigh (1972a) gave counts for *Thyrsites*: XVIII–XXI first dorsal fin spines and 34–35 vertebrae. Grey (1953) gave XX first dorsal fin spines and 37 vertebrae and Parin and Bekker (1972) gave XX–XXI first dorsal fin spines.

De Jager (1955) fertilized the eggs of a ripe *Thyrsites* female with sperm from a male in the laboratory. The eggs hatched and the larvae were fed drops of human blood. After 9 days they died, visibly undernourished. De Jager illustrated the development of the eggs and very early stages of the larvae. The illustrations are not helpful for identification of wild caught gempylid larvae because of starvation and underdevelopment.

The larvae figured by Regan (1916) as *Thyrsites* are probably *Promethichthys* or *Revea* because the first dorsal fin in the figure of the largest specimen shows XVIII spines and no pelvic fin rays. Regan stated in the text that total vertebrae were 35.

Fig. 317. Lateral views of gempylid larvae from top to bottom: *Promethichthys prometheus*, 8.5 mm SL, modified after Gorbunova (1982); *Revea solandri*, 21.7 mm SL, Indian Ocean, DANA, Cr. 3915III, from a cleared and stained specimen drawn by J. Javech; and *Nealotus tripes*, 9.0 mm SL, modified after Strasburg (1964).

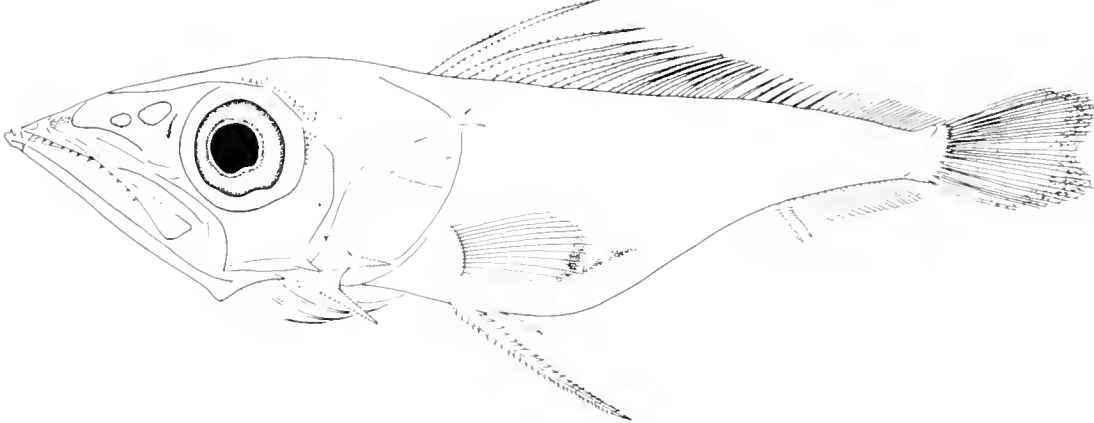
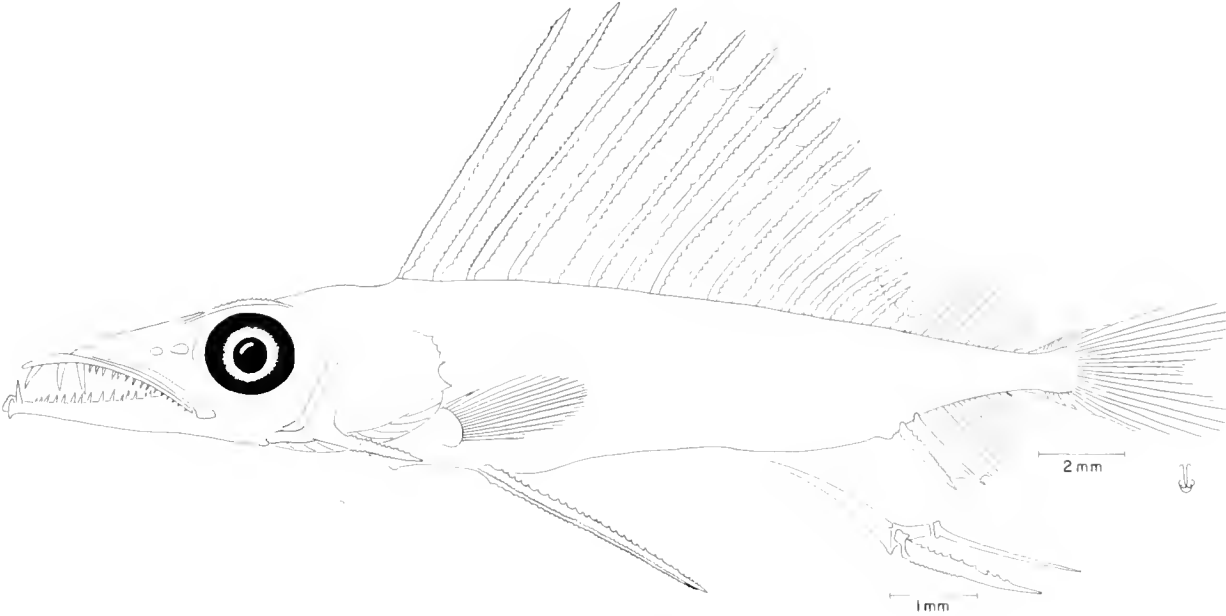
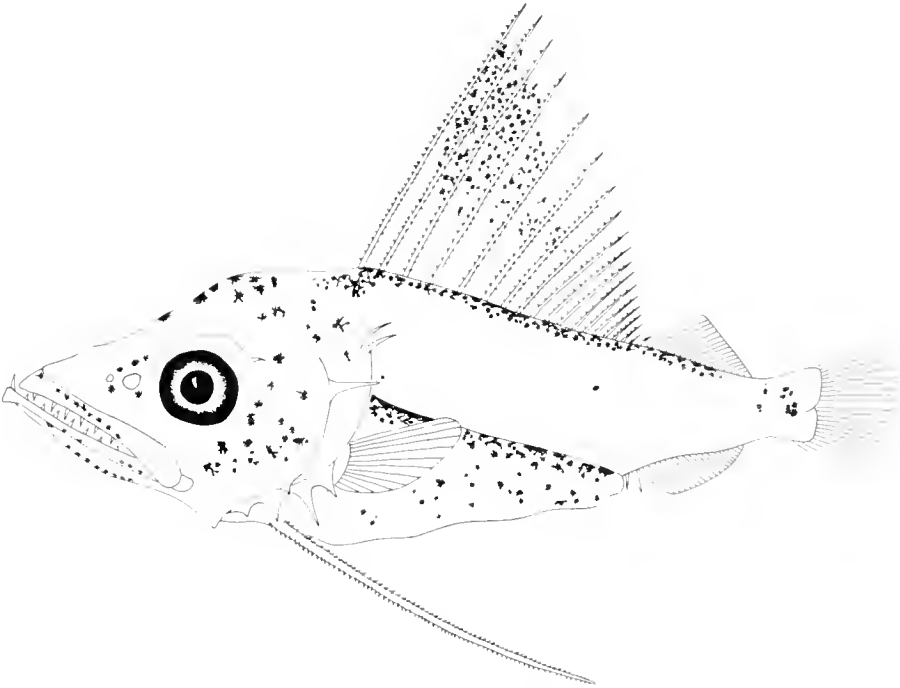

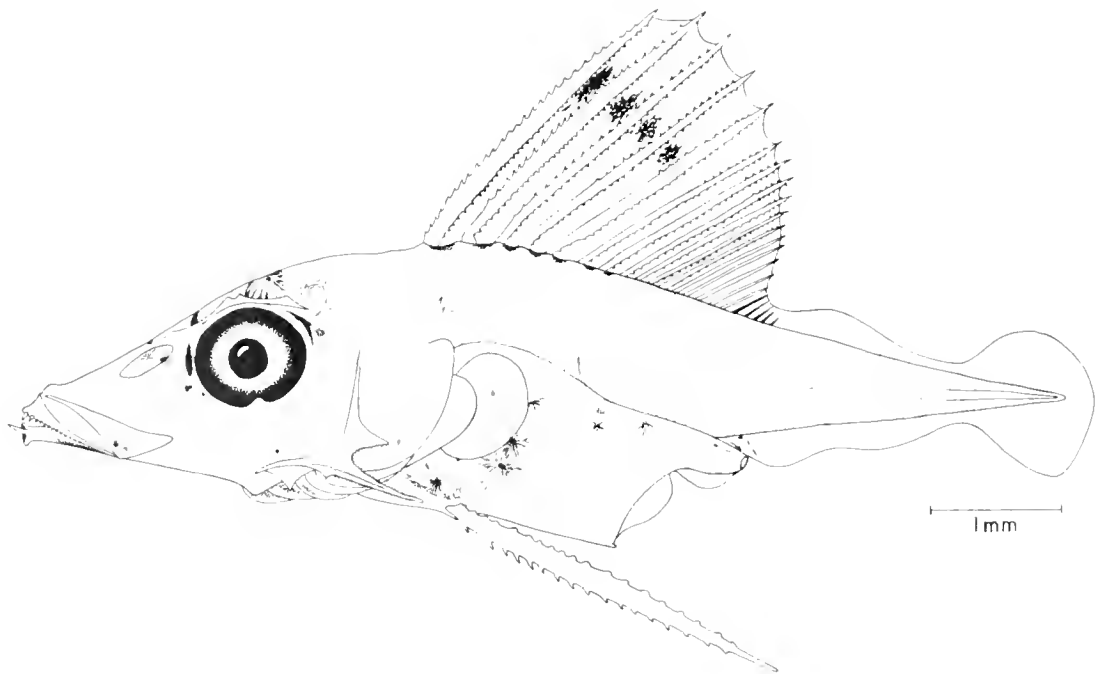
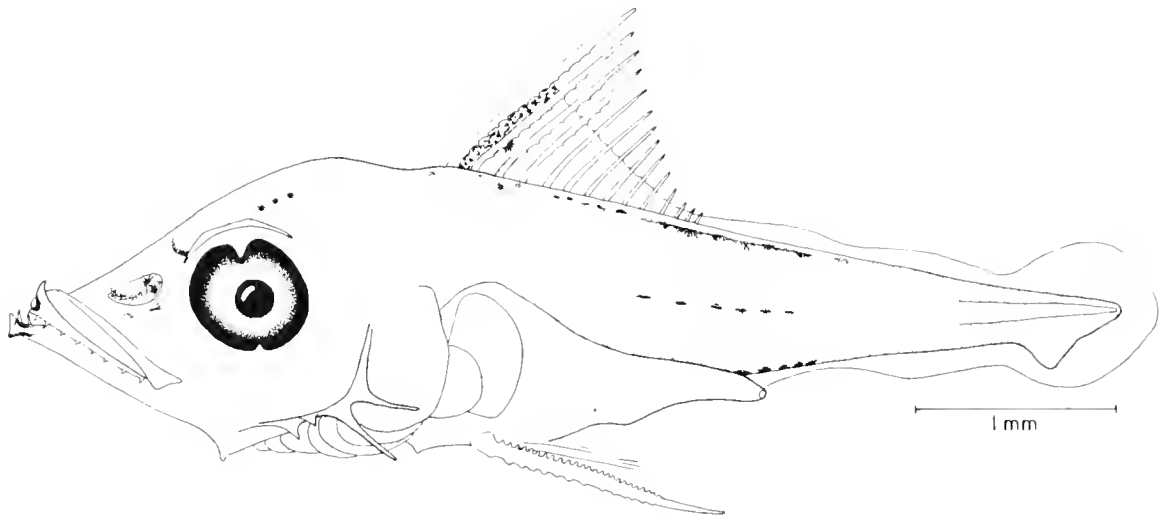
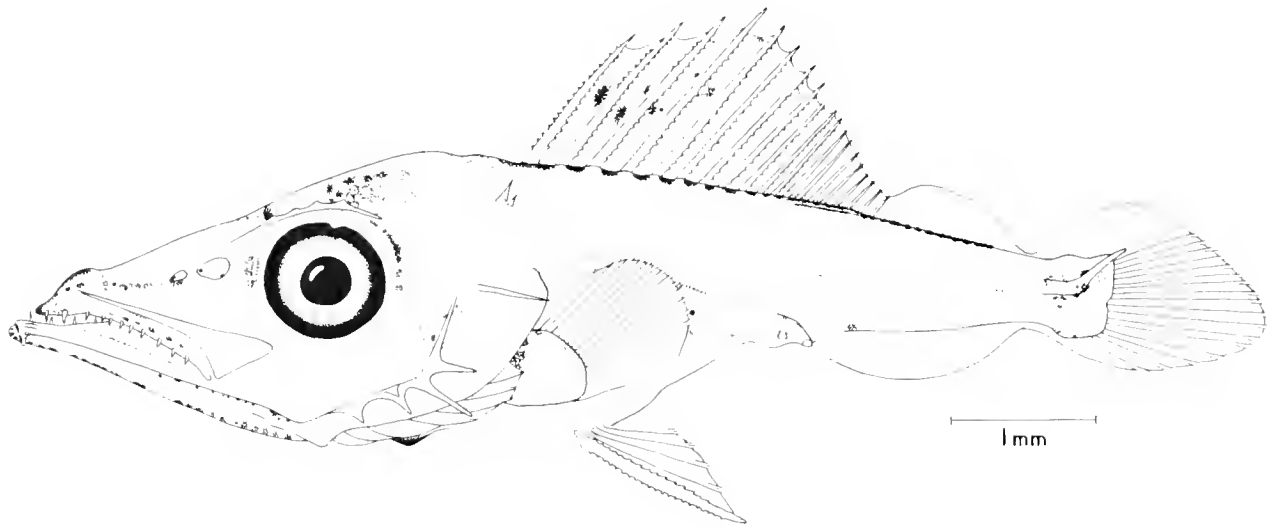

TABLE 153. COMPARISON OF CHARACTERS AMONG LARVAE AND JUVENILES OF *Scombrobrax*, OF KNOWN GEMPYLIDAE AND OF THE SCOMBRID TRIBE SCOMBRINI.

	<i>Scombrobrax</i>	Gempylidae	Tribe Scombrini
First dorsal fin develops before or after second	after	before	after
First dorsal fin pterygiophore inserts in interneural space number	3	2	3
First dorsal, anal and pelvic fin spines of larvae serrated or smooth	smooth	serrated, except smooth in <i>Thyrstos</i>	smooth
Number of epurals	3	3	2
Number of uro-neurals	2	2	1
Procurrent spur of caudal fin (Johnson, 1975)	present	absent or present reduced	absent
Hypural fusion	absent	present	present
Dorsal and anal stay of posterior-most pterygiophore bifurcated posteriorly or not	not bifurcated	bifurcated	bifurcated

Rexea solandri (Fig. 317).—*Rexea* larvae are poorly known. Parin and Bekker (1972) reported a 10.5 mm larva but did not describe it. Six cleared and stained *Rexea* (21.7–28.9 mm SL) from the "Dana" collections were identified by Potthoff from meristics, but pigment was lost due to the age of specimens which had been collected in the 1920s. In general, *Rexea* larvae look similar to *Promethichthys* larvae. The pelvic spine is shorter and does not reach the anus in *Rexea*, whereas in *Promethichthys* the spine reaches past the anus. Also, *Promethichthys* has 3 elements associated with the first anal pterygiophore; *Rexea* has only 2. All our *Rexea* larvae had one long serrate spine and a miniscule vestige of a ray in each pelvic fin. The larvae of *Rexea promethoides* are not known. Adult *R. promethoides* have a fully developed pelvic fin with a count of 1,5 rays.

Promethichthys prometheus (Fig. 317).—The larvae and young of *Promethichthys* are poorly known. Günther (1889) described and figured two larvae 5 mm and 10 mm as *Thyrstites prometheus* (= *Promethichthys prometheus*). These larvae are not *Promethichthys*. The smaller one cannot be positively identified but could be a serranid larva because of body shape and number of myomeres. The larger specimen is definitively *Diplospinus multistriatus*. Roule and Angel (1930) described and figured two *P. prometheus* larvae 6 mm and 10 mm. From their description and figures it is impossible to confirm their identification. We

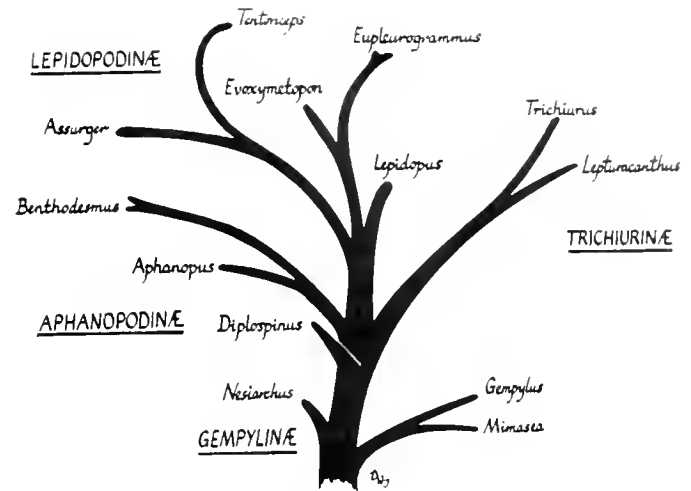

Fig. 319. Relationships of the Trichiuridae and the gempylid subfamily Gempylinae (from Tucker, 1956: fig. 23).

do not think they are *Promethichthys* because the pelvic rays are too long and well developed, and there are 21 first dorsal fin spines on the larger specimen. The larger specimen may be *Nesiarchus*. Gorbunova (1982) described and figured two *P. prometheus* larvae 3.9 mm and 8.5 mm from the northern Caribbean Sea. The smaller specimen has only dorsal gut pigment, a high first dorsal fin and long pelvic spines reaching past the anus. The larger larva has a very high, moderately pigmented first dorsal fin and a very long pelvic spine extending to the anterior portion of the anal fin and a distinct pigment patch near the hypurals. In body shape *Promethichthys* larvae resemble those of *Rexea*. The first dorsal fin spine count in Parin and Bekker (1972) for *Promethichthys* is a printing error. Total vertebral counts for this genus given by Grey (1953) and Matsubara and Iwai (1958) are 33 and 34 respectively, but ours were 34 or 35. This difference between our counts and Grey's and Matsubara and Iwai's is probably one of methodology. We counted the urostyle as the last vertebra.

Nealotus tripes (Fig. 317).—The larvae of *Nealotus* are not well known. Lütken (1880) figured two advanced *Nealotus* larvae, but we are not certain of his identification. Strasburg (1964) described a size series of *Nealotus* from 9 mm–41 mm. The 9 mm specimen had fully formed fins and probably had attained some juvenile pigmentation. *Nealotus* has a very long posterior process in the first anal pterygiophore which is evident in larvae as small as about 8 mm. This is an excellent character to separate *Nealotus* from *Nesiarchus*. *Nealotus* and *Nesiarchus* can be distinguished by their pelvic fin ray count and by the number of middle radials in the second dorsal and anal fins. In juvenile *Nealotus* the middle of the three anal spines fuses lengthwise to the posterior process of the first anal pterygiophore. Thus, in adult *Nealotus* only 2 anal spines are visible. One of us (Potthoff) obtained many vertebral counts from post-larval stages and

Fig. 318. Lateral views of gempylid larvae from top to bottom: *Nesiarchus nasutus*, 7.5 mm SL, Gulf Stream off Miami, Virginia Key, Cr. F1, June 30, 1982, drawn by J. Javech; *Gempylus serpens*, 5.6 mm NL, Gulf of Mexico, OREGON II, Cr. 117, Sta. 34521, May 22, 1981, drawn by J. Javech; and *Diplospinus multistriatus*, 7.1 mm NL, no data, drawn by J. Javech.

TABLE 154. NUMBER OF TOTAL FIRST ARCH GILLRAKERS AND NUMBER OF VERTEBRAE IN THE GENERA OF SCOMBROIDEL.

Family and genus	Number of species	Total number of gillrakers on first arch	Number of vertebrae		
			Precaudal	Caudal	Total
Scombrolabracidae					
<i>Scombrolabrax</i>	1	4-5	13	17	30
Gempylidae					
<i>Lepidocybium</i>	1	0	16	15	31*
<i>Ruvettus</i>	1	1, (6-8)***	17	15	32**
<i>Epinnula</i>	1		16	16	32**
<i>Neoeppinnula</i>	1	1, (2-4)***	15	17	32**
<i>Thyrstitops</i>	1	1, (2-4)***	16	16	32**
<i>Thyrstites</i>	1	4, (13, 14)***	17	16	32**
			20	15	35*
			22	15	37**
<i>Rexea</i>	2	1, (4-9)***	19, 20	14, 15	34**
<i>Promethichthys</i>	1	1, (10)***	18	16	34*
			20, 21	14	34, 35**
<i>Nealotus</i>	1	1, (0-5)***	20-22	14-17	36-39**
<i>Thyrstitoides</i>	1		19, 20	14, 15	34**
<i>Nestarchus</i>	1	1, (0)***	20-23	13-15	33-37**
<i>Tongaichthys</i>	1		17	16	33
<i>Gempylus</i>	1	1, (5, 6)***	26	23	49*
			24-26	23-25	48-50** Pacific
			26-29	24-26	51-55** Atlantic
<i>Diplospinus</i>	1	28	22-28	30-37	58-61**
<i>Paradiplospinus</i>	1	Present	33, 34	34	67**
Trichiuridae					
<i>Aphanopus</i>	1		42-44	55-56	98, 99
<i>Benthodesmus</i>	8	10-16	38-53	65-103	123-156
<i>Lepidopus</i>	2		41	70-73	111-113
<i>Evoxymetopon</i>	1	15-18	39, 40	63-65	103-104**
<i>Assurger</i>	1		43	86	129
<i>Eupleurogrammus</i>	2		32-41	125-151	157-192
<i>Tentoriceps</i>	1				
<i>Trichiurus</i>	1	10-22	39, 40	123-128	162-168
<i>Lepturacanthus</i>	1		32-35	124-130	159-162
Xiphiidae					
<i>Xiphias</i>	1	Absent, small teeth found on epibranchial in one juvenile.	15, 16	10, 11	26
Istiophoridae					
<i>Tetrapturus</i>	5	Rakers modified to numerous toothpatches in Istiophoridae.	12	12	24
<i>Makaira</i>	3		11	13	24
<i>Istiophorus</i>	1-2		12	12	24
Scomberidae					
<i>Gasterochisma</i>	1	0	20, 21	23	43, 44
<i>Scomber</i>	3	29-51	13, 14	17, 18	31
<i>Rastrelliger</i>	3	33-66	13	18	31
<i>Grammatorcynus</i>	2	14-24	12-14	17-19	31
<i>Scomberomorus</i>	18	1-27	16-32	21-36	41-56
<i>Acanthocybium</i>	1	0	30-32	31-33	62-64
<i>Orcynopsis</i>	1	12-17	17, 18	19-21	37-39
<i>Cybiosarda</i>	1	12-15	22-24	23-26	47, 48
<i>Gymnosarda</i>	1	11-14	19	19	38
<i>Sarda</i>	4	8-27	22-28	20-27	43-55
<i>Allothunnus</i>	1	72-80	20	19	39
<i>Auxis</i>	2	36-47	20	19	39
<i>Euthynnus</i>	3	29-47	20	17-19	37-39
<i>Katsuwonus</i>	1	51-63	20	21	41
<i>Thunnus</i>	7	19-43	18, 19	20, 21	39

* From Matsubara and Iwai (1958)

** Vertebral counts mostly from Potthoff's unpublished data

*** Numbers in parentheses are large spines emerging from toothpatches. The number one outside parentheses represents a large raker in the epi-ceratobranchial angle. Numerous toothpatches are present. During ontogeny gillrakers transform to toothpatches.

TABLE 155. NUMBERS OF SPINES AND RAYS IN ALL FINS OF SCOMBROID GENERA. Numbers in parentheses denote vestigial rays and were counted on cleared and stained specimens only.

Family and genus	Number of fin spines and rays										
	First dorsal	Second dorsal	Dorsal finlets	Anal	Anal finlets	Pectoral	Pelvic	Caudal			Total
								Dorsal secondary	Principal	Ventral secondary	
Scombrolabracidae											
<i>Scombrolabrax</i>	12	II, 15-16	0	III, 16-17	0	18-19	1.5	8-9	9 + 8	9-10	34-36
Gempylidae											
<i>Lepidocybium</i>	8-12	16-18	4-6	II, 10-14	4-5	15-17	1.5	10	9 + 8	10	37
<i>Ruvettus</i>	13-15	15-18	2-3	III, 12-16	2-3	14-15	1.5	10	9 + 8	9-10	36-37
<i>Epinmula</i>	15-16	I, 16-19	0	III, 13-16	0	15	1.5	10	9 + 8	10	37
<i>Neoepinmula</i>	16	I, 16-20	0	III, 17-20	0	13-16	1.5	9-10	9 + 8	9-10	35-37
<i>Thyrstops</i>	16-18	I, 14-16	4-5	III, 14-15	5	14-16	1.5	8-9	9 + 8	8-9	33-35
<i>Thyrstites</i>	20-21	II, 10-11	5-7	II, 11-12	6-7	14-15	1.5				
<i>Rexea</i>	16-19	I-II, 13-16	2-3	I, 12-16	2-3	12-15	0-1, (1)1, 2-3	8-10	9 + 8	8-9	33-36
<i>Promethichthys</i>	17-19	I, 17-21	2	I-II, 15-17	2	14	1 (1-2)	10-11	9 + 8	10	37-38
<i>Nealotus</i>	19-21	I, 16-19	2	II, 15-19	2	12-14	1 (1-2)	8	9 + 8	9	34
<i>Thyrstoides</i>	18-19	II, 8	8	III, 8	7	13-15	1.5	9	9 + 8	9	35
<i>Nesiarchus</i>	19-22	I, 19-22	2-3	II-III, 15-17	2-3	13	1.5	8-9	9 + 8	8-9	33-35
<i>Gempylus</i>	26-32	I-II, 10-12	5-7	II + I, 10-12	5-7	12-15	1, 3-4	8-10	9 + 8	9-10	34-37
<i>Diplospinus</i>	30-36	I, 35-41	0	II, 29-35	0	14	1	4	9 + 8	5	26
<i>Paradiplospinus</i>	36-44	28-33	0	II, 25-30	0	13-14	1				
<i>Tongachthys</i>	12	I, 14	6	III, 14	5	17-18	1.5	9	9 + 8	11	37
Trichiuridae											
<i>Aphanopus</i>	38-41	II, 53-57	0	II, 44-50	0	12	I, 1 (juv.)		Present		
<i>Benthodesmus</i>	32-46	70-109	0	II, 65-101	0	12-13	I, 1	5	9 + 8	5	27
<i>Lepidopus</i>	9	90-97	0	II, 61-64	0		I (1)		Present		
<i>Evocyometopon</i>	10	77-86	0	II, 56	0	11-12	I, (1-3)	7	9 + 8	6-7	30-31
<i>Assurger</i>	Total 122		0	II, 80	0	12	1		Present		17
<i>Eupleurogrammus</i>	3	123-147	0	II, 114-121	0		1, 2		Absent		
<i>Tentoriceps</i>	Total 120		0		0		Present		Absent		
<i>Trichiurus</i>	3	120-140	0	II, 105-108	0		Absent		Absent		
<i>Lepturacanthus</i>	4	105-134	0	II, 72	0		Absent		Absent		
Xiphiidae											
<i>Xiphias</i> adults	38-45	4-5	0	(12-16) + (3-4)	0	17-19	0	8-10	9 + 8	9-11	34-38
<i>Xiphias</i> juveniles*	Total 44-49		0	16-19	0	16-19	0	8-10	9 + 8	9-11	34-38
Istiophoridae											
<i>Tetrapturus</i>	38-55	5-7	0	(11-19) + (5-8)	0	16-22	1, 2				
<i>Makaira</i> adults	38-46	6-8	0	(13-18) + (5-7)	0	18-23	1, 2	13	9 + 8	13	43
<i>Makaira</i> juveniles*	Total 51		0	25	0	18-23	1, 2	13	9 + 8	13	43
<i>Istiophorus</i> adults	37-49	6-8	0	(8-16) + (5-8)	0	17-23	1, 2	11-12	9 + 8	11-12	39-41
<i>Istiophorus</i> juveniles	Total 53-54		0	23-24	0	17-23	1, 2	11-12	9 + 8	11-12	39-41
Scombridae											
<i>Gasterochisma</i>	17-19	9-10	6-8	10-13	5-8	19-22	1.5				
<i>Scomber</i>	9-13	11-12	5	I, 11-12	5	19-21	1.5	10-11	9 + 8	10-12	37-39
<i>Rastrelliger</i>	9-11	12	5	1, 12	5	19-20	1.5	10	9 + 8	10	37
<i>Grammatorcynus</i>	11-13	10-12	6-7	11-13	6-7	22-26	1.5				
<i>Scomberomorus</i>	12-22	15-25	6-11	15-29	5-12	19-26	1.5	11-13	9 + 8	11-13	39-43
<i>Acanthocybium</i>	23-27	12-16	7-10	12-14	7-10	22-26	1.5				
<i>Orcynopsis</i>	12-14	12-15	7-9	14-16	6-8	22-23	1.5				
<i>Cybiosarda</i>	16-18	17-19	8-10	15-17	6-7	23-24	1.5				
<i>Gymnosarda</i>	13-15	12-14	6-7	12-13	6	25-27	1.5				
<i>Sarda</i>	16-23	13-18	7-9	12-17	5-8	23-26	1.5	15-16	9 + 8	16-17	48-50
<i>Allothunnus</i>	15-18	12-13	6-8	13-14	6-7	24-26	1.5				
<i>Auxis</i>	10-12	10-12	7-9	11-14	7	23-25	1.5	15	9 + 8	16	48
<i>Euthynnus</i>	13-17	11-13	8-9	11-15	7-8	25-29	1.5	15-16	9 + 8	14-16	47-49
<i>Katsuwonus</i>	14-16	14-16	7-8	14-16	6-8	26-28	1.5	16-17	9 + 8	17-18	50-51
<i>Thunnus</i>	11-14	12-16	7-10	11-16	6-10	30-36	1.5	15-17	9 + 8	15-17	47-51

* *Xiphias* and *Istiophoridae* postlarvae and juvenile have a continuous dorsal and anal fin

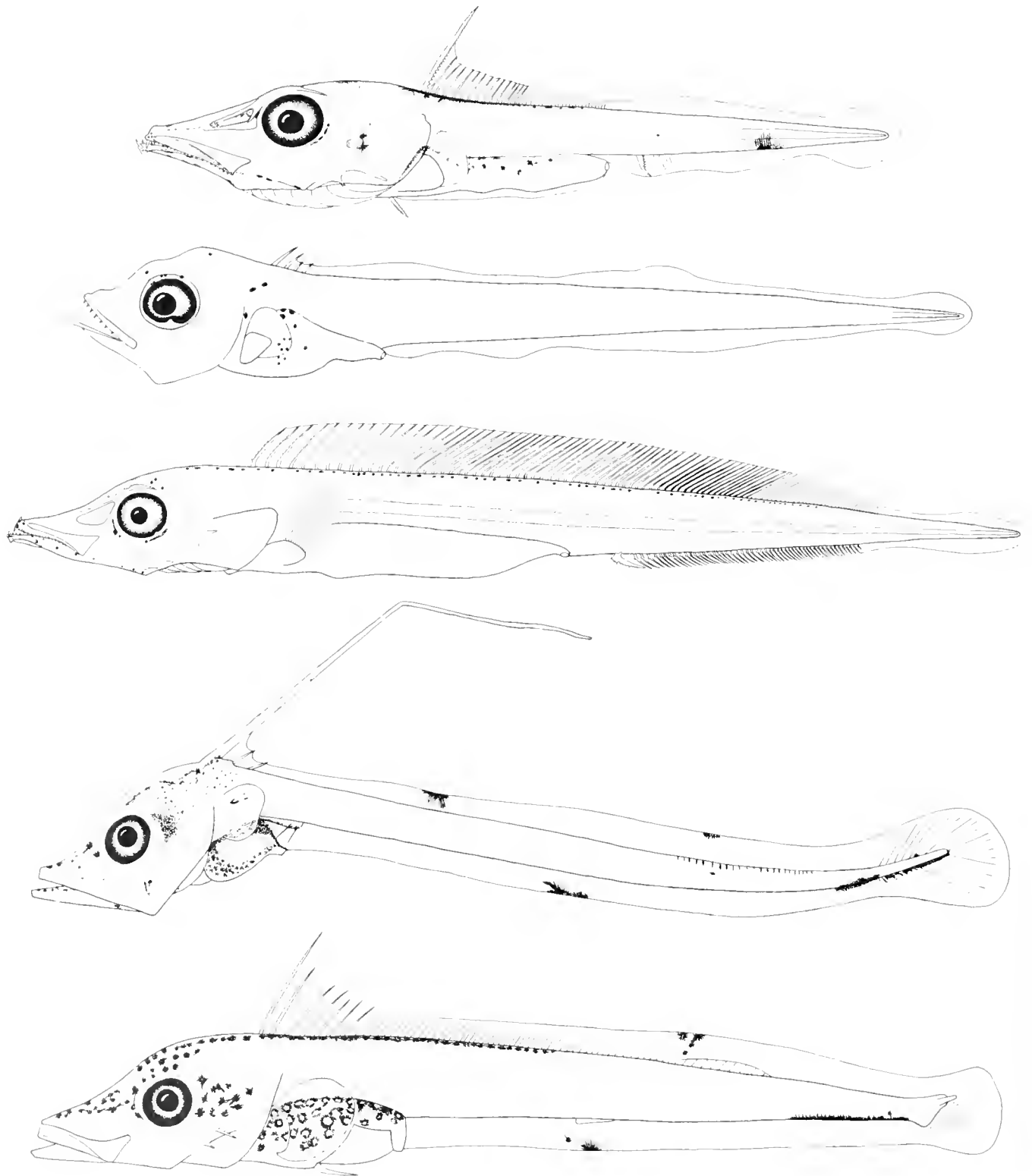

Fig. 320. Lateral views of trichiurid larvae from top to bottom: *Benthodesmus* sp., 8.1 mm NL, Gulf of Mexico, OREGON II, Cr. 113, Dec. 6, 1980, drawn by J. Javech; *Trichiurus lepturus*, 6.3 mm NL and 17.0 mm NL, Gulf of Mexico, OREGON II, cruise unknown, Dec. 12, 1979, drawn by J. Javech; and *Lepidopus caudatus*, 9.0 mm NL and 12.0 mm SL, modified from Padoa (1956a).

TABLE 156. CHARACTERS FOR GEMPYLID LARVAE, JUVENILES AND ADULTS AND OUR KNOWLEDGE OF GEMPYLID LARVAE AND THEIR OCCURRENCE.

Species	Elements associated with first anal pterygiophore	Middle radials, Dorsal/Ventral	Dorsal and anal stay, one or two parts, posteriorly bifurcated	Predorsal bones	Larvae known or unknown	Occurrence
<i>Lepidocybium flavobrunneum</i>	3	$\frac{7}{5}$	one part bifurcated	0	known	worldwide
<i>Ruvettus pretiosus</i>	3	$\frac{2, 3}{2, 3}$	two parts bifurcated	1	not known	worldwide
<i>Epinnula magistralis</i>	3	$\frac{1}{1}$	two parts	0	poorly known	worldwide
<i>Neopinnula orientalis</i>	3	$\frac{0}{0}$	two parts bifurcated	0	known	worldwide
<i>Thyrsitops lepidopoides</i>	3	$\frac{4}{4, 5}$	two parts bifurcated	1	known	off east and west coasts of South America
<i>Thyrsites atun</i>	—	—	—	—	known	all southern oceans 20°–50°S
<i>Rexca</i> spp.	2	$\frac{2, 3}{2, 3}$	one part bifurcated	0	not known	Indian and West Pacific oceans
<i>Promethichthys prometheus</i>	3	$\frac{2}{2}$	two parts bifurcated	0	poorly known	worldwide
<i>Nealotus tripes</i>	3*	$\frac{2}{2}$	two parts bifurcated	0	poorly known	worldwide
<i>Thyrsitoides marleyi</i>	—	$\frac{8}{7}$	two parts bifurcated	0	not known	Indian Ocean, West Pacific
<i>Nesiarchus nasutus</i>	3	$\frac{3}{3}$	two parts bifurcated	0	known	worldwide
<i>Tongaichthys robustus</i>	—	$\frac{6}{5}$	two parts bifurcated	1	not known	Tonga Ridge
<i>Gempylus serpens</i>	3	$\frac{6, 7}{6, 7}$	one part bifurcated	0	known	worldwide
<i>Diplospinus multistriatus</i>	3	$\frac{1}{1}$	one part bifurcated	0	known	worldwide
<i>Paradiplospinus gracilis</i>	3	$\frac{1}{1}$	one part bifurcated	0	poorly known	temperate and arctic waters of Southern Hemisphere oceans

* *Nealotus* has 3 fin spine-ray elements associated in larvae and juveniles. The middle element gradually fuses to the long posterior process of the first anal pterygiophore.

juveniles of *Nealotus*. The great variability in vertebral counts suggests that more than one species exists in the genus *Nealotus*.

Thyrsitoides marleyi.—*Thyrsitoides* larvae are unknown. This is not surprising since the adults are considered to be rare (Nakamura, 1980).

Nesiarchus nasutus (Fig. 318).—The larvae of *Nesiarchus* are well known. Günther (1887) described a 33 mm pre-juvenile specimen. A size series of 26 specimens 5.1–23.5 mm NL or SL from the Atlantic Ocean was described by Voss (1954). The 5.1 mm NL specimen shown in Voss (1954; fig. 3A) and identified as *Nesiarchus* is *Gempylus serpens* because of the mid-lateral pigment stripe and the large number of myomeres as indicated by the close spacing. *Nesiarchus* larvae are easily identified by a heavily pigmented gular membrane. Larvae larger than 6 mm develop pigment in the hypural area and a distinct pigment stripe from the tip of the snout to the eye. One of us

(Potthoff) obtained many vertebral counts from post-larval specimens and juveniles of *Nesiarchus*. The great variability in vertebral counts suggests that more than one species exists in the genus *Nesiarchus*.

Gempylus serpens (Fig. 318).—The larvae of *Gempylus* are known. Lütken (1880) figured four post-larvae and juvenile *G. serpens*. We believe that these were correctly identified because at least 6 finlets are present on all but the smallest specimens. Voss (1954) described 2 series of *Gempylus* larvae. Her *Gempylus* A is *Diplospinus* and *Gempylus* B is *G. serpens*. Eight larvae from 4.4 to 11.6 mm were described and the 5.1 mm specimen in fig. 3A is a *G. serpens* not a *Nesiarchus*. *Gempylus serpens* larvae can be distinguished from other gempylid larvae by having a distinct line of lateral body pigment and up to 4 rays in the pelvic fin. The preopercular spines of *Gempylus* are smooth, but the first dorsal and pelvic fin spines are serrate. Late larvae and juvenile *Gempylus* develop 6 or 7 dorsal and

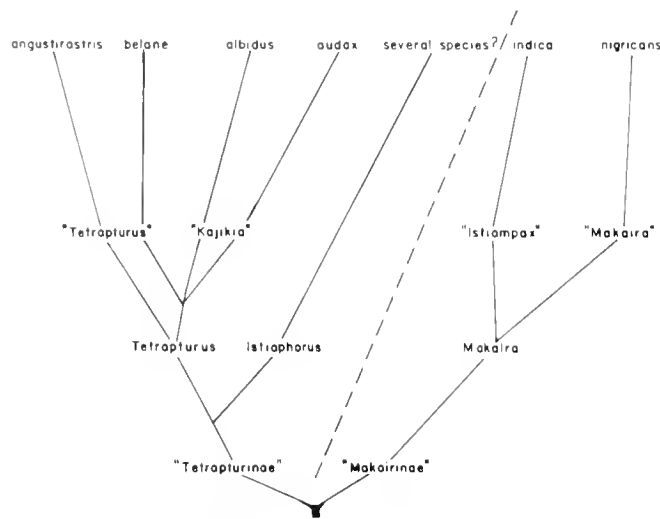

Fig. 321. Phylogenetic relationships within the family Istiophoridae (from Robins and de Sylva (1960: fig. 5), names in quotations not employed by Robins and de Sylva).

TABLE 157. COMPARISON OF CHARACTERS AMONG JUVENILES OF *XIPHIAS* AND ISTIOPHORIDAE.

	<i>Xiphias</i>	Istiophoridae
Dorsal and anal fin development, addition	from a center in an anterior and posterior direction	mostly from anterior in a posterior direction
First dorsal fin pterygiophore inserts in interneural space number	2	1
Dorsal and anal stay posteriorly bifurcated or not	not bifurcated	bifurcated
Middle radial present or absent for posteriormost dorsal and anal pterygiophore	absent	present
Number of post-cleithra	1	2
Pelvic fin and basipterygium present or absent	absent	present, fin ray number reduced
Caudal fin rays supported by how many centra including urostyle	2	3
Number of autogenous haemal spines in hypural complex	1	2
One pair of ribs on centra	1-4 and 13-14	1-12

anal finlets and consequently have 6 or 7 middle radials. One of us (Potthoff) obtained vertebral counts from late larval and juvenile specimens from the Atlantic and Indo-Pacific oceans. Total counts are higher for the Atlantic and lower for the Indo-Pacific with a definite separation which may indicate that there are separate species.

Diplospinus multistriatus (Fig. 318).—The larvae of *Diplospinus* are very well known, but some earlier researchers described them under other names. The 10 mm specimen figured as *Thyrsites prometheus* in Günther (1889) is *Diplospinus* because of the anteriorly protruding spines on the tip of the lower jaw and because of the distinct flatness of the ventral gut, although the first dorsal fin spine count is too low for *Diplospinus*. Voss (1954 and 1957) described *Gempylus* type A larvae, which definitively are *Diplospinus*. Strasburg (1964) and Yevseyenko and Serebryakov (1974) correctly identified and described *Diplospinus* larvae.

The larvae of *Diplospinus* (Fig. 318) superficially resemble those of *Gempylus*, but the larvae of *Gempylus* lack the following characters present in *Diplospinus*: two horizontal spines at the lower jaw tip, serrate preopercular spine, absence of pelvic fin rays, flatness of ventral gut due to posterior process of basipterygium, and pigmented gular membrane. Larval *Diplospinus* lack the lateral body pigment stripe characteristic of *Gempylus*. *Diplospinus* juveniles lack dorsal and anal finlets and supporting middle radials, features present in *Gempylus*.

Paradiplospinus gracilis.—The larvae of *Paradiplospinus* are not well known. One of us (Nishikawa) has an unpublished manuscript on the larval description.

Trichiuridae

Body elongate, strongly compressed; maxilla sheathed by preorbital; anterior canine teeth strong; spinous dorsal not longer than soft dorsal (very slightly longer in occasional specimens of *Aphanopus*); two anal spines immediately posterior to the vent; pelvic fins reduced to 1,1 or absent; caudal fin greatly

reduced or absent; dorsal spines and interneurals correspond to vertebrae, dorsal soft rays correspond to or are slightly more numerous (in *Aphanopus* and *Benthodesmus*) than vertebrae (Table 155); vertebrae numerous, 98-99 (*Aphanopus*) to 192 (*Eupleurogrammus*) (Table 154); ribs feeble, sessile (Regan, 1909; Tucker, 1956). The family contains 9 genera and at least 18 species (Parin and Mikhailin, 1981). Most genera have only one or two species; *Benthodesmus* has at least 8 valid described species (Parin and Bekker, 1972; Parin, 1976, 1978).

Tucker (1956) recognized three subfamilies within the Trichiuridae (Fig. 319): Aphanopinae (*Aphanopus*, *Benthodesmus*, and *Diplospinus*); Lepidopinae (*Lepidopus*, *Assurger*, *Tentoriiceps*, *Evoxymetopon*, and *Eupleurogrammus*), and Trichiurinae (*Trichiurus* and *Lepturacanthus*). *Diplospinus* and *Paradiplospinus* have been transferred from a primitive position in the Trichiuridae to an advanced position in the Gempylidae by Russo (1983).

DEVELOPMENT

Information on larval trichiurids is scarce. Of 9 trichiurid genera only 3 species in 3 different genera have been described. The known trichiurid larvae are characterized by very long bodies, more than 100 myomeres, pelvic fins reduced or absent, serrate spines in the first dorsal and anal fins and in the pelvic fin if present. The first dorsal fin is the first fin to develop. The

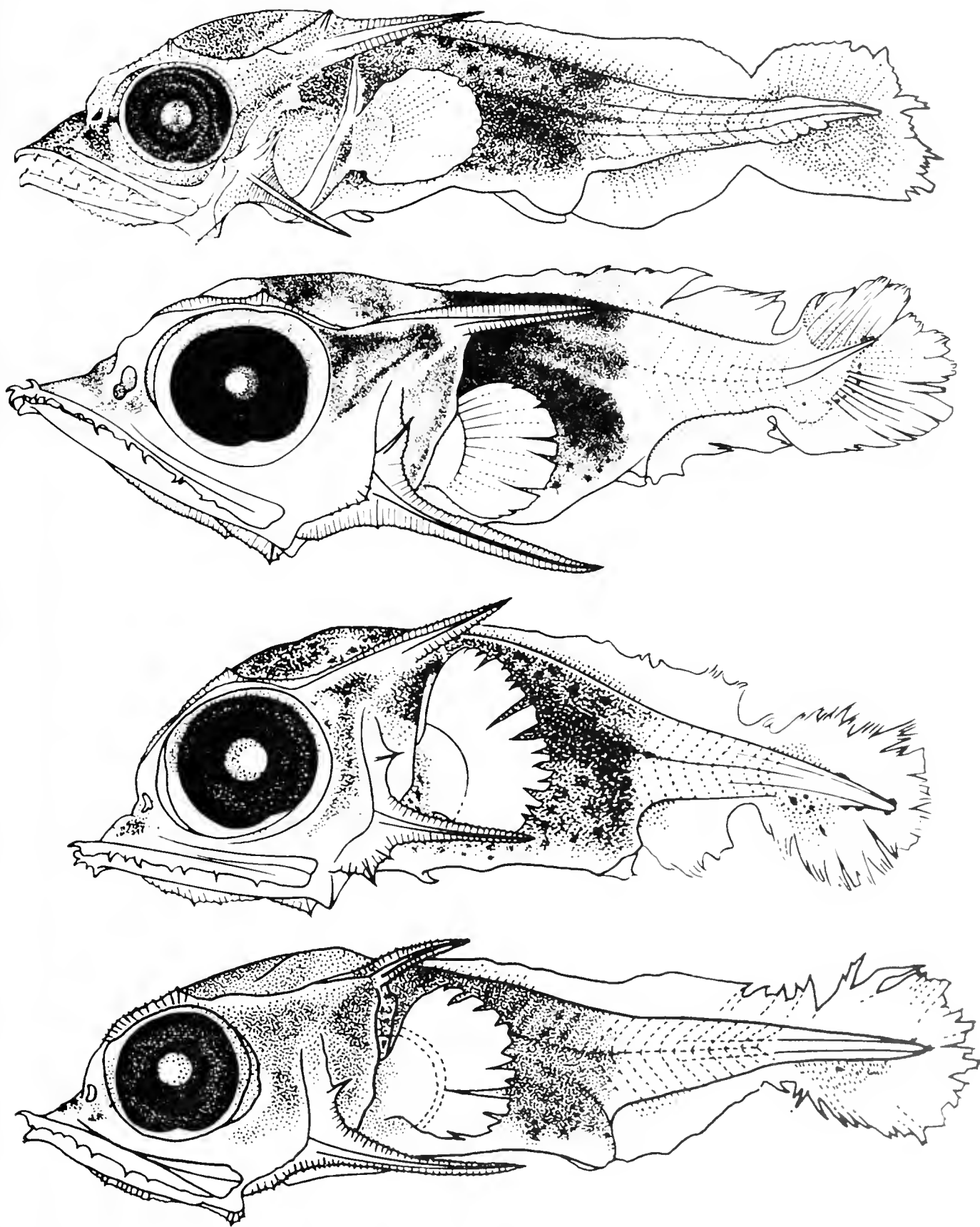

Fig. 322. Lateral views of istiophorid larvae from Ueyanagi (1963a) from top to bottom: *Istiophorus platypterus*, 5.1 mm NL; *Tetrapturus audax*, 5.0 mm NL; *T. angustirostris*, 4.5 mm NL; and *Makaira mazara*, 4.4 mm NL.

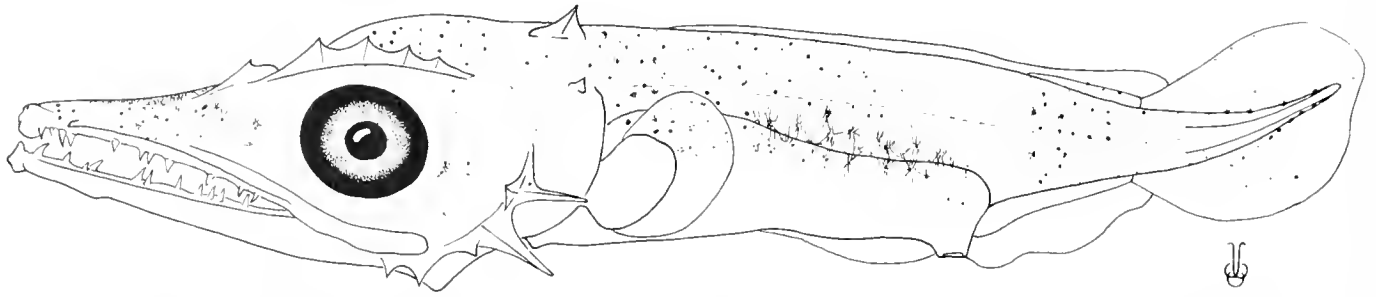

Fig. 323. Lateral view of *Xiphias gladius* larva 6.1 mm NL, Gulf of Mexico, OREGON II, Cr. 126, Sta. 36784, May 25, 1982, drawn by J. Javech.

gut in preflexion larvae is visibly short, but elongates during flexion and post-flexion.

Benthodesmus (Fig. 320).—Gorbunova (1982) described *B. elongatus simonyi* from a size series of 5 larvae 3.5–18 mm and

Evseenko (1982b) described a 20.3 mm SL specimen. Pigmentation in these larvae is strikingly similar to *Lepidopus caudatus* larvae described by Padoa (1956a). However, in *B. elongatus simonyi* the first dorsal fin spine is not more elongate than the other spines as in *Lepidopus* and *Trichiurus* (Fig. 320). Bely-

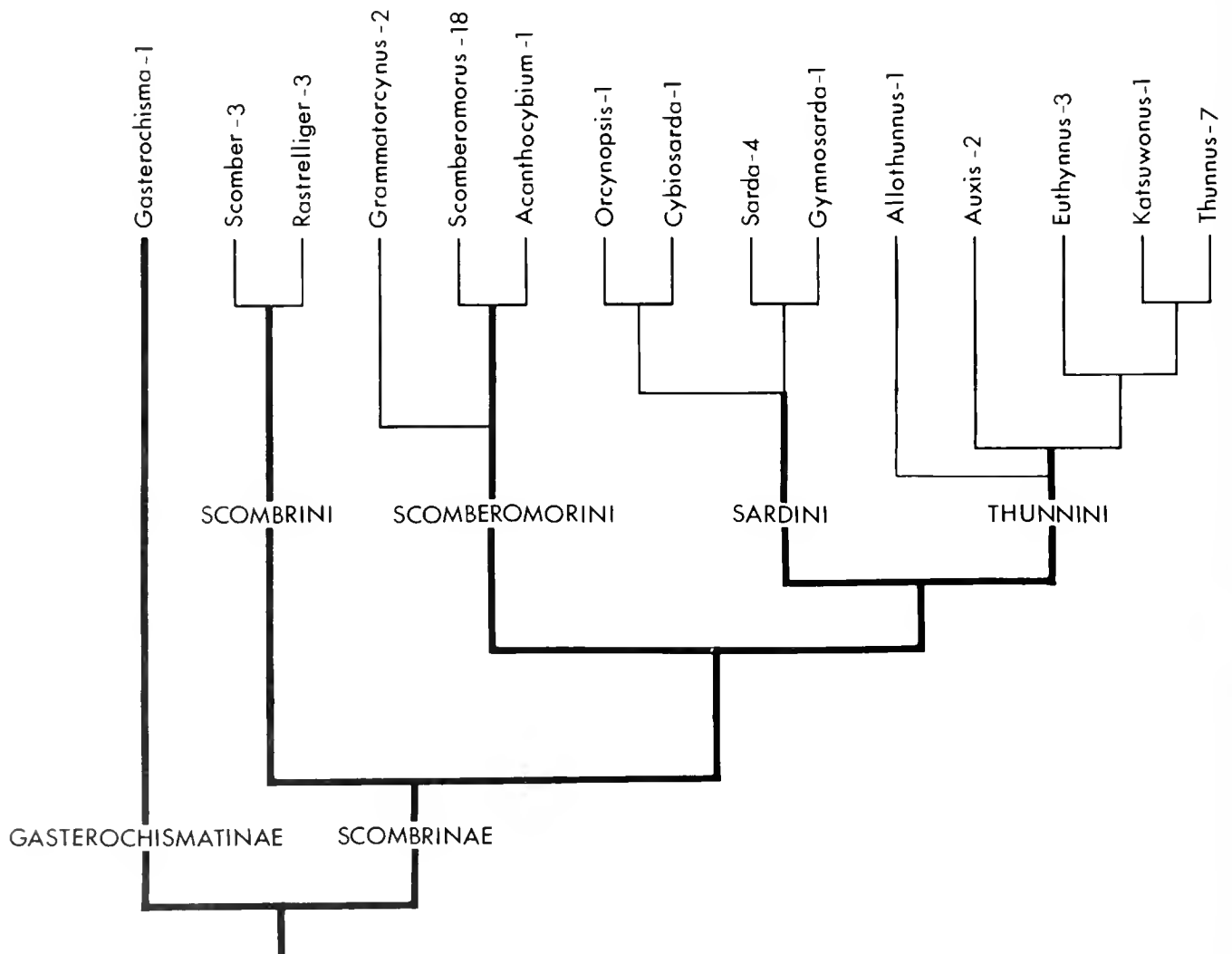

Fig. 324. Subfamilies, tribes and genera of Scombridae with number of species in each genus indicated (modified from Collette and Russo 1979: fig. 1).

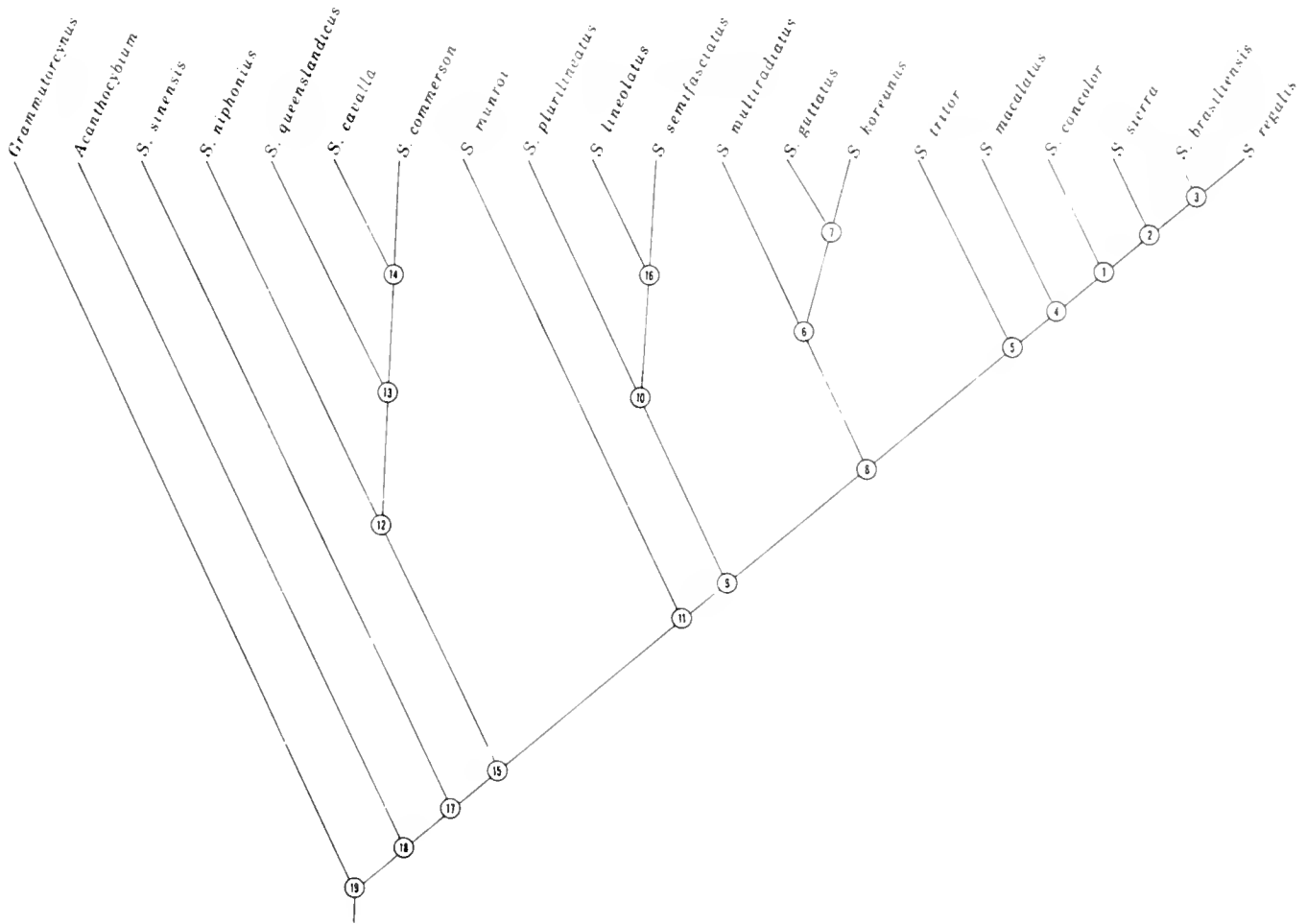

Fig. 325. Cladogram of relationships within the Scomberomorini (from Collette and Russo, in press).

anina (1982b) reported on a series of 22 *B. elongatus pacificus* 8.0–44 mm and on a *B. vityazi* 31 mm (Fig. 320). *Benthodesmus vityazi* lacks dorsal pigmentation and has only two pigment blotches ventrad, and the pelvic spine is reduced.

Lepidopus (Fig. 320).—The eggs and larvae of *L. caudatus* were described by Padoa (1956a). The larvae are strikingly similar to *Benthodesmus* in pigmentation; in *Lepidopus* the first dorsal fin spine is longer than the following spines. Regan (1916) figured an 11 mm larva as *L. caudatus*. It is impossible to determine from the drawing and from the brief description if, in fact, it is a larva of *L. caudatus*. The figured specimen is alcohol shrunk, body and trunk pigments are absent, and the first dorsal fin spine is shorter than the following spines.

Trichiurus lepturus (Fig. 320).—Delsman (1927) described *Trichiurus* eggs and early larval stages hatched from wild caught eggs. He believed that his descriptions were based on a number of *Trichiurus* species. Newly hatched and early *Trichiurus* larvae have a dendritic blotch of pigment, usually in the ventral finfold. This blotch disappears when the first dorsal fin spines begin to form anteriorly. Cutlass-fish larvae were also described by Gorbunova (1982) from a series of 59 specimens 5.0–17.2 mm and by Tsukahara (1961) from a series of laboratory-reared and wild-

caught specimens. Small larvae lack pigment on the ventral trunk and tail. With growth, a single row of melanophores appears just anterior to the first dorsal fin and develops posteriorly. Ventral and lateral tail pigment is conspicuously absent even in larger larvae. *Trichiurus* belongs to the tail-less trichiurids and has no flexion stage. The pelvic fin in *Trichiurus* is absent.

Istiophoridae

Hypural plate mostly covered by caudal fin rays; caudal fin supported by 3 centra (urostyle and preural centra 2 and 3); long rounded rostrum formed by united premaxillae; nasals not forming part of the bill; prementary bone present; teeth present; pectoral fins placed low on body; scales present on body throughout life; pelvic fins consisting of one spine and two long rays; vertebrae few, $(11-12) + (12-13) = 24$; neural and haemal spines expanded into strong overlapping laminae; ribs sessile (Regan, 1909; Gregory and Conrad, 1937). Three genera: *Tetrapturus*, the spearfishes (six species), *Makaira*, the marlins (three species), and *Istiophorus*, the sailfish (one or two species).

A diagram of relationships within the Istiophoridae was presented by Robins and de Sylva (1960) and is included here as Fig. 321. Two additional species of *Tetrapturus* have been validated since then: *T. pluegeri* Robins and de Sylva and *T. georgei* Lowe. The former is most closely related to *T. angus-*

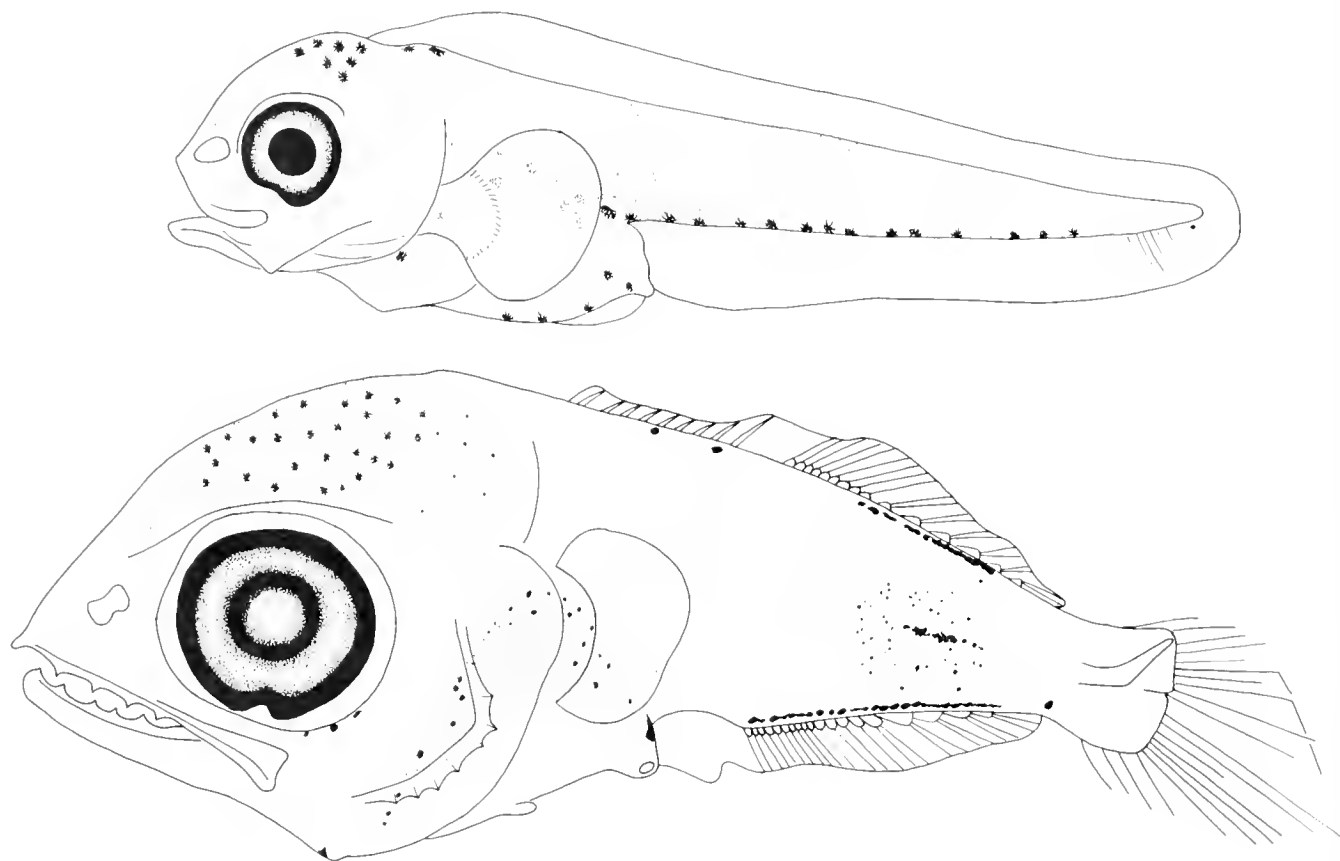

Fig. 326. Lateral views of scombrid larvae from top to bottom: *Scomber japonicus*, 5.0 mm NL, modified after Kramer (1960); and *Grammatocygnus bilineatus*, 4.1 mm SL, modified after Nishikawa (1979).

tirostris and *T. belone*, the latter to *T. albidus* (Robins, 1974). Nakamura (1974) recognized two species of blue marlins, the Atlantic *M. nigricans* and the Indo-Pacific *M. mazara* instead of only *M. nigricans*. Morrow and Harbo (1969) considered *Istiophorus monotypic*; Nakamura (1974) recognized the Atlantic sailfish *I. albicans* as specifically, or subspecifically, distinct from the Indo-Pacific *I. platypterus*.

Development

Eggs.—No information is available on the identification of istiophorid eggs, except for a brief account of eggs identified as *Tetrapturus belone* by Sparta (1953).

Larvae.—Three studies, all of which appeared in 1974, summarized the identification status of istiophorids (Richards, 1974; Ueyanagi, 1974a, b). These larvae are extremely difficult to identify. Two types of larvae are generally recognized—those with short bills and those with long bills. The short-billed group is generally referable to *Makaira*, the long-billed group to *Istiophorus* and *Tetrapturus* (Fig. 322). Specimens less than 7.0 mm in length are all very similar. Other useful characters include melanophore distribution on the gular and branchiostegal membranes, relation of the pterotic and preopercular spines with the body axis, shape of the orbit and position of the eye.

Meristic factors such as fin ray counts and vertebral formula are not particularly useful in distinguishing istiophorid species

from each other (Richards, 1974; Tables 154 and 155). Vertebral counts can be used to distinguish *Istiophorus* and *Tetrapturus* ($12 + 12 = 24$) from *Makaira* ($11 + 13 = 24$) at sizes greater than about 20 mm (Richards, 1974). Probably the most useful character is head morphology (Ueyanagi, 1963a). The snout is short in all istiophorid larvae under about 5 mm in body length, but in larger specimens the snout lengthens greatly in *Istiophorus* and *Tetrapturus*. At lengths greater than about 12 mm, the elongate snouts of *Istiophorus* and *Tetrapturus* readily distinguish them from the shorter-snouted *Makaira*. Thus, in vertebral numbers and relative snout length, *Istiophorus* and *Tetrapturus* are more similar to each other than to *Makaira*, confirming the first subdivision in the family shown in Fig. 321.

For Pacific species, larval and juvenile stages are known for all species except juvenile black marlin, *M. indica*. *Makaira indica* larvae have a characteristic pectoral fin which is erect from the body in larvae and adults and presumably juveniles, too. *Makaira mazara* larvae are characterized by a short snout, large eyes, and forward placement of the anterior edge of the orbit. The characteristic lateral line appears in juveniles at about 30 mm SL. *Tetrapturus audax* larvae do not have forward projecting orbits and the center of the eye is located at the same level as the tip of the snout. The pterotic spine is parallel to the body axis, and the preopercular spine is inclined sharply downward, forming a large angle with the body axis. Melanophores occur above the midline of the gular membrane or on the mid

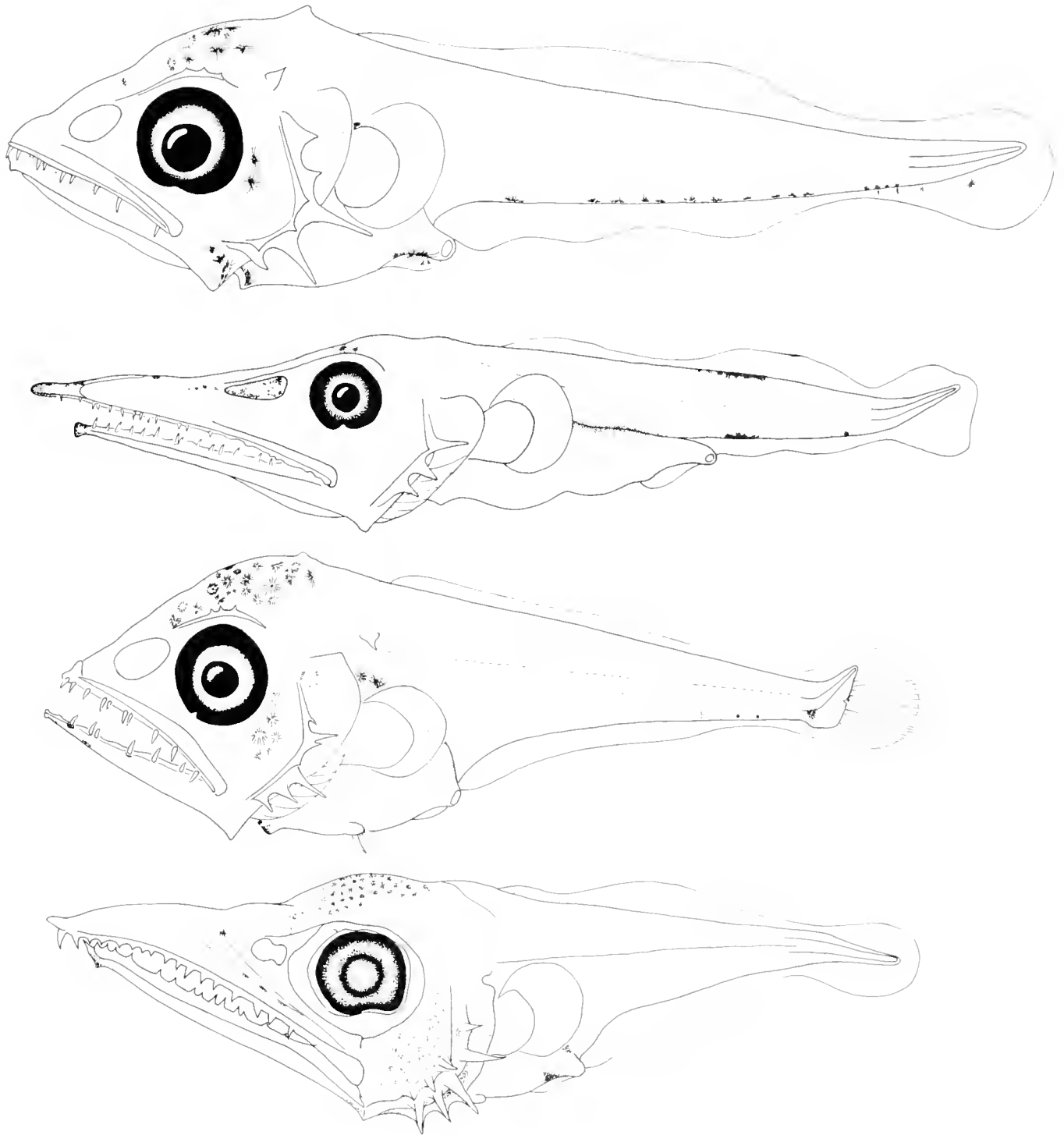

Fig. 327. Lateral views of scombrid larvae from top to bottom: *Scomberomorus cavalla*, 5.0 mm NL, eastern Atlantic, ALBATROSS IV, Cr. 7206, Sta. 79, capture date unknown, drawn by J. Javech; *Acanthocybium solanderi*, 7.2 mm NL, Gulf of Mexico, OREGON II, Cr. 117, Sta. 34463, drawn by J. Javech; *Sarda sarda*, 6.4 mm SL, Atlantic, GERONIMO, Cr. 3, Sta. 133, capture date unknown, drawn by J. Javech; and *Gymnosarda unicolor*, 5.1 mm NL, modified after Okiyama and Ueyanagi (1977).

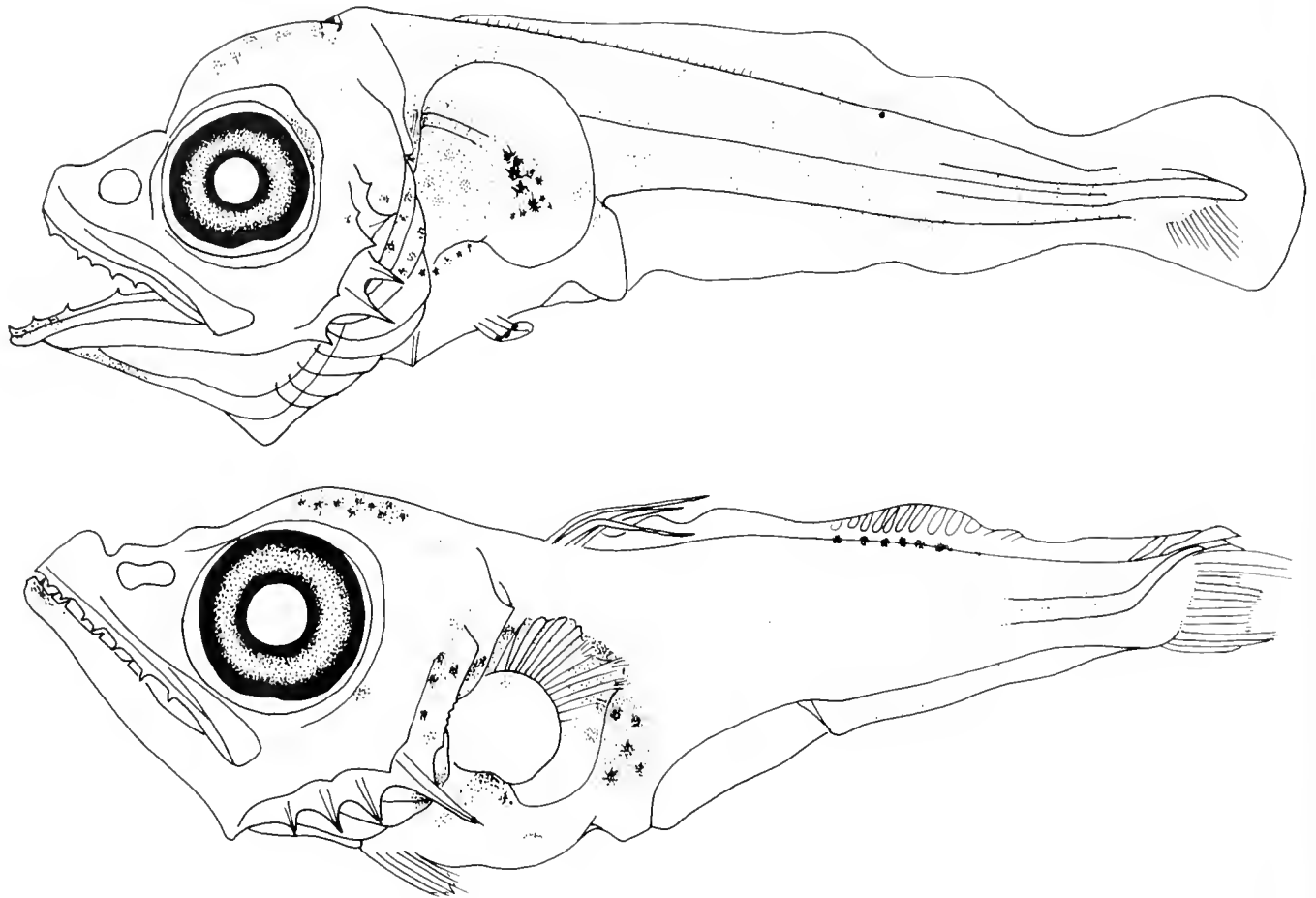

Fig. 328. Lateral views of *Allothunnus fallai* larvae (upper) 5.7 mm NL and (lower) 6.9 mm SL modified after Watanabe et al. (1966).

anterior portion of the branchiostegal membrane. *Istiophorus platypterus* has an elongate snout, small eyes, and a relatively small head depth. Melanophores appear characteristically on the posterior peripheral area of the gular membrane. However, there are some sailfish larvae which lack gular melanophores, and these are thought to belong to a different population. *Tetrapturus angustirostris* larvae of small size are similar to *M. mazara*, but the anterior edge of the orbital rim does not project forward and melanophores occur on the branchiostegal membrane.

In the Atlantic, specific differences are not nearly as clear. *Makaira indica* larvae have not been identified although adults are known. *Makaira nigricans* larvae are indistinguishable from *Makaira mazara* and are characterized by the short snout, anterior projection of the orbital rim, and a lack of gular melanophores. *Tetrapturus pfluegeri* larvae are very similar to *T. angustirostris* and characteristically possess melanophores on the branchiostegal membrane. It is also a winter spawning species, whereas the others are spring and summer spawners. *Tetrap-*

turus albidus larvae are very similar to *T. audax* in the profile of the head and possessing melanophores on gular membranes. *Tetrapturus georgei* larvae are unknown, and *T. belone* have been briefly described without mention of the presence or absence of branchiostegal melanophores. A great amount of time has been spent attempting to separate Atlantic *I. platypterus* and *T. albidus* with no success (Richards, 1974). Both have relatively long snouts and pigmented gular membranes. Variation in gular and branchiostegal pigmentation has been described in Atlantic *T. pfluegeri* (Ueyanagi, 1974b).

The elongate upper jaw, a characteristic of istiophorid fishes, is also found in the fossils *Palaeorhynchus* and *Blochius* which are thought to be the ancestral forms (Fierstine, 1972); hence, the elongate upper jaw may have phyletic meaning. When the character of upper jaw length compared to body length is examined during the larval period, clear differences were observed (e.g., longer upper jaw in *Istiophorus* and *Tetrapturus*, and shorter in *Makaira*). Adult *T. angustirostris* possess an especially short snout among the species in the genus; elongation of the

Fig. 329. Lateral views of scombrid larvae from top to bottom: all drawn by J. Javech, Gulf of Mexico, OREGON II, Cr. 117. *Axius* sp., 5.0 mm NL, Sta. 34463; *Euthynnus alletteratus*, 6.2 mm SL, Sta. 34463; *Katsuwonus pelamis*, 5.9 mm SL, Sta. 34448; and *Thunnus thynnus*, 6.0 mm SL, Sta. 34497.

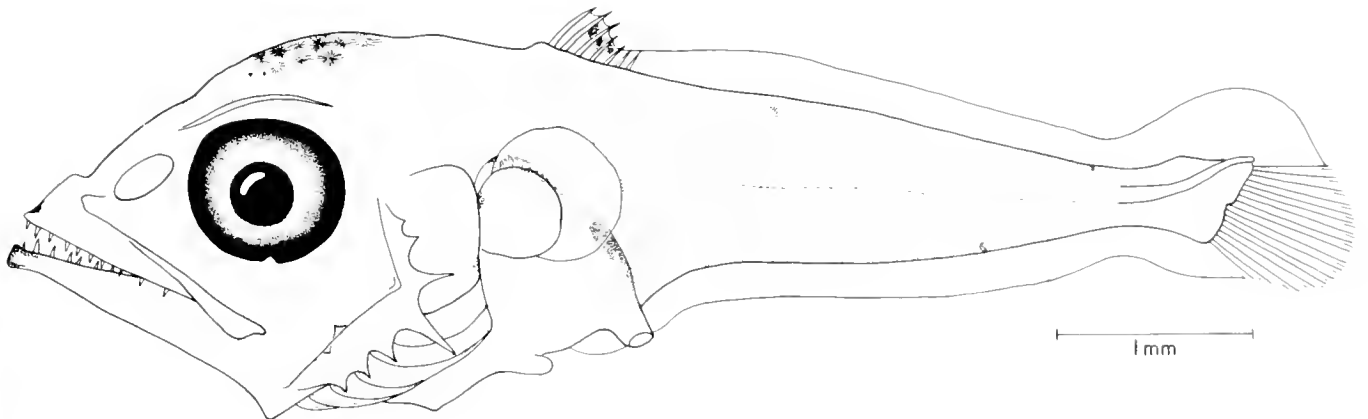
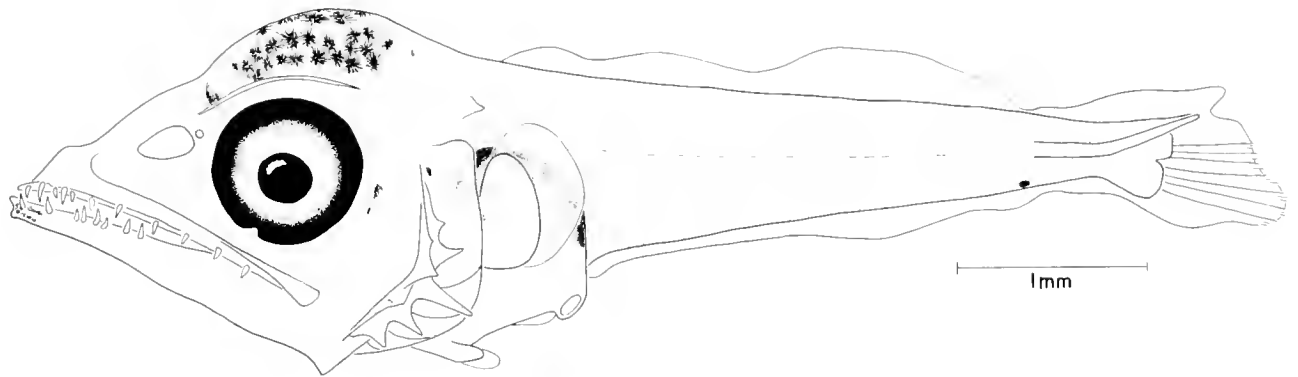
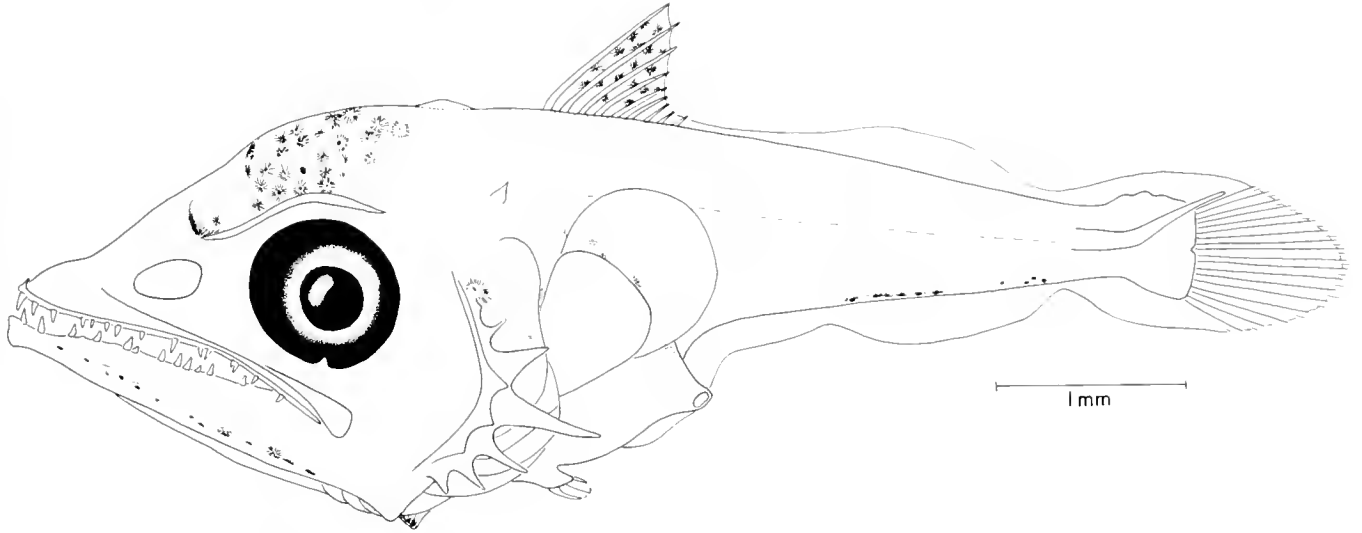
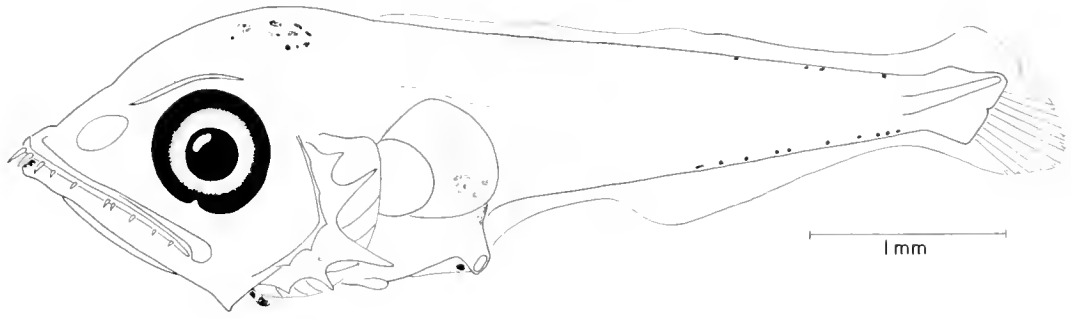

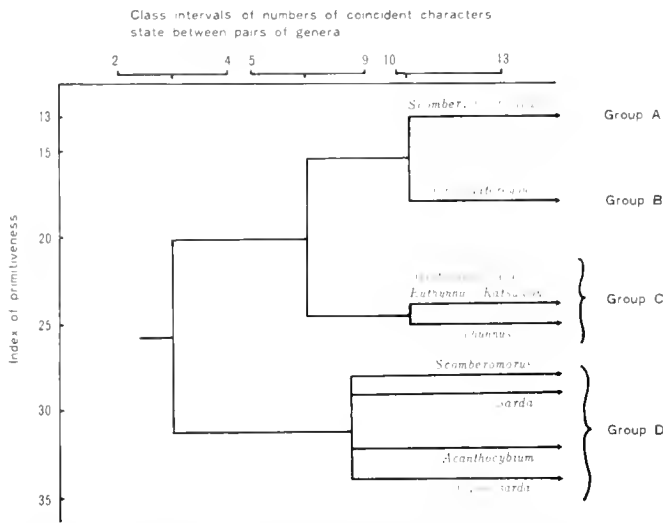

Fig. 330. Dendrogram depicting larval relationships among 12 genera of Scombrinae (from Okiyama and Ueyanagi, 1978: fig. 2).

snout is greatest in the larval period. In the case of *T. audax*, however, the snout/body length value is not so high among *Tetrapturus*, and it is thought to be intermediate between *Makaira* and *Tetrapturus*. The pattern of morphological change in snout length with ontogeny in various genera corresponds to the classification of adult fishes and is thought to reflect phylogeny among the genera of istiophorid fishes (Ueyanagi, 1963b).

TABLE 158. PRESENT STATUS OF THE LARVAL FISH TAXONOMY OF THE FAMILY SCOMBRIDAE (MODIFIED AFTER OKIYAMA AND UEYANAGI, 1978: TABLE 1).

Subfamily, tribe, and genus	Present state of the larval fish taxonomy	
	Generic level	Species level
Scombrinae		
Scombrini		
<i>Scomber</i>	well established	well established
<i>Rastrelliger</i>	well established	well established
Scomberomorini		
<i>Grammatorcynus</i>	well established	well established
<i>Scomberomorus</i>	well established	incomplete or none for many species
<i>Acanthocybium</i>	well established	well established
Sardini		
<i>Orcynopsis</i>	no information	no information
<i>Cybiosarda</i>	no information	no information
<i>Sarda</i>	rather well established	no problem in identification but poor information
<i>Gymnosarda</i>	well established	well established
Thunnini		
<i>Allothunnus</i>	well established	well established
<i>Auxis</i>	well established	incomplete
<i>Euthynnus</i>	well established	well established
<i>Katsuwonus</i>	well established	well established
<i>Thunnus</i>	well established	established for most, but identification very difficult to accomplish

TABLE 159. PRESUMED PHYLOGENETICALLY IMPORTANT LARVAL (CHIEFLY ADVANCED POSTLARVAL OR EARLY JUVENILE STAGES) CHARACTERS AS CODED STATE FOR COMPARISON OF 12 GENERA OF THE SUBFAMILY SCOMBRINAE. (After Okiyama and Ueyanagi, 1978: table 2).

Character index	Character	Coded state		
		1	2	3
1	Supraoccipital spine	absent	—	present
2	Head	small; less than 1/3 of SL	—	large; more than 1/3 of SL
3	Viscera and vent	compact with wide space from anal fin	—	elongated, with vent just in front of anal fin
4	Snout	rounded	pointed	elongated
5	Premaxillary teeth	minute	large	large; some fang-like
6	Jaw	equal size	equal or unequal size	unequal with distinct upper jaw projection
7	Preopercular spine	absent	—	present
8	Spiny supraorbital crest	absent	present or absent	present
9	Pterotic spine	absent	—	present
10	Cartilaginous pad on lower jaw	absent	present or absent	present
11	Dorsal body pigmentation	heavier	—	lighter
12	Post vent pigmentation	present, extensive	absent or a few dots	absent
13	Myotome counts	low; 30-31	middle; 38-41	high; 40-65

Xiphiidae

Hypural plate mostly covered by caudal fin rays; caudal fin supported by only two centra (urostyle and preural centrum 2); long depressed rostrum formed only by united premaxillae; nasals not forming part of the bill; prementary bone absent; supratergital absent; one postcleithrum; anteriormost dorsal pterygiophore inserts in second (rather than third) interneural space; no teeth in adult; pectoral fins placed low; scales lost in adult; pelvic fins and pelvic girdle absent; vertebrae few, 15 + 11 = 26; neural and haemal spines not expanded; ribs present on only the first four centra and the last two precaudal vertebrae (Regan, 1909; Gregory and Conrad, 1937; Potthoff and Kelley, 1982; G. D. Johnson, pers. comm.). Monotypic, contains only *Xiphias gladius*.

Development

Xiphias gladius (Fig. 323).—Eggs and larvae of *Xiphias* have been described by a number of authors during the 19th and 20th centuries as summarized by Richards (1974). The most recent and complete description is by Arata (1954) and drawings of a developmental series are by Täning (1955). Osteological development was studied by Potthoff and Kelley (1982).

Early larvae of swordfish are distinguished by having overall body pigmentation and lacking the strong pterotic and preopercular spines so characteristic of the istiophorids (Richards, 1974). Late preflexion larvae to juveniles acquire prickly squa-

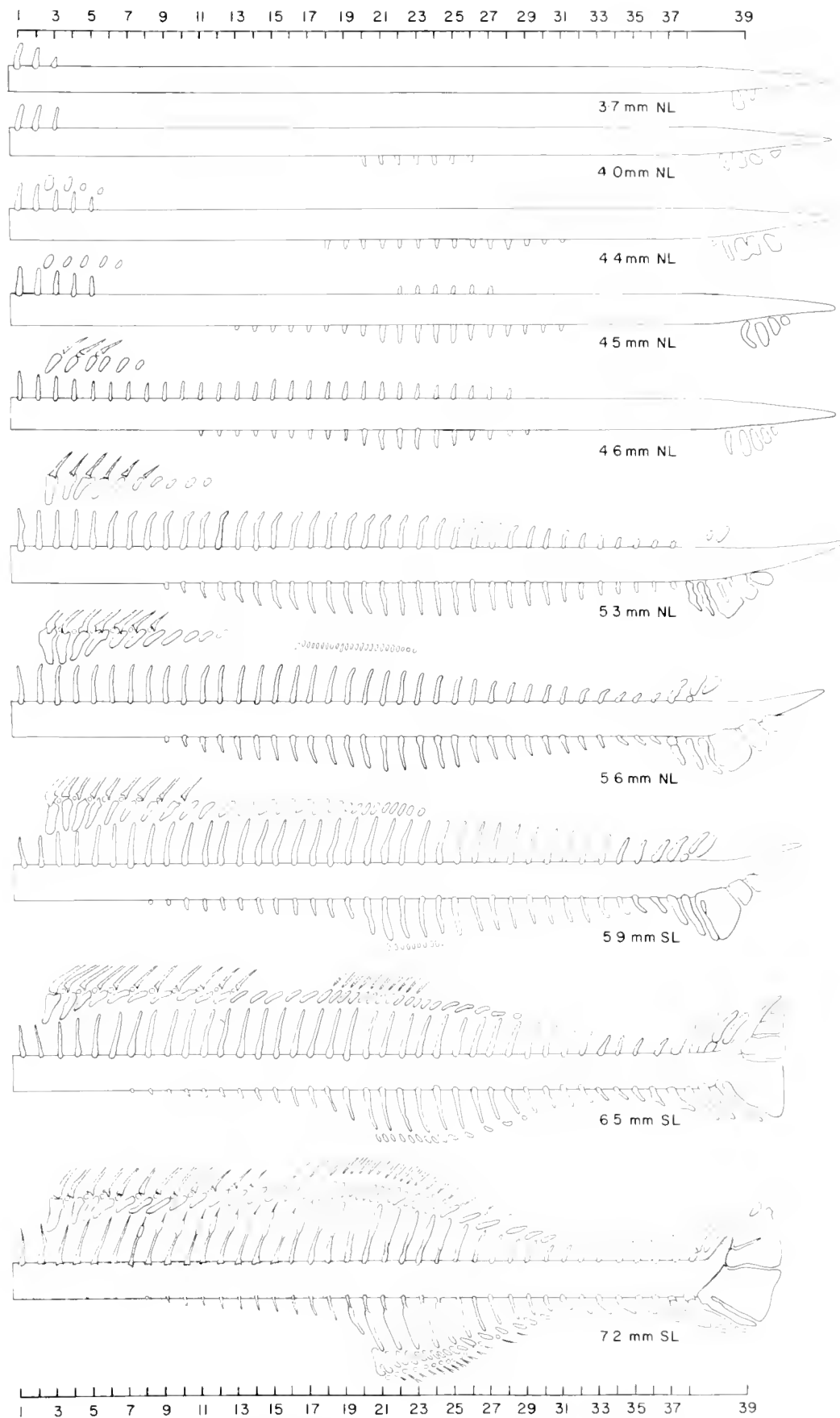

Fig. 331. Osteological development of *Thunnus atlanticus*, family Scombridae.

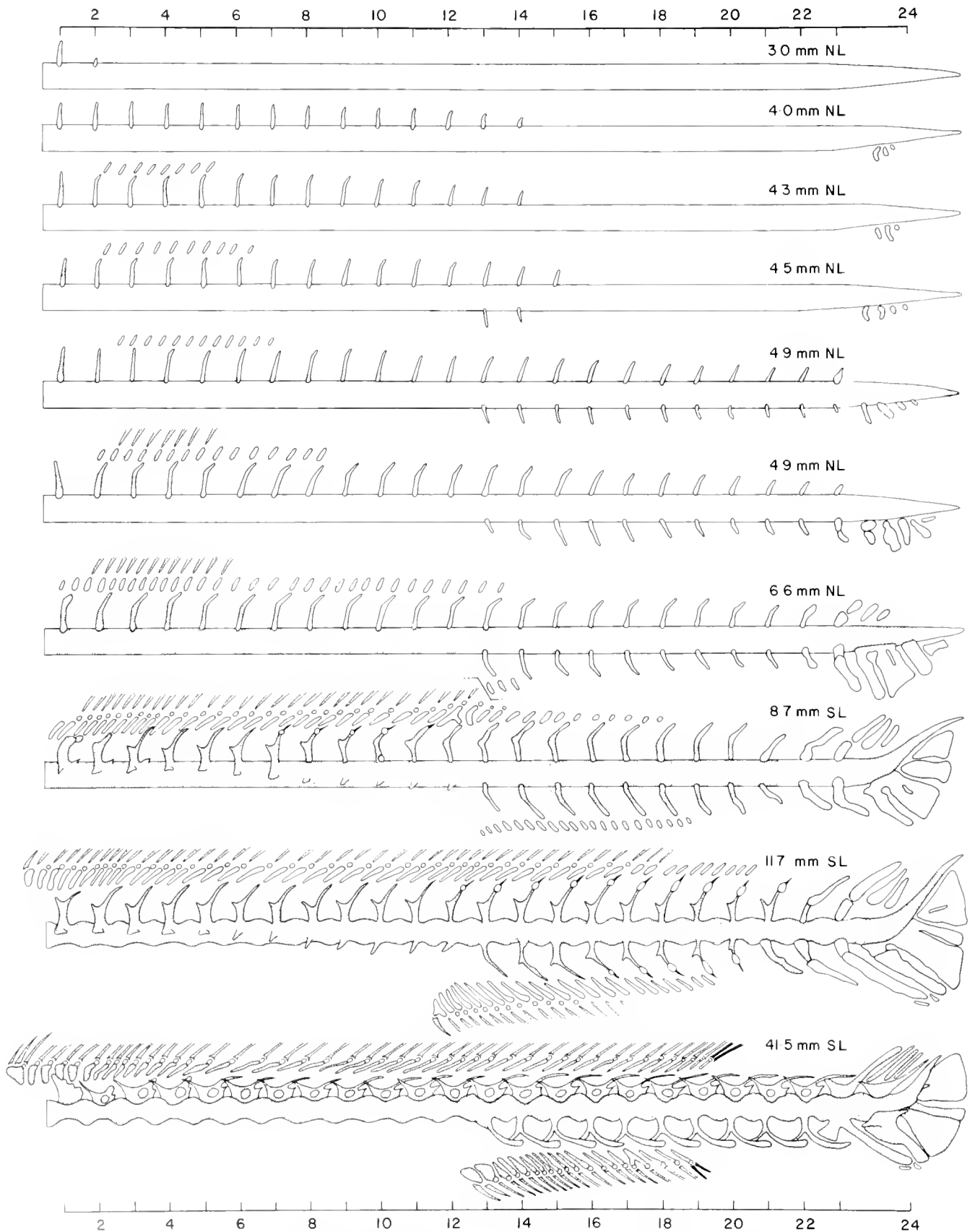

Fig. 332. Osteological development of *Istiophorus platypterus*, family Istiophoridae.

TABLE 160. DEVELOPMENTAL FEATURES FOR THE SCOMBROID FAMILIES AND *Morone*, A PRIMITIVE PERCIFORM FISH.

	Scombro- labracidae (<i>Scombro- labrax</i>)	Gempylidae (<i>Gempylus</i> , <i>Nesarchus</i>)	Gempylidae (<i>Diplospinus</i>)	Thunnini (<i>Thunnus</i>)	Scombrini (<i>Scomber</i>)	Istiophoridae (<i>Istiophorus</i>)	Xiphiidae (<i>Xiphias</i>)	Percichthyidae (<i>Morone</i>)*
Developing neural and haemal spines and arches and hypural complex parts are added in a direction.	Anterior column: posteriorly. Center column: anteriorly and posteriorly. Hypural complex: anteriorly and posteriorly.	Entire column: posteriorly. Hypural complex: anteriorly and posteriorly.	Entire column: posteriorly. Hypural complex: anteriorly and posteriorly.	Anterior column: posteriorly. Center column: anteriorly and posteriorly. Hypural complex: anteriorly and posteriorly.	Not known.	Entire column: posteriorly. Hypural complex: anteriorly and posteriorly.	Entire column: posteriorly. Hypural complex: anteriorly and posteriorly.	Anterior column: posteriorly. Center column: anteriorly and posteriorly. Hypural complex: anteriorly and posteriorly.
Developing pterygiophores and fin spines and rays are added in a direction.	First dorsal: anteriorly and posteriorly. Second dorsal: anteriorly and posteriorly. Anal: anteriorly and posteriorly.	First dorsal: posteriorly. Second dorsal: anteriorly and posteriorly. Anal: anteriorly and posteriorly.	First dorsal: posteriorly. Second dorsal: some anteriorly, most posteriorly. Anal: few anteriorly, most posteriorly.	First dorsal: posteriorly. Second dorsal: anteriorly and posteriorly. Anal: some anteriorly, most posteriorly.	First dorsal: very few anteriorly, most posteriorly. Second dorsal: anteriorly and posteriorly. Anal: anteriorly and posteriorly.	Entire dorsal: very few anteriorly, most posteriorly. Anal: very few anteriorly, most posteriorly.	Entire dorsal: anteriorly and posteriorly. Anal: very few anteriorly, most posteriorly.	First dorsal: anteriorly and posteriorly. Second dorsal: anteriorly and posteriorly. Anal: anteriorly and posteriorly.
Sequence of fin and associated pterygiophore development.	1. Second dorsal and anal concurrently. 2. First dorsal. First dorsal separated from second dorsal during part of development.	1. First dorsal. 2. Second dorsal and anal concurrently. First dorsal separated from second dorsal during part of development.	1. First dorsal. 2. Second dorsal and anal concurrently. First dorsal only briefly separated from second dorsal during development.	1. First dorsal. 2. Second dorsal and anal concurrently. First dorsal separated from second dorsal during part of development.	1. Second dorsal and anal concurrently. 2. First dorsal.	1. First dorsal. 2. Second dorsal and anal concurrently. First dorsal <i>not</i> separated from second dorsal during development.	1. Second dorsal and anal concurrently. 2. First dorsal and anal <i>not</i> separated during development.	1. Second dorsal and anal concurrently. 2. First dorsal. Separation or continuity of first and second dorsals not given.
First anteriormost dorsal and anal pterygiophore develop from one or two pieces of cartilage.	Dorsal from one piece, anal from two pieces.	Dorsal from one piece, anal from two pieces.	Dorsal from one piece, anal from two pieces.	Dorsal from one piece, anal from two pieces.	Dorsal from one piece, and anal from one piece.	Dorsal and anal from two pieces.	Variable, dorsal and anal may develop from one or two pieces.	Dorsal and anal develop from two pieces.
Centra develop from saddle-shaped ossifications at bases of neural and haemal spines.	Yes	Yes	Yes	Yes	Yes	No	No	No

* Data from Fritzsche and Johnson (1980).

mation (Arata, 1954; Yabe et al., 1959; Potthoff and Kelley, 1982), and the scales are supposedly lost in adults (Palko et al., 1981). One of us (Potthoff) has found that scales are retained in adult swordfish, at least on some parts of the body. Larval and juvenile swordfish differ from istiophorids in a number of characters (Table 157).

Adult *Xiphias* have two dorsal and two anal fins but larvae and juveniles have single continuous dorsal and anal fins (Yabe et al., 1959; fig. 9). During development, the fin rays in the center of the fins stop growing and the rays become subcutaneous. The subcutaneous rays and their pterygiophores are present in the adults (Potthoff and Kelley, 1982). In three scombrid

TABLE 161. OSTEOLOGICAL FEATURES AND COUNTS FOR THE SCOMBROID FAMILIES AND *Morone*, A PRIMITIVE PERCIFORM FISH.

	Scombro- labracidae (<i>Scombrolabrax</i>)	Gempylidae (<i>Gempylus</i> , <i>Nesiarchus</i>)	Trichiuridae	Thunnini (<i>Thunnus</i>)	Scombrini (<i>Scomber</i>)	Istiophoridae (<i>Istiophorus</i>)	Xiphidae (<i>Xiphias</i>)	Percichthyidae (<i>Morone</i>)*
Predorsal bones:								
Present or absent	absent	usually ab- sent#	absent	absent	absent	absent	absent	present
Number	0	0 or 1	0	0	0	0	0	3
First anteriormost dorsal pterygiophore:								
Supports how many spines	2	2	2	2	2	3	1 to 3, mostly 2	3
Inserts in inter- neural space number	3	2	2	3	3	1	2	3
First anteriormost anal pterygiophore:								
Supports how many spines	3	2 or 3†	2 or 3***	3	2	2	1 to 3, mostly 2	3
Middle radials:								
Present or absent	present	present	present or absent	present	present	present	absent	present
Dorsal and anal stay:								
Present or ab- sent, ossifies to one or two parts, poste- riorly	present: one part	present: usu- ally 2 parts@	present: one part	present: one part	present: one part	present: one part	present: one part	present: one part
Bifurcated or non-bifurcated	non-bifur- cated	bifurcated	bifurcated	bifurcated	bifurcated	bifurcated	non-bifur- cated	non-bifurcat- ed
Pelvic fin:								
Spine, ray count	1, 5	1, 5; 1, 4; 1, 2; 1, 1; 1	1, 3; 1, 2; 1, 1; 1	1, 5	1, 5	1, 2	0	1, 5
Preural centrum 3:								
Neural spine with or with- out cartilage tip	with	with	with	with	with	with	without	with
Haemal spine au- togenous or nonautogenous	autogenous	autogenous	autogenous	autogenous	autogenous	autogenous	non-autog- enous	autogenous
Epurals:								
Number	3	3	1 to 3**	2	2	3	3	3
Anterior epural fused with neural arch of PU ₂	No	No	No	Yes		No	No	No
Uroneural:								
1 or 2	2	2	1	1	1	1	1	2
Hypural 5:								
Present or absent	present	present	absent	present	present	absent	present	present
Fused or separate	separate	separate	fused early	separate	separate	—	separate	separate
Ontogenetic hypural fusion:								
Present or absent	absent	present	present	present	present	present	present	absent
Procurrent spur (Johnson, 1975):								
Present or absent	present	present, re- duced or absent	absent	absent	absent	absent	absent	present
Vertebrae inclusive of urostyle supporting caudal rays:								
Number	3	3	3	4	3	3	2	3

TABLE 161. CONTINUED.

	Scombro- labracoidei (Scombrolabracoidei)	Gempylidae (Gempylus, Nesiarctus)	Trichuridae	Thunnini (Thunnus)	Scobrini (Scomber)	Istiophoridae (Istiophorus)	Xiphiidae (Xiphias)	Percichthyidae (Morone)*
Number of vertebrae:								
Precau- dal + caudal = total	13 + 17 = 30	usually more pre- caudal, fewer caudal. 31 to 53	usually few- er precau- dal, more caudal. 58-192	usually few- er precau- dal, more caudal. 39-41	13, 14 + 17, 18 = 31	12 + 12 = 24 11 + 13 = 24	15 + 11 = 26 16 + 10 = 26	12 + 13 = 25 11 + 14 = 25
Stay on 4th pharyngobranchial (G. D. Johnson, pers. comm.):								
Present or absent	absent	absent	absent	present	present	present	present	absent

* Data from Fritzsche and Johnson (1980) and G. D. Johnson, pers. comm.

† *Ruvettus*, *Thyrstops* and *Tongaichthys* have one predorsal bone.

‡ *Revea* has 2 spines, *Nealotus* ontogenetically has 3 spines but center spine fuses to basiptyrgium during development

§ *Lepidocybium*, *Revea* and *Gempylus* have a one-part stay

** *Diplospinus* ontogenetically has 3 epurals, posterior 2 epurals are fused to one in adults, some *Diplospinus* develop only 2 epurals

*** *Trichurus* has only 2 spines on the first anal pterygiophore.

genera, *Scomber*, *Rastrelliger*, and *Auxis*, there is a separation between the first and second dorsal fins similar to that in adult *Xiphias*, except that in these scombrids the two fins are separate initially even though the first and second dorsal fin pterygiophores are continuous (Kramer, 1960).

Scombridae

Hypural plate mostly covered by caudal fin rays; caudal fin rays supported by 3 centra (*Scobrini* and *Grammatorcynus*) or 4 to 5 centra (all other tribes) (urostyle and preural centra 2 to 4); premaxillae beak-like, free from the nasals which are separated by the ethmoid; no canine teeth; pectoral fins placed high on the body, with 19-36 rays; pelvic fins 1,5; vertebrae 31-64 (Tables 154 and 155); 5-12 finlets follow the second dorsal and anal fins. The family contains 15 genera and 49 species (Collette, 1979, 1983).

The family Scombridae can be divided into two subfamilies (Fig. 324): the Gasterochismatinae, which contains only the distinctive *Gasterochisma melampus*, and the Scobrini. There are problems with the placement of *Gasterochisma*. To be included in the Scombridae, it must have lost the extension of the cartilaginous tip of the second epibranchial that extends over the top of the third infrapharyngobranchial (Fig. 312, character 1; G. D. Johnson, pers. comm.), regain well developed predorsal bones (character 2), and lose the pharyngeal tooth plate stay characteristic of all other higher scombrids except *Gasterochisma* and *Grammatorcynus* (G. D. Johnson, pers. comm.). However, *Gasterochisma* agrees with the billfishes and other scombrids in several caudal skeletal characters (Fig. 312, characters 8, 12, 14).

The Scobrini is composed of two groups of tribes. The primitive mackerels (*Scobrini*—*Scomber* and *Rastrelliger*) and Spanish mackerels (*Scomberomorini*—*Scomberomorus*, *Acanthocybium*, and *Grammatorcynus*) have a distinct notch in the hypural plate, lack any bony support for the fleshy keels on the caudal peduncle, and do not have preural centra two and three greatly shortened. The more advanced bonitos (*Sardini*) and tunas (*Thunnini*) form a monophyletic group showing: loss of the notch between the fused lower and fused upper hypural bones (Fig. 312, character 33), bony support for the medial caudal peduncle keel (character 16), anterior corselet of enlarged

scales (character 22) and have preural centra two and three greatly shortened. The *Scomberomorini*, like the two more advanced tribes, have a median fleshy keel on the caudal peduncle between the pair of small keels (character 11). However, there is no bony support for this keel as there is in the bonitos and tunas. *Grammatorcynus* shares this character state with the other two genera of *Scomberomorini* but has only three centra supporting the caudal fin (reversal at character 8), as in the *Scobrini*, rather than four or five as in the *Scomberomorini*, *Sardini* and *Thunnini*. The *Sardini* (*Orcynopsis*, *Cybiosarda*, *Sarda*, *Gymnosarda*, and *Allothunnus*; Collette and Chao, 1975) differ from the *Thunnini* (*Auxis*, *Euthynnus*, *Katsuwonus*, and *Thunnus*) in lacking any trace of the subcutaneous vascular system (Fig. 312, character 23) that permits the members of the *Thunnini* to be warmer than the water around them. Instead of being considered as a bonito, *Allothunnus* can better be interpreted as the most primitive member of the *Thunnini*, sharing the presence of a prootic pit on the skull with the higher tunas (character 26) but lacking their subcutaneous vascular system. *Allothunnus* also has an autogenous second epibranchial cartilage as in the *Thunnini* (G. D. Johnson, pers. comm.) and shares a common parasitic copepod, *Elytrophora brachyptera*, with six of the seven species of *Thunnus* (Gibbs and Collette, 1967; Cressey et al., 1983).

The *Scomberomorini* is the most speciose group within the Scombroidei and so merits further attention. After comparing the 18 species of *Scomberomorus* with each other and with *Acanthocybium* and *Grammatorcynus* (Collette and Russo, in press), characters that differentiated among species or genera were listed. *Grammatorcynus* clearly is more primitive than *Scomberomorus* and, therefore, it was used as the outgroup for comparison with *Scomberomorus*. Character polarities were determined by considering the character state present in *Grammatorcynus* to represent the plesiomorphic condition. Of the 72 characters that differentiated at least one taxon from the others, 14 were autapomorphies of *Acanthocybium*. These cannot contribute to an understanding of relationships within *Scomberomorus* and were omitted from the analysis. The remaining 58 characters were employed to generate a cladogram (Fig. 325) using a computer program (WAGNER 78) written by J. S. Farris (following Farris, 1970 and Farris et al., 1970).

The numbers at the nodes indicate characters that are discussed by Collette and Russo (in press).

Scomberomorus differs from *Acanthocybium* at character 17 and from all other scombrids in possessing a spatulate vomer that projects anteriorly well beyond the neurocranium. *Scomberomorus* differs from both *Acanthocybium* and *Grammatorcynus* in 12 osteological characters. In three more characters, *Scomberomorus* differs from both genera but is closer to *Acanthocybium*. *Scomberomorus* and *Acanthocybium* share 17 osteological synapomorphies at character 18 but differ from *Grammatorcynus*. There are six species groups within *Scomberomorus*: *sinensis*, *commerson*, *munroi*, *semifasciatus*, *guttatus*, and *regalis* (Fig. 325; Collette and Russo, in press).

The young stages of scombrids are difficult to identify to genus and particularly to the species level (Richards and Potthoff, 1974). Young stages are, for the most part, easily identified to family, but the eggs are unknown except for a few species. To give some indication of the amount of work already directed to these problems, a recent bibliography of young scombrids covering the years 1880–1970 listed 170 papers dealing with identification of eggs, larvae, and juveniles (Richards and Klawe, 1972). Where no specific references are indicated, information is from papers listed by Richards and Klawe (1972) or Fritzsche (1978).

DEVELOPMENT

Scombrid eggs are very difficult to identify because they resemble the vast majority of perciform eggs characterized by 0.8–1.9 mm in diameter, smooth shell, usually a single oil globule (several in *Sarda*), narrow perivitelline space, homogenous yolk and a variety of distribution patterns of pigment cells including melanophores and other pigments, usually yellow, white or green. The latter three colors are lost upon preservation and are only useful for identifying living eggs. Because of the great interest in rearing scombrids from eggs, several papers have appeared which describe living eggs, but not enough species have been described to shed light on relationships. The following works should be consulted: Harada et al. (1971); Mori et al. (1971); Richards and Klawe (1972); Harada, Muruta and Miyashita (1973); Harada, Muruta and Furutani (1973); Yasutake et al. (1973); Harada et al. (1974); Ueyanagi et al. (1974); and Mayo (1973).

Most larvae can be identified using a combination of characters, principally number of myomeres, body shape, head spination, and distribution of melanophores. Larvae are unknown for only three genera—*Gasterochisma*, *Orcynopsis* and *Cybiosarda*. The present state of knowledge of larval scombrids is shown in Table 158. Morphological characters common to larvae of this family are: (1) large head, large mouth opening and large eye; (2) development of head spination; (3) posterior migration of anus (anus located in anterior region of body in early larval stage; it migrates posteriorly toward anal fin during development).

The following accounts follow the order of presentation in Table 158.

Scomber and *Rastrelliger* (Fig. 326).—These two genera are thought to be the most primitive and lack some of the larval specialization seen in the other genera (*Rastrelliger* is not illustrated). The first dorsal fin forms after the second dorsal whereas in other genera the first dorsal develops before the second dorsal.

The head is not large (less than $\frac{1}{3}$ SL) in comparison with other genera. The dorsal profile of the head is gently arched from above the eye to the tip of the snout which is rounded. Head spination is not developed. The typical pigmentation is the presence of melanophores on the mid-ventral side of the trunk and tail in both genera. Myomeres number 31. The species of *Scomber* can be separated except it is difficult to distinguish *S. japonicus* from *S. australasicus*. Head proportion and pre-anal length may be useful as diagnostic characters.

Grammatorcynus (Fig. 326).—*Grammatorcynus bilineatus* larvae resemble *Scomber* and *Rastrelliger* in dorsal profile of head but have a pointed snout. Head spination is not developed but preopercular spines are present. Typical pigmentation is the presence of a lateral pigmented blotch above the anal fin and the development of saddle-shaped pigment blotches on the body and a pigment patch on the caudal fin base in larger larvae. Also characteristic are two lateral lines which are discernible at 57 mm SL in juveniles. Myomeres number 31. The larvae were recently re-described by Nishikawa (1979), but larvae of the second species, *G. bicarinatus*, recently recognized by Collette (1983) are unknown.

Scomberomorus (Fig. 327).—This speciose genus is characterized by having a supraoccipital protuberance (*Euthynnus* has a slightly discernible protuberance). The head is large with an elongate snout and large mouth. Preopercular spines are well developed, and in at least one species, *S. cavalla*, are the longest in the family. A spiny supraorbital crest is well developed. Melanophores appear on the mid-dorsal and mid-ventral side of the trunk and tail. Adequate descriptions have been published for *S. cavalla* and *S. maculatus* and recently (Jenkins et al., 1984) for *S. commerson*, *S. queenslandicus* and *S. semifasciatus*.

Acanthocybium (Fig. 327).—This single species has been well described and is very easy to recognize (Wollam, 1969; Matsumoto, 1968). It is characterized by a large number of myomeres (62–64), elongate gut, elongate snout, and melanophores on the bases of the second dorsal and anal fins (on larvae >6 mm SL). It is the only species which does not exhibit posterior migration of the anus.

Sarda (Fig. 327).—The snout is moderately elongate and the head spination, consisting of supraorbital crests, preopercular spines and pterotic spines, are well developed. Dentition on both jaws is well-developed. Melanophores occurring on the ventral midline appear to migrate dorsally along myosepta with growth in a posterior to anterior direction. In postflexion larvae the pelvic and first dorsal fin are heavily pigmented. Good, thorough descriptions are lacking for all of the species.

Gymnosarda (Fig. 327).—The larvae of this monotypic genus are unique in the remarkable development of the head, especially elongation of the snout, wide mouth with fang-like dentition, and spinous preopercles, supraorbital crests, and pterotic spines. The extremes of the body proportions are: ca. 60% for head in SL, ca. 60% for snout in head, and ca. 85% for upper jaw in head. Melanophores are absent from the tail region and the branchiostegal rays are heavily pigmented. The larvae were described by Okiyama and Ueyanagi (1977).

Allothunnus (Fig. 328).—This and the other genera of Thunnini are very similar in appearance and are separated on the basis of pigment patterns. All five genera have similar myomere counts, preopercular spines present and spiny supraorbital crests absent. *Allothunnus fallai* has 39 myomeres and unique melanophore patterns are present on the mid-ventral surface of the lower jaw along the base of the second dorsal fin.

Auxis (Fig. 329).—There appear to be two world-wide species with 39 myomeres but there is some variation in pigment pattern. The genus is characterized by having melanophores deeply embedded behind the midbrain, cleithral symphysis, along the ventral margin of the tail and melanophores absent from the forebrain. The first dorsal fin is weakly developed and melanophores occur along the lateral midline of the tail and on the dorsal margin of the caudal peduncle in some specimens. The profile of the head is blunt and the jaws are short giving the larvae a characteristic "Auxis-look" which is different from the next three genera.

Euthynnus (Fig. 329).—Two species have 39 myomeres and a third, *E. lineatus*, has 37. These larvae have slightly longer snouts than other Thunnini and a slight supraoccipital protuberance. The unique pigment pattern is characterized by melanophores occurring on the forebrain, midbrain, cleithral symphysis, and ventrally, laterally and dorsally on the tail. The first dorsal fin is strongly developed and heavily pigmented.

Katsuwonus (Fig. 329).—The single species, *K. pelamis*, has 41 myomeres and a reduction in melanophores as they occur only on the forebrain, midbrain, one to three distinct melanophores on the ventral margin of the tail and rarely one or two on the dorsal margin of the caudal peduncle.

Thunnus (Fig. 329).—All 7 species (Gibbs and Collette, 1967) have 39 myomeres and show the greatest reduction in melanophores in the family. Most species can be separated on the basis of melanophores. *Thunnus thynnus* and *T. maccoyii* have melanophores on the ventral margin of the tail and the dorsal margin of the trunk and tail. *Thunnus obesus* and *T. atlanticus* have melanophores only on the ventral margin of the tail. *Thunnus albacares* and *T. alalunga* lack tail melanophores. *Thunnus tongol* is unidentified. Geographic distribution, time of spawning and internal characters must be used to identify larvae of this genus. We recommend that the following publications be carefully consulted before attempting specific identifications: Matsumoto et al. (1972), Richards and Potthoff (1974), Potthoff (1974, 1975) and Kohno et al. (1982).

RELATIONSHIPS

Okiyama and Ueyanagi (1978) compared a classification based on larval characters of 12 genera of Scombrinae with the classification of Collette and Chao (1975). They selected 13 presumed phylogenetically important larval characters (Okiyama and Ueyanagi, 1978: table 2) and then coded the character states (Table 159). Their dendrogram (Fig. 330) shows four groups. Group A, *Scomber* and *Rastrelliger*, corresponds to the tribe Scombrini (Fig. 324). Group B consists only of *Grammatocygnus*. Group C equals the Thunnini (Fig. 324) plus *Allothunnus*.

This interpretation is reasonable on cladistic grounds as discussed in the family section. Group D is a mixture of the Scomberomorini and Sardini. Okiyama and Ueyanagi admitted that this group is a "heterogeneous assemblage."

The question of whether or not the billfishes should be considered scombroids has been addressed by Potthoff et al. (ms). They studied osteological developmental features as shown in Tables 160 and 161 and Figs. 331 and 332. Although their research is still preliminary because of lack of adequate developmental series for many genera, they conclude that the Istiophoridae and Xiphiidae should not be placed within the Scombroidei because of three developmental characters which are not shared by any other scombroids. First, all scombroids, except the Istiophoridae and Xiphiidae, have distinctive saddle-shaped ossifications on the vertebrae before the centra are fully formed. Second, development of the cartilaginous neural and haemal spines also is similar in all scombroids, except istiophorids and xiphiids. Third, scombroids except istiophorids and xiphiids share a primitive and an advanced development of the first and second dorsal and anal fins and their supporting pterygiophores. In the primitive development, which is shared by *Scombrolabrax* and Scombrini (and which is the basic developmental pattern of percoids), the second dorsal fin, anal fin and pterygiophores develop first from a center anteriorly and posteriorly and the first dorsal fin and pterygiophores develop second, also from a center anteriorly and posteriorly. In the advanced development, which is shared by the Gempylidae, Trichiuridae and Thunnini, the first dorsal fin and pterygiophores develop first from the anteriormost element in a posterior direction, and the second dorsal fin, anal fin and pterygiophores develop second from a center anteriorly and posteriorly. In the Istiophoridae, the first dorsal fin and pterygiophores develop first from a center anteriorly and posteriorly. When the posterior portion of the first dorsal fin development reaches above the anterior portion of the anal fin, a few anal rays and pterygiophores develop anteriorly but most are added posteriorly. The second dorsal fin develops only in a posterior direction consecutive to the first dorsal fin. In *Xiphias* the second dorsal and anal fins and pterygiophores develop first from a center anteriorly and posteriorly. Development of the first dorsal fin and pterygiophores then is continuous with the second dorsal fin and in an anterior direction only.

In addition to their work, one can see the striking differences between billfish larvae and other scombroids simply by reviewing the illustrations of larvae in this report. However, these synapomorphies of istiophorids and xiphiids are not shared with any other group of fishes and so cannot be used as an argument to relate the billfishes to any other taxa. Billfishes have another unique synapomorphy: a specialized organ for heat production located beneath the brain and adjacent to the eyes (Block, 1983). The Scombridae, Istiophoridae and Xiphiidae have a stay on the 4th pharyngobranchial that is absent in other perciforms (G. D. Johnson, pers. comm.). Until further work is completed and other characters thoroughly studied, the billfishes are retained in the Scombroidei. The larval evidence presented indicates a close relationship among the families Scombrolabracidae, Gempylidae, Trichiuridae and Scombridae and much more distant, if any, relationship to the Istiophoridae and Xiphiidae.

APPENDIX

Characters and character states used for cladogram of scombroid fishes (Fig. 312). 1. Epibranchials. Tip of 2nd epibranchial short (0, plesiomorphous); 2nd epibranchial extends over top of 3rd infrapharyngobranchial to connect with 3rd epibranchial (1, apomorphous). 2. Predorsal bones. Absent (1); present (0). 3. Pharyngeal tooth plate stay. Stay absent (0); stay present on 3rd pharyngeal tooth plate where it contacts 4th pharyngeal tooth plate (1). 4. Dorsal fin developmental sequence. Second dorsal develops before first dorsal (1); first dorsal develops before second dorsal (0). 5. Shape of premaxilla in larvae. Not beak-like (0); beak-like (1). 6. Cross-connections of gill filaments. No cross-connections (0); cross-connections present (1). 7. Number of epurals. Three (0); two (1). 8. Number of vertebrae supporting caudal fin. Two (0); 3–4 (1). 9. Infraorbital bones. Not expanded into large plates (0); expanded into large plates (1). 10. Subocular shelf. Present (0); absent (1). 11. Mid-lateral keel on caudal peduncle. Absent (0); present (1). 12. Pair of small keels at base of caudal fin. Absent (0); present (1). 13. Bill. Absent (0); present (1). 14. Extension of caudal fin rays over hypural plate. Not overlapping or slightly overlapping plate (0); completely covering plate (1). 15. Anterior end of infraorbital bone. Not tubular (0); tubular (1). 16. Bony keels on caudal peduncular vertebrae. Absent (0); present (1). 17. Bony caudal peduncle keels. Poorly or irregularly developed (0); well-developed, forming a wide plate (1). 18. Inner row of premaxillary teeth. Additional row of teeth present on antero-medial end of premaxilla (1); single row of premaxillary teeth (0). 19. Protrusability of premaxilla. Upper jaw protrusible, premaxilla free from maxilla (0); premaxilla anchored to maxilla (1). 20. Number of ossifications in last dorsal and anal pterygiophores. A single ossification (0); two ossifications (1). 21. Relationship of second dorsal fin pterygiophores to neural spines. Relationship 2:1 (0); 1:1 (1). 22. Corselet. Absent (0); present (1). 23. Subcutaneous vascular system. Absent (0); present (1). 24. Fronto-parietal fenestra. Absent (0); present (1). 25. Tooth shape. Conical (0); compressed (1). 26. Prootic pits (on ventral surface of skull). Absent (0); present (1). 27. Vertebral trellis work. Absent (0); present (1). 28. Joint between first and second infraorbital bones. Simple contact (0); tightly bound (1). 29. Number of vertebrae. Moderate numbers, 30–31 (1); few, 24–26 (0); many, 35–170 (2). 30. Number of uroneurals in adult. Two (0); one (1). 31. Fusion of uroneural to urostyle. No fusion (0); fused (1). 32. Fusion of upper hypural bones. Hypurals 3, 4, and 5 separate (0); 3 and 4 fused (1); 3, 4, and 5 fused (2). 33. Notch in hypural plate. Large (0); small (1); absent (2). 34. Fusion of upper and lower hypural plates. Not fused (0); fused (1). 35. Fusion of lower hypural bones. Hypurals 1 and 2 separate (0); fused (1). 36. Fusion of parahypural to hypural plate. Separate (0); fused (1). 37. Number of autogenous haemal spines. Two (0); one (1). 38. Tips of neural and haemal spines of preural vertebra 4. Tips of both flattened (2); tip of one flattened (1); tips not flattened (0). 39. Number of pectoral fin rays. 17–19 (1, plesiomorphous); 10–17 (0, apomorphous); and along another transition series to 17–23 (2), 20–27 (3), 25–29 (4), and 30–36 (5). 40. Tongue teeth. None fused to glossohyal (0); two patches fused to glossohyal (1).

(B.B.C. AND J.L.R.) NATIONAL MARINE FISHERIES SERVICE, NATIONAL SYSTEMATICS LABORATORY, NATIONAL MUSEUM OF NATURAL HISTORY, WASHINGTON, DISTRICT OF COLUMBIA 20560; (T.P. AND W.J.R.) NATIONAL MARINE FISHERIES SERVICE, SOUTHEAST FISHERIES CENTER, 75 VIRGINIA BEACH

DRIVE, MIAMI, FLORIDA 33149; (S.U.) FACULTY OF MARINE SCIENCE AND TECHNOLOGY, TOKAI UNIVERSITY, 3-20-1 ORIDO, SHIMIZU-SHI, 424, JAPAN; (Y.N.) FAR SEAS FISHERY RESEARCH LABORATORY, FISHERIES AGENCY, 1000 ORIDO, SHIMIZU-SHI, JAPAN.

Stromateoidei: Development and Relationships

M. H. HORN

THE Stromateoidei is a suborder of perciform fishes composed of six families, 16 genera and approximately 65 species. These fishes form a reasonably well-defined group that, with one exception, is characterized by toothed saccular outgrowths in the alimentary tract immediately posterior to the last gill arch. All species have small uniserial teeth in the jaws.

Stromateoids are marine fishes of temperate and tropical latitudes and range from inshore coastal waters to the open ocean and from pelagic (primarily) to demersal habitats. Of the 16 stromateoid genera, eight are exclusively oceanic, two are mixed coastal and oceanic and six are exclusively coastal (Table 162). Although several coastal species are locally abundant and commercially important, oceanic stromateoids tend to be rare and sporadic in occurrence. Juveniles commonly associate with animate or inanimate floating objects in the surface layers of the ocean.

Since the completion of Haedrich's (1967) comprehensive review of the stromateoid fishes, several taxonomically-oriented studies have been conducted. These works include descriptions of a new monotypic family (Haedrich, 1969) and four new species

(Haedrich, 1970; Horn, 1970b; Chirichigno, 1973; McAllister and Randall, 1975), generic reviews or revisions (Horn, 1970b, 1973; Butler, 1979), regional reviews of certain centrolophid taxa (Stehmann and Lenz, 1973; McDowall, 1982) and an extensive account of the early life history stages of pelagic stromateoids (Ahlstrom et al., 1976). The present paper, which includes a phylogenetic analysis of stromateoid genera, draws heavily upon information in Haedrich (1967) and Ahlstrom et al. (1976).

DEVELOPMENT

Eggs

The eggs of approximately 14 species representing six genera and four families of stromateoids have been described (Table 163). Stromateoid eggs typically are relatively small (0.70–1.80 mm in diameter), pelagic, separate and spherical. They have unsculptured surfaces, unsegmented yolks and single oil globules. The few distinctive features of the eggs limit their value as a source of taxonomic characters.

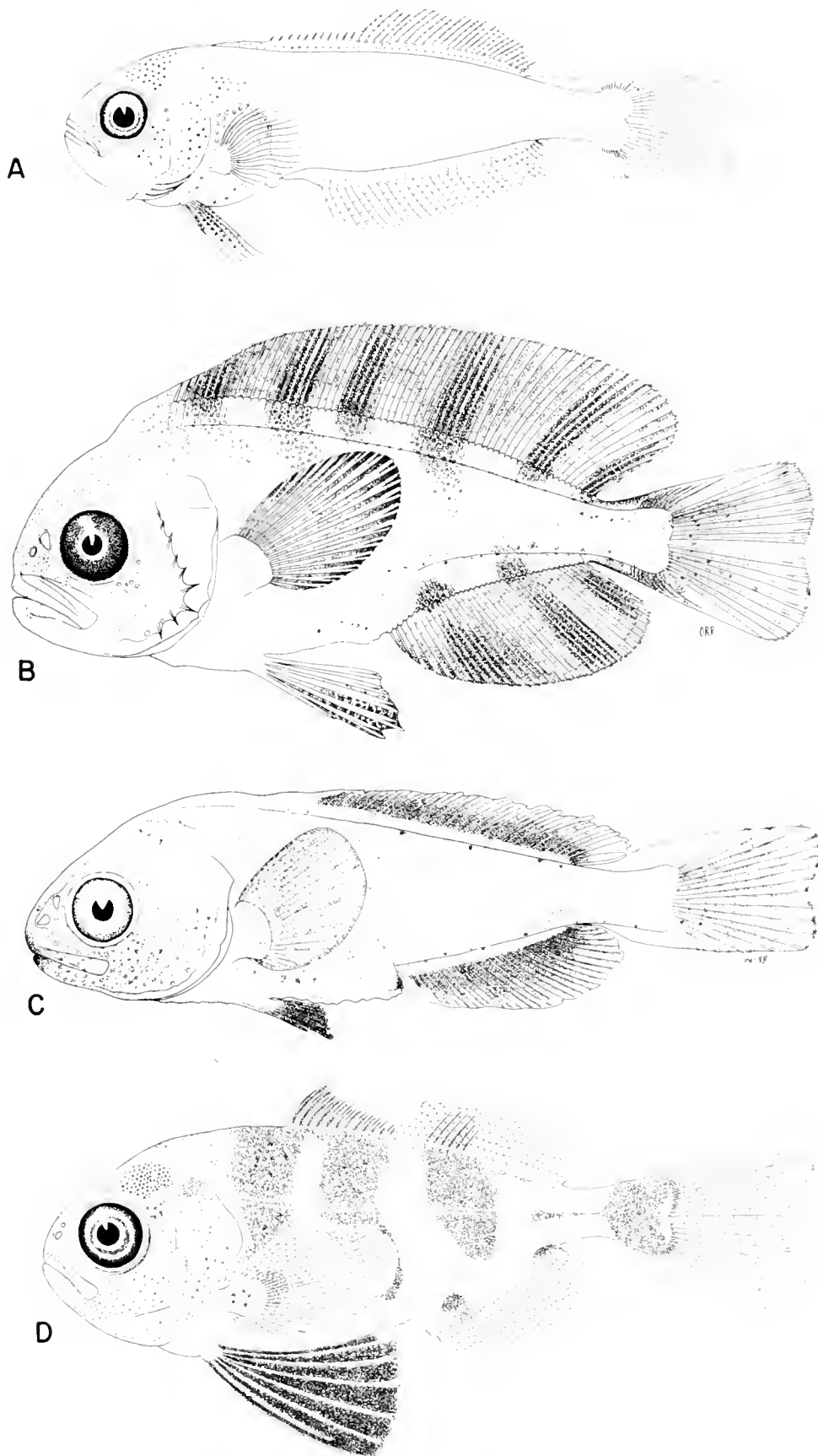

Fig. 333. Examples of stromateoid larvae and early juveniles. (A) *Amarsipus carlsbergi* (Amarsipidae), 16.7 mm postflexion larva; (B) *Schedophilus huttoni* (Centrolophidae), 25.0 mm early juvenile; (C) *Icichthys lockingtoni* (Centrolophidae), 20.0 mm early juvenile; (D) *Nomeus gronovii* (Nomeidae), 22.7 mm early juvenile; all from Ahlstrom et al. (1976).

TABLE 162. FAMILY AFFILIATION, HABITAT AND RANGES OF MERISTIC VALUES FOR STROMATEOID GENERA.

	Amarsipidae		Centrolophidae				
	<i>Amarsipus</i>	<i>Hyperoglyphe</i>	<i>Centrolophus</i>	<i>Schedophilus</i>	<i>Ichthyos</i>	<i>Tubbia</i>	<i>Seriolella</i>
Habitat							
Coastal		X					X
Oceanic	X		X		X	X	
Coastal and oceanic				X			
Meristic							
First dorsal spines	X–XII	—	—	—	—	—	—
Second dorsal spines and rays	23–27 ^a	VI–VIII, 15–26	V, 32–37	V–IX, 23–54	38–46 ^a	47–51 ^a	VII–IX, 25–39
Anal spines and rays	29–32 ^a	III, 14–20	III, 21–24	II–III, 16–35	25–32 ^a	33–37 ^a	II–III, 19–24
Pectoral rays	17–19	18–23	19–23	19–22	16–21	18–21	19–23
Precaudal vertebrae	16–18	10	10	10–12	23–25	?	10–11
Caudal vertebrae	29–31	14–15	15	15–20	34–37	?	14–16
Total vertebrae	46–48	24–25	25	25–32	49–61	43–45	25–26

^a Total fin elements

Larvae and Juveniles

The larvae and/or early juveniles of approximately 28 species representing 13 genera and all six stromateoid families have been described (Table 163; see Figs. 333 and 334).

Ahlstrom et al. (1976) considered a young stromateoid to be a larva and not a juvenile if it (1) had not completely formed rays in all fins and/or (2) had not initiated development of scales. Scale formation is seldom encountered on specimens that lack the full complement of fin rays.

Characters of larvae and early juveniles that Ahlstrom et al. (1976) found useful in distinguishing among stromateoid fishes include meristics, sequence of fin formation, morphometrics, pigmentation and skeletal features. Of the strictly ontogenetic characters, sequence of fin formation and pigmentation pattern are the most important. The overlap in character states and the lack of data for certain genera strongly limit the number of unambiguous characters useful in developing a stromateoid phylogeny.

TABLE 163. STROMATEOID SPECIES FOR WHICH EGGS AND/OR LARVAE HAVE BEEN DESCRIBED.

Family	Species	Eggs	Larvae	Reference
Amarsipidae	<i>Amarsipus carlsbergi</i>		x	Ahlstrom et al. (1976)
Centrolophidae	<i>Schedophilus ovalis</i>		x	Padoa (1956b)
	<i>Centrolophus niger</i>		x	Sanzo (1932b) (as <i>C. pomptilus</i>)
	<i>Seriolella brama</i>	x		Grimes and Robertson (1981)
	<i>Seriolella caerulea</i>	x		Grimes and Robertson (1981)
	<i>Seriolella punctata</i>	x	x	Grimes and Robertson (1981)
	<i>Ichthyos lockingtoni</i>	x	x	Ahlstrom et al. (1976)
Nomeidae	<i>Cubiceps baxteri</i>	x	x	Ahlstrom et al. (1976) (as <i>C. caeruleus</i> , see Butler, 1979)
	<i>Cubiceps caeruleus</i>		x ^a	Ahlstrom et al. (1976) (as <i>C. capensis</i> , see Butler, 1979)
	<i>Cubiceps capensis</i>		x ^a	Ahlstrom et al. (1976) (as <i>C. sp. A</i> , see Butler, 1979)
	<i>Cubiceps gracilis</i>		x	Sparta (1946)
	<i>Cubiceps paradoxus</i>		x ^a	Ahlstrom et al. (1976) (as <i>C. sp. B</i> , see Butler, 1979)
	<i>Cubiceps pauciradiatus</i>	x	x	Ahlstrom et al. (1976)
	<i>Cubiceps squamiceps</i>		x	Nellen (1973b) (as <i>Psenes whiteleggi</i> , see Ahlstrom et al., 1976)
	<i>Nomeus gronovii</i>		x	Ahlstrom et al. (1976)
	<i>Psenes arafurensis</i>	x?	x	Ahlstrom et al. (1976)
	<i>Psenes cyanophrys</i>		x	Ahlstrom et al. (1976)
	<i>Psenes maculatus</i>		x	Ahlstrom et al. (1976)
	<i>Psenes pellucidus</i>	x?	x	Ahlstrom et al. (1976)
<i>Psenes sio</i>	x	x	Ahlstrom et al. (1976)	
Tetragonuridae	<i>Tetragonurus atlanticus</i>	x	x	Grey (1955b), Ahlstrom et al. (1976)
	<i>Tetragonurus cuvieri</i>	x	x	Grey (1955b), Ahlstrom et al. (1976)
	<i>Tetragonurus pacificus</i>		x	Grey (1955b), Ahlstrom et al. (1976)
Ariommidae	<i>Ariomma regulus</i>		x	McKenney (1961) (as <i>Psenes regulus</i>)
Stromateidae	<i>Stromateus fatola</i>		x	Padoa (1956b)
	<i>Peprilus burti</i>		x	Ditty and Truesdale (1983)
	<i>Peprilus paru</i>	x	x	Martin and Drewry (1978), Ditty and Truesdale (1983)
	<i>Peprilus simillimus</i>		x	D'Vincent et al. (1980)
	<i>Peprilus triacanthus</i>	x	x	Colton and Honey (1963), Martin and Drewry (1978), Ditty and Truesdale (1983)
	<i>Pampus chinensis</i>	x	x	Pati (1979)

^a Early juveniles

TABLE 162. EXTENDED.

Centrolophidae		Nomeidae		Anommidae	Tetragonuridae	Stromateidae		
<i>Psenopsis</i>	<i>Cubiceps</i>	<i>Nomeus</i>	<i>Psenes</i>	<i>Ariomma</i>	<i>Tetragonurus</i>	<i>Stromateus</i>	<i>Peprius</i>	<i>Pampus</i>
X								
	X	X	X	X	X	X	X	X
—	X-XII	XI-XII	IX-XII	XI-XII	XI-XVIII	—	—	—
V-VII, 26-32	I, 15-27	25-27 ^a	I, 19-30	I, 13-17	10-13	42-56 ^a	II-IV, 38-49	0-X, 33-50
II-IV, 22-27	II-III, 14-23	II, 24-26	II-III, 19-30	II-III, 13-16	I-II, 8-10	II-III, 31-45	II-IV, 35-47	0-VII, 39-47
16-23	17-23	21-23	16-22	20-25	14-21	18-25	17-24	24-27
10	12-13	14	12-13	13-14	18-27	18-19	12-15	14-16
15	18-21	27	19-29	17	20-28	24-26	16-22	19-26
25	30-34	41	31-42	30-31	39-54	41-49	29-36	33-41

Behavioral and morphological features of young stromateoids are potentially informative as taxonomic characters. Certain ones of these traits appear to be related to the widespread association of these fishes with a variety of floating objects in the ocean. In general, loss of the swimbladder accompanies allometric growth in pectoral fin length and changes in pigmentation pattern as part of the transition from the juvenile to the adult stage (Horn, 1975). Stromateoid fishes associated with floating objects usually have conspicuous blotches or bands of pigment on their bodies as juveniles then become more uniformly pigmented as deeper-living, presumably independent and continuously swimming adult fish. Haedrich (1967) proposed that banding is protective coloration for the fishes during the period when they live in the shifting shadows beneath jellyfishes. There are exceptions to this apparent relationship between pigmentation and behavior. For example, juveniles of *Ariomma* are banded yet appear to seldom associate with floating objects whereas young *Tetragonurus* are uniformly pigmented but, as Janssen and Harbison (1981) observed, associate intimately with salps and pyrosomes. The *Tetragonurus*-salp/pyrosome association, however, is different in that the fish are inside rather than beneath the floating objects. Pigmentation pattern and type of association are the two ontogenetic characters used in the phylogenetic analysis (see below).

Fin characters.—Meristic characters (Table 162) have been used widely to distinguish stromateoid taxa especially at the species level (e.g., Haedrich, 1967; Haedrich and Horn, 1972; Horn, 1970b, 1973; Horn and Haedrich, 1973; Ahlstrom et al., 1976; Butler, 1979; McDowall, 1982). As in most other perciform fishes, the pelvic fin (I, 5) and caudal fin (17 principal rays, 15 branched) of stromateoids have stabilized counts (the pelvic fin, however, is absent in three stromateoid genera). The number of secondary caudal rays, although exhibiting intraspecific variation, can be an important taxonomic character among species within a genus (Ahlstrom et al., 1976). The dorsal fin of stromateoids may be continuous or divided into two fins. This trait is used as a generic character in the present paper (Tables 164, 165). It is not always possible to distinguish between spines and rays in those species with a continuous dorsal fin (see Table 162). The complement of anal fin rays in stromateoids is preceded by 0 to 7 anal spines with most species having 2 or 3 spines. The number of pectoral fin rays varies from 14 to 27

among stromateoids, but the overlap among species limits its use as a taxonomic character.

Two different sequences of fin formation occur in oceanic stromateoids depending primarily on whether the pelvic fins form early (before the other fins) or whether they form late. Ahlstrom et al. (1976) found that the pelvics are first to form in *Amarsipus*, *Psenes* and probably also *Nomeus* whereas they are last to form in *Cubiceps*, *Ichthyos* and *Tetragonurus*. Fahay (1983) reported that the pelvics are also last to form in *Centrolophus*. These ontogenetic patterns have potential significance as taxonomic characters; however, they must be described for other genera before they can contribute to an understanding of stromateoid relationships.

Morphometrics.—Stromateoids vary substantially in their morphologies, especially body depth, but show no abrupt metamorphic changes in the transition from the larval to the juvenile to the adult stage. Allometric growth is common in these fishes and complicates the use of morphometrics as taxonomic characters. Taxa at similar stages of development must be compared if morphometric characters are to have validity. Ahlstrom et al. (1976) used morphometrics in distinguishing among species in genera such as *Schedophilus* and *Psenes*. Because of allometry and the less than complete information on different development stages of several genera, morphometric characters were not used in the phylogenetic analysis of stromateoid genera (see below).

Skeletal characters.—Ahlstrom et al. (1976) in their study of the early life history stages of oceanic stromateoids found the following skeletal characters to be of particular relevance: (1) total number of vertebrae, (2) co-occurrence of a pair of pleural ribs and a haemal spine on each of one or more caudal vertebrae, (3) separation of vertebrae into precaudal and caudal groups, (4) position of anal fin pterygiophores in relation to haemal spines, (5) number and position of dorsal fin pterygiophores and predorsal bones in relation to neural spines, and, (6) the number of supporting bones of the caudal fin. While not strictly ontogenetic in nature, these characters are most readily discerned from examination of cleared and stained larvae and early juveniles.

Of the above characters, only the number of predorsal bones and the number of hypurals were used in the phylogenetic anal-

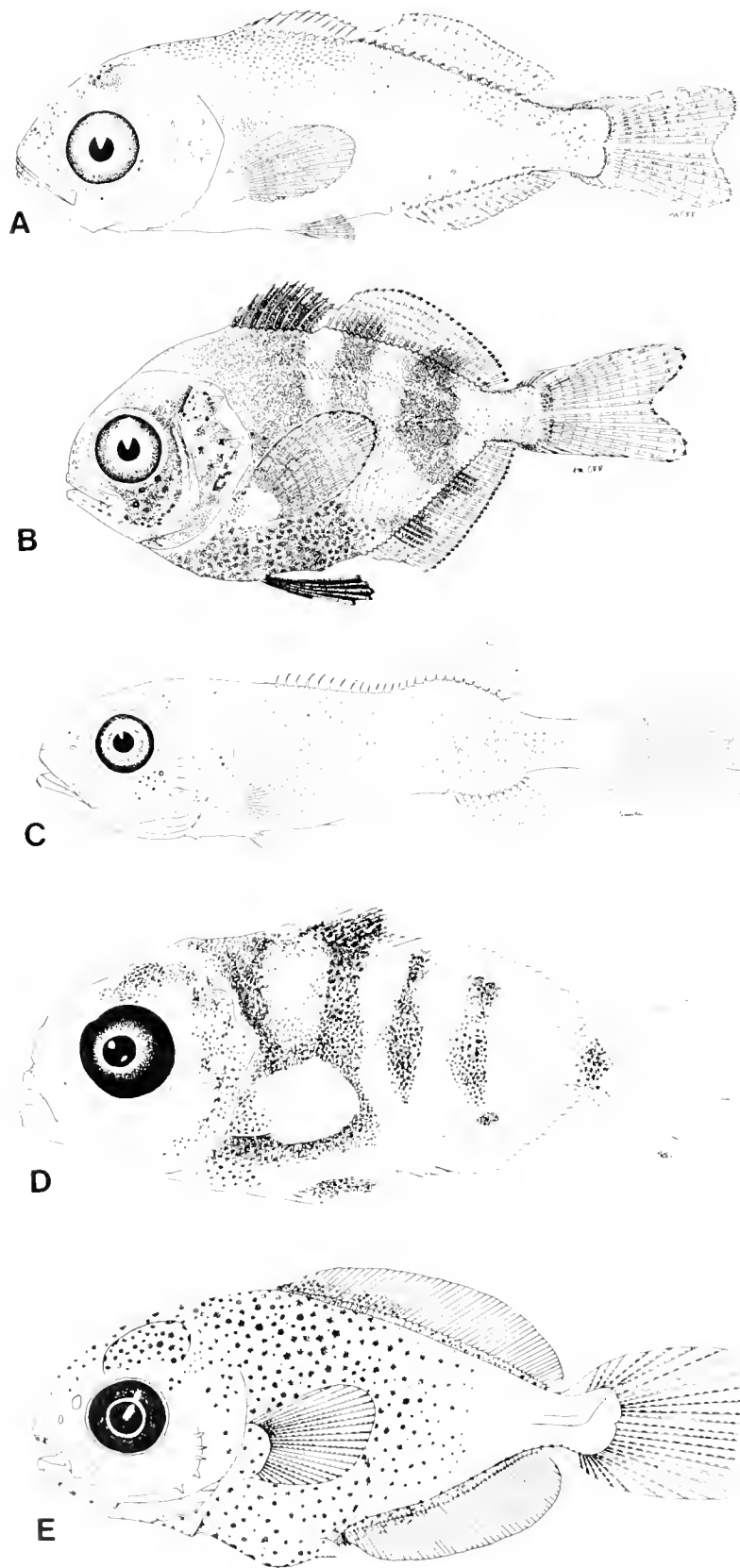

Fig. 334. Examples of stromateoid larvae and early juveniles. (A) *Cubiceps pauciradiatus* (Nomeidae), 17.5 mm early juvenile; (B) *Psenes cyanophrys* (Nomeidae), 19.1 mm early juvenile; (C) *Tetragonurus atlanticus* (Tetragonuridae), 17.2 mm postflexion larva; (D) *Ariomma* sp. (Ariommidae), 14.4 mm early juvenile, Gulf of Mexico; (E) *Peprilus simullimus* (Stromateidae), 10.8 mm postflexion larva. A–C from Ahlstrom et al. (1976), D drawn by Betsy Washington, E from D'Vincent et al. (1980).

TABLE 164. CHARACTERS AND CHARACTER STATES USED IN THE PHYLOGENETIC ANALYSIS OF STROMATEOID GENERA.

Character	Character state codes			
	0	1	2	3
1. Number of rows of premaxillary teeth	1	2		
2. Number of rows of dentary teeth	1	2		
3. Pharyngeal sac	absent	present		
4. Shape of pharyngeal sac	height > length	height ≈ length	height < length	
5. Arrangement of papillae in pharyngeal sac	10-20 bands	5-7 bands	not in bands	
6. Papillae on upper portion of pharyngeal sac	present	absent		
7. Position of papillae in pharyngeal sac	not on stalks	short stalks, teeth on end	long stalks, teeth along stalk	
8. Shape of papillae base in pharyngeal sac	round	stellate		
9. Condition of maxilla	mobile	fixed		
10. Supramaxillary bone	present	absent		
11. Lacrimal bone	prominent	reduced	highly reduced	
12. Relationship of gills to isthmus	free	united		
13. Pseudobranch	present	absent		
14. Scale type	cycloid	etenoid		
15. Opercular scalation	present	absent		
16. Preopercular scalation	present	absent		
17. Prominent preopercular spines	absent	present		
18. Number of branchiostegal rays	7	6	5	
19. Pelvic bone and fin	fin present	fin absent, bone with spine	fin absent, reduced bone	fin absent, highly reduced bone
20. Number of predorsal bones	3	2-3 ^a	0	7-12
21. Number of dorsal fins	1	2		
22. Keels on caudal peduncle	absent	present		
23. Number of hypurals	6	3-5	2	
24. Procurrent spur	present	reduced	absent	
25. Ray base preceding procurrent spur	shortened	slightly shortened	not shortened	
26. Juvenile pigmentation	uniform	patterned		
27. Primary juvenile association	independent	floating objects	inanimate floating objects	animate floating objects

^a This character state overlaps adjacent state but occurs in only one taxon (Girellidae).

ysis of stromateoid genera (Tables 164, 165; Fig. 335). The other characters were not used because they are not known for all genera or, if known, their values overlap and, therefore, cannot be coded without ambiguity.

The pharyngeal sac as a skeletal feature was a rich source of characters in developing the phylogenetic hypothesis for stromateoid genera. Five characters were used ranging from the shape of the sac to the arrangement, location and position of papillae within the sac (Tables 164, 165; Fig. 335).

Pigmentation.—Differences in pigmentation are mainly of value in distinguishing species within genera for which the larval and juvenile stages are relatively well known. Ahlstrom et al. (1976) used pigmentation patterns to demonstrate differences among species of oceanic stromateoid genera (see Figs. 333 and 334). Adults tend to be more uniform in pigmentation and, hence, offer fewer apparent taxonomic characters.

Stromateoids vary both in the density and in the pattern of their pigmentation. As larvae and early juveniles, some species, e.g., *Amarsipus carlsbergi* (Fig. 333A) are sparsely pigmented whereas others are more heavily pigmented, e.g., *Ichthyos lockingtoni* (Fig. 333C). Certain larvae and juveniles are rather uniformly pigmented, e.g., *Cubiceps pauciradiatus* (Fig. 334A), *Tetragonurus atlanticus* (Fig. 334C) and *Peprilus simillimus* (Fig. 334E) while others have their pigment concentrated into bands or blotches, e.g., *Schedophilus huttoni* (Fig. 333B), *Nomeus*

gronovi (Fig. 333D), *Psenes cyanophrys* (Fig. 334B) and *Ariomma* sp. (Fig. 334D). Ahlstrom et al. (1976) used various detailed patterns to distinguish the larvae, especially, and early juveniles of species within certain stromateoid genera. In the present study, uniform vs patterned pigmentation was the only pigmentation character available that could be coded unambiguously for all stromateoid genera (Tables 164, 165).

RELATIONSHIPS

Relationships within the Stromateoidei

Haedrich's (1967) analysis continues to be the major systematic work on stromateoid fishes. He recognized five families and two main lineages in the stromateoids. One lineage is composed of the Centrolophidae and its derivative, the Stromateidae. The other, a less compact assemblage, is comprised of the Nomeidae and its two derivatives, the Ariommidae and the Tetragonuridae. The Centrolophidae and the Nomeidae contain the basal stocks with the centrolophids having the more primitive members. Haedrich (1967) considered members of the centrolophid genus *Hyperoglyphe* to be the most generalized fishes in the suborder and probably not unlike the ancestral form. He viewed the Stromateidae as the current zenith of stromateoid evolution with *Pampus* as the most advanced stromateoid genus. In his interpretation of stromateoid relationships, Haedrich (1967) recognized trends in the evolution of several characters includ-

TABLE 165. MATRIX OF CHARACTER STATE CODES (see Table 164 and Fig. 335 for the stromateoid genera and for the three perciform families used as out-groups in the phylogenetic analysis). Dashes indicate characters that are inapplicable. Question marks indicate unknown character states and were designated as "missing observations" in the analysis.

Character	Stromateoid genera						
	<i>Amarsipus</i>	<i>Hyperoglyphe</i>	<i>Centrolophus</i>	<i>Schedophilus</i>	<i>Icichthys</i>	<i>Tubbia</i>	<i>Seriolella</i>
1. Number of rows of premaxillary teeth	0	0	0	0	0	0	0
2. Number of rows of dentary teeth	0	0	0	0	0	0	0
3. Pharyngeal sac	0	1	1	1	1	1	1
4. Shape of pharyngeal sac	—	0	0	0	0	0	0
5. Arrangement of papillae in pharyngeal sac	—	0	0	0	0	0	0
6. Papillae on upper portion of pharyngeal sac	—	0	0	0	0	0	0
7. Position of papillae in pharyngeal sac	—	0	0	0	0	0	0
8. Shape of papillae base in pharyngeal sac	—	0	0	0	0	0	0
9. Condition of maxilla	0	0	0	0	0	0	0
10. Supramaxillary bone	1	0	0	0	0	0	0
11. Lacrimal bone	1	0	0	0	0	0	0
12. Relationship of gills to isthmus	0	0	0	0	0	0	0
13. Pseudobranch	0	0	0	0	0	0	0
14. Scale type	0	0	0	0	0	0	0
15. Opercular scalation	1	0	0	0	0	0	0
16. Preopercular scalation	1	1	1	1	0	0	1
17. Prominent preopercular spines	0	0	0	1	0	0	0
18. Number of branchiostegal rays	1	0	0	0	0	0	0
19. Pelvic bone and fin	0	0	0	0	0	0	0
20. Number of predorsal bones	0	0	0	0	3	0	0
21. Number of dorsal fins	1	0	0	0	0	0	0
22. Keels on caudal peduncle	0	0	0	0	0	0	0
23. Number of hypurals	0	0	0	0	0	0	0
24. Procurrent spur	0	0	?	0	2	?	0
25. Ray base preceding procurrent spur	0	0	?	0	2	?	2
26. Juvenile pigmentation	0	1	1	1	1	1	1
27. Primary juvenile association	0	2	3	3	3	3	3

ing body size and shape, fin pattern, presence or absence of palatal dentition, shape of the papillae in the pharyngeal sacs and the number of branchiostegal rays, vertebrae and epural plus hypural elements in the caudal skeleton.

Haedrich (1969) in describing the Amarsipidae added a sixth family to the stromateoid suborder. This family exhibits a mixture of primitive and derived characters. It lacks pharyngeal sacs, but the pharyngeal teeth are extraordinarily developed and may perform a shredding function analogous to the sacs of other stromateoids. Haedrich (1967) argued that possession of a perciform caudal skeleton, uniserial jaw teeth, an expanded lacrimal bone, an inflated and protruding top of the head, an extensive subdermal canal system and a bony bridge over the anterior vertical canal of the ear provides the basis for placement of *Amarsipus* in the suborder Stromateoidei. He considered the new family to be distantly allied with the Nomeidae.

In the present study, a phylogeny of the 16 stromateoid genera was constructed using a set of 27 characters (Tables 164, 165) that could be coded for all genera with little or no overlap and ambiguity. Initially, a larger number of prospective characters (~65) were identified and evaluated. Comparison of stromateoids with presumed out-groups helped to generate characters and to establish polarity in the transformation series. Characters, however, were omitted if they could not be quantified or if insufficient information was available to characterize every taxon. In a few cases, character states were coded as "missing observations" if three or fewer genera required this coding and the characters were judged important in resolving relationships between the other genera.

Three closely related perciform families—Girellidae, Ky-

phosidae and Scorpididae—were used as potential out-groups in the analysis (see below for rationale). Although these three taxa are frequently classified as subfamilies of the Kyphosidae (e.g., Nelson, 1976), G. D. Johnson (pers. comm.) considers them to be distinct families.

The analysis was performed using the PHYSYS package which differentiates taxa based on the presence of shared derived characters (synapomorphies). Several phylogenetic trees were generated from the genus-character data matrix using the Wagner distance algorithm (see Farris, 1970; Wiley, 1981). These trees were diagnosed to identify the origin of each apomorphy and to examine character reversals and convergences. Transformation Series Analysis was performed on the data to verify polarities developed through out-group comparison (see Mickevich, 1982) and to resolve nonlinear series. Further optimizing produced the most parsimonious tree from the data matrix (Fig. 335).

This phylogenetic tree (Fig. 335) was basically similar, with certain exceptions, to that proposed by Haedrich (1967). *Hyperoglyphe* emerged as the most plesiomorphic stromateoid taxon possessing a pharyngeal sac and *Pampus* as the genus with the greatest number of apomorphies. *Ariomma* also ranked as a highly derived genus in the suborder. Despite its several synapomorphies with advanced stromateoid genera, *Amarsipus* emerged as the sister taxon of all other stromateoid genera primarily because it lacks a pharyngeal sac. The major differences between the present analysis and Haedrich's interpretation lie with the relationships of *Ariomma* and *Tetragonurus* to other stromateoids and with the family limits of the suborder. Based on the cladogram, *Tetragonurus* and *Ariomma* are more closely

TABLE 165. EXTENDED.

Stromateoid genera									Perciform families		
<i>Psenopsis</i>	<i>Cubiceps</i>	<i>Nomeus</i>	<i>Psenes</i>	<i>Ariommia</i>	<i>Tetragonurus</i>	<i>Stromateus</i>	<i>Peprilus</i>	<i>Pampus</i>	Kyphosidae	Scorpididae	Girellidae
0	0	0	0	0	0	0	0	0	0	1	1
0	0	0	0	0	0	0	0	0	0	1	1
1	1	1	1	1	1	1	1	1	0	0	0
0	0	0	0	2	2	1	1	1	—	—	—
0	1	1	1	2	2	2	2	2	—	—	—
0	0	0	0	1	0	0	0	0	—	—	—
0	1	1	1	2	1	2	2	2	—	—	—
0	1	1	1	0	0	1	1	1	—	—	—
0	0	0	0	0	0	0	0	1	0	0	0
1	1	1	1	1	1	1	1	1	0	0	0
0	0	0	0	0	0	1	1	2	0	0	0
0	0	0	0	0	0	0	0	1	0	0	0
0	0	0	0	0	0	0	0	1	0	0	0
0	0	0	1	0	1	0	0	0	1	1	1
1	0	0	0	1	0	0	0	0	0	0	0
1	0	0	0	1	0	0	0	0	0	0	0
0	0	0	0	0	0	0	0	0	0	0	0
0	1	1	1	1	1	1	1	2	0	0	1
0	0	0	0	0	0	3	1	2	0	0	0
0	0	0	0	0	2	0	0	0	0	0	1
0	1	1	1	1	1	0	0	0	0	0	0
0	0	0	0	1	1	0	0	0	0	0	0
0	1	1	1	2	1	1	1	1	1	1	1
?	1	0	0	2	2	0	0	0	0	0	0
?	1	1	2	2	2	2	2	2	0	0	2
0	0	1	1	1	0	1	0	0	1	0	0
3	3	3	1	0	3	3	3	3	1	0	1

related to the stromateids than to the nomeids as proposed by Haedrich (1967). Of the six families recognized by Haedrich and Horn (1972), only the Amarsipidae, Nomeidae and Stromateidae appear to be monophyletic based on the generic relationships expressed in the cladogram. The Centrolophidae, on the other hand, lacks a synapomorphy and there is no indication that Tetragonuridae and Ariommidae should be considered distinct families. Additional characters, however, should be examined before a change in classification is proposed.

The Scorpididae and Girellidae were part of a trichotomy at the base of the tree and together formed the plesiomorphic out-group cluster in the analysis.

Character diagnosis showed that reversals in character transformation occurred most frequently (≥ 3 taxa or stems/character state) for scale type (no. 14) and juvenile pigmentation (no. 26). In the same diagnosis, character convergences occurred most often for the supramaxillary bone (no. 10), opercular scalation (no. 15), number of branchiostegal rays (no. 18), number of dorsal fins (no. 21) and juvenile associations (no. 27). *Amarsipus* was involved in all five of these cases of apparent convergence, an indication of its uncertain phylogenetic position.

The tree remains incompletely resolved with three polychotomies (Fig. 335). In addition to the trichotomy at the base of the tree, the other two nodes with multiple branches involve centrolophid genera. Lack of full resolution in this region of the tree indicates that further work is needed to clarify the intergeneric relationships of the Centrolophidae. Extending the analysis to the species level would provide greater resolution.

Strictly larval or juvenile characters have contributed little to

the broad understanding of stromateoid intergeneric relationships as perceived by Haedrich (1967) or as analyzed in the present study. Elimination of the two juvenile characters (pigmentation and associations) from the present analysis resulted in a tree virtually identical to that with them included (Fig. 335). The study of the early life history stages of pelagic stromateoids by Ahlstrom et al. (1976), however, is a major contribution to stromateoid systematics especially in developing an approach that can potentially expand to all taxa in the suborder. Their use of ontogenetic characters was important at the species level and particularly valuable in distinguishing the species and genera of nomeids.

Characters employed by Ahlstrom et al. (1976) that hold promise for resolving relationships among stromateoids in general include (1) sequence of fin formation, (2) arrangement of anal fin pterygiophores in relation to haemal spines, (3) head armature and (4) pigmentation patterns. The caudal fin complex, while not representing a strictly ontogenetic suite of features, also appears likely to provide characters if a full spectrum of cleared and stained larvae are carefully examined. Finally, the various types of associations juvenile stromateoids hold with floating objects may be more specific than generally thought and could become a rich source of characters.

Relationships of the Stromateoidei to other groups

Haedrich (1967) in his review of stromateoid systematics proposed that the group arose from within a relatively undifferentiated assemblage of perciform families including the Arri-

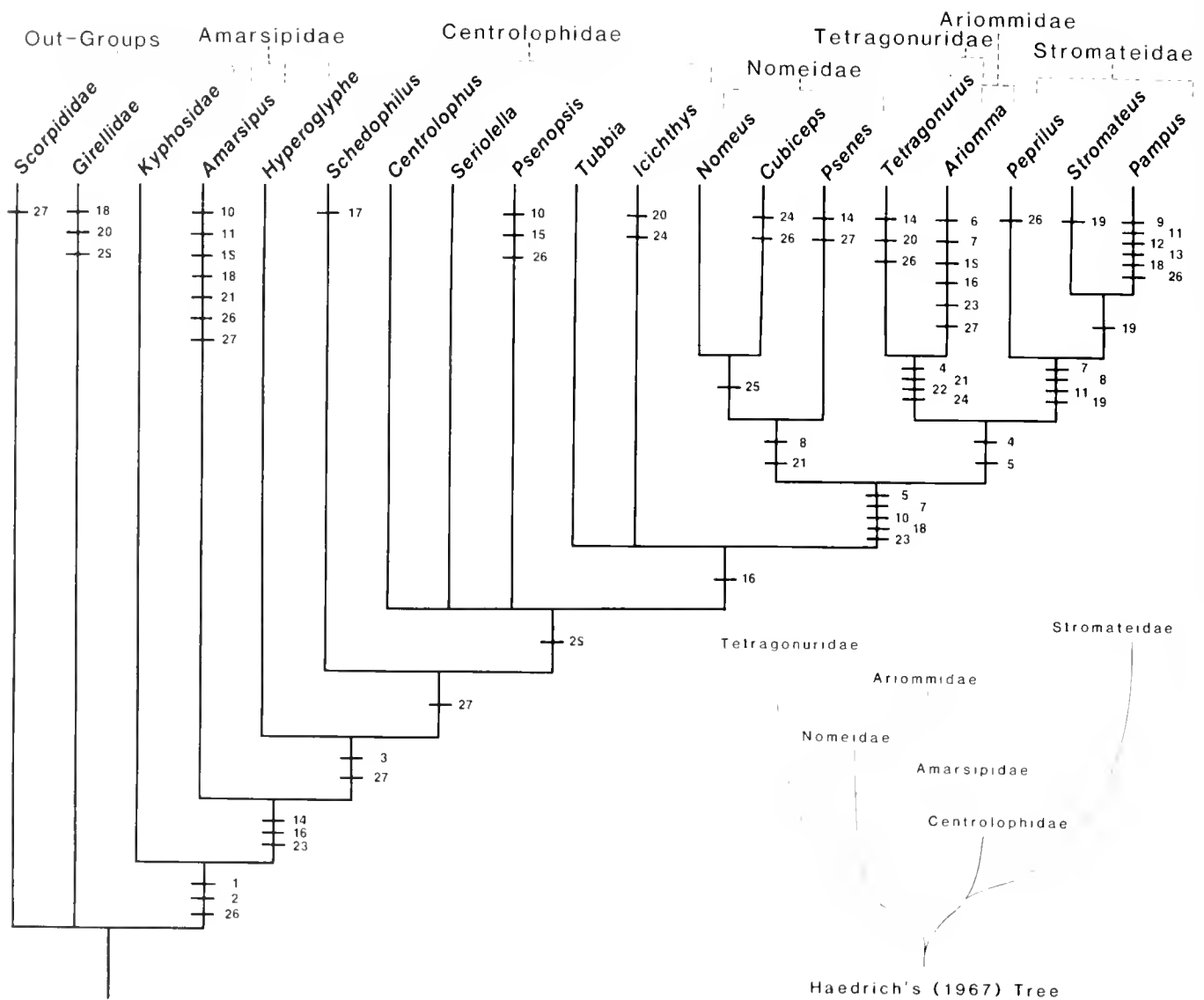

Fig. 335. Phylogenetic hypothesis of relationships among the genera of stromateoid fishes. The perciform families Scorpididae, Girellidae and Kyphosidae are out-groups. Each number represents a character and each horizontal bar represents a character state indicating a synapomorphy or autapomorphy. Character transformation series 1–27 are shown in Table 165. Relationships of the stromateoid families as perceived by Haedrich (1967) are shown, with addition of the Amarsipidae, in the lower right. Limits of the six stromateoid families as recognized by Haedrich and Horn (1972) are shown at the top of the cladogram.

pididae, Girellidae, Kuhliidae, Kyphosidae, Pomatomidae, Scorpididae and Theraponidae. All are Pattern-10 teleosts in terms of the *ramus lateralis accessorius* (a facial nerve complex) and have a bony bridge over the anterior vertical canal of the ear. Of these families, the Kyphosidae bear a strong resemblance to the Centrolophidae, the most primitive stromateoids. Haedrich (1967) implicitly favored the hypothesis that the kyphosids are the closest perciform relatives of the most primitive stromateoids pointing out that both have 10 + 15 vertebrae, a caudal skeleton with six hypural and three epural elements (actually five hypurals in kyphosids), a perforate ceratohyal, seven branchiostegals, an expanded lacrimal bone and scaled fin bases. The present analysis (Fig. 335) supports this hypothesis.

Ontogenetic characters have not been used previously in ana-

lyzing the relationships of stromateoids to other perciform groups. Use of the two juvenile characters in the present analysis did not alter the phylogeny based on adult characters. Although they were not examined in the present study, kyphosid larvae are more generalized than girellid or scorpidid larvae and, therefore, more similar to stromateoid larvae (G. D. Johnson, pers. commun.). The generalized nature of stromateoid larvae suggests that their characters will continue to be most useful in distinguishing species (e.g., Ditty and Truesdale, 1983) and less valuable at higher levels of classification.

DEPARTMENT OF BIOLOGICAL SCIENCE, CALIFORNIA STATE UNIVERSITY, FULLERTON, CALIFORNIA 92634.

Gobiesociformes: Development and Relationships

L. G. ALLEN

THE Gobiesociformes includes three families, the Gobiesocidae, Callionymidae and Draconettidae, according to Gosline (1970) and Nelson (1976). Members of this order are primarily marine bottom-dwellers in shallow-waters and occur worldwide in tropical and temperate seas. Distinguishing characteristics of the order include: a scaleless head and body; 5-7 branchiostegal rays; no circumorbital bones behind the lacrimal; articular processes of the premaxillae either fused with ascending process or absent; pelvic fin base well in advance of pectoral fin; no swim bladder (in adults) (Nelson, 1976). The order contains about 54 genera with 246 species in the three families (Briggs, 1955; Nakabo, 1982a, b).

Briggs' (1955) review of the Gobiesocidae remains as the most thorough treatment of this family to date. Revisions of both the Callionymidae and the Draconettidae have recently been pub-

lished by Nakabo (1982a, b). Hypotheses of systematic relationships within the families are based entirely on adult characteristics.

The Callionymidae (dragonets) is a large and diverse group within the Gobiesociformes. The ontogeny and systematics of the Callionymidae is presented in this volume by E. D. Houde.

The smallest family of the order, the Draconettidae, consists of two genera and seven species (Nakabo, 1982a). Draconettids are small demersal fishes inhabiting sand-mud bottoms along the edge of the continental shelf or on seamounts. They occur widely in tropical and temperate waters of the world except the eastern Pacific. Adult draconettids resemble callionymids which lead one author (Davis, 1966) to include the draconettids within the Callionymidae. Gosline (1970) and Nakabo (1982a) disagreed with this inclusion.

TABLE 166. EGG CHARACTERISTICS OF 18 SPECIES OF GOBIESOCIDS FOR WHICH LARVAE ARE KNOWN ORGANIZED INTO SUBFAMILIES AFTER BRIGGS (1955).

Species-Reference	Subfamily	Shape	Egg characteristics				
			Size (mm) (long axis)	Number eggs in mass	Oil globules	Color	Where laid
<i>Conidens laticephalus</i> (Shiogaki and Dotsu, 1971d)	Trachelochisminae	flat, ellipsoid	1.28-1.38	77-109	+	green-orange	under rock
<i>Trachelochismus melobesia</i> (Ruck, 1971)	Trachelochisminae	flat, oval	\bar{x} = 1.65	3-~300	10-100	red, pink	under rock
<i>Trachelochismus pinnulatus</i> (Ruck, 1973b)	Trachelochisminae	oval	\bar{x} = 1.81	198-1,500	1-6	yellow-red	under rock
<i>Lepadogaster lepadogaster</i> (Gütel, 1888; Russell, 1976)	Lepadogastrinae	flat, oval	1.8-1.9	200-250	1	yellow/amber	under rock
<i>Lepadogaster candolei</i> (Gütel, 1888; Russell, 1976)	Lepadogastrinae	flat, oval	1.2	—	1	yellow	under rock
<i>Apletodon microcephalus</i> (Gütel, 1888; Russell, 1976)	Lepadogastrinae	—	—	—	1 to several	—	kelp stems
<i>Diplecogaster bimaculata</i> (Gütel, 1888; Russell, 1976)	Lepadogastrinae	flat, oval	1.37-1.54	—	1	—	empty shells
<i>Diplocrepis puniceus</i> (Ruck, 1973b)	Diplocrepinae	spherical	1.80	<2,400	20-30	purple	under rock
<i>Gastroscyphus hectoris</i> (Ruck, 1976)	Diplocrepinae	—	—	—	—	—	—
<i>Gastrocyathus gracilis</i> (Ruck, 1976)	Diplocrepinae	—	—	—	—	—	—
<i>Acrytops beryllinus</i> (Gould, 1965)	Gobiesocinae	oval	1.1	2-40	2.5	green-yellow	<i>Thalassia</i> blades
<i>Gobiesox maeandricus</i> (Allen and Ilg, 1983)	Gobiesocinae	oval	1.68-1.92	—	—	—	under rock
<i>Gobiesox rhessodon</i> (Allen, 1979)	Gobiesocinae	oval	—	150-200	—	orange	under rock
<i>Gobiesox strumosus</i> (Runyan, 1961; Dovel, 1963)	Gobiesocinae	elongate oval	0.75-0.94	650-2,500	70-80	—	empty shells
<i>Rimicola muscarum</i> (Allen, 1979)	Gobiesocinae	—	—	—	—	—	kelp blades
<i>Lepadichthys frenatus</i> (Shiogaki and Dotsu, 1971b, c)	Diademichthyinae	flat, ellipsoid	1.31-1.36	240-301	1-6	—	shell
<i>Aspasma minima</i> (Shiogaki and Dotsu, 1971a)	Aspasminae	ellipsoid	1.25-1.35	140-619	20	yellow	under rock
<i>Aspasmichthys ciconiae</i> (Shiogaki and Dotsu, 1972d)	Aspasminae	—	—	—	—	—	—

TABLE 167. LARVAL CHARACTERISTICS OF 18 SPECIES OF GOBIESOCIDS FOR WHICH LARVAE ARE KNOWN ORGANIZED INTO SUBFAMILIES AFTER BRIGGS (1955). See Fig. 338 for abbreviations for regions of pigmentation (coding of pigment patterns depended on illustrations in most species. * denotes counts on older postflexion larvae).

Species Reference	Subfamily	Pigmentation (left side)			
		DH	DT	LT	DG
<i>Contidens laticephalus</i> (Shiogaki and Dotsu, 1971d)	Trachelochisminae	5	6-10	3-7	11-15
<i>Trachelochismus melobesia</i> (Ruck, 1971)	Trachelochisminae	0	0	0	26-35
<i>Trachelochismus pinnulatus</i> (Ruck, 1973b)	Trachelochisminae	0	0	0	14
<i>Lepadogaster lepadogaster</i> (Guitel, 1888; Russell, 1976)	Lepadogastrinae	8	23-24	43	11
<i>Lepadogaster candolei</i> (Guitel, 1888; Russell, 1976)	Lepadogastrinae	4	0	5-6	0
<i>Apletodon microcephalus</i> (Guitel, 1888; Russell, 1976)	Lepadogastrinae	4	15	36	13
<i>Diplecogaster bimaculata</i> (Guitel, 1888; Russell, 1976)	Lepadogastrinae	0-4	13-25	32-62	0
<i>Diplocrepis puniceus</i> (Ruck, 1973b)	Diplocrepinae	0	0	30-50	19-23
<i>Gastroscyphus hectoris</i> (Ruck, 1976)	Diplocrepinae	0	0	2-3	19-23
<i>Gastrocyathus gracilis</i> (Ruck, 1976)	Diplocrepinae	0	0-2	7-10	15-25
<i>Acrytops beryllinus</i> (Gould, 1965)	Gobiesocinae	?	+	+	+
<i>Gobiesox macandricus</i> (Allen and Ilg, 1983)	Gobiesocinae	0	0	0	9-15
<i>Gobiesox rhessodon</i> (Allen, 1979)	Gobiesocinae	0-5	0	8-17	13-15
<i>Gobiesox strumosus</i> (Runyan, 1961; Dovel, 1963)	Gobiesocinae	0-10	10-15	0-24*	9-12
<i>Rimicola muscarum</i> (Allen, 1979)	Gobiesocinae	7	0	10-50	21
<i>Lepadichthys frenatus</i> (Shiogaki and Dotsu, 1971b, c)	Diademichthyinae	5-12	15-21	70-105	12-19
<i>Aspasma minima</i> (Shiogaki and Dotsu, 1971a)	Aspasminae	0	0*-13	10-13	7-17
<i>Aspasmichthys ciconiae</i> (Shiogaki and Dotsu, 1972d)	Aspasminae	5	16-17	24-31	6-7

The early life history stages of draconettids are unknown at this time. Therefore, the Draconettidae will receive little further attention in this paper.

The Gobiesocidae (clingfishes) is a diverse group of primarily shallow water or intertidal marine (although a few species are freshwater) fishes consisting of about 33 genera and 100 species. Clingfishes occur along tropical and temperate shores in the Atlantic, Indian and Pacific Oceans. Distinguishing characteristics of gobiesocids include: pelvic fins modified into a thoracic suction disc; pelvic fin with one small modified spine and four or five soft rays; single dorsal fin without spines; no basibranchials; vertebrae 25-54 (or 78 if the genus *Alabes* is included, see below); lateral line confined to head; two postcleithra; hypurals fused into a single plate. Most species are small (normally <70 mm), but a few attain relatively large size (up to 300 mm) (Nelson, 1976). Eight subfamilies are recognized (Briggs, 1955). Springer and Fraser (1976) synonymized the family Cheilobranchiidae (=Alabetidae) with the Gobiesocidae based on shared specializations particularly of the structure of the joint between the supracleithrum and cleithrum. If valid, this synonymy adds one more genus (*Alabes*) and four species to the Gobiesocidae.

DEVELOPMENT

Eggs

Spawning occurs in rocky intertidal or subtidal areas. Eggs are demersal and are attached to the underside of rocks or shells or on kelp blades. The adults (usually the male) guard the eggs during development. Eggs are ovate to ellipsoidal in shape and range from about 0.7 to 1.9 mm in greatest dimension (Table 166). The monolayered egg masses usually contain between 100 and 600 eggs with some reports of up to 2,500 eggs in a patch (*Gobiesox strumosus*) (Table 166). The initial coloration of the eggs ranges between purple and green (with pink, yellow and orange predominating). Eggs contain anywhere from one to 100

oil globules depending on species and stage of development. As development proceeds, oil globules tend to coalesce ultimately into one.

Larvae

Larvae of 18 species of gobiesocids have been described in varying detail (Table 167). Larval series are available for 10 of these species. Larvae are well developed at hatching and possess functional jaws, fully pigmented eyes, body pigment similar to that of later larval stages and a small (sometimes bilobed) yolk sac in most species which is probably absorbed soon after hatching. Size at hatching ranges from 2.4 mm in *Gobiesox strumosus* to 6.8 mm in *G. macandricus* and appears to be related to egg size and maximum size of the adults (Table 168). Larvae are cylindrical and somewhat laterally compressed becoming more robust with growth. All clingfish larvae have long, underslung guts which usually extend beyond the midline of the body (preanal length 50-70% SL) in both pre- and postflexion larvae. Size at notochord flexion was difficult to determine from most of the larval descriptions, but generally ranged between 5.0 and 8.0 mm depending on the species (Table 167). Gobiesocid larvae have well-developed swimbladders in the early stages of development which are located in the dorso-anterior portion of the peritoneal cavity. In several species the swimbladder is hidden by the heavy pigmentation on the dorsum of the gut. No sudden change occurs at settlement; rather, larvae gradually attain juvenile characteristics. Size at settlement is, therefore, difficult to determine. Juvenile characteristics are attained at a wide range of sizes (6.3-13.0 mm) with a trend toward larger species "settling" at larger sizes (Tables 167 and 168). Presumably, the loss of the swimbladder occurs during settlement.

Most gobiesocid larvae are heavily pigmented. Furthermore, the numbers and patterns of the large, stellate melanophores on the body are species specific, and are invaluable in the identification of species (Figs. 336 and 337). Melanophores occur primarily in the seven regions designated in Fig. 338. Larvae of

TABLE 167. EXTENDED.

Pigmentation (left side)			Myomere count	Size (mm) at				Prenatal length SL (%)	
LG	VG	PV		Hatching	Notochord flexion	Onset of P ₂ develop	Settling	Preflexion	Postflexion
0	11-14	4-5	26-31	3.4	4.5-5.5	4.5	6.3	61.4	72.4
0	0	5-9	31-36	4.8-5.5	6.3-7.0	6.5	7.8?	62.9	64.9
0	0	0	31	5.3-6.1	—	—	—	59.6	—
16	13	12	—	5.1	—	—	—	62.1	—
12	1	9	—	5.0-6.0	—	6.5?	—	57.2	—
20	0	2	—	—	—	—	7.0?	59.9	—
15-20	19	0	—	3.0-4.3	4.5-6.5	8.0	—	63.5	72.4
9-26	0	5-6	—	5.0-6.0	6.2-7.7	7.7	—	65.7	65.0
0	3	12-16	—	—	—	—	—	61.8	60.2
4-7	4	0-1	—	—	5.5-6.9	—	—	60.7	72.3
+	+	?	—	2.6	—	—	—	—	—
0	0	9-16	32-35	5.6-6.8	6.7-7.0	7.3	13.0	50.0	63.6
0	0	4-7	24-29	3.9-4.1	5.5-6.9	5.5	~10.0	58.0	68.0
0	0-1	4-8	28-29	2.4-3.4	4.7-6.5	6.6	~12.0	61.4	72.9
0	0	0	—	4.0	—	—	—	55.3	—
0-4	0	9-14	36-37	4.2	6.0	6.0	9.9	58.8	79.0
0-12	2-4	6-12	35	3.6-4.0	5.5-6.8	4.5	6.7-7.4	67.3	76.7
6-21	14-15	0	—	—	—	—	—	62.7	75.5

each species exhibit a unique distribution of melanophores within and among these regions (Table 167). The distribution of melanophores within regions can be coded. For example, *Conidens laticephalus* has a pigment pattern which can be designated as the following: DH5, DT6-10, LT3-7, DG11-15, LG0, VG11-14, PV4-5. *Trachelochismus melobesia* by the same process is designated as: DH0, DT0, LT0, DG26-35, LG0, VG0, DV5-9. If adopted, this system of coding pigment patterns will serve two purposes. It will greatly aid identification of clingfish larvae and will also lead to more comparable descriptions of gobiesocid larvae in the future.

Pigment patterns do not appear to be related to phylogenetic hypotheses based on adult characteristics. In virtually all known cases closely related species (subfamilial levels) tend to have noticeably different patterns and often range from heavily to lightly pigmented (Table 167). Within the Trachelochisminae, *Conidens laticephalus* is heavily pigmented while both *Trachelochismus melobesia* and *T. pinnulata* are lightly pigmented. The same pattern is exhibited in all other subfamilies (Table 167) especially the Lepadogastrinae and Gobiesocinae (particularly in the genus *Gobiesox*). Members of subfamilies often overlap in their distributions (Briggs, 1955). Diverse pigment patterns among closely related, sympatric clingfish larvae may well represent ecotypic variation. Heavily pigmented larvae often live in surface waters where the pigmentation may protect them against solar radiation or serve as protective coloration (Moser, 1981). Less pigmentation may indicate that the larvae normally occur deeper in the water column where irradiance does not present problems for development.

Only a few published descriptions included myomere counts. Those accounts which did revealed a range from 24 up to 37 (Table 167). The number of myomeres appears to have great diagnostic value in some cases when used in conjunction with pigment, i.e., among the species of *Gobiesox* (Table 167). The lack of myomere count data among the described gobiesocid larvae may, in part, be due to the difficulty in counting caused

by heavy trunk pigmentation. Nonetheless, it is unfortunate that this important character has not received greater attention especially since vertebral counts are not available for many species. Adult characteristics which are valuable for identifying older larvae are also included in Table 168.

The most distinctive characteristic of clingfishes is the suction disc which is supported by the pelvic fins and distal postcleithra of the pectoral girdle. The two types of discs are found in gobiesocids. The "double" disc has a small, posterior disc with a free anterior margin separating it from an anterior disc. In the "single" disc the anterior and posterior portions are coalesced into one continuous structure (Briggs, 1955). The onset of suction disc development occurs fairly early in larval development (ranges from 4.5 to 8.0 mm SL) and appears to be closely allied to time of notochord flexion in most species (Table 167). Disc development does not appear to differ appreciably between single and double disc types except that in the single type a consistent connection remains between the anterior and posterior elements throughout development (Fig. 339). The completion of the suction disc is undoubtedly critical in late larval stages. Settlement seems unlikely to occur without a functional disc.

Specialized glandular tissues appear on the body surface and out onto the finfolds in several species of gobiesocids (Shiogaki and Dotsu, 1971b; Allen and Ilg, 1983). Although these structures are not specifically mentioned in other descriptions, illustrations of larvae from some of these studies include structures in the finfolds which may be these same glandular tissues. Further studies are needed to ascertain the extent of this specialization within the Gobiesocidae and the possible function of these tissues.

RELATIONSHIPS

The systematic relationships among the Gobiesocidae were addressed, as previously mentioned, by Briggs (1955). His eight subfamilies reflected both morphological similarities and zoogeographic distributions (subfamilies occupy fairly distinct re-

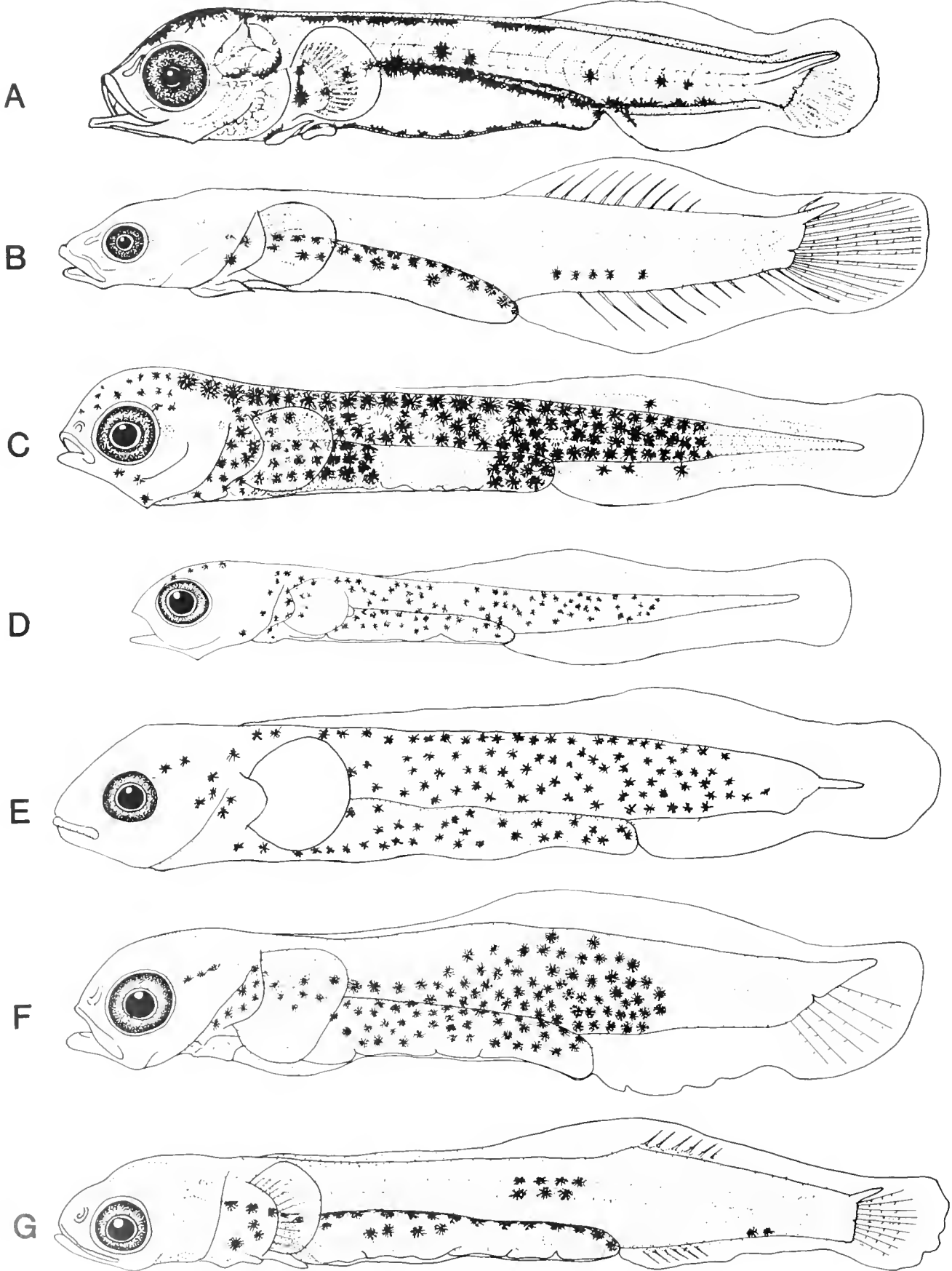

TABLE 168. ADULT CHARACTERISTICS FOR 18 SPECIES OF GOBIESOCIDS FOR WHICH LARVAE ARE KNOWN ARRANGED BY SUBFAMILY (BRIGGS, 1955).

Species/Reference	Subfamily	No. dorsal rays	No anal rays	No pectoral rays	No. caudal rays	No vertebrae	Max length (mm SL)	General distribution
<i>Conidens laticephalus</i> (Shiogaki and Dotsu, 1971d)	Trachelochisminae	7-9	5-7	19-20	11-13	28	33.0	Southern Japan
<i>Trachelochismus melobesia</i> (Ruck, 1971)	Trachelochisminae	9-11	7-8	22-24	12	—	30.0	New Zealand
<i>Trachelochismus pinnulatus</i> (Ruck, 1973b)	Trachelochisminae	7-9	5-7	24-26	11-12	—	71.2	New Zealand
<i>Lepadogaster lepadogaster</i> (Gütel, 1888; Russell, 1976)	Lepadogastrinae	16-19	9-11	20-23	12-13	—	65.0	NE Atlantic/ Mediterranean
<i>Lepadogaster candolei</i> (Gütel, 1888; Russell, 1976)	Lepadogastrinae	13-16	9-11	26-29	10-13	—	75.0	NE Atlantic/ Mediterranean
<i>Apletodon microcephalus</i> (Gütel, 1888; Russell, 1976)	Lepadogastrinae	5-6	5-7	21-24	10-11	—	41.6	NE Atlantic/ Mediterranean
<i>Diplecogaster bimaculata</i> (Gütel, 1888; Russell, 1976)	Lepadogastrinae	5-7	4-6	21-25	9-10	—	41.0	NE Atlantic/ Mediterranean
<i>Diplocrepis puniceus</i> (Ruck, 1973b)	Diplocrepinae	10-11	4-5	23-24	10	—	100.0	New Zealand
<i>Gastrosocyphus hectoris</i> (Ruck, 1976)	Diplocrepinae	6-8	6-7	20-22	8	—	43.6	New Zealand
<i>Gastrocyathus gracilis</i> (Ruck, 1976)	Diplocrepinae	5-6	5-7	18-19	8	—	31.0?	New Zealand
<i>Acrytops beryllinus</i> (Gould, 1965)	Gobiesocinae	5-7	5-7	19-23	10	—	20.0	NW Atlantic
<i>Gobiesox maeandricus</i> (Allen and Ilg, 1983)	Gobiesocinae	14-16	13-15	21-23	11-13	32-34	114.0	NE Pacific
<i>Gobiesox rhesodon</i> (Allen, 1979)	Gobiesocinae	12-14	11-12	18-21	11-12	28-29	39.3	NE Pacific
<i>Gobiesox strumosus</i> (Runyan, 1961; Dovel, 1963)	Gobiesocinae	10-13	9-11	22-26	11-13	25-27	69.3	NW Atlantic
<i>Rimicola muscarum</i> (Allen, 1979)	Gobiesocinae	6-8	6-8	14-16	8	35-36	53.2	NE Pacific
<i>Lepadichthys frenatus</i> (Shiogaki and Dotsu, 1971b, c)	Diademichthyinae	15-17	12-15	25-31	11	—	52.5	W Pacific
<i>Aspasma minima</i> (Shiogaki and Dotsu, 1971a)	Aspasmae	7-9	6-9	21-24	8-9	—	52.3	NW Pacific
<i>Aspasmichthys ciconiae</i> (Shiogaki and Dotsu, 1972d)	Aspasmae	11-13	8-9	23	10-11	—	56.0	NW Pacific

gions of the world). The relationships among the subfamilies were based primarily on four characters: the number of gill arches; gill membrane state; type of suction disc and dentition type.

In my opinion, the evolutionary scheme presented in Briggs (1955) is in drastic need of revision from a cladistic viewpoint. The independent derivation of the single suction disc and mixed derived character states in several divergent evolutionary lines, plus the "evolution" of one subfamily from another through primitive and derived genera are particularly troubling aspects of his analysis.

Gosline (1970) was first to include the Callionymidae, Draconettidae and Gobiesocidae in the order Gobiesociformes. According to Gosline (1970) the three families share a number of characteristics including a scaleless head and body, no circum-orbital bones behind lacrimal, articular processes of the pre-

maxillae, as well as others (see Gosline, 1970: 365 and 377). These similarities coupled with evidence that, in Gosline's words, "the Gobiesocidae has evolved from the notothenoid section of the perciform suborder Blennioidei and in small part at least over the same route as the draconettids and callionymids" form the basis for including all three families in the order Gobiesociformes.

Greenwood et al. (1966) placed the Gobiesociformes which included only the Gobiesocidae into the superorder Paracanthopterygii in their provisional classification of teleostean fishes. Apparently this placement was based on a relationship between batrachoidids and gobiesocids proposed by Briggs (1955) and McAllister (1968), although Briggs did note some resemblance between the Gobiesocidae and the Callionymoidea. Gosline (1970) believed that characteristics held in common by gobiesocoid and batrachoid fishes (e.g., the usually scaleless body,

Fig. 336. Representative larvae of seven genera within the Gobiesocidae: (A) *Conidens laticephalus*, 5.5 mm (from Shiogaki and Dotsu, 1971d); (B) *Trachelochismus melobesia*, 7.8 mm (after Ruck, 1971); (C) *Lepadogaster lepadogaster*, 6.0 mm (after Russell, 1976); (D) *Apletodon microcephalus*, 4.5 mm (after Russell, 1976); (E) *Diplecogaster bimaculata*, 6.5 mm (after Russell, 1976); (F) *Diplocrepis puniceus*, 7.7 mm (after Ruck, 1973b); and (G) *Gastrocyathus gracilis*, 6.9 mm (after Ruck, 1976).

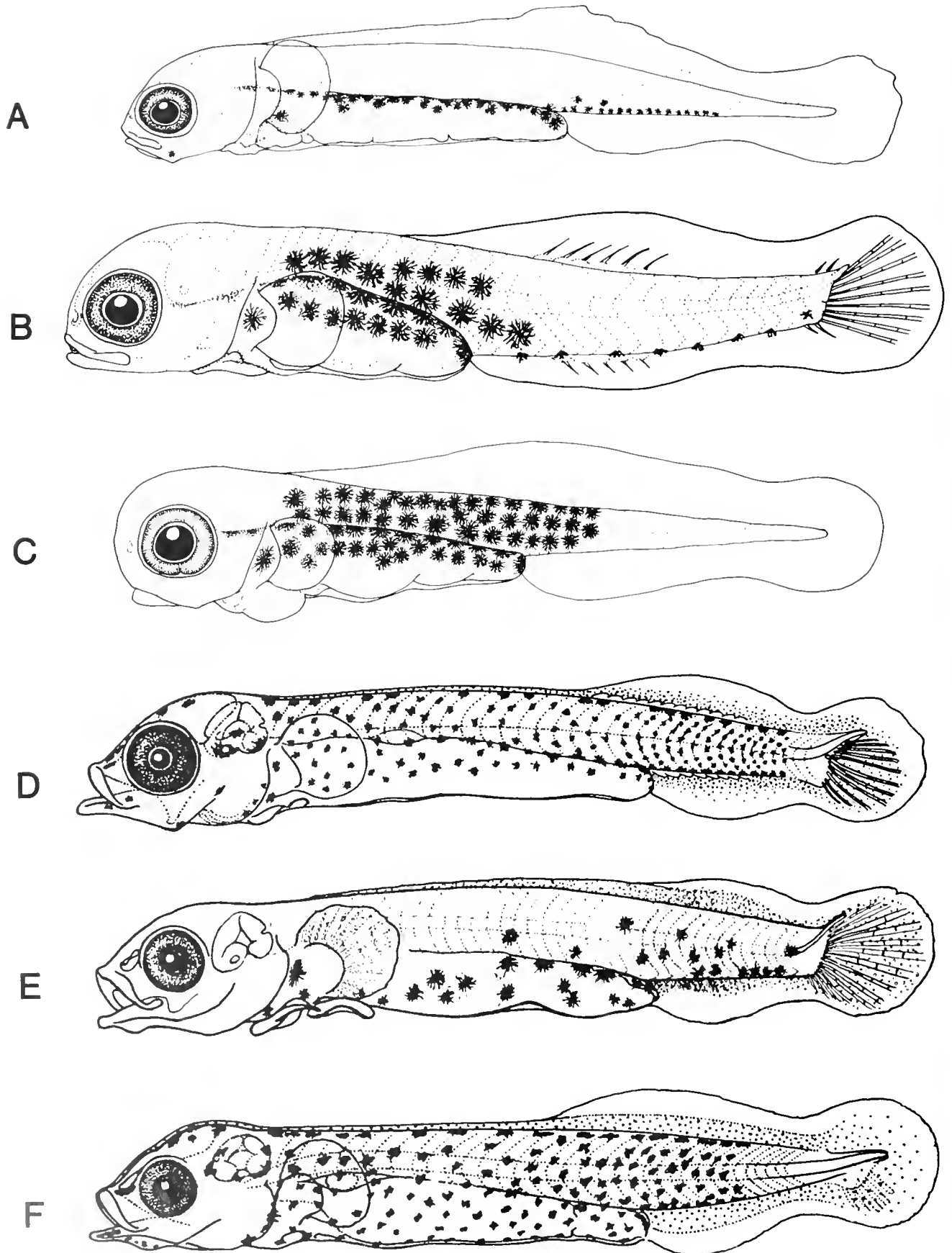

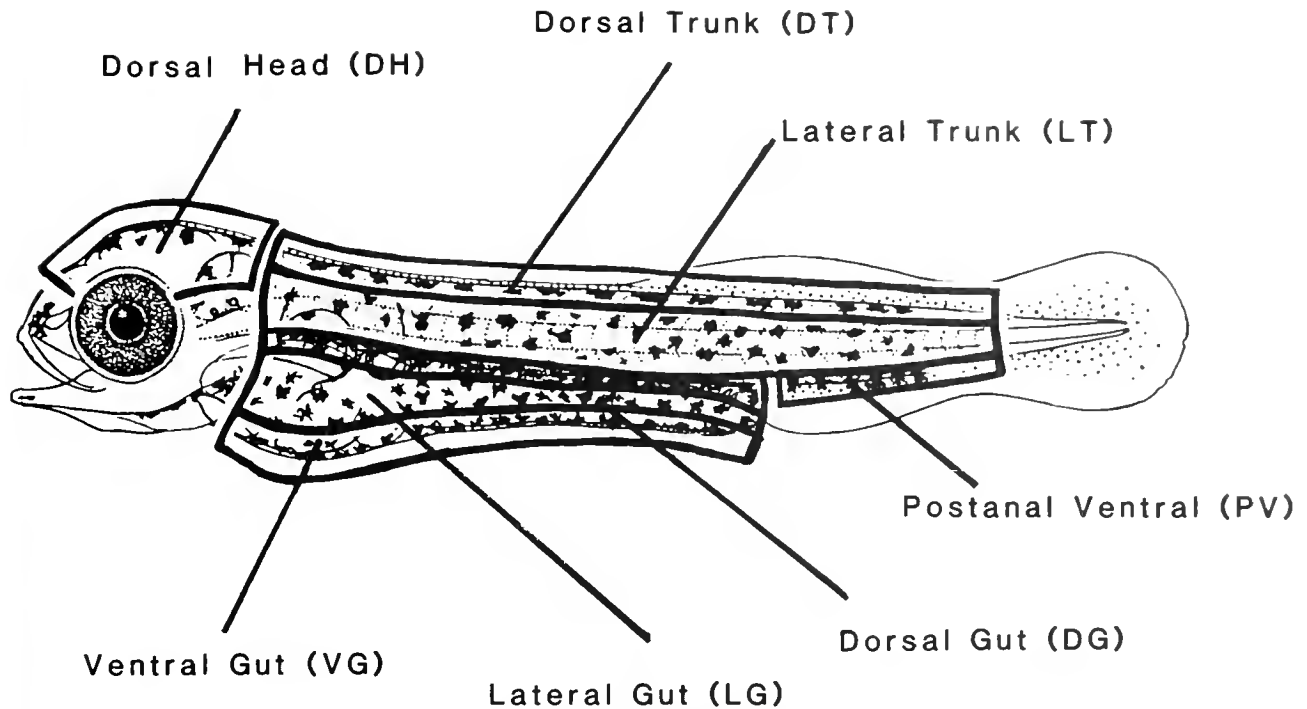

Fig. 338. Hypothetical clingfish larva showing regions which form the basis for coding patterns of melanophores.

flattened head, anterior pelvics, incomplete circumorbital series) are the result of convergence. Gosline (1970) then cited five morphological and osteological features which differ between the Gobiesociformes (including the three families) and the Batrachoidiformes. These features include differences in pelvic fin structure and orientation, structure of the upper hypurals, ascending process of premaxilla, ossification of the median ethmoid and presence (Batrachoidiformes) or absence (Gobiesociformes) of a swimbladder. On the other hand, he upheld that gobiesociform (three families) fishes have almost all of the diagnostic characteristics of the superfamily Notothenioidea of the perciform suborder Blennioidea (see Gosline, 1968). He further pointed out structural similarities between members of the Gobiesociformes and certain genera of notothenioid fishes as evidence supporting this proposed relationship. Based on this work on adults, gobiesociform fishes are currently considered perciform derivatives in the superorder Acanthopterygii. However, the issue remains far from resolved and future investigations into both the ordinal and superordinal relationships are still very much in order. In fact, William Eschmeyer (California Academy of Sciences) is currently investigating possible relationships between gobiesociform (particularly gobiesocids) and scorpaeniform fishes (pers. comm.).

The early life history stages of gobiesocids and callionymids (see Houde, this volume) lend little support to Gosline's classification. Gobiesocid and callionymid larvae are usually pigmented heavily, but there are very few additional similarities at the current level of examination. Gobiesocid and callionymid early life history stages differ in: egg type (demersal versus pelagic eggs, respectively), preanal length (>50% versus <50% of standard length), general body shape (relatively large cylindrical versus small, laterally compressed larvae), myomere/vertebral counts (24 to 37 versus 19 to 23), and shape of the notochord tip (no extension versus a long extension beyond the hypural plate). These basic differences may, in part, represent divergence due to dissimilar reproductive strategies. A more thorough, detailed comparison of the early life history stages (larvae in particular) will be necessary before any solid conclusions can be drawn. Unfortunately, the eggs and larvae of draconettids (presumably the most primitive members of the order) are unknown and cannot help clarify the situation.

The use of larval characteristics to assess higher level relationships between the Gobiesociformes and the Batrachoidiformes or Notothenioidea is limited since batrachoids have direct development (no larval form) and the larvae of notothenioids bear little, general resemblance to gobiesocid and callionymid

Fig. 337. Representative larvae of six genera within the Gobiesocidae: (A) *Gastroscyphus hectoris*, 5.4 mm (after Ruck, 1976); (B) *Gobiesox rhesodon*, 6.2 mm (from Allen, 1979); (C) *Rumicola muscarum*, 4.0 mm (from Allen, 1979); (D) *Lepadichthys frenatus*, 7.3 mm (from Shiogaki and Dotsu, in prep.); (E) *Aspasma minima*, 6.8 mm (from Shiogaki and Dotsu, 1971a); and (F) *Aspasmichthys ciconiae*, 6.9 mm (from Shiogaki and Dotsu, 1972d).

Aspasma minima

(double disc)

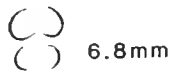

6.8mm

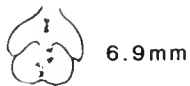

6.9mm

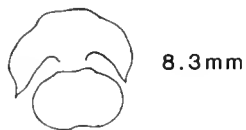

8.3mm

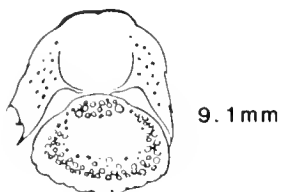

9.1mm

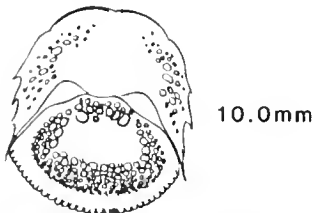

10.0mm

Lepadichthys frenatus

(single disc)

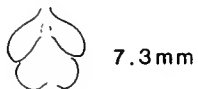

7.3mm

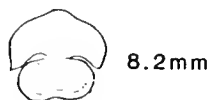

8.2mm

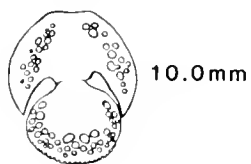

10.0mm

larvae. Detailed studies with the larval (or embryonic) forms of the above mentioned groups should be fruitful in leading, I believe, to a clearer understanding of their relationships.

Future investigation into gobiesociform systematics should first concentrate on whether the current gobiesociformes represents a monophyletic grouping. Only when this question is answered satisfactorily can the higher order relationships be addressed.

DEPARTMENT OF BIOLOGY, CALIFORNIA STATE UNIVERSITY,
NORTHRIDGE, NORTHRIDGE, CALIFORNIA 91330.

Fig. 339. Development sequences of the pelvic suction disc in larval gobiesocids (double and single types).

Callionymidae: Development and Relationships

E. D. HOUDE

THE Callionymidae are one of three families in the order Gobiesociformes (Gosline, 1970; Nelson, 1976). Systematics, ontogeny and relationships of Callionymidae and the other families, Gobiesocidae and Draconettidae, have been reviewed and summarized for this symposium by Allen (this volume). The callionymids are small demersal fishes found in all warm seas. Most species are less than 100 mm in length. Maximum length is about 200 mm (Nelson, 1976; Nakabo, 1982b). Nelson (1976) indicated that there are eight genera with about 40 species in the family. Fricke (1980, 1981a, 1981b) believed the family to be more diverse with perhaps 130 species worldwide, 75 in the genus *Callionymus*, and Nakabo (1982b) recently has proposed 19 genera and 139 species. Callionymids are most abundant and diverse in shallow marine waters of the Indo-Pacific (Smith, 1963; Fricke, 1980, 1981b). They also are common in the Atlantic (Davis, 1966). Although usually found in depths less than 100 m, some species occur to depths of >600 m (Davis,

1966). Larvae sometimes are abundant in coastal ichthyoplankton surveys. For example, *Callionymus pauciradiatus* was the second most common species of larva in Biscayne Bay, Florida (Houde and Alpern Lovdal, in press) while Callionymidae were the sixth most abundant family of larvae in Persian Gulf fish larvae collections.¹

Nakabo (1982b) has extensively revised the Callionymidae, establishing 7 new genera and redefining 12 previously recognized genera/subgenera. Genera are defined based on cephalic lateral lines, lateral lines on the body, morphology, secondary

¹ Houde, E. D., J. C. Leak, S. Al-Matar and C. E. Dowd. 1981. Ichthyoplankton abundance and diversity in the western Arabian Gulf. Kuwait Institute for Scientific Research, Mariculture and Fisheries Department, Final Report, Project MB-16. 3 volumes. (This report was not available for distribution at the time the present paper was written.)

TABLE 169. MERISTICS OF CALLIONYMID GENERA RECOGNIZED BY NAKABO (1982B). His new genera are designated n.g.

Genus	Dorsal	Anal	Pectoral	Pelvic	Caudal	Type species by original designation
<i>Callionymus</i>	III-IV, 6-10	9	i + 16-20	I, 5	i + 7 + ii	<i>Callionymus lyra</i>
<i>Bathycallionymus</i> n.g.	IV, 9	9	ii + 17-19	I, 5	i + 3 + ii + 2 + ii or i + 3 + i + 3 + ii	<i>Callionymus katanus</i>
<i>Foctoropus</i>	IV, 8	7	i + 18-21	I, 5	i + 7 + ii	<i>Callionymus calauropomus</i>
<i>Eocallionymus</i> n.g.	IV, 7	6	i + 18-19	I, 5	i + 7 + ii	<i>Callionymus papilio</i>
<i>Paracallionymus</i>	IV, 9-10	9	i + 18-19	I, 5	i + 7 + ii	<i>Callionymus costatus</i>
<i>Neosynchiropus</i> n.g.	IV, 8	7	i + 17-21 or ii + 17-19 or iii + 18	I, 5	i + 7 + ii	<i>Callionymus ocellatus</i>
<i>Pterosynchiropus</i> n.g.	IV, 8	7	i + 29-30	I, 5	i + 8 + i	<i>Callionymus splendidus</i>
<i>Minysynchiropus</i> n.g.	IV, 9	8	ii + 16 or iii + 14-15 or iv + 13-14	I, 5	i + 7 + ii	<i>Synchiropus laddi</i>
<i>Paradiplogrammus</i> n.g.	IV, 8-9	7-8	i + 15-20 or ii + 14-15	I, 5	i + 7 + ii	<i>Callionymus enneactis</i>
<i>Diplogrammus</i>	IV, 6-8	4-7	i + 16-18 or ii + 15-17	I, 5	i + 7 + ii	<i>Callionymus goramensis</i>
<i>Synchiropus</i>	IV, 8	7	i + 18	I, 5	i + 7 + ii	<i>Callionymus lateralis</i>
<i>Orbonymus</i>	IV, 8	7	i + 17-18	I, 5	i + 7 + ii	<i>Callionymus rameus</i>
<i>Dactylopus</i>	IV, 8	7	ii + 17	I, 1-4	i + 7 + ii	<i>Callionymus dactylopus</i>
<i>Calliurichthys</i>	IV, 9	8	ii + 16-19	I, 5	i + 7 + ii	<i>Callionymus japonicus</i>
<i>Pseudocalliurichthys</i> n.g.	IV, 8	7	i + 17-18 or ii + 14-17	I, 5	i + 7 + ii	<i>Callionymus variegatus</i>
<i>Repomucenus</i>	III-IV, 9	8-9	i + 16-21	I, 5	i + 7 + ii	<i>Callionymus calcaratus</i>
<i>Spinecapitichthys</i>	IV, 8	8	i + 18-20	I, 5	i + 7 + ii	<i>Callionymus spineps</i>
<i>Anaora</i>	IV, 8	7	21-25	I, 5	ii + 6 + ii	<i>Anaora tentaculata</i>
<i>Eleutherochur</i>	absent or I-IV, 9-13	9-13	i + 16-23	I, 5	i + 7 + ii or ii + 6 + ii	<i>Callionymus opercularoides</i>

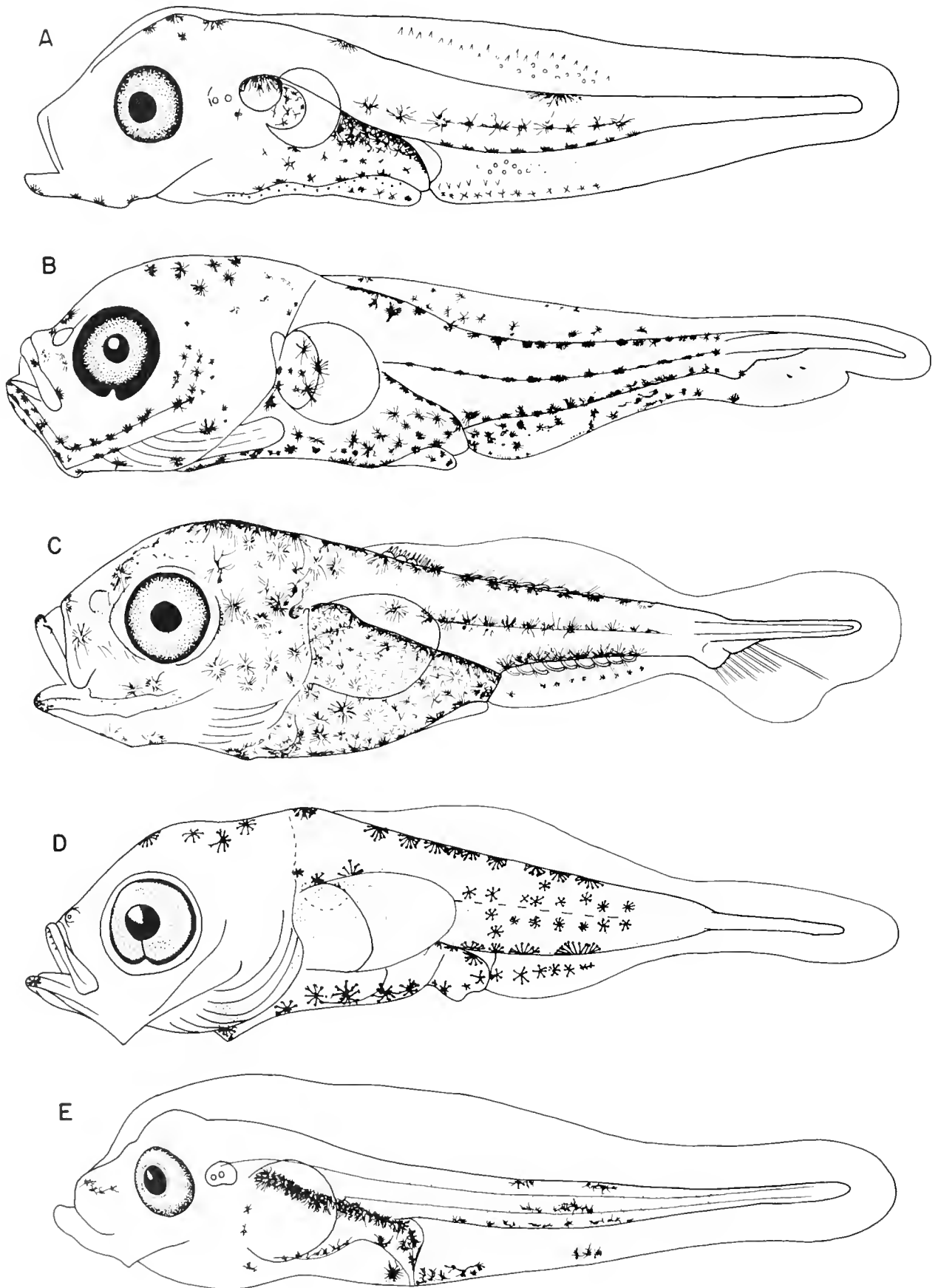

sex characteristics and body size. Meristics also vary among species (Table 169). In Nakabo's classification the genus *Callionymus* includes only five species, all of which are found in the northeast Atlantic, Mediterranean or Black seas. Nakabo (1982b) assigned 39 species to the Indo-Pacific genus *Repomucenus*, making it the most species-rich genus of Callionymidae, followed by the Indo-Pacific genus *Calliurichthys* with 16 species. Neither eggs nor larvae were described or discussed by Nakabo in his systematic account of the Callionymidae.

DESCRIPTION

The Callionymidae are characterized by having a small, pore-like gill opening, greatly reduced in size compared to that of Draconettidae, their closest relatives in the Gobiesociformes. The preopercular has a strong, often serrate, spine, useful for specific identifications; the operculum and suboperculum are spineless. Eyes are dorsal and adjacent. Hypurals are fused into a single plate. Vertebrae number 21 to 23. Dorsal fin spines usually four; soft rays 6–13; anal fin with 4–13 soft rays. Pelvic fins are inserted in advance of the pectoral base, the two fins often connected at their bases by a membrane. The sexes usually are dimorphic, males having longer and broader median fins, sometimes with filamentous rays in the dorsal and caudal fins.

DEVELOPMENT

Size at maturity varies among species but generally is less than 100 mm. Some species may mature at <15 mm in length (Davis, 1966). Callionymid male-female pairs exhibit well-defined courtship and spawning behavior (Wilson, 1978; Takita and Okamoto, 1979) in which male display plays a prominent role. Individual females may spawn on successive days. Judging from larval occurrences, spawning seasons are protracted, lasting 6 months or more for temperate species such as *C. lyra*, *C. maculatus* and *C. reticulatus* (Demir, 1972; Russell, 1976). Spawning may occur year-round in subtropical species such as *C. pauciradiatus* (Houde and Alpern Lovdal, in press) and *Paracallionymus costatus* (Brownell, 1979) or tropical species such as *C. decoratus* (Watson and Leis, 1974).

Eggs

Eggs are colorless, pelagic and spherical, reported diameters ranging from 0.55 to 0.97 mm (Mito, 1962a; Watson and Leis, 1974; Russell, 1976; Brownell, 1979; Miller et al., 1979; Takai and Yoshioka, 1979; Takita, 1980, 1983). A polygonal (usually hexagonal) sculpturing, sometimes with fine cilia-like processes, usually is associated with the chorion, but in some species (e.g., *P. costatus*) the chorion apparently is unsculptured (Brownell, 1979). Buoyant, adhesive egg masses have been described for *C. calliste*, which break up into individual pelagic eggs prior to hatching (Takita, 1983). The yolk is segmented peripherally. The perivitelline space is narrow. There are no oil globules. Takai and Yoshioka (1979) and Takita (1980) have provided good illustrations and photographs of typical callionymid eggs.

Larvae

At hatching, pelagic larvae of callionymids range from approximately 1.0 to 2.1 mm in length. Most species are less than 1.5 mm at hatching, making them among the smallest of larval fishes. Reported myomere numbers range from 19–22. Callionymid larvae are distinctive and easy to recognize. Larvae of several species (referred to as *Callionymus*) have been described (e.g., Fage, 1918; Mito, 1962a; Demir, 1972, 1976; Miller et al., 1979; Takai and Yoshioka, 1979; Takita, 1980, 1983). Brownell (1979) has illustrated larvae of *Paracallionymus costatus*. All larvae described to date are similar, differing in pigmentation patterns, meristic characters and sizes at which fin development and metamorphosis are completed.

Yolk-sac larvae are short and deep-bodied with a large, bulbous yolk sac (Mito, 1962a; Brownell, 1979; Takita, 1980, 1983). The yolk is segmented peripherally. Dendritic or stellate melanophores may develop in the finfold (Fig. 340B) within one day after hatching (Mito, 1962a; Brownell, 1979; Takai and Yoshioka, 1979; Takita, 1980, 1983). The snout-to-anus length of newly-hatched larvae is >50% of notochord length, but it declines to <50% within several hours after hatching.

Preflexion larvae are moderately deep-bodied and laterally compressed both preanally and postanally. All species described to date have a broken line of melanophores along the lateral midline, particularly on the tail (Fig. 340). The larvae are moderately to heavily pigmented and often are first recognized in samples because of their relatively dark color. A swimbladder which develops at this stage subsequently is lost during metamorphosis. Curious processes, termed "spine-like" by Takita (1980, 1983) or called "serrations" by Mito (1962a) develop at the margins of the dorsal and ventral finfolds (Fig. 340A), which apparently vary in number among individual larvae. Takita (1980) described and illustrated a "vacuole" in the dorsal finfold of small, preflexion larvae of *C. flagris*, *C. richardsoni* and *C. ornatipinnis*. Multiple vacuoles were reported in the finfolds of *C. calliste* (Takita, 1983).

Postflexion larvae are heavily pigmented and robust (Fig. 340C). They have a prominent and highly visible, upturned notochord tip (urostyle). Caudal, pelvic, second dorsal and anal fin ray counts may be complete in some species at 3–4 mm SL (Miller et al., 1979; Takai and Yoshioka, 1979). The head becomes flatter and broader as development progresses and the eyes gradually assume their dorsal, adjacent position. The preopercular spine first appears in the length range 3.5 to 5.0 mm SL. For most species, size at metamorphosis is approximately 10 mm SL.

RELATIONSHIPS

Callionymid eggs and larvae offer little clue to systematic relationships among gobiesociform fishes. Like the gobiesocids, callionymid larvae are heavily pigmented (Allen, this volume) but there are few additional similarities. Callionymid larvae hatch from pelagic eggs; gobiesocids have demersal eggs. From

Fig. 340. Larvae of Callionymidae: (A) 1.7 mm larva of *Callionymus (Paradiplogrammus) calliste* (from Takita, 1983: fig. 21, p. 443); (B) 4.7 mm larva of *Callionymus reticulatus* (from Demir, 1972: fig. 2, p. 998); (C) 4.1 mm larva of *Callionymus (Repomucenus) beniteguri* (from Takai and Yoshioka, 1979: fig. 2–4, p. 150); (D) 2.9 mm larva of *Callionymus (Calliurichthys) decoratus* (from Miller et al., 1979: fig. 96, p. 96); and (E) 2.3 mm larva of *Paracallionymus costatus* (from Brownell, 1979: fig. 69, p. 50).

several hours after hatching and during preflexion stages, most species of callionymid larvae have snout-to-vent lengths <50% of standard length, while gobiesocids have snout-to-vent lengths >50%. Both callionymids and gobiesocid larvae have swimbladders which are lost during metamorphosis, a characteristic common to many teleost families. Callionymid preflexion larvae are small and laterally compressed. They have low myomere/vertebral numbers (19 to 23). Gobiesocid larvae are relatively large, basically cylindrical in shape, with high myomere/vertebral counts (24 to 37) (Allen, this volume). The various species of callionymid larvae differ little from each other but they can be identified by distinctive pigment patterns and median fin ray counts (Demir, 1972; Miller et al., 1979; Takai and Yoshioka, 1979; Takita, 1980, 1983; Olney and Sedberry, in press). There

has been no attempt yet to relate larval characters or differences among larvae to the generic characters proposed by Nakabo (1982b). There are no descriptions of eggs or larvae of Draconettidae, adults of which bear close resemblance to Callionymidae (Davis, 1966). The discovery and description of larval draconettids might resolve the systematic uncertainties among gobiesociform fishes. A careful, comparative analysis of callionymid larval development may clarify the generic relationships among species within Callionymidae.

UNIVERSITY OF MARYLAND, CENTER FOR ENVIRONMENTAL AND ESTUARINE STUDIES, CHESAPEAKE BIOLOGICAL LABORATORY, SOLOMONS, MARYLAND 20688.

Pleuronectiformes: Development

E. H. AHLSTROM, K. AMAOKA, D. A. HENSLEY,
H. G. MOSER AND B. Y. SUMIDA

PLEURONECTIFORM fishes have both eyes on one side of the head in juveniles and adults. The eyes are symmetrical in larvae, and migration of either the left or right eye occurs during metamorphosis. In some flatfish groups the eyes are on the left side (sinistral) while in others they are on the right side (dextral); relatively few species are indiscriminate. In some flatfishes the ocular nerve of the migrating eye usually lies dorsal to the other nerve in the optic chiasma; in other groups the nerve of the migrating eye is dorsal or ventral in the chiasma with about equal frequency. In most groups the nasal organ of the blind side also migrates to a position near the dorsal midline. Features of the dentition and cranial osteology may also show asymmetry. Flatfishes are highly compressed with the underside of the body usually unpigmented. The lateral line may be lacking on the blind side; the pectoral fin is often shorter on the blind side and has fewer rays; the pelvic fin on the blind side is often shorter, smaller and differently placed with respect to the ventral midline compared with the pelvic fin on the ocular side; squamation may be different on the two sides of the body. The dorsal and anal fins are long-based; the dorsal extends anteriorly to at least the eye in all flatfishes except *Psettodes* and the anal fin extends well forward of the first haemal spine. The caudal fin is typically rounded or truncate with few or no secondary rays. Pleuronectiforms are benthic carnivores, occurring worldwide, primarily in shallow to moderate depths, with some representatives in brackish and fresh water habitats. Nelson (1976) notes a total of 520 species.

The classification presented below is based on the works of Regan (1910, 1929) and Norman (1934, 1966) with modifications by Hubbs (1945), Amaoka (1969), Hensley (1977), and Futch (1977). Our removal of *Perissias* from the Paralichthyidae and placement in the Bothidae are based on previously unpublished information. Those genera marked with an asterisk are misplaced in this classification and are discussed in this paper and in Hensley and Ahlstrom (this volume).

Order Pleuronectiformes

Suborder Psettodoidei

Family Psettodidae (Indo-Pacific, West Africa)

Psettodes

Suborder Pleuronectoidei

Family Citharidae

Subfamily Brachypleurinae (Indo-Pacific)

Brachypleura,* *Lepidoblepharon*

Subfamily Citharinae (Indo-Pacific, Mediterranean, West Africa)

Citharoides, *Eucitharus*

Family Scophthalmidae (North Atlantic, Mediterranean, Black Sea)

Lepidorhombus, *Phrynorhombus*, *Scophthalmus*, *Zeugopterus*

Family Paralichthyidae (Western and Eastern Atlantic, Eastern Pacific, Indo-Pacific)

Ancylosetta, *Cephalopsetta*, *Citharichthys*, *Cyclop-*

Fig. 341. Eggs of Pleuronectiformes. Captions in each illustration indicate the species and diameter of the egg in mm. *Scophthalmus maeoticus maeoticus*, from Dekhnik, 1973; *Paralichthys olivaceus*, from Mito, 1963; Bothidae, from Mito, 1963; *Limanda aspera*, from Pertseva-Ostroumova, 1954; *Hippoglossoides dubius*, from Pertseva-Ostroumova, 1961; *Microstomus pacificus*, original, CalCOFI; *Pleuronichthys cornutus*, from Mito, 1963; *Pelotretis flavilatus*, from Robertson, 1975a; *Peltorhamphus novaezeelandiae*, from Robertson, 1975a; *Trinectes maculatus*, from Hildebrand and Cable, 1938; *Pegusa lascaris nasuta*, from Dekhnik, 1973; *Cynoglossus robustus*, from Fujita and Uchida, 1957.





<p>1.10 - 1.33</p>  <p><i>Scophthalmus maeoticus maeoticus</i></p>	<p>0.92</p>  <p><i>Paralichthys olivaceus</i></p>	<p>0.64</p>  <p>Bothidae</p>
<p>0.76 - 0.85</p>  <p><i>Limanda aspera</i></p>	<p>2.10 - 2.94</p>  <p><i>Hippoglossoides dubius</i></p>	<p>2.05 - 2.57</p>  <p><i>Microstomus pacificus</i></p>
<p>1.22</p>  <p><i>Pleuronichthys cornutus</i></p>	<p>0.62 - 0.68</p>  <p><i>Pelotretis flavilatus</i></p>	<p>0.62 - 0.68</p>  <p><i>Peltorhamphus novaezeelandiae</i></p>
<p>0.67 - 0.86</p>  <p><i>Trinectes maculatus</i></p>	<p>1.09 - 1.35</p>  <p><i>Pegusa lascaris nasuta</i></p>	<p>0.85 - 0.90</p>  <p><i>Cynoglossus robustus</i></p>

TABLE 170. CHARACTERS OF EGGS OF PLEURONECTINAE SPECIES WHICH LACK OIL GLOBULES.

Species	Region ¹	Type of egg (pelagic or demersal)	Egg size (mm)	Chorion	References
<i>Cleisthenes herzensteini</i>	WNP	P	0.84–1.03	—	Pertseva-Ostroumova, 1961
<i>Embassichthys bathybius</i>	ENP	P	3.0	smooth	Richardson, 1981b
<i>Eopsetta grigorjewi</i>	WNP	P	1.10–1.20	striations	Yusa, 1961; Fujita, 1965
<i>E. jordani</i>	ENP	P	1.21–1.25	smooth	Alderdice and Forrester, 1971
<i>Glyptocephalus cynoglossus</i>	NA	P	1.07–1.25	striations	Cunningham, 1887; Ehrenbaum, 1905–1909
<i>G. stelleri</i>	WNP	P	1.20–1.61	thick, reticulate	Pertseva-Ostroumova, 1961; Dekhnik, 1959
<i>G. zachirus</i>	ENP	P	1.9–2.15	striations	Original
<i>Hippoglossoides dubius</i>	WNP	P	2.10–2.94	smooth	Pertseva-Ostroumova, 1961
<i>H. classodon</i>	NP	P	2.45–3.75	smooth	Thompson and Van Cleve, 1936; Pertseva-Ostroumova, 1961
<i>H. platessoides</i>	WNA	P	1.38–2.64	smooth	Russell, 1976 (summary)
<i>H. robustus</i>	WNP	P	2.04–2.69	smooth, thin	Pertseva-Ostroumova, 1961
<i>Hippoglossus hippoglossus</i>	NA	P	3.0–3.8	smooth, thick	Täning, 1936; Pertseva-Ostroumova, 1961
<i>H. stenolepis</i>	NP	P	2.9–3.8	minute honey-comb structure	Thompson and Van Cleve, 1936
<i>Isopsetta isolepis</i>	ENP	P	0.90–1.10	smooth	Richardson et al., 1980
<i>Kareius bicoloratus</i>	WNP	P	1.00–1.15	reticulate	Pertseva-Ostroumova, 1961
<i>Lepidopsetta bilineata</i>	NP	D	1.02–1.09	sticky-orange	Pertseva-Ostroumova, 1961
<i>L. mochigarei</i>	WNP	D	0.87–0.95	thick, gluey	Pertseva-Ostroumova, 1961
<i>Limanda aspera</i>	NP	P	0.76–0.85	smooth	Pertseva-Ostroumova, 1954
<i>L. ferruginea</i>	WNA	P	0.79–1.01	striations	Miller, 1958; Colton and Marak, 1969
<i>L. limanda</i>	ENA	P	0.66–1.20	—	Russell, 1976 (summary)
<i>L. punctatissima</i>	WNP	P	0.66–0.87	smooth	Pertseva-Ostroumova, 1961
<i>L. proboscidea</i>	WNP	P	0.72–0.87	smooth	Pertseva-Ostroumova, 1961
<i>L. schrenki</i>	WNP	D	0.73–0.83	adhesive	Yusa, 1960a
<i>L. schrenki</i> (as <i>Pseudopleuronectes yokohamae</i>)	WNP	D	0.74–0.83	adhesive	Pertseva-Ostroumova, 1961
<i>L. yokohamae</i>	WNP	D	0.81–0.84	adhesive	Yusa, 1960a, b
<i>Liopsetta glacialis</i>	NP	P	1.20–1.60	thin	Pertseva-Ostroumova, 1961
<i>L. obscura</i>	WNP	D	0.78–0.94	thick, sticky	Pertseva-Ostroumova, 1961
<i>L. puntfasciata</i>	WNP	P	1.43–1.66	thin, folds	Pertseva-Ostroumova, 1961
<i>Lyopsetta exilis</i>	ENP	P	1.47–1.68	smooth	Original; Ahlstrom and Moser, 1975
<i>Microstomus kitt</i>	WNA	P	1.13–1.45	striations	Russell, 1976; Dekhnik, 1959
<i>M. pacificus</i>	ENP	P	2.05–2.57	smooth	Original; Ahlstrom and Moser, 1975
<i>Parophrys vetulus</i>	ENP	P	0.89–0.93	striations	Budd, 1940; Original
<i>Platichthys flesus</i>	ENA	P	0.80–1.13	—	Russell, 1976 (summary)
<i>P. f. luscus</i>	B	P	1.05–1.35	smooth	Dekhnik, 1973
<i>P. stellatus</i>	NP	P	0.89–1.01	smooth, thin	Orcutt, 1950; Yusa, 1957
<i>Pleuronectes pallasii</i>	NP	P	1.67–2.21	—	Pertseva-Ostroumova, 1961
<i>P. platessa</i>	ENA	P	1.66–2.17	—	Russell, 1976 (summary)
<i>Pleuronichthys coenosus</i>	ENP	P	1.20–1.56	polygonal pattern	Sumida et al., 1979; Budd, 1940
<i>P. decurrens</i>	ENP	P	1.84–2.08	polygonal pattern	Sumida et al., 1979; Budd, 1940
<i>P. verticalis</i>	ENP	P	1.00–1.16	polygonal pattern	Sumida et al., 1979; Budd, 1940
<i>Psettichthys melanostictus</i>	ENP	P	ca. 1.0	—	Hickman, 1959
<i>Pseudopleuronectes americanus</i>	WNA	D	0.71–0.96	adhesive	Breder, 1923
<i>P. herzensteini</i>	WNP	P	0.80–1.0	smooth	Pertseva-Ostroumova, 1961
<i>Reinhardtius hippoglossoides</i>	NA/NP	P	4.00–4.50	—	Jensen, 1935
<i>Tanakius kitaharai</i>	WNP	P	1.20–1.30	striations	Fujita, 1965
<i>Verasper variegatus</i>	WNP	P	1.60–1.64	smooth	Takita et al., 1967; Mito, 1963

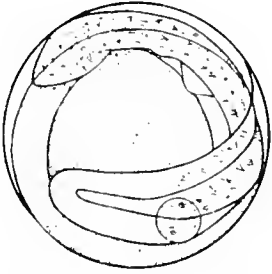
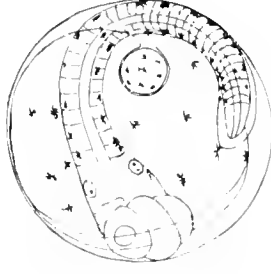
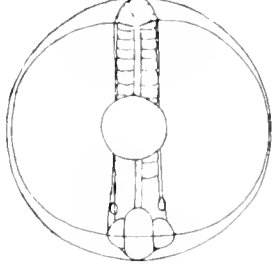
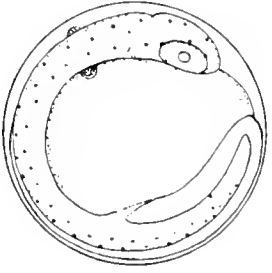
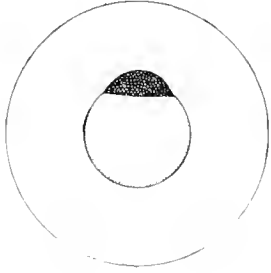
¹ B = Black Sea, ENA = eastern North Atlantic, ENP = eastern North Pacific, I = India, NA = North Atlantic, NP = North Pacific, WNA = western North Atlantic, WNP = western North Pacific

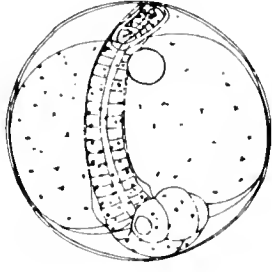
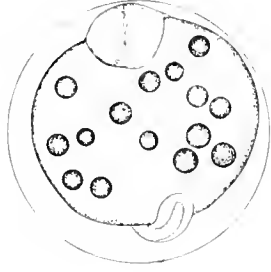
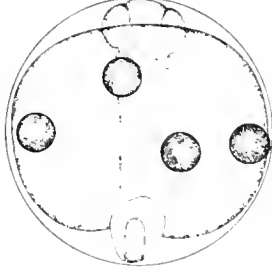
setta, *Etropus*, *Gastropsetta*, *Hippoglossina*, *Lioglossina*, *Paralichthys*, *Pseudorhombus*, *Syacium*, *Tarphops*, *Tephrinectes*.* *Thysanopsetta*,* *Verecundum*, *Xystreureys*

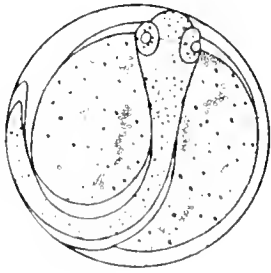
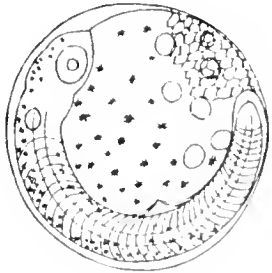
Family Bothidae

Subfamily Taeniopsettinae (Western Atlantic, Eastern Pacific, Indo-Pacific)

Engyophrys, *Perissias*, *Taeniopsetta*, *Trichopsetta*
Subfamily Bothinae (Indian, Pacific, Atlantic, Mediterranean, Southern oceans)

Arnoglossus, *Asterorhombus*, *Bothus*, *Chascanopsetta*, *Crossorhombus*, *Engypropon*, *Grammatobothus*, *Japonolaeops*, *Kamoharaita*, *Laeops*, *Lophonectes*, *Monolene*, *Mancopsetta*,* *Neo-*

TABLE 171. CHARACTERS OF PLEURONECTIFORM EGGS WITH A SINGLE OIL GLOBULE.

Taxon	Region ¹	Egg size (mm)	Oil globule size (mm)	Choron	Size at hatching (mm)	References
Pleuronectidae						
<i>Hypsopsetta guttulata</i>	ENP	0.78–0.89	0.12–0.14	smooth	1.7–2.3	Sumida et al., 1979; Eldridge, 1975
<i>Pleuronichthys cornutus</i>	WNP	1.03–1.25		polygonal pattern	2.8–3.8	Mito, 1963; Takita and Fujita, 1964
<i>P. ritteri</i>	ENP	0.94–1.08	0.08–0.14	polygonal pattern	2.1	Sumida et al., 1979
Scophthalmidae						
<i>Lepidorhombus whiffiagonis</i>	ENA	1.02–1.22	0.25–0.30	striations	ca. 4.0	McIntosh, 1892; Holt, 1893
<i>Phrynorhombus norvegicus</i>	ENA	0.72–0.92	0.09–0.16	rugose	2.5–2.8	Ehrenbaum, 1905–1909; Hefford, 1910
<i>P. regius</i>	ENA	0.90–0.99	0.16–0.18	—	2.4	Holt, 1897
<i>Scophthalmus aquosus</i>	WNA	0.90–1.38	0.15–0.30	striations	ca. 2.0	Martin and Drewry, 1978 (summary)
<i>S. maeoticus</i>	B	1.10–1.33	0.17–0.23	—	3.5 TL	Dekhnik, 1973
<i>S. maximus</i>	ENA	0.90–1.20	0.15–0.22	rugose	2.1–3.0	Holt, 1892; Jones, 1972
<i>S. rhombus</i>	B	1.20–1.50	0.16–0.25	striations	3.8	Jones, 1972
<i>Zeuopterus punctatus</i>	ENA	0.92–1.07	0.17–0.20	—	2.5–2.9	Hefford, 1910
Paralichthyidae						
<i>Hippoglossina oblonga</i>	WNA	0.91–1.12	0.17	smooth	2.7–3.2	Miller and Marak, 1962
<i>H. stomata</i>	ENP	1.22–1.38	0.20–0.26	smooth	3.7	Sumida et al., 1979
<i>Paralichthys californicus</i>	ENP	0.74–0.82	0.10–0.19	smooth	ca. 2.0	Original
<i>P. dentatus</i>	WNA	0.90–1.10	0.18–0.31	—	2.4–2.8	Smith and Fahay, 1970
<i>P. olivaceus</i>	WNP	0.83–1.03	0.13–0.21	smooth	2.6–2.8	Mito, 1963
<i>Pseudorhombus cinnamomeus</i>	WNP	0.77–0.89	0.12–0.14	—	1.8–2.0	Mito, 1963
<i>Cuharichthys arcuifrons</i>	WNA	0.70–0.82	—	smooth	ca. 2.0	Richardson and Joseph, 1973
Bothidae						
<i>Arnoglossus capensis</i>	ESA	0.72	0.12	smooth	2.2	Brownell, 1979
<i>A. kessleri</i>	B	0.59–0.70	0.10–0.13	smooth	1.8–1.9	Dekhnik, 1973
<i>A. laterna</i>	ENA	0.60–0.76	0.11–0.15	smooth	2.6	Russell, 1976 (summary)
<i>A. scapha</i>	NZ	0.78–0.88	0.11–0.12	smooth	—	Robertson, 1975a
<i>A. thori</i>	ENA	0.67–0.74	0.12	smooth	1.6–2.0	Russell, 1976 (summary)

¹ ESA = eastern South Atlantic, NZ = New Zealand; key to other regions as in Table 170

lacops, Parabothus, Pelecanichthys, Psettina, Tosarhombus

Family Pleuronectidae

Subfamily Pleuronectinae (Atlantic, Mediterranean, Pacific, Arctic)

Acanthopsetta, Atheresthes, Cleisthenes, Clidoderma, Dexistes, Embassichthys, Eopsetta, Glyptocephalus, Hippoglossoides, Hippoglossus, Hypsopsetta, Isopsetta, Lepidopsetta, Limanda, Liopsetta, Lyopsetta, Microstomus, Parophrys, Platicthys, Pleuronectes, Pleuronichthys, Pset-tichthys, Pseudopleuronectes, Reinhardtius, Tanakius, Verasper

Subfamily Poecilopsettinae (Indo-Pacific, Atlantic)

Marleyella, Nematops, Poecilopsetta

Subfamily Paralichthodinae (Indian Ocean off South Africa)

Paralichthodes

Subfamily Samarinae (Indo-Pacific)

Samaris, Samariscus

Subfamily Rhombosoleinae (New Zealand, Southern Australia, South America)

Ammotretis, Azygopus, Colistium, Oncopterus, Pelotretis, Peltorhamphus, Psammodiscus, Rhombosolea

Suborder Soleoidei

Family Soleidae

Subfamily Soleinae (Worldwide, tropical to temperate)
Norman (1966) recognized 22 genera

Subfamily Achirinae (American coasts, some fresh water)
Norman (1966) recognized 9 genera

Family Cynoglossidae

Subfamily Symphurinae (Tropical-Subtropical American coasts, Mediterranean, West Africa, Indo-Pacific)

Symphurus

Subfamily Cynoglossinae (Indo-Pacific, Mediterranean, West Africa, Japan, some fresh water)

Cynoglossus, Paraplagusia

A profuse literature on the life history stages of flatfishes has accumulated since the early work of Cunningham (1887, 1889, 1890, 1891) who described numerous series reared from eggs collected from running ripe females. Other European workers (Holt, 1893; McIntosh and Prince, 1890; Petersen, 1904, 1905, 1906, 1909; Schmidt, 1904; Kyle, 1913) identified early life history series of additional species so that, by the time of Ehrenbaum's (1905–1909) summary, ontogenetic stages of a major portion of the eastern North Atlantic flatfish fauna were known. Padoa (1956k) summarized ontogenetic information on Medi-

TABLE 172. CHARACTERS OF PLEURONECTIFORM EGGS WITH MULTIPLE OIL GLOBULES.

	Region ¹	Egg size (mm)	Number of oil globules	Yolk	Chorion	References
Achirinae						
<i>Achirus lineatus</i>	WNA	0.71–0.76	12–14	homogeneous	smooth, thin	Houde et al., 1970
<i>Trinectes maculatus</i>	WNA	0.67–0.86	15–34	homogeneous	smooth	Hildebrand and Cable, 1938
Soleinae						
<i>Aesopia cornuta</i>	WNP	1.45–1.60	many; scattered	homogeneous	polygonal mesh	Mito, 1963
<i>Austroglossus microlepis</i>	ESA	0.88	12–20	homogeneous	smooth	Brownell, 1979
<i>Buglossidium luteum</i>	ENA	0.64–0.94	12–21; scattered	peripheral	smooth	Holt, 1891; Hefford, 1910
<i>Dicologlossa cuneata</i>	ENA	0.70–0.84	60–80; scattered	peripheral segmentation		Lagardere, 1980
<i>Microchirus ocellatus</i>	ENA	0.90–1.10	30–40; scattered	peripheral segmentation	smooth	Palomera and Rubies, 1977
<i>M. variegatus</i>	ENA	1.28–1.42	to 50+; scattered	peripheral segmentation	smooth	Cunningham, 1889
<i>Pegusa impar</i>	M	1.06				Padoa, 1956k
<i>P. lascaris lascaris</i>	ENA	1.28–1.38	to 50+	peripheral segmentation		Holt, 1891; Hefford, 1910
<i>P. lascaris nasuta</i>	B	1.36–1.38	many; clumped	homogeneous	polygonal mesh	Dekhnik, 1973
<i>Solea solea</i>	ENA	0.98–1.58	many; highly clumped	peripheral segmentation	smooth	Cunningham, 1889; Fabre-Domergue and Biérix, 1905
<i>Synaptura kleini</i>	ESA	1.34	many; clumped	homogeneous	smooth	Brownell, 1979
<i>Zebrias japonicus</i>	WNP	1.75	many; scattered	homogeneous	smooth	Mito, 1963
<i>Z. zebra</i>	WNP	1.60	many; scattered	homogeneous		Mito, 1963
Symphurinae						
<i>Symphurus atricauda</i>	ENP	0.71–0.78	10–23	homogeneous	smooth, colored	Original
Cynoglossinae						
<i>Cynoglossus capensis</i>	ESA	0.75	2–16	homogeneous	smooth	Brownell, 1979
<i>C. robustus</i>	WNP	0.85–0.90	5–15	homogeneous	fine hexagonal network	Fujita and Uchida, 1957
<i>C. (Areliscus) trigrammus</i>	WNP	1.19–1.23	30–50	homogeneous	smooth	Fujita and Takita, 1965
Cynoglossidae no. 5	WNP	0.71	14	homogeneous	smooth	Mito, 1963
Cynoglossidae sp. A	I	0.84	13–15	homogeneous	smooth	Vijayaraghavan, 1957
Cynoglossidae sp. B	I	0.82	18–22; clustered	homogeneous	smooth	Vijayaraghavan, 1957
<i>Cynoglossus</i> 1	I	0.60	16–30	homogeneous	smooth	Nair, 1952a
Cynoglossidae (as <i>Solea ovata</i>)	I	0.61–0.71	17–25	homogeneous	smooth	John, 1951b
Rhombosoleinae						
<i>Ammotretis rostratus</i>	NZ	ca. 0.8	8–11	homogeneous	smooth	Thomson, 1906
<i>Colistium guntheri</i>	NZ	1.0–1.08	14–26	homogeneous		Robertson, 1975a
<i>C. nudipinnis</i>	NZ	ca. 1.5	21–28	homogeneous		Robertson, 1975a
<i>Pelotretis flavilatus</i>	NZ	0.85–0.95	8–18	homogeneous	smooth	Robertson, 1975a
<i>Peltorhamphus novaezeelandiae</i>	NZ	0.62–0.68	2–6	homogeneous	smooth	Robertson, 1975a
<i>P. tenuis</i>	NZ	0.58–0.68	2–4	homogeneous	smooth	Robertson, 1975a
<i>Rhombosolea leporina</i>	NZ	0.58–0.70	2–7	homogeneous	smooth	Robertson, 1975a
<i>R. plebeia</i>	NZ	0.58–0.72	2–13	homogeneous	smooth	Robertson, 1975a; Robertson and Raj, 1971
Bothinae						
<i>Mancopsetta maculata antarctica</i>	S	2.45–3.00	20+	homogeneous	smooth	Efremenko et al., 1981

¹ M = Mediterranean, S = southern oceans, key to other regions as in Table 170

terranean flatfishes and more recently Russell (1976) provided an extensive review of previous European contributions. Knowledge of ontogenetic stages of western Atlantic flatfishes is summarized by Martin and Drewry (1978) and Fahay (1983). Early life histories of North Pacific flatfishes are treated comprehensively by Pertseva-Ostroumova (1961). Japanese and Indian workers have provided a long list of contributions to flatfish life history studies and Amaoka (1969, 1979), Hensley (1977) and Futch (1977) employed ontogenetic characters in assessing

phylogenetic relationships. The individual contributions to flatfish ontogeny are too numerous to summarize concisely and are cited in the section that follows.

DEVELOPMENT

Eggs

Eggs are known for most species in Pleuronectidae and Scophthalmidae and for only a few to moderate numbers of

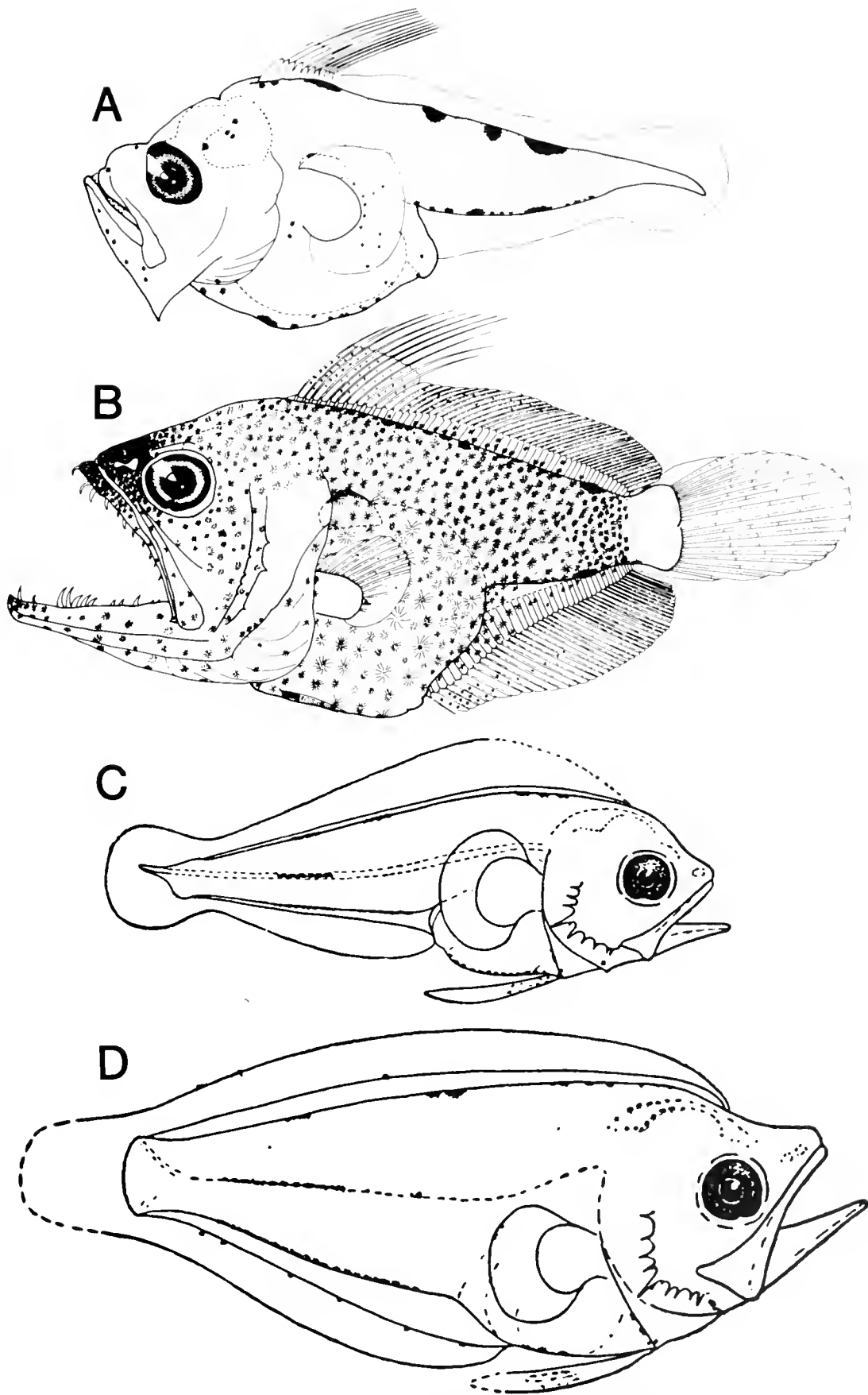

Fig. 342. Larvae of Psettididae and Citharidae. (A) *Psettodes erumei*, 4.3 mm, from Leis and Rennis, 1983; (B) *P. erumei*, 8.7 mm, *ibid.*; (C) *Brachypleura novaezeelandiae*, 5.0 mm, from Pertseva-Ostroumova, 1965; (D) *B. novaezeelandiae*, 7.5 mm, *ibid.*

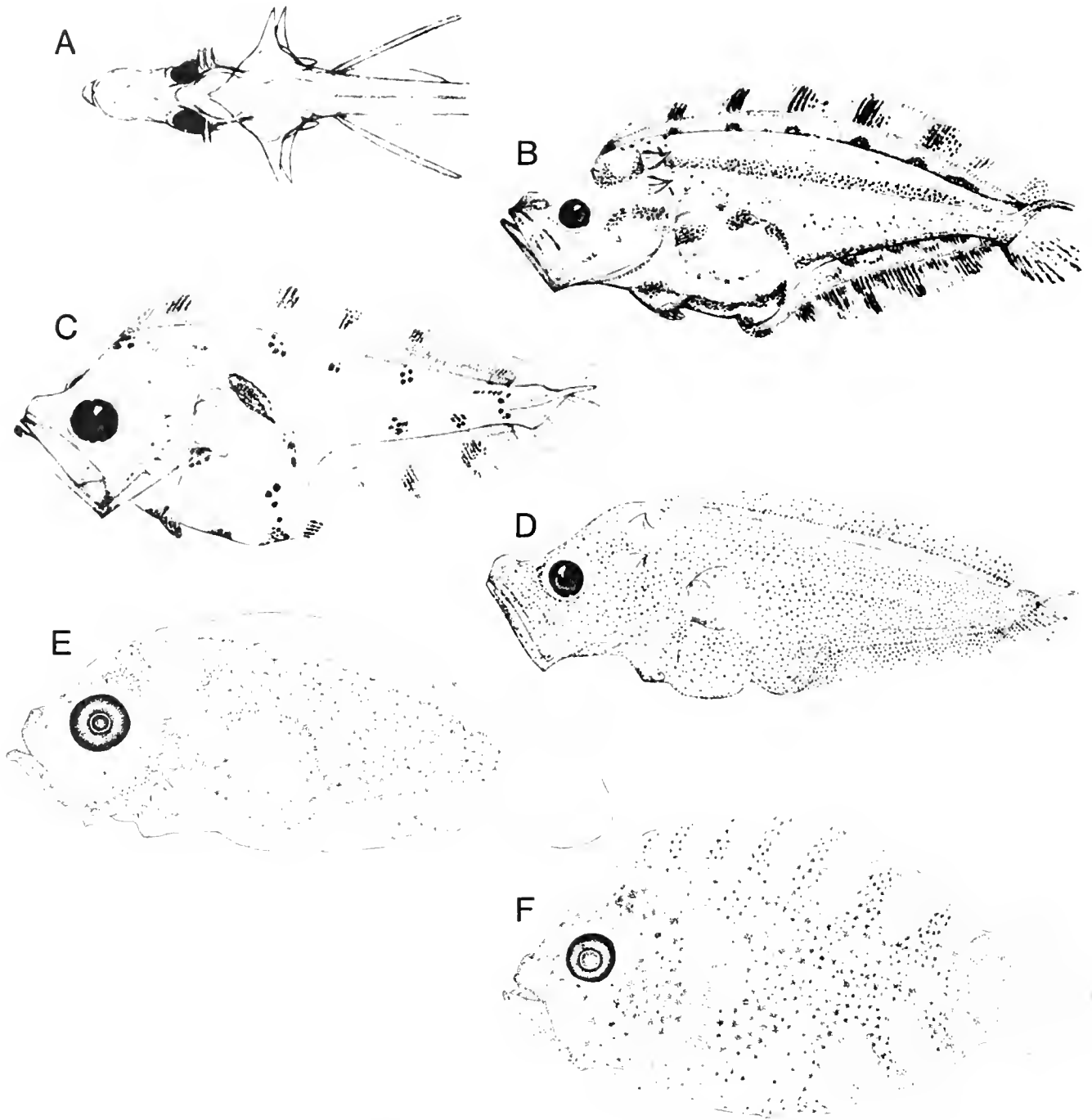

Fig. 343. Larvae of Scophthalmidae. (A) *Zeugopterus punctatus*, 8.9 mm, dorsal view, from Petersen, 1909; (B) *Z. punctatus*, 9.0 mm, *ibid*; (C) *Lepidorhombus boscu*, 9.7 mm, *ibid*; (D) *Phrynorhombus regius*, 8.0 mm, *ibid*; (E) *Scophthalmus maximus*, 7.4 mm, from Jones, 1972; (F) *S. rhombus*, 8.0 mm, *ibid*.

Fig. 344. Larvae of Paralichthyidae. (A) *Paralichthys californicus*, 7.0 mm, original, CalCOFI; (B) As above, dorsal view; (C) *Xystreurus liolepis*, 6.7 mm, original, CalCOFI; (D) As above, dorsal view; (E) *Hippoglossina stomata*, 8.6 mm, from Sumida et al., 1979; (F) *Pseudorhombus pentophthalmus*, 9.2 mm, from Okiyama, 1974a; (G) *Tarphops oligolepis*, 9.2 mm, *ibid*.

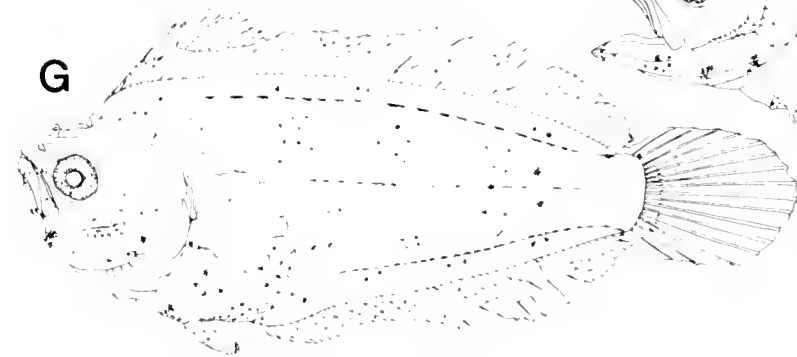
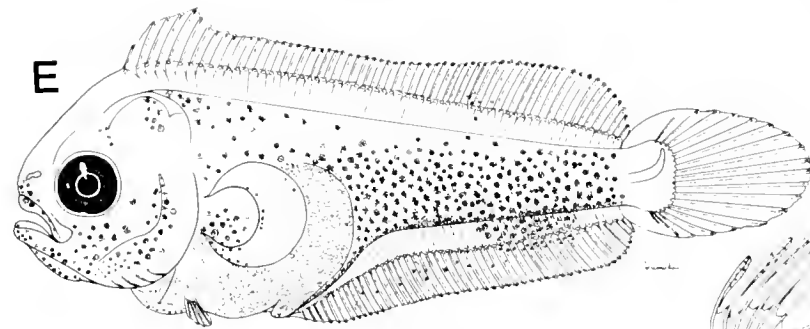
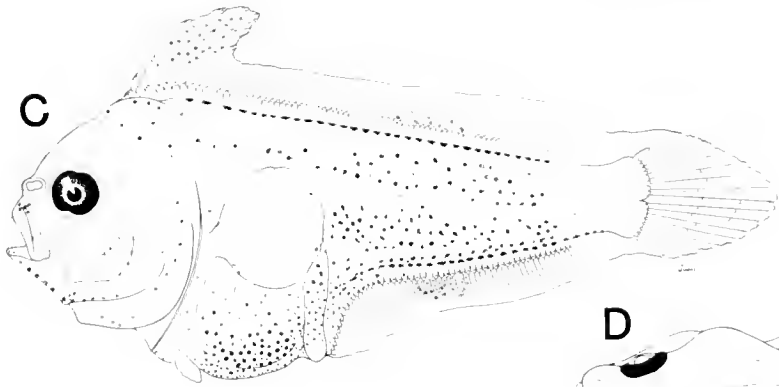
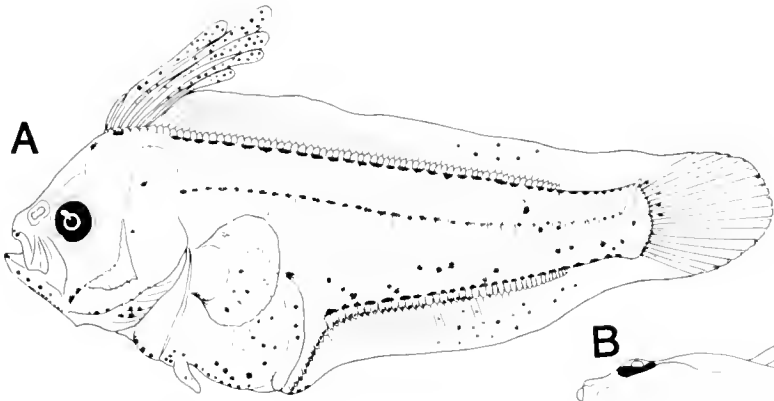

TABLE 173. SUMMARY OF ONTOGENETIC CHARACTERS OF PLEURONECTIFORMS. (Line indicates data unavailable or presented elsewhere in column.)

Taxon	Eggs				Larvae		
	Egg size (mm)	Oil globule: Single/Multiple/Absent	Yolk Homogeneous/Segmented	Chorion: Smooth/Striated/Polygonal	Size at hatching (mm)	Size at metamorphosis (mm)	Elongate dorsal rays: Present (no.)/Absent
Psettodidae	—	—	—	—	—	9–10	10
Citharidae	—	—	—	—	—	—	—
<i>Brachypleura</i>	—	—	—	—	—	7–8	ca. 6
Scophthalmidae	0.72–1.5	S	H	St	2.0–4.0	8–>20	A
Paralichthyidae	<0.70–1.38	S	H	S	1.8–3.7	—	—
<i>Paralichthys</i> group	—	—	—	—	—	7.5–15	4–5
<i>Pseudorhombus</i> group	—	—	—	—	—	8.7–12.5	5–9
<i>Cyclosetta</i> group	—	—	—	—	—	9–>35	**
Bothidae	0.59–0.88	S	H	S	1.8–2.6	—	—
Taeniopsettinae	—	—	—	—	—	19–60	1
Bothinae	—	—	—	—	—	15–120	1
Pleuronectidae	—	—	—	—	—	—	—
Pleuronectinae	0.66–4.5	A*	H	S, P, St	1.7–16.0	4.4–65	A
Pocillopsettinae	—	—	—	—	—	ca. 30	A
Samarinae	—	—	—	—	—	ca. 30	1
Rhombosoleinae	0.58–1.5	M	H	S	ca. 1.8	—	—
Soleidae	0.64–1.75	M	H, S	S, P	1.6–4.1	—	—
Soleinae	—	—	—	—	—	3.4–18	A
Achirinae	—	—	—	—	—	3–5.5	***
Cynoglossidae	0.60–1.23	M	H	S, P	1.3–3.2	—	—
Cynoglossinae	—	—	—	—	—	ca. 4–18	2
Symphurinae	—	—	—	—	—	ca. 12–32	usually 4–5

* Single oil globule present in 3 species

** 0–2 in *Etropus*; 0, 2, 3 in *Citharichthys*; 5–8 in *Syacium*; 8–11 in *Cyclosetta*

*** Third ray elongated in *Achirus*

**** 0, 1, or 2 in *Citharichthys*; 2 or 3 in *Cyclosetta* and *Syacium*; 0 or 1 in *Etropus*

***** *S. ligulata* develops elongate third and fourth rays

***** Protruding in *Chascanopsetta*, *Pelecichthys*, and *Kamoharata*

species in other groups, including Soleidae, Cynoglossidae, Paralichthyidae, and Bothidae.

With a few exceptions, the eggs of flatfishes are pelagic, round, have homogeneous yolk, a narrow perivitelline space, and an unsculptured chorion (Fig. 341). The eggs of all flatfishes are spawned separately. The characters of eggs showing greatest differences among flatfishes are 1) egg size, and 2) the presence or absence of an oil globule(s) (Tables 170–172).

Of the approximately 60 species of pleuronectine flatfishes of the North Pacific and North Atlantic, eggs are known for at least 45 (Table 170). Six species are known to have demersal eggs; these are round or occasionally off-round and have a sticky, adhesive chorion that permits clustering or adhesion to bottom objects. Egg diameters range from 0.66 to 4.5 mm within the subfamily. The yolk is homogeneous in all pleuronectine eggs. The perivitelline space is narrow to moderate, except for eggs of *Hippoglossoides*, which have a wide perivitelline space, usually 25–30% of the egg diameter on either side of the yolk mass. The chorion has the appearance of being smooth on eggs of most species, but closer inspection reveals striations or reticulations on the chorion of some kinds. The chorion of *Pleuronichthys* eggs has a striking hexagonal pattern. The eggs of pleuronectine flatfishes, except for three species, lack an oil globule. The state of embryonic development achieved in the egg is related to egg size, more specifically to yolk size. Larvae hatching from small eggs lack eye pigment, a functional mouth and pectoral fins; those hatching from larger eggs are much more advanced, with pigmented eyes, a functional mouth and pectorals. Embryos in

middle- and late-stage eggs are pigmented, with patterns varying between genera and species. Among species, yolk pigment can range from unpigmented, to some pigment on yolk adjacent to the embryo, to heavily pigmented. Pigment can also be present on finfolds of late-stage eggs of some flatfishes.

Eggs of Scophthalmidae, Paralichthyidae and Bothidae have a single, small to moderate-sized oil globule, are pelagic, round, have a narrow to moderate perivitelline space, and homogeneous yolk (Fig. 341, Table 171). In late-stage eggs and newly hatched larvae the single oil globule usually is in the rear of the yolk mass.

Eggs are known for 8 of the 10 species of scophthalmid flatfishes. They range in size from 0.72 to 1.50 mm. The chorion is striated or rugose in six species and this may apply to all. Embryos develop considerable pigment over the head and body and often in finfolds; pigment over the yolk mass and oil globule can range from none, or sparse, to intense.

Eggs are known for only a few species in the family Paralichthyidae. These range in size from 0.70–1.38 mm; chorions are unsculptured. Except for a few species of *Arnoglossus*, eggs of bothid flatfishes are practically unknown. Mito (1963) lists 10 kinds of bothid eggs off Japan, unidentified to genus; 8 of these have diameters under 1.0 mm. Eggs of his Bothidae No. 9 are slightly off-round and three different eggs have a conspicuous wart-like appendage. Much work remains to be done in identifying eggs of fishes of these families, preferably through rearing eggs from known parents.

Eggs with multiple oil globules are typical of the families

TABLE 173. EXTENDED.

Larvae								
Elongate pelvic rays: Present/Absent	Gut: Normal/Protruding/Trailing	Preopercular spines: Present/Absent	Otic region spines: Present/Absent	Frontal region spines: Present/Absent	Urohyal spines: Present/Absent	Basipterygial spines: Present/Absent	Cleithral spines: Present/Absent	Body spines: Present/Absent
A	N	P	A	A	A	A	A	A
—	—	—	—	—	—	—	—	—
P	N	P	A	A	A	A	A	A
A	N	P, A	P, A	P, A	A	A	A	A
—	—	—	—	—	—	—	—	—
A	N	P	A, P	A	A	A	A	A
A	N	P	A, P	A	A	A	A	A
****	N	P	P, A	A	A	A	A	A
—	—	—	—	—	—	—	—	—
A	N	A	P	A	P	P	P	A
A	*****	A	A	A	P, A	P, A	P, A	P, A
—	—	—	—	—	—	—	—	—
A	N	A, P	A, P	A, P	A	A	A	A
A	N	A	A	A	A	A	A	A
A	P	A	A	A	A	A	A	A
—	—	—	—	—	—	—	—	—
—	—	—	—	—	—	—	—	—
A	N, P	A	A	A	A	A	A	A
A	N, P	A, P	A, P	A, P	A	A	A	P, A
—	—	—	—	—	—	—	—	—
A	P	A	A	A	A	A	A	A
A, *****	P, T	A	A	A	A	A	A	A

Soleidae, Cynoglossidae, the pleuronectid subfamily Rhombosoleinae, and *Mancopsetta*, previously considered a bothid (Fig. 341, Table 172). Eggs have been described for about a dozen kinds of soleids ranging in size from 0.64–1.75 mm. Eggs are round, or occasionally slightly off-round. Oil globules are usually numerous but vary in number, size and distribution within the yolk. They can be highly clumped, as in *Solea solea*, or scattered throughout the yolk, as in *Microchirus variegatus*. In eggs of the latter, oil globules were observed to range in size from 0.015–0.12 mm, whereas they are much smaller and more uniform in size in *Solea solea* or *Pegusa lascaris*. Eggs of the two achirine soleids described from the western Atlantic have a relatively low number of oil globules. Perivitelline space is narrow to negligible in soleid eggs. The yolk is peripherally segmented in eggs of the four species known from the eastern North Atlantic. Yolk is more completely segmented in the egg designated as Synapturinae No. 1 by Mito (1963). Yolk can remain unsegmented, however, as for example in *Achirus lineatus* and *Trinectes maculatus*. Although the chorion of soleid eggs is usually smooth and unsculptured, Mito (1963) found eggs of *Aesopia cornuta* to have a pattern of large hexagonal meshes, 0.18–0.24 mm wide, covering the chorion, and Dekhnik (1973) shows fine polygonal sculpturing on the chorion of *P. lascaris*.

Eggs of the few cynoglossid species known (Table 172) are small, have homogeneous yolk without secondary segmentation, a narrow perivitelline space and either an unsculptured chorion or one with small polygonal meshes. Oil globules range in number between 5–50, and can be variously distributed in the yolk.

Robertson (1975a) described eggs of seven species of Rhombosoleinae, belonging to four genera (Table 172). Egg diameters range from 0.58 to 1.5 mm. Oil globules in described eggs range

in number from 2–28. Yolk is homogeneous, the perivitelline space is narrow, and the chorion is smooth.

Efremenko et al. (1981) described the ovarian and planktonic eggs of *Mancopsetta maculata antarctica* and showed that they are large (2.45–2.75 mm) and have multiple oil globules (>20). This finding provides evidence that *Mancopsetta* does not belong in the Bothidae.

Larvae

In addition to such features as meristics, fin arrangement, and osteology of the fin supports and axial skeleton (which develop gradually during ontogeny and are essential for identification of flatfish larvae) the larval stage itself provides many characters useful in identification and systematic analysis. Larval characters are summarized in Table 173 and below.

Psettodidae (Fig. 342).—Aboussouan's (1972c) description of preflexion larvae of *Psettodes bennetti* was based on five specimens, 4.4–5.7 mm in length. Leis and Rennis (1983) describe a series of five larval specimens of *Psettodes erumei*, 3.0–8.7 mm in length. The smallest specimen has a large yolk sac, the 6.0-mm larva is in mid-flexion and the largest specimen is undergoing eye migration. Larvae have: a deep, relatively thick body; large head with massive jaws that extend well beyond the rear margin of the eye and bear large, early-forming curved teeth; large eye; small preopercular spines; and 10 early-forming elongate dorsal rays. Dorsal and anal fin rays are all present at 6.0 mm but rays do not appear in paired fins until about 8.0 mm. Preflexion larvae have a series of large melanophores along the dorsal midline, large melanophores alternating with smaller ones

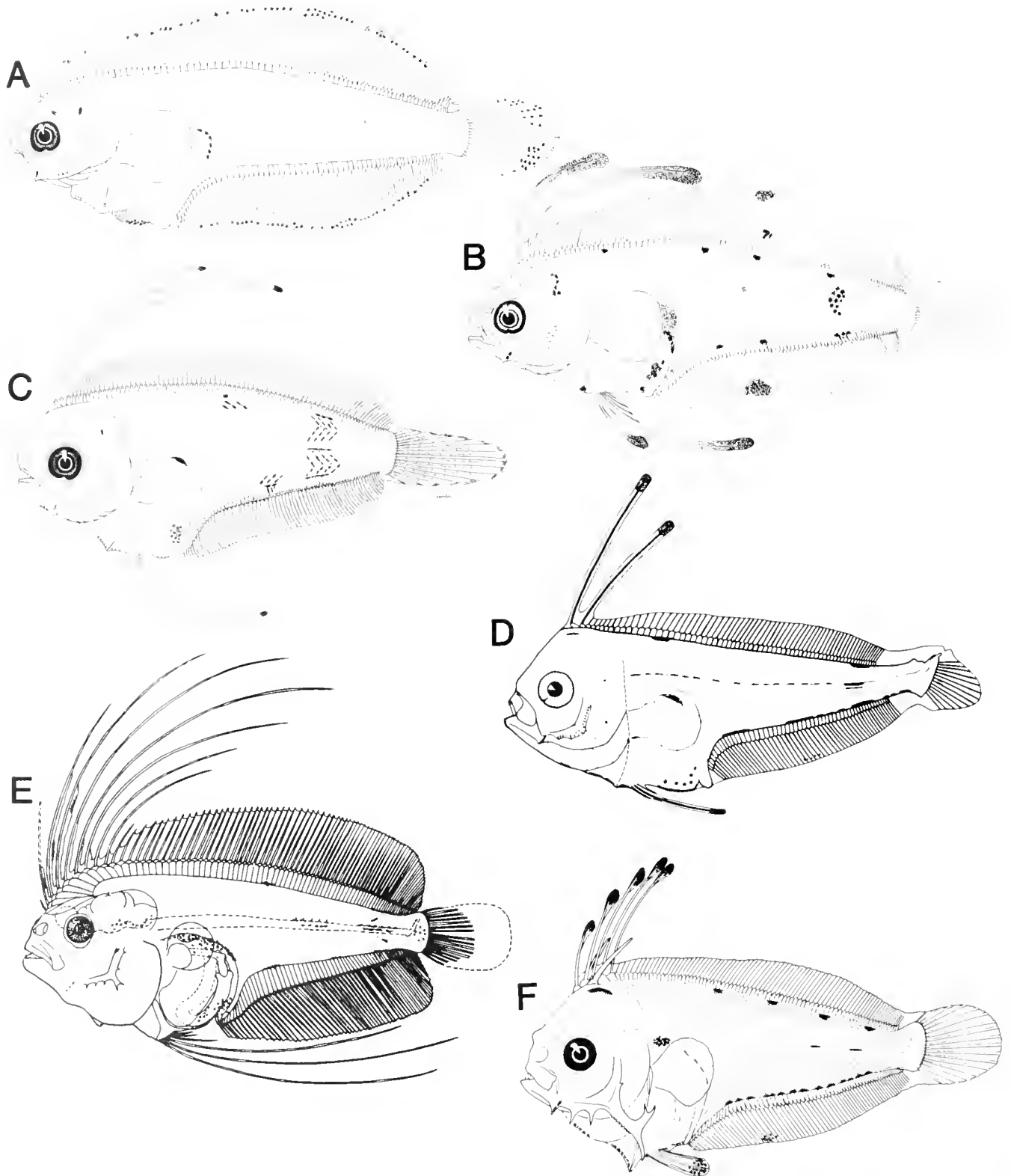

Fig. 345. Larvae of Paralichthyidae. (A) *Cutharchthys stigmaeus*, 14.8 mm, from Ahlstrom and Moser, 1975; (B) *C. sordidus*, 14.5 mm, *ibid*; (C) *C. platophrys*, 8.6 mm, original, CalCOFI; (D) *Etropus crossotus*, 6.0 mm, from Tucker, 1982; (E) *Cyclopsetta chuttendani*, 13.0 mm, from Evseenko, 1982a; (F) *Syacium ovale*, 6.5 mm, original, CalCOFI.

TABLE 174. NUMBERS OF RAYS IN DORSAL CREST AND SIZE AT DEVELOPMENTAL EVENTS IN PARALICHTHYIDAE.

Species	Number of elongate dorsal fin rays	Size at hatching (mm)	Size at flexion (mm)	Size at transformation (mm)	References
<i>Hippoglossina stomata</i>	6	3.7	6.2-8.8	9.1->11.7	Sumida et al., 1979
<i>H. oblonga</i>	~6	2.7-3.2	6.3-7.7	10-14	Leonard, 1971
<i>Paralichthys californicus</i>	5	2.0	6.0-7.3	7.5-9.4	Original, Ahlstrom and Moser, 1975
<i>P. dentatus</i>	4-8	2.4-2.8	7-9.5	~9.5	Smith and Fahay, 1970
<i>P. olivaceus</i>	5-6	2.6-2.8	7.1-8.7	10.2->14.2	Okiyama, 1967
<i>Xystreureys hiolepis</i>	6	2.0	6.0-6.7	7.5->8.7	Original
<i>Pseudorhombus elevatus</i>	9	—	5.5-6.4	~10	Devi, 1969
<i>P. pentophthalmus</i>	7	—	7.1-7.6	8.7-12.2	Okiyama, 1974a; Minami, 1981a
<i>Tarphops oligolepis</i>	8	—	—	9.2-12.5	Okiyama, 1974a
<i>Citharichthys arctifrons</i>	3	<2.3	~5-8	13-15	Richardson and Joseph, 1973
<i>C. cornutus</i>	3	<2.2	5.8-8.9	~18	Tucker, 1982
<i>C. gymnorhinus</i>	3	—	5.3-7.7	~18	Tucker, 1982
<i>C. platophrys</i>	3	<2.0	5.3-6.1	11.2-18.5	Original
<i>C. sordidus</i>	2	~2.0	10.4-11.4	20->39	Ahlstrom, 1965; original; Ahlstrom and Moser, 1975
<i>C. spilopterus</i>	2	—	5.7-6.8	9-12	Tucker, 1982
<i>C. stigmaeus</i>	0	~2.0	9.2-10.2	24.0->35.5	Ahlstrom, 1965; original; Ahlstrom and Moser, 1975
<i>Etropus crossotus</i>	2	<2.3	4.9-9.5	~11	Tucker, 1982
<i>E. microstomus</i>	0	<2.3	5-7	10-12	Richardson and Joseph, 1973
<i>Cyclosetta chittendeni</i>	8-9	—	~7.5	>13.0	Evseenko, 1982a
<i>C. fimbriata</i>	~9	~1.5	6.9	14.0	Gutherz, 1970; Evseenko, 1982a
<i>C. querna</i>	8-11	—	—	>32	Ahlstrom, 1972a
<i>Syacium guineensis</i>	7	<2.1	<6.5	>13.9	Aboussouan, 1968b
<i>S. gunteri</i>	5-8	<1.8	—	—	Evseenko, 1982a
<i>S. micrurum</i>	5-8	<1.8	—	—	Evseenko, 1982a
<i>S. ovale</i>	5-8	~1.6	4.1-4.8	~14-~20	Ahlstrom, 1972a; original
<i>S. papillosum</i>	5-8	<2.3	5.5-6.0	15-13	Futch and Hoff, 1971; Evseenko, 1982a

along the ventral midline, and small melanophores on the trunk, tail, ventral gut, pectoral fin, brain and lower jaw. During flexion the entire body except for the caudal fin base becomes solidly pigmented, a darker band forms forward of the caudal peduncle, and the snout becomes heavily pigmented.

Citharidae (Fig. 342).—Larvae of this family are known from five specimens (4.0-8.0 mm) of *Brachypleura novaezeelandiae* described by Pertseva-Ostroumova (1965). Notochord flexion occurs between 5.0 and 7.0 mm and transformation at about 8.0 mm. Larvae have a moderately deep, thick body and a large head with large jaws and eyes and about 10 large preopercular spines; the sixth dorsal ray is elongate and the rays anterior to it are assumed to be elongate, although damaged in all available specimens; pelvic fins are elongate, extending beyond the anus; pigment consists of a series of melanophores along the dorsum, a series along the horizontal septum, and a postanal series along the ventrum, melanophores below the gut, and on the pelvic fin.

Scophthalmidae (Fig. 343).—Larvae are known for 9 of the 10 species of this family. Petersen (1909) described 5 of the 7 species occurring in the eastern North Atlantic; Jones (1972) provided excellent illustrations of the 2 species of eastern Atlantic *Scophthalmus* and Bigelow and Welsh (1925) described larvae of *S. aquosus*, the only western Atlantic representative of the family. Newly hatched larvae are 2.0-4.0 mm in length (Table 171); size at notochord flexion for most species is 6.0-8.0 mm. Meta-

morphosis can begin by 8 or 9 mm and be completed by 13 mm (*S. aquosus*, *Phrynorhombus norvegicus*, *Zeugopterus punctatus*) or delayed to over 20 mm (*S. maximus*, *S. rhombus*). Larvae are deep- and thick-bodied, especially at the gut, have a large head and jaws and moderate to large eyes. Scophthalmid larvae develop extensive head spination. Three species (*Z. punctatus*, *P. regius*, *Lepidorhombus whiffiagonis*) develop paired otic spines. In *Z. punctatus*, spines also develop at the lateral aspect of the midbrain and on the opercle. Larvae of *P. norvegicus* develop spines along the lower jaw, on the opercle and preopercle, and at the shoulder (posttemporal region) while *L. boscii* has preopercular spines and a shoulder cluster. *S. maximus* and *S. rhombus* have a supraocular spiny ridge, numerous spines on the opercle and preopercle and a shoulder cluster. Pigmentation is heavy on the head and body in most species. *Z. punctatus* has a series of finfold bars and *L. boscii* develops these and also incomplete bars on the body. Late larvae of all species develop bars on the dorsal and anal fins.

Paralichthyidae (Figs. 344, 345).—Three subgroups are recognized in this family on the basis of adult characters: *Paralichthys* and relatives (*Ancylopsetta*, *Gastropsetta*, *Hippoglossina*, *Lio-glossina*, *Verceundum*, *Xystreureys*); *Pseudorhombus* and relatives (*Cephalopsetta*, *Tarphops*); and *Cyclosetta* and relatives (*Citharichthys*, *Etropus*, *Syacium*).

In the first group larvae are known for species of *Paralichthys* and *Hippoglossina* and for *Xystreureys hiolepis* and in the second group larvae are known for *Pseudorhombus* and *Tarphops*. In

TABLE 175. MERISTIC AND LARVAL CHARACTERS OF BOTHIDAE.

Taxon	Larvae described ¹	Number of vertebrae	Urohyal spines ²	Basipterygial spines	Cleithral spines	Otic spines	Scale spines	2nd dorsal ray ³	Length at transformation (mm)	References
Taeniopsettinæ										
<i>Engyophrys</i>	+	10 + 27-31 = 37-41	++	++	++	+	0	M	~19	Hensley, 1977
<i>Taeniopsetta</i>	+	10 + 30-32 = 40-42	++	++	++	+	0	S	~60	Amaoka, 1970
<i>Trichopsetta</i>	+	10-11 + 30-33 = 40-43	++	++	++	+	0	S	~28	Futch, 1977
<i>Perissias</i>	-	10 + 29-30 = 39-40								
Bothinæ										
<i>Arnoglossus</i>	+	10-12 + 27-36 = 37-48	0	0	0	0	+	M, L	21-46	Kyle, 1913; Pertseva-Ostroumova, 1965; Amaoka, 1973, 1974
<i>Bothus</i>	+	10 + 25-32 = 35-42	0	0	0	0	0	M, L	9-42	Kyle, 1913
<i>Chascanopsetta</i>	+	16-18 + 37-44 = 53-59	0	0	0	0	0	M	78-120	Bruun, 1937; Nielsen, 1963b; Amaoka, 1971; Pertseva-Ostroumova, 1971
<i>Crossorhombus</i>	+	10 + 24-27 = 34-37	0	+	0	0	+	M, L	15-20	Ochiai and Amaoka, 1963
<i>Engyprosonon</i>	+	10 + 23-27 = 33-37	++	++	0, ++	0	0	M	16-18	Pertseva-Ostroumova, 1965
<i>Grammatobothus</i>	+	10 + 27-28 = 37-38	+	+	0	0	0	M	~15	
<i>Kamoharaia</i>	+	13-14 + 37-39 = 50-53	0	0	0	0	0	M	~91	Nielsen, 1963c
<i>Laeops</i>	+	10-12 + 35-42 = 46-53	0	0	0	0	0	L	51-80	Balakrishnan, 1963; Amaoka, 1972a; Hubbs and Chu, 1934
<i>Lophonectes</i>	+	10 + 32-33 = 42-43	0	+	0	0	0	M	~20	Original
<i>Monolene</i>	+	10 + 28-38 = 38-48	0	0	0	0	0	L	~30	Futch, 1971
<i>Pelecanichthys</i>	+	17 + 40 = 57	0	0	0	0	0	M	>90	Struhsaker, pers. comm.
<i>Psetinna</i>	+	10 + 29-30 = 35-40	+	+	0	0	+	M	16-20	Pertseva-Ostroumova, 1965; Amaoka, 1976
<i>Asterorhombus</i>	-	10 + 26-27 = 36-37								
<i>Japonolaeops</i>	-	11 + 41-44 = 52-53								
<i>Mancopsetta</i>	-	13-16 + 38-50 = 52-66								
<i>Neolaeops</i>	-	13 + 38 = 51								
<i>Parabothus</i>	-	10 + 31-36 = 41-46								
<i>Tosarhombus</i>	-	10 + 28-30 = 38-40								

¹ + = yes, - = no, ² 0 = absent; + = present, ++ = strong.

³ S = short, M = moderate; L = long

these two subgroups hatching, notochord flexion and metamorphosis occur at a small size (Table 174). Larvae of these groups are noted for a dorsal crest consisting of elongate early forming rays, beginning with the second dorsal ray (Table 174). Larvae of the *Paralichthys* group are moderate in body depth, with a deep head and moderate-size jaws. Body thickness is moderate except that *Paralichthys* is more laterally compressed than in other genera reported (Fig. 344). The gut mass is large. Preopercular spination consists of an anterior and posterior series in *Paralichthys*, *Pseudorhombus* and *Tarphops* and an anterior series only in *Hippoglossina*. Larvae of *Paralichthys dentatus* have one to several minute sphenotic spines (Smith and Fahay, 1970) and *P. olivaceus* develops a spine cluster on the sphenotic, one spine on the epiotic, and 1-2 spines on each bone in the opercular series. Larvae of *Pseudorhombus pentophthalmus* have a single sphenotic spine, and some on the opercular bones (Okiyama, 1974a); Devi (1969) shows two rows of sphenotic spines in *P. elevatus*.

Yolk-sac larve of the *Paralichthys* and *Pseudorhombus* groups develop moderate to heavy pigmentation with some on the finfolds. Later-stage larvae have pigment over the brain, on the lower head and jaw region and below and lateral to the gut. Most species have a melanophore series along the dorsum and

ventrum. Lateral pigment may consist of a series along the horizontal septum (*Paralichthys*, *Tarphops*), a wide-spread zone of melanophores (*Xystreureys*, *Hippoglossina*) or a posterior bar (*Pseudorhombus pentophthalmus*). Most species have a series of internal melanophores above the spinal column and some melanophores on the posterior region of the finfold and developing dorsal and anal fins.

Larvae of the *Cyclosetta* assemblage are similar morphologically to those of the *Paralichthys* and *Pseudorhombus* assemblages, but differ in spination and fin ray development. The rays forming the dorsal crest are typically longer and stand out more abruptly compared with *Paralichthys* and associated genera. The fin ray complement of the crest, along with other characters, divides the assemblage into two generic pairs: *Citharichthys-Etropus* and *Cyclosetta-Syacium*. Species of the former group have either two or three elongate rays, except for two species which lack a crest altogether (Table 174). Species of *Syacium* have 5-8 elongate dorsal rays and 8-11 occur in *Cyclosetta*. The left pelvic fin forms before the right and may develop elongate rays in some species. The first two pelvic rays are elongate in *Citharichthys sordidus* and *C. platophrys*, the second ray only is elongate in *C. cornutus*, *C. gymnorhinus*, *C. spilopterus* and *Etropus crossotus*; *C. arctifrons*, *C. stigmaeus* and *E. micros-*

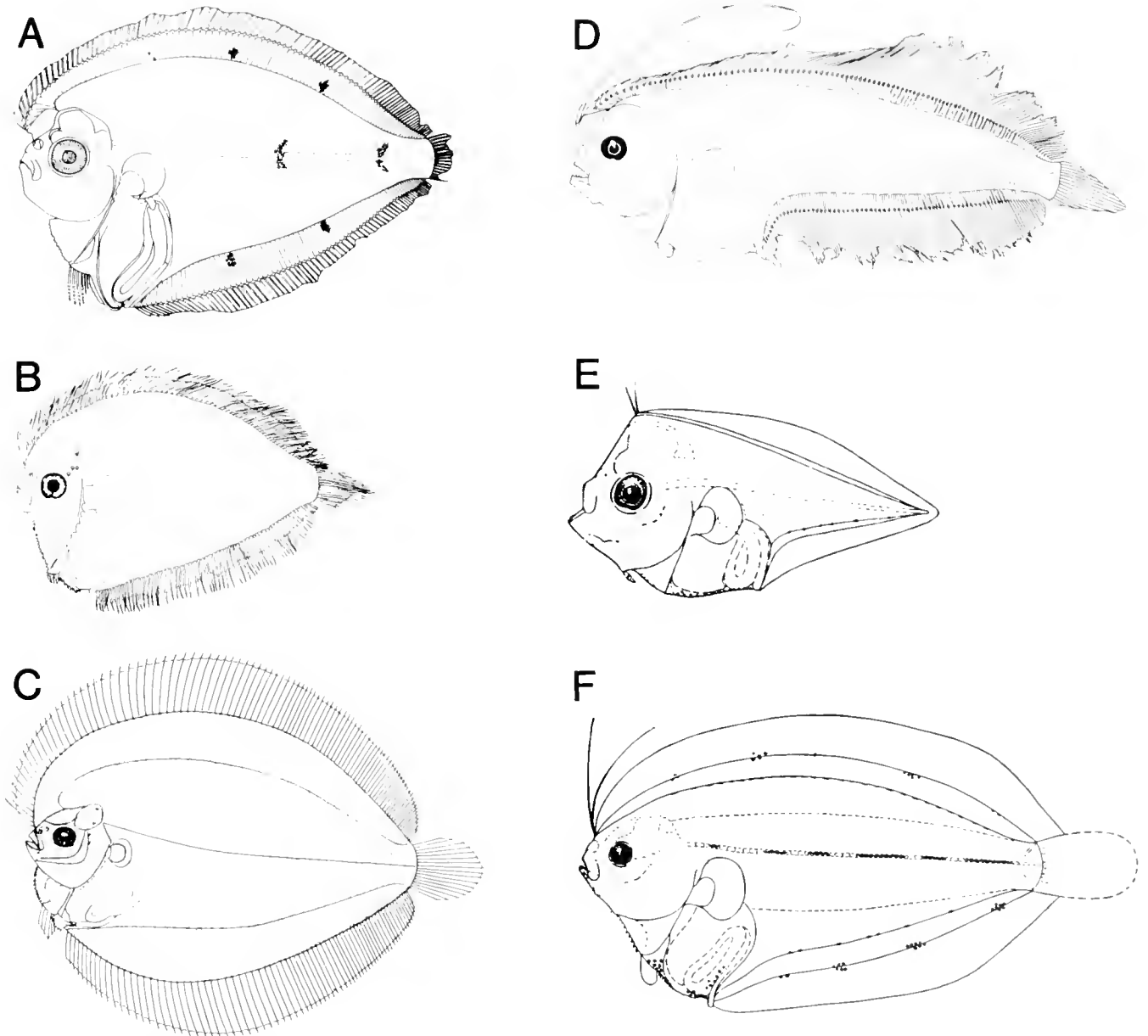

Fig. 346. Larvae of Bothidae. (A) *Trichopsetta ventralis*, 21.9 mm, from Evseenko, 1982a; (B) *Engyophrys senta*, 12.3 mm, from Hensley, 1977; (C) *Taeniopsetta ocellata*, 59.0 mm, from Amaoka, 1970; (D) *Monolene sessilicauda*, 14.3 mm, redrawn from Futch, 1971; (E) *Psetinna hamanensis*, 4.2 mm, from Pertseva-Ostroumova, 1965; (F) *P. hamanensis*, 18.1 mm, *ibid.*

tomus lack elongate pelvic rays. The first three pelvic rays become markedly elongate in *Cyclopsetta* and the entire left fin becomes moderately elongate in *Syacium*.

Etropus and *Citharichthys* (except for *C. arctifrons*) develop one or more rows of small preopercular spines. According to Tucker (1982), small frontal-sphenotic spines are present in some species of *Citharichthys* and *Etropus* (6–8 spines on each side in *C. cornutus*, up to 6 in *C. gymnorhinus*, 1–2 in *C. spilopterus*, and 3–4 in *E. crossotus*). *Syacium* and *Cyclopsetta* develop a series of large preopercular spines at the margin of the bone and, in some species, an irregular anterior series. The

spine at the angle of the primary series becomes antler-like in preflexion larvae of *Syacium* and in postflexion larvae of *Cyclopsetta*. Early preflexion larvae of *Syacium* develop single elongate sphenotic spines which remain prominent during the remainder of the larval period. Sphenotic spines in *Cyclopsetta* are early-forming but short.

Larvae of both subgroups of the *Cyclopsetta* assemblage typically have pigment above the brain, on the lower head region, below the gut, lateral to the posterior region of the gut, and above the gas bladder. Early preflexion larvae of most species have a series of small postanal melanophores and a bar or a

TABLE 176. SIZE DATA FOR PLEURONECTINAE LARVAE.

	Size at hatching (mm)	Size at notochord flexion (mm)	Size at transformation (mm)	References
<i>Acanthopsetta nadeshnyi</i>	<3.0	8.4–9.9	ca. 20–?	Pertseva-Ostroumova, 1961
<i>Atheresthes evermanni</i>	<8.4	ca. 11.5–15	—	Pertseva-Ostroumova, 1961
<i>A. stomas</i>	—	—	32.9–?	Pertseva-Ostroumova, 1961
<i>Cleisthenes herzensteini</i>	2.2–2.6	7.0–7.9	8.1–11.4	Okiyama and Takahashi, 1976; Dekhnik, 1959
<i>Embassichthys bathybius</i>	ca. 9.0	—	16.2–?	Richardson, 1981b
<i>Eopsetta grigorjewi</i>	2.5–3.0	7.2–8.9	11.4	Okiyama and Takahashi, 1976
<i>E. jordani</i>	2.8	—	—	Alderdice and Forrester, 1971
<i>Glyptocephalus cynoglossus</i>	3.5–5.6	15–21	25–?	Petersen, 1904
<i>G. stelleri</i>	4.1–5.2	15–17	19–48	Okiyama, 1963; Dekhnik, 1959; Pertseva-Ostroumova, 1961
<i>G. zachirus</i>	ca. 6	15.3–24.0	49–72	Original; Ahlstrom and Moser, 1975
<i>Hippoglossoides dubius</i>	3.0–3.4 TL	<12.4	18.1	Okiyama and Takahashi, 1976
<i>H. classodon</i>	5.4–6.6 TL	9.0–10.2	—	Dekhnik, 1959; Pertseva-Ostroumova, 1961
<i>H. platessoides</i>	4.0–6.0	9.5–17.5	18–30	Petersen, 1904; Russell, 1976; Nichols, 1971; Colton and Marak, 1969
<i>H. robustus</i>	ca. 4.0	ca. 11–?	>28.6	Pertseva-Ostroumova, 1961
<i>Hippoglossus hippoglossus</i>	6.5–7.0	16–18	22–34	Schmidt, 1904; Russell, 1976 (summary)
<i>H. stenolepis</i>	7.8–8.5	13.6–17.8	14.7–24.1	Thompson and Van Cleve, 1936; Pertseva-Ostroumova, 1961
<i>Hypsopsetta guttulata</i>	1.7–2.3	4.0–5.2	4.4–>8.8	Sumida et al., 1979
<i>Isopsetta isolepis</i>	2.7–2.9	9.1–14.0	15–>21.9	Richardson et al., 1980
<i>Kareus bicoloratus</i>	ca. 3.0	ca. 4.0–9.0	ca. 14–?	Pertseva-Ostroumova, 1961
<i>Lepidopsetta bilineata</i>	3.4–3.8	ca. 8.4–9.9	>17.7	Pertseva-Ostroumova, 1961
<i>L. mochigarei</i>	3.95–4.48	ca. 8.9	—	Yusa, 1958; Okiyama and Takahashi, 1976
<i>Limanda aspera</i>	2.2–2.8	7.5–9.5	ca. 10–?	Dekhnik, 1959; Pertseva-Ostroumova, 1961
<i>L. ferruginea</i>	2.0–3.5	5.9–ca. 10	ca. 14	Bigelow and Welsh, 1925; Miller, 1958
<i>L. limanda</i>	2.7–4.0	7–8.7	12–20	Russell, 1976 (summary)
<i>L. punctatissima</i>	1.79–2.21	—	8.1–>9.6	Pertseva-Ostroumova, 1961
<i>L. schrenki</i>	ca. 2.4	—	—	Hikita, 1952
<i>L. schrenki</i> (as <i>Pseudopleuronectes yokohamae</i>)	ca. 2.4	<7.4	12.0–?	Pertseva-Ostroumova, 1961
<i>L. yokohamae</i>	3.5–3.8	ca. 7.0	ca. 7.5–10.0	Yusa, et al., 1971; Minami, 1981a
<i>Liopsetta glacialis</i>	3.7	—	—	Pertseva-Ostroumova, 1961
<i>L. obscura</i>	2.5–3.5	~6.6	>9.0	Pertseva-Ostroumova, 1961; Kurata, 1956
<i>L. punifasciata</i>	3.15–3.93	8.11–8.45	>8.5	Pertseva-Ostroumova, 1961
<i>L. putnami</i>	3.1–3.6	6.0–7.1	7.3	Laroche, 1981
<i>Lyopsetta exilis</i>	ca. 5.6	9.0–10.9	15.7–24.7	Original; Ahlstrom and Moser, 1975
<i>Microstomus achne</i>	—	8.8	—	Okiyama and Takahashi, 1976
<i>M. kitt</i>	4.84	12–15	18–28	Petersen, 1904
<i>M. pacificus</i>	ca. 6.0	ca. 10–15	ca. 20–>45	Original; Ahlstrom and Moser, 1975
<i>Parophrys vetulus</i>	2.3–2.8	8.8–10.5	ca. 20	Original; Budd, 1940; Ahlstrom and Moser, 1975
<i>Platichthys flesus</i>	2.25	5.9–7.1	9–12	Nichols, 1971; Russell, 1976 (summary)
<i>P. stellatus</i>	1.9–2.1	5.5–6.0	—	Orcutt, 1950; Yusa, 1957; Pertseva-Ostroumova, 1961
<i>P. pallasi</i> (as <i>Platessa quadrituberculata</i>)	5.6	8.9	ca. 10.0–?	Pertseva-Ostroumova, 1961
<i>P. platessa</i>	6.0–7.5	8.9–10.2	10.5–14	Nichols, 1971; Russell, 1976 (summary)
<i>Pleuronichthys coenosus</i>	3.9	6.2–8.5	8.2–>11.4	Sumida et al., 1979; Budd, 1940
<i>P. cornutus</i>	2.65–2.8	>3.6	7.25–13.0	Takita and Fujita, 1964; Minami, 1982a
<i>P. decurrens</i>	4.9–5.5	7.8–11.0	10.5–>21.0	Sumida et al., 1979; Budd, 1940
<i>P. rutteri</i>	2.1	4.3–5.6	6.0–>10.0	Sumida et al., 1979
<i>P. verticalis</i>	2.4	5.0–7.2	7.3–>11.0	Sumida et al., 1979; Ahlstrom and Moser, 1975; Budd, 1940
<i>Psettichthys melanostictus</i>	<3.0	ca. 8.0	>22.6	Hickman, 1959
<i>Pseudopleuronectes americanus</i>	2.3–3.5	5.0–7.1	6.8	Breder, 1923; Laroche, 1981
<i>P. herzensteini</i>	2.6–2.9	ca. 6.0–8.5	ca. 10.4–?	Dekhnik, 1959
<i>Reinhardius hippoglossoides</i>	10–16	25–27	45–65	Jensen, 1935
<i>Tanakus kutaharai</i>	ca. 3.0	—	18.9–ca. 20	Okiyama and Takahashi, 1976
<i>Verasper variegatus</i>	3.8	ca. 9–12.4	ca. 16.4–?	Takita et al., 1967; Pertseva-Ostroumova, 1961; Uchida, 1933

short lateral pigment series posteriad on the tail. In some species of *Citharichthys* the ventral series coalesces into a more sparse series of larger spots and a similar series develops along the dorsum (e.g., *C. arctiformis*, *C. cornutus*, *C. sordidus*). In other species, series along the dorsum and ventrum are abbreviated or absent and only the tail bar may be present (e.g., *C. gym-*

norhinus, *C. platophrys*) or absent (*C. spilopterus*). *Etropus* larvae have dorsal and ventral series and either a short lateral series (*E. crossotus*) or a long one (*C. microstomus*). *Cyclopsetta* and *Syacium* have dorsal and ventral series and a short lateral series posteriad on the tail. Fin pigment is principally on the spatulate tips of the elongate dorsal and pelvic fin rays. Late-

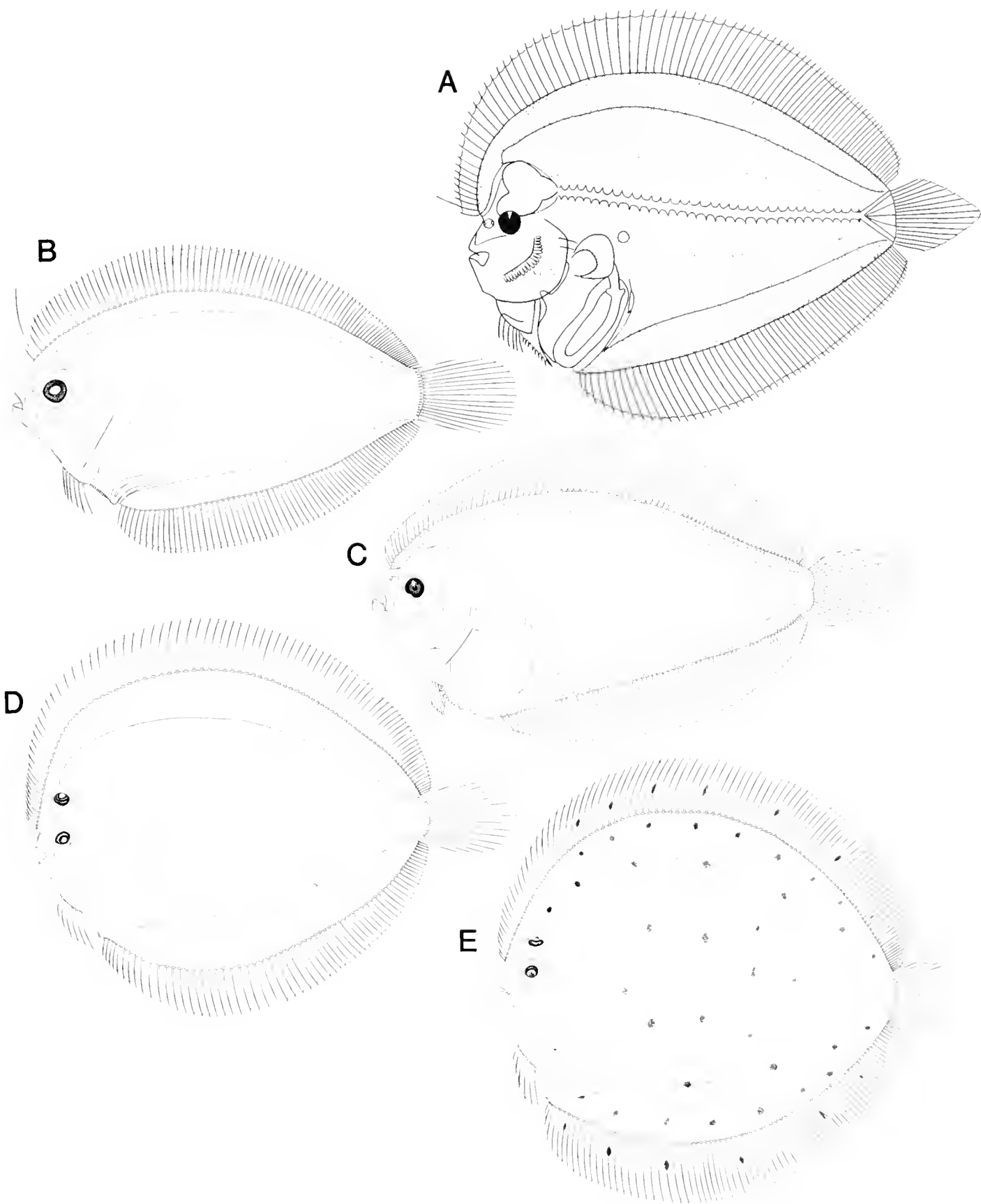

Fig. 347. Larvae and transforming specimens of Bothidae. (A) *Crossorhombus kobensis*, 16.0 mm, from Amaoka, 1979; (B) *Engyprosopon xenandrus*, ca. 20.0 mm; (C) *Lophonectes gallus*, 18.5 mm, original, K 138/74, New Zealand; (D) *Bothus thompsoni*, ca. 36.0 mm; (E) *B. mancus*, ca. 30.0 mm. B, D, and E from P. Struhsaker, unpublished.

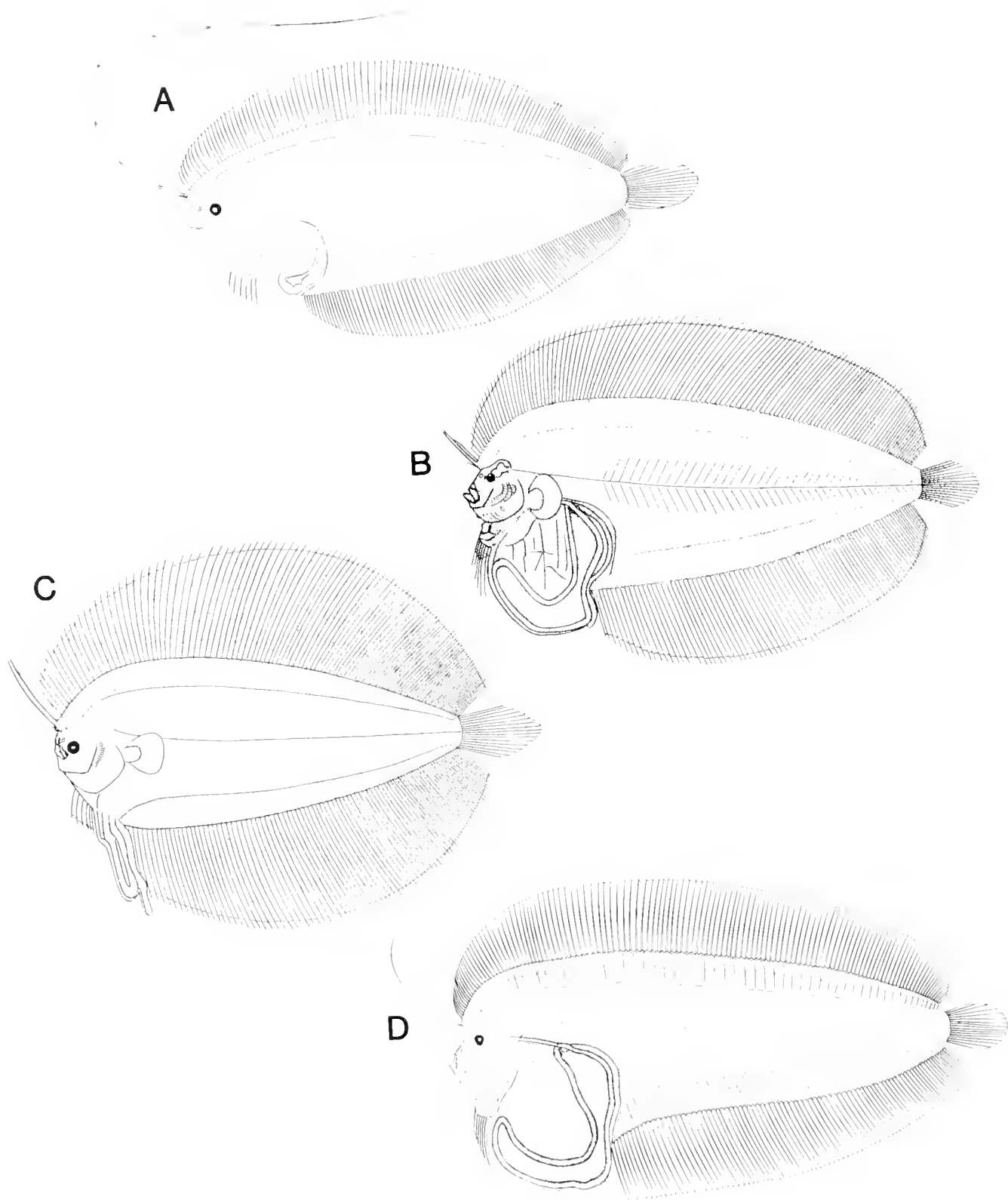

Fig. 348. Larvae of Bothidae. (A) *Arnoglossus debilis*, ca. 59.0 mm, from P. Struhsaker, unpublished; (B) *Chascanopsetta lugubris*, 120.0 mm, from Amaoka, 1971; (C) *Laeops kitaharae*, 79.0 mm, from Amaoka, 1972; (D) *Pelecanichthys* sp., ca. 95.0 mm, from P. Struhsaker, unpublished.

TABLE 177. SIZE DATA FOR LARVAE OF ACHIRINAE AND SOLEINAE.

Taxon	Size at hatching (mm)	Size at flexion (mm)	Size at transformation (mm)	References
Achirinae				
<i>Achirus lineatus</i>	1.6	ca. 2.5-3	3.0-5.5	Houde et al., 1970
<i>Trinectes maculatus</i>	1.7-1.9	ca. 3-4	ca. 5	Hildebrand and Cable, 1938
Soleinae				
<i>Aesopia cornuta</i>	4.1	—	9.2-?	Mito, 1963
<i>Austroglossus microlepis</i>	1.7	5.5-6.6	8.5-ca. 16	O'Toole, 1977; Brownell, 1979
<i>Bathysolea profundicola</i>	—	—	4.32	Aboussouan, 1972c
<i>Buglossidium luteum</i>	1.8-2.3	ca. 6-8	ca. 6-10	Holt, 1891; Ehrenbaum, 1897
<i>Dicologlossa cuneata</i>	1.3	ca. 6.3-6.5	7-7.5	Lagardere, 1980; Lagardere and Aboussouan, 1981
<i>Euryglossa pan</i>	<2.66	<4.6	3.4-6.5	Jones and Menon, 1951
<i>Heteromycteris capensis</i>	1.7	?-6.5	ca. 6.2-?	Brownell, 1979
<i>H. japonicus</i>	—	ca. 4.55	5.0-7.0	Minami, 1981b
<i>Microchirus boscanion</i>	—	—	7.2	Aboussouan, 1972c
<i>M. frechkopi</i>	—	—	5.68	Aboussouan, 1972c
<i>M. ocellatus</i>	2.0	4.6-5.1	6.8->8.2	Palomera and Rubies, 1977
<i>M. variegatus</i>	2.4-2.9	6.1->7.1	ca. 7-12 (18)	Cunningham, 1890; Petersen, 1909
<i>Pegusa cadenati</i>	—	—	7.0	Aboussouan, 1972c
<i>P. impar</i>	—	—	8.5->12	Padoa, 1956k
<i>P. lascaris lascaris</i>	<3.5	5.3-8.1	9.5->11.2	Clark, 1914
<i>P. lascaris nasuta</i>	2.1-2.5	—	—	Dekhnik, 1973; Padoa, 1956k
<i>Solea cuneata</i>	—	—	7.0	Aboussouan, 1972c
<i>S. heinii</i>	<2.2	>2.7-3.2	—	Balakrishnan and Devi, 1974
<i>S. hexophthalma</i>	—	—	8.0	Aboussouan, 1972c
<i>S. ovata</i>	—	ca. 3-4	4.5-?	Balakrishnan, 1963
<i>S. solea</i>	2.5-3.8	5.5-?	ca. 7-14.6	Russell, 1976 (summary)
<i>Synaptura kleini</i>	3.0	?-6.5	ca. 7-9	Brownell, 1979
<i>Zebrias japonicus</i>	4.1 TL	—	—	Mito, 1963
<i>Z. zebra</i>	4.0 TL	—	—	Mito, 1963

stage larvae of most species develop chevron-shaped bars on the epaxial and hypaxial myosepta. Metamorphosing specimens of *Cyclosetta* have series of large ocelli on the dorsal and anal fins. *Dorsopsetta norma* described by Nielsen (1963b) on the basis of two metamorphosing specimens is apparently a species of *Cyclosetta*.

Bothidae (Figs. 346-348).—Two bothid subfamilies are recognized, Taeniopsettinae and Bothinae. Bothid larvae are thin-bodied to diaphanous, sparsely pigmented, and all develop an elongate second dorsal ray (Table 175). Also, spines may appear on the urohyal, basipterygia, cleithra and epiotics in a pattern which is generally consistent for subfamilies and genera (Table 175). Bothid larvae reach a relatively large size before metamorphosis. Early larval stages are often poorly represented in collections.

Larval series are known for all taeniopsettine genera, except *Perissias*. Larvae of *Trichopsetta* and *Engyphrys* are ovate while those of *Taeniopsetta* are round (Fig. 346). All have a complete complement of head spines (Table 175). The second dorsal fin ray is slightly or moderately elongate. *Taeniopsetta* lacks melanophores, but live larvae have four reddish-orange spots along the bases of the dorsal and anal fins, and orange, reddish and yellow blotches and bands on the body and head. *Trichopsetta* has three series of melanistic blotches along the dorsal and anal pterygiophores and along the body axis (left side). *Engyphrys* lacks melanophores.

Larvae of Bothinae have an ovate, round, or elongate shape (Figs. 347, 348) and lack epiotic spines. *Engyproson* has numerous urohyal and basipterygial spines and some species have numerous spines on the cleithrum. *Psettina* and *Grammato-*

bothus have urohyal and basipterygial spines, and early larvae of the former have a hook-like projection on the lower jaw (Fig. 346). *Crossorhombus* and *Lophonectes* have basipterygial spines only and all other known bothid larvae lack head spines. *Crossorhombus* larvae have a series of scale spines along the bases of the dorsal and anal fins, one scale per ray, and species of *Psettina* and *Arnoglossus* also develop such scale spines. In the species of *Arnoglossus* described by Kyle (1913), patches of scale spines develop on the median and ventral regions of the abdomen. The second dorsal ray is usually moderately elongate but can be greatly elongate and ornamented, as in *Arnoglossus*.

Pigmentation is sparse in most bothine larvae and lacking in some species. Exceptions are found in species of *Arnoglossus* and *Psettina* which usually have melanophores above the brain, ventrally on the gut, above the gas bladder, in series along the dorsal and ventral midlines, and along the horizontal septum; in some species a complete or partial bar is present posteriad on the tail. Preflexion larvae of *Bothus* have a melanistic blotch near the tip of the notochord; later larval stages are unpigmented, except that transforming specimens of some species, *B. myriaster* (Amaoka, 1964) and *B. mancus* (Fig. 347), become heavily spotted over the body and fins. *Lacops* has melanistic blotches forming an irregular pattern over the body and median fins.

Monolene shares some adult characters with taeniopsettines but larval characters place it with the bothines. Larvae are elongate, lack head spines, have an elongate ornamented second dorsal ray, and melanistic pigment above the gut, on the right side of the brain and on the dorsal fin membrane (Fig. 346).

Pleuronectidae (Figs. 349-355).—Of the five pleuronectid

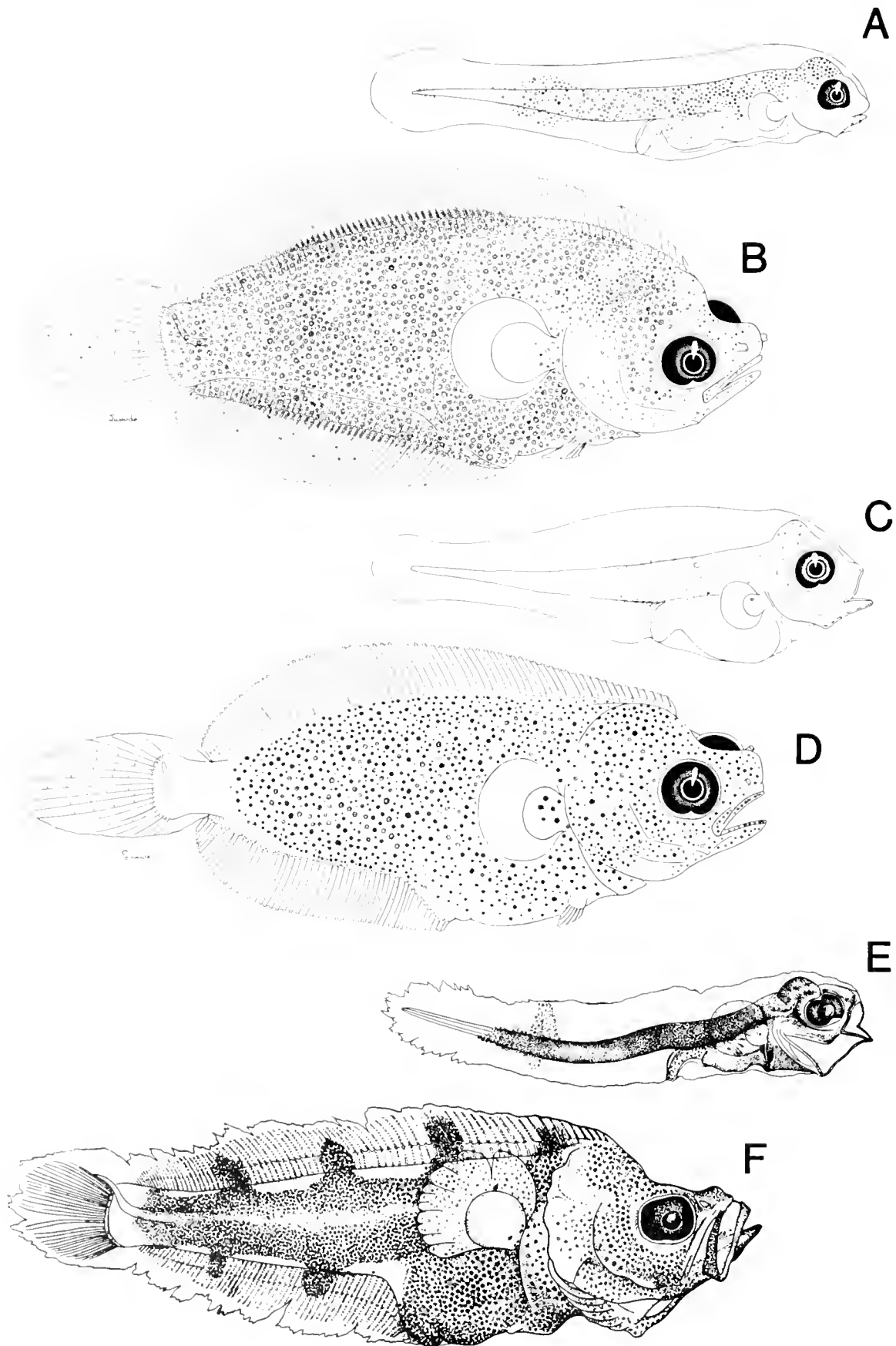

subfamilies recognized (see introduction), the Pleuronectinae is the largest with 26 genera, representing $\frac{2}{3}$ of the genera in the family. Three contributions that summarize egg and larval information for pleuronectine flatfishes from the eastern North Atlantic and Mediterranean are Ehrenbaum (1905–1909), Padoa (1956k), and Nichols (1971). Bigelow and Welsh (1925), Bigelow and Schroeder (1953), Martin and Drewry (1978), and Fahay (1983) give information on eggs and larvae of western Atlantic pleuronectine flatfishes. The most comprehensive work dealing with early life history stages of flatfishes from the western North Pacific is Pertseva-Ostroumova (1961).

Yolk-sac larvae of pleuronectine flatfishes can be as small as 1.7 mm (*Hypsopsetta guttulata*) or as large as 10–16 mm (*Reinhardtius hippoglossoides*) and size at hatching is a primary character for identifying yolk-sac larvae (Table 176). The pigment pattern can be quite distinctive, as for example in the genus *Pleuronichthys*, but in many pleuronectines the body pigment migrates during the yolk-sac stage, and is variable from specimen to specimen of the same species. The yolk sac itself can lack pigment (as in *Parophrys vetulus*, *Hippoglossus stenolepis* or *Eopsetta jordani*), can be moderately pigmented (as in *Lyopsetta exilis*, *Lepidopsetta bilineata* or *Psettichthys melanostictus*) or can be heavily pigmented (as in *Pleuronichthys decurrens* or *Verasper variegatus*). Similarly the finfold can lack pigment or be variously pigmented and useful in identification.

Early preflexion pleuronectine larvae are slender; the head is of moderate size; snout-anus length can be as much as 50% NL (as in four species of *Pleuronichthys* larvae, Sumida et al., 1979) but usually is shorter (i.e., 35–45% NL). The gut is initially straight but develops a coil soon after the completion of yolk absorption. Greatest body depth after the gut becomes looped is either at the anus or slightly anterior to it. Body shape of preflexion larvae is quite similar from species to species. There are few distinctive characters unique to the larval period of pleuronectine flatfishes. Only a few kinds of pleuronectine larvae develop head spination. Preopercular spines form in larvae of *Atheresthes*, *Glyptocephalus*, *Tanakius* and *Eopsetta*; otic spines develop on larvae of *Microstomus* (at least on 2 species), *Hypsopsetta*, and *Pleuronichthys* (1 species); *Atheresthes* has a spinous supraocular crest. Head spination develops during the preflexion stage, but usually is best developed on flexion or early postflexion larvae.

The caudal fin begins forming either slightly before or together with the dorsal and anal fins. The first caudal supporting bones to form as cartilage are the hypurals. Usually several caudal rays (2 + 2 or 3 + 3) are formed before flexion begins. In late flexion and early postflexion larvae, the end of the notochord can project beyond the hypural plates. The complete complement of caudal rays is usually laid down during the flexion period.

The dorsal and anal fins form in the finfold at some distance from the main part of the body. The intervening space becomes filled with the pterygiophores that support the dorsal and anal fin rays, causing an increase in body depth. In both dorsal and anal fins the rays begin forming at the anterior ends of the fins and the differentiation proceeds posteriad. The first few rays in both fins are reduced in size and the terminal ray is often minute.

Pelvic fin buds usually form during the flexion stage but pelvic rays usually are not developed until the postflexion stage. As in all flatfishes, formation of pectoral fin rays is delayed to the end of the transformation stage.

The vertebral processes ossify before the centra. In the caudal group of vertebrae, ossification of haemal and neural processes proceeds posteriad. Ossification of abdominal neural processes can follow several patterns, but usually proceeds anteriad. The last neural and haemal processes to ossify are the truncate spines of the 2 or 3 vertebrae anterior to the urostyle. Centra ossify initially at the bases of neural and haemal processes and ossification proceeds peripherally until a complete ring is formed. On first formation only the middle portion of a vertebral centrum is ossified, hence the space between adjacent centra may be as wide as the ossified portions of the centra. The ural centra are the first to ossify in some pleuronectines or they can ossify at the same time as other centra. The last centra to form are those of the 2 (or 3) vertebrae anterior to the urostyle.

All pleuronectine larvae that have been described have body pigment. The pigment pattern changes with growth, often markedly. Also, there is often considerable variation in pigmentation of larvae of similar sizes of the same species. Notwithstanding, body and finfold pigment constitutes a primary character for identification of flatfish larvae during the preflexion stage.

To show the variety of pigment patterns found on preflexion stage pleuronectine larvae, preflexion larvae of 17 species from the North Pacific are illustrated (Figs. 349–351). Heavily pigmented larvae are in the genera *Pleuronichthys*, *Hypsopsetta*, and *Verasper* (Fig. 349). The posterior portion of the tail is unpigmented or pigment is confined to marginal spots along the notochord. The unpigmented tail area is more extensive in some species than in others. Finfold pigment is very useful in identifying these larvae to species taken in conjunction with larval size and extent of tail pigment.

In the other 14 kinds of larvae representing as many genera, tail pigment appears in a number of patterns. The larvae illustrated in Figs. 350 and 351 are arranged in the order of increasing complexity. In the simplest pattern pigment is concentrated along the ventral midline with only moderate dorsal or lateral pigment, as in *Hippoglossus stenolepis* or *Reinhardtius hippoglossoides*. Although *Parophrys vetulus* and *Lyopsetta exilis* have more ventral margin pigment than dorsal, it is almost continuous on both margins. *Platichthys stellatus* has more diffused pigment over the tail portion of the body, but it is not in a pattern. The most unusual pigment is found in *Atheresthes*. There are two conspicuous dorsal patches as opposed to almost no ventral pigment. Pigment on *Eopsetta jordani* is limited to a mid-tail band and a terminal notochord patch. A more common pattern is encountered in *Isopsetta*, which has two pigment bands across the tail together with the terminal notochord pigment. A basically similar pattern is found in *Lepidopsetta bilineata*. *Psettichthys* is unusual in having alternating dorsal and ventral blotches. *Hippoglossoides classodon* has three tail pigment areas (i.e., opposing dorsal and ventral pigment patches) together with terminal notochord pigment. This is also the basic pattern in *Microstomus*. *Embassichthys* increases opposing tail patches to

Fig. 349. Larvae and transforming specimens of Pleuronectidae. (A) *Pleuronichthys coenosus*, 3.7 mm, from Sumida et al., 1979; (B) *P. coenosus*, 8.9 mm, *ibid*; (C) *Hypsopsetta guttulata*, 2.6 mm, *ibid*; (D) *H. guttulata*, 6.6 mm, *ibid*; (E) *Verasper variegatus*, 5.6 mm, from Pertseva-Ostroumova, 1961 after Uchida, 1933; (F) *V. variegatus*, 12.4 mm, *ibid*.

four plus terminal notochord pigment (Richardson, 1981b); *Glyptocephalus zachurus* has pigment bands which alternate with ventral patches, plus the terminal notochord pigment.

At least four other genera of pleuronectine flatfishes occur in the eastern North Pacific. The preflexion stage larvae of *Pleuronectes pallasii*, *Liopsetta glacialis*, and *Limanda aspera* lack melanistic bands (Pertseva-Ostroumova, 1961). Larvae are unknown for the fourth genus, *Clidoderma*.

Larvae are known for species representing six additional genera in the western North Pacific. According to Pertseva-Ostroumova (1961), preflexion larvae of *Acanthopsetta nadeshnyi* and *Kareius bicoloratus* lack bands; those of *Cleisthenes herzensteini* (see also Okiyama and Takahashi, 1976), *Pseudopleuronectes herzensteini* and *P. yokohamae* (see also Dekhnik, 1959; Yusa, 1960a, b; Yusa et al., 1971) have two tail pigment bands plus terminal notochord pigment. Preflexion larvae of *Verasper variegatus* (Fig. 349) are as heavily pigmented as those of *Pleuronichthys* (Takita et al., 1967; Uchida, 1933). The pigment pattern on preflexion larvae of *Tanakius kitaharai* is very similar to that on larvae of *Glyptocephalus stelleri* (Okiyama and Takahashi, 1976). Larvae have not been described for the monotypic genus *Dexistes*.

In species with banded preflexion larvae, the bands usually persist into later larval stages; those with diffuse or linear pigment patterns generally do not develop bands in later stages, although pigment may become associated with myosepta (Figs. 352, 353). Virtually all late postflexion and metamorphic pleuronectines develop a distinct pattern of bars or blotches on the body and median fins, which persists into the juvenile stage (Fig. 354).

Of the four other pleuronectid subfamilies, larvae have not been described for Paralichthodinae, while some information is available on the Samarinae, Poecilopsettiniae, and Rhombosoleinae. Pertseva-Ostroumova (1965) described two larval specimens (6.4, 8.7 mm) of *Samaris cristatus* and Struhsaker (pers. comm.) has described large pelagic larvae of *Samariscus* sp. and *Poecilopsetta hawaiiensis* (Fig. 355). Larvae of *S. cristatus* are deep-bodied in the gut region, have a relatively large head and jaws and a pigment pattern consisting of melanophore patches along the dorsum and ventrum, along the outer margins of the pterygiophore zones, and along the dorsal and anal fins; the ventral region of the gut is pigmented. A series of *Samariscus triocellatus*, 7.3–19.0 mm (provided by Dr. T. A. Clarke, Univ. of Hawaii), is similar to *Samaris cristatus* in having a slender body and wide pterygiophore zones but the gut coil is elongate, protrudes beyond the ventral profile, and the fourth dorsal ray

is elongate. The left eye has begun to migrate at 7.3 mm and is at the dorsal midline by 12.0 mm. Larvae of *Samariscus corallinus* are similar but attain a larger size (ca. 26 mm). Both species lack pigment. Late postflexion larvae of *Poecilopsetta* have a body form similar to samarines (slender body with wide pterygiophore zones) but have a different gut structure, no elongate dorsal ray, and have a striking pigment pattern consisting of dorsal and ventral myoseptal series and large blotches over the pterygiophore zones, dorsal and anal fins, and gut (Fig. 355). A 29-mm late postflexion larva from the North Atlantic has a pigment pattern identical to Hawaiian specimens.

Reared yolk-sac and early preflexion larvae of rhombosoleine species have been illustrated and briefly described: *Ammotretis rostratus* (Thomson, 1906); *Rhombosolea plebeia* (Anderton, 1907); *Colistium guntheri*, *Pelotretis flavilatus*, and *Peltorhamphus novaezeelandiae* (Thomson and Anderton, 1921). The oil globules remain evenly dispersed throughout the yolk-sac period. Heavy melanistic pigmentation develops on the head, body, yolk sac, and finfold. Late yolk-sac larvae of *C. guntheri* develop an unusual lobate projection of the dorsal finfold, which extends well anterior to the head. A similar structure appears in yolk-sac larvae of the soleid, *Pegusa lascaris* (Holt, 1891). Rapson (1940) described and illustrated with photographs a reared series of *Pelotretis flavilatus*. Flexion-stage larvae of this species are deep-bodied and similar in appearance to paralichthyids, although they lack elongate dorsal fin rays (Fig. 355). Pigmentation consists of dorsal and ventral midline series, series above and below the spinal column, a linear patch below the gut, and embedded melanophores in the otic region. Postflexion larvae become mottled with large blotches on the body and fins. Crossland (1981) briefly described and illustrated pre- and postflexion stages of a similar larva which he identified as *Peltorhamphus latus* and stated that Rapson's (1940) series was a species of *Peltorhamphus*. Crossland's (1982) illustration of a flexion-stage *Pelotretis flavilatus* has heavy pigmentation, a protruding gut mass and looks very much like a soleid.

Soleidae (Fig. 356).—Two subfamilies, Soleinae and Achirinae, are recognized in the family. In the Soleinae, life history stages are well known for the eastern North Atlantic species, *Solea solea*, *Microchirus variegatus*, *Buglossidium luteum* and *Pegusa lascaris* (references summarized in Ehrenbaum, 1905–1909 and Russell, 1976). A comprehensive volume on the development of *S. solea* was produced by Fabre-Domergue and Biérix (1905). Padoa (1956k) summarized information on eggs and larvae of soles from the Mediterranean, and Aboussouan (1972c) briefly

Fig. 350. Larvae of Pleuronectidae. (A) *Hippoglossus stenolepis*, 15.0 mm, from Pertseva-Ostroumova, 1961; (B) *Reinhardtius hippoglossoides*, 17.0 mm, from Jensen, 1935; (C) *Lyopsetta exilis*, 5.9 mm from Ahlstrom and Moser, 1975; (D) *Parophrys vetulus*, 4.3 mm, ibid; (E) *Platichthys stellatus*, 2.6 mm, from Orcutt, 1950; (F) *Atheresthes stomias*, 10.5 mm, original; (G) *Eopsetta jordani*, 6.2 mm, from Alderdice and Forrester, 1971.

Fig. 351. Larvae of Pleuronectidae. (A) *Isopsetta isolepis*, 9.5 mm, original, CalCOFI 7205, Sta. 40.38; (B) *Lepidopsetta bilineata*, 4.6 mm, from Pertseva-Ostroumova, 1965; (C) *Psettichthys melanostictus*, 6.7 mm, original, CalCOFI 5807 Sta. 40.38; (D) *Hippoglossodes elassodon*, 9.2 mm, from Pertseva-Ostroumova, 1961; (E) *Microstomus pacificus*, 7.0 mm, redrawn from Ahlstrom and Moser, 1975; (F) *Embassichthys bathybius*, 18.5 mm, original, CalCOFI 4905, Sta. 29.83; (G) *Glyptocephalus zachurus*, 22.8 mm, redrawn from Ahlstrom and Moser, 1975.

Fig. 352. Larvae of Pleuronectidae. (A) *Lyopsetta exilis*, 14.7 mm, original, CalCOFI 7805, Sta. 100.29; (B) *Parophrys vetulus*, 16.0 mm, redrawn from Ahlstrom and Moser, 1975; (C) *Isopsetta isolepis*, 14.2 mm, original, CalCOFI 7205, Sta. 40.38, (D) *Eopsetta grigorjewi*, 10.0 mm, from Okiyama and Takahashi, 1976; (E) *Psettichthys melanostictus*, 9.4 mm, original, CalCOFI.

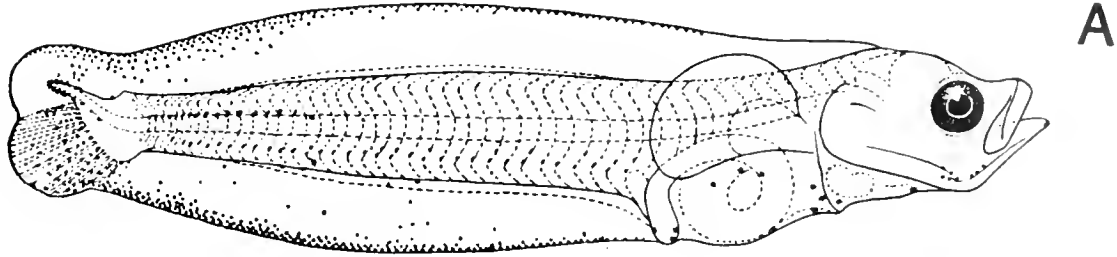

A

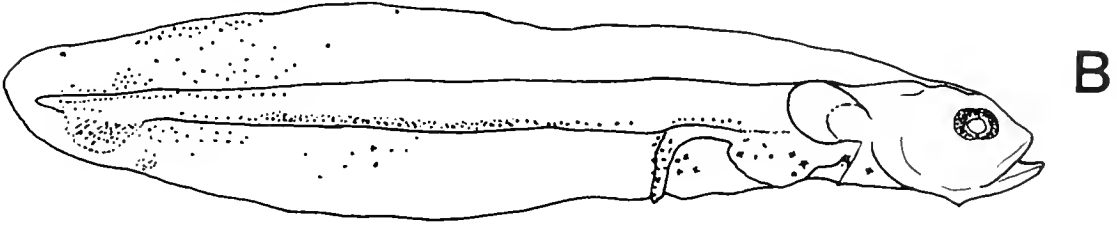

B

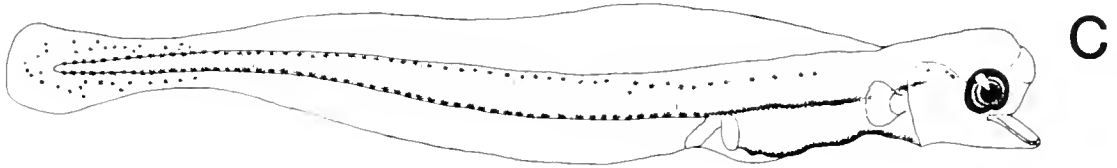

C

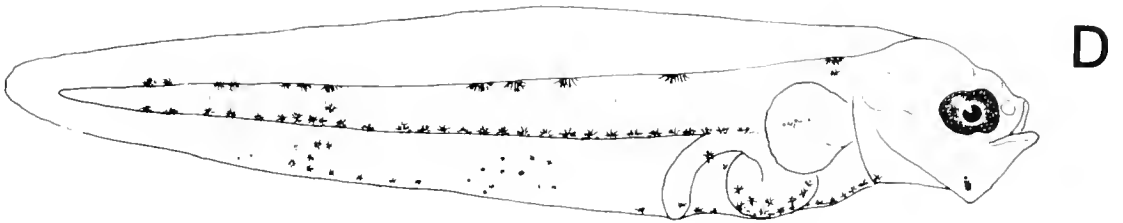

D



E

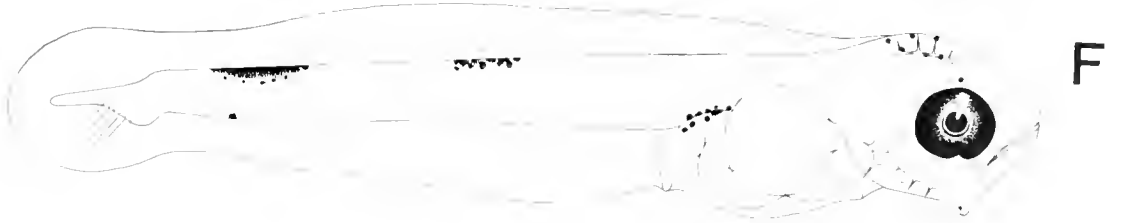

F



G

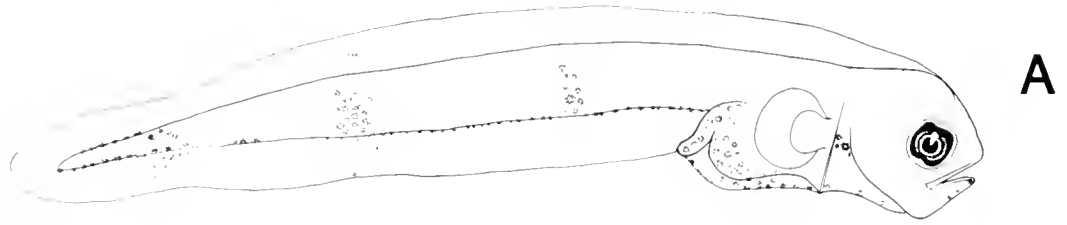

A

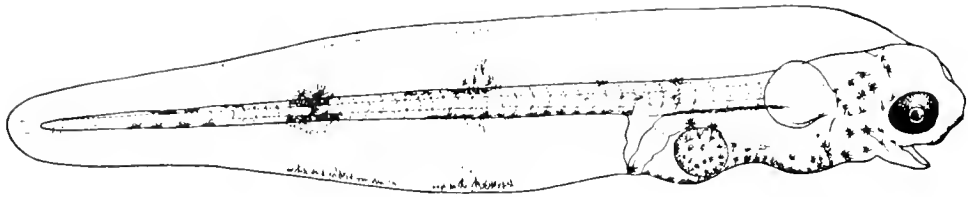

B

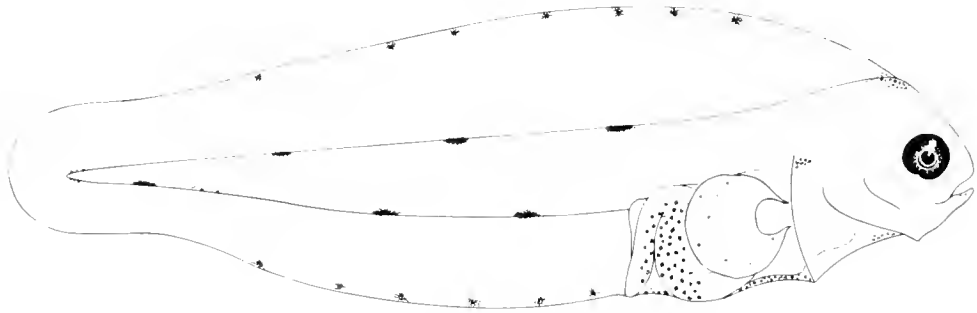

C

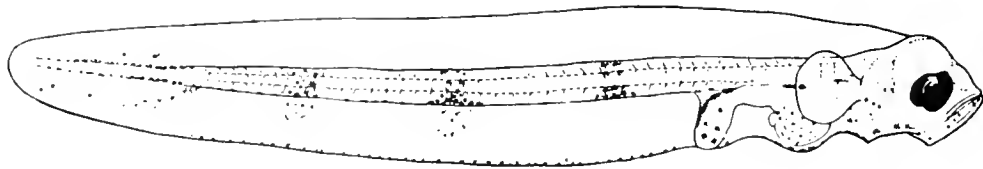

D

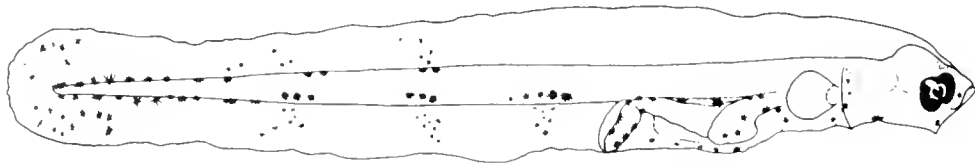

E



F



G

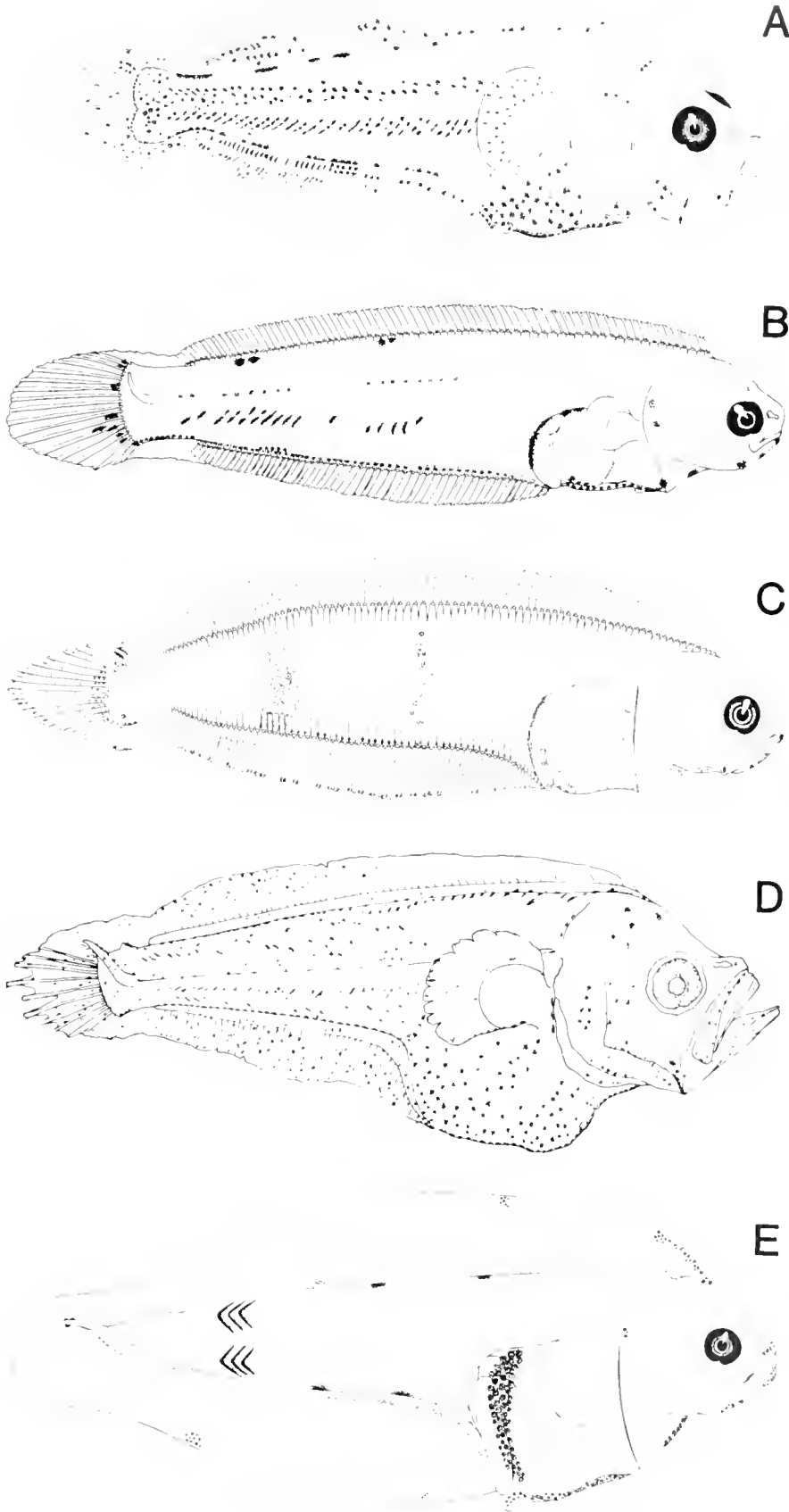

TABLE 178. SIZE DATA AND NUMBER OF ELONGATE DORSAL RAYS FOR LARVAE OF SYMPHURINAE AND CYNOGLOSSINAE.

Taxon	Number of elongate dorsal rays	Size at hatching (mm)	Size at flexion (mm)	Size at transformation (mm)	References
Symphurinae					
<i>Symphurus atricauda</i>	5	1.9	9.4–10.8	19–24.2	Original
<i>S. lacteus</i>	4–5	—	6–<10	18	Kyle, 1913
<i>S. ligulata</i>	5	—	<10.5	32	Kyle, 1913
<i>S. orientalis</i>	5	—	>4.4–<9.3	>12.3	Pertseva-Ostroumova, 1965
<i>S. plagiusa</i>	4–5	<1.3	<6.2	<13	Hildebrand and Cable, 1930; Olney and Grant, 1976
Cynoglossinae					
<i>Cynoglossus abbreviatus</i> (as <i>Areliscus trigrammus</i>)	2	3.2	—	—	Fujita and Takita, 1965
<i>C. arel</i> (as <i>C. oligolepis</i>)	2	—	—	—	Pertseva-Ostroumova, 1965
<i>C. bilineatus</i>	2	—	>4.0	6–8	Vijayaraghavan, 1957; Pertseva-Ostroumova, 1965
<i>C. brevis</i>	—	—	—	ca. 4.0	Balakrishnan and Devi, 1974
<i>C. capensis</i>	2–4	1.2	ca. 9.9	10–15	Brownell, 1979
<i>C. cynoglossus</i>	2	≤1.6	ca. 4.1	<4.7	Balakrishnan and Devi, 1974
<i>C. kopsi</i> (as <i>C. sibogae</i>)	2	—	7.6	—	Pertseva-Ostroumova, 1965
<i>C. lida</i>	2	<2.1	>4.6	—	Balakrishnan and Devi, 1974
<i>C. lingua</i>	—	—	—	17.7–?	Jones and Menon, 1951
<i>C. macrostomus</i> (as <i>C. semifasciatus</i>)	2	<2.5	4.2	ca. 5	Seshappa and Bhimachar, 1955
<i>C. monopis</i>	2	—	5–7	7.0	Balakrishnan, 1963
<i>C. puncticeps</i>	2	<1.4	ca. 4.2–?	ca. 4–5	Balakrishnan and Devi, 1974
<i>C. robustus</i>	2	1.85	—	—	Fujita and Uchida, 1957
<i>C. semifasciatus</i>	2	<2.0	7.2–11	11–12.5	Balakrishnan, 1961
<i>Paraplagusia japonica</i>	2	—	<10.2	ca. 12.2	Minami, 1982b

described several species from off west Africa. Life history series have been described for two achirine species of the western North Atlantic, *Trinectes maculatus* and *Achirus lineatus*. Eggs of achirines are smaller than in most soleines (Table 172) and, accordingly, size at hatching is also smaller; achirines and some soleines undergo notochord flexion and transformation at very small sizes (Table 177). Achirines are deep-bodied, with a large gut that occupies a major portion of the body volume, a large deep head with a distinct dorsal hump; eyes and jaws are large (Fig. 356). Preflexion larvae of *A. lineatus* develop spinous ridges above the eye (frontal bone), at the otic region (parietal and autopterotic bones) and on the preopercle. Also, five rows of papilla-like spines develop on the body. Larvae of *T. maculatus* develop bony ridges on the frontal, parietal and autopterotic bones. *A. lineatus* larvae are unique among described soleids in having an elongate third dorsal ray. Early larvae of *A. lineatus* are unpigmented but by late preflexion stage have developed pigment on the head, gut, elongate dorsal ray, dorsal and ventral body margins and blotches on the dorsal and anal fins. Early larvae of *T. maculatus* are heavily pigmented and have three large blotches in the dorsal finfold and two in the ventral finfold. In later larvae these blotches become dusky bars that overlie the nearly solid background pigment.

Soleines have a large head and jaws as in achirines but the eye is relatively smaller and the dorsal hump is less prominent

(Fig. 356). Also, soleines are less deep-bodied and the gut occupies a relatively smaller portion of the body mass; in many soleine species the rounded gut mass protrudes well beyond the ventral profile. Pigmentation is highly varied ranging from species of *Aseraggodes* which lack pigment to species such as *Solea solea*, *Pegusa lascaris*, *Microchirus variegatus* and *Euryglossa pan* which are solidly covered with melanophores. A typical pattern appearing in many described species consists of a series of melanophores along the dorsum, ventrum and horizontal septum, and melanophores on the head, gas bladder and finfolds (Fig. 356).

Cynoglossidae (Fig. 357).—Two subfamilies, Symphurinae and Cynoglossinae, are recognized in the family. The first larval descriptions of the former are of *Symphurus lacteus*, *S. ligulata* and *S. pusilla* (Kyle, 1913). Hildebrand and Cable (1930) described a series as *S. plagiusa*, but Olney and Grant (1976) described a different series as *S. plagiusa* and pointed out that Hildebrand and Cable's descriptions must refer to another species. Pertseva-Ostroumova (1965) ascribed a larval series to *S. orientalis* and we have identified eggs and larvae of *S. atricauda*. Larval series or metamorphosing specimens have been ascribed to at least 11 types of cynoglossines; however, most of these are incomplete series and identifications are tentative (Table 178). Most cynoglossids are less than 2.5 mm at hatching;



A

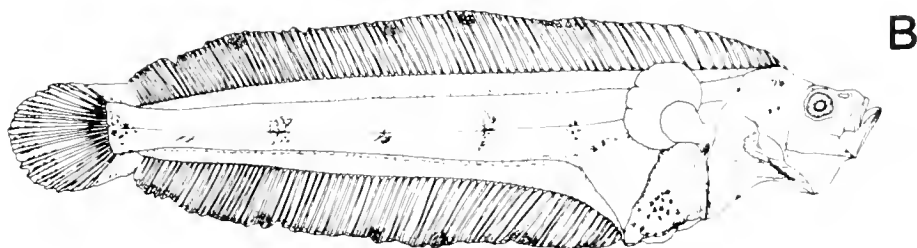

B

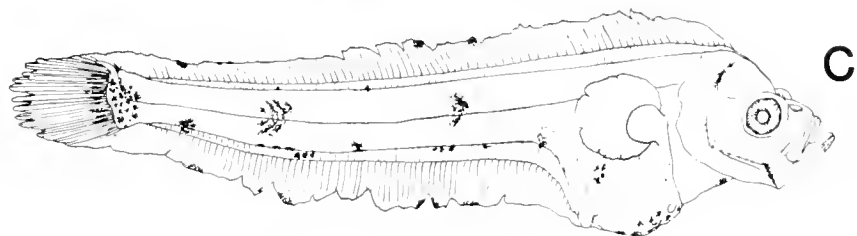

C



D



E

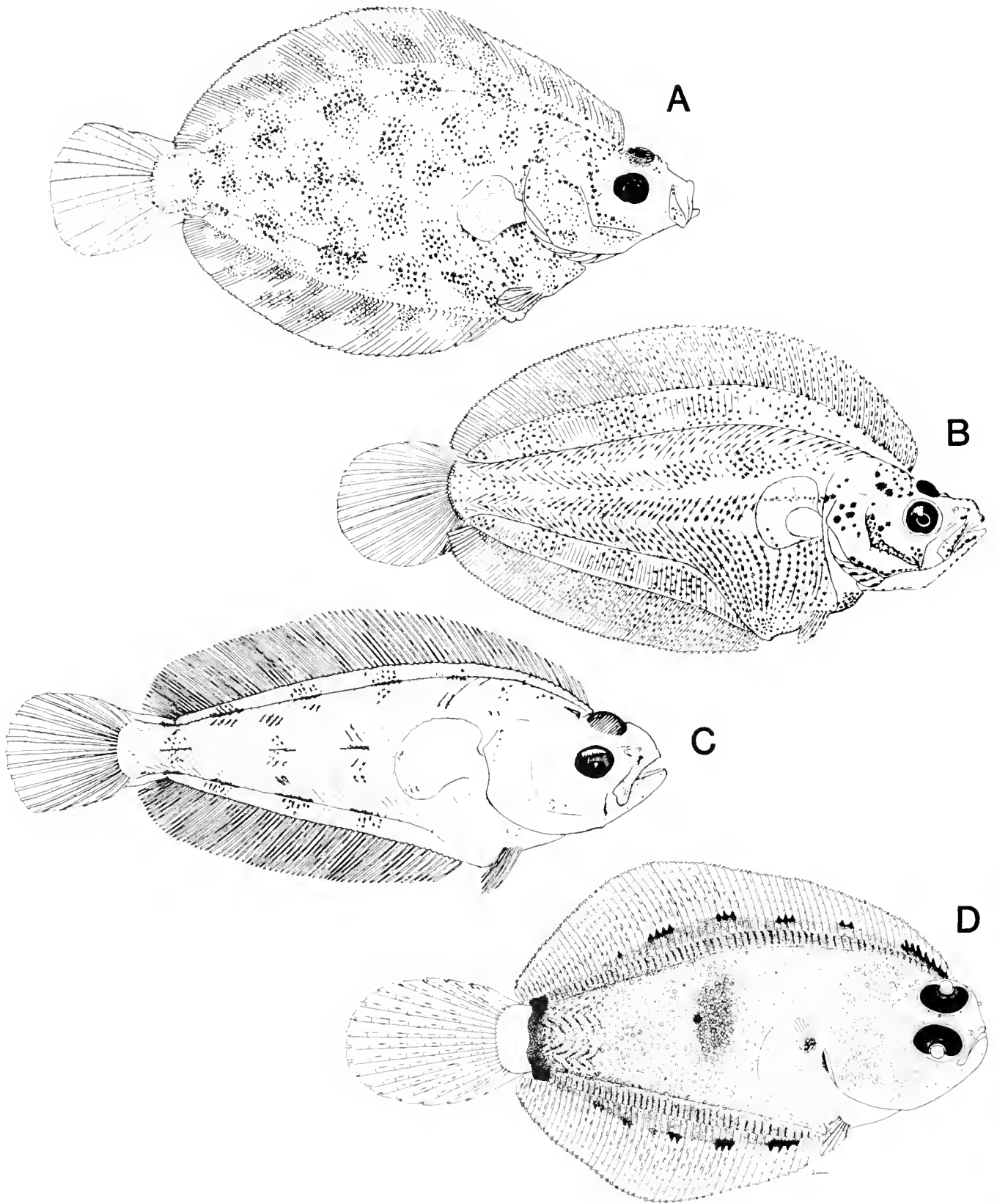

Fig. 354. Transforming specimens of Pleuronectidae. (A) *Hippoglossus stenolepis*, 24.0 mm, original; (B) *Eopsetta jordani*, 16.2 mm, CalCOFI 5104, Sta. 70.55; (C) *Lyopsetta exilis*, 22.0 mm, from Ahlstrom and Moser, 1975; (D) *Pleuronichthys ritteri*, 10.0 mm, from Sumida et al., 1979.

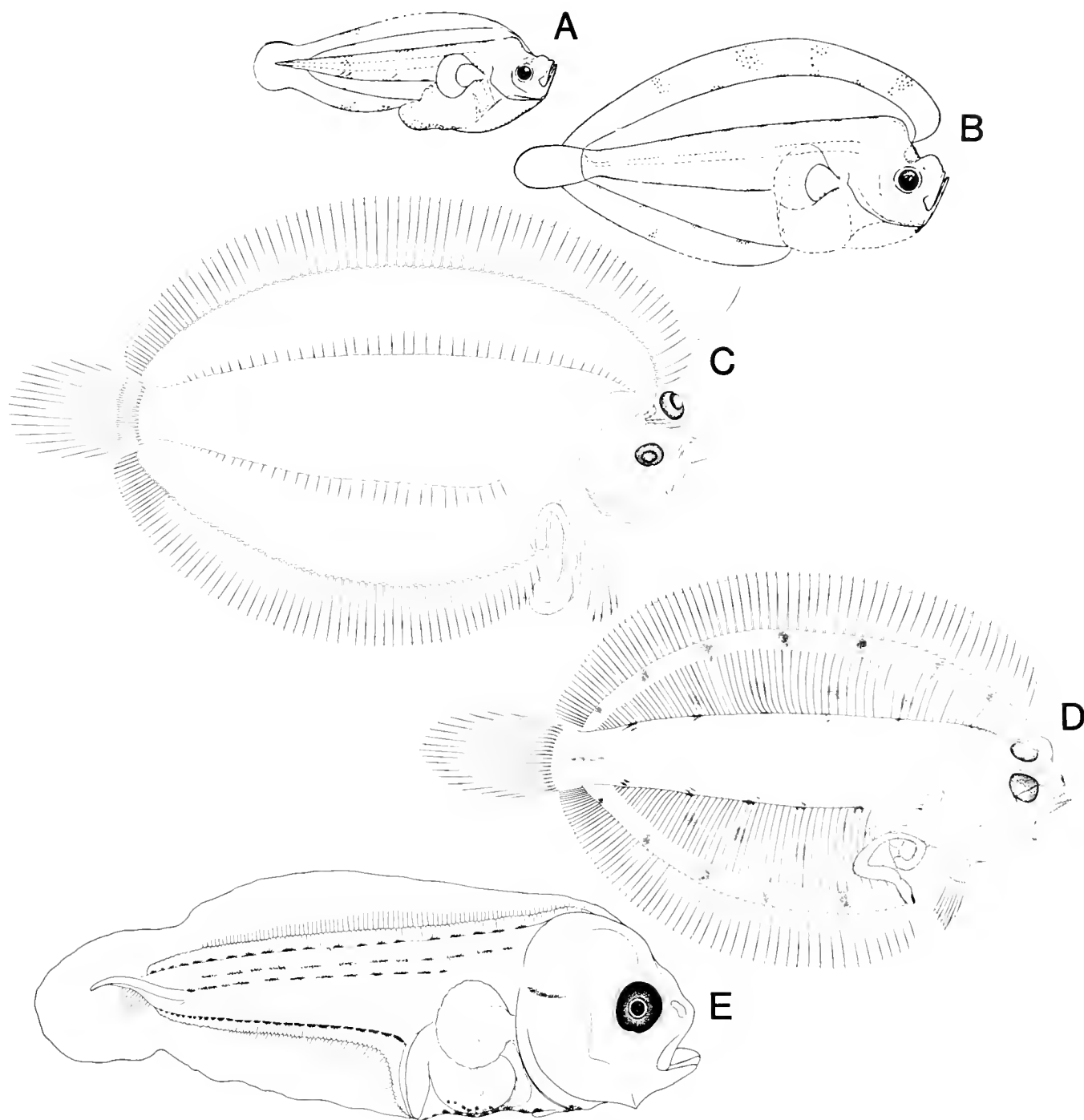

Fig. 355. Larvae and transforming specimens of Pleuronectidae. (A) *Samaris cristatus*, 6.4 mm, from Pertseva-Ostroumova, 1965; (B) *S. cristatus*, 8.7 mm, *ibid*; (C) *Samariscus* sp., ca. 24.0 mm; (D) *Poecilopsetta hawaiiensis*, ca. 29.0 mm; (E) *Pelotretis flavilatus*, 4.3 mm, redrawn from Rapson, 1940. C and D from P. Struhsaker, unpublished.

an exception is *C. abbreviatus* which has a relatively large egg. Notochord flexion and transformation occur at larger sizes in symphurines compared with cynoglossines and some *Symphurus* have an extended larval stage that exceeds 30 mm in length (Table 178). Cynoglossid larvae are similar to those of soleids

in having a large deep head and tapering body, but the jaws are relatively smaller in cynoglossids and the body is more attenuate (Fig. 357). The gut mass protrudes beyond the ventral profile and in some species it trails posteriad. In *S. lactea* a conical structure is attached to the trailing gut coil (Kyle, 1913). Cy-

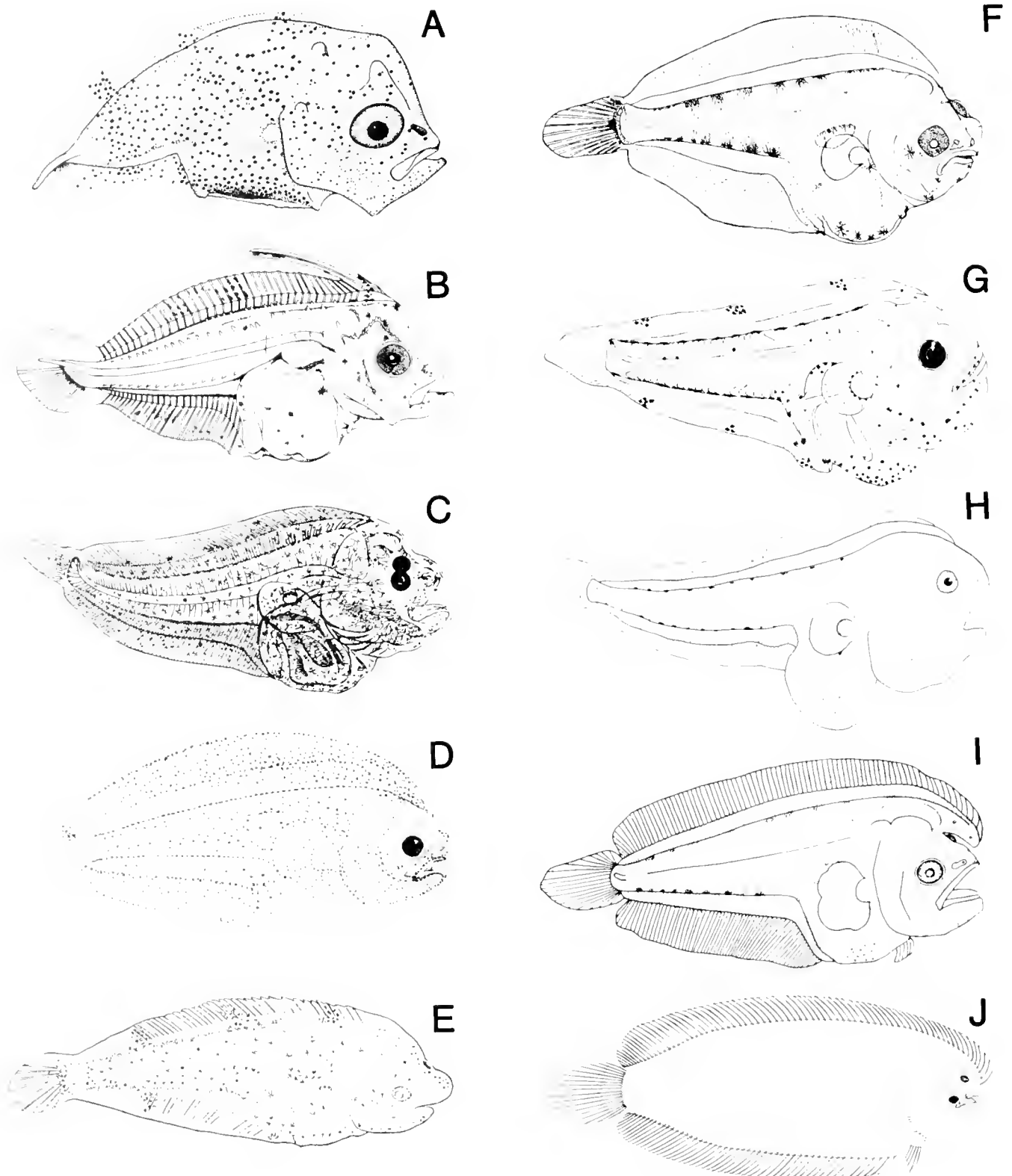

Fig. 356. Larvae and transforming specimens of Soleidae. (A) *Trinectes maculatus*, 2.0 mm, from Hildebrand and Cable, 1938; (B) *Achirus lineatus*, 3.1 mm, from Houde et al., 1970; (C) *Solea solea*, 7.5 mm, from Ehrenbaum, 1905–1909; (D) *Microchirus variegatus*, 10.0 mm, from Petersen, 1909; (E) *Euryglossa pan*, 4.6 mm, from Jones and Menon, 1951; (F) *Solea ovata*, 4.7 mm, from Jones and Pantulu, 1958; (G) *Microchirus ocellatus*, 5.1 mm, from Palomera and Rubies, 1977; (H) *Austroglossus microlepis*, 6.6 mm, from O'Toole, 1977; (I) *Heteromycteris japonicus*, 4.9 mm, from Minami, 1981b; (J) *Aseraggodes whittakeri*, ca. 27.0 mm, from P. Struhsaker, unpublished.

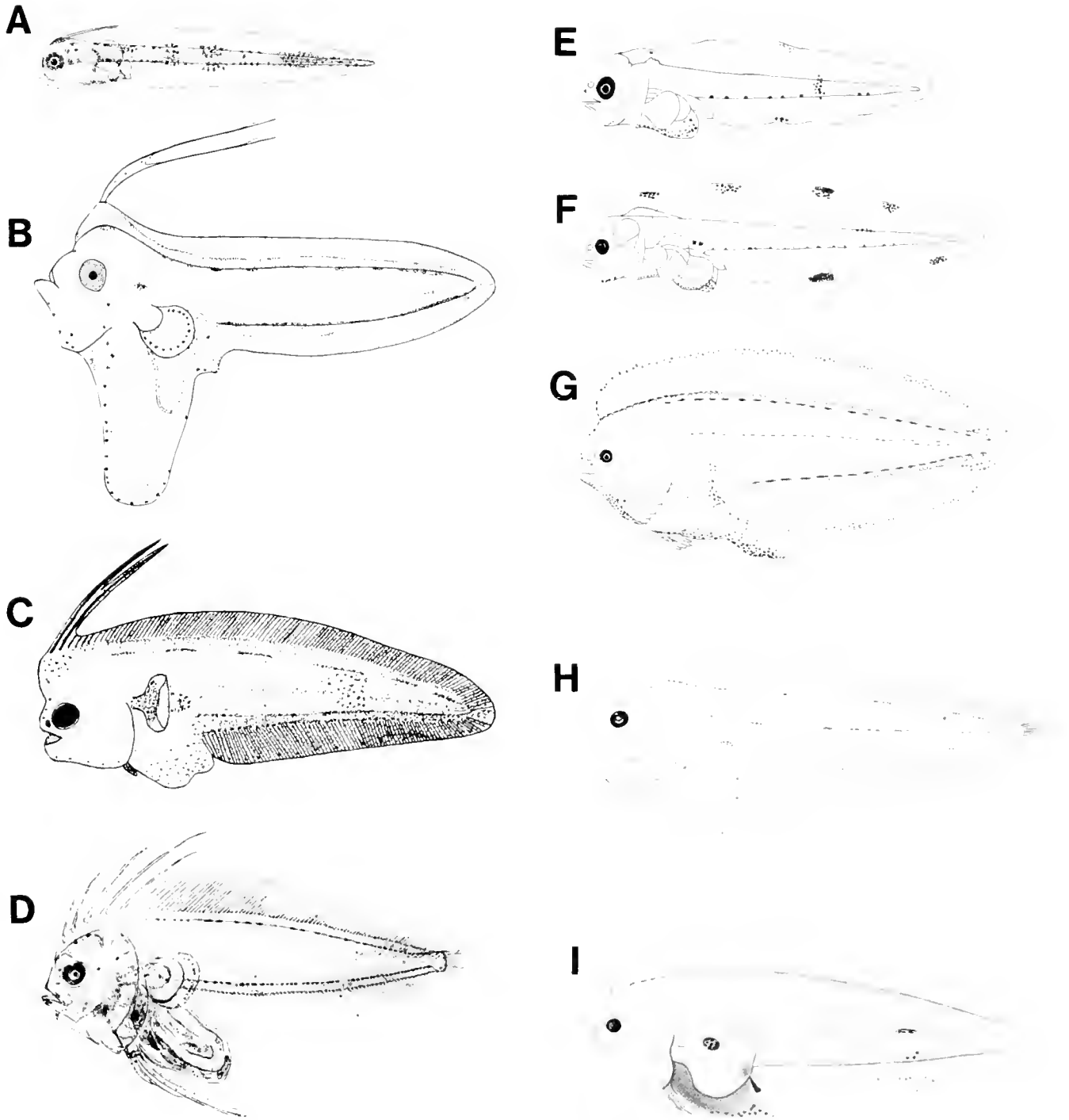

Fig. 357. Larvae of Cynoglossidae. (A) *Cynoglossus abbreviatus*, 5.0 mm, from Fujita and Takita, 1965; (B) *C. monopus*, 7.0 mm, from Balakrishnan, 1963; (C) *C. macrostomus*, 4.5 mm, from Seshappa and Bhimachar, 1955; (D) *Symphurus ligulata*, 10.5 mm, from Kyle, 1913; (E) *S. atricauda*, 4.0 mm, original, CalCOFI; (F) *S. atricauda*, 6.5 mm, original, CalCOFI; (G) *S. atricauda*, 12.8 mm, original, CalCOFI; (H) *S. plagusa*, 6.2 mm, redrawn by Fahay (1983) from Olney and Grant, 1976; (I) *S. lactea*, 18.0 mm, from Padoa, 1956k.

noglossid larvae develop a crest consisting of elongate anterior dorsal rays, 2 rays in *Cynoglossus* and usually 4 or 5 in *Symphurus*. Pectoral fins are present during the larval period, but do not develop rays and disappear at metamorphosis. One

species, *S. ligulata*, develops elongate third and fourth pelvic rays (Kyle, 1913; Padoa, 1956k).

Pigmentation in early larvae of *Cynoglossus* consists of 4–5 opposing blotches along the dorsum and ventrum, pigment on

the head, gut and gas bladder. In some species, large blotches in the finfold distal to the dorsal and ventral midline blotches give the larvae a barred appearance. In later stages the midline blotches become more numerous and some species develop a series along the horizontal septum. Early larvae of *Symphurus* have small melanophores along the ventral midline, and in some species, also along the dorsal midline. Most species have a single bar posteriad on the tail and at least one, *S. atricauda*, has large blotches at the finfold margins. The head (particularly ventrally), gut, gas bladder and horizontal septum become pigmented and later-stage larvae have pigment patterns similar to *Cynoglossus* species.

Metamorphic stages

Pleuronectiforms undergo a remarkable metamorphosis during which one of the eyes, the left in dextral and the right in sinistral species, migrates around or through the head to a position dorsal to the non-migrating eye. Metamorphosis occurs over a wide size range among flatfishes, from about 5 mm in achirine soles (Houde et al., 1970) to greater than 120 mm in some bothines (Amaoka, 1971). Capture of specimens of the enormous flatfish larva observed by Barham (1966) from a diving saucer may double the maximum size for flatfish larvae. Most flatfishes metamorphose within the range of 10–25 mm (see preceding sections and Tables 173–178); the size interval over which the process occurs is smaller in species which metamorphose at a small size.

Metamorphosing specimens are relatively rare in plankton collections because 1) the process is transitory, 2) avoidance is increased at larger sizes, and 3) metamorphosing individuals may change habitat. Existing information indicates a variety of mechanisms of eye migration among flatfishes. In groups where the dorsal fin origin in larvae is at the posterior margin of the eye or more rearward (psettodids, citharids, scophthalmids, most paralichthyids, pleuronectids), a depression forms in the interocular region and the eye migrates over the dorsal midline anterior to the fin origin. Subsequently the dorsal fin extends forward to its adult position (except in psettodids). In larvae of

bothids and the paralichthyid genera *Cyclopeseta*, *Syacnum* and *Citharichthys* (some species), the dorsal fin is attached to the skull anterior to the eye and, during metamorphosis, the eye migrates through a slit which forms between the fin base and the skull. In some metamorphosing soleids the dorsal fin projects forward above the snout and the eye migrates through the space between this protuberance and the skull; subsequently the fin projection fuses to the skull (Houde et al., 1970; Palomera and Rubies, 1977; Minami, 1981b). Seshappa and Bhimachar (1955) described the process of eye migration in a captive specimen of *Cynoglossus macrostomus*. Just before eye migration a fleshy hook-shaped protuberance grew forward from the region of the head anterior to the dorsal fin origin. The right eye migrated through the space between the protuberance and the skull, after which the fleshy appendage fused to the dorsal region of the skull. The entire process took place over a 5-hour period during the night. A similar structure appears on advanced larvae of an unidentified cynoglossid illustrated by John (1951b) and this mechanism of eye migration may be widespread among cynoglossids.

During eye migration in flatfishes a number of other metamorphic events occur: 1) larval spines are lost, 2) elongate rays assume their juvenile proportions, 3) gut protrusions are brought into the body cavity and internal organs are rearranged, 4) gas bladder, if present, is lost, 5) pectoral fins develop rays, except in cynoglossids, some soleids, some bothids and *Mancopsetta*, where (one or both) fins are lost altogether during this period, 6) larval pigment patterns are replaced by juvenile patterns, 7) ossification of the vertebral column and other bony structures is completed, 8) intermuscular bones appear in bothids, and 9) scales form.

(H.G.M., B.Y.S.) NATIONAL MARINE FISHERIES SERVICE, SOUTHWEST FISHERIES CENTER, P.O. BOX 271, LA JOLLA, CALIFORNIA 92038; (K.A.) FACULTY OF FISHERIES, HOKKAIDO UNIVERSITY, HAKODATE, JAPAN; (D.A.H.) DEPARTMENT OF MARINE SCIENCES, UNIVERSITY OF PUERTO RICO, MAYAGUEZ, PUERTO RICO.

Pleuronectiformes: Relationships

D. A. HENSLEY AND E. H. AHLSTROM

BASICS of the current working model for evolution of pleuronectiforms were proposed by Regan (1910, 1929) and Norman (1934). In his monograph, Norman treated the flounders (Psettodidae, Bothidae, Pleuronectidae), and though he did not publish a revision of the remaining pleuronectiforms, his key and classification of the soleoids were published posthumously (1966). Norman's model and classification with the modifications of Hubbs (1945), Amaoka (1969), Futch (1977), and Hensley (1977) represent the most recent, detailed hypothesis for pleuronectiform evolution. We will refer to this as the Regan-Norman model (Fig. 358) and classification (preceding

article, this volume) and consider it the working hypothesis to be reexamined using adult, larval, and egg characters.

Formation of the Regan-Norman model involved an eclectic approach, i.e., a combination of phyletic and phenetic methods. Although some of the groups currently recognized appear to be based on synapomorphies, many are clearly based on sympleiomorphies and were recognized as such by the authors. This search for horizontal relationships among pleuronectiforms using eclectic methods, with one exception, has been the only approach used in this group. The exception is the recent work of Lauder and Liem (1983) in which a cladogram for flatfishes

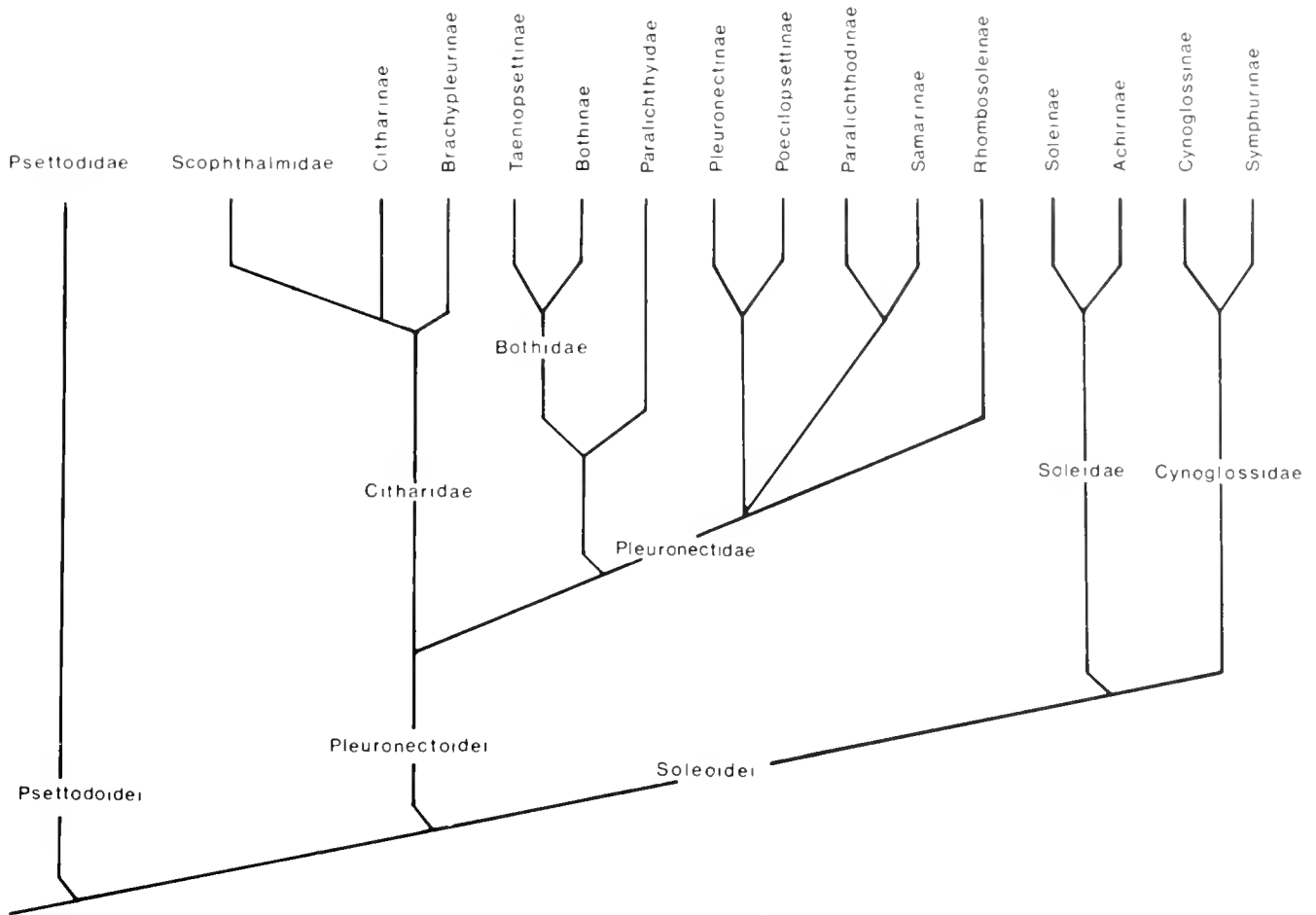

Fig. 358. Current hypothesis for interrelationships of pleuronectiform fishes. Based on Norman (1934, 1966), Hubbs (1945), and Amaoka (1969).

is presented. However, these authors present this as a tentative hypothesis and admit that the interrelationships expressed are still problematic. Most of the character states they use are reductive, few characters were analyzed, and the authors were understandably unaware of recent character surveys, since much of this information is unpublished.

We have made the assumption that the order Pleuronectiformes is monophyletic and the sister group is the remaining percomorph fishes (sensu Rosen and Patterson, 1969 and Rosen, 1973). Although the monophyly and origin of the group is still open to question and hypotheses of multiple origins have been proposed (e.g., Kyle, 1921; Chabanaud, 1949; Amaoka, 1969), a monophyletic model with a percomorph sister group still appears to be the most parsimonious. In other words, with the information available, there appears to be no need to hypothesize multiple origins for flatfishes; to do so demands the inclusion of a great deal of convergence.

RELATIONSHIPS

The following discussion of relationships within the pleuronectiforms is cursory and preliminary. In fact, it asks more questions than it answers and illustrates that more work (particularly osteological) is needed in certain groups before the

order can be subjected to an in-depth cladistic analysis. Until this work is completed, it is premature to offer a new hypothesis of interrelationships for the entire order.

Adult characters

Several criteria were used for selecting characters for discussion: (1) amount of information available on the distribution of character states; (2) characters commonly used in the past to define groups of pleuronectiforms; (3) those for which our knowledge of distributions of states is limited, but appear to indicate groupings different from those hypothesized in the working classification and which need additional study; and (4) characters which are well known in certain groups and are potentially useful for elucidating relationships within these groups. Characters and character complexes used in this study are discussed below. Characters and states are presented in Table 179.

Optic chiasma.—The relationship between the optic chiasma and ocular asymmetry of pleuronectiforms has been investigated by several workers beginning mainly with the work of Parker (1903). Hubbs (1945) examined this relationship further and presented all data from previous studies. Parker found that most fishes have a dimorphic optic chiasma, i.e., the nerve of the left

or right eye is dorsal with about equal frequency (state referred to here as truly dimorphic). Exceptions to this are species of paralichthyids (sinistral) and pleuronectines (dextral) where the right or left optic nerve, respectively, is always dorsal, even in reversed individuals, i.e., the optic chiasma is monomorphic. The Soleidae and Cynoglossidae, however, retain a truly dimorphic optic chiasma. Subsequent work by Regan (1910) and Hubbs (1945) showed that in the indiscriminately dextral or sinistral *Psettodes* the optic chiasma is also truly dimorphic. In addition, Hubbs presented evidence of a third state, at least in *Citharoides* (sinistral), where the nerve of the migrating eye is dorsal even in reversed individuals. He thus interpreted the Citharidae as having a basically dimorphic optic chiasma and predicted the same for scophthalmids, although apparently no one has examined a reversed scophthalmid to test this prediction. A truly dimorphic optic chiasma as found in *Psettodes* and the soleoids has been interpreted as plesiomorphic for pleuronectiforms. The type of optic chiasma found in *Citharoides* and predicted for scophthalmids (i.e., nerve of the migrating eye always dorsal) was interpreted as an intermediate state between the truly dimorphic and the monomorphic chiasmata as found in pleuronectoids. We agree with this interpretation of polarity. However, some plesiomorphic states have been used to define groups: Psettodidae, truly dimorphic; Citharidae, basically dimorphic; Scophthalmidae, predicted to be basically dimorphic; and Soleoidei, truly dimorphic.

Major problems exist with the use of the optic chiasma for phylogenetic inference. One of these concerns the feasibility of actually determining which state exists in a group. Demonstrating the occurrence of truly dimorphic chiasmata is relatively simple. All that is needed is to show that either optic nerve is dorsal regardless of which eye has migrated; reversed individuals are not necessary. To demonstrate occurrence of the basically dimorphic state, reversals are needed and the nerve of the migrating eye must always be dorsal. Likewise, reversed individuals must be examined to show a monomorphic chiasma. Here the nerve to the right eye must be dorsal in all individuals (including reversals) of normally sinistral species and the nerve of the left eye must be dorsal in all individuals of normally dextral species. When one actually examines the data for this character (see Hubbs, 1945), states have been determined for very few pleuronectiform groups. The occurrence of the basically dimorphic state in the Citharidae was demonstrated in only one species. Of greater significance, however, is the fact that a monomorphic state has been shown for very few pleuronectoid species. Within the pleuronectoids it has been widely assumed that all paralichthyids, bothids, and pleuronectids have monomorphic optic chiasmata, and that because of this they are monophyletic and not closely related to the soleoids (truly dimorphic). It is worthy of note here that a monomorphic optic chiasma has never been demonstrated for four pleuronectid subfamilies (Poecilopsettinae, Rhombosoleinae, Samarinae, Paralichthodinae), the Bothidae, or the paralichthyid genus *Thysanopsetta*.

Ocular asymmetry.—This character (sinistral, dextral, indiscriminate) is obviously interrelated with the optic chiasma in certain groups, i.e., those with basically dimorphic and monomorphic chiasmata. The evolution of ocular asymmetry and its relationship to the optic chiasma is not well understood, although there is one major hypothesis (Norman, 1934; Hubbs, 1945) which states that primitively, pleuronectiforms were indiscriminate in ocular asymmetry and the optic chiasma was

truly dimorphic. Soleoids became discriminate (soleids dextral and cynoglossids sinistral), but retained a truly dimorphic chiasma. Psettodids remained indiscriminate and truly dimorphic. Citharids and presumably scophthalmids became discriminate (scophthalmids and citharines sinistral and brachypleurines dextral) but retained some ontogenetic plasticity in regard to the optic chiasma, since reversed individuals still have the nerve of the migrating eye dorsal (basically dimorphic). The remaining pleuronectoids became discriminate (Paralichthyidae and Bothidae sinistral and Pleuronectidae dextral) and evolved a monomorphic chiasma. The only exceptions with regard to ocular asymmetry are certain indiscriminate paralichthyids and pleuronectines. However, most of these indiscriminate pleuronectoids have been shown to have a monomorphic optic chiasma (a possible exception is *Tephrinectes*). It would thus appear that indiscriminate ocular asymmetry in pleuronectoids developed secondarily from discriminate ancestors (Hubbs and Hubbs, 1945).

Making phylogenetic interpretations from two states of ocular asymmetry is difficult or impossible without corroborative evidence. Thus, a statement to the effect that two or more dextral (or sinistral) pleuronectoid groups are most closely related to each other because they are dextral (or sinistral) without additional evidence of synapomorphies is circular, and may lead to the recognition of polyphyletic groups. This reasoning was the basis for the proposed close relationship in the Regan-Norman model between the Pleuronectinae and the remaining pleuronectid subfamilies (Poecilopsettinae, Rhombosoleinae, Samarinae, Paralichthodinae) and for treating the genera *Mancopsetta* and *Thysanopsetta* as members of the Bothidae and Paralichthyidae, respectively.

Ribs and intermuscular bones.—In pleuronectiforms that possess ribs, these appear to be homologous with the pleural and epipleural ribs of other teleosts, and the presence of these bones should be considered plesiomorphic for the order. Two groups lack both series of ribs, the Achirinae and apparently the Cynoglossidae. Chabanaud (1940) reports epipleural ribs in some cynoglossids but mentions no genera or species. We have not seen them in cleared-and-stained *Symphurus* species or in radiographs of several *Cynoglossus* species. Although it is still commonly believed that all soleoids lack both series of ribs (e.g., Nelson, 1976; Lauder and Liem, 1983), Chabanaud (1940, 1941) found short epipleural ribs in *Solea*, *Microchirus*, and *Aesopia*, and we have seen them in *Aseragodes*.

Chabanaud (1940, 1950, 1969) found additional rib-like bones ("metaxymyostes") in certain pleuronectiforms. Some of his statements about these were in error, and it is now clear he was referring to *Bothus podas* and *Samaris cristatus* (Hensley, 1977). Amaoka (1969) found these ("intermuscular") bones in all species of his Bothidae and presented very detailed descriptions of their morphology. One of his primary justifications for elevating Norman's (1934) Bothinae to the family level was the presence of these bones in the group and their absence in Norman's Paralichthyinae. Norman considered *Engyophrys*, *Trichopsetta*, *Monolene*, *Taeniopsetta*, and *Perissias* to be paralichthyines. All of these genera have intermuscular bones (Amaoka, 1969; Futch, 1977; Hensley, 1977; pers. observ.) and are considered here to be bothids.

Bothid intermuscular bones are in five series. Amaoka (1969) called these series epimerals, epicentrals, hypomerals, and myorhabdoi (two series). He interpreted three of these (epi-

merals, epicentrals, hypomerals) as homologous with those of lower teleosts (see Phillips, 1942). The presence of these bones was the main reason both Chabanaud (1949a) and Amaoka (1969) hypothesized that pleuronectiforms were polyphyletic and that at least the Bothidae, and in the case of Chabanaud also the Samarinae, were derived from some lower teleostean group. Hensley (1977) presented arguments for interpreting the pleuronectiforms as monophyletic and the presence of intermuscular bones in at least the Bothidae as being apomorphic.

Chabanaud (1969) described intermuscular bones in *Samaris* as being in two series. However, we recently examined a cleared-and-stained specimen and found differences with Chabanaud's description. In the abdominal region, rib-like or intermuscular bones are in three series. Bones of the middle series are unbranched and in the horizontal skeletogenous septum. Most bones of the dorsal and ventral series are branched. In the region of the caudal vertebrae, there are only the dorsal and ventral series. There are none of the dorsal and ventral myorhabdoi as found in the Bothidae. Although the three series of bones found in *Samaris* resemble the epimerals, epicentrals, and hypomerals of bothids, a more detailed comparison is required before a statement about homologies can be made.

Amaoka (1969) interpreted bothids as lacking pleural and epipleural ribs, but possessing the five series of intermuscular bones. However, there is another interpretation. It is possible that Amaoka's epicentrals (limited to the horizontal skeletogenous septum of the abdominal region) and abdominal hypomerals are homologous to epipleural and pleural ribs, respectively, of other pleuronectiforms, and that the presence of myorhabdoi, epimerals, and caudal hypomerals are apomorphic states.

Postcleithra.—The absence of postcleithra was a character state, apparently apomorphic, used by Norman (1934) and subsequent authors to distinguish the Soleoidei from the Psettoidoidei and Pleuronectoidei. However, an adequate survey of this character has never been made among the pleuronectoids. In a preliminary survey, we found postcleithra absent in certain pleuronectoids, i.e., the Samarinae and the bothid genera *Mancopsetta* and *Pelecanichthys*. Postcleithra are definitely present in the rhombosoleines *Oncopterus*, *Azygopus*, *Ammotretis*, and *Colistium*, but they may be absent in *Pelotretis*, *Peltorhamphus*, and *Rhombosolea* (Norman, 1934: fig. 25c; Chabanaud, 1949). Although lack of postcleithra in pleuronectiforms is reductive, their absence in certain pleuronectoids may indicate a closer relationship between some of these groups and soleoids than hypothesized in the Regan-Norman model. The occurrence of this specialization in *Pelecanichthys* is almost certainly an independent reduction, since this genus shows several synapomorphies with other bothids.

Vomerine teeth.—Hubbs (1945, 1946) interpreted the presence of vomerine teeth as a primitive state for the order, and we concur. However, Hubbs presented this interpretation as evidence that citharids and scophthalmids were closely related and represented an intermediate grade in pleuronectoid evolution. The presence of vomerine teeth cannot be used to infer phylogenetic relationships among pleuronectiforms.

Fin spines.—Hubbs (1945, 1946) presented the distributions for dorsal, anal, and ventral-fin spines in pleuronectiforms. *Psettodes* is the only genus with dorsal and anal spines. This genus and the Citharidae are the only flatfishes with ventral-fin spines.

Hubbs properly interpreted their presence in these groups as plesiomorphic for the order. However, again, he used a horizontal or eclectic approach and inferred a close relationship between the citharid genera and interpreted the group as an intermediate grade in pleuronectoid evolution. The presence of these spines does not indicate phylogenetic (vertical) relationships.

Supramaxillae.—Supramaxillae occur in *Psettodes* and the citharids *Eucitharus* and *Citharoides* (Hubbs, 1945). In *Psettodes*, the bones are well developed and apparently present on both sides. The two citharid genera have them reduced in size, confined to the blind side, or sometimes missing. The presence of these bones is plesiomorphic for the order and should not be used to infer phylogenetic relationships.

Ventral-fin placements and base lengths.—Evolution of ventral-fin asymmetry in pleuronectiforms is not well understood. Most of our knowledge concerning the relationship between ocular and ventral-fin asymmetry has come from some rare examples of reversals in forms with asymmetrical ventral-fin morphology (see Norman, 1934). For comparative purposes, i.e., attempting to determine homologous states, it would appear to be more correct to compare ocular and blind-side ventral fins between groups rather than those of the right and left sides (see Hubbs and Hubbs, 1945). At present, there are several problems in using ventral-fin morphology to elucidate phylogenetic relationships. Most work here has dealt only with external morphology and much of this has not been sufficiently detailed or accurate. What is needed are thorough comparisons of basipterygia as well as fins. Due to the paucity of accurate and detailed studies of these structures in flatfishes, it is not possible to adequately define character states for an in-depth comparison throughout the order. Thus, ventral-fin characters were not included in Table 179. What follows is a discussion of general patterns of ventral-fin morphology.

Ventral fins with short bases and symmetrical placements have been correctly considered plesiomorphic states in pleuronectiforms, and any type of asymmetry in placement, size, shape, or meristics as having been derived from symmetrical states (e.g., Norman, 1934; Hubbs, 1945; Amaoka, 1969). Most ventral-fin characters used have involved positions of the fins relative to the midventral line and relative lengths of the fin bases. Unfortunately, symmetry (plesiomorphic states) in both of these characters has been used to define groups. Short-based fins and symmetry or near symmetry in placement and base lengths occur in *Psettodes*, the Paralichthyidae (except the *Cyclosetta* group), the Citharidae, most soleines, most or all Pleuronectinae, and the Poecilopsettinae. States where the ocular ventral fin is on the midventral line and has a base extending farther anteriorly than that of the blind side form a continuum. Thus, groups with the base of the ocular ventral fin only slightly extended anterior to that of the blind side (origin of blind fin at transverse level of about the second or third ray of the ocular fin) are the Samarinae, possibly some Soleinae, *Paralichthodes*, the Taeniopsettinae, and *Monolene*; groups where the origin of the ocular fin is farther anterior relative to that of the blind fin are the Rhombosoleinae, all Bothinae (except *Monolene*), and possibly some Soleinae. Two groups, the Scophthalmidae and Achirinae, have both ventral-fin bases close to or virtually on the midventral line and the anterior basipterygial processes extended. The *Cyclosetta* group has the ocular fin on the mid-

TABLE 179. CHARACTERS AND STATES FOR PLEURONECTIFORM GROUPS. Where appropriate states are indicated by underlined letters. See text and Figs. 359–364 for hypural fusion patterns.

Taxon	Optic chiasma (Truly Dimorphic, Basically Dimorphic, Monomorphic)	Ocular asymmetry (Dextral, Sinistral, Indiscrinate)	Ribs (Present, Absent)		Intermuscular Bones (Present, Absent)				Post-clethra (Present, Absent, only in Larvae)	Vomerine teeth (Present, Absent)	Ventral-fin formula (ocular side/ blind side)	Supra-maxilla (Present, Absent)
			Epi-pleural	Pleural	Epi-centrals	Hypo-merals	Epi-merals	Myo-rhabdoi				
Psettodidae	TD	I	P	P	A	A	A	A	P	P	I, 5/I, 5	P
Citharidae												
Brachypleurinae												
<i>Brachypleura</i>	?	D	P	P	A	A	A	A	P	P	I, 5/I, 5	A
<i>Lepidoblepharon</i>	?	D	P	P	A	A	A	A	P	P	I, 5/I, 5	?
Citharinae												
<i>Citharoides</i>	BD	S	P	P	A	A	A	A	P	A	I, 5/I, 5	P
<i>Eucitharus</i>	?	S	P	P	A	A	A	A	P	P	I, 5/I, 5	P
Scophthalmidae	?	S	P	P	A	A	A	A	P	P, A	6/6	A
Paralichthyidae												
* <i>Cyclopssetta</i> group	?	S	P	P	A	A	A	A	P	A	5–6/6	A
** <i>Pseudorhombus</i> group	?	S	P	P	A	A	A	A	P	A	6/6	A
*** <i>Paralichthys</i> group	M	S, I	P	P	A	A	A	A	P	A	6/6	A
<i>Tephroctes</i>	M?	I	P	P	A	A	A	A	P	A	6/6	A
<i>Thysanopsetta</i>	?	S	P	P	A	A	A	A	P	A	6/6	A
Bothidae												
Taeniopsettinae	?	S	P?	P?	P	P	P	P	P	A	6/6	A
Bothinae	?	S	P?	P?	P	P	P	P	P, A	A	6/6	A
**** <i>Mancopsetta</i>	?	S	P	P	A	A	A	A	A	A	7/5–7	A
Pleuronectidae												
Pleuronectinae	M	D, I	P	P	A	A	A	A	P	A	4–7/4–7	A
Pocillopsettinae	?	D	P	P	A	A	A	A	P	A	6/6	A
Paralichthodinae	?	D	?	?	?	?	?	?	?	A	6/6	A
Samarinae	?	D	P?	P?	P	P	P	A	A	A	5/5	A
Rhombosoleinae	?	D	P	P	A	A	A	A	P, A?	A	6–13/0–6	A
Soleidae												
Solcinae	TD	D	P	A	A	A	A	A	A	A	5/5	A
Achirinae	TD	D	A	A	A	A	A	A	PL	A	3–5/2–4	A
Cynoglossidae	TD	S	A	A	A	A	A	A	A	A	0–2/4	A

* *Citharichthys*, *Cyclopssetta*, *Etropus*, *Syacium*** *Cephalopsetta*, *Pseudorhombus*, *Tarphops**** *Anclopssetta*, *Gastropsetta*, *Hippoglossina*, *Lioglossina*, *Paralichthys*, *Verecundum*, *Aystreurus***** *Achiropsetta* and *Neochiropsetta* are considered synonyms

ventral line, but the basipterygium of the blind fin is placed in a more anterior position than that of the ocular side. Another unique state is the loss of the blind ventral fin in some genera of the Rhombosoleinae, although the basipterygium of the blind side is probably still present. The Cynoglossidae are the only pleuronectiforms in which the blind ventral-fin base is oriented along the midventral line and the ocular fin is in a more dorsal position or absent. In cynoglossids missing the ocular fin, at least the dorsal process of the left basipterygium is still present.

Vertebral transverse apophyses.—Regan (1910) used the presence of transverse apophyses on caudal vertebrae as a state to distinguish his bothid subfamilies Platophrinae and Bothinae from the Paralichthyinae (=Paralichthyidae with modifications). Norman (1934) combined the Platophrinae and Bothinae into his Bothinae and Scophthalminae and again used transverse apophyses on caudal vertebrae to distinguish the bothines and scophthalmines from the paralichthyines. Amaoka (1969) used the presence of these structures to define his Bothidae and distinguish them from the other sinistral flounders he treated (Paralichthyidae, Citharidae, Psettodidae). Hensley (1977) and Futch

(1977) found transverse apophyses in *Engyophrys*, *Trichopsetta*, and *Monolene* and suggested this as a character state indicating these genera were more closely related to the Bothidae than the Paralichthyidae. We have since found them in *Perissias*. As previously stated, Norman (1934) had placed these four genera in the Paralichthyinae. Amaoka (1969) presented the most detailed descriptions of these structures. Basically, there are two pairs of transverse apophyses on the vertebrae, an anterior and a posterior pair. They are found on many abdominal and most caudal vertebrae. Subsequently, we have found that the transverse apophyses seen by Regan (1910) and Kyle (1921: fig. 32) in the scophthalmids are very similar to those present in the Bothidae. They are similar in shape and occur in two pairs.

Amaoka (1969) interpreted the occurrence of these structures in the Bothidae as indicative of a relationship to some fish group other than the Percomorpha and used this as evidence that the Bothidae arose independently from the remaining pleuronectiforms. To support this, he cites the occurrence of similar structures in anguilliforms (Trewavas, 1932; Asano, 1962).

Recently in a preliminary survey of this character or complex in other flatfishes, we found transverse apophyses on some vertebrae in the Samarinae, Cynoglossidae, and Solcinae. However,

TABLE 179. EXTENDED.

Vertebral transverse apophyses (Present, Absent)		First neural spine (Present, Absent, or Reduced)	Position of urinary papilla (Midventral, Ocular side, Blind side)	Position of vent (Midventral, Ocular side, Blind side)	Haemal arch on parhypural (Present, Absent, Rudimentary)	Articulation of parhypural with terminal half centrum (Present, Absent)	Hypural fusion pattern (1-6)	Number of autogenous epurals	Haemal spine on PU2 (Autogenous, Fused)	Total caudal-fin rays	Branched caudal-fin rays	Infra-orbital lateral-line canal on ocular side (Present, Absent)
Anterior	Posterior											
A	A	P	M	M	P	P	1	1	A	24-25	15	P
A	A	P	O	O	R?	A	6	1	F	21	13	A
A	A	P	O	O	P?	P	1	2, 3?	A	23	15	P
A	A	P	O	O	R?	A	2	2, 3?	A	22-23 (usually 23)	15	P
A	A	P	O	O	A	A	4	1	F	21	14-15	P
P	P	P	O	M, B	A	A	6	1, 2?	F	16-17	13-15	P
P	P	A	B	B	A	A	6	0	F	17	11	A
A	A	P	O	B	R?	A	6	0	F	17-18 (usually 17)	10-13	P
A	A	P	O	M, B	A	A	6	0, 1, 2?	F	18	13	P
?	?	P	O	M	R?	A	1	2	F	20	14	P?
?	?	P	O	B	R?	A	1	1	F	15-16	0	A?
P	P	A	O	B	A	A	6	0	F	16-18 (usually 17)	10-13	A
P	P	A	O	B	A	A	6	0	F	15-18 (usually 17)	9-13	A
A	A	AR	O	M	R?	A	1	1	F	14-19 (usually 16-18)	13-14	A
A	A	P	O	M, B	A	A	6	1, 2?	F	17-24	10-16	P
A?	A?	AR	O	M	R	A	1	1	F	20	14-15	?
?	?	P	?	B	?	?	1	?	?	16	12	?
P	A	A	O	M	A	A	5	1?	F	16	0-12	A
A	A	AR	O	M, B	A	A	1, 4	1	F	17-20	8-15	A
P	A	A	O	M	A	A	4	1	F	16-20 (usually 18)	0-18	?
A	A	AR	O	B	A	A	1, 2?, 3	1, 2?	A	15-18 (usually 16)	11-17	P
P	A	AR	M	B	A	A	4	0, 1	F	8-14	0	A

in these groups, they occur only as one pair on the anterior end of the vertebra. In addition, the *Cyclosetta* group has two pairs of very small lateral protuberances on most vertebrae. How to interpret the presence of vertebral transverse apophyses in pleuronectiforms is still open to question.

First neural spine.—Amaoka (1969) found that the neural spine of the first vertebra is missing in the Bothidae and interpreted this as a synapomorphy for the group, since absence of this spine is apparently rare or unknown in other teleosts. We have made a preliminary survey for this in other pleuronectiforms not treated by Amaoka. Some of this survey was based on radiographs, and due to the close proximity of the first vertebra and neurocranium, in some groups we are not sure if the first neural spine is present, absent, or greatly reduced. The states in other groups are more certain, since some cleared-and-stained material was available. A greatly reduced or missing first neural spine is not limited to the Bothidae (Table 179).

Position of the urinary papilla.—All flatfishes have a papilla on the posteroventral area of the abdomen near the anal-fin origin. Schmidt (1915, cited by Norman, 1934) commented on its position in flatfishes, claiming it was located on the ocular side in all species. However, Chabanaud (1934), Hubbs (1945), and Hubbs and Hubbs (1945) found it to be on the midventral line

in *Psettodes*. In addition, Hubbs (1945) and Hubbs and Hubbs (1945) found the papilla on the blind side in the paralichthyid genera *Syacium*, *Citharichthys*, and *Etropus*. We have found it in the same position in *Cyclosetta*. Another exception here may be certain cynoglossids. Menon (1977: fig. 45) shows the urinary papilla on the blind side in a species of *Cynoglossus*, but claims it is attached to the first anal-fin ray in all species of the family. A midventral position for the papilla is generalized for teleosts and plesiomorphic for pleuronectiforms.

Position of vent.—Position of the anus in flatfishes has been reviewed by Norman (1934), Hubbs (1945), and Hubbs and Hubbs (1945). A midventral position is plesiomorphic for the order. In flatfishes where the vent is on or near the midventral line, it is often very difficult to determine what state is represented. It is on the blind side in several groups, but apparently on the ocular side only in the Citharidae. Hubbs (1945) interpreted the distribution of these states as indicating that deflection of the vent to the blind side has occurred several times within the order.

Caudal-fin complex.—The caudal fin and skeleton of many species of pleuronectiforms have been illustrated and discussed (e.g., Monod, 1968; Amaoka, 1969). The caudal skeleton of *Psettodes* is reported to be the most primitive among living

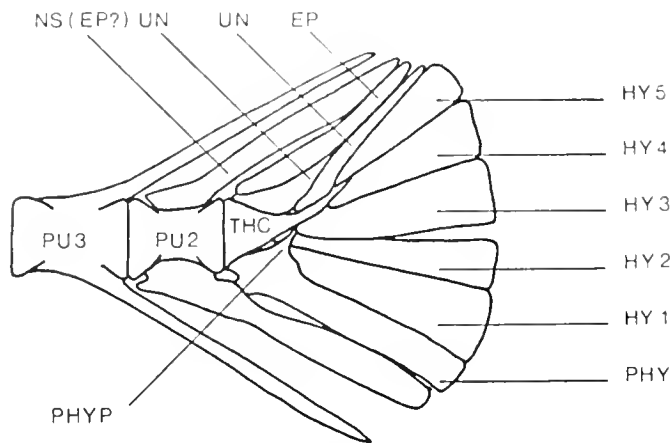

Fig. 359. Caudal skeleton of *Psettodes bennetti*. Hypural pattern 1. EP = epural, HY 1-5 = hypurals 1-5, NS = neural spine, PHYP = parhypural, PHYP = parhypural, PU 2, 3 = preural centrum 2, 3, THC = terminal half centrum, UN = uroneural. Redrawn from Monod (1968).

flatfishes. It can be characterized as follows (Fig. 359): a parhypural with a haemal arch and parhypuralapophysis; five autogenous hypurals; two pairs of uroneurals, i.e., pairs of stegurals and splinter bones; two epurals, the first between the neural-arch remnants of the second preural centrum; terminal half centrum, i.e., fusion of two ural centra and the first preural centrum; haemal spine of the second preural centrum autogenous; haemal spine of the third preural centrum fused; and 24-25 caudal rays, 17 principal, 15 branched. The caudal skeleton of *Psettodes* has been labelled as basically percoid (e.g., Wu, 1932; Monod, 1968; Amaoka, 1969). It should be noted here that the neural spine of the second preural centrum is interpreted as probably a captured epural, and that apparently only one free epural remains. This is one of the more important differences between *Psettodes* and all other pleuronectiforms, which have a neural spine on the second preural centrum and apparently a basal number of two epurals. There are at least two hypotheses which may explain this difference: (1) The earliest pleuronectiforms may have had three free epurals, the anteriormost becoming wedged in the neural-arch remnant on the second preural centrum (i.e., captured) and, thus forming a secondary neural spine. In *Psettodes* the remaining epurals were fused (Amaoka, 1969) or one was lost, while both were retained in the remaining flatfishes, at least primitively. (2) The earliest pleuronectiforms had two epurals, the anteriormost being captured in *Psettodes*, leaving one free epural. In the remaining flatfishes a neural spine on the second preural centrum was acquired by fusion of this vertebra with an anterior one bearing a spine. Rosen (1973) has discussed the second hypothesis to account for secondary acquisition of a neural spine on the second preural centrum and offered as evidence the frequent occurrence of double spines on the second preural centrum. Such anomalies are frequent in

pleuronectiforms (see Cole and Johnstone, 1902; Barrington, 1937; Chabanaud, 1937; Amaoka, 1969; Okiyama, 1974; Futch, 1977; Fig. 360H). However, although a detailed survey for these doubled spines has never been done, it appears that doubled neural spines on this vertebra are just as frequent as doubled haemal spines.

In spite of the work that has been done on pleuronectiform caudal osteology, there is still little agreement on interpretation of some structures. We cannot solve these problems here or discuss them in great detail. Most of these differences in interpretation concern certain epaxial elements. More detailed comparative work needs to be done on these elements before homologies can be determined. For example, there is one interpretation that uroneurals occur only in *Psettodes* (Ahlstrom). However, what appear to be remnants of a stegural may remain in *Citharoides*, *Lepidoblepharon*, *Scophthalmus*, and some achirines (Fig. 361; Amaoka, 1969; Hensley, pers. observ.). Although sufficient comparative work has not been done to treat these dorsal structures across all lines of flatfishes, within certain groups we can be fairly sure of homologies, due to certain consistent patterns of placement and shape and to some larval work where fusions have been observed.

In regard to neural and haemal spines of the second preural centrum, the parhypural, and hypurals, our knowledge rests on firmer ground. Characteristics of these structures have been widely surveyed and there is much more agreement on interpretation of homologous states. We interpret autogenous neural and haemal spines on the second preural centrum, retention of a parhypuralapophysis and haemal arch on the parhypural, and articulation of the parhypural with the terminal half centrum as plesiomorphic for the order.

Several patterns of fusions occur in regard to hypurals 1-4. Hypural 5 moves to an epaxial position during ontogeny in flatfishes (Figs. 360, 362), and its fate is more properly discussed in reference to fusion (or lack of it) with epurals. The most primitive condition is where hypurals 1-4 are not fused to the terminal half centrum or among themselves (pattern 1; Figs. 359, 363 upper).

There are three patterns which are slightly different from each other. The interpretation of these is not so obvious, and we are hesitant here to make statements concerning homologies between groups. One of these (pattern 2) is where hypurals 3 and 4 are fused to the terminal half centrum (Fig. 361). This pattern is shown by *Citharoides* and apparently some Achirinae. In some achirines, a somewhat different pattern (3) occurs where hypurals 2, 3, and 4 are fused to the terminal half centrum (Fig. 363 middle). A fusion of hypurals 1-4 to the terminal half centrum (pattern 4) is found in the Soleinae, Cynoglossidae, one citharid (*Eucitharus*), and two genera of Rhombosoleinae (*Peltorhamphus*, *Rhombosolea*; Figs. 362, 363 lower). Caudal-fin development in a soleine is illustrated in Fig. 362.

Another pattern of hypurals (5) is unique to the Samarinae (Fig. 364). There are two ways to interpret this pattern. Here the central hypurals (2 and 3 or 2-4) are fused to the terminal half centrum. However, unlike the patterns previously de-

Fig. 360. Caudal-fin structure of *Engvophrys senta* larvae (A-F), juveniles and adults (G-H). Standard lengths of specimens: (A) 4.6 mm; (B) 5.5 mm; (C) 7.0 mm; (D) 7.6 mm; (E) 7.7 mm; (F) 15.3 mm; (G) 45.7 mm; (H) 82.4 mm. NC = notochord, other abbreviations as in Fig. 359. Redrawn from Hensley (1977).

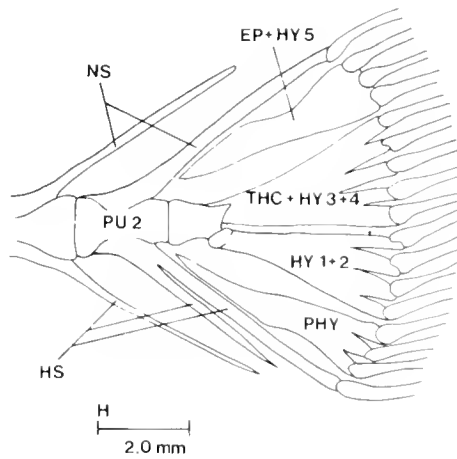
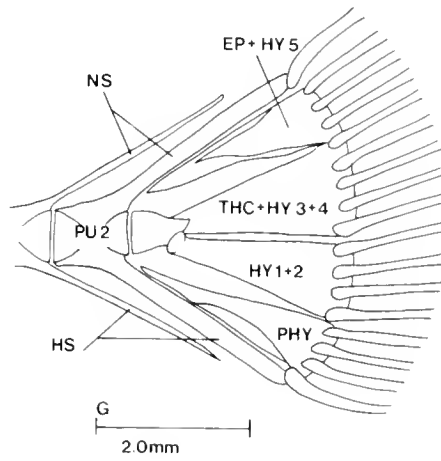
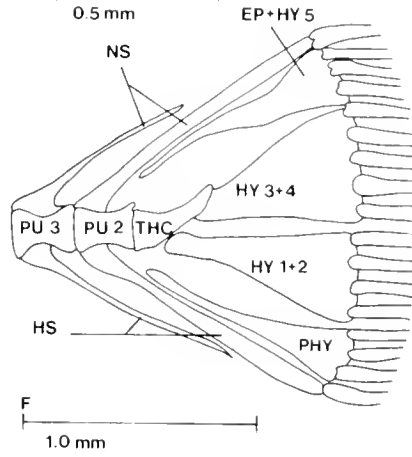
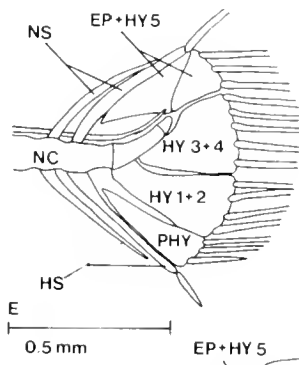
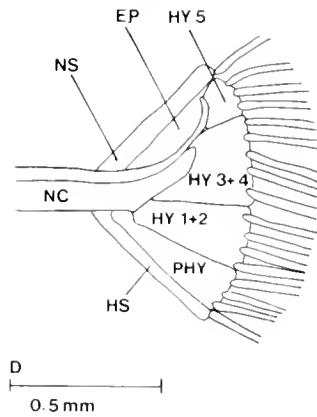
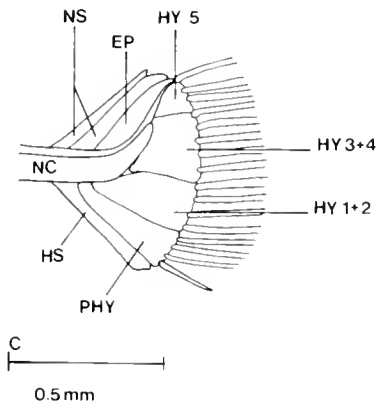
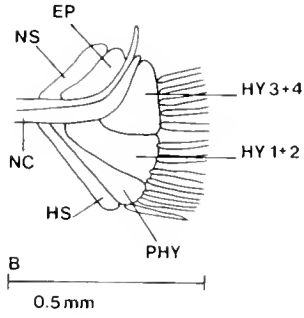
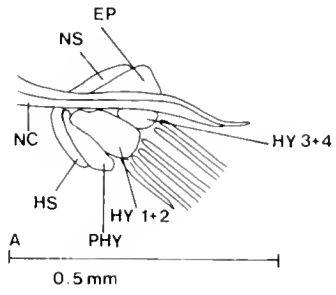

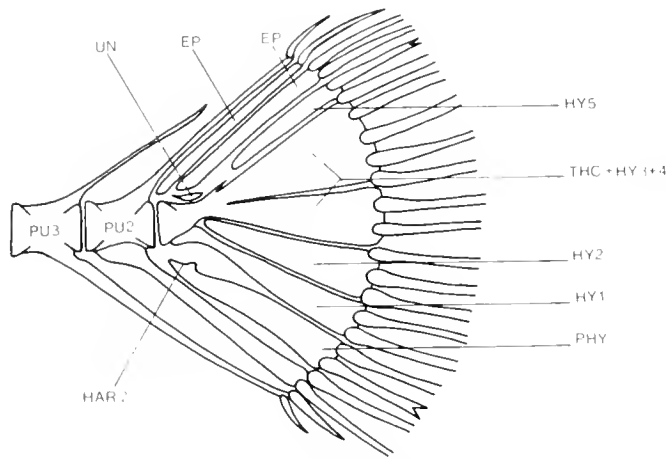

Fig. 361. Caudal skeleton of *Citharoides macrolepis*. Hypural pattern 2. HAR = haemal-arch remnant, other abbreviations as in Fig. 359. "V" on distal end of fin ray indicates dorsal- and ventralmost branched ray.

scribed, in the samarines hypural 1 does not articulate with the terminal half centrum.

The last pattern of hypurals (6) is characterized as follows (Figs. 360, 364 middle and lower): hypurals 1 and 2 are fused together forming one element which articulates with the posteroventral surface of the terminal half centrum; and hypurals 3 and 4 are fused together and to the terminal half centrum. This pattern occurs in the Pleuronectinae, Paralichthyidae (except *Tephrinectes* and *Thysanopsetta*), Scophthalmidae, one citharid (*Brachypleura*), and the Bothidae (except *Mancopsetta*). We interpret this pattern as homologous between these groups, derived, and indicative of a monophyletic origin. We will refer to these fishes as the bothoid group. Caudal-fin development in a bothid is illustrated in Fig. 360.

Although there is still some doubt concerning interpretations of certain epaxial caudal elements in flatfishes, some patterns are apparent. Most of the information indicates that at least in most pleuronectiform groups, the basal epural number is two. However, there is a small third element that appears in many species (Fig. 361; first uroneural of Amaoka, 1969). This element does not appear to be paired and its interpretation and fate in some groups is questionable. The two larger epural elements are still present in some flatfishes (Figs. 361, 363 upper), the citharids *Lepidoblepharon* and *Citharoides* and the paralichthyid *Tephrinectes*. The fate of these from the perspective of the entire order is questionable. However, it is obvious that these epurals have been reduced to one or zero in several groups. Which of these reductions are homologous is unknown. Within groups defined by other specializations, however, we are probably justified in assuming these epural reductions took the same course and are homologous states.

Although space does not allow a more detailed discussion of other caudal-fin characters, some obvious trends should be men-

tioned: Symmetrization—There is a marked trend among flatfishes toward dorsoventral symmetry in the caudal fin and skeleton. This has occurred by various types of fusions, losses, and secondary divisions of elements. These secondary divisions occur as scissures of varying depths in many caudal elements (Figs. 360H, 362F, 363 lower, 364 upper). Reduction of total and branched caudal rays—It has long been recognized that more primitive flatfishes tend to have larger numbers of total and branched caudal rays. Thus, *Psettodes* has a total caudal ray count of 24–25, 15 of which are branched. In many groups, caudal rays have been reduced to less than 18 and branched rays to 0–13.

Infraorbital lateral-line canal on ocular side.—In his study of sinistral flounders (i.e., Psettodidae and Pleuronectoidei) of Japan, Amaoka (1969) found ocular infraorbital bones present in the Psettodidae, two citharid genera (*Citharoides*, *Lepidoblepharon*), and the Paralichthyidae; they were absent from Japanese bothids. We have since done some survey work on this character in other groups not treated by Amaoka and found ocular infraorbital bones missing in additional groups (Table 179).

Examination of the Regan-Norman model using adult characters

In the following discussion, the groups and classification resulting from the current model for pleuronectiform evolution will be reexamined. The limited analysis presented here sheds much doubt on the monophyly of many of the currently recognized groups and their interrelationships. In a few cases, the evidence favoring different interpretations is so strong that these should be recognized in classifications. However, most of this analysis has produced questions and alternative suggestions that need additional study.

Psettodoidei, Psettodidae.—Nearly all of the character states used to define this group (*Psettodes*, two species) are symplesiomorphies or have been interpreted as such. Two exceptions, gill arches with groups of teeth and barbed jaw teeth, are states that Hubbs (1945) proposed as synapomorphies. Although we have no reason to doubt that *Psettodes* is a natural group, it should be redefined using character states which have been shown to be synapomorphies.

Soleoidei.—The differences between the Soleoidei and Pleuronectoidei were noted and expressed in important classifications before the works of Regan and Norman (e.g., Jordan and Evermann, 1896–1900) and they are obviously evident in the current model and classification. In most previous systematic research on pleuronectiforms, the author has concerned himself with one or the other group and assumed that the two were related only through a common ancestor near the early pleuronectiform line. The possibility, for example, that some soleoids may be most closely related to some pleuronectoids has only rarely been addressed. In any cladistic analysis of pleuronectiform interrelationships, character states used to unite the soleoids will need to be reinterpreted. Some character states

Fig. 362. Caudal-fin structure of *Solea solea* larvae (A–C), juveniles and adults (D–F). Total lengths of specimens: (A) 6.0 mm; (B) 6.8 mm; (C) 8.1 mm; (D) 11.5 mm; (E) 18 mm; (F) 470 mm. HA = haemal arch, NA = neural arch, other abbreviations as in Figs. 359, 360. Redrawn from Fabre-Domergue and Biétreix (1905).

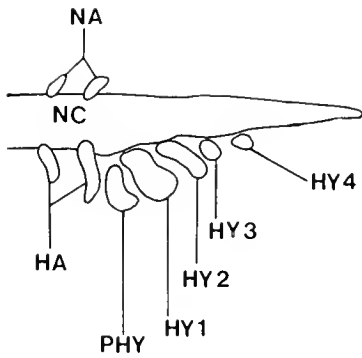

A
0.5 mm

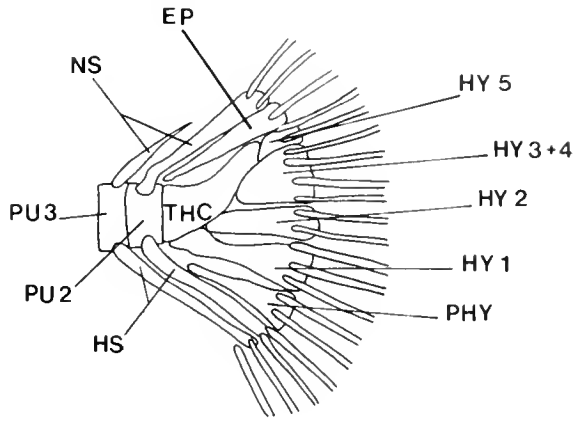

D
0.5 mm

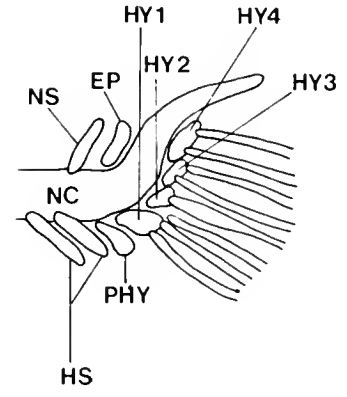

B
0.5 mm

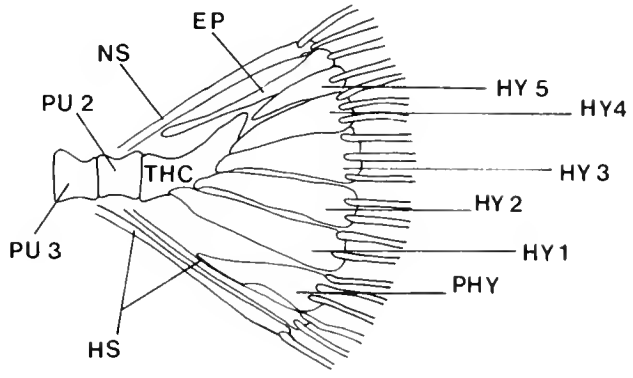

E
0.5 mm

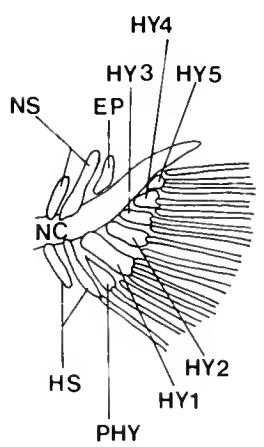

C
0.5 mm

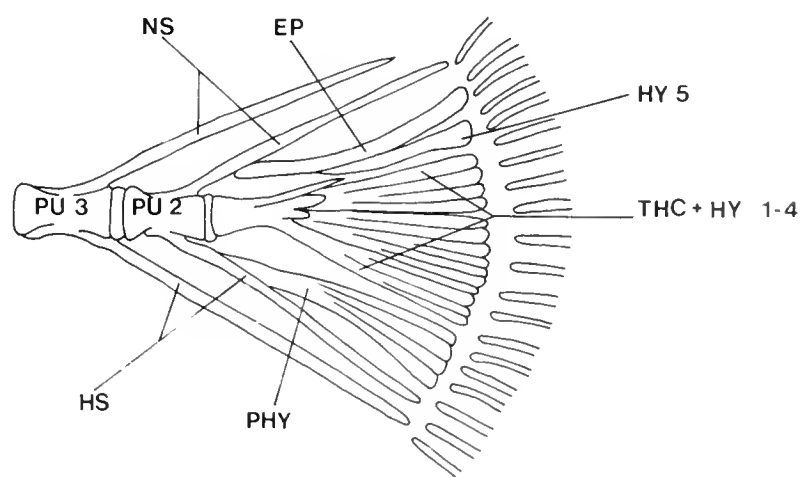

F
0.5 mm

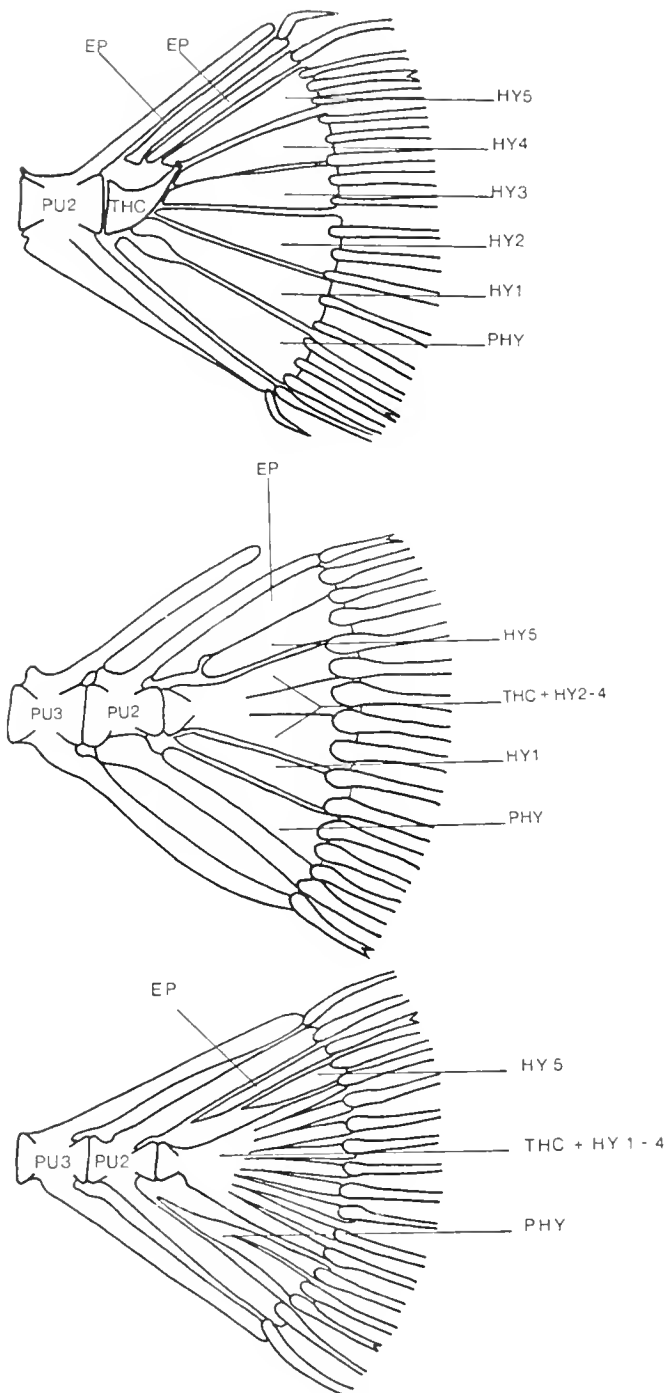

Fig. 363. Caudal skeleton of *Tephrinectes sinensis*. Hypural pattern 1 (upper); caudal skeleton of *Trinectes fimbriata*. Hypural pattern 3 (middle); and caudal skeleton of *Rhombosolea plebeia*. Hypural pattern 4 (lower). Abbreviations as in Fig. 359. "V" on distal end of fin ray indicates dorsal- and ventralmost branched ray.

used as evidence that soleids and cynoglossids are most closely related are plesiomorphic for the order (symmetrical nasal organs, dimorphic optic chiasmata), found in some pleuronectoids but dismissed as parallelisms [lower jaw not prominent, absence

of postcleithra, several "soleoid characters" found in rhombosoleines, (see Norman, 1934)], or are incorrect (absence of all ribs). Other states used to unite the soleoid families include: (1) a preopercular margin covered by skin and scales; and (2) skin covering the dentary and interopercular bones being continuous across the chin, hiding the isthmus and branchiostegal rays (Norman, 1966). A covered preopercular margin is not limited to soleoids; it occurs in some rhombosoleine genera (Chabanaud, 1949; Hensley, pers. observ.). The second state as well as the absence of pleural ribs are possible synapomorphies for the group.

Cynoglossidae.—There is little doubt that the tonguesoles are monophyletic. They are unique in having the ventral fin of the blind side oriented along the midventral line and the ocular fin placed more dorsally or missing. The relationship of this family to other groups, however, is obscure (see Soleidae).

Soleidae.—The main character state proposed as uniting the two soleid subfamilies (Soleinae, Achirinae) appears to be that all species are dextral. This is still a poorly known group, and we are not prepared to make much of a contribution here. However, there are some marked differences between these subfamilies. In several characters, the Achirinae are more primitive than originally thought. Some species have hypural pattern 1, the most primitive. In species where hypural fusions have occurred, the first hypural remains free and articulates with the terminal half centrum (Fig. 363 middle). The haemal spine of the second preural centrum is autogenous (i.e., the plesiomorphic state for the order) in achirines. Uro-neurals may still be present in some species. Although postcleithra are lacking in adult soleoids, at least one achirine species has them during larval development (Futch et al., 1972). Soleines differ from achirines in these characters in that they show what appear to be more derived states. The Soleinae have hypurals 1–4 fused to the terminal half centrum (Fig. 362F), the haemal spine of the second preural centrum is attached, there is no indication of uro-neurals, and postcleithra have not been reported in larvae or adults. Soleines share these states with the *Cynoglossidae*. In addition, both groups have vertebral transverse apophyses, which are missing in achirines. The possibilities that the Soleidae are not monophyletic and the Soleinae are more closely related to the *Cynoglossidae* should be more thoroughly explored.

Pleuronectoidei.—Some of the character states used to define this group are plesiomorphic for the order: (1) preoperculum with free margin; (2) presence of postcleithra; and (3) presence of pleural and epipleural ribs. Some apomorphic states for the order are not limited to pleuronectoids; e.g., loss of dorsal and anal spines. The Regan-Norman model has used the position of the nasal organ of the blind side to separate pleuronectoids from soleoids and psettodids. In pleuronectoids, this nasal organ follows the migrating eye during metamorphosis. After metamorphosis, it remains near the dorsal edge of the head. This was interpreted as a specialization of pleuronectoids, except that this state does not occur in all Rhombosoleinae (i.e., nasal organs remain symmetrically placed). Thus, it is not a synapomorphy for the group, unless it can be shown that the nasal-organ symmetry in these rhombosoleines was secondarily derived from the asymmetrical state. We have not done a survey of nasal-organ symmetry, but incidental observations indicate that the supposed differences between these states (i.e., symmetrical vs

asymmetrical placement) are not as great as formerly thought. Loss of a truly dimorphic optic chiasma would appear to be the only synapomorphy proposed to date uniting the pleuronectoids. However, as previously discussed, a basically dimorphic or monomorphic optic chiasma has been demonstrated in very few pleuronectoid species.

One might expect that we are well informed about the interrelationships among pleuronectoids. Unfortunately, all of the past work has used the eclectic approach. Thus, scophthalmids and citharids have been related horizontally as primitive pleuronectoids, and bothids, paralichthyids, and pleuronectids as higher groups. Again, an important character here is the optic chiasma. Two states were recognized in pleuronectoids: (1) the primitive one (for pleuronectoids) where the nerve of the migrating eye is always dorsal regardless of eye position (i.e., the basically dimorphic state); and (2) the monomorphic state characteristic of "higher" pleuronectoids where the chiasma is fixed regardless of reversals. It has been assumed that all bothids, pleuronectids, and paralichthyids show the monomorphic state. Some evidence from other characters indicates this assumption is not valid.

Due mainly to the work of Amaoka (1969) and one of us (Ahlstrom), we have a good survey of the caudal-fin complex of pleuronectoids. Patterns of hypurals 1-4 are fairly well known. The distributions of these patterns call into question much of the current evolutionary model and classification of the Pleuronectoidei. There are five patterns of hypurals in this group as defined in the Regan-Norman model: Pattern 1 (Fig. 363 upper)—This is plesiomorphic for the order. Pattern 5 (Fig. 364 upper)—This pattern is limited to the Samarinae. We interpret this pattern as a synapomorphy uniting the samarines. Pattern 2 (Fig. 361)—Within pleuronectoids this pattern seems to be limited to *Citharoides*. It is apparently derived from pattern 1. Pattern 6 (Figs. 360, 364 middle and lower)—This is an apomorphic pattern which is very distinctive. We consider it homologous in pleuronectoids where it occurs and a synapomorphy uniting these groups. Again, we are calling this group the bothoids and it includes the Pleuronectinae, Paralichthyidae (except *Tephrinectes* and *Thysanopsetta*), Scophthalmidae, Bothidae (except *Mancopsetta*), and *Brachypleura*. Pattern 4 (Fig. 363 lower)—Within the pleuronectoids this pattern is limited to certain genera of Rhombosoleinae and *Eucitharus*. Based on other characters, the homology of pattern 4 between these groups is probably not true.

Citharidae.—Many character states used to define this family (Hubbs, 1945, 1946) are plesiomorphic for the order: (1) retention of pelvic spines; (2) retention of supramaxillae (*Eucitharus* and *Citharoides*); (3) urinary papilla close to anus; (4) no union of branchiostegals; (5) retention of vomerine teeth (*Eucitharus*, *Brachypleura*, *Lepidoblepharon*); and (6) retention of short-based ventral fins. Some are plesiomorphic for the Pleuronectoidei: (1) basically dimorphic optic chiasma (at least in *Citharoides*); (2) gill membranes showing some degree of union, but still fairly widely separated; and (3) loss of dorsal and anal-fin spines. The only possible character state proposed to date that could be interpreted as a synapomorphy for this family is the position of the anus on the ocular side. Although we have not examined many specimens for this character, it appears that deflection of the anus to the ocular side is probably slight. Amaoka (1972b) examined *Brachypleura* and attempted to redefine the Citharidae. However, he still showed no synapomorphies for the group.

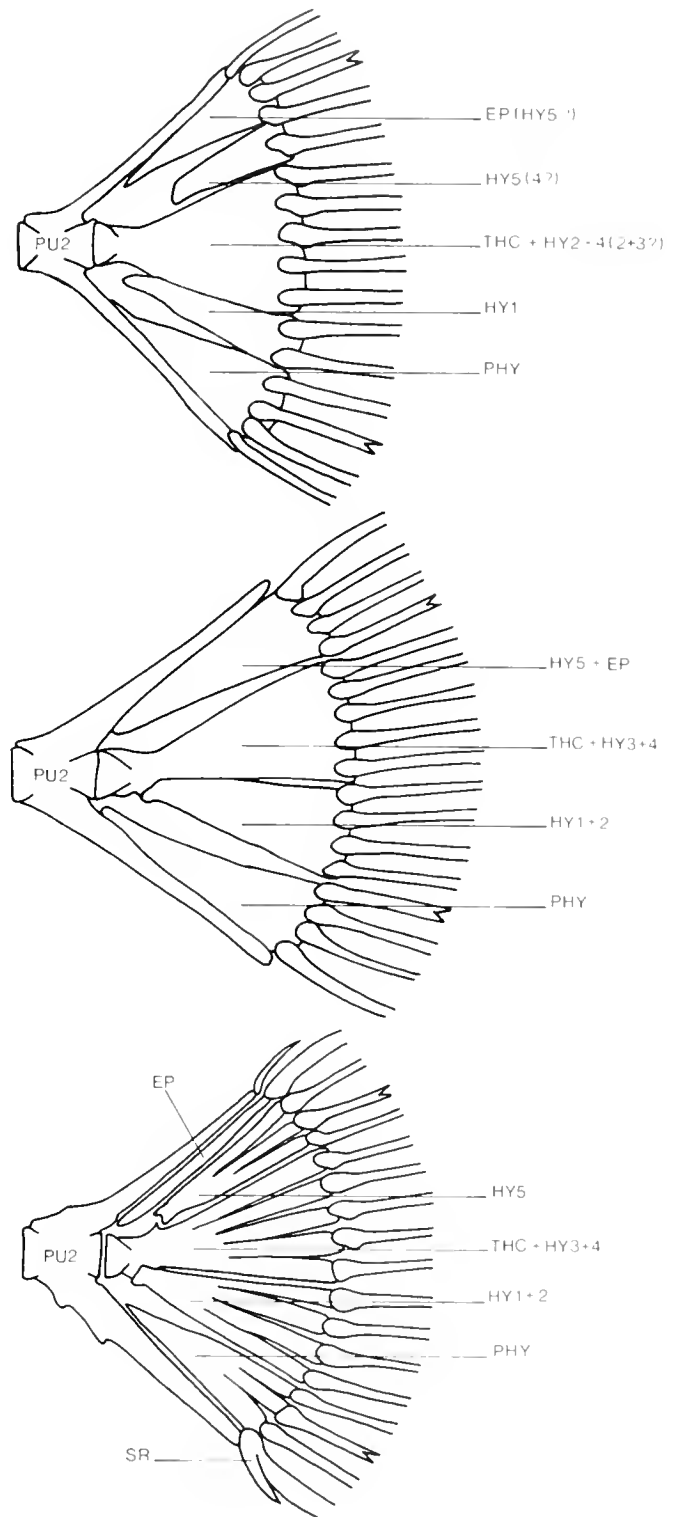

Fig. 364. Caudal skeleton of *Samariscus triocellatus*. Hypural pattern 5 (upper), caudal skeleton of *Citharichthys macrops*. Hypural pattern 6 (middle), and caudal skeleton of *Hippoglossina oblonga*. Hypural pattern 6 (lower), SR = splinter ray, other abbreviations as in Fig. 359. "V" on distal end of fin ray indicates dorsal- and ventralmost branched ray.

The family Citharidae as presently defined is a grade. Examination of the caudal osteology has shown two derived and one plesiomorphic pattern of hypurals. *Lepidoblepharon* shows pattern 1, which is plesiomorphic for the order. *Citharoides* shows pattern 2, a derived pattern (Fig. 361). This pattern could represent a state on a line leading toward pattern 6, which is shown by *Brachypleura*. *Eucitharus* shows pattern 4, which possibly developed independently in some rhombosoleines. The most obvious result of this is that *Brachypleura* belongs to the bothoid group, which shares the derived hypural pattern 6. In this interpretation, the character states shown by *Brachypleura* that are primitive for the order (e.g., vomerine teeth, ventral-fin spines) are also primitive for bothoids.

Scophthalmidae.—Based on ventral-fin morphology, the Scophthalmidae appear to be monophyletic. There are certain similarities in ventral-fin morphology between this family and the achirines, but these are probably superficial. Scophthalmids were previously thought to be closely related to and derived from the Citharidae (Hubbs, 1945). This hypothesis was based on certain symplesiomorphies, e.g., the low degree of fusion of the gill membranes and the presence of vomerine teeth. The Scophthalmidae show hypural pattern 6 and are thus members of the bothoid group.

Paralichthyidae.—Norman (1934) basically defined the Paralichthyinae (=Paralichthyidae with modifications) on external pelvic-fin morphology and vertebral structure (absence of transverse apophyses). The group was supposed to have the ventral fins nearly symmetrical in position and base lengths, or the ocular fin on the midventral line and its base slightly extended anteriorly. Symmetries in ventral-fin position and base lengths are plesiomorphic for the order and bothoids. Norman's paralichthyid genera with an ocular ventral fin on the midventral line and its base extended anteriorly are bothids (i.e., *Trichopsetta*, *Engyophrys*, *Taeniopsetta*, *Monolene*, *Perissias*).

Amaoka (1969) presented a more thorough, detailed definition of the family. However, many or most of the character states he used appear to be plesiomorphic for bothoid fishes (i.e., those defined by hypural pattern 6). A second limitation of Amaoka's work on this group is that it was limited to three genera (*Paralichthys*, *Pseudorhombus*, *Tarphops*). An important change in Norman's classification was made by Amaoka when he removed *Taeniopsetta* from the Paralichthyidae and placed it in the Bothidae. Hensley (1977) and Futch (1977) did the same for *Monolene*, *Engyophrys*, and *Trichopsetta*.

We have now examined some characters in the remaining Paralichthyidae, and additional changes are required in the composition of this group. In a survey of caudal-fin structure, it was found that *Thysanopsetta* and *Tephrinectes* show the most primitive type of hypural pattern (1; Fig. 363 upper). These two genera are much more primitive than expressed in the current classification and definitely do not belong to the bothoid group.

Within the remaining Paralichthyidae another group is discernible. This is composed of *Cyclopsetta*, *Syacium*, *Citharichthys*, and *Etropus*, i.e., the *Cyclopsetta* group. States for two complexes of characters, ventral-fin morphology and urinary-papilla position, are unique to this group and interpreted as synapomorphic. Arrangement of caudal-fin rays in the *Cyclopsetta* group is also unique and probably apomorphic (Fig. 364 middle). All species have 17 caudal rays, none of which are

supported by preural, neural or haemal spines. It should also be noted that the fifth hypural has fused with an epural. This fusion has been observed in larval development (Tucker, 1982; Ahlstrom, pers. observ.). However, fusion of the fifth hypural and one or more epurals has apparently occurred several times in pleuronectiforms, possibly including the bothoids (e.g., see Fig. 360). A detailed analysis of relationships between the *Cyclopsetta* group and other bothoids is not possible here. However, some character states may indicate a close relationship with bothids (absence of first neural spine, presence of vertebral transverse apophyses).

Amaoka (1969) and one of us (Ahlstrom) recognized another group within the Paralichthyidae composed of *Pseudorhombus*, *Tarphops*, and *Cephalopsetta*, i.e., the *Pseudorhombus* group. We interpret these genera as more specialized in certain characters than most other members of the family. Species of this group usually have a total caudal ray count of 17, the epural is fused to the fifth hypural, and they lack a splinter ray on the ventralmost caudal-fin ray. With the exceptions noted above (the primitive non-bothoid genera *Tephrinectes* and *Thysanopsetta* and the *Cyclopsetta* group), the remaining paralichthyids of the Regan-Norman classification (what we are calling the *Paralichthys* group) have the apparently plesiomorphic states of 18 caudal rays, at least one free epural (except in one species of *Hippoglossina* (Sumida et al., 1979)), and a splinter ray on the ventralmost caudal-fin ray (Fig. 364 lower). The splinter ray is probably a remnant of a ray lost through fusion with an adjacent ray (Okiyama, 1974). The *Pseudorhombus* group may be definable by synapomorphies but a detailed analysis has not been done.

After removal of the bothids (*Trichopsetta*, *Engyophrys*, *Taeniopsetta*, *Monolene*, *Perissias*) and the primitive non-bothoid genera (*Tephrinectes*, *Thysanopsetta*), recognition of the *Cyclopsetta* group as monophyletic, and recognition of the *Pseudorhombus* group as possibly monophyletic, few of the original paralichthyid genera remain. We have been referring to these as the *Paralichthys* group (*Ancylopsetta*, *Gastropsetta*, *Hippoglossina*, *Lioglossina*, *Paralichthys*, *Verecundum*, and *Xystreureus*). At least most of the character states known for these remaining genera are plesiomorphic for the order (e.g., symmetrical ventral-fin states) or for bothoids (e.g., usual presence of at least one free epural). The *Paralichthys* group is probably not monophyletic.

Bothidae.—Norman (1934) defined the Bothinae (=Bothidae with modifications) on the basis of a high degree of ventral-fin asymmetry and the presence of vertebral transverse apophyses. The ocular ventral fin was said to be on the midventral line with its base extending anteriorly to the urohyal. Norman excluded *Taeniopsetta*, *Engyophrys*, *Trichopsetta*, *Monolene*, and *Perissias* from this group because the base of the ocular ventral fin, although on the midventral line and somewhat longer than that of the blind side, does not extend to the urohyal.

Amaoka (1969) examined many bothid genera and redefined the family using more characters. Most of the characters stressed by Amaoka have now been examined in other bothoids. These are discussed below:

Ventral-fin asymmetry.—In bothids the ocular fin base is on the midventral line, elongated, and has its origin anteriorly placed relative to the base of the blind fin. Within the bothoids this combination of states appears to be derived and unique.

Preorbital on blind side.—This bone is absent in the Bothidae. It appears to be present in all other bothoids (Pleuronectinae not examined for this character). Based on this comparison, we interpret the loss of this bone a derived state within the bothoids defining the family Bothidae.

Infraorbital bones of the ocular side.—All bothids have an ocular preorbital bone but lack the remainder of the series. The presence or absence of the ocular preorbital has not been surveyed in most bothoid groups. However, an ocular infraorbital lateral line is present in most bothoids. In addition to the Bothidae, it is missing in *Brachypleura* and the *Cyclosetta* group.

Intermuscular bones.—We interpret the presence of at least two of the series of these bones (myorhabdoi) as a derived state unique to and defining the Bothidae.

First neural spine.—Although the first neural arch is present, the neural spine is missing in the Bothidae. It is present in all other bothoids except the *Cyclosetta* group.

Vertebral transverse apophyses.—All bothids have two pairs of transverse apophyses on most vertebrae. As previously discussed, how to interpret these on the pleuronectiform level and within the bothoid group is questionable. Within the bothoids well-developed and very similar structures occur only in the Bothidae and Scophthalmidae. Very small transverse apophyses also occur in the *Cyclosetta* group.

Based on these characters, the Bothidae appear to be monophyletic and definable by synapomorphies in at least three characters or complexes: (1) loss of the preorbital on the blind side; (2) presence of myorhabdoi; and (3) asymmetrical states of ventral-fin morphology.

Since Amaoka's (1969) work, we have examined the remaining genera not examined by him that have been considered bothids (i.e., *Grammatobothus*, *Lophonectes*, *Pelecanichthys*, *Mancopsetta*). All of these except *Mancopsetta* are bothids. *Mancopsetta* exhibits the following character states: (1) hypural pattern 1, i.e., the most primitive type; (2) presence of pleural and epipleural ribs, but no myorhabdoi or other intermuscular bones in the caudal region; (3) at least one free epural (none in adult bothids); (4) anus on midventral line (clearly on blind side in bothids); (5) no vertebral transverse apophyses; and (6) seven rays in the ocular ventral fin, 5–7 in that of the blind side (six in both fins in bothids). These are all characters in which *Mancopsetta* differs from the Bothidae. Due to the primitive hypural pattern, it is not a bothoid (see Rhombosoleinae).

Amaoka (1969) analyzed intergeneric relationships of Japanese bothids. However, his analysis was eclectic and did not include all genera (i.e., *Engyophrys*, *Trichopsetta*, *Monolene*, *Perissias*, *Grammatobothus*, *Lophonectes*, and *Pelecanichthys* were not examined). He recognized two subfamilies, the Taeniopsettinae and Bothinae. He erected the first subfamily for *Taeniopsetta*. Hensley (1977), Futch (1977), Evseenko (1977, 1981), and Amaoka (1979) implied that *Engyophrys* and *Trichopsetta* should be included in the Taeniopsettinae. This was done on the basis of larval characters and ventral-fin morphology. Most of the states used to define the Taeniopsettinae were considered by Amaoka (1969) to be plesiomorphic at the family level. Three characters were emphasized: (1) degree of anterior

extension of the base of the ocular ventral fin; (2) shape of the ventral (sciatic) area of the urohyal; and (3) number of suborbital bones on the blind side. In the taeniopsettines, the origin of the blind ventral fin is at the same transverse level as the second ray of the ocular ventral fin, i.e., the base of the ocular fin is only slightly elongated. In the Bothinae, extension of the base of the ocular fin is greater and the origin of the blind fin is on the same transverse level as the third or fourth ray of the ocular fin. Obviously, the taeniopsettine state here is the more plesiomorphic. *Engyophrys*, *Trichopsetta*, *Monolene*, and *Perissias* show this state. *Taeniopsetta* has a broad, truncate margin on the sciatic part of the urohyal. In bothines, this area of the urohyal is pointed. Amaoka (1969) clearly showed that the plesiomorphic state for bothoids is closer to the condition shown in taeniopsettines. *Engyophrys*, *Trichopsetta*, and *Perissias* show the taeniopsettine condition, *Monolene* the bothine state. Amaoka (1969) noted an apparent trend among bothoids in reduction of the number of suborbital bones of the blind side. This reduction may have occurred in several bothoid groups and interpretation of this character is not clear. Thus, infraorbital counts for bothoids are as follows (preorbital + suborbitals): Scophthalmidae 1 + 5; *Brachypleura* 1 + 0; *Paralichthys* group 1 + 4–5; *Pseudorhombus* group 1 + 5–7; *Cyclosetta* group 1 + 5–6; and Bothidae 0 + 3–5. Pleuronectines were not examined for this character. The most common count in bothoids other than bothids is 1 + 5–7. Thus, there is some evidence that the basal or plesiomorphic count for bothids may be five suborbitals on the blind side. Among bothids this count apparently occurs only in *Taeniopsetta* and *Pelecanichthys*. *Engyophrys*, *Trichopsetta*, *Perissias*, and *Monolene* have three suborbitals on the blind side. In summary, there is good evidence, at least for the first two characters discussed above, that the Taeniopsettinae show states that are plesiomorphic for the family and may not be monophyletic.

Pleuronectidae.—Norman (1934) considered this family to be one of the "higher" flatfish groups, i.e., those with a monomorphic optic chiasma. Hubbs (1945) basically followed this interpretation, but showed that two of Norman's pleuronectid genera, *Brachypleura* and *Lepidoblepharon*, possessed some primitive states not shown in other pleuronectids. These two genera were removed by Hubbs and placed in his family Citharidae.

Norman (1934) defined the Pleuronectidae as being dextral and having eggs without oil globules. Basic to his concept of this family were the assumptions that all members were monomorphic in regard to the optic chiasma and that nearly all species were discriminately dextral. He divided the family into five subfamilies. All members of the Poecilopsettinae, Paralichthodinae, Samarinae, and Rhombosoleinae, as presently interpreted, are discriminately dextral, i.e., sinistral individuals occur so rarely in any one species that they can be considered anomalies. Most species of Pleuronectinae are also discriminately dextral. The few exceptions have probably returned to indiscriminate ocular asymmetry secondarily (Hubbs and Hubbs, 1945). We have no reason to doubt Norman's or Hubbs' assumption that the Pleuronectinae have a monomorphic optic chiasma. However, as previously discussed, there are no data showing this for the other pleuronectid subfamilies. Uniting these groups in the family Pleuronectidae appears to have rested only on ocular asymmetry. We have surveyed these subfamilies for various

characters and are confident that the Pleuronectidae as currently defined are not monophyletic. In fact, four of the pleuronectid subfamilies are not bothoids as we define the group. However, what the true relationships of these groups are is unknown. We discuss these subfamilies individually:

Poecilopsettinae.—We have examined radiographs of specimens of *Poecilopsetta* and *Nematops*. These genera have hypural pattern 1, at least one free epural, 20 caudal rays, and what appears to be a haemal-arch remnant on the parhypural. The caudal structure here is primitive compared to the bothoids and these fishes do not belong to that group. Poecilopsettines are poorly known and character states defining the group or relating it to others have not been investigated.

Paralichthodinae.—*Paralichthodes algoensis* has hypural pattern 1 (Ahlstrom, pers. observ.) and does not belong to the bothoid group. Its relationships to other groups are unknown.

Samarinae.—Since Hubbs' (1945) removal of *Brachypleura* and *Lepidoblepharon* from this group, it has been composed of *Samaris* and *Samariscus*. We have not done a detailed study of these genera, but some characters we have examined are worthy of note: (1) These genera show a unique hypural pattern (5; Fig. 364 upper). We interpret this pattern as derived relative to pattern 1 and as indicative that the group is monophyletic. Using this pattern to relate the group is more difficult; however, one of us (Ahlstrom) noted that in late-stage larvae of *Samariscus*, hypural pattern 1 is present, and fusions resulting in pattern 5 must occur very late in development. This is evidence that pattern 5 may have evolved directly from pattern 1 and does not represent a modification of the bothoid pattern 6. (2) Samarines are the only pleuronectiforms known other than the Bothidae to have intermuscular bones, although they do not have the two series of myorhabdoi as found in bothids. We have not done a detailed study of these bones in samarines, but they appear very similar to the epimerals, epicentrals, and hypomerals of bothids. (3) Samarines, cynoglossids, and soleines have an anterior pair of well-developed transverse apophyses on many vertebrae. Two pairs of these structures are found in the Bothidae and Scophthalmidae. (4) The Samarinae, Soleoidei, and *Mancopsetta* lack postcleithra, at least in adults. How to interpret these last three character states is open to question. Are three of the series of intermuscular bones homologous in samarines and bothids? Are the anterior vertebral transverse apophyses homologous between all of the groups? Do some of these character states indicate a close relationship between samarines and some soleoids (i.e., cynoglossids and soleines)? Our tentative hypothesis is that the samarines are a line that is at least independent from the bothoids. Here we are obviously stressing caudal characters. The corollary of this is that we are interpreting similarities between samarines and bothoids in intermuscular bones and vertebral transverse apophyses as homoplasies.

Rhombosoleinae.—The main character states used by Norman (1926, 1934) to define this subfamily were the high degree of asymmetry in the ventral fins and the absence of pectoral radials. The ocular ventral fin is on the midventral line and its base is considerably extended. The blind ventral fin is short based or missing. Another interesting characteristic of this group is that

several genera show high numbers of fin rays in the ocular ventral fin. There is a great deal of morphological diversity in rhombosoleines. Some genera appear fairly generalized in many characters (*Oncopterus*, *Psammodiscus*, *Rhombosolea*, *Azygopus*, and *Pelotretis*); others are more specialized (*Colistium*, *Peltorhamphus*, and *Ammotretis*). Many of the specializations in the latter genera are similar to those in some soleoids. This has been interpreted as parallel evolution (Norman, 1934; Hubbs, 1945). Norman apparently had some doubts about aligning this group with the Pleuronectinae. He realized that Parker's (1903) examination of one specimen of *Oncopterus darwinii* in his survey of optic chiasmata did not prove the group to be monomorphic in this character. This group has still not been studied in detail. It may be monophyletic, but its relationship to other flatfishes is unknown.

We have examined the caudal skeleton of all rhombosoleine genera except *Psammodiscus*. They show hypural patterns 1 and 4 (Fig. 363 upper and lower). Assuming the group is monophyletic, there are two implications here: (1) The primitive pleuronectiform hypural pattern 1 is also plesiomorphic for the Rhombosoleinae, and the derived pattern 4 arose within the group independently from the same pattern in the Soleinae, Cynoglossidae, and *Eucitharus*. (2) The Rhombosoleinae are not bothoids and should not be aligned with the Pleuronectinae.

The possibility has recently become apparent that *Mancopsetta* may be most closely related to the Rhombosoleinae. All known specimens of *Mancopsetta* are sinistral and it has been considered a bothid. However, it shares certain character states with at least some rhombosoleines. This genus has ventral-fin ray counts of 7 on the ocular side and 5–7 on the blind side. Although not strictly limited to the rhombosoleines, these high counts, at least in the fin of the ocular side, are characteristic of at least four rhombosoleine genera. The eyes are densely scaled in *Mancopsetta* and in *Azygopus* and *Pelotretis*. However, scaled eyes are found in some genera of other groups also (e.g., some pleuronectines). Andriashev (1960) and Penrith (1965) have both remarked on a fleshy lip-like structure which overhangs the anterior end of the upper jaw in *Mancopsetta*. One of the soleoid-type characteristics exhibited by the more specialized rhombosoleines is the dorsal fin originating in a rostral hook that overhangs the mouth. In the more generalized genera, there is no rostral hook and the dorsal fin originates at some posterior position. In at least one of these generalized genera (*Azygopus*, the only one examined for this character) there is a fleshy structure (possibly a precursor to the rostral hook?) overhanging the anterior end of the upper jaw which is very similar to that in *Mancopsetta*. Obviously more comparative work needs to be done here. However, it is possible that *Mancopsetta* and the Rhombosoleinae may form a monophyletic group with an indiscriminately dextral or sinistral common ancestor.

Pleuronectinae.—Norman (1934) stressed two character states in defining this subfamily: (1) lateral line well developed on both sides of the body; and (2) olfactory laminae parallel (except in *Atheresthes*), without rachis. A well-developed lateral line on both sides of the body is plesiomorphic for the order and bothoids. We have not examined olfactory laminae or attempted to analyze distributions of states for the character.

We have shown that the Pleuronectidae is probably not monophyletic, due to the inclusion of the four non-bothoid subfamilies. The subfamily Pleuronectinae is the only bothoid group

in Norman's Pleuronectidae. Members of this subfamily are dextral or apparently secondarily indiscriminate (Hubbs and Hubbs, 1945). They apparently have a monomorphic optic chiasma. However, most character states which species of this subfamily share appear to be plesiomorphic for the order or bothoids, e.g., symmetrical or nearly symmetrical ventral-fin placement and fin-base lengths, anus on or close to the mid-ventral line. We have examined the caudal osteology of about half of the pleuronectine genera. All have the bothoid hypural pattern (6) and one or possibly two free epurals. We have found no synapomorphies in the caudal fin for this group.

Larval characters

In the previous discussion, many doubts were raised concerning pleuronectiform interrelationships as expressed in the Regan-Norman model. Unfortunately, larvae for many of these groups are unknown. A second problem is that surveys for many characters where larvae are known have been incomplete and inconsistent. Most descriptive larval research has dealt with characters useful for identification and has not involved comparative work of sufficient detail to determine homologous states. Such work is sorely needed before distributions of homologous states can be determined for many characters.

Below is a list and discussion of certain characters and complexes. Selection of these was based mainly on the amount of available information.

Preopercular spines.—The presence of preopercular spines appears to be plesiomorphic for the order and some pleuronectiform groups. This is based on the observation that the state is widespread among flatfish and percomorph larvae.

Neurocranial spines.—Spines occur in some regions of the neurocranium in some pleuronectiform larvae. Most of these are said to occur in the otic or frontal regions. However, determining homologies here is difficult due to a general lack of detailed osteological study of the bones carrying these spines. Spines in the otic and frontal regions appear to be of two types. One of these is where spines are associated with neurocranial ridge systems. These are known for larvae of achirines (Houde et al., 1970; Futch et al., 1972), some scophthalmids (Jones, 1972), and some pleuronectines (Pertseva-Ostroumova, 1961). In the second type, spines occur singly or in small groups but are not part of a pronounced ridge. These have been said to occur on various bones of the otic region (epiotics, autosphenotics, autopterotics) or on the frontals. Tucker (1982) was not able to determine the origin of such spines in the larvae of *Citharichthys* and *Etropus* and referred to them as frontal-sphenotic spines. Although thorough studies are needed before neurocranial spines can be used to infer or test pleuronectiform interrelationships, certain patterns are noteworthy: (1) Spines that are not part of some pronounced ridge system appear to be limited to some bothoids (some species of the *Paralichthys* group, *Cyclopsetta* group, *Pseudorhombus* group, Scophthalmidae, Pleuronectinae, and Bothidae). (2) Within the Bothidae, only the larvae of *Enngyphrys*, *Taeniopsetta*, and *Trichopsetta* (Taeniopsettinæ; larvae of *Perissias* are unknown) are known to have otic spines (Amaoka, 1979). In these genera, the spines are on the same bones (epiotics and autosphenotics) and are probably homologous. (3) Within the *Cyclopsetta* group, a relatively well-de-

veloped otic or frontal spine occurs in *Cyclopsetta* and *Syacium* (Aboussouan, 1968b; Gutherz, 1970; Ahlstrom, 1971; Futch and Hoff, 1971; Evseenko, 1979), while series of small spines occur in *Citharichthys* and *Etropus* (Tucker, 1982).

Urohyal, basipterygial, and cleithral spines.—Spines on these bones are limited to certain genera of the Bothidae. Thus, they are considered apomorphic at the pleuronectiform and bothoid levels of universality.

Early-forming elongated dorsal-fin rays.—The presence of elongated dorsal-fin rays in pleuronectiform larvae has been extensively and justifiably used for identification purposes. However, use of these structures for phylogenetic interpretations is presently difficult and generally premature. There are several reasons for this. Surveys for these characters are inadequate, since larvae for many groups are unknown. Characters and character states have never been adequately defined to allow proper comparisons to be made. The only pattern here that is clear and phylogenetically interpretable is the state in bothoids. All species of this family for which larvae are known show elongation of only the second dorsal-fin ray. This state is known only in this family and thus appears to be apomorphic within the order and bothoids.

Early-forming elongated ventral-fin rays.—Ocular ventral-fin rays which are elongated relative to those of the blind side are limited to certain species of the *Cyclopsetta* group. Due to the restricted occurrence of these, they are probably apomorphic for the order and bothoids. However, within the *Cyclopsetta* group, the distribution of elongated ocular ventral-fin rays does not conform to generic groups based on adult morphology. At least one species of cynoglossid is known to have elongated rays in the ventral fin of the blind side (Kyle, 1913; Padoa, 1956k).

Size at metamorphosis.—Most flatfishes metamorphose in the size range of ca. 10–25 mm. When size at metamorphosis has been discussed in regard to evolution in pleuronectiforms, the usual hypothesis has been that certain species and groups have evolved mechanisms for prolonging larval life for greater dispersal, and others have actually shortened larval life for recruitment to limited habitats (Amaoka, 1979; Moser, 1981). There are several implications in this hypothesis that are relevant here: (1) There is some size range for transformation that is plesiomorphic for the order. This is usually implied to be ca. 10–25 mm because most pleuronectiforms metamorphose in this range. (2) Metamorphosis at markedly smaller (e.g., Achirinae) or larger (e.g., Bothidae, some pleuronectines) sizes are derived states. (3) According to the Regan-Norman model, prolonged larval development must have developed independently in several lines. Although metamorphosis at large sizes is most common in bothoids, it is also known for some Pleuronectinae, the Poecilopsettinæ, some species of the *Cyclopsetta* group, and some cynoglossids.

Size at metamorphosis is an important character for larval identification, but its use for inferring phylogenetic relationships in most instances is premature. Exceptions may exist in the Bothidae, where the extremely long premetamorphic lengths exhibited by some genera are probably apomorphic within the family and can be used for phylogenetic information.

Relative time of caudal-fin formation.—In most known larvae of flatfishes and other teleosts, formation of the caudal fin precedes or occurs with that of the dorsal and anal fins. The only exceptions known in pleuronectiforms are the cynoglossids. In this family, the caudal fin does not develop until the dorsal and anal fins are nearly completely developed. This pattern of development is considered apomorphic in pleuronectiforms.

Eye migration and dorsal-fin position at metamorphosis.—Eye migration has been observed in some flatfish groups. In the Psettodidae, Pleuronectinae, Paralichthyidae (excluding the *Cyclopsetta* group), Scophthalmidae, and apparently some Soleidae, the first ray of the dorsal fin is above or posterior to the eyes. At metamorphosis, the migrating eye crosses anterior to the dorsal-fin origin. These types of eye migration and dorsal-fin position appear to be plesiomorphic for the order. Several derived states for these characters occur. In at least one species of cynoglossid, a fleshy rostral beak is formed anterior to the dorsal-fin origin. Eye migration takes place between the rostral beak and the interorbital region. In some soleids, the dorsal-fin origin projects above the snout and the eye migrates between this projection and the neurocranium. In the Bothidae, the dorsal fin is anterior to the eye and attached to the ethmoid region. During migration, the eye goes between the base of the dorsal fin and the ethmoid region. A path for the migrating eye is created by detachment of the anterior section of the dorsal fin from the ethmoid region so that a narrow slit is formed, or some tissue in the path of the migrating eye is absorbed. A very similar type of eye migration occurs in some species of the *Cyclopsetta* group. However, in other members of this group, the eye migrates around the dorsal-fin origin (Gutherz, 1970; Tucker, 1982).

Phylogenetic information provided by larval characters

Although larvae of some critical groups are unknown or poorly known, some comments about phylogenetic relationships can be made in regard to groups where our knowledge is on a higher level.

Bothoids.—Spines in the otic or frontal regions of the neurocranium which are isolated or in small clusters appear to be limited to various groups of bothoids. If these spines prove to be homologous between these groups, they may be apomorphic within the order. In this interpretation, they would be primitive for bothoids and lost in various lines.

Paralichthyidae.—As discussed in the section on adult characters, this family as currently interpreted is polyphyletic due to the inclusion of *Tephrinectes* and *Thysanopsetta*. We do not consider these genera bothoids as defined by the caudal-fin complex. Their larvae are unknown.

We have interpreted the *Cyclopsetta* group as monophyletic based on some adult character states which are probably apomorphic. Although larvae of this group show certain states which appear to be apomorphic within bothoids (e.g., elongated left ventral-fin rays), not all species in this group show these.

The *Pseudorhombus* group is possibly definable by adult synapomorphies. In larvae of this group, we see no character states that are presently interpretable with certainty as synapomorphies.

In examining adult characters of the *Paralichthys* group, it appeared likely that this group had no synapomorphies. Larvae

tend to support this. They show the following character states which appear to be plesiomorphic for the order: (1) presence of preopercular spines; (2) origin of the dorsal fin behind the eyes; (3) metamorphosis in a size range of 7.5–14.2 mm; and (4) eye migration anterior to the dorsal fin. In addition, at least some species show the following states which may prove to be plesiomorphic at least within the bothoids: (1) four or five elongated, early-forming dorsal-fin rays; and (2) presence of otic spines.

Bothidae.—With the exclusion of *Mancopsetta* and inclusion of *Perissias*, this family is definable by adult synapomorphies. Larvae of the Bothidae are probably better known than for any other family of flatfishes. However, larvae of many genera are still unknown (i.e., *Parabothus*, *Asterorhombus*, *Tosarhombus*, *Neolaeops*, *Japonolaeops*, and *Perissias*). Amaoka (1979) reviewed larval characters of most genera for which larvae are known. Known bothid larvae show the following character states which are interpreted as synapomorphies: (1) metamorphosis at a relatively large size (ca. 15–120 mm); (2) eye migration below the dorsal fin; (3) dorsal-fin origin anterior to eyes just prior to metamorphosis; (4) elongated, early-forming second dorsal-fin ray; and (5) lack of preopercular spines.

Larvae of some bothid genera have various combinations of otic-region, urohyal, cleithral, and basipterygial spines. It is tempting to use the presence of these spines to define bothid groups, and therefore, assume that they are apomorphic within the family. Spines in the otic region within the Bothidae are limited to the Taeniopsettinae as presently defined. However, spines in this region occur in other bothoid groups. Although sufficient comparative osteological work has not been done to show that these spines are homologous between taeniopsettines and other bothoids, use of these spines to infer close relationships between *Engyophrys*, *Taeniopsetta*, and *Trichopsetta* is questionable. Urohyal, cleithral, and basipterygial spines are known only from larvae of nine bothid genera. They occur in various combinations inter- and intragenerically. Amaoka (1969) presented a model of intergeneric relationships for Japanese bothids based on adult characters. Occurrence of these larval spines is scattered among the bothid lines hypothesized by Amaoka. This could indicate two possibilities: (1) the spines are apomorphic within the family, and Amaoka's model is incorrect; or (2) Amaoka's model is correct and the spines are plesiomorphic within the family and have been lost in several lines. Two major problems exist with Amaoka's phylogeny based on adult characters; it was constructed using eclectic methods and it did not include all genera. Interpretation of urohyal, basipterygial, and cleithral spines should await a cladistic analysis of bothid interrelationships based on adult characters.

Pleuronectidae.—Based on adult characters, we interpret this family as polyphyletic. Larvae of the four non-bothoid subfamilies are poorly known, and hence, of little aid in determining relationships of these groups. However, there are certain similarities in general body morphology between the few known samarine and poecilopsettine larvae. In regard to the Pleuronectinae, many adult states that are shared are plesiomorphic for pleuronectiforms or bothoids. This also appears to be true for most larval characters. The position of the dorsal-fin origin (posterior to the eyes) and the type of eye migration (anterior to the dorsal-fin origin) are plesiomorphic for the order. Some pleuronectine larvae have preopercular spines, which again, are

probably plesiomorphic for flatfishes. Some genera show spines in the otic region of the neurocranium; these are possibly plesiomorphic for bothoids. All known pleuronectine larvae lack elongated dorsal-fin rays. However, this state is not limited to this group and a phylogenetic interpretation of it would be premature. In short, at present, we know of no character states that are unique to pleuronectine larvae or that can confidently be interpreted as apomorphic.

Egg characters

Except in certain groups, eggs of flatfishes are still too poorly known to be of much value in phylogenetic studies. One character of pleuronectiform eggs was used by Regan (1910) and Norman (1934) to interpret phylogeny, the presence of one oil globule in bothid eggs to separate them from those of pleuronectids which lack oil globules. We now have more information about the occurrence of oil globules in flatfish eggs, and the distribution of these character states is not exactly that predicted by the Regan-Norman model (preceding article, this volume). The obvious pattern here is that bothoids have 0-1 and soleoids, rhombosoleines, and *Mancopsetta* multiple oil globules. There are published exceptions to this. Watson and Leis (1974) identified three types of eggs with multiple oil globules as those of

bothids. However, these authors expressed some doubt about the identifications of at least two of these egg types. These eggs are probably some other group (poecilopsettines or samarines?). Brownell (1979) identified some eggs which lacked oil globules as the soleid *Heteromycteris capensis*. This is the only soleid we are aware of that lacks multiple oil globules.

It is probably premature to use the oil-globule character for phylogenetic information until eggs from other groups are known. However, it is interesting and possibly significant that the soleoids, rhombosoleines, and *Mancopsetta* are so sharply separable from the bothoids in this character. One oil globule appears to be the most common state in the eggs of percomorph fishes (based on accounts in Watson and Leis, 1974; Russell, 1976; Fritzsche, 1978; Hardy, 1978b; Johnson, 1978; and Brownell, 1979). This may indicate that this state is plesiomorphic for pleuronectiforms. Corollaries of this would be that oil globules were lost in most pleuronectines, and multiple oil globules developed in a line leading to the soleoids, rhombosoleines, and *Mancopsetta*.

(D.A.H.) DEPARTMENT OF MARINE SCIENCES, UNIVERSITY OF PUERTO RICO, MAYAGUEZ, PUERTO RICO 00708.

LITERATURE CITED

- ABE, T. 1954. New, rare or uncommon fishes from Japanese waters. IV. Records of rare fishes of the families Lophotidae, Nomeidae, Icosteidae. *Jpn. J. Ichthyol.* 3:90-95.
- . 1957. Notes on fishes from the stomachs of whales taken in the Antarctic. *Sci. Rep. Whales Res. Inst. (Tokyo)* No. 12:225-233.
- , AND S. KAJI. 1972. A record of *Oreosoma atlanticum* (Oreosomatidae, Zeiformes, Teleostei) from Tasman Sea. *U.O. No.* 8:5-7.
- ABLE, K. W. 1984. Variation in spawning site preference of the mummichog, *Fundulus heterochitus*. *Copeia* 1984:522-525.
- . MS. Comments on the distribution and reproductive seasonality of snailfishes and lumpfishes in the estuary and Gulf of St. Lawrence.
- , J. D. FELLE AND D. POWERS. MS. Taxonomy of Bermuda *Fundulus* (Pisces: Fundulidae).
- , D. F. MARKLE AND M. P. FAHAY. MS. Development of larval liparidine snailfishes from the western North Atlantic.
- , AND D. E. McALLISTER. 1980. Revision of the snailfish genus *Liparis* from Arctic Canada. *Can. Bull. Fish. Aquat. Sci.* No. 208.
- , AND J. A. MUSICK. 1976. Life history, ecology and behavior of *Liparis inquilinus* (Pisces: Cyclopteridae) associated with the sea scallop, *Placopecten magellanicus*. *Fish. Bull. U.S.* 74:409-421.
- ABOUSSOUAN, A. 1964. Contribution à l'étude des oeufs et larves pélagiques des poissons téléostéens dans la Golfe de Marseille. *Rec. Trav. Stn. Mar. Endoume Fac. Sci. Mars.* 32(48):87-173.
- . 1965. Oeufs et larves de téléostéens de l'ouest africain. I. *Acanthurus monroviae* Steind. *Bull. Inst. Fondam. Afr. Noire, Ser. A Sci. Nat.* 27:1183-1187.
- . 1966a. Sur quelques larves pélagiques de téléostéens récoltées à Tulear. *Recl. Trav. Stn. Mar. Endoume-Mars. Suppl.* 5:149-164.
- . 1966b. Sur quelques larves pélagiques de téléostéens récoltées à Tulear. *Cent. Oceanogr. Fac. Sci. Mars.* 1966:147-159.
- . 1966c. Oeufs et larves de téléostéens de l'ouest africain. III. Larves de *Monacanthus hispidus* (L.) et de *Balistes forcipatus* Gm. *Bull. Inst. Fondam. Afr. Noire, Ser. A* 28:276-282.
- . 1966d. Oeufs et larves de téléostéens de l'ouest africain. IV. *Galeoides polydactylus* (Vahl) [Polynemidae]. *Bull. Inst. Fondam. Afr. Noire, Ser. A Sci. Nat.* 28:1037-1040.
- . 1967. Oeufs et larves de téléostéens de l'ouest africain. V. *Caranx rhonchus* Geoffroy Saint-Hilaire (Carangidae). Affinités avec *Trachurus trecae* Cadenat. *Bull. Inst. Fondam. Afr. Noire, Ser. A Sci. Nat.* 29:1039-1050.
- . 1968a. Oeufs et larves de téléostéens de l'ouest africain. VI. Larves de *Chloroscombrus chrysurus* (Linné) et de *Blepharius crinitus* (Mitchill) (Carangidae). *Bull. Inst. Fondam. Afr. Noire, Ser. A Sci. Nat.* 30:226-237.
- . 1968b. Oeufs et larves de téléostéens de l'ouest africain VII. Larves de *Syacium gunneensis* (Blkr.) [Bothidae]. *Bull. Inst. Fondam. Afr. Noire, Ser. A Sci. Nat.* 30:1188-1197.
- . 1968c. Oeufs et larves de téléostéens de l'ouest africain. VIII. Larves de *Bregmaceros maclellandi* Thompson (Bregmacerotidae). *Bull. Inst. Fondam. Afr. Noire, Ser. A Sci. Nat.* 30:1590-1602.
- . 1969. Sur une petite collection de larves de téléostéens récoltée au large du Brésil (Campagne "Calypso" 1962). *Vie Milieu, Ser. A Biol. Mar.* 20:595-610.
- . 1972a. Oeufs et larves de téléostéens de l'ouest africain. X. Larves d'Ophidioidéi (*Oligopus*, *Ophidion* et *Carapus*) et de Percoidéi (*Pseudupeneus*). *Bull. Inst. Fondam. Afr. Noire, Ser. A Sci. Nat.* 34:169-178.
- . 1972b. Oeufs et larves de téléostéens de l'ouest africain. XI. Larves serraniformes. *Bull. Inst. Fondam. Afr. Noire, Ser. A Sci. Nat.* 34:485-502.
- . 1972c. Oeufs et larves de téléostéens de l'ouest africain. XII. Les larves d'Heterosomata récoltées aux environs de l'île de Gorée (Sénégal). *Bull. Inst. Fondam. Afr. Noire, Ser. A Sci. Nat.* 34:974-1003.
- . 1975. Oeufs et larves de téléostéens de l'ouest africain. XIII. Contribution à l'identification des larves de Carangidae. *Bull. Inst. Fondam. Afr. Noire, Ser. A Sci. Nat.* 37:899-938.
- . 1980. Description d'une larve géante "rubaniforme," attribuée au genre *Brotulataenia* (Pisces, Gadiformes, Ophidioidéi, Ophidiidae) et récoltée à l'est des nouvelles Hébrides. *Cybium, 3rd Ser.*, (10):51-64.
- ADAMS, J. A. 1960. A contribution to the biology and postlarval development of the sargassum fish, *Histrio histrio* (Linnaeus), with a discussion of the *Sargassum* complex. *Bull. Mar. Sci. Gulf Caribb.* 10:55-82.
- AGASSIZ, A. 1882. On the young stages of some osseous fishes. *Proc. Am. Acad. Arts Sci.* 16(Pt. 3):271-303.
- , AND C. O. WHITMAN. 1885. The development of osseous fishes. I. The pelagic stages of young fishes. *Mem. Mus. Comp. Zool. Harv.* 14(1):1-56.
- AHLSTROM, E. H. 1943. Studies on the Pacific pilchard or sardine (*Sardinops caerulea*). 4. Influence of temperature on the rate of development of pilchard eggs in nature. *U.S. Fish Wildl. Serv. SSRF* 23.
- . 1956. Eggs and larvae of anchovy, jack mackerel, and Pacific mackerel, p. 33-42. *In: Progress Rep., Calif. Coop. Oceanic Fish. Invest.*, 1 April 1955-30 June 1956, Sacramento.
- . 1965. Kinds and abundance of fishes in the California Current region based on egg and larval surveys. *Calif. Coop. Oceanic Fish. Invest. Rep.* 10:31-52.
- . 1968. Review of "Development of fishes of the Chesapeake Bay region, an atlas of egg, larval and juvenile stages, Part 1". *Copeia* 1968:648-651.
- . 1969. Remarkable movements of oil globules in eggs of bathylagid smelts during embryonic development. *J. Mar. Biol. Assoc. India* 11:206-217.
- . 1971. Kinds and abundance of fish larvae in the eastern tropical Pacific, based on collections made on EASTROPAC I. *Fish. Bull. U.S.* 69:3-77.
- . 1972a. Kinds and abundance of fish larvae in the eastern tropical Pacific on the second multivessel EASTROPAC survey, and observations on the annual cycle of larval abundance. *Fish. Bull. U.S.* 70:1153-1242.
- . 1972b. Distributional atlas of fish larvae in the California Current region: six common mesopelagic fishes. *Calif. Coop. Oceanic Fish. Invest. Atlas* 17.
- . 1974. The diverse patterns of metamorphosis in gonostomatid fishes - an aid to classification, p. 659-674. *In: The early life history of fish.* J. H. S. Blaxter (ed.), Springer-Verlag, Berlin.
- . 1976. Maintenance of quality in fish eggs and larvae collected during plankton hauls, p. 313-318. *In: Zooplankton fixation and preservation.* H. F. Steedman (ed.), Unesco Press, Paris.
- , AND O. P. BALL. 1954. Description of eggs and larvae of jack mackerel (*Trachurus symmetricus*) and distribution and abundance of larvae in 1950 and 1951. *Fish. Bull. U.S.* 56:209-245.
- , J. L. BUTLER AND B. Y. SUMIDA. 1976. Pelagic stromateoid fishes (Pisces, Perciformes) of the eastern Pacific: kinds, distributions and early life histories and observations on five of these from the northwest Atlantic. *Bull. Mar. Sci.* 26:285-402.
- , AND R. C. COUNTS. 1955. Eggs and larvae of the Pacific hake *Merluccius productus*. *Fish. Bull. U.S.* 56:295-329.
- , AND ———. 1958. Development and distribution of *Vinciguerrria lucetia* and related species in the eastern Pacific. *U.S. Fish Wildl. Serv. Fish. Bull.* 58:363-416.
- , AND H. G. MOSER. 1969. A new gonostomatid fish from the tropical eastern Pacific. *Copeia* 1969:493-500.
- , AND ———. 1975. Distributional atlas of fish larvae in the California Current region: Flatfishes, 1955 through 1960. *Calif. Coop. Oceanic Fish. Invest. Atlas* 23.
- , AND ———. 1976. Eggs and larvae of fishes and their role in systematic investigations and in fisheries. *Rev. Trav. Inst. Peches Marit.* 40:379-398.

- , AND ———. 1980. Characters useful in identification of pelagic marine fish eggs. Calif. Coop. Oceanic Fish. Invest. Rep. 21:121-131.
- , AND ———. 1981. Systematics and development of early life history stages of marine fishes: achievements during the past century, present status and suggestions for the future. Rapp. P. V. Reun. Cons. Int. Explor. Mer 178:541-546.
- , AND M. J. O'TOOLE. 1976. Development and distribution of larvae and early juveniles of the commercial lanternfish, *Lampanyctodes hectoris* (Günther), off the west coast of southern Africa with a discussion of phylogenetic relationships of the genus. Bull. South. Calif. Acad. Sci. 75:138-152.
- , AND E. G. STEVENS. 1977. Report of neuston (surface) collections made on an extended CALCOFI cruise during May 1972. Calif. Coop. Oceanic Fish. Invest. Rep. 18:167-180.
- , AND B. Y. SUMIDA. MS. Early life history of eastern Pacific carangids. NMFS, La Jolla, CA 92038.
- AKATSU, S., Y. OGASAWARA AND F. YASUDA. 1977. Spawning behavior and development of eggs and larvae of the striped fingerfish, *Monodactylus sebae*. Jpn. J. Ichthyol. 23:208-214.
- AKAZAKI, M., H. NAKAJIMA, H. KAWAHARA AND S. TAKAMATSU. 1976. Embryonic development and metamorphosis after hatching in the sharksucker, *Echeneis naucrates*. Jpn. J. Ichthyol. 23:153-159. (In Japanese, English abstract.)
- AKIHITO, P. 1963. On the scapula of gobiid fishes. Jpn. J. Ichthyol. 11:1-26.
- . 1967. Additional research on the scapula of gobiid fishes. Jpn. J. Ichthyol. 14:167-182.
- . 1969. A systematic examination of the gobiid fishes based on the mesopterygoid, postcleithra, branchiostegals, pelvic fins, scapula, and suborbital. Jpn. J. Ichthyol. 16:93-114.
- , AND K. MEGURO. 1981. A gobiid fish belonging to the genus *Heteroleotris* collected in Japan. Jpn. J. Ichthyol. 28:329-339.
- ALCOCK, A. 1889. Natural history notes from H. M. Indian Marine Survey Steamer 'Investigator,' Commander Alfred Carpenter, R.N., D.S.O., Commanding. —No. 13. On the bathyhal fishes of the Bay of Bengal and neighbouring waters, obtained during the seasons 1885-1889. Ann. Mag. Nat. Hist., Ser. 6, 4:450-461.
- ALDERDICE, D. F., AND C. R. FORRESTER. 1971. Effects of salinity and temperature on embryonic development of petrale sole (*Eopsetta jordani*). J. Fish. Res. Board Can. 28:727-744.
- ALEXANDER, E. C. 1961. A contribution to the life history, biology and geographical distribution of the bonefish, *Albula vulpes* (Linnaeus). Dana-Rep. Carlsberg Found. 53.
- ALLEN, G. H. 1968. Fecundity of the brown ragfish, *Icosteus acugnaticus* Lockington, from northern California. Calif. Fish Game 54:207-214.
- ALLEN, G. R. 1972. The anemonefishes. Their classification and biology. T.F.H. Publications, Inc., Neptune City, NJ.
- . 1975a. Damsel-fishes of the south seas. T.F.H. Publ., Inc., Neptune City, NJ.
- . 1975b. The biology and taxonomy of the cardinalfish *Sphaeramia orbicularis* (Pisces: Apogonidae). J. R. Soc. West. Aust. 58(3): 86-92.
- . 1980. A generic classification of the rainbowfishes (family Melanotaeniidae). Rec. West. Aust. Mus. 8:449-490.
- . 1981. Polynemidae. In: FAO species identification sheets. Eastern Central Atlantic, Fishing Areas 34, 37. W. Fischer and W. B. Scott (eds.). FAO, Rome.
- , AND H. J. CROSS. 1980. Descriptions of five new rainbowfishes (Melanotaeniidae) from New Guinea. Rec. West. Aust. Mus. 8: 377-396.
- , AND R. H. KUITER. 1976. A review of the plesiopid fish genus *Assesor*, with descriptions of two new species. Rec. West. Aust. Mus. 4(3):201-215.
- ALLEN, J. M., J. H. S. BLAXTER AND E. J. DENTON. 1976. The functional anatomy and development of the swimbladder—inner ear—lateral line system in herring and sprat. J. Mar. Biol. Assoc. U.K. 56:471-486.
- ALLEN, L. G. 1979. Larval development of *Gobiesox rhessodon* (Gobiesocidae) with notes on the larva of *Rimicola muscarum*. Fish. Bull. U.S. 77:300-304.
- , AND J. M. ILG. 1983. Larval development of the northern clingfish, *Gobiesox macandricus*. Copeia 1983:551-554.
- ALTUKHOV, K. A. 1978. On the reproduction and abundance of the lesser sand lance, *Ammodytes marinus*, in the White Sea. J. Ichthyol. (Engl. Transl. Vopr. Ikhtiol.) 18:560-567.
- . 1979. A contribution to the biology of non-commercial and rare fish species from the White Sea in the early stages of development. J. Ichthyol. (Engl. Transl. Vopr. Ikhtiol.) 19(6):105-115.
- ALVAREZ-LAJONCHERE, L. L. 1975. Estudio sistemático de *Mugil brasiliensis*, *Mugil gaimardianus*, y *Mugil curema*. Cienc. Ser. 8 Invest. Mar. (Havana) No. 14:1-18.
- AMAOKA, K. 1964. Development and growth of the sinistral flounder, *Bothus myriaster* (Temminck and Schlegel) found in the Indian and Pacific Oceans. Bull. Misaki Mar. Biol. Inst. Kyoto Univ. 5:11-29.
- . 1969. Studies on the sinistral flounders found in the waters around Japan. Taxonomy, anatomy, and phylogeny. J. Shimono-seki Univ. Fish. 18:65-340.
- . 1970. Studies on the larvae and juveniles of the sinistral flounders. I. *Taeniopsetta ocellata* (Gunther). Jpn. J. Ichthyol. 17:95-104.
- . 1971. Studies on the larvae and juveniles of the sinistral flounders. II. *Chascanopsetta lugubris*. Jpn. J. Ichthyol. 18:25-32.
- . 1972a. Studies on the larvae and juveniles of the sinistral flounders. III. *Lacops kitaharae*. Jpn. J. Ichthyol. 19:154-165.
- . 1972b. Osteology and relationships of the citharid flatfish *Brachypleura novaezeelandiae*. Jpn. J. Ichthyol. 19:263-273.
- . 1973. Studies on the larvae and juveniles of the sinistral flounders. IV. *Arnoglossus japonicus*. Jpn. J. Ichthyol. 20:145-156.
- . 1974. Studies on the larvae and juveniles of the sinistral flounders. V. *Arnoglossus tenuis*. Jpn. J. Ichthyol. 21:153-157.
- . 1976. Studies on the larvae and juveniles of the sinistral flounders. VI. *Psettina ujimae*, *P. tosana*, and *P. gigantea*. Jpn. J. Ichthyol. 22:201-206.
- . 1979. Phylogeny and larval morphology of pleuronectiform fishes. (Psettodidae, Citharidae, Paralichthyidae and Bothidae). Kaiyo Kagaku 11(2):100-110. (English transl., 1981. Edited by J. R. Dunn, Translated by A. Shiga. Natl. Mar. Fish. Serv., Northwest and Alaska Fish. Center, Seattle).
- , M. TOKOSHIMA AND T. INADA. 1977. New records of the stichaeid fish *Ascoldia variegata knipowitschi* and the zoarcid fish *Puzanovia rubra* from Japan. Jpn. J. Ichthyol. 24:91-97.
- AMBROSE, D. A., J. L. BUTLER, H. G. MOSER, B. Y. SUMIDA, E. M. SANDKNOP AND E. G. STEVENS. 1983. Description of the larvae of the cusk-eels *Ophidion scrippsae* and *Chilara taylora* (Ophidiidae). Calif. Coop. Oceanic Fish. Invest. Rep. 24:226-234.
- ANDERSEN, N. C. 1984. Genera and subfamilies of the family Nototheniidae (Pisces, Perciformes) from the antarctic and subantarctic. Steenstrupia 10:1-34.
- , AND J. C. HUREAU. 1979. Proposition pour une nouvelle classification des Nototheniinae (Pisces, Perciformes, Nototheniidae). Cymbium, 3rd Ser., 3(6):47-53.
- ANDERSON, M. E. 1981. Aspects of the natural history of the midwater fish *Lycodapus mandibularis* (Zoarcidae) in Monterey Bay, California. Pac. Sci. 34:181-194.
- . 1982. Revision of the fish genera *Gymnelus* Reinhardt and *Gymnelopsis* Soldatov (Zoarcidae), with two new species and comparative osteology of *Gymnelus viridis*. Natl. Mus. Nat. Sci. (Ottawa) Publ. Zool. 17:1-76.
- . 1984. On the anatomy and phylogeny of Zoarcidae (Teleostei: Perciformes). Unpubl. PhD dissertation. Coll. William and Mary, Williamsburg, VA.
- , AND G. M. CAILLIET. 1974. Crab and snailfish commensalism in Monterey Bay. Underwater Nat. 8(3):29-31.
- , AND C. L. HUBBS. 1981. Redescription and osteology of the northeastern Pacific fish *Derepodichthys alepidotus* (Zoarcidae). Copeia 1981:341-352.

- ANDERSON, W. D., JR., AND P. C. HEEMSTRA. 1980. Two new species of western Atlantic *Anthias* (Pisces: Serranidae), redescription of *A. asperlingus* and review of *Iolanthias martinicensis*. *Copeia* 1980:72-87.
- ANDERSON, W. W. 1957. Early development, spawning, growth, and occurrence of the silver mullet (*Mugil curema*) along the south Atlantic coast of the United States. *Fish. Bull. U.S.* 57:397-414.
- , J. W. GEHRINGER AND F. H. BERRY. 1966. Family Synodontidae, p. 30-102. *In: Fishes of the western North Atlantic*. G. W. Mead (ed.). Mem. Sears Found. Mar. Res. No. 1 (Pt. 5).
- ANDERTON, T. 1907. Observations on New Zealand fishes, etc., made at the Portobello marine fish-hatchery. *Trans. NZ Inst.* 39:477-496.
- ANDREW, W. 1959. Textbook of comparative histology. Oxford Univ. Press, New York.
- ANDRIASHEV, A. P. 1938. Review of the genus *Krusensterniella* Schmidt (Pisces, Zoarcidae), with description of a new species from the Japan Sea. *Bull. Far East. Br. Acad. Sci. USSR* 32:117-121.
- . 1952. A new fish of the eelpout family (Pisces, Zoarcidae) from the Bering Sea. *Zool. Inst. Acad. Nauk SSSR* 12:415-417.
- . 1954. Fishes of the northern seas of the USSR. *Tr. Zool. Inst. Akad. Nauk SSSR*, No. 53. (In Russian, translated by Isr. Program for Sci. Transl., Jerusalem, 1964. Available from NTIS, Springfield, VA; OTS 63-11160.
- . 1955a. A fish new to the fauna of the USSR—*Eritelepis* [*Eritelepis zonifer* (Lock.) Pisces, Anoplopomidae] from the Kamchatkan waters of the Pacific Ocean. *Vopr. Ikhtiol.* 4:3-9.
- . 1955b. Observations on the eel-like likods (*Lycenchelys* Gill (Pisces, Zoarcidae) and related forms) in the seas of the USSR and adjacent waters. *Tr. Zool. Inst. Acad. Nauk SSSR* 18:349-384.
- . 1959. On the number of vertebrae and certain other osteological characters of Antarctic fishes. *Vopr. Ikhtiol.* 12:3-7. (In Russian.)
- . 1960. Families of fishes new to the Antarctic. *Communiqué 3. Pelagic young of flatfish (Pisces, Bothidae) off the Antarctic coast.* *Zool. Zh.* 39:1056-1061.
- . 1962. Bathypelagic fishes of the Antarctic. 1. Family Myctophidae. *Akad. Nauk SSSR Issled. Fauny Morei* 1(9):216-294. (In Russian; *Bur. Comm. Fish. Ichthyol. Lab. Transl.* 29.)
- . 1965. A general review of the Antarctic fish fauna. *Monogr. Biol.* 15:491-550.
- . 1975. A new ultra-abysal fish, *Notoliparis kurchatovi* gen. et sp. n. (Liparidae) from the South Orkney Trench (Antarctica). *Tr. Inst. Okeanol. Akad. Nauk SSSR* 103:313-319.
- , AND A. V. NEELOV. 1976. *Genuliparis lindbergi*, gen. et sp. n.—a new fish of the family of sea snails (Liparidae) from the bathyal depths of Antarctica, p. 68-77. *In: Zoogeography and systematics of fishes*. V. M. Korovina (ed.). *Zool. Inst. Acad. Sci. USSR, Leningrad.*
- , AND V. P. PRIRODINA. 1977. On methods of study of the morphology and systematics of the fish family of sea snails (Liparidae). *Zool. Zh.* 50:141-147.
- AOYAMA, T. 1959. On the egg and larval stages of *Liparis tanakae* (Gilbert and Burke). *Bull. Seikai Reg. Fish. Res. Lab.* 18:69-73.
- , AND N. SOTOGAKI. 1955. On the development of the egg of *Nemipterus virgatus* (Houttuyn). *Jpn. J. Ichthyol.* 6:130-132.
- APRIETO, V. L. 1974. Early development of five carangid fishes of the Gulf of Mexico and the south Atlantic coast of the United States. *Fish. Bull. U.S.* 72:415-443.
- APSANGIKAR, D. K. 1953. The systematic position of *Stromateus niger*. *J. Univ. Bombay, N.S.* 21B(5):41-50.
- APSTEIN, C. 1909. Die Bestimmung des Alters pelagisch lebender See-fischeier. *Mitt. Dtsch. Seefischereiver* 25:364-373.
- ARATA, G. F., JR. 1954. A contribution to the life history of the swordfish, *Xiphias gladius* Linnaeus, from the South Atlantic coast of the United States and the Gulf of Mexico. *Bull. Mar. Sci. Gulf Caribb.* 4:183-243.
- ARBAULT, S., AND N. BOUTIN. 1968a. Ichthyoplankton. Oeufs et larves de poissons téléostéens dans le golfe de Gascogne en 1964. *Rev. Trav. Inst. Peches Marit.* 32:413-476.
- , AND ———. 1968b. Ichthyoplankton. Oeufs et larves de poissons téléostéens dans le Golfe Gascogne en 1964. *Rev. Trav. Inst. Peches Marit.* 32:477-506.
- , AND ———. 1968c. Ichthyoplankton. Oeufs et larves de poissons téléostéens dans le Golfe de Gascogne en 1965-1966 (Oeufs et larves). *Rev. Trav. Inst. Peches Marit.* 33:181-202.
- ARMSTRONG, P. B. 1962. Stages in the development of *Ictalurus nebulosus*. Syracuse University Press, Syracuse, New York.
- , AND J. S. CHILD. 1965. Stages in the normal development of *Fundulus heteroclitus*. *Biol. Bull. (Woods Hole)* 128(2):143-168.
- ARNOLD, D. C. 1956. A systematic revision of the teleost family Carapidae (Percomorphi, Blennioidea), with descriptions of two new species. *Bull. Brit. Mus. (Nat. Hist.) Zool.* 4:245-307.
- ARONOVICH, T. M., S. I. DOROSHEV, L. V. SPECTOROVA AND V. M. MAKHOTIN. 1975. Egg incubation and larval rearing of navaga (*Eleginus navaga* Pall) polar cod (*Boreogadus saida* Lepechin) and arctic flounder (*Liopsetta glacialis* Poll.) in the laboratory. *Aquaculture* 6:233-242.
- ASANO, H. 1962. Studies on the congrid eels of Japan. *Bull. Misaki Mar. Biol. Inst. Kyoto Univ.* 1:1-143.
- ASTAKHOV, D. A. 1980. Cranial lateral-line canals of the beloniform fishes (Beloniformes, Osteichthyes). *Tr. Inst. Okeanol. Akad. Nauk SSSR* 97:174-211. (In Russian, English abstract.)
- AUER, N. A. (ED.). 1982. Identification of larval fishes of the Great Lake Basin with emphasis on the Lake Michigan Drainage. *Great Lakes Fish. Comm. Spec. Publ.* 82-3.
- AUIEN, M., AND F. BONHOMME. 1980. Éléments de systématique biochimique chez les Mugilides de Méditerranée. *Biochim. Syst. Ecol.* 8(3):305-308.
- AZUMA, H. 1975. Spawning the red-bellied piranha, *Serrasalmus nattereri*. *Trop. Fish Hobby.* 23(11):4-6, 8-12, 14-15, 96-97.
- . 1982. Spawning silver. *Trop. Fish Hobby.* 30(7):70-73.
- BACKHOUSE, G. N., AND R. W. VANNER. 1978. Observations on the biology of the dwarf galaxiid *Galaxiella pusilla* (Mack) (Pisces: Galaxiidae). *Victorian Nat.* 95:128-132.
- BACKUS, R. H., J. E. CRADDOCK, R. L. HAEDRICH AND B. H. ROBISON. 1977. Atlantic mesopelagic zoogeography, p. 266-287. *In: Fishes of the western North Atlantic*. R. H. Gibbs, Jr. (ed.). Mem. Sears Found. Mar. Res. No. 1 (Pt. 7).
- , G. W. MEAD, R. L. HAEDRICH AND A. W. EBELING. 1965. The mesopelagic fishes collected during Cruise 17 of the R/V Chain, with a method for analyzing faunal transects. *Bull. Mus. Comp. Zool.* 134:139-157.
- BADCOCK, J. R. 1982. A new species of the deep-sea fish genus *Cyathothone* Goode and Bean (Stomiatoidei, Gonostomatidae) from the tropical Atlantic. *J. Fish Biol.* 20:197-211.
- , AND N. R. MERRETT. 1972. On *Argyripnus atlanticus*, Maul 1952 (Pisces, Stomiatoidei), with a description of post-larval forms. *J. Fish Biol.* 4:277-287.
- , AND ———. 1976. Midwater fishes in the eastern North Atlantic. I. Vertical distribution and associated biology in 30°N, 23°W, with developmental notes on certain myctophids. *Prog. Oceanogr.* 7:3-58.
- BAGARINAO, T., AND J. R. HUNTER. 1983. The visual feeding threshold and action spectrum of northern anchovy (*Engraulis mordax* G.) larvae. *Calif. Coop. Oceanic Fish. Invest. Rep.* 24:245-254.
- BAILEY, C. F. 1973. Lipids of the fertilized egg and adult brain of *Fundulus heteroclitus*. *J. Exp. Zool.* 185:265-276.
- BAILEY, K. M. 1982. The early life history of the Pacific hake *Merluccius productus*. *Fish. Bull. U.S.* 80:589-598.
- , AND R. S. BATTY. 1983. A laboratory study of predation by *Aurelia aurita* on larval herring (*Clupea harengus*). Experimental observations compared with model predictions. *Mar. Biol.* 72:295-301.
- BAILEY, R. G. 1972. Observations on the biology of *Nothobranchius guentheri* (Pfeffer) (Cyprinodontidae), an annual fish from the coastal region of East Africa. *Afr. J. Trop. Hydrobiol. Fish.* 2:33-47.
- BAINBRIDGE, V. 1961. The early life history of the bonga *Ethmalosa dorsalis* (Cuvier and Valenciennes). *J. Cons. Int. Explor. Mer* 26:347-353.

- . 1962. The larvae of *Pellonula vorax* Gunther (Clupeidae) in Sierra Leone coastal waters. *Bull. Inst. Fr. Afr. Noire, Ser. A* 24: 262-269.
- BAIRD, R. C. 1971. The systematics, distribution, and zoogeography of the marine hachetfishes (Family Sternoptychidae). *Bull. Mus. Comp. Zool.* 142:1-128.
- , D. F. WILSON, R. C. BECKETT AND T. L. HOPKINS. 1974. *Dia-
phus taaningi* Norman, the principal component of a shallow sound-
scattering layer in the Cariaco Trench, Venezuela. *J. Mar. Res.* 32:
301-312.
- , AND D. M. MILLIKEN. 1973. Observations on *Breg-
maceros nectabanus* Whitley in the anoxic, sulfurous waters of the
Cariaco Trench. *Deep-Sea Res.* 20:503-504.
- BAKER, A. N. 1973. Spawning and development of the New Zealand
sprat *Sprattus antipodum*. *Zool. Publ. Victoria Univ. Wellington*
62:1-12.
- BALAKRISHNAN, K. P. 1961. Fish eggs and larvae collected by the
research vessel "Conch" during 1957-61. I. Larvae of *Cynoglossus*
semifasciatus Day. *Bull. Cent. Res. Inst. Univ. Kerala India Ser. C*
Nat. Sci. 8:131-139.
- . 1963. Fish eggs and larvae collected by the research vessel
"Conch": I. Larvae of *Arnoglossus tapaeinosoma* Blkr., *Bothus*
ocellatus Agassiz, *Laeops guentheri* Alc., *Solea ovata* Rich., and
Cynoglossus monopus Blkr. *Bull. Dep. Mar. Biol. Oceanogr. Univ.*
Kerala 1:81-96.
- , AND C. B. L. DEVI. 1974. Larvae of some flat fishes from a
tropical estuary, p. 677-684. *In: The early life history of fish.* J. H.
S. Blaxter (ed.). Springer-Verlag, New York.
- BALBONTIN, F., I. CAMPODONICO AND L. GUZMAN. 1979. Descripción
de huevos y larvas de especies de *Careproctus* comensales de *Par-
alomis granulosa* y *Lithodes antarctica*. *An. Inst. Patagonia* 10:235-
243.
- , AND R. PEREZ. 1980. Descripción de los estados larvales de
Normanichthys crockeri Clark (Perciformes: Normanichthyidae) del
área de Valparaíso. *Rev. Biol. Mar.* 17(1):81-95.
- BALLARD, J. 1970. Aquarium briefs. *Bull. S. Afr. Assoc. Mar. Biol.*
Res. 8:31-34.
- BALON, E. K. 1956. Development of the huchen [*Hucho hucho* (L.)]
during the period of exogenous feeding after hatching. *Pol'nohospodarstvo*
3:433-455. (In Slovak.)
- . 1959. Die Entwicklung der Texas-Cichlide (*Herichthys cya-
noguttatus* Baird et Girard) nach dem Schlüpfen. *Zool. Anz.* 162
(11-12):339-355.
- . 1975a. Reproductive guilds of fishes: a proposal and defini-
tion. *J. Fish. Res. Board Can.* 32:821-864.
- . 1975b. Terminology of intervals in fish development. *J. Fish.*
Res. Board Can. 32:1663-1670.
- . 1977. Early ontogeny of *Labeotropheus* Ahl, 1927 (Mbuna,
Cichlidae, Lake Malawi), with a discussion on advanced protective
styles in fish reproduction and development. *Environ. Biol. Fishes*
2:147-176.
- (ED.). 1980. Charrs: salmonid fishes of the genus *Salvelinus*.
Perspectives in vertebrate science 1. Dr. W. Junk, The Hague.
- . 1981a. Additions and amendments to the classification of
reproductive styles in fishes. *Environ. Biol. Fishes* 6:377-389.
- . 1981b. Saltatory processes and altricial to precocial forms in
the ontogeny of fishes. *Am. Zool.* 21:573-596.
- BANARESÇU, P. 1964. Pisces. Osteichthyes. *Fauna Repub. Pop. Rom.*
(Bucuresti) 13.
- BANISTER, K. E. 1967. The anatomy and classification of the order
Gasterosteiformes (Pisces). Unpubl. PhD dissertation. Univ. New-
castle upon Tyne.
- BAPAT, S. V. 1955. A preliminary study of the pelagic fish eggs and
larvae of the Gulf of Mannar and the Palk Bay. *Indian J. Fish.*
2:231-255.
- , AND R. R. PRASAD. 1952. On some developmental stages of
Caranx kalla Cuv. & Val. *J. Bombay Nat. Hist. Soc.* 51:111-115.
- BARACLOUGH, W. E. 1964. Contribution of the marine life history of
Thaleichthys pacificus. *J. Fish. Res. Board Can.* 21:1333-1337.
- BARANS, C. A., AND A. C. BARANS. 1972. Eggs and early larval stages
of the spotted hake, *Urophycis regius*. *Copeia* 1972:188-190.
- BARHAM, E. G. 1966. An unusual pelagic flatfish observed and pho-
tographed from a diving saucer. *Copeia* 1966:865-867.
- BARKMAN, R. C. 1978. The use of otolith growth rings to age young
Atlantic silversides. *Menidia menidia*. *Trans. Am. Fish. Soc.* 107:
790-792.
- BARNARD, K. H. 1926. The eggs of the pilot-fish (*Naucrates ductor*).
Nature (Lond.) 118:228.
- . 1927. A monograph of the marine fishes of South Africa. Part
II. *Ann. S. Afr. Mus.* 21:419-1065.
- BARNHART, P. S. 1927. Pelagic fish eggs of La Jolla, California. *Bull.*
Scripps Inst. Oceanogr. Univ. Calif. 1:91-92.
- . 1932. Notes on the habits, eggs, and young of some fishes of
southern California. *Bull. Scripps Inst. Oceanogr. Univ. Calif.* 3(4):
87-99.
- BARRINGTON, E. J. W. 1937. The structure and development of the
tail in the plaice (*Pleuronectes platessa*) and the cod (*Gadus mor-
rhua*). *Q. J. Microsc. Sci.* 79:447-469.
- BARSUKOV, V. V. 1959. The wolfish (Anarhichadidae). *Fauna SSSR*
Moscow N.S. 73. (Transl. by Smithson. Inst., 1972. Available from:
NTIS, Springfield, VA.; TT 67-59074.)
- . 1973. The species composition of the genus *Helicolenus* (Se-
bastinae, Scorpaenidae: Pisces) and a description of a new species.
J. Ichthyol. (Engl. Transl. Vopr. Ikhtiol.) 13:161-167.
- . 1981. A brief review of the subfamily Sebastinae. *J. Ichthyol.*
(Engl. Transl. Vopr. Ikhtiol.) 21(1):1-26.
- BARTLETT, M. R. AND R. L. HAEDRICH. 1966. Techniques in the
radiography of fishes. *Trans. Am. Fish. Soc.* 95:99-101.
- BASSOT, J.-M. 1966. On the comparative morphology of some lu-
minous organs, p. 557-610. *In: Bioluminescence in Progress.* F.
Johnson and Y. Haneda (eds.). Princeton Univ. Press, Princeton,
N.J.
- . 1971. Structure and evolution of the light organs of the sto-
miatoidei (Abstract), p. 253-254. *In: The ocean world.* M. Uda
(ed.). Proc. Joint Oceanogr. Assembly.
- BATH, H. 1973. Wiederbeschreibung und neuer Nachweis von *Tripte-
rygion melanurus* (Guichenot) (Pisces: Blennioidea: Tripterygi-
idae). *Senckenb. Biol.* 54:47-56.
- . 1976. Revision der Blenniini (Pisces: Blenniidae). *Senckenb.*
Biol. 57:167-234.
- . 1978. Ergänzungen zur Revision der Blenniini mit zwei neun
Gattungen (Pisces: Blenniidae). *Senckenb. Biol.* 59:183-190.
- BAUCHOT, M. L. 1959. Étude des larves leptocéphales du group *Lep-
tocephalus lanceolatus* Stromman et identification à la famille des
Serrivomeridae. *Dana-Rep. Carlsberg Found.* 48:1-148.
- BAUGH, T. M. 1980. Spawning and hatching the Olympic mudminnow
(*Novumbra hubbsi*) in aquaria. *J. Aquaric.* 1(3):63-64.
- BAXTER, J. L. 1960. A study of the yellowtail *Seriola dorsalis* (Gill).
Calif. Dep. Fish Game Fish Bull. 110.
- BECK, A. D., D. A. BENGTON AND W. H. HOWELL. 1980. International
study on *Artemia*. V. Nutritional value of five geographical strains
of *Artemia*: effects on survival and growth of larval Atlantic sil-
verside, *Menidia menidia*, p. 249-259. *In: The brine shrimp Ar-
temia.* Vol. 3. Ecology, culturing, use in aquaculture. G. Persoone,
P. Sorgeloos, O. Roels and E. Jaspers (eds.). Universa Press, Wet-
teren, Belgium.
- BEEBE, W. 1932. Nineteen new species and four post-larval deepsea
fish. *Zoologica (N.Y.)* 13:47-107.
- . 1933a. Deep-sea fishes of the Bermuda Oceanographic Ex-
peditions. No. 2. Family Alepocephalidae. *Zoologica (N.Y.)* 16(2):
15-93.
- . 1933b. Deep-sea fishes of the Bermuda Oceanographic Ex-
peditions. No. 3. Family Argentinidae. *Zoologica (N.Y.)* 16(3):97-
147.
- . 1934. Deep-sea fishes of the Bermuda Oceanographic Ex-
peditions. Family Idiacephalidae. *Zoologica (N.Y.)* 16(4):149-241.
- , AND J. CRANE. 1939. Deep-sea fishes of the Bermuda Ocean-
ographic Expeditions. Family Melanostomiidae. *Zoologica (N.Y.)*
24(2):65-238.

- BEHNKE, R. J. 1968. A new subgenus and species of trout, *Salmo (Platysalmo) platycephalus*, from southcentral Turkey, with comments on the classification of the subfamily salmoninae. *Mitt. Hamb. Zool. Mus. Inst.* 66.
- BEKKER, V. E. 1963. Taxonomy and distribution of *Tarletonbeania* (Myctophidae, Pisces). *Tr. Inst. Okeanol. Akad. Nauk SSSR* 62: 145-163. (In Russian.)
- . 1964. Slendertailed myctophids (genera *Loweina*, *Tarletonbeania*, *Gonichthys* and *Centrobranchus*) of the Pacific and Indian Oceans, systematics and distribution. *Tr. Inst. Okeanol. Akad. Nauk SSSR* 73:11-75 (In Russian.)
- . 1965. Lanternfishes of the genus *Hygophum* (Myctophidae, Pisces), systematics and distribution. *Tr. Inst. Okeanol. Akad. Nauk SSSR* 80:62-103. (In Russian; *Bur. Comm. Fish. Ichthyol. Lab. Transl.* 45.)
- . 1967. The lanternfishes (Myctophidae) from the "Peter Lebedev" Atlantic Expeditions 1961-1964. *Tr. Inst. Okeanol. Akad. Nauk SSSR* 84:84-124. (In Russian.)
- , AND O. D. BORODULINA. 1968. Lanternfishes of the genus *Ceratoscopelus* Gunther, systematics and distribution. *Vopr. Ikhtiol.* 8(5):779-798. (In Russian.)
- , AND ———. 1978. "Myctophum asperum" species-group with description of a new species, and *Myctophum selenops* Tåning (Myctophidae, Osteichthys), taxonomy and distribution. *Tr. Inst. Okeanol. Akad. Nauk SSSR* 111:108-128. (In Russian.)
- BELANGER, L. F. 1973. The skeletal tissues, p. 175-215. *In: Histology*. R. O. Greep and L. Weiss (eds.), McGraw Hill, New York.
- BELL, M. A. 1976. Evolution of phenotypic diversity in *Gasterosteus aculeatus* superspecies on the Pacific Coast of North America. *Syst. Zool.* 25:211-227.
- BELMAN, B. W., AND M. E. ANDERSON. 1979. Aquarium observations on feeding by *Melanostigma pammelas* (Pisces, Zoarcidae). *Copeia* 1979:365-369.
- BELYANINA, T. N. 1974. Materials on the development, systematics and distribution of fish of the family Bregmacerotidae. *Tr. Inst. Okeanol. Akad. Nauk. SSSR* 96:143-188.
- . 1977. Materials on development of *Chauliodus* fishes (Chauliodontidae, Pisces). *Tr. Inst. Okeanol. Akad. Nauk. SSSR* 109: 113-132.
- . 1980. Codlets (Bregmacerotidae, Osteichthyes) of the Caribbean Sea and the Gulf of Mexico. *J. Ichthyol. (Engl. Transl. Vopr. Ikhtiol.)* 20(1):138-141.
- . 1981. The larvae of some rare mesopelagic fishes from the Caribbean and the Gulf of Mexico. *J. Ichthyol. (Engl. Transl. Vopr. Ikhtiol.)* 21(1):82-95.
- . 1982a. Larvae of the family Scopelarchidae (collections of the Institute of Oceanology Academy of Sciences of USSR). *Tr. Inst. Okeanol. Akad. Nauk SSSR*. 118:133-150. (In Russian.)
- . 1982b. Larvae of the midwater fishes in the western tropical Pacific Ocean and the seas of the Indo-Australian Archipelago. *Tr. Inst. Okeanol. Akad. Nauk SSSR* 118:5-42.
- , AND N. V. KOVALEVSKAYA. 1979. Materials of development and distribution of myctophid larvae (Family Myctophidae) of the sub-antarctic waters of the Australian-New Zealand waters. *Tr. Inst. Okeanol. Akad. Nauk SSSR* 106:69-96.
- , AND G. R. LOPES. 1974. The occurrence of *Bregmaceros nectabanus* (Pisces, Bregmacerotidae) in the Caribbean Sea. *J. Ichthyol. (Engl. Transl. Vopr. Ikhtiol.)* 14:447-449.
- BENNETT, H. S., A. D. WYRICK, S. W. LEE AND J. H. MCNEIL. 1976. Science and art in preparing tissue embedded in plastic for light microscopy, with special reference to glycol methacrylate, glass knives and simple stains. *Stain Technol.* 51:71-97.
- BENSAM, P. 1967. The embryonic and early larval development of the long-finned herring, *Opisthopterus tardoore* (Cuvier). *J. Mar. Biol. Assoc. India* 9:76-83.
- . 1970. Notes on the eggs, larvae and juveniles of the Indian Sprat, *Sardinella jussieu* (Lacepede). *Indian J. Fish.* 13:219-231.
- BEN-TUVIA, A. 1975. Mugilid fishes of the Red Sea with a key to the Mediterranean and Red Sea species. *Bamidgeh* 27(1):14-20.
- BENZIE, V. 1968a. Stages in the normal development of *Galaxias maculatus attenuatus* (Jenyns). *N.Z. J. Mar. Freshwater Res.* 2:606-627.
- . 1968b. The life history of *Galaxias vulgaris* Stokell, with a comparison with *G. maculatus attenuatus*. *N.Z. J. Mar. Freshwater Res.* 2:628-653.
- BERG, L. S. 1940. Classification of fishes, both recent and fossil. *Tr. Zool. Inst. Akad. Nauk SSSR* 5(2). (In Russian.)
- . 1947. Classification of fishes both recent and fossil. J. W. Edwards, Ann Arbor, Michigan.
- . 1948. Freshwater fishes of the U.S.S.R. and adjacent countries. Vol. 1. *Acad. Sci. U.S.S.R. Zool. Inst., Keys to the fauna of the U.S.S.R., No. 27.* (Translated from the Russian, 1962, Israel Program for Scientific Translations.)
- BERKELEY, S. A., AND E. D. HOUDE. 1978. Biology of two exploited species of halfbeaks, *Hemiramphus brasiliensis* and *H. balao* from southeast Florida. *Bull. Mar. Sci.* 28:624-644.
- BERRA, T. M. 1982. Life history of the Australian grayling *Prototroctes maraena* (Salmoniformes: Prototroctidae) in the Tambo River, Victoria. *Copeia* 1982:795-805.
- BERRIEN, P. L., N. A. NAPLIN AND M. R. PENNINGTON. 1981. Atlantic mackerel *Scomber scombrus*, egg production and spawning population estimates for 1977 in the Gulf of Maine, Georges Bank and Middle Atlantic Bight. *Rapp. P. V. Reun. Cons. Int. Explor. Mer* 178:279-288.
- BERRY, F. H. 1958. A new species of fish from the western North Atlantic, *Dikellorhynchus tropidolepis*, and relationships of the genera *Dikellorhynchus* and *Malacanthus*. *Copeia* 1958:116-125.
- . 1959a. Boarfishes of the genus *Antigonia* of the western Atlantic. *Bull. Fla. State Mus. Biol. Sci.* 4(7):205-250.
- . 1959b. Young jack crevasses (*Caranx* species) off the southeastern Atlantic coast of the United States. *U.S. Fish Wildl. Serv. Fish. Bull.* 59:417-535.
- . 1960. Scale and scute development of the carangid fish *Caranx crysos* (Mitchell). *Q. J. Fla. Acad. Sci.* 23:59-66.
- . 1964a. Aspects of the development of the upper jaw bones in teleosts. *Copeia* 1964:375-384.
- . 1964b. Review and emendation of: Family Clupeidae. *Copeia* 1964:720-730.
- . 1969. *Elagatis bipinnulata* (Pisces: Carangidae): morphology of the fins and other characters. *Copeia* 1969:454-463.
- , AND W. W. ANDERSON. 1961. Stargazer fishes from the western North Atlantic (family Uranoscopidae). *Proc. U.S. Natl. Mus.* 112 (3448):563-586.
- , AND W. J. BALDWIN. 1966. Triggerfish (Balistidae) of the eastern Pacific. *Proc. Calif. Acad. Sci.* 34:429-474.
- , AND I. BARRETT. 1963. Gillraker analysis and speciation in the thread herring genus *Opisthonema*. *Inter-Am. Trop. Tuna Comm. Bull.* 7:112-190.
- , AND H. C. PERKINS. 1966. Survey of pelagic fishes of the California Current area. *U.S. Fish Wildl. Serv. Fish. Bull.* 65:625-682.
- , AND W. J. RICHARDS. 1973. Characters useful to the study of larval fishes. *Mid. Atl. Coast. Fish. Cent. Tech. Pap.* 1:48-65.
- , AND C. R. ROBINS. 1967. *Macristiella perlucens*, a new clupeiform fish from the Gulf of Mexico. *Copeia* 1967:46-50.
- , AND W. F. SMITH-VANIZ. 1978. Carangidae. *In: FAO species identification sheets for fisheries purposes. Western Central Atlantic, Fishing Area 31.* Vol. 1. W. Fischer (ed.). FAO, Rome.
- , AND L. E. VOGELE. 1961. Filefishes (Monacanthidae) of the western north Atlantic. *U.S. Fish Wildl. Serv. Fish. Bull.* 61:61-109.
- BERTELSEN, E. 1951. The ceratioid fishes. *Ontogeny, taxonomy, distribution and biology.* Dana-Rep. Carlsberg Found. 39.
- . 1958. The argentinoid fish *Xenopthalmichthys danae*. *Dana-Rep. Carlsberg Found.* 45.
- . 1980. Notes on Linophryniids. V. A revision of the deep-sea anglerfishes (Ceratioidae) of the *Linophryne arborifera*-group. *Steenstrupia* 6(6):29-70.

- . 1982. Notes on Linophryinae. VIII. A review of the genus *Linophryne*, with new records and descriptions of two new species. *Steenstrupia* 8(3):49-104.
- . 1983. First records of metamorphosed males of the families Diceratiidae and Centropomyidae. *Steenstrupia* 8(16):309-316.
- , G. KREFFT AND N. B. MARSHALL. 1976. The fishes of the family Notosudidae. Dana-Rep. Carlsberg Found. 86.
- , AND N. B. MARSHALL. 1956. The Mirapinnati, a new order of teleost fishes. Dana-Rep. Carlsberg Found. 42.
- , AND ———. 1958. Notes on Miripinnati (an addendum to Dana-Rep. 42). Dana-Rep. Carlsberg Found. 45:9-10.
- , AND O. MUNK. 1964. Rectal light organs in the argentinoid fishes *Opisthoproctus* and *Winteria*. Dana-Rep. Carlsberg Found. 62.
- , AND T. W. PIETSCH. 1975. Results of research cruises of FRV "Walther Herwig" to South America. XXXVIII. Osteology and relationships of the ceratioid anglerfish genus *Spinophryne* (family Oneirodidae). *Arch. Fischereiwiss.* 26(1):1-11.
- , AND R. J. LAVENBERG. 1981. Ceratioid anglerfishes of the family Gigantactinidae: morphology, systematics, and distribution. *Nat. Hist. Mus. Los Ang. Cty. Contrib. Sci.* 332.
- , AND P. J. STRUHSAKER. 1977. The ceratioid fishes of the genus *Thaumatchthys*: osteology, relationships, distribution and biology. *Galathea Rep.* 14:7-40.
- , B. THEISEN AND O. MUNK. 1965. On a post-larval specimen, anal light organ, and tubular eyes of the argentinoid fish *Rhynchohyalus natalensis* (Gilchrist and von Bonde). *Vidensk. Medd. Dan. Naturhist. Foren.* 128:357-371.
- BERTIN, L. 1937. Les poissons abyssaux du genre *Cyema* Gunther (anatomie, embryologie, bionomie). Dana-Rep. Carlsberg Found. 10:1-30.
- BERTMAR, G. 1959. On the ontogeny of the chondral skull in Characidae, with a discussion on the chondrocranial base and the visceral chondrocranium in fishes. *Acta Zool. (Stockh.)* 40:203-364.
- BERTOLINI, F. 1933a. Famiglia 1: Apogonidae, p. 306-309. *In: Uova, larve e stadi giovanili di Teleostei. Fauna Flora Golfo Napoli Monogr.* 38.
- . 1933b. Famiglia 2: Serranidae, p. 310-331. *In: Uova, larve e stadi giovanili di Teleostei. Fauna Flora Golfo Napoli Monogr.* 38.
- BEYER, J. E., AND G. C. LAURENCE. 1981. Aspects of stochasticity in modelling growth and survival of clupeoid fish larvae. *Rapp. P. V. Reun. Cons. Int. Explor. Mer* 178:17-23.
- BHARGAVA, H. N. 1958. The development of the chondrocranium of *Mastacembelus armatus* (Cuv. et Val.). *J. Morphol.* 102:401-426.
- BHIMACHAR, B. S., AND A. DAVID. 1945. On the occurrence of "external gills" in the loach—*Lepidocephalus thermalis* (C. V.). *Curr. Sci.* 14(3):74.
- BIGELOW, H. B., AND W. C. SCHROEDER. 1953. Fishes of the Gulf of Maine. U.S. Fish Wildl. Serv. Fish. Bull. 53.
- , AND ———. 1963. Family Osmeridae, p. 553-597. *In: Fishes of the western North Atlantic.* H. B. Bigelow (ed.). Mem. Sears Found. Mar. Res. No. 1 (Pt. 3).
- , AND W. W. WELSH. 1925. Fishes of the Gulf of Maine. *Bull. Bur. Fish. Wash.* 40:1-567.
- BINI, G. 1971. *Atlante dei pesci delle Coste italiane.* Vol. 3. Mondo Sommerso, Milano.
- BIRDSONG, R. S. 1975. The osteology of *Microgobius signatus* Poey (Pisces: Gobiidae), with comments on other gobiid fishes. *Bull. Fl. State Mus. Biol. Sci.* 19(3):135-187.
- BLABER, S. J., D. P. CYRUS AND A. K. WHITFIELD. 1981. The influence of zooplankton food resources on the morphology of the estuarine clupeid *Gilchristella aequiaris* (Gilchrist, 1914). *Environ. Biol. Fishes* 6:351-355.
- BLACHE, J. 1964. Sur la présence de *Luvarus imperiales* Raf. 1810 dans l'Atlantique orientale sud révélée par la découverte de deux larves au Stade Hystricinella de L. Roule (1924) (Pisces, Téléostei, Perciformi, Luvareidei, Luvariidae) Cah. ORSTOM Ser. Oceanogr. 5:57-59.
- . 1977. Leptocephales des poissons Anguilliformes dans la zone sud du Golfe de Guinée. *Faune Trop.* 20:1-381.
- BLACKBURN, J. E. 1973. A survey of the abundance and distribution of ichthyoplankton in Skagit Bay. Unpubl. MS thesis. Univ. Washington, Seattle.
- BLACKBURN, M. 1950. The Tasmanian whitebait, *Lovettia seali* (Johnston) and the whitebait fishery. *Aust. J. Mar. Freshwater Res.* 1:155-198.
- BLACKLER, R. W. 1974. Recent advances in otolith studies, p. 67-90. *In: Sea fisheries research.* F. R. Harden Jones (ed.). John Wiley & Sons, New York.
- BLAXTER, J. H. S. 1965. The feeding of herring larvae and their ecology in relation to feeding. *Calif. Coop. Oceanic Fish. Invest. Rep.* 10:78-88.
- . 1966. The effect of light intensity on the feeding ecology of herring, p. 393-409. *In: Light as an ecological factor.* R. Bainbridge, G. C. Evans and O. Rackman (eds.). Blackwell, Oxford.
- . 1968. Rearing herring larvae to metamorphosis and beyond. *J. Mar. Biol. Assoc. U.K.* 43:17-28.
- . 1969a. Development: eggs and larvae, p. 177-252. *In: Fish physiology.* Vol. 3. W. S. Hoar and D. J. Randall (eds.). Academic Press, New York.
- . 1969b. Experimental rearing of pilchard larvae, *Sardina pilchardus*. *J. Mar. Biol. Assoc. U.K.* 49:557-575.
- . 1971. Feeding and condition of Clyde herring larvae. *Rapp. P. V. Reun. Cons. Int. Explor. Mer* 160:129-136.
- , (ED.). 1974. *The early life history of fish.* Springer-Verlag, Berlin.
- . 1976. Reared and wild fish—how do they compare? Tenth Europ. Symp. Mar. Biol., Ostend, Belgium, Sept. 17-23, 1975. Vol. 1:11-26.
- , J. A. GRAY AND A. C. BEST. 1983. Structure and development of the free neuromasts and lateral line system of the herring. *J. Mar. Biol. Assoc. U.K.* 63:247-260.
- , AND G. HEMPEL. 1963. The influence of egg size on herring larvae. *J. Cons. Int. Explor. Mer* 28:211-240.
- , AND F. G. T. HOLLIDAY. 1963. The behaviour and physiology of herring and other clupeids. *Adv. Mar. Biol.* 1:261-393.
- , AND J. R. HUNTER. 1982. The biology of the clupeoid fishes. *Adv. Mar. Biol.* 20:1-223.
- , AND M. E. STAINES. 1971. Food searching potential in marine fish larvae, p. 467-485. *In: Fourth European marine biology symposium.* D. J. Crisp (ed.). University Press, Cambridge.
- BLEEKER, P. 1854-1857. Bidrage tot de kennis der Sphæraenoiden van den Indischen Archipel. *Verh. Baravi Genoot.* 26:1-22.
- . 1874. Equisse d'un système naturel des Gobioides. *Arch. Neerl. Sci.* 9:289-331.
- BLOCK, B. A. 1983. Brain heaters in the billfish. *Am. Zool.* 23(4):936. (Abstract.)
- BOCK, W. J. 1969. The concept of homology. *Ann. N.Y. Acad. Sci.* 167:71-73.
- BÖHLKE, J. E. 1957. A review of the blenny genus *Chaenopsis*, and the description of a related new genus from the Bahamas. *Proc. Acad. Nat. Sci. Phila.* 109:81-122.
- . 1960a. Comments on serranoid fishes with disjunct lateral lines, with the description of a new one from the Bahamas. *Not. Nat. (Phila.)* 330:1-11.
- . 1960b. Two new Bahaman species of the clinid fish genus *Parachanna*. *Not. Nat. (Phila.)* 337:1-8.
- . 1966. Order Lyomeri. Deep-sea gulpers, p. 603-628. *In: Fishes of the western North Atlantic.* G. W. Mead (ed.). Mem. Sears Found. Mar. Res. No. 1 (Pt. 5).
- . 1978. Muraenidae, Ophichthidae. *In: FAO species identification sheets for fishery purposes.* Western Central Atlantic, Fishing Area 31. Vol. 3. W. Fischer (ed.). FAO, Rome.
- , AND D. K. CALDWELL. 1961. On the occurrence of the dactyloscopid fish genus *Dactylagnus* in the west Atlantic. *Bull. Mar. Sci. Gulf Caribb.* 11:537-542.

- , AND C. C. G. CHAPLIN. 1968. Fishes of the Bahamas and adjacent tropical waters. Livingston Publ. Co., Wynnewood, PA.
- , AND C. R. ROBINS. 1959. Studies on fishes of the family Ophiidiidae. II. Three new species from the Bahamas. *Proc. Acad. Nat. Sci. Phila.* 111:37–52.
- , AND C. H. ROBINS. 1974. Description of a new genus and species of clinid fish from the western Caribbean, with comments on the families of the Blennioidea. *Proc. Acad. Nat. Sci. Phila.* 126(1):1–8.
- , AND D. G. SMITH. 1968. A new xenocongrid eel from the Bahamas, with notes on other species of the family. *Proc. Acad. Nat. Sci. Phila.* 120:25–43.
- , AND V. G. SPRINGER. 1961. A review of the Atlantic species of the clinid fish genus *Starksia*. *Proc. Acad. Nat. Sci. Phila.* 113(3):29–60.
- , AND ———. 1975. A new genus and species of fish (*Nemaclinus atelestos*) from the western Atlantic (Perciformes: Clinidae). *Proc. Acad. Nat. Sci. Phila.* 127(7):57–61.
- BOLIN, R. 1930. Embryonic development of the labrid fish *Oxyjulis californicus* Günther. *Copeia* 1930(4):122–128.
- . 1934. Studies on California Cottidae: an analysis of the principles of systematic ichthyology. Unpubl. PhD dissertation. Stanford Univ., Stanford, CA.
- . 1936a. Embryonic and early larval stages of the California anchovy. *Calif. Fish Game* 22:314–321.
- . 1936b. The systematic position of *Indostomus paradoxus* Prashad and Mukerji, a new fresh water fish from Burma. *J. Wash. Acad. Sci.* 26:420–423.
- . 1939a. A new stomioid fish from California. *Copeia* 1939(1):39–41.
- . 1939b. A review of the myctophid fishes of the Pacific Coast of the United States and of lower California. *Stanford Ichthyol. Bull.* 1(4):89–156.
- . 1941. Embryonic and early larval stages of the cottid fish *Orthonopias triacis* Starks and Mann. *Stanford Ichthyol. Bull.* 2(3):73–82.
- BOND, C. E., AND T. UYENO. 1981. Remarkable changes in the vertebrae of perciform fish *Scombrolabrax* with notes on its anatomy and systematics. *Jpn. J. Ichthyol.* 28:259–262.
- BONHAM, K., AND W. H. BAYLIFF. 1953. Radiography of small fishes for meristic studies. *Copeia* 1953:150–151.
- BOOTH, R. A. 1967. A description of the larval stages of the tomcod, *Microgadus tomcod*, with comments on its spawning ecology. Unpubl. PhD dissertation. Univ. Connecticut, Storrs.
- BORTONE, S. A. 1977. Osteological notes on the genus *Centropristis* (Pisces: Serranidae). *Northeast Gulf Sci.* 1:23–33.
- BOULENGER, G. A. 1902. Notes on the classification of teleostean fishes. IV. On the systematic position of the Pleuronectidae. *Ann. Mag. Nat. Hist., Ser. 7.* 10:295–304.
- . 1904. *Teleostei*. *Cambridge Nat. Hist. (Lond.)* 7:539–727.
- . 1915. *Catalogue of the freshwater fishes of Africa in the British Museum (Natural History)*. Vol. 3.
- BOWMAN, A. 1920. The eggs and larvae of the angler (*Lophius piscatorius* L.) in Scottish waters. *Sci. Invest. Fish. Board Scotl.* 2:1–42.
- BOYD, J. F., AND R. C. SIMMONDS. 1974. Continuous laboratory production of fertile *Fundulus heteroclitus* (Walbaum) eggs lacking chorionic fibrils. *J. Fish Biol.* 6:389–394.
- BOYDE, A., AND C. WOOD. 1969. Preparation of animal tissues for surface scanning electron microscopy. *J. Microsc.* 90:221.
- BRADBURY, M. G. 1967. The genera of batfishes (family Ogcocephalidae). *Copeia* 1967:399–422.
- BRANSON, B. A., AND G. A. MOORE. 1962. The lateralis components of the acoustico-lateralis system in the sunfish family Centrarchidae. *Copeia* 1962:1–108.
- BRAUER, A. 1902. Über einige von der Valdivia-Expedition gesammelte Tiefseefische und ihre Augen. *Sitzungsber. Ges. Beford. Naturwiss. Marburg* (1901) nr. 8:115–130.
- . 1906. Die Tiefsee-Fische. I. Systematischer Teil. *Wiss. Ergebn. Dtsch. Tiefsee-Exped. Valdivia* 15(1).
- . 1908. Die Tiefsee-Fische. II. Anatomischer Teil. *Wiss. Ergebn. Dtsch. Tiefsee-Exped. Valdivia* 15(2).
- BRAY, D. 1983. A revision of the family Zeidae. Unpubl. MSc thesis. Australia. (Complete reference not available.)
- BREder, C. M., JR. 1923. Some embryonic and larval stages of the winter flounder. *Bull. Bur. Fish. Wash.* 38:311–315.
- . 1927. Scientific results of the first oceanographic expedition of the "Pawnee" 1925. *Fishes. Bull. Bingham Oceanogr. Collect. Yale Univ.* 1(1):1–90.
- . 1932. On the habits and development of certain Atlantic Synentognathi. *Carnegie Inst. Wash. Publ.* 435, Pap. Tortugas Lab. 28(1):1–35.
- . 1938. A contribution to the life histories of Atlantic flying fishes. *Bull. Bingham Oceanogr. Collect. Yale Univ.* 6(5):1–121.
- . 1939. On the life history and development of the sponge blenny, *Paraclinus marmoratus* (Steindachner). *Zoologica (N.Y.)* 24:487–496.
- . 1941. On the reproductive behavior of the sponge blenny, *Paraclinus marmoratus* (Steindachner). *Zoologica (N.Y.)* 26:233–236.
- . 1944. Materials for study of the life history of *Tarpon atlanticus*. *Zoologica (N.Y.)* 29:217–252.
- . 1959. Observations on the spawning behavior and egg development of *Strongylura notata* (Poey). *Zoologica (N.Y.)* 44:141–147.
- . 1962. On the significance of transparency in osteichthid fish eggs and larvae. *Copeia* 1962:561–567.
- , AND E. CLARK. 1947. A contribution to the visceral anatomy, development, and relationships of the Plectognathi. *Bull. Am. Mus. Nat. Hist.* 88:287–320.
- , AND P. RASQUIN. 1952. The sloughing of the melanic area of the dorsal fin, an ontogenic process in *Tylosurus raphidoma*. *Bull. Am. Mus. Nat. Hist.* 99(1):1–24.
- , AND ———. 1954. The nature of post-larval transformation in *Tylosurus acus* (Lacepede). *Zoologica (N.Y.)* 39:17–30.
- , AND D. E. ROSEN. 1966. *Modes of reproduction in fishes*. T. F. H. Publ., Inc., Neptune City, New Jersey.
- BREMBACH, M. 1976. Anatomische Beiträge zur Systematik lebendgebärender Halbschnabler (Hemirhamphidae, Pisces). *Z. Zool. Syst. Evolutionsforsch.* 14(3):169–177.
- BRIGGS, J. C. 1952. Systematic notes on the oceanic fishes of the genus *Lophotus*. *Copeia* 1952:206–207.
- . 1955. A monograph of the clingfishes (order Xenopterygii). *Stanford Ichthyol. Bull.* 6:1–224.
- BRILL, J. 1981. *Crenichthys baileyi* (Gilbert, 1983). *J. Am. Killifish Assoc.* 14(5):172–184.
- BRINLEY, F. J. 1939. Spawning habits and development of beaugregory (*Pomacentrus leucostictus*). *Copeia* 1939:185–188.
- BROOK, G. 1890. Notes on larval stages of *Motella*. *Proc. R. Phys. Soc. Edinb.* 10:156–161.
- BROTHERS, E. B. 1981. What can otolith microstructure tell us about daily and subdaily events in the early life history of fish? *Rapp. P.V. Reun. Cons. Int. Explor. Mer* 178:393–394.
- , C. P. MATHEWS AND R. LASKER. 1976. Daily growth increments in otoliths from larval and adult fishes. *Fish. Bull. U.S.* 74:1–8.
- , AND W. N. MCFARLAND. 1981. Correlations between otolith microstructure, growth, and life history transitions in newly recruited French grunts. [*Haemulon flavolineatum* (Desmarest), Haemulidae]. *Rapp. P.V. Reun. Cons. Int. Explor. Mer* 178:369–374.
- , E. D. PRINCE AND D. W. LEE. 1984. Age and growth of young-of-the-year bluefin tuna (*Thunnus thynnus*) from otolith microstructure. NOAA Tech. Rep. 8. In press.
- , AND R. E. THRESHER. MS. Interspecific differences in the duration of the pelagic larval stage of Western Atlantic angelfishes (Pomacanthidae): possible biogeographic and systematic applications.

- , D. M. WILLIAMS AND P. F. SALE. 1983. Length of larval life in 12 families of fishes at One Tree Lagoon, Great Barrier Reef, Australia. *Mar. Biol. (Berl.)* 76:319-324.
- BROWNELL, C. L. 1979. Stages in the early development of 40 marine fish species with pelagic eggs from the Cape of Good Hope. *Rhodes Univ. J. L. B. Smith Inst. Ichthyol. Bull.* 40.
- . 1980a. Water quality requirements for first-feeding in marine fish larvae. I. Ammonia, nitrite, and nitrate. *J. Exp. Mar. Biol. Ecol.* 44:269-283.
- . 1980b. Water quality requirements for first-feeding in marine fish larvae. II. pH, oxygen, and carbon dioxide. *J. Exp. Mar. Biol. Ecol.* 44:285-298.
- BRUGGEMAN, E., P. SORGELOOS AND P. VAN HAECKE. 1980. Improvements in the decapsulation technique of *Artemia* cysts, p. 261-269. *In: The brine shrimp Artemia*. Vol. 3. Ecology, culturing, use in aquaculture. G. Persoone, P. Sorgeloos, O. Roels, and E. Jaspers (eds.). Universa Press, Wetteren, Belgium.
- BRUMMETT, A. R., AND J. N. DUMONT. 1981. A comparison of chorions from eggs from northern and southern populations of *Fundulus heteroclitus*. *Copeia* 1981:607-614.
- BRUNDIN, L. 1966. Transantarctic relationships and their significance as evidenced by chironomid midges. *K. Sven. Vetenskapsakad. Handl.* 4(111):1-472.
- BRUTON, M. N. 1979. The breeding biology and early development of *Clarias gariepinus* (Pisces: Clariidae) in Lake Sibaya, South Africa, with a review of breeding in species of the subgenus *Clarias* (*Clarias*). *Trans. Zool. Soc. Lond.* 35:1-45.
- BRUNN, A. F. 1935. Flying-fishes (Exocoetidae) of the Atlantic. *Dana-Rap. Carlsberg Found.* 6.
- . 1937. *Chascanopsetta* in the Atlantic: a bathypelagic occurrence of flatfish with remarks on distribution and development of certain other forms. *Vidensk. Medd. Dan. Naturhist. Foren.* 101:125-135.
- . 1940. A study of a collection of the fish *Schmidleria* from south Pacific waters. *Dana-Rap. Carlsberg Found.* 21.
- BRYAN, P. G., AND B. B. MADRAISAU. 1977. Larval rearing and development of *Siganus lineatus* (Pisces: Siganidae) from hatching through metamorphosis. *Aquaculture* 10:243-252.
- BUDD, P. L. 1940. Development of the eggs and early larvae of six California fishes. *Calif. Dep. Fish Game Fish. Bull.* 56.
- BUDGETT, J. S. 1902. The habits and development of some West African fishes. *Proc. Camb. Philos. Soc.* 11:102-104.
- . 1903. On the breeding-habits of some West-African fishes, with an account of the external features in development of *Protopterus annectens*, and a description of the larva of *Protopterus la-pradei*. *Trans. Zool. Soc. Lond.* 16:115-136.
- BURDAK, V. D. 1969. Ontogenesis of squamation in the mullet (*Mugil saliens* Risso). *Zool. Zh.* 48:241-247.
- BURGESS, W. E. 1965. Larvae of the surgeonfish genus *Acanthurus* of the tropical western Atlantic. Unpubl. MS thesis. Univ. Miami, Coral Gables, FL.
- . 1974. Evidence for the elevation to family status of the angelfishes (Pomacanthidae), previously considered to be a subfamily of the butterfly-fish family, Chaetodontidae. *Pac. Sci.* 28:57-71.
- . 1978. Butterflyfishes of the world. TFH Publications, Ltd. Neptune City, NJ.
- . 1982. The first aquarium spawning of the woodcat, *Trachycorystes insignis*. *Trop. Fish Hobby.* 1982 (August):84-89.
- BURKE, V. 1930. Revision of the fishes of the family Liparidae. *U.S. Natl. Mus. Bull.* 150:1-204.
- BUSSING, W. A. 1965. Studies of the midwater fishes of the Peru-Chile Trench. *Antarct. Res. Ser.* 5:185-227.
- BUTLER, J. L. 1979. The nomeid genus *Cubiceps* (Pisces) with a description of a new species. *Bull. Mar. Sci.* 29:226-241.
- , AND E. H. AHLSTROM. 1976. Review of the deep-sea fish genus *Scopelengys* (Neoscopelidae) with a description of a new species, *Scopelengys clarkei*, from the central Pacific. *Fish. Bull. U.S.* 74:142-150.
- , H. G. MOSER, G. S. HAGEMAN AND L. L. NORDGREN. 1982. Developmental stages of three California sea basses (*Paralabrax*, Pisces, Serranidae). *Calif. Coop. Oceanic Fish. Invest. Rep.* 23:252-268.
- BYRNE, D. M. 1978. Life history of the spotfin killifish, *Fundulus luciae* (Pisces: Cyprinodontidae), in Fox Creek Marsh, Virginia. *Estuaries* 1:211-227.
- CADWALLADER, P. L. 1976. Breeding biology of a non-diadromous galaxiid *Galaxias vulgaris* Stokell in a New Zealand river. *J. Fish Biol.* 8:157-177.
- CAILLIET, G. M., AND R. N. LEA. 1977. Abundance of the "rare" zoarcid, *Maynea californica* Gilbert, 1915, in the Monterey Canyon, Monterey Bay, California. *Calif. Fish Game* 63:253-261.
- CALDWELL, D. K. 1962. Development and distribution of the short bigeye, *Pseudopriacanthus altus* (Gill) in the western North Atlantic. *U.S. Fish Wildl. Serv. Fish. Bull.* 62(203):103-150.
- CALDWELL, M. C. 1962. Development and distribution of larval and juvenile fishes of the family Mullidae of the western North Atlantic. *U.S. Fish Wildl. Serv. Fish. Bull.* 62(213):403-457.
- CALLEGRI, C., AND F. BASAGLIA. 1978. Biochemical characteristics of Mugilids in the lagoons of the Po Delta. *Boll. Zool.* 45(1):35-40.
- CAMERON, J. 1959. The larval and post-larval stages of *Gymnamodytes semisquamatus* (Jourdain). *J. Mar. Biol. Assoc. U.K.* 38:17-25.
- CAMPANA, S. E. 1983. Calcium deposition and otolith check formation during periods of stress in coho salmon, *Oncorhynchus kisutch*. *Comp. Biochem. Physiol.* 75A:215-220.
- CAMPOS, H. 1969. Reproducción del *Aplocheilichthys taeniatus* Jenyns. *Bol. Mus. Nac. Hist. Nat. Chile* 29:207-222.
- . 1972. Breeding season and early development of *Brachygalaxias bullocki* (Osteichthyes: Galaxiidae). *Tex. J. Sci.* 23:531-544.
- . 1979. Multivariate analysis of the taxonomy of the fish family Galaxiidae. *Zool. Anz.* 202:280-288.
- CANTWELL, G. E. 1964. A revision of the genus *Paraperca*, family Mugiloididae. *Pac. Sci.* 18:239-280.
- CARBINE, W. F. 1944. Egg production of the northern pike, *Esox lucius* L., and the percentage survival of eggs and young on the spawning grounds. *Pap. Mich. Acad. of Sci. Arts Lett.* 29:123-137.
- CARDEILHAC, P. T. 1976. Induced maturation and development of pinfish eggs. *Aquaculture* 8:389-393.
- CARLSTROM, D. 1963. A crystallographic study of vertebrate otoliths. *Biol. Bull. (Woods Hole)* 125:441-463.
- CARR, J. 1982. *Aphyosemion amiati* Radda, 1976. *J. Am. Killifish Assoc.* 15(3):102-104.
- CARR, W. E. S., AND C. A. ADAMS. 1972. Food habits of juvenile marine fishes: evidence of the cleaning habit in the leatherjacket, *Oligoplites saurus*, and the spottail pinfish, *Diplodus holbrookii*. *Fish Bull. U.S.* 70:1111-1120.
- CARUSO, J. H. 1981. The systematics and distribution of the lophiid anglerfishes: I. A revision of the genus *Lophioides* with the description of two new species. *Copeia* 1981:522-549.
- . 1983. The systematics and distribution of the lophiid anglerfishes: II. Revisions of the genera *Lophomus* and *Lophius*. *Copeia* 1983:11-30.
- , AND H. R. BULLIS, JR. 1976. A review of the lophiid angler fish genus *Sladenia* with a description of a new species from the Caribbean Sea. *Bull. Mar. Sci.* 26:59-64.
- CASSEL, A. 1981. *Garmanella pulchra*, a fascinating killifish from Mexico. *J. Am. Killifish Assoc.* 14(5):167-168.
- CASTEEL, R. W. 1974. Identification of the species of Pacific salmon (Genus *Oncorhynchus*) native to North America based on otoliths. *Copeia* 1974:305-311.
- CASTLE, P. H. J. 1968. Larval development of the congrid eel *Gnathophip capensis* (Kaup), off southern Africa, with notes on the identity of *Conger muraena australis* Barnard. *Zool. Afr.* 3:139-154.
- . 1969. An index and bibliography of eel larvae. *Rhodes Univ. J. L. B. Smith Inst. Ichthyol. Spec. Publ.* 7:1-121.
- . 1973. A giant notacanthiform leptocephalus from the Chat-

- ham Islands, New Zealand. Rec. Dom. Mus. Wellington 8(8):121-124.
- . 1976. Criteria of satisfactory fixation and preservation of eel larvae (Leptocephali), p. 319-321. In: Zooplankton fixation and preservation. H. F. Steedman (ed.). Unesco Press, Paris.
- . 1979. Early life-history of the eel *Moringua edwardsi* (Pisces, Moringuidae) in the western North Atlantic. Bull. Mar. Sci. 29:1-18.
- . 1980. Larvae of the ophichthid eel genus *Neenchelys* in the Indo-Pacific. Pac. Sci. 34:165-171.
- , AND J. E. BÖHLKE. 1976. Sexual dimorphism in size and vertebral number in the western Atlantic eel *Moringua edwardsi* (Anguilliformes, Moringuidae). Bull. Mar. Sci. 26:615-619.
- , AND N. S. RAJU. 1975. Some rare leptocephali from the Atlantic and Indo-Pacific oceans. Dana-Rep. Carlsberg Found. 85:1-25.
- , AND D. A. ROBERTSON. 1974. Early life history of the congrid eels *Gnathophis habenatus* and *G. incognitus* in New Zealand waters. N.Z. J. Mar. Freshwater Res. 8:95-110.
- CAVENDER, T. M. 1969. An Oligocene mudminnow (family Umbridae) from Oregon with remarks on relationships within the Esocoidae. Occas. Pap. Mus. Zool. Univ. Mich. No. 660.
- . 1970. A comparison of coregonines and other salmonids with the earliest known teleost fishes, p. 1-32. In: Biology of coregonid fishes. C. C. Lindsey and C. S. Woods (eds.). Univ. Manitoba Press, Winnipeg.
- CERNY, K. 1977. The early development of chub *Leuciscus cephalus* (L., 1758), rudd-*Scardinius erythrophthalmus* (L., 1758) and roach-*Rutilus rutilus* (L., 1758). Acta Univ. Carol. Biol. 1977(1-2):1-149.
- CERVIGON M., F. 1966. Los peces marinos de Venezuela. Fund. La Salle Cienc. Nat. (Caracas), Vol. I and 2.
- , AND E. VELAZQUEZ. 1978. Revisión sistemática y estudio osteológico de las especies del género *Jenkinsia* de las costas de Venezuela (Osteichthyes: Clupeiformes). Cuad. Oceanogr. Univ. Oriente 7:3-54.
- CHABANAUD, P. 1934. Contribution à la morphologie des poissons hétérosomes. Bull. Soc. Zool. Fr. 59:123-129.
- . 1937. L'extension proxe périphérique, la contraction axiale post-hypophysaire et l'anisoconie rhachidienne des téléostéens dissymétriques. Bull. Soc. Zool. Fr. 62:368-385.
- . 1940. Notules ichtyologiques. Bull. Mus. Natl. Hist. Nat. (2) 12:149-156.
- . 1941. Sur la classification et la géonémie de soleides du genre *Aesopia*. Copeia 1941:31-32.
- . 1949. Le problème de la phylogénèse des Heterosomata. Bull. Inst. Oceanogr. (Monaco) 950:1-24.
- . 1950. Contribution à l'anatomie et à la systématique de la famille des Bothidae, s. str. Bull. Soc. Zool. Fr. 74:246-253.
- . 1969. Sur la morphologie de *Samaris cristatus* Gray et de *Samaris cristatus erythraeus* P. Chabanaud natio nova (Pleuronectoidea Samaridae). Bull. Mus. Natl. Hist. Nat. (2) 40:874-890.
- CHACKO, P. I. 1944. On the bionomics of the big-jawed jumper, *Lactarius lactarius* (Cuv. and Val.). Curr. Sci. (Bangalore) 13(4):108.
- CHAMBERS, J. R., J. A. MUSICK AND J. DAVIS. 1976. Methods of distinguishing larval alewife from larval blueback herring. Chesapeake Sci. 17:93-100.
- CHANG, H., X. SHA, Z. CHEN, H. RUAN AND G. HE. 1981. Observations on the egg and larval development of a clupeid *Harengula zunasi* Bleeker. Trans. Chin. Ichthyol. Soc. 1:57-64.
- , G. HE AND L. SONG. 1980. A description of the morphological characters of the eggs and larvae of the flathead fish, *Platycephalus indicus*. Oceanol. Limnol. Sin. 11(2):161-168.
- CHANGJIANG, Y. 1976. Fishes of the Yangtze River. Hunan Province Inst. Hydrobiol., Science Press, Peking. (In Chinese.)
- CHAPMAN, W. M. 1939. Eleven new species and three new genera of oceanic fishes collected by the International Fisheries Commission from the northeastern Pacific. Proc. U.S. Natl. Mus. 86:501-542.
- . 1942. The osteology and relationships of the Argentinidae, a family of oceanic fishes. J. Wash. Acad. Sci. 32:104-117.
- . 1948. The osteology and relationships of the Microstomidae, a family of oceanic fishes. Proc. Calif. Acad. Sci., Ser. 4, 26:1-22.
- , AND L. D. TOWNSEND. 1938. The osteology of *Zaprora silenus*, with notes on its distribution and early life history. Ann. Mag. Nat. Hist., Ser. 11, 2:89-117.
- CHAUDHURI, H. 1962. Induced breeding and development of a common catfish, *Ompok bimaculatus* (Bloch). Proc. Indian Sci. Congr. 49:390-391.
- , J. V. JUARIO, J. H. PRIMAVERA, R. SAMSON AND R. MATEO. 1978. Observations on artificial fertilization of eggs and the embryonic and larval development of milkfish, *Chanos chanos* (Forsk.). Aquaculture 13:95-113.
- CHEN, F. Y., M. CHOW, T. M. CHAO AND R. LIM. 1977. Artificial spawning and larval rearing of the grouper, *Epinephelus tauwina* (Forsk.) in Singapore. Singapore J. Primary Ind. 5:1-21.
- CHENOWETH, S. B. 1970. Seasonal variations in condition of larval herring in Boothbay Harbor area of the Maine coast. J. Fish. Res. Board Can. 27:1875-1879.
- CHERESHNEV, I. A., AND A. V. BALUSHKIN. 1980. A new species of blackfish, *Dallia asmirabilis* sp. n. (Umbridae, Esociformes) from the Amguema River basin (Arctic Chukotka). J. Ichthyol. (Engl. Transl. Vopr. Ikhtiol.) 20(6):25-30.
- CHERNYAYEV, ZH. A. 1971. Some data on the reproduction and development of the cottoid fish (*Comephorus dybowskii* Korotneff). J. Ichthyol. (Engl. Transl. Vopr. Ikhtiol.) 11:706-716.
- . 1975. Morphological and ecological features of the reproduction and development of the "Big Golomyanka" or Baikal oil-fish (*Comephorus baicalensis*). J. Ichthyol. (Engl. Transl. Vopr. Ikhtiol.) 14:856-868.
- . 1978. Morpho-ecological characteristics of the reproduction and development of the Baikal sand sculpin, *Paracottus (Leocottus) kessleri*. J. Ichthyol. (Engl. Transl. Vopr. Ikhtiol.) 17:890-903.
- . 1981. Reproduction and development of the "Big-head" sculpin, *Batrachocottus baicalensis*, from Lake Baikal. J. Ichthyol. (Engl. Transl. Vopr. Ikhtiol.) 19(6):83-94.
- CHIDAMBARAM, K. 1942. Observations on the development of *Arius jella* (Day). Proc. Indian Acad. Sci. Sect. B 14:502-508.
- CHIGIRINSKIY, A. I. 1970. The nature of oogenesis and fecundity in the Japanese horse mackerel [*Trachurus japonicus* (Temminck et Schlegel)]. J. Ichthyol. (Engl. Transl. Vopr. Ikhtiol.) 10:755-760.
- CHIRICHIGNO, N. 1973. Nuevas especies de peces de los géneros *Mustelus* (fam. Triakidae), *Raja* (fam. Rajidae) y *Schedophilus* (fam. Centrolophidae). Inst. Mar. Peru (Callao) Inf. 42.
- CHRAPKOVA-KOVALEVSKAYA, N. V. 1963. Data on reproduction, development and distribution of larvae and young fish of *Oxyporhamphus micropterus* Val. (Pisces, Oxyporhamphidae). Tr. Inst. Okeanol. Acad. Nauk SSSR 62:49-61.
- CHUNG, M. 1961. Illustrated encyclopedia. The fauna of Korea (2). Fishes.
- . 1977. The fishes of Korea. Il Ji Sa Publishing Co., Seoul.
- CIPRIA, G. 1927. Contributo alla conoscenza dello sviluppo postembrionale di *Hypsirhynchus hepaticus* Facciola. Mem. R. Com. Talassogr. Ital. 130.
- . 1934. Uova, stadi embrionali e post-embriionali di *Blennius palmicornis* Cuv. Mem. R. Com. Talassogr. Ital. 218.
- . 1936. Uova, stadi embrionali e post-embriionali, nei Blennidi. I. *Blennius pavo* Risso. II. *Blennius inaequalis* C. V. Mem. R. Com. Talassogr. Ital. 231.
- CLANCEY, J. F. 1956. A contribution to the life history of the fish, *Bregmaceros atlanticus* Goode and Bean, from the Florida Current. Bull. Mar. Sci. Gulf Carrib. 6:233-260.
- CLARK, E. 1950. Notes on the behavior and morphology of some West Indian plectognath fishes. Zoologica (N.Y.) 35:159-168.
- CLARK, F. N. 1925. The life history of *Leuresthes tenuis*, an atherine fish with tide controlled spawning habits. Calif. Dep. Fish Game Fish Bull. 10:1-51.
- . 1929. The life history of the California jack smelt, *Athermopsis californiensis*. Calif. Dep. Fish Game Fish Bull. 16:1-22.
- CLARK, J., W. G. SMITH, A. W. KENDALL, JR. AND M. P. FAHAY. 1969.

- Studies of estuarine dependence of Atlantic coastal fishes. U.S. Bur. Sport Fish. Wildl. Tech. Pap. 28.
- CLARK, R. S. 1914. General report on the larval and post-larval teleosts in Plymouth waters. J. Mar. Biol. Assoc. U.K. 10:327.
- . 1920. The pelagic young and early bottom stages of teleosts. J. Mar. Biol. Assoc. U.K. 12:159–240.
- CLARKE, T. A. 1973. Some aspects of the ecology of lanternfishes (Myctophidae) in the Pacific Ocean near Hawaii. Fish. Bull. U.S. 71:401–434.
- , AND P. J. WAGNER. 1976. Vertical distribution and other aspects of the ecology of certain mesopelagic fishes taken near Hawaii. Fish. Bull. U.S. 74:635–645.
- CLAUSEN, H. S. 1959. Denticipitidae, a new family of isospondylous teleosts from west African freshwater. Vidensk. Medd. Dan. Naturhist. Foren. 121:141–156.
- COHEN, D. M. 1958. A revision of the fishes of the subfamily Argentininae. Bull. Fl. State Mus. Biol. Ser. 3:93–172.
- . 1960. New records of the opisthoproctid genus *Bathylachnops*, with a notice of neoteny in the related genus *Dolichopteryx*. Copeia 1960:147–149.
- . 1964a. Bioluminescence in the Gulf of Mexico anacanthine fish *Steindachneria argentea*. Copeia 1964:406–409.
- . 1964b. Suborder Argentinoidea, p. 1–70. In: Fishes of the western North Atlantic. H. B. Bigelow (ed.), Mem. Sears Found. Mar. Res. No. 1 (Pt. 4).
- . 1973. Eretmophoridae, p. 322–326. In: Check-list of the fishes of the north-eastern Atlantic and of the Mediterranean (Clofnam). Vol. 1. J. C. Hureau and T. Monod (eds.), UNESCO, Paris.
- . 1974. A review of the pelagic ophidioid fish genus *Brotulataenia* with descriptions of two new species. Zool. J. Linn. Soc. 55: 119–149.
- . 1979. Notes on the morid fish genera *Lotella* and *Physiculus* in Japanese waters. Jpn. J. Ichthyol. 26:225–230.
- , AND J. G. NIELSEN. 1978. Guide to the identification of genera of the fish order Ophidiiformes with a tentative classification of the order. NOAA Tech. Rep. NMFS Circ. 147.
- , AND J. L. RUSSO. 1979. Variations in the fourbeard rockling, *Enchelyopus cimbrius*, a North Atlantic gadid fish, with comments on the genera of rocklings. Fish. Bull. U.S. 77:91–104.
- COLE, F. J., AND J. JOHNSTONE. 1902. *Pleuronectes* (the plaice), Mem. Liverpool Mar. Biol. Comm. 8.
- COLEMAN, L. R., AND B. G. NAFAKITIS. 1972. *Dorsadena yaqunae*, a new genus and species of myctophid fish from the eastern north Pacific Ocean. Nat. Hist. Mus. Los Ang. Cty. Contrib. Sci. 225:1–11.
- COLIN, P. L. 1975. The neon gobies. The comparative biology of the gobies of the genus *Gobiosoma*, subgenus *Elacatinus*, (Pisces: Gobiidae) in the tropical western north Atlantic Ocean. T.F.H. Publications, Neptune City, NJ.
- . 1982. Spawning and larval development of the hogfish, *Lachnolaimus maximus*, (Pisces, Labridae). Fish. Bull. U.S. 80:853–862.
- COLLETT, R. 1905. Fiske indsamlede under "Michael Sars" toget i nordhavet 1900–1902. Rep. Norw. Fish. Mar. Invest. 2(3):1–147.
- COLLETTE, B. B. 1962. *Hemiramphus bermudensis*, a new halfbeak from Bermuda, with a survey of endemism in Bermudian shore fishes. Bull. Mar. Sci. Gulf Caribb. 12:432–449.
- . 1966. *Belonion*, a new genus of fresh-water needlefishes from South America. Am. Mus. Novit. No. 2274.
- . 1974a. South American freshwater needlefishes (Belonidae) of the genus *Pseudotyllosurus*. Zool. Meded. (Leiden) 48(16):169–186.
- . 1974b. The garfishes (Hemiramphidae) of Australia and New Zealand. Rec. Aust. Mus. 29(2):11–105.
- . 1974c. *Strongylura hubbsi*, a new species of freshwater needlefish from the Usumacinta Province of Guatemala and Mexico. Copeia 1974:611–619.
- . 1979. Adaptations and systematics of the mackerels and tunas, p. 7–39. In: The physiological ecology of tunas. G. Sharp and A. Dizon (eds.). Academic Press, NY.
- . 1982a. South American freshwater needlefishes of the genus *Potamorhaphis* (Beloniformes: Belonidae). Proc. Biol. Soc. Wash. 95:714–747.
- . 1982b. Rediscovery of *Hyporhamphus xanthopterus*, a half-beak endemic to Vembanad Lake, Kerala, southern India. Matsya 7:1–12.
- . 1982c. Two new species of freshwater halfbeaks (Pisces: Hemiramphidae) of the genus *Zenarchopterus* from New Guinea. Copeia 1982:265–276.
- . 1983. Recognition of two species of double-lined mackerels (*Grammatorcynus*: Scombridae). Proc. Biol. Soc. Wash. 96:715–718.
- , AND F. H. BERRY. 1965. Recent studies on the needlefishes (Belonidae): An evaluation. Copeia 1965:386–392.
- , AND L. N. CHAO. 1975. Systematics and morphology of the bonitos (*Sarda*) and their relatives (Scombridae, Sardini). Fish. Bull. U.S. 73:516–625.
- , AND N. V. PARIN. 1970. Needlefishes (Belonidae) of the eastern Atlantic Ocean. Atl. Rep. 11:7–60.
- , AND J. L. RUSSO. 1979. An introduction to the Spanish mackerels, genus *Scomberomorus*, p. 3–16. In: Proc. Mackerel Colloquium. E. L. Nakamura and H. R. Bullis, Jr. (eds.). Gulf States Mar. Fish. Comm.
- , AND ———. In press. Morphology, systematics, and biology of the Spanish mackerels (*Scomberomorus*, Scombridae). Fish. Bull. U.S.
- COLLINS, L. A., J. H. FINUCANE AND L. E. BARGER. 1980. Description of larval and juvenile red snapper, *Lutjanus campechanus*. Fish. Bull. U.S. 77:965–974.
- COLLINS, S. P., AND M. P. BARRON. 1981. Demersal and pelagic trawling survey of the M.T. "Denebola" in southern Australian waters, 1979–80 summer. Tasmanian Fish. Res. 24:2–48.
- COLTON, J. B., AND K. A. HONEY. 1963. The eggs and larval stages of the butterfish, *Poronotus triacanthus*. Copeia 1963:447–450.
- , AND R. R. MARAK. 1969. Guide for identifying the common planktonic fish eggs and larvae of continental shelf waters. Cape Sable to Block Island. NMFS Woods Hole Biol. Lab. Ref. Doc. 69-9.
- CONAND, F. 1978. Systématique des larves de Clupeides de l'Atlantique orientale entre 20°N et 15°S (eaux marine et saumâtres). Cah. ORSTOM Ser. Oceanogr. 16:3–8.
- , AND E. FAGETTI. 1971. Description et distribution saisonnière des larves de sardinelles des côtes du Sénégal et de la Gambie en 1968 et 1969. Cah. ORSTOM Ser. Oceanogr. 9:293–318.
- , AND C. FRANQUEVILLE. 1973. Identification et distribution saisonnière de larves de Carangides au large du Sénégal et de la Gambie. Bull. Inst. Fondam. Afr. Noire, Ser. A Sci. Nat. 35:951–978.
- CONSTANTZ, G. D. 1981. Life history patterns of desert fishes, p. 237–290. In: Fishes in North American deserts. R. J. Naiman and D. L. Soltz (eds.). John Wiley & Sons, N.Y.
- COOMBS, S. H., AND A. R. HIBY. 1979. The development of the eggs and early larvae of blue whiting, *Micromesistius potassou* and the effect of temperature on development. J. Fish Biol. 14:111–123.
- COOPER, J. E. 1978. Identification of eggs, larvae, and juveniles of the rainbow smelt, *Osmerus mordax*, with comparisons to larval alewife, *Alosa pseudoharengus*, and gizzard shad, *Dorosoma cepedianum*. Trans. Am. Fish. Soc. 107:56–62.
- COSTA, A. 1869. Osservazioni sul *Krohnus filamentosus* e sullo sviluppo della pinna caudale del *Trachypterus*. Ann. Mus. Napoli 5:1–41.
- COURTENAY, W. R., JR. 1971. Sexual dimorphism of the sound producing mechanism of the striped cusk-eel, *Rissola marginata* (Pisces: Ophidiidae). Copeia 1971:259–268.
- , AND F. A. MCKITTRICK. 1970. Sound-producing mechanisms in carapid fishes, with notes on phylogenetic implications. Mar. Biol. (Berl.) 7:131–137.

- CRESSEY, R. 1981. Revision of Indo-Pacific lizardfishes of the genus *Synodus* (Pisces: Synodontidae). *Smithson. Contrib. Zool.* 342.
- CRESSEY, R. F., B. B. COLLETTE AND J. L. RUSSO. 1983. Copepods and scombrid fishes: A study in host-parasite relationships. *Fish. Bull. U.S.* 81:227-265.
- CROSSLAND, J. 1981. Fish eggs and larvae of the Hauraki Gulf, New Zealand. *N.Z. Minist. Agric. Fish. Res. Bull.* 23.
- . 1982. Distribution and abundance of fish eggs and larvae from the spring and summer plankton of north-east New Zealand, 1976-78. *N.Z. Minist. Agric. Fish. Res. Bull.* 24.
- CROSSMAN, E. J. 1980. *Esox americanus*, *Esox lucius*, *Esox masquinongy*, *Esox niger*, pp. 131-138. In: Atlas of North American freshwater fishes. D. S. Lee, C. R. Gilbert, C. H. Hocutt, R. E. Jenkins, D. E. McAllister and Jay R. Stauffer, Jr. (eds.). North Carolina State Mus. Nat. Hist., Raleigh, NC.
- CUNNINGHAM, J. T. 1887. The eggs and larvae of teleosteans. *Trans. R. Soc. Edinb.* 33:97-136.
- . 1889. Studies of the reproduction and development of teleostean fishes occurring in the neighbourhood of Plymouth. *J. Mar. Biol. Assoc. U.K.* 1:10-54.
- . 1890. A treatise on the common sole (*Solea vulgaris*), considered both as an organism and as a commodity. *Mar. Biol. Assoc. U.K.*, Plymouth.
- . 1891. On some larval stages of fishes. *J. Mar. Biol. Assoc. U.K.* 2:68-74.
- CURLISS, W. W. 1979. Early development and larval biology of the California topsmelt, *Atherinops affinis*. *Amer. Zool.* 19:949. (Abstract.)
- CUSHING, D. H. 1975. Marine ecology and fisheries. Cambridge Univ. Press, Cambridge.
- . 1977. Science and the fisheries. Camelot Press Ltd., Southampton.
- CUVIER, G. 1829. De l'Oreosome (*Oreosoma*, nov.) et particulièrement de l'Oreosome de l'Atlantique (*Oreosoma atlanticum*, nov.), p. 515-518. In: Histoire naturelle des poissons. 4. Des Acanthopterygiens. G. Cuvier and A. Valenciennes (eds.). F. G. Levrault, Paris.
- CZOLOWSKA, R. 1962. Morphogenesis of skin scuta in *Siphonostoma typhle* L. *Zool. Pol.* 12(3):269-303.
- DAAN, N. 1981. Comparison of estimates of egg production of the Southern Bight cod stock from plankton surveys and market statistics. *Rapp. P.V. Reun. Cons. Int. Explor. Mer* 178:242-243.
- DAKIN, W. J., AND G. L. KESTEVEN. 1938. The Murray cod (*Maccullochella macquariei* (Cuv. et Val.)). Some experiments on breeding with notes on the early stages and a reference to the problems of depletion and restocking. *State Fish. N.S.W. Res. Bull.* 1.
- DALE, T. 1984. Embryogenesis and growth of otoliths in the cod (*Gadus morhua* L.), p. 231-250. In: The propagation of cod. E. Dahl, D. S. Daniellssen, E. Moksness and P. Solemdal (eds.). Flodevigen Rapp. 1.
- D'ANCONA, U. 1929. Note di ittiologia mediterranea. 1. Stadi giovanili e uova di *Exocoetus*. *Pubbl. Staz. Zool. Napoli* 9:203-211.
- . 1931a. Clupeidae, p. 1-16. In: Uova, larve e stadi giovanili di Teleostei. *Fauna Flora Golfo Napoli Monogr.* 38.
- . 1931b. Ordine: Apodes (Muraenoidei), p. 94-156. In: Uova, larve e stadi giovanili di Teleostei. *Fauna Flora Golfo Napoli Monogr.* 38.
- . 1933a. Famiglia I: Gadidae, p. 178-255. In: Uova, larve e stadi giovanili di Teleostei. *Fauna Flora Golfo Napoli Monogr.* 38.
- . 1933b. Famiglia: Lampridae, p. 280. In: Uova, larve e stadi giovanili di Teleostei. *Fauna Flora Golfo Napoli Monogr.* 38.
- . 1933c. Famiglia: Syngnathidae, p. 281-298. In: Uova, larve e stadi giovanili di Teleostei. *Fauna Flora Golfo Napoli Monogr.* 38.
- . 1933d. Famiglia: Macrorhamphosidae, p. 299-306. In: Uova, larve e stadi giovanili di Teleostei. *Fauna Flora Golfo Napoli Monogr.* 38.
- , AND G. CAVINATO. 1965. The fishes of the family Bregmacrotidae. *Dana-Rep. Carlsberg Found.* 64.
- DANDO, P. R. 1975. On the northern rockling *Ciliata septentrionalis* (Collett) in the Plymouth area. *J. Mar. Biol. Assoc. U.K.* 55:925-931.
- DANIELS, R. A. 1978. Nesting behaviour of *Harpagifer bispinus* in Arthur Harbour, Antarctic Peninsula. *J. Fish Biol.* 12:465-474.
- . 1981. *Cryotheria peninsulacae*, a new genus and species of nototheniid fish from the Antarctic Peninsula. *Copeia* 1981:558-562.
- DANIL'CHENKO, P. G. 1947. Phylogenetic relations between the genera *Palaeogadus* and *Merluccius*. *Dokl. Akad. Nauk SSSR* 58:659-662. (In Russian; transl. by J. H. Slep, 1967, U.S. Bur. Commer. Fish., Washington, D.C., Transl. 46.)
- . 1950. The genus *Palaeogadus* and its development. *Tr. Paleontol. Inst. Akad. Nauk SSSR* 25:3-25. (In Russian, transl. by J. H. Slep, 1968, U.S. Bur. Commer. Fish., Washington, D.C., Transl. 53.)
- . 1960. Bony fishes of the Maikop Deposits of the Caucasus. *Tr. Paleontol. Inst. Akad. Nauk SSSR* 78:1-247.
- DANNEVIG, A. 1919. Fish eggs and larvae, p. 1-80. In: Canadian fisheries expedition 1914-15 in the Gulf of St. Lawrence and Atlantic waters of Canada. J. Hjort (ed.). Can. Nav. Serv., King's Printer, Ottawa.
- DAVID, A. 1961. Notes on the embryonic and larval development of the "Goonch,"—*Bagarius bagarius* (Hamilton). *J. Zool. Soc. India* 13:194-205.
- DAVID, L. R. 1939. Embryonic and early larval stages of the grunion, *Leuresthes tenuis*, and the sculpin, *Scorpaena guttata*. *Copeia* 1939:79-81.
- DAVIS, J. R., AND D. E. LOUDER. 1969. Life history and ecology of *Menidia extensa*. *Trans. Am. Fish. Soc.* 98:466-472.
- DAVIS, W. P. 1966. A review of the dragonets (Pisces: Callionymidae) of the western Atlantic. *Bull. Mar. Sci.* 16:834-862.
- DAVY, B. 1972. A review of the lanternfish genus *Taaningichthys* (family Myctophidae) with the description of a new species. *Fish. Bull. U.S.* 70:67-78.
- DAWSON, C. E. 1971a. Occurrence and description of prejuvenile and early juvenile Gulf of Mexico cobia, *Rachycentron canadum*. *Copeia* 1971:65-71.
- . 1971b. Records of the pearlfish, *Carapus bermudensis*, in the Northern Gulf of Mexico and of a new host species. *Copeia* 1971:730-731.
- . 1973. Indo-Pacific distribution of microdesmid fishes (Gobioidea). *J. Mar. Biol. Assoc. India* 15(1):318-322.
- . 1974a. Studies on eastern Pacific sand stargazers (Pisces: Dactyloscopidae). 1. *Platygillellus* new genus, with descriptions of new species. *Copeia* 1974:39-55.
- . 1974b. A review of the Microdesmidae (Pisces: Gobioidea). 1. *Cerdale* and *Clarkichthys* with descriptions of three new species. *Copeia* 1974:409-448.
- . 1975. Studies on eastern Pacific sand stargazers (Pisces: Dactyloscopidae). 2. Genus *Dactyloscopus*, with descriptions of new species and subspecies. *Nat. Hist. Mus. Los Ang. Cty. Sci. Bull.* 22.
- . 1976. Studies on eastern Pacific sand stargazers. 3. *Dactylagnus* and *Myxodagnus*, with description of a new species and subspecies. *Copeia* 1976:13-43.
- . 1982. Atlantic sand stargazers (Pisces: Dactyloscopidae), with descriptions of one new genus and seven new species. *Bull. Mar. Sci.* 32:14-85.
- , F. YASUDA AND C. IMAI. 1979. Elongate dermal appendages in species of *Yozia* (Syngnathidae) with remarks on *Trachyrhamphus*. *Jpn. J. Ichthyol.* 25:244-250.
- DEAN, D. M. 1972. Osteology and systematics of the echeline worm eels of the Atlantic Ocean (Pisces, Anguilliformes). Unpubl. PhD dissertation. Univ. Miami, Coral Gables, FL.
- DEARBORN, J. H. 1965. Reproduction in the nototheniid fish *Trematomus bernacchii* Boulenger at McMurdo Sound, Antarctica. *Copeia* 1965:302-307.
- DE AZEVEDO, P., AND A. L. GOMES. 1942. Contribuição ao estudo da biologia da traíra *Hoplias malabarica* (Bloch, 1749). *Bol. Ind. Anim.* 5:15-64.

- , M. VIANNA DIAS AND B. BORGES VIEIRA. 1938. Biología do saguiri. Mem. Inst. Oswaldo Cruz Rio de J. 33(4):481-554.
- DE BEAUFORT, L. F., AND W. M. CHAPMAN. 1951. The fishes of the IndoAustralian Archipelago. E. J. Brill, Ltd., Leiden.
- DE BEER, G. R. 1937. The development of the vertebrate skull. Oxford Univ. Press, London.
- . 1951. Embryos and ancestors (revised edition). Oxford at the Clarendon Press, London.
- DE BUEN, F. 1940. Huevos, crías, larvas y juvenes de *Chrostoma* del Lago de Patzcuaro. Trab. Estac. Limnol. Patzcuaro 3:1-14.
- DE CIECHOMSKI, J. D. 1965. Observaciones sobre la reproducción, desarrollo embrionario y larval de la anchoíta argentina (*Engraulis anchoíta*). Bol. Inst. Biol. Mar. 9:1-29.
- . 1968. Huevos y larvas de tres especies de peces marinos, *Anchoa mitchilli*, *Brevoortia aurea* y *Prionotus nudigula* de la zona de Mar del Plata. Bol. Inst. Biol. Mar. 17:1-28.
- . 1972. Desarrollo embrionario y larval del cornalito *Austrotherina incisa* (Jenyns, 1942) Marrero, 1950. Pisces Atherinidae. An. Soc. Cient. Argent. 193:273-281.
- . 1981. Ictioplancton. In: Atlas del zooplancton del Atlántico sudoccidental y métodos de trabajo con zooplancton marino. D. Bórovskoy (ed.). Instituto Nacional de Investigación y Desarrollo Pesquero (INIDEP), Ministerio de Comercio e Intereses Marítimos, República Argentina.
- , AND C. I. BOOMAN. 1981. Descripción de embriones y de áreas de reproducción de los granaderos *Macrourus whitsoni* y *Cochlosynchus fasciatus*, de la polaca *Micromesistius australis* y del bacalao austral *Salpilota australis* en la zona patagónica y fueguina del Atlántico sudoccidental. Physis Secc. A Oceanos Org. 40 (98):5-14.
- , AND G. WEISS. 1973. Reproducción, desarrollo embrionario y larval del surel, *Trachurus picturatus australis* (Pisces), en el área del Mar del Plata y zonas adyacentes. Physis Secc. A Oceanos Org. 32:85-93.
- , AND ——. 1974. Distribución de huevos y larvas de la merluza, *Merluccius merluccius hubbsi*, en las aguas de la plataforma de la Argentina y Uruguay en relación con la anchoíta, *Engraulis anchoíta*, y las condiciones ambientales. Physis Secc. A Oceanos Org. 33(86):185-198.
- , AND ——. 1976. Desarrollo y distribución de postlarvas del róbalo *Eleginops maclovinus* (Valenciennes, 1830) Dollo 1904; de la merluza negra *Dissostichus eleginoides* Smitt, 1899 y de las nototenis *Notothenia* spp. Pisces. Nototheniidae. Physis Secc. A Oceanos Org. 35(91):115-125.
- DE GAETANI, D. 1926. Contributo alla conoscenza dello sviluppo post-larvale di *Mora mediterranea* Risso. Mem. R. Com. Talassogr. Ital. 129.
- . 1928. Uova y larve de *Physiculus dalwigkii* Kp. Mem. R. Com. Talassogr. Ital. 137.
- . 1937. Contributo alla conoscenza dello sviluppo post-embrionale in *Apogon imberbis* L. Mem. R. Com. Talassogr. Ital. 243.
- . 1940. Stadi larvali e giovanili di *Lichia glauca* Risso. Mem. R. Com. Talassogr. Ital. 270:1-15.
- DEGENS, E. T., W. G. DEUSER AND R. L. HAEDRICH. 1969. Molecular structure and composition of fish otoliths. Mar. Biol. (Berl.) 2:105-113.
- DE JAGER, B. V. D. 1955. The South African pilchard (*Sardinops ocellata*)—The development of the snoek (*Thyrsites atun*), a fish predator of the pilchard. Invest. Rep. Div. Fish. S. Afr. 19:1-16.
- DEKHNİK, T. V. 1959. Material on spawning and development of certain far eastern flatfishes. Akad. Nauk. SSSR, Zool. Inst. Issled. Dal'nevost. Morei SSSR 6:109-131. (In Russian.)
- . 1973. Iktioplankton Chernogo moria. (Ichthyoplankton of the Black Sea). Naukova Dumka, Kiev.
- , M. HUARES AND D. SALABARIYA. 1966. Distribution of pelagic eggs and larvae of fishes in the coastal waters of Cuba. Inst. Biol. Southern Seas. Acad. Sci. USSR 1(1):138-161. (English translation 1973, U.S. Dep. Commerce, TT70-57762 Investigations of the Central American Seas).
- , AND V. I. SINYUKOVA. 1966. Distribution of pelagic fish eggs and larvae in the Mediterranean Sea. Part II. On the reproduction and ecology of larvae in Mediterranean Myctophidae. In: Studies on the plankton of southern seas. Nauka, Moscow. (In Russian; English transl. No. 55. Bur. Commer. Fish., Syst. Lab., Washington.)
- DE LACY, A. C., AND B. S. BATTIS. 1963. Possible heterogeneity in the Columbia River smelt. Univ. Wash. Fish. Res. Inst. Circ., No. 198.
- , C. R. HITZ, AND R. L. DRYFOOS. 1964. Maturation, gestation and birth of rockfish (*Sebastes*) from Washington and adjacent waters. Wash. Dep. Fish. Fish. Res. Pap. 2(3):51-67.
- DE LAMATER, E. D., AND W. R. COURTENAY, JR. 1973a. Studies on the scale structure of flat-fishes I. the genus *Trinectes*, with notes on related forms. Proc. Southeast Game Fish Comm. 1973:591-608.
- , AND ——. 1973b. Variations in the structure of the lateral line canal on scales of teleostean fishes. Z. Morphol. Tiere 75:259-326.
- , AND ——. 1974. Fish scales as seen by scanning electron microscopy. Fla. Sci. 37:141-149.
- DELSMAN, H. C. 1921. Fish eggs and larvae from the Java Sea. 1. *Fistularia serrata* Cuv. Treubia 2:92-108.
- . 1923. Fish eggs and larvae from the Java Sea. 2. *Chirocentrus dorab*. Treubia 3:38-46.
- . 1925. Fish eggs and larvae from the Java Sea. 4. *Dussumeria haseltii*. Treubia 6:297-307.
- . 1926a. Fish eggs and larvae from the Java Sea. 5. *Caranx kurra*, *macrosoma*, and *crumenophthalmus*. Treubia 8:199-211.
- . 1926b. Fish eggs and larvae from the Java Sea. 7. The genus *Clupea*. Treubia 8:218-239.
- . 1926c. Fish eggs and larvae from the Java Sea. 8. *Dorosoma chacunda* (H.B.). Treubia 8:389-394.
- . 1926d. Fish eggs and larvae from the Java Sea. 10. On a few larvae of empang fishes. Treubia 8:400-412.
- . 1927. Fish eggs and larvae from the Java Sea. 11. The genus *Trichurus*. Treubia 9:338-351.
- . 1929a. Fish eggs and larvae from the Java Sea. 12. The genus *Engraulis*. Treubia 11:275-281.
- . 1929b. Fish eggs and larvae from the Java Sea. 13. *Chanos chanos* (Forsk.). Treubia 11:281-286.
- . 1929c. The study of pelagic fish eggs. Proc. Pac. Sci. Congr., 4th Ses. 3:61-67.
- . 1930a. Fish eggs and larvae from the Java Sea. 14. The genus *Pellona*. Treubia 12:37-46.
- . 1930b. Fish eggs and larvae from the Java Sea. 15. On *Chirocentrus hypselosoma* and *dorab*. Treubia 12:46-50.
- . 1930c. Fish eggs and larvae from the Java Sea. 16. *Amphiprion percula* c.v. Treubia 12:367-370.
- . 1930d. The study of pelagic fish-eggs. Proc. Fourth Pac. Sci. Congr. (1929) 3:61-67.
- . 1931. Fish eggs and larvae from the Java Sea. 17. The genus *Stolephorus*. Treubia 13:217-243.
- . 1932a. Fish eggs and larvae from the Java Sea. 19. The genus *Setipinna*. Treubia 14:109-114.
- . 1932b. Fish eggs and larvae from the Java Sea. 20. The genus *Coilia*. Treubia 14:114-116.
- . 1933a. Fish eggs and larvae from the Java Sea. 22. *Clupeoides hle* (C.V.). Treubia 14:247-249.
- . 1933b. Fish eggs and larvae of the Java Sea. 23. A few more *Clupea*-eggs. Treubia 14:249-254.
- . 1938. Fish eggs and larvae from the Java Sea. 24. Myctophoidea. Treubia 16:415-420.
- , AND J. D. G. HARDENBERG. 1934. De Indische Zeevissen en Zeevischerij. p. 330-333. N. V. Boekhandel en Drukkerij Visser Co., Batavia.
- DEMARTINI, E. E. 1976. The adaptive significance of territoriality and egg cannibalism in the painted greenling, *Oxylebius pictus* Gill, a northeastern Pacific marine fish. Unpubl. PhD thesis. Univ. Washington, Seattle.

- . 1978. Apparent paternal care in *Liparis fucensis* (Pisces: Cyclopteridae). *Copeia* 1978:537-539.
- DEMIR, M. 1961. On the eggs and larvae of *Trachurus trachurus* (L.) and *Trachurus mediterraneus* (Stohr.) from the Sea of Marmara and the Black Sea. Rapp. P. V. Reun. Comm. Int. Explor. Sci. Mer Mediterr. Monaco 16:317-320.
- DEMIR, N. 1972. The abundance and distribution of the eggs and larvae of some teleost fishes off Plymouth in 1969 and 1970. II. The postlarvae of *Callionymus*. *J. Mar. Biol. Assoc. U.K.* 52:997-1010.
- . 1976. Callionymidae of the northeastern North Atlantic. *Fich. Ident. Zooplancton* 148:1-5.
- . 1982. On postlarvae and pelagic juveniles of rocklings, *Gaidropsarus mediterraneus* and *G. biscayensis*. *J. Mar. Biol. Assoc. U.K.* 62:647-665.
- DESSIER, A. 1969. Note sur les stades larvaires et post-larvaires d' *Ilisha africana* (Bloch, 1795) (Pisces, Clupeidae). *Cah. ORSTOM Ser. Oceanogr.* 8(4):21-27.
- DI SYLVA, D. P. 1963. Systematics and life history of the great barracuda, *Sphyræna barracuda* (Walbaum). *Stud. Trop. Oceanogr.* (Miami).
- . 1975. Barracudas (Pisces: Sphyrænidae) of the Indian Ocean and adjacent seas—a preliminary review of their systematics and ecology. *J. Mar. Biol. Assoc. India* 15(1):74-94.
- , AND W. N. ESCHMEYER. 1977. Systematics and biology of the deep-sea fish family Gibberichthyidae, a senior synonym of the family Kasidoroidae. *Proc. Calif. Acad. Sci., Ser. 4*, 41:215-231.
- , AND L. N. SCOTTON. 1972. Larvae of deep-sea fishes (Stomiatoidea) from Biscayne Bay, Florida, USA, and their ecological significance. *Mar. Biol. (Berl.)* 12:122-128.
- DETWYLER, R. 1963. Some aspects of the biology of the seasnail, *Liparis atlanticus* (Jordan and Evermann). Unpubl. PhD dissertation. Univ. of New Hampshire.
- DEUEL, D. G., J. R. CLARK AND A. J. MANSUETI. 1966. Description of embryonic and early larval stages of the bluefish, *Pomatomus saltatrix*. *Trans. Am. Fish. Soc.* 95:264-271.
- DEVANESAN, D. W. 1937. On the spawning habits and the hatching experiments with the eggs of *Hemirhamphus georgii* Cuv. et Val. *C. R. 12th Congr. Internat. Zool. (Lisbon)* 3:2175-2181.
- DEVARAJ, K. V., T. J. VARGHESE AND G. P. S. RAO. 1972. Induced breeding of the freshwater catfish, *Clarias batrachus* (Linn.) by using pituitary glands from marine catfish. *Curr. Sci.* 41:868-870.
- DEVI, C. B. L. 1969. Occurrence of larvae of *Pseudorhombus elevatus* Ogilby (Heterosomata-Pisces) along the south-west coast of India. *Proc. Indian Acad. Sci. Sect. B*:178-186.
- DEWITT, H. H. 1962a. A new genus and species of zoarcid fish from McMurdo Sound, Antarctica. *Copeia* 1962:819-826.
- . 1962b. A new Antarctic nototheniid fish with notes on two recently described nototheniiformes. *Copeia* 1962:826-833.
- . 1964a. A revision of the Antarctic genus *Racovitzia* (Pisces, Bathydraconidae). *Copeia* 1964:496-506.
- . 1964b. A redescription of *Pathogems antarctica*, with remarks on the genus *Trematomus* (Pisces, Nototheniidae). *Copeia* 1964:683-686.
- . 1970. A revision of the fishes of the genus *Notothenia* from the New Zealand region, including Macquarie Island. *Proc. Calif. Acad. Sci.* 38(16):299-340.
- . 1971. Coastal and deep-water benthic fishes of the Antarctic. *Am. Geogr. Soc., Antarct. Map Folio Ser., Folio* 15.
- . 1977. A new genus and species of eelpout (Pisces, Zoarcidae) from the Gulf of Mexico. *Fish. Bull. U.S.* 75:789-793.
- , AND J. C. HUREAU. 1979. Fishes collected during "Hero" Cruise 72-2 in the Palmer Archipelago Antarctica with the descriptions of two new genera and three new species. *Bull. Mus. Nat. Hist. Nat. 4e Ser. 1*, 1979, Sec. A (3):775-820.
- , AND J. C. TYLER. 1960. Fishes from the Stanford Antarctic Biological Research Program 1958-1959. *Stanford Ichthyol. Bull.* 7(4):162-199.
- DILEEP, M. P. 1977. The larval development and distribution of *Saurida tumbil* (Bloch) off southwest coast of India, p. 460-473. *In: Proc. Symp. Warm Water Zooplankton. Natl. Inst. Oceanogr.*
- DI MICHELE, L., AND M. H. TAYLOR. 1980. The environmental control of hatching in *Fundulus heteroclitus*. *J. Exp. Zool.* 214:181-187.
- DINGKUS, G., AND L. D. UHLER. 1977. Enzyme clearing of alcian blue stained whole small vertebrates for demonstration of cartilage. *Stain Technol.* 52:229-232.
- DITTY, J. G., AND F. M. TRUESDALE. 1983. Comparative larval development of *Peprilus burti*, *P. triacanthus* and *P. paru* (Pisces: Stromateidae) from the western North Atlantic. *Copeia* 1983:397-406.
- DOBBS, G. H. 1974. Soft tissues of marine teleosts, p. 72-82. *In: Principles and techniques of scanning electron microscopy.* M. A. Hayat (ed.). Van Nostrand Reinhold Co., New York.
- . 1975. Scanning electron microscopy of intraovarian embryos of the viviparous teleost, *Micrometrus minimus* (Gibbons), (Perciformes: Embiotocidae). *J. Fish Biol.* 7:209-214.
- DOI, M., AND O. OKAMURA. 1983. The chlorophthalmid fishes collected from the western Pacific. Abstract of paper presented at the 15th Ann. Meet. of the Ichthyol. Soc. Jpn., 1983.
- DOOLEY, J. S. 1978. Systematics and biology of the tilefishes (Perciformes: Branchiostegidae and Malacanthidae) with descriptions of two new species. NOAA Tech. Rep. NMFS Circ. 411.
- DOROFYEVA, Y. A., Y. A. ZINOV'YEV, V. A. KLYUKANOV, Y. S. RESHETNIKOV, K. A. SAVVAITOVA AND G. K. SHAPOSHNIKOVA. 1980. The present state of research into the phylogeny and classification of Salmonoidei. *J. Ichthyol. (Engl. Transl. Vopr. Ikhtiol.)* 20(5):1-20.
- DOROSHEV, S. I. 1970. Biological features of the eggs, larvae, and young of the striped bass (*Roccus saxatilis* (Walbaum)) in connection with the problem of its acclimatization in the U.S.S.R. *J. Ichthyol. (Engl. Transl. Vopr. Ikhtiol.)* 10:235-248.
- , AND J. W. CORNACCHIA. 1979. Initial swim bladder inflation in the larvae of *Tilapia mossambica* (Peters) and *Morone saxatilis* (Walbaum). *Aquaculture* 16:57-66.
- , AND K. HOGAN. 1981. Initial swim bladder inflation in the larvae of physoclistous fishes and its importance for larval culture. *Rapp. P. V. Reun. Cons. Int. Explor. Mer* 178:495-500.
- DOTSU, Y. 1954. On the life history of a goby *Chaenogobius castanea* O'Shaughnessy. *Contrib. Biol. Lab. Sci. Soc. China* 11(6):133-138.
- . 1957. On the bionomics and life history of the eel-like goby, *Odontamblyopus rubicundus* (Hamilton). *Sci. Bull. Fac. Agric. Kyushu Univ.* 16(1):101-110.
- . 1958. The bionomics and larvae of the goboid fishes, *Ctenopoma microcephalus* (Bleeker) and *Taenioides cirratus* (Blyth). *Sci. Bull. Fac. Agric. Kyushu Univ.* 16(3):371-380.
- . 1979. Eggs, larvae, and juveniles of gobioid fishes. *Kaiyo Kagaku (Mar. Sci.)* 11:111-116. (In Japanese.)
- . 1982. The early life history of the combtooth blenny, *Dasson trossulus* and spawnings of the laboratory-reared fish about three months after hatching. *Bull. Fac. Fish. Nagasaki Univ.* 52:19-27. (In Japanese, English summary.)
- , AND S. FUJITA. 1959. The bionomics and life history of the eleotrid fish, *Eleotris oxycephala* Temminck and Schlegel. *Bull. Fac. Fish. Nagasaki Univ.* 8:191-195.
- , AND S. MITO. 1955. On the breeding habits, larvae, and young of a goby, *Acanthogobius flavimanus* (Temminck et Schlegel). *Jpn. J. Ichthyol.* 4:152-161.
- , AND ———. 1963. The bionomics and life history of the eleotrid fish, *Asterropteryx semipunctatus* Ruppell. *Bull. Fac. Fish. Nagasaki Univ.* 15:1-3.
- , AND S. MORIUCHI. 1980. The life history of the blennioid fish, *Blennius yatabei* (Jordan et Snyder). *Bull. Fac. Fish. Nagasaki Univ.* 49:17-24. (In Japanese, English summary.)
- , AND T. OOTA. 1973. The life history of the blennioid fish, *Omobranchus loxozonus*. *Bull. Fac. Fish. Nagasaki Univ.* 36:13-22. (In Japanese, English summary.)
- , AND M. SHIOGAKI. 1971. Larvae, juveniles and young of the gobioid fish, *Astrabe lactisella*. *Jpn. J. Ichthyol.* 18:182-186.

- DOVEL, W. L. 1963. Larval development of clingfish, *Gobiesox strumosus*, 4.0 to 12.0 millimeters in total length. Chesapeake Sci. 4:161-166.
- DRYFOOS, R. L. 1965. The life history and ecology of the longfin smelt in Lake Washington. Unpubl. PhD dissertation, University of Washington.
- DUDNIK, Y. I. 1977. A contribution to the biology of larvae and fry of morwongs (Pisces, Cheilodactylidae) of the Atlantic Ocean. Zool. Zh. 56(11):1658-1667.
- DUMONT, J. N., AND A. R. BRUMMETT. 1980. The vitelline envelope, chorion, and micropyle of *Fundulus heteroclitus* eggs. Gamete Res. 3:25-44.
- DUNBAR, M. J. 1947. Marine young fish from the Canadian eastern Arctic. Bull. Fish. Res. Board Can. 73:1-11.
- DUNCKER, G., AND E. MOHR. 1939. Revision der Ammodytidae. Mitt. Zool. Mus. Berl. 24(1):3-31.
- DUNKELBURGER, D. G., J. M. DEAN AND N. WATABE. 1980. The ultrastructure of the otolithic membrane and otolith in the juvenile mummichog, *Fundulus heteroclitus*. J. Morphol. 163:367-377.
- DUNN, J. R. 1983a. Development and distribution of the young of northern smoothtongue, *Leuroglossus schmidti* (Bathylagidae), in the northeast Pacific, with comments on the systematics of the Genus *Leuroglossus* Gilbert. Fish. Bull. U.S. 81:23-40.
- . 1983b. The utility of developmental osteology in taxonomic and systematic studies of teleost larvae: a review. NOAA Tech. Rep. NMFS Circ 450.
- , AND B. M. VINTER. 1984. Development of larvae of saffron cod, *Eleginus gracilis*, with comments on the identification of gadid larvae in Pacific and Arctic waters contiguous to Canada and Alaska. Can. J. Fish. Aquat. Sci. 41:304-318.
- , AND ———. MS. The developmental osteology of the North Pacific gadid fish, *Theragra chalcogramma*. Unpubl. manuscr., Northwest and Alaska Fisheries Center, National Marine Fisheries Service, NOAA, 2725 Montlake Blvd. E., Seattle, WA 98112.
- DURAND, J. R., AND G. LOUBENS. 1971. Développement embryonnaire et larvaire d'*Alestes baremoze*. Cah. ORSTOM. Ser. Hydrobiol. 5:137-145.
- DUTT, S., AND V. V. RAO. 1960. On the breeding habits and early developmental stages of *Petroscirtes bipunctata* (Day). J. Zool. Soc. India 12:158-161.
- D'VINCENT, S., H. G. MOSER AND E. H. AHLSTROM. 1980. Description of the larvae and early juveniles of the Pacific butterfish, *Peprilus simillimus* (Family Stromateidae). Calif. Coop. Oceanic Fish. Invest. Rep. 21:172-179.
- DYE, J. E. 1980. The production and efficient use of freshly hatched brine shrimp nauplii (*Artemia*) in the larval rearing of marine fish at the hatcheries of the British Whitefish Authority. In: The Brine Shrimp *Artemia*. Vol. 3. G. Persoone, P. Sorgeloos, O. Roels and E. Jaspers (eds.). Universa Press, Wetteren, Belgium.
- EATON, T. H. 1953. Pygmy sunfishes and the meaning of pygmyism. J. Elisha Mitchell Sci. Soc. 69:98-99.
- . 1956. Notes on the olfactory organs in Centrarchidae. Copeia 1956:196-199.
- EBELING, A. W. 1957. The dentition of eastern Pacific mullets, with special reference to adaptation and taxonomy. Copeia 1957:173-185.
- . 1961. *Mugil galapagensis*, a new mullet from the Galapagos Islands, with notes on related species and a key to the Mugilidae of the eastern Pacific. Copeia 1961:295-304.
- . 1962. Melamphidae. I. Systematics and zoogeography of the species in the bathypelagic fish genus *Melamphaes* Gunther. Dana-Rep. Carlsberg Found. 58.
- , AND W. WEED. 1963. Melamphidae. III. Systematics and distribution of the species in the bathypelagic fish genus *Scopelogadus* Vaillant. Dana-Rep. Carlsberg Found. 60.
- , AND ———. 1973. Order Xenoberyces (Sephanoberyci-formes), p. 397-478. In: Fishes of the western North Atlantic. D. M. Cohen (ed.). Mem. Sears Found. Mar. Res. No. 1 (Pt. 6).
- EFREMIENKO, V. N. 1978. A description of the larvae of *Notolepis coatsi* (Paralepididae, Pisces). J. Ichthyol. (Engl. Transl. Vopr. Ikhtiol.) 18:500-504.
- . 1983a. Atlas of fish larvae from the Southern Ocean. Cybium, 3e Ser. 7(2):1-74.
- . 1983b. Description of eggs and larvae of *Muraenolepis microps* Lonnberg (Muraenolepidae) from the Scotia Sea. J. Ichthyol. (Engl. Transl. Vopr. Ikhtiol.) 23(1):139-142.
- , A. N. KOTLYAR AND L. A. LISOVENKO. 1981. Sex cycles, fecundity, and distribution of "limbless" soles of family Bothidae from the southwestern Atlantic. J. Ichthyol. (Engl. Transl. Vopr. Ikhtiol.) 21(6):89-99.
- , AND L. A. LISOVENKO. 1970. Morphological features of intraovarian and pelagic larvae of some *Sebastes* species inhabiting the Gulf of Alaska, p. 267-286. In: Soviet fisheries investigations in the northeast Pacific. Part V. P. A. Moiseev (ed.). (Transl. from Russian; available from: NTIS, Springfield, VA TT71-50127.)
- EGE, V. 1918. Stomiidae. Rep. Dan. Oceanogr. Exped. Mediterr. 2(A.4).
- . 1930. Sudidae (*Paralepis*). Rep. Dan. Oceanogr. Exped. Mediterr. 2(A.13).
- . 1953. Paralepididae I (*Paralepis* and *Lestidium*). Taxonomy, ontogeny, phylogeny and distribution. Dana-Rep. Carlsberg Found. 40.
- . 1957. Paralepididae II (*Macroparalepis*). Taxonomy, ontogeny, phylogeny and distribution. Dana-Rep. Carlsberg Found. 43.
- . 1958. *Omosudis* Gunther, bathypelagic genus of fish. Dana-Rep. Carlsberg Found. 47.
- EGGERT, B. 1932. Zur Kenntnis der Biologie, der sekundären Geschlechtsmerkmale und des Eies von *Blennius pavo* (Risso). Z. Morphol. Oekol. Tiere 24:682-703.
- EHRENBAUM, E. 1894. Beiträge zur Naturgeschichte einiger Elbfische. (*Osmerus eperlanus* L., *Chupea finta* Cuv., *Acerina cernua* L., *Acipenser sturio* L.). Wiss. Meeresunters. (Helgol.) 1(Pt. 1):35-82. (Cited in: W. C. Kendall. 1927. The smelts. Bull. Bur. Fish. Wash. 42(1926):217-375.)
- . 1897. Eier und Larven von Fischen der Deutschen Bucht. Wiss. Meeresunters. (Helgol.) 2:253-324.
- . 1904. Eier und Larven von Fischen der Deutschen Bucht. III. Fische mit festsitzenden Eiern. Wiss. Meeresunters. (Helgol.) N.F. 6:127-200.
- . 1905-1909. Eier und Larven von Fischen. Nord. Plankton 1 and 2.
- , AND S. STRODTMANN. 1904. Eier und Jugendformen der Ostseefische. Wiss. Meeresunters. (Helgol.) 6:57-126.
- EHRICH, S. 1976. Zur Taxonomie, Ökologie und Wachstum von *Macrorhamphosus scolopax* (Linnaeus, 1758) (Pisces, Syngnathiformes) aus dem subtropischen Nordostatlantik. Ber. Dtsch. Wiss. Komm. Meeresforsch. 24:523-537.
- EHRlich, K. F., J. H. S. BLAXIER AND R. PEMBERTON. 1976. Morphological and histological changes during the growth and starvation of herring and plaice larvae. Mar. Biol. 35:105-118.
- EIGENMANN, C. H. 1902. The egg and development of the conger eel. Bull. U.S. Fish Comm. 21:37-44.
- . 1928. The freshwater fishes of Chile. Mem. Natl. Acad. Sci. 22:1-80.
- EINARSSON, H. 1951. The post-larval stages of sandeels in Faroe, Iceland, and W-Greenland waters. Acta Nat. Isl. 1(7):5-75.
- . 1955. On the post-larval stages of *Ammodytes lancea* (Cuvier). Acta Nat. Isl. 2(1):3-7.
- , AND B. ROJAS DE MENDIOLA. 1963. Descripción de huevos y larvas de anchoveta Peruana (*Engraulis ringens* J.). Bol. Inst. Mar Peru (Callao) 1.
- ELDRED, B. 1967a. Larval bonefish, *Albula vulpes* (Linnaeus, 1758) (Albulidae) in Florida and adjacent waters. Fla. Board Conserv. Mar. Res. Lab. Leaf. Ser. 4 (Pt. 1, No. 3).
- . 1967b. Larval tarpon, *Megalops atlanticus* Valenciennes (Megalopidae) in Florida waters. Fla. Board Mar. Res. Lab. Leaf. Ser. 4 (Pt. 1, No. 4).
- . 1968. The larval development and taxonomy of the pygmy

- moray eel, *Anarchias yoshuae* Kanazawa 1952. Fla. Board Conserv. Mar. Res. Lab. Leaflet Ser. 4 (Pt. 1, No. 10).
- . 1969. Embryology and development of the Blackedge moray *Gymnothorax nigromarginatus* (Girard, 1859). Fla. Board Conserv. Mar. Res. Lab. Leaflet Ser. 4 (Pt. 1, No. 13).
- . 1972. Note on larval tarpon, *Megalops atlanticus* (Megalopidae), in the Florida Straits. Fla. Dep. Nat. Resour. Mar. Res. Lab. Leaflet Ser. 4 (Pt. 1, No. 22).
- , AND W. G. LYONS. 1966. Larval ladyfish, *Elops saurus* Linnaeus 1766, (Elopidae) in Florida and adjacent waters. Fla. Board Conserv. Mar. Res. Lab., Leaflet Ser. 4 (Pt. 1, No. 2).
- ELDRIDGE, M. B. 1970. Larval fish survey of Humboldt Bay. Unpubl. MS thesis. Humboldt State Univ., Arcata, CA.
- . 1975. Early larvae of the diamond turbot, *Hypsopsetta guttulata*. Calif. Fish Game 61:26-34.
- ELSTON, R., L. CORAZZA AND J. G. NICKUM. 1981. Morphology and development of the olfactory organ in larval walleye, *Stizostedion vitreum*. Copeia 1981:890-893.
- EMERY, A. 1973. Biology survey—summer expedition. In: Arctic Div. Adv. Comm. Nor. Dev., No. 60, Govt. Canada, Ottawa.
- EMERY, C. 1879. Le metamorfosi del *Trachipterus taenia*. Mitt. Zool. Sta. Neapel 1:58-588.
- . 1880. Le specie del genere *Fierasfer* nel golfo di Napoli e regione limitrofe. Fauna Flora Golf. Neapel 2:1-76.
- . 1886. Contribuzioni all'ittologia. XVII. Larva di genere ignoto. Mitt. Zool. Sta. Neapel 6:149-164.
- ENG, C. T. 1969. Early development of the glassfish (*Ambassis kopsu* Blk). J. Singapore Natl. Acad. Sci. 1(2):37-44.
- ENGEN, P. C. 1968. Organogenesis in the walleye surfperch, *Hyperpropon argenteum* (Gibbons). Calif. Fish Game 54:156-169.
- ERDAHL, D. A., AND E. F. GRAHM. 1980. Preservation of gametes of freshwater fish, p. 317-336. In: Proc. 9th International Congress on Animal Reproduction and A.I. Vol. II, Round Tables, Invited Guests. Madrid, Spain.
- ESCHMEYER, W. N., AND B. B. COLLETTE. 1966. The scorpionfish subfamily Setarchinae, including the genus *Ectreposebastes*. Bull. Mar. Sci. 16:349-375.
- , E. HERALD AND H. HAMMANN. 1983. A field guide to Pacific Coast fishes of North America. Peterson Field Guide Series 28. Houghton Mifflin Co., Boston.
- , AND J. C. HUREAU. 1971. *Sebastes mouchezi*, a senior synonym of *Helicolenus tristanensis*, with comments on *Sebastes capensis* and zoogeographical considerations. Copeia 1971:576-579.
- ESPINOSA, F. A. 1968. Spawning periodicity and fecundity of *Crenichthys baileyi*, a fish endemic to Nevada. Unpubl. MS thesis. Nevada South. Univ., Las Vegas.
- ESTABROOK, G. F., C. S. JOHNSON, JR. AND F. R. MCMORRIS. 1976. A mathematical foundation for the analysis of cladistic character compatibility. Math. Biosci. 29:181-187.
- EVANS, J. W. 1962. Normal stages of the early development of the flying fish, *Hirundichthys affinis* (Gunther). Bull. Mar. Sci. Gulf Carib. 11(4):483-502.
- EVANS, R. R. 1973. The swimbladder and associated structures in western Atlantic sea robins (Triglidae). Copeia 1973:315-321.
- EVERMANN, B. W., AND W. C. KENDALL. 1898. Descriptions of new or little known genera and species of fishes from the United States. Bull. U.S. Fish. Comm. 17:125-133.
- EVERSON, I. 1968. Larval stages of certain Antarctic fishes. Bull. Br. Antarct. Surv. 16:65-70.
- . 1970. Reproduction in *Notothema neglecta* Nybelin. Bull. Br. Antarct. Surv. 33:81-92.
- EVSEENKO, S. A. 1977. Larval *Engyophrys sentus* Ginsburg, 1933 (Pisces, Bothidae) from the American Mediterranean Sea. Coop. Invest. Carib. Adjac. Reg.—II. FAO Fish. Rep. 200:171-185.
- . 1979. Larvae of the flounder *Cyclopsetta* Gill, 1888 (Bothidae, Pisces) from the north-western Atlantic. Biol. Morya (Vladivost.) 2:67-75.
- . 1981. On the sinistral flatfish larvae (Scophthalmidae, Bothidae, Pisces) from the west Atlantic, p. 593-594. In: The early life history of fish. Recent studies. R. Lasker and K. Sherman (eds.). Rapp. P. V. Reun. Cons. Int. Explor. Mer 178.
- . 1982a. Eco-morphological peculiarities of the early life history of flatfishes of the western North Atlantic. Proc. Ichthyoplankton and Nekton of the World Ocean. P. P. Shirshov Inst. Oceanol. Acad. Sci. USSR. 118:43-84.
- . 1982b. Ichthyoplankton of slope and Gulf Stream waters off Nova Scotia in late autumn 1974. J. Northwest Atl. Fish. Sci. 3:127-139.
- FABER, D. J. 1970. Ecology of larval whitefishes in Lake Huron, p. 481-500. In: Biology of coregonid fishes. C. C. Lindsey and D. S. Woods (eds.). Univ. Manitoba Press, Winnipeg.
- . 1976. Identification of four northern blennioid fish larvae in the Canadian Atlantic Ocean (Stichaeidae, Lumpenidae). J. Fish. Res. Board Can. 33:1798-1802.
- . 1982. Fish larvae caught by a light-trap at littoral sites in Lac Heney, Quebec, 1979 and 1980, p. 42-46. In: Proc. 5th Annual Larval Fish Conference. La. Coop. Fish. Res. Unit, Baton Rouge, LA.
- FABRE-DOMERGUE, P., AND E. BIÉTRIX. 1905. Développement de la Sole (*Solea vulgaris*). Trav. Lab. Zool. Mar. Concarneau.
- FACCIOLEA, L. 1882. La forma giovanile del *Phycis blennioides*. Nota. Nat. Siciliano (Palermo) 2:25-29.
- FAGE, L. 1910. Recherches sur les Stades pélagiques de quelques Téléostéens de la mer de Nice (Parages de Monaco) et du Golfe du Lion. Anns. Inst. Oceanogr. (Monaco) 1, Fasc. 7.
- . 1918. Shore Fishes. Rep. Dan. Oceanogr. Exped. Mediterr. 2(A.3).
- FAHAY, M. P. 1975. An annotated list of larval and juvenile fishes captured with surface-towed meter net in the south Atlantic Bight during four R/V Dolphin cruises between May 1967 and February 1968. NOAA Tech. Rept. NMFS SSRF 685.
- . 1983. Guide to the early stages of marine fishes occurring in the western North Atlantic Ocean, Cape Hatteras to the southern Scotian Shelf. J. Northwest. Atl. Fish. Sci. 4.
- , AND P. BERRIEN. 1981. Preliminary description of larval tilefish (*Lopholatilus chamaeleonticeps*). Rapp. P. V. Cons. Int. Explor. Mer 178:600-602.
- , AND C. L. OBENCHAIN. 1978. Leptocephali of the ophichthid genera *Ahlia*, *Myrophis*, *Ophichthus*, *Pisodonophis*, *Callechelys*, *Letharchus*, and *Apterichtus* on the Atlantic continental shelf of the United States. Bull. Mar. Sci. 28:442-486.
- FAHY, W. E. 1982. The influence of temperature change on number of pectoral fin rays developing in *Fundulus majalis* (Walbaum). J. Cons. Int. Explor. Mer 40:21-26.
- FANARA, D. M. 1964. Notes on the biology of a salt marsh minnow. Proc. N.J. Mosq. Exterm. Assoc. 51:152-159.
- FANGE, R. 1958. The structure and function of the gas-bladder in *Argentina silus*. Q. J. Microsc. Sci. 99:95-102.
- F.A.O. 1983. Catches and landings 1981. Yearbook of fishery statistics, 52. FAO, Rome.
- FARRIS, J. S. 1970. Methods for computing Wagner trees. Syst. Zool. 19:83-92.
- , A. G. KLUGE AND M. J. ECKARDT. 1970. A numerical approach to phylogenetic systematics. Syst. Zool. 19:172-191.
- FARRUGIO, H. 1977. Clés commentées pour la détermination des adultes et des alevins de Mugilidae de Tunisie. Cybium, 3rd Ser. (2):57-73.
- FAST, T. N. 1960. Some aspects of the natural history of *Stenobranchius leucopsarus* Eigenmann and Eigenmann. Unpubl. PhD dissertation. Stanford Univ., Stanford, CA.
- FEDOROV, V. V. 1975. Description of a new genus and species of zoarcid fish, *Puzanovia rubra*, gen. et sp. n. (Pisces, Zoarcidae) from the northern Pacific Ocean. J. Ichthyol. (Engl. Transl. Vopr. Ikhtiol.) 15:527-531.
- . 1982. A new eelpout, *Hadropogonichthys lindbergi* Fedorov, gen. et sp. nov. (Zoarcidae), from the bathyal depths of the fourth

- Kurile Strait. *J. Ichthyol. (Engl. Transl. Vopr. Ikhtiol.)* 22(5):16-23.
- , AND A. V. NEYLOV. 1978. A new genus and species of celpout, *Andriashveia aptera* (Perciformes, Zoarcidae). *J. Ichthyol. (Engl. Transl. Vopr. Ikhtiol.)* 18:846-850.
- FEDOTOV, V. F. 1976. Gadidae of the Palaeogene-Neogene from the USSR. *Tr. Paleontol. Inst. Akad. Nauk SSSR* 157.
- FIELDS, H. M. 1962. Pompanos (*Trachinotus* spp.) of South Atlantic coast of the United States. U.S. Fish Wildl. Serv. Fish. Bull.
- FIERSTINE, H. L. 1972. The paleontology of billfish—the state of the art, p. 34-44. *In: Proc. Internat. Billfish Symp., Kailua-Kona, Hawaii, 9-12 August 1972, Part 2. Review and contributed papers.* R. S. Shomura and F. Williams (eds.). NOAA Tech. Rep. NMFS SSRF-675.
- FINK, S. V., AND W. L. FINK. 1981. Interrelationships of the ostariphsyan fishes (Teleostei). *Zool. J. Linn. Soc.* 72:297-353.
- FINK, W. L. 1981. Ontogeny and phylogeny of tooth attachment modes in actinopterygian fishes. *J. Morphol.* 167:167-184.
- . 1982. The conceptual relationship between ontogeny and phylogeny. *Paleobiology* 8:254-264.
- , K. E. HARTEL, W. G. SAUL, E. M. MOON AND E. O. WILEY. MS. A report on current supplies and practices used in curation of ichthyoplankton collections. Am. Soc. Ichthyol. & Herpetol. Mimeo.
- , AND S. H. WEITZMAN. 1982. Relationships of the stomiiform fishes (Teleostei), with a description of *Diplophos*. *Bull. Mus. Comp. Zool. Harv. Univ.* 150(2):31-93.
- FISCHER, W. K. 1958a. Primeras fases del desarrollo del blanquillo (*Prolatilus jugularis*) Cuv. et Val. (Pisces). *Rev. Biol. Mar.* 8:3-24.
- . 1958b. Huevos, crías y primeras prelarvas de la "anchoveta" (*Engraulis ringens*) Jenyns. *Rev. Biol. Mar. (Chile)* 8:111-124.
- . 1959. Huevos, crías y prelarvas de la merluza. *Rev. Biol. Mar.* 9(1,2,3):229-249.
- . 1963. Die Fische des Brackwassergebietes Lenga bei Concepcion (Chile). *Int. Rev. Gesamten Hydrobiol.* 48:419-511.
- FISH, M. P. 1928. Contributions to the embryology of the American eel (*Anguilla rostrata* Lesueur). *Zoologica (N.Y.)* 8:289-324.
- . 1932. Contributions to the early life histories of sixty-two species of fishes from Lake Erie and its tributary waters. *Bull. Bur. Fish. Wash.* 47(10):293-398.
- FISHELSON, L. 1963. Observations on littoral fishes of Israel. II. Larval development and metamorphosis of *Blennius pavo* (Risso) (Teleostei, Blenniidae). *Isr. J. Zool.* 12:81-91.
- . 1975. Ethology and reproduction of pteroid fishes found in the Gulf of Aqaba (Red Sea), especially *Dendrochirus brachypterus* (Cuvier), (Pteroidae, Teleostei). *Publ. Staz. Zool. Napoli* 39 (Suppl.): 635-656.
- . 1976. Spawning and larval development of the blennioid fish, *Meiacanthus nigrolineatus* from the Red Sea. *Copeia* 1976:798-800.
- FITCH, J. E. 1964. The ribbonfishes (Family Trachipteridae) of the eastern Pacific Ocean, with a description of a new species. *Calif. Fish Game* 50:228-240.
- . 1966. The unicornfish, *Eumecichthys fiski* (Gunther) in the Eastern Tropical Pacific. *Calif. Fish Game* 52:208-210.
- . 1967. The tapertail ribbon-fish (*Trachipterus fukuzakii* Fitch) added to the marine fauna of California. *Calif. Fish Game* 53:298-299.
- . 1982. Revision of the eastern North Pacific anthiine basses (Pisces: Serranidae). *Contrib. Sci. (Los Ang.)* 339.
- , AND L. W. BARKER. 1972. The fish family Moridae in the eastern North Pacific with notes on morid otoliths, caudal skeletons, and the fossil record. *Fish. Bull. U.S.* 70:565-584.
- , AND R. J. LAVENBERG. 1968. Deep-water fishes of California. Univ. Calif. Press, Berkeley.
- , AND ———. 1975. Tidepool and nearshore fishes of California. Univ. Calif. Press, Berkeley.
- FIVES, J. M. 1970a. Blenniidae of the North Atlantic. *Cons. Int. Explor. Mer. Fiches Identification Oeufs Poissons* 3.
- . 1970b. Investigations of the plankton of the west coast of Ireland. IV. Larval and post-larval stages of fishes taken from the plankton of the west coast in surveys during the years 1958-1966. *Proc. R. Ir. Acad. Sect. B* 70:15-93.
- FLEGLER, C. 1977. Electron microscopic studies on the development of the chorion of the viviparous teleost *Dermogenys pusillus* (Hemirhamphidae). *Cell Tissue Res.* 179:255-270.
- FOERSCH, W. 1966. Spawning *Phractura ansorgei*. *Trop. Fish Hobby.* 1966 (April):4-6, 8-9.
- FOLLETT, W. I. 1952. Annotated list of fishes obtained by the California Academy of Sciences during six cruises of the U.S.S. Mulberry conducted by the U.S. Navy of Central California in 1949 and 1950. *Proc. Calif. Acad. Sci., Ser. 4.* 27:399-432.
- FORD, E. 1922. On the young stages of *Blennius ocellaris* (L.), *Blennius pholis* (L.), and *Blennius gattorugne* (L.). *J. Mar. Biol. Assoc. U.K.* 12:688-692.
- FOREY, P. L. 1973a. A revision of elopiform fishes, fossil and recent. *Bull. Br. Mus. (Nat. Hist.) Geol. Suppl.* 10.
- . 1973b. Relationships of elopomorphs, p. 351-368. *In: Interrelationships of fishes.* P. H. Greenwood, R. S. Miles and C. Patterson (eds.). *Zool. J. Linn. Soc.* 53(Suppl. 1).
- FORSTER, R. P., AND S. K. HONG. 1958. *In vitro* transport of dyes by isolated renal tubules of the flounder as disclosed by direct visualization: Intracellular accumulation and transcellular movement. *J. Cell. Comp. Physiol.* 51:259-272.
- FOSTER, N. R. 1967. Comparative studies on the biology of killifishes (Pisces: Cyprinodontidae). Unpubl. PhD dissertation. Cornell University, NY.
- . 1968. Utility of egg and larval characters in the classification of atheriniform fishes. *Am. Zool.* 8:338.
- . 1969. Field and aquarium observations on *Chriopeoides pengelleyi* Fowler, 1939. The Jamaican killifish. *J. Am. Killifish Assoc.* 6(1):17-25.
- . 1973. Behavior, development, and early life history of the Asian needlefish, *Xenentodon cancila*. *Proc. Acad. Nat. Sci. Phila.* 125(5):77-88.
- . 1974. Cyprinodontidae, p. 127-141. *In: Manual for identification of early developmental stages of fishes of the Potomac River estuary.* A. J. Lippson and R. L. Moran (eds.). Power Plant Siting Program of Md. Dep. Nat. Resour. PPSP-MP-13.
- . 1982. Literature review. *J. Am. Killifish Assoc.* 15(1):4-9.
- , AND L. FUIMAN. MS. Ecology, behavior, and early life history of the lyre goby, *Evorthodus lyricus*.
- FOURMANOIR, P. 1970. Notes ichthyologiques (1). *Cah. ORSTOM Ser. Oceanogr.* 8:19-33.
- . 1971a. Notes ichthyologiques (3). *Cah. ORSTOM Ser. Oceanogr.* 9:267-278.
- . 1971b. Notes ichthyologiques (4). *Cah. ORSTOM Ser. Oceanogr.* 9:491-500.
- . 1973. Notes ichthyologiques (5). *Cah. ORSTOM Ser. Oceanogr.* 11:33-39.
- . 1976. Formes post-larvaires et juvéniles de poissons côtiers pris au chalut pélagique dans le sud-ouest Pacifique. *Cah. Pac.* 19: 47-48.
- FOWLER, H. W. 1934. Descriptions of new fishes obtained 1907 to 1910, chiefly in the Philippine islands and adjacent seas. *Proc. Acad. Nat. Sci. Phila.* 85:233-267.
- . 1936. Carangidae, p. 675-756. *In: The marine fishes of West Africa.* *Bull. Am. Mus. Nat. Hist.* 70(2).
- . 1944. The fishes, p. 57-583. *In: Results of the Fifth George Vanderbilt expedition (1941).* *Monogr. Acad. Nat. Sci. Phila.* 6.
- . 1945. A study of the fishes of the southern Piedmont and coastal plain. *Monogr. Acad. Nat. Sci. Phila.* 7.
- FRANCIS, M. P. 1981. Meristic and morphometric variation in the lancetfish, *Alepisaurus*, with notes on the distribution of *A. ferocis* and *A. brevirostris*. *N.Z. J. Zool.* 8:403-408.

- FRANK, K. T., AND W. C. LEGGETT. 1983. Multispecies larval fish associations: Accident or adaptation? *Can. J. Fish. Aquat. Sci.* 40: 754-762.
- FRANK, S. 1972. Entwicklung der Eier des Langflossensalmers *Bryconalestes longipinnis* (Günther, 1864) (Pisces: Characinoidei). *Vestn. Cesk. Spol. Zool.* 36:237-240.
- . 1978. Beobachtung der Embryonalentwicklung. Beispiel: das Fischei. *Mikrokosmos* 1978:251-255.
- FRANKE, H.-J. 1979. Algenbekämpfung ohne Chemic, Zucht des algenfressenden Antennenwelses *Ancistrus* spec. *Aquarien Mag.* 1975: 216-221.
- . 1981. *Ctenolucius hujeta* (Valenciennes in Cuvier and Valenciennes, 1849). *Aquarien Terrarien* 28:345-348.
- FRASER, T. H. 1971. The fish *Dinolestes lewini* with comments on its osteology and relationship. *Jpn. J. Ichthyol.* 18:157-163.
- . 1972a. Comparative osteology of the shallow water cardinal fishes (Perciformes: Apogonidae) with reference to the systematics and evolution of the family. *Rhodes Univ. J. L. B. Smith Inst. Ichthyol. Bull.* No. 34.
- . 1972b. Some thoughts about the teleostean fish concept—the Paracanthopterygii. *Jpn. J. Ichthyol.* 19:232-242.
- , AND M. M. SMITH. 1974. An exterilium larval fish from South Africa with comments on its classification. *Copeia* 1974:886-892.
- FRASER-BRUNNER, A. 1931. Some interesting West African fishes, with descriptions of a new genus and two new species. *Ann. Mag. Nat. Hist., Ser.* 8(45):217-225.
- . 1949. A classification of the fishes of the family Myctophidae. *Proc. Zool. Soc. Lond.* 118(4):1019-1106.
- . 1950. Studies in plectognath fishes from the "Dana" Expeditions. I. An interesting new genus of triacanthodid fishes from the Celebes Sea. *Dana-Rep. Carlsberg Found.* 35:1-8.
- FREEMAN, H. W. 1951. Contribution to the evolution and classification of the fishes of the family Agonidae. Unpubl. PhD dissertation. Stanford Univ., Stanford, CA.
- FREIHOFER, W. C. 1963. Patterns of the ramus lateralis accessorius and their systematic significance in teleostean fishes. *Stanford Ichthyol. Bull.* 8:80-189.
- . 1970. Some nerve patterns and their systematic significance in paracanthopterygian, salmoniform, gobioid, and apogonid fishes. *Proc. Calif. Acad. Sci., Ser. 4.* 38:215-264.
- . 1978. Cranial nerves of a percoid fish, *Polycentrus schomburgku* (family Nandidae), a contribution to the morphology and classification of the order Perciformes. *Occas. Pap. Calif. Acad. Sci.* 128.
- FRICKE, H. W. 1980. Mating systems, maternal and biparental care in triggerfish (Balistidae). *Z. Tierpsychol.* 53(2):105-122.
- FRICKE, R. 1980. Neue Fundorte und noch nicht beschriebene Geschlechtsunterschiede einiger Arten der Gattung *Callionymus* (Pisces, Perciformes, Callionymidae), mit Bemerkungen zur Systematik innerhalb dieser Gattung und Beschreibung einer neuen Untergattung und einer neuen Art. *Ann. Mus. Civ. Stor. Nat. Giacomo Doria* 83:57-105.
- . 1981a. Revision of the genus *Synchiropus* (Teleostei: Callionymidae). *J. Cramer, Braunschweig, F.R.G.*
- . 1981b. The *katanus*-group of the genus *Callionymus* (Pisces: Callionymidae), with descriptions of six new species. *Proc. Cal. Acad. Sci.* 42:349-377.
- FRIDGEIRSSON, E. 1978. Embryonic development of five species of gadoid fishes in Icelandic waters. *Rit Fiskideildar* 5.
- FRITZSCHE, R. A. 1978. Development of fishes of the Mid-Atlantic Bight. An atlas of egg, larval and juvenile stages. Vol. V. Chaetodontidae through Ophididae. *U.S. Fish Wildl. Ser. Biol. Serv. Prog. FWS OBS-78-12.*
- . 1980. Revision of the eastern Pacific Syngnathidae (Pisces: Syngnathiformes), including both recent and fossil forms. *Proc. Calif. Acad. Sci.* 42(6):181-227.
- . 1982. Osteichthyes, p. 858-944. *In: Synopsis and classification of living organisms.* S. P. Parker (ed.), McGraw-Hill, Inc., New York.
- , AND G. D. JOHNSON. 1980. Early osteological development of white perch and striped bass with emphasis on identification of their larvae. *Trans. Am. Fish. Soc.* 109:387-406.
- FROST, B. W., AND L. E. McCRONE. 1979. Vertical distribution, diel vertical migration and abundance of some mesopelagic fishes in the eastern subarctic Pacific Ocean. *Fish. Bull. U.S.* 76:751-770.
- FUJMAN, L. A. 1976. Notes on the early development of the sea raven, *Hemirhamphus americanus*. *Fish. Bull. U.S.* 74:467-470.
- . 1979. Descriptions and comparisons of catostomid fish larvae: northern Atlantic drainage species. *Trans. Am. Fish. Soc.* 108:560-603.
- . 1982a. Correspondence of myomeres and vertebrae and their natural variability during the first year of life in yellow perch, p. 56-69. *In: Proceedings of the Fifth Annual Larval Fish Conference.* C. F. Bryan, J. V. Conner and F. M. Truesdale, (eds.), Louisiana Cooperative Fishery Research Unit, Louisiana State University, Baton Rouge, LA.
- . 1982b. Family Esocidae, pikes, p. 155-193. *In: Identification of larval fishes of the Great Lakes Basin with emphasis on the Lake Michigan drainage.* N. A. Auer (ed.), Ann Arbor, Michigan, Great Lakes Fish. Comm. Spec. Publ. 82-3.
- . 1983a. Analysis of egg and larval characters for their use in the systematics of ostariophysan fishes. Unpubl. PhD dissertation. University of Michigan, Ann Arbor, MI.
- . 1983b. Growth gradients in fish larvae. *J. Fish Biol.* 23(1): 117-123.
- , J. V. CONNER, B. F. LATHROP, G. L. BUYNACK, D. E. SNYDER AND J. J. LOOS. 1983. State of the art of identification for cyprinid fish larvae from eastern North America. *Trans. Am. Fish. Soc.* 112(2B):319-322.
- FUJITA, K. 1971. Early development of the squamation in *Tilapia sparrmanni*. *Jpn. J. Ichthyol.* 18:90-93.
- FUJITA, S. 1955. On the development and prelarval stages of the file-fish, *Monacanthus tomentosus* Temminck et Schlegel. *Sci. Bull. Fac. Agri. Kyushu Univ.* 15(2):229-234. (In Japanese, English summary.)
- . 1957a. On the development and prelarval stage of a damselfish, *Chromis notatus* (Temminck et Schlegel). *Jpn. J. Ichthyol.* 6: 87-90.
- . 1957b. On the larval stages of a scorpaenid fish, *Sebastes pachycephalus nigricans* (Schmidt). *Jap. J. Ichthyol.* 6:91-93. (In Japanese, English summary.)
- . 1958. On the egg development and larval stages of a viviparous scorpaenid fish, *Sebastes oblongus* Gunther. *Bull. Jpn. Soc. Sci. Fish.* 24:475-479. (In Japanese, English summary.)
- . 1959. On the egg development of a viviparous scorpaenid fish *Sebastes pachycephalus nigricans* (Schmidt). *J. Jpn. Assoc. Zool. Gardens and Aquariums* 1(2):42-43.
- . 1960. Egg development and prelarval stages of a silver-belly, *Leiognathus nuchalis* (Temminck et Schlegel). *Bull. Jap. Soc. Sci. Fish.* 26:1091-1094.
- . 1962. Studies on the life history of common pufferfishes in Japan. *Rep. Nagasaki Prefect. Fish. Res. Stn.* 2. (In Japanese.)
- . 1965. Early development and rearing of two common flatfishes, *Eopsetta grigorjewi* (Herzenstein) and *Tanakius kutaharat* (Jordan et Starks). *Bull. Jpn. Soc. Sci. Fish.* 31:258-262.
- . 1966. Egg development, larval stages and rearing of the puffer, *Lagocephalus lunaris spadiceus* (Richardson). *Jpn. J. Ichthyol.* 13: 162-168. (In Japanese, English summary.)
- , AND S. MITO. 1960. Egg development and hatched larvae of a chaetodontid fish, *Chaetodontoplus septentrionalis* (Temminck et Schlegel). *Bull. Jap. Soc. Sci. Fish.* 26:227-29. (In Japanese, English abstract.)
- , AND K. NAKAHARA. 1955. On the development of the egg and the prelarval stages of a scorpaenid fish, *Inimicus japonicus* (Cuvier et Valenciennes). *Sci. Bull. Fac. Agric. Kyushu Univ.* 15:223-228. (In Japanese, English summary.)
- , AND T. TAKITA. 1965. Egg development and prelarval stages

- of a sole, *Arechiscus trigrammus* (Gunther). Bull. Jpn. Soc. Sci. Fish. 31:488-492. (In Japanese, English abstract.)
- , AND K. UCHIDA. 1957. On the development of the egg and prelarval stages of a sole, *Cynoglossus robustus* Gunther. Sci. Bull. Fac. Agric. Kyushu Univ. 16:319-322. (In Japanese, English summary.)
- , AND M. UENO. 1954. On the development of the egg and prelarval stages of *Siganus fuscescens* (Houttuyn) by artificial insemination. Jpn. J. Ichthyol. 3:129-132.
- FUKUHARA, O. 1971. Development of eggs and larvae of *Agrammus agrammus*. Suisan Yoshoka 19:159-165. (In Japanese.)
- , AND K. ITO. 1978. On the formation of the fins and squamation in the Japanese parrot fish, *Oplegnathus fasciatus* reared in the laboratory. Bull. Nansei Reg. Fish. Res. Lab. 11:9-17.
- FUKUSHO, K. 1975. Development of color pattern in *Oplegnathus fasciatus*, useful indicator in rearing. Jpn. J. Ichthyol. 22:23-30.
- FULTON, T. W. 1898. The ovaries and ovarian eggs of the angler or frog-fish (*Lophius piscatorius*) and of the John Dory (*Zeus faber*). Ann. Rep. Fish. Board Scotl. 16:125-134.
- FURUKAWA, I. 1951. Clupeoid fry possibly referable to *Gonorynchus abbreviatus* Temminck et Schlegel. Jpn. J. Ichthyol. 4:292-294. (In Japanese, English summary.)
- FUSTER DE PLAZA, M. L., AND J. C. PLAZA. 1955. Nuevos ensayos para obtener la reproducción artificial de las percas o truchas criollas (*Percichthys* sp.). Misc. Publ. Minist. Agric. Ganad. (Buenos Aires) 407.
- FUTCH, C. R. 1971. Larvae of *Monolene sessilicauda* Goode, 1880 (Bothidae). Fla. Dep. Nat. Resour. Leaf. Ser. 4 (Pt. 1, No. 21).
- . 1977. Larvae of *Trichopsetta ventralis* (Pisces: Bothidae), with comments on intergeneric relationships within the Bothidae. Bull. Mar. Sci. 27:740-757.
- , AND F. H. HOFF, JR. 1971. Larval development of *Syacium papillosum* (Bothidae) with notes on adult morphology. Fla. Dep. Nat. Resour. Leaf. Ser. 4 (Pt. 1, No. 20).
- , R. W. TOPP AND E. D. HOUDE. 1972. Developmental osteology of the lined sole, *Achirus lineatus* (Pisces: Soleidae). Contrib. Mar. Sci. 16:33-58.
- GABRIEL, M. L. 1944. Factors affecting the number and form of vertebrae in *Fundulus heterochilus*. J. Exp. Zool. 95:105-143.
- GAMBLE, J. C., AND E. D. HOUDE. 1984. Growth, mortality and feeding of cod (*Gadus morhua* L.) larvae in enclosed water columns and in laboratory tanks, p. 123-143. In: The propagation of cod. E. Dahl, D. Danielsen, E. Moksness and P. Solemdal (eds.). Flodevigen Rapp. 1.
- , P. MACLACHLAN, N. T. NICOLL AND I. G. BAXTER. 1981. Growth and feeding of Atlantic herring reared in large plastic enclosures. Rapp. P. V. Reun. Cons. Int. Explor. Mer 178:121-134.
- GARMAN, S. 1892. The discoboli. Mem. Mus. Comp. Zool. Harv. 14(2):1-96.
- GARNAUD, J. 1960. La ponte, l'éclosion, la larve du baliste *Balistes capricus* Linne 1758. Bull. Inst. Oceanogr. Monaco 1081:1-6.
- GARRETT, G. P. 1982. Variation in the reproductive traits of the Pecos pupfish, *Cyprinodon pecosensis*. Am. Midl. Nat. 180:355-363.
- GATESOUBE, F.-J., AND P. LUQUET. 1981. Practical diet for mass culture of the rotifer *Brachionus plicatilis*: application to larval rearing of sea bass, *Dicentrarchus labrax*. Aquaculture 22:149-163.
- , AND J. ROBIN. 1981. Commercial single-cell proteins either as sole food source or in formulated diets for intensive and continuous production of rotifers (*Brachionus plicatilis*). Aquaculture 25:1-15.
- GAULDIE, R. W., E. J. GRAYNOOTH AND J. ILLINGWORTH. 1980. The relationship of the iron content of some fish otoliths to temperature. Comp. Biochem. Physiol. 66:19-24.
- GIFFEN, A. 1982. Otolith ring deposition in relation to growth rate in herring (*Clupea harengus*) and turbot (*Scophthalmus maximus*) larvae. Mar. Biol. 71:317-326.
- GEHRINGER, J. W. 1959a. Early development and metamorphosis of the ten-pounder *Elops saurus* Linnaeus. U.S. Fish Wildl. Serv. Fish. Bull. 59(155):619-647.
- . 1959b. Leptocephalus of the Atlantic tarpon, *Megalops atlanticus* Valenciennes, from offshore waters. Q. J. Fla. Acad. Sci. 21(3):235-240.
- GEORGE, A., AND V. G. SPRINGER. 1980. Revision of the clinid fish tribe Ophiellini, including five new species, and definition of the family Clinidae. Smithson. Contrib. Zool. 307:1-31.
- GERKING, S. D., AND R. R. RAUSCH. 1979. Relative importance of size and chronological age in the life programme of fishes. Arch. Hydrobiol. 13:181-194.
- GÉRY, J. 1977. Characoids of the World. T.F.H. Publications, Inc., Neptune City, NJ.
- GIBBS, R. H., JR. 1959. A synopsis of the post larva of western Atlantic lizard-fishes (Synodontidae). Copeia 1959:232-236.
- . 1964a. Family Astronesthidae, p. 1-10. In: Fishes of the western North Atlantic. H. B. Bigelow (ed.). Mem. Sears Found. Mar. Res. No. 1 (Pt. 4).
- . 1964b. Family Ildiacanthidae, p. 512-522. In: Fishes of the Western North Atlantic. H. B. Bigelow (ed.). Mem. Sears Found. Mar. Res. No. 1 (Pt. 4).
- , T. A. CLARKE AND J. R. GOMON. 1983. Taxonomy and distribution of the stomioid fish Genus *Eustomias* (Melanostomidae), I: Subgenus *Nominostomias*. Smithson. Contrib. Zool. No. 380.
- , AND B. B. COLLETTE. 1959. On the identification, distribution, and biology of the dolphins *Coryphaena hippurus* and *C. equiselis*. Bull. Mar. Sci. Gulf Caribb. 9:117-152.
- , AND ———. 1967. Comparative anatomy and systematics of the tunas, genus *Thunnus*. U.S. Fish. Wildl. Serv. Fish. Bull. 66:65-130.
- , AND J. C. STAIGER. 1970. Eastern tropical Atlantic flyingfishes of the genus *Cypselurus* (Exocoetidae). Stud. Trop. Oceanogr. (Miami) No. 4 (Pt. 2):432-466.
- GILBERT, C. H. 1893. Scientific results of explorations by the U.S. Fish Commission Steamer Albatross. No. XXII. Descriptions of thirty-four new species of fishes collected in 1888 and 1889, principally among the Santa Barbara Islands and in the Gulf of California. Proc. U.S. Natl. Mus. 14(880):539-566.
- . 1905. The deep sea fishes of the Hawaiian Islands. Bull. U.S. Fish Comm. 23(2):577-713.
- , AND C. V. BURKE. 1912. Fishes from Bering Sea and Kamchatka. Bull. Bur. Fish. Wash. 30(1910):31-96.
- , AND C. L. HUBBS. 1916. Report on the Japanese macrourid fishes collected by the United States fisheries steamer "Albatross" in 1906, with a synopsis of the genera. Proc. U.S. Natl. Mus. 51(2149):135-214.
- , AND W. F. THOMPSON. 1916. Family Macrouridae, p. 471-476. In: Fishes collected by the United States Bureau of Fisheries steamer "Albatross" during 1888, between Montevideo, Uruguay, and Tome, Chile, on the voyage through the Straits of Magellan. W. F. Thompson (ed.). Proc. U.S. Natl. Mus. 50(2133):401-476.
- GILBERT, C. R. 1980. *Umbra lmi*, *Umbra pygmaea*, p. 129-130. In: Atlas of North American freshwater fishes. D. S. Lee, C. R. Gilbert, C. H. Hocutt, R. E. Jenkins, D. E. McAllister and J. R. Stauffer, Jr. (eds.). North Carolina Mus. Nat. Hist., Raleigh, NC.
- GILCHRIST, J. D. F. 1903. The development of South African fishes. Part 1. Mar. Invest. S. Afr. 2:181-201.
- . 1904. The development of South African fishes. Part 2. Mar. Invest. S. Afr. 3:131-150.
- . 1918. The eggs and spawning-habits of the pilot fish (*Vaucrates ductor*). Ann. Mag. Nat. Hist., Ser. 9, 2(7):114-118.
- , AND H. HUNTER. 1919. Reproduction of fishes in Table Bay. Trans. R. Soc. S. Afr. 8(1):1-16.
- GILL, T. N. 1862. Synopsis of the polynematoids. Proc. Acad. Nat. Sci. Phila. 13:271-282.
- . 1863. Descriptive enumeration of a collection of fishes from the western coast of Central America. Proc. Acad. Nat. Sci. Phila. 15(4):153-200.
- . 1865. Synopsis of the cyclopteroids of eastern North America. Proc. Acad. Nat. Sci. Phila. 16:189-194.

- . 1872. Arrangement of the families of fishes, or classes Pisces, Marsipobranchii and Leptocardii. *Smithson. Misc. Collect.* 11:247.
- . 1888. On the classification of the mail-cheeked fishes. *Proc. U.S. Natl. Mus.* 11:567–592.
- . 1891. On the relations of Cyclopteroidea. *Proc. U.S. Natl. Mus.* 13:361–376.
- . 1893. A comparison of antipodal faunas. *Mem. Natl. Acad. Sci.* 6:91–124.
- GINSBURG, I. 1952. Fishes of the family Carangidae of the northern Gulf of Mexico and three related species. *Publ. Inst. Mar. Sci. Univ. Tex.* 2:43–117.
- . 1955. Fishes of the family Percophididae from the coasts of eastern United States and the West Indies, with descriptions of four new species. *Proc. U.S. Natl. Mus.* 104(3347):623–649.
- GINZBURG, A. S. 1972. Fertilization in fishes and the problem of polyspermy. *Acad. Sci. USSR, Inst. Develop. Biol.* 1968. Translated from Russian by the Isr. Program Sci. Transl.
- GJOSAETER, J. 1973. Age, growth and mortality of the myctophid fish, *Benthosema glaciale* (Reinhardt), from western Norway. *Sarsia* 52: 1–14.
- , AND K. KAWAGUCHI. 1980. A review of the world resources of mesopelagic fish. *FAO Fish. Tech. Pap.* 193.
- GOIN, C. J., AND D. S. ERDMAN. 1951. The crested oarfish, *Lophotus lacepedei*, from Florida: first record from the western North Atlantic. *Copeia* 1951:285–288.
- GOLD, J. R. 1979. Cytogenetics, p. 353–405. *In: Fish Physiology*, W. S. Hoar, D. J. Randall and J. R. Brett (eds.). Academic Press, New York.
- GOLVAN, Y.-J. 1962. Catalogue systématique des noms de genres de poissons actuels. *Ann. Parasitol. Hum. Comp.* 37(6):1–227.
- GOMEZ GASPAR, A. 1981. Observaciones taxonómicas y ecológicas de estados larvales Elopiformes en la Laguna de la Restinga y áreas próximas (Isla Margarita, Venezuela). *Bol. Mus. Mar. Univ. Bogota* 10:3–23.
- GONZALES, T. 1946. Contributo alla conoscenza dello sviluppo post-embriionale in *Microidichthys coccoi*. *Ruppell. Boll. Pesca Pesci. Idrobiol.* 1:39–46.
- GOODE, G. B., AND T. H. BEAN. 1896. *Oceanic Ichthyology*. U.S. Natl. Mus. Spec. Bull.
- GOODY, P. C. 1969. The relationships of certain Upper Cretaceous teleosts with special reference to the myctophoids. *Bull. Brit. Mus. (Nat. Hist.) Geol. Suppl.* 7.
- GOODYEAR, R. H. 1970. A new species of *Ataxolepis*, a bathypelagic fish from the Gulf of Panama (Pisces, Lampridiformes, Megalomycteridae). *Steenstrupia* 1(3):17–20.
- GOPINATH, K. 1946. Notes on the larval and post-larval stages of fishes found along the Trivandrum coast. *Proc. Indian Natl. Sci. Acad.* 12(1):7–21.
- GORBUNOVA, N. N. 1954. The reproduction and development of the walleye pollock, *Theragra chalcogramma* (Pallas). *Tr. Inst. Okeanol. Akad. Nauk SSSR* 11:132–195.
- . 1964a. Breeding and development of hemilepidotine sculpins (Cottidae, Pisces), p. 249–266. *In: Fishes of the Pacific and Indian Oceans. Biology and distribution*. T. S. Rass (ed.). (Isr. Program Sci. Transl. No. 1411.)
- . 1964b. Spawning and development of greenlings (family Hexagrammidae), p. 121–185. *In: Greenlings: taxonomy, biology, interoceanic transplantation*. T. S. Rass (ed.). Springfield, Va. (Transl. available from: NTIS, TT69-55097.)
- . 1981. Larvae of the genus *Vinciguerria* (Gonostomatidae) with keys. *J. Ichthyol. (Engl. Transl. Vopr. Ikhtiol.)* 21(4):138–141.
- . 1982. Larvae of trichiurid fishes from collection of the International Mexican Biological Center (Gempylidae, Trichiuridae, Pisces). *Proc. P. P. Shirshov Inst. Oceanol.* 118:85–104. (In Russian.)
- , AND N. V. PARIN. 1963. Development of eggs and larvae of the flying fish, *Cheilopogon unicolor* (Cuv. et Val.). *Tr. Inst. Okeanol. Akad. Nauk SSSR* 62:62–67. (In Russian, English abstract.)
- , AND O. A. ZVYAGINA. 1975. Eggs and larvae of the scaled sardine (*Harengula pensacolatae*) (Pisces, Clupeidae). *J. Ichthyol. (Engl. Transl. Vopr. Ikhtiol.)* 15:829–833.
- GORDON, D. J. 1982. Systematics and distribution of larval fishes of the subfamily Ophidiinae (Pisces, Ophidiidae) in the eastern Gulf of Mexico. Unpubl. MS thesis. Univ. Miami, Coral Gables, FL.
- GOSLINE, W. A. 1948. Some possible uses of X-rays in ichthyology and fishery research. *Copeia* 1948:58–61.
- . 1951. The osteology and classification of the ophichthid eels of the Hawaiian Islands. *Pac. Sci.* 5:298–320.
- . 1955. The osteology and relationships of certain gobioid fishes, with particular reference to the genera *Kraemaria* and *Microdesmus*. *Pac. Sci.* 9:158–170.
- . 1960a. Contributions toward a classification of modern isospondylous fishes. *Bull. Br. Mus. Nat. Hist. Zool.* 6:325–365.
- . 1960b. Hawaiian lava-flow fishes, Part IV. *Snyderidia canna* Gilbert, with notes on the osteology of ophidioid families. *Pac. Sci.* 14:373–381.
- . 1961. Some osteological features of modern lower teleostean fishes. *Smithson. Misc. Collect.* 142:1–42.
- . 1962. Systematic position and relationships of the percopsine fishes. *Pac. Sci.* 16:207–217.
- . 1963a. Considerations regarding the relationships of the Percopsiform, Cyprinodontiform, and Gadiform fishes. *Occas. Pap. Mus. Zool. Univ. Mich.* No. 629.
- . 1963b. Notes on the osteology and systematic position of *Hypoptichus dybowskii* Steindachner and other elongate perciform fishes. *Pac. Sci.* 17:90–101.
- . 1966. The limits of the fish family Serranidae, with notes on other lower percoids. *Proc. Calif. Acad. Sci.* 33:91–111.
- . 1968. The suborders of perciform fishes. *Proc. U.S. Natl. Mus.* 124(3647):1–78.
- . 1970. A reinterpretation of the teleostean fish order Gobiociformes. *Proc. Cal. Acad. Sci.* 38:363–382.
- . 1971. Functional morphology and classification of teleostean fishes. *Univ. Press Hawaii, Honolulu.*
- . 1978. Unbranched dorsal-fin rays and subfamily classification in the fish family Cyprinidae. *Occas. Pap. Mus. Zool. Univ. Mich.* 684.
- . 1980. The evolution of some structural systems with reference to the interrelationships of modern lower Teleostean fish groups. *Jpn. J. Ichthyol.* 27:1–28.
- , N. B. MARSHALL AND G. W. MEAD. 1966. Order Iniomi: characters and synopsis of the families. *Mem. Sears Found. Mar. Res.* 21(Pt. 5):1–29.
- GOSZTONYI, A. E. 1977. Results of the research cruises of FRV "Walther Herwig" to South America. XLVIII. Revision of the South American Zoarcidae (Osteichthyes, Blennioidei), with the description of three new genera and five new species. *Arch. Fischereiwiss.* 27:191–249.
- GOTSHALL, D. W. 1971. Occurrences of the bearded eelpout, *Lycinema barbatum*, off northern California and southern Oregon. *Calif. Fish Game* 57:295–297.
- GOULD, W. R. 1965. The biology and morphology of *Acyrtops beryllinus*, the emerald clingfish. *Bull. Mar. Sci. Gulf Caribb.* 15:165–188.
- GOULD, S. J. 1977. *Ontogeny and phylogeny*. Belknap Press, Cambridge, MA.
- GOVONI, J. J. 1980. Morphological, histological and functional aspects of alimentary canal and associated organ development in larval *Leiostomus xanthurus*. *Rev. Can. Biol.* 39:69–80.
- , J. E. OLNEY, D. F. MARKLE AND W. R. CURTSINGER. 1984. Observations on structure and evaluation of possible functions of the vexillum in larval Carapidae (Ophidiiformes). *Bull. Mar. Sci.* 34:60–70.
- GRAHAM, D. H. 1939. Breeding habits of fishes of Otago Harbour and adjacent seas. *Trans. R. Soc. N.Z.* 69:361–372.
- GRASSI, G. B. 1913. *Metamorfosi dei murenoidei. Ricerche sistematiche ed ecologiche*. Fischer, Jena.
- , AND S. A. CALANDRUCIO. 1897. *Descrizione d'un Lepto-*

- cephalus brevirostris* in via transformarzi in *Anguilla vulgaris*. Atti Accad. Naz. Lincei, Ser. 6, 5(Pt. 1):239-240.
- GRAVES, J. E., AND G. N. SOMERO. 1982. Electrophoretic and functional enzymic evolution in four species of eastern Pacific barracudas from different thermal environments. *Evolution* 36:97-106.
- GREENFIELD, D. W. 1965. Systematics and zoogeography of *Myripristis* in the eastern tropical Pacific. *Calif. Fish Game* 51:229-247.
- . 1972. Notes on the biology of the arrow blenny *Lucayablennius zingaro* (Böhlke) from British Honduras. *Copeia* 1972:591-592.
- . 1974. A revision of the squirrelfish genus *Myripristis* Cuvier (Pisces: Holocentridae). *Nat. Hist. Mus. Los Ang. Cty. Sci. Bull.* 19.
- GREENWOOD, P. H. 1955. Reproduction in the catfish, *Clarias mossambicus* Peters. *Nature* (Lond.) 176:516-519.
- . 1956. The reproduction of *Clarias mossambicus* Peters in Lake Victoria. *Sci. Counc. Afr. South Sahara Publ.* 25:77-78.
- . 1973. Interrelationships of osteoglossomorphs, p. 307-332. *In*: P. H. Greenwood, R. S. Miles and C. Patterson (eds.), *Interrelationships of fishes*. Academic Press, New York.
- . 1976. A review of the family Centropomidae (Pisces, Perciformes). *Bull. Brit. Mus. (Nat. Hist.) Zool.* 29:1-81.
- . 1977. Notes on the anatomy and classification of elopomorph fishes. *Bull. Br. Mus. (Nat. Hist.) Zool.* 32(4):65-102.
- , G. S. MYERS, D. E. ROSEN AND S. H. WEITZMAN. 1967. Named main divisions of teleostean fishes. *Proc. Biol. Soc. Wash.* 80:227-228.
- , AND D. E. ROSEN. 1971. Notes on the structure and relationships of the alepocephaloid fishes. *Am. Mus. Novit.* 2473.
- , S. H. WEITZMAN AND G. S. MYERS. 1966. Phyletic studies of teleostean fishes, with a provisional classification of living forms. *Bull. Amer. Mus. Nat. Hist.* 131:339-456.
- GREGORY, W. K. 1933. Fish skulls. A study of the evolution of natural mechanisms. *Trans. Am. Philos. Soc.* 23:75-481.
- . 1959. Fish skulls. A study of the evolution of natural mechanisms. Noble Offset Printers, Inc., New York. (First published in 1933. *Trans. Am. Philos. Soc.* 23:75-481.)
- , AND G. M. CONRAD. 1936. Pictorial phylogenies of deep-sea isopondyli and inioi. *Copeia* 1936:21-36.
- , AND ———. 1937. The comparative osteology of the swordfish (*Xiphias*) and the sailfish (*Istiophorus*). *Am. Mus. Novit.* 952.
- , AND ———. 1943. The osteology of *Livarus imperialis*, a scombroid fish: a study in adaptive evolution. *Bull. Am. Mus. Nat. Hist.* 31(2):225-283.
- GREY, M. 1953. Fishes of the family Gempylidae, with records of *Nesiarichus* and *Epinnula* from the western Atlantic and descriptions of two new subspecies of *Epinnula orientalis*. *Copeia* 1953:135-141.
- . 1955a. Notes on a collection of Bermuda deepsea fishes. *Fieldiana Zool.* 37:265-302.
- . 1955b. The fishes of the genus *Tetragonurus* Risso. *Dana-Rep. Carlsberg Found.* 41.
- . 1960. Description of a western Atlantic specimen of *Scombrobrax heterolepis* Roule and notes on fishes of the family Gempylidae. *Copeia* 1960:210-215.
- . 1964. Family Gonostomatidae, p. 78-240. *In*: *Fishes of the western North Atlantic*, H. B. Bigelow (ed.). *Mem. Sears Found. Mar. Res.* No. 1 (Pt. 4).
- GRIGOREV, G. V., AND V. P. SEREBRYAKOV. 1981. Eggs of roundnose grenadier, *Coryphaenoides rupestris* Gunnerus 1765. *J. Northwest Atl. Fish. Sci.* 2:73-74.
- GRIMES, P. J., AND D. A. ROBERTSON. 1981. Egg and larval development of the silver warehou, *Seriotelella punctata* (Pisces: Centrolipidae). *N.Z. J. Mar. Freshwater Res.* 15:261-266.
- GRIMM, H. 1979a. Egg size and fecundity within the genus *Aphanius* (Pisces, Cyprinodontidae). *Meersforsch. Rep. Mar. Res.* 27(3):177-185.
- . 1979b. Investigations of the evolution of differently sealed populations found in the species *Aphanius anatoliae* (Leidenfrost, 1912) (Pisces, Cyprinodontidae). *Genetics of the egg size*. *Z. Zool. Syst. Evolutionsforsch.* 17(1):66-77.
- GRINDLEY, J. R., AND M. J. PENRITH. 1965. Notes on the bathypelagic fauna of the seas around South Africa. *Zool. Afr.* 1(2):275-295.
- GUDGER, E. W. 1905. The breeding habits and the segmentation of the egg of the pipefish (*Siphostoma floridae*). *Proc. U.S. Natl. Mus.* 29(1431):447-500.
- . 1912. Oral gestation in the gaff-topsail cat-fish, *Felichthys felis*. *Science* 35:192.
- . 1916. The gaff-topsail (*Felichthys felis*): A sea catfish that carries its eggs in its mouth. *Zoologica (N.Y.)* 2(5):125-158.
- . 1918. Oral gestation in the gaff-topsail catfish, *Felichthys felis*. *Carnegie Inst. Wash. Publ.* 252:25-52.
- . 1926. A study of the smallest shark-suckers (Echeneidae) on record, with special reference to metamorphosis. *Am. Mus. Novit.* 234:1-26.
- . 1928. The smallest known specimens of the sucking-fishes, *Remora brachyptera* and *Rhombochirus osteochir*. *Am. Mus. Novit.* 294:1-5.
- . 1930. The opah or moonfish, *Lampris luna*, on the coasts of California and of Hawaii. *Am. Nat.* 65:531-541.
- . 1931. The triple-tail, *Lobotes surinamensis*, its names, occurrence on our coasts and its natural history. *Am. Nat.* 65:49-69.
- GUILLARD, R. R. L. 1975. Culture of phytoplankton for feeding marine invertebrates, p. 29-60. *In*: *Culture of marine invertebrate animals*, W. L. Smith and M. H. Chanley (eds.). Plenum Publ. Corp., N.Y.
- GUITART MANDAY, D., AND D. JUAREZ FERNANDEZ. 1966. Desarrollo embrionario primeros estadios larvales de cherna criolla, *Epinephelus striatus* (Bloch) (Perciformes: Serranidae). *Acad. Cienc. Cuba Estud.-Inst. Oceanol.* 1:35-45.
- GUITEL, R. 1888. Recherches sur les Ledapogasters. *Arch. Zool. Exp. Gen., Ser. 2.* 6:423-647.
- GUNTER, G., L. L. SULTY AND B. E. BOX. 1961. Some evolutionary patterns in fishes' blood. *Biol. Bull. (Woods Hole)* 121:302-306.
- GÜNTHER, A. 1861. Catalogue of the Acanthopterygian fishes in the collection of the British Museum, Vol. 3-4. *British Museum, London.*
- . 1862. Chromides, p. 264-316. *In*: *Catalogue of the fishes in the British Museum*. Vol. 4.
- . 1887. Report on the deep-sea fishes collected by H.M.S. Challenger during the years 1873-76. *Rep. Sci. Results Challenger, Zool.* 22:1-335. (Reprint 1963. Wheldon and Wesley, Ltd., and Hafner Publishing Co., New York.)
- . 1889. Report on the pelagic fishes collected by H.M.S. Challenger during the years 1873-1876. *Rep. Sci. Results Challenger, Zool.* 31:1-44.
- GUSTATO, G. 1976. Osservazioni sulla biologia e sul comportamento di *Carapus acus* (Ophidiioidea, Percomorphi). *Boll. Soc. Nat. Napoli* 85:505-535.
- GUTHERZ, E. J. 1970. Characteristics of some larval bothid flatfish, and development and distribution of larval spotfin flounder, *Cyclosetta fimbriata* (Bothidae). *U.S. Fish. Wild. Serv. Fish. Bull.* 68:261-283.
- HAAKE, P. W., C. A. WILSON AND J. M. DEAN. 1982. A technique for the examination of otoliths by SEM with application to larval fishes. *In*: *Proc. 5th Annual Larval Fish Conference*, Baton Rouge, LA.
- HAEDRICH, R. L. 1967. The stromateoid fishes: systematics and a classification. *Bull. Mus. Comp. Zool. Harv. Univ.* 135:31-139.
- . 1969. A new family of stromateoid fishes from the equatorial Indo-Pacific. *Dana-Rep. Carlsberg Found.* 76.
- . 1970. A new species in the nomeid fish genus *Psenes* from the equatorial eastern Pacific. *Breviora* 351.
- . 1971. The pons moultion: a significant character. *Copeia* 1971:167-169.
- . 1974. A rotating eye in *Trachipterus*. *Copeia* 1974:972-973.
- , AND M. H. HORN. 1972. A key to the stromateoid fishes. *Woods Hole Oceanogr. Inst. Tech. Rep.* 72-15.
- , AND J. G. NIELSEN. 1966. Fishes eaten by *Alepisaurus* (Pisces,

- Inioi) in the southeastern Pacific Ocean. *Deep-Sea Res.* 13:909-919.
- HAEGELE, C. W., AND J. F. SCHWEIGERT. 1984. Distribution and characteristics of herring spawning grounds and description of spawning behavior. *Can. J. Spec. Publ. Fish Aquat. Sci.* In press.
- HAIGH, E. H. 1972a. Larval development of three species of economically important South African fishes. *Ann. S. Afr. Mus.* 59(3):47-70.
- . 1972b. Development of *Trachurus trachurus* (Carangidae), the south African maasbanker. *Ann. S. Afr. Mus.* 59(8):139-149.
- HALLACHER, L. E. 1974. The comparative morphology of extrinsic gasbladder musculature in the scorpionfish genus *Sebastes* (Pisces: Scorpaenidae). *Proc. Calif. Acad. Sci.* 40:59-86.
- HALSTEAD, B. W., D. D. DANIELSON, W. J. BALDWIN AND P. C. ENGEN. 1972. Morphology of the venom apparatus of the leatherback fish *Scomberoides sanctipetri* (Cuvier). *Toxicon* 10:249-258.
- HAMANDA, K. 1961. Taxonomic and ecological studies of the genus *Hyppomesus* of Japan. *Mem. Fac. Fish. Hokkaido Univ.* 9(1):1-56.
- HANSEN, E., AND P. J. HERRING. 1977. Dual bioluminescent systems in the anglerfish genus *Linophryne*. *J. Zool. (Lond.)* 182:103-124.
- HARA, S., J. P. CANTO, JR., AND J. M. E. ALMENDRAS. 1982. A comparative study of various extenders for milkfish, *Chanos chanos* (Forsskal), sperm preservation. *Aquaculture* 28:339-346.
- HARADA, T. 1962. A contribution to the biology of the black rockfish, *Sebastes inermis* Cuvier et Valenciennes. *Publ. Seto Mar. Biol. Lab.* 10:307-361.
- , K. MIZUNO, O. MURATA, S. MIYASHITA AND H. HURUTANI. 1971. On the artificial fertilization and rearing of larvae in yellowfin tuna. *Mem. Fac. Agric. Kinki Univ.* (4):145-151.
- , O. MURATA AND H. FURUTANI. 1973. On the artificial fertilization and rearing of larvae in *Marusoda*, *Auxis tapemosoma*. *Mem. Fac. Agric. Kinki Univ.* (6):113-116.
- , AND S. MIYASHITA. 1973. On the artificial fertilization and rearing of larvae in *Hirasoda*, *Auxis thazard*. *Mem. Fac. Agric. Kinki Univ.* (6):109-112.
- , AND ———. 1974. On the artificial fertilization and rearing of larvae in bonito. *Mem. Fac. Agric. Kinki Univ.* (7):1-4.
- HARBISON, G. R., L. P. MADIN AND N. R. SWANBERG. 1978. On the natural history and distribution of oceanic ctenophores. *Deep-Sea Res.* 25:233-256.
- HARDY, G. S. 1982. A revision of the fishes of the family Pentacerotidae (Perciformes). *N.Z. J. Zool.* 10:177-220.
- HARDY, J. D., JR. 1978a. Development of fishes of mid-Atlantic bight, an atlas of egg, larval, and juvenile stages. Vol. II. Anguillidae through Syngnathidae. U.S. Fish Wildl. Serv. Biol. Serv. Program FWS/OBS-78/12.
- . 1978b. Development of fishes of the mid-Atlantic Bight. An atlas of egg, larval and juvenile stages. Vol. III. Aphredoderidae through Rachycentridae. U.S. Fish Wildl. Ser. Biol. Serv. Program FWS/OBS-78/12.
- HARRINGTON, R. W., JR. 1958. Morphometry and ecology of small tarpon *Megalops atlantica* Valenciennes from transitional stage through onset of scale formation. *Copeia* 1958:1-10.
- . 1959. Delayed hatching in stranded eggs of marsh killifish, *Fundulus confluentus*. *Ecology* 40:430-437.
- . 1961. Oviparous hermaphroditic fish with internal self-fertilization. *Science* 135(3492):1749-1750.
- , AND J. S. HAEGER. 1958. Prolonged natural deferment of hatching in killifish. *Science* 128(3337):1511.
- HARRISON, C. M. H., AND G. PALMER. 1968. On the neotype of *Raducephalus elongatus* Osorio with remarks on its biology. *Bull. Brit. Mus. (Nat. Hist.) Zool.* 16:187-211.
- HARRY, R. R. 1951. A new cusk-eel of the genus *Ophidion* from California with notes on the genus. *Stanford Ichthyol. Bull.* 4:30-35.
- HART, J. L. 1973. Pacific fishes of Canada. *Bull. Fish. Res. Board Can.* 180.
- HART, N. H., R. PIETRI AND M. DONOVAN. 1984. The structure of the chorion and associated surface filaments in *Oryzias*—evidence for the presence of extracellular tubules. *J. Exp. Zool.* 230:273-296.
- HARYU, T., AND T. NISHIYAMA. 1981. Larval form of Zaprorid fish, *Zaproro silenus* from the Bering Sea and the Northern Pacific. *Jpn. J. Ichthyol.* 28:313-318.
- HASTINGS, R. W., AND R. W. YERGER. 1971. Ecology and life history of the diamond killifish, *Adinia xenica* (Jordan and Gilbert). *Am. Midl. Nat.* 86:276-291.
- HATTORI, S. 1964. Studies on fish larvae in the Kuroshio and adjacent waters. *Bull. Tokai Reg. Fish. Res. Lab.* (40):158 pp.
- . 1970. Reproductive aspects of fish resources, p. 209-222. *In: Ocean development, 4. Exploitation of fisheries resources.* T. Sasaki (ed.). Ocean Dev. Cent. Press, Tokyo. (In Japanese.)
- HAY, D. E. 1981. Effects of capture and fixation on gut contents and body size of Pacific herring larvae. *Rapp. P. V. Reun. Cons. Int. Explor. Mer* 178:395-400.
- . 1984. Reproductive biology of Pacific herring. *Can. J. Spec. Publ. Fish Aquat. Sci.* In Press.
- HAYDOCK, I. 1971. Gonad maturation and hormone-induced spawning of the Gulf croaker, *Bairdiella icistia*. *Fish. Bull. U.S.* 69:157-180.
- HEARNE, M. 1983. Identification of larval and juvenile smelts (Osmeridae) from Oregon and California using selected morphometric characters. Unpubl. MS thesis. San Francisco State University, San Francisco, CA.
- HECHT, T. 1978. A descriptive systematic study of the otoliths of the neopterygian marine fishes of South Africa. Part I. Introduction. *Trans. R. Soc. S. Afr.* 43(2):191.
- HECK, K. L., AND M. P. WEINSTEIN. 1978. Mimetic relationships between tropical burrfishes and opisthobranchs. *Biotropica* 10:78-79.
- HEEMSTRA, P. C. 1974. On the identity of certain Pacific and Caribbean post-larval fishes (Perciformes) described by Henry Fowler. *Proc. Acad. Nat. Sci. Phila.* 126:21-26.
- . 1980. A revision of the zeid fishes (Zeiformes: Zeidae) of South Africa. *Rhodes Univ. J. L. B. Smith Inst. Ichthyol. Bull.* 41.
- . In press. Families Regalecidae, Lophotidae, Veliferidae, Lampridae. *In: Sea Fishes of South Africa*, Grahamstown, S.A.
- , AND S. X. KANNEMEYER. In press. The families Trachipteridae and Radiicephalidae (Pisces: Lampriformes) and a new species of *Zu* from South Africa. *Ann. S. Afr. Mus.*
- , AND J. E. RANDALL. 1977. A revision of the Emmelichthyidae (Pisces: Perciformes). *Aust. J. Mar. Freshwater Res.* 1977(28):361-396.
- HEFFORD, A. E. 1910. Notes on teleostean ova and larvae observed at Plymouth in spring and summer, 1909. *J. Mar. Biol. Assoc. U.K.* 9:2-58.
- HEINCKE, F., AND E. EHRENBaum. 1900. Eier und Larven von Fischen der Deutschen Bucht. II. Die Bestimmung der schwimmenden Fischeier und die Methodik der Eimessungen. *Wiss. Meeresunters. (Helgol.)* 3:239-243.
- HELFRICH, P. H. 1958. The early life history and reproductive behavior of the maomao, *Abudefduf abdominalis* (Quoy and Gaimard). Unpubl. PhD dissertation. Univ. Hawaii, Honolulu.
- HEMPEL, G. 1979. Early life history of marine fish: the egg stage. Univ. Washington Press, Seattle.
- , AND J. H. S. BLAXTER. 1961. The experimental modification of meristic characters in herring (*Clupea harengus* L.). *J. Cons. Int. Explor. Mer* 26:336-346.
- , AND H. WEIKERT. 1972. The neuston of the subtropical and boreal Northeastern Atlantic Ocean. *A Review. Mar. Biol. (Berl.)* 13:70-88.
- HENNIG, W. 1950. Grundzüge einer Theorie der phylogenetischen Systematik. Deutscher Zentralverlag, Berlin.
- . 1966. *Phylogenetic Systematics.* Univ. Illinois Press, Urbana.
- HENSLEY, D. A. 1976. Collection of postlarval juvenile *Hoplias malabaricus* (Characoidae: Erythrinidae) in Florida. *Fla. Sci.* 39:236-238.

- . 1977. Larval development of *Engyophrys senta* (Bothidae), with comments on intermuscular bones in flatfishes. *Bull. Mar. Sci.* 27:681-703.
- HENZELMANN, E. 1930. Etwas über *Jordanella floridae* Goode et Bean. (Floridäkärpfling). *Wochenschr. Aquar. Terrarien.* 27(19):307-309.
- HERALD, E. S. 1939. The opah (*Lampris regius*) and its occurrence off the California coast. *Calif. Fish Game* 25:228-232.
- HERRE, A. W. 1942. New and little known phallostethids, with keys to the genera and Phillipine species. *Stanford Ichthyol. Bull.* 2:137-156.
- HERRING, P. J., AND J. G. MORIN. 1978. Bioluminescence in fishes, p. 273-329. *In: Bioluminescence in action.* P. J. Herring (ed.). Academic Press, London.
- HERWIG, N., AND D. DEWEY. 1982. *Congrogadus subduscens*: A new challenge for the marine aquarist. *Freshwater Mar. Aquarium* 5:6-91.
- HETTLER, W. 1981. Spawning and rearing Atlantic menhaden. *Prog. Fish Cult.* 43:80-84.
- HUEFFELDER, G. R. 1982. Family Cottidae, sculpins, pp. 656-676. *In: Identification of larval fishes of the Great Lakes Basin with emphasis on the Lake Michigan drainage.* N. A. Auer (ed.). Great Lakes Fish. Comm. Spec. Publ. 82-3.
- HEYWOOD, V. H. (ED.). 1971. Scanning electron microscopy: systematic and evolutionary applications. Academic Press, New York.
- HICKEY, G. M. 1979. Survival of fish larvae after injury. *J. Exp. Mar. Biol. Ecol.* 37:1-17.
- . 1982. Wound healing in fish larvae. *J. Exp. Mar. Biol. Ecol.* 57:149-168.
- HICKLING, C. F. 1931. The structure of the otolith of the hake. *Q. J. Microsc. Sci.* 74:547-561.
- HICKMAN, C. P., JR. 1959. The larval development of the sand sole (*Psettichthys melanostictus*). *Wash. Dep. Fish. Res. Pap.* 2(2):38-47.
- HIKITA, T. 1952. On the development of *Limanda schrenki* (Schmidt). *Sci. Rep. Hokkaido Fish Hatchery* 7(1,2):133-144.
- . 1958. On the development of long finned smelt, *Spirinchus lanceolatus*. *Sci. Rep. Hokkaido Fish Hatch.* 13:1-4.
- HILDEBRAND, S. F. 1922. Notes on habits and development of eggs and larvae of the silversides, *Menidia menidia* and *Menidia beryllina*. *Bull. Bur. Fish. Wash.* 38:113-120.
- . 1946. A descriptive catalogue of the shore fishes of Peru. *U.S. Natl. Mus. Bull.* 189.
- . 1963a. Family Elopidae, p. 111-113. *In: Fishes of the Western North Atlantic.* H. B. Bigelow (ed.). Mem. Sears Found. Mar. Res. No. 1(Pt. 3).
- . 1963b. Family Albulidae, p. 132-147. *In: Fishes of the Western North Atlantic.* H. B. Bigelow (ed.). Mem. Sears Found. Mar. Res. No. 1(Pt. 3).
- . 1963c. Family Engraulidae, p. 152-249. *In: Fishes of the western North Atlantic.* H. B. Bigelow (ed.). Mem. Sears Found. Mar. Res. No. 1(Pt. 3).
- . 1963d. Family Clupeidae, p. 257-454. *In: Fishes of the western North Atlantic.* H. B. Bigelow (ed.). Mem. Sears Found. Mar. Res. No. 1(Pt. 3).
- , AND L. E. CABLE. 1930. Development and life history of fourteen teleostean fishes at Beaufort, N.C. *Bull. Bur. Fish. Wash.* 46 (1093):383-488.
- , AND L. E. CABLE. 1938. Further notes on the development and life history of some teleosts at Beaufort, N.C. *Bull. Bur. Fish. Wash.* 48(24):505-642.
- , AND W. C. SCHROEDER. 1928. Fishes of Chesapeake Bay. *Bull. Bur. Fish. Wash.* 43(Pt. 1):1-388.
- HUPEAU-JACQUOTIE, R. 1967. Notes de faunistique et biologie marine de Madagascar. IV—Observations sur le comportement du poisson Carapidae: *Carapus homei* (Richardson 1844) de Madagascar. *Recl. Trav. Stn. Mar. Endoume Mars. Fasc. Ser. Suppl.* 6:141-151.
- HODA, S. M. S., AND H. TSUKAHARA. 1971. Studies on the development and relative growth in the carp, *Cyprinus carpio* (Linne). *J. Fac. Agric. Kyushu Univ.* 16:387-509.
- HOEDEMAN, J. J. 1960a. Studies on callichthyid fishes. 3. Notes on the development of *Callichthys* (1) (Pisces-Siluriformes). *Bull. Aquat. Biol.* 1:53-72.
- . 1960b. Studies on callichthyid fishes. 4. Development of the skull of *Callichthys* and *Hoplosternum* (1) (Pisces-Siluriformes). *Bull. Aquat. Biol.* 1:73-84.
- . 1960c. Studies on callichthyid fishes. 5. Development of the skull of *Callichthys* and *Hoplosternum* (2) (Pisces-Siluriformes). *Bull. Aquat. Biol.* 2:21-36.
- . 1960d. Studies on callichthyid fishes. 6. The axial skeleton of *Callichthys* and *Hoplosternum* (Pisces-Siluriformes). *Bull. Aquat. Biol.* 2:37-44.
- HOESE, D. F. 1971. A revision of the eastern Pacific species of the gobiid fish genus *Gobiosoma*, with a discussion of relationships of the genus. Unpubl. PhD dissertation. Univ. Calif., San Diego.
- . 1976. A redescription of *Heterochnus adelaide* Costelneau (Pisces: Clinidae) with description of related new species. *Aust. Zool.* 19:51-67.
- HOESE, H. D., AND R. H. MOORE. 1977. Fishes of the Gulf of Mexico, Texas, Louisiana, and adjacent waters. Texas A&M Univ. Press, College Station and London.
- HOFF, F. H., JR. 1970. Artificial spawning of black sea bass, *Centropristis striatus melanus* Ginsburg, aided by chorionic gonadotrophic hormones. *Fla. Dep. Nat. Resour. Mar. Res. Lab. Spec. Sci. Rep.* 25.
- HOLCIK, J. 1982. Towards the characteristics of the genera *Hucho* and *Brachymystax* (Pisces, Salmonidae). *Folia Zool.* 31:369-380.
- HOLL, E. A. 1968. Notes of spawning behavior of barbel *Clarias gariepinus* Burchell in Rhodesia. *Zool. Afr.* 3:185-188.
- HOLLISTER, G. 1936. Caudal skeleton of Bermuda shallow water fishes. I. Order Isospondyli: Elopidae, Megalopidae, Albulidae, Clupeidae, Dussumieriidae, Engraulidae. *Zoologica (N.Y.)* 21:257-290.
- . 1937. Caudal skeleton of Bermuda shallow water fishes. II. Order Percomorphi, suborder Percocetes: Atherinidae, Mugilidae, Sphyraenidae. *Zoologica (N.Y.)* 22(3):265-279.
- HOLT, E. W. L. 1891. Survey of fishing grounds, west coast of Ireland, 1890. On the eggs and larvae of teleosteans. *Sci. Trans. R. Dubl. Soc., Ser. 2.* 4:435-474.
- . 1892. *Rhombus maximus* Linn. (The turbot). *In: "Notes and Memoranda."* J. Mar. Biol. Assoc. U.K. 2:399-404.
- . 1893. Survey of fishing grounds, west coast of Ireland, 1890-91: on the eggs and post-larval stages of teleosteans. *Sci. Trans. R. Dubl. Soc., Ser. 2.* 5.
- . 1897. Preliminary notes on the reproduction of teleostean fishes in the south-western district. *J. Mar. Biol. Assoc. U.K.* 5:41-50.
- . 1898. Contributions to our knowledge of the plankton of the Faeroe channel. No. V. Report on a collection of very young fishes obtained by Dr. G. H. Fowler in the Faeroe Channel. *Proc. Zool. Soc. Lond.* 1898:550-557.
- HONMA, Y. 1956. Short note on the breeding habit of a spiny lumpfish, *Cyclohumpus asperimus*. *Collect. Breed.* 18:342-343.
- . 1957. Notes on a smooth lumpsucker, *Aptocyclus ventricosus* (Pallas), during its breeding season. *Collect. Breed.* 19:235-236.
- HORN, M. H. 1970a. The swimbladder as a juvenile organ in stromateoid fishes. *Breviora* 359.
- . 1970b. Systematics and biology of the stromateoid fishes of the genus *Peprilus*. *Bull. Mus. Comp. Zool. Harv. Univ.* 140:165-262.
- . 1973. Systematic comparison of the stromateoid fishes *Stromateus brasiliensis* Fowler and *Stromateus stellatus* Cuvier from coastal South America with a review of the genus. *Bull. Br. Mus. (Nat. Hist.) Zool.* 24:317-339.
- . 1975. Swim-bladder state and structure in relation to behavior and mode of life in stromateoid fishes. *Fish. Bull. U.S.* 73:95-109.
- , AND R. L. HALDRICH. 1973. Systematic and distributional

- status of *Psenes sto* and *Psenes pellucidus* (Pisces, Stromateoidei) in the eastern Pacific. *Copeia* 1973:167-169.
- HOSS, D. E., AND J. H. S. BLAXTER. 1982. Development and function of the swimbladder—inner ear—lateral line system in the Atlantic menhaden *Brevoortia tyrannus* (Latrobe). *J. Fish Biol.* 20:131-142.
- HOTTA, H. 1955. On the mature mugilid fish from Kabashima, Nagasaki Pref., Japan, with additional notes on the intestinal convolution of Mugilidae. *Jpn. J. Ichthyol.* 4:162-169.
- , AND I.-S. TUNG. 1972. Identification of fishes of the family Mugilidae based on the pyloric caeca and the position on inserted first interneural spine. *Jpn. J. Ichthyol.*, 14:62-66. (In Japanese, English summary.)
- HOUDE, E. D. 1972a. Some recent advances and unsolved problems in the culture of marine fish larvae. *Proc. World Maricult. Soc.* 3: 83-112.
- . 1972b. Development and early life history of the northern sennet, *Sphyræna borealis* DeKay (Pisces: Sphyrænidae) reared in the laboratory. *Fish. Bull. U.S.* 70:185-195.
- . 1974. Effects of temperature and delayed feeding on growth and survival of larvae of three species of subtropical marine fishes. *Mar. Biol. (Berl.)* 26:271-285.
- . 1975. Effects of stocking density and food density on survival, growth and yield of laboratory-reared larvae of sea bream *Archosargus rhomboidalis* (L.) (Sparidae). *J. Fish Biol.* 7:115-127.
- . 1977. Food concentrations and stocking density effects on survival and growth of laboratory-reared larvae of bay anchovy *Anchoa mitchilli* and lined sole *Achirus lineatus*. *Mar. Biol.* 43: 333-341.
- . 1978. Critical food concentrations for larvae of three species of subtropical marine fishes. *Bull. Mar. Sci.* 28:395-411.
- . 1981. Distribution and abundance of four types of codlet (Pisces: Bregmacerotidae) larvae from the eastern Gulf of Mexico. *Biol. Oceanogr.* 1:81-104.
- , AND J. D. ALPERN-LOVDAL. MS. Seasonality of occurrence, foods and food preferences of ichthyoplankton in Biscayne Bay, Florida.
- , AND P. L. FORE. 1973. Guide to identity of eggs and larvae of some Gulf of Mexico clupeid fishes. *Fla. Dep. Nat. Resour. Mar. Res. Lab. Leaflet Ser. 4 (Pt. 1, No. 23).*
- , C. R. FUTCH AND R. DEWYLER. 1970. Development of the lined sole, *Achirus lineatus*, described from laboratory-reared and Tampa Bay specimens. *Fla. Dep. Nat. Resour. Mar. Res. Lab. Tech. Ser.* 62.
- , J. C. LEAK, C. E. DOWD, S. A. BERKELEY AND W. J. RICHARDS. 1979. Ichthyoplankton abundance and diversity in the eastern Gulf of Mexico. Final Rep. to U.S. Bur. Land Mgt., Contract No. AA550-CT7-28. Rosensteil School of Marine and Atmospheric Science, Univ. Miami, FL.
- , AND T. POTTHOFF. 1976. Eggs and larval development of the sea bream *Archosargus rhomboidalis* (Linnaeus): Pisces, Sparidae. *Bull. Mar. Sci.* 26:506-529.
- , W. J. RICHARDS AND V. P. SAKSANA. 1974. Description of eggs and larvae of scaled sardine, *Harengula jaguana*. *Fish. Bull. U.S.* 72:1106-1122.
- , AND R. C. SCHEKTER. 1978. Simulated food patches and survival of larval bay anchovy *Anchoa mitchilli* and sea bream *Archosargus rhomboidalis*. *Fish. Bull. U.S.* 76:483-487.
- , AND L. J. SWANSON, JR. 1975. Description of eggs and larvae of yellowfin menhaden, *Brevoortia smithi*. *Fish. Bull. U.S.* 73:660-674.
- , AND A. K. TANIGUCHI. 1979. Laboratory culture of marine fish larvae and their role in marine environmental research, p. 176-205. *In: Advances in marine environmental research. Proceedings of a Symposium.* F. S. Jacoff (ed.). Environ. Res. Lab., U.S. Environ. Prot. Agency, Narragansett, RI. Rep. No. EPA-600/9-79-035.
- HOWE, K. M., AND S. L. RICHARDSON. 1978. Taxonomic review and meristic variation in marine sculpins (Osteichthyes: Cottidae) of the northeast Pacific Ocean. *Fin. Rep.*, NOAA-NMFS Contrib. No. 03-78-M02-120.
- HOWELL, B. R. 1973. Marine fish culture in Britain VIII. A marine rotifer *Brachionus plicatilis* Muller and the larvae of the mussel *Mytilus edulis* L. as food for larval flatfish. *J. Cons. Int. Explor. Mer* 35:1-6.
- HUBBS, C. 1952. A contribution to the classification of the blennioid fishes of the family Clinidae, with a partial revision of the eastern Pacific forms. *Stanford Ichthyol. Bull.* 4(2):41-165.
- . 1953a. Revision and systematic position of the blennioid fishes of the genus *Neochmus*. *Copeia* 1953:11-23.
- . 1953b. Revision of the eastern Pacific fishes of the clinid genus *Labrisomus*. *Zoologica (N.Y.)* 38:113-136.
- . 1965. Developmental temperature tolerance and rates of four southern California fishes. *Fundulus parvipinnis*, *Atherinops affinis*, *Leuresthes tenuis*, and *Hypsoblennius* sp. *Calif. Fish Game* 51:113-122.
- , AND D. F. BURNSIDE. 1972. Developmental sequences of *Zygo-nectes notatus* at several temperatures. *Copeia* 1972:862-865.
- HUBBS, C. L. 1918. The fishes of the genus *Atherinops*, their variation, distribution, relationships, and history. *Bull. Amer. Mus. Nat. Hist.* 38:409-440.
- . 1925. The metamorphosis of the California ribbonfish *Trachipterus rex-salmonorum*. *Pap. Mich. Acad. Sci. Arts Lett.* 5:469-476.
- . 1934. *Coelorhynchus marini*, a new macrourid fish from Argentina and South Georgia. *Occas. Pap. Mus. Zool. Univ. Mich.* 298:1-9.
- . 1943. Terminology of early stages of fishes. *Copeia* 1943:260.
- . 1945. Phylogenetic position of the Citharidae, a family of flatfishes. *Univ. Mich. Mus. Zool. Misc. Publ.* 63.
- . 1946. Pertinence of the East Indian heterosomate fish genus *Lepidoblepharon* to the Citharidae. *Copeia* 1946:97.
- . 1951. Identification as osmerids of two fishes described from the North Pacific as paralepidids. *Copeia* 1951:296.
- . 1953. Synonymy of the bathypelagic fish genus *Rhynchohyalus*, referred to the expanded family Argentinidae. *Copeia* 1953: 96-97.
- . 1958. *Dikellorhynchus* and *Kanazawaichthys*: nominal fish genera interpreted as based on prejuveniles of *Malacanthus* and *Antennarius*, respectively. *Copeia* 1958:282-285.
- , AND Y. T. CHU. 1934. Asiatic fishes (*Diploprion* and *Lacops*) having a greatly elongated dorsal ray in very large post-larvae. *Occas. Pap. Mus. Zool. Univ. Mich.* 299:1-7.
- , AND L. C. HUBBS. 1945. Bilateral asymmetry and bilateral variation in fishes. *Pap. Mich. Acad. Sci. Arts Lett.* 30:229-310.
- , AND T. IWAMOTO. 1977. A new genus (*Mesobius*), and three new bathypelagic species of Macrouridae (Pisces, Gadiformes) from the Pacific Ocean. *Proc. Calif. Acad. Sci. Fourth Ser.* 41(7):233-251.
- , AND E. M. KAMPA. 1946. The early stages (egg, prolarva and juvenile) and the classification of the California flying fish. *Copeia* 1946:188-218.
- , AND R. L. WISNER. 1964. *Parvilux*, a new genus of myctophid fishes from the northeastern Pacific, with two new species. *Zool. Meded. (Leiden)* 39:445-463.
- , AND ———. 1980. Revision of the sauries (Pisces, Scomberosocidae) with descriptions of two new genera and one new species. *Fish Bull. U.S.* 77:521-566.
- HUDSON, L. L., AND J. D. HARDY, JR. 1975. Eggs and larvae of the Atlantic seahorse, *Hippocampus hudsonius*. *Univ. Md., CEES, Ref.* 175-12CBL.
- HUGHES, D. R. 1981. Development and organization of the posterior field of ctenoid scales in the Platycephalidae. *Copeia* 1981:596-606.
- HULET, W. H. 1978. Structure and functional development of the eel leptocephalus *Ariosoma balearicum* (De La Roche, 1809). *Philos. Trans. R. Soc. Lond.* 282(987):107-138.
- HULLEY, P. A. 1972. A report on the mesopelagic fishes collected

- during the deep-sea cruises on R.S. "Africana II," 1961-1966. *Ann. S. Afr. Mus.* 60:197-236.
- . 1981. Results of the research cruise of FRV "Walter Herwig" to South America. LVIII. Family Myctophidae (Osteichthyes, Myctophiformes). *Arch. Fischereiwiss.* 31(1):1-300.
- , AND R. E. RAU. 1969. A female *Regalecus glesne* from Cape Province, South Africa. *Copeia* 1969:835-839.
- HUMASON, G. L. 1979. Animal tissue techniques. W. H. Freeman and Co., San Francisco.
- HUMPHRIES, J. M., F. L. BOOKSTEIN, B. CHERNOFF, C. R. SMITH, R. L. ELDER AND S. G. POSS. 1981. Multivariate discrimination by shape in relation to size. *Syst. Zool.* 30:291-308.
- HUNTER, C. J. 1969. Confirmation of symbiotic relationship between liparid fishes and male king crab. *Pac. Sci.* 23:546-547.
- HUNTER, J. R. 1972. Swimming and feeding behavior of larval anchovy *Engraulis mordax*. *Fish. Bull. U.S.* 70:821-838.
- . 1976. Culture and growth of northern anchovy *Engraulis mordax* larvae. *Fish. Bull. U.S.* 78:81-88.
- . 1981. Feeding ecology and predation of marine fish larvae, p. 33-77. *In: Marine fish larvae. Morphology, ecology and relation to fisheries.* R. Lasker (ed.). Univ. Washington Press, Seattle, WA.
- . 1984. Inferences regarding predation on the early life stages of cod and other fishes, p. 533-562. *In: The propagation of cod.* E. Dahl, D. S. Danielssen, E. Moksness and P. Solemdal (eds.). Flodevigen Rapp. 1.
- , AND K. M. COYNE. 1982. The onset of schooling in northern anchovy larvae *Engraulis mordax*. *Calif. Coop. Oceanic Fish. Invest. Rep.* 23:246-251.
- , S. E. KAUPP AND J. T. TAYLOR. 1982. Assessment of effects of UV radiation on marine fish larvae, p. 459-497. *In: The role of solar ultraviolet radiation in marine ecosystems.* NATO Conference Series IV: Marine Sciences. J. Calkins (ed.). Plenum Press, New York.
- , AND C. A. KIMBRELL. 1980. Egg cannibalism in the northern anchovy *Engraulis mordax*. *Fish. Bull. U.S.* 78:811-816.
- HUREAU, J. C. 1971. Notes sur la famille des Congiopodidae (Téléostéens, Perciformes): redécouverte de *Zanclorhynchus spinifer* (Günther, 1880) aux îles Kerguelen et rehabilitation de *Congiopodus kienert* (Sauvage, 1878). *Bull. Mus. Natl. Hist. Nat.* 42:1019-1026.
- , AND A. TOMO. 1977. *Bovichthys elongatus* n. sp. Poisson Bovichthyidae, famille nouveau pour l'Antarctique. *Cybius* 3e Ser. 1977 (1):67-74.
- HUSSAIN, N., S. AKATSU AND C. EL-ZAHR. 1981. Spawning, egg and early development, and growth of *Acanthopagrus cuvieri* (Sparidae). *Aquaculture* 22:125-136.
- HUSSAIN, N. A., AND M. HIGUCHI. 1980. Larval rearing and development of the brown spotted grouper, *Epinephelus tauvina* (Forsk.). *Aquaculture* 19:339-350.
- HUXLEY, J. S. 1932. Problems of relative growth. Methuen and Co., London.
- HUYGHEBAERT, B., AND D. NOLF. 1979. An annotated bibliography of paleontological and systematic papers on fish-otoliths, published since 1968. *Meded. Werkg. Tert. Kwart. Geol.* 16(4):139-170.
- IDA, H. 1976. Removal of the family Hypoptychidae from the suborder Ammodytoidei, order Perciformes, to the suborder Gasterosteoidae, order Syngnathiformes. *Jpn. J. Ichthyol.* 23:33-42.
- ILJIN, B. S. 1930. Le système des Gobiides. *Trab. Inst. Esp. Oceanogr.* (2):1-63.
- IMAI, S. 1941. Seven new deep-sea fishes obtained in Sagami Bay. *Jpn. J. Zool.* 9(2):233-250.
- . 1958. Young of *Myctophum orientale* (Gilbert), p. 21. *In: Studies on the eggs, larvae and juveniles of Japanese fishes.* Ser. 1. Uchida et al. (eds.). Fac. Agric. Kyushu Univ., Fukuoka, Japan. (In Japanese.)
- . 1959. Studies on the life histories of the flying-fishes found in the adjacent waters of Japan.—I. *Mem. Fac. Fish. Kagoshima Univ.* 7:1-85. (In Japanese.)
- . 1960. Studies on the life histories of flying-fishes found in the adjacent waters of Japan—II. *Mem. Fac. Fish. Kagoshima Univ.* 8:8-45. (In Japanese.)
- , AND K. NAKAHARA. 1957. *Coreoperca kawamurai* and its life history, p. 591-601. *In: Syehiro et al. (eds.). Suisangaku Shusei.* (In Japanese.)
- INABA, D., M. NOMURA, AND M. NAKAMURA. 1957. Preliminary report on the spawning of grass-carp and silver-carp in the Tone River, Japan and the development of their eggs. *J. Tokyo Univ. Fish.* 43(1):81-96.
- INADA, T. 1981a. Two nominal species of *Merluccius* from New Zealand and southern South America. *Jpn. J. Ichthyol.* 28:31-36.
- . 1981b. Studies on the merlucciid fishes. *Bull. Far Seas Fish. Res. Lab. (Shimizu)* 18:1-172.
- , AND I. NAKAMURA. 1975. A comparative study of two populations of the gadoid fish *Micromesistius australis* from the New Zealand and Patagonian-Falkland regions. *Bull. Far. Seas Fish. Res. Lab. (Shimizu)* 13:1-26.
- INGLIS, W. G. 1966. The observational basis of homology. *Syst. Zool.* 15:219-228.
- INNES, W. T. 1956. Exotic aquarium fishes. 19th Ed. G. S. Myers (ed.). Innes Publ. Co., Phila.
- IRIE, T. 1960. The growth of the fish otolith. *J. Fac. Fish. Anim. Husb. Hiroshima Univ.* 3:203-221.
- ISHIGAKI, T. 1957. A few informations concerning "Shiwa-ikanago, *Hypoptychus dybowskii* Steindachner", in the waters around Hokkaido. *Month. J. Hokkaido Fish. Res. Stn.* 14(8):14-24. (In Japanese.)
- ISHIYAMA, R. 1951. Revision of the Japanese mugilid fishes especially based upon the osteological characters of the cranium. *Jpn. J. Ichthyol.* 1:230-250. (In Japanese, English summary.)
- IVANKOV, V. N., AND V. P. KURDYAYEVA. 1973. Systematic differences and the ecological importance of the membranes in fish eggs. *J. Ichthyol. (Engl. Transl. Vopr. Ikhtiol.)* 13:864-873.
- IVANTSOFF, W. 1978. Taxonomic and systematic review of the Australian fish species of the family Atherinidae with references to related species of the Old World. Unpubl. PhD dissertation, Macquarie University, Sydney.
- IWAMI, T., AND T. ABE. 1980. Records of adults of some scopelarchid fishes from the western North Pacific and the Southern Ocean, with osteological notes on five species of the genus *Benthalbella*. *U. O. No.* 31:1-20.
- IWAMOTO, T. 1966. The macrourid fish *Cetonus globiceps* in the Gulf of Mexico. *Copeia* 1966:439-442.
- . 1974. *Nezumia (Kuronezumia) bubonis*, a new subgenus and species of grenadier (Macrouridae: Pisces) from Hawaii and the western North Atlantic. *Proc. Calif. Acad. Sci., Fourth Ser.* 39(22):507-516.
- . 1978. Eastern Pacific macrourids of the genus *Coelorhynchus* Giorna (Pisces: Gadiformes), with description of a new species from Chile. *Proc. Calif. Acad. Sci., Fourth Ser.* 41(12):307-337.
- . 1979. Eastern Pacific macrourine grenadiers with seven branchiostegal rays (Pisces: Macrouridae). *Proc. Calif. Acad. Sci.* 42(5):135-179.
- , AND J. C. STAIGER. 1976. Percophid fishes of the genus *Chironema* Gilbert. *Bull. Mar. Sci.* 26:488-498.
- , AND D. L. STEIN. 1974. A systematic review of the rattail fishes (Macrouridae: Gadiformes) from Oregon and adjacent waters. *Ocas. Pap. Calif. Acad. Sci., No.* 111:1-79.
- JACINO, A. 1909. Uovo e larve di *Trachipterus* sp. *Arch. Zool. Napoli* 3(4):479-484.
- JACKSON, P. D. 1978. Spawning and early development of the river blackfish, *Gadopsis marmoratus* Richardson (Gadopsiformes: Gadopsidae) in the McKenzie River, Victoria. *Aust. J. Mar. Freshwater Res.* 29:293-298.
- JAMES, G. D. 1976a. Eggs and larvae of the trevally *Caranx georgianus* (Teleostei: Carangidae). *N.Z. Mar. Freshwater Res.* 10:301-310.
- . 1976b. *Cyttus traversi* Hutton: Juvenile form of *C. ventralis* Barnard and Davies (Pisces, Zeidae). *J. R. Soc. N.Z.* 6(4):493-498.

- JAMES, P. S. B. R. 1970. *Micrognathus brevirostris* (Ruppell) (Family Syngnathidae: Pisces)—a new record from the Indian Seas with observations on its early development. *J. Mar. Biol. Assoc. India* 12:158-162.
- JANSSEN, J., AND G. R. HARBISON. 1981. Fish in salps: the association of squaretails (*Tetragomus* spp.) with pelagic tunicates. *J. Mar. Biol. Ass. U. K.* 61:917-927.
- JENKINS, G. P., N. E. MILWARD AND R. F. HARTWICK. 1984. Identification and description of larvae of Spanish mackerels, genus *Scomberomus* (Teleostei: Scombridae), in shelf waters of the Great Barrier Reef. *Aust. J. Mar. Freshwater Res.* 35:341-353.
- JENSEN, A. S. 1935. The Greenland halibut (*Reinhardtius hippoglossoides*), its development and migrations. *K. Dan. Vidensk. Selsk. Skr.* 9(4):1-32.
- . 1948. Contributions to the ichthyofauna of Greenland. *Spolia Zool. Mus. Haun.* 9:1-176.
- JENSEN, R. J. 1981. Wagner networks and Wagner trees: a presentation of methods for estimating parsimonious solutions. *Taxon* 30:576-590.
- JERZMANSKA, A. 1968. Ichthyofaune des couches a menilite (flysch des Karpathes). *Acta Palaeontol. Pol.* 13(3):379-488.
- JESPERSEN, P. 1942. Indo-Pacific leptocephalids of the genus *Anguilla*. Systematic and biological studies. Dana-Rep. Carlsberg Found. 22.
- , AND A. V. TANING. 1919. Some Mediterranean and Atlantic Sternoptychidae. Preliminary Note. *Saertryk af Vidensk. Medd. Dansk Naturh. Foren.* 70:215-226.
- , AND ———. 1926. Mediterranean Sternoptychidae. Rep. Dan. Oceanogr. Exped. Mediterr. 2 (A.12):1-59.
- JHINGRAN, V. G. 1975. Fish and fisheries of India. Hindustan Publishing Corporation, Delhi, India.
- JILLETT, J. B. 1968. The biology of *Acanthochinus quadridactylus* (Bloch and Schneider) (Teleostei—Blennioidea). II. Breeding and development. *Aust. J. Mar. Freshwater Res.* 19:9-18.
- JOB, T. J. 1940. On the breeding and development of Indian "mosquito-fish" of the genera *Aplocheilichthys* McClelland and *Oryzias* Jordan and Snyder. *Rec. Indian Mus. (Calcutta)* 42:51-79.
- , AND S. JONES. 1938. Studies on the development of the Indian garfish, *Tylosurus strongylurus* (van Hass.) with notes on the young stages of *Hemirhamphus gaimardi* Cuv. & Val. *Rec. Indian Mus. (Calcutta)* 40(3):245-253.
- JOHANSEN, F. 1912. The fishes of the Danmark Expedition. *Medd. Gronl.* 45(12):633-675.
- JOHN, C. M. 1950. Early stages in the development of the sucker fish *Echeiichthys naucrates* Linn. *Bull. Cent. Res. Inst. Univ. Travancore India* 1C(1):47-55.
- JOHN, M. A. 1951a. Pelagic fish eggs and larvae of the Madras coast. *J. Zool. Soc. India* 2:267-268.
- . 1951b. Pelagic fish eggs and larvae of the Madras coast. *J. Zool. Soc. India* 3:41-69.
- JOHNSON, S. 1921. Ichthyologische notiser I. *Bergens Mus. Aarbok* 1918-1919. *Naturvid. Raekke* No. 6. (English summary.)
- . 1927. On some bathypelagic stages of macrourid fishes. *Nytt Mag. Naturvid.* 65:221-241.
- JOHNSON, C. R. 1969. Contributions to the biology of the showy snailfish, *Liparis pulchellus* (Liparidae). *Copeia* 1969:830-835.
- , D. A. RATKOWSKY AND R. W. G. WHITE. 1983. Multivariate analysis of the phenotypic relationships of the species of *Paragalaxias* and *Galaxias* (Pisces: Galaxiidae) in Tasmania. *J. Fish Biol.* 23:49-63.
- , R. W. G. WHITE AND Y. A. E. BECK. 1981. Cytotaxonomy of seven species of *Galaxias* (Pisces: Galaxiidae) in Tasmania. *Genetica* 56:17-21.
- JOHNSON, G. D. 1975. The procurvent spur, an undescribed perciform character and its phylogenetic implications. *Occas. Pap. Calif. Acad. Sci.* 121:1-23.
- . 1978. Development of fishes of the Mid-Atlantic Bight. An Atlas of egg, larval and juvenile stages. Vol. IV. Carangidae through Ehippiidae. U.S. Fish Wildl. Serv. Biol. Serv. Program FWS/OBS-78/12.
- . 1980. The limits and relationships of the Lutjanidae and associated families. *Bull. Scripps Inst. Oceanogr. Univ. Calif.* 24.
- . 1983. *Niphon spinosus*: a primitive epinepheline serranid, with comments on the monophyly and intrarelationships of the Serranidae. *Copeia* 1983:777-787.
- , AND P. KEENER. 1984. Aid to identification of American grouper larvae. *Bull. Mar. Sci.* 34:106-134.
- JOHNSON, R. K. 1970. A second record of *Korsogaster nanus* Parr (Beryciformes: Korsogasteridae). *Copeia* 1970:758-760.
- . 1974a. A *Macristium* larva from the Gulf of Mexico with additional evidence for the synonymy of *Macristium* with *Bathysaurus* (Myctophiformes: Bathysauridae). *Copeia* 1974:973-977.
- . 1974b. A revision of the alepisauroid family Scopelarchidae (Pisces: Myctophiformes). *Fieldiana Zool.* 66.
- . 1975. A new myctophid fish, *Bolinichthys distofax*, from the western and central north Pacific Ocean, with notes on other species of *Bolinichthys*. *Copeia* 1975:53-60.
- . 1982. Fishes of the families Evermannellidae and Scopelarchidae: systematics, morphology, interrelationships and zoogeography. *Fieldiana Zool. N.S.* 12.
- , AND D. M. COHEN. 1974. Results of the research cruises of FRV "Walther Herwig" to South America. 30. Revision of the chiasmodontid fish genera *Dysalotus* and *Kali*, with descriptions of two new species. *Arch. Fischereiwiss.* 25:13-46.
- , AND R. M. FELTES. 1984. A new species of *Inciguerria* (Salmoniformes: Photichthyidae) from the Red Sea and Gulf of Aqaba, with comments on the depauperacy of the Red Sea mesopelagic fish fauna. *Fieldiana Zool. N. S.* 22.
- , AND D. W. GREENFIELD. 1976. A new chaenopsid fish, *Emblemaria hyltoni*, from Isla Roatan, Honduras. *Fieldiana Zool.* 70(2):13-28.
- JOHNSON, S. E. 1918. Osteology of the gruntfish, *Rhamphocottus richardsoni*. *J. Morphol.* 31:461-477.
- JOLICOEUR, P. 1963. The multivariate generalization of the allometry equation. *Biometrics* 19:497-499.
- JOLLY, V. H. 1967. Observations on the smelt *Retropinna lacustris* Stokell. *N.Z. J. Sci.* 10:330-355.
- JONES, A. 1972. Studies on egg development and larval rearing of turbot, *Scophthalmus maximus* L., and brill *Scophthalmus rhombus* L., in the laboratory. *J. Mar. Biol. Assoc. U.K.* 52:965-986.
- JONES, A. C. 1962. The biology of the euryhaline fish *Leptocottus armatus armatus* Girard. *Univ. Calif. Publ. Zool.* 67(4):321-368.
- JONES, G. G., AND M. A. TABERY. 1980. Larval development of the banded killifish (*Fundulus diaphanus*) with notes on the distribution in the Hudson River estuary, p. 25-35. *In: Proc. Fourth Ann. Larval Fish Conf.* L. A. Fuiman (ed.). U.S. Fish Wildl. Serv., National Power Plant Team, Ann Arbor, Mich., FWS/OBS-80/43.
- JONES, M. P., F. G. T. HOLLIDAY AND A. E. G. DUNN. 1966. The ultrastructure of the epidermis of larvae of the herring (*Clupea harengus*) in relation to the rearing salinity. *J. Mar. Biol. Assoc. U.K.* 46:235-239.
- JONES, P. W., F. D. MARTIN AND J. D. HARDY, JR. 1978. Development of fishes of the mid-Atlantic bight, an atlas of egg, larval, and juvenile stages. Volume 1. Acipenseridae through Ictaluridae. U.S. Fish Wildl. Serv., Biol. Serv. Prog. FWS/OBS-78/12.
- JONES, R., AND W. B. HALL. 1974. Some observations on the population dynamics of the larval stage in the common gadoids, p. 87-102. *In: The early life history of fish.* J. H. S. Blaxter (ed.). Springer Verlag, Berlin.
- JONES, S. 1937. Observations on the breeding habits and development of certain brackish water fishes of Adyar, Madras. *Proc. Indian Acad. Sci. Sect. B* 5:261-289.
- . 1938. On the breeding habits and development of a cyprinid, *Datto (Datto) malabaricus* (Jerdon) in Ceylon. *Ceylon J. Sci. Sec. C* 6:79-90.

- , AND M. KUMARAN. 1962. Notes on eggs, larvae and juveniles of fishes from Indian waters. XII. *Myripristis murdjan*. XIII. *Holoocentrus* sp. Indian J. Fish. Sect. A 9(1):155-167.
- , AND —. 1964. On the fishes of the genus *Schundleria* Gil-
tay from the Indian Ocean. J. Mar. Biol. Assoc. India 6:257-264.
- , AND —. 1967. Notes on eggs, larvae, and juveniles of
fishes from Indian waters. XV. *Pegasus volitans* Linnaeus. XVI.
Dactyloptena orientalis (Cuvier and Valenciennes). XVII. *Dacty-*
loptena macracanthus Bleeker). Indian J. Fish. 11:232-246.
- , AND —. 1950. Spawning habits and development of the
Gangetic anchovy, *Setipinna phasa* (Hamilton). Curr. Sci. 19:25.
- , AND —. 1951. Notes on the bionomics and developmental
stages of some Indian flatfishes. J. Zool. Soc. India 3:71-83.
- , AND —. 1952. Observations on the development and
systematics of the fishes of the genus *Colia* Gray. J. Zool. Soc.
India 4:17-36.
- , AND V. B. PANTULU. 1958. On some larval and juvenile fishes
from the Bengal and Orissa coasts. Indian J. Fish. 5:118-143.
- JORDAN, D. S. 1892. Relations of temperature to vertebrae among
fishes. Proc. U.S. Natl. Mus. 14:107-120.
- , 1923. A classification of fishes including families and genera
as far as known. Stanford Univ. Publ. Biol. Sci. 3(2):77-243.
- , AND B. W. EVERMANN. 1896-1900. The fishes of North and
Middle America. U.S. Natl. Mus. Bull. 47.
- , AND C. H. GILBERT. 1899. The fishes of the Bering Sea, p.
433-492. In: Fur-seals and fur-seal islands of the North Pacific
Ocean, Pt. 3. D. S. Jordan (ed.). Washington, D.C.
- , AND E. C. STARKS. 1904. A review of the Cottidae or sculpins
found in the waters of Japan. Proc. U.S. Natl. Mus. 27:231-335.
- JUDE, D. J. 1982a. Family Cyprinodontidae, p. 477-486. In: Identifi-
cation of larval fishes of the Great Lakes basin with emphasis on
the Lake Michigan drainage. N. A. Auer (ed.). Great Lakes Fish.
Comm. Spec. Publ. 82-3.
- , 1982b. Family Gadidae, codfishes, p. 470-476. In: Identifi-
cation of larval fishes of the Great Lakes basin with emphasis on
the Lake Michigan drainage. N. A. Auer (ed.). Great Lakes Fish.
Comm. Spec. Publ. 82-3.
- JUNGERSEN, H. F. E. 1910. Ichthyotomical contributions. II. The struc-
ture of the Aulostomidae, Syngnathidae and Solenostomidae. K.
Dan. Vidensk. Selsk. Skr. Ser. 8, 7:268-364.
- KADAM, K. M. 1961. The development of the skull in *Nerophis*. Acta.
Zool. (Stockh.) 42:257-298.
- KAHAN, D., G. UHLIG, D. SCHWENZER AND L. HOROWITZ. 1982. A
simple method for cultivating harpacticoid copepods and offering
them to fish larvae. Aquaculture 26:303-310.
- KAILL, W. M. 1967. Ecology and behavior of the cyprinodontid fishes
Jordanella floridae Goode and Bean, *Flordichthys carpio* (Gunther)
and *Cyprinodon variegatus* Lacepede. Unpubl. PhD dissertation,
Cornell Univ., Ithaca, NY.
- KAISER, C. E. 1973. Age and growth of horse mackerel *Trachurus*
murphyi off Chile. Trans. Am. Fish. Soc. 102(3):591-595.
- KAMLYA, T. 1925. The pelagic eggs and larvae of fishes in the Tateya-
ma Bay (Pref. Chiba) 3rd Report. J. Imp. Fish. Inst. (Tokyo) 21(3):
27-35.
- KANAZAWA, R. H. 1952. More new species and new records of fishes
from Bermuda. Fieldiana Zool. 34(7):71-100.
- KANIDEV, A. N. 1961. Embryonic development of *Atherina hepsetus*
and *A. mochon pontica*. Tr. Karadag. Biol. Stn. 17:24-45.
- KARAMCHANDANI, S. J., AND M. P. MOTWANI. 1955. Early life-history,
bionomics and breeding of *Rita rita* (Hamilton). J. Zool. Soc. India
7:115-126.
- , AND —. 1956. On the larval development of four species
of freshwater cat fishes from the River Ganga. J. Zool. Soc. India
8(1):19-34.
- KARRER, C. 1976. Über drei mesopelagische fisharten aus dem Golf
von Guinea. Mitt. Zool. Mus. Berl. 52:177-182.
- , 1982. Anguilliformes du Canal de Mozambique (Pisces, Te-
leostei). Faune Trop. 23:1-116.
- KATAYAMA, M. 1960. Fauna Japonica Serranidae. (Pisces). Tokyo
News Serv., Ltd., Tokyo.
- KAUFMAN, L. S., AND K. F. LIEM. 1982. Fishes of the suborder La-
broidei (Pisces: Perciformes): phylogeny, ecology, and evolutionary
significance. Breviora (472):1-19.
- KAWAGUCHI, K., AND K. AIOL. 1972. Myctophid fishes of the genus
Myctophum (Myctophidae) in the Pacific and Indian Oceans. J.
Oceanogr. Soc. Jpn. 28:161-175.
- , AND J. L. BUTLER. In press. Fishes of the genus *Nansena*
(Microstomatidae) with descriptions of seven new species. Contrib.
Sci. (Los Ang.).
- , H. IKEDA, M. TAMURA AND S. UEYANAGI. 1972. Geographical
distribution of surface migrating myctophid fishes (genus *Mycto-*
phum) in the tropical and subtropical Pacific and Indian Oceans.
Bull. Far. Seas Fish. Res. Lab. (Shimizu) 6:23-37.
- , AND R. MARUMO. 1967. Biology of *Gonostoma gracile* (Gon-
ostomatidae). I. Morphology, life history and sex reversal, p. 253-
269. In: Information Bulletin on Planktology in Japan, Commem-
oration Number of Dr. Y. Matsue.
- , AND J. MAUCLINE. 1982. Biology of myctophid fishes (family
Myctophidae) in the Rockall Trough, Northeastern Atlantic Ocean.
Biol. Oceanogr. 1:337-373.
- KAYA, C. M., A. E. DIZON, S. D. HENDRIX, T. K. KAZAMA AND M. K.
K. QUEENTH. 1982. Rapid and spontaneous maturation, ovula-
tion, and spawning of ova by newly captured skipjack tuna, *Kat-*
suwonus pelamis. Fish. Bull. U.S. 80:393-396.
- KEENE, M. 1973. *Melamphaes ebelingi*, a new species of beryciform
fish (Melamphidae) from the North Atlantic. Copeia 1973:794-
800.
- KEEVIN, T. M., G. PHILLIPS, J. E. THOMERSON AND D. C. TAPHORN.
1980. Egg chorion ornamentation and taxonomy of the annual
killifishes *Austrofundulus*, *Rachovia*, and *Terranatos*. Am. Soc. Ich-
thyol. Herpetol., 60th Annual Meeting. Fort Worth, Texas. (Ab-
stract.)
- KELLEY, S. MS. A description of laboratory-reared larvae of the labrid
fish, *Lachnolaimus maximus*.
- KENDALL, A. W., JR. 1972. Description of black sea bass, *Centropristis*
striata (Linnaeus), larvae and their occurrence north of Cape Look-
out, North Carolina, in 1966. Fish. Bull. U.S. 70:1243-1260.
- , 1976. Predorsal and associated bones in serranid and gram-
mistid fishes. Bull. Mar. Sci. 26:585-592.
- , 1977. Relationships among American serranid fishes based
on the morphology of their larvae. Unpubl. PhD dissertation, Univ.
Calif. San Diego, San Diego, CA.
- , 1979. Morphological comparisons of North American sea bass
larvae (Pisces: Serranidae). NOAA Tech. Rep. NMFS Circ. 428.
- , 1982. Elucidating relationships among fishes using larval char-
acters. Mimeogr.
- , AND M. P. FAHAY. 1979. Larva of the serranid fish *Gomo-*
plectrus huspamus with comments on its relationships. Bull. Mar.
Sci. 29:117-121.
- , AND D. GORDON. 1981. Growth rate of Atlantic mackerel
(*Scomber scombrus*) larvae in the middle Atlantic Bight. Rapp. P.
V. Reun. Cons. Int. Explor. Mer 178:337-341.
- , C. D. JENNINGS, T. M. BEASLEY, R. CARPENTER AND B. L. J.
SOMAYAJULU. 1983. Discovery of a fish (zoarcid) egg cluster bur-
ied 10-12 cm deep in Washington continental slope sediments.
Mar. Biol. 74:193-200.
- , AND B. VINTER. 1984. Development of hexagrammids (Pisces:
Scorpaeniformes) in the Northeastern Pacific Ocean. NOAA Tech.
Rep. NMFS 2.
- KENDALL, W. C., AND E. L. GOLDSBOROUGH. 1911. Reports on the
scientific results of the expedition to the tropical Pacific, in charge
of Alexander Agassiz, by the U.S. Fish Commission Steamer "Al-
batross," from August 1899 to March 1900. 13. The Shore fishes.
Mem. Mus. Comp. Zool. Harvard 26(7):293-344.
- KENNEDY, M., AND T. CHAMP. 1971. Occurrence of eggs of *Echodon*

- drummondi* Thompson on the coast of County Kerry. Ir. Fish. Invest. Ser. B (Mar.):7:55-59.
- AND P. FITZMAURICE. 1969. Pelagic eggs and young stages of fishes taken on the south coast of Ireland in 1967. Ir. Fish. Invest. Ser. B (Mar.):5:5-36.
- KHALDINOVA, N. A. 1936. Study of spawning, eggs, and larvae of *Eleginus (Gadus) navaga* Pall. Zool. Zh. 15(2):321-339. (In Russian, English summary.)
- KHAN, N. Y. 1972. Comparative morphology and ecology of the pelagic larvae of nine Cottidae (Pisces) of the northwest Atlantic and St. Lawrence drainage. Unpubl. PhD thesis. Univ. Ottawa, Canada.
- AND D. J. FABER. 1974. A comparison of larvae of the deepwater and fourhorn sculpin, *Myoxocephalus quadricornis* L. from North America. 1. Morphological development, pp. 703-712. In: The early life history of fish. Blaxter, J. H. S. (ed.). Springer-Verlag, New York.
- KIDO, K. 1983. New and rare liparidid species from the Okhotsk and Bering Seas and their adjacent waters. Jpn. J. Ichthyol. 29:374-384.
- KILIACHENKOVA, V. A. 1970. Development and distribution of eggs and larvae of *Trachurus trachurus* L. Rapp. P. V. Reun. Cons. Int. Explor. Mer. 159:194-198.
- KIM, Y. U., P. CHIN, T. Y. LEE AND Y. J. KANG. 1981. Studies on the fish larvae of coastal waters in Korea. Publ. Inst. Mar. Sci. Natl. Fish. Univ. Busan 13:1-35.
- KINDRED, J. E. 1921. The chondrocranium of *Synanathus fuscus*. J. Morphol. 35:425-456.
- KING, D. P. F., M. J. O'TOOLE AND A. A. ROBERTSON. 1977. Early development of the south African maasbanker, *Trachurus trachurus*, at controlled temperatures. Fish. Bull. S. Afr. 9:16-22.
- KINNE, O. 1977. Research Cultivation: (13) Pisces, p. 968-1035. In: Marine ecology. Vol. III, part 2. O. Kinne (ed.). John Wiley & Sons, Chichester.
- KIRSCHBAUM, F. 1984. Reproduction of weakly electric teleosts: just another example of convergent development? Environ. Biol. Fishes 10:3-14.
- AND J. P. DENIZOT. 1975. Sur la différenciation des électro-récepteurs chez *Marcusenius* sp. (Mormyridés) et *Eigenmannia virescens* (Gymnotoïdes), poissons électriques à faible décharge. C. R. Hebd. Sciences Acad. Sci. Sér. D. Sci. Nat 28:419-422.
- AND G. W. M. WESTBY. 1975. Development of the electric discharge in mormyrid and gymnotid fish (*Marcusenius* sp. and *Eigenmannia virescens*). Experientia (Basel) 31:1290-1293.
- KLAWE, W. L. 1960. Animals from night-light collections. In: Physical, chemical, and biological observations in the eastern Tropical Pacific Ocean—Scot Expedition, April-June 1958. R. W. Holmes and M. Blackburn (eds.). U.S. Fish Wildl. Serv. SSRF 345.
- KLEE, A. J. 1982. Comments on the genus *Rivulus*. J. Am. Killifish Assoc. 15(3):76-79.
- KLEIN-MACPHEE, G., W. H. HOWELL AND A. D. BECK. 1982. Comparison of a reference strain and four geographical strains of *Artemia* as food for winter flounder (*Pseudopleuronectes americanus*) larvae. Aquaculture 29:279-288.
- KLIEVER, R. G. 1976. Natural history of *Mayneca californica* (Pisces: Zoarcidae) in a drift seaweed habitat in the Monterey Submarine Canyon, Monterey Bay, California. Unpubl. MA Thesis. San Jose State Univ., San Jose, CA.
- KLUGE, A. G., AND J. S. FARRIS. 1969. Quantitative phyletics and the evolution of anurans. Syst. Zool. 18:1-32.
- KOBAYASHI, K. 1957. Larvae and young of the sable fish, *Anoplopoma fimbria* (Pallas), from the sea near the Aleutian Islands. Bull. Jpn. Soc. Sci. Fish 23:376-382. (In Japanese, English abstract.)
- 1961a. Young of the wolffish, *Anarchichthys orientalis* (Pallas). Bull. Fac. Fish. Hokkaido Univ. 12(1):1-4. (In Japanese, English abstr.)
- 1961b. Larvae and young of the quillfish, *Ptilichthys gooderi* (Bean), from the Okhotsk Sea. Bull. Fac. Fish. Hokkaido Univ. 12(1):5-8. (In Japanese, English abstr.)
- 1961c. Larvae and young of the sand lance, *Ammodytes hexapterus* (Pallas) from the north Pacific. Bull. Fac. Fish. Hokkaido Univ. 12:111-120.
- 1962. Larvae of the smooth lumpsucker, *Aptocyclus ventricosus* (Pallas), with discussion on revision of the taxonomy of the species. Bull. Fac. Fish. Hokkaido Univ. 13(3):153-164.
- AND K. ABE. 1962. Studies on the larvae and young of fishes from the boundary zones off the south-eastern coast of Hokkaido, Japan. Bull. Fac. Fish. Hokkaido Univ. 13:165-179. (In Japanese, English summary.)
- AND M. IGARASHI. 1961. Larvae and young of *Girella punctata* Gray from Hakodate Bay in southern Hokkaido. Bull. Fac. Fish. Hokkaido 12:121-127. (In Japanese, English abstract.)
- M. MIKAWA, AND J. ITO. 1968. Descriptions of the young and one, immature adult specimen of the coster dory, *Alloctytus verrucosus* (Gilchrist) from the northern part of the Pacific. Bull. Fac. Fish. Hokkaido Univ. 19(1):1-5.
- KOBAYASHI, T., Y. DOTSU AND N. MIURA. 1973. Egg development and rearing experiments of the larvae of the mud skipper, *Periophthalmus cantonensis*. Bull. Fac. Fish. Nagasaki Univ. 33:49-62.
- KOBAYASHI, H., AND S. MORIYANA. 1957. On the development of a loach, *Barbatula toni oreas* (Jordan et Fowler). Jpn. J. Ichthyol. 6:177-183.
- KOBELKOWSKY, A. D., AND A. M. RESENDEZ. 1972. Estudio comparativo del endosqueleto de *Mugil cephalus* y *Mugil curema* (Pisces, Perciformes). An. Inst. Biol. Univ. Nac. Auton. Mex. Ser. Cienc. Mar. Limnol. 43(1):33-81.
- KOBLITSKAIA, A. F. 1981. Opredelitel' molodi presnovodnykh ryb. Legkaia i pishevaia promyshlennost', Moskova.
- KOCK, K. H. 1981. Fischereibiologische Untersuchungen an drei antarktischen Fischarten: *Champscephalus gunnari* Lönnberg, 1905, *Chaenocephalus aceratus* (Lönnberg, 1906) und *Pseudochaenichthys georgianus* Norman, 1937 (Notothenioidei, Channichthyidae). Mitt. Inst. Seefisch. 32:1-226.
- KOEFOD, E. 1909. Poissons. Croisière océanographique accomplie à bord de la Belgica dans la mer de Gronland 1905. Bruxelles.
- 1927. Fishes from the sea-bottom. Rep. Sci. Results Michael Sars N. Atl. Deep-Sea Exped. 4(Pt. 1):1-147.
- 1953. Syntognathi, Solenichthyes, Anacanthini, Berycomorphi, Xenoberycerys. Rep. Sci. Results Michael Sars N. Atl. Deep-Sea Exped. 4(Pt. 2, No. 3):3-36.
- KOENIG, C. C., AND R. J. LIVINGSTON. 1976. The embryological development of the diamond killifish (*Adinia xenica*). Copeia 1976: 435-445.
- KOHNO, H., T. HOSHINO, F. YASUDA AND Y. TAKI. 1982. Larval melanophore patterns of *Thunnus alalunga* and *T. thynnus* from the Mediterranean. Jpn. J. Ichthyol. 28:461-465.
- KOKHANOVA, N. A. 1957. Razvitie shchipovki (*Cobitis taenia* L.). Vopr. Ikhtiol. 8:89-101.
- KOMAROV, Y. A. 1964. Some data of the reproduction of the horse mackerel-*Trachurus trachurus* L. from the Southwest African coast. Tr. Atl. Nauchno-Issled. Inst. Rybn. Khoz. Okeanogr. 11:87-99.
- KOPEC, J. A. 1949. Ecology, breeding habits and young stages of *Crenichthys baileyi*, a cyprinodont fish of Nevada. Copeia 1949:56-61.
- KORMENDY, A. C. 1975. Microorganisms, p. 82-108. In: Principles and techniques of scanning electron microscopy. Vol. 3. M. A. Hayat (ed.). Van Nostrand Reinhold Co., New York.
- KOSTER, W. J. 1948. Notes on the spawning activities and the young stages of *Plancterus kansae* (Garman). Copeia 1948:25-33.
- KOTLYAR, A. N. 1981. A new family, genus and species of Beryciformes, Hispidoberycidae fam., *Hispidoberyx ambagiosus* gen. et sp. n. (Beryciformes). J. Ichthyol. (Engl. Transl. Vopr. Ikhtiol.) 21(3):9-13.
- KOTTHAUS, A. 1969. 2. Fische des Indischen Ozeans. A. Systematischer Teil, V. Solenichthyes und Anacanthini. Meteor Forschungsergeb. Reihe D. Biol. 4:32-46.
- 1970. *Flagelloserranus* a new genus of serranid fishes with the

- description of two new species (Pisces, Percomorpha). Dana-Rep. Carlsberg Found. 78.
- . 1972. Fische des Indischen Ozeans. A. Systematischer Teil. IX. Iniomi (Nachtrag: Fam. Myctophidae). Meteor Forschungsergeb. Reihe D Biol. 12:12–35.
- KOUMANS, F. P. 1931. A preliminary revision of the genera of gobioid fishes with united ventral fins. Drukkerij Imperator, N.V., Lisse.
- KOVALEVSKAYA, N. V. 1964. Study of development of the "two winged" flying fishes of the genus *Exocoetus* (Exocoetidae, Pisces). Tr. Inst. Okeanol. Akad. Nauk SSSR 73:204–223. (In Russian, English summary.)
- . 1965. The eggs and larvae of synentognathous fishes (Beloniformes, Pisces) of the Gulf of Tonkin. Tr. Inst. Okeanol. Akad. Nauk. SSSR 80:124–146. (In Russian, English summary.)
- . 1972. New materials on reproduction, development and distribution of larvae and juveniles of flying fishes of the genus *Hirundichthys* (Exocoetus, Pisces) in the Pacific and Indian Oceans. Tr. Inst. Okeanol. Akad. Nauk SSSR 93:42–69. (In Russian, English summary.)
- . 1982. Superfluous reproduction and development of flying fishes of the family Exocoetidae. J. Ichthyol. (Engl. Transl. Vopr. Ikhtiol.) 22(4):48–54.
- KOWAL, G. V. 1972. Observations on the breeding and larval development of Chilka 'Sabal' *Eleutheronema tetradeactylum* (Shaw). India J. Fish. 19(1–2):70–75.
- KOZHOV, M. 1963. Lake Baikal and its life. Monographiae Biologicae, Vol. II. Dr. W. Junk, The Hague.
- KOZLOV, B. M. 1952. Observations on the development of navaga eggs. Izv. Tikhookean Nauchno-Issled. Inst. Rybn. Khoz. Okeanogr. 34:261–262. (In Russian.)
- KRAMER, D. 1960. Development of eggs and larvae of Pacific mackerel and distribution and abundance of larvae 1952–56. U.S. Fish Wildl. Ser. Fish. Bull. 60:393–438.
- KRAUL, S. 1983. Results and hypotheses for the propagation of the grey mullet, *Mugil cephalus* L. Aquaculture 30:273–284.
- KREFFT, G. 1961. A contribution to the reproductive biology of *Helicolenus dactylopterus* (De la Roche, 1809) with remarks on the evolution of the Sebastinae. Rapp. P. V. Reun. Cons. Perm. Int. Explor. Mer 150:243–244.
- . 1970. Zur Systematik und Verbreitung der Gattung *Lampadena* Goode and Bean, 1896 (Osteichthyes, Myctophoidei, Myctophidae) im Atlantischen Ozean, mit Beschreibung einer neuen Art. Ber. Dtsch. Wiss. Komm. Meeresforsch. 21:271–289.
- . 1974. Investigations on midwater fish in the Atlantic Ocean. Ber. Dtsch. Wiss. Komm. Meeresforsch. 23:226–254.
- KRYZHANOVSKII, S. G. 1947. Sistema semeistva karpovykh ryb (Cyprinidae). Zool. Zh. 26:53–64.
- . 1948. Ekologicheskie gruppy ryb i zakonomernosti ikh razvitiia. Izv. Tikhookean Nauchno-Issled. Inst. Rybn. Khoz. Okeanogr. 27:5–114.
- . 1949. Ekologo-morphologicheskie zakonomernosti razvitiia karpovykh, v'ionovyykh i somovykh ryb (Cyprinoidei i Siluroidei). Tr. Inst. Morfol. Zhivotn., Akad. Nauk SSSR 1:1–232.
- , A. I. SMIRNOV AND S. G. SOIN. 1951. Materialy po razvitiu ryb r. Amura. Truy Amurskoi Ikhtiologicheskoi Ekspeditsii 1945–1949. Mater. Poznaniyu Fauny Flory SSSR otd. Zool. 24:5–222.
- KUBO, I. 1939. Note on the development of a teleost, *Thalassoma cupido* (Temminck and Schlegel). Bull. Jpn. Soc. Sci. Fish. 8(3): 165–167. (In Japanese, English summary.)
- KUCHNOW, K. P., AND J. R. SCOTT. 1977. Ultrastructure of the chorion and its micropyle apparatus in the mature *Fundulus heteroclitus* ovum. J. Fish Biol. 10:197–201.
- KUHLMAN, D., G. QUANTZ AND U. WITT. 1981. Rearing of turbot larvae (*Scophthalmus maximus* L.) on cultured food organisms and postmetamorphosis growth on natural and artificial food. Aquaculture 23:183–196.
- KULKARNI, C. V. 1940. On the systematic position, structural modifications, bionomics and development of a cyprinodont fishes from the province of Bombay. Rec. Indian Mus. (Calcutta) 42:379–423.
- . 1950. Breeding habits, eggs and early life history of the Indian shad. *Hilsa ilisha* (Ham.), in the Narbada River. Proc. Natl. Inst. Sci. (India) 16:169–176.
- KUNTZ, A. 1914a. Notes on the habits, morphology of the reproductive organs and embryology of the viviparous fish *Gambusia affinis*. Bull. Bur. Fish. Wash. 33(1913):181–190.
- . 1914b. The embryology and larval development of *Bairdiella chrysura* and *Anchovia mitchilli*. Bull. Bur. Fish. Wash. 33:1–19.
- . 1916. Notes on the embryology and larval development of five species of teleostean fishes. Bull. Bur. Fish. Wash. 34(1914): 407–429.
- , AND L. RADCLIFFE. 1917. Notes on the embryology and larval development of twelve teleostean fishes. Bull. Bur. Fish. Wash. 35: 87–134.
- KUNZ, Y. 1964. Morphologische Studien über die embryonale und postembryonale Entwicklung bei Teleostiern mit besonderer Berücksichtigung des Dottersystems und der Leber. Rev. Suisse Zool. 71:445–525.
- KUO, C.-M., H. SHEHADEH AND K. K. MILISEN. 1973. A preliminary report on the development, growth and survival of laboratory reared larvae of the grey mullet, *Mugil cephalus* L. J. Fish Biol. 5:459–470.
- KURATA, H. 1956. On the rearing of larvae of the flatfish, *Liopsetta obscura* in small aquaria. Bull. Hokkaido Reg. Fish. Res. Lab., Fish. Agency 13:20–28.
- KURODA, K., T. YAMAMOTO AND Y. HIRANO. 1982. Development and identification of the egg of the Pacific mackerel (*Scomber japonicus* Houttuyn) and a similar egg. Bull. Tokai Reg. Fish. Res. 107:33–52.
- KUTHALINGAM, M. D. K. 1959a. A contribution to the life histories and feeding habits of horse-mackerels, *Megalaspis cordyla* (Linn.) and *Caranx mate* (Cuv. & Val.) and notes on the effect of absence of light on the development and feeding habits of larvae and post-larvae of *Megalaspis cordyla*. J. Madras Univ. Sect. B 29(2):79–96.
- . 1959b. The life history and feeding habits of a tripod fish (*Triacanthus brevirostris* Temm. & Schleg.) of the Indian Sea. Treubia 25:159–164.
- KUWABARA, S. 1954. Occurrence of luminous organs on the tongue of two scopelid fishes, *Neoscopelus macrolepidotus* and *N. microchir*. J. Schimonoseki Coll. Fish. 3:283–287.
- KUZ'MIN-KAROVAEV, G. A. 1930. Biology of the White Sea navaga. Tr. Nauchno. Inst. Rybn. Khoz. (5) 4:83–86. (In Russian.)
- KVENSETH, P. G., AND V. OIESTAD. 1984. Large-scale rearing of cod fry on the natural food production of an enclosed pond, p. 644–655. In: The propagation of cod. E. Dahl, D. Danielssen, E. Moksness and P. Solemdal (eds.). Flodevigen Rapp. 1.
- KYLE, H. M. 1913. Flat-fishes (Heterosomata). Rep. Dan. Oceanogr. Exped. Mediterr. 2(A.1):1–150.
- . 1921. The asymmetry, metamorphosis and origin of flat-fishes. Philos. Trans. R. Soc. London Ser. B 211:75–129.
- KYUSHIN, K. 1968. The embryonic and larval stages of *Hemimtripterus villosus* (Pallas). Bull. Fac. Fish. Hokkaido Univ. 18:277–289.
- . 1970. Embryonic development and larvae of *Gymnocanthus herzensteini* Jordan and Starks. Jpn. J. Ichthyol. 17:74–79.
- . 1975. The embryonic and larval development, growth, survival and changes in body form, and the effect of temperature on these characteristics of the smooth lumpsucker, *Aptocyclus ventriosus* (Pallas). Bull. Fac. Fish. Hokkaido Univ. 26(1):49–72.
- LAALE, H. W. 1980. The perivitelline space and egg envelopes of bony fishes: a review. Copeia 1980:210–226.
- LAGARDERE, F. 1980. Développement du cétéau, *Dicologlossa cuneata* (Moreau) (Poissons-Soleidae). Cybium. 3rd Ser. 4(4):61–81.
- , AND A. ABOUSSOUJAN. 1981. Développement du cétéau, *Dicologlossa cuneata* (Moreau, 1881) (Pisces, Pleuronectiformes, Soleidae): II—Description des larves. Cybium, 3rd Ser. 5(2):53–72.

- LAI, J. 1979. The development of stages of mullet, *Mugil so-iug* Basilevsky L. Acta. Oceanol. Sin. 1(1):157-175.
- LAKE, J. S. 1967. Rearing experiments with five species of Australian freshwater fishes. II. Morphogenesis and ontogeny. Aust. J. Mar. Freshwater Res. 18:155-173.
- LAM, T. J. 1982. Applications of endocrinology to fish culture. Can. J. Fish. Aquat. Sci. 39:111-137.
- LAROCHE, J. L., S. RICHARDSON AND A. A. ROSENBERG. 1982. Age and growth of a pleuronectid, *Parophrys vetulus*, during the pelagic larval period in Oregon coastal waters. Fish. Bull. U.S. 80:93-104.
- LAROCHE, W. A. 1977. Description of larval and early juvenile vermilion snapper, *Rhomboplites aurorubens*. Fish. Bull. U.S. 75:547-554.
- . 1981. Development of larval smooth flounder, *Liopsetta putnami*, with a redescription of winter flounder, *Pseudopleuronectes americanus* (Family Pleuronectidae). Fish. Bull. U.S. 78:897-909.
- , AND S. L. RICHARDSON. 1980. Development and occurrence of larvae and juveniles of the rockfishes *Sebastes flavidus* and *Sebastes melanops* (Scorpaenidae) off Oregon. Fish. Bull. U.S. 77:901-924.
- , AND ———. 1981. Development of larvae and juveniles of the rockfishes *Sebastes entomelas* and *S. zacentrus* (Family Scorpaenidae) and occurrence off Oregon, with notes on head spines of *S. mystinus*, *S. flavidus* and *S. melanops*. Fish. Bull. U.S. 79:231-257.
- , D. RUPLE AND S. L. RICHARDSON. MS. Young carangid fishes from the Gulf of Mexico: A generic diagnosis of larvae, with additional descriptive notes including early development of three species. Gulf Coast Research Lab., Ocean Springs, MS 39564.
- LASKER, R. 1975. Field criteria for survival of anchovy larvae: the relation between inshore chlorophyll maximum layers and successful first feeding. Fish. Bull. U.S. 73:453-462.
- . 1981. The role of a stable ocean in larval fish survival and subsequent recruitment, p. 80-87. In: Marine fish larvae. Morphology, ecology and relation to fisheries. R. Lasker (ed.). University of Washington Press, Seattle, WA.
- , H. M. FEDER, G. H. THEILACKER AND R. C. MAY. 1970. Feeding, growth and survival of *Engraulis mordax* reared in the laboratory. Mar. Biol. 5:345-353.
- , AND K. SHERMAN (eds.). 1981. The early life history of fish: recent studies. Rapp. P.V. Reun. Cons. Int. Explor. Mer 178:1-607.
- , AND L. T. THREADGOLD. 1968. "Chloride cells" in the skin of larval sardine (*Sardinops caerulea*). Exp. Cell Res. 52:582-590.
- LAU, S. R., AND P. L. SHAFLAND. 1982. Larval development of the snook, *Centropomus undecimalis* (Pisces: Centropomidae). Copeia 1982:618-626.
- LAUDER, G. V., JR. 1980. On the relationship of the myotome to the axial skeleton in vertebrate evolution. Paleobiology 6:51-56.
- , AND K. F. LIEM. 1983. The evolution and interrelationships of the Actinopterygian fishes. Bull. Museum Comp. Zool. Harv. Univ. 150(3):95-197.
- LAURENCE, G. C. 1981. Overview—modelling—an esoteric or potentially utilitarian approach to understanding larval fish dynamics. Rapp. P. V. Reun. Cons. Int. Explor. Mer 178:3-6.
- LEA, R. N. 1980. Systematics and zoogeography of cusk-eels of the family Ophidiidae, subfamily Ophidiinae, from the eastern Pacific Ocean. Unpubl. PhD dissertation. Univ. Miami, Coral Gables, FL.
- LEACH, G. C. 1923. Artificial propagation of whitefish, grayling and lake trout. Rep. U.S. Comm. Fish. Appendix 3, Doc. 949:1-32.
- LEBOUR, M. V. 1919. The young of the Gobiidae from the neighborhood of Plymouth. J. Mar. Biol. Assoc. U.K. 12:48-80.
- . 1921. The larval and post-larval stages of the pilchard, sprat, and herring from the Plymouth District. J. Mar. Biol. Assoc. U.K. 12:427-457.
- . 1927. The eggs and newly hatched young of the common blennies from the Plymouth neighbourhood. J. Mar. Biol. Assoc. U.K. 14:647-650.
- LE DANOIS, Y. 1959. Étude ostéologique, myologique et systématique des poissons du sous-ordre des Orbiculates. Ann. Inst. Oceanogr. 36(1).
- . 1961. Remarques sur les poissons orbiculates du sous-ordre des Ostracioniformes. Mém. Mus. Natl. Hist. Nat. Sér. A Zool. 29:207-338.
- LEGAND, M. 1967. Cycles biologiques des poissons mésopélagiques dans l'est de l'océan Indian. Première note. *Scopelopsis multipunctatus* Brauer, *Gonostoma* sp., *Notolychnus valdiviae* Brauer. Cah ORSTOM Ser. Oceanogr. 5(4):47-71.
- LEIBY, M. M. 1979a. Leptocephalus larvae of the eel family Ophichthidae. I. *Ophichthus gomesi* Castelnau. Bull. Mar. Sci. 29:329-343.
- . 1979b. Morphological development of the eel *Myrophys punctatus* (Ophichthidae) from hatching to metamorphosis, with emphasis on the developing head skeleton. Bull. Mar. Sci. 29:509-521.
- . 1981. Larval morphology of the eels *Bascanichthys bascanium*, *B. scuticaris*, *Ophichthus melanoporus* and *O. ophis* (Ophichthidae), with a discussion of larval identification methods. Bull. Mar. Sci. 31:46-71.
- . 1982. Leptocephalus larvae of the tribe Sphagebranchini (Pisces, Ophichthidae) in the western North Atlantic. Bull. Mar. Sci. 32:220-236.
- . 1984. Leptocephalus larvae of the tribe Callechelyini (Anguilliformes, Ophichthidae, Ophichthinae) in the western North Atlantic. Bull. Mar. Sci. 34:398-423.
- . In press. Ophichthidae. In: Leptocephalus larvae of the Gulf of Mexico and Yucatan Channel. D. G. Smith and W. H. Hulet (eds.). Stud. Trop. Oceanogr. (Miami).
- LEIM, A. H., AND W. B. SCOTT. 1966. Fishes of the Atlantic coast of Canada. Bull. Fish. Res. Board Can. 155.
- LEIS, J. M. 1977. Development of the eggs and larvae of the slender mola, *Ranzania laevis* (Pisces, Molidae). Bull. Mar. Sci. 27:448-466.
- . 1978. Systematics and zoogeography of the porcupine fishes (*Diodon*, Diodontidae, Tetraodontiformes), with comments on egg and larval development. Fish. Bull. U.S. 76:535-567.
- . 1982. Hawaiian creediid fishes (*Crystallodytes cooki* and *Linnichthys donaldsoni*): development of eggs and larvae and use of pelagic eggs to trace coastal water movement. Bull. Mar. Sci. 32:166-180.
- . 1983. Coral reef fish larvae (Labridae) in the East Pacific Barrier. Copeia 1983:826-828.
- , AND B. GOLDMAN. 1983. Studies on the biology of larval fishes in the Lizard Island area, Northern Great Barrier Reef, p. 221-225. In: Proc. Inaugural Great Barrier Reef Conf. J. T. Baker, R. M. Carter, P. W. Sammarco and K. P. Stark (eds.). J. Cook University Press, Townsville, Australia.
- , AND J. T. MOYER. MS. Development of eggs and larvae of three Indo-Pacific trunkfishes (Tetraodontiformes, Ostraciidae).
- , AND D. S. RENNIS. 1983. The larvae of Indo-Pacific coral reef fishes. New South Wales University Press, Sydney.
- LENTZ, T. L., AND J. P. TRINKHAUS. 1967. A fine structural study of cytodifferentiation during cleavage, blastula, and gastrula stages of *Fundulus heteroclitus*. J. Cell. Biol. 32:121-138.
- LEONARD, S. B. 1971. Larvae of the fourspot flounder, *Hippoglossina oblonga* (Pisces: Bothidae), from the Chesapeake Bight, western North Atlantic. Copeia 1971:676-681.
- LEONG, R. 1971. Induced spawning of the northern anchovy *Engraulis mordax* Girard. Fish. Bull. U.S. 69:357-360.
- . 1977. Maturation and induced spawning of captive Pacific mackerel, *Scomber japonicus*. Fish. Bull. U.S. 75:205-211.
- LETACONNOUX, R. 1951. Contribution à l'étude des espèces du genre *Trachurus* et spécialement du *Trachurus trachurus* (L.). Mem. Off. Sci. Pech. Marit. 15:1-67.
- LEVINGS, C. D. 1969. The zoarcid *Lycodopsis pacifica* in outer Burrard Inlet, British Columbia. J. Fish. Res. Board Can. 26:2403-2412.
- LIAO, I. C., J. C. JUARRO, S. KUMAGAI, H. NAKAJIMA, M. NATIVIDAD AND P. BURL. 1979. On the induced spawning and larval rearing of the milkfish, *Chanos chanos* (Forsk.). Aquaculture 18:75-93.

- LIMBAUGH, C. 1962. Life history and ecological notes on the tubenose, *Aulorhynchus flavidus*, a hemibranch fish of western North America. *Copeia* 1962:549-555.
- LINDBERG, G. U., AND Z. V. KRASYUKOVA. 1975. Fishes of the Sea of Japan and the adjacent areas of the Sea of Okhotsk and the Yellow Sea. Part 4. Nauka, Leningrad. (In Russian.)
- , AND M. I. LEGEZA. 1955. A review of the genera and species of the subfamily Cyclopterinae (Pisces). *Bull. Zool. Inst. Acad. Sci. USSR* 18:389-458.
- , AND ———. 1969. Fishes of the Sea of Japan and the adjacent areas of the Sea of Okhotsk and the Yellow Sea. Part 2. Teleostomi. XII. Acipenseriformes—XXVIII. Polynemiformes. *Akad. Nauk. SSSR. No. 84:1-389*. (First published in 1965. Transl. from Russian by Isr. Prog. Sci. Transl. cat. no. 1852. Available from: NTIS, Springfield, VA; TT68-50361.)
- LINDSEY, C. C. 1975. Pleomerism, the widespread tendency among related fish species for vertebral number to be correlated with maximum body length. *J. Fish. Res. Board Can.* 32:2453-2469.
- LIPPSON, A. J., AND R. L. MORAN. 1974. Manual for identification of early developmental stages of fishes of the Potomac River Estuary. Md. Dep. Nat. Resour. Power Plant Siting Program PPSP-MP-13: 236-241.
- LISOVENKO, L. A., AND M. F. SVETLOV. 1981. Some data on the biology of *Paraliparis* (Family Liparidae) off the South Shetlands. *J. Ichthyol. (Engl. Transl. Vopr. Ikhtiol.)* 20(1):131-135.
- , A. V. BARABANOV AND V. N. EFREMFENKO. 1982. New data on the reproduction of the "southern putassu", *Micromesistius australis* (Gadidae), from the Falkland-Patagonian zoogeographical region. *J. Ichthyol. (Engl. Transl. Vopr. Ikhtiol.)* 22(4):55-67.
- LIFWELLYN, L. C. 1973. Spawning, development, and temperature tolerance of the spangled perch, *Madigania unicolor* (Gunther), from inland waters in Australia. *Aust. J. Mar. Freshwater Res.* 24: 73-94.
- . 1974. Spawning, development and distribution of the southern pigmy perch *Nannoperca australis australis* Günther from inland waters of eastern Australia. *Aust. J. Mar. Freshwater Res.* 25:121-149.
- LOBEL, P., AND R. JOHANNES. 1980. Nesting, eggs and larvae of triggerfishes (Balistidae). *Environ. Biol. Fishes* 5:251-252.
- LO BIANCO, S. 1903. Le pesche abissali eseguite da F. A. Krupp col yacht (Puritan) nelle adiacenze di Capri ed in altre localita del Mediterraneo. *Mitt. Zool. Sta. Neapel* 16:109-279.
- . 1908a. Uova e larve di *Trachipterus taenia* Bl. *Mitt. Zool. Sta. Neapel* 19(1):1-17.
- . 1908b. Sviluppo larvale, metamorfosi biologia della "Triglia di fango" (*Mullus barbatus* Lin.) *Mitt. Zool. Sta. Neapel* 19:18.
- . 1909. Notizie biologiche riguardanti specialmente il periodo di maturita sessuale degli animali del Golfo di Napoli. *Mitt. Zool. Sta. Neapel* 19(4):513-763.
- . 1911. Su alcuni stadi postlarvali appartenenti a Gadidi rari del golfo di Napoli. *Mitt. Zool. Sta. Neapel* 20:170-187.
- LOCKE, N. A. 1970. Eyes for the deep. *Spectrum* 78:10-15.
- LOCKWOOD, S. J., J. H. NICHOLS AND W. A. DAWSON. 1981. The estimation of a mackerel (*Scomber scombrus* L.) spawning stock size by plankton survey. *J. Plankton Res.* 3:217-233.
- LOEB, V. J. 1979. Larval fishes in the zooplankton community of the North Pacific central gyre. *Mar. Biol.* 53:173-191.
- LONGHURST, A. R. 1971. The clupeoid resources of tropical seas. *Oceanogr. Mar. Biol. Annu. Rev.* 9:349-386.
- LONNING, S. 1972. Comparative electron microscopic studies of teleostean eggs with special reference to the chorion. *Sarsia* 49:41-48.
- , AND B. E. HAGSTROM. 1975. Scanning electron microscope studies of the surface of the fish egg. *Astarte* 8:17-22.
- LOOS, J. J., AND L. A. FUIMAN. 1978. Subordinate taxa of the genus *Notropis*: a preliminary survey of their developmental traits, p. 1-50. *In: Proc. First Symp. on Freshwater Larval Fish.* L. L. Olmsted (ed.). Southeastern Electric Exchange.
- , E. K. JANKOWSKI AND N. R. FOSTER. 1979. Notes on early life histories of cyprinoid fishes of the upper Potomac River, p. 93-139. *In: Proceedings of a workshop on freshwater larval fishes.* R. Wallus and C. W. Voigtlander (eds.). Tennessee Valley Authority, Norris, TN.
- LOPEZ ROJAS, H., AND A. MACHADO ALLISON. 1975. Algunos aspectos del desarrollo y crecimiento de *Loricaria laticeps* (Osteichthyes, Siluriformes, Loricariidae). *Acta Biol. Venez.* 9(1):51-76.
- LOUGH, R. G., M. PENNINGTON, G. R. BOLZ AND A. A. ROSENBERG. 1982. Age and growth of larval Atlantic herring, *Clupea harengus* L., in the Gulf of Maine-Georges Bank region based on otolith growth increments. *Fish. Bull. U.S.* 80:187-199.
- LOUW, E., AND M. J. O'TOOLE. 1977. Larval development of *Sardinops ocellata* (Pisces: Clupeidae). *Ann. S. Afr. Mus.* 72(7):125-145.
- LOWELL, N. E. 1971. Some aspects of the life history and spawning of the moi (*Polydactylus saxtilis*). Unpubl. MS thesis. Univ. Hawaii, Honolulu.
- LOWENSTAM, H. A. 1980. Bioinorganic constituents of hard parts, p. 3-16. *In: Biogeochemistry of Amino Acids.* P. E. Hare (ed.). John Wiley & Sons, New York.
- . 1981. Minerals formed by organisms. *Science* 211:1126-1131.
- , AND J. E. FITCH. 1978. Morphology, mineral diversity and ontogenetic mineralogic changes in extant elasmobranch ootoconia. *Geol. Soc. Am. Abstr.* 10:114.
- , AND ———. 1981. Vaterite formation in otoliths of higher teleost fishes. Abstract, Pacific Division, AAAS, Annual Meeting, June 14-19, 1981, Univ. of Oregon, Eugene.
- LUBBOKK, R. 1975. Fishes of the family Pseudochromidae (Perciformes) in the northwest Indian Ocean and Red Sea. *J. Zool. (Lond.)* 176(2):115-157.
- LUND, W. A., JR., AND B. C. MARCY, JR. 1975. Early development of the grubby, *Myoxocephalus aeneus* (Mitchell). *Biol. Bull. (Woods Hole)* 149:373-383.
- LUNDBERG, J. G. 1972. Wagner networks and ancestors. *Syst. Zool.* 21:398-413.
- LUTHER, G. 1975a. New characters for consideration in the taxonomic appraisal of grey mullets. *Aquaculture* 5:107. (Abstract.)
- . 1975b. On the little-known mullet, *Valamugil buehanani* (Bleeker) (Mugilidae: Pisces) in the Indian waters. *J. Mar. Biol. Assoc. India* 16(1):290-291.
- LÜTKEN, C. 1880. Spolia Atlantica. Bidrag til kundskab om forafandringer nos fiske under deres vaekt og udvikling, saerlight nus nogle af Atlantic Lavets honostiske. *Kgt. Dan. Vidensk. Selsk. Biol. Skr.* 5(12):409-613. (In Danish, French summary.)
- LYTHGOE, J., AND G. LYTHGOE. 1975. Fishes of the sea. Anchor Press Doubleday, Garden City, New York.
- MACCALL, A. D. 1980. The consequences of cannibalism in the stock-recruitment relationship of planktivorous pelagic fishes such as *Engraulis*. *IOC Workshop Rep. No. 28:201-220*.
- MACDONALD, C. M. 1978. Morphological and biochemical systematics of Australian freshwater and estuarine percichthyid fishes. *Aust. J. Mar. Freshwater Res.* 1978:667-698.
- MACER, C. T. 1967. Ammodytidae. *Cons. Int. Explor. Mer. Fiches Identification Oeufs Larves Poissons.* 2.
- MACGREGOR, J. S. 1976. Ovarian development and fecundity of five species of California current fishes. *Calif. Coop. Oceanic Fish. Invest. Rep.* 18:181-188.
- MACHADO ALLISON, A., AND H. LOPEZ ROJAS. 1975. Etapas del desarrollo de *Loricarichthys typus* (Bleeker) 1864 (Osteichthyes, Siluriformes, Loricariidae). *Acta Biol. Venez.* 9(1):93-119.
- MAJOR, P. F. 1973. Scale feeding behaviour of the leatherjacket, *Scomberoides lysan* (Forsk.) and two species of the genus *Oligoplites* (Pisces: Carangidae). *Copeia* 1973:151-154.
- MAKEEVA, A. P. 1976. Characteristics of the early developmental stages of a bitterling *Rhodeus ocellatus ocellatus* new to the ichthyofauna of the USSR. *J. Ichthyol. (English Trans. Vopr. Ikhtiol.)* 16:756-767.
- , AND I. N. RYABOV. 1973. Reproduction and development of *Opsarichthys uncirostris* (Temminck et Schlegel) and its systematic

- position in the family Cyprinidae. J. Ichthyol. (English Transl. Vopr. Ikhtiol.) 13:392-399.
- MAKSIMOV, V. P. 1969. On the spawning of *Naucrates ductor*. Tr. Atl. Nauchno-Issled. Inst. Rybn. Khoz. Okeanogr. 25:206-209. (In Russian, taken from Biol. Abstr., 1971, abstr. no. 42506.)
- MAKUSHOK, V. M. 1958. The morphology and classification of the northern blennioid fishes (Stichaeoidea, Blennioidei, Pisces). Tr. Zool. Inst. Akad. Nauk SSSR 25:3-129. (Transl. by A. R. Gosline, 1959, Ichthyol. Lab., U.S. Fish Wildl. Serv., U.S. Natl. Mus., Wash., D.C.)
- . 1961. The group Neozoarcinae and its place in the classification of fishes (Zoarcidae, Blennioidei, Pisces). Tr. Zool. Inst. Akad. Nauk SSSR 43:198-224.
- . 1966. The specific identity of *Nematomurus longifilis* (Gunther, 1877) and *N. clarki* (Jordan and Gilbert, 1898) and some remarks on age-dependant variations in Macruridae (Pisces), p. 147-172. In: Fishes of the Pacific and Indian Oceans. Biology and Distribution. T. S. Rass (ed.). Tr. Inst. Okeanol. Akad. Nauk. SSSR 73: 147-172.
- MALLOY, R., AND F. D. MARTIN. 1982. Comparative development of redefin pickerel (*Esox americanus americanus*) and the eastern mudminnow (*Umbra pygmaea*), p. 70-72. In: Proc. 5th Annual Larval Fish Conference. C. F. Bryan, J. V. Conner and F. M. Truesdale (eds.). Louisiana Cooperative Fishery Unit, L.S.U., Baton Rouge, LA.
- MANACOP, P. R. 1936. A new phallostethid fish with notes on its development. Philipp. J. Sci. 59:375-381.
- MANCUSO, B. 1926. Contributo alla conoscenza dello sviluppo larvale di *Physiculus dalwigki* Kp. Mem. R. Comm. Tallasogr. Ital. 124.
- MANSUETI, A. J. 1964. Early development of the yellow perch, *Perca flavescens*. Chesapeake Sci. 5(1-2):46-66.
- , AND J. D. HARDY. 1967. Development of fishes of the Chesapeake Bay region: An atlas of egg, larval, and juvenile stages. Part I. Nat. Resour. Inst. Univ. MD Port City Press, Baltimore, MD.
- MANSUETI, R. J. 1958. Eggs, larvae, and young of the striped bass, *Rocuss saxatilis*. Md. Dep. Res. Educ. CBL Contrib. 112.
- . 1963. Symbiotic behavior between small fishes and jellyfishes with new data on that between the stromateid, *Peprilus alepidotus*, and the Scyphomedusa, *Chrysaora quinquecirrha*. Copeia 1963:40-80.
- . 1964. Eggs, larvae, and young of the white perch, *Rocuss americanus*, with comments on its ecology in the estuary. Chesapeake Sci. 5(1-2):3-45.
- MARAK, R. R. 1967. Eggs and early larval stages of the offshore hake, *Merluccius albidus*. Trans. Am. Fish. Soc. 96:227-228.
- MARATHE, V. B., AND D. V. BAL. 1958. A brief comparative account of the axial skeleton of six polynemids from Bombay waters. J. Univ. Bombay 268:139-151.
- MARCHAL, E. G. 1966. Oeufs, larves et post-larves de l'anchois du Golfe de Guinée, *Anchoiella guineensis* (Blache et Rossignol). Doc. Sci. Prov. (Abidjan) No. 005SR.
- . 1967. Clé provisoire de détermination des oeufs et larves des Clupeidae et Engraulidae Ouest-africains. Doc. Sci. Prov. (Abidjan) No. 014SR.
- MARINARO, J.-Y. 1971. Contribution à l'étude des oeufs et larves pélagiques de poissons méditerranéens. V. Oeufs pélagiques de la baie d'Alger. Pelagos 3(1):1-115.
- MARINO, R. P., AND J. K. DOOLEY. 1982. Phylogenetic relationships of the tilefish family Branchiostegidae (Perciformes) based on comparative myology. J. Zool. (Lond.) 1982(196):151-163.
- MARION, A. F. 1894a. Sur la pêche et la reproduction du "Siouidet" (*Atherina hepsetus* L.). Ann. Mus. Hist. Nat. Marseille (Zool.) 4:93-99.
- . 1894b. Oeufs flottants et alevins observés dans le Golfe de Marseille durant l'année 1890. Ann. Mus. Hist. Nat. Marseille 4(11): 112-121.
- MARKLE, D. F. 1982. Identification of larval and juvenile Canadian Atlantic gadoids with comments on the systematics of gadid subfamilies. Can. J. Zool. 60(12):3420-3438.
- . 1984. Phosphate buffered formalin for long term preservation of formalin fixed ichthyoplankton. Copeia 1984:525-528.
- , AND L.-A. FROST. MS. Comparative morphology and identification of planktonic fish eggs from the Nova Scotian Shelf.
- , AND J. E. OLNEY. 1980. A description of the vexillifer larvae of *Pyramodon ventralis* and *Snyderia canina* (Pisces, Carpaidea) with comments on classification. Pac. Sci. 34:173-180.
- , W. B. SCOTT AND A. C. KOHLER. 1980. New and rare records of Canadian fishes and the influence of hydrography on resident and nonresident Scotian Shelf ichthyofauna. Can. J. Fish. Aquat. Sci. 37:49-65.
- , AND C. A. WENNER. 1979. Evidence of demersal spawning in the mesopelagic zoarcid fish *Melanostigma atlanticum*, with comments on demersal spawning in the alepocephalid fish *Xenodermichthys copei*. Copeia 1979:363-366.
- , J. T. WILLIAMS AND J. E. OLNEY. 1983. Description of a new species of *Echodon* (Teleostei, Carpaidea) from Antarctic and adjacent seas. Proc. Biol. Soc. Wash. 97(1).
- MARLIAVE, J. B. 1975. The behavioral transformation from the planktonic larval stage of some marine fishes reared in the laboratory. Unpubl. PhD dissertation. Univ. British Columbia, Vancouver.
- . 1976. A theory of storm-induced drift dispersal of the gasterosteid fish *Aulorhynchus flavidus*. Copeia 1976:794-796.
- . 1978. Spawning and yolk-sac larvae of the agonid fish species, *Agonomalus mozinoi* Wilimovsky and Wilson. Syscis 11:285-286.
- . 1981. Spawn and larvae of the Pacific sandfish, *Trichodon trichodon*. Fish. Bull. U.S. 78:959-964.
- MARSHALL, N. B. 1953. Egg sizes of Arctic, Antarctic and deep-sea fishes. Evolution 7:328-341.
- . 1955. Alepisauroid fishes. Discovery Rep. 27:303-336.
- . 1960. Swimbladder structure of deep-sea fishes in relation to their systematics and biology. Discovery Rep. 31:1-122.
- . 1961. A young *Macristium* and the etenothrissid fishes. Bull. Br. Mus. (Nat. Hist.) Zool. 7:355-370.
- . 1962. Observations on the Heteromi, an order of teleost fishes. Bull. Br. Mus. (Nat. Hist.) Zool. 9:249-270.
- . 1964. Bathypelagic macrourid fishes. Copeia 1964:86-93.
- . 1965. Systematic and biological studies of the macrourid fishes (Anacanthini-Teleostii). Deep-Sea Res. 12:299-322.
- . 1966a. Family Scopelosauridae, p. 194-204. In: Fishes of the western North Atlantic. D. M. Cohen (ed.). Mem. Sears Found. Mar. Res. No. 1 (Pt. 5).
- . 1966b. The relationships of the anacanthine fishes, *Macruronus*, *Lycemus*, and *Steindachneria*. Copeia 1966:275-280.
- . 1971. Explorations in the life of fishes. Harvard Univ. Press, Cambridge, MA.
- . 1973. Family Macouridae, p. 496-665. In: Fishes of the western North Atlantic. D. M. Cohen (ed.). Mem. Sears Found. Mar. Res. No. 1 (Pt. 6).
- , AND D. M. COHEN. 1973. Order Anacanthini (Gadiformes). Characters and synopsis of families, p. 479-495. In: Fishes of the western North Atlantic. D. M. Cohen (ed.). Mem. Sears Found. Mar. Res. No. 1 (Pt. 6).
- , AND T. IWAMOTO. 1973. Family Macrouridae (Genera *Coryphaeonichthys*, *Coryphaenoides*, *Hymenoccephalus* and *Nezumia*), p. 496-665. In: Fishes of the western North Atlantic. D. M. Cohen (ed.). Mem. Sears Found. Mar. Res. No. 1 (Pt. 6).
- , AND J. C. STAIGER. 1975. Aspects of the structure, relationships, and biology of the deep-sea fish *Ipnops murrayi* (Family Bathypetrolidae). Bull. Mar. Sci. 25:101-111.
- MARSHALL, T. C. 1965. Fishes of the Great Barrier Reef and coastal waters of Queensland. Livingstone Publ. Co., Narberth, PA.
- MARTIN, F. D., AND G. E. DREWRY. 1978. Development of the fishes of the Mid-Atlantic Bight. An atlas of egg, larval and juvenile stages. Vol. VI. Stromateidae through Ogocephalidae. U.S. Fish Wildl. Serv. Biol. Serv. Prog. FWS/OBS-78/12.
- MARTIN, R. A., AND J. H. FINUCANE. 1969. Reproduction and ecology of the longnose killifish. Q. J. Fla. Acad. Sci. 31(2):101-111.
- MARTINEZ, A. M. 1983. Identification of brook, brown, rainbow, and

- cutthroat trout larvae. Unpubl. MS Thesis. Colorado State Univ., Ft. Collins, CO.
- MARUYAMA, K. 1970. Some deep-water fishes from off the Tohoku and adjacent regions. Bull. Tohoku Reg. Fish. Res. Lab. 30:43-66. (In Japanese.)
- MARR, H., AND D. B. RABB. 1972. Phyletic analysis of fifty characters of advanced snakes. Fieldiana Zool. 63:1-321.
- MASTERMAN, A. T. 1901. A contribution to the life histories of the cod and whiting. Trans. R. Soc. Edinb. 40:1-14.
- MASUDA, H., C. ARAGA AND T. YOSHINO. 1975. Coastal fishes of Southern Japan. Tokai Univ. Press, Tokyo.
- MASUDA, S., AND T. OZAWA. 1979. Reexamination of the holotypes of *Bregmaceros japonicus* Tanaka and *B. nectabanus* Whitley. Jpn. J. Ichthyol. 25:266-268.
- MASUDA, T., AND K. TANAKA. 1962. Young of labroid and scaroid fishes from the central Pacific of Japan. J. Tokyo Univ. Fish. 48:1-98.
- MASUREKAR, V. B. 1968. Eggs and development stages of *Tylosurus crocodilus* (Lesueur). J. Mar. Biol. Assoc. India. 9:70-76.
- MATARESE, A. C., AND S. F. BORTON. MS. Reproductive biology and development of the Pacific spiny lump sucker, *Eumicrotremus orbis* (Cyclopteridae).
- , AND J. B. MARLIAVE. 1982. Larval development of laboratory-reared rosy lip sculpin, *Aselchthys rhodorus* (Cottidae). Fish. Bull. U.S. 80:345-355.
- , S. L. RICHARDSON AND J. R. DUNN. 1981. Larval development of Pacific tomcod, *Microgadus proximus*, in the northeast Pacific Ocean with comparative notes on larvae of walleye pollock, *Theragra chalcogramma*, and Pacific cod, *Gadus macrocephalus* (Gadidae). Fish. Bull. U.S. 78:923-940.
- , AND B. VINTER. MS. Development and occurrence of larvae of the longfin Irish lord, *Hemilepidotus zapus* (Cottidae).
- MATHER, F. J. 1958. A preliminary review of the amberjacks, genus *Seriola*, of the western Atlantic. Proc. 3rd Int. Game Fish Conf.
- MATIAS, J. R. 1982. Embryonic diapause in annual fishes: Evaporative water loss and survival. *Experientia* (Basel) 38:1315-1316.
- MATSUBARA, K. 1936. A review of two genera of the Japanese sculpins, *Ereunias* and *Marukawichthys* with special reference to their systematic positions. J. Imp. Fish. Inst. (Tokyo) 31:97-114.
- . 1942. On the metamorphosis of a clupeoid fish *Pterothrissus gissu* Hilgendorf. J. Imp. Fish. Inst. (Tokyo) 35(1):1-16.
- . 1943. Studies on the scorpaenoid fishes of Japan. Trans. Sigekagaku Kenyusho. Nos. 1 and 2.
- . 1955. Fish morphology and hierarchy. Part II. Ishizaki-Shoten, Tokyo.
- , AND T. IWAI. 1952. Studies on some Japanese fishes of the family Gempylidae. Pac. Sci. 6:193-212.
- , AND ———. 1958. Anatomy and relationships of the Japanese fishes of the family Gempylidae. Mem. Coll. Agric. Kyoto Univ. Fish Ser. Spec. No., p. 23-54.
- , AND ———. 1959. Description of a new sandfish, *Kraemaria sexradiata*, from Japan, with special reference to its osteology. J. Wash. Acad. Sci. 49:27-32.
- , AND A. OCHIALI. 1955. A revision of the Japanese fishes of the family Platycephalidae (the flatheads). Mem. Coll. Agric. Kyoto Univ. 68:1-109.
- , ———, K. AMAOKA AND I. NAKAMURA. 1964. Revisional study of the trachinoid fishes of the family Champsodontidae from the waters around Japan, and Tonking Bay. Bull. Misaki Mar. Biol. Inst. Kyoto Univ. 6:1-20.
- MATSUI, K. 1949. Illustration of the normal courses of development in the fish, *Oryzias latipes*. Jikken-keitai Gaku 5:33-42. (In Japanese.)
- MATSUMOTO, W. M. 1968. Morphology and distribution of larval wahoo *Acanthocybium solandri* (Cuvier) in the central Pacific Ocean fishery. U.S. Fish Wildl. Serv. Fish. Bull. 66:299-322.
- , E. H. AHLSTROM, S. JONES, W. L. KLAWE, W. J. RICHARDS AND S. UEYANAGI. 1972. On the clarification of larval tuna identification particularly in the genus *Thunnus*. Fish. Bull. U.S. 70:1-12.
- MATSUOKA, M., AND T. IWAI. 1983. Adipose fin cartilage found in some teleostean fishes. Jpn. J. Ichthyol. 30:37-46.
- MATSUURA, K. 1979. Phylogeny of the superfamily Balistoidea (Pisces: Tetraodontiformes). Mem. Fac. Fish. Hokkaido Univ. 26:49-169.
- . 1982. A list of the fishes collected in the Palau and Yap Islands. Proc. Jpn. Soc. Syst. Zool. 23:80-89.
- MATSUURA, Y. 1975. A study of the life history of Brazilian sardine, *Sardinella brasiliensis*. III. Development of sardine larvae. Bol. Inst. Oceanogr. 23:17-29.
- , AND M. KATSURAGAWA. 1981. Larvae and juveniles of grey triggerfish, *Balistes caprisus*, from Southern Brazil. Jpn. J. Ichthyol. 28:267-275.
- MATTSON, C. R., AND B. L. WING. 1978. Ichthyoplankton composition and planktonic volumes from inland coastal waters of southeastern Alaska, April-November 1972. NOAA Tech. Rep. NMFS SSRF 723.
- MAUL, G. E. 1951. Monografia dos Peixes do Museu Municipal do Funchal, Familia Macrouridae e Merlucciidae. Bol. Mus. Munic. Funchal No. 5 (Art. 12):5-55.
- . 1976. The fishes taken in bottom trawls by R.V. Meteor during the 1967 Seamount Cruises in the Northeast Atlantic. Meteor Forschungsergeb. 22:1-69.
- , AND E. KOEFOED. 1950. On a new genus and species of macrourid fish, *Phalacromacrus pantherinus*. Ann. Mag. Nat. Hist., Ser. 12, 3:970-976.
- MAY, R. C. 1970. Feeding larval marine fishes in the laboratory: a review. Calif. Coop. Oceanic Fish. Invest. Rep. 14:76-83.
- . 1974. Larval mortality in marine fishes and the critical period concept, p. 3-19. In: The early life history of fish. J. H. S. Blaxter (ed.). Springer Verlag, Berlin.
- , D. POPPER AND J. P. McVEY. 1974. Rearing and larval development of *Siganus canaliculatus* (Park) (Pisces: Siganidae). *Micronesica* 10:285-298.
- MAYER, F. 1933. *Cubanichthys cubensis* Eigenmann. Blatt. Aquar-Terrarien. 44(22):375-376.
- MAYER, G. F. 1972. Systematics, functional anatomy, and ecology of the cardinalfish genus *Epigonus* (Apogonidae). Unpubl. PhD dissertation. Harvard Univ., Cambridge, MA.
- MAYO, C. A. 1973. Rearing, growth, and development of the eggs and larvae of seven scombrid fishes from the straits of Florida. Unpubl. PhD thesis. University of Miami, Coral Gables, FL.
- MAYR, E. 1969. Principles of systematic zoology. McGraw-Hill Publ., New York.
- . 1981. Biological classification: toward a synthesis of opposing methodologies. *Science* 214:510-516.
- MAZZA, F. 1902. La *Lebias calaritana* Bon. Segmentazione dell'uovo e stadi successivi di sviluppo. Atti Soc. Ligust. Sci. Nat. Genova 13:181-223.
- MAZZARELLI, G. 1917. Contributo alla conoscenza delle metamorfosi dell'*Eretmophorus kleinenbergi* Gigl. Pubbl. Staz. Zool. Napoli 2.
- MCALLISTER, D. E. 1963. A revision of the smelt family, Osmeridae. Natl. Mus. Can. Bull. 191.
- . 1968. Evolution of branchiostegals and classification of teleostome fishes. Natl. Mus. Canada Bull. 221.
- , AND J. E. RANDALL. 1975. A new species of centrolophid fish from Easter Island and Rapa Iti Island in the South Pacific. Natl. Mus. Nat. Sci. (Ottawa) Publ. Biol. Oceanogr. 8.
- McCANN, C., AND D. G. McKNIGHT. 1980. The marine fauna of New Zealand: macrourid fishes (Pisces: Gadida). N.Z. Oceanogr. Inst. Mem. 61:1-91.
- McCOSKER, J. E. 1977. The osteology, classification and relationships of the eel family Ophichthidae. Proc. Calif. Acad. Sci. 41(1):1-123.
- . 1979. The snake eels (Pisces: Ophichthidae) of the Hawaiian Islands, with the description of two new species. Proc. Calif. Acad. Sci. 42(2):57-67.
- . 1982. A new genus and two new species of remarkable Pacific worm eels (Ophichthidae, subfamily Myrophinae). Proc. Calif. Acad. Sci. 43:59-66.
- , AND R. H. ROSENBLATT. 1972. Eastern Pacific snake-eels of

- the genus *Callechelys* (Apodes: Ophichthidae). Trans. San Diego Soc. Nat. Hist. 17:15–24.
- McCULLOCH, A. R. 1926. Report on some fishes obtained by the F.I.S. "Endeavor" on the coasts of Queensland, New South Wales, Victoria, Tasmania, South and south-western Australia. Part V, p. 157–216. Commonw. Aust. Dep. of Trade and Customs.
- MCCULLY, H. 1961. The comparative anatomy of the scales of the serranid fishes. Unpubl. PhD dissertation, Stanford Univ., Stanford, CA.
- . 1970. Amputation and replacement of marginal spines in ctenoid percoid scales. Proc. Calif. Acad. Sci. 38:411–414.
- MCDOWALL, R. M. 1968a. The status of *Nesogalaxias neocaledonicus* (Weber and de Beaufort) (Pisces: Galaxiidae). Breviora 286:1–8.
- . 1968b. *Galaxias maculatus* (Jenyns), the New Zealand whitebait. Fish. Bull. N.Z. 2:1–84.
- . 1969. Relationships of galaxioid fishes with further discussion of salmoniform classification. Copeia 1969:796–824.
- . 1970. The galaxiid fishes of New Zealand. Bull. Mus. Comp. Zool. Harv. Univ. 139:341–431.
- . 1971a. Fishes of the family Aplochitonidae. J. R. Soc. N.Z. 1:37–52.
- . 1971b. The galaxiid fishes of South America. Zool. J. Linn. Soc. 50:33–73.
- . 1973a. The status of the South African galaxiid (Pisces: Galaxiidae). Ann. Cape Prov. Mus. Nat. Hist. 9(5):91–101.
- . 1973b. Limitation of the genus *Brachygalaxias* Eigenmann, 1928 (Pisces: Galaxiidae). J. R. Soc. N.Z. 3:193–197.
- . 1973c. Relationships and taxonomy of the New Zealand torrent fish, *Cheimarrichthys fosteri* Haast (Pisces: Mugiloididae). J. R. Soc. N.Z. 3:199–217.
- . 1976. Fishes of the family Prototroctidae (Salmoniformes). Aust. J. Mar. Freshwater Res. 27:641–659.
- . 1978. New Zealand freshwater fishes—a guide and natural history. Heinemann Educational Books, Auckland.
- . 1979. Fishes of the family Retropinnidae (Pisces: Salmoniformes)—a taxonomic revision and synopsis. J. Soc. N.Z. 9:85–121.
- . 1980. Freshwater fishes and plate tectonics in the southwest Pacific. Palaeogeogr. Palaeoclimatol. Palaeoecol. 31:337–351.
- . 1982. The centrolophid fishes of New Zealand (Pisces: Stromateoidei). J. R. Soc. N.Z. 12:103–142.
- , AND G. A. ELDON. 1980. The ecology of whitebait migrations. Fish. Bull. N.Z. 20:1–171.
- , AND R. S. FRANKENBERG. 1981. The galaxiid fishes of Australia (Pisces: Galaxiidae). Rec. Aust. Mus. 33:433–605.
- , D. A. ROBERTSON AND R. SAITO. 1975. Occurrence of galaxiid larvae and juveniles in the sea. N.Z. J. Mar. Freshwater Res. 9:1–9.
- MCDOWELL, S. B. 1973. Order Heteromi (Notacanthiformes), p. 1–228. In: Fishes of the western North Atlantic. D. M. Cohen (ed.). Mem. Sears Found. Mar. Res. No. 1 (Pt. 6).
- MCGINNIS, R. F. 1982. Biogeography of lanternfishes (Myctophidae) south of 30°S. Biol. Antarct. Seas 12, Antarct. Res. Ser. 35:1–110.
- MCINTOSH, W. C. 1892. Contributions to the life-histories and development of the food- and other fishes. 10th Annu. Rep. Fish. Board Scotl., Pt. 3:273–322.
- . 1893. Contributions to the life-histories and development of the food- and other fishes. Scotl. Fish. Board Annu. Rep. 11(1892): 239–249.
- , AND A. T. MASTERMANN. 1897. The life-histories of the British marine food fishes. Cambridge Univ. Press, London.
- , AND E. E. PRINCE. 1890. On the development and life-histories of the teleostean food- and other fishes. Trans. R. Soc. Edinb. 35: 665–946.
- MCKENNEY, T. W. 1959. A contribution to the life history of the squirrel fish *Holocentrus vexillarius* Poey. Bull. Mar. Sci. Gulf Caribb. 9:174–221.
- . 1961. Larval and adult stages of the stromateoid fish *Psenes regulus* with comments on its classification. Bull. Mar. Sci. Gulf Caribb. 11:210–236.
- , E. C. ALEXANDER AND G. S. VOSS. 1958. Early development and larval distribution of the carangid fish, *Caranx crysos* (Mitchill). Bull. Mar. Sci. Gulf Caribb. 8:167–200.
- MCKENZIE, R. A., AND S. N. TIBBO. 1963. An occurrence of the opah, *Lampris regus* (Bonnaterre) in the northwest Atlantic. J. Fish. Res. Board Can. 20:1097–1099.
- McKERN, J. L., H. F. HORTON AND K. V. KOSKI. 1974. Development of steelhead trout (*Salmo gairdneri*) otoliths and their use for age analysis and for separating summer from winter races from hatchery stocks. J. Fish. Res. Board Can. 31:1420–1426.
- MCELLAN, T. 1977. Feeding strategies of the macrourids. Deep-Sea Res. 24:1019–1036.
- McMAHON, T. E., AND J. C. TASH. 1979. Effects of formalin (buffered and unbuffered) and hydrochloric acid on fish otoliths. Copeia 1979:155–156.
- McMILLAN, C. W. 1979. The embryological development of *Rivulus marmoratus* (Pisces: Cyprinodontidae). Unpubl. MS thesis. College of Charleston.
- McMILLAN, H. M. 1961. An addition to the knowledge of the fish *Retropinna anisodon* Stokell (Retropinnidae). Trans. R. Soc. N.Z. Zool. 1(10):139–144.
- MEAD, G. W. 1957. An Atlantic record of the zeoid fish *Parazen pacificus*. Copeia 1957:235–237.
- . 1963. Observations on fishes caught over the anoxic waters of the Cariaco Trench, Venezuela. Deep-Sea Res. 10:251–257.
- . 1972. Bramidae. Dana-Rep. Carlsberg Found. 81.
- , E. BERTELSEN AND D. M. COHEN. 1964. Reproduction among deep sea fishes. Deep-Sea Res. 11:569–596.
- MEEK, S. E., AND S. F. HILDEBRAND. 1923. The marine fishes of Panama. Field Mus. Nat. Hist. Publ. Zool. Ser. 15(215).
- MEIDRIM, J. W. 1980. *Novumbra hubbsi*, p. 128. In: Atlas of North American freshwater fishes. D. S. Lee, C. R. Gilbert, C. H. Hocutt, R. E. Jenkins, D. E. McAllister and J. R. Stauffer, Jr. (eds.). North Carolina State Mus. Nat. Hist., Raleigh, NC.
- MENASSE, V. 1970. The spined loach, *Cobitis taenia*. Trop. Fish Hobby. 18(6):36–37, 40–41, 44.
- MENON, A. G. K. 1977. A systematic monograph of the tongue soles of the genus *Cynoglossus* Hamilton-Buchanan (Pisces: Cynoglossidae). Smithsonian Contrib. Zool. 238.
- MERCADO S., J. E., AND A. CIARDELLI. 1972. Contribución a la morfología y organogénesis de los leptocéfalos del sábalo *Megalops atlanticus* (Pisces: Megalopidae). Bull. Mar. Sci. 22:153–184.
- MERRETT, N. R. 1963. Pelagic gadoid fish in the Antarctic. Nor. Hvalfangst-tidsskr. 52:245–247.
- . 1978. On the identity and pelagic occurrence of larval and juvenile stages of rattail fishes (family Macrouridae) from 60°N, 20°W and 53°N, 20°W. Deep-Sea Res. 25:147–160.
- . 1980. *Bathytyphlops sewehi* (Pisces: Chlorophthalmidae) a senior synonym of *B. azorensis*, from the eastern North Atlantic with notes on its biology. Zool. J. Linn. Soc. 68:99–109.
- , J. BADCOCK AND P. J. HERRING. 1973. The status of *Benthallbella infans* (Pisces, Myctophoidei), its development, bioluminescence, general biology and distribution in the eastern North Atlantic. J. Zool. Lond. 170:1–48.
- , AND N. B. MARSHALL. 1981. Observations on the ecology of deep-sea bottom-living fishes collected off northwest Africa (08°–27°N). Prog. Oceanogr. 9:185–244.
- , Y. I. SAZONOV AND Y. N. SHCHERBACHEV. 1983. A new genus and species of rattail fish (Macrouridae) from the eastern North Atlantic and eastern Indian Ocean, with notes on its ecology. J. Fish Biol. 22:549–561.
- MESHKOV, M. M. 1967. The phases in the development of *Lota lota* (Linné). Izv. Vses. Nauchno-Issled. Inst. Ozern. Rechn. Rybn. Khoz. 62:181–194.
- METHOT, R. D. 1981. Spatial covariation of daily growth rates of larval northern anchovy, *Engraulis mordax*, and northern lampfish, *Stenobrachius leucopsarus*. Rapp. P. V. Reun. Cons. Int. Explor. Mer 178:424–431.

- , AND D. KRAMER. 1979. Growth of northern anchovy, *Engraulis mordax*, larvae in the sea. *Fish. Bull. U. S.* 77:1124-1127.
- METTEE, M. F., JR., AND E. C. BECKMAN, III. 1978. Notes on the breeding behavior, embryology and larval development of *Cyprinodon variegatus* Lacepede in aquaria. *Tulane Stud. Zool. Bot.* 20(3-4):137-148.
- MEYER-ROCHOW, V. B. 1974. Leptocephali and other transparent fish larvae from the south-eastern Atlantic Ocean. *Zool. Anz.* 192(34):240-251.
- MICHENER, C. 1977. Discordant evolution and the classification of allodapine bees. *Syst. Zool.* 26:32-56.
- MICKEVICH, M. F. 1982. Transformation series analysis. *Syst. Zool.* 31:461-478.
- MIDDAUGH, D. P., G. I. SCOTT AND J. M. DEAN. 1981. Reproductive behavior of the Atlantic silverside, *Menidia menidia* (Pisces, Atherinidae). *Environ. Biol. Fishes* 6:269-276.
- MILLER, D. 1958. A key to some of the more common larval fishes of the Gulf of Maine. NMFS Woods Hole Lab. Misc. Rep. 58-1.
- , AND R. R. MARAK. 1959. The early larval stages of the red hake, *Urophycis chuss*. *Copeia* 1959:248-250.
- , AND R. R. MARAK. 1962. Early larval stages of the fourspot flounder, *Paralichthys oblongus*. *Copeia* 1962:454-455.
- MILLER, D. J. 1952. Development through the prelarval stage of artificially fertilized eggs of the Pacific sardine (*Sardinops caerulea*). *Calif. Fish Game* 38:587-595.
- , AND R. N. LEA. 1972. Guide to the coastal marine fishes of California. *Calif. Dep. Fish Game Fish Bull.* 157.
- MILLER, G. L., AND S. C. JORGENSEN. 1973. Meristic characters of some marine fishes in the western Atlantic Ocean. *Fish. Bull. U.S.* 71:301-312.
- MILLER, J. M., AND B. Y. SUMIDA. 1974. Development and life history of *Caranx mate* (Carangidae). *Fish. Bull. U.S.* 72:497-514.
- , AND J. W. TUCKER, JR. 1979. X-radiography of larval and juvenile fishes. *Copeia* 1979:535-538.
- , W. WATSON AND J. M. LEIS. 1979. An atlas of nearshore marine fish larvae of the Hawaiian Islands. Sea Grant Misc. Rep. UNIHI-SEAGRANT-MR-80-02. Univ. Hawaii Sea Grant College Program, Honolulu.
- MILLER, P. J. 1961. Evidence for the breeding in Manx waters of the sand-smelt, *Atherina presbyter* C. & V. *Rep. Mar. Biol. Sta. Point Erin* 74:27-28.
- . 1973. The osteology and adaptive features of *Rhyacichthys aspro* (Teleostei: Gobioidei) and the classification of gobioid fishes. *J. Zool. (Lond.)* 171:397-434.
- MILLER, R. R. 1960. Systematics and biology of the gizzard shad (*Dorosoma cepedianum*) and related fishes. *U.S. Fish Wildl. Serv. Fish. Bull.* 60:371-392.
- , AND J. C. BRIGGS. 1962. *Dactyloscopus amnis*, a new sand stargazer from rivers of the Pacific slope of southern Mexico. *Occas. Pap. Univ. Mich. Mus. Zool.* 627.
- MILLER, R. V. 1969. Constancy of epibranchial organs and fourth epibranchial bones within species groups of clupeid fishes. *Copeia* 1969:308-312.
- , AND J. W. VAN LANDINGHAM. 1969. Additional procedures for effective enzyme clearing and staining of fishes. *Copeia* 1969:829-830.
- MILLIKEN, D. M. 1975. Species of the genus *Bregmaceros* in the Gulf of Mexico and Caribbean Sea, including the description of a new species from the Cariaco Trench. Unpubl. MS thesis. Univ. South Florida, Tampa, FL.
- , AND E. D. HOUDE. 1984. A new species of Bregmaceroidae (Pisces), *Bregmaceros cantori*, from the western Atlantic Ocean. *Bull. Mar. Sci.* In press.
- MILWARD, N. H. 1966. Development of eggs and early larvae of the Australian smelt *Retropinna semoni* (Weber). *Proc. Linn. Soc. N.S.W.* 90:218-227.
- MINAMI, T. 1981a. The early life history of a flounder *Pseudorhombus pentophthalmus*. *Bull. Jap. Soc. Sci. Fish.* 47:849-856.
- . 1981b. The early life history of a sole *Heteromyxeter japonicus*. *Bull. Jap. Soc. Sci. Fish.* 47:857-862. (In Japanese, English abstract.)
- . 1981c. The early life history of a flounder *Limanda yokohamae*. *Bull. Jpn. Soc. Sci. Fish.* 47:1411-1419.
- . 1982a. The early life history of a flounder *Pleuronichthys cornutus*. *Bull. Jap. Soc. Sci. Fish.* 48:369-374. (In Japanese, English abstract.)
- . 1982b. The early life history of a tongue fish *Paraplagusia japonica*. *Bull. Jap. Soc. Sci. Fish.* 48:1041-1046.
- MINOPRIO, J. L. 1944. Considerations sobre el desarrollo embrionario del Perjerrey. *Acta. Zool. Lilloana* 2:9-14.
- MISITANO, D. 1978. Description of laboratory-reared larvae of the Buffalo Sculpin, *Enophrys bison* (Pisces, Cottidae). *Copeia* 1978:635-642.
- . 1980. A record of internal fertilization in the roughback sculpin *Chytonotus pugetensis* with descriptive notes of their early larvae. *Copeia* 1980:162-165.
- MITANI, F. 1960. Fishery biology of the yellowtail, *Seriola quinqueradiata* T. & S., inhabiting the water around Japan. *Mem. Fac. Agric. Kinki Univ.* 1:81-300.
- MITCHELL, C. P., AND B. P. PENNINGTON. 1982. Spawning of *Galaxias fasciatus* Gray (Salmoniformes: Galaxiidae). *N.Z. J. Mar. Freshwater Res.* 16:131-133.
- , AND D. SCOTT. 1979. Muscle myogens in New Zealand Galaxiidae. *N.Z. J. Mar. Freshwater Res.* 13:285-294.
- MITO, S. 1954. Breeding habits of a blennioid fish, *Salarias enosimae*. *Jpn. J. Ichthyol.* 3:144-152. (In Japanese, English summary.)
- . 1955. Breeding habits of a percoid fish, *Plesiops semeion*. *Sci. Bull. Fac. Agric. Kyushu Univ.* 15(1):95-99.
- . 1956a. On the egg development and hatched larvae of *Lethrinus nematacanthus* Bleeker. *Sci. Bull. Fac. Agric. Kyushu Univ.* 15:497-500.
- . 1956b. On the egg development and hatched larvae of *Oplegnathus fasciatus* (Temminck et Schlegel). *Sci. Bull. Fac. Agric. Kyushu Univ.* 15:501-506.
- . 1957a. Egg development and hatched larvae of *Girella punctata* Gray (Girellidae, Teleostei). *Jpn. J. Ichthyol.* 6:105-108. (In Japanese, English summary.)
- . 1957b. On the egg development and larvae of a Japanese sea bass, *Lateolabrax japonicus* (Cuvier). *Sci. Bull. Fac. Agric. Kyushu Univ.* 16:115-124. (In Japanese, English summary.)
- . 1958. Studies on the eggs, larvae and juvenile of Japanese fishes. Series I. *In*: K. Uchida et al. 1958. *Fish Dep., Fac. Agric. Kyushu Univ., Fukuoka, Japan.* (In Japanese.)
- . 1960. Egg development and hatched larvae of the common dolphin-fish, *Coryphacna hippurus* Linne. *Bull. Jap. Soc. Sci. Fish.* 26(3):223-226. (In Japanese, English abstract.)
- . 1961a. Pelagic fish eggs from Japanese waters—I. Clupeina, Chanina, Stomiata, Myctophida, Anguillida, Belonida and Syngnathida. *Sci. Bull. Fac. Agric. Kyushu Univ.* 18:285-310.
- . 1961b. Pelagic eggs from Japanese waters—II. Lamprida, Zerda, Mugilina, Scombrina, Carangina and Stromateina. *Sci. Bull. Fac. Agric. Kyushu Univ.* 18:451-465.
- . 1962a. Pelagic fish eggs from Japanese waters—V. Callionymina and Ophidiina. *Sci. Bull. Fac. Agric. Kyushu Univ.* 19:377-380.
- . 1962b. Pelagic fish eggs from Japanese waters—VI. Labrina. *Sci. Bull. Fac. Agric. Kyushu Univ.* 19:493-502. (In Japanese, English summary.)
- . 1962c. Pelagic fish eggs from Japanese waters—VII. Chaetodontina, Balistina and Ostracronina. *Sci. Bull. Fac. Agric. Kyushu Univ.* 19:503-506. (In Japanese, English summary.)
- . 1962d. On the egg development and early larvae of a trachinoid fish, *Champsodon snyderi* (Franz). *Bull. Jpn. Soc. Sci. Fish.* 28(5):499-503.
- . 1963. Pelagic fish eggs from Japanese waters—III. Percina, VIII. Cottina. IX. Echenecida and Pleuronectida. *Jpn. J. Ichthyol.* 11:39-102.
- . 1966. Fish eggs and larvae. *In*: Illustrated encyclopedia of the

- marine plankton of Japan, Vol. 7. S. Motoda (ed.). Soyo-Sha, Tokyo. (In Japanese.)
- . 1979a. A perspective on morphology and phylogeny of fish eggs and larvae. *Kaiyo Kagaku* (Mar. Sci.) 11:87–92. (In Japanese.)
- . 1979b. Fish eggs. *Kaiyo Kagaku* (Mar. Sci.) 11:126–130. (In Japanese.)
- , AND K. UCHIDA. 1958. On the egg development and hatched larvae of a scorpaenoid fish, *Pterois lunulata* Temminck et Schlegel. *Sci. Bull. Fac. Agric. Kyushu Univ.* 16:381–385. (In Japanese. English summary.)
- , M. UKAWA AND M. HIGUCHI. 1967. On the larval and young stages of a serranid fish, *Epinephelus akaara* (Temminck et Schlegel). *Bull. Naikai Reg. Fish. Res. Lab.* 25:337–347.
- MOCHIOKA, N., S. KAKUDA AND O. TABETA. 1982. Congrid leptocephali in the western North and Middle Pacific. I. Exterilium *Ariosoma*-type larvae. *J. Fac. Appl. Biol. Sci. Hiroshima Univ.* 21:35–66.
- MOFFATT, N. M. 1981. Survival and growth of northern anchovy larvae on low zooplankton densities as affected by the presence of a *Chlorella* bloom. *Rapp. P. V. Reun. Cons. Int. Explor. Mer* 178:475–480.
- MOHR, E. 1926. Die Gattung *Zenarchopterus* Gill. *Zool. Jahrb. Jena Abt. Syst.* 52:231–266.
- . 1936a. Hemirhamphiden-Studien IV.–VI. IV. Die Gattung *Dermogenys* van Hasselt. *Mitt. Zool. Mus. Berl.* 21(1):34–55.
- . 1936b. Hemirhamphiden-Studien IV.–VI. V. Die Gattung *Nomorhamphus* Weber & de Beaufort. *Mitt. Zool. Mus. Berl.* 21(1):55–58.
- . 1936c. Hemirhamphiden-Studien IV.–VI. VI. Die Gattung *Hemirhamphodon* Bleeker 1866. *Mitt. Zool. Mus. Berl.* 21(1):59–64.
- . 1937. Revision der Centriscidae (Acanthopterygii Centrisciformes) (in German). Dana-Rep. Carlsberg Found. 18.
- MOHSIN, A. K. M. 1978. The osteology of the grey mullet, *Lisa subviridis* (Valenciennes). The branchiocranium, vertebral column, and girdles. *Malayan Nat. J.* 31(4):203–218.
- MOK, H. K., AND S. C. SHEN. 1983. Osteology and phylogeny of Squamipinnes. *Spec. Publ. Taiwan Mus. Zool. Ser.* 1.
- MONOD, T. 1968. Le complexe urophore des poissons téléostéens. *Mem. Inst. Fondam. Afr. Noire.* 81.
- MONTALENTI, G. 1933. Famiglia 5: Maenidae, p. 383–384. *In: Uova, larve e stadi giovanili di Teleostei. Fauna Flora Golfo Napoli Monogr.* 38.
- . 1937a. Famiglia 6: Mullidae, p. 391–398. *In: Uova, larve e stadi giovanili di Teleostei. Fauna Flora Golfo Napoli Monogr.* 38.
- . 1937b. Cepolidae, p. 407–410. *In: Uova, larve e stadi giovanili di Teleostei. Fauna Flora Golfo Napoli Monogr.* 38.
- MONTOLIO, M. A. 1976. Estudio taxónomico y morfométrico de los estadios larvales de dos especies de Carangidae *Decapterus punctatus* (Agassiz, 1829) y *Caranx crysos* (Mitchill, 1815) y su distribución en el Golfo de México. *Rev. Invest. Inst. Nac. Pesca* 2:85–125.
- MOOK, D. 1977. Larval and osteological development of the sheepshead, *Archosargus probatocephalus* (Pisces: Sparidae). *Copeia* 1977:126–133.
- MOOKERJEE, H. K. 1946. Identification of eggs of common freshwater fishes of Bengal. *Sci. Cult.* 11(1):48.
- , AND S. R. MAZUMDAR. 1950. Some aspects of the life history of *Clarias batrachus* (Linn.). *Proc. Zool. Soc. Bengal* 3(1):71–83.
- MOORE, C. J. 1980. Spawning of *Menidia menidia* (Pisces: Atherinidae). *Copeia* 1980:886–887.
- MOORE, D. 1962. Development, distribution, and comparison of rudder fishes *Kyphosus sectatrix* (Linnaeus) and *K. incisor* (Cuvier) in the western North Atlantic. *U. S. Fish Wildl. Serv. Fish. Bull.* 196:451–480.
- MOREIRA, C. 1920. Recherches sur la reproduction de l'*Hoplostus malabaricus* (Bloch) et sur l'incubation d'oeufs de *Salmo fario* au Brésil. *Bull. Soc. Zool. Fr.* 44:329–336.
- MORELAND, J. 1960. A new species and genus of congiopodid fish from southern New Zealand. *Rec. Dom. Mus. (Wellington)* 3:241–246.
- MORENO, C. A. 1980. Observations on food and reproduction in *Trematomus bernacchii* (Pisces: Nototheniidae) from the Palmer Archipelago, Antarctica. *Copeia* 1980:171–173.
- MORI, K. 1984. Early life history of *Lutjanus vitta* (Lutjanidae) in Yuya Bay, the Sea of Japan. *Jpn. J. Ichthyol.* 30:374–392.
- , S. UEYANAGI AND Y. NISHIKAWA. 1971. The development of artificially fertilized and reared larvae of the yellowfin tuna, *Thunnus albacares*. *Bull. Far Seas Fish. Res. Lab. (Shimizu)* 5:219–232.
- MORIN, R. P., AND K. W. ABLE. 1983. Patterns of geographic variation in the egg morphology of the fundulid fish, *Fundulus heterochthus*. *Copeia* 1983:726–740.
- MORITA, S. 1984. History of the herring fishery and review of the artificial propagation technique for herring in Japan. *Can. J. Spec. Publ. Fish. Aquat. Sci.* In press.
- MORK, J., P. SOLEMDAL AND G. SUNDNESS. 1983. Identification of marine fish eggs: a biochemical genetics approach. *Can. J. Fish. Aquat. Sci.* 40:361–369.
- MOROVIC, D. 1953. Sur la détermination des muges adriatiques d'après la forme de l'otolith sagitta. *Notes Inst. Oceanogr. Split* 9:1–7.
- MORRIS, D. E., AND R. KANAYAMA. 1964–1969. Life history study of the Moi, *Polydactylus sextilis*. Job Completion Rep., Proj. No. F-S-R-11. Div. Fish Game, Honolulu, Hawaii. Mimeogr.
- MORRIS, R. 1951. Early development of the cottid fish *Clinocottus recalvus* (Greeley). *Calif. Fish Game* 37:281–300.
- . MS. Some notes on the early life history of the night smelt, *Sprinchus starksi* (Fisk).
- MORROW, J. E., JR. 1964a. Family Chauliodontidae, p. 274–289. *In: Fishes of the western North Atlantic.* H. B. Bigelow (ed.). Mem. Sears Found. Mar. Res. No. 1 (Pt. 4).
- . 1964b. Stomiidae, p. 290–310. *In: Fishes of the western North Atlantic.* H. B. Bigelow (ed.). Mem. Sears Found. Mar. Res. No. 1 (Pt. 4).
- . 1964c. Family Malacosteidae, p. 523–549. *In: Fishes of the western North Atlantic.* H. B. Bigelow (ed.). Mem. Sears Found. Mar. Res. No. 1 (Pt. 4).
- . 1980. The freshwater fishes of Alaska. Alaska Northwest Publ. Co., Anchorage.
- , AND R. H. GIBBS, JR. 1964. Family Melanostomiidae, p. 351–510. *In: Fishes of the western North Atlantic.* H. B. Bigelow (ed.). Mem. Sears Found. Mar. Res. No. 1 (Pt. 4). (Genera *Melanostomias* and *Eustomias* by R. H. Gibbs, Jr., the remainder by J. E. Morrow, Jr.)
- , AND S. J. HARBO. 1969. A revision of the sailfish genus *Istiophorus*. *Copeia* 1969:34–44.
- MOSER, H. G. 1972. Development and geographical distribution of the rockfish, *Sebastes macdonaldi* (Eigenmann and Beeson, 1893), family Scorpaenidae, off southern California and Baja California. *Fish. Bull. U.S.* 70:941–958.
- . 1974. Development and distribution of larvae and juveniles of *Sebastes* (Pisces: Family Scorpaenidae). *Fish. Bull. U.S.* 72:865–884.
- . 1981. Morphological and functional aspects of marine fish larvae, p. 89–131. *In: Marine fish larvae. Morphology, ecology and relation to fisheries.* R. Lasker (ed.). Univ. Washington Press, Seattle.
- , AND E. H. AHLSTROM. 1970. Development of lanternfishes (family Myctophidae) in the California Current. Part I. Species with narrow-eyed larvae. *Nat. Hist. Mus. Los Ang. Cty. Sci. Bull.* 7.
- , AND ———. 1972. Development of the lanternfish, *Scopelogadus multipunctatus* Brauer 1906, with a discussion of its phylogenetic position in the family Myctophidae and its role in a proposed mechanism for the evolution of photophore patterns in lanternfishes. *Fish. Bull. U.S.* 70:541–564.
- , AND ———. 1974. Role of larval stages in systematic investigations of marine teleosts: the Myctophidae, a case study. *Fish. Bull. U.S.* 72:391–413.

- , AND ———. 1978. Larvae and pelagic juveniles of blackgill rockfish, *Sebastes melanostomus*, taken in midwater trawls off southern California. *J. Fish. Res. Board Can.* 35:981-996.
- , ———, D. KRAMER AND E. G. STEVENS. 1973. Distribution and abundance of fish eggs and larvae in the Gulf of California. *Cal. Coop. Oceanic Fish. Invest. Rep.* 17:112-128.
- , AND E. M. SANDKNOP. 1977. Guide to the identification of scorpionfish larvae in the eastern Pacific with comparative notes on species of *Sebastes* and *Helicolenus* from other oceans. NOAA Tech. Rep. NMFS Circ. 402.
- , AND J. L. BUTLER. 1981. Description of reared larvae and early juveniles of the calico rockfish, *Sebastes dallii*. *Calif. Coop. Oceanic Fish. Invest. Rep.* 22:88-95.
- , AND ———. MS. Descriptions of reared larvae of six species of *Sebastes*. In: Proc. of a workshop on widow rockfish (*Sebastes entomelas*). W. H. Lenarz and D. Gunderson (eds.).
- MOSHER, C. 1954. Observations on the spawning behavior and the early larval development of the Sargassum fish, *Histrio histrio* (Linnaeus). *Zoologica (N.Y.)* 39:141-152.
- MOULTON, L. 1970. The 1970 longfin smelt population spawning run in Lake Washington with notes on egg development and changes in the population since 1964. Unpubl. MS thesis. Univ. Washington, Seattle.
- MOYER, J. T. 1979. Mating strategies and reproductive behaviour of ostraciid fishes at Miyake-jima, Japan. *Jpn. J. Ichthyol.* 26:148-160.
- MUJIB, K. A. 1967. The cranial osteology of the Gadidae. *J. Fish. Res. Board Can.* 24:1315-1375.
- . 1969. Cranial osteology of *Brosme brosme* with notes on its position within the subfamily Lotinae (Gadidae). *J. Fish. Res. Board Can.* 26:421-432.
- MUKHACHEVA, V. A. 1957. Notes on the development of the Far Eastern navaga (*Eleginus gracilis* Tilesius). *Tr. Inst. Okeanol. Akad. Nauk SSSR* 20:356-370. (In Russian, Transl. by Am. Inst. Biol. Sci., 1959, p. 291-302.)
- . 1964. The composition of species of the genus *Cyclothone* (Pisces, Gonostomatidae) in the Pacific Ocean, p. 98-146. In: *Fishes of the Pacific and Indian Oceans. Biology and Distribution*. T. S. Rass (ed.). *Tr. Inst. Okean.* 73. (English translation 1966 by Isr. Program Sci. Transl.)
- . 1978. A review of the species of *Diplophos* Günther (Gonostomatidae, Osteichthyes) and their vertical and geographical distribution. *Trans. P. P. Shirshov Inst. Ocean.* 111:10-27. (In Russian, English abstract.)
- , AND O. A. ZVIAGINA. 1960. Development of the Pacific cod, *Gadus morhua macrocephalus* Tilesius. *Tr. Inst. Okeanol. Akad. Nauk SSSR* 31:145-165. (Transl. from Russian by W. E. Ricker, 1969. *Fish. Res. Board Can.*, Transl. Ser. 393.)
- MÜLLER, H., AND G. STERBA. 1963. Elektronenmikroskopische Untersuchungen über Bildung und Struktur der Eihüllen bei Knochenfischen. II. Die Eihüllen jungerer und älterer Oozyten von *Cynolebias bellottii* Steindachner (Cyprinodontidae). *Zool. Jahrb. Abt. Anat.* 80(4):469-488.
- MUNK, O. 1966. Ocular anatomy of some deep-sea teleosts. Dana-Rep. Carlsberg Found. 70.
- , AND E. BERTELSEN. 1980. On the esca light organ and its associated light-guiding structures in the deep-sea anglerfish *Chaenophryne draco*. *Vindensk. Medd. Dan. Naturhist. Foren.* 142:103-129.
- MUNRO, I. S. R. 1945. Postlarval stages of Australian fishes—No. 1. *Mem. Queensl. Mus.* 12:148-152.
- . 1950. Revision of *Bregmaceros* with descriptions of larval stages from Australasia. *Proc. R. Soc. Queensl.* 61:37-53.
- . 1954. Eggs and larvae of the four-winged flying fish, *Hirundichthys speculiger* (Valenciennes). *Aust. J. Mar. Freshwater Res.* 5(1):64-69.
- . 1955. Eggs and larvae of the sabre-toothed oyster blenny *Dasson steadi* (Whitley) (Blenniidae). *Aust. J. Mar. Freshwater Res.* 6:30-34.
- . 1967. The Fishes of New Guinea. New Guinea Dep. Agric. Stock Fish., Port Moresby.
- MUNTZ, W. R. A. 1976. On yellow lenses in mesopelagic animals. *J. Mar. Biol. Assoc. U.K.* 56:963-976.
- MURRAY, J., AND J. HJORT. 1912. The depths of the ocean. Macmillan and Co., London.
- MUSICK, J. A. 1973. A meristic and morphometric comparison of the hakes, *Urophycis chuss*, and *U. tenuis* (Pisces, Gadidae). *Fish. Bull. U.S.* 71:479-488.
- MUSIENKO, L. N. 1963. Ichthyoplankton of the Bering Sea (data of the Bering Sea Expedition of 1958-1959), p. 251-286. In: P. A. Moiseev (ed.), *Soviet Fisheries Investigations in the Northeast Pacific*, J. Tr. Vses. Nauchno-Issled. Inst. Morsk. Rybn. Khoz. Okeanogs. 48.
- MUSIN, Y. I., AND V. A. SERGIYENKO. 1977. Fingerlings of the genus *Lutjanus* (Lutjanidae, Perciformes) from the Gulf of Aden. *J. Ichthyol. (Engl. Transl. Vopr. Ikhtiol.)* 17:151-154.
- MYERS, G. S. 1937. The deep-sea Zeomorph fishes of the family Grammicolepidae. *Proc. U.S. Natl. Mus.* 84:145-156.
- . 1958. Trends in the evolution of teleostean fishes. *Stanford Ichthyol. Bull.* 7(3):27-30.
- . 1960. A new zeomorph fish of the Family Oreosomatidae from the coast of California, with notes on the family. *Stanford Ichthyol. Bull.* 7(4):89-98.
- , AND W. C. FREIHOFFER. 1966. Megalomycetidae, a previously unrecognized family of deep-sea cetomimiform fishes based on two new genera from the North Atlantic. *Stanford Ichthyol. Bull.* 8:193-206.
- , AND C. B. WADE. 1946. New fishes of the families Dactyloscopidae, Microdesmidae, and Antennariidae from the west coast of Mexico and the Galapagos Islands with a brief account of the use of rotenone fish poisons in ichthyological collecting. *Allan Hancock Found. Pac. Exped.* 9(6):151-179.
- NAEPAKTITIS, B. G. 1975. Review of the lanternfish genus *Notoscopelus* (family Myctophidae) in the north Atlantic and Mediterranean. *Bull. Mar. Sci.* 25:75-87.
- . 1977. Family Neoscopelidae, p. 1-12. In: *Fishes of the western North Atlantic*. R. H. Gibbs, Jr. (ed.). *Mem. Sears Found. Mar. Res. No. 1*(Pt. 7).
- . 1978. Systematics and distribution of lanternfishes of the genera *Lobianchia* and *Diaphus* (Myctophidae) in the Indian Ocean. *Nat. Hist. Mus. Los Ang. Cty. Sci. Bull.* 30:1-92.
- , AND M. NAEPAKTITIS. 1969. Lanternfishes (family Myctophidae) collected during cruises 3 and 6 of the R V "Anton Bruun" in the Indian Ocean. *Nat. Hist. Mus. Los Ang. Cty. Sci. Bull.* 5:1-79.
- , AND J. R. PAXTON. 1968. Review of the lanternfish genus *Lampadena* with a description of a new species. *Contrib. Sci. (Los Ang.)* 138.
- , AND ———. 1978. *Idiolychnus*, a new genus of Myctophidae based on *Diaphus urolampus*. *Copeia* 1978:492-497.
- , R. H. BAKUS, J. E. CRADDOCK, R. L. HAEDRICH, B. H. ROBISON AND C. KARNELLA. 1977. Family Myctophidae, p. 13-265. In: *Fishes of the western North Atlantic*. R. H. Gibbs, Jr. (ed.). *Mem. Sears Found. Mar. Res. No. 1*(Pt. 7).
- NAGIEC, C. 1979. On the developmental stages of the fins and axial skeleton of whitefish *Coregonus lavaretus* L. *Pol. Arch. Hydrobiol.* 26:529-543.
- NAIR, G. S. 1958. On the breeding habits and development of *Ambassis gymnocephalus* (Lac.). *Bull. Cent. Res. Inst. Univ. Travancore, India* 5C(1):69-76.
- NAIR, R. V. 1952a. Studies on some fish eggs and larvae of the Madras plankton. *Proc. Indian Acad. Sci. Sec. B* 35:181-208.
- . 1952b. Studies on some post-larval fishes of the Madras plankton. *Proc. Indian Acad. Sci. Sect. B* 35:225-244.
- . 1960. Notes on the spawning habits and early life-history of

- the oil sardine, *Sardnella longiceps* Cuv. & Val. Indian J. Fish. 6:342-359.
- NAKABO, T. 1982a. Revision of the family Draconettidae. Jpn. J. Ichthyol. 28:335-367.
- . 1982b. Revision of genera of the dragonets (Pisces: Callionymidae). Publ. Seto Mar. Biol. Lab. 27:77-131.
- NAKAHARA, K. 1962. A note on the larvae of *Antigonia capros* Lowe and *Erythrocles schlegelii* (Richardson) collected off the southern coast of Kyushu. Bull. Jpn. Soc. Sci. Fish. 28:484-488.
- NAKAMURA, I. 1974. Some aspects of the systematics and distribution of billfishes. NOAA Tech. Rep. NMFS SSRF-675(2):45-53.
- . 1977. Gempylidae. In: FAO species identification sheets for fishery purposes. Western Central Atlantic, Fishing Area 31. Vol. 2. FAO, Rome.
- . 1980. New record of a rare gempylid, *Thyrstitoides marleyi*, from the Sea of Japan. Jpn. J. Ichthyol. 26:357-360.
- , AND E. FUJI. 1983. A new genus and species of Gempylidae (Pisces: Perciformes) from Tonga Ridge. Publ. Seto Mar. Biol. Lab. 28(4/6):173-191.
- , T. IWAI AND K. MATSUBARA. 1968. A review of the sailfish, spearfish, marlin and swordfish of the world. Kyoto Univ. Spec. Rep. 4.
- NAKAMURA, M. 1951. The life history of a cyprinid fish, *Opsarichthys uncirostris* (Temminck et Schlegel) in Lake Biwa. Misc. Rep. Res. Inst. Nat. Resour. (Tokyo) 19-21:70-78.
- NAKAMURA, M. N. 1969. Cyprinid fishes of Japan: Studies on the life history of cyprinid fishes of Japan. Res. Inst. Nat. Resour. (Tokyo) Spec. Publ. 4.
- NAKAMURA, S. 1936. Larvae and young of fishes found in the vicinity of Kominato, II-IV. II. *Atherion elymus* Jordan and Starks. J. Imp. Fish. Inst. (Tokyo) 30:219-225.
- . 1937. Larvae and young of fishes found in the vicinity of Kominato, VII-VIII. J. Imp. Fish. Inst. (Tokyo) 32:17-25.
- NAPLIN, N. A., AND C. L. OBENCHAIN. 1980. A description of eggs and larvae of the snake eel, *Pisodonophis cruentifer* (Ophichthidae). Bull. Mar. Sci. 30:413-423.
- NASH, C. E. 1973. Automated mass-production of *Artemia salina* nauplii for hatcheries. Aquaculture 2:289-298.
- , C.-M. KUO, W. D. MADDEN AND C. L. PAULSEN. 1977. Swim bladder inflation and survival of *Mugil cephalus* to 50 days. Aquaculture 12:89-94.
- NASSOGNE, A. 1970. Influence of food organisms on the development and culture of pelagic copepods. Helgol. Wiss. Meeresunters. 20:333-345.
- NELLEN, W. 1973a. Untersuchungen zur Verteilung von Fischlarven und Plankton im Gebiet der Grossen Meteorbank. Meteor Forschungsergeb. 13:47-69.
- . 1973b. Fischlarven des Indischen Ozeans. Meteor Forschungsergeb. Biol. 14:1-66. (English summary.)
- , AND G. HEMPEL. 1970. Beobachtungen am Ichthyoneuston der Nordsee. Ber. Dtsch. Wiss. Komm. Meeresforsch. 21:311-348.
- NELLIS, D. W. 1980. Reproduction in the ocean triggerfish *Canthidermus sufflamen*. Caribb. J. Sci. 16(1-4):167.
- NELSEN, O. E. 1953. Comparative embryology of the vertebrates. Blakiston, New York.
- NELSON, G. J. 1966a. Osteology and relationships of the eel, *Neencheilus butendijki*. Copeia 1966:321-324.
- . 1966b. Gill arches of teleostean fishes of the order Anguilliformes. Pac. Sci. 20:391-408.
- . 1967. Gill arches of teleostean fishes of the family Clupeidae. Copeia 1967:389-399.
- . 1969. Gill arches and the phylogeny of fishes, with notes on the classification of vertebrates. Bull. Amer. Mus. Nat. Hist. 141:479-552.
- . 1970. The hyobranchial apparatus of teleostean fishes of the families Engraulidae and Chirocentridae. Am. Mus. Novit. 2410.
- . 1972. Cephalic sensory canals, pitlines, and the classification of esocoid fishes, with notes on galaxiids and other teleosts. Am. Mus. Novit. 2492:1-49.
- . 1973. Relationships of clupeomorphs, with remarks on the structure of the lower jaw in fishes, p. 333-349. In: Interrelationships of fishes. P. H. Greenwood, R. S. Miles and C. Patterson (eds.). Zool. J. Linn. Soc. 53 (Suppl. 1).
- . 1978. Ontogeny, phylogeny, palaeontology, and the biogenetic law. Syst. Zool. 27:324-345.
- . 1983. *Anchoa argentivittata* with notes on other eastern Pacific anchovies and the Indo-Pacific genus *Encrasicholina*. Copeia 1983:48-54.
- . 1984. Identity of the anchovy *Hildebrandichthys setiger* with notes on relationships and biogeography of the genera *Engraulis* and *Cetengraulis*. Copeia 1984:422-427.
- , AND N. PLATNICK. 1981. Systematics and biogeography. Cladistics and vicariance. Columbia Univ. Press, New York.
- NELSON, J. S. 1975. Records of a new form of the marine cottid fish *Antpodocottus galathea* from the east coast of New Zealand. Natl. Mus. N.Z. Rec. 1(4):80-86.
- . 1976. Fishes of the world. John Wiley & Sons, New York.
- . 1977. Fishes of the Southern Hemisphere genus *Ncophrynichthys* (Scorpaeniformes: Cottoidei), with descriptions of two new species from New Zealand and Macquarie Island. J. R. Soc. N.Z. 7:485-511.
- . 1978. *Limnichthys polyactis*, a new species of blennioid fish from New Zealand, with notes on the taxonomy and distribution of other Creediidae (including Limnichthyidae). N.Z. J. Zool. 5:351-364.
- . 1982. Two new South Pacific fishes of the genus *Ebinania* and contributions to the systematics of Psychrolutidae (Scorpaeniformes). Can. J. Zool. 60:1470-1504.
- NICHOLS, J. H. 1971. Pleuronectidae. Cons. Int. Explor. Mer. Fiches d'identification des oeufs et larves de poissons, No. 4-6:2-18.
- NICHOLS, J. T., AND C. M. BREDER, JR. 1927. The marine fishes of New York and southern New England. Zoologica (N.Y.) 9(1):1-192.
- , AND C. M. BREDER, JR. 1928. An annotated list of the Synentognathi with remarks on their development and relationships. Collected by the *Arcturus*. Zoologica (N.Y.) 8:423-448.
- NIELSEN, J. G. 1963a. On the development of *Cheilodactylus variegatus* Valenciennes 1883 (Cheilodactylidae). Copeia 1963:528-533.
- . 1963b. Notes on some Heterosomata (Pisces) from NW South America with the description of a new genus and species and a new subspecies of Paralichthinae. Vidensk. Medd. Dan. Naturhist. Foren. 125:375-400.
- . 1963c. Description of two large unmetamorphosed flatfish larvae (Heterosomata). Vidensk. Medd. Dan. Naturhist. Foren 125:401-406.
- . 1964. Fishes from depths exceeding 6000 meters. Galathea Rep. 7:113-124.
- . 1966. Synopsis of the Ipnopidae (Pisces, Iniomi). Galathea Rep. 8:49-75.
- . 1969. Systematics and biology of the Aphyonidae (Pisces, Ophidiioidea). Galathea Rep. 10:7-88.
- . 1973. Stylephoridae, p. 335. In: Check-list of the fishes of the north-eastern Atlantic and of the Mediterranean (Clofnam). Vol. I. J. C. Hureau and T. Monod (eds.). UNESCO, Paris.
- , AND J.-C. HUREAU. 1980. Revision of the ophidiid genus *Spectrunculus*, a senior synonym of *Parabassogigas* (Pisces, Ophidiiformes). Steenstrupia 6(11):149-169.
- , AND D. G. SMITH. 1978. The eel family Nemichthyidae (Pisces, Anguilliformes). Dana-Rep. Carlsberg Found. 88:1-71.
- NIKOLSKY, G. V. 1961. Special ichthyology. Second revised and enlarged edition (translated from Russian, original date of publication 1954). Jerusalem. (Not seen; cited by Tyler, 1968.)
- . 1963. The ecology of fishes. Academic Press, London.
- NISHIKAWA, Y. 1979. Early development of the double-lined mackerel, *Grammatorcynus bicarinatus* (Quoy and Gaimard), from the western tropical Pacific. Bull. Far Seas Fish. Res. Lab. (Shimizu) 17:125-140.
- . 1982. Early development of the fishes of the family Gempy-

- lidae. I. Larvae and juveniles of escolar, *Lepidocybium flavobrunneum* (Smith). Bull. Far Seas Fish. Res. Lab. (Shimizu) (19):1-13.
- , AND I. NAKAMURA. 1978. Post larvae and juveniles of the gempylid fish *Neopinnula orientalis* (Gilchrist and Von Bonde), from the North Arabian Sea. Bull. Far Seas Fish. Res. Lab. (Shimizu) (16):75-91.
- NISHIMURA, S. 1964. Additional information on the biology of the dealfish, *Trachipterus ishikawai* Jordan and Snyder. Bull. Jpn. Sea Reg. Fish. Res. Lab. 13:127-129.
- . 1966. Early life history of the deep-sea smelt, *Glossanodon semifasciatus* (Kishinouye) (Teleostei: Clupeida). Pt. 1. Publ. Seto Mar. Biol. Lab. 13:349-360.
- NOAKES, D. L. G., AND E. K. BALON. 1982. Life histories of tilapia: an evolutionary perspective, p. 61-68. In: biology and culture of tilapia. R. S. V. Pullin and R. H. Lowe-McConnell (eds.), ICLARM Conference Proceedings 7. International Center for Living Aquatic Research Management, Manila, Philippines.
- NORCROSS, J. J., W. H. MASSMANN AND E. B. JOSEPH. 1961. Investigations of inner continental shelf waters off lower Chesapeake Bay. Part 2. Sand lance larvae, *Ammodytes americanus*. Chesapeake Sci. 2:46-59.
- , S. L. RICHARDSON, W. H. MASSMAN AND E. B. JOSEPH. 1974. Development of young bluefin (*Pomatomus saltatrix*) and distribution of eggs and young in Virginia coastal waters. Trans. Am. Fish. Soc. 103:477-497.
- NORDEN, C. R. 1961. Comparative osteology of representative salmonid fishes with particular reference to the grayling (*Thymallus arcticus*) and its phylogeny. J. Fish. Res. Board Can. 18:679-791.
- NORMAN, J. R. 1926a. A report on the flatfishes (Heterosomata) collected by the F. I. S. "Endeavour," with a synopsis of the flatfishes of Australia and a revision of the Rhombosoleinae. Biol. Res. Fishing Exped. F. I. S. Endeavour 5:217-308.
- . 1926b. The development of the chondrocranium of the eel (*Anguilla vulgaris*) with observations on the comparative morphology and development of the chondrocranium in bony fishes. Philos. Trans. R. Soc. Lond. B. Biol. Sci. 214:369-464.
- . 1929. The teleostean fishes of the family Chiasmodontidae. Ann. Mag. Nat. Hist. 3(10):529-544.
- . 1930. Oceanic fishes and flatfishes collected in 1925-1927. Part I. Oceanic fishes. Part II. Flatfishes. Discovery Rep. 2:261-370.
- . 1934. A systematic monograph of the flatfishes (Heterosomata). Vol. 1. Psettodidae, Bothidae, Pleuronectidae. Br. Mus. (Nat. Hist.) Lond.
- . 1937. Coast fishes, part 2, the Patagonian Region. Discovery Rep. 16:1-50.
- . 1938a. Coast fishes, part 3, the Antarctic Zone. Discovery Rep. 18:1-104.
- . 1938b. On the affinities of the Chilean fish, *Normanichthys crockeri* Clark. Copeia 1938:29-32.
- . 1966. A draft synopsis of the orders, families and genera of recent fishes and fish-like vertebrates. Br. Mus. (Nat. Hist.) Lond.
- NORTH, A. W., AND M. G. WHITE. 1982. Key to fish postlarvae from the Scotia Sea, Antarctica. Cybium, 3rd Ser. 6(1):13-32.
- NYBELIN, O. 1947. Antarctic fishes. Sci. Results Norw. Antarct. Exped. 26.
- . 1948. Fishes collected by the "Skagerak" Expedition in the eastern Atlantic 1946. Goteb. Vetensk. Samh. Handl. 6:1-95.
- . 1951. Subantarctic and Antarctic fishes. Sci. Results Bratæg Expedition. 2.
- OBREHELOVA, N. 1961. Vergleichende Osteologie der tertiären Süßwasserfische Böhmens (Gobioidei). Sb. Ustred. Ustavu Geol. 26:103-192.
- OCHIAI, A., AND K. AMAOKA. 1963. Description of larvae and young of four species of flatfishes referable to subfamily Bothidae. Bull. Jpn. Soc. Sci. Fish. 29(2):127-134. (In Japanese.)
- , AND Y. NOZAWA. 1980. On the metamorphosis and burrowing habits of the snake eel, *Muraenichthys gymnotus*. Jpn. J. Ichthyol. 27:237-242.
- O'CONNELL, C. P. 1953. The life history of the cabezon, *Scorpaenichthys marmoratus* (Ayres). Calif. Dep. Fish Game Fish Bull. 93:1-10.
- . 1976. Histological criteria for diagnosing the starving condition in early post yolk-sac larvae of the northern anchovy *Engraulis mordax* Girard. J. Exp. Mar. Biol. Ecol. 25:285-312.
- . 1980. Percentage of starving northern anchovy, *Engraulis mordax*, larvae in the sea as estimated by histological methods. Fish. Bull. U.S. 78:475-489.
- . 1981a. Development of organ systems in the northern anchovy *Engraulis mordax* and other teleosts. Am. Zool. 21:429-446.
- . 1981b. Estimation by histological methods of the percent of starving northern anchovy larvae in the sea. Rapp. P. V. Reun. Cons. Int. Explor. Mer 178:357-360.
- O'DAY, W. T. 1972. The histology and fine structure of some bioluminescent organs in deep sea fishes. Unpubl. PhD dissertation. Univ. South. Calif., Los Angeles.
- . 1974. Bacterial luminescence in the deep-sea anglerfish *Oneirodes acanthias* (Gilbert, 1915). Contrib. Sci. (Los Ang.) 255:1-12.
- OELSCHLAGER, H. A. 1974. Das Caudalskelett von *Lampris regius* und seine Ableitung von *Velifer hypselopterus*. Senckenb. Biol. 55(1 3): 77-85.
- . 1976a. On the evolution and ecological adaptations of the Allotriognathi. Rev. Trav. Int. Peches Marit. 40(3,4):691-694.
- . 1976b. Gotteslachse und Bandfische—Erforschungsgeschichte und Evolution der Glanzfischartigen. Nat. Mus. 106(2):48-54.
- . 1978a. Comparative morphological and functional investigations on the pelvis of the oarfishes (Teleostei: Allotriognathi). Zool. Beitr. 24(2):165-192.
- . 1978b. On the morphology and biomechanics of *Agrostichthys* Phillippis in comparison with other Allotriognathi (Pisces, Teleostei). Zool. Jahrb. Abt. Anat. 100:118-153.
- . 1979. On the functional osteology of the Lophotidae (Pisces: Teleostei). Zool. Jahrb. Abt. Anat. 102:336-360.
- OGASAWARA, Y., S. AKATSU AND Y. TAKI. 1978. Juvenile stages and effect of salinity on the survival of larvae and juveniles in the striped fingerfish, *Monodactylus sebae*. Jpn. J. Ichthyol. 24:246-250.
- OHSIMA, Y., AND N. NAKAMURA. 1941. Note on the life history of *Triacanthus brevirostris* Temminck et Schlegel. Bull. Jpn. Soc. Sci. Fish. 10(4):171-176. (In Japanese, English summary.)
- OJESTAD, V., AND E. MOKSNES. 1981. Study of growth and survival of herring larvae (*Clupea harengus*) using plastic bag and concrete basin enclosures. Rapp. P. V. Reun. Cons. Int. Explor. Mer 178: 144-149.
- OKADA, Y. 1960. Studies on the freshwater fishes of Japan. II. Special part. J. Fac. Fish. Prefect. Univ. Mie 4(2):267-588.
- , AND R. SEISHI. 1938. Studies on the early life history of 9 species of freshwater fishes of Japan. Bull. Biogeogr. Soc. Jpn. 8(15): 223-263.
- OKAMURA, O. 1970a. Studies on the macrouroid fishes of Japan— morphology, ecology and phylogeny. Rep. Usa Mar. Biol. Stn. 17(1-2):1-179.
- . 1970b. Fauna Japonica: Macrourina (Pisces). Academic Press Japan.
- OKIYAMA, M. 1963. Larvae and young of the witch flounder, *Glyptocephalus stelleri* (Schmidt) at metamorphosis stages. Bull. Jpn. Sea Reg. Fish. Res. Lab. 11:101-108.
- . 1964. Early life history of the Japanese blunquillos, *Branchiostegus japonicus japonicus* (Houttuyn). Bull. Jap. Sea Reg. Fish. Res. Lab. 13:1-14. (In Japanese, English abstract.)
- . 1967. Study on the early life history of a flounder, *Paralichthys olivaceus* (Temminck et Schlegel). I. Descriptions of postlarvae. Bull. Jpn. Sea Reg. Fish. Res. Lab. 17:1-12.
- . 1970. Studies on the early life history of the rainbow runner, *Elagatis bipinnulatus* (Quoy and Gaimard) in the Indo-Pacific Oceans. Bull. Far Seas Fish. Res. Lab. (Shimizu) 3:167-186.
- . 1971. Early life history of the gonostomatid fish, *Maurolucius muelleri* (Gmelin), in the Japan Sea. Bull. Jpn. Sea Reg. Fish. Res. Lab. 23:21-53.

- . 1972. Morphology and identification of the young ipnoid, "*Macristiella*" from the tropical western Pacific. *Jpn. J. Ichthyol.* 19:145-153.
- . 1974a. Studies on the early life history of a flounder, *Paralichthys olivaceus* (Temminck et Schlegel). II. Descriptions of juveniles and the comparison with those of the related species. *Bull. Jpn. Sea Reg. Fish. Res. Lab* 25:39-61.
- . 1974b. The larval taxonomy of the primitive myctophiform fishes, p. 609-621. *In: The early life history of fish.* J. H. S. Blaxter (ed.). Springer-Verlag, New York.
- . 1979a. Manuals for the larval fish taxonomy. (1) Definition and classification of larval stages. *Kaiyo to Seibutsu (Ocean and Its Life)* 1:54-59. (In Japanese.)
- . 1979b. Larval morphology and interrelationships of the myctophoid fishes. *Kaiyo Kagaku (Mar. Sci.)* 11:131-145. (In Japanese.)
- . 1980. Manuals for the larval fish taxonomy (5). Diversity of Myctophiformes larvae. *Aquabiology* 2:124-129.
- . 1981. A larval *Ipnops* and its possible metamorphosing process. *Jpn. J. Ichthyol.* 28:247-253.
- . 1982a. Manuals for the larval fish taxonomy (9). Percoid larvae and spination. *Oceans Mammals* 4(2):92-99. (In Japanese, English abstract.)
- . 1982b. Embryo of *Allolepis hollandi* Jordan and Hubbs, 1925. *Aquabiology* 4(4):cover.
- , AND H. SANDO. 1976. Early life history of sea raven. *Bull. Jap. Sea Reg. Fish. Res. Lab.* 27:1-10.
- , AND K. TAKAHASHI. 1976. Larval stages of the right eye flounders (subfamily Pleuronectinae) occurring in the Japan Sea. *Bull. Jpn. Sea Reg. Fish. Res. Lab.* 27:11-34.
- , AND S. UEYANAGI. 1977. Larvae and juvenile of the Indo-Pacific dogtooth tuna, *Gymnosarda unicolor* (Ruppell). *Bull. Far Seas Fish. Res. Lab. (Shimizu)* 15:35-49.
- , AND ———. 1978. Interrelationships of scombroid fishes: an aspect from larval morphology. *Bull. Far Seas Fish. Res. Lab. (Shimizu)* 16:103-113.
- OLNEY, J. E., AND G. C. GRANT. 1976. Early planktonic larvae of the blackcheek tonguefish, *Symphurus plagiusa* (Pisces: Cynoglossidae), in the lower Chesapeake Bay. *Chesapeake Sci.* 17(4):229-237.
- , AND D. F. MARKLE. 1979. Description and occurrence of vexillifer larvae of *Echiodon* (Pisces: Carapidae) in the western North Atlantic and notes on other carapid vexillifers. *Bull. Mar. Sci.* 29:365-379.
- , AND A. NAPLIN. 1980. Eggs of the scalloped ribbon-fish, *Zu cristatus*, (Pisces: Trachipteridae) in the western North Atlantic. *Copeia* 1:165-166.
- , AND G. R. SEDBERRY. In press. Dragonet larvae (Teleostei, Callionymidae) in continental shelf waters off the eastern United States. *Biol. Oceanogr.*
- OLSEN, Y., AND D. MERRIMAN. 1946. Studies on the marine resources of southern New England. IV. The biology and economic importance of the ocean pout, *Macrozoarces americanus* (Bloch and Schneider). *Bull. Bingham Oceanogr. Collect. Yale Univ.* 9(4):1-184.
- ORCUTT, H. G. 1950. The life history of the starry flounder, *Platichthys stellatus* (Pallas). *Calif. Dep. Fish Game Fish Bull.* 78.
- ORELLANA, M. C., AND F. BALBONTIN. 1983. Estudio comparativo de las larvas de Clupeiformes de la costa de Chile. *Rev. Biol. Mar. (Chile)* 19:1-46.
- ORTON, G. L. 1953a. Development and migrations of pigment cells in some teleost fishes. *J. Morphol.* 93:69-99.
- . 1953b. The systematics of vertebrate larvae. *Syst. Zool.* 2:63-75.
- . 1955a. Separation of eggs of synentognath and allotriognath fishes in early embryonic stages. *Calif. Fish Game* 41:103-105.
- . 1955b. Early developmental series of the California barracuda, *Sphyracna argentea* Girard. *Calif. Fish Game* 41:167-176.
- . 1955c. The role of ontogeny in systematics and evolution. *Evolution* 9:75-83.
- . 1955d. Early developmental stages of the California scorpionfish, *Scorpaena guttata*. *Copeia* 1955:210-214.
- . 1957. The bearing of larval evolution on some problems in frog classification. *Syst. Zool.* 6:285-292.
- . 1964. The eggs of scomberesocid fishes. *Copeia* 1964:144-150.
- O'TOOLE, M. J. 1977. Development and distributional ecology of the larvae of the west coast sole *Austroglossus microlepis*. *Fish. Bull. S. Afr.* 9:32-45.
- , AND D. P. F. KING. 1974. Early development of the round herring *Etrumeus teres* (De Kay) from the southeast Atlantic. *Vie Milieu* 24:443-452.
- OWEN, R. 1866. On the anatomy of the vertebrates. Vol. 1. Fishes and Reptiles. Longman Green, London.
- OWEN, R. W. 1980. Patterning of flow and organisms in the larval anchovy environment. *IOC Workshop Rep. No. 28*:167-200.
- OZAWA, T. 1976. Early life history of the gonostomatid fish, *Pollichthys mauii*, in the oceanic region off southern Japan. *Jpn. J. Ichthyol.* 23:43-54.
- . 1978. Notosudid fish larvae in the ocean off southern Japan. *Jpn. J. Ichthyol.* 25:79-88.
- . 1983. Study on the early life history and the distribution of oceanic fish larvae in the ocean off southern Japan. Unpubl. PhD dissertation. Kyushu Univ.
- , AND S. MATSUI. 1979. First record of the schindlerid fish, *Schindleria praematura*, from southern Japan and the south China Sea. *Jpn. J. Ichthyol.* 25:283-285.
- PADMANABHAN, K. G. 1961. The early development of *Solcnostomus cyanopterus*. *Bull. Cent. Res. Inst. Trivandrum* 80:1-13.
- PADOA, E. 1947. Forme post-larvali e giovanili di *Carapus*. *Pubbl. Staz. Zool. Napoli* 20:111-120.
- . 1956a. Famiglia 4: Trichiuridae, p. 508-513. *In: Uova, larve e stadi giovanili di Teleostei.* Fauna Flora Golfo Napoli Monogr. 38.
- . 1956b. Famiglia 10-13: Stromateidae, Centrolophidae, Nomeidae, Tetragonuridae, p. 534-547. *In: Uova, larve, e stadi giovanili di Teleostei.* Fauna Flora Golfo Napoli Monogr. 38.
- . 1956c. Divisione: Carangiformes, p. 548-572. *In: Uova larve e stadi giovanili di Teleostei.* Fauna Flora Golfo Napoli Monogr. 38.
- . 1956d. Sottordine: Chromides, p. 573-576. *In: Uova, larve e stadi giovanili di Teleostei.* Fauna Flora Golfo Napoli Monogr. 38.
- . 1956e. Triglidae, Peristediidae, Dactylopteridae, Gobiidae, Echeidae, Jugulares, Gobiesocidae, Heterosomata, Pediculati, p. 627-888. *In: Uova, larve, e stadi giovanili di Teleostei.* Fauna Flora Golfo Napoli Monogr. 38.
- . 1956f. Famiglia: Gobiidae, p. 648-678. *In: Uova, larve e stadi giovanili di Teleostei.* Fauna Flora Golfo Napoli Monogr. 38.
- . 1956g. Famiglia 1: Trachinidae, p. 687-697. *In: Uova, larve e stadi giovanili di Teleostei.* Fauna Flora Golfo Napoli Monogr. 38.
- . 1956h. Famiglia 6: Clinidae, p. 745-752. *In: Uova, larve e stadi giovanili di Teleostei.* Fauna Flora Golfo Napoli Monogr. 38.
- . 1956i. Famiglia 8: Ophidiidae, p. 755-761. *In: Uova, larve e stadi giovanili di Teleostei.* Fauna Flora Golfo Napoli Monogr. 38.
- . 1956j. Famiglia 9: Carapidae, p. 761-774. *In: Uova, larve e stadi giovanili di Teleostei.* Fauna Flora Golfo Napoli Monogr. 38.
- . 1956k. Heterosomata, p. 783-877. *In: Uova, larve e stadi giovanili di Teleostei.* Fauna Flora Golfo Napoli Monogr. 38.
- PAL, R. N., AND H. A. KHAN. 1969. Breeding and development of *Heteropneustes fossilis* (Bloch). *Proc. Indian Sci. Congr.* 56:543-544.
- PALKO, B. J., G. L. BEARDSLEY AND W. J. RICHARDS. 1981. Synopsis of the biology of the swordfish, *Xiphias gladius* Linnaeus. NOAA Tech. Rep. NMFS Circ. 441.
- , AND W. J. RICHARDS. 1969. The rearing of cowfish. *Salt water Aquar. Mag.* 5(3):67-70.

- PALMER, G. 1961. The dealfishes (Trachipteridae) of the Mediterranean and northeast Atlantic. *Bull. Br. Mus. (Nat. Hist.) Zool.* 7:335-351.
- . 1973. Lampridae, Regalecidae, Trachipteridae, Radiicephalidae, Lophotidae, p. 328-334. *In*: J. C. Hureau and T. Monod (eds.). Check-list of the fishes of the north-eastern Atlantic and of the Mediterranean (Clofnam). Vol. 1. UNESCO, Paris.
- PALOMERA, I., AND J. M. FORTUNO. 1981. Larvas leptocéfalas de peces anguilliformes en la costa noroccidental de Africa. *Res. Exped. Cient.* 9:3-15.
- , AND P. RUBIES. 1977. Descripción de huevos y larvas de *Microchirus ocellatus* y *M. azevia* (Pleuronectiformes, Soleidae) de las costas del NW de Africa. *Res. Exped. Cient. B/O Cornide* 6:211-220.
- PANCHEN, A. L. 1982. The use of parsimony in testing phylogenetic hypotheses. *Zool. J. Linn. Soc.* 74:305-328.
- PANNELLA, G. 1971. Fish otoliths: daily growth layers and periodical patterns. *Science (Wash. D.C.)* 173:1124-1127.
- . 1980. Growth patterns in fish sagittae, p. 519-560. *In*: Skeletal growth of aquatic organisms; biological records of environmental change. D. C. Rhoads and R. A. Lutz (eds.). Plenum Press, New York.
- PAPADOPOULU, C., G. D. KANIAS AND E. MORAITOPOULOU-KASSIMATI. 1978. Zinc content in otoliths of mackerel from the Aegean. *Mar. Pollut. Bull.* 9:106-108.
- , AND ———. 1980. Trace element content in fish otoliths in relation to age and size. *Mar. Pollut. Bull.* 11:68-72.
- PARENTI, L. R. 1981. A phylogenetic and biogeographic analysis of cyprinodontiform fishes (Teleostei, Atherinomorpha). *Bull. Am. Mus. Nat. Hist.* 168:335-557.
- . 1984. On the relationships of phallostethid fishes (Atherinomorpha), with notes on the anatomy of *Phallostethus dunckeri* Regan, 1913. *Am. Mus. Novit.* 2779.
- PARIN, N. V. 1961. The basis of classification of the flying fishes (families Oxyporhamphidae, Exocoetidae). *Tr. Inst. Okeanol. Akad. Nauk SSSR* 43:92-183.
- . 1967. Review of the marine Belonidae of the western Pacific and Indian oceans. *Tr. Inst. Okeanol. Akad. Nauk SSSR* 84:3-83. (*In Russian*; *Natl. Mar. Fish. Serv. Syst. Lab. Transl. No.* 68.)
- . 1968. Scomberosocidae (Pisces, Synentognathi) of the eastern Atlantic Ocean. *Atl. Rep.* 10:275-290.
- . 1976. Two new species of *Benthodesmus* (Trichiuridae, Osteichthyes) from the western Tropical Pacific Ocean. *Tr. Inst. Okeanol. Akad. Nauk SSSR* 104:191-194. (*In Russian*, English abstract.)
- . 1977. New species of *Melanostigma* (Zoarcidae, Osteichthyes), *M. inexpectatum*, from the western equatorial Pacific. *Tr. Inst. Okeanol. Acad. Nauk SSSR* 107:63-67.
- . 1978. New records of midwater fishes from off New Guinea and Tonga Islands with descriptions of two new species of *Eustomias* (Family Melanostomiidae) and *Benthodesmus* (Family Trichiuridae). *Tr. Inst. Okeanol. Akad. Nauk SSSR* 111:156-168. (*In Russian*, English Abstract.)
- , AND D. A. ASTAKHOV. 1982. Studies on the acoustico-lateralis system of beloniform fishes in connection with their systematics. *Copeia* 1982:276-291.
- , AND V. E. BEKKER. 1972. Materials on taxonomy and distribution of some trichiurid fishes (Pisces, Trichiuroidae: Scombracidae, Gempylidae, Trichiuridae). *Proc. P. P. Shirshov Inst. Oceanol.* 93:110-204 (*In Russian*, English abstract.)
- , AND T. N. BELYANINA. 1972. New data on the distribution and morphology of fish of the genus *Macristiella*. *J. Ichthyol. (Engl. Transl. Vopr. Ikhtiol.)* 12:1018-1022.
- , B. B. COLLETTE AND YU. N. SHCHERBACHEV. 1980. Preliminary review of the marine halfbeaks (Hemiramphidae, Beloniformes) of the tropical Indo-West Pacific. *Tr. Inst. Okeanol. Akad. Nauk SSSR* 97:7-173. (*In Russian*, English abstract.)
- , AND N. N. GORBUNOVA. 1964. On the reproduction and development of some synentognaths (Pisces, Beloniformes) from the Indian Ocean (based on material from the R/S "Vityaz"). *Tr. Inst. Okeanol. Akad. Nauk SSSR* 73:224-234.
- , AND Y. I. KUKUYEV. 1983. Re-establishment of the validity of *Lampris immaculata* Gilchrist and the geographical distribution of Lampridae. *J. Ichthyol. (Engl. Transl. Vopr. Ikhtiol.)* 23(1):1-12.
- , AND S. MIKHAILIN. 1981. A new species of cutlassfish, *Lepidodus dubius* Parin and Mikhailin (Trichiuridae), from the eastern tropical Atlantic Ocean. *J. Ichthyol. (Engl. Transl. Vopr. Ikhtiol.)* 21(3):1-8.
- , AND G. N. POKHIL'SKAYA. 1968. The age variability and distribution of a rare oceanic fish *Eumecichthys fiski* (Pisces, Lophotidae). *Probl. Ichthyol. (Engl. Transl. Vopr. Ikhtiol.)* 8:808-812.
- PARKER, G. H. 1903. The optic chiasma in teleosts and its bearing on the asymmetry of the Heterosomata (flatfishes). *Bull. Mus. Comp. Zool. Harv.* 40:221-242.
- PARKER, K. R. 1980. A direct method for estimating northern anchovy, *Engraulis mordax*, spawning biomass. *Fish. Bull. U.S.* 78:541-544.
- PARR, A. E. 1926. Investigations on the Cyclopterini. *Bergens Mus. Aarbok* 1924-25, Naturvid. Raekke (7).
- . 1927. The stomiatoid fishes of the suborder Gymnophotodermi (Astronesthidae, Melanostomiidae, Idiacanthidae) with a complete review of the species. *Bull. Bingham Oceanogr. Collect. Yale Univ.* 3.
- . 1933. Deep-sea Berycomorphi and Percomorphi from the waters around the Bahama and Bermuda Islands. *Bull. Bingham Oceanogr. Collect. Yale Univ.* 3(6).
- . 1946. The Macrouridae of the western North Atlantic and Central American seas. *Bull. Bingham Oceanogr. Collect. Yale Univ.* 10 (Art. 1):1-99.
- PATI, S. 1979. On the maturation and spawning of Chinese pomfret *Pampus chinensis* (Euphrasen) from Orissa coast. *Indian J. Fish.* 26:150-162.
- PATTERSON, C. 1968. The caudal skeleton in mesozoic acanthopterygian fishes. *Bull. British Mus. (Nat. Hist.) Geol.* 17:5-102.
- . 1981a. Agassiz, Darwin, Huxley, and the fossil record of teleost fishes. *Bull. British Mus. (Nat. Hist.) Geol.* 35:213-224.
- . 1981b. Significance of fossils in determining evolutionary relationships. *Annu. Rev. Ecol. Syst.* 12:195-223.
- . 1982. Morphological characters and homology. *In*: Problems of Phylogenetic Reconstruction. K. A. Joysey and A. E. Friday (eds.). Proceedings of a symposium, Cambridge, England, April 1980. Published for the Systematics Association by Academic Press, New York. *Syst. Assoc. Spec.* Vol. 21.
- , AND D. E. ROSEN. 1977. Review of ichthyodectiform and other Mesozoic teleost fishes and the theory and practice of classifying fossils. *Bull. Am. Mus. Nat. Hist.* 158:83-172.
- PAULIN, C. D. 1983. A revision of the family Moridae (Pisces: Anacanthini) within the New Zealand region. *Natl. Mus. N.Z. Rec.* 2(9): 81-126.
- PAXTON, J. R. 1967. A distributional analysis for the lanternfishes (family Myctophidae) of the San Pedro Basin, California. *Copeia* 1967:422-440.
- . 1972. Osteology and relationships of the lanternfishes (family Myctophidae). *Nat. Hist. Mus. Los Ang. Cty. Sci. Bull.* 13:1-81.
- . 1979. Nominal genera and species of lanternfishes (family Myctophidae). *Contrib. Sci. (Los Ang.)* 322.
- PEARCY, W. G. 1962. Egg masses and early developmental stages of the scorpaenid fish, *Sebastolobus*. *J. Fish. Res. Board Can.* 19:1169-1173.
- PEARSE, A. G. E. 1968. *Histochemistry—theory and applied*. Vol. 2. Little Brown, Boston.
- PEARSON, J. C. 1938. Life history of the striped bass, or rockfish, *Roccus saxatilis* (Walbaum). *Bull. Bur. Fish. Wash.* 49(28):825-851.
- . 1941. The young of some marine fishes taken in lower Chesapeake Bay, Virginia, with special reference to the gray sea trout

- Cynoscion regalis* (Bloch). U.S. Fish Wildl. Serv. Fish. Bull. 50:79-102.
- PEDEN, A. E. 1970. A new cottid fish, *Nautichthys robustus*, from Alaska and British Columbia. Natl. Mus. Nat. Sci. (Ottawa) Publ. Biol. Oceanogr. 2.
- . 1981. On the identity of two cottid subspecies, *Icelinus burchami burchami* and *I. b. fuscescens*. Copeia 1981:482-484.
- , AND M. E. ANDERSON. 1978. A systematic review of the fish genus *Lycodapus* (Zoarcidae) with descriptions of two new species. Can. J. Zool. 56:1925-1961.
- , AND ———. 1981. *Lycodapus* (Pisces: Zoarcidae) of eastern Bering Sea and nearby Pacific Ocean, with three new species and a revised key to the species. Can. J. Zool. 59:667-678.
- , AND C. A. CORBETT. 1973. Commensalism between a liparid fish, *Careproctus* sp. and the lithodid box crab, *Lipholithodes foraminatus*. Can. J. Zool. 51:555-556.
- PELLEGRIN, J. 1907. Liste des poissons recueillis à Madagascar par M. F. Geay. Description d'une espèce nouvelle. Bull. Mus. Paris 1907: 201-206.
- . 1914. Sur un atherinide nouveau de Madagascar appartenant au genre *Bedotta*. Bull. Soc. Zool. Fr. 39:178-180.
- . 1935. Les poissons africains de la famille des cromeriides et leurs affinités. Arch. Mus., Ser. 6, 12:461-463.
- PEÑÁZ, M. 1968. Development of the chub, *Leuciscus cephalus* (Linnaeus 1758) in the posthatching period. Zool. Listy 17(3):269-278.
- . 1975. Early development of the grayling *Thymallus thymallus* (Linnaeus, 1758). Acta. Sci. Nat. Acad. Sci. Bohemoslov. Brno. 9:1-35.
- , AND J. GAJDUŠEK. 1979. Early development of bream, *Abramis brama*, from the water reservoir Mostiste, Czechoslovakia. Folia Zool. 28(4):347-360.
- PENRITH, M. J. 1965. A new species of flat fish, *Mancopsetta milfordi*, from South Africa, with notes on the genus *Mancopsetta*. Ann. S. Afr. Mus. 48:181-188.
- PENRITH, M.-L. 1969. The systematics of the fishes of the family Clinidae in South Africa. Ann. S. Afr. Mus. 55:1-121.
- PEPPAR, J. L. 1965. Some features of the life history of cockscomb prickleback, *Anoplarchus purpureus*. Unpubl. MS thesis. Univ. British Columbia, Vancouver.
- PERLMUTTER, A. 1939. An ecological survey of young fish and eggs identified from two-net collections, p. 11-71. In: A biological survey of the salt waters of Long Island. Suppl. 28th Ann. Rep., 1938, New York State Cons. Dep. Albany, No. 15, Pt. 2, Sect. 1.
- , L. BOGRAD AND J. J. PRUGININ. 1957. Use of the estuarine and sea fish of the family Mugilidae (grey mullets) for pond culture in Israel. Proc. Fish. Coun. Mediterr., FAO 4:289-304.
- PERTSEVA, T. A. 1936. Key to pelagic eggs of fishes of the Barents Sea. Pischepromizdat, Moscow.
- PERTSEVA-OSTROUMOVA, T. A. 1954. Materials on the development of far eastern flounders (Pleuronectidae). I. Development of the yellowfin sole-*Limanda aspera* Pallas. Tr. Inst. Okeanol. Acad. Nauk. SSSR 11:221-232.
- . 1961. The reproduction and development of far eastern flounders. Tr. Inst. Okeanol. Akad. Nauk. SSSR. (In Russian; transl. avail. Fish. Res. Bd. Canada, Transl. Serv. No. 856, 1967.)
- . 1964. Some morphological characteristics of myctophid larvae (Myctophidae, Pisces). In: Fishes of the Pacific and Indian Oceans, biology and distribution. T. S. Rass (ed.). Tr. Inst. Okeanol. Akad. Nauk SSSR 73:79-97. (In Russian, English transl., U.S. Dep. Commerce 65-5120.)
- . 1965. Flatfish larvae from the Gulf of Tonkin. Tr. Inst. Okeanol. Acad. Nauk. SSSR 80:177-220. (In Russian.)
- . 1967. Larval stages of some *Protomyctophum* and *Electrona* species (Pisces, Myctophidae). Tr. Inst. Okeanol. Akad. Nauk SSSR, 84:222-236. (In Russian, English transl. Bur. Commer. Fish., Southwest Fish. Ctr., La Jolla.)
- . 1971. Unusual flounder larvae (Pleuronectiformes, Pisces). J. Ichthyol. (Engl. Transl. Vopr. Ikhtiol.) 11:817-822.
- . 1972. The larvae of lanternfish (Myctophidae) collected by Australian Expeditions on H.M.A.S. Gasecoyne and H.M.A.S. Diamantina. J. Ichthyol. (Engl. Transl. Vopr. Ikhtiol.) 12:634-643.
- . 1974. New data on lanternfish larvae (Myctophidae, Pisces) with oval eyes from the Indian and Pacific Oceans. Tr. Inst. Okeanol. Akad. Nauk SSSR 96:77-142.
- . 1975. Larvae of the lanternfish, *Diaphus agassizii* (Myctophidae, Pisces). J. Ichthyol. (Engl. Transl. Vopr. Ikhtiol.) 15:606-610.
- . 1977. On the development of some species of the genus *Gymnoscopelus* (Myctophidae). J. Ichthyol. (Engl. Transl. Vopr. Ikhtiol.) 17:58-65.
- , AND T. S. RASS. 1973. Ichthyoplankton of the southeastern Pacific Ocean. Trudy Inst. Okeanol. Acad. Nauk SSSR 94:7-70.
- PETERS, K. M. 1981. Reproductive biology and developmental osteology of the Florida blenny, *Chasmodes saburrae* (Perciformes: Blenniidae). Northeast Gulf Sci. 4(2):79-98.
- PETERS, N. 1963. Embryonale Anpassungen oviparer Zahnkarpfen aus periodisch austrocknenden Gewässern. Int. Rev. Gesamten Hydrobiol. 48(2):257-313.
- PETERSEN, C. G. J. 1904. On the larval and postlarval stages of the long rough dab and the genus *Pleuronectes*. Medd. Komm. Havunders. Ser. Fiskeri 1 (1).
- . 1905. On the young stages of the genus *Zeugopterus*. Rep. Dan. Biol. Stn. 12:25-32.
- . 1906. On the larval and post-larval stages of some Pleuronectidae (*Pleuronectes*, *Zeugopterus*). Medd. Komm. Havunders. Ser. Fiskeri 2 (1).
- . 1909. On the larval and post-larval stages of some Pleuronectidae (*Zeugopterus*, *Arnoglossus*, *Solea*). Medd. Komm. Havunders., Ser. Fiskeri 3 (1):1-18.
- . 1917. On the development of our common gobies (*Gobius*) from the egg to the adult stages etc. Rep. Dan. Biol. Stn. 24:5-16.
- . 1919. Our gobies (Gobiidae). From the egg to the adult stages. Rep. Dan. Biol. Stn. 25:45-66.
- PETERSON, C. L. 1956. Observations on the taxonomy, biology, and ecology of the engraulid and elupeid fishes in the Gulf of Nicoya, Costa Rica. Bull. Inter-Am. Trop. Tuna Comm. Bull. 1:139-280.
- PHILLIPS, J. B. 1942. Osteology of the sardine (*Sardinops caerulea*). J. Morphol. 70:463-500.
- PHONLOR, G. 1978. Morfologia e biologia dos ovos de Engraulidae do Sul do Brasil (Osteichthyes, Engraulidae). Unpubl. thesis. Univ. São Paulo, Brazil.
- . 1979. Fecundação artificial e desenvolvimento dos ovos e larvas de *Parona signata* em laboratório (Osteichthyes, Carangidae). Atl. Rio Grand, 3:47-56.
- PICQUELLE, S. J., AND R. P. HEWITT. 1983. Northern anchovy spawning biomass for the 1982-83 California fishing season. Calif. Coop. Oceanic Fish. Invest. Rep. 24.
- PIETRI, R. 1983. An ultrastructural study of the chorion and its filaments in *Oryzias latipes*. Unpubl. MS thesis. Rutgers, State Univ. New Jersey, New Brunswick.
- PIETSCH, T. W. 1972. A review of the monotypic deepsea anglerfish family Tretophrynidae: taxonomy, distribution, and osteology. Copeia 1972:17-47.
- . 1974. Osteology and relationships of deep-sea anglerfishes of the family Oneirodidae with a review of the genus *Oneirodes* Lütken. Nat. Hist. Mus. Los Ang. Cty. Sci. Bull. 18:1-113.
- . 1975. Systematics and distribution of ceratioid anglerfishes of the genus *Chaenophryne* (family Oneirodidae). Bull. Mus. Comp. Zool. Harv. Univ. 147(2):75-100.
- . 1976. Dimorphism, parasitism and sex: Reproductive strategies among deepsea ceratioid anglerfishes. Copeia 1976:781-793.
- . 1978a. The feeding mechanisms of *Stylephorus chordatus* (Teleostei: Lampriformes): functional and ecological implications. Copeia 1978:255-262.
- . 1978b. Evolutionary relationships of the sea moths (Teleostei: Pegasidae) with a classification of gasterosteiform families. Copeia 1978:517-529.

- . 1979. Systematics and distribution of the ceratoid anglerfishes of the family Caulophrynidae. *Contrib. Sci.* (Los Ang.) 310.
- . 1981. The osteology and relationships of the anglerfish genus *Tetrabrachium* with comments on lophiiform classification. *U.S. Fish. Bull.* 79:387-419.
- . 1984. The genera of frogfishes (family Antennariidae). *Copeia* 1984:27-44.
- , AND D. B. GROBECKER. 1980. Parental care as an alternative reproductive mode in an antennariid anglerfish. *Copeia* 1980:551-553.
- , AND ———. In press. Frogfishes of the world: Systematics, zoogeography and behavioral ecology. Stanford University Press, Stanford, CA.
- PIVNICKA, K. 1970. Morphological variation in the burbot (*Lota lota*) and recognition of the subspecies: a review. *J. Fish. Res. Board Can.* 27:1757-1765.
- PLATT, C., AND A. N. POPPER. 1981. Fine structure and function of the ear, p. 3-36. *In: Hearing and Sound Communication in Fishes.* W. N. Tavolga, A. N. Popper and R. R. Fay (eds.). Springer-Verlag, New York.
- PODOSINNIKOV, A. Y. 1977. Early ontogeny of the "striped grunt," *Parapristipoma humile* (Pomadasyidae, Pisces). *J. Ichthyol.* (Engl. Transl. *Vopr. Ikhtiol.*) 17:683-685.
- POLL, M. 1953. Poissons. III. Téléostéens Malacopterygiens. *Result. Scient. Exped. Océanogr. Belge Eaux Cot. Afr. Atlant. Sud.* 4(2).
- . 1964. Une famille dulcicole nouvelle de poissons Africains: les Congothrissidae. *Acad. R. Sci. Outre-Mer. Mem. N. S.* 15:1-40.
- PONOMAREVA, L. A. 1949. Eggs and fry of fishes of the Kara Sea. *Tr. Uses. Nauchno-Issled. Inst. Morsk. Rybn. Khoz. Okeanogr.* 17: 189-205.
- POPPER, A. N., AND S. COOMBS. 1980a. Acoustic detection by fish, p. 403-430. *In: Environmental Physiology of Fish.* M. A. Ali (ed.). Plenum Publ. Corp., New York.
- , AND S. COOMBS. 1980b. Auditory mechanisms in teleost fishes. *Am. Sci.* 68:429-440.
- POPPER, D., H. GORDON AND G. W. KISSIL. 1973. Fertilization and hatching of rabbitfish *Siganus rivulatus*. *Aquaculture* 2:37-44.
- POSS, S. G. 1975. Infraorbital bones in cottid and hexagrammid fishes. Unpubl. MA thesis. San Francisco State Univ., San Francisco, CA.
- . 1982. Taxonomy and systematics of the velvetfishes (Pisces: Aploactinidae). Unpubl. PhD dissertation. Univ. Michigan. Ann Arbor.
- , AND W. N. ESCHMEYER. 1975. The Indo-West Pacific scorpionfish genus *Ocosia* Jordan and Starks (Scorpaenidae, Tetraroginae), with descriptions of three new species. *Matsya* 1:1-18.
- , AND ———. 1978. Two new Australian velvetfishes, genus *Paraploactis* (Scorpaeniformes: Aploactinidae), with a revision of the genus and comments on the genera and species of the Aploactinidae. *Proc. Calif. Acad. Sci.* 41:401-426.
- POST, A. 1976. Ergebnisse der Forschungreisen des FFS "Walther Herwig" nach Südamerika. XLII. *Diretmus* Johnson, 1863 (Beryciiformes, Berycoidei, Diretmidae). 2. Morphologie, Entwicklung, Verbreitung. *Arch. Fischereiwiss.* 26(2/3):87-114.
- , AND J. QUERO. 1981. Révision des Diretmidae (Pisces, Trachichthyoidei) de l'Atlantique avec description d'un nouveau genre et d'une nouvelle espèce. *Cybiurn*, 3rd Ser. 5(1):33-60.
- POSTUMA, K. H. 1974. The nucleus of the herring otolith as a racial character. *J. Cons. Int. Explor. Mer* 35:121-129.
- POTTHOFF, T. 1974. Osteological development and variation in young tunas, genus *Thunnus* (Pisces, Scombridae) from the Atlantic Ocean. *Fish. Bull. U.S.* 72:563-588.
- . 1975. Development and structure of the caudal complex, the vertebral column, and the pterygiophores in the blackfin tuna *Thunnus atlanticus* (Pisces, Scombridae). *Bull. Mar. Sci.* 25:205-231.
- . 1980. Development and structure of fins and fin supports in dolphin fishes *Coryphaena hippurus* and *Coryphaena equisetus* (Coryphaenidae). *Fish. Bull. U.S.* 78:277-312.
- , AND S. KELLEY. 1982. Development of the vertebral column, fins and fin supports, branchiostegal rays, and squamation in the swordfish, *Xiphias gladius*. *Fish. Bull. U.S.* 80:161-186.
- , AND J. JAVECH. MS. Comparisons of the development of the vertebral column, fins and fin supports in scombroid fishes.
- , M. MOE AND F. YOUNG. 1984. Description of porkfish larvae (*Anisotremus virginicus*, Haemulidae) and their osteological development. *Bull. Mar. Sci.* 34:21-59.
- , W. J. RICHARDS AND S. UFYANAGI. 1980. Development of *Scombrobrachx heterolepis* (Pisces, Scombrobrachidae) and comments on familial relationships. *Bull. Mar. Sci.* 30:329-357.
- POWLES, H. 1977. Description of larval *Jenkinsia lamprotaenia* (Clupeidae, Dussumieriinae) and their distribution off Barbados, West Indies. *Bull. Mar. Sci.* 27:788-801.
- . 1980. Descriptions of larval silver perch, *Bairdiella chrysoura*, banded drum, *Larimus fasciatus*, and star drum, *Stellifer lanceolatus* (Sciaenidae). *Fish. Bull. U.S.* 78:119-136.
- , AND B. W. STENDER. 1978. Taxonomic data on the early life history stages of Sciaenidae of the South Atlantic Bight of the United States. *S. C. Mar. Resour. Cent. Tech. Rep.* 31.
- PREMALATHA, P. 1977. A study of the development and distribution of the larvae of leather skin *Chorinemus sanctipetri* (Cuv. & Val.) (Carangidae-Pisces) along the southwest coast of India. *Proc. Symp. warm water zooplankton Spec. Publ. UNESCO/NIO:450-459.*
- PRESLEY, R. F. 1970. Larval snowy grouper, *Epinephelus niveatus* (Valenciennes, 1828), from the Florida straits. *Fla. Dep. Nat. Resour. Mar. Res. Lab. Leaflet. Ser.* 4(18).
- PROKES, M., AND M. PENAZ. 1980. Early development of the chub, *Leuciscus cephalus*. *Acta Sci. Nat. Acad. Sci. Bohemoslov Brno* 14(7):1-40.
- QASIM, S. Z. 1956. The spawning habits and embryonic development of the shanny (*Blennius pholis* L.). *Proc. Zool. Soc. Lond.* 127:79-93.
- QUAST, J. C. 1965. Osteological characteristics and affinities of the hexagrammid fishes, with a synopsis. *Proc. Calif. Acad. Sci.* 31: 563-600.
- QUERO, J. 1978. Répartition des Zeides (Pisces, Zeiformes) captures dans l'Atlantique oriental entre le Cap Vert (15°N) et le Cap Juby (28°N) au cours des campagnes de la "Thalassa." *Bull. Off. Natl. Pech. Tunis.* 1978. 2(1-2):49-61.
- . 1979. Remarques sur le *Grammicolepis brachusculus* (Pisces, Zeiformes, Grammicolepididae) observé au port de la Rochelle. *Ann. Soc. Sci. Nat. Charente-Marit.* 6:573-576.
- QUINN, R. A., AND C. C. SIGL (eds.). 1980. Radiography in modern industry. Eastman Kodak Co., Rochester, NY.
- RABALAIS, N. N., S. C. RABALAIS AND C. R. ARNOLD. 1980. Description of eggs and larvae of laboratory-reared red snapper (*Lutjanus campechanus*). *Copeia* 1980:704-708.
- RACHOW, A. 1924. Über *Cyprinodon iberus* Valenciennes und *Fundulus hispanicus* (Valenciennes). *Blatt Aquar.-Terrarienk.* 22(21): 369-371.
- RADTKE, R. L. 1984. Otolith formation and increment deposition in laboratory reared skipjack tuna, *Katsuwonus pelamis* larvae. NOAA Tech. Rep. In Press.
- , AND J. M. DEAN. 1982. Increment formation in the otoliths of embryos, larvae and juveniles of the mummichog, *Fundulus heterochtus*. *Fish. Bull. U.S.* 80:201-216.
- , AND K. G. WAIWOOD. 1980. Otolith formation and body shrinkage due to fixation in larval cod (*Gadus morhua*). *Can. Tech. Rep. Fish. Aquat. Sci.* 929.
- RAFFAELE, F. 1888. Le uova galleggianti e le larve dei Teleostei nel golfo di Napoli. *Mitt. Zool. Sta. Neapel* 8.
- RAJAGOPAL, P. K. 1979. The embryonic development and the thermal effects on the development of the mountain whitefish, *Prosopium williamsoni* (Girard). *J. Fish Biol.* 15:153-158.
- RAJU, S. N. 1974. Three new species of the genus *Monognathus* and the leptocephali of the order Saccopharyngiformes. *Fish Bull. U.S.* 72:547-562.

- RANDALL, J. E. 1955a. An analysis of the genera of surgeon fishes (family Acanthuridae). *Pac. Sci.* 9:359-367.
- . 1955b. A revision of the surgeonfish genera *Zebrosoma* and *Paracanthurus*. *Pac. Sci.* 9:396-412.
- . 1955c. A revision of the surgeonfish genus *Ctenochaetus*, family Acanthuridae, with descriptions of five new species. *Zoologica (N.Y.)* 40:149-166.
- . 1956. A revision of the surgeon fish genus *Acanthurus*. *Pac. Sci.* 10:159-235.
- . 1961. A contribution to the biology of the convict surgeonfish of the Hawaiian Islands, *Acanthurus triostegus sandvicensis*. *Pac. Sci.* 15:215-272.
- . 1980. Revision of the fish genus *Plectranthias* (Serranidae: Anthiinae) with descriptions of 13 new species. *Micronesica* 16: 101-187.
- . 1981. Underwater guide to Hawaiian reef fishes. Harwood Books, Newton Square, PA.
- , AND R. LUBBOCK. 1981. A revision of the serranid fishes of the subgenus *Mirolabrichthys* (Anthiinae: Anthias), with descriptions of five new species. *Contrib. Sci. (Los Ang.)* 333.
- , AND J. E. MCCOSKER. 1975. The eels of Easter Island with a description of a new moray. *Contrib. Sci. (Los Ang.)* 264.
- , AND H. RANDALL. 1963. The spawning and early development of the Atlantic parrot fish, *Sparisoma rubripinne*, with notes on other scarid and labrid fishes. *Zoologica (N.Y.)* 48(2):49-60.
- , T. SHIMIZU AND T. YAMAKAWA. 1982. A revision of the Holocentrid fish genus *Ostichthys*, with descriptions of four new species and a related new genus. *Jpn. J. Ichthyol.* 29:1-26.
- RANZI, S. 1933. Famiglia 3: Sparidae, p. 332-382. In: Uova, larve e stadi giovanili di Teleostei. *Fauna Flora Golfo Napoli Monogr.* 38.
- RAO, K. S. 1973. Eggs and early developmental stages of *Hilsa keele* (Cuvier). *Indian J. Fish.* 20:250-255.
- RAO, R. T. 1977. Enhancement of natural populations of moi (*Polydactylus sextilis*) in Hawaii through the release of hatchery-reared juveniles—a feasibility study of sea ranching. *Hawaii Inst. Mar. Biol. Tech. Rep.* 33.
- RAO, V. V. 1970. Breeding habits and early development of two blennioid fishes *Omobranchus japonicus* (Bleeker) and *Cruantus smithi* (Visweswara Rao) from Godavari Estuary. *J. Mar. Biol. Assoc. India* 12(1&2):175-182.
- RAPSON, A. M. 1940. The reproduction, growth, and distribution of the lemon soles (*Pelotretis flavilatus* Waite) of Tasman Bay and Marlborough Sounds. *N.Z. Mar. Dep. Fish. Bull.* 7:1-56.
- RASQUIN, P. 1958. Ovarian morphology and early embryology of the pediculate fishes *Antennarius* and *Histrio*. *Bull. Am. Mus. Nat. Hist.* 114:327-372.
- RASS, T. S. 1949. Composition of the ichthyoplankton of the Barents Sea. In: T. S. Rass, I. I. Kazanova, S. P. Alekseyeva and L. A. Ponomareva (eds.). Material on the reproduction and development of fishes of the Northern Seas. *Tr. Vses. Nauchno-Issled. Inst. Morsk. Rybn. Khoz. Okeanogr.* 17:1-68.
- . 1950. An unusual instance of a biological relation between fish and crabs. *Prioroda* 39(7):68-69.
- . 1954. Contribution to the study of Pacific Ocean Moridae (Pisces, Gadiformes). *Tr. Inst. Okeanol. Akad. Nauk. SSSR* 11:56-61.
- . 1960. On the geographical distribution of bathypelagic fishes of the family Myctophidae in the Pacific Ocean. *Tr. Inst. Okeanol. Akad. Nauk SSSR* 41:146-152. (In Russian.)
- . 1968. Spawning and development of polar cod. *Rapp. P. V. Reun. Cons. Perm. Int. Explor. Mer* 158:135-137.
- . 1972. Ichthyoplankton and the deep-sea fishes of the world ocean. *Trans. P. P. Shirshov. Inst. Oceanol. Acad. Sci. USSR* 93: 34-35. (In Russian.)
- . 1973. Systematics of pelagic fish eggs and larvae (Ichthyoplankton). Unpubl. manuscript. FAO, Rome.
- RATHBUN, R. 1893. Report upon the inquiry respecting food fishes and the fishing grounds. *Rep. U.S. Comm. Fish.* 17:97-171.
- RAY, D. 1950. The peripheral nervous system of *Lampanyctus leucopsarus*. *J. Morphol.* 87:61-178.
- RÉ, P. 1980. The eggs and newly hatched larvae of *Abudefduf luridus* (Cuvier, 1830) (Pisces: Pomacentridae) from the Azores. *Arq. Mus. Bocage, 2nd Ser.* 7(8):109-116.
- REAY, P. J. 1970. Synopsis of biological data on North Atlantic sand-eels of the genus *Ammodytes*, *A. tobianus*, *A. dubius*, *A. americanus*, and *A. marinus*. *FAO Fish. Synop.* 82, Rome.
- REGAN, C. T. 1902. On the systematic position of *Luvarus imperialis* Rafinesque. *Ann. Mag. Nat. Hist., Ser. 7*, 10:278-281.
- . 1903a. Descriptions de poissons nouveaux faisant partie de la collection du Musée d'histoire naturelle de Genève. *Rev. Suisse Zool.* 11:413-418.
- . 1903b. LXII.—On the systematic position and classification of the gadoid or anacanthine fishes. *Ann. Mag. Nat. Hist., Ser. 7*, 11:459-466.
- . 1907. On the anatomy, classification and systematic position of the teleostean fishes of the suborder Allotriognathi. *Proc. Zool. Soc. Lond.* 1907:634-643.
- . 1909. On the anatomy and classification of the scombroid fishes. *Ann. Mag. Nat. Hist., Ser. 8*, 3:66-75.
- . 1910. The origin and evolution of the teleostean fishes of the order Heterosomata. *Ann. Mag. Nat. Hist., Ser. 8*, 6:484-496.
- . 1911a. The anatomy and classification of the teleostean fishes of the order Inioi. *Ann. Mag. Nat. Hist., Ser. 8*, 7:120-133.
- . 1911b. The classification of the teleostean fishes of the order Syntentognathi. *Ann. Mag. Nat. Hist., Ser. 8*, 7:327-335.
- . 1911c. The osteology and classification of the gobioid fishes. *Ann. Mag. Nat. Hist., Ser. 8*, 8:729-733.
- . 1912a. The classification of the teleostean fishes of the order Pediculati. *Ann. Mag. Nat. Hist., Ser. 8*, 9:277-289.
- . 1912b. The classification of the blennioid fishes. *Ann. Mag. Nat. Hist., Ser. 8*, 10:265-280.
- . 1912c. The osteology and classification of the teleostean fishes of the order Apodes. *Ann. Mag. Nat. Hist., Ser. 8*, 10:377-387.
- . 1913a. Osteology and classification of the teleostean fishes of the order Scleroparei. *Ann. Mag. Nat. Hist., Ser. 8*, 11:169-184.
- . 1913b. On the classification of the percoid fishes. *Ann. Mag. Nat. Hist., Ser. 8*, 12:111-145.
- . 1913c. *Phallostethus dunckeri*, a remarkable new cyprinodont fish from Johore. *Ann. Mag. Nat. Hist., Ser. 8*, 12:548-555.
- . 1913d. The Antarctic fishes of the Scottish National Antarctic Expedition. *Trans. R. Soc. Edinb.* 49(2):229-292.
- . 1916. Larval and post-larval fishes. *Nat. Hist. Rep. Br. Ant. arct. Terra Nova Exped. Zool.* 1:125-156.
- . 1923. The classification of the stomioid fishes. *Ann. Mag. Nat. Hist., Ser. 9*, 11:612-614.
- . 1924. The morphology of a rare oceanic fish, *Stylophorus chordatus* Shaw; based on specimens collected in the Atlantic by the "Dana" expeditions, 1920-1922. *Proc. R. Soc. Lond.* 96:193-207.
- . 1925. III. The fishes of the genus *Gigantura*, A. Brauer; based on the specimens collected in the Atlantic by the "Dana" Expeditions, 1920-22. *Ann. Mag. Nat. Hist.* 15(9):53-59.
- . 1926. The pediculate fishes of the suborder Ceratioidea. *Oceanogr. Rep. Dana Exped.* 2.
- . 1929. Fishes. *Encyclopaedia Britannica*, 14th ed. 9:305-328.
- , AND E. TREWAVAS. 1929. The fishes of the families Astronesthidae and Chauliodontidae. *Dana-Rep. Carlsberg Found.* 5.
- , AND ———. 1930. The fishes of the families Stomiidae and Malacosteidae. *Dana-Rep. Carlsberg Found.* 6.
- , AND ———. 1932. Deep-sea angler-fishes (Ceratioidea). *Dana-Rep. Carlsberg Found.* 2.
- RENZHAI, Z., AND L. SUIFEN. 1980a. Studies on the eggs and larvae development of wise porgy, *Gymnocranius griseus* (Temminck et Schlegel). *Acta Zool. Sin.* 26(2):132-135. (In Chinese, English abstract.)
- , AND ———. 1980b. On the eggs and larvae of the golden-

- thread *Nemipterus virgatus* (Houttuyn). Acta Zool. 26(2):136-139. In Chinese, English abstract.)
- RESHETNIKOV, YU. S. 1975. The systematic position of whitefishes. Zool. Zh. 54:1651-1671. (In Russian.)
- RICHARDS, S. W. 1965. Description of the postlarvae of the sand lance (*Ammodytes*) from the east coast of North America. J. Fish. Res. Board Can. 22:1313-1317.
- . 1982. Aspects of the biology of *Ammodytes americanus* from the St. Lawrence River to Chesapeake Bay, 1972-75, including a comparison of the Long Island Sound postlarvae with *Ammodytes dubius*. J. Northwest Atl. Fish. Sci. 3:93-104.
- RICHARDS, W. J. 1969. Elopoid leptocephali from Angolan waters. Copeia 1969:515-518.
- . 1974. Evaluation of identification methods for young billfishes, p. 62-72. In: Proc. Internatl. Billfish Symp., Kailua-Kona, Hawaii, 9-12 August 1972, Part 2. Review and contributed papers. R. S. Shomura and F. Williams (eds.).
- . 1981. Kinds and abundances of fish larvae in the Caribbean Sea. Rapp. P. V. Reun. Cons. Int. Explor. Mer 178:240-241.
- . 1984. Kinds and abundances of fish larvae in the Caribbean Sea and adjacent areas. NOAA Tech. Rep. NMFS SSRF-776.
- , AND G. R. DOVE. 1971. Internal development of young tunas of the genera *Katsuwonus*, *Euthynnus*, *Auxis*, and *Thunnus* (Pisces, Scombridae). Copeia 1971:72-78.
- , AND W. L. KLAWE. 1972. Indexed bibliography of the eggs and young of tunas and other scombrids (Pisces, Scombridae) 1880-1970. NOAA Tech. Rep. NMFS SSRF-652.
- , R. V. MILLER AND E. D. HOUDE. 1974. Eggs and larval development of the Atlantic thread herring, *Opisthonema oglinum*. Fish. Bull. U.S. 72:1123-1136.
- , AND T. POTTHOFF. 1974. Analysis of the taxonomic characters of young scombrid fishes, genus *Thunnus*, p. 623-648. In: The early life history of fish. J. H. S. Blaxter (ed.). Springer-Verlag, Berlin.
- , AND V. P. SAKSENA. 1980. Description of larvae and early juveniles of laboratory-reared gray snapper, *Lutjanus griseus* (Linnaeus) (Pisces, Lutjanidae). Bull. Mar. Sci. 30:515-521.
- RICHARDSON, S. L. 1981a. Current knowledge of larvae of sculpins (Pisces: Cottidae and allies) in northeast Pacific genera with notes on intergeneric relationships. Fish. Bull. U.S. 79:103-121.
- . 1981b. Pelagic eggs and larvae of the deepsea sole, *Embassichthys bathybius* (Pisces: Pleuronectidae), with comments on generic affinities. Fish. Bull. U.S. 79:163-170.
- . 1981c. Current knowledge of northeast Pacific sculpin larvae (Pisces: Cottidae and allies) with notes on relationships within the group. Rapp. P. V. Reun. Cons. Int. Explor. Mer 178:603-604.
- , AND D. A. DEHART. 1975. Records of larval, transforming, and adult specimens of the quillfish, *Ptilichthys goodei* from waters off Oregon. Fish. Bull. U.S. 73:681-684.
- , J. R. DUNN AND N. A. NAPLIN. 1980. Eggs and larvae of butter sole, *Isopsetta isolepis* (Pleuronectidae), off Oregon and Washington. Fish. Bull. U.S. 78:401-417.
- , AND E. B. JOSEPH. 1973. Larvae and young of western North Atlantic bothid flatfishes *Etropus microstomus* and *Citharichthys arctifrons* in the Chesapeake Bight. Fish. Bull. U.S. 71:735-767.
- , AND W. A. LAROCHE. 1979. Development and occurrence of larvae and juveniles of the rockfishes, *Sebastes cramerii*, *Sebastes pinniger* and *Sebastes helvomaculatus* (Family Scorpaenidae) off Oregon. Fish. Bull. U.S. 77:1-41.
- , AND W. G. PEARCY. 1977. Coastal and oceanic fish larvae in an area of upwelling off Yaquina Bay, Oregon. Fish. Bull. U.S. 75:125-145.
- , AND B. B. WASHINGTON. 1980. Guide to identification of some sculpin (Cottidae) larvae from marine and brackish waters off Oregon and adjacent areas in the northeast Pacific. NOAA Tech. Rep. NMFS Circ. 430.
- RIEHL, R. 1980. Micropyle of some salmonids and coregonids. Environ. Biol. Fishes 5:59-66.
- RILEY, J. D. 1966. Marine fish culture in Britain. VII. Plaice (*Pleuronectes platessa* L.) post-larval feeding on *Artemia salina* L. nauplii and the effects of varying feeding levels. J. Cons. Int. Explor. Mer 30:204-221.
- RITTER, W. E., AND S. E. BAILEY. 1908. On the weight of developing eggs. Univ. Calif. Publ. Zool. 6:1-10.
- RIVAS, L. R. 1972. *Opisthonema captiva*, a new western Atlantic clupeid fish from Columbia. Copeia 1972:1-3.
- , AND S. M. WARLEN. 1967. Systematics and biology of the bonefish, *Albula nemoptera* (Fowler). U.S. Fish Wildl. Serv. Fish. Bull. 66(2):251-258.
- ROBERTS, R. J., M. BELL AND H. YOUNG. 1973. Studies on the skin of plaice (*Pleuronectes platessa* L.). II. The development of larval plaice skin. J. Fish Biol. 5:103-108.
- ROBERTS, T. R. 1970. Description, osteology and relationships of the Amazonion cyprinodont fish *Fluviphylax pygmaeus* (Myers and Carvalho). Breviora 347:1-28.
- . 1971. The fishes of the Malaysian family Phallostethidae (Atheriniformes). Breviora 374:1-27.
- . 1981. Sundasalangidae, a new family of minute freshwater salmoniform fishes from southeast Asia. Proc. Calif. Acad. Sci. 42:295-302.
- . 1982a. The southeast Asian freshwater pufferfish genus *Chonerhinus* (Tetraodontidae), with descriptions of new species. Proc. Calif. Acad. Sci. 43:1-16.
- . 1982b. Unculi (horny projections arising from single cells), an adaptive feature of the epidermis of ostariophysan fishes. Zool. Scr. 11(1):55-76.
- ROBERTSON, D. A. 1973. Planktonic eggs and larvae of some New Zealand marine teleosts. Unpubl. PhD thesis. Univ. Otago, Dunedin, N.Z.
- . 1974. Developmental energetics of the southern pigfish (Teleostei: Congiopoidea). N.Z. J. Mar. Freshwater Res. 8:611-620.
- . 1975a. A key to the planktonic eggs of some New Zealand marine teleosts. N.Z. Fish. Res. Div. Occas. Publ. No. 9.
- . 1975b. Planktonic stages of the teleost family Carapidae in eastern New Zealand waters. N.Z. J. Mar. Freshwater Res. 9:403-409.
- . 1976. Planktonic stages of *Maurollicus muelleri* (Teleostei: Sternoptychidae) in New Zealand waters. N.Z. J. Mar. Freshwater Res. 10:311-328.
- . 1977. Planktonic eggs of the lanternfish *Lampanyctodes hectortis* (family Myctophidae). Deep-Sea Res. 24:1-4.
- . 1978. Spawning of the tarakihi (Pisces: Cheilodactylidae) in New Zealand waters. N.Z. J. Mar. Freshwater Res. 12:277-286.
- . 1981. Possible functions of surface structure and size in some planktonic eggs of marine fishes. N.Z. J. Mar. Freshwater Res. 15:147-153.
- , AND S. MITO. 1979. Sea surface ichthyoplankton off southeastern New Zealand, summer 1977-78. N.Z. J. Mar. Freshwater Res. 13:415-424.
- , AND U. RAJ. 1971. Egg and yolk sac stages of the sand flounder (Teleostei: Pleuronectidae). N.Z. J. Mar. Freshwater Res. 5:404-414.
- , P. E. ROBERTS AND J. B. WILSON. 1978. Mesopelagic faunal transition across the Subtropical Convergence east of New Zealand. N.Z. J. Mar. Freshwater Res. 12:295-312.
- ROBERTSON, D. R. 1973. Field observations on the reproductive behaviour of a pomacentrid fish, *Acanthochromis polyacanthus*. Z. Tierpsychol. 32:319-324.
- ROBINS, C. H., AND C. R. ROBINS. 1976. New genera and species of dysommidae and synphobranchine eels (Synphobranchidae) with an analysis of the Dysommidae. Proc. Acad. Nat. Sci. Phila. 127:249-280.
- ROBINS, C. R. 1958. Studies on fishes of the family Ophidiidae. I. A new species of *Lepophidium* from the Caribbean Sea. Bull. Mar. Sci. Gulf Caribb. 8:360-368.

- . 1959. Studies on fishes of the family Ophidiidae. III. A new species of *Lepophidium* from Barbados. *Breviora* 104.
- . 1960. Studies on fishes of the family Ophidiidae. V. *Lepophidium pheromystax*, a new Atlantic species allied to *Lepophidium jeannae* Fowler. *Bull. Mar. Sci. Gulf Caribb.* 10:83–95.
- . 1961. Studies on fishes of the family Ophidiidae. VI. Two new genera and a new species from American waters. *Copeia* 1961: 212–221.
- . 1962. Studies on fishes of the family Ophidiidae. VII. The Pacific species of *Lepophidium*. *Copeia* 1962:487–498.
- . 1967. The status of the serranid fish *Liopropoma aberrans* with the description of a new, apparently related genus. *Copeia* 1967:591–595.
- . 1974. The validity and status of the roundscale spearfish, *Tetrapturus georgei*, p. 54–61. *In: Proc. Int. Billfish Symposium Kailua-Kona, Hawaii, 9–12 August 1972. Part 2. Review and Contributed Papers.* R. S. Shomura and F. Williams (eds.). NOAA Tech. Rep. NMFS SSRF-675.
- , R. M. BAILEY, C. E. BOND, J. R. BROOKER, E. A. LACHNER, R. N. LEA AND W. B. SCOTT. 1980. A list of common and scientific names of fishes from the United States and Canada (Fourth Edition). *Am. Fish. Soc. Spec. Publ.* 12.
- , AND J. E. BÖHLKE. 1959. Studies on fishes of the family Ophidiidae. IV. Two new dwarf cusk-eels (genus *Ophidion*) from the tropical western Atlantic. *Not. Nat. (Phila.)* 325.
- , AND ———. 1970. The first Atlantic species of the ammodytid fish genus *Embolichthys*. *Not. Nat. (Phila.)* 430:1–11.
- , AND D. P. DE SYLVA. 1960. Description and relationships of the longbill spearfish, *Tetrapterus belone*, based on western North Atlantic specimens. *Bull. Mar. Sci. Gulf and Caribb.* 10:383–413.
- , AND ———. 1965. The Kasidoridae, a new family of mirapinniform fishes from the western Atlantic Ocean. *Bull. Mar. Sci.* 15:189–201.
- , AND R. N. LEA. 1978. Fishes of the family Ophidiidae. IX. Analysis of geographic variation in *Lepophidium microlepis* with descriptions of two new subspecies. *Bull. Mar. Sci.* 28:716–727.
- , AND J. G. NIELSEN. 1970. *Snyderidia bothrops*, a new tropical, ampho-Atlantic species (Pisces: Carapidae). *Stud. Trop. Oceanogr. (Miami)* 4(2):285–293.
- , AND J. E. RANDALL. 1965. Three new western Atlantic fishes of the blennioid genus *Chaenopsis*, with notes on the related *Lucayablennius zingaro*. *Proc. Acad. Nat. Sci. Phila.* 117:213–277.
- ROFEN, R. R. 1958. The marine fishes of Rennell Island, p. 149–218. *In: The natural history of Rennell Island British Solomon Islands.* Vol. 1. Danish Science Press, Ltd., Copenhagen.
- . 1966a. Family Paralepididae, p. 205–461. *In: Fishes of the western North Atlantic.* G. W. Mead (ed.). Mem. Sears Found. Mar. Res. No. 1 (Pt. 5).
- . 1966b. Family Omosudidae, p. 462–481. *In: Fishes of the western North Atlantic.* G. W. Mead (ed.). Mem. Sears Found. Mar. Res. No. 1 (Pt. 5).
- . 1966c. Family Anoptentidae, p. 498–410. *In: Fishes of the western North Atlantic.* G. W. Mead (ed.). Mem. Sears Found. Mar. Res. No. 1 (Pt. 5).
- . 1966d. Family Evermannellidae, p. 511–565. *In: Fishes of the western North Atlantic.* G. W. Mead (ed.). Mem. Sears Found. Mar. Res. No. 1 (Pt. 5).
- ROHDE, F. C. 1980. *Dallia pectoralis*, p. 127. *In: Atlas of North American freshwater fishes.* D. S. Lee, C. R. Gilbert, C. H. Hocutt, R. E. Jenkins, D. E. McAllister and J. R. Stauffer, Jr. (eds.). North Carolina State Mus. Nat. Hist., Raleigh, NC.
- ROSE, J. A. 1961. Anatomy and sexual dimorphism of the swim bladder and vertebral column in *Ophidion holbrookii* (Pisces: Ophidiidae). *Bull. Mar. Sci. Gulf Caribb.* 11:280–308.
- ROSEN, D. E. 1964. The relationships and taxonomic position of the halfbeaks, killifishes, silversides, and their relatives. *Bull. Am. Mus. Nat. Hist.* 127:217–268.
- . 1971. The Macristidae, a ctenothrissiform family based on juvenile and larval scopelomorph fishes. *Am. Mus. Nov.* 2452.
- . 1973. Interrelationships of higher euteleostean fishes, p. 397–513. *In: Interrelationships of fishes.* P. H. Greenwood, R. S. Miles, and C. Patterson (eds.). *Zool. J. Linn. Soc.* 53 (Suppl. 1).
- . 1974. Phylogeny and zoogeography of salmoniform fishes and relationships of *Lepidogalaxias salamandroides*. *Bull. Am. Mus. Nat. Hist.* 153:267–325.
- . 1978. Vicariant patterns and historical explanation in biogeography. *Syst. Zool.* 27:159–188.
- . 1982. Teleostean interrelationships, morphological function and evolutionary inference. *Am. Zool.* 22:261–273.
- . 1983. Zeoids are tetraodontiforms, acanthurids are not. *ASIH Program & Abstracts*, 1983.
- . 1984. Zeiforms as primitive plectognath fishes. *Am. Mus. Novit.* 2782.
- , AND P. H. GREENWOOD. 1970. Origin of the Weberian apparatus and the relationships of the ostariophysan and gonorynchiform fishes. *Am. Mus. Novit.* 2428.
- , AND L. R. PARENTI. 1981. Relationships of *Oryzias*, and the groups of atherinomorph fishes. *Am. Mus. Novit.* 2719.
- , AND C. PATTERSON. 1969. The structure and relationships of the paracanthopterygian fishes. *Bull. Am. Mus. Nat. Hist.* 141:357–474.
- ROSENBLATT, R. H. 1959. A revisionary study of the blennioid fish family Tripterygiidae. Unpubl. PhD dissertation. Univ. Calif., Los Angeles.
- . 1960. The Atlantic species of the blennioid fish genus *Eneanectes*. *Proc. Acad. Nat. Sci. Phila.* 112(1):1–23.
- , AND M. A. BELL. 1976. Osteology and relationships of the roosterfish, *Nematistius pectoralis* Gill. *Contrib. Sci. (Los Ang.)* 279:1–23.
- , AND J. L. BUTLER. 1977. The ribbonfish genus *Desmodema*, with the description of a new species (Pisces, Trachipteridae). *Fish. Bull. U.S.* 75:843–855.
- , AND G. D. JOHNSON. 1976. Anatomical considerations of pectoral swimming in the opah, *Lampris guttatus*. *Copeia* 1976:367–370.
- , AND T. D. PARR. 1969. The Pacific species of the clinid fish genus *Parachnus*. *Copeia* 1969:1–20.
- , AND J. S. STEPHENS. 1978. *Mccoskerichthys sandae*, a new and unusual chaenopsid blenny from the Pacific coast of Panama and Costa Rica. *Contrib. Sci. (Los Ang.)* 293:1–21.
- , AND L. R. TAYLOR, JR. 1971. The Pacific species of the clinid fish tribe Starksiini. *Pac. Sci.* 25:436–463.
- ROSENTHAL, H. 1969. Verdauungsgeschwindigkeit, Nahrungswahl und Nahrungsbedarf bei den Larven des Herings, *Clupea harengus* L. *Ber. Dtsch. Wiss. Komm. Meeresforsch.* 20:60–69.
- , AND G. HEMPEL. 1970. Experimental studies in feeding and food requirements of herring larvae (*Clupea harengus* L.), p. 344–364. *In: Marine food chains.* J. H. Steele (ed.). Univ. Calif. Press, Berkeley.
- ROSTAND, J. 1964. Biological and geological sciences. Chapt. 1. General biology. *In: The beginnings of modern science.* Basic Books, New York.
- ROULE, L. 1922. Description de *Scombrolabrax heterolepis* nov. gen. nov. sp., poisson abyssal nouveau de l'île Madère. *Bull. Inst. Oceanogr. (Monaco)* 408.
- . 1924. Étude sur l'ontogénèse et al croissance avec hypermetamorphose de *Luvarus imperialis* Raf. (poisson rapporté à l'ordre des Scombriformes). *Ann. Inst. Oceanogr. Monaco (n.s.)* 1:119–157.
- , AND F. ANGEL. 1930. Larves et alevins de poissons provenant des croisières du Prince Albert I de Monaco. *Result. Camp. Sci. Prince Albert I*, 79:1–148.
- ROXAS, H. A. 1934. A review of Philippine Mugilidae. *Philipp. J. Sci.* 54(3):393–429.
- RUCK, J. G. 1971. Development of the lumpfish, *Trachelochismus melobesia* (Pisces: Gobiesocidae). *Zool. Publ. Victoria Univ. Wellington* 57:1–9.
- . 1973a. Development of *Tripterygion capito* and *T. robustum*

- (Pisces: Tripterygiidae). Zool. Publ. Victoria Univ. Wellington 63: 1-10.
- . 1973b. Development of the clingfishes, *Diplocrepis puniceus* and *Trachelochismus pinnulatus* (Pisces: Gobiesocidae). Zool. Publ. Victoria Univ. Wellington 64:1-12.
- . 1976. Studies on the development and osteology of some New Zealand inshore fishes. Unpubl. PhD dissertation, Victoria Univ. Wellington, New Zealand.
- . 1980. Early development of *Forsterygion varium*, *Gilloblennius decemdigitatus*, and *G. tripennis* (Pisces: Tripterygiidae). N. Z. J. Mar. Freshwater Res. 14:313-326.
- RUDDLELL, C. L. In press. Initiating polymerization of glycol methacrylate with cyclic diketo carbon acids. Stain Technol.
- RUDOMETKINA, G. P. 1980. Larvae of lizardfish (family Synodontidae) from the eastern tropical Atlantic. J. Ichthyol. (Engl. Transl. Vopr. Ikhtiol.) 20(3):147-152.
- . 1981. Postembryonic development of *Diplophos taenia* Gunther, 1873 (Gonostomatidae) from the Atlantic Ocean. J. Ichthyol. (Engl. Transl. Vopr. Ikhtiol.) 21(4):106-113.
- RUNYAN, S. 1961. Early development of clingfish, *Gobiesox strumosus* Cope. Chesapeake Sci. 2:113-141.
- RUPLE, D. MS. Larvae of some gobioid fishes from the Western North Atlantic.
- RUSSELL, B. C. 1980. Revision of the fish genus *Pseudolabrus* and allied genera (family Labridae) with a phylogenetic analysis of relationships. Unpubl. PhD dissertation, Macquarie Univ., Sydney.
- RUSSELL, F. S. 1976. The eggs and planktonic stages of British marine fishes. Academic Press, London.
- RUSO, J. L. 1983. Interrelationships of the gempylid fishes (Teleostei, Scombroidei). Unpubl. PhD dissertation, George Washington Univ., Washington, D.C.
- RUTENBERG, E. P. 1962. Obzor ryb semeistva terpugovykh (Hexagrammidae) (Survey of the fishes of family Hexagrammidae). Tr. Inst. Okeanol. Akad. Nauk SSSR 59:3-100. (Transl. Isr. Prog. Sci. Transl., 1970, p. 1-103. In: Greenlings: Taxonomy, biology, interoceanic transplantation. T. S. Rass (ed.). Avail.: NTIS, Springfield, VA: TT69-55097.)
- RYDER, J. A. 1883. Observations on the absorption of the yolk, the food, feeding, and development of embryo fishes, comprising some investigations conducted at the central hatchery, Armory Building, Washington D.C. in 1882. Bull. U.S. Fish. Comm. 2(1882):179-205.
- . 1884. A contribution to the embryography of osseous fishes, with special reference to the cod (*Gadus morhua*). Rep. U.S. Comm. Fish. 10(1882):455-605.
- . 1885. On the development of viviparous osseous fishes and of the Atlantic salmon. Proc. U.S. Natl. Mus. 8:128-162.
- . 1887. On the development of osseous fishes, including marine and freshwater forms. Rep. U.S. Comm. Fish. 13(1885):489-603.
- . 1888. Development of the sea-bass (*Serranus atrarius*). Am. Nat. 22:755.
- SAF'YANOVA, T. Y., AND N. I. REVINA. 1960. The biology of the large horse mackerel and fishing for it. Tr. Azovo-Chernomorsk. Nauchno-Issled. Inst. Mosrsk. Rybn. Khoz. Okeanogr. 18.
- SAIGAL, B. N., AND M. P. MOTWANI. 1962. Studies on the fishery and biology of the commercial cat-fishes of the Ganga River system. 1. Early life-history, bionomics and breeding of *Mystus (Osteobagrus) seenghala* Sykes. Indian J. Fish. 8(1):60-74.
- SAKAMOTO, T., AND K. SUZUKI. 1978. Spawning behavior and early life history of the porcupine puffer, *Diodon holacanthus*, in aquaria. Jpn. J. Ichthyol. 24:261-270.
- SAKSENA, V. P., AND W. J. RICHARDS. 1975. Description of eggs and larvae of laboratory-reared white grunt, *Haemulon plumieri* (Lacepede) (Pisces: Pomadasysidae). Bull. Mar. Sci. 25:523-526.
- SALDANHA, L., AND N. C. PEREIRA. 1977. *Lophotus lacepedei* Giorna, 1809 (Pisces, Lophotidae) segnale pour la première fois sur la côte portugaise. Arq. Mus. Bocage 6(4):51-59.
- SALEKHOVA, L. P. 1959. O razvitii lufarya (*Pomatomus saltatrix* Linne). Tr. Sevastop. Biol. Stn. Im. A. D. Kovalenskogo Acad. Nauk Ukr. SSR 11:182-188.
- SANCHEZ DELGADO, F. 1981. Contribución al conocimiento de los Labridos (Familia Labridae) de la costas Ibéricas. Parte I. Descripción de las especies. Bol. Inst. Esp. Oceanogr. 6(3):19-57.
- SANDERCOCK, F. K., AND N. J. WILIMOVSKY. 1968. Revision of the cottid genus *Enophrys*. Copeia 1968:832-853.
- SANTANDER, H., AND O. S. DE CASTILLO. 1969. Desarrollo y distribución de huevos y larvas de merluza, *Merluccius gairi* (Guichenot) en la costa peruana. Bol. Inst. Mar Peru (Callao) 2(3):79-107.
- , AND ———. 1971. Desarrollo y distribución de huevos y larvas de jurel (*Trachurus symmetricus murphyi* Nichols) en la costa peruana. Inst. Mar Peru (Callao) Inf. 36:1-22.
- SANTERRE, M. T., AND R. C. MAY. 1977. Some effects of temperature on laboratory-reared eggs and larvae of *Polydactylus sextilis* (Pisces: Polynemidae). Aquaculture 10:341-351.
- SANZO, L. 1911. Distribuzione delle papille cutanee (Organi ciatiiformi) e suo valore sistematico nei Gobi. Mitt. Zool. Sta. Neapel 20:249-328.
- . 1912a. Larva di *Stomias boa* Risso. Mem. R. Com. Talassogr. Ital. 10.
- . 1912b. Uova di "Sternoptychidae" Gthr. R. Com. Talassogr. Ital. Boll. Bimest. 19:384-386.
- . 1915a. Stadi larvali di *Bathophilus nigerrimus* Gigl. Mem. R. Com. Talassogr. Ital. 48.
- . 1915b. *Stylophalmoides lobiancoi* Mazzarelli e *S. mediterraneus* Mazzarelli sono le rispettive forme larvali di *Scopelus caninianus* C. e V. e *S. humboldti* Rissoi. R. Com. Talassogr. Ital. Boll. 44:1-24.
- . 1917. Stadi larvali di *Paralepis hyalina* C.V. Mem. R. Com. Talassogr. Ital. 59.
- . 1918. Uova e larve di *Trachipterus cristatus* Bp. Mem. R. Com. Talassogr. Ital. 64.
- . 1925. Uova e larve di *Regalecus glesne* Asc. Mem. R. Com. Talassogr. Ital. 118.
- . 1928. Uova e larve di *Remora remora* L. Mem. R. Com. Talassogr. Ital. 138.
- . 1930a. Contributo alla conoscenza di uova, larve e stadi giovanili in *Echeneis naucrates* Linn. Ann. Idrogr. Genova 11:201-209.
- . 1930b. Uova, sviluppo embrionale, stadi larvali, post larvali e giovanili di Sternoptychidae e Stomatidae. Sternoptychidae. 2. *Ichthyococcus ovatus* Cocco. R. Com. Talassogr. Ital. Monogr. 2:69-119.
- . 1930c. Contributo alla conoscenza della sviluppo nei Carancidi: *Seriola dumerilii* Risso. Boll. Zool. 1:33-34.
- . 1930d. Ricerche biologiche su materiale raccolti dal Prof. L. Sanzo nella campagna idiografica nel Mar Rosso della R.N. Ammiraglio Magnaghi 1923-1924. VII. Plectognati. Mem. R. Com. Talassogr. Ital. Monogr. 167.
- . 1931a. Uova stadi embrionali e post-embrionali di *Naucrates ductor* L. Mem. R. Com. Talassogr. Ital. 185.
- . 1931b. Uova e larve di *Zeus faber* L. Arch. Zool. Ital. 15: 475.
- . 1931c. Uova e primi stadi larvali di *Myctophum gemellari* Cocco (= *Scopelus gemellari* C. e V.). Atti Accad. Naz. Lincei 14: 515-519.
- . 1931d. Sottordine: Salmonoidei, p. 21-92. In: Uova, larve e stadi giovanili di Teleostei. Fauna Flora Golfo Napoli Monogr. 38.
- . 1932a. Uova e primi stadi larvali di *Trachurus mediterraneus*. Boll. Zool. 3:73.
- . 1932b. Uova, stadi larvali e giovanili di *Centrolophus pomphus* C.V. Mem. R. Com. Talassogr. Ital. 196.
- . 1933a. Famiglia 2: Macruridae, p. 255-265. In: Uova, larve e stadi giovanili di Teleostei. Fauna Flora Golfo Napoli Monogr. 38:255-265.
- . 1933b. Uova larve e stadi giovanili di *Seriola dumerilii* Risso. Mem. R. Com. Talassogr. Ital. 205.

- . 1933c. Uova stadi larvali e giovanili di *Dactylopterus volitans* L. Mem. R. Com. Talassogr. Ital. 207.
- . 1936. Contributi alla conoscenza dello sviluppo embrionio nei Mugilidi. I. Uova e larve di *Mugil cephalus* Cuv. Ottenute per fecondazione artificiale. II. Uova e larve di *Mugil chelo* Cuv. Mem. R. Com. Talassogr. Ital. 230.
- . 1938a. Uova, stadi embrionali, prelarve e larve di *Saurenchelys cancrivora* Peters. Mem. R. Com. Talassogr. Ital. 249.
- . 1938b. Uova, ovariche e sviluppo larvale di *Aulopus filamentosus* Cuv. Mem. R. Com. Talassogr. Ital. 254:3-7.
- . 1939a. Nuovo contributo alla conoscenza dello sviluppo di *Myctophum rissoi* (Cocco). Atti Accad. Gioenia Sci. Nat. Catania (6)3(25):1-8.
- . 1939b. Rarissimi stadi larvali di Teleostei. Arch. Zool. Ital. 26:121-151.
- . 1939c. Uova e larve di *Smaris insidiator* C.V. Mem. R. Com. Talassogr. Ital. 262.
- . 1940. Uova e larve appena achiuse di *Lophotes cepedianus* (Giorna). Mem. R. Com. Talassogr. Ital. 272.
- . 1956. Divisione: Zeomorphi Regan, p. 461-470. In: Uova, larve e stadi giovanili di Teleostei. Fauna Flora Golfo Napoli Monogr. 38.
- SARDOU, J. 1966. Oeuf et développement embryonnaire de *Trachypterus taenia* Bloch (ordre des Lampridiformes = Allotriognathes famille des Trachypteridae) Vie Milieu, Fasc. 1-A, 15:199-215.
- . 1974. Contribution à la connaissance de la faune ichthyologique Malgache: découverte de poissons de la famille des Schindleriidae dans le canal de Mozambique, à Nosy-Bé et étude d'une collection de *Schindleria*. Cah. ORSTOM, Ser. Oceanogr. 12(1):3-15.
- SAROJINI, K. E., AND J. C. MALHOTRA. 1952. The larval development of the so-called Indian salmon, *Eleutheronema tetradactylum* (Shaw). J. Zool. Soc. India 4(1):63-72.
- SASAKI, T. 1974. On the larvae of three species of rockfish (Genus: *Sebastes*) in Hokkaido. Bull. Fac. Fish Hokkaido Univ. 25:169-173.
- SATO, G. 1983. Identificação, distribuicao e desenvolvimento larval de "Lanceta" *Thyrsitops lepidopoides* (Cuvier, 1931) (Pisces: Gempylidae) da região compreendida entre Cabo Frio (23°S) e Cabo de Sta. Marta Grande (29°S). Unpubl. MS thesis. Instituto Oceanográfico da Universidade de São Paulo, São Paulo, Brazil. (In Portuguese.)
- SATO, M., AND F. YASUDA. 1980. Metamorphosis of the leptocephali of the ten-pounder, *Elops hawaiiensis*, from Ishigaki Island, Japan. Jpn. J. Ichthyol. 26:315-324.
- SAUSKAN, V. I., AND V. P. SEREBRYAKOV. 1968. Reproduction and development of the silver hake (*Merluccius bilinearis* Mitchell). J. Ichthyol. (Engl. Trans. Vopr. Ikhtiol.) 8:398-414.
- SAVILLE, A. 1964. Clupeoidae. Identification sheets on eggs and larvae, Sheet 1. Cons. Int. Explor. Mer.
- . 1981. The estimation of spawning stock size from fish egg and larval surveys. Rapp. P. V. Reun. Cons. Int. Explor. Mer 178:268-278.
- , I. G. BAXTER AND D. W. MCKAY. 1974. Relations between egg production, larval production and spawning stock size in Clyde herring, p. 129-138. In: The early life history of fish. J. H. S. Blaxter (ed.). Springer-Verlag, Berlin.
- SAWADA, Y. 1982. Phylogeny and zoogeography of the superfamily Cobitoidea (Cyprinoidei, Cypriniformes). Mem. Fac. Fish. Hokkaido Univ. 28(2):65-223.
- SAWYER, P. J. 1967. Intertidal life-history of the rock gunnel, *Pholis gunnellus* in the western Atlantic. Copeia 1967:55-61.
- SAZIMA, I., AND V. S. UIEDA. 1979. Adaptações defensivas em jovens de *Oligoplites palometa* (Pisces, Carangidae). Rev. Bras. Biol. 39:687-694.
- SCHHEEL, J. J. 1961. Nigerian lamprey. Aquarium J. 32(9):411-416.
- . 1962. Factors governing development of killie eggs. Tropicals 7(2):9-15.
- . 1968. Rivulins of the Old World. T.F.H. Publ. Neptune City, N.J.
- SCHINDLER, O. 1932. Sexually mature larval Hemirhamphidae from the Hawaiian Islands. Bull. Bernice P. Bishop Mus. 197:1-28.
- SCHLESINGER, G. 1909. Zur Phylogenie und Ethologie der Scombro-sociden. Verh. Zool. Bot. Ges. Wien 59:302-339.
- SCHLOTTERBECK, R. E., AND D. W. CONNALLY. 1982. Vertical stratification of three nearshore Southern California larval fishes (*Engraulis mordax*, *Genyonemus lineatus*, and *Seriplus politus*). Fish. Bull. U.S., 80:895-902.
- SCHMIDT, J. 1904. On the pelagic post-larval halibut (*Hippoglossus vulgaris* Flem. and *H. hippoglossoides* (Walb.). Medd. Komm. Havunders. Ser. Fiskeri 1(3).
- . 1905a. The pelagic post-larval stages of the Atlantic species of *Gadus*, Part I. Medd. Komm. Dan. Havunders. Ser. Fiskeri 1(4).
- . 1905b. On the larval and post-larval stages of the torsk (*Bros-mus brosme* (Ascan.)). Medd. Komm. Havunders. Ser. Fiskeri 1(8).
- . 1906a. The pelagic post-larval stages of the Atlantic species of *Gadus*. Part II. Medd. Komm. Havunders. Ser. Fiskeri 2(2).
- . 1906b. The pelagic post-larval stages of the ling (*Molva molva* (Linné) and *Molva byrelange* (Walbaum)). Medd. Komm. Havunders. Ser. Fiskeri 2(3).
- . 1906c. On the larval and post-larval development of the argentinines *Argentina silus* (Ascan.) and *Argentina sphyraena* (Linné) with some notes on *Mallotus villosus* (O. F. Muller). Medd. Komm. Havunders. Ser. Fiskeri 2(4).
- . 1907a. On the post-larval development of the hake (*Merluccius vulgaris* Flem.). Medd. Komm. Havunders. Ser. Fiskeri 2(7).
- . 1907b. On the post-larval development of some north Atlantic gadoids (*Raniceps raninus* Linné) and *Molva elongata* (Risso). Medd. Komm. Havunders. Ser. Fiskeri 2(8).
- . 1908. On the post-larval stages of the John Dory (*Zeus faber* L.) and some other Acanthopterygian fishes. Medd. Komm. Havunders. Ser. Fiskeri 2(9):1-12.
- . 1913. On the identification of muraenoid larvae in their early ("pre-leptocephaline") stages. Medd. Komm. Havunders. Ser. Fiskeri, 4(2):1-13.
- . 1915. Respiratory adaptations of pleuronectids. Bull. Acad. Imp. Sci. Petrograd 1915:421-444.
- . 1917. Racial investigations. I. *Zoarces viviparus* L. and local races of same. C.-R. Trav. Lab. Carlsberg 13(3):279-396.
- . 1918. Argentinidae, Microstomidae, Opisthoproctridae. Mediterranean Odontostomidae. Rep. Dan. Oceanogr. Exped. Mediterr. 2(A.5).
- . 1921. Contributions to the knowledge of the young of the sun-fishes (*Mola* and *Ranzania*). Medd. Komm. Havunders. Ser. Fiskeri 6(6):3-13.
- SCHMIDT, P. Y. 1950. Fishes of the Sea of Okhtsk. Tr. Zool. Inst. Akad. Nauk SSSR 6:1-392. (Translated by Isr. Program Sci. Transl. No. 1263).
- SCHNACK, D., AND H. ROSENTHAL. 1978. Shrinkage of Pacific herring larvae due to formalin fixation and preservation. Ber. Dtsch. Wiss. Komm. Meeresforsch. 26:222-226.
- SCHNAKENBECK, W. 1928. Beitrag zur Kenntnis der Entwicklung einiger Meeresfische. I. Ber. Dtsch. Wiss. Komm. Meeresforsch., N.F. 4(4):119-229.
- . 1931. Carangidae. Rep. Dan. Oceanogr. Exped. Mediterr. 2(A.14):1-20.
- SCHONEVELDE, S. 1624. Ichthyologia et nomenclaturae animalium marinarum, quae in florentissimus ducatus. Slesvici et Holstatae. Hamburg.
- SCHULTZ, L. P. 1945. *Emmelichthyops atlanticus*, a new genus and species of fish (family Emmelichthyidae) from the Bahamas, with a key to related genera. J. Wash. Acad. Sci. 35:132-136.
- . 1946. A revision of the genera of mullets, fishes of the family Mugilidae, with descriptions of three new genera. Proc. U.S. Natl. Mus. 96(3204):377-395.
- . 1953. Sphyraenidae. In: Fishes of the Marshall and Marianas Islands. Vol. 1. Families from Asymmetronidae through Siganidae. Schultz, L. P., E. S. Herald, E. A. Lachner, A. D. Welander and L. P. Woods (eds.). U. S. Natl. Mus. Bull. 202.

- . 1957. The frogfishes of the family Antennariidae. Proc. U.S. Natl. Mus. 107:47-105.
- . 1958. Review of the parrotfishes family Scaridae. U.S. Natl. Mus. Bull. 214.
- . 1967. A new genus and species of zoarcid fish from the North Pacific Ocean. Proc. U.S. Natl. Mus. 122:1-5.
- SCHWARZHANS, W. 1978. Otolith-morphology and its usage for higher systematic units, with special reference to the Myctophiformes. Meded. Werkgr. Tert. Kwart. Geol. 15(4):167-185.
- SCOTT, A. P., AND C. MIDDLETON. 1979. Unicellular algae as a food for turbot (*Scophthalmus maximus* L.) larvae—the importance of dietary long-chain polyunsaturated fatty acids. Aquaculture 18:227-240.
- SCOTT, E. O. G. 1955. Observations on some Tasmanian fishes, part 7. Pap. Proc. R. Soc. Tasmania 89:131-146.
- . 1966. Observations on some Tasmanian fishes, part 14. Pap. Proc. R. Soc. Tasmania 100:93-115.
- . 1967. Observations on some Tasmanian fishes, part 15. Pap. Proc. R. Soc. Tasmania 101:189-220.
- SCOTT, J. S. 1972. Eggs and larvae of northern sand lance (*Ammodytes dubius*) from the Scotian Shelf. J. Fish. Res. Board Can. 29:1667-1671.
- . 1982. Distribution of juvenile haddock around Sable Island on the Scotian Shelf. J. Northwest Atl. Fish. Sci. 3:87-90.
- SCOTT, T. D. 1962. The marine and freshwater fishes of South Australia. W. L. Harves, Gov. Printer, Adelaide.
- , C. J. M. GLOVER AND R. V. SOUTHCOTT. 1974. The marine and freshwater fishes of South Australia. 2nd ed. A. B. James, Gov. Printer, South Australia.
- , AND ———. 1980. The marine and freshwater fishes of South Australia. 3rd ed. Gov. Printer, South Australia.
- SCOTT, W. B., AND E. J. CROSSMAN. 1973. Freshwater fishes of Canada. Bull. Fish. Res. Board Can. 184.
- SCOTTEN, L. M., R. E. SMITH, N. S. SMITH, K. S. PRICE AND D. P. DE SYLVA. 1973. Pictorial guide to fish larvae of Delaware Bay. Univ. Del., Del. Bay Rep. Ser. 7.
- SCRIMSHAW, N. S. 1945. Embryonic development in poeciliid fishes. Biol. Bull. (Woods Hole) 88(3):233-246.
- . 1946. Egg size in poeciliid fishes. Copeia 1946:20-23.
- SCURA, E. D., AND C. W. JERDE. 1977. Various species of phytoplankton as food for larval northern anchovy, *Engraulis mordax*, and relative nutritional value of the dinoflagellates *Gymnodinium splendens* and *Gonyaulax polyedra*. Fish. Bull. U.S. 75:577-583.
- SEATON, D. D., AND R. S. BAILEY. 1971. The identification and development of the eggs and larvae of the blue whiting *Micromesistius poutassou* (Risso). J. Cons. Int. Explor. Mer 34:76-83.
- SENTA, T. 1958. Young of *Daicocys peterseni* (Nyström). In: Studies on the eggs, larvae and juveniles of Japanese fishes. Ser. 1. Uchida et al. (eds.). Fac. Agric. Kyushu Univ. Fukuoka, Japan. (In Japanese.)
- . 1965. The buoyancy of sandeel eggs and their distribution in the Seto Inland Sea. Bull. Jpn. Soc. Sci. Fish. 31:511-517.
- , AND S. KUMAGAI. 1977. Variation in the vertebral number of milkfish *Chanos chanos*, collected from various localities. Bull. Fac. Fish. Nagasaki Univ. 43:35-40.
- SEREBRYAKOV, V. P. 1978. Development of the spotted hake, *Urophycis regius*, from the Northwestern Atlantic. J. Ichthyol. (Engl. Transl. Vopr. Ikhtiol.) 18:793-799.
- . 1980. Fish eggs and larvae from the Flemish Cap area. NAFO SCR Doc., No. 90, Serial No. N145.
- SESHAPPA, G., AND B. S. BHIMACHAR. 1955. Studies on the fishery and biology of the Malabar sole, *Cynoglossus semifasciatus* Day. Indian J. Fish. 2:180-230.
- SETTE, O. E. 1943. Biology of the Atlantic mackerel (*Scomber scombrus*) of North America: Part I. Early life history, including growth, drift and mortality of the egg and larval populations. U.S. Fish Wildl. Serv. Fish. Bull. 50:149-237.
- , AND E. H. AHLSTROM. 1948. Estimation of abundance of the eggs of the Pacific pilchard *Sardinops caerulea* off southern California during 1940 and 1941. J. Mar. Res. 7:511-542.
- SHA, X., AND H. RUAN. 1981. The habits and morphological development of early stages of *Ilisha elongata* (Bennett). Trans. Chin. Ichthyol. Soc. 2:81-88.
- , AND G. HE. 1981. The development of the egg and larval stages of the lumpfish, *Inimicus japonicus* (C. and V.). Oceanol. Limnol. Sin. 12(4):365-371.
- SHAKLEE, J. B., AND C. S. TAMARU. 1981. Biochemical and morphological evolution of Hawaiian bonefishes (Albula). Syst. Zool. 30:125-146.
- , AND G. S. WHITT. 1981. Lactate dehydrogenase isozymes of gadiform fishes: divergent patterns of gene expression indicate a heterogeneous taxon. Copeia 1981:563-578.
- SHAW, E. S. 1955. The embryology of the sergeant major, *Abudefduf saxatilis*. Copeia 1955:85-99.
- SHELBOURNE, J. E. 1964. The artificial propagation of marine fish. Adv. Mar. Biol. 2:1-83.
- . 1975. Marine fish cultivation: pioneering studies on the culture of the larvae of the plaice (*Pleuronectes platessa* L.) and the sole (*Solea solea* L.). Fish. Invest. Ser. II Mar. Fish. G. B. Minist. Agric. Fish. Food, Vol. 9.
- SHELTON, W. L. 1978. Fate of the follicular epithelium in *Dorosoma petenense* (Pisces: Clupeidae). Copeia 1978:237-244.
- , AND R. STEPHENS. 1980. Comparative embryogeny and early development of threadfin and gizzard shad. Prog. Fish-Cult. 42:34-41.
- SHEN, S. C. 1971. A new genus of clinid fishes from the Indo-West Pacific, with a redescription of *Clinus nematopterus*. Copeia 1971:697-706.
- SHIGANOVA, T. A. 1974. Postembryonic development of *Hygophum benoiti* (Myctophidae, Pisces). J. Ichthyol. (Engl. Transl. Vopr. Ikhtiol.) 14:746-754.
- . 1975. Postembryonic development of *Hygophum macrochir* (Myctophidae, Pisces). J. Ichthyol. (Engl. Transl. Vopr. Ikhtiol.) 15:429-437.
- . 1977. Larvae and juveniles of the lanternfishes (Myctophidae, Pisces) of the Atlantic Ocean. Tr. Inst. Okeanol. Akad. Nauk SSSR 109:42-12.
- SHIOGAKI, M. 1980. Redescription of the stichaeid fish *Chirolophis saitone*. Jpn. J. Ichthyol. 28:129-134.
- . 1981. Life history of the stichaeid fish, *Opisthocentrus ocellatus*. Jpn. J. Ichthyol. 29:77-85.
- . 1982. Larvae, juveniles, and a gravid female of the blennioid *Cryptacanthodes bergi*, collected from Aomori, Japan. Jpn. J. Ichthyol. 29:102-104.
- . 1983. On the life history of the stichaeid fish *Chirolophis japonicus*. Jpn. J. Ichthyol. 29:446-455.
- , AND Y. DOTSU. 1971a. The life history of the clingfish, *Aspasma minima*. Jpn. J. Ichthyol. 18:76-84.
- , AND ———. 1971b. Larvae and juveniles of the clingfishes, *Lepidichthys frenatus* and *Aspasmichthys ciconiae*. Jpn. J. Ichthyol. 18:85-89.
- , AND ———. 1971c. Egg development and hatched larva of the clingfish, *Lepidichthys frenatus*. Bull. Fac. Fish. Nagasaki Univ. 32:1-5.
- , AND ———. 1971d. The life history of the clingfish, *Conidens laticephalus*. Bull. Fac. Fish. Nagasaki Univ. 32:7-16.
- , AND ———. 1971e. The life history of the gobiid fish, *Expeditio parvulus*. Bull. Fac. Fish. Nagasaki Univ. 32:17-25.
- , AND ———. 1972a. Life history of the blennioid fish, *Dictyosoma burgeri*. Bull. Fac. Fish. Nagasaki Univ. 33:21-38. (In Japanese.)
- , AND ———. 1972b. The life history of the blennioid fish *Neoclinus byrope*. Bull. Fac. Fish. Nagasaki Univ. 34:1-8. (In Japanese.)
- , AND ———. 1972c. The life history of the gobiid fish, *Luciogobius elongatus*. Bull. Fac. Fish. Nagasaki Univ. 34:9-18.
- , AND ———. 1972d. The spawning and the larva rearing of the clingfish, *Aspasma ciconiae* and the spawning of the clingfish, *Aspasma minima*. Bull. Fac. Fish. Nagasaki Univ. 34:39-33.
- , AND ———. 1973. The egg development and larva rearing of the tripterygiid blenny, *Tripterygion etheostoma*. Jpn. J. Ichthyol. 20:42-46. (In Japanese, English summary.)

- SHIOKAWA, T., AND H. TSUKAHARA. 1961. Studies on habits of coastal fishes in the Amakusa Islands. I. Early life history of the purple rockfish, *Sebastes pachycephalus pachycephalus* Temminck et Schlegel. Rec. Oceanogr. Works Jpn., Spec. No. 5:123-127.
- SHOJIMA, Y. 1962. On the postlarvae and juveniles of carangid fishes collected together with jelly-fishes. Bull. Seikai Reg. Fish. Res. Lab. 27:49-58.
- , S. FUJITA AND K. UCHIDA. 1957. On the egg development and prelarval stages of a kind of barracuda, *Sphyræna pinguis* Günther. Sci. Bull. Fac. Agric. Kyushu Univ. 16:313-318.
- SHORES, D. L. 1969. Postlarval *Sudis* (Pisces: Paralepididae) in the Atlantic Ocean. Breviora 334.
- SHULEIKIN, V. V. 1958. How the pilot fish moves with the speed of the shark. Dokl. Akad. Nauk SSSR 119(106):140-143. (Transl. by the Amer. Inst. of Biol. Sci.).
- SHUST, K. V. 1978. On the distribution and biology of members of the genus *Micromesistius* (family Gadidae). J. Ichthyol. (Engl. Transl. Vopr. Ikhtiol.) 18:490-493.
- SIBLEY, C. G., AND J. E. AHLQUIST. 1981. The phylogeny and relationships of the ratite birds as indicated by DNA-DNA hybridization, p. 301-335. In: Evolution today. G. G. E. Scudder and J. J. Reveal (eds.). Proc. Sec. Int. Congr. Syst. Evol. Biol.
- SILVERMAN, M. J. 1975. Scale development in the bluefish, *Pomatomus saltatrix*. Trans. Am. Fish. Soc. 104:773-774.
- SIMONS, E. V., AND J. R. VAN HORN. 1971. A new procedure for whole-mount alcian blue staining of the cartilaginous skeleton of chicken embryos, adapted to the clearing procedure in potassium hydroxide. Acta Morphol. Neerl. Scand. 8(1970/1971):281-292.
- SIMONSEN, M. 1978. The use of discriminant analysis in the identification of two species of larval smelt, *Spirinchus thaleichthys*, and *Hypomesus t. transpacificus* in the Sacramento-San Joaquin estuary. Unpubl. MS thesis. Univ. of Pacific, Stockton, CA.
- SIMPSON, A. C. 1959. The spawning of plaice in the North Sea. Fish. Invest. Ser. II Mar. Fish. Gr. Brit. Minist. Agric. Fish. Food 22(7).
- SIMPSON, J. G. 1959. Identification of the egg, early life history and spawning areas of the anchoveta, *Cetengraulis mysticetus* (Günther), in the Gulf of Panama. Inter-Amer. Trop. Tuna Comm. Bull. 3:437-580.
- SINGER, C. 1950. A history of biology. Henry Schuman, New York.
- . 1959. A short history of scientific ideas to 1900. Clarendon Press, Oxford.
- SLIPP, J. W., AND A. C. DELACY. 1952. On the distribution and habits of the wattled eelpout, *Lycodes palearis*. Copeia 1952:201-203.
- SMIGIELSKI, A. 1975a. Hormone-induced spawnings of the summer flounder and rearing of the larvae in the laboratory. Prog. Fish-Cult. 37:3-8.
- . 1975b. Hormonal-induced ovulation of the winter flounder, *Pseudopleuronectes americanus*. Fish. Bull. U.S. 73:431-438.
- SMITH, C. L. 1957. Two new clinid blennies (*Malacoctenus*) from Puerto Rico. Univ. Mich. Mus. Zool. Occas. Pap. 585:1-15.
- . 1971. A revision of the American groupers: *Epinephelus* and allied genera. Bull. Am. Mus. Nat. Hist. 146:67-241.
- , AND R. M. BAILEY. 1961. Evolution of the dorsal-fin supports of percid fishes. Pap. Mich. Acad. Sci. Arts Lett. 46:345-361.
- , J. C. TYLER AND M. N. FEINBERG. 1981. Population ecology and biology of the pearlfish (*Carapus bermudensis*) in the lagoon at Bimini, Bahamas. Bull. Mar. Sci. 31:876-902.
- SMITH, D. G. 1969. Xenocongrid eel larvae in the western North Atlantic. Bull. Mar. Sci. 19:377-408.
- . 1970. Notacanthiform leptocephali in the western North Atlantic. Copeia 1970:1-9.
- . 1971. Osteology and relationships of the congrid eels of the western North Atlantic (Pisces, Anguilliformes). Unpubl. PhD dissertation. Univ. of Miami (Coral Gables, FL).
- . 1979. Guide to the leptocephali (Elopiiformes, Anguilliformes and Notacanthiformes). NOAA Tech. Rep. NMFS Circ. 424.
- . 1980. Early larvae of the tarpon, *Megalops atlantica* Valenciennes (Pisces: Elopidae), with notes on spawning in the Gulf of Mexico and the Yucatan Channel. Bull. Mar. Sci. 30:136-141.
- , AND P. H. J. CASTLE. 1972. The eel genus *Neoconger* Girard: Systematics, osteology, and life history. Bull. Mar. Sci. 22:196-249.
- , AND ———. 1982. Larvae of the nettastomatid eels: systematics and distribution. Dana-Rep. Carlsberg Found. 90:1-44.
- , AND M. M. LEIBY. 1980. The larva of the congrid eel *Acromycter alcocki* (Pisces: Anguilliformes), and the distinction between congrid and ophichthid larvae. Proc. Biol. Soc. Wash. 93(2):388-394.
- , AND T. POTTHOFF. 1975. Leptocephali taxonomy, p. 19-20. In: Ichthyoplankton Rep. CICAR Ichthyoplankton Workshop, Mexico City, 17-26 July 1974. UNESCO Tech. Pap. Mar. Sci. 20.
- SMITH, H. M. 1907. The fishes of North Carolina. N.C. Geol. Econ. Surv. 2:1-453.
- SMITH, J. L. B. 1933a. An interesting new myctophid fish from South Africa. Trans. R. Soc. S. Afr., 21(2):125-127.
- . 1933b. The South African species of the genus *Hemirhamphus* Cuv. Trans. R. Soc. S. Afr. 21(2):129-150.
- . 1935. The fishes of the family Mugilidae in South Africa. Ann. S. Afr. Mus. 30:587-644.
- . 1938. An interesting early post-larval stage of the "Galjoen." Trans. R. Soc. S. Afr. 25:389-390.
- . 1947. A generic revision of the mugilid fishes of South Africa. Ann. Mag. Nat. Hist., Ser. 11, 14:833-843.
- . 1949. The sea fishes of southern Africa. Central News Agency, Ltd., Johannesburg.
- . 1956a. A new dealfish from South Africa. Ann. Mag. Nat. Hist. 12:449-453.
- . 1956b. The fishes of the family Sphyrænidae in the western Indian Ocean. Rhodes Univ. Dep. Ichthyol. Bull. 3:37-46.
- . 1958a. The gunnelichthid fishes with description of two new species from East Africa and of *Gunnellichthys* (*Clarkichthys*) *bilineatus* (Clark), 1936. Rhodes Univ. Dep. Ichthyol. Bull. 9:123-129.
- . 1958b. Fishes of the family Tetrarogidae, Caracanthidae, and Synanciidae from the Western Indian Ocean with further notes on scorpaenid fishes. Rhodes Univ. Dep. Ichthyol. Bull. 12:167-181.
- . 1961. The sea fishes of southern Africa. Central News Agency, Ltd., South Africa.
- . 1963. Fishes of the families Draconettidae and Callionymidae from the Red Sea and the western Indian Ocean. Rhodes Univ. Dep. Ichthyol. Bull. 28:547-564.
- . 1966a. Fishes of the sub-family Nasinae with a synopsis of the Prionurinae. Rhodes Univ. Dep. Ichthyol. Bull. 32:635-681.
- . 1966b. Hitherto unknown early developmental larval stadia of the west African albulid fish, *Pterothrissus belloci* Cadenat, 1937. Rhodes Univ. Dep. Ichthyol. Occas. Pap. (6):57-61.
- . 1968. A new liparine fish from the Red Sea. J. Nat. Hist. 2: 105-109.
- SMITH, P. E. 1972. The increase in spawning biomass of northern anchovy *Engraulis mordax*. Fish. Bull. U.S. 70:849-874.
- , AND S. L. RICHARDSON. 1977. Standard techniques for pelagic fish egg and larval surveys. FAO Fish. Tech. Pap. No. 175.
- , AND ———. 1979. Selected bibliography on pelagic fish egg and larva surveys. FAO Fish. Circ. No. 706.
- SMITH, S. 1957. Early development and hatching, p. 323-359. In: The Physiology of Fishes. Vol. 1. M. E. Brown (ed.). Academic Press, New York.
- SMITH, W. G., AND M. P. FAHAY. 1970. Description of eggs and larvae of the summer flounder, *Paralichthys dentatus*. U.S. Fish Wildl. Serv. Res. Rep. 75.
- SMITH-VANIZ, W. F. 1975. Supplemental description of a rare blennioid fish *Phenablennius heyligeri* (Bleeker). Proc. Acad. Nat. Sci. Phila. 127(6):53-55.
- . 1976. The saber-toothed blennies, tribe Nemophini (Pisces: Blenniidae). Proc. Acad. Nat. Sci. Phila. Monogr. 19:1-196.
- , AND F. J. PALACIO. 1974. Atlantic fishes of the genus *Acanthemblemaria*, with descriptions of three new species and comments on Pacific species (Clinidae: Chaenopsinae). Proc. Acad. Nat. Sci. Phila. 125(11):197-224.

- , AND V. G. SPRINGER. 1971. Synopsis of the tribe Salariae, with description of five new genera and three new species (Pisces: Blenniidae). *Smithson. Contrib. Zool.* 73:1-72.
- , AND J. C. STAIGER. 1973. Comparative revision of *Scomberoides*, *Oligoplites*, *Parona*, and *Hypacanthus* with comments on the phylogenetic position of *Campogramma* (Pisces: Carangidae). *Proc. Calif. Acad. Sci.* 39:185-256.
- SMITT, F. A. 1895. A history of Scandinavian fishes. II. Stockholm and London:567-1240.
- SMOKER, W., AND W. C. PEARCY. 1970. Growth and reproduction of the lanternfish *Stenobrachius leucopsarus*. *J. Fish. Res. Board Can.* 27:1265-1275.
- SMOL'YANOV, I. I. 1961. The development of *Brachymystax lenok* (Pallas). *Vopr. Ikhtiol.* 18:136-148. (In Russian.)
- SNEATH, P., AND R. SOKAL. 1973. Numerical taxonomy. W. H. Freeman, San Francisco.
- SNYDER, D. E. 1976. Terminologies for intervals of larval fish development, p. 41-58. In: Great Lakes fish egg and larvae identification: Proceedings of a workshop. J. Boreman (ed.). U.S. Fish Wildl. Serv. Biol. Serv. Prog. FWS/OBS-76/23.
- . 1979. Burbot: larval evidence for more than one North American species, p. 204-219. In: Proc. 3rd Symp. Larval Fish. West. Kentucky Univ. Dep. Biol., Bowling Green.
- . 1981. Contributions to a guide to the cypriniform fish larvae of the upper Colorado River system. U.S. Dep. Inter., Bur. Land Manage., Colo. Off., Biol. Sci. Ser. 3.
- , AND S. C. DOUGLAS. 1978. Description and identification of mooneye, *Hiodon tergisus*, protolarvae. *Trans. Am. Fish. Soc.* 107:590-594.
- , M. B. M. SNYDER AND S. C. DOUGLAS. 1977. Identification of golden shiner, *Notemigonus crysoleucas*, spotfin shiner, *Notropis spilopterus*, and fathead minnow, *Pimephales promelas*, larvae. *J. Fish. Res. Board Can.* 34:1397-1409.
- SOIN, S. C. 1966. Development types of structures and phylogeny of vascular systems of the vitelline sac in fish embryos, performing a respiratory function. *Zool. Zh.* 45:1382-1397. (In Russian.)
- . 1968. Some features in the development of the blenny [*Zoarces viviparus* (L.)] in relation to viviparity. *Prob. Ichthyol.* (Eng. Transl. *Vopr. Ikhtiol.*) 8:222-229.
- . 1980. Types of development of salmoniform fishes and their taxonomic importance. *J. Ichthyol.* (Engl. Transl. *Vopr. Ikhtiol.*) 20(1):49-56.
- SOKAL, R., AND SNEATH, P. 1963. Principles of numerical taxonomy. W. H. Freeman, San Francisco.
- SOLDATOV, V. K., AND G. U. LINDBERG. 1930. A review of the fishes of the seas of the Far East. *Izv. Tikhookean. Nauchno-Issled. Inst. Rybn. Khoz. Okeanogr.* 5.
- SOLTZ, D. L., AND M. F. HIRSCFIELD. 1981. Genetic differentiation of pupfishes (Genus *Cyprinodon*) in the American southwest, p. 291-333. In: Fishes in North American Deserts. R. J. Naiman and D. L. Soltz (eds.). John Wiley & Sons, New York.
- SOONG, M. H. H. 1968. Aspects of reproduction in freshwater half-beaks. *Malay. Nat. J.* 21(suppl.):xxxiii-xxxiv.
- SPARTA, A. 1926. Uova e larve di *Fierasfer dentatus* Cuv. *Mem. R. Com. Talassogr. Ital.* 122.
- . 1928. Stadi larvali di *Uraleptus maraldi* Risso. *Mem. R. Com. Talassogr. Ital.* 141.
- . 1932. Contributo alla conoscenza dello sviluppo post-embriale in *Anthias sacer* Bloch. *Mem. R. Com. Talassogr. Ital.* 195.
- . 1933. Ordine: Allotriognathi, p. 266-279. In: Uova, larve e stadi giovanili di Teleostei. Fauna Flora Golfo Napoli Monogr. 38.
- . 1934. Uova e larve di Gobiidae. I. *Gobius paganelus* L. *Mem. R. Com. Talassogr. Ital.* 211.
- . 1935. Contributo alla conoscenza dello sviluppo nei Percidi. Uova ovariche mature di *Epinephelus guaza* L. e stadi post-embriale e larvali di *Epinephelus alexandrinus* Cuv. e Val. *Mem. R. Com. Talassogr. Ital.* 224.
- . 1936. Contributo alla conoscenza di uova, stadi embrionali e post-embriale in *Macrorhamphosus scolopax* L. *Mem. R. Com. Talassogr. Ital.* 225.
- . 1937. Contributo alla conoscenza dello sviluppo embrionale e post-embriale nei Murenoidi. 1.—*Coecula imberbis* (De la Roche). 2.—*Ophichthys remicaudus* (Kaup). *Mem. R. Com. Talassogr. Ital.* 244.
- . 1938a. Contributo alla conoscenza dello sviluppo embrionale e post-embriale nei Murenoidi. 3.—*Coecula coeca* (L.). *Mem. R. Com. Talassogr. Ital.* 248.
- . 1938b. Contributo alla conoscenza dello sviluppo embrionale e post-embriale nei Murenoidi. 4.—*Ophisoma balearicum* De la Roche. *Mem. R. Com. Talassogr. Ital.* 252.
- . 1939a. Contributo alla conoscenza dello sviluppo nei Percidi. Uova, stadi embrionali e post-embriale di *Polyprion cernium* (Val.) *Mem. R. Com. Talassogr. Ital.* 259.
- . 1939b. Contributo alla conoscenza dello sviluppo embrionale e post-embriale nei Murenoidi. 5.—Nuova specie di uovo di Murenoidi (*Conger conger?*). *Mem. R. Com. Talassogr. Ital.* 264.
- . 1939c. Contributo alla conoscenza dello sviluppo embrionale e post-embriale nei Murenoidi. 6.—*Ophisurus serpens* L. *Mem. R. Com. Talassogr. Ital.* 267.
- . 1939d. Contributo alla conoscenza dello sviluppo embrionale e post-embriale nei Murenoidi. 7.—*Chlopsis bicolor* (Raf.). *Mem. R. Com. Talassogr. Ital.* 268.
- . 1940a. Contributo alla conoscenza dello sviluppo embrionale e post-embriale nei Murenoidi. 8.—*Echelus myrus* L. *Mem. R. Com. Talassogr. Ital.* 273.
- . 1940b. Contributo alla conoscenza dello sviluppo embrionale e post-embriale nei Murenoidi. 9.—Seconda nuova specie di uova di Murenoidi. *Mem. R. Com. Talassogr. Ital.* 279.
- . 1942a. Uova, stadi embrionali, prelarve e larve di *Nettastoma melanurum* Raf. *Arch. Oceanogr. Limnol.* 2:151-158.
- . 1942b. Uova e larve di *Atherina rissoi* C. V. ottenute da fecondazione artificiale, e stadi post-embriale raccolti nel plancton. *Arch. Oceanogr. Limnol.* 2:161-168.
- . 1946. Contributo alla conoscenza dello sviluppo post-embriale in *Cubiceps gracilis* Lowe. *Boll. Pesca Piscic. Idrobiol.* 22(1).
- . 1948. Uova ovariche, uova fecondate tenute in coltura, larva alla schiusa, stadi larvali e giovanili di *Cristiceps argentatus* Risso. *Arch. Oceanogr. Limnol., Mem.* 315, 5(1-3):79-84.
- . 1951. Rarissimi stadi larvali e giovanili di *Myctophum glaciale* (Reinhardt). *Boll. Pesca Piscic. Idrobiol.* 6(2):101-107.
- . 1952. Contributo alla conoscenza dello sviluppo larvale di *Myctophum metopoclampum* Cocco. *Boll. Pesca Piscic. Idrobiol.* 7(1):5-10.
- . 1953. Uova e larve di *Tetrapturus belone* Raf. (Aguglia Imperiale). *Boll. Pesca Piscic. Idrobiol.* 8(1):58-62.
- . 1954. Des stades jeunes rares de téléostéens marins (*Uraleptus maraldi* Risso, *Temnodon saltator* C. V., *Lophotes cepedianus* Giorno). *Rapp. P. V. Reun. Comm. Int. Explor. Sci. Mer. Mediterr. Monaco* 12:79-84.
- . 1956a. Sottordine: Pharyngognathi J. Müller, p. 576-598. In: Uova, larve e stadi giovanili di Teleostei. Fauna Flora Golfo Napoli Monogr. 38.
- . 1956b. Sottordine: Scleroparei. Famiglia 1: Scorpaenidae, p. 599-626. In: Uova, larve e stadi giovanili di Teleostei. Fauna Flora Golfo Napoli Monogr. 38.
- . 1962. Uova, larve alla schiusa ed al 4 giorno de vita. *Pomatomus saltatrix* Gill. (Syn. *Temnodon saltator*, C.V.). *Boll. Pesca Piscic. Idrobiol.* 17(1):5-8.
- SPONAUGLE, D. L., AND J. P. WOURMS. 1979. Secondary egg envelope pre-patterning by follicle cells during fish oogenesis. *Am. Zool.* 19:946.
- SPRINGER, V. G. 1954. Western Atlantic fishes of the genus *Parachinus*. *Tex. J. Sci.* 4:422-441.
- . 1955. The taxonomic status of the fishes of the genus *Stathmonotus*, including a review of the Atlantic species. *Bull. Mar. Sci. Gulf Caribb.* 5:66-80.

- . 1958. Systematics and zoogeography of the clinid fish of the subtribe Labrisomini. *Tex. Inst. Mar. Sci., Hubbs Publ.* 5:418–492.
- . 1959. A new species of *Labrisomus* from the Caribbean Sea, with notes on other fishes of the subtribe Labrisomini. *Copeia* 1959: 289–292.
- . 1967. Revision of the circumtropical shorefish genus *Entomacrodus* (Blenniidae: Salariae). *Proc. U.S. Natl. Mus.* 122(3582): 1–150.
- . 1968. Osteology and classification of the fishes of the family Blenniidae. *U.S. Natl. Mus. Bull.* 284.
- . 1970. The western south Atlantic clinid fish *Ribeiroclinus eigenmanni*, with discussion of the intrarelationships and zoogeography of the Clinidae. *Copeia* 1970:430–436.
- . 1971. Revision of the fish genus *Ecsenius* (Blenniidae, Blenniinae, Salariae). *Smithson. Contrib. Zool.* 72.
- . 1972a. Synopsis of the tribe of Omobranchini with descriptions of three new genera and two new species (Pisces: Blenniidae). *Smithson. Contrib. Zool.* 130.
- . 1972b. Additions to revisions of the blennioid fish genera *Ecsenius* and *Entomacrodus*, with descriptions of three new species of *Ecsenius*. *Smithson. Contrib. Zool.* 134.
- . 1976. *Cirrisalurius bunares*, new genus and species of blennioid fish from the Indian Ocean. *Proc. Biol. Soc. Wash.* 89(3):199–203.
- . 1978. Synonymization of the family Oxudercidae, with comments on the identity of *Apocryptes cantoris* Day (Pisces: Gobiidae). *Smithson. Contrib. Zool.* 270.
- . 1982. Pacific plate biogeography, with special reference to shorefishes. *Smithson. Contrib. Zool.* 367.
- . 1983. *Tyson belos*, new genus and species of western Pacific fish (Gobiidae, Xenisthminae), with discussions of gobioid osteology and classification. *Smithson. Contrib. Zool.* 390.
- . MS. A new genus and species of western Pacific fish (Gobiidae, Xenisthminae), with discussions of gobioid osteology and classification.
- , AND T. H. FRASER. 1976. Synonymy of the fish families Cheilobranchidae (=Alabetidae) and Gobiessocidae, with descriptions of two new species of *Alabes*. *Smithson. Contrib. Zool.* 234.
- , AND M. F. GOMON. 1975a. Revision of the blennioid fish genus *Omobranchus* with descriptions of three new species and notes on other species of the tribe Omobranchini. *Smithson. Contrib. Zool.* 177.
- , AND ———. 1975b. Variation in the western Atlantic clinid fish *Malacoctemus triangulatus* with a revised key to the Atlantic species of *Malacoctemus*. *Smithson. Contrib. Zool.* 200.
- , C. L. SMITH AND T. H. FRASER. 1977. New species of protogynous hermaphroditic fish, and synonymy of Anisochromidae, Pseudoplesiopidae, and Pseudochromidae. *Smithson. Contrib. Zool.* 252.
- , AND W. F. SMITH-VANIZ. 1972. A new tribe (*Phenablenniini*) and genus (*Phenablennius*) of blennioid fishes based on *Petroscirtes heylieri* (Bleeker). *Copeia* 1972:64–71.
- , AND A. E. SPREITZER. 1978. Five new species and a new genus of Indian Ocean blennioid fishes, tribe Salariae, with a key to genera of the tribe. *Smithson. Contrib. Zool.* 268.
- STAIGER, J. C. 1965. Atlantic flying fishes of the genus *Cypselurus*, with descriptions of the juveniles. *Bull. Mar. Sci.* 15:672–725.
- STARK, W. A., II. 1971. Biology of the gray snapper, *Lutjanus griseus* (Linnaeus), in the Florida Keys, p. 11–150. *In: Investigations on the gray snapper, Lutjanus griseus*. W. A. Stark, II, and R. E. Schroeder (eds.). *Stud. Trop. Oceanogr.* (Miami) 10.
- STARCK, E. C. 1900. The osteological characters of the fishes of the Suborder Percesoces. *Proc. U.S. Natl. Mus.* 22:1–10.
- . 1902. The shoulder girdle and characteristic osteology of the hemibranchiate fishes. *Proc. U.S. Natl. Mus.* 25:619–634.
- . 1911. The osteology and relationships of fishes belonging to the family Carangidae. *Leland Stanford Jr. Univ. Publ. Univ. Ser.* 5:27–49.
- STEEDMAN, H. F. 1976. General and applied data on formaldehyde fixation and preservation of marine zooplankton, p. 103–154. *In: Zooplankton fixation and preservation*. H. F. Steedman (ed.). UNESCO Press, Paris.
- STEFFENSEN, E. 1980. Daily growth increments observed in otoliths from juvenile East Baltic cod. *Dana* 1:29–37.
- STEHMANN, M., AND W. LENZ. 1973. Ergebnisse der Forschungsreisen des FFS "Walther Herwig" nach Südamerika. XXVI. Systematik und Verbreitung der Artengruppe—*Seriola punctata* (Schneider, 1801), *S. porosa* Guichenot, 1848, *S. dobula* Günther, 1869—sowie taxonomische Bemerkungen zu *Hyperoglyphe* Günther, 1859 und *Schedophilus* Cocco, 1839 (Osteichthyes, Stromateoidei, Centrolophidae). *Arch. Fischereiwiss.* 23:179–201.
- STEHR, C. M. 1979. The development of the hexagonal surface structure of the C-O sole (*Pleuronichthys coenosus*). *Am. Zool.* 19:976.
- . 1982. The development of the hexagonally structured egg envelope of the C-O sole (*Pleuronichthys coenosus*). Unpubl. MS thesis, Univ. Washington, Seattle.
- , AND J. W. HAWKES. 1979. The comparative ultrastructure of the egg membrane and associated pore structures in the starry flounder, *Platichthys stellatus* (Pallas), and pink salmon, *Oncorhynchus gorbuscha* (Walbaum). *Cell Tissue Res.* 202:347–356.
- STEIN, D. L. 1978. A review of the deepwater Liparidae (Pisces) from the coast of Oregon and adjacent waters. *Occ. Pap. Calif. Acad. Sci.* No. 127.
- . 1980a. Aspects of reproduction of liparid fishes from the continental slope and abyssal plain off Oregon, with notes on growth. *Copeia* 1980:687–699.
- . 1980b. Description and occurrence of macrourid larvae and juveniles in the northeast Pacific Ocean off Oregon, U.S.A. *Deep-Sea Res.* 27A:889–900.
- , AND C. E. BOND. 1978. A new deep-sea fish from the eastern North Pacific *Psychrolutes phrictus* (Pisces: Cottidae [Psychrolutidae]). *Nat. Hist. Mus. Los Ang. Cty. Contrib. Sci.* 296:1–9.
- , AND W. G. PEARCY. 1982. Aspects of reproduction, early life history, and biology of macrourid fishes off Oregon, U.S.A. *Deep-Sea Res.* 29:1313–1300.
- STEIN, R. 1972. Identification of some larval Pacific cottids. Unpubl. MS Thesis. Humboldt State Coll., Arcata, CA.
- . 1973. Description of laboratory-reared larvae of *Oligocottus maculosus* Girard (Pisces: Cottidae). *Copeia* 1973:373–377.
- STEPHENS, J. S. 1963. A revised classification of the blennioid fishes of the American family Chaenopsidae. *Univ. Calif. Publ. Zool.* 68.
- . 1970. Seven new chaenopsid fishes from the western Atlantic. *Copeia* 1970:280–309.
- , E. S. HOBSON AND R. K. JOHNSON. 1966. Notes on distribution, behavior, and morphological variation in some chaenopsid fishes from the tropical eastern Pacific, with descriptions of two new species, *Acanthemblemaria castroi* and *Coralliozetus springeri*. *Copeia* 1966:424–438.
- , AND V. G. SPRINGER. 1974. Clinid fishes of Chile and Peru, with description of a new species, *Myxodes ornatus* from Chile. *Smithson. Contrib. Zool.* 159.
- STEPHENSON, A. B. 1977. *Metavelifer multiradiatus* (Regan, 1907) (Pisces: Veliferidae), a new record from New Zealand waters. *Rec. Auckl. Inst. Mus.* 14:143–144.
- STERBA, G. 1962. Die Schmerlenartigen (Cobitidae), p. 201–234. *In: Handbuch der Binnenfischerei Mitteleuropas*. 3B(9). R. Demoll and H. N. Maier (eds.). E. Schweizerbart'sche Verlagsbuchhandlung, Stuttgart, West Germany.
- , AND H. MÜLLER. 1962. Elektronenmikroskopische untersuchungen über Bildung und Struktur der Eihüllen bei Knochenfischen, I. Die Hüllen junger Oocyten von *Cyrolebias bellottii*. *Steindachner (Cyprinodontidae)*. *Zool. Jb. Abt. Anat.* 80(1):65–80.
- STEVENS, E. G., AND H. G. MOSER. 1982. Observations on the early life history of the mussel blenny, *Hypsoblennius jenkinsi*, and the bay blenny, *Hypsoblennius gentilis*, from specimens reared in the laboratory. *Calif. Coop. Oceanic Fish. Invest. Rep.* 23:269–275.
- STEYSKAL, G. C. 1980. The grammar of family-group names as exemplified by those of fishes. *Proc. Biol. Soc. Wash.* 93:168–177.
- STIASSNY, M. L. J. 1981. The phyletic status of the family Cichlidae

- (Pisces, Perciformes): A comparative anatomical investigation. *Neth. J. Zool.* 31(2):275-314.
- STRASBURG, D. W. 1960. A new Hawaiian engraulid fish. *Pac. Sci.* 14: 395-399.
- . 1961. Larval carapid fishes from Hawaii, with remarks on the ecology of adults. *Copeia* 1961:478-480.
- . 1962. Pelagic stages of *Zanclus canescens* from Hawaii. *Copeia* 1962:344-345.
- . 1964. Postlarval scombroid fishes of the genera *Acanthocybium*, *Nealotus* and *Diplospinus* from the Central Pacific Ocean. *Pac. Sci.* 18:174-185.
- . 1965. Description of the larva and familial relationships of the fish *Snyderidia canina*. *Copeia* 1965:20-24.
- STROUD, G. J., B. GOLDMAN, F. H. TALBOT AND W. GLADSTONE. MS. Development, growth and age determination of the short-nosed pufferfish *Canthigaster valentini* (Pisces: Tetraodontidae).
- STRUHSAKER, P., AND J. H. UCHIYAMA. 1976. Age and growth of the nehu *Stolephorus purpureus* (Pisces: Engraulidae) from the Hawaiian Islands as indicated by daily growth increments of sagittae. *Fish. Bull. U.S.* 74:9-17.
- SUAREZ, S. S. 1975. The reproductive biology of *Ogilbia cayorum*, a viviparous brotulid fish. *Bull. Mar. Sci.* 25:143-173.
- SUDARSAN, D. 1968a. On the early development of the pipe-fish *Syngnathoides biaculeatus* (Bloch). *J. Mar. Biol. Assoc. India* 8:222-224.
- SUDARSAN, D. 1968b. Eggs and larvae of a hemirhamphid fish from Mandapam. *J. Mar. Biol. Assoc. India* 8:342-346.
- SULAK, K. J. 1977. The systematics and biology of *Bathypterois* (Pisces, Chlorophthalmidae) with a revised classification of benthic myctophiform fishes. *Galathea Rep.* 14:49-108.
- SULYA, L. L., B. E. BOX AND G. GUNTER. 1960. Distribution of some blood constituents in fishes from the Gulf of Mexico. *Am. J. Physiol.* 199:1177-1180.
- SUMIDA, B., E. H. AHLSTROM AND H. G. MOSER. 1979. Early development of seven flatfishes of the eastern North Pacific with heavily pigmented larvae (Pisces, Pleuronectiformes). *Fish. Bull. U.S.* 77: 105-145.
- , AND H. G. MOSER. 1980. Food and feeding of Pacific hake larvae, *Merluccius productus*, off southern California and northern Baja California. *Calif. Coop. Oceanic Fish. Invest. Rep.* 21:161-171.
- SUNNY, K. G. 1971. Morphology of the vertebral column of *Mugil macrolepis* (Smith). *Bull. Dep. Mar. Biol. Oceanogr. Univ. Cochín* 5:101-108.
- SUZUKI, K. 1962. Anatomical and taxonomical studies on the carangid fishes of Japan. *Rep. Fac. Fish. Prefect. Univ. Mie* 4(2):43-232.
- , AND S. HIOKI. 1978. Spawning behavior, eggs, and larvae of the sea bream, *Gymnocranius griseus*, in an aquarium. *Jpn. J. Ichthyol.* 24:271-277.
- , AND ———. 1979a. Morphology and phyletic aspects of the newly hatched larvae, with special references to those of family Serranidae. *Kaiyo Kagaku (Mar. Sci.)* 11:117-125. (In Japanese).
- , AND ———. 1979b. Spawning behavior, eggs, and larvae of the lutjanid fish, *Lutjanus kasmira*, in an aquarium. *Jpn. J. Ichthyol.* 26:161-166.
- , ———, K. KOBAYASHI AND Y. TANAKA. 1981. Developing eggs and early larvae of the wrasses, *Cirrhitilabrus temminckii* and *Labroides dimidiatus*, with a note on their spawning behaviors. *J. Fac. Mar. Sci. Technol. Tokai Univ.* 14:369-372. (In Japanese, English Abstr.)
- , ———, Y. TANAKA AND K. IWASA. 1979. Spawning behaviour, eggs, larvae, and sex reversal of two Pomacanthine fish, *Gemcanthus lemarek* and *G. semifasciatus*, in the aquarium. *J. Fac. Mar. Sci. Technol. Tokai Univ.* 12:149-165.
- , K. KOBAYASHI, S. HIOKI AND T. SAKAMOTO. 1974. Ecological studies of the anthiine fish *Sacura margaritacea* in Suruga Bay. *Jpn. J. Ichthyol.* 21:21-33.
- , ———, ——— AND ———. 1978. Ecological studies of the anthiine fish, *Franzia squamipinnis* in Suruga Bay, Japan. *Jpn. J. Ichthyol.* 25:124-140. (In Japanese, English abstract.)
- , ———, ——— AND ———. In press. Ecological studies of the anthiine fish, *Pseudanthias elongatus*, in Suruga Bay, Japan.
- , H. SYOZO, Y. TANAKA AND H. KITAZAWA. 1983. Spawning and early life history of *Hapalogenys mucronatus* (Eydoux et Souleyet) (Pisces: Pomadasyidae) in an aquarium. *J. Fac. Mar. Sci. Technol. Tokai Univ.* 16:183-191.
- , Y. TANAKA AND S. HIOKI. 1980. Spawning behaviour, eggs, and larvae of the butterflyfish, *Chaetodon nippon*, in an aquarium. *Jpn. J. Ichthyol.* 26:334-341.
- , ———, ——— AND Y. SHIOBARA. 1980. Studies on reproduction and larval rearing of coastal marine fishes, p. 53-82. *In: Research in a large-scale culture of marine fisheries resources*. G. Yamamoto (ed.). Inst. Oceanic Res. and Dev., Tokai Univ., Shimizu. (In Japanese.)
- , ———, ——— AND S. UENO. 1981. Spawning behavior and early life history of *Hypodytes rubripinnis* (Pisces: Congiopodidae) in an aquarium. *J. Fac. Oceanogr. Tokai Univ.* 14:357-367.
- SUZUKI, R. 1955. Note on the interfamilial hybrid larvae between mud loach (*Misgurnus anguillicaudatus*) and Crucian carp (*Carassius carassius*) or goldfish (*Carassius auratus*). *Jpn. J. Ichthyol.* 4:50-58.
- . 1968. Hybridization experiments in cyprinid fishes. XI. Survival rate of F₁ hybrids with special reference to the closeness of taxonomical position of combined fishes. *Bull. Freshwater Fish. Res. Lab. (Tokyo)* 18(2):113-155.
- SVERDRUP, H. U., M. W. JOHNSON AND R. H. FLEMING. 1942. The Oceans. Their physics, chemistry, and general biology. Prentice-Hall, Inc., Englewood Cliffs, NJ.
- SVETOVIDOV, A. N. 1937. Über die Klassifikation der Gadiformes oder Anacanthini. *Bull. Acad. Sci. URSS*, p. 1281-1288.
- . 1948. Treskoobraznye (Gadiformes). *Akad. Nauk SSSR, Zool. Inst., Fauna SSSR* 9(4), N.S. 34. (In Russian, transl. by Isr. Program Sci. Transl., 1962. Avail. from: NTIS, Springfield, VA., OTS 63-11071.)
- . 1956. Morphological principles of the classification of the Gadidae. *Proc. Int. Congr. Zool.* 14(1953):535-540.
- . 1963. Fauna of U.S.S.R. Fishes. Vol. 2, No. 1. Clupeidae. Transl. from Russian by Isr. Program Sci. Transl. OTS 61-11435. (First published in 1952, *Zool. Inst. Akad. Nauk SSSR, N.S.* 48.)
- . 1969. On the taxonomical position of the genus *Eulichthys* (Pisces, Gadiformes). *Zool. Zh.* 48:1824-1831.
- . 1982. Taxonomic differences between red hake, *Urophycis chuss*, and *U. tenuis* (Gadidae). *J. Ichthyol. (Engl. Transl. Vopr. Ikhtiol.)* 22(3):150-153.
- SWARUP, H. 1958. Stages in the development of the stickleback *Gasterosteus ocellatus* (L.). *J. Embryol. Exp. Morphol.* 6(3):373-383.
- TAKAGI, K. 1950. On the glossohyal bone of the gobioid fishes of Japan, with some phylogenetic considerations. *Jpn. J. Ichthyol.* 1:37-52. (In Japanese.)
- . 1953. A study on the scale of the gobioid fishes of Japan. *J. Tokyo Univ. Fish.* 39:231-253.
- . 1966. Distributions and ecology of the gobioid fishes in the Japanese waters. *J. Tokyo Univ. Fish.* 52:83-127.
- TAKAI, T., AND T. FUKUNAGA. 1971. The life history of a ovo-viviparous scorpaenoid fish, *Sebastes longispinus* (Matsubara). 1. Egg and larval stages. *J. Shimonoseki Univ. Fish.* 20:91-95.
- , AND A. MIZOKAMI. 1959. On the reproduction, eggs, and larvae of the pipefish, *Synagathus schlegelii* Kaup. *J. Shimonoseki Coll. Fish.* 8:85-89.
- , AND T. YOSHIOKA. 1979. The life history of the dragonet, *Callionymus beniteguri* in the Seto Inland Sea. 1. Egg, larva and juvenile. *J. Shimonoseki Univ. Fish.* 27:147-154.
- TAKITA, T. 1966. Egg development and larval stages of the small clupeoid fish, *Harengula zunasi* Bleeker and some information about the spawning and nursery in Ariake Sound. *Bull. Fac. Fish. Nagasaki Univ.* 21:171-179.
- . 1967. The spawning and early life history of the engraulid fish

- Coilia* sp. distributed in Ariake Sound. Bull. Fac. Fish. Nagasaki Univ. 23:107-122.
- . 1980. Embryonic development and larvae of three dragonets. Bull. Jap. Soc. Sci. Fish. 46:1-7.
- . 1983. Embryonic and larval development of the callionymid fish, *Callionymus calliste*. Jpn. J. Ichthyol. 29:441-445.
- , AND S. FUJITA. 1964. Egg development and prolarval stages of the turbot, *Pleuronichthys cornutus* (Temminck et Schlegel). Bull. Jpn. Soc. Sci. Fish. 30:613-618. (In Japanese, English summary.)
- , AND Y. DOTSU. 1967. Egg development and pro-larval stages of flatfish, *Verasper variegatus* (Temminck et Schlegel). Bull. Fac. Fish. Nagasaki Univ. 23:101-106.
- , AND E. OKAMOTO. 1979. Spawning behavior of the two dragonets, *Callionymus flagris* and *C. richardsoni* in the aquarium. Jpn. J. Ichthyol. 26:282-288.
- TALIEV, D. N. 1955. Bullheads and sculpins (Cottoidei) from Lake Baikal. Akad. Nauk. SSSR. (In Russian.)
- TALWAR, P. K. 1968. Studies on the biology of *Hemirhamphus marginatus* (Forsk.) (Hemirhamphidae-Pisces). J. Mar. Biol. Assoc. India 9:61-69.
- TANING, A. V. 1918. Mediterranean Scopelidae (*Saurus aulopus*, *Chlorophthalmus*, and *Myctophum*). Rep. Dan. Oceanogr. Exped. Mediterr. 2(A.7).
- . 1923. *Lophius*. Rep. Dan. Oceanogr. Exped. Mediterr. 2(A.10).
- . 1931. Postlarval stages of *Bathylagus* from the North Atlantic. Vidensk. Medd. Dansk. Naturhist. Foren. Kjobenhavn 92:269-274.
- . 1936. On the eggs and young stages of the halibut. Medd. Komm. Havunders. Ser. Fiskeri 10(4).
- . 1952. Experimental study of meristic characters in fishes. Biol. Rev. 27:169-193.
- . 1955. On the breeding areas of the swordfish (*Xiphias*). Deep-Sea Res. 3 (Suppl.):438-450.
- . 1961. Larval and postlarval stages of *Sebastes* species and *Helicolenus dactylopterus*. Rapp. P.V. Reun. Cons. Int. Explor. Mer 150:234-240.
- TARANETS, S. Y. 1941. On the classification and origin of the family Cottidae. Izv. Akad. Nauk SSSR Otd. Biol. 1941(3):427-447. (Translated from Russian, Univ. Brit. Columbia Mus. Contrib. 5.)
- TARANETS, A. Y. 1935. Brief survey of species of the genus *Porocottus*. Bull. Far Eastern Branch Acad. Sci. USSR 14:177-180.
- . 1937. Handbook for identification of fishes of Soviet, Far East and adjacent waters. Bull. Pac. Sci. Inst. Fish. Oceanogr. 11(11):1-200.
- TARP, F. H. 1952. A revision of the family Embiotocidae (the surfperches). Calif. Dep. Fish Game Fish Bull. 88:1-99.
- TAVOLGA, W. N. 1949. Embryonic development of the platyfish (*Platycoelilius*) and swordtail (*Xiphophorus*) and their hybrid. Bull. Am. Mus. Nat. Hist. 94:165-229.
- TAYLOR, J. N. 1983. Field observations on the reproductive ecology of three species of armored catfishes (Loricariidae: Loricariinae) in Paraguay. Copeia 1983:257-259.
- TAYLOR, M. N., L. DiMICHELE AND G. J. LEACH. 1977. Egg stranding in the life cycle of the mummichog, *Fundulus heteroclitus*. Copeia 1977:397-399.
- TAYLOR, W. R. 1964. Fishes of Arnhem Land. Rec. Am. Aust. Sci. Exped. Arnhem Land. 4:45-307.
- . 1967. An enzyme method of clearing and staining small vertebrates. Proc. U.S. Natl. Mus. 122(3596):1-17.
- . 1977. Observations on specimen fixation. Proc. Biol. Soc. Wash. 90:753-763.
- , AND G. C. VAN DYKE. MS. Staining and clearing small vertebrates for bone and cartilage study.
- TEMPLEMAN, W. 1948. The life history of the capelin, *Mallotus villosus* in Newfoundland waters. Res. Bull. Div. Fish. Res. Newfoundland 17:1-151.
- . 1968. A review of the morid fish genus *Halargyreus* with first records from the western North Atlantic. J. Fish. Res. Board Can. 25:877-901.
- TERNER, C. 1979. Metabolism and energy conversion, p. 261-278. In: Fish Physiology. Vol. 8. W. S. Hoar, D. J. Randall and J. R. Brett (eds.). Academic Press, New York.
- THANGARAJA, M., AND K. RAMAMOORTHY. 1980. Early life history of *Anadontostoma chacunda* (Ham.-Buch.) from Porto Novo. Indian J. Mar. Sci. 9:136-139.
- THEILACKER, G. H. 1978. Effect of starvation on the histological and morphological characteristics of jack mackerel *Trachurus symmetricus* larvae. Fish. Bull. U.S. 76:403-414.
- . 1980a. Changes in body measurements of larval northern anchovy *Engraulis mordax* and other fishes due to handling and preservation. Fish. Bull. U.S. 78:685-692.
- . 1980b. Rearing container size affects morphology and nutritional condition of larval jack mackerel, *Trachurus symmetricus*. Fish. Bull. U.S. 78:789-791.
- , AND K. DORSEY. 1980. Larval fish diversity, a summary of laboratory and field research. IOC Workshop Rep. No. 28:105-142.
- , AND M. F. McMASTER. 1971. Mass culture of the rotifer *Brachionus plicatilis* and its evaluation as a food for larval anchovies. Mar. Biol. 10:183-188.
- THIBAUT, R. E., AND R. J. SCHULTZ. 1978. Reproductive adaptation among viviparous fishes (Cyprinodontiformes: Pociiliidae). Evolution 32:320-332.
- THOMOPOULOS, A. 1954. Sur quelques oeufs planctoniques de téléostéens de la Baie de Villefranche. Bull. Inst. Oceanogr. (Monaco) 1043:1-15.
- . 1956. Sur quelques oeufs planctoniques de téléostéens de la Baie de Villefranche. II. Pêches de mois de Septembre. Bull. Inst. Oceanogr. Monaco 1072.
- THOMPSON, W. 1840. On a new genus of fishes from India. Charlesworth's Mag. Nat. Hist. 4:184-187.
- THOMPSON, W. F. 1916. Fishes collected by the United States Bureau of Fisheries steamer "Albatross" during 1888, between Montevideo, Uruguay, and Tome, Chile, on the voyage through the Straits of Magellan. Proc. U.S. Natl. Mus. 50(2133):401-476.
- , AND J. B. THOMPSON. 1919. The spawning of the grunion (*Leuresthes tenuis*). Calif. Fish Game Fish Bull. 3:1-29.
- , AND R. VAN CLEVE. 1936. Life history of the Pacific halibut. 2. Distribution and early life history. Rep. Int. Fish. Comm. 9.
- , F. H. BELL, H. A. DUNLOP, L. P. SCHULTZ AND R. VAN CLEVE. 1936. The spawning of the silver smelt *Hypomesus pretiosus*. Ecology 17:158-168.
- THOMSON, G. M. 1906. The Portobello marine fish-hatchery and biological station. Trans. N.Z. Inst. 38 (Art. 61):1-31.
- , AND T. ANDERTON. 1921. History of the Portobello Marine Fish-Hatchery and Biological Station. Bull. Board Sci. Art N.Z. No. 2.
- THOMSON, J. M. 1954. The Mugilidae of Australia and adjacent seas. Aust. J. Mar. Freshwater Res. 5:70-131.
- . 1966. The grey mullets. Oceanogr. Mar. Biol. Annu. Rev. 4: 301-355.
- . 1975. The dentition of grey mullets. Aquaculture 5:100. (Abstract.)
- . 1982. The taxonomy of grey mullets, p. 1-63. In: Aquaculture of grey mullets. O. H. Oren (ed.). Cambridge Univ. Press, Cambridge.
- , AND A. E. BENNETT. 1953. The oyster blenny, *Omobranchus anchus* (Valenciennes) (Blenniidae). Aust. J. Mar. Freshwater Res. 4:227-233.
- THORP, C. H. 1969. A new species of mirapinniform fish (family Kasidoridae) from the western Indian Ocean. J. Nat. Hist. 3:61-70.
- THORSTEINSSON, V. 1981. The aging validation of the lumpsucker (*Cyclopterus lumpus*) and the age composition of the lumpsucker in Icelandic lumpsucker fisheries. Int. Counc. Explor. Sea C.M. 1981/G58.
- THRESHER, R. E., AND E. B. BROTHERS. In press. Reproductive ecology and biogeography of Indo-west Pacific angelfishes. (Pisces: Pomacanthidae). Evolution.

- TIN, H. T. 1982a. Family Clupeidae, herrings, p. 64-73. *In*: Identification of larval fishes of the Great Lakes basin with emphasis on the Lake Michigan drainage. N. A. Auer (ed.). Great Lakes Fish. Comm. Spec. Publ. 82-3, Ann Arbor, MI.
- . 1982b. Family Osmeridae, smelts, p. 146-151. *In*: Identification of larval fishes of the Great Lakes basin with emphasis on the Lake Michigan drainage. N. A. Auer (ed.). Great Lakes Fish. Comm. Spec. Publ. 82-3, Ann Arbor, MI.
- . 1982c. Family Ictaluridae, bullhead catfishes, p. 436-457. *In*: Identification of larval fishes of the Great Lakes basin with emphasis on the Lake Michigan drainage. N. A. Auer (ed.). Great Lakes Fish. Comm. Spec. Publ. 82-3, Ann Arbor, MI.
- TOKUYA, K., AND K. AMAOKA. 1980. Studies on larval and juvenile blennies in the coastal waters of southern Hokkaido. Bull. Fac. Fish. Hokkaido Univ. 31(1):16-49.
- TOMINAGA, Y. 1965. The internal morphology and systematic position of *Leptobrama mulleri*, formerly included in the family Pempheridae. Jpn. J. Ichthyol. 12:33-56.
- TONG, L. J., AND R. SAITO. 1977. Further postlarvae of the tarakihi in New Zealand waters. N.Z. J. Mar. Freshwater Res. 11:159-162.
- TORNO, A. E., A. P. TOMO AND E. MARSCHOFF. 1977. Una nueva especie del genero *Oidiphorus* McAllister y Rees (Pisces, Zoarcidae) capturado en la adyacencia de las Islas Sandwich del Sur. Contrib. Inst. Antarct. Argent. 223:1-10.
- TORTONESE, E. 1956. Plectognathi, p. 960-977. *In*: Uova, larve e stadi giovanili di Teleostei. Fauna Flora Golfo Napoli Monogr. 38.
- . 1973. Serranidae, p. 355-362. *In*: Checklist of the fishes of the north-eastern Atlantic and of the Mediterranean. J. C. Hureau and Th. Monod (eds.). UNESCO, Paris.
- TOWNSEND, D. W., AND J. J. GRAHAM. 1981. Growth and age structure of larval Atlantic herring, *Clupea harengus*, in the Sheepscot River estuary, Maine, as determined by daily growth increments in otoliths. Fish. Bull. U.S. 79:123-130.
- TOYOSHIMA, M. 1981. Redescription of the zoarcid fish *Lyczoarces regani*. Jpn. J. Ichthyol. 27:296-300.
- TRANter, D. J. (ed.). 1968. Zooplankton sampling. UNESCO Monogr. Oceanogr. Methodol. 2.
- TREWAVAS, E. 1932. A contribution to the classification of the fishes of the order Apodes, based on the osteology of some rare eels. Proc. Zool. Soc. Lond. 1932:639-659.
- TROEMNER, J. L. 1932. Recent importations-*Fundulus cubensis*. Aquarium, Philadelphia 1(3):70, 82.
- . 1941. *Cubanichthys cubensis* Eigenmann. Aquarium, Philadelphia 10(8):129-130.
- TROTT, L. B. 1970. Contributions to the biology of carapid fishes (Paracanthopterygii: Gadiformes). Univ. Calif. Publ. Zool. 89:1-60.
- . 1981. A general review of the pearlfishes (Pisces, Carapidae). Bull. Mar. Sci. 31:623-629.
- TRUNOV, I. A. 1981. *Parakumba maculisquama* (New genus and species) family Macrouridae from the South Atlantic. J. Ichthyol. (Engl. Trans. Vopr. Ikhti.) 21(1):27-34.
- . 1982. Species of the family Regalecidae (Lampriformes) from the Southeastern Atlantic Ocean. J. Ichthyol. (Engl. Transl. Vopr. Ikhti.) 22(1):1-6.
- TSINOVSKY, V. D., AND I. A. MEL'NIKOV. 1980. On the discovery of *Liparis koefoedi* (Liparidae, Osteichthyes) in the waters of the central Arctic Basin, p. 211-214. *In*: Biology of the Central Arctic Basin. Nauka Publ., Moscow.
- TSOKUR, A. G. 1975. Data on the development of the Malayan Headlight fish, *Diaphus malayanus* (Myctophidae, Pisces). J. Ichthyol. (Engl. Transl. Vopr. Ikhti.) 15:611-622.
- . 1977. Larvae of carangid fishes (Carangidae, Pisces) of the Arabian Sea. *In*: Ichthyoplankton of tropical waters of the world ocean. Acad. Sci. U.S.S.R., Proc. P. P. Shirshov Inst. Oceanol. 109: 149-227. (In Russian.)
- . 1981. The larvae of *Benthosema pterota* (Alcock, 1891) Myctophidae, from the Arabian Sea. J. Ichthyol. (Engl. Transl. Vopr. Ikhti.) 21(3):38-53.
- TSUKAHARA, H. 1961. Biology of the cutlassfish, *Trichiurus lepturus* Linnaeus. Part 1. Early life history. Rec. Oceanogr. Works Jpn. Spec. No. 5:117-121.
- . 1962. Studies on habits of coastal fishes in the Amakusa Islands. Part 2. Early life history of the rockfish, *Sebastes marmoratus* (Cuvier and Valenciennes). Rec. Oceanogr. Works Jpn., Spec. No. 6:49-55.
- , AND T. SHIOKAWA. 1957. Studies on the flying-fishes of the Amakusa Islands. Part 2. The life history and habits of *Parexocoetus mento* (Cuvier et Valenciennes). Sci. Bull. Fac. Agri. Kyushu Univ. 16(2):275-286. (In Japanese, English summary.)
- TUCKER, D. W. 1954. Report on the fishes collected by S. Y. "Rosaura" in the North and Central Atlantic, 1937-38. Part IV. Families Carcharhinidae, Torpedinidae, Rosauridae (nov.), Salmonidae, Alepocephalidae, Searsidae, Clupeidae. Bull. Br. Mus. (Nat. Hist.) 2(6):163-214.
- . 1956. Studies on the Trichiuroid fishes. 3. A preliminary revision of the family Trichiuridae. Bull. Brit. Mus. (Nat. Hist.) Zool. 4(3):73-130.
- TUCKER, J. W., JR. 1982. Larval development of *Citharichthys cornutus*, *C. gymnorhinus*, *C. spilopterus*, and *Etropus crossotus* (Bothidae), with notes on larval occurrence. Fish. Bull. U.S. 80:35-73.
- , AND A. J. CHESTER. In press. Effects of salinity, formalin concentration, and buffer on quality of preservation of southern flounder (*Paralichthys lethostigma*) larvae. Copeia.
- TUNG, I.-H. 1973. On the egg development and larval stages of the grey mullet, *Mugil cephalus* Linnaeus. Rep. Inst. Fish. Biol. Taipei 3(1):187-210. (In Chinese, English summary.)
- TURNER, C. H., AND E. E. EBERT. 1962. The nesting of *Chromis punctipinnis* (Cooper) and a description of their eggs and larvae. Calif. Fish Game 48(4):243-248.
- TURNER, C. L. 1937. Reproductive cycles and superfetation in poeciliid fishes. Biol. Bull. (Woods Hole) 72:145-164.
- . 1940a. Superfetation in viviparous cyprinodont fishes. Copeia 1940:88-91.
- . 1940b. Pseudoamion, pseudochorion and follicular pseudoplacenta in poeciliid fishes. J. Morphol. 67:59-89.
- . 1940c. Follicular pseudoplacenta and gut modifications in anablepid fishes. J. Morphol. 67:91-105.
- . 1940d. Adaptations for viviparity in jennynsiid fishes. J. Morphol. 67:291-297.
- TYLER, J. C. 1968. A monograph on plectognath fishes of the superfamily Triacanthoidea. Monogr. Acad. Nat. Sci. Phila. 16.
- . 1970. Osteological aspects of interrelationships of surgeonfish genera (Acanthuridae). Proc. Acad. Nat. Sci. Phila. 122(2):87-124.
- . 1980. Osteology, phylogeny, and higher classification of the fishes of the order Plectognathi (Tetraodontiformes). NOAA Tech. Rept. NMFS Circ. 434.
- , I. NAKAMURA AND B. B. COLLETTE. MS. Osteology and relationships of the oceanic fish *Luvarus imperialis* (Luvaridae): an acanthuroid, not a scombroid.
- UCHIDA, K. 1933. Studies on the early life history of Japanese Heterosomata. II. *Verasper variegatus*. Zool. Soc. Jpn. 45:268-277.
- . 1936. A note on the pelagic postlarval stages of *Antigonia rubescens* (Pisces, Capriiformes). Zool. Mag. (Tokyo) 48:935-939.
- , Y. DOTSU, S. MITO AND K. NAKAHARA. 1958. The spawning and early life history of "Buri" Japanese yellowtail, *Seriola quinqueradiata* Temminck et Schlegel. Sci. Bull. Fac. Agric. Kyushu Univ. 16(3):329-342.
- , S. IMAI, S. MITO, S. FUJITA, M. UENO, Y. SHOJIMA, T. SENTA, M. TAHUKA AND Y. DOTSU. 1958. Studies on the eggs, larvae, and juveniles of Japanese fishes. Series 1. Second Laboratory of Fisheries Biology. Fish. Dep., Fac. Agric. Kyushu Univ., Fukuoka, Japan. (In Japanese.)
- UENO, M., AND S. FUJITA. 1954. On the development of the egg of *Sillago sihama* (Forsk.) Jpn. J. Ichthyol. 3:118-120. (In Japanese, English summary.)
- , AND ———. 1958. Eggs, larvae, and juveniles of *Platycephalus indicus* (Linné) (Platycephalidae), p. 86. *In*: Studies on the

- eggs, larvae and juveniles of Japanese fishes. K. Uchida et al., (eds.). Fac. Agric. Kyushu Univ., Fukuoka, Japan. (In Japanese.)
- UENO, T. 1970. Fauna Japonica: Cyclopteridae (Pisces). Academic Press of Japan, Tokyo.
- UEYANAGI, S. 1963a. Methods for identification and discrimination of the larvae of five istiophorid species distributed in the Indo-Pacific. Rep. Nankai Reg. Fish. Res. Lab. (17):137-151. (In Japanese, English summary.)
- . 1963b. A study of the relationships of the Indo-Pacific istiophorids. Rep. Nankai Reg. Fish. Res. Lab. (17):151-165. (In Japanese, English summary.)
- . 1974a. On an additional diagnostic character for the identification of billfish larvae with some notes on the variations in pigmentation, p. 73-78. In: Proc. Internatl. Billfish Symp., Kailua-Kona, Hawaii, 9-12 August 1972. Part 2. Review and contributed papers. R. S. Shomura and F. Williams (eds.). NOAA Tech. Rep. NMFS SSRF 675.
- . 1974b. Present state of billfish larval taxonomy, p. 649-654. In: The early life history of fish. J. H. S. Blaxter (ed.). Springer-Verlag, Berlin.
- , Y. NISHIKAWA AND T. MATSUOKA. 1974. Artificial fertilization and larval development of skipjack tuna, *Katsuwonus pelamis*. Bull. Far Seas Fish. Res. Lab. (Shimizu) 10:179-188.
- , AND M. OKIYAMA. 1979. Morphology and phylogeny of fish larvae - scombroids. Kaiyo Kagaku (Mar. Sci.) 11:93-99. (In Japanese.)
- UKAWA, M., M. HIGUCHI, AND S. MITO. 1966. Spawning habits and early life history of a serranid fish, *Epinephelus akaara* (Temminck et Schlegel). Jpn. J. Ichthyol. 13:156-161.
- UMEDA, S., AND A. OCHIALI. 1975. On the histological structure and function of digestive organs of the fed and starved larvae of the yellowtail, *Seriola quinqueradiata*. Jpn. J. Ichthyol. 21:213-219.
- UTTER, F. M. 1981. Biological criteria for definition of species and district intraspecific populations of anadromous salmonids under the U.S. Endangered Species Act of 1973. Can. J. Fish. Aquat. Sci. 38:1626-1635.
- VAN DER VEER, J. 1982. Simple and reliable methods for the fixation, mounting and staining of small and delicate marine plankton for light microscopic identification. Mar. Biol. (Berl.) 66:9-14.
- VARIKUL, V., AND C. BOONSOM. 1969. Illustrations of the gross egg and larval development of Pla Swai *Pangastius suchi* Fowler. Indo-Pac. Fish. Council. Occas. Pap. 14:1-4.
- VATANACHI, S. N. 1972. The identification of fish eggs and fish larvae obtained from the survey cruises in the South China Sea. Proc. 15 Session Indo-Pac. Fish. Council., FAO, Bangkok.
- VENKATARAMANUJAN, K., AND K. RAMANORTHY. 1981. Fish eggs of Porto Novo coastal waters, east coast of India. Rapp. P. V. Reun. Cons. Int. Explor. Mer 178:597-599.
- VERGARA, R. 1972. Analisis taxonomico y consideraciones filogeneticas sobre las especies Cubanas del genero *Caranx* (Teleostei, Perciformes, Carangidae). Cent. Invest. Pesq. Cuba, Contrib. 34.
- . 1974. Estudio fenetico de los Carangidos Cubanos. (Pisces, Teleostei). Acad. Cienc. Cuba Ser. Oceanogr. 23:1-30.
- VIALLI, M. 1937. Famiglia 2: Mugilidae, p. 433-456. In: Uova, larve e stadi giovanili di Teleostei. Fauna Flora Golfo Napoli Monogr. 38.
- . 1956. Famiglia 3: Sphraenidae, p. 457-461. In: Uova, larve e stadi giovanili di Teleostei. Fauna Flora Golfo Napoli Monogr. 38.
- VICTOR, B. C. 1982. Daily growth increments and recruitment in two coral-reef wrasses, *Thalassoma bifasciatum* and *Halichoeres bivittatus*. Mar. Biol. (Berl.) 71:203-208.
- . 1983. Recruitment and population dynamics of a coral-reef fish. Science (Wash. D.C.) 219:419-420.
- , AND E. B. BROTHERS. 1982. Age and growth of the fallfish *Semotilus corporalis* with daily otolith increments as a method of annulus verification. Can. J. Zool. 60:2543-2550.
- VIJAYARAGHAVAN, P. 1957. Studies on fish-eggs and larvae of Madras coast. PhD thesis submitted to Univ. Madras, India.
- . 1958. Studies on fish eggs and larvae of Madras Coast. Univ. Madras, G. S. Press.
- . 1973. Studies on fish eggs and larvae from Indian waters. 1. Development of egg and larvae of *Hirundichthys (Hirundichthys) coromandelensis* (Hornell). Indian J. Fish. 20(1):108-137.
- . 1975. Studies on fish eggs and larvae from Indian waters. 3. Development of egg and early larva of *Cypselurus spilopterus* (Cuvier and Valenciennes). Indian J. Fish. 21(1):211-219.
- VILELA, M. H., AND J. J. ZIJLSTRA. 1971. On the condition of herring larvae in the central and southern North Sea. Rapp. P. V. Reun. Cons. Int. Explor. Mer 160:137-141.
- VILLADOLID, D. V., AND P. R. MANACOP. 1934. The Philippine Phallostethidae, a description of a new species, and a report on the biology of *Gullaphallus mirabilis* Herre. Philipp. J. Sci. 55:193-220.
- VILLWOCK, W. 1960. Über Bastarde zwischen Angehörigen zweier Subfamilien oviparer Zahnkarpfen (Microcyprini, Cyprinodontidae). Zool. Anz. 165(9-10):349-352.
- VINAGRAOV, K. A. 1950. Biology of the Pacific lumpfishes in Kamchatka waters. Priroda 39(3):69-70.
- VLADYKOV, V. D. 1970. Pearl tubercles and certain cranial peculiarities useful in the taxonomy of coregonid genera., p. 167-193. In: Biology of coregonid fishes. C. C. Lindsey and C. S. Woods (eds.). Univ. Manitoba Press, Winnipeg.
- VLYMEN, W. J. 1977. A mathematical model of the relationship between larval anchovy (*Engraulis mordax*) growth, prey, microdistribution, and larval behavior. Environ. Biol. Fishes 2:211-233.
- VODYANITSKY, V. A., AND I. I. KAZANOVA. 1954. Key to the pelagic fish eggs and larvae of the Black Sea. Tr. Vses. Nauchno-Issled. Inst. Morsk. Rybn. Khoz. Okeanogr. 28:240-345. (In Russian.)
- VON IHERING, R., J. DE CAMARGO B. AND N. PLANET. 1928. Os ovos e a desova dos peixes d'agua doce do Brasil. Bol. Biol. 14:97-109.
- VON WESTERNHAGEN, H. 1974. Observations on the natural spawning of *Alectis indicus* (Ruppell) and *Caranx ignobilis* (Forsk.) (Carangidae). J. Fish Biol. 6:513-516.
- , AND ———. 1975. Rearing and spawning siganids (Pisces: Teleostei) in a closed seawater system. Helgol. Wiss. Meeresunters. 27:1-18.
- , AND H. ROSENTHAL. 1976. Induced multiple spawning of reared *Siganus oramin* (Schneider) (= *S. canaliculatus* Park). Aquaculture 7:193-196.
- VOOREN, C. M. 1972. Postlarvae and juveniles of the tarakihi (Teleostei: Cheilodactylidae) in New Zealand. N.Z. J. Mar. and Freshwater Res. 6:602-618.
- VOSS, N. A. 1954. The postlarval development of the fishes of the family Gempylidae from the Florida Current. I. *Nesiarchus nasutus* Johnson and *Gempylus* Cuv. and Val. Bull. Mar. Sci. Gulf Caribb. 4:120-159.
- . 1957. Fishes of the family Gempylidae collected by the Bermuda Oceanographic Expeditions 1929, 1930, 1931 and 1934. Copeia 1957:304-305.
- VRAT, V. 1949. Reproductive behavior and development of eggs of the three-spined stickleback (*Gasterosteus aculeatus*) of California. Copeia 1949:252-260.
- WADE, C. B. 1946. New fishes in the collections of the Allan Hancock Foundation. Allan Hancock Found. Pac. Exped. 9(8):215-237.
- WADE, R. A. 1962. The biology of the tarpon, *Megalops atlanticus*, and the ox-eye, *Megalops cyprinoides*, with emphasis on larval development. Bull. Mar. Sci. Gulf Caribb. 12:545-622.
- WAKE, M. H. 1979. Hyman's comparative anatomy. 3rd ed. Univ. Chicago Press, Chicago.
- WAKIYA, Y., AND N. TAKAHASHI. 1913. Study on fishes of the family Salangidae. J. Coll. Agric. Univ. Tokyo 14:265-295.
- WALDRON, K. D. 1968. Early larvae of the canary rockfish, *Sebastes pinniger*. J. Fish. Res. Board Can. 25:801-803.
- , AND B. M. VINTER. 1978. Ichthyoplankton of the eastern Bering Sea. Unpubl. Rep., Northwest Alaska Fish. Cent., Seattle.
- WALKER, B. W. 1952. A guide to the grunion. Calif. Fish Game 38:409-420.

- WALLACE, J., AND R. VAN DER ELST. 1973. Identification of juvenile mullet. *Bull. S. Afr. Assoc. Mar. Biol. Res.* 10:26-27.
- WALLUS, R. 1981. Early development of the mooneye, *Hiodon tergisus* LeSueur, with discussion of larval hiodontid taxonomy. *Rapp. P.V. Reun. Cons. Int. Explor. Mer* 178:583-584.
- , AND K. L. GRANNEMANN. 1979. Spawning behavior and early development of the banded sculpin *Cottus caroliniae* (Gill), 199-235. *In: Proceedings of a workshop on freshwater larval fishes.* R. Wallus and C. W. Voiglander (eds.). Tennessee Valley Authority, Norris, TN.
- WALTERS, V. 1960. Synopsis of the lampriform suborder Veliferoidei. *Copeia* 3:245-247.
- . 1961. A contribution to the biology of the Giganturidae with the description of a new genus and species. *Bull. Mus. Comp. Zool.* 125(10):297-319.
- . 1963. The trachipterid integument and an hypothesis on its hydrodynamic function. *Copeia* 1963:260-270.
- . 1964. Order Giganturoidei, p. 566-577. *In: Fishes of the western North Atlantic.* Mem. Sears Found. Mar. Res. No. 1(Pt. 4):566-577.
- , AND J. E. FITCH. 1960. The families and genera of the Lampridiform (Allotriognath) suborder Trachipteroidei. *Calif. Fish Game* 46:441-451.
- , AND ———. 1964. The ribbonfishes (family Trachipteridae) of the eastern Pacific Ocean with a description of a new species. *Calif. Fish Game* 50:228-240.
- WANG, J. C. 1981. Taxonomy of the early life stages of fishes—fishes of the Sacramento-San Joaquin Estuary and Moss Landing Harbor-Elkhorn Slough, California. Ecological Analysts, Inc., Concord, CA.
- WANG, J. C. S., AND R. J. KERNEHAN. 1979. Fishes of the Delaware estuaries, a guide to the early life histories. Ecological Analysts, Inc., Towson, MD.
- WARD, J. W. 1957. The reproduction and early development of the sea catfish, *Galeichthys felis*, in the Biloxi (Mississippi) Bay. *Copeia* 1957:295-298.
- WASHINGTON, B. B. 1981. Identification and systematics of larvae of *Artemis*, *Clinocottus*, and *Oligocottus* (Scorpaeniformes: Cottidae). Unpubl. MS thesis. Oregon State Univ., Corvallis.
- , AND S. L. RICHARDSON. MS. Systematic relationships among cottid fishes based on developmental osteology with notes on their allies. Gulf Coast Res. Lab., Ocean Springs, MS.
- WASSERSUG, R. J., AND R. K. JOHNSON. 1976. A remarkable pyloric caecum in the evermannellid genus *Coccorella* with notes on gut structure and function in the alepisaurid fishes (Pisces: Myctophiformes). *J. Zool. (Lond.)* 179:273-289.
- WATANABE, H., M. YUKINAWA, S. NAKAZAWA AND S. UYANAGI. 1966. On the larvae probably referable to slender tuna, *Allothunnus fallai* Serventy. *Rep. Nankai Reg. Fish. Res. Lab.* 23:85-94. (In Japanese, English summary.)
- WATANABE, M. 1960. Fauna Japonica Cottidae. Biogeographical Society of Japan, Tokyo.
- . 1976. Studies on the sculpin of Japan and its adjacent waters. *Bull. Watanabe Ichthyol. Inst.* No. 1.
- WATLING, H., AND C. J. D. BROWN. 1955. The embryological development of the American grayling (*Thymallus signifer tricolor*) from fertilization to hatching. *Trans. Am. Microsc. Soc.* 74:85-93.
- WATSON, M. E., AND F. J. MATHER, III. MS. Species identification of juvenile tunas (genus *Thunnus*) from the Straits of Messina, north-western Atlantic and the Gulf of Mexico. Manuscript distributed for information in connection with the informal Pacific Tuna Biology Conference, Honolulu, August 1961.
- WATSON, W. 1974. Diel changes in the vertical distributions of some common fish larvae in southern Kaneohe Bay, Oahu, Hawaii. Unpubl. MS thesis. Univ. Hawaii, Honolulu.
- . 1982. Development of eggs and larvae of the white croaker, *Genyonemus lineatus* Ayres (Pisces: Sciaenidae) off the southern California coast. *Fish. Bull.* U.S. 80:403-417.
- , AND J. M. LEIS. 1974. Ichthyoplankton of Kaneohe Bay, Hawaii: a one-year study of the fish eggs and larvae. Univ. Hawaii Sea Grant College Program, Honolulu, Tech. Rep. UNIHI-SEA-GRANT-TR-75-01.
- WEBER, M. 1913. Die Fische. *Siboga Exped.* 57:1-710.
- , AND L. F. DE BEAUFORT. 1922. The fishes of the Indo-Australian archipelago. Vol. 4. E. J. Brill, Leiden.
- , AND ———. 1936. The fishes of the Indo-Australian Archipelago. Vol. 7. E. J. Brill, Leiden.
- WEIHS, D., AND H. G. MOSER. 1981. Stalked eyes as an adaptation towards more efficient foraging in marine fish larvae. *Bull. Mar. Sci.* 31:31-36.
- WEILER, W. 1968. Fossilium Catalogus I: Animalia, Otolithi piscium 117.
- WEISEL, G. F. 1967. Early ossification in the skeleton of the sucker (*Catostomus macrocheilus*) and the guppy (*Poecilia reticulata*). *J. Morphol.* 121:1-18.
- WEISS, G. 1974. Hallazgo y descripción de larvas de las polaca *Micromesistius australis* en aguas del sector Patagónico Argentino (Pisces, Gadidae) (Finding and description of larvae of *Micromesistius australis* in Patagonic waters of Argentina (Pisces, Gadidae). *Physis Secc. A Oceanos. Org.* 33(87):537-542.
- . 1975. Hallazgo, descripción y distribución de las postlarvas del bacalao criollo, *Sahlota australis* y del pez sable *Lepidopus caudatus* en aguas de la plataforma argentina. *Physis Secc. A Oceanos Org.* 34(89):319-325.
- WEITZMAN, S. H. 1967. The origin of the stomiatooid fishes with comments on the classification of salmoniform fishes. *Copeia* 1967:507-540.
- . 1974. Osteology and evolutionary relationships of the Sternopychidae, with a new classification of stomiatooid families. *Bull. Am. Mus. Nat. Hist.* 153(3):327-478.
- , AND W. L. FINK. 1983. Relationships of the neon tetras, a group of South American freshwater fishes (Teleostei, Characidae), with comments on the phylogeny of new world characiforms. *Bull. Mus. Comp. Zool.* 150:339-395.
- WELLINGS, S. R., AND G. A. BROWN. 1969. Larval skin of the flathead sole, *Hippoglossoides elassodon*. *Z. Zellforsch.* 100:167-179.
- WELSH, W. W., AND C. M. BREDER. 1921. A contribution to the life history of the puffer, *Spheroides maculatus* (Schneider). *Zoologica (N.Y.)* 2:261-276.
- WENNER, C. A. 1978. Making a living on the continental slope and in the deep-sea: life history of some dominant fishes of the Norfolk Canyon area. Unpubl. PhD dissertation. Coll. William and Mary, Williamsburg, VA.
- . 1979. Notes on fishes of the genus *Paraliparis* (Cyclopteridae) on the middle Atlantic continental slope. *Copeia* 1979:145-146.
- WERNER, R. C., AND J. H. S. BLAXTER. 1980. Growth and survival of larval herring (*Clupea harengus*) in relation to prey density. *Can. J. Fish. Aquat. Sci.* 37:1063-1069.
- WESTRHEIM, S. J. 1975. Reproduction, maturation, and identification of larvae of some *Sebastes* (Scorpaenidae) species in the northeast Pacific Ocean. *J. Fish. Res. Board Can.* 32:2399-2411.
- WHEELER, A. 1969. The fishes of the British Isles and north-west Europe. Macmillan, London.
- , AND J. DUNNE. 1975. *Tripterygion atlanticum* sp. nov. (Teleostei-Tripterygiidae) the first record of a tripterygiid fish in north-western Europe. *J. Fish Biol.* 7:639-649.
- , J. QUERO AND G. KREFFT. 1973. Zeomorphi (Zeiformes), p. 349-354. *In: Check list of the fishes of the north-eastern Atlantic and of the Mediterranean (Clofnam).* Vol. 1. J. C. Hureau and Th. Monod (ed.). Paris, UNESCO.
- WHITE, D. S. 1977. Early development and pattern of scale formation in the spotted sucker, *Minytrema melanops* (Catostomidae). *Copeia* 1977:400-403.
- WHITE, H. C. 1939. The nesting and embryo of *Zoarces anguillar*. *J. Fish. Res. Board Can.* 4:337-338.
- WHITE, M. W., A. W. NORTH, E. L. TWELVES AND S. JONES. 1982. Early development of *Notothenia neglecta* from the Scotia Sea, Antarctica. *Cybiurn*, 3rd Ser., 6(1):43-51.
- WHITEHEAD, P. J. P. 1964. A redescription of the holotype of *Clupalosa*

- bulan* Bleeker, and notes on the genera *Herklotsichthys*, *Sardinella* and *Escualosa* (Pisces: Clupeidae). Ann. Mag. Nat. Hist., Ser. 13, 7:33-47.
- . 1965. A new genus and subgenus of clupeid fishes and notes on the genera *Chupea*, *Sprattus* and *Clupeonella*. Ann. Mag. Nat. Hist. Ser. 13, 7(78):321-330.
- . 1972. A synopsis of the clupeoid fishes of India. J. Mar. Biol. Assoc. India 14:160-256.
- . 1973. The clupeoid fishes of the Guianas. Bull. Br. Mus. (Nat. Hist.) Zool. Suppl. 5:1-227.
- . 1981. Clupeidae. In: FAO species identification sheets for fishery purposes, Eastern Central Atlantic, Vol. 2: Fishing Areas 34, 47 (in part). W. Fischer, G. Bianchi and W. B. Scott, (eds.). Canada Funds-in-Trust. Ottawa, Department of Fisheries and Oceans Canada, by arrangement with FAO.
- WHITLEY, G. P. 1926. The biology of north-west Islet, Capricorn Group. (C.) Fishes. Aust. Zool. 4:227-236.
- . 1941. Ichthyological notes and illustrations. Aust. Zool. 10(1): 1-50.
- . 1945. New sharks and fishes from Western Australia. Part 2. Aust. Zool. 11:43-45.
- . 1948. Studies in ichthyology. 13. Rec. Aust. Mus. 22(1):70-94.
- , AND A. N. COLEFAX. 1938. Fishes from Nauru, Gilbert Islands, Oceania. Proc. Linn. Soc. N.S.W. 43(3-4):282-304.
- WICKLER, W. 1957. Die Larve von *Blennius shuivatlus* (Asso 1784). Biol. Zentralbl. 76:453-466. (In German.)
- . 1959. Weitere  tersuchungen  ber Haftfaden an Teleosteeriern, speziell an *Cyprinodon variegatus* Lacepede 1803. Zool. Anz. 163:90-107.
- WILEY, E. O. 1981. Phylogenetics, the theory and practice of phylogenetic systematics. John Wiley & Sons, New York.
- WILLIAMS, F. 1959. The barracudas (genus *Sphyræna*) in British East African waters. Ann. Mag. Nat. Hist., Ser. 2, 13:92-128.
- WILLIAMS, G. C., S. W. RICHARDS AND E. G. FARNSWORTH. 1964. Eggs of *Ammodytes hexapterus* from Long Island, New York. Copeia 1964:242-243.
- WILLIAMS, J. T. 1984. Synopsis of the pearlfish subfamily Pyramodontinae (Pisces: Carapidae). Bull. Mar. Sci. 33:846-854.
- , AND R. L. SHIPP. 1982. A new species of the genus *Echiodon* (Pisces: Carapidae) from the eastern Gulf of Mexico. Copeia 1982: 845-851.
- WILSON, D. E. 1973. Revision of the cottid genus *Gymnocanthus*, with a description of their osteology. Unpubl. MS thesis. Univ. British Columbia.
- WILSON, D. F. 1972. Diel migration of sound scatterers into, and out of, the Cariaco Trench anoxic water. J. Mar. Res. 30:168-176.
- WILSON, D. P. 1956. Nesting of the black sea-bream. Neptune (April): 15, 17.
- . 1958. Notes from the Plymouth aquarium. III. J. Mar. Biol. Assoc. U.K. 37:299-307.
- . 1978. Territorial behavior of male dragonets (*Callionymus lyra*). J. Mar. Biol. Assoc. U.K. 58:731-734.
- WILSON, H. V. 1891. The embryology of the sea bass (*Serranus atrarius*). Bull. U.S. Fish. Comm. 9(1889):209-277.
- WILSON, K. H., AND P. A. LARKIN. 1980. Daily growth increments in the otoliths of juvenile sockeye salmon (*Oncorhynchus nerka*). Can. J. Fish. Aquat. Sci. 37:1495-1498.
- WILSON, M. V. H., AND P. VEILLEUX. 1982. Comparative osteology and relationships of the Umbridae (Pisces: Salmoniformes). Zool. J. Linn. Soc. 76:321-352.
- WINN, H. E., AND J. E. BARDACH. 1960. Some aspects of the comparative biology of parrot fishes at Bermuda. Zoologica (N.Y.) 45(1): 29-34.
- WINTERBOTTOM, R. 1974a. The familial phylogeny of the Tetraodontiformes (Acanthopterygii: Pisces) as evidenced by their comparative myology. Smithsonian. Contrib. Zool. 155.
- . 1974b. A descriptive synonymy of the striated muscles of the Teleostei. Proc. Acad. Nat. Sci. Phila. 125:255-317.
- , AND J. C. TYLER. 1983. Phylogenetic relationships of aracanin genera of boxfishes (Ostraciidae, Tetraodontiformes). Copeia 1983: 902-917.
- WIRTZ, P. 1978. The behavior of the Mediterranean *Tripterygion* species (Pisces, Blennioidei). Z. Tierpsychol. 48:142-174.
- WISNER, R. L. 1963. A new genus and species of myctophid fish from the south-central Pacific Ocean, with notes on related genera and the designation of a new tribe, Electronini. Copeia 1963:24-28.
- . 1976. The taxonomy and distribution of lanternfishes (family Myctophidae) in the eastern Pacific Ocean. Navy Oceanographic Research Development Activity, Washington D.C.
- WOLLAM, M. B. 1969. Larval wahoo, *Acanthocybium solanderi* (Cuvier), (Scombridae) from the Straits of Yucatan and Florida. Fla. Dep. Nat. Resour. Leaf. 4 (Pt. 1, No. 12):1-7.
- WONGRATANA, T. 1980. Systematics of clupeoid fishes of the Indo-Pacific region. Unpubl. PhD dissertation. Univ. London.
- . 1983. Diagnoses of 24 new species and proposal of a new name for a species of Indo-Pacific clupeoid fishes. Jpn. J. Ichthyol. 29:385-407.
- WOODLAND, D. J. 1983. Zoogeography of the Siganidae (Pisces); an interpretation of distribution and richness patterns. Bull. Mar. Sci. 33:713-717.
- WOODS, L., AND P. SONODA. 1973. Order Berycomorphi (Beryciformes), p. 263-396. In: Fishes of the western North Atlantic. D. M. Cohen (ed.). Mem. Sears Found. Mar. Res. No. 1 (Pt. 6).
- WOURMS, J. P. 1972a. Developmental biology of annual fishes. I. Stages in the normal development of *Austrofundulus myersi* Dahl. J. Exp. Zool. 182:143-168.
- . 1972b. Developmental biology of annual fishes. II. Naturally occurring dispersion and reaggregation of blastomeres during the development of annual fish eggs. J. Exp. Zool. 182:169-200.
- . 1972c. Developmental biology of annual fishes. III. Pre-embryonic and embryonic diapause of variable duration in the eggs of annual fishes. J. Exp. Zool. 182:389-414.
- . 1981. Viviparity: the maternal-fetal relationship in fishes. Am. Zool. 21:473-515.
- , AND O. BAYNE. 1973. Development of the viviparous brotulid fish *Dinematichthys ilucoeteoides*. Copeia 1973:32-40.
- , AND D. M. COHEN. 1975. Trophotaeniae, embryonic adaptations, in the viviparous ophidioid fish, *Oligopus longhursti*: a study of museum specimens. J. Morphol. 147:385-402.
- , AND D. EVANS. 1974. The embryonic development of the black prickleback, *Xiphister atropurpureus*, a Pacific coast blennioid fish. Can. J. Zool. 52:879-887.
- , AND G. S. WHITT. 1981. Future directions of research on the developmental biology of fishes. Am. Zool. 21:597-604.
- WU, H.-W. 1932. Contribution a l' tude morphologique, biologique et systématique des poissons h terosomes (Pisces Heterosomata) de la Chine. Thesis, Univ. Paris.
- WYANSKI, D. S., AND T. E. TARGETT. 1981. Feeding biology of fishes of the endemic Antarctic family Harpagiferidae. Copeia 1981:686-693.
- WYMAN, J. 1859. On some unusual modes of gestation. Am. J. Science and Arts 27:5-13.
- YABE, H., S. UEYANAGI, S. KIKAWA AND H. WATANABE. 1959. Study of the life-history of the sword-fish *Xiphias gladius* Linnaeus. Rep. Nankai Reg. Fish. Res. Lab. 10:107-150. (In Japanese, English summary.)
- YABE, M. 1981. Osteological review of the family Icelidae Berg 1940, (Pisces: Scorpaeniformes), with comment on the validity of this family. Bull. Fac. Fish. Hokkaido Univ. 32(4):293-315.
- , D. M. COHEN, K. WAKABAYASHI AND T. IWAMOTO. 1981. Fishes new to the eastern Bering Sea. Fish. Bull. U.S. 79:353-356.
- , K. TSUMURA AND M. KATAYAMA. 1980. Description of a new cottid fish, *Icelinus japonicus* from Japanese waters. Jpn. J. Ichthyology 27:106-110.
- YAMAMOTO, K., K. YAMAUCHI AND S. KASUGA. 1975a. On the development of the Japanese eel, *Anguilla japonica*. Bull. Jpn. Soc. Sci. Fish. 41:21-28.

- , AND T. MORIOKA. 1975b. Pre-leptocephalic larvae of the Japanese eel. Bull. Jap. Soc. Sci. Fish. 41:29-34.
- YAMAMOTO, M., AND K. UEDA. 1978. Comparative morphology of fish olfactory epithelium—2. Clupeiformes. Bull. Jpn. Soc. Sci. Fish. 44:855-859.
- YANAGAWA, H. 1978. Embryonic development of the kyuruiuo, *Osmernus eperlanus mordax* (Mitchill). Bull. Fac. Fish. Hokkaido Univ. 29(3):195-198.
- YANG, W. T., AND U. B. KIM. 1962. A preliminary report on the artificial culture of grey mullet in Korea. Proc. Indo-Pac. Fish Council. 9:62-70.
- YANULOV, K. P. 1962. On the reproduction of the roughhead grenadier. Zool. Zh. 41:1259-1262.
- YAPCHIONGES, J. V. 1949. *Hypomesus pretiosus* its development and early life history. Nat. Appl. Sci. Bull. 9.
- YARBERRY, E. L. 1965. Osteology of the zoarcid fish *Melanostigma pammelas*. Copeia 1965:442-462.
- YASHOUV, A., AND E. BERNER-SAMSONOV. 1970. Contribution to the knowledge of eggs and early larval stages of mullets (Mugilidae) along the Israeli coast. Bamidgah 22:72-89.
- YASUTAKE, H., G. NISHI AND K. MORI. 1973. Artificial fertilization and rearing of bigeye tuna (*Thunnus obesus*) on board, with morphological observations on embryonic through to early post-larval stage. Bull. Far Seas Fish. Res. Lab. (Shimizu) (8):71-78.
- YEFREMENKO, V. N. 1976. Morphological characteristics of *Protomyctophum anderssoni* larvae (Myctophidae). J. Ichthyol. (Engl. Transl. Vopr. Ikhti.) 16:958-963.
- . 1977. Morphological features of the larvae of *Gymnoscopelus opisthopterus* (Myctophidae, Pisces). J. Ichthyol. (Engl. Transl. Vopr. Ikhti.) 17:797-800.
- . 1979a. A description of the larvae of *Bathylagus antarcticus* (Bathylagidae). J. Ichthyol. (Engl. Transl. Vopr. Ikhti.) 19(1):156-160.
- . 1979b. Description of the larvae of six species of the family Chaenichthyidae from the Scotia Sea. J. Ichthyol. (Engl. Transl. Vopr. Ikhti.) 19(3):65-75.
- . 1979c. The larvae of six species of the family Nototheniidae from the Scotia Sea. J. Ichthyol. (Engl. Transl. Vopr. Ikhti.) 19(6):95-104.
- . 1982. The finding of *Bathylagus antarcticus* (Bathylagidae) eggs, their characteristics and distribution in the Scotia Sea. J. Ichthyol. (Engl. Transl. Vopr. Ikhti.) 22(2):135-137.
- . 1983. Atlas of fish larvae of the Southern Ocean. Cybium 7(2):1-74.
- YEVSEYENKO, S. A. 1974. New data concerning eel eggs on Georges Bank. J. Ichthyol. (Engl. Transl. Vopr. Ikhti.) 14:294-298.
- , AND V. P. SEREBRYAKOV. 1974. Larvae of *Diplospinus multistriatus* Maul (Pisces, Gempylidae) from the northwestern Atlantic. J. Ichthyol. (Engl. Transl. Vopr. Ikhti.) 14:92-98.
- YUSA, T. 1954. On the normal development of the fish, *Theragra chalcogramma* (Pallas), Alaska pollock. Bull. Hokkaido Reg. Fish. Res. Lab. 10:1-15. (In Japanese, English summary.)
- . 1957. Eggs and larvae of flatfishes in the coastal waters of Hokkaido. I. Embryonic development of the starry flounder *Platichthys stellatus* (Pallas). Bull. Hokkaido Reg. Fish. Res. Lab. 15:1-14.
- . 1958. Eggs and larvae of flatfishes in the coastal waters of Hokkaido. III. Post-embryonic development and larvae of the flatfish *Lepidopsetta mochigarei* Snyder. Bull. Hokkaido Reg. Fish. Res. Lab. 18:1-10.
- . 1960a. Differences of structures of eggs and larvae between *Limanda yokohamae* Günther and *Limanda schrenki* Schmidt. Bull. Mar. Biol. Stn. Asamushi 10(2):127-131.
- . 1960b. Eggs and larvae of flatfishes in the coastal waters of Hokkaido. IV. Embryonic development of mud dab *Limanda yokohamae* Günther. Bull. Tohoku Reg. Fish. Res. Lab. 17:15-30.
- . 1960c. Embryonic development and larvae of the greenling fish, *Hexagrammus otakii* Jordan and Starks. Groundfish Rep. Tohoku Reg. Fish. Res. Lab. 26:76-80. (In Japanese.)
- . 1961. Eggs and larvae of flatfishes in the coastal waters of Hokkaido. V. Embryonic development of the flatfish, *Xystrais grigorjewi* (Herzenstein). Bull. Tohoku Reg. Fish. Res. Lab., 19:109-118.
- . 1967. Embryonic development of the Atka mackerel, *Pleuragrammus azonus* Jordan et Metz. Sci. Rep. Tohoku Univ. Fourth Ser. (Biol.) 33:301-318.
- , C. R. FORRESTER AND C. IOKA. 1971. Eggs and larvae of *Limanda yokohamae* (Günther). Fish. Res. Board Can. Tech. Rep. No. 236.
- YUSCHAK, P. 1982. Description of the eggs and larvae and osteological development of the northern searobin, *Prionotus carolinus* (Pisces: Triglidae). Unpubl. MS thesis. Univ. Connecticut, Storrs.
- ZAHRADKA, K., AND S. FRANK. 1976. Observations sur la reproduction de *Nothobranchius korthausae*. Aquarama 10(36):16-24.
- ZAHURANEC, B. J. 1980. Zoogeography and systematics of the lanternfishes of the genus *Nannobranchium* (Lampnactini: Myctophidae). Unpubl. PhD dissertation. George Washington Univ., Washington, D.C.
- ZAITSEV, Y. P. 1970. Marine neustonology. Israel Program for Scientific Translations, Jerusalem.
- ZAMA, A., M. ASAI AND F. YASUDA. 1977. Changes with growth in bony cranial projections and color patterns in the Japanese boarfish, *Pentaceros japonicus*. Jpn. J. Ichthyol. 24:26-34.
- ZEHNEN, S. J. 1979. The comparative osteology and phylogeny of the Beryciformes (Pisces: Teleostei). Evol. Monogr. (Univ. Chicago) 1.
- ZHENG, W. 1981. Comparative studies on the scales of Chinese Carangidae. Trans. Chin. Ichthyol. Soc. 1:33-45. (In Chinese, English summary.)
- ZHITENEV, A. N. 1970. Ecological and morphological features of the reproduction of the lumpsucker (*Cyclopterus lumpus* (L.)). J. Ichthyol. (Engl. Transl. Vopr. Ikhti.) 10:77-83.
- ZISMAN, L. 1982. Means of identification of grey mullet fry for culture, p. 17-63. In: Aquaculture of grey mullets. Intl. Biol. Programme 26. O. H. Oren (ed.). Cambridge Univ. Press, Cambridge.
- ZURLINI, G., I. FERRARI AND A. NASSOGNE. 1978. Reproduction and growth of *Euterpina acutifrons* (Copepoda: Harpacticoida) under experimental conditions. Mar. Biol. (Berl.) 46:59-64.
- ZVIAGINA, O. A. 1961. Data on the propagation and development of fish of Laptev Sea. 1. East-Siberian cod (*Arcotogadus borisovi*, Gadidae). Tr. Inst. Okeanol. Akad. Nauk SSSR 43:320-327. (In Russian Transl. by Fish. Res. Board Can., 1969, Transl. Ser. 1278.)
- ZVIAGINA, O. A. 1965a. Materialy orazvitiia jashcherogolobykh ryb (Pisces, Synodontidae). Tr. Inst. Okeanol. Akad. Nauk SSSR 80:147-161.
- . 1965b. On the development of *Therapon theraps* Cuv. et Val. (Pisces, Theraponidae). Tr. Inst. Okeanol. Akad. Nauk. SSSR 80:162-166. (In Russian, English summary.)
- ZVIAGINA, O. A., AND T. S. RASS. 1977. Materials on development of tropical carangid fishes (Carangidae, Pisces). Proc. P. P. Shirshov Inst. Oceanol. 109:211-227.

INDEX

Italicized page numbers indicate illustrations. Index includes all genera and only higher taxa that are illustrated.

- Abbottina* 31
Ablabys 440
Ablennes 336, 345, 347, 350, 352
Abramis 131
Absalom 513
Abudedefduf 544
Abyssocottus 409–10, 443
Acanthistius 500–1
Acanthocephala 474, 490
Acanthochromis 542, 544, 547
Acanthoclinus 467
Acanthocybium 592, 600–1, 606, 609, 612, 617–8
Acanthogobius 582
Acantholiparis 429–30
Acanthopagrus 471
Acanthopthalmus 129
Acanthopsetta 643, 654, 660
Acanthosphex 440
Acanthostracion 452, 453, 454, 459
Acanthurus 548, 549
Acentrophryne 333
Achiropichthys 103
Achirosetta 674
Achirus 23, 25, 644, 649, 657, 664, 668
Acromycter 74, 98, 101
Acropoma 464, 466
Acrytops 629–30, 633
Adelosebastes 440
Adinia 363–6
Adioryx 18, 392
Adrianichthys 345, 352
Adventor 440
Aeoliscus 403, 404
Aesopia 644, 649, 657, 672
Aetapcus 440
Aethotaxis 563
Agonomalus 408, 425, 428, 442, 447
Agonopsis 408, 442
Agonostomus 541
Agonus 408, 442
Agrostichthys 368–9, 371–2, 379
Ahlia 71, 103, 105
Ahliesaurus 207–8, 211, 212
Aiakas 578
Akarotaxis 563
Albula 52, 60, 61, 62, 98–9, 126, 138
Alcichthys 442
Aldrovandia 94–5
Alectis 511, 515, 518–9, 524
Alepes 511, 518, 524
Alepisaurus 200, 207–8, 212, 216, 245, 259
Alertichthys 440
Alestes 133–4
Allanetta 360
Allips 103
Allolepis 580
Allothunnus 592, 600–1, 610, 612, 617
Alosa 112, 118, 124–5, 129–130, 133
Alphestes 500, 507–8
Alutera 452, 455–6, 457
Amanses 452, 455, 457
Amarsipus 621, 622–3, 625–8
Ambloplites 473
Amblycirrhitus 471
Amblygaster 109, 124
Ammodytes 574, 575
Ammotretis 643–4, 660, 673
Amphiprion 544
Anableps 363
Anacanthus 452, 454, 455
Anaora 637
Anarchias 65, 71
Anarhichas 568, 571
Anarrhichthys 568
Anchoa 25, 29, 115, 117, 118, 125
Anchoviella 116–7, 125
Ancistrus 131, 133
Ancyclopsetta 640, 651, 682
Andriashevia 557–8
Anguilla 56, 65, 69, 72, 94, 126
ANGUILLIDAE 87
Anisotremus 49, 489
Anodontostoma 111, 118, 124
Anomalops 392
Anoplagonus 442
Anoplarchus 571
Anoplogaster 7, 387, 390, 392, 490
Anoplopoma 408, 414, 421–2, 442, 444–5
Anotopterus 207–8, 212, 216, 245
Antennarius 15, 44, 320, 322, 323
Anthias 500, 503, 505, 509
Antigonia 393, 396, 405, 460, 489–490
Antimora 266, 280
Antipodocottus 442
Anyperodon 500
Apeltes 399, 404
Aphanius 362, 365
Aphanopus 599–601, 604
Aphredoderus 483
Apistius 440–1
Aplatophis 71, 103, 106
Apletodon 629–30, 633
Aploactis 440
Aploactisoma 440
Aplocheilus 364, 366
Aplochiton 150–1, 152, 153, 202–4
APOGONIDAE 470
Apogonops 464
Apolectus 530
Aporops 501, 508
Aprognathodon 103
Apterichtus 71, 103
Apteronotus
Aptocyclus 429–31, 437

- Araiophos* 185–6, 188, 190, 197
Archaulus 442
Archistes 442
Arctogadus 266, 268, 280, 284, 286–7, 290, 294–5, 297
Argentina 14, 156–7, 158–9, 161, 163–4, 168–9
Argyripnus 185–6, 188, 190, 197
Argyrocectus 442
Argyropelecus 185–8, 190–1, 197
Ariomma 622–3, 624, 625–8
Ariosoma 67, 69–70, 74
Aristostomias 171–2, 175–6, 179, 181, 183
Arnoglossus 19, 642–3, 648, 652, 656, 657
Arrhamphus 342–3, 352–3
Artedidraco 562, 563–4
Artediellichthys 442
Artediellina 442
Artedielliscus 442
Artediellus 442
Artedius 408, 419, 421, 422, 427, 442, 446–7
Ascelichthys 419, 442
Asemichthys 442
Aseraggodes 664, 668, 672
Aspasma 629–30, 633, 635–6
Aspasmichthys 629–30, 633, 635
Aspidophoroides 426, 428, 442
Aspredo 130
Assurger 599–601, 604
Asterorhombus 642, 652, 686
Asterropteryx 582
Astrabe 584, 587
Astrocottus 442
Astronesthes 171–2, 174–5, 183
 ASTRONESTHIDAE 172
Astroscopus 560
Ateleobranchium 269
Atheresthes 643, 654, 659, 660, 684
Atherina 355–6, 360, 533
Atherinason 360
Atherinomorus 355, 357, 359, 360
Atherinops 44, 48, 355–6, 360, 361, 367
Atherinopsis 44, 48, 355–6, 357, 360
Atherinosoma 360
Atherion 355–6, 360
Atractoscion 25
Atrophacanthus 452–4
Atropus 511, 518, 524
Atule 511, 515, 517–8, 520, 524
Atypichthys 469
Auchenoceros 266, 268
Aulacocephalus 500
Aulopus 207–8, 211, 258
Aulorhynchus 399, 400–4
Aulostomus 401
Austroglossus 644, 657, 668
Austrolychus 580
Austrolycichthys 578
Austromeniidae 355–6
Auxis 592, 600–1, 606, 610, 612, 617, 619
Azygopus 643, 673, 684

Bagarius 129–30, 134, 137
Bairdiella 24

Balistes 452, 457
Balistapus 452
Barbatula 129
Barbourisia 382
Barbus 129
Bascanichthys 71, 98, 101, 103, 107
Bathophilus 171, 174–6, 179, 181, 183
Bathygobius 442
Bathyaploactes 440
Bathycallionymus 637
Bathychlupea 474, 479
Bathhydraco 563
Bathygadus 274–5
Bathylagus 11, 156–7, 158, 161, 162, 163–4, 165, 167, 169
Bathyleptus 199, 201
Bathylchnops 156–7, 161, 163–4, 167
Bathymicrops 207–9, 211, 212, 256, 258
Bathymyrus 70, 73
Bathypterois 207–9, 211, 212, 256, 258
Bathysauropsis 207–8, 258
Bathysaurus 207–8, 212
Bathysolea 657
Bathystethus 469
Bathytrophops 207–9, 212, 256, 258
Batrachocottus 410, 422, 443
Bedotia 355–7, 359, 360
Bellator 419
Belone 336, 342, 343, 347, 350, 352
Belonion 342, 345, 347, 350, 352
Belonoperca 500
Bembradium 441
Bembradon 441
Bembras 441
Benthabella 245, 246, 247–50, 256
Benthenchelys 103, 106
Benthocometes 312
Benthodesmus 599–601, 602, 604, 606–7
Benthoosema 218–9, 221–2, 226, 227, 229, 241–3
Bero 442
Beryx 392
Bilabria 578
Bleekeria 574
Blepsias 408, 425, 428, 442, 447
Bodianus 544
Bolinichthys 218, 220–2, 226, 235, 236, 240–3
Bonapartia 182, 185–6, 188–9, 190–1, 193, 195, 198
Boreogadus 266, 268, 280, 284, 286–7, 290, 294–5, 297
Borichthys 563–4
Borophryne 327, 328, 329, 333–4
Borostomias 171, 174–5, 183
Bostockia 469–70
 BOTHIDAE 641
Bothragobius 408, 426, 428, 442
Bothrocarina 578, 580, 581, 582
Bothrocarina 578
Bothus 642, 652, 655, 657, 672
Botia 131, 137
Brachaluteres 452, 455
Brachydano 131
Brachygalaxias 150, 153
Brachymystax 143–4, 146, 148–9
Brachyopsis 442

- Brachypleura* 640, 645, 648, 651, 674, 678, 681–4
Brachysomophis 103, 106
Brama 474
Branchiostegus 495
Bregmaceros 40, 42, 260–3, 266, 268, 280–2, 300, 301–8, 319
Brevoortia 40, 113, 123, 125
Brinkmanella 469, 479
Brosme 260–1, 266, 268, 277, 278, 280, 282, 284, 285, 286–9, 294–5, 297–9
Brosmiculus 266, 280
Brosmophycis 309, 311
Brotula 282, 308, 311, 319
Brotulotaenia 308, 311
Brycinus 131
Buglossidium 644, 657, 660
 BYTHITIDAE 309
- Caecula* 103
Caesio 468
Caesioperca 500, 503
Caesioscorpis 465, 476
Cairnsichthys 360
Callanthis 464, 467, 499
Callechelys 71, 100, 103, 107
Callionymus 44, 48, 637, 639
Calliurichthys 637–9
Calotomus 544, 546
Campogramma 511, 518, 523–4, 527
Cantherines 452, 455
Canthidermis 452, 455
Canthigaster 448, 449
Capoeta 129
Caprodon 500
Capromimus 405
Capros 393, 395, 405, 460–1
Caralophia 103, 107
Carangoides 511, 513, 518, 524
Caranx 510, 513, 522, 524, 528–9
Carapus 19, 309, 312–4, 316, 317–9
Careproctus 429–32, 434, 437
Carinotetraodon 448
Caristius 474
Carolophia 71
Caspialosa 114, 125
Cateshya 100
Catostomus 53, 129
Caulolatilus 468, 495
Caulolepis 7
Caulophryne 321, 326–7, 328, 334
 CENTRISCIDAE 401
Centroberyx 392
Centrobranchus 218–9, 221–2, 229, 234, 240–3
Centrolabrus 544
Centrolophus 622–3, 626, 628
Centrophryne 329
Centropogon 440
Centropomus 473
Centropristis 499–501, 503, 509
Centropyge 468
Cephalopholis 500, 507–8
Cephalopsetta 641, 651, 674, 682
- Ceratias* 327, 329
Ceratoscopeus 218, 220–2, 226, 235, 236, 240–3
Ceratostethus 361
Cerdale 587
Cetengraulis 117, 121, 125
Cetomurus 267, 274–5
Chaenichthys 563
Chaenocephalus 563
Chaenodraco 563
Chaenogobius 582
Chaenophryne 326, 331, 333
Chaetodipterus 465, 468, 487, 489–90
 CHAETODONTIDAE 474
Chalinura 274–5
Champscephalus 563
Champsodon 559, 560
Channomuraena 72
Chanos 24, 126, 129, 130, 133, 138, 139, 206
Chascanopsetta 642, 652, 656
Chauliodus 29, 30, 170, 171–2, 174, 181, 198
Chaunax 321, 322
Cheilinus 544
Cheilopogon 337–9, 341, 342, 343, 345, 347, 349, 352, 354
Chelidonichthys 407, 419
Chelidoperca 500
Chelmon 474
Chelonodon 448
Cheroscorpaena 440–1
Cherublemma 313, 318
Chilara 312–4, 319
Chilatherina 360
Chilomycterus 448, 450, 463
Chilonetus 408
Chionobathyscus 563
Chionodraco 563
Chirocentron 114
Chirocentrus 108–9, 118, 120, 124
Chirostoma 355–6
Chirostomias 171–2, 183
Chitonotus 419, 442
Chlorophthalmus 207–9, 211, 256, 258
Chloroscombrus 511, 514, 518, 524
Choerodon 544
Chonerhinos 448
Choridactylus 440
Chriodorus 343, 352–3
Chromis 544
Cichlasoma 542, 543
Ciliata 266, 268, 279, 284–90, 294–5, 297–9
Cirrhilabrus 544
Cirrhimuraena 103
Cirricaecula 103
Citharichthys 641, 643, 650, 651–4, 670, 675, 681, 682, 685
Citharoides 641, 672–3, 676, 678, 681–2
Clarias 130–1, 133, 134
Claringer 586
Cleidopus 392
Cleisthenes 642–3, 654, 660
Clidoderma 643, 660
Clinocottus 409, 421, 422, 427, 442, 447
Clupanodon 111, 122
Clupea 15, 24–6, 110, 118, 122–4

- Clupeichthys* 112
Clupeoides 113
Clupeonella 110, 114
Cobitis 129, 131, 137
Coccorella 250, 251–254
Coccotropsis 440
Cocotrops 439–41
Coelorhynchus 44, 269, 274–5, 279
Coilia 114, 118, 121, 125
Colistium 643–4, 660, 672
Coloconger 70
 COLOCONGRIDAE 83
Cololabis 14, 29, 30, 336, 338, 339, 342, 347, 349, 350, 352, 354
Colpichthys 360
Comephorus 408, 416, 442
Conger 65
Congiopodus 407, 414, 419, 440
Congothrissa 111
Congresox 94
 CONGRIDAE 81, 83
Congrogadus 467
Conidens 629, 630–1, 633
Conodon 473, 489–90
Coracinus 465
Coradion 474
Coregonus 142–4, 145, 148
Coreoperca 469, 473
Corica 113
Coris 544
Coryphaena 474, 489–90, 496–7, 498
Coryphaenoides 44, 48, 267, 269, 272, 274–5
Cottapistus 440
Cottinella 410, 443
Cottiusculus 442
Cottocomephorus 410, 416, 443
Cottoperca 563
Cottunculus 444
Cottus 422, 427, 442, 446–7
Craterocephalus 360
Cratinus 500–1
Crenichthys 362–4
Cromeria 138
Cromileptes 500
Crossias 442
Crossorhombus 642, 652, 655, 657
Crossostomus 578
Crydraco 563
Cryothernia 563
Cryptopsaras 327, 329, 333
Crystallias 429
Crystallichthys 429
Ctenochaetus 548
Ctenochirichthys 327
Ctenolabrus 544
Ctenolucius 127, 130
Ctenopharyngodon 129, 131
Ctenotrypauchen 587
Cubanichthys 363, 365
Cubiceps 622–3, 624, 625–8
Cybiosarda 592, 600–1, 606, 612, 617
Cyclops 641, 650, 651–3, 657, 670, 673–5, 682–3, 685–6
Cyclopsis 429–30
Cyclopteropsis 429–30, 437
Cyclopterus 429–30, 432, 436, 437
Cyclothone 182, 185–6, 188–91, 193, 195, 198
Cyema 69, 72, 97
 CYEMATIDAE 93
Cygnodraco 563
Cynoglossus 640, 641, 643–4, 664, 667, 669, 670, 672, 675
Cynolebias 363–4
Cynomacrurus 274–5
Cynoponticus 94
Cynothrissa 113
Cyprinodon 359, 362–3, 365
Cyprinus 131, 133–4
Cypselurus 338, 341, 345, 347–8, 352, 354
Cyttus 379, 394

Dactylanthias 500
Dactyloptena 408, 441
Dactylopterus 408, 427, 441
Dactylopus 637
Dadyanos 578, 580
Daicocus 408
Dallia 140, 142, 202
Dalophis 103, 107
Dampierosa 440
Danaphos 185–6, 188, 190, 197
Danio 131
Daruma 442
Dasycottus 410, 424, 428, 444
Datnioides 465, 478
Davidjordania 578
Dayella 113
Decapterus 510, 512, 514, 518–20, 522, 524
Dendrochirus 407, 416
Dentatherina 357
Denticeps 108–9
Derepodichthys 578, 580
 DERICHTHYIDAE 87
Derichthys 96
Dermatolepis 500, 507
Dermogenys 336–8, 347, 352–3, 361
Desmodema 368–9, 371–2, 377–9
Dexistes 643
Diaphus 207–8, 218–9, 221–2, 229, 236, 241–3
Dicentrarchus 26, 469, 509
Diceratias 330
Dicologlossa 644, 657
Dicotylichthys 450
Dinematichthys 311
Dinoperca 465, 478
Diodon 448, 449
Diogenichthys 218–9, 221–2, 226, 227, 229, 241–3
Diplecogaster 629, 633
Diplectrum 500–1, 503, 509
Diplocrepis 629–30, 633
Diplodus 14
Diplogrammus 637
Diplomystus 122
Diplophus 182, 185–6, 188–9, 190–1, 192, 193, 198
Diplopriion 500, 510
Diplospinus 593, 599, 600–1, 603–4, 615–7

- Dipterygonotus* 491
Diretmoides 379
Diretmus 379, 390, 392, 490
Dissostichus 563
Doderleinia 464, 466
Dolichopteryx 156–7, 161, 163–4, 167
Dolichosudis 207–8
Dolliodraco 563
Dolopichthys 327, 331
Doratonotus 546
Dormitator 585, 586–7
Dorosoma 111, 118, 124
Dorsopsetta 657
Dracodraco 563
Drepane 465
Dules 500–1
Dussumieria 110, 118, 120, 123–4
Dysomma 101
 DYSOMMATIDAE 75, 96
- Ebinania* 414
Echelus 102–3, 106
Echeneis 474, 497
Echinomacrurus 274–5
Echiodon 40, 42, 309, 312, 314, 315, 317
Echiophis 71, 103, 106
Echiostoma 171–2, 174–5, 181, 183–4
Ectreposebastes 407, 413, 417
Edelia 469–70
Edriolychnus 333
Ehirava 113
Eigenmannia 127, 131, 133, 134, 137
Elagatis 512, 517–20, 523–4, 526–7
Elapsopsis 103
Elassichthys 335, 342, 350, 352
Elassodiscus 429
Elassoma 465–6, 469
Electrona 218–9, 221–2, 225, 226, 229, 240–243
Eleginops 563
Eleginus 266, 268, 280, 284, 286–7, 290, 294–5, 297
Eleotris 582, 584, 586–7
Eleutherochir 637
Eleutheronemus 540
Ellerkeldia 500
Elops 60, 61, 62, 98–99, 126
Elytrophora 617
Embassichthys 642–3, 654, 659, 660, 664
Embolichthys 575
Emmelichthyops 491
Encheliophis 312, 314, 317–9
Enchelyopus 266, 268, 279–80, 284–9, 290, 294–5, 297, 319
Enchelyurus 570
Encrasichelina 116, 123
Engraulis 24, 28, 108, 114, 118, 121, 122, 125
Engyphrys 642, 652, 653, 657, 672, 674, 676, 682–3, 685–6
Engyprosopon 642, 652, 655, 657
Enneapterygius 570
Enophrys 409, 421, 427, 442
Eocallionymus 637
Eophycis 264
Eopsetta 642–3, 654, 659, 660, 666
- Ephippus* 465
Epigonus 469, 470, 487
Epinephelus 18, 499, 500, 507–8, 509
Epinnula 593, 594, 596, 600–1, 603
Epiplatys 359, 364
Eretmophorus 266, 268, 272, 280
Ereunias 443, 445
Erilepis 442, 444
Erips 103
Erisphex 441
Erosa 440
Erotelis 584, 586–7
Erythrocles 473
Eschmeyer 441
Escualosa 109, 124
Esox 140–1, 142, 202
Ethadophis 103
Ethmalosa 113, 125
Ethmidium 113, 122
Etropus 642, 650, 651, 674–5, 685
Etrumeus 15, 28, 29, 102, 108, 110, 118, 120, 122–4
Eucnostomus 473
Eucitharus 641, 673–4, 676, 681, 684
Euclichthys 260–1, 263, 264, 266, 280
Euleptorhamphus 336–7, 352
Eumecichthys 368–9, 371–2, 277–9
Eumicrotremus 30, 31, 429–30, 431–2, 434, 437
Eupleurogrammus 599–601, 604
Euryglossa 657, 664, 668
Eurymen 444
Eurypegasus 402
Eurystole 355–6, 357–8
Eustomias 171–2, 175–6, 179, 181, 183
Eutaeniophorus 380–1, 382
Euthynnus 542, 600–1, 606, 610, 612, 617, 619
Evermannella 207–8, 251, 252–4
Eviota 587
Evorthodus 582
Evoxymetopon 599–601, 604
Exechodontes 578
Exocoetus 338, 341, 345, 349, 352
Expedio 584, 586
- Filimanus* 540
Fistularia 398, 400–1, 403–4
Flagelloserranus 508
Flagellostomias 171–2, 174, 176, 181, 183
Florenciella 469
Floridichthys 365
Fluviophylax 362
Foa 470
Fodiator 335, 338–9, 341, 343, 349, 352, 354
Foetorepus 637
Forcipiger 21, 474
Franzia 500, 503
Fugu 448, 449
Fundulopanchax 364
Fundulus 43, 53, 359, 362–5, 365–7
Furcina 442
- Gadella* 266, 268, 272, 279–80
Gadiculus 266, 268, 279–80, 284, 286–7, 290, 292, 294–5, 297

- Gadomus* 267, 272, 274–5
Gadopsis 469–70, 473, 482
Gadus 15, 29, 31, 260, 266, 268, 278, 279, 281, 284, 286–7, 290, 292, 294–7
Gadusia 112
Gaidropsarus 266, 269, 279–80, 284–90, 294–5, 297–9
Galaxias 150–1, 152, 153
Galaxiella 150–1, 153
Galeoides 540, 541
Gambusia 363–4
Gargariscus 419
Gargaropteron 21
Gargilius 279
Garialiceps 71
Gasterochisma 591–2, 600–1, 617–8
Gasteroclupea 122
Gasterosteus 398, 399
Gastrocyathus 629–30, 633
Gastropsetta 642, 651, 674, 682
Gastroseypheus 629–30, 633, 635
Gempylus 593–4, 599, 600–1, 603–4, 615–7
Genioliparis 429
Genypterus 309, 312, 318
Gephyroberyx 392
Gerlachea 563
Gibberichthys 7, 15, 391–2
Gigantactis 325, 329, 333
Gigantias 500
Gigantura 199, 201
Gilbertidia 410, 424, 427, 447
Gilchristella 113, 122, 125
Girella 471
Glenoglossa 103
Glossanodon 156–7, 159, 163–4, 168–9
Glossolepis 360
Glyptauchen 440
Glyptocephalus 28, 29, 642–3, 659, 660, 664
Gnathanacanthus 440
Gnathanodon 512, 515, 518, 524
Gnathophis 66, 70
Gnathopogon 131
Gobiesox 629–31, 633, 635
GOBIIDAE 583
Gobioides 585, 587
Gobiomorphus 589–91
Gobionellus 584, 587
Gobiosoma 584–5
Gonialosa 111
Gonichthys 218–9, 221–2, 229, 234, 240–3
Gonioplectrus 500, 508, 510
Gonorhynchus 138, 139
Gonostoma 182, 185–91, 194, 195, 198
Gordüichthys 71, 103, 107
Gracilia 500
Grahamichthys 590
Gramma 465
Grammatobothus 642, 652, 657, 683
Grammatonotus 464–5, 467
Grammatorcynus 592, 600–1, 606, 608, 612, 617–9
Grammatostomias 171–2, 183
Grammicolepis 393
Grammistes 501, 508
Grammistops 501
Grasseichthys 138
Gulaphallus 356–7, 361
Gunnellichthys 582, 587
Gymnammodytes 574–5
Gymnapistes 440
Gymnelopsis 578
Gymnelus 578–80, 581, 582
Gymnocaesio 468
Gymnocanthus 409, 421, 442
Gymnocorymbus 129
Gymnodraco 563
Gymnosarda 592, 600–1, 606, 609, 612, 617–8
Gymnoscopelus 218, 220–2, 226, 229, 236, 241–3
Gymnothorax 72–3
Gyrinichthys 429

Hadropareia 578
Hadropogonichthys 578
Haemulon 51, 53
Halargyreus 262, 266
Halichoeres 544
Halosauropsis 94–5
Halosaurus 94–5
Hapalogenys 465, 466, 480, 485, 487, 489–90, 493
Haplophryne 326–7, 328, 334
Harengula 110, 118, 122–4
Harpadon 206–8, 212
Harpagifer 562, 563–4
Helicolenis 406, 410, 412, 439–40
Hemanthias 500, 503, 505, 507
Hemerocoetes 557
Hemerorhinus 103
Hemicaranx 512, 518, 520, 524
Hemilepidotus 409, 417, 425, 427, 442, 446
Hemilutjanus 465, 480
Heminodus 419
Hemirhamphus 336–9, 340, 346, 347, 351, 352
Hemirhamphodon 337, 339, 345, 352–3
Hemitripterus 409, 421, 425, 428, 442, 446–7
Herklotsichthys 109, 123
Hermosilla 469
Herpetoichthys 103
Heterandria 362
HETERENCHELYIDAE 83
Heteromycteris 657, 668, 687
Heterophotus 171–2
Heteropneustes 130
Heterostichus 564, 570
Heterothrissa 117, 125
Hexagrammos 20, 410, 414, 421–2, 443–5
Hildebrandia 101
Hildebrandichthys 117
Hilsa 111, 123–4
Himantolophus 325–7, 330
Hintonia 218, 220–1, 241–3
Hiodon 126, 129, 133
Hippocampus 53, 398, 400, 402, 403
Hippoglossina 642, 646, 651–2, 674, 681, 682
Hippoglossoides 29, 640, 641, 642–3, 654, 659, 660, 666
Hippoglossus 14, 642–3, 654, 659, 660, 666
Hirundichthys 338–9, 341, 343, 352, 354

- Histiodraco* 563
Histiophryne 324
Histrio 321
Holanthias 500, 505, 507
Holocentrus 18, 384, 385, 387, 392
Hoplias 133–4, 136–7
Hoplichthys 408, 414, 421
Hoplostethus 468, 495
Hoplostethus 389, 392
Hoplunnis 94–95, 96
Horaichthys 335, 339, 345, 347, 352
Howella 465, 470, 480, 483, 487, 493
Hozuki 410, 440
Hucho 143–4, 146, 148–9
Hygophum 218–9, 221–2, 226, 228, 234, 241–3
Hymenocephalus 269, 274–5, 279
Hyomacrurus 274–5
Hypentelium 129
Hyperlophus 112
Hyperoglyphe 622, 625–6, 628
Hyperophus 574, 575
Hyphalophis 103
Hyphessobrycon 133–4
Hypoatherina 360
Hypomesus 154
Hypophthalmichthys 129, 131
Hypoplectrus 500–1, 503
Hypoptychus 400–4
Hyporhamphus 337–9, 342, 345, 347, 352–3
Hypsagonus 425, 426, 428, 442, 447
Hypsoblennius 31
Hypsopsetta 29, 643, 654, 659
- Icelinus* 419, 442
Icelus 409, 419, 442, 445
Ichthyapus 71
Ichthyococcus 185–9, 191, 192, 198
Ichthyupus 103
Icichthys 29, 621–3, 625–6, 628
Icosteus 28, 29, 576–7
Ictalurus 29, 130, 134, 137
Idiacanthus 11, 171–2, 175, 180, 181, 183–4
Ilisha 112, 117, 120, 123, 125
Iluocoetes 578–80
Indostomus 404
Inermia 491
Inimicus 405, 407, 419, 440
Inistius 544
Ipnops 207–9, 212, 256, 258
Iriatherina 360
Iso 355, 357, 359, 360
Isopsetta 15, 642–3, 654, 660
Istiblennius 570
Istiompax 604, 605
Istiophorus 600–1, 604, 605, 607–8, 614–7
- Japonolaeops* 642, 686
Jeboehlkia 500, 508
Jenkinsia 33, 111, 122, 123–4
Jenynsia 363
Jordanella 363, 365
Jordania 442
- Kali* 20, 555
Kamoharua 642, 652
Kanazawaichthys 322
Kanekonia 441
Kareus 642, 654
Kasidoron 7
Katsuwonus 24, 26, 592, 600–1, 606, 610, 612, 617, 619
Kaupichthys 100
Kertomichthys 103
Kneria 138
Knightia 122
Konosirus 111, 124
Korogaster 389
Kraemaria 588
Krefflichthys 218–9, 221, 223, 225, 229, 241–3
Krohnii 269, 279
Krusensterniella 578
Kumba 274–5
Kyphosus 469, 473
- Labeotropheus* 542
Labracoglossa 469, 471, 491
Labrisomus 53
Labroides 544
Labrus 544
Lachnolaimus 544, 545
Lactophrys 458
Lactoria 44, 48, 452
Laemonema 261, 266–7, 279–80
Laeops 642, 652, 656
Laeviscutella 112, 125
Lagocephalus 448, 449
Lamnostoma 103
Lampadena 218, 220–2, 226, 229, 236, 240–3
Lampanyctodes 218, 220–1, 223, 226, 229, 236, 241–3
Lampanyctus 218, 220–1, 223, 226, 237–8, 239, 240–3, 257
Lampichthys 218, 220–1, 223, 226, 229, 236, 241–3
Lampris 368–9, 371–2, 374–5, 377–9
Lateolabrax 465, 469, 473, 480, 485, 487, 493, 509
Lates 469
Latimeria 55
Lefua 131
Leiocottus 443
 LEIOGNATHIDAE 468
Leiostomus 40, 42
Leiuranus 103
Lepadichthys 629–30, 633, 635, 636
Lepadogaster 629–30, 633
Lepidion 261, 266–7, 280
Lepidoblepharon 640, 676, 678, 681–2, 684
Lepidocephalus 131
Lepidocybium 593, 594–6, 600–1, 603
Lepidogalaxias 139, 202, 205
Lepidophanes 218, 220–1, 223, 226, 235, 236, 240–3
Lepidopsetta 15, 642–3, 654, 659
Lepidopus 599–601, 602, 606–7
Lepidorhombus 640, 643, 646
Lepidorhynchus 274–5
Lepidotrigla 407, 419
Lepophidium 311, 312–4, 318
Leptenchelys 102–3
Leptobrama 464, 471, 479

- Leptocephalus* 62, 63, 69–70, 94, 96
Leptocottus 409, 422, 427, 443, 447
Leptolucania 363–4
Leptophilypmus 589–91
Leptosynanceia 440
Lepturacanthus 599–601, 604
Letharchus 71, 103
Lethogoleos 103
Lethotremus 429–30
Lethrinus 474
Leucichthys 143, 148
Leuciscus 133–4
Leuresthes 355–6, 360, 362
Leuropharus 103
Lhotskia 345
Lichia 512, 518, 523–4, 526, 528–9
Lile 110, 124
Limanda 640, 641, 642–3, 654, 660
Limnichthys 557
Limnothrissa 113
Linophryne 325–6, 328, 329, 333–4
Liocranium 440
Lioglossina 642, 651, 674, 682
Lionurus 274–5
Liopropoma 20, 42, 500, 507, 508, 510
Liopsetta 642–3, 654, 660
Liparis 429–30, 431, 432, 433–4, 436–7
Lipariscus 429, 432
Lipogenys 94–5
Lipogramma 465
Lobianchia 218–9, 221, 223, 226, 229, 234, 241–3
Lobotes 466, 490
Lophiodes 320
Lophius 269, 320, 321
Lophodolos 333
Lopholatilus 18, 495
Lophonectes 642, 652, 655, 657, 683
Lophotus 19, 368–9, 370, 371–2, 377, 379
Loricaria 129–30
Loricariichthys 130
Lota 261, 266, 268, 280, 284, 285, 286–9, 294–5, 297–9
Lotella 266, 279–80
Loweina 19, 218–9, 221, 223, 229, 234, 240–3
Lucania 359, 363–4, 365, 368
Luciogobius 582, 583, 585–6
Lutjanus 468, 469
Luvarus 547, 550, 591
Luzonichthys 500, 503
Lycenchelys 578, 582
Lycengraulis 117–8, 125
Lycodapus 578–80, 582
Lycodes 578, 580, 582
Lycodichthys 578
Lycodomus 578
Lycogrammoides 578
Lyconectes 571
Lyconema 578
Lyconus 261–3, 267, 269, 272
Lycotrissa 117
Lyczoarces 578
Lyopsetta 642–3, 654, 659, 660, 666
Lyosphaera 448, 450
Maccullochella 469, 473
Macquaria 469
Macristiella 209
Macristium 211
Macroparalepis 207–8, 259
Macropinna 156–8, 161, 163–4, 167, 168
Macrorhamphosodes 452–3
Macrorhamphosus 398, 399–400, 401, 403, 404–5
Macrosmia 274–5
Macrostomias 171–2, 174, 183
MACROURIDAE 272, 276
Macrouroides 274–5
Macrourus 269, 274–5
Macrozoarces 578–80, 581, 582
Macruocyttus 394, 396
Macruonus 262–3, 267, 269, 272, 281
Magalespis 512, 518, 524
Mahia 274–5
Makaira 600–1, 604, 605, 607–8
Malacanthus 495
Malacocephalus 269, 274–5
Malacocottus 410, 424, 428, 444, 446–7
MALACOSTEIDAE 179
Malacosteus 171–2, 183
Malakichthys 464
Mallotus 154–5
Malvoliophis 103, 106
Manacopus 361
Mancopsetta 642–4, 649, 652, 670, 672–4, 678, 681, 683–4, 686–7
Manducus 185–90, 193, 195, 198
Margrethia 182, 185–6, 188–91, 193, 195, 198
Marlyella 643
Marukawickthys 443–5
Masturus 448, 450, 463
Mataeocephalus 274–5
Maulichthys 207–8
Mauroliticus 43, 44, 185–6, 188, 190, 197, 269
Maynea 578, 580
Medialuna 469, 471
Megalocottus 443
Megalomycter 382
Megalops 60, 61, 62, 98–99, 126
Melamphaes 386–7, 389, 392
Melanocetus 327, 330
Melanogrammus 31, 267–8, 279, 281, 284, 286–9, 292, 294–5, 297
Melanonus 260–3, 266, 268, 270, 280
Melanostigma 578–80, 582
Melanostomias 171–2, 174, 175, 181, 183–4
Melanotaenia 355–7, 360–1
Melapedalion 337–43, 352–3
Membras 355–6
Mene 468, 479
Menidia 26, 355–7, 362
Merlangius 267–8, 284, 286–9, 292, 294–5, 297
Merluccius 25, 29, 30, 51, 260–5, 267, 269, 272, 278, 279, 281, 283, 294, 297–9
Mesobius 269, 274–5, 277
Mesocottus 443, 445
Metacottus 443
Metavelifer 368–9, 372, 376, 378–9

- Metelectrona* 218–9, 221, 223, 225, 229, 240–3
Metynnix 131
Microcanthus 469, 473
Microchirus 644, 649, 657, 660, 664, 668, 672
Microcottus 443
Microdesmus 585, 586–7
Microgadus 266–8, 281, 284, 290, 294–5, 297
Microgobius 583, 587
Microlabrichthys 500
Microlepidium 266
Microlophichthys 327, 331
Micromesistius 267–8, 281, 283–4, 286–7, 290, 294–5, 297
Micropercops 590
Micropterus 51
Microspathodon 543, 544
Microstoma 156–7, 158, 161, 163–4, 169
Microstomus 640, 641, 642–3, 654, 659, 660, 664
Microthrissa 112
Mimasea 599
Minous 407, 414, 419
Minysynchiropus 637
Mirapinna 380, 381
Mirophallus 361
Misgurnus 129, 131, 137
Mola 448, 450, 463
Molacanthus 448, 450
Molva 266, 268, 280–1, 284–289, 285, 294–5, 297–9
Monacanthus 452, 455
Monocentrus 392
Monodactylus 467
Monolene 642, 652, 657, 672–4, 682–3
Mora 261, 266–8, 272, 281
Moringua 64, 70, 72, 95–6
MURINGUIDAE 93
Moroco 131
Morone 25, 29, 49, 469, 473, 485, 489, 508, 615–7
Mugil 24–5, 29, 30, 44, 48, 531, 532–3, 541
MURAENESOCIDAE 81
Muraenichthys 103, 105
MURAENIDAE 89
Muraenolepis 260–3, 265–6, 268, 270, 279–80, 282, 319
Mycteroperca 500, 508
Myctophum 11, 18, 218–9, 221, 223, 226, 228–9, 234, 241–3
Myoxocephalus 409, 419, 421, 427, 443, 446–7
Myrichthys 71, 73, 103
Myripristis 384–5, 392
MYROPHINAE 77
Myrophis 69–70, 103, 104, 105
Mystriophis 103
Mystus 133–4

Nalbantichthys 578
Nanichthys 335, 340, 342, 350, 352
Nannatherina 469
Nannoperca 469–70
Nansenia 156–7, 158, 161, 163–4, 169
Naso 548, 549
Naucrates 498, 510, 512, 516, 518, 523–4, 526, 527
Nautichthys 409, 425, 428, 443, 447
Navodon 452, 455
Nealotus 593–4, 596, 599, 600–1, 603
Neaploactis 441

Neatypus 469
Nectoliparis 429, 432
Neenchelys 103, 104, 106
Nemacheilus 129, 131, 137
Nemanthias 500
Nematolosa 111, 114
Nematistius 496–8, 522–3, 526, 527, 528, 529–30
Nematonurus 274–5
Nematops 643, 684
NEMICHTHYIDAE 85
Nemichthys 69, 72, 97
NEMIPTERIDAE 471
Neoachirosetta 674
NEOBYTHITINAE 309
Neocentropogon 440
Neoceratias 326–7, 328
Neochanna 150–1, 153
Neoconger 69, 95, 96
Neocyema 72
Neopinnula 593–4, 596, 600–1, 603
Neolaeops 642–3, 652, 686
Neonesthes 171–2, 183
Neoodax 544
Neopisthopterus 112, 125
Neopagetopsis 563
Neopataecus 440
Neophos 185
Neophrinichthys 444
Neoscombrops 464
Neoscopelus 207–9, 211, 243, 257
Neoscorpis 465, 469, 482
Neostethus 361
Neosynchiropus 637
Nesiarchus 593–4, 599, 600–1, 603, 615–7
Nesogalaxias 150, 151
Nettastoma 96
NETTASTOMATIDAE 69, 85
Nezumia 267, 269, 274–5
Nicholsina 544
Nippon 500, 507, 510
Nomeus 621, 622–3, 625
Nomorhamphus 337–8, 352–3
Normanichthys 410, 416, 422, 443, 445
Notacanthus 94–5
Notemigonus 131
Notestes 440
Nothobranchius 362–4, 368
Notolepis 207–8, 217, 218, 256
Notoliparis 429, 430
Notolychnus 218–9, 221, 223, 226, 229, 234, 240–4
Notolycodes 578
Notoscopelus 218, 220–1, 223, 226, 229, 236, 241–3
Notothenia 563–4
Notropis 29, 131
Novaculichthys 544
Novumbra 140, 142, 202

Ocella 426, 428, 442
Ocosia 440–1
Ocyanthias 500
Ocynectes 443
Odax 544, 546

- Odaxothrissa* 112
Odontanthias 500
Odontesthes 355–7, 359
Odontognathus 114, 125
Odontoliparis 429
Odontomacurus 269, 274–5
Odontopysix 442
Odontostomias 174, 181, 183
Odontostomops 251, 254
Odonus 452
Ogcocephalus 321, 322
Oidiphorus 578
Oligocottus 409, 422, 427, 443, 447
Oligoplites 510, 512, 517, 518, 522–4, 528–9
Oligopus 311
Omosudis 200, 207–8, 212, 216, 245, 259
Ompak 130–1
Oncopterus 643, 673, 684
Oncorhynchus 20, 44, 143–4, 146, 148–9
Oneiroides 325, 327, 331, 333
Omuxodon 312, 314, 316, 318
 OPHICHTHIDAE 79
 OPHICHTHINAE 77
Ophichthus 65–6, 68, 69, 71, 103, 105, 106–7
Ophidion 28, 311, 312–4, 318
Ophiodon 410, 414, 421–5
Ophisurus 103
Ophthalmolycus 578
Opisthonema 109, 118, 122, 124
Opisthoproctus 156–8, 161, 164, 167
Opisthopterus 113, 118, 123, 125
Opistognathus 467
Oplegnathus 467
Opostomias 171–2, 174, 176, 181, 183
Opsarichthys 133–4
Optivus 389, 390
Orbonymus 637
Orcynopsis 592, 600–1, 606, 612
Oreosoma 394, 396
Orthonopias 409, 421, 427, 443
Oryzias 335, 339, 342, 345, 347, 349, 352, 357, 368, 533
Osmerus 29, 129, 131, 133, 153, 154
Osteodiscus 429–30
Ostichthys 392
 OSTRACIDAE 30, 453
Ostracion 452, 459
Otophidium 311, 312–4, 318
Oxyjulis 544
Oxylebius 410, 414, 422, 443–5
Oxyporhamphus 44, 48, 337, 340, 343, 345, 346, 347, 353

Pachycara 578
Pachystomias 171–2, 183
Pageopsis 562, 563
Pagothenia 563
Pagrus 489–90
Paleogadus 262–5
Pallasina 408, 442
Palunolepis 471
Pampus 622–3, 625–8
Pangasius 130, 134
Pantolabus 512–3, 518, 524

Papuengraulis 117, 122
Paraaploactis 441
Parabothus 643, 652, 686
Parabramis 133–4
Parabembas 441
Paracallionymus 14, 44, 48, 637, 639
Paracentropogon 440
Paracentropristis 500
Paracetonus 274–5
Parachaenichthys 563
Paraclinus 570
Paraconger 70
Paracottus 410, 443
Paradiplogrammus 637
Paradiplospinus 593–4, 600–1, 603–4
Paragalaxias 150–1
Paraheminodus 419
Parakneria 138
Parakumba 274–5
Paralabrax 499, 500–1, 509
Paralepis 207–8, 217
Paraletharchus 103
Paralichthodes 643, 673, 684
Paralichthys 24, 39, 640, 641, 642–3, 646, 648, 651–2, 674, 682, 685–6
Paraliparis 429–30, 434, 437
Paranthias 500, 507, 508, 510
Parapercis 560
Paraplagusia 643, 664
Parapsettus 465
Parapterygotrigla 419
Parasalmo 143–4, 146, 148–9
Parascorpius 469
Parasilurus 130
Parastromateus 512, 518, 521, 526, 528, 530
Parasudis 206–8, 258
Parataeniophorus 380, 381, 382–3
Paratrachichthys 392
Paraxenomystax 94
Parexocoetus 335, 338–9, 343, 349, 350, 352, 354
Paricelinus 409, 419, 443
Parika 452, 455, 457
Parkraemaria 590
Parona 512, 518, 522–4, 528
Parophidion 311, 312–3, 318
Parophrys 642–3, 654, 659, 660
Parvilux 218, 220–1, 224, 235, 236, 240–3
Pataecus 440
Patagonotothen 562, 563–4
Paxanovia 578
 PEGASIDAE 400
Pegasus 404
Pegusa 640, 641, 644, 649, 657, 660, 664
Pelagocyclus 429, 432
Pelecanichthys 643, 652, 656, 673, 683
Pellona 113
Pellonula 112, 125
Pelotretis 640, 641, 643–4, 660, 667, 673, 684
Peltorhamphus 640, 641, 643–4, 660, 673, 676
Pempheris 467
Pentanemus 540
Pentherichthys 327, 331

- Peprius* 622–3, 624, 625, 627–8
Perca 29
Perca 473
Percalates 469
Percichthys 469
Percilia 469
Percis 442
Percopsis 55
Percottus 582
Perissias 642, 652, 657, 672, 674, 682–6
Peristedion 407, 419
Peristrominous 441
Perryena 440
Petalichthys 342, 350, 352
Phaenomomas 71, 103
Phallocottus 443
Phallostethus 361
Phenacostethus 361
Philypnodon 590
Pholis 571
Photichthys 185–8, 193
Photoblepharon 392
Photocorynus 326, 333
Photonectes 171–2, 174, 181, 183–4
Photostomias 171–2, 175–6, 179, 181, 183
Phractolemus 138
Phractura 130
Phrynichthys 333
Phrynorhombus 640, 643, 646, 651
Phucocoetes 578–80
Phycis 264, 266, 268, 279–80, 284–9, 290, 292, 294–5, 297–9
Phyllophichthys 103
Physiculus 266–8, 272, 279–80
Piedrabuenia 578
Pikea 501, 508
Pisodonophis 103
Plancterus 363–4
Platanichthys 110
Platax 465
Platichthys 44, 642–3, 654, 659, 660
Platybelone 342, 345, 350, 352
 PLATYCEPHALIDAE 414
Platycephalus 407, 421
Plecoglossus 154, 202–4
Plectranthias 500, 503, 505
Plectrogenium 439, 441
Plectroplites 469
Plectropomus 500
Plectrypops 392
Pleuragramma 563
Pleurogrammus 410, 414, 421–2, 443–5
Pleuronectes 25, 260, 642–3, 660
Pleuronichthys 16, 29, 44, 48, 640, 641, 643, 648, 654, 659, 660, 666
Pliosteostoma 114
Poecilia 364
Poeciliopsis 364
Poecilopsetta 643, 660, 667, 684
Poecilothrissa 112
Pogonolyceus 578
Pogonoperca 501
Pogonophryne 563–4
Polistonemus 540
Pollachius 261, 267–8, 279, 281, 283–4, 286–9, 292, 294–5, 297
Pollichthys 185–89, 192, 193, 198
Polyacanthonotus 94–5
Polydactylus 540–1
Polyipnus 185–91, 197
Polymetme 185–9
Polymixia 379
Polynemus 540
Polypera 429
Polyprion 465, 466, 482, 485, 488, 490, 494
Pomacentrus 544
Pomatomus 471
Pontinus 406–7, 413, 414
Popondetta 361
Porichthys 324
Porocottus 443
Poromitra 387, 389, 391–2
Potamalosa 113, 122–3
Potamorrhaphis 350
Potamothrissa 112
 PRIACANTHIDAE 474
Priacanthus 474
Prionedraeo 563
Prionotus 28, 29, 407, 414, 419
Pristigaster 113
Procatopus 364
Procottus 410, 422, 443
Profundulus 366
Prognichthys 338–9, 349, 354
Promethichthys 594, 596, 599–601, 603
Promicrops 500, 507
Pronotogrammus 500, 503, 505, 507
Prosopium 143–5, 148, 204–5
Prosoproctus 441
Prosphyraena 534
Proteracanthus 465
Protomyctophum 218–9, 221, 224, 225, 229, 241–3, 256
Protosphyraena 534
Prototroctes 151, 152, 153, 203–4
Psammiodiscus 643, 684
Psenes 622–3, 624, 625, 627–8
Psenopsis 623, 627–8
Psettichthys 642–3, 654, 659, 660
Psettina 643, 652, 653, 657
Psettodes 640, 645, 649, 672–3, 675, 676, 678
Pseudalutaris 452, 455, 456
Pseudamia 470
Pseudamiops 470
Pseudanthias 500
Pseudobalstes 452
Pseudoblennius 409, 443
Pseudocalliurichthys 637
Pseudocaranx 512, 518, 526
Pseudochaenichthys 563
Pseudocheilimus 544
 PSEUDOCHROMIDAE 467
Pseudocyttus 394
Pseudogramma 501, 508, 509
Pseudolabrus 544
Pseudomugil 356–7, 361

- Pseudomyrophis* 71, 103, 105–6
Pseudonezumia 274–5
Pseudopentaceros 474, 490
Pseudophrites 563
Pseudophycis 266
Pseudopleuronectes 24, 642–3, 654, 660
Pseudopristopoma 473
Pseudorhombus 642–3, 646, 648, 651–2, 674, 682–6
Pseudoscopelus 557
Pseudosynanceia 440
Pseudotylosaurus 336, 350, 352
Psilodraco 562, 563
Psychrolutes 410, 424, 427–8, 444, 446–7
Ptarmus 441
Pteragogus 544
Pterengraulis 117
Pterois 416, 405
Pterosmaris 471
Pterosynchiropus 637
Pterothrissus 60, 61, 62, 99
Pterygotrigla 419
Ptilichthys 565, 570
Pyramodon 312, 314, 317, 318–9

Quassiremus 103, 106

Rachycentron 474, 489–90, 496, 497–8
Raconda 113
Racovitza 563
Radiicephalus 368–9, 371–2, 376, 378–9
Radulinus 409, 421, 427, 443
Rainfordia 501
Ramnogaster 110
Raniceps 261–2, 266, 268, 279, 284–90, 294–5, 297–9
Ranzania 448, 449, 450, 463
Rastrelliger 592, 594, 600–1, 606, 612, 618–9
Regalecus 368–9, 371–2, 373, 375, 377–9
Reinhardtius 642–3, 654, 659, 660
Repomucenus 637
Reporhamphus 353
Retropinna 150–1, 152, 153, 203–4
Rexea 593, 596, 599–601, 603
Rhadinesthes 171–2, 183
Rhadinocentrus 361
Rhadulinopsis 443
Rhamphocottus 409, 417, 422, 425, 443, 446
Rhinesomus 452, 458, 459
Rhinocephalus 262–5
Rhinogobius 584
Rhinoliparis 429–30
Rhinoprenes 465
Rhinosardina 110
Rhizophryne 328
Rhodichthys 429–30
Rhomboserranus 464
Rhombosolea 643–4, 660, 673, 676, 680, 684
Rhyacichthys 586, 588, 590
Rhynchactis 325–7, 329, 333
Rhynchogadus 266, 268, 272
Rhynchohyalus 156–7, 163–4, 167, 168
Rhynchorhamphus 337–8, 340, 352
Richardsonichthys 440

Ricuzenius 443
Rimicola 629–30, 633, 635
Rita 133–4
Rivulus 362–3, 365–6, 368
Robia 333
Roccus 469
Rondeletia 382
Ronquilus 571
Rosaura 7, 199, 200, 201
Rosenblattia 469
Rosenblattichthys 246, 247–250, 256
Rudarius 452
Ruvettus 591, 593–4, 596, 600–1, 603
Rypticus 501, 507, 508

SACCOPHARYNGOIDEA 93
Sacura 499, 500, 507
Salangichthys 154, 155
Salilota 266, 268, 280
Salmo 53, 143–4, 146, 148–9
Salvelinus 143–4, 146, 148–9
Samaris 643, 660, 667, 672–3
Samariscus 643, 660, 667, 681, 684
Sarda 592–4, 600–1, 606, 609, 612, 617–8
Sardina 108–9, 123–4
Sardinella 109, 118, 120, 122–4
Sardinops 18, 29, 30, 108, 110, 118, 123–4
Sarritor 442
Satyrichthys 419
Saurenchelys 96
Saurida 207–8, 212, 258
Sauromuraenesox 94
Scalanago 65
SCARIDAE 546
Scarus 544
Scatophagus 474
Schedophilus 621, 622–3, 625–8
Schindleria 11, 552, 553, 554
Schismorhynchus 103
Schultzea 500–1
Schultzidia 103
Scomber 24, 592, 594, 600–1, 606, 608, 615–9
Scomberesox 44, 48, 335, 336, 339, 340, 347, 350, 352, 354
Scomberoides 512, 516, 518, 522–4, 528–9
Scomberomorus 591–2, 594, 600–1, 606–7, 609, 612, 617–8
Scombrolabrax 591–2, 593, 594, 599–601, 615–7
Scombrops 474, 490
Scopelarchoides 245, 246, 247–250, 256
Scopelarchus 207–8, 211, 245, 246, 247–50, 256
Scopelengys 207–8, 211
Scopeloberyx 387, 389, 392
Scopelogadus 387, 392
Scopelopsis 218, 220–1, 224, 226, 229, 236, 241–3
Scopelosaurus 207–8, 212
Scopthalmus 27, 640, 641, 643, 646, 651, 676
Scorpaena 405, 407, 413, 414, 439, 445
Scorpaenichthys 409, 417, 425, 427, 443, 446
Scorpaenodes 407, 413, 414
Scorpis 469
Scytalichthys 103
Sebastes 13, 23, 44, 405–6, 410, 411–2, 438–40, 445

- Sebastiscus* 440
Sebastolobus 20, 405, 407, 413, 416–7, 439–40, 445
Sectator 469
Selar 512, 514, 518–9, 522, 526
Selaroides 512, 518, 526
Selenanthias 500, 507
Selene 512, 518, 520, 522, 526
Semicossyphus 544
Semotilus 129
Seriola 497, 498, 510, 512–3, 517, 518, 520, 523–4, 528–9
Seriolla 622–3, 627–8
Seriolina 518–9, 528
Serraniculus 501, 503, 509
Serranus 500–1, 503, 509
Serrasalmus 129, 130, 131, 133, 134
 SERRIVOMERIDAE 87
Serrivomer 69
Setipinna 117, 118, 125
Sicydium 55
Sierrathrissa 108, 114
Siganus 26, 548, 549
Sigmistes 443
Sillago 473
Silonia 137
Siniperca 465, 469, 473, 484–5, 489, 495
Snyderidia 312, 314, 317, 318–9
Snyderina 440–1
Solea 644, 649, 657, 660, 664, 668, 672, 678
Solenophallus 361
Solenostomus 400, 402, 403–4
Solvomer 207–8, 256, 258
Sonoda 185–8
Sparisoma 544
Spectrunculus 311
Sphagebranchus 269
Sphagemacrurus 274–5
Sphoeroides 448, 450
Sphyraena 26, 533–4, 535–6, 537, 538–9, 541
Sphyraenodus 534
Sphyraenops 469, 470, 487, 490
Spinicapitichthys 637
Spiniphryne 333
Spirinchus 154, 155
Spratelloides 111, 122–4
Spratellomorpha 112
Sprattus 108, 110, 122–4
Squalidus 131, 133–4
Squalogadus 274–5
Stegastes 544
Steindachneria 261–4, 267, 269, 277, 282–3
Stelgistrum 443
Stellerina 426, 442
Stellifer 470
Stemonosudis 207–8, 217, 218, 259
Stenatherina 360
Stenobranchius 218, 220–1, 224, 235, 236, 241–3
Stenodus 142–5, 148
Stephanoberyx 392
Stephanolepis 452, 454, 455–6
Stephanophryne 327
Stereolepis 465, 466, 484, 489–90, 495
Sternias 443
Sternoptyx 185–6, 188, 190–1, 197
Stethojulis 544
Sthenopus 441
Stictorhinus 71, 103
Stigmatonotus 465
Stlegicottus 443
Stlengis 443
Stokellia 150–1, 203–4
Stolephorus 116, 118, 121, 123, 125
Stolothrissa 113
Stomias 30, 31, 170, 171–2, 174, 181, 183
Stromateus 622–3, 627–8
Strongylura 336, 339, 340, 342, 345, 350, 352
Stylephorus 368–9, 371–2, 375, 377, 378–9
Stylophthalmus 181
Sudis 20, 155, 207–8, 216, 217, 256
Sufflamen 452, 454
Sundasalanx 204
Suttonia 501
Svetovidovia 7, 266–8, 270, 279–81
Syacium 642, 651–3, 670, 674–5, 682, 685
Symbolophorus 218–9, 221, 224, 226, 228, 229, 234, 241–3
Symphodus 544
Symphurus 28, 29, 643, 664, 667, 669, 670, 672
Symphysanodon 464–5, 466, 483, 489–90, 495
Symphysodon 542
Synagrops 464, 466, 490
Synanceia 440
 SYNAPHOBRANCHIDAE 75
Synaptura 644, 657
Synchiropus 637
Synchirus 443
Syngnathus 400, 402, 403
Synodus 16, 29, 48, 207–8, 216, 256, 258

Taaningichthys 218, 220–1, 224, 229, 236, 240–3
Tactostoma 10, 171–2, 174, 176, 181, 183–4
Taenioides 582, 586–7
Taeniopsetta 642, 652, 653, 657, 672, 682–3, 685–6
Tanakius 642–3, 654, 659, 660, 664
Tandanus 129
Taranetzella 578
Tarletonbeania 218–9, 221, 224, 229, 234, 240–3
Tarphops 642, 646, 651, 674, 682
Tarpon 98
Taurocottus 443
Taurulus 409
Tautoga 544
Telmatherina 355–6, 361–2
Temnocora 429
Tentoriceps 599–601, 604
Tenuialosa 108, 111, 124
Tephrinectes 642, 672, 674, 678, 680, 681
Tetragonurus 622–3, 624, 625–8
Tetraodon 448
Tetrapturus 600–1, 604, 605, 607–8
Tetraroge 440
Tetrosomus 452
Thalassenchelys 69–70
Thalassoma 544, 545
Thaleichthys 154–5
Thaumatichthys 326–7, 330, 333

- Thecopterus* 443
Theragra 29, 267, 269, 281, 284, 286–7, 290, 294–5, 297, 298–9
Therapon 473
Thorophos 185–8, 190–1
Thrattidion 108, 114
Thryssa 116, 121, 125
Thunnus 592, 600–1, 606, 610, 612, 613, 615–7, 619
Thymallus 142–4, 148, 204–5
Thyriscus 443
Thyrsites 591, 593–4, 596, 599–601, 603–4
Thyrsitoides 593–4, 600–1, 603
Thyrsitops 593, 594, 596, 600–1, 603
Thysanactis 171–2
Thysanopsetta 642, 672, 674, 678, 681–2, 686
Tilesina 442
Tilurus 62, 63, 94
Tiluropsis 62, 63, 70, 94
Tomeurus 364
Tongaichthys 591, 593–4, 596, 600–1, 603, 612, 615–7
Torquigener 448, 450
Tosana 500
Tosarhombus 643, 652, 686
Trachelochismus 629, 630–1, 633
Trachicephalus 440
 TRACHICHTHYIDAE 390
Trachichthys 389, 392
Trachidermus 443
Trachinocephalus 207–8, 212, 216
Trachinotus 498, 513, 516, 518, 523–4, 526, 528–9
Trachinus 31, 559, 560
Trachipterus 30, 368–9, 370, 372, 375, 377–9
Trachonurus 274–5
Trachurus 12, 14, 23, 510, 511, 513–4, 518, 520, 526
Trachycorystes 130
Trachydermis 445
Trachyrhynchus 267, 269, 274–5
Trachyscorpia 440
Tragulichthys 448, 449
Triacanthodes 453
Triacanthus 452, 453, 454
Tribolodon 129
Trichiurus 600–1, 602, 604, 606–7
Trichodon 31, 557, 564
Trichonotus 557
Trichopsetta 642, 652, 657, 672, 674, 682–3, 685–6
Trigla 419
Triglops 409, 419, 443
Trigonolampa 171–2
Trinectes 640, 641, 644, 649, 657, 668, 680
Tripnoturus 218, 220–1, 224, 226, 235, 236, 241–3
Triplophos 182, 185–90, 193, 198
Tripteron 465
Tripteroptychis 261, 266
Tripterygion 570
Trisopterus 267, 269, 284, 286–9, 292, 294–5, 297–9
Trisotropis 500
Trypauchen 584, 585, 587, 589–90
Tubbia 622, 626–628
Tylosurus 336, 340, 345, 347, 350, 352
Ulua 513, 518, 526
Umbra 140, 141, 142, 202
Uncisudis 207–8
Uradia 419
Uraspis 513, 518, 521, 526
Urophycis 264, 266, 268, 278, 279, 280–1, 284–9, 290, 294
Uropterygius 72

Valencia 364
Valenciennellus 185–6, 188, 190, 197
Variola 500
Velambassis 467
Velifer 368–9, 375
Vellitor 443
Ventrifossa 274–5
Verasper 642–3, 654, 659, 660
Verecundum 642, 651, 674, 682
Verilus 464
Vinciguerra 28, 29, 185–6, 188, 190, 192, 193, 197
Vomeridens 563

Winteria 156, 163
Woodsia 185, 188–9, 191, 192, 193, 198

Xaniolepis 50
Xantichthys 452, 456
Xenaploactis 441
Xeneretmus 408, 426, 442
Xenentodon 336, 342, 347, 350, 352
Xenisthmus 590
Xenistius 473
 XENOCONGRIDAE 91
Xenolepidichthys 393
Xenomystax 94
Xenopocilus 345, 352
Xenophthalmichthys 156, 161, 163–4
Xiphias 49, 489, 495, 591, 600–1, 604, 606, 612, 615–7, 619
Xiphophorus 363
Xyrichthys 544, 545
Xyrlas 103
Xystreurus 642, 646, 651, 674, 682

Yarella 185–6, 188–9, 191, 192, 193
Yirrkala 103
Yonogobius 584–5
Yozia 402

Zanchlorynchus 440
Zanclus 548, 550
Zaniolepis 410, 414, 422, 443–5
Zaprora 571
Zebrosoma 548
Zebrias 644, 657
Zenarchopterus 337–8, 352–3
Zenopsis 393
Zesticelus 443
Zeugopterus 640, 643, 646, 651
Zeus 398
Zoarcis 578–9
Zu 368–9, 371, 372, 373, 375, 378–9



Photo of symposium attendees, La Jolla, California, August 17, 1983.





