

Idaho Cubic Log Scaling Manual

Cubic Measurement Rules

**Idaho Board of Scaling Practices
2020 Edition**

This manual explains official measurement rules for determining cubic foot volumes of harvested forest products by Idaho licensed log scalers

TABLE OF CONTENTS

CHAPTER 1 – INTRODUCTION6

1.1 SCOPE AND USE OF THE MANUAL..... 6

 1.11 Official Rules.....6

 1.12 Product Classification.....6

1.2 GENERAL LOG SCALER REQUIREMENTS.....6

 1.21 Log Scaler License.....7

 1.22 Written Scaling Specifications.....7

 1.23 Recording Measurements on Scale Tickets7

 1.24 Load Identification7

1.3 PRINCIPLES OF LOG SCALING..... 8

 1.31 Theory and Use of Smalian Formula.....8

 1.32 Scribner decimal “C” Scale Stick (Coconino-type).....8

 1.33 Log Scaling Measurement Tools9

CHAPTER 2 – GROSS SCALE 10

2.1 GENERAL..... 10

 2.11 Scaling Cylinder10

 2.12 Computing Gross Scale for Logs in Round Form.....11

2.2 SCALING LENGTH..... 11

 2.21 Trim Allowance12

 2.22 Single Segment Logs.....12

 2.23 Multi-Segment Logs12

 2.24 Measuring Log Lengths in General14

 2.25 Measuring Lengths of Broken-end Logs14

 2.26 Measuring Lengths of Forked Logs15

2.3 SCALING DIAMETERS.....16

 2.31 Measuring Diameters of Logs in Round Form16

 2.32 Minimum Top Diameter.....17

 2.33 Crotched and Forked Shaped Log Ends.....18

 2.34 Catfaced and Sap Rotted Log Ends19

 2.35 Broken Log Ends.....19

 2.36 Taper in Long Logs19

 2.37 Distribution of Taper in Second-Cut Long Logs20

 2.38 Distribution of Taper in Butt-Cut Long Logs.....21

 2.39 Identifying Characteristics of Butt-Cut Logs.....22

2.4 LOGS IN FRACTIONAL OR SLAB FORM..... 22

 2.41 Fractional Form Log.....23

 2.42 Slab Form Log23

2.5 SPECIAL SITUATIONS MEASUREMENT..... 25

 2.51 Cedar Products Pieces Shorter Than Eight Feet25

 2.52 Truckload Volume Formula26

 2.53 Conversion Factors for Miscellaneous Forest Products27

CHAPTER 3 – SAWLOG NET SCALE..... 28

3.1 GENERAL..... 29

3.2 PRODUCT CLASSIFICATION REQUIREMENTS 29

3.3 MERCHANTABILITY STANDARDS..... 30

3.4 DEFECT DEDUCTION METHODS..... 30

 3.41 Length-cut.....30

 3.42 Diameter-cut31

 3.43 Squared-defect / Squared area32

 3.431 Squared-Defect in Multi-segment Logs33

 3.432 Squared-Defect Using the Coconino Scale Stick34

3.44 Pie-Cut 34

3.5 DEDUCTION APPLICATIONS FOR SAWLOG DEFECTS..... 35

3.51 Breakage 35

 3.511 Broken Log Ends 35

 3.512 Splits and Stump Pull 37

 3.513 Barber chair 38

 3.514 Processor..... 38

3.52 Checks..... 38

 3.521 Heart Checks and Pitch Seams 38

 Straight Checks 39

 Twisting Checks 40

 Cross-checks and Breakouts 41

 “Give and Take Procedure” 42

 3.522 Frost Checks..... 42

 3.523 Weather or Surface Checks 44

3.53 Crook and Sweep 46

 Crook..... 46

 Sweep..... 48

3.54 Foreign Material or Hardware..... 49

3.55 Multiple Defects 49

3.56 Other Natural Defects 51

 3.561 Bark Seam..... 51

 3.562 Burls 51

 3.563 Char or Fire Scars 52

 3.564 Catface 53

 3.565 Crotch..... 54

 3.566 Insect Damage 55

 Scolytus 55

 Wormholes..... 56

 3.567 Knots..... 57

 3.568 Lightning Scar 58

3.57 Pitch..... 59

 3.571 Pitch Seam (**refer to Heart Checks and Pitch Seams*)..... 59

 3.572 Pitch Spangle..... 59

 3.573 Massed Pitch 60

 3.574 Pitch Pockets..... 61

3.58 Rings – Pitch and Shake..... 61

 Interior Rings..... 61

 Perimeter Rings..... 63

 Combination Rings..... 63

3.59 Rots..... 64

 3.591 Butt or Stump 64

 3.592 Heart 64

 3.593 Sap..... 64

 3.594 Conk 65

 3.595 Pocket Rot Associated with Rotten Knots 66

CHAPTER 4 – PULP NET SCALE 67

4.1 GENERAL..... 67

4.2 PRODUCT CLASSIFICATION REQUIREMENTS..... 67

4.3 MERCHANTABILITY STANDARDS 67

4.4 DEDUCTION METHODS AND APPLICATIONS..... 68

 4.41 Interior-Defect Deduction Method 68

 4.42 Diameter-Cut Method 69

 4.43 Pie-Cut/Length-Cut Method..... 69

4.5 MULTIPLE DEFECTS..... 70

CHAPTER 5 – CEDAR PRODUCTS NET SCALE..... 71

5.1 GENERAL..... 71

5.2 PRODUCT CLASSIFICATION REQUIREMENTS..... 71

5.3 MERCHANTABILITY STANDARDS 71

5.4 DEDUCTION METHODS AND APPLICATIONS..... 72

 5.41 Length-Cut Method72

 5.42 Interior-Defect Deduction Method72

 5.43 Diameter-Cut Method74

 5.44 Pie-Cut Method74

5.5 MULTIPLE DEFECTS..... 75

5.6 SLABS..... 76

5.7 PIECES SHORTER THAN EIGHT FEET 76

(Appendix Sections)

APPENDIX A-1 – SPECIES IDENTIFICATION..... 77

A-1.1 GENERAL..... 77

A-1.2 MAJOR COMMERCIAL SPECIES..... 78

 A-1.21 Cedar78

 A-1.22 Douglas Fir.....79

 A-1.23 Hemlock.....80

 A-1.24 Larch.....81

 A-1.25 Lodgepole Pine.....82

 A-1.26 Ponderosa Pine.....83

 A-1.27 White Pine84

 A-1.28 Spruce.....85

 A-1.29 Grand Fir86

 A-1.210Alpine Fir87

A-1.3 MINOR COMMERCIAL SPECIES..... 88

 A-1.31 Mountain Hemlock.....88

 A-1.32 Whitebark Pine.....88

 A-1.33 Limber Pine89

 A-1.34 White Fir89

A-1.4 SPECIES IDENTIFICATION CHART 90

APPENDIX A-2 – CUBIC VOLUME TABLES 91

APPENDIX A-3 – SCRIBNER VOLUME TABLE104

APPENDIX A-4 – LENGTH DETERMINATION TABLE..... 106

APPENDIX A-5 – TAPER TABLE..... 109

 Region 1 - North Idaho Area109

 Region 2 - East-Central Idaho Area.....109

 Region 3 - Eastern Idaho Area.....109

 Region 4 - Southwest Idaho Area.....110

 Region 5 – Nevada-Utah-Wyoming Area110

 Region 6 – Southeast Washington & East Oregon Area110

 Region 7 – All Other Areas110

APPENDIX A-6 – COMMON ROTS OF IDAHO LOGS..... 111

A-6.1 GENERAL..... 111

A-6.2 TRUNK ROTS..... 112

 A-6.21 Paint Rot (*Echinodontium tinctorium*).....112

 A-6.22 Fomes or Pini Rot (*Phellinus pini*).....114

 A-6.23 Red Ray or Anceps Rot (*Dichomitus squalens*).....117

 A-6.24 Brown Top Rot (*Fomitopsis roseus*)118

 A-6.25 Quinine Rot (*Fomitopsis officinalis*).....118

 A-6.26 Yellow Pitted Trunk Rot (*Hericium abietis*).....119

A-6.3 BUTT ROTS..... 120

 A-6.31 Red-Brown Butt Rot (*Phaeolus schweinitzii*).....120

 A-6.32 Feather Rot (*Perenniporia subacida*).....121

 A-6.33 Weirii Butt Rot (*Phellinus weirii*).....121

 A-6.34 Brown Pocket Rot of Cedar (*Postia sericeomollis*).....122

 A-6.35 Red Root and Butt Rot (*Inonotus tomentosus*).....123

 A-6.36 Annosus Root or Butt Rot (*Heterobasidion annosum*)124

 A-6.37 Big White Pocket Rot (*Phellinus nigrolimitatus*).....124

 A-6.38 Shoestring Root Rot (*Armillaria ostoyae*).....125

 A-6.39 Brown Cubical Rot (*Laetiporus sulphureus*)125

A-6.4 SAP ROTS AND STAINS 126

 A-6.41 Gray-Brown Sap Rot (*Cryptoporus volvatus*).....126

 A-6.42 Pitted Sap Rot (*Trichaptum abietinum*).....126

 A-6.43 Brown Pocket Sap Rot (*Lenzites saepiaria*)127

 A-6.44 Brown Crumbly Rot (*Fomitopsis pinicola*)128

 A-6.45 Blue and other Sap Stains128

CHAPTER 1 – INTRODUCTION

1.1	SCOPE AND USE OF THE MANUAL	6
1.11	Official Rules.....	6
1.12	Product Classification.....	6
1.2	GENERAL LOG SCALER REQUIREMENTS	6
1.21	Log Scaler License	7
1.22	Written Scaling Specifications	7
1.23	Recording Measurements on Scale Tickets.....	7
1.24	Load Identification.....	7
1.3	PRINCIPLES OF LOG SCALING	8
1.31	Theory and Use of Smalian and Scribner decimal “C” Log Rule....	8
1.32	Scribner decimal “C” Scale Stick (Coconino-type)	8
1.33	Log Scaling Measurement Tools.....	9

1.1 SCOPE AND USE OF THE MANUAL

Idaho forests are a source for a variety of different forest products, but the most significant are logs manufactured during the course of timber harvest. The majority of commercial transactions involving logs require scaling measurement as the means for quantity determination. The rules and procedures for cubic scaling in Idaho are outlined within this manual. These rules and procedures are based on using a dual Scribner/cubic scaling program. The Scribner portion will be “standard” Scribner decimal C; the cubic portion will be based on the National Forest Smalian formula. The National Forest cubic program utilizes a cull determination factor for each log segment based on “Revised” Scribner volumes and various algorithms for defects, which are built into the program. Idaho uses “Standard” Scribner volumes. This difference results in some logs that do have one-third merchantability remaining being culled in the cubic program. To alleviate these discrepancies, the computer programs must be set to use standard Scribner decimal C as the “driver” and all logs must be scaled using a dual Scribner/cubic program. This will maintain the current merchantability standards for sawlog, pulp and cedar products based on the standard Scribner volumes.

Each chapter of this manual includes a table of contents, listing sections and subsections describing scaling practices of concern to an Idaho licensed log scaler. Some useful tables and detailed reference information may be found in the appendix section.

1.11 Official Rules

This scaling manual contains official cubic measurement rules of the Idaho Board of Scaling Practices and applies to all commercial log scaling performed within the state of Idaho.

Gross scale determination shall be made according to rules and procedures explained in Chapter 2 of this manual. Gross scale determination is mandatory and cannot be modified by contract agreement.

Net scale determination shall be made according to rules and procedures explained in Chapters 3, 4 and 5 of this manual. Net scale determination may be modified by contract agreement.

1.12 Product Classification

Product classification refers to different methodologies of net scale determination. This manual explains rules and procedures for:

- Sawlog net scale (Chapter 3).
- Pulp net scale (Chapter 4).
- Cedar Products net scale (Chapter 5).

All net scale determination is sawlog product classification only, unless contract agreements indicate otherwise.

Contract agreements may modify any net scale determination rules. Any modification of net scale determination rules must be furnished to the scaler *in writing*. Log scalers are directed to have written scaling specifications before using any modified net scale rules, and cannot comply with solely verbal directives.

1.2 GENERAL LOG SCALER REQUIREMENTS

The responsibilities of a scaler will vary to some extent, according to individual employer situations, requirements, and methods of operation. Essentially the job of a scaler is to provide an accurate and unbiased log scale.

A common means of verifying scaling accuracy is check scaling. This involves another scaler re-scaling logs that have been scaled, and then comparing volumes and scaling practices with the original scaler's determinations. The Idaho Board of Scaling Practices performs periodic check scales on licensed scalers working within the state. When check scale results are within certain allowable limits of variation, it indicates acceptable scaling practices are being met. Log scalers should always remain aware of the importance of accuracy and consistency in their scale determination. In addition to a thorough knowledge of scaling practices and procedures, a log scaler should be aware of certain job-specific requirements pertaining to any scaling performed within the state of Idaho. An overview is provided in remaining subsections.

1.21 Log Scaler License

Idaho law requires that every person performing log scaling for commercial purposes must first be licensed by the Idaho Board of Scaling Practices. Licensed professional log scalers are issued a certificate of registration that serves as proof they have been tested and qualified to scale logs. License registrations are valid for a two-year period. Log scalers must pass an examination every two years in order to maintain active license status.

Subject to certain conditions, the Idaho Board of Scaling Practices may issue a Temporary Permit or Apprenticeship Certificate to a qualified person, which allows them to engage in scaling for commercial purposes.

Scaling is the quantitative measurement of logs or other forest products by means of a log rule. Scaling also includes any professional scaling service rendered in connection with the measurement of forest products, or supervision of scaling when such service is rendered requiring the application of scaling principles and data.

Scaling in Idaho without first being duly licensed is a violation of law, and may result in civil or criminal penalties.

1.22 Written Scaling Specifications

Administrative rules of the Idaho Board of Scaling Practices govern how logs are scaled within the state. Gross scale determination rules are mandatory in nature, but net scale rules allow parties in a scaling agreement to modify net scale determination. In these situations, the employer of a scaler is required to provide written scaling specifications, and scalers must have ready access at any scaling site where they are being used.

Written scaling specifications describe which aspect of net scale is being modified, and the substitute specifications, rules or procedures to use in its place. It is noted that these must be furnished to a scaler *in writing*. A verbal directive is not an acceptable substitute. When written scaling specifications have been furnished to a scaler, they must be followed in arriving at net scale determination. A scaler should request changes in writing from their employer for any written scaling specification that is unclear.

In the absence of written scaling specifications, or in instances where written scaling specifications omit items of specific information necessary to scale logs, scalers are required to use the net scaling rules contained in this manual.

1.23 Recording Measurements on Scale Tickets

Scale tickets (or scale slips) are documentation of the total quantity delivered in a truckload of logs. They are important business records that often serve to identify the transfer of ownership of logs from one party to another.

Scale tickets should always identify the scaler(s) who scaled the logs. Care must be taken by the scaler to accurately record all data entered. For each log scaled, scalers are required to record on the scale ticket a combination of data from which both the gross and net scale can be derived. Scaling length and scaling diameter must be included.

1.24 Load Identification

For a period after completion of scaling, loads of logs may remain where they have been scaled before being put into log deck storage. New loads may arrive and be spread out for scaling next to loads that have already been scaled. During the busy seasons, or in log yards with more than one scaler, it is important to identify which loads have been scaled and which have not been scaled. Marking or flagging of scaled loads is often the preferred method.

Upon completion of scaling, all scalers are required to be able to identify which loads they have scaled. When a trip ticket number is painted on a log end, this often can be done by simply matching it with the appropriate scale ticket. At times, scalers may have to utilize other means to ensure scaled loads can be readily identified. Some employers require scalers to mark scaled loads in a manner that identifies the load and the scaler who scaled it.

1.3 PRINCIPLES OF LOG SCALING

Log scaling is a means for expressing quantity in a log, based upon making measurements to determine its size. These measurements are neither a guess nor an estimate, but rather the result of applying certain fundamental rules and techniques.

The quantities of different sizes of logs are expressed in a log rule, and serve as an arbitrarily accepted basis for determining log volume.

A log rule is a designed standard that is used to convey the volume in a log. The volume of a log is most commonly expressed as a quantity of basic units of measure. In Idaho, contents of a log may be expressed in both Scribner and dual Scribner/cubic units of measure. The basic unit of measure for expressing log quantity is the board foot, a unit of wood measuring 12-inches wide, by 1-inch thick, and 1-foot long (or its equivalent). Cubic utilizes a cubic foot, a unit of wood measuring 12-inches wide, by 12-inch thick, by 12-inches long (or its equivalent).

1.31 Theory and Use of Smalian Formula

Many types of log rules have been used to express the volume in a log. Their log volumes were developed based upon formulas, sawing diagrams, or mill tallies for logs of different diameters and lengths. Results of these various computations were assembled in tables that show the incremental increase of volumes (the scale) for larger and/or longer logs. Throughout the country, most commonly used today are the International ¼-inch, Doyle, Scribner and Smalian log rules.

Idaho uses the Smalian formula as the standard for determining cubic volume.

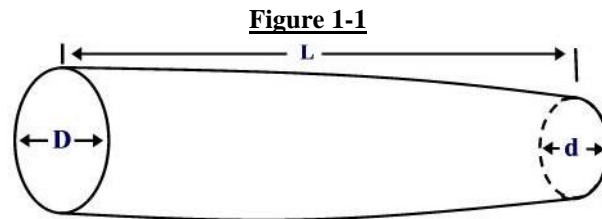

Frustrum of a Paraboloid

$$V = \frac{(A + B)}{2} \times L$$

$$V = \frac{\frac{3.1416 D^2}{4 \times 144} + \frac{3.1416 d^2}{4 \times 144}}{2} \times L$$

$$V = 0.002727 (D^2 + d^2) L$$

Where:

V = Volume in cubic feet (ft³)

A = Large end cross-section area (ft²)

B = Small end cross-section area (ft²)

D = Large end diameter (inches)

d = Small end diameter (inches)

L = Length (feet)

1.32 Scribner decimal "C" Scale Stick (Coconino-type)

This scale stick is the officially recognized measuring device within the State of Idaho and is the primary tool for taking diameter measurements for determining both Scribner and cubic volumes.

The defining characteristic of a Coconino-type scale stick is that its principal faces are marked with lines at the ½-inch locations. Board foot figures are also given at the ½-inch mark, thereby making it unnecessary for the scaler to decide whether to drop to the next lower inch or advance to the next higher inch in measuring diameters that do not fall on exact inch markings.

1.33 Log Scaling Measurement Tools

Professional log scalers utilize various tools and equipment to perform log scaling. To ensure accurate scaling it is important that scaling equipment is kept in good working order, with proper maintenance and replacement when necessary. Some of this equipment and their uses are described below.

Scribner decimal “C” Scale Stick (Coconino-type). This is a measuring device made of wood with a pointed metal head at the lower end. It has graduated inch-markings on the half-inch (Coconino-type) and lists Scribner decimal “C” volumes for various lengths and diameters. It also generally includes “squared-defect” volumes printed in red. The scale stick is used for diameter measurement of logs and scale computation.

Log Calipers. This is a measuring device with a sliding arm and graduated inch markings. It is used to determine diameter measure at uncut positions on a log.

Logger Tape. Marked with feet and inches, scalers generally use 50- or 75-foot self-winding steel tapes for measuring log or defect lengths.

Hand Tape. Most often a common carpenter tape measure, hand tapes allow a scaler to measure log end diameters when an accurate scale stick measure cannot be made. Some scalers use hand tapes as a primary tool for measuring diameters.

Hatchet. Most scalers use a single-bitted, tempered hand hatchet with a durable belt scabbard that allows for easy access. This tool is used for determining the nature and extent of various defects by chopping into them. It is most effective when the hatchet edge is kept sharp.

Recording Device. Most often this is a specialized “handheld” data recorder (mini-computer) used for recording information of each log scaled. The handheld computes log scale from data entered by the scaler, which then can be printed to a paper scale ticket.

Safety Equipment. A brightly colored vest helps make a log scaler visible to machine operators in a log yard. A hard hat, safety glasses, or other safety equipment is required by some employers.

Tree Paint or Flagging. These are often used to identify loads of logs that have been scaled. Paint is also used to identify certain logs that must be sorted in some log yard operations.

CHAPTER 2 – GROSS SCALE

2.1	GENERAL.....	10
2.11	Scaling Cylinder	10
2.12	Computing Gross Scale for Logs in Round Form.....	11
2.2	SCALING LENGTH.....	11
2.21	Trim Allowance	12
2.22	Single Segment Logs.....	12
2.23	Multi-Segment Logs	12
2.24	Measuring Log Lengths in General	14
2.25	Measuring Lengths of Broken-end Logs	14
2.26	Measuring Lengths of Forked Logs	15
2.3	SCALING DIAMETERS.....	16
2.31	Measuring Diameters of Logs in Round Form	16
2.32	Minimum Top Diameter.....	17
2.33	Crotched and Forked Shaped Log Ends.....	18
2.34	Catfaced and Sap Rotted Log Ends	19
2.35	Broken Log Ends.....	19
2.36	Taper in Long Logs	19
2.37	Distribution of Taper in Second-Cut Long Logs	20
2.38	Distribution of Taper in Butt-Cut Long Logs.....	21
2.39	Identifying Characteristics of Butt-Cut Logs.....	22
2.4	LOGS IN FRACTIONAL OR SLAB FORM.....	22
2.41	Fractional Form Log.....	23
2.42	Slab Form Log	23
2.5	SPECIAL SITUATIONS MEASUREMENT.....	25
2.51	Cedar Products Pieces Shorter Than Eight Feet	25
2.52	Truckload Volume Formula	26
2.53	Conversion Factors for Miscellaneous Forest Products	27

2.1 GENERAL

Gross scale is defined as the total board foot contents of the scaling cylinder or the total cubic volume of a log segment, before deductions for any defects are made. A log scaler must determine two measures – the scaling length and the scaling diameters – to arrive at the gross volume of a log segment.

All logs are gross scaled “as presented” – this means each log presented for scaling is recorded with its own identifying scaling length and scaling diameters. Logs that may have broken apart and are no longer attached are recorded separately. The only exceptions are those pieces that do not meet the minimum length and/or diameter measurement criteria described within this chapter – recording of these pieces is not required, but it is a valuable means of identifying all pieces presented in a scaled load of logs.

Measuring is basic to scaling, and it is extremely important that measurements be made in accordance with rules described within this chapter. An accurate gross scale provides the foundation for determining net scale.

2.11 Scaling Cylinder

Cubic scaling itself does not recognize a scaling cylinder. However, some references to a scaling cylinder are still utilized in this manual. Log lengths are one example where a scaling cylinder is still used to determine the scaling length of a log. If a log has a 32-foot scaling length in Scribner it must also have a 32-foot scaling length in cubic. Further, Scribner gross and net volumes will be used to determine the minimum net merchantability requirements for each log segment and product. An important concept in Scribner decimal “C” log scaling is an understanding of the scaling cylinder, because gross scale of a log segment reflects the board foot contents of the scaling cylinder. Good scaling practices require that a log scaler develop the ability to “see” the scaling cylinder in any log being scaled. In a perfectly straight log segment, the scaling cylinder is an imaginary cylinder projected through the center of the log and extending the scaling length of the log segment. The diameter of a Scribner cylinder is always identical to the small end scaling diameter of the log segment. Figure 2-1 illustrates the Scribner cylinder in a straight log segment. The solid outside line represents the cubic cylinder of the log.

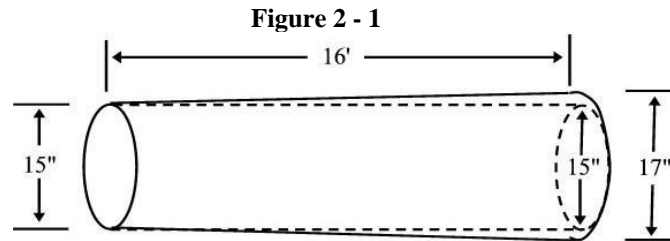

Although many log segments are not perfectly straight, the useable portion or scaling cylinder is always projected as a straight line. It is never re-directed or bent to conform to the shape of a log segment. When this type of log segment is encountered, visualize the useable portion as being in the longest straight section of the log segment, and projecting for the length of the log segment. Figure 2-2 illustrates the cubic useable portion in a crooked log segment.

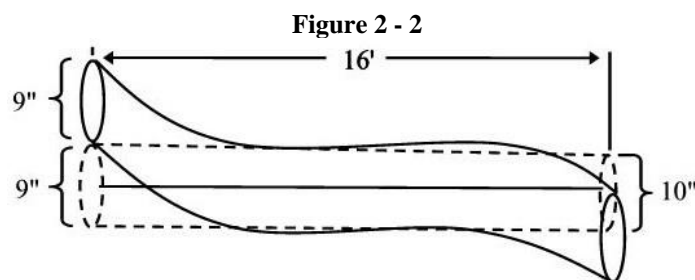

2.12 Computing Gross Scale for Logs in Round Form

The term “log in round form” applies to those typical and vast majorities of logs that are manufactured from the merchantable-size bole portion of trees. Although a log in round form can be a short log, long log, or forked log, the gross scale is commonly expressed by one number, which is the sum of the individual scaling segment volumes.

Once an accurate scaling length and scaling diameters have been determined, the process of computing gross scale is relatively easy. For cubic volume, with all the complex formulas, it would not be a reasonable expectation for the scaler to scale on paper. Therefore, scalers will use handheld scaling recorders that automatically compute the gross scale volume from the scaling length and scaling diameter(s) entered. A new scaler should still become familiar with determining Scribner scale volume from the scale stick as it will be necessary to use it in some instances for cubic volume. Volume tables list the scale volume for logs of various diameters and lengths.

The official cubic volume table and the official Scribner decimal “C” volume table used in the state of Idaho are listed in the Appendix, Section A-2. They list the cubic volume and the decimal “C” volume for logs of all length and diameter combinations that an Idaho log scaler will encounter. Although they list volumes for logs ranging from 3 inches in diameter and 4 feet in length, a log must usually measure at least the 6-inch diameter class and have an 8-foot scaling length to receive gross scale.

2.2 SCALING LENGTH

The overall scaling length of a log is comprised of one or more segment lengths, with the gross scale of each log segment being separately determined. The total gross scale for any log is the sum of the gross scales for each log segment. The scaling length of a log is always expressed in whole, one-foot increments. It is determined from the overall measured length of a log in feet and inches, rounded to whole foot increments in accordance with specific rules. Most often, logs are cut a little longer than their scaling length and this additional length is referred to as trim allowance.

2.21 Trim Allowance

The overall length of a log usually includes a trim allowance that serves as the “packaging” for the wood. Trim allowance is needed in the manufacture of finished lumber lengths, to trim off short weather checks or other minor log end damage and to square the ends of boards sawn from logs. Full trim allowance is six inches per log segment, but it is not unusual for logs to vary from this trim by two inches. When measured log lengths exceed full trim allowance, plus an additional two inches, the scaling length is rounded to the next higher foot. The proper scaling length for logs with various measured lengths is listed in the Appendix, Section A-3.

To arrive at the scaling length, a log scaler first measures the overall length of a log in feet and inches. Any fraction of an inch is disregarded in determining this length. For example, a log measuring exactly sixteen feet, eight and seven-eighths inches, has a determined measured length of 16 feet, 8 inches (the fraction of an inch is disregarded).

A single segment log may have a maximum of eight inches trim allowance added to its scaling length. For example, a log measuring 16 feet 8 inches has a 16-foot scaling length, whereas a log measuring 16 feet 9 inches has a 17-foot scaling length.

The maximum trim allowance on multi-segment logs is six inches for each segment, plus an additional two inches for the overall length. For example, a log measuring 41 feet 2 inches has a 40-foot scaling length, whereas a log measuring 41 feet 3 inches has a 41-foot scaling length.

Commonly manufactured log lengths usually have a minimum trim allowance of at least four inches on a single segment log and at least ten inches on a double segment log.

2.22 Single Segment Logs

A single segment log is any log with a scaling length of 8 feet through 20 feet. It is important to note that the minimum scaling length is an 8-foot log segment (this is a log with a measured length of at least 8 feet 1 inch). Any piece with a scaling length shorter than 8 feet has zero gross scale volume. The maximum scaling length for a single segment log is a 20-foot log segment.

2.23 Multi-Segment Logs

Multi-segment logs are those logs exceeding the 20-foot maximum single segment length. These logs are divided into two or more segments, as nearly the same length as practicable, in accordance with specific rules, and no scaling segment length can ever be longer than 20 feet. Logs with scaling lengths of 21-foot through 40-foot are scaled as two-segment logs. Logs with scaling lengths of 41-foot through 60-foot are scaled as three-segment logs, 61-foot through 80-foot as four-segment logs, etc.

Since lumber is commonly sold in lengths that are multiples of two feet, multiple segment logs are generally divided into lengths that are multiples of two feet. For example, a log measuring 33 feet 0 inches has the allowable trim for a 32-foot scaling length. Logs whose overall scaling length is an even number are called “even length” logs. Figure 2-3 illustrates the two 16-foot scaling segments that are used for a 32-foot scaling length.

Figure 2 - 3

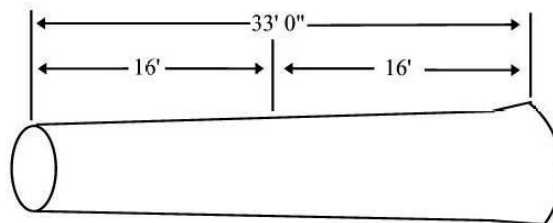

When an even length log must be divided into unequal lengths, the shorter segment(s) is always in the small end (top) of the log and the longer segment(s) in the large end. For example, a log measuring 35 feet 2 inches has the allowable maximum trim for a 34-foot scaling length. Figure 2-4 shows how it is divided as a 16-foot top segment and an 18-foot bottom segment.

Figure 2 - 4

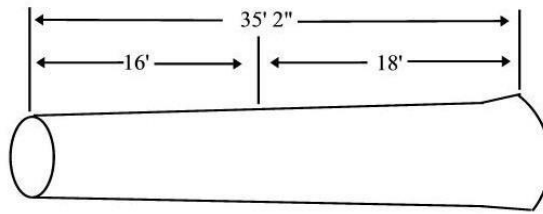

A log measuring 45 feet 2 inches is scaled as a 44-foot scaling length. As shown in Figure 2-5, it is divided into three segments: a 14-foot top segment, a 14-foot middle segment, and a 16-foot bottom segment.

Figure 2 - 5

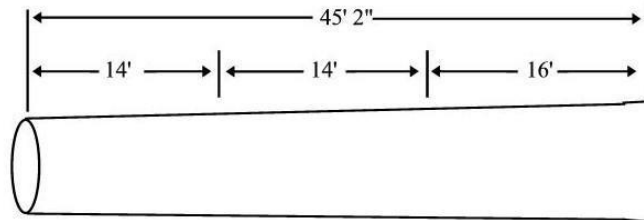

Logs whose overall scaling length is an odd number are called “odd length” logs. Odd length, multi-segment logs cannot be evenly divided into multiples of two feet. In these instances, one of the segments will be an odd length segment and the other(s) will be even length segments. Again, the overall scaling length is divided into two or more segments as nearly the same length as practicable. For example, a log measuring 31 feet 10 inches is scaled as a 31-foot scaling length. Figure 2-6 shows how it is segmented as a 15-foot top segment and a 16-foot bottom segment.

Figure 2 - 6

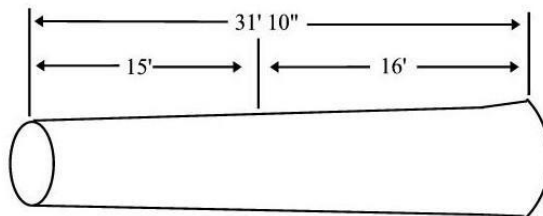

A log measuring 41 feet 3 inches is scaled as a three-segment, 41-foot scaling length. Figure 2-7 shows the proper segmenting: a 13-foot top segment, a 14-foot middle segment, and a 14-foot bottom segment.

Figure 2 - 7

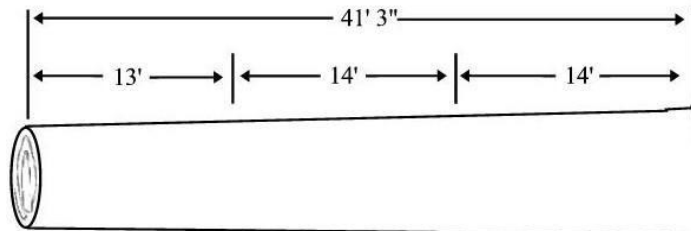

In all instances when determining segmentation on an odd length multi-segment log, only one segment will be an odd length segment and the difference between the shortest and longest segment will never be more than two feet. Refer to the Appendix, Section A-3, to find the appropriate scaling length and segment lengths for logs measuring from 8 feet 1 inch to 123 feet 2 inches.

2.24 Measuring Log Lengths in General

For stump cuts, measure lengths from a point on the butt end where the scaling cylinder emerges to the short side at the top end. For other cuts, make length measurements from the short side to the short side. Determine all log lengths by measuring the shortest length between the applicable points at the log ends.

Logs with sweep and crook are particularly difficult to measure. Figures 2-8 through 2-11 illustrate length measurements.

Figure 2 - 8

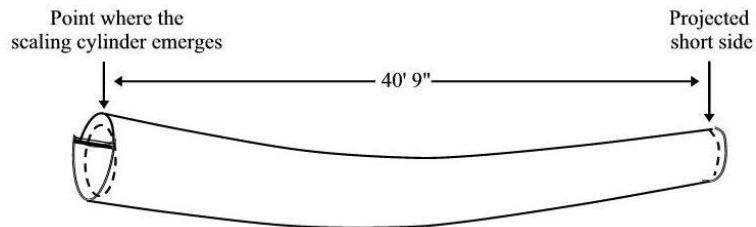

Figure 2 - 9

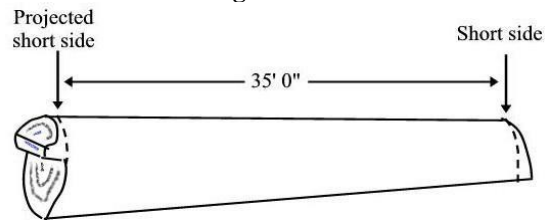

Figure 2 - 10

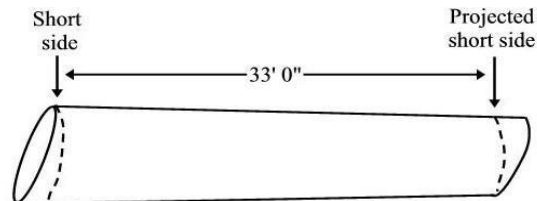
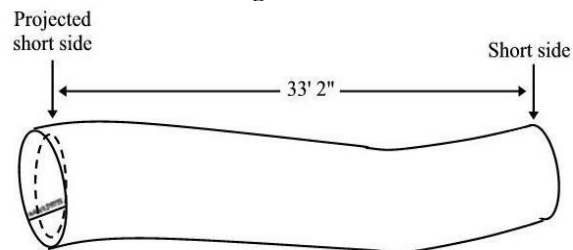
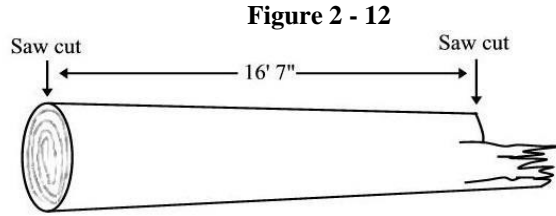

Figure 2 - 11



2.25 Measuring Lengths of Broken-end Logs

The measured length of a log that has been wholly or partially bucked is determined by measuring the log from saw cut to saw cut, as illustrated in Figure 2-12.



The measured length of broken end logs when only one end is bucked, or when neither end is bucked, is determined from points where the log should have been bucked to square it up. Whenever this measured length is shorter than 8 feet 6 inches, the piece has no gross scale. Always include full trim allowance (six inches per segment) in determining this measured length, to arrive at the applicable scaling length. The applicable scaling length for these types of broken end logs is always a two-foot multiple. Figure 2-13 illustrates determination of applicable scaling length of a broken end log when only one end is bucked.

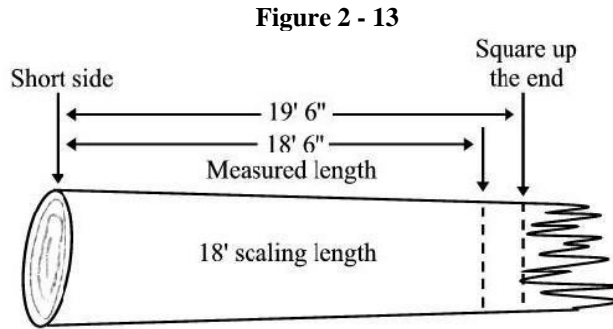
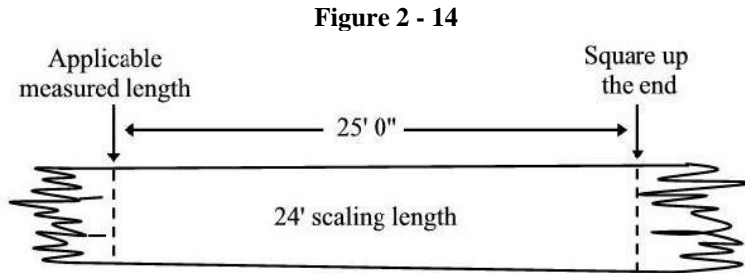

Figure 2-14 illustrates determination of applicable scaling length of a broken end log when neither end is bucked.



Broken-end logs may also be encountered where the small end diameter is smaller than the minimum diameter, which is usually the 6-inch diameter class. In these instances, the measured length of the log will be from the large end to the furthest point on the small end with the minimum top diameter, including the appropriate full trim allowance, to arrive at the applicable 2-foot multiple scaling length (refer to Section 2.32).

2.26 Measuring Lengths of Forked Logs

Forked logs are rarely encountered, but under certain conditions, each stem from the fork will be included in gross scale. This occurs when a forked stem has an 8-foot or longer scaling length, including full trim, containing at least a minimum scaling diameter (refer to Section 2.32). Length measurement of a forked stem begins at the point of daylight.

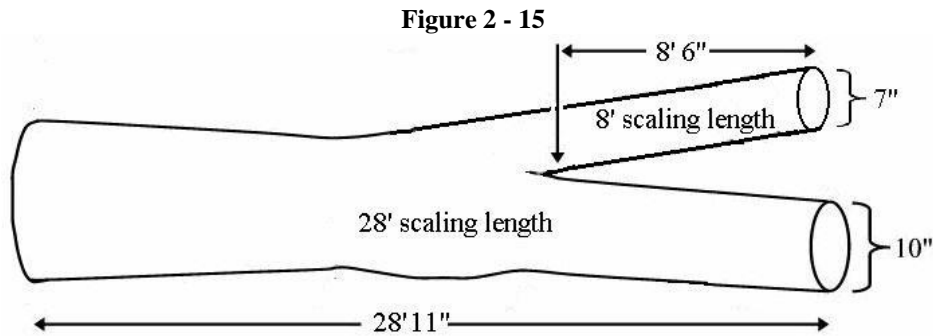

Figure 2-15 illustrates measurement of a forked log for gross scale. Initial measurement is inclusive of the prominent fork, for the full length of the log. When the length and diameter of a minor fork meets merchantable minimums, the length will be determined in 2-foot multiples, with allowance for full trim

2.3 SCALING DIAMETERS

Probably the most critical element in log scaling practices is measuring an accurate log diameter. The scaling diameter of a log is measured and recorded in whole, one-inch increments. It is determined by the average of two measurements – a “narrow way” diameter and a “right angle to the narrow way” diameter.

Common tools used to measure diameters include the Coconino Scribner decimal “C” scale stick, steel hand tape, and sliding calipers. The Coconino Scribner decimal “C” scale stick is the primary tool used to obtain the diameter of log ends. The steel tape is versatile and is particularly useful for obtaining diameters that cannot be measured with the scale stick, such as recessed logs. Calipers are useful in measuring diameters at points along the log other than at the ends.

2.3.1 Measuring Diameters of Logs in Round Form

Follow these procedures to determine scaling diameters:

1. Measure log diameters inside the bark at the small end of the log (except when a smaller log diameter can be measured further down the log due to an abnormally shaped small end).
2. Measure through the true (geometric) center of the log, not the center of the log as shown by the growth rings and pith.
3. In measuring, disregard abnormal bumps, depressions, breakage, brooming, burls, knots, swelling, and flare; in other words, measure as though such conditions do not exist.
4. Where possible, read the scale stick directly from the end of the log, not obliquely from the side.
5. Take a pair of diameter measurements at right angles to each other. Measure the short axis or narrow-way first, then take the second measurement through the true center of the log at right angles to the first measurement. Take each of these two diameter measurements to the nearest inch. In Figure 2-16, measurement "A" is read as 11 inches and measurement "B" as 12 inches.

Figure 2 - 16

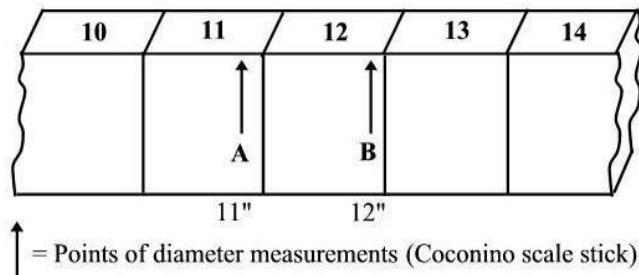

6. Measurements that fall exactly on the 1/2-inch are rounded:
- when only one of the diameter measurements falls on the 1/2-inch, round up
 - when both of the diameter measurements fall on the 1/2-inch, round one up and one down.

Figure 2 - 17

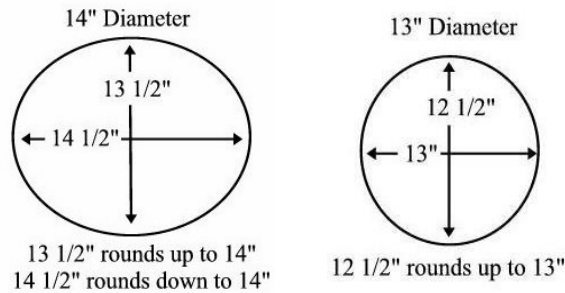

7. The scaling diameter is the average of the narrow-way diameter and the right angle-to-the-narrow-way diameter. When this average of the two diameter measurements results in a 1/2-inch, round down for the final scaling diameter.

Figure 2 - 18

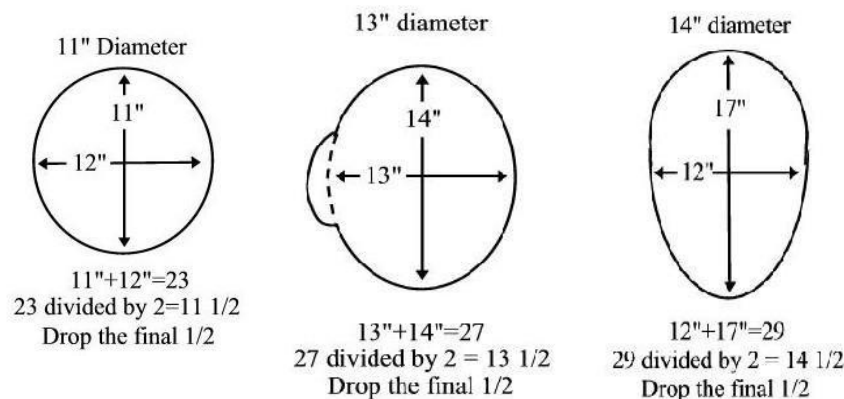

2.32 Minimum Top Diameter

The minimum top (small end) diameter measurement for all gross scale determination is generally 5.51 inches (actual measure) which corresponds to the 6-inch diameter class on the Coconino Scribner decimal “C” scale stick. The part of any log having a diameter smaller than the minimum top diameter is disregarded. However, by contractual agreement, a smaller minimum top diameter may be established, but contract agreements cannot specify a minimum top diameter larger than 5.51 inches. When a contractual agreement specifies a minimum diameter smaller than 5.51 inches (actual measure) a log scaler must be notified by means of written scaling specifications. Only then will a log scaler scale to the smaller minimum top diameter; otherwise, log scalers are required to use 5.51” (actual measure) as the minimum top diameter measurement.

When a log scaler encounters logs or pieces presented for scaling which have not been bucked to separate material meeting minimum diameter standards from material not meeting minimum diameter standards, the log or piece will be scaled as though such bucking had been done. Proceeding from the large end of the log, the scaler will determine the furthest point where the full extent of the 5.51-inch minimum top diameter is met. The minimum diameter is always located by the narrow-way measurement (not by the average of the narrow and right angle measurements). The measured length of the log to the point of the minimum top diameter must always include full trim allowance for a resulting scaling length in 2-foot multiples, otherwise reduce the recorded length to the next lower 2-foot multiple.

Figure 2-19 shows a 33’ 0” log with a 5.0” top diameter. At “full trim” length of 31’ 0”, the narrow-way diameter measure is just under the half-inch mark. The log does not meet the minimum top diameter of 5.51” until 30’ 9” up from the butt end. Since this is not a 2-foot multiple with full trim the log must be recorded as a 28-foot scaling length with an 11-inch large end diameter and a 6-inch top diameter that is measured at 29’ 0”.

Figure 2 – 19

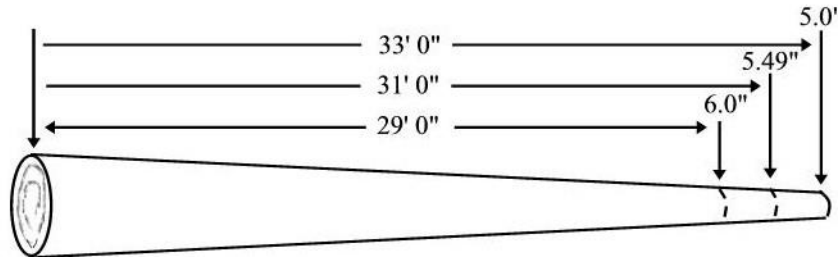

When the recorded scaling length must be reduced (due to insufficient full trim allowance at the minimum top diameter point) and the scaling diameter (narrow and right angle measurements) gets larger, use this larger scaling diameter to determine gross scale. Figure 2-20 illustrates this; by caliper measurement at 29' 0" a scaler determines the narrow-way diameter at 6.8" (7" diameter class) and right angle diameter at 7.6" (8" diameter class). The log is recorded as a 28-foot scaling length with a 7-inch top diameter and a 12-inch large end diameter.

Figure 2 - 20

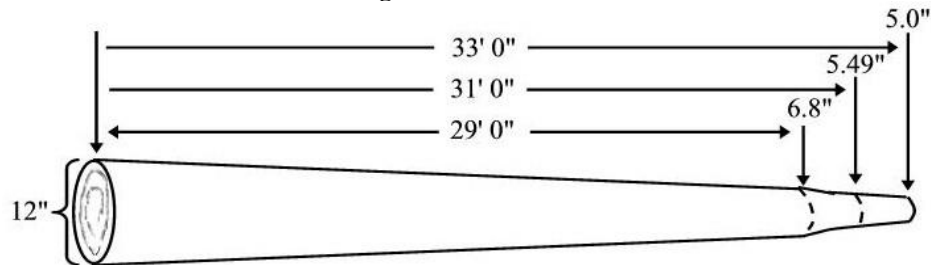

In the case of a contract agreement specifying a minimum top diameter smaller than 5.51 inches, the minimum diameter measurement is exactly that specified in the contract and not a diameter class. For example, a contract that lists the minimum diameter as 5 inches will be considered to be 5.0 inches. Take a single measurement across the short axis of the log to determine if the top meets the contract minimum.

2.33 Crotched and Forked Shaped Log Ends

When diameters cannot be accurately measured on log ends due to abnormalities, measure the smallest average diameter above or below the abnormality and project the log taper to determine the scaling diameter. If calipers are not available, use a scale stick at this measurement point, remembering to allow for bark thickness. The scaling diameter at this point is the average of the narrow and right angle measurements, illustrated in Figure 2-21.

Figure 2 - 21

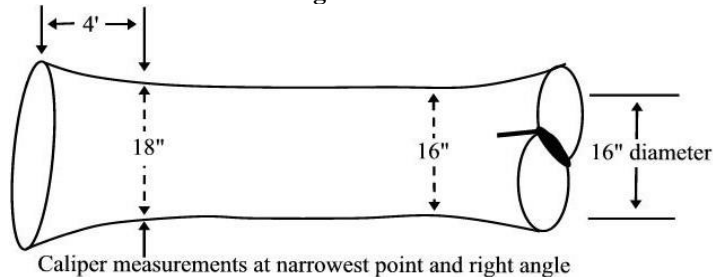
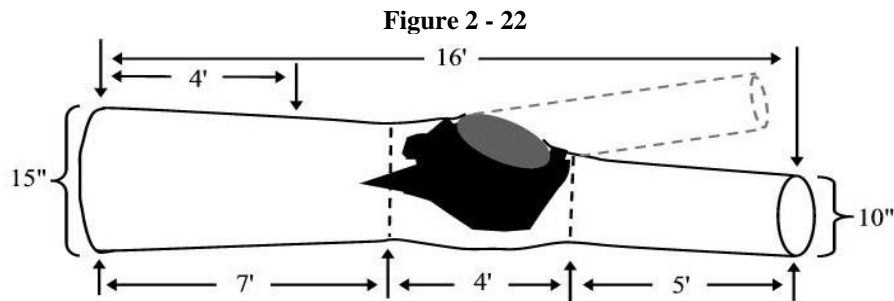
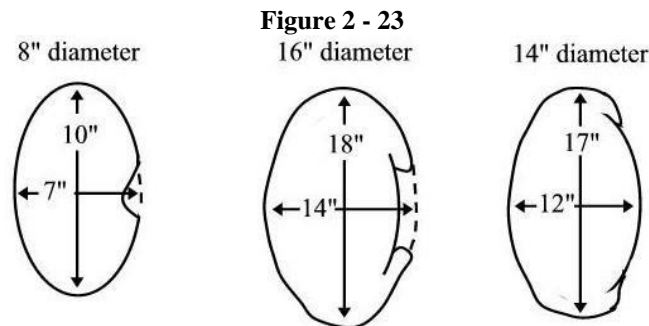

Figure 2-22 illustrates a 16-foot forked log with one fork sawn or broken off. The scaler must remember that all logs are scaled as presented. The scaling diameter is 10 inches as measured on the small end. Even if the sawn or broken off fork had been located one foot down from the small end, the scaling diameter would still be 10 inches as measured on the small end. When the sawn or broken off fork occurs less than one foot from the small end, treat diameter measurement the same as previously described for crotched logs.



2.34 Catfaced and Sap Rotted Log Ends

Special care must be taken by the scaler to ensure accurate diameter measurements. This process becomes increasingly difficult when a portion of the diameter is missing, such as might occur when a catface affects the log end. When less than one-third of the diameter is missing visually project the diameter through the void area and take appropriate diameter measurements. When one-third or more of the circumference (outside area) is affected, take diameter measurements inside the affected area. Figures 2-23 illustrates various degrees of void (due to catface) affecting the scaling cylinder and the proper method for determining the gross scale diameter measurements.



Logs having sap rot, some of which may be sloughed away, can pose difficult challenges in taking diameter measurements. When sap rot extends the length and circumference of the log and the sapwood is still in place, the gross diameter measurements will be determined the same as for green logs. When some (or most) of the rotten sapwood has sloughed away, the gross diameter or outside diameter will be determined by measuring the remaining sound wood and adding thereto the estimated thickness of the missing sapwood. When all of the sapwood has sloughed away, the diameter will be determined by measuring the remaining wood in a normal manner (narrow and right angle measurements).

2.35 Broken Log Ends

After the scaler has made the appropriate length determination, including full trim, the diameter measurement (narrow and right angle measurements) is made at the point where the log should have been bucked. Use a scale stick or calipers to accurately determine the small end scaling diameter.

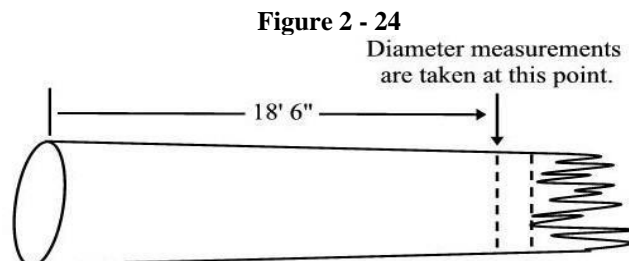

2.36 Taper in Long Logs

Since trees gradually taper from butt to top, it seems reasonable to expect that logs, which are sections of a tree, also

uniformly taper in the same manner. This is generally true but not in all instances. Though giving the general appearance of a cone, trees usually taper quite rapidly for several feet above the ground, then for a distance, the rate of taper can be slight or nonexistent. In the upper reaches, the tree begins to taper more rapidly, with the rate of taper continuing to increase as the top is approached.

The rate of taper can be measured at assumed bucking points with a set of calipers, either making allowance for the thickness of bark or removing the bark from that area before measuring. However, accurate measurements by caliper are time consuming, and logs frequently lie in a position that makes the task of determining both the narrow-way and right angle measurements impossible.

Long logs, logs with a scaling length of 21 feet or longer, have systematic rules for determining the taper and resulting small end diameter of log segments that cannot be measured. Except for butt logs, the overall taper of a log is the difference between the two end diameters that can be measured.

2.37 Distribution of Taper in Second-Cut Long Logs

A second-cut, long log is any log with a scaling length of 21 feet or longer that is not affected by butt swell. The first step is to measure the scaling diameters on both the small end and large end of the log. The difference between these two measurements is the total taper of the log. For example, a log with a scaling length of 32 feet, having a small end diameter of 12 inches and a large end diameter of 16 inches has total taper of 4 inches (16 inches minus 12 inches = 4 inches).

The second step is to divide the total taper by the number of log segments to determine the taper of the top segment. Using our example, a 32-foot scaling length is a 2-segment log (it has two 16-foot scaling length segments). Four inches of total taper divided by 2, equals 2 inches of taper for the top segment. The small end scaling diameter of 12 inches is increased by the 2 inches of taper to arrive at 14 inches for the midpoint, which is the calculated small end diameter of the second segment.

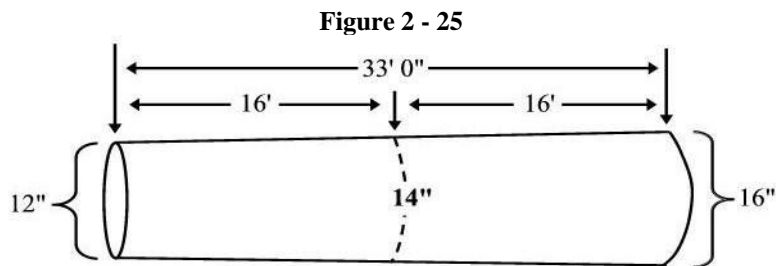

When taper can be apportioned in an equal amount to each segment (such as 4 inches of taper in a 2-segment log can be apportioned 2 inches to each segment) it is said to be even taper. When taper cannot be apportioned in an equal amount to each segment (such as 5 inches of taper in a 2-segment log) it is said to be uneven taper.

As noted earlier, trees grow with increased taper in the top end. Distribute uneven taper by applying the excess taper to the top log segment(s). For example, a log with a scaling length of 32 feet having a small end diameter of 12 inches and a large end diameter of 17 inches has total taper of 5 inches (17 inches minus 12 inches = 5 inches). Applying the excess taper to the top segment results in 3 inches of taper for the top segment and 2 inches of taper for the bottom segment. The midpoint, small end diameter of the bottom segment is 15 inches, determined by taking the top diameter of 12 inches and adding 3 inches of taper.

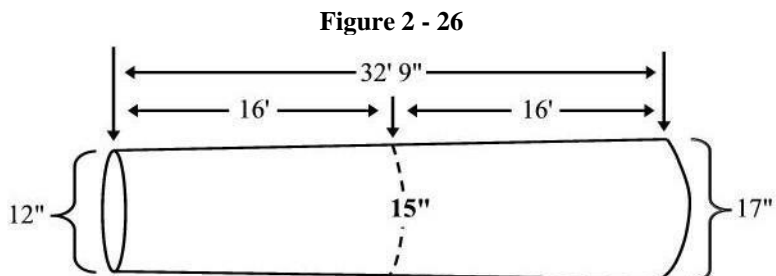

To determine midpoint diameters for any second-cut, long log follow these steps:

1. Determine the number of log segments in the scaling length of the log.
2. Determine the total taper of the log.
3. The taper is even taper when the total taper divided by the number of segments equals a whole number (a whole number

means there is no fraction left over after dividing). For example, 9 inches of taper on a 3-segment log would equal 3 inches of taper per segment (9 divided by 3 = 3). Apportion the taper to each log segment by adding the taper per segment to the previous segment's small end diameter.

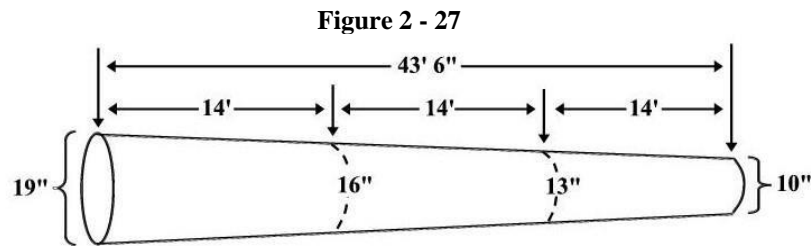

The taper is uneven taper when the total taper divided by the number of segments equals a fractional number. For example, 7 inches of taper on a 3-segment log would equal 2-1/3 inches of taper per segment (7 divided by 3 = 2-1/3). Since a scaling diameter is determined in whole-inches, follow these steps to determine midpoint taper when working with uneven total taper:

- First, raise the total taper to a figure that results in a whole number when divided by the number of segments.
- Take this whole number and add it to the small end diameter of the log to arrive at the first midpoint diameter.
- Repeat this process by dividing the remaining taper by the remaining number of segments until all small end diameters have been determined.

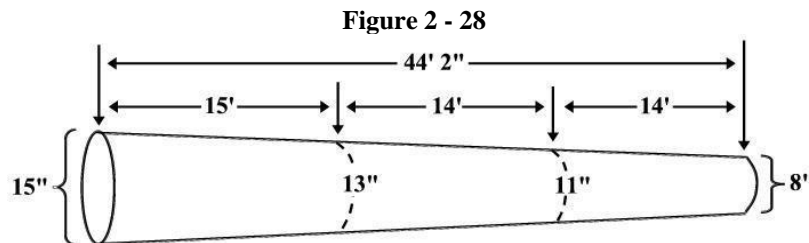

2.38 Distribution of Taper in Butt-Cut and Multi-Segment Logs

There is normally a noticeable "flare" or swell on butt logs at the point of severance from the stump, and a greater rate of taper may be present for several feet above this point. Therefore, for cubic taper distribution, butt-cut logs are caliper measured four-feet up from the butt on the large end. On multi-segment logs, this measurement is used to calculate a small end diameter for the butt segment. For Scribner volume, the small end diameter of the butt segment is determined by either actual measure or the use of "standard" taper. Standard taper is an average taper that is uniformly applied to butt-cut, long logs. It is developed from actual measure studies, based upon species, log lengths, and localities of origin (different geographic areas). Dual Scribner/cubic scaling will require both methods to be used when a standard taper exists for the point of origin.

In Idaho, all gross scale determination of butt-cut, long logs must be determined in accordance with criteria set forth in the table listed in the Appendix, Section A-4. Various standard tapers will apply to the gross scale determination of butt-cut, long logs that are scaled in most areas of Idaho. However, in the absence of a standard taper listing for butt-cut, long logs from a particular locale, actual taper (caliper measure) will apply to each segment.

The standard tapers listed in the table are based on averages developed from caliper measurements. Any particular log may, or may not, have the actual taper predicted by the taper table. It is important to remember that regardless of the actual, physical midpoint diameter(s) of any particular log, that midpoint diameter(s) will be treated as if it is the size predicted by the taper table. For example, depicted in Figure 2-29 is an illustration showing a Ponderosa Pine butt-cut log with a 32-foot scaling length. The small end diameter is measured as 16 inches. Standard taper assigns a midpoint diameter of 18 inches, even though the actual, physical measurement is 17 inches. Cubic measurement is actual measurement 4-feet up from the butt.

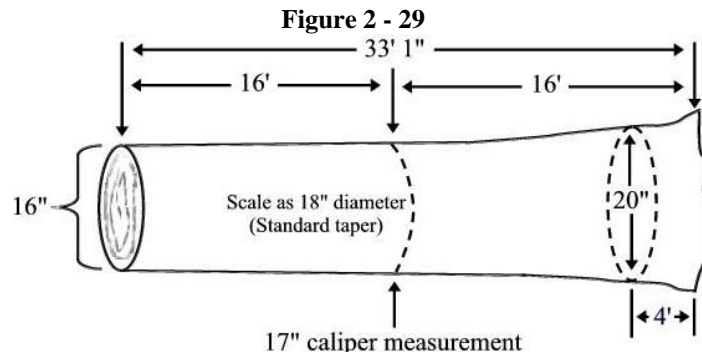

Another Ponderosa Pine may also have a small end diameter of 16 inches, but an actual physical size at midpoint of 19 inches, as depicted in Figure 2-30. Again, standard taper requires that the midpoint will be treated as if it measures 18 inches for gross scale computation purposes. A log scaler must always visualize the scaling cylinder as conforming to the actual, physical size of the log at midpoint(s) regardless of the “inch-size” assigned by the standard taper rules. Cubic measurement is the actual measurement 4-feet up from the butt.

Butt logs with a scaling length of 50 feet and longer require an additional measured diameter at the top of the butt segment on three-segment logs for cubic, and at the mid-point (top of the second segment) on four-segment logs.

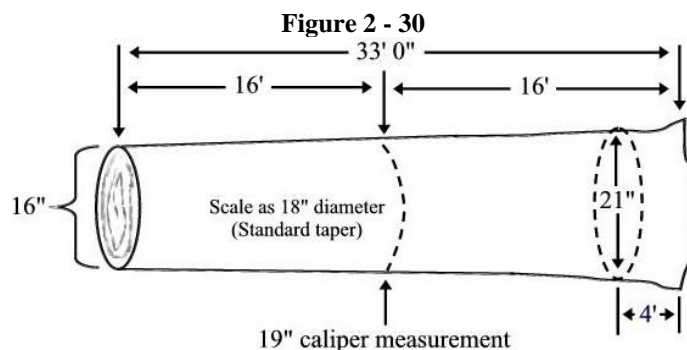

2.39 Identifying Characteristics of Butt-Cut Logs

It is critically important to good scaling practices, that a log scaler has the ability to distinguish between second-cut and butt-cut, long logs. Some butt-cut logs may not show an obvious butt flare because of the logging process, growing conditions, or “squaring” of undercuts. In addition to obvious butt-cut logs, a long log will be identified and treated as a butt-cut when a “long-butt” may have been made, but did not completely remove the swell or flare of the butt end.

A log scaler often must look for subtle distinctions to identify a long log as a butt-cut. Some useful techniques include:

- stand at the small end of a log and visually sight the large end to identify small amounts of flare (or excess taper in the last few feet of the large end),
- look at bark characteristics to identify a log as a butt-cut (the bark is often a little thicker, or different in shape, near the butt end), the presence of
- tree-marking paint (when used on timber sales to identify trees to be harvested),
- remember that small limbs at or near the butt end of a log are not necessarily “proof” of a second-cut log.

It is also important not to mistake the large end of abnormally shaped second-cut logs with butt-cut characteristics. A log bucked through a knot whorl often gives the appearance of flare, but is still a second-cut log. Additionally, logs bucked just above a crotch, or through a burl or mistletoe gall, should be measured as described in the section on “Crotched or Irregularly Shaped Log Ends”. Any log that has been long-buttied at a point above the swell is treated as a second-cut log.

2.4 LOGS IN FRACTIONAL OR SLAB FORM

Although trees grow in a variety of shapes, most often logs that are manufactured and presented for scaling appear cylindrical in shape, and end size is determined by taking measurements to approximate a circle (i.e., diameter measurement). This common type of log is referred to as “a log in round form.”

Occasionally, portions of logs are presented for scaling that are intentionally manufactured, or occur in the logging operation. Examples of these include logs that are ripped lengthwise for helicopter handling, or merchantable size slabs that may result from handling large cedar logs with interior rot. These types of logs are referred to as “a log in fractional form” or “a log in slab form.”

If the diameter and scale computation for these types of logs were to be determined in a conventional manner, it would result in the gross scale being overstated. This is because there would be one gross scale computed from the diameter measurement of the larger portion of the log (the fractional form), and an additional gross scale for the smaller portion of the log (the slab form). Therefore, special rules apply to the recording of diameter measurements and determination of scale volume for fractional form and slab form logs.

2.41 Fractional Form Log

The definition of a fractional form log is a portion of a log in round form, presented for scaling in a form that is greater than or equal to one-half of the original diameter, and having a comparable, unattached portion that would make a merchantable size slab form log. For cedar species logs, the small end diameter must be at least a 15-inch scaling diameter. For all other species of logs, the small end diameter must be at least a 21-inch scaling diameter. These diameter size requirements are necessary to ensure that the unattached portion will be a merchantable size slab. Any logs with diameters smaller than these prescribed minimums are treated as regular “logs in round form” (with breakage defect for the non-merchantable slab missing).

Use the following procedures to determine the scale of a fractional form log:

1. Measure the scaling diameter in the same manner used for logs in round form.
2. Determine what percentage of the log exists.
3. Multiply the scale volume of a log in round form by the percentage determined in step #2 to arrive at the gross scale for the fractional form log.

Figure 2-31 depicts a 16-foot log with a 24-inch diameter, which has a gross scale of 40 boards. Multiply 40×0.7 (the 70% percentage of log remaining) = 28. This is the gross scale recorded for the log. When using a handheld data recorder, a scaler may need to adjust the recorded scaling length and/or diameter to arrive at the proper gross volume. The scaler should always try to keep the scaling length the same as the actual log to ensure the cubic volume remains as accurate as possible. For cubic, record the large end diameter or taper of the “adjusted” diameter equal to the taper of the actual log. If the actual log has 2-inches taper, the adjusted log would also be recorded with 2-inches taper.

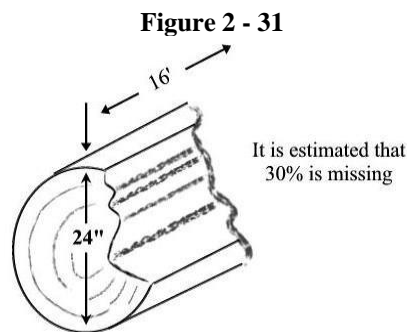

2.42 Slab Form Log

The definition of a slab form log is a portion of a log that is presented for scaling in a form that is less than one-half of the original diameter. For cedar species logs, the minimum size is 4 inches by 5 inches as measured using a Coconino-type scale stick. For all other species of logs, the minimum size is 6 inches by 6 inches as measured using a Coconino-type scale stick.

Use the following procedures to determine the scale of a slab form log: The Scribner volume will be used to determine the cubic volume for all slabs.

1. First, a small end slab size is needed for computing gross scale volume. Mentally "square-up" the sound wood within the slab; figure an approximate square or rectangle that can be shaped on the end of the slab. Determine a whole-inch average height or shell thickness and whole-inch average width of the slab (drop any fractions in arriving at a whole-inch average).

2. Next, use the following formula to determine board feet volume:
 $H \times W \times (L/16) = \text{Volume in board feet}$
 H = height of the slab in inches
 W = width of the slab in inches
 L = scaling length of the slab in feet
3. Round the board feet volume (determined in step #2) to the nearest ten board feet, to arrive at Scribner decimal “C” volume (5 board feet or more rounds up).

Figure 2 - 32

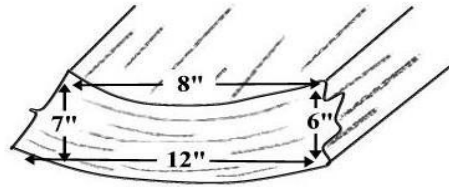

For example, computing the volume for a 16 foot scaling length using the illustration in Figure 2-32:

Step #1 –

- the average height is 6 inches ($6''+7'' = 13 \frac{1}{2} / 2 = 6 \frac{1}{2}$ (drop the final half) = 6'')
- the average width is ten inches ($8''+12'' = 20 / 2 = 10''$)
- this approximates a rectangle of six inches (6'') by ten inches (10'')

Step #2 –

- $6 \times 10 \times (16/16) = 60$ board feet

Step #3 –

- 60 board feet rounded to the nearest ten board feet remains 60 board feet, or 6 boards (6 decimal “C”)

When using a handheld data recorder, a scaler will need to adjust the recorded scaling length and/or diameter to arrive at the proper gross volume. Find a log with as near the same length as the slab that scales 6 boards and record that length and diameter; also record appropriate taper on single segment slab to match the taper of the slab for cubic volume. The scaler should always try to keep the scaling length within one-foot the same as the actual log to ensure the cubic volume remains as accurate as possible. For cubic, record a large end diameter equal to the taper of the actual slab. If the slab has 1-inch taper, the adjusted round log would be recorded with 1-inch taper.

For slabs that are second-cut, multi-segment pieces, the midpoint is determined by measuring the slab dimensions on the small end and large end, and using calculated taper rules for determining the appropriate height and width at midpoint. For example, a slab measuring 4” x 10” on the small end, and 7” x 16” on the large end, has midpoint dimensions of 6” x 13.”

Figure 2-33 illustrates a 28-foot butt-cut cedar slab. The top (small end) slab size is determined as previously described. Even though this is a butt-cut, long log, the slab dimensions for the butt segment are determined by actual measurements. This may be accomplished with the use of calipers, a steel hand-tape, or laying a scale stick across the midpoint to determine the width and height dimensions.

Figure 2 - 33

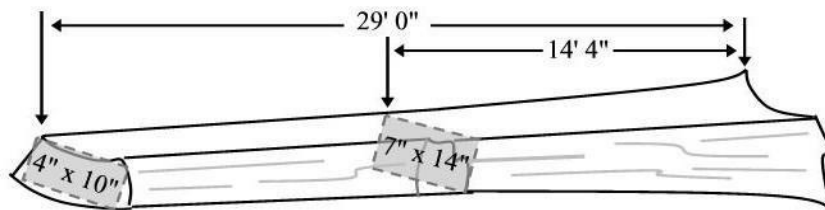

Using the dimensions shown in Figure 2-33:

Gross scale of top segment –

$$4 \times 10 \times (14/16) = 35 \text{ board feet, rounds to 40 or 4 decimal "C"}$$

Gross scale of butt segment –

$$7 \times 14 \times (14/16) = 86 \text{ board feet, rounds to 90 or 9 decimal "C"}$$

The total gross scale for Figure 2-33 is 13 bds (13 decimal “C”). Enter a 28’, 11” top, 14” bottom measure for 25.0 cubic feet.

When using a handheld data recorder, a scaler will need to record a scaling length and/or diameter to arrive at the proper gross volume. First, add the 4 boards (bds) and the 9 bds together for 13 bds. Find a log with as near the same length as the slab that scales 13 bds and record that length and diameter. A 28-foot, 11-inches small end diameter and 13-inches mid diameter scales 13 Dec C. Record this log as a 28-foot, 11-inch small end diameter and a 14-inch large end diameter to achieve the proper Scribner gross volume of 13 bds. Gross cubic volume for this log will be 25.0 cf.

Slab form logs are sometimes encountered where the shell thickness (height) and/or width dimensions do not meet minimum size criteria. When this occurs, reduce the length of the slab until the minimum criteria is met. The resulting scaling length is always determined in 2-foot multiples, and includes allowance for full trim.

Figure 2-34 illustrates a cedar slab form log with a small end shell thickness of 3" x 5". Since the 3" shell thickness (height) does not meet the minimum size of 4" for cedar species slabs, the slab will be "cut back" to a point where it meets the minimum size requirements. Because the log has its length reduced due to a "small top" (would also apply to a broken-end) the slab dimensions are measured at a point where the resulting scaling length is in a 2-foot multiple, with full trim allowance.

Figure 2 - 34

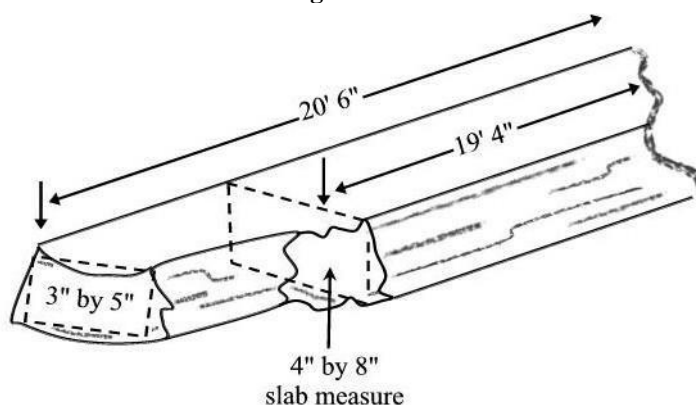

The gross scale volume for Figure 2-34 is calculated for a "cut back" length of 18' with slab dimensions of 4" x 8" as follows:

- $H \times W \times (L/16) = \text{Volume in board feet}$
- $4 \times 8 \times (18/16) = 36$ board feet, rounds to 40 or 4 boards (4 decimal "C").
- Determine the amount of taper in the slab.
- In the handheld record an 18-foot log, 9-inches small end diameter, and 10-inches large end diameter.
- Scribner gross volume would be 40 bf, cubic gross volume would be 8.9 cf.

2.5 SPECIAL SITUATIONS MEASUREMENT

In some instances, measurement of harvested forest products is made in a fashion other than log scaling and quantities are expressed in a manner other than board feet. Some of these other quantities may be expressed in their equivalent board feet, using conversion factors. This section describes other gross volume measurements, and their conversion to Scribner decimal "C" gross scale that have been approved by the Idaho Board of Scaling Practices.

2.51 Cedar Products Pieces Shorter Than Eight Feet

A special provision in cedar products net scale rules allows cord measurement to be used on material shorter than 8' 1" in length, when a contractual scaling agreement has been made to this effect. When this situation exists, and the scaler has been provided with appropriate written scaling specifications, a gross scale conversion must be made and recorded.

Cord measure and conversion to gross scale may be applied to a stacked pile or an individual piece. The cubic area occupied by the cedar products pieces (or individual piece) includes bark and air. Measurements are made with a tape measure. A standard cord measuring 4' x 4' x 8' equals 128 cubic feet, and the accepted equivalent Scribner decimal "C" scale is 500 board feet. To make a conversion of cord measurement to gross scale, use the following formula:

$$(H \times W \times L) \div 0.256 = \text{Volume in board feet}$$

The product of (H x W x L) is expressed to the nearest cubic foot. Height (H), width (W), and length (L) are measured and expressed to the nearest one-tenth (1/10) of a foot. Round "Volume in board feet" to the nearest 10 board feet to arrive at Scribner decimal "C" volume; five board feet or more rounds up.

2.52 Truckload Volume Formula

For purposes of determining a conversion to gross scale, the truckload volume formula may be used. This involves application of cord measurement and conversion to board feet. The truckload volume formula is:

$$(H \times W \times L) \div 0.256 = \text{Volume in board feet}$$

The product of (H x W x L) is expressed to the nearest cubic foot. Height (H), width (W), and length (L) are measured and expressed to the nearest one-tenth (1/10) of a foot. Measurements are made using a logger tape for length, and calibrated pole for width and height.

The first step involves determining an average height for the load. Height is determined by measuring from the bottom of a log on the bunk to the average top point of the load. Visually estimate a balance point for the top of the load, squaring-off where wood and air balance out. An average of the height at the front and back bunks should be used. Record this height to the nearest tenth of a foot.

Width is the inside measure, between the bunks, that is occupied by the logs. Record this width to the nearest tenth of a foot.

The length of the load reflects the average space occupied by wood between the front and back ends. The front of the load is sized-up to determine a balance point of the various log ends (visually determine the point where wood and air balance out). Measure to the back end of the load to determine average load length, again, sizing-up the back of the load to determine a balance point. Record this length to the nearest tenth of a foot.

Volume is determined by applying the measurements to the truckload volume formula. For example, assume the following measurements were made:

- Height = 6.7 feet (after averaging 6.8 feet at front of load and 6.6 feet at back of load)
- Width = 7.3 feet
- Length = 27.6 feet

$$(6.7 \times 7.3 \times 27.6) = 1350 \text{ cubic feet} \div 0.256 = 5,273 \text{ board feet.}$$

2.53 Conversion Factors for Miscellaneous Forest Products

In addition to scaled logs, it is sometimes convenient to express quantities of other harvested forest products in board feet. These forest products are in a finished form, and their equivalent volume content in board feet is expressed in the following table:

Standard Converting Factors		
Product	Assumed Dimensions	Equivalent in Board Feet
Cord, standard	4 by 4 by 8 feet	500
Cord, long	4 by 5 by 8 feet	625
Cord, shingle bolts	4 by 4 by 8 feet	600
Cord, small material (averaging less than 5" middle diameter in the round)	4 by 4 by 8 feet	333-1/3
Cord, short	4 by 3 by 8 feet	375
Cord, short, small material	4 by 3 by 8 feet	250
Load (small, irregular pieces that cannot be ricked)	4 by 4 by 8 feet	333-1/3
Tie, standard	7 by 9 inches by 8 feet	35
Tie, standard	7 by 8 inches by 8 feet	30
Tie, standard	6 by 6 inches by 8 feet	20
Tie, narrow gage	7 by 8 inches by 6-1/2 feet	25
Tie, narrow gage	6 by 7 inches by 6-1/2 feet	20
Tie, narrow gage	6 by 6 inches by 6-1/2 feet	15
Pole (telephone) or piling	8 inches by 45 feet	200
Pole (telephone) or piling	8 inches by 40 feet	150
Pole (telephone) or piling	8 inches by 35 feet	100
Pole (telephone) or piling	7 inches by 60 feet	280
Pole (telephone) or piling	7 inches by 50 feet	200
Pole (telephone) or piling	7 inches by 40 feet	100
Pole (telephone) or piling	7 inches by 35 feet	80
Pole (telephone) or piling	7 inches by 30 feet	60
Pole (telephone) or piling	7 inches by 25 feet	50
Pole (telephone) or piling	5 inches by 25 feet	30
cubic foot (cylinder shape)	13.6 inches diameter by 1 foot	6
Linear foot	10 inches by 1 foot	3
Linear foot (long piling)	80 to 125 feet by 6 inches	5-1/2
Derrick pole	7 inches by 30 feet	60
Post, fence	6 inches by 7 feet	7
Post, fence	5 inches by 7 feet	5
Post, split	18 inches circumference by 7 feet	6
Brace, fence	4 inches by 6 feet	2
Stake, fence	3 inches by 5 feet	1
Stay, fence	2 inches by 6 feet	1/2
Rail, fence (split)	20 inches circumference by 16 feet	15
Pole, fence	4 inches by 20 feet	10
Pole (12 pieces)	4 inches by 16 feet	100
Pole, converter	4 inches by 20 feet	10
Prop	6 inches by 10 feet	10
Lagging (6 pieces)	3 inches by 6 feet	10
Topwood (miscellaneous lengths of 20 feet or shorter)	5.5 inches or less (small end diameter measure)	6

CHAPTER 3 – SAWLOG NET SCALE

3.1	GENERAL	29
3.2	PRODUCT CLASSIFICATION REQUIREMENTS	29
3.3	MERCHANTABILITY STANDARDS	30
3.4	DEFECT DEDUCTION METHODS	30
3.41	Length-cut.....	30
3.42	Diameter-cut.....	31
3.43	Squared area / Squared-defect.....	32
3.431	Squared-Defect in Multi-segment Logs.....	33
3.432	Squared-Defect Using the Coconino Scale Stick.....	34
3.44	Pie-Cut.....	34
3.5	DEDUCTION APPLICATIONS FOR SAWLOG DEFECTS	35
3.51	Breakage.....	35
3.511	Broken Log Ends.....	35
3.512	Splits and Stump Pull.....	37
3.513	Barber chair.....	38
3.514	Processor.....	38
3.52	Checks.....	38
3.521	Heart Checks and Pitch Seams.....	38
Straight Checks.....	39	
Twisting Checks.....	40	
Cross-checks and Breakouts.....	41	
“Give and Take Procedure”.....	42	
3.522	Frost Checks.....	42
3.523	Weather or Surface Checks.....	44
3.53	Crook and Sweep.....	46
Crook.....	46	
Sweep.....	48	
3.54	Foreign Material or Hardware.....	49
3.55	Multiple Defects.....	49
3.56	Other Natural Defects.....	51
3.561	Bark Seam.....	51
3.562	Burls.....	51
3.563	Char or Fire Scars.....	52
3.564	Catface.....	53
3.565	Crotch.....	54
3.566	Insect Damage.....	55
Scolytus.....	55	
Wormholes.....	56	
3.567	Knots.....	57
3.568	Lightning Scar.....	58
3.57	Pitch.....	59
3.571	Pitch Seam (<i>*refer to Heart Checks and Pitch Seams</i>).....	59
3.572	Pitch Spangle.....	59
3.573	Massed Pitch.....	60
3.574	Pitch Pockets.....	61
3.58	Rings – Pitch and Shake.....	61
Interior Rings.....	61	
Perimeter Rings.....	63	
Combination Rings.....	63	
3.59	Rots.....	64
3.591	Butt or Stump.....	64
3.592	Heart.....	64
3.593	Sap.....	64
3.594	Conk.....	65
3.595	Pocket Rot Associated with Rotten Knots.....	66

3.1 GENERAL

Sawlog net scale is the most common product classification and is used primarily for logs that will be manufactured into lumber or veneer. Sawlog net scale is defined as the remaining volume available for the manufacture of lumber or veneer of a log segment, after deductions for any defects are made. A log scaler must recognize defects, and apply specific deduction rules, to arrive at the net scale of a log segment.

If all logs were straight, smooth, round, and sound the operation of scaling would be purely mechanical. Because they are not, it is necessary for the scaler to know how to determine the amount of loss or unsound material resulting from various defects.

A defect may be caused by a fungus such as rots, by natural means such as bark seam, or mechanical defects such as breakage. Other irregularities can also actually reduce the amount of sound usable material within the scaling cylinder. It is important to note that a condition which may be considered a defect in the grading of lumber is not necessarily considered a defect in scaling a log. In making deductions for defect, the scaler should bear in mind the following:

No deduction is made for discoloration of firm stain; however, such discoloration or stain may indicate a deductible defect in a log.

No deduction should be made for unseen defects that cannot be determined by good scaling practices.

For sawlog product classification, there are four methods of defect deduction:

- Length-cut.
- Diameter-cut.
- Squared-area.
- Pie-cut.

In applying any of the above defect methods, the loss is reflecting those portions of boards within the log which must be trimmed off because of defect, provided that the remainder of each board is in a two-foot multiple, with at least a minimum length of 6 feet and a minimum board size of 1 inch by 4 inches. If the remainder of any board is shorter or narrower than the limits for minimum length and size, the entire board will be considered lost. Enter actual defect dimensions in the handheld, do not add the 1-inch for waste. Deduct defects on log ends, such as stump pull, only when the defect exceeds 4-inches in length. The minimum single occurring defect for cubic volume is 0.2 cubic feet before rounding.

Defect deduction rules for cubic and Scribner are basically the same with few exceptions. The handheld programs take care of most of the procedural differences as well as the complex computations for both rules. When a procedural difference does occur, the default will sway to Scribner as it determines the minimum merchantability for all logs. All methods must be used with judgment and skill. More than one defect deduction method may be used in scaling a log segment. Good judgment is necessary in the application of any formula, method, or rule. Do not use rules of thumb.

3.2 PRODUCT CLASSIFICATION REQUIREMENTS

All log segments shall be net scaled as sawlog product classification, unless a contractual scaling agreement provides otherwise. If this occurs, a log scaler must be provided with written scaling specifications that note what other product classifications are to be net scaled, and any special provisions that may apply. In other words, noting if pulp and/or cedar products product classification is to be net scaled, under what conditions (e.g., when a log segment is “cull” for sawlog) and whether or not “combination logs” are to be scaled.

Additionally, all sawlog net scale shall be determined in accordance with procedures stated within this chapter, unless a contractual scaling agreement provides otherwise. Contractual scaling agreements are allowed to modify any rules or provisions relating to net scale determination. If this occurs, a log scaler must be provided with written scaling specifications that note what these provisions may be (for example, minimum trim requirements or changes in application of specific defect deduction rules).

In the absence of written scaling specifications to the contrary, net scale for sawlog product classification shall be made in accordance with procedures described within this chapter. It is not necessary to have written scaling specifications when all sawlog net scale is done in this manner.

3.3 MERCHANTABILITY STANDARDS

Unless written scaling specifications provide otherwise, the following shall be the merchantability standards for sawlog net scale:

1. Minimum merchantability of net scale in relation to gross scale is one-third (33-1/3%) standard Scribner volume.
2. Minimum diameter is 5.51", actual measure (6" class on a scale stick). This size also applies as the minimum sound core recovery within a defect.
3. Minimum log length is a log having an 8-foot scaling length (as determined by gross scale rules).
4. Minimum lumber recovery on defective logs is 6-foot length and minimum board size is 1" x 4".
5. Net scaling length is the same as the gross scaling length, when no defect is present.
6. Application of any defect deduction must always allow for net lumber recovery that is in a multiple of two feet.
7. There is no scaling of "combination logs" on multi-segment logs. If a log segment is cull for sawlog net scale, its entire gross scale is recorded as defect.
8. All logs are scaled "as presented" and each log segment is judged individually for merchantability.

3.4 DEFECT DEDUCTION METHODS

3.41 Length-cut

A length-cut means reducing the gross scaling length to a usable net scaling length. The volume of any defect is the difference in scale between the original gross scaling length and the resultant net scaling length. This method is useful to deduct for defects that can be confined to a portion of a log length. Such defects may include sweep, crook, fire scar, knot clusters, large burls and pitch spangles, breaks, crotch, massed pitch, and rot. This is also the method used when the Scribner squared defect deduction equals or exceeds the scale of the affected log length. Use the scaling diameter to determine the scale of the affected log length (this scale is determined by subtracting the defect length from the original segment length).

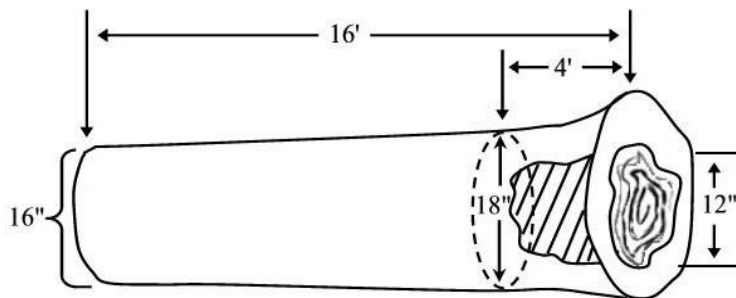

Figure 3 - 1

Figure 3-1 shows a 16-foot log, 16 inches small end diameter (sed), 18 inches large end diameter (led), scaling 160 board feet, with heart rot 12 inches in diameter affecting 4 feet of the log, the squared defect deduction (explained in Section 3.43) would be 50 board feet. As the squared defect deduction exceeds the volume of a 4-foot cut, or 40 board feet, use a length cut. Cubic volume would be 25.3 cubic feet (cf) gross, 6.3 cf defect, and 19.0 cf net. Scribner gross 16 boards (bds), defect 4 bds, and net of 12 bds.

In use, the length-cut method is often combined with the pie-cut method. For instance, a deduction for a defect that affects one-half the scaling cylinder for 4 feet is equivalent to a 2-foot length cut. This combination length-cut/pie-cut is always converted to a length-cut to determine defect volume, for example, 1/4 of four feet equals a 1-foot length-cut. Then, the difference between the gross scaling length volume and the net scaling length volume is the amount of defect volume attributable to the length-cut.

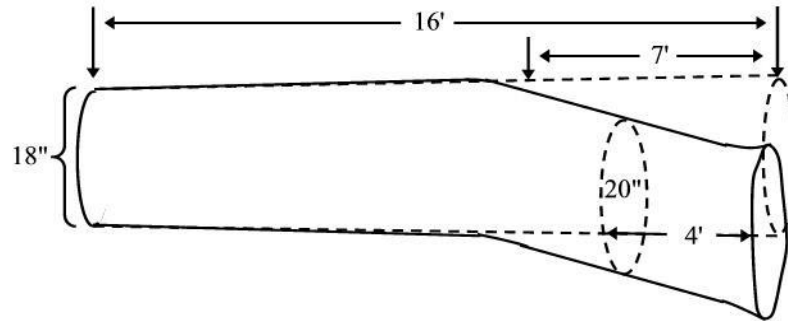

Figure 3 - 2

Figure 3-2 shows a 16-foot log, 18 inches sed, 20 inches led, with a crook defect affecting 1/2 of 7 feet. The deduction of 1/2 of 8 feet (to reflect lumber recovery in 2-foot multiples) is made as a 4-foot length-cut. Cubic gross scale of a 16-foot length is 31.6 cf, defect 7.9 cf, net scale of 23.7 cf. Scribner gross is 21 bds, net scale is 16 bds, and defect is 5 bds.

3.42 Diameter-cut

A diameter cut means reducing the scaling diameter of a log. A diameter cut always creates a new scaling cylinder for the length of the defect. This method is used in deductions for defects such as sap rot, weather checks, shallow catfaces, perimeter rings, and knots when they cause a loss of merchantable material.

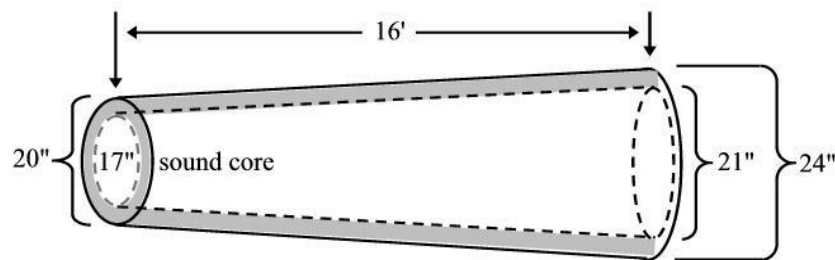

Figure 3 - 3

Figure 3-3 shows a 16-foot log, 20 inches sed, 24 inches led, with sap rot. Inside the rotten sapwood the sound core measures 17 inches small end diameter. Use the diameter-cut to reduce the gross diameter of 20 inches by 3 inches, creating a new scaling cylinder diameter of 17 inches. Net scale is that of a 17 inch log (the difference between the gross scale and the net scale is the defect.) Cubic gross 42.6 cf, 10.7 cf defect, 31.9 cf net. Scribner gross 28 bds, 10 bds defect, 18 bds net.

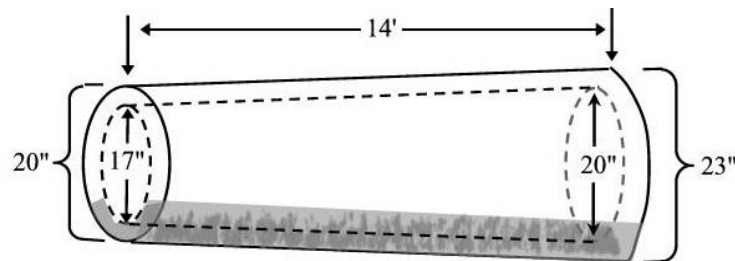

Figure 3 - 4

Figure 3-4 shows a portion of a diameter-cut. A 14-foot log, 20 inches sed, 23 inches led, has sap rot extending the entire length, but only affecting 1/4 the circumference. The deduction is determined by projecting the sap rot as if it affected the entire circumference, measuring the sound core within this projection. Using the diameter percent enter 25% of a 3-inch diameter-cut. Cubic gross is 35.5 cf, 2.3 cf defect, and 33.2 cf net. Scribner gross is 24 bds, defect is 2 bds, and net is 22 bds.

3.43 Squared-area / Squared-defect

Defects showing in one or both ends can often be treated as if sawn out in squares or rectangles. This deduction method is called the squared area method for cubic or squared-defect method for Scribner. It is generally the most accurate method of scaling interior defects. However, when the deduction indicated by the squared-defect method results in greater volume deduction than the log scale of the portion affected, use the length-deduction method.

	Scribner	Cubic
X = deduction in board feet		
W = width of defect in inches	$X = \frac{W'' \times H'' \times L' \times 80}{12 \times 100}$	$X = \frac{W'' \times H'' \times L'}{144}$
H = height of defect in inches		
L = length of defect in feet		

In the preceding formulae **W''** and **H''** represent end dimensions of the defect in inches for each dimension one inch is added for waste, **L'** is the length of the defect in feet, and **X** is the contents of the defect in board feet after 20 percent is deducted for saw kerf. **X** is raised or lowered to the nearest "10" for the first formula. The second formula is the one used for cubic volume and does not have an inch added for waste. Enter actual dimensions in the handheld, the program will take care of these differences.

Figure 3-5 (below) illustrates a 16-foot log, 16 inches sed, 18 inches led, which has a gross scale of 25.3 cubic feet. The large end shows an area of butt rot measuring 5 inches square. The rot is estimated to extend 4 feet into the log. Stated in terms of the cubic formula above:

$$X = \frac{5'' \times 5'' \times 4'}{144} = \frac{100}{144} = .69 \text{ cubic feet}$$

In this example, the .69 cubic feet is rounded to the nearest tenth, which results in a defect deduction of 0.7 cubic feet. This amount is subtracted from the gross scale of 25.3 cf for a net scale of 24.6 cf. Scribner gross of 16 bds, 1 bd defect, net of 15 bds.

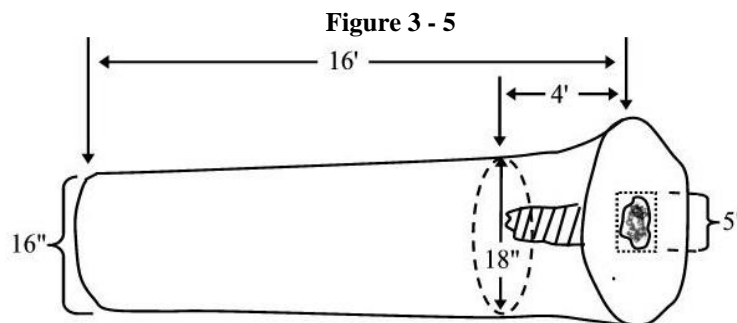

Interior defects are common to all species. In some instances, the defect will extend through the entire length of the log. When the defect does not extend through the entire length of the log, the scaler should determine the length of the defect by close inspection of the log seams, conks, scars, abnormal swellings or other visible indicators. A scaler should be guided by judgment and by local defect characteristics in making this length determination. If the defect is so close to either end of the log that the sound material from that point to the end is below the 6-foot minimum merchantable lumber length, the length of the defect is extended to the end of the log.

In making calculations for squared-defect, average of the large and small dimensions of the defect when the length of the log segment is 16 feet through 20 feet and the defect is showing on both ends. For Scribner use the larger dimension of the defect when the length of the log segment is 15 feet or shorter and the defect is showing on both ends, cubic averages these dimensions also. For rings the handheld program will do the calculations for you, just enter the actual ring measurements for both ends. Depending on your program, the handheld may also do the proper calculations for seams and rots too.

For example, consider a 14-foot log, 19 inches sed, 20 inches led, with a pitch ring extending the entire length (illustrated below, Figure 3-6). The pitch ring measures 8 inches in diameter on the large end, and 6 inches in diameter on the small end. There is a six-inch sound core inside the pitch ring that must be replaced. Enter a single ring of 6 inches on the small end and the large end of 8 inches for 14 feet. The cubic defect is 1.0 cf. Gross scale of 29.1 cf, net is 28.1 cubic feet. Scribner gross is 21 bds, defect 7 bds, net of 14 bds. Measurement procedures to determine the size of the sound core are the same as any diameter measurement. Do not replace a core that measures smaller than the six-inch diameter class.

Figure 3 – 6

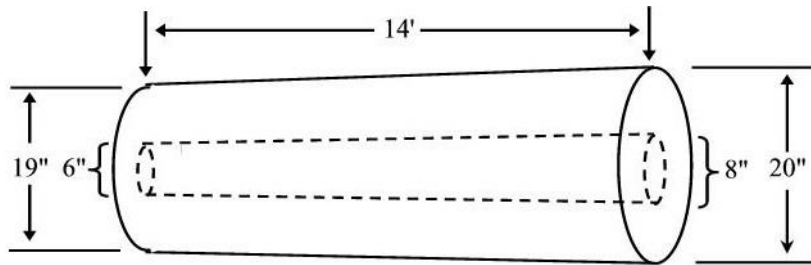

3.431 Squared-Defect in Multi-segment Logs

To determine the mid-point dimensions of the defect in logs longer than one segment, the average of the dimensions of the defect on both ends of the two-segment log should be used (see Figure 3-7). Scale logs with uneven taper distribution on defects by applying the excess taper to the top log or logs. When dimensions of end defects are averaged to determine mid-point size and this result ends in one-half, round up to the next whole number. For example (referring to Figure 3-7) $6'' + 11'' = 17 \div 2 = 8 \frac{1}{2}$, which rounds up to $9''$ at mid-point.

Figure 3 – 7

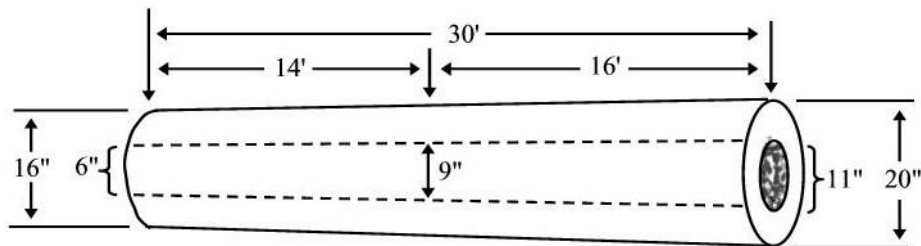

Once the mid-point defect size has been determined, the defect deductions can be calculated for individual log segments.

Figure 3-8 shows the 14-foot log segment, 16-inch sed, 19 inch led, with heart rot extending the full length that measures 9 inches on the large end and 6 inches on the small end. For cubic volume, the scaler will need to average $6'' + 9'' = 15 \div 2 = 7 \frac{1}{2} = 8$ inches, using squared defect enter 8×8 for 14 feet = 6.2 cubic feet. Since the length of the log segment is shorter than 16 feet, Scribner requires only the large end defect dimensions are used to calculate the deduction. 9×9 for 14' = 9 bds. Cubic gross scale of 23.6 cf, defect of 6.2 cf, net of 17.4 cf. Scribner gross of 14 bds, 9 bds defect, 5 bds net.

Figure 3 - 8

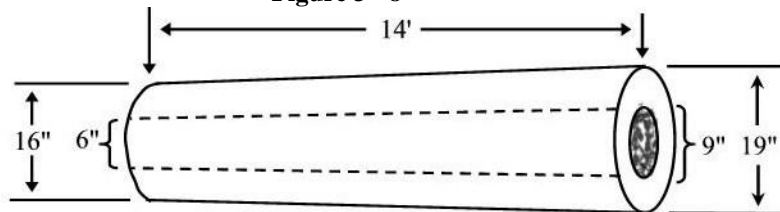
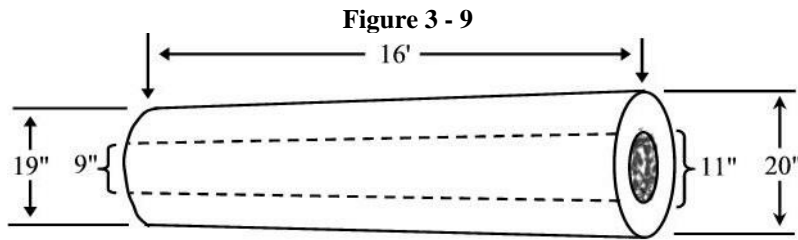

Figure 3-9 shows the 16-foot log segment, 19-inch sed, 20 inch led, with a heart rot extending the full length that measures 11 inches on the large end and 9 inches on the small end. Since the log segment is 16 feet or more in length the average mid-point dimensions is used for both cubic and Scribner. $9'' + 11'' = 20 \div 2 = 10''$. Using squared defect 10×10 for 16 feet = 11.1 cf. gross scale would be 33.2 cf, defect 11.1 cf, net of 22.1 cf. Scribner gross 24 bds, 13 bds defect, 11 bds net.



3.432 Squared-Defect Using the Coconino Scale Stick (Scribner only)

Defect deduction for squares up to 30 inches can be read directly from Coconino-style scale-sticks for those log lengths imprinted on the scale stick. These deductions are printed in red and are based on calculations for the various sized squares using the squared-defect formula. The “inch-sizes” of the squares do not include the 1-inch allowance for waste. For example, the squared defect number of “3 boards” for a defect measuring 5” x 5” and extending for 12 feet is found by reading the red figure for a 12-foot length at the 6-inch diameter.

3.44 Pie-Cut

This method may be applied where the defect can be enclosed in a sector of a circle. The deduction bears the same relation as the sector bears to the circle. The deduction is the amount determined by the fraction of the length affected. This deduction method usually applies well to catfaces, fire scars, grub wormholes, and rotten knots. When the defect extends the full length of the log segment, use the length percentage deduction in the handheld. When the defect does not affect the entire segment length, convert the portion affected to a length cut. Remember to extend defects the full length of the log segment when the sound portion would be less than 6-foot minimum merchantable lumber length, and make the deduction using the length percent procedure.

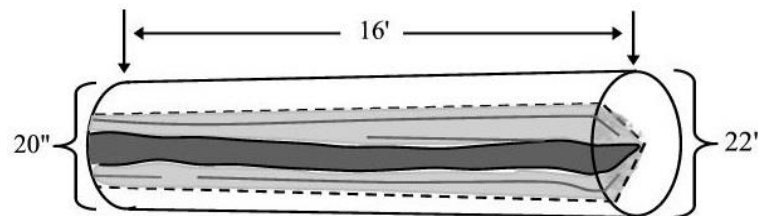

Figure 3 - 11

Figure 3-11 shows a 16-foot log, 20 inches sed, 22 inches led, the log has a gross scale of 38.6 cf with a lightning scar running the entire length. The defect can be enclosed in a sector equaling 1/4 of the scaling cylinder. Enter a length percent deduction of 25% of 16 feet, which is 9.7 cf. The net scale would be 28.9 cf. Scribner gross scale is 28 bds, defect 7 bds, net scale is 21 bds.

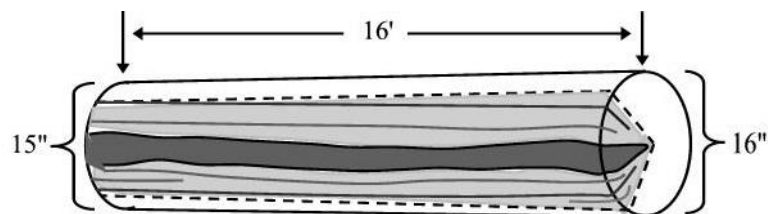

Figure 3 - 12

Figure 3-12 shows a 16-foot log, 15-inch sed, and 16 inch led, with a lightning scar and weather checks running the entire length. The defect can be enclosed in a sector equaling 1/3 of the log. Enter a length percent deduction of 33% of 16-feet = 6.9 cf. The cubic scale is 21.0 cf, and net is 14.1 cf. Scribner gross scale is 14 bds, defect 5 bds, and net 9 bds.

When the defect only affects a portion of the length – convert the pie-cut to a length cut. When a pie cut is converted to a length cut and the calculation ends in a fraction, generally this fraction can be rounded to the nearest whole foot. For example, $1/3$ of 4' = 1.33 rounds down to 1-foot, $1/3$ of 8' = 2.66 rounds up to 3 feet. However, on some larger diameter logs the fraction should be utilized so that defect is not overstated. For example, on a 16-foot, 22" diameter log, a pie-cut for $1/8$ of 4' = 0.5 feet (half of 1-foot) for a deduction of "one board" (whereas rounding to the nearest whole foot would result in a 1-foot deduction of "two boards" which overstates the defect).

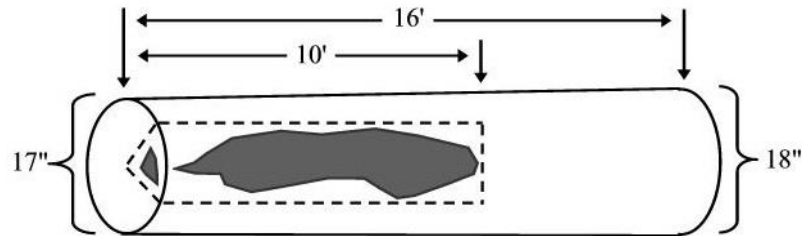

Figure 3 - 13

Figure 3-13 illustrates a 16-foot log with a deep and partially grown-over catface. The defect is 10 feet long and is confined to a quarter section of the log. The diameter at the small end of the log is 17 inches, large end is 18 inches. The gross cubic scale is 26.7 cf. The defect deduction is calculated as $1/4$ of 10' for a 3-foot length-cut. Record this for a deduction of 5.0 cf and a net scale of 21.7 cf. Scribner gross of 18 bds, defect 3 bds, net of 15 bds.

3.5 DEDUCTION APPLICATIONS FOR SAWLOG DEFECTS

A sawlog scaling defect is defined as any unsound material or abnormal shape in a log that reduces lumber recovery. A scaling defect is said to be deductible when it results in reducing the gross scale to a lower net scale.

Defects can be naturally occurring, may result from logging or handling of logs, or can be due to metal or other foreign material embedded in a log. Some defects in logs are caused by negligence in log manufacture or abnormal delay before being presented for scaling.

Sawlog scaling considers deductions for all defects. All logs shall be scaled as presented.

The types of defect and applicable procedures are discussed in detail throughout the remainder of this chapter.

3.51 Breakage

Breakage is a natural or mechanical defect that requires special consideration. Wind and ice storms are responsible for most naturally occurring breakage. Modern-day logging, much of it in steep country, also can result in damage to logs when felled, bucked, transported, and handled by various mechanical devices. In many instances, this damage may result in a considerable loss of sound timber. These are the most common types of breaks and splits:

- Broken-ends (shatter breaks) caused by falling.
- Split or slabbed ends caused by poor bucking or falling.
- Slivers (stump pull) pulled from logs in falling.
- Damage from mechanical processors.

Breakage may occur regardless of what precautions are taken, or it may result from felling trees across stumps, logs or rocks, or during log handling while loading and unloading. Accurate determination of the extent of lengthwise breakage is often difficult as it may be hidden by bark. Remove enough bark to insure inclusion of the entire defect in the deduction.

3.511 Broken Log Ends

This is the most common breakage defect encountered by a log scaler. In a properly manufactured log, the defect usually runs one to four feet in length and may only affect a portion of the scaling cylinder. Deduction in this instance will usually be made by length-cut for the fraction of the length affected (for example, one-half of two feet affected is the equivalent of a 1-foot length-cut). Shattered log ends will result in greater loss. For example, there may be no lumber recovery in the first two feet, with half of the next two feet affected – deduction in this instance is a 3-foot length-cut.

The following deduction rules are used to simplify and standardize treatment of broken-end logs:

Rule 1. Logs under 16 inches small end diameter (sed). If one-quarter to one-half of the end section is broken or gone, deduct one-half the length affected. If more than one-half the end section is broken or gone, consider the entire end lost and deduct for the full length affected.

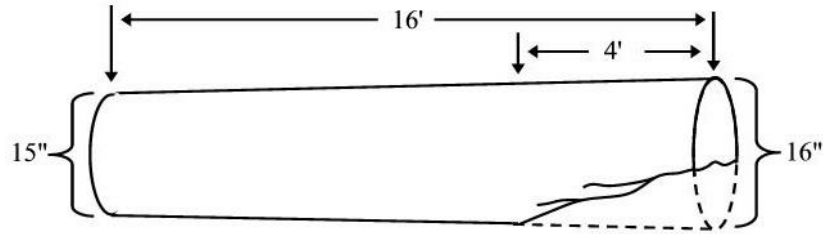

Figure 3 - 14

Figure 3-14 illustrates a 15-inch log with breakage affecting one-half of four feet which will require a 2-foot length cut deduction ($1/2 \times 4' = 2\text{-foot length cut}$). A 16-foot 15-inch sed, and 16 inch led, log has a gross scale of 21.0 cf. Making a 2-foot length-cut results in lumber recovery equivalent to a 14-foot, 15-inch log which scales 18.4 cf for defect of 2.6 cf. This is the net scale for this log. Scribner gross scale is 14 bds, defect 2 bds, net of 12 bds.

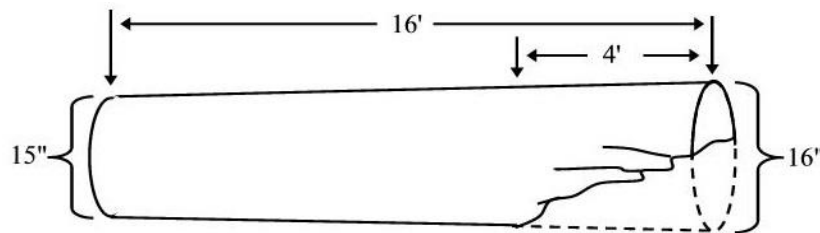

Figure 3 - 15

Figure 3-15 illustrates a 15-inch log with breakage affecting more than half of the end section for four feet. This will require a full 4-foot length cut deduction. Net scale is 15.7 cf (equivalent to a 12-foot, 15-inch log). Scribner gross scale 14 bds, defect 3 bds, net 11 bds.

Rule 2. Logs 16 inches small end diameter (sed) and over. When any portion of the end section is broken, use a pie-cut deduction for the length affected.

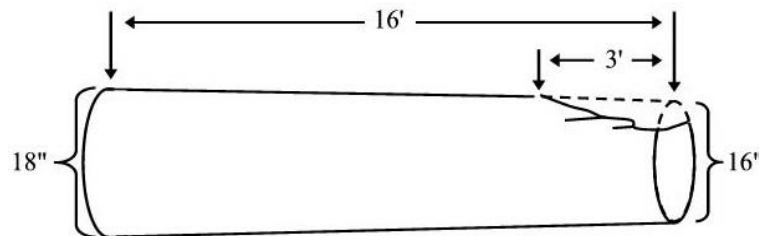

Figure 3 - 16

Figure 3-16 illustrates a 16-foot log with 1/4 of three feet affected by breakage. When calculating defect, remember to allow for lumber recovery in 2-foot multiples. Therefore, the length of the breakage must be extended to four feet. The defect would be calculated as $1/4 \times 4' = 1\text{-foot length-cut deduction}$. Net scale is 23.7 cf (equivalent to a 15-foot, 16-inch log). Scribner gross scale is 16 bds, defect 1 bd, net scale of 15 bds.

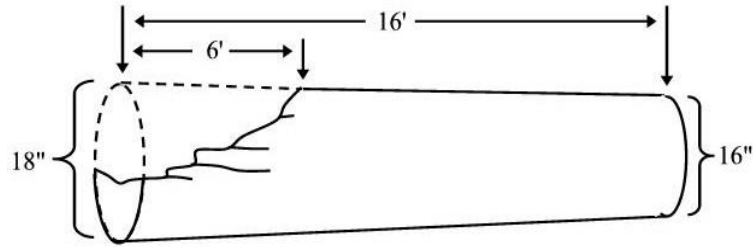

Figure 3 - 17

Figure 3-17 illustrates a 16-foot log with 2/3 of 6 feet affected by breakage. The defect is calculated as $\frac{2}{3} \times 6' = 4$ -foot length cut deduction. Net scale is 19.0 cf (equivalent to a 12-foot, 16-inch log). Scribner net scale is 12 bds.

3.512 Splits and Stump Pull

A split is a single break across the face of the scaling diameter. Since lumber can be recovered on either side of a straight split, deduction is made by the squared-defect method. However, a scaler is cautioned to watch for splits that are angled as they run through the log – these are appropriately deducted for by the combination length-cut/pie-cut method. Stump pull creates a void within the log, usually runs from one to four feet, and may result in a deductible defect by the squared-defect method. Only deduct defects on log ends that exceed 4 inches in length.

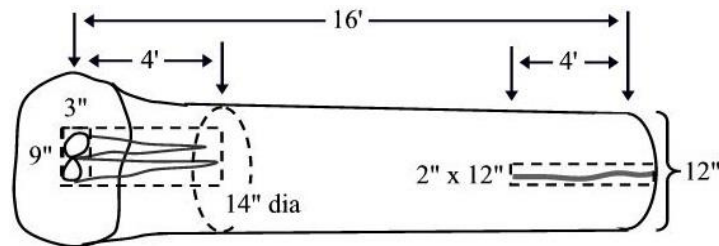

Figure 3 – 18

Figure 3-18 illustrates a 16-foot log with a measured 2" x 12" bucking break (split) extending 4 feet down from the top end. Enter the squared defect deduction, 2" x 12" x 4' for a defect of 0.7 cf. There is also stump pull in the butt extending 4 feet up the log with actual measurements of 3" x 9". Enter the dimensions of the squared defect method, 3" x 9" x 4' = 0.8 cf. The total defect deduction for this log is 1.5 cf, gross 14.8 cf, net 13.3 cf. Scribner gross 8 bds, defect 2 bds, net of 6 bds.

3.513 Barber chair

A barber chair is a breakage defect that occurs when a tree splits lengthwise from the stump end while it is being felled. The large portion of wood that is missing results in a void within the log. Depending upon the severity, the appropriate deduction is either a combination length-cut/pie-cut for the length affected, or solely a pie-cut if the defect affects the entire scaling length. Remember to extend the defect to the end of the log segment if there is less than 6-foot lumber length recovery.

3.514 Processor

Processor breakage is a defect that may occur when mechanized equipment is used for harvesting and bucking trees. Processor breakage appears as a crack or split (or series of cracks or splits) across the log end, confined to one-half or less of the log end. The breaks generally run straight on the butt end of a log, and may run straight or angled at other bucking points. This defect may extend from mere inches to a foot or more in length (rarely beyond two feet). Make no deduction when the defect can be eliminated in the trim, or for splits located solely within two inches of the outside edge of the log. The appropriate deduction method in most other instances is a combination length-cut/pie-cut.

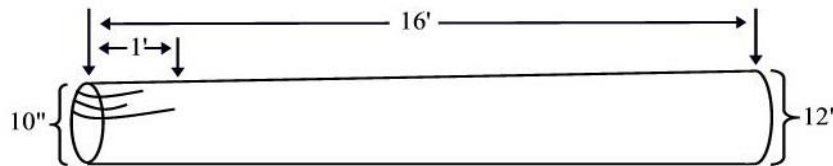

Figure 3 - 19

Figure 3-19 illustrates a 16-foot log with a processor break in the top that extends one-foot down the log. Even though the wood is not "gone", there is an actual volume loss in the top of this log. In order to reflect lumber recovery in two-foot multiples the defect must be extended to two feet. The defect deduction is one-half of 2 feet for a 1-foot length cut. Cubic gross scale 10.6 cf, 0.7 cf defect, net scale is 9.9 cf. Scribner gross is 6 bds, 1 bd defect, and net 5 bds; that of a 15' log.

3.52 Checks

Checks are sawlog defects that show as cracks or separations across the growth rings of a log. Checks in or on a log can be internal or external. Minor weather checking, occurring due to drying of exposed wood, often appears on the ends and outside of logs. In most instances, this type of checking causes no lumber loss and therefore is not a deductible defect. It is important for a log scaler to acquire the ability to distinguish between true, deductible checks and those that are not.

3.521 Heart Checks and Pitch Seams

A heart check is an opening or separation across the log heart at right angles to the annual rings. In Douglas fir and Larch, when filled with pitch, it is called a pitch seam (or pitch check). Most often, deductions for heart checks and pitch seams are made by measuring the width and height of the check, and applying the squared-defect method for the length of the defect. Recognize that when logs are exposed to the sun and wind for an extended period, weather (or season) checks often occur on the log ends. This can sometimes make heart checks appear larger than they actually are, or cause difficulty in discerning them. Using a thin wire or knife blade on doubtful checks is sometimes helpful. Non-deductible, end-checking penetrates only a few inches. Look for sawdust in checks, as sometimes this is an indication of a natural heart check.

In measuring the width (and height) of a heart check or pitch seam, search for "breakouts" or branches from the main check or seam. These are sometimes difficult to see, especially when log ends are dirty or wet. Checks with a height of five inches or more will usually run at least eight feet and are therefore a deductible defect. Checks with a height of three or four inches which run only six feet or less are non-deductible, but at times they may also be indication of a deductible check (for example, a 16-foot log with a 1" x 3" pitch seam on the small end and 1" x 5" on the large end). Also note that the minimum width of a check is 1 inch. Do not deduct for that portion of the height that exceeds the scaling diameter, but do use the full height to determine an average height for checks that extend through 16-foot to 20-foot segment lengths (the resulting average height cannot exceed the scaling diameter). Cubic measurement rules require that you use the actual defect dimensions when the defect only shows on one end. Because we are using Scribner as the driver for determining merchantability, squared defecting rules will generally default to Scribner also. There will be some give and take using the rules for squared defect especially with logs that have checks or frost seams that exceed the diameter of the scaling cylinder which cubic would deduct for and Scribner would not. Measurements of heart checks and pitch seams are based on using a Coconino-type scale stick not the actual inch.

Straight Checks. Figure 3-20 illustrates a 16-foot log with a hairline pitch seam showing only in the large end. The estimated depth of penetration in the log is 8 feet. Top diameter of the log is 16 inches. The actual width of the pitch seam is 1 inch. Enter a squared defect of 1 x 16 inches for 8 feet for a cubic deduction of 0.9 cf, and 1X 16" for a Scribner defect of 2 bds. Do not enter the portion of a check that exceeds the Scribner scaling cylinder for that segment.

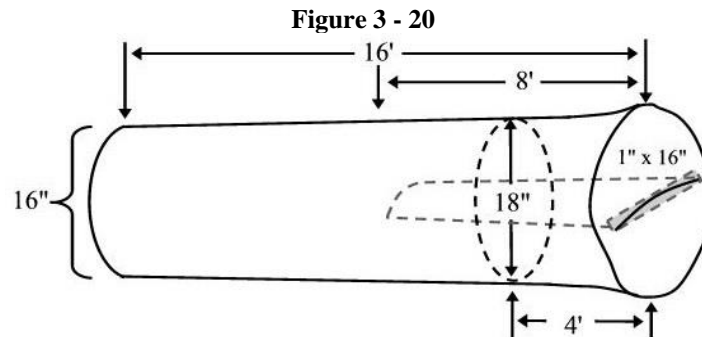

When a check shows on both ends of a log or log segment, and apparently extends through the log without significant twisting, deduction is made in a similar manner – by the squared-defect method. Remember to average the end defect dimensions for 16-foot to 20-foot log segments, and use the large end dimensions for log segments 15 feet or shorter.

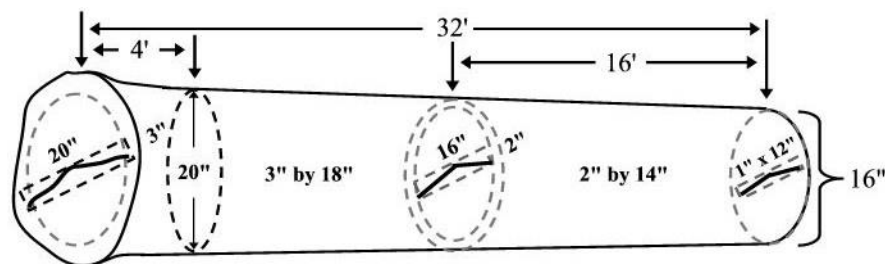

Figure 3 - 21

Figure 3-21 illustrates a 32-foot butt-cut log with heart check showing on both ends that extends through the log without significant twisting. Small end diameter of the 32-foot log is 16 inches, Butt measurement is 20 inches, and midpoint diameter is given to be 18 inches. Depending on your program, you would enter the measured end-dimensions of the defect which are 1 by 12 inches on the small end and 3 by 20 inches on the butt end and the program would take care of all the calculations. If not, you would enter them by log segment, when the defect height dimensions of 12 and 20 inches are averaged the midpoint height dimension is 16 inches. When the defect width dimensions of 1 and 3 inches are averaged, the midpoint width dimension is 2 inches.

For the butt segment, average 3 by 20 inches and 2 by 16 inches – the result is 3 by 18 inches. For the top segment, average 2 by 16 inches and 1 by 12 inches – the result is 2 by 14 inches. The squared-defect method then gives the following deductions: Butt segment, enter a squared defect of 3 x 18 for 16 feet, for a deduction of 6.0 cubic feet. Top segment, enter a squared defect of 2 x 14 inches for 16 feet, for a deduction of 3.1 cubic feet. The total deduction for heart check in this log is 9.1 cf. Gross 56.9 cf, 9.1 cf defect, 47.8 cf net. Scribner gross 37 bds. 13 bds defect, and 24 bds net.

Twisting Checks. Heart checks and pitch seams showing on both ends of a log at different angles indicate twist. Cubic scaling does not make any concessions for twisting a check. Scribner does, depending upon the severity of the twist, the loss can be significantly greater than when the check runs straight. Twist results in the production of shorter length lumber. Special rules apply to Scribner defect deduction for twisting heart checks or pitch seams:

- When twist is 45 degrees from one end to the other of a log segment, use 1.5 times the deduction of a straight check.
- When twist is 90 degrees from one end to the other of a log segment, use 2.0 times the deduction of a straight check.

Application of these rules requires additional consideration because a check that twists 44 degrees is treated as a straight check, and a check that twists 89 degrees is treated as 1.5 times the deduction of a straight check. Diagramming checks and determining their degree of twist in a field setting is very difficult. Even under optimum log presentation conditions, estimation of degree of twist lands somewhere within a 15-degree window. Make sure that twist criteria is met in order to apply the rules. In practical application, this approach means:

- A twisting check in a single segment log will have 1.5 times the deduction of a straight check.
- A twist in a multi-segment log will be treated the same as a straight check.

The only exception to this approach is a visible bark seam in conjunction with the interior check that demonstrates additional twist.

In determining the degree of twist through a log segment, it may be helpful to mentally picture a clock face superimposed on the log end. For example, a vertical check on one end of the log would be pointing to the 12 o'clock position; if that check shows pointing to the 2 o'clock position on the other end, it twists 60 degrees.

Figure 3-22 illustrates a 16-foot log with a 2" x 12" heart check showing on the large end. The same check at the small end is 1" x 7", but shows a twist of "plus or minus" 45 degrees (on the large end, somewhere between the 1:00 and 2:00 position at the top of the check and between 6:00 and 7:00 at the bottom of the check, 12:00/6:00 position at small end). Since it cannot be determined with accuracy that the check is 45 degrees, it is treated as a straight check. After averaging the defect sizes 2" x 10" x 16', enter these dimensions for a deduction of 2.2 cf and 4 bds Scribner. (Note: If this check had pointed more towards the 2:00 position, adjusting for certain twist the actual Scribner deduction for the log would be 1.5 times the deduction of a straight check, or Scribner deduction of 4 bds for a straight check times 1.5 = 6 bds for a twisting check. Cubic deduction would remain at 2.2 cf.

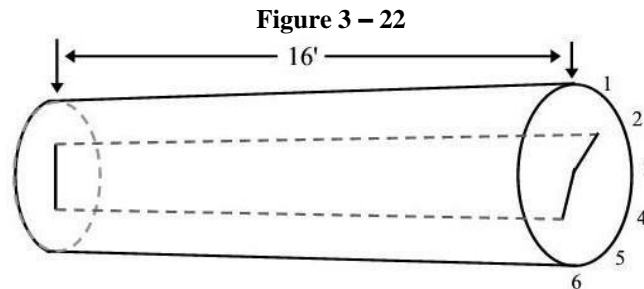
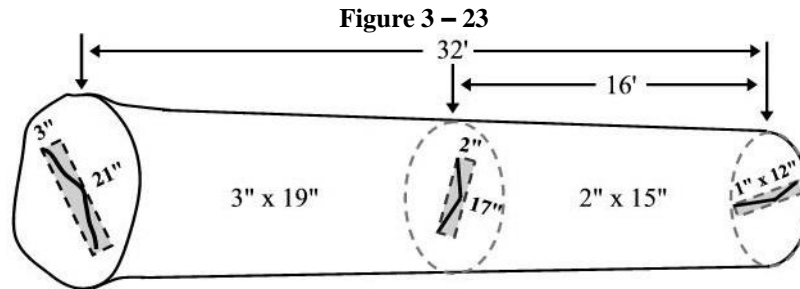

Figure 3-23 illustrates a 32-foot log with a heart check showing on both ends. End measurements of the defect are 3" x 21" and 1" x 12". The check at the small end indicates twist that is taken to be 89 degrees from that showing on the large end.



Average the end defect dimensions to obtain dimensions of defect at the middle of the log. Determine defect for each log segment separately by averaging end defects and determining degree of twist. Since twist is less than 45 degrees in each segment, the check is treated as a straight check. Unless there is a bark seam or scar showing on the outside of a log (such as a frost seam) it cannot be determined that a check twists 90 degrees or more.

Butt segment defect: 3" x 21" and 2" x 17" average to 3" x 19". Enter this as the square defect average for a defect of 6.3 cf, 9 bds Scribner.

Top segment defect: 2" x 17" and 1" x 12" average to 2" x 15". Enter this as the square defect average for a defect of 3.3 cf, 5 bds Scribner.

The total defect deduction for the 32-foot log is 6.3 cf + 3.3 cf = 9.9 cf, and 14 bds Scribner.

Cross-checks and Breakouts. When using the squared-defect deduction method for more than one defect showing on the log end, always diagram the defects at right angles. This is done because lumber manufactured from logs is sawn at right angles. In measuring the defect dimensions, determine the most prominent check first. The cross check is then diagrammed at right angles to the first check.

Deductions for two cross-checks are illustrated in Figure 3-24. In measuring the height of the second check, do not include the width of the first check measured (which has already been accounted for in deduction).

Figure 3 - 24

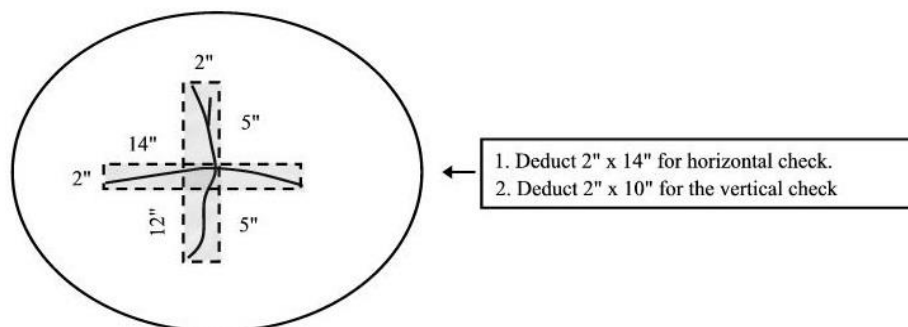

When using the squared-defect method, diagramming for any unconnected defects are also done at right angles, as illustrated on the left side of Figure 3-25. Diagram cross-checks having more of an “X-shaped” appearance as shown on the right side of Figure 3-25.

Figure 3 - 25

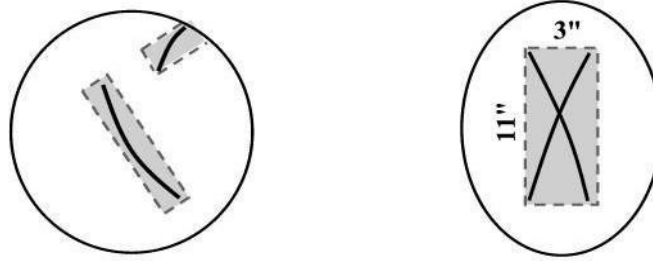

Heart checks or pitch seams with breakouts exhibit a “Y-shaped” appearance. Generally, half of the check height conforms to the top part of a “Y-shape” and half conforms to the bottom part of a “Y-shape”. Determine the width on these types of checks by using an average of the top-part-width and bottom-part-width, as shown in Figure 3-26.

Figure 3 – 26

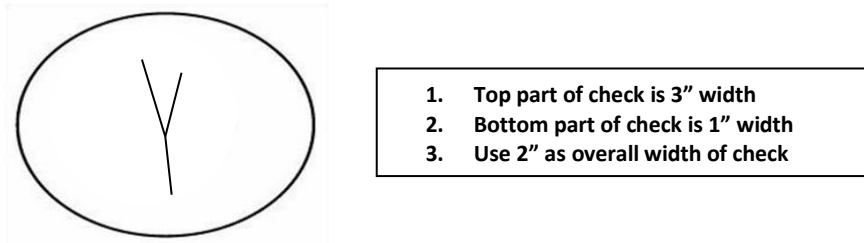

“Give and Take Procedure”. Deductions for more than two cross checks (called multiple checks or spangle) are usually made using the squared-defect method unless the defect is large and results in a length-cut deduction. Some recovery might show between the ends of the checks. “Give and take” when using the squared-defect deduction method on this type of defect. In Figure 3-27, note that some recovery appears inside the rectangle (the “take” area). This is offset by the loss in the check ends outside the rectangle (the “give” area).

Figure 3 - 27

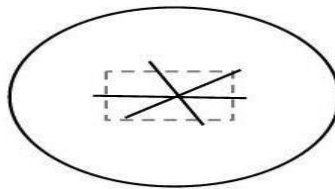

3.522 Frost Checks

Frost checks (frost cracks or seams) are radial cracks or splits extending from the outside of the log into the heartwood. They are caused when a tree freezes and breaks open (“pops”) during cold winter months. Due to their high water content, this defect is commonly seen in the butt end of true-firs, but may also be found elsewhere in the tree. Recognition of this defect is usually made by examining log ends for radial cracks, and following the visible seam or ridge showing in the bark on the outside of the log to determine the length affected. In the butt-end of logs, this defect is often found associated with partial or full shake rings, especially when multiple frost checks exist. A tree having frost checks may “heal over” in time and the frost check will no longer extend all the way to the outside perimeter. Careful inspection of the bark, or when no bark is present looking for irregularities on the outside sapwood, will aid the scaler in determining the length affected. Chopping into the log at a suspected area will often reveal a frost check that has healed over, but it may be necessary to chop quite deeply in some instances.

Pitch seams sometimes found on the outside of Douglas fir logs are similar in appearance to frost checks. Use the same procedures previously described for frost checks to determine the extent affected by this defect.

Deductions for frost check defects vary considerably, depending upon the depth and length of penetration, whether they run straight or spiral, and if they are associated with other defects. Frost checks are deducted by using squared-defect, or pie-cut, or the length-cut method.

Figure 3-28 shows a 16-foot, 18-inch sed, and 20 inch led, Grand fir with a frost check extending to within 2 inches of the heart or center of the butt. There is a visible scar or seam in the bark running 7 feet up the log. In conjunction with a partial shake ring, the defect measures 2-inches by 11-inches. In making deductions, defaulting to Scribner, remember that defect which exists outside the scaling cylinder is not taken. The diameter of the small end scaling cylinder is 18 inches, thereby making half of the scaling cylinder 9 inches. Since the frost check penetration stops at 2 inches from the center of the scaling cylinder at 2 inches from the center of the scaling cylinder, subtracting 2 inches from 9 inches leaves 7 inches as the height of the defect as the defect extends to the outside edge of the scaling cylinder. The length of the defect will be 8 feet to allow for lumber recovery in 2-foot multiples. Using the squared defect method, enter a 2 x 7 for 8 feet. Cubic gross scale is 31.6 cf, defect 0.8 cf, net of 30.8 cf. Scribner gross scale is 21 bds, defect is 1 bd, and net scale is 20 bds.

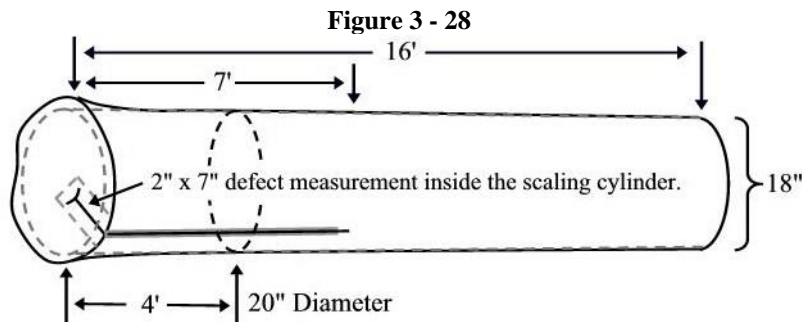

The pie-cut method is used when frost checks "twist" or spiral in the log.

Figure 3-29 illustrates a 16-foot, 16-inch Hemlock with a frost check showing in the butt. The seam on the outside of the log indicates a pronounced spiral as the check extends up the tree. Using the pie-cut method, the frost check is affecting an area of 1/6 of 6'. Reducing the pie-cut to its equivalent length-cut, 1/6 of 6 feet equals a 1-foot deduction. Gross cubic scale is 25.3 cf, defect is 1.6 cf, and net scale is 23.7 cf. Scribner gross scale of 16 bds, defect 1 bd, net 15 bds.

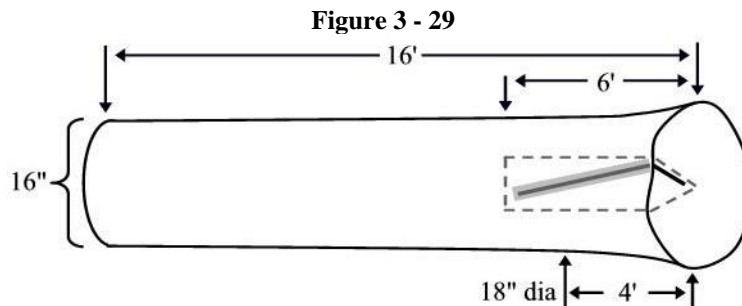
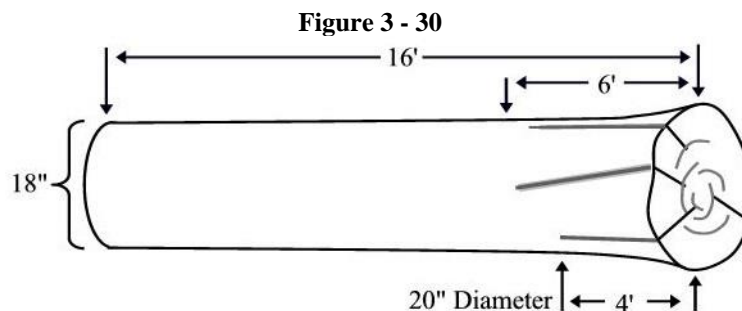

Figure 3-30 illustrates a 16-foot, 18-inch Grand fir with multiple frost checks and associated shake rings affecting 6 feet of the butt end. Using the squared-defect method on the multiple frost checks in this log would exceed the gross volume of the portion affected. Therefore, a 6-foot length-cut deduction is made. Gross cubic scale is 31.6 cf, defect is 11.9 cf, and net scale is 19.7 cf. Scribner gross scale of 21 bds, defect 8 bds, net 13 bds.



3.523 Weather or Surface Checks

Certain weathering conditions are conducive to an uneven and oftentimes rapid drying of wood, resulting in a variety of different size cracks (checks) appearing on exposed surfaces of a log. Minor checks on a log are often called season checks (they are also referred to as wind and/or sun checks). Make no deductions for occasional, minor sun checks that are scattered and shallow in depth when this defect will be eliminated in the slab. Make no deductions for season checks showing on log ends that will be eliminated in the trim allowance.

When weather conditions such as sun, wind, heat, and low humidity result in severe checking on log surfaces it becomes a deductible defect. Weather or surface checks can occur before and/or after a tree is felled, in both green logs (cut from live trees) and dead logs. Surface checks are deducted by using the diameter-cut or pie-cut methods.

When weather checks on green cut logs are numerous and penetrate the scaling cylinder (after allowing for the slab), they cause a volume loss in recoverable lumber. Such checks commonly appear to be about twice their actual depth at the exposed ends of a log than elsewhere. A scaler is advised to determine the average depth of weather check penetration at a place on the log other than the log end, by using some type of thin probe such as a pocket knife blade or a piece of a logging tape.

Figure 3-31 illustrates a log with a 32-foot scaling length that was cut from a live tree (green log). End diameters are 24 and 28 inches, respectively. Weather checks occurred after the tree was felled and bucked. On the log ends, many of these surface checks appear four to seven inches deep. However, measuring check penetration with a thin probe at several spots away from the log ends, along the length of both scaling segments, the scaler determines an average check depth of 3 inches deep.

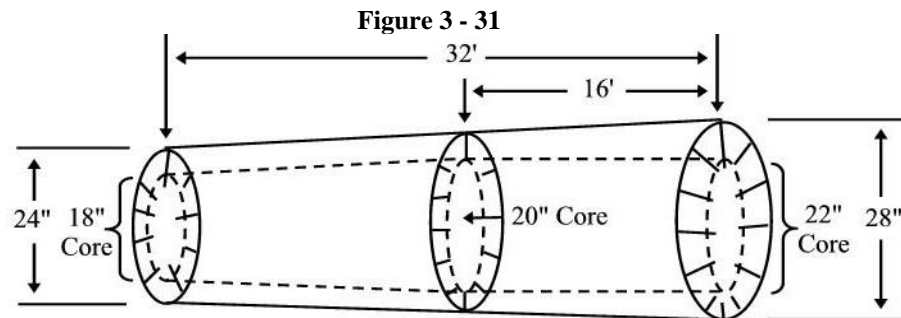

Diameter-cut deduction procedure for the top segment:

- Measure the small end diameter (In the illustration, 24 inches).
- Reduce this gross scale diameter by twice the average depth of the surface checks to obtain a sound cylinder diameter. (In the illustration, 24 inches minus 6 inches equals 18 inches).
- Determine the midpoint small end diameter by use of applicable taper rules. (In the illustration, this second-cut log has total taper of 4 inches from top to bottom, resulting in a midpoint small end diameter of 26 inches).
- Reduce this gross scale diameter by twice the average depth of the surface checks to obtain a sound cylinder diameter. (In the illustration, 26 inches minus 6 inches equals 20 inches).
- Apply a six-inch diameter cut to both segments. Top segment, gross 54.6 cf, defect 23.0 cf, net 31.6 cf. Bottom segment, gross 63.7 cf, defect 25.1 cf, net 38.6 cf for a total gross scale of 118.3 cf, defect 48.1 cf, net of 70.2 cf.
- Scribner gross scale of 90 bds, defect 41 bds, net of 49 bds.

When only a fraction of the log surface is affected with deductible weather checks, use the following procedure:

- First, determine a defect deduction as if the entire surface of the log segment was affected.
- Use diameter percent and enter the fraction as a percentage of the 6-inch diameter cut to arrive at the appropriate defect volume.

Weather checks in logs cut from dead trees are often different from those previously described. These checks likely occurred before the tree was felled. The depths of checks in the sides of logs and at midpoint are generally about as deep as what is showing on log ends. However, when logs are manufactured and transported during hot summer weather, log ends may dry out and show deeper checking than actually exists. Also, because of moisture retained in butts of standing trees, checks in the large end of a butt log may not be as deep as those in the top. Again, a scaler is advised to determine the average depth of check penetrations at places on the log other than the log end, by using some type of thin probe such as a pocketknife blade.

Weather checks often penetrate deep into the center of dead logs. Where only a fraction of the log surface or end is affected and the checks are deep, use the length percent method to determine defect deduction.

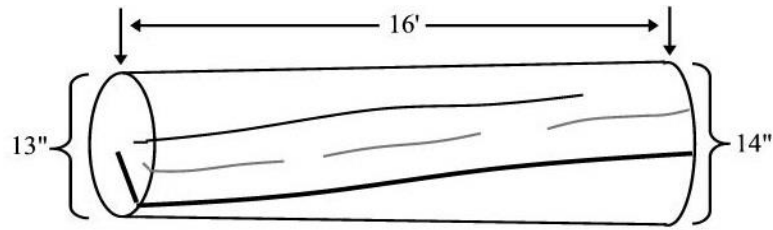

Figure 3 - 32

Figure 3-32 illustrates a dead log with a dry side. The log has one prominent check to the heart with a slight spiral and a few more minor checks. Using the length percent method, 1/4 of the log is affected for the entire length. Gross scale of a 16-foot, 13-inch sed, 14 inch led, log is 15.9 cf. Defect deduction is 25% of a 16-foot length cut, 4.0 cf. Net scale is 11.9 cf. Scribner is 10 bds gross, 3 bds defect, 7 bds net.

When surface checks on a dead log are straight grained, or the spiral is not severe, consider the possibility of cutting merchantable length lumber between the checks. However, if surface checking is spiral grained, the log may be cull for sawlog. To be merchantable, a log must have a net Scribner scale that is 33-1/3 percent of the gross scale.

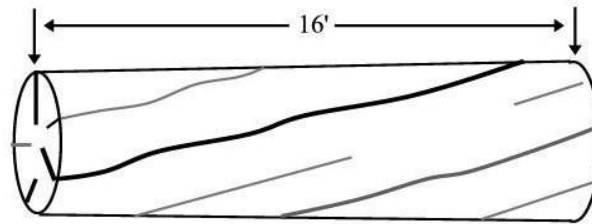

Figure 3 - 33

Figure 3-33 illustrates a dead log with numerous checks spiraling around the log. With three deep checks that spiral 45 degrees every six feet, 75% of the volume is lost. Additional, shallower checks result in further volume loss. This log will not produce enough 6-foot lumber between the checks to yield 33 1/3 % and is therefore a cull sawlog.

In small diameter logs (logs with less than a 12-inch scaling diameter), a single, prominent weather check that penetrates to the pith can cause a considerable percentage of volume loss. This happens because one inch by four inches is the minimum board size considered for lumber recovery. Figure 3-34 illustrates lumber recovery of three 1" x 4" minimum size boards in a 6-inch diameter log.

Figure 3 - 34

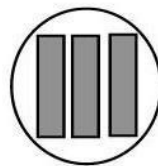

Figure 3-35 shows a 6-inch diameter log end with one prominent deep weather check. Deduction is determined by the pie-cut method, one-third is affected.

Figure 3 - 35



The following deduction procedures should be used to simplify and standardize treatment of deep straight weather checks in small diameter logs:

1. Logs with 6-inch and 7-inch diameters. Determine the fraction of the log affected by the weather check(s) and deduct by pie-cut. The presence of one check requires a pie-cut deduction of at least one-third of the length affected.
2. Logs with 8-inch and 9-inch diameters. Determine the fraction of the log affected by the weather check(s) and deduct by pie-cut. The presence of one check requires a pie-cut deduction of at least one-fourth of the length affected.
3. Logs with 10-inch and 11-inch diameters. Determine the fraction of the log affected by the weather check(s) and deduct by pie-cut. The presence of one check requires a pie-cut deduction of at least one-sixth of the length affected.

3.53 Crook and Sweep

Trees often do not grow perfectly straight, and the logs manufactured from these trees contain various bends and curves that reduce the amount of lumber that can be sawn from them. In second-growth timber, crook and sweep are probably the most common defects encountered by a log scaler. Crook in a log is a sudden curve or bend from a straight line. Sweep in a log is a gradual curve or bend from a straight line. Compared with crook, sweep is less abrupt and more continuous. Deductions for both crook and sweep are similar in that they reflect the loss of lumber recovery from the cylinder. The ability to visualize the cylinder is most important in determining defect deductions.

Crook. Deductions for crook are calculated by using a combination pie-cut and length-cut. This procedure requires determining the length and what fraction of the cylinder is being affected by crook. The calculation process involves multiplying the fraction of the cylinder affected by the crook, times the length affected by the crook, to arrive at an equivalent length-cut deduction. In making deductions for crook, consider the loss in squaring up the ends of uneven length lumber. When figuring any defect deduction, remember that net lumber recovery is always in two-foot multiples.

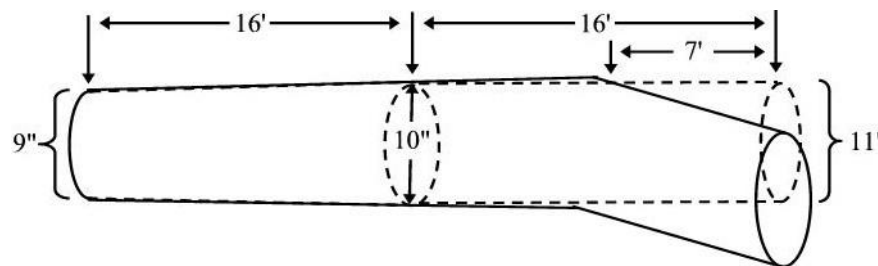

Figure 3 - 36

Figure 3-36 illustrates a 32-foot log, 9-inch sed, 11-inch led, with crook in the large end. In the illustration, 1/2 the large end segment will produce 16-foot lumber and 1/2 the large end segment will not. The net scale is determined by deducting 1/2 of 8 feet, for a 4-foot length-cut from the 16-foot large end segment. Cubic gross 17.5 cf, defect 2.4 cf, net 15.1 cf. Scribner gross 10 bds, 3 bds defect, 7 bds net.

There are instances when multiplying the fraction of the scaling cylinder times the length affected will result in a fractional length-cut (for example, 1/8 of 4 feet = 1/2-foot length-cut). In most cases, these fractional length-cuts will round to the nearest whole foot (1/8 of 4 feet = 1-foot deduction; 1/3 of 4 feet = 1-foot deduction; 1/3 of 8 feet = 3-foot deduction) unless other factors are present that warrant additional consideration.

Cross-grained wood is associated with the abrupt change in direction of a crook defect. Consider as defect any cross-grain within the scaling cylinder that is in excess of 1:3 and include it in determining the crook deduction.

- 1:1 cross-grain = 12" per foot = 45 degrees = deductible defect
- 1:2 cross-grain = 6" per foot = 27 degrees (approximately) = deductible defect
- 1:3 cross-grain = 4" per foot = 18 degrees (approximately) = Not deductible (but anything more severe is deductible)
- 1:4 cross-grain = 3" per foot = 14 degrees (approximately) = Not deductible

One type of crook occurs in the large end of butt logs and is commonly called "pistol butt." This is caused by young trees having been pushed over by snow, or forced to grow outward from steep slopes. Later these trees assume a natural position and grow upward but retain a pronounced "hook" or crook in the butt. If the grain distortion due to crook is not severe, the deduction will be a fraction of the length affected. If cross-grain is present, the crook deduction will be greater.

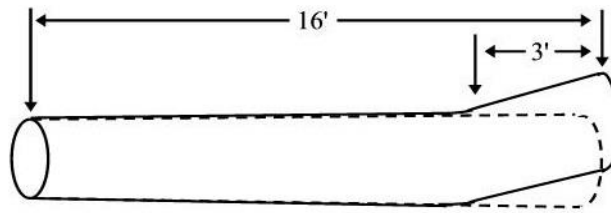

Figure 3 - 37

Figure 3-37 illustrates a log with a 16-foot scaling length and crook affecting the scaling cylinder for 3 feet. It is estimated that 1/3 of the scaling cylinder is affected. Since lumber recovery must be in multiples of two feet, the defect is treated as affecting 4 feet of the scaling length. Cross grain is 1:8 (about 1-1/2 inches in a foot) and is not severe enough to be considered deductible. Deduction calculation is 4 feet x 1/3 = 1-1/3 feet. If this log has a 16-inch scaling diameter, round the fractional length-cut to the nearest whole-foot, for a 1-foot length-cut deduction (since 1/3-foot is less than one-half of a board it is dropped, for a length deduction of 1-foot). If this log has a 48-inch scaling diameter, include the fractional foot, for a 1-1/3 foot length-cut deduction (since a 1-foot deduction with a 48-inch diameter equals 11 bds, appropriately include an additional 4 bds for the 1/3 fractional foot). Use the squared defect method and enter a combination that will deduct 4 bds Scribner, this will also make a deduction for cubic volume.

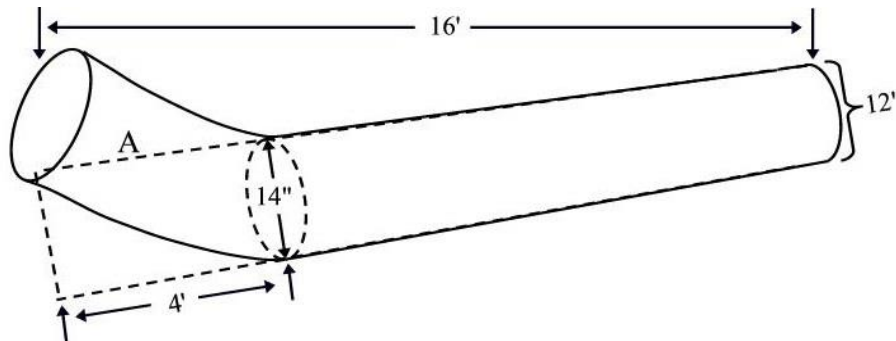
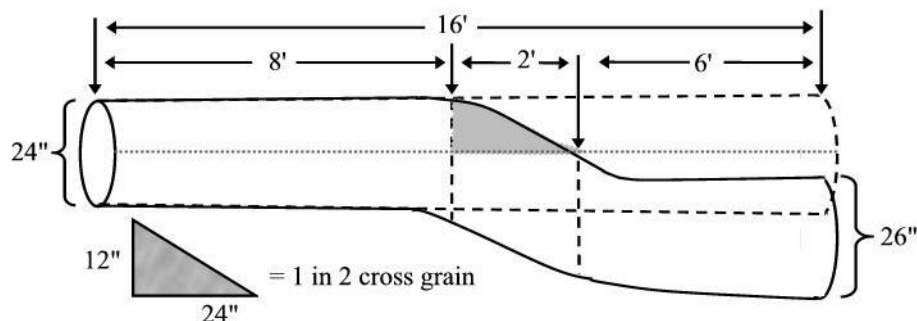

Figure 3 - 38

Figure 3-38 shows a 16-foot, 12-inch sed, 14 inch led, butt log with a "pistol butt" affecting three feet of the butt end. Position the cylinder down the center of the longest straightest portion of the segment. Allowing for lumber recovery in 2-foot multiples, twelve feet of the log is unaffected by the crook. The misplaced material designated by "A" aids the scaler in determining un-merchantable cross-grain existing in a 4-foot portion of the cylinder. Cross-grain is in excess of 1:3 and will require a complete 4-foot length-cut. Cubic gross is 14.8 cf, defect is 3.7 cf, and net scale is 11.1 cf, equivalent to a 12-foot, 12 to 14-inch log. Scribner gross is 8 bds, 2 bds defect, 6 bds net.

Figure 3-39 shows a 16-foot, 24-inch sed, 26-inch led, log with a "dog leg" located near the center. Position of the cylinder is determined by using the longest, straightest portion of the log. Due to severe cross grain (determined by making measurement at the gray area), only 8-foot lumber will be recovered from the top end of this log. A full 2-foot length-cut deduction is made for cross-grain. To calculate the remaining defect deduction, measure the length of the crook and determine what fraction of this length is affected. Two-thirds of the remaining six feet of the scaling cylinder is equivalent to a 4-foot length-cut. This log would require a total 6-foot length-cut deduction. Cubic gross 54.6 cf, defect 20.5 cf, net 34.1 cf. Scribner gross 40 bds, defect 15 bds, net 25 bds.

Figure 3 - 39



Another type of crook is found in logs from upper portions of trees. Snow or falling trees that break off tops of other trees can cause this defect. Before a new leader starts, rot and black massed pitch may enter the wound. The new leader may die, leaving a large sucker-type dead knot. Breakage may occur at this point due to weakness caused by cross grain in the “dog leg”. Position the cylinder down the center of the longest straightest portion of the log. Deduction for Figure 3-40 should be a 4-foot length-cut (2 feet for the rot pocket and 1/3 of 6 feet for crook) since 6-foot lumber can be recovered from the small end of the log. Had the small end section of the log been less than 6 feet in length, a deduction for this complete portion of log would be necessary.

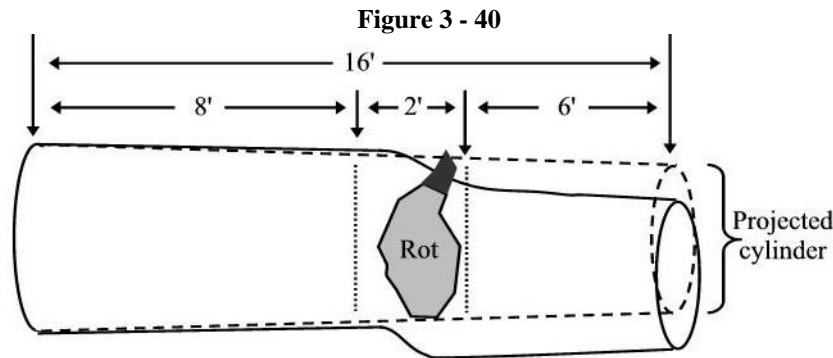

Sweep. Deductions for sweep defect are made in a manner similar to crook defect deductions. Because sweep compared with crook is less abrupt and more continuous, it may be a little more difficult to determine the length affected. Although sweep is often long enough to affect more than one segment, remember to deduct for sweep in logs by scaling each segment as presented. Sweep can affect all or only part of a scaling segment. Visualize the cylinder positioned in a manner equidistant from the sides of the log that results in maximum volume recovery. The cylinder may extend from either end of the log segment or may be positioned in the middle.

Make deductions for sweep as follows:

- Measure the length of the log segment affected by sweep.
- Determine the fraction of this length lost in sawing lumber, considering standard lumber length recovery in two-foot multiples.
- The calculation process involves multiplying the fraction of the scaling cylinder affected by the sweep, times the length affected by the sweep, to arrive at an equivalent length-cut deduction.

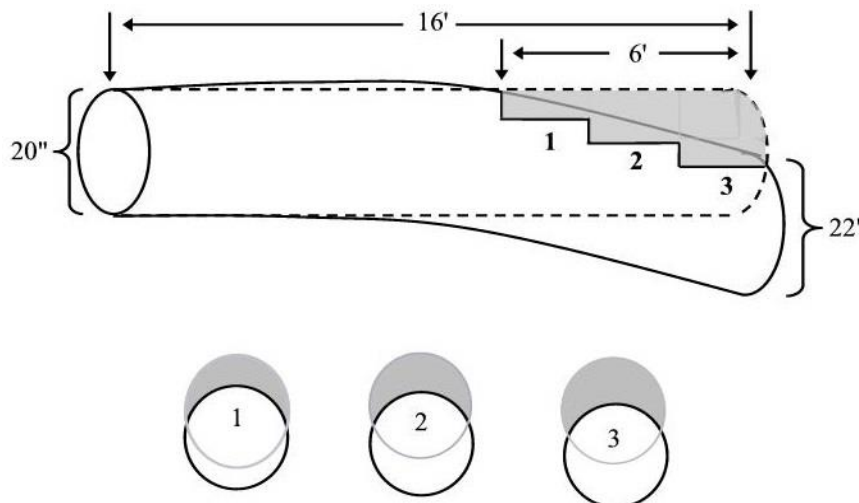

Figure 3 - 41

Figure 3-41 illustrates a 16-foot, 20-inch log with sweep affecting 6 feet of the cylinder. It is estimated that one-half of the affected area will be lost in sawing. In this case, a 3-foot length-cut is deducted. The stair steps (1, 2, 3) illustrate lumber recovery in 2-foot multiples. The grayed areas show where lumber recovery loss occurs within the cylinder.

Sweep in combination with an interior defect such as rot, shake, heart check or pitch seam may indicate a cull log.

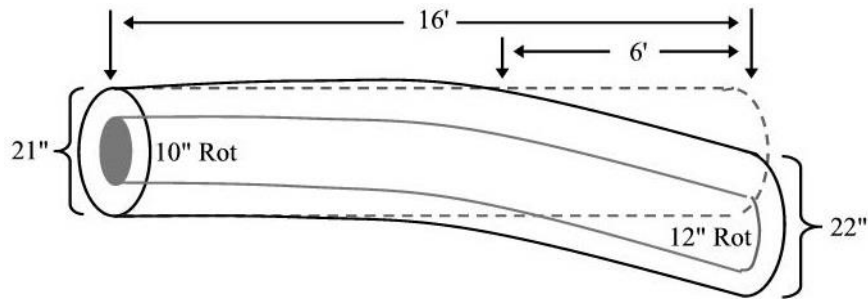

Figure 3 - 42

Figure 3-42 shows a 16-foot, 21-inch sed, 22-inch led, log with a gross scale of 40.4 cf. The log not only has a heart rot with actual measurements of 10 inches on the small end and 12 inches on the large end but also has 1/2 of 6 feet of sweep. An 11-inch by 11-inch rot for 16 feet = 13.4 cf or 15 bds. The scaler needs to keep in mind that the sweep deduction is actually a percentage cut converted to a length cut to come up with the defect volume and is not a true length cut. Deduction for the void area due to sweep is equal to a 3-foot length-cut. Additional consideration must be made for the loss in lumber recovery on the bottom of the log; where the rot curves due to sweep deduct an additional 1-foot length-cut. The result is a 4-foot length-cut for the sweep 10.1 cf or 7 bds in conjunction with the squared-defect for rot (13.4 cf) equals a total of 23.5 cubic defect. Cubic gross is 40.4 cf, defect 23.5 cf, net 16.9 cf, or 41.8%. Subtracting Scribner volumes from the gross scale of 30 bds leaves 8 bds. Scribner sawlog merchantability requires at least 33 1/3 % sound, 8 is less than one-third of 30, and therefore this is a cull log. Sawlog net scale is zero.

3.54 Foreign Material or Hardware

Foreign material refers to any unnatural object embedded within a log that requires removal before the log is suitable to be sawn into lumber. Most often, this is some metal object containing iron (large nails or spikes, fence staples, barb wire, etc.) but may also be a non-ferrous object such as ceramic insulators. Hardware is of significant concern because of the damage it can cause to milling, planing, and chipping equipment, as well as the obvious safety reasons.

The presence of foreign objects is most often made by visual recognition such as pieces of wire, nails, or insulators protruding from the log. Identification is sometimes made by use of metal detectors in the log yard. A gray or black stain in the wood on the log ends is often associated with iron in the log. However, this depends on the species, how long metal has been in the log, how large the piece of metal is, and how close to the bucking point the metal is. Other indicators of hardware may be scars, swells or bulges, particularly where the tree may have grown over the embedded object. A log scaler should identify and mark all logs containing foreign material.

Any log containing metal or foreign material will have a length-cut deduction made for the portion of the log segment affected. Consider standard lumber length recovery in two-foot multiples, at least six feet in length, in deducting for this defect.

Log scalers should be aware that written scaling specifications may have different provisions for deduction of foreign material defect.

3.55 Multiple Defects

A scaler often encounters more than one type of defect in a log segment. When lumber recovery exists around multiple defects affecting the cylinder, great care must be exercised not to overstate or understate deductions. Many logs display more than two types of defect, with visible indication occurring on the ends and sides, affecting some or all of the segment length. To apply one or more deduction methods to each defect is often difficult and time consuming, and if done improperly it will result in erroneous deductions. However, the separate use of the most applicable deduction method for each defect is usually the most appropriate in determining total defect deduction.

Figure 3-43 illustrates a 16-foot, 16-inch sed, 18-inch led, butt log with multiple defects in the large end, no defects showing on the small end. First, assess how the defects are affecting the cylinder. There is one interior defect (heart check) and two defects affecting outer areas of the cylinder (fire scar, rot). The heart check is judged to run halfway through the segment, for 8 feet. Enter the squared-defect for actual measure of 2" x 13" x 8' = 1.4 cf, or 2 bds defect. Next, enter actual measure of the rot 4' x 7" x 6' = 1.2 cf, or 2 bds. The fire scar affects 1/3 of 10 feet for a 3-foot length-cut for 4.7 cf, or 3 bds.

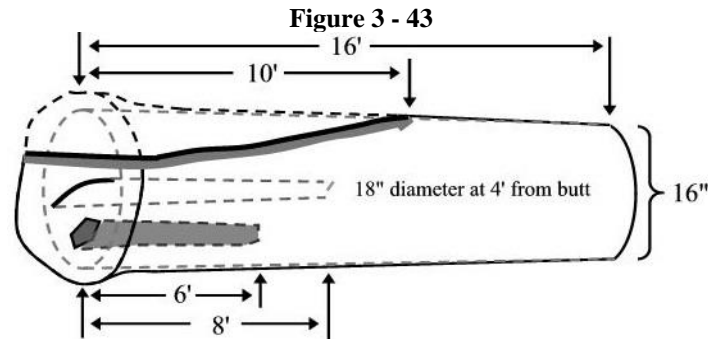

Total defect on the log is 7.3 cf, or 7 bds. An experienced log scaler may be tempted to determine the total defect deduction, or a close approximation, by using a different approach. First, carefully estimate what fraction of the cylinder is affected. About three-fourths is affected to some extent. Next, estimate the average length of the defects. In this example, the fire scar affects 10 feet, rot 6 feet, heart check 8 feet, making an average of 8 feet. The deduction then is 3/4 of 8 feet, for a 6-foot length-cut deduction, which would only be 6 bds but would be 9.5 cf. This would under state the Scribner deduction and over state cubic deduction.

When working with multiple defects the most applicable method usually involves a length-cut, or combination pie-cut and length-cut, for the length of defect on such logs. In some cases, the squared-defect method may be involved.

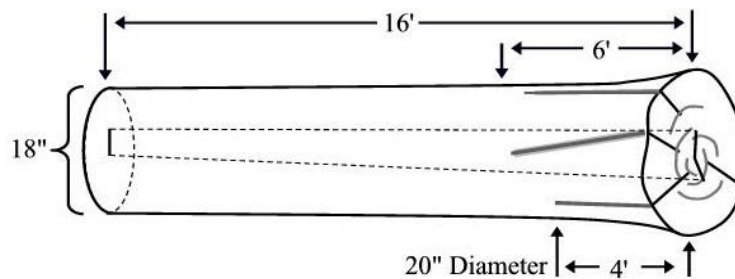

Figure 3 - 44

Illustrated in Figure 3-44 is a 16-foot Grand fir log with multiple defects showing in the butt end (frost checks, ring shake, heart check) and a heart check showing on the top end. The heart check defect extends through the entire scaling segment, with actual measure of 1" x 5" on the top end and 2" x 10" on the butt end. Deduction is calculated by first making a 6-foot length-cut for the multiple defects in the butt, and squared-defect for 10 feet on the remaining heart check. On logs 16-20 feet in length, the average size of the defect is used, which would be an actual measure of 2" x 8", but only calculate for 10 feet since 6 feet of the heart check has already been deducted in the 6-foot length-cut for multiple defects. Deduction for the 6-foot length-cut is 11.9 cubic feet, deduction for the remaining 10 feet of heart check is 1.1 cf. Cubic gross scale is 31.6 cf, defect is 13.0 cf, net scale is 18.6 cf. Scribner scale is 21 bds, defect is 10 bds and net scale is 11 bds.

3.56 Other Natural Defects

A variety of unique natural defects may result in loss of lumber recovery and are categorized and discussed in this section. Depending upon types of logs that are scaled, many of these types of defects may be infrequently encountered.

3.561 Bark Seam

A bark seam is a natural defect that generally extends inward from the outer edge of a log. Most often, they are found on the butt-cut ends of logs, although they occasionally occur further up a tree. The bark penetration is usually deepest as showing on the log end. The length affected can be determined by following the obvious furrow of the seam on the outside of the log. Depending on severity, deduction is made by pie-cut, portion of a pie-cut, or squared defect. Especially on butt-cuts, much of a bark seam may have little or no deductibility due to the natural flare and taper of the log, and consideration of where the scaling cylinder projects. Deduct only for that portion of a bark seam that affects the scaling cylinder.

Bark inclusions are similar to bark seams, except that they usually show no furrow on the outside of the log and are localized in effect. Bark inclusions may be found in conjunction with sucker limbs, dead limbs, tree forks or crotches, and occasionally as a growth characteristic in some species of otherwise apparently normal-growing limbs (notably, Ponderosa pine). Length affected by any individual bark inclusion is seldom more than a foot or two, unless so close to the log end that minimum six-foot lumber length cannot be realized. Deduction for bark inclusions is often accomplished in conjunction with the main associated defect. Where it is necessary to deduct solely for bark inclusion, determine defect by use of pie-cut or squared-defect method.

Figure 3-45 illustrates a bark seam remaining after a crotch had been bucked off. Using the squared-defect method, enter 2" x 9" by 4 feet (length of bark inclusion). The defect will be 0.5 cf. Scribner defect will be a deduction of 1 bd.

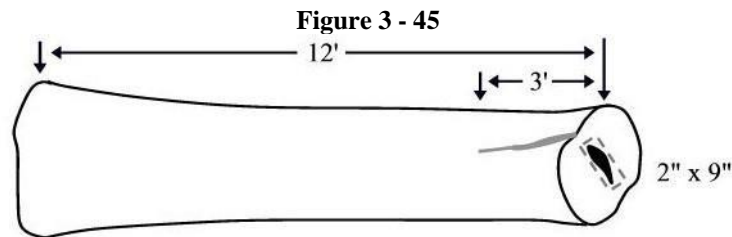

3.562 Burls

Burls are dome-shaped growths of various sizes sometimes found on tree trunks. A characteristic of burls is distorted and twisted grain, unsuitable for lumber. At times, burls penetrate into logs as far as their height above the log surface. Normally, burls have been sawn off flush with the surface of the log by the time a scaler sees the log presented for scaling.

When large burls are found on the outside surface of a log, make a pie-cut deduction to cover the volume loss in the affected portion of the scaling cylinder. If multiple burls are so close together as to prevent the manufacture of 6-foot minimum length lumber between them, apply the pie-cut method for the entire portion of the length affected.

Figure 3-46 illustrates a log where large burls are so close to the log ends as to prevent the recovery of merchantable length lumber. There are two burls illustrated, one on the top face of the log and one on a side face of the log. Since the minimum 6-foot lumber recovery does not exist from the defects to the ends of the log, the defects are treated as affecting four feet on one end and a full six feet on the other end. In the illustration, the fraction affected is estimated at 1/4 for each burl. The deduction is a pie-cut of 1/4 of 4' and 1/4 of 6', for a total of 2-1/2 feet which is rounded to a 3-foot length-cut deduction.

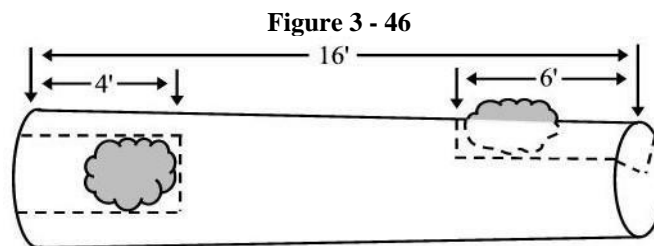

3.563 Char or Fire Scars

Char (fire or burn scars) is a scaling defect that occurs when the wood of a log has been burnt. Scorching or burn marks limited solely to the bark and knot surfaces will be removed in the debarking process and are not deductible defect. Be aware that weathered and exposed catfaces often give the appearance of being charred, particularly when wet. If char exists, it is readily identifiable by the presence of residual carbon. When char exists solely outside of the scaling cylinder on a log, it is not a deductible defect. However, in the production of wood chips, a by-product of sawlog manufacturing, char is unacceptable. A log scaler may be provided with written scaling specifications containing special provisions relating to net scale for any log containing char.

Where char affects the scaling cylinder, it may result in deductible defect. The amount of deduction, if any, depends on the severity of the defect. Figure 3-47 shows a 16-foot, 19-inch sed, 20 inch led, log with numerous spots burned into the surface. The char penetrates deep into the wood around the entire circumference of the log. After careful examination of the log, a scaler returns to the small end and measures a diameter for a new special cylinder inside of the external burn defects, resulting in a 5-inch diameter cut. Enter a 5-inch diameter cut for a resulting scale of: Gross scale of 33.2 cf, defect of 14.8 cf, net 18.4 cf. Scribner gross of 24 bds, defect 13 bds, net of 11 bds.

Figure 3 - 47

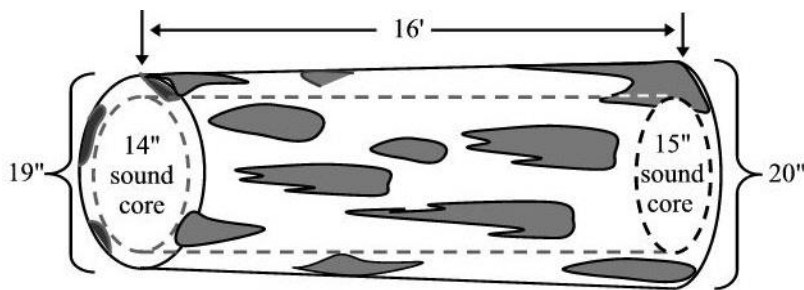

The term “fire scar(s)” is used when referring to a deeply burnt face (or faces) of a log. Fire scars are normally localized only in butt logs, often in conjunction with a catface, but occasionally extend into the second segment. In some species, this defect may be accompanied by massed black or red pitch, weather checks, wormholes, or rot. Part of the scar at the top end may have healed over; consider possible defect here in measuring its length within the scaling cylinder.

Figure 3-48 illustrates a 16-foot log with fire scar extending 8 feet from the butt. Use a pie-cut for this defect. First, estimate what portion of the cylinder is affected, then what length is lost by defect. Half of the cross section of the scaling cylinder is affected for 8 feet in length. Deduct 1/2 of 8 feet, which is a 4-foot length cut. Net scale is equivalent to that of a log 12 feet long.

Figure 3 - 48

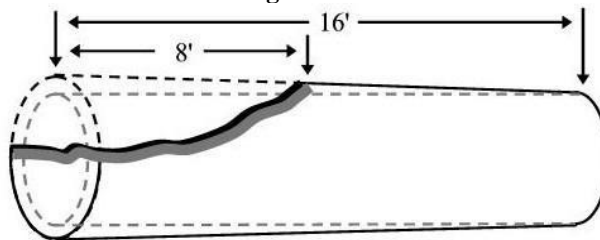

3.564 Catface

Scars or wounds, often caused by falling objects scraping against a tree, are called catfaces. They are recognized on the external surface of a log as an area where the tree is no longer growing. The exposed wood surface is often weather checked and may be rotted. Watch also for massed pitch or wormholes in conjunction with a catface. If ants are present, they are usually an indication of a deep dry rot somewhere deeper within the log.

Catfaces that are solely outside of the scaling cylinder, or very shallow in depth and removable with the slab, need no deduction for Scribner. However, they may need a cubic deduction using the squared area method if the deduction is at least 0.02 cubic feet. Normally, a catface is deducted by applying a portion of a diameter-cut for the length affected:

- First, determine a diameter for a sound core inside the catface, treating the catface defect as if it affected the entire circumference (most often this is equal to twice the depth of the catface, subtracted from the gross diameter).
- Consider this as a new special scaling cylinder. Deduct the scale of the special scaling cylinder from the gross scale. This would be the deduction if the defect affected the entire circumference.
- Arrive at the final defect volume by determining what portion of the log circumference is affected by catface, multiplied by the defect volume determined in the previous step.

Figure 3-49 illustrates a 16-foot log with a catface extending the entire length. The small end diameter of the log is 15 inches and the large end is 17-inch with a gross scale of 22.4 cf. The catface is 2 inches deep and covers 1/4 of the circumference. Take a diameter cut for 25% of 4 inches for the full length, the defect is 2.4 cf. Gross scale is 22.4 cf, defect is 2.4 cf, net is 20.0 cf. Scribner gross volume is 14 bds, 2 bds defect, 12 bds net.

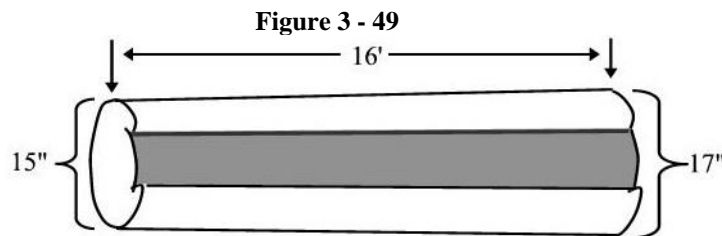

When a catface with other associated defects penetrates deep into a log, use the pie-cut method. Figure 3-50 illustrates a 16-foot log with a deep and partially grown-over catface. The defect is 10 feet long, confined to a quarter section of the log. The small end diameter is 17-inch and larger end is 19-inch. Gross cubic scale is 28.4 cf. Defect is calculated as, 1/4 of a 10' for a 3 foot length deduction, or 5.3 cf, for a net scale of 23.1 cf. Scribner gross volume is 18 bds, 3 bds defect, 15 bds net.

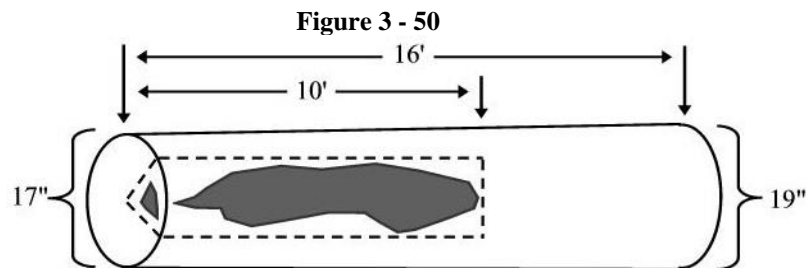

3.565 Crotch

A crotch is the point in a tree where it forks into two or more leaders or stems. Deductible defect may result from flat sides or voids, which are often characteristic of a crotch condition. Figure 3-51 illustrates a log which should have had more of the crotch bucked out. One-half of six feet is affected in this illustration, for a 3-foot length cut.

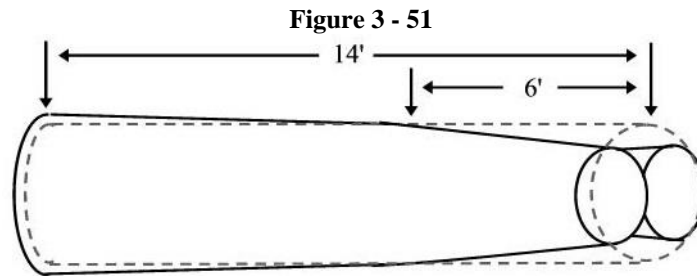

Proper bucking usually eliminates much of the defect. The remaining loss occurs from a bark seam, split, or cross-grain in the end of such logs. A deduction of 1 or 2 feet in length is often made for this type of defect, but the actual deduction depends on each individual log. It may be sufficient merely to square out the bark seam for 2 to 4 feet, depending on the point of bucking. When two distinct forks are showing, the bark inclusion will likely extend several feet down the log.

Figure 3-52 illustrates a 16-foot, 10-inch forked log with one fork missing. Where the fork is missing, a localized pocket of rot has developed. The length of lumber that can be recovered above the rot pocket is 5 feet; however, the minimum lumber recovery length considered in scaling is 6 feet. Due to the rot in the middle of the log, 6-foot lumber can only be sawn from the butt portion. This log will require a 10-foot length-cut for defect.

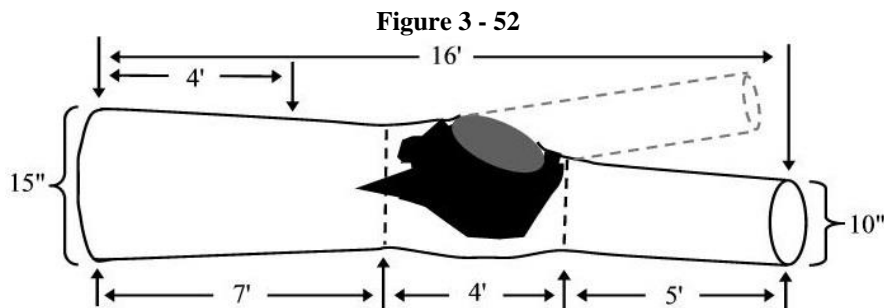

3.566 Insect Damage

A number of different types of insects spend all or part of their lives in trees. At times, their activities affect the amount of lumber that can be sawn from a log resulting in deductible defect. Some insects do not directly cause damage, but their presence may be indicative of other defects (for example: a beehive in a hollowed out rot pocket, or ants associated with interior rots and woodpecker holes). Two types of insect damage defects are of significance in Idaho and are referred to as scolytus defect and worm hole defect.

Scolytus. This defect is caused by the fir engraver beetle, and is called “scolytus” from its scientific classification name, *scolytus ventralis*. Although scolytus has been reported to occasionally affect Douglas fir, Subalpine fir, Hemlock or Spruce, the unique characteristics of this defect are associated with Grand fir species.

Activities of the fir engraver beetle and its larva result in localized damage to the cambium layer, leaving a distinct annual growth ring separation. Affected areas are the larval galleries, 1 to 2 feet in length, about half as wide as they are long. The affected areas often heal over, leaving a swollen lump on the log with a short, distinguishing ridge of cracked bark. When logs are bucked through these damaged areas, a short arc of wood separation is evident. In severe infestations, the tree may not heal and displays scattered catface pockets around the outside of the log. A scaler should pay close attention to the wood just under these cat faces as they may have pockets of rot. Scolytus is generally found above the butt-cut (commonly, 8 feet or more).

Deduction for scolytus defect damage is usually done by using a diameter-cut deduction, or portion of a diameter-cut, for the area and length affected. When log ends do not show evidence of scolytus ring separation, a scaler must rely on surface indications to determine if only part of the log is affected. Often, a log may be bucked at a point between larvae galleries, and further damage is evident at a short distance from the log end. If suspected defect is close to the surface, it can be verified by chopping into the log to reveal ring separation.

Figure 3-53 shows a 16-foot, 15-inch sed, 16-inch led, log with multiple scolytus defects, resulting in the appearance of an almost “full ring separation” showing on the small and large ends. Numerous scars on the log surface indicate the defect affects the entire length. The scolytus ring has a diameter measurement of 11 inches, requiring a 4-inch diameter-cut. Enter a 4-inch diameter cut. Gross scale is 21.0 cf, defect 9.4 cf, net of 11.6 cf. Scribner gross scale is 14 bds, defect is 7 bds, and net scale is 7 bds.

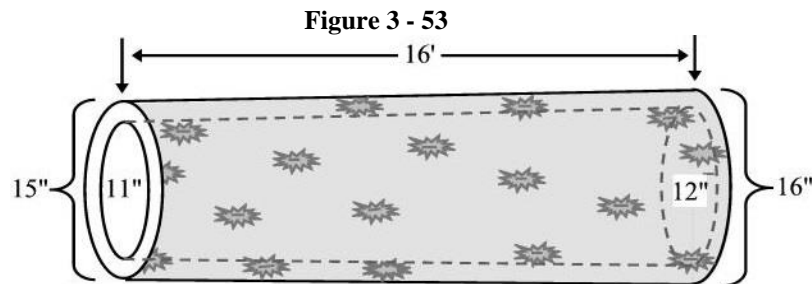

Occasionally, scolytus damage may have occurred many years ago in the life of a tree and is confined to the interior of the scaling cylinder. Evidence of scolytus scars may still be found on the bark. In these circumstances, deduction is made by the squared-defect method.

Figure 3-54 illustrates a 16-foot, 14-inch sed, 16-inch led, Grand fir with a 6-inch scolytus ring showing at the small end and an 8-inch scolytus ring showing at the large end. Using the single ring deduction, enter the actual end dimensions of both rings. The handheld will calculate the mid-point and replace the sound core. Total defect deduction is 1.2 cf. Cubic gross scale is 19.7 cf, defect of 1.2 cf, net of 18.5 cf. Scribner gross scale is 11 bds, defect is 5 bds, and net scale is 6 bds.

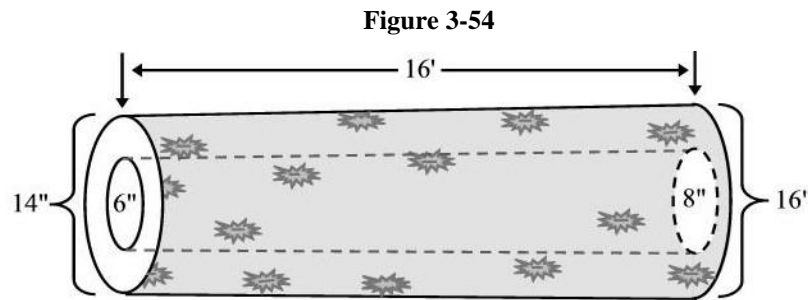
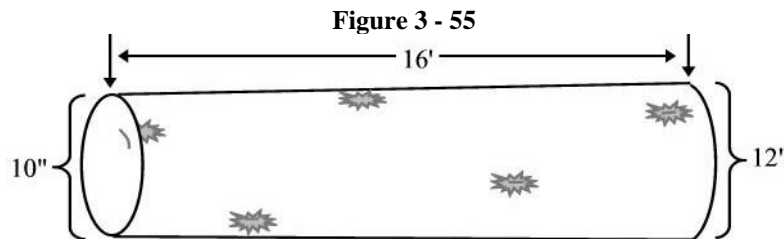

Figure 3-55 shows a 16-foot, 10-inch sed, 12-inch led, Grand fir log with a few scattered scolytus scars showing in the bark. Close inspection reveals a small separation in the growth ring on the small end of the log under the scar. Due to the attacks being few and scattered, and the ability to recover 6-foot lumber between scolytus defects, the resulting damage would be a lumber grading deduction and not a log scaling defect. Cubic gross is 10.6 cf, defect 0 cf, net scale of 10.6 cf. Gross Scribner scale is 6 bds, defect is 0 bds, and net scale is 6 bds.



Wormholes. Wormholes are sometimes found in logs cut from standing dead trees, or dead areas on living trees such as catfaces. Wormholes typically range in size from a little over 1/8 inch to 1/2 inch in diameter. In addition to the damage caused by larval activity (worms), holes caused by various beetles are also called wormholes. These beetle holes may range in size from 1/16 inch in diameter to 1/8 inch in diameter.

Evidence of wormholes is found by examining the outside surface and ends of logs. Examination of the log ends gives indication on depth of wormhole penetration, and whether the holes go straight into the log (perpendicular to the surface) or meander across the grain of the wood (parallel to the surface). Examination of the surface gives a scaler the extent of the log affected. When wormholes are not near the log ends, surface examination may be the only indication to guide a scaler in determining defect deduction.

Wormholes become deductible as a scaling defect when they cause an actual loss of volume in the amount of lumber that can be produced. This condition is referred to as massed wormholes. It exists when wormholes are so numerous that they weaken the lumber, or may occur when scattered wormholes meander so much that they weaken the lumber.

Wormholes are classed as pin size, not over 1/16 inch in diameter; small, not over 1/4 inch in diameter; and large, over 1/4 inch in diameter.

No deduction is made for pin size wormholes. Typically, ambrosia beetles cause holes of this size. These beetles tend to bore straight into the log (perpendicular to the surface). Often, these holes are shallow in penetration and will be removed in the slab. Since hole size is so small, weakening of lumber does not occur, although numerous holes may result in a lumber grading defect.

Small size wormholes usually will not require a deduction unless examination of log ends indicates meandering across the grain of the wood (parallel to the surface). When this condition is present on log ends, it indicates larval tunneling activity will result in weakening of lumber produced from the affected area. Consideration must be given to the number and distribution of wormholes showing on the log surface to determine if a defect deduction is necessary. When holes on the log surface are found 6 inches or less apart in any direction, and meandering of wormholes is showing on the log end(s), treat the area affected as massed wormholes. Depending on penetration depth showing on log end(s), deduction will be made by diameter-cut, percentage of a diameter-cut, or pie-cut.

Large size wormholes are deductible when they are numerous enough to cause a volume loss. This condition exists when large wormholes on the log surface are 6 inches or less apart in any direction. Examining the log ends will often indicate the depth of penetration. Unless examination of the log ends indicates otherwise, deduction for large massed wormholes will be by the pie-cut method, for the area and length of the log affected. The diameter-deduction method may occasionally be applicable if these wormholes are shallow and uniformly distributed around the log.

Figure 3-56 shows a 16-foot, 14-inch sed, 16-inch led, log with numerous wormholes affecting 1/6 of the log. Using the pie-cut method for defects extending the full length of the segment, use the length percent. 1/6 of 16' is approximately 17%. The defect deduction would be 17 % of the length. Gross 19.7 cf, defect 3.3 cf, and net scale of 16.4 cf. Scribner gross of 11 bds, defect of 2 bds, net of 9 bds.

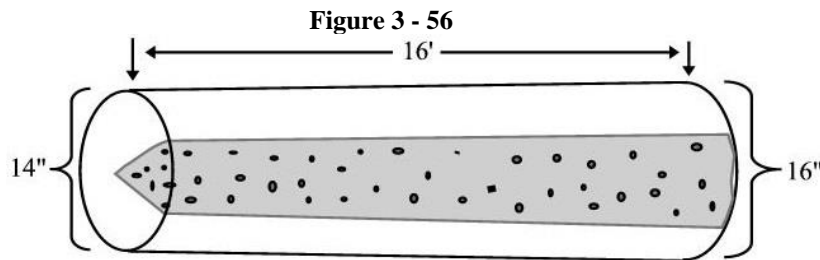

3.567 Knots

Knots are normally a lumber grading (quality) defect and not a log scaling defect. An extremely knotty log ("roughness") does not automatically create a need for defect consideration. When knots are so large and/or numerous on a log segment that they cause weakness in the lumber, they are treated as defect.

Knots cause weakness in lumber because of grain distortion around the knot, even though the actual knot fibers may be denser and stronger. Live knots taper internally immediately, whereas dead knots do not taper until they reach the last growth ring before the limb died. The defect is generally limited to the outer portion of the scaling cylinder, but volume loss may be greater under conditions created by dead knots than live knots of the same size.

The determination for making a defect deduction is based on the maximum allowable knot size of four inches. All size measurements are based on using a "Coconino" scale stick. In making the measurement of knot size, only the actual heartwood of the knot is measured and not the shoulder surrounding it. Critical in measuring a knot diameter is to exclude grain distortion around the knot. Under close examination, the knot has a circular pattern, like a log end, and this is the diameter measured for knot size. The tree stem wood (the grain distortion) grows around the knot and forms the shoulder wood. It is easy to measure dead knots because there is a clear distinction between the knot wood and tree wood; live or tight knots are harder to assess because the two are interconnected. Figure 3-57 illustrates the measurement of knots.

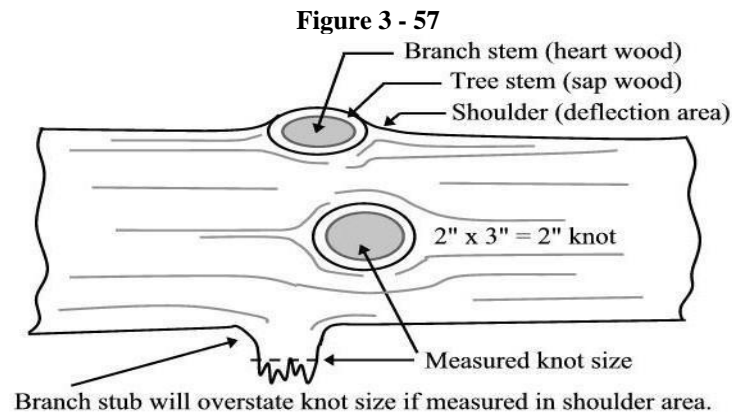

Knot clusters occur where the majority of the grain distortion is around, rather than through or between, a close grouping of knots. A knot cluster is measured in a similar manner as large knots. The smallest circle or ellipse that will surround the individual knots in the cluster is taken as the knot diameter. Figure 3-58 illustrates the measurement of knot clusters.

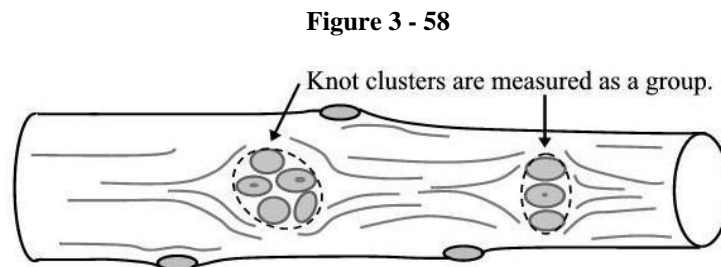

Some species such as Douglas fir, Larch, and Cedar may produce adventitious buds (sucker limbs) which, after a period of time, give the appearance of knots or knot clusters. These types of limbs, however, do not penetrate very far into the log since they form much later than regular branches. They therefore do not have as much impact on lumber produced as their size might suggest. Scalers should recognize this characteristic and not treat these as knot clusters. Another type of knot cluster consists of a group of larger limbs, often with a large dead limb in the center, which penetrate deeply into the log. It results in breakage in lumber produced. This second type also commonly occurs in Douglas fir and Larch. Often massed pitch and twisted or disrupted grain occur in connection with such knots. When these cause a loss in the volume of lumber produced, a deduction is made.

The maximum allowable size for a knot (or knot cluster) is four inches. Larger knot measurements are treated as a defect. Measurements are based on a "Coconino" scale stick.

In addition to their size and characteristics, the location and distribution of knots affect when a deduction must be made. A few, scattered, oversized knots on a log segment do not create a significant volume loss. In general, one oversized knot per log segment will not result in defect deduction, provided 6-foot lumber recovery can be realized above or below the knot. Two oversized knots per log segment are allowed when 6-foot lumber recovery can be realized between the knots and above or below one of the knots. Several oversized knots on one face or unusually large knots will likely require computation to determine defect volume.

Use the diameter-cut deduction method when oversized knots affect the entire log surface or length. In determining the depth of the diameter cut, the scaler needs to keep in mind the knot taper. Deduction is made only for the portion where the knot size is greater than four inches. When oversized knots do not affect the entire surface, use the appropriate percentage of the surface and/or length to determine a fractional portion of the prescribed diameter-cut.

3.568 Lightning Scar

Lightning scars are recognized as a narrow band, commonly twisting, on the outside surface of the log. Bark will be missing where lightning traveled down the tree. The spiral effect of lightning scars, sometimes with shatter, massed pitch, wormholes, and weather checks, presents a difficult scaling problem. The degree of spiral and volume loss varies. Give consideration to short-length lumber the log will produce.

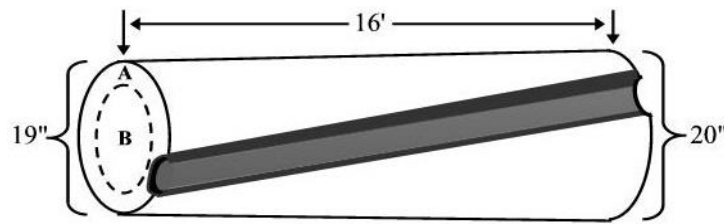

Figure 3 - 59

To determine defect deduction for lightning scar (refer to Figure 3-59):

1. Obtain gross scale of the log.

(Gross scale of 16-foot, 19-inch sed, 20-inch led log = 33.2 cf)

2. Measure depth of scar. Include massed pitch and other defects if present.

(Depth of scar equals 3 inches)

3. Double the scar depth and subtract from gross scale diameter. This result is the diameter of a new special cylinder. (Section B in Figure 3-59)

(Doubled depth of scar = 6 inches. Gross diameter 19" - 6" = 13")

4. Using diameter percent defect enter a 6-inch diameter cut, full length.

5. Judge how much of this collar is lost, such as 1/6, 1/4, 1/3, 1/2, 2/3. Short-length lumber recovery might also reduce the amount lost.

(In 16 feet, the scar spirals 1/3 around the log. Allowing for some shorter length lumber recovery, about 1/4 of the collar area "A" is affected)

6. Enter 25% into the percentage column for a deduction of 4.3 cubic feet.)

7. Gross scale is 33.2 cf, defect is 4.3 cf, net is 28.9 cf.

(Scribner gross scale of 24 bds, minus defect volume of 4 bds, equals 20 bds net scale)

Occasionally, lightning scar defect is deep. This may occur when the lightning scar has been on a tree for a long period of time and commonly includes weathering, wormholes, or rot defects. Use the pie-cut method when lightning scars are deep.

3.57 Pitch

Different types of pitch defects are found in resinous log species. Douglas fir and Western larch are species commonly affected.

3.571 Pitch Seam (*refer to Heart Checks and Pitch Seams)

In Douglas fir and Western Larch, heart checks most commonly become filled with pitch and are referred to as pitch seams. This condition is unique to these two species, although in some larger diameter logs a log scaler may encounter heart checks that have not filled with pitch. Defect identification is simplified, as it becomes rather easy to measure the size of a pitch seam. Any part of the crack or separation which does not contain pitch should be disregarded in measuring the height of this defect. Deduction procedures are described in Section 3.521, Heart Checks and Pitch Seams.

Some stands of Douglas fir timber have surface checks filled with pitch that a scaler may find along the length of logs. Deduct for these in a fashion similar to procedures described in Section 3.522, Frost Checks.

Occasionally, a seam associated with a crotch condition, mainly in pine logs, may be filled with pitch. These generally will not run very far and should not be confused with true pitch seams.

3.572 Pitch Spangle

When more than two pitch seams occur in the large ends of butt logs, the defect is called a pitch spangle. Breakouts from the seams often occur and pitch rings may also be present. Sometimes parts of these defects extend into the second log. This type of defect causes heavy loss in lumber manufacture. Normally, apply the squared-defect method of deduction. Sometimes, a length-cut deduction is appropriate for severe pitch spangle in the butt log when the size of the spangle approaches the scaling diameter.

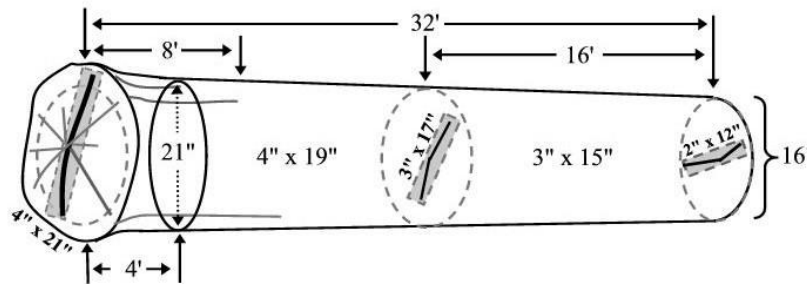

Figure 3 - 60

Figure 3-60 illustrates a 32-foot Douglas-fir butt-cut log, with a 16" sed, 21-inch led, resulting in an 18" Scriber midpoint, and a 19" cubic midpoint diameter. The log has one prominent pitch seam twisting approximately 89 degrees through the entire log, and a highly defective pitch spangle with bark seams showing on the butt end.

- The pitch spangle extends between 6 and 10 feet up the log, affecting most of the scaling cylinder. The butt 16-foot segment will need an 8-foot length-cut for the pitch spangle.
- A pitch seam affects the remaining length of the log, measuring 4" x 21" on the butt end and 2" x 12" on the top end. Determine the midpoint size of the defect by averaging the sizes measured on both ends, equals 3" x 17". Since both log segments are at least 16 feet in length, the defect must be averaged for height and width in each segment. The pitch seam will be treated as if it runs straight, since the degree of twist is less than 45 degrees in each segment.
- The midpoint of the butt 16-foot segment is 4" x 19" (average of 3 x 17 and 4 x 21). This cubic defect will be calculated for 8 feet (since an 8-foot length-cut has already been made for the pitch spangle). For Scribner, the square defect dimensions 4" x 18" for 8' at 100 percent for the remaining pitch seam on the butt segment. The defect will be 4.2 cubic feet. The defect for the length cut is 17.5 cf with 4.2 cf for the check; total defect is 21.7 cf.
- Gross scale for the butt segment in Scribner is 21 bds and defect is 15 bds (10 bds for 8-foot length cut plus 5 bds for remaining pitch seam). This leaves 6 bds remaining, which is less than 33 1/3% merchantable, and results in a cull butt segment with a zero net scale ("0").
- Treat the top 16-foot log segment by averaging the size measured on the small end with the calculated size determined for the midpoint. This results in an average defect size of 3" x 15" = 5.0 cf. The Scribner gross scale of the top segment is 16 bds, defect is 7 bds, resulting in net scale of 9 bds.
- Remember, defect for each segment is computed separately to determine if minimum merchantability is met. Then, results of calculations on each segment are totaled together to reflect the scale of the log. Total gross scale of the 32-foot log is 61.9 cf, defect is 40.0 cf for a net of 21.9 cf. Scribner gross scale of the 32-foot log is 37 bds, defect is 28 bds, and net scale is 9 bds.

3.573 Massed Pitch

Abnormal concentrations of pitch in resinous species result in a defect called massed pitch. This heavy accumulation of pitch, visible on the ends and/or sides of logs, must be "trimmed off" the boards sawn from logs containing this defect. Wood with massed pitch often has a "glassy" look and is brittle. Massed pitch in Douglas fir and Larch often has an oily look and the wood will feel more rubbery when chopped into with a hatchet. Using a hatchet to remove a "wedge" from an area with massed pitch will chip out like a piece of hard candy instead of cutting a smooth, clean chip.

During spring, the sap is naturally "up" in the trees. Species such as Ponderosa pine or White pine may have very heavy amounts of pitch exuding out of the sapwood on ends of logs after they have been bucked. This naturally occurring process is not what is meant by the term "massed pitch". Massed pitch becomes deductible when the accumulation is very heavy and the annual growth rings become difficult to discern.

Douglas fir, Ponderosa pine, and Larch often display this defect in the heartwood on the butt ends of logs. Small areas of massed pitch generally do not run very far and may not result in deductible defect. Larger areas affected require a pie-cut deduction, and full length-cuts are appropriate when the entire cylinder is affected. A swell or bulge on the outside of the log may help determine the extent of defect. Look carefully for rot or ring shake in the butts of logs with this defect, if neither are present the defect generally will not extend beyond the swell.

It may also occur in other areas on a log, most often identified as a healing wound associated with some injury to a live tree. White pine may have this defect displayed on the sides of logs, as a reaction to being infected with blister rust. Lodgepole pine often has this defect associated with catfaces. Often massed pitch occurs in connection with fire scars and may extend beyond the scar at the top end. It is considered in the deduction for this defect. Use the pie-cut or length-cut deduction method. Occasionally, a diameter-cut or portion of a diameter-cut will be used when the defect is confined to the outer circumference of the log segment.

3.574 Pitch Pockets

Small pitch pockets (also called gum pockets) are sometimes observed on log ends, notably in Douglas fir, Ponderosa pine and Engelmann spruce species. They are recognized as small crescent-shaped arcs of separation on an annual growth ring, filled with pitch, about one to two inches wide. Scattered, unconnected and isolated pitch pockets generally affect the wood for only a foot or so and are a lumber grading defect, not a deductible scaling defect. However, the appearance of a pitch pocket on a log end may be indicative of a deductible catface scar away from the end, so the log should be carefully examined.

When pitch pockets are so numerous on an annual growth ring that they resemble a pitch ring, there will be loss of lumber recovery. Close examination of the log ends usually reveals the depth of penetration for this type of defect. This is most commonly encountered in Douglas fir, often in the sapwood portion of the wood. Removing the bark will reveal numerous “bumps” on the wood surface, giving the appearance of small burls or pitch scabs. Chopping into the wood will reveal pockets of separation filled with pitch, causing a loss in the outer portion of the log. A diameter-cut deduction for this defect equal to the depth and portion affected as for sap rot may be equitable, but should be checked and not applied automatically. If the defect is shallow and will be removed with the slab, no deduction is necessary. Deductions include all loss of standard-length lumber.

3.58 Rings – Pitch and Shake

Ring defects are identified as the full or partial separation of one or more annual growth rings. When this occurs in a resinous species it is referred to as a pitch ring, in other species it is called a shake ring. Whether referred to as pitch or shake ring, this defect affects logs in a similar fashion. This defect is recognized from its appearance on the ends of logs.

Shake ring defects follow the annual rings. Sometimes they stop where knots start, for knots tend to hold the annual rings together. On some logs, an indication of the length affected by a shake or pitch ring may be a narrow scar or pitchy seam (breakout) running lengthwise in the bark. In such instances keep in mind the ring will extend farther than the scar. A scaler must look closely at log ends to locate rings and determine their size and shape. The scaler should bear in mind that a ring that opens wide may have deep penetration into the log and that numerous rings may penetrate deeper than one or two rings.

- Rings are measured and averaged for size in the same manner as log diameters.
- The basic procedure for scaling pitch and shake rings is to square the defect and replace a sound core, a “log inside a log”. Core diameters are determined at the small and large end of the ring defect.
- Ring defect will extend to the end of a log segment when 6-foot lumber recovery cannot be realized.
- Minimum size for sound core replacement is a six-inch diameter class.
- Do not replace any portion of the core when the small end diameter is less than six-inch diameter class.
- Using the handheld, this process is simplified by using the single ring function. Enter the large and small end diameters of the ring and the program will do the calculations for you and replace the sound. If the sound core is smaller than the ring diameter use the multi ring function, which will only replace the sound core of the smaller ring.

The need for considering the number of rings, ring location, ring taper, and the scale of any solid core often makes pitch and shake rings a complex scaling situation. One way of classifying and determining deduction procedure is by type of ring(s) encountered: interior, perimeter, and combination rings.

Interior Rings. These are full or partial rings, whose diameter for deduction calculation is more than 5 inches smaller than the scaling diameter of the log segment. Also included in this category is a partial ring in conjunction with heart or frost check defect. Deductions for interior rings are made by the ring deduction method.

Figure 3-61 illustrates a 14-foot log, 17-inch sed, 19-inch led, with an 8-inch shake ring showing in the large end. The defect extends an estimated 8 feet.

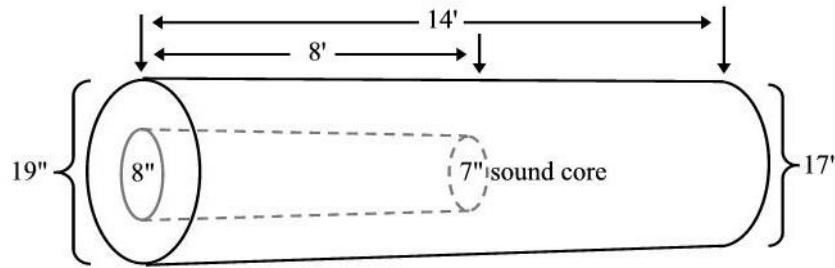

Figure 3 - 61

Proceed as follows:

Enter a single ring with actual dimensions of 7 inches on the small end, and 8 inches on the large end for 8 feet. When a ring shows on only one end of the log, the taper of the ring is determined proportional to the taper of the log and based on the length of defect. Gross scale would be 24.8 cf, defect 0.7 cf, net 24.1 cf. Scribner gross volume is 16 bds, 3 bds defect, 13 bds net.

Figure 3-62 illustrates a 16-foot log with a 6-inch shake ring showing at the small end and an 8-inch shake ring showing at the large end.

Figure 3 - 62

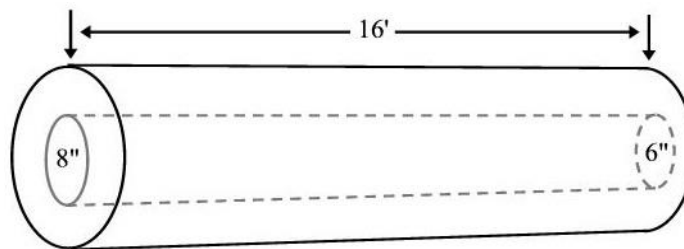

Proceed as follows: enter a single ring with actual dimensions of 6 inches and 8 inches for 16 feet. Cubic defect is 1.2 cf, Scribner defect is 5 bds.

When partial (rather than full) rings are encountered, make the following adjustments in determining defect deduction:

- For one-quarter rings, use the squared-defect method as for checks and do not consider core.
- For a half ring, enter 50 percent for the length affected.
- For a three-quarter ring, enter 75 percent for the length affected.

At times, a scaler may encounter multiple rings showing on one or both ends of a log. These require additional considerations:

- When multiple rings are not more than 2.5 inches apart use the multiple ring selection. Enter the dimensions of both rings and the program will replace only inside smallest core.
- When multiple rings are over 2.5 inches apart, measure the diameters of each ring separately and compute as previously described.

Figure 3-63 illustrates a 16-foot log, 20-inch sed, 22-inch led, with 6-inch and 12-inch shake rings showing on the small end, and respective 8-inch and 14-inch rings showing on the large end.

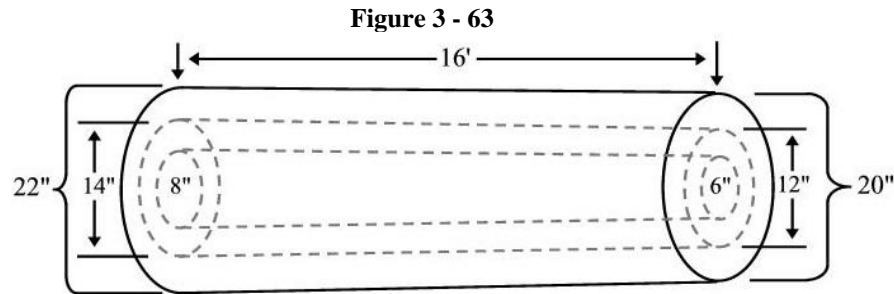

Proceed as follows:

- The two ring defects are more than 2.5 inches apart (in this example they are 3" apart) so each ring will be computed separately. Starting with the larger ring, enter the actual ring dimensions of 12" and 14" = 4.0 cf, 13 bds Scribner. Moving to the inner ring, enter the actual dimension 6" and 8" = 1.2 cf, 5 bds Scribner. Total gross volume for the log is 38.6 cf, defect 5.2 cf, and net 33.4 cf. Scribner gross volume is 28 bds, defect 18 bds, and net 10 bds.

Perimeter Rings. These are full or partial rings whose diameter for deduction calculation is 5 inches or less than the scaling diameter of the log segment (2.5 inches or less from the outside of the cylinder). Calculate the defect loss by the diameter-deduction method for the portion of the circumference and length affected.

Figure 3-64 illustrates a 16-foot log, 16-inch sed, 18-inch led, with a 14-inch shake ring showing in the large end. The defect extends an estimated 8 feet to where the estimated ring diameter (based on log taper) is 13 inches. It is therefore a perimeter ring (5 inches or less than the scaling diameter) and a diameter reduction is used. Deduction is determined by entering a 3-inch diameter cut for 8 feet. Gross scale 25.3 cf, defect 4.1 cf, net scale 21.2 cf. Scribner gross scale 16 bds, defect 3 bds, net 13 bds.

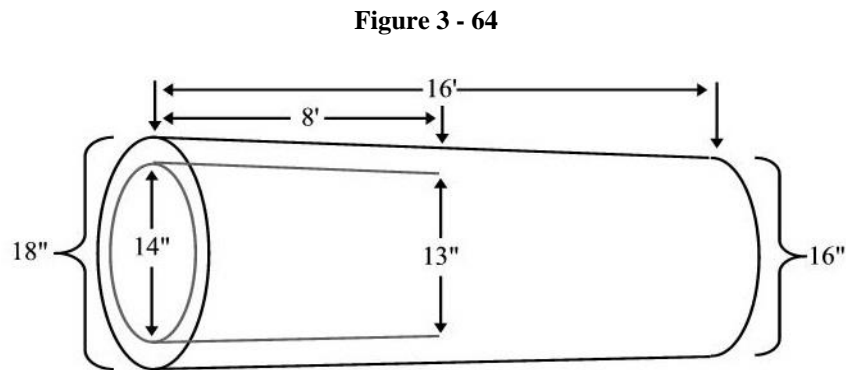

Combination Rings. This refers to a variety of situations involving logs where rings are found in combination with other types of defects, or logs with both interior and perimeter ring defects. Butt-cut logs with ring defect often have other kinds of associated defects. In Grand fir and Hemlock species a combination of ring shake and frost checks is common. This combination often requires a length-cut deduction. Splits or seams on the outside of the log often indicate the extent of the defect.

Breakouts from a pitch ring are commonly seen in Douglas fir logs. Determine the additional defect deduction by using squared defect, diameter-cut, or pie-cut methods. Make a length-cut if deductions by the squared-defect method exceed the log scale of the part affected.

3.59 Rots

Rot defects often result in a significant loss of volume and in some instances will result in a cull log. It is therefore important for a log scaler to know and recognize the distinguishing characteristics of different types of rots. Advanced stages of rot decay are easily identified, but a scaler must also know how to identify early or incipient stages of various rots.

This section categorizes and explains deduction procedures for general types of rots likely to be encountered during log scaling. For additional information, refer to the more detailed narrative about specific types of rots, which is found in the APPENDIX section, COMMON ROTS OF IDAHO LOGS.

3.591 Butt or Stump

In log scaling (as the name implies) butt or stump rot refers to those rots most commonly encountered in the large end of a butt-cut log. However, not all rots appearing on the butt-cut end are butt rots. At times, some of the rots seen on the butt are more appropriately identified with defect occurring further up the log. Familiarity with identifying characteristics of different rots is gained through experience. Based upon the way they affect a log, there are two categories of butt rots.

The first category includes those types of butt rots that affect the outer areas, rather than the center, of the butt end. Quite often, the center area of the end may show little or no defect. This kind of butt rot commonly appears as isolated pockets of rot that generally will not extend very far up the log. Early stages of decay may only show as discoloration in comparison with visual appearance of sound wood. Chopping into suspected areas, the wood will be softer than adjoining sound wood if rot is present. As decay becomes more advanced, the rot will appear stringy and isolated pockets around the center may grow together. Depending upon severity of decay, deduction most often will be a pie-cut of two to four feet in length. In old-growth timber, the defect may run a little further up the log.

The second category includes various types of butt rots affecting the center of the butt end. These are roughly circular in appearance and range in size from a few inches in diameter to almost the entire heartwood area. The rotted area is often, but not always, distinctly different in appearance from surrounding sound wood. Some types of rots exhibit a very subtle appearance difference from sound wood. Chopping into the heartwood will reveal the softer texture of rotted wood. Where the rot has been active many years, a hollowed-out hole may be present. These butt rots generally do not extend very far up the log, commonly running anywhere from two to six feet. Rot that has been active for a longer period of time may affect a longer length. In Western red cedar (and to a lesser degree, Engelmann spruce) the appearance of rot in the center of butt-cuts likely penetrates further than a similar appearing rot in other species.

For butt rots that appear in the center of logs, generally apply the squared-defect method of deduction when the rot diameter is roughly 2/3 or less of the log segment scaling diameter. On larger rot measure, apply a length-cut deduction. When multiple defects are involved, most often a length-cut is the appropriate deduction method to apply.

3.592 Heart

As used in this section, heart rot refers to those types of rots affecting the heartwood of logs, and without external “conk indicators” of decay. They include various rots occurring in conjunction with other types of scaling defects previously described, wherein deduction is most often made by pie-cut method, limited to a localized area of the log.

More commonly, heart rot refers to rots affecting part, or most, of a centered position of the heartwood. Any species may be affected, but these types of rots are most commonly encountered in Western red cedar, Ponderosa pine, and Lodgepole pine. In many cases, heart rots show on both ends of a log and where appropriate, deduction is made by application of the squared-defect method. In Lodgepole pine, or when rot affects most of the heartwood, it may be necessary to apply the length-cut method. However, due to the oftentimes thick sapwood in Ponderosa pine, squaring out the rot-affected portion of the heartwood may still leave 33-1/3% merchantable net scale.

When heart rot shows only on one log end, it becomes necessary to estimate the length affected. The appearance of the rot on the log end helps as an indication of the length affected. When the majority of the heartwood is affected or when rot is severe, it likely will affect a greater length. Sometimes, knots on the outside of the log (not to be confused with *conk rot* knot indicators described in section 3.594) serve as a guide for extent of decay. Certain discoloration or the presence of rot in knots indicates the rot showing on the log end is present in the heartwood at that point of the log. Chopping through the relatively thin sapwood of Lodgepole pine can reveal whether or not rot is present. Use the full estimated length of heart rot because it does not taper like some stump rots. Make deductions by the squared-defect or length-cut method for most heart rot.

3.593 Sap

Sap rots are so named because decayed wood commonly is limited to the sapwood area. It is recognized by finding sapwood that has become soft and crumbly. It is most often encountered on logs cut from dead trees, but not all logs cut from dead

trees have deductible sap rot defect. Mere staining of the sapwood does not create a deductible defect. Especially when logs are wet, sapwood may “feel” soft when chopped into, but this does not automatically create a need for sap rot deduction. Examine a wedge of chopped wood to discern whether or not there is breakdown between fibers of the wood. In addition, if sap rot is present, a wedge of wood will easily separate when rubbed briskly between the hands.

The variety of rots that affect sapwood, species involved, and site conditions of individual trees all contribute to different effects in sap-rotted logs. Scalers are cautioned not to rely solely on the appearance of log ends to determine deductions for sap rot. Examine the outside along the length of a log and check the sapwood under areas that have bark in place.

Some sap rots begin at scattered locations on a tree, which result in separated areas of decay. When 6-foot lumber cannot be recovered between these areas, make a diameter-cut deduction for the entire portion of the sapwood affected. Other sap rots affect the entire sapwood in a uniform manner, progressively decaying from the outside in. Make a full diameter-cut deduction by creating a new special scaling cylinder, measuring the diameter of the sound wood that exists under part or all of the sapwood affected by decay.

Some sap rots eventually progress to decay underlying heartwood. Often this results in deeper, scattered pockets of decay that may not be apparent on the log ends. Sometimes a deep weather check is associated with this. In addition to the diameter-cut for sapwood decay, make a pie-cut deduction of the inside special cylinder, for the length that is affected.

3.594 Conk

A broad definition of “conk” refers to a plethora of spore-bearing reproductive structures of wood-decaying fungi. However, this section is limited to two types of “conk rot” that may be found on logs cut from any section of a tree, and the special rules that apply to defect deduction when they are encountered. These rots affect the heartwood in a log, and in Idaho may be found in any of the common commercial species.

A unique characteristic of conk rots is that they have indicators of decay, which aid in determining how much of the length of a log is affected by rot decay. These indicators of decay appear in knots on the outside of the log and when found, are easily identified. Special rules are used for consistency in scale determination. These rules dictate the length above and below an indicator that is used for defect deduction purposes.

The most common rot associated with the term “conk” is caused by a fungus currently named *Phellinus pini*. It is commonly called conk or *fomes* rot (from a prior scientific classification, *Fomes pini*, pronounced “fo-meez pie-nie”). It is also referred to as ring rot or red rot. It is recognized on log ends by arc-shaped areas of wood decay, red or brown in color, or by a white-speck mottled appearance. Indicators of decay are found in knots, or bulges in the bark. Chopping into these reveals a light to dark brown punky material, resembling snuff tobacco (“snoose”) or used coffee grounds. In the absence of indications to the contrary, from an indicator of decay use the following guidelines to determine length affected by rot:

- In White pine species, rot extends 2 feet up the log, 4 feet down the log, and affects one-half of the cylinder.
- In other species, rot extends 4 feet up the log, 6 feet down the log, and affects the entire heartwood.

Effects of *fomes* rot are variable. When evidence shows a greater or lesser amount of the log affected by rot, make an appropriate adjustment in deduction.

The second type of conk rot is caused by a fungus named *Echinodontium tinctorium*. Its common name is paint rot (also called Indian paint or stringy rot). It is recognized on log ends in early stages of decay as wood breakdown with a yellow to orange to brown color, or sometimes as apparently sound wood having faint, jagged orange streaks. More advanced decay results in pockets of stringy brown material, eventually progressing to consume the entire heartwood. Indicators of decay are found in knots on the outside of the log. Chopping these to reveal a fresh surface reveals a rotted core having a yellow to brilliant orange-red color. Any pointed tool resembling an ice pick can be pushed into the rotted portion of the knot to confirm questionable indicators. . In the absence of indications to the contrary, from an indicator of decay use the following guideline to determine length affected by rot: In all species, rot extends 4 feet up the log, 6 feet down the log, and affects the entire heartwood.

Effects of paint rot are variable. When evidence shows a greater or lesser amount of the log affected by rot, make an appropriate adjustment in deduction.

3.595 Pocket Rot Associated with Rotten Knots

In some species and areas within Idaho, rotten knots indicate a pocket of interior rot. Rot may follow the knot into the log, and then spread out one or both ways. The length of this spread varies with species, age, and locality, but usually affects a localized one to three feet. It is important to note that this type of rotten knot is not to be confused with rotten knot indicators of trunk or conk rots. When localized rot pockets in combination with a rotten knot show on one or both ends, make deductions using the pie-cut method for the length affected.

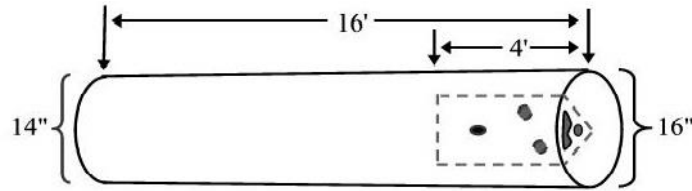

Figure 3 - 65

Figure 3-65 shows a 16-foot, 14-inch sed, 16-inch led, log with rotten knots found near the large end, and rot affecting 1/4 of the end area. The last rotten knot is located 3 feet up from the end. Remembering lumber recovery is in 2-foot multiples a deduction of 1/4 of 4 feet is needed for a 1-foot length-cut. Gross scale is 19.7 cf and calculation of defect for a 1-foot length-cut results in 1.2 cf deduction. Net scale is 18.5 cf. Scribner gross scale is 11 bds, 0 defect, 11 bds net. Logs having rotten knots and no end indications are a challenge to any scaler. Observe log ends bucked through rotten knots and/or rot pockets to establish a pattern for making a deduction on this defect. Do not confuse rotten knots with merely dead limbs. Chopping off the surface of a dead limb will reveal a hard, sound knot below. Pocket rot association is made when chopping fails to reveal a sound core, or if the dead limb has hollowed out due to rot.

CHAPTER 4 – PULP NET SCALE

4.1	GENERAL.....	67
4.2	PRODUCT CLASSIFICATION REQUIREMENTS.....	67
4.3	MERCHANTABILITY STANDARDS.....	67
4.4	DEDUCTION METHODS AND APPLICATIONS.....	68
4.41	Interior-Defect Deduction Method	68
4.42	Diameter-Cut Method	69
4.43	Pie-Cut/Length-Cut Method.....	69
4.5	MULTIPLE DEFECTS.....	70

4.1 GENERAL

Most log scaling involves the determination of board foot volume of sawlogs. Logs that do not meet merchantability standards for product classification as sawlog may be suitable for the manufacture of other products. This chapter describes the log scaling procedures that are used for determining cubic foot volume of pulp logs, in the absence of written scaling specifications to the contrary.

Contractual agreements relating to net scale of pulp logs may establish scaling requirements that differ from these rules. In the event this occurs, scalers must be furnished with written scaling specifications detailing how net scale will be determined differently than described herein.

Pulp logs are log segments that are suitable for the manufacture of wood chips rather than lumber. The gross scale of pulp logs is determined in the same manner as any other log. Log scaling methodology for determining net scale is considerably different from that used for sawlogs.

The concept of a scaling cylinder is not used when net scaling pulp logs. The entire size, shape, and taper of a log segment is considered in applying defect deductions, because the whole log is capable of producing usable wood chips rather than only that area within a cylinder. Defects that reduce the recovery volume of wood chips are deducted.

4.2 PRODUCT CLASSIFICATION REQUIREMENTS

Scaling of logs for pulp log product classification is optional, depending upon whether or not parties to a log scaling agreement elect to do so. When the option to scale log segments for pulp log product classification is exercised, all log scaling will be determined and recorded according to one of the following methods:

- (1) PULP ONLY. All logs will be scaled only for pulp log product classification.

OR

- (2) SAWLOG PLUS PULP. All logs will be scaled for sawlog product classification first, and any logs not meeting merchantability standards for sawlog will then be scaled for pulp log product classification. Unless provided for and described within written scaling specifications, there are no “combination logs” on multi-segment logs (a “combination log” means at least one segment of a multi-segment log meets sawlog merchantability requirements).

Prior to any scaling, a log scaler must be provided with a written document that clearly specifies the intent to scale logs for pulp log product classification and which method will be used (pulp only, or sawlog plus pulp).

Generally, no species differentiation is made when scaling pulp logs. Cedar is normally an unacceptable species when scaling pulp logs. If species differentiation is necessary or if cedar will be accepted for pulp scaling, written instructions must so note and be provided to the scaler.

4.3 MERCHANTABILITY STANDARDS

Pulp log segments must be mechanically debarkable. A scaler makes this determination at the time of scaling, and minor breakage or occasional bark inclusion is permissible. A log segment with a deep split or shattered log end cannot go through the debarking process without tearing apart. Forked logs, or logs with excessive sweep or crook, cannot be debarked. A log segment containing significant bark inclusion along an overgrown, deep catface cannot be totally debarked. When non-debarkable situations occur, the log segment will automatically be culled.

Pulp log segments can contain no char. There is no degree of tolerance for char in production of wood chips. Char residue cannot be broken down or removed in the pulping process. However, minor scorching on the bark that will be removed in the debarking process is permissible. Any fire scar leaving char burned into the wood will automatically cull the entire segment.

Pulp log segments can contain no embedded metal or other foreign objects. When these situations occur, the log segment will automatically be culled.

Pulp log segments must have a net scale volume greater than or equal to 50% of the Scribner gross scale volume to be considered merchantable. Any pulp log segment with a net scale less than 50% is culled.

4.4 DEDUCTION METHODS AND APPLICATIONS

Since pulp log scaling reflects wood chip recovery from a log, only those defects that reduce the volume of usable wood chips are deducted. Minimum product recovery length is one foot, rather than the 6-foot lumber length needed in sawlog scaling. Except for defects noted under merchantability standards that automatically cull a log segment, deductible defects in pulp log scaling are limited to soft rot, voids, and massed pitch. Defect deduction procedures used in pulp scaling are the interior soft rot-defect deduction, diameter-cut, and pie-cut/length-cut methods.

4.41 Interior Soft Rot-Defect Deduction Method

This is the most commonly used procedure for defect deduction on pulp log segments. Its application is used for soft rot, voids, and massed pitch affecting the heartwood of a log.

This deduction method reflects the volume loss caused by various fungi that decay the heartwood to a point where it no longer holds together during the manufacture of wood chips. Not all stages of decay cause loss of volume. The common field test is to chop into the defect with a sharp ax and remove a wedge of wood. If the wood holds together, it is usable; if the wood crumbles or falls apart, it is not usable.

The deduction procedure is to take out “a log within a log” for the length affected. This is accomplished by following these steps:

- _ Measure the size of the defect to approximate an equivalent log diameter. This measurement is made in the same manner as a scaling diameter, on the small end of the defect. The minimum defect size is 3 inches.
- _ Determine the length in feet affected by the defect. Since pulp log scaling reflects wood chip recovery rather than lumber recovery, take note that the minimum product length is 1-foot rather than 6-foot.
- _ When there is some wood chip recovery within the size of the measured defect, determine what percentage is usable and deduct accordingly.

Figure 4-1 shows a Hemlock, butt-cut log with a 16-foot scaling length, 20-inch sed, and a 22-inch led. The size of the rot measured on the small end is 14 inches (narrow-way) by 15 inches (right angle). The wood on the butt end is discolored, but firm. The scaler estimates the measured rot decay will extend 8 feet down the log. The scaler also determines that 2/3 of the measured defect is soft rot, and 1/3 will hold together to make wood chips. Using the soft rot deduction enter a 14-inch sed, 15-inch led “log within a log” for 8-feet and 67% of that volume. The gross scale is 38.6 cf, defect is 6.2 cf, and net scale is 32.4 cf. Scribner gross is 28 bds, defect is 3 bds, net scale of 25 bds.

Figure 4 - 1

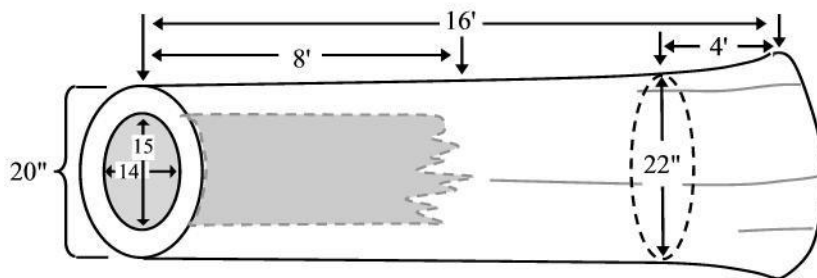

Another common situation confronting a scaler is when rot shows only on the large end. A scaler must remember that defect size is based on the small end measurement. Figure 4-2 shows the determination of defect size and method application when this occurs.

Figure 4-2 illustrates a Grand fir, butt-cut log with a 15-foot scaling length and a 16-inch sed, 20-inch led. The size of the hole (void) and rot on the flared butt end is 12 inches by 14 inches. The scaler determines the rot will taper down and runs 10 feet up the log. Because the rot tapers, on this log the scaler estimates rot size as 9 inches at 10 feet up from the butt. Deduction is a soft rot with a 9-inch sed, and 13-inch led, “log within a log” for 10 feet, defect is 6.8 cf or 3 Scribner bds defect.

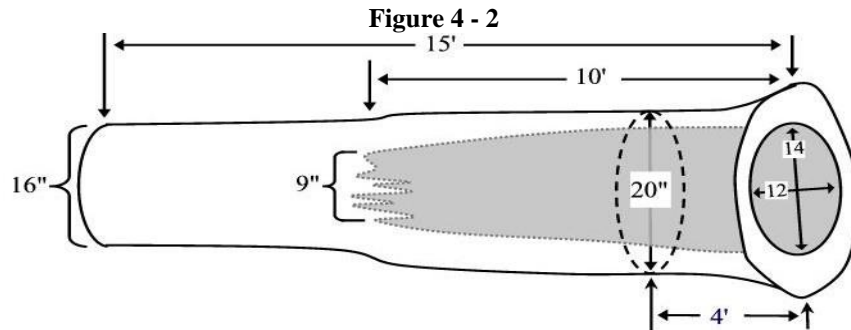

On multi-segment, second-cut logs, determine midpoint rot size by averaging the defects measured on the log ends. Averaging of defect is done in the same manner as determining midpoint diameter for gross scale.

Old growth, multi-segment, butt-cut logs with deductible rot defects extending the entire length are challenging for any scaler. When determining midpoint rot size on logs with flared butts having large holes or large rot size, use of averaging may overstate midpoint rot size. When these types of logs are encountered, the scaler should determine midpoint rot size based on small end measurement plus the appropriate increase according to butt log taper rules.

4.42 Diameter-Cut Method

This is used for rotten sapwood extending around, or partway around, the circumference of a pulp log segment. Deduct only for wood that has deteriorated to a degree where it will not hold together as a wood chip. If only a portion of the circumference and/or length is deductible, a scaler must determine the appropriate percentage and deduct accordingly.

Figure 4-3 shows a Douglas fir log with a 34-foot scaling length and end diameters of 9 inches and 15 inches. Deductible sap rot is affecting the entire circumference of the log on the large end. The small end displays numerous spiral weather checks, but firm sapwood. The scaler measures a core size of 12 inches firm heartwood on the large end, and by chopping finds 1 ½ inches of sap rot affecting the entire collar of the log to within 8 feet of the top end.

On the top end, the measured heartwood core size is 6 inches. Since deductible sap rot occurs only on half the segment length, enter a 3-inch diameter cut for 8 feet for a deduction of 2.4 cf. Scribner defect is 1 bd.

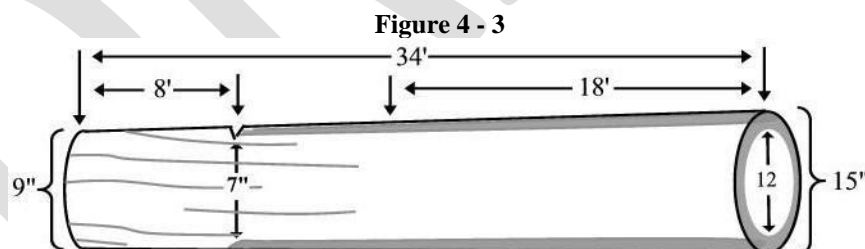

On the large end, the measured core size is 12 inches, or a 3-inch diameter-cut for sap rot defect. Midpoint scaling diameter is 12 inches, and midpoint core size is 9 inches. The 3-inch diameter cut for sap rot is 5 bds. Since the Scribner net scale is less than 50% of the gross scale, the log segment is culled; Scribner gross is 9 bds, defect 5 bds, net 0 bds. Total gross is 27.9 cf, defect 20.5 cf, net 7.4 cf. Scribner gross scale is 13 bds, defect is 10 bds, and net scale is 3 bds.

4.43 Pie-Cut/Length-Cut Method

This is used for defects that can be confined to a sector of a circle for the length affected. It applies to V-shaped rot pockets sometimes found in conjunction with sap rot or surface scars. The application of this method is done in a manner similar to that used for sawlogs. When the defect affects the entire length of a pulp log segment, use a percentage of the scale volume. When the defect affects less than the entire segment length, convert the portion affected to an equivalent length-cut (for example, 1/3 of 3 feet is equivalent to a 1-foot length-cut). Reduce the gross scale length by the length of the equivalent length-cut to arrive at the net scale length. Defect volume is the difference between gross and net scale of these lengths.

Figure 4-4 shows a White pine log with a 32-foot scaling length and end diameters of 12 inches and 15 inches. Numerous weather checks on this log render it cull for saw log product classification. On the large end, a V-shaped rot pocket is showing in conjunction with massed pitch on a blister rust scar. The scaler finds three other blister rust scars, all on the large end log segment. When the scaler chops through the massed pitch and into the scars, rot pockets are found underneath. Each of the three massed pitch scars, and associated rot pockets, are determined to affect 1/6 of 4 feet.

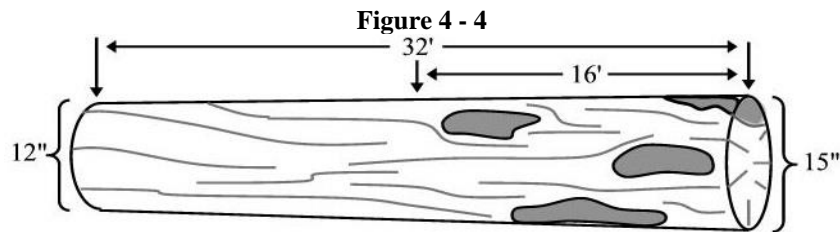

On the top end, there is no defect deduction for pulp log scaling. Gross and net scale are 14.8 cubic feet. On the large end, each defect results in a 2/3-foot deduction (1/6 of 4 feet). Since there are four defects, total deduction is equivalent to a 3-foot length-cut. Gross scale of the large end log segment is 18.4 cf, defect is 3.5 cf, net is 14.9 cf. Total gross for the log is 33.2 cf, defect 3.5 cf, net 29.7 cf. Scribner gross scale is 19 bds, defect is 2 bds, and net scale is 17 bds.

4.5 MULTIPLE DEFECTS

Pulp logs may be affected by more than one type of defect. Careful examination of the log and assessment of differing defects is necessary in order to make an appropriate deduction. Sometimes more than one deduction method will apply, such as for a log having both sap rot and interior soft rot. A scaler must also bear in mind that interior defect deductions are based on the small end size of the defect and deductions are not made for firm rot that will produce wood chips.

Figure 4-5 illustrates a butt-cut Douglas fir pulp log. On the small end the scaler notices faint mottled white specks in the heartwood, an indication of *fomes* rot. Chopping into the affected end area the wood “feels firm” rather than “spongy”. Removing a wedge of wood, it “holds together” even though the rot is apparent. This is “firm white speck” and will not be deducted, unless indications of more advanced decay are found elsewhere in the log. One conk knot is found, a little less than 2 feet from the log end, and the non-deductible rot is estimated to extend another 6 feet down the log.

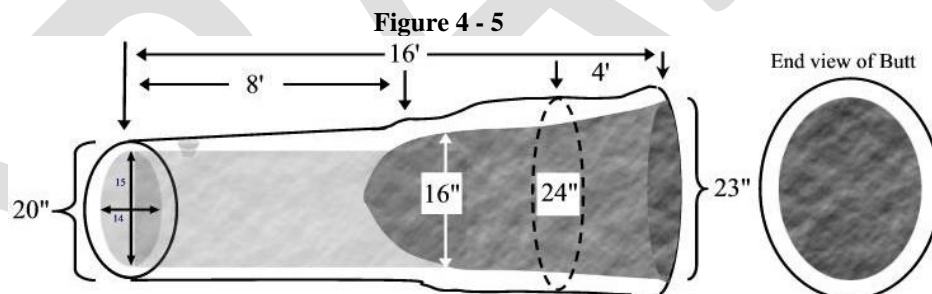

On the butt end, the scaler finds advanced decay. Recognizing a “dry rot” by the soft, brown crumbly cubes, it is clearly different from the rot showing on the top end. Even in initial stages of decay, areas affected by this type of rot will not make usable wood chips. This type of rot will be uniform in size, and end as “blunt-nosed” or “bullet-shaped” (rather than “cone-shaped”).

The size of the affected area on the butt end is 23 inches, larger than the scaling diameter of 20 inches. “Full length-cuts” are not made when scaling pulp logs because of the need to reflect wood chip recovery existing in the outer shell. Rather, the loss is reflected by applying the soft rot interior-defect deduction method. Noticing a pronounced bulge on the outside of the log, extending 7 feet up the log, the scaler estimates butt rot will affect 8 feet in length. Allowing for the flare of the butt and taper of the log, rot is estimated as a 16” diameter (determine this by figuring how much of the heartwood diameter is affected by rot on the butt end, measure the same proportion of heartwood diameter on the small end, and add thereto any estimated taper of the heartwood measure). In figure 4-5, interior defect deduction is a “log within a log” measuring 16-inch diameter and 23-inch length for 8’ length, or 17.1 cf. Cubic gross is 42.6 cf, defect 17.1 cf, net 25.5 cf. Scribner gross scale is 28 bds, defect 8 bds, and net scale is 20 bds.

CHAPTER 5 – CEDAR PRODUCTS NET SCALE

5.1	GENERAL	71
5.2	PRODUCT CLASSIFICATION REQUIREMENTS	71
5.3	MERCHANTABILITY STANDARDS	71
5.4	DEDUCTION METHODS AND APPLICATIONS	72
5.45	Length-Cut Method	72
5.46	Interior-Defect Deduction Method	72
5.47	Diameter-Cut Method	74
5.48	Pie-Cut Method	74
5.5	MULTIPLE DEFECTS	75
5.6	SLABS	76
5.7	PIECES SHORTER THAN EIGHT FEET	76

5.1 GENERAL

For logs that will not be sawn into lumber, the unique characteristics of Western red cedar require the application of a different set of scaling rules to determine log volumes. Cedar is used for manufacturing a variety of products other than lumber, such as posts, rails, pickets, shakes, and shingles. Usually, these are made from cedar logs that do not meet merchantability standards for product classification as sawlog. This section describes the log scaling procedures that are used for determining the cubic foot volume of cedar products logs.

Contractual agreements relating to net scale of cedar products logs may establish scaling requirements that differ from these rules. In the event this occurs, scalers must be furnished with written scaling specifications detailing how net scale will be determined differently than described herein.

Cedar products logs are log segments that are suitable for the manufacture of split cedar end-products rather than lumber. The gross scale of cedar products logs is determined in the same manner as any other log. Log scaling methodology for determining net scale is considerably different from that used for sawlogs.

The concept of a scaling cylinder is not used when net scaling cedar products logs. The entire size, shape, and taper of a log segment is considered in applying defect deductions, because it is primarily the outer shell thickness that reflects net scale volume. Defects that reduce the recovery volume of split cedar end-products are deducted.

5.2 PRODUCT CLASSIFICATION REQUIREMENTS

Scaling of log segments for cedar products is optional, depending upon whether or not parties to a log scaling agreement elect to do so. When the option to scale cedar products is exercised, all log scaling will be determined and recorded according to one of the following methods:

(1) **CEDAR PRODUCTS ONLY.** All log segments will be scaled only as cedar products classification.

OR

(2) **SAWLOG PLUS CEDAR PRODUCTS.** All log segments will be scaled for sawlog product classification first, and any log segments not meeting merchantability standards for sawlog will then be scaled as cedar products classification.

Prior to any scaling, a log scaler must be provided with a written document that clearly specifies the intent to scale logs for cedar products classification and which method will be used (cedar products only, or sawlogs plus cedar products).

5.3 MERCHANTABILITY STANDARDS

Cedar products logs must be at least 8' 1" in length with a minimum top diameter of at least 5.51", actual measure (6-inch diameter, Coconino scale stick).

Cedar products log segments must have a minimum shell thickness of 3.51", actual measure (4-inch diameter class).

Minimum product recovery size is a piece measuring 3.51" by 4.51" (4" x 5" diameter class measure) by 6-foot length, actual measure

Cedar products log segments must have a net scale volume greater than or equal to 20% of the gross scale volume to be considered merchantable. Any cedar products log segment with a net scale less than 20% is culled.

Record any single defect that is at least 0.2 cubic feet

5.4 DEDUCTION METHODS AND APPLICATIONS

Deductible defects are those defects that reduce the usable quantity of split cedar products that can be derived. Deductible defects do not include such things as heart checks and straight splits. Shell thickness less than required minimum size is treated as deductible defect.

Defect deduction procedures used in cedar products scaling are length-cut, interior-defect (soft rot) deduction, diameter-cut, and pie-cut methods.

5.41 Length-Cut Method

This is used for defects that can be confined or reduced to an equivalent loss of length in product recovery. Defects such as abrupt flare on butts, fluted butts, thin shell (less than 4") in conjunction with interior rot, and crook reduce the quantity of split cedar end-products that can be derived. The procedure is to determine the length affected by the defect, and make a length-cut deduction that provides a net scale length that is in a multiple of 2 feet. Remember to extend any defect to the end of the log segment when product recovery will be less than a 6-foot length.

Figure 5-1 illustrates a butt-cut, cedar products log with a 16-foot scaling length and 9-inch sed, 11-inch led. Deep weather checks render this log cull for sawlog product classification, but are not a deductible defect for cedar products scaling. There is an abrupt butt flare affecting the large end for 2 feet. Due to this defect, any split cedar product would have a noticeable hook on one end that would have to be trimmed off during manufacture. The scaler makes a length-cut deduction of 2 feet, gross volume 8.8 cf, defect 1.1 cf, net 7.7 cf. Scribner gross 4 bds, defect 1 bd, and net 3 bds.

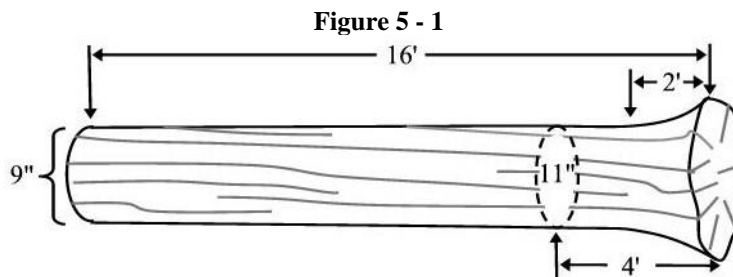

5.42 Interior-Defect Soft Rot Deduction Method

This is the most commonly used procedure for defect deduction on cedar products log segments. Its application is mainly used for interior rot and voids (holes) affecting the heartwood of a log. It also applies in instances of multiple ring shake, when there is no product recovery between the rings.

The deduction procedure is to take out "a log within a log" for the length affected. Measure the size of the defect to approximate an equivalent log diameter. This measurement is made in the same manner as a scaling diameter, on both ends of the defect. The resulting diameters are entered into the soft rot deduction method. The program will calculate the appropriate defect volume for both Scribner and cubic.

On multi-segment, second-cut logs, the midpoint diameter of the rot is determined by using calculated taper distribution for the sizes of the rots showing on the ends of the log.

Figure 5-2 shows a cedar products log with a 28-foot scaling length and end diameters of 20 inches and 25 inches. Average rot diameters measure 11 inches on the small end and 16 inches on the large end.

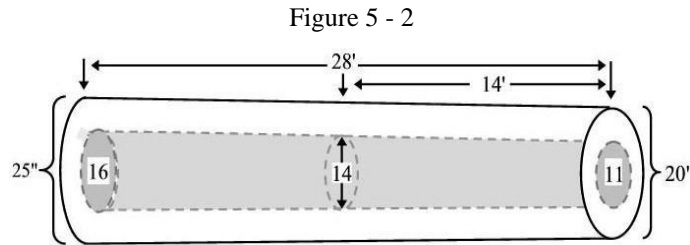

On the top segment, gross scale is 35.5 cf. Defect is entered as soft rot for a 14-foot log with an 11-inch sed, and a 14-inch led, for 12.1 cf or 5 bds. On the butt segment, gross scale is 44.1 cf. Midpoint rot diameter is 14 inches. Defect is entered as soft rot for a 14-foot log with a 14-inch sed, 16-inch led, for 17.3 cf or 10 bds. Total gross 79.6 cf, defect 29.4 cf, net 50.2 cf. Scribner gross scale is 57 bds, defect 15 bds, net 42 bds.

On multi-segment, butt-cut logs, the rot is first measured on the top end. The mid-point diameter of the rot is then increased according to the taper of the log, unless there are definite indications to the contrary.

Figure 5-3 shows a butt-cut cedar products log with a 32-foot log, 19-inch sed, and 23-inch led. Average rot diameters measure 10 inches on the small end and 23 inches on the butt end. The butt end has a pronounced flare for 2 feet.

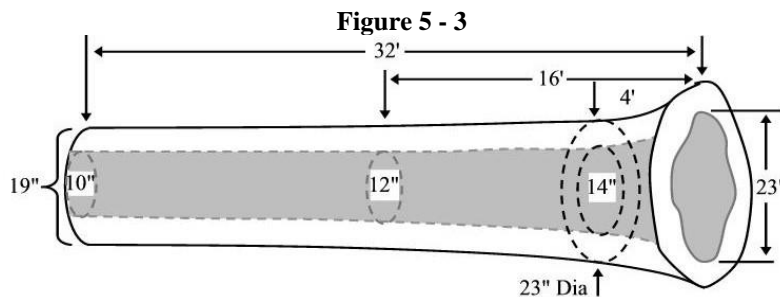

On the top segment, gross scale is 35.0 cf. The midpoint rot size is increased according to the taper of the log, from 10 inches on the small end to 12 inches at midpoint. Enter the rot as soft rot, 10 inches on the top and 12 inches on the large end for 10.6 cf. On the butt segment, gross scale is 42.3 cf. The butt end needs a 2-foot length-cut for flare. The midpoint rot size is also increased according to the taper of the log, from 12 inches at midpoint to 14 inches on the large end. Total defect is 5.3 cf for the 2-foot length cut, plus 13.0 cf for interior rot remaining for 14 feet, for 18.3 cf on the butt segment. Total cubic gross 77.3 cf, 28.9 cf defect, 48.4 cf net. Scribner gross scale is 54 bds, defect is 16 bds, and net scale is 38 bds.

If sound wood exists within any interior defect, as is sometimes the case with "ring rot," it must have a diameter of at least ten (10) inches, Coconino measure, on the small end. Careful examination of the log must be made to ensure that there is indeed recoverable sound material, including recoverable minimum product length.

Figure 5-4 shows a 16-foot cedar products log 24-inch sed, and 27-inch led . Ring rot measuring 15 inches on the small end, with a sound core of 12 inches. On the large end, solid rot of 18 inches is measured. The scaler first deducts a ring rot of 15 inches outside diameter for 6 feet, inside diameter would be 12 inches for 6 feet (no taper), for a deduction of 3.2 cf and 2 bds. Next, enter a soft rot 16-inch sed, 18-inch led for 10 feet. The resulting defect deduction is 15.8 cf and 10 bds. Total gross scale is 56.9 cf, 19.0 cf defect, and 37.9 cf net. Scribner gross is 40 bds, defect is 12 bds, and net 28 bds.

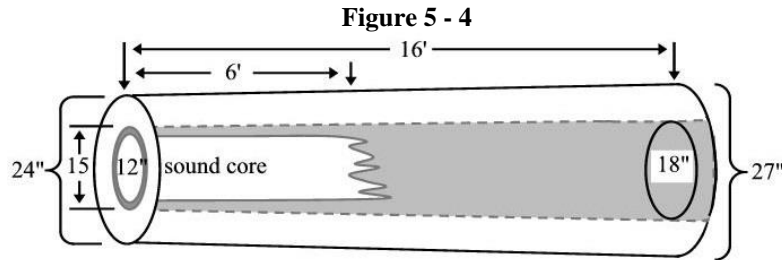

5.43 Diameter-Cut Method

This is used for defects affecting only the outer circumference of a cedar products log, such as sap rot, large massed wormholes, and shallow catfaces. The procedure is to reduce the diameter to obtain a "new" diameter for the resulting sound core. The difference of these corresponding volumes is the defect deduction. If only a portion of the circumference is affected, the defect is a fraction of the volume difference.

5.44 Pie-Cut Method

Defects such as large knots, burls, deep catfaces, scars, twisted grain, and portions of "thin shells" can be deducted using the pie-cut method. Based on the fraction of the length affected, the procedure is to compute the volume of the affected length, then reduce it by the affected fraction. All defect computations ending in five (5) board feet are rounded up for a deduction of ten (10) board feet or one (1) decimal "C".

Figure 5-5 shows an 18-foot cedar products log, 16-inch sed, 21-inch led. There is 8 inches of rot showing on the small end, and 14 inches on the large end, which is not centered on the log end. This results in 1/3 of the shell measuring less than the 4-inch minimum shell thickness. Defect is calculated by first deducting by entering a soft rot of 8-inch sed, 14-inch led, for 18 feet, for 12.8 cf and 3 bds. Scale of 34.2 cf, defect 12.8 cf, leaves 21.4 cf net. Next take an 8-inch diameter cut for 18 feet, at 33 %. For an additional defect of 7.5 cf or 5 bds. Total gross scale is 34.2 cf, 20.3 cf defect, 13.9 cf net. Scribner gross volume is 18 bds, 8 bds defect, and 10 bds net.

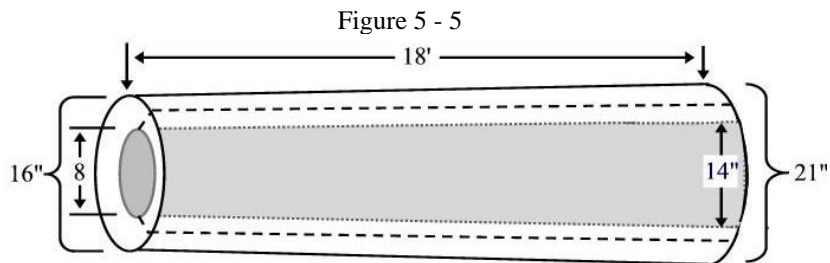

5.5 MULTIPLE DEFECTS

One or more of these defect deduction methods may be applied to any particular log, in the following order of application: (1) length-cut method, (2) interior-defect deduction method, (3) diameter-cut method, (4) pie-cut method.

Figure 5-6 shows a 16-foot cedar products log with a 28-inch sed, and 30-inch led. The defects are:
 -- a flared "thin shell" estimated to affect the butt end for four feet (4'),
 -- interior rot measuring eighteen inches (18") on the small end,
 -- sap rot affecting the collar to a one-inch (1") depth,
 -- a catface affecting one-fourth (1/4) of the shell.

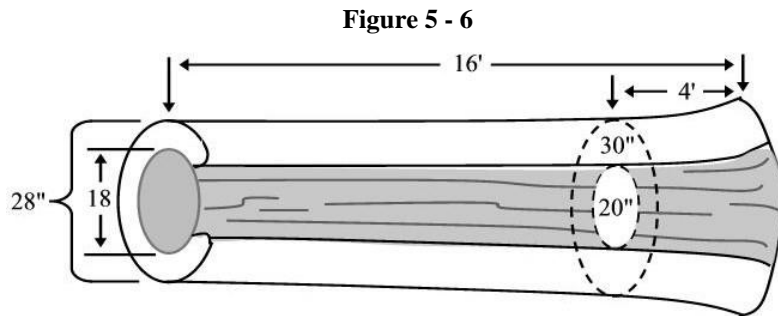

- After determining that the shell thickness meets merchantability requirements – 4” of sound shell wood thickness in this example -- the next step is the determination of gross scale: 28-inch sed, 30-inch led, 16’ length = 73.5 cf. The next step is defect deductions, in the order of application.

First is the length cut:

- Length-cut method. The butt end of this log requires a 4’ length-cut; 18.4 cf or 14 bds, leave 55.1cf or 44 bds remaining.

Next, deduct the interior rot:

- Interior soft rot defect deduction method. This log has 18” of rot, which will be deducted for a 12’ length, since 4’ has already been deducted; 18-inch small end, 20-inch large end, for 12’ equals 23.7 cf or 16 bds. Remaining volume was 55.1 cf minus 23.7 cf leaves 31.4 cf or 44 bds minus 16 bds leaves 28 bds.

Next, deduct the sap rot:

- Diameter cut method. This log has rotten sapwood affecting the collar to a 1” depth, which requires a 2” diameter cut; for 7.3 cf or 7 bds. Remaining volume was 31.4 cf minus 7.4 cf equals 24.1 cf or 28 bds minus 7 bds equal 21 bds.

Next, deduct the catface:

- Length percent method. The catface causes a loss of one-fourth (1/4) of the remaining volume (shell thickness). The remaining volume is 24.1 cf times 25 % equals 6.0 cf or 21 bds times 25 % equals 5 bds. If you deduct 25% of a 12-foot length cut, it will take too much. Adjust the percentage to deduct 5 bds (Scribner driver). Adjusted percentage of 13 % of a 12-foot length deduction will take 5 bds or 6.2 cf. Remaining volume is 24.1 cf minus 6.2 cf equals 17.9 cf or 21 bds minus 5 bds equal 16 bds net scale.

This cedar products log has a total gross scale of 73.5 cf, defect 55.6 cf, and 17.9 cf net. Scribner gross is 58 bds, defects totaling 42 bds, leaving a net scale of 16 bds. Scribner net equals 27.6 percent for a merchantable cedar products log. Cubic net is 24.4%.

5.6 SLABS

Cedar slabs are gross scaled as explained in Chapter 2, Gross Scale. In many instances, net scale is the same as gross scale because slab measurement is made on the “sound wood” end area. However, sometimes deductible defects within the slab will reduce cedar product recovery. Commonly these defects include butt-flare, large knots, or rot within the interior portion of the slab. At times, a pie-cut of the length affected may be appropriate. Most often, the applicable deduction method is a length-cut.

Figure 5-7 illustrates a cedar slab that came from a butt-cut log. When the scaler examines the butt end, numerous pockets of rot are visible. Rot is estimated to affect 6' of the butt end. The required minimum shell thickness (4" diameter class) does not exist for the length affected by rot.

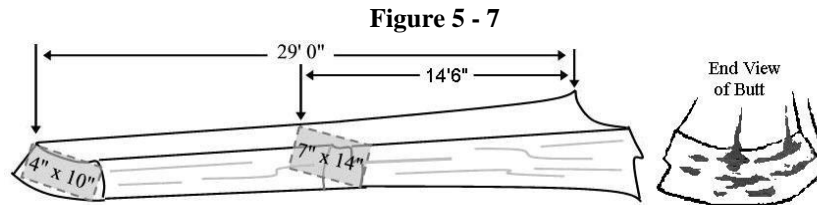

Gross and net scale of top segment is the same since there is no defect:

- $4 \times 10 \times (14/16) = 35$ board feet, rounds to 40 or 4 bds.

Gross scale of butt segment is:

- $7 \times 14 \times (14/16) = 86$ board feet, rounds to 90 or 9 bds.

Net scale of butt segment is 14 feet minus 6-foot length-cut equals 8 feet:

- $7 \times 14 \times (8/16) = 49$ board feet, rounds to 50 or 5 bds.

Total gross scale for Figure 5-7 is 13 bds, net scale is 9 bds, and defect is 4 bds.

When using a handheld data recorder, a scaler will need to record a scaling length and/or diameter to arrive at the proper gross volume. First, add the 4 bds and the 9 bds together for 13 bds. Find a log with as near the same length as the slab that scales 13 bds and record that length and diameter. A 28-foot, 11-inches small end diameter and 13-inches mid diameter scales 13 Dec C. Record this log as a 28-foot, 11-inch small end diameter and a 14-inch large end diameter to achieve the proper Scribner gross volume of 13 bds. Gross cubic volume for this log will be 25.0 cf.

The slab requires a 6-foot length cut of the butt segment for the rot. Total volume is 25.0 cf of gross, 4.0 cf defect, 21.0 cf net or 13 bds gross, 2 bds defect, and 11 bds net.

5.7 PIECES SHORTER THAN EIGHT FEET

Normally, any cedar products piece shorter than 8' 1" has no gross scale, and therefore no net scale. However, it is not uncommon at a specialized cedar products mill to come across pieces 8' or shorter in length. When this situation exists, and the scaler has been provided with appropriate written scaling specifications, a gross/net scale conversion must be made and recorded.

Cord measure and conversion to gross/net scale may be applied to a stacked pile or an individual piece. The cubic area occupied by the cedar products pieces (or individual piece) includes bark and air. Measurements are made with a tape measure.

A standard cord measuring 4' x 4' x 8' equals 128 cubic feet, and the accepted equivalent Scribner decimal "C" scale is 500 board feet. To make a conversion of cord measurement to gross scale, use the following formula:

$$(H \times W \times L) \div 0.256 = \text{Volume in board feet}$$

The product of (H x W x L) is expressed to the nearest cubic foot. Height (H), width (W), and length (L) are measured and expressed to the nearest one-tenth (1/10) of a foot. Round "Volume in board feet" to the nearest 10 board feet to arrive at Scribner decimal "C" volume; five board feet or more rounds up.

APPENDIX A-1 – SPECIES IDENTIFICATION

APPENDIX A-1 – SPECIES IDENTIFICATION..... 77
A-1.1 GENERAL..... 77
A-1.2 MAJOR COMMERCIAL SPECIES..... 78
 A-1.21 Cedar78
 A-1.22 Douglas Fir.....79
 A-1.23 Hemlock.....80
 A-1.24 Larch.....81
 A-1.25 Lodgepole Pine.....82
 A-1.26 Ponderosa Pine.....83
 A-1.27 White Pine84
 A-1.28 Spruce.....85
 A-1.29 Grand Fir86
 A-1.210Alpine Fir87
A-1.3 MINOR COMMERCIAL SPECIES..... 88
 A-1.31 Mountain Hemlock.....88
 A-1.32 Whitebark Pine.....88
 A-1.33 Limber Pine89
 A-1.34 White Fir89
A-1.4 SPECIES IDENTIFICATION CHART90

A-1.1 GENERAL

The ability to identify logs by species is extremely important to the scaler because of the wide differences in value of the various species; for example, a cedar log may be worth significantly more than a Grand fir log of equal volume. Consequently, errors in species identification by a scaler may result in considerable financial loss to the buyer or the seller. Through study and properly supervised experience, however, the scaler should develop the skills required for accurate species identification in a short time.

The problem of species identification in Idaho is somewhat involved because of the number of commercial species that occur in the state. In any given area or operation the number of species that the scaler must identify may be half a dozen or more. Most of the commercial species in Idaho are conifers, with the following eleven considered to be those of major importance:

C	Cedar.....	<i>Thuja plicata</i>
DF	Douglas Fir.....	<i>Pseudotsuga menziesii</i>
H	Western Hemlock.....	<i>Tsuga heterophylla</i>
L	Larch.....	<i>Larix occidentalis</i>
LP	Lodgepole Pine.....	<i>Pinus contorta</i>
PP	Ponderosa Pine.....	<i>Pinus ponderosa</i>
WP	White Pine.....	<i>Pinus monticola</i>
S	Engelmann Spruce.....	<i>Picea engelmanni</i>
AF	Alpine Fir.....	<i>Abies lasiocarpa</i>
GF	Grand Fir & White Fir.....	<i>Abies grandis & Abies concolor</i>

It is generally not necessary for a scaler to distinguish between Grand fir and White fir, but occasionally a scaler may be required to separately identify Western Hemlock and Mountain Hemlock. Conifers of lesser commercial importance because of their scrubby growth characteristic, inaccessibility, or widely scattered distribution include:

MH	Mountain Hemlock.....	<i>Tsuga mertensiana</i>
WB	Whitebark Pine & Limber Pine....	<i>Pinus albicaulis & Pinus flexilis</i>

Hardwoods are usually of little importance as timber trees in Idaho. Black cottonwood and Quaking aspen have occasionally been commercially harvested.

CW	Black Cottonwood.....	<i>Populus trichocarpa</i>
QA	Quaking Aspen.....	<i>Populus tremuloides</i>

Rarely, some other tree or shrub species not previously mentioned may be presented for scaling. They may be classified as “Other” using species abbreviation “O”.

Generally speaking, a scaler depends largely on bark characteristics, and color and amounts of sapwood and heartwood for identification purposes. Scalers must also be able to accurately identify species of dead or barked logs. Especially in the spring and early summer, bark can slough off easily during the logging process. Under these conditions a scaler depends

largely on things such as color and amounts of sapwood and heartwood, presence of pitch, and the size, color, and distribution of knots as the basis for identification.

In using bark characteristics for identification of logs, a scaler must keep in mind that in many species, the bark on young trees may be very different in color and texture from the bark on older or mature trees. Logs cut from the lower boles of older trees may also have different bark characteristics than those cut from the upper boles. These differences are pointed out in the descriptions given in this chapter.

The descriptions of species that follow are designed to give the features of greatest value in scaling practice. An effort has been made to list all printable common names in use in Idaho for each species.

A-1.2 MAJOR COMMERCIAL SPECIES

A-1.21 Cedar



Species. (*Thuja plicata*) Common name is cedar, also called red cedar or western red cedar.

Bark. The bark, light reddish-brown on young trees and grayish-brown on old trunks, is thin (1 to 3 inches thick), and forms a network of long, thin, fibrous strips. The stringy shreds of bark adhering to logs are one of the most identifiable characteristics.

Sapwood. The sapwood is thin, nearly white, and non-resinous.

Heartwood. The heartwood is soft and brittle, reddish-brown to pinkish-brown, and has a pungent, distinctive odor. The contrast between heartwood and sapwood is pronounced.

Knots. Knots are generally scattered around the tree with a dark brown center surrounded by lighter brown or tan colored wood.

Foliage. The leaves of cedar, borne in flattened groups of four, are very small and scale-like. The branch-lets have a "fern-like" appearance and are dark, glossy green on the upper surface.

A-1.22 Douglas fir



Species. (*Pseudotsuga menziesii* variety *glauca*) Common name is Douglas fir, also called red fir or simply “Doug” fir.

Bark. On young trees, the bark is smooth, gray-brown, and broken by pitch blisters. On mature trees, it gradually becomes corky and deeply furrowed. Mature bark, dark red-brown to a very light gray, usually shows a lighter, almost orange color deep in the furrows. The mature bark is 2 to 6 inches thick. Second growth bark is usually 1/2 inch to 2 inches thick.

Sapwood. The sapwood is a pale yellow or off white to a reddish-cream color, rather narrow, and pitchy.

Heartwood. The heartwood is hard and yellowish-brown to deep reddish-brown in color. The contrast between heartwood and sapwood is usually very distinct.

Knots. Douglas fir knots are usually reddish brown in the center surrounded by a darker brown wood and will generally be pitchy.

Foliage. Douglas fir needles -- medium green to blue-green in color, 3/4 inch to 1 inch long, flexible, and with rounded ends -- are borne singly and are arranged all around the twig. The most notable feature of foliage is the pointed, red-brown buds.

A-1.23 Hemlock



Species. (*Tsuga heterophylla*) Common name is Hemlock, also called western hemlock. Similar in appearance to mountain hemlock, it is usually not necessary to separately identify “western” and “mountain” hemlock when scaling in Idaho.

Bark. On young trees the bark is dark reddish-brown to purple-brown and is broken into small, rounded scales; on mature trees, the bark has deep furrows between flat ridges, which are covered with close-set, dark brown to purple-gray scales. The underbark on Hemlock of all ages is a bright red streaked with purple when cut lengthwise. Inner-bark on Hemlock is a dark cocoa-brown compared to a lighter brown inner-bark on grand fir.

Close-up showing difference of inner-bark between Hemlock and Grand fir



Sapwood. The sapwood is quite thin. The last few outer rings, sometimes almost white, are the only portion of the sapwood, which may show any contrast to the heartwood. A slightly dented or wavy surface is common in areas where the bark is missing on the outside of the log.

Heartwood. The heartwood is hard, tough, and closely-grained, usually pale tan or cream colored; but occasionally it may have a reddish or purplish cast, especially in the summerwood portion of the annual rings. Usually there is little or no contrast between heartwood and sapwood. The absence of resin and lack of contrast between the cream-colored heartwood and sapwood are typical of both western and mountain hemlocks.

Knots. The larger knots are hard, dark cream colored and may be surrounded by a black ring on the outside edge. Smaller knots are usually black and may show a black stain in the bark.

Foliage. The needles are small and flat, 1/4 inch to 1 inch long, and irregular in length. They are dark green on top and pale green with two white bands beneath.

A-1.24 Larch



Species. (*Larix occidentalis*) Common name is Larch, also called western larch or tamarack.

Bark. On young trees, the bark is scaly and reddish-brown to purplish-brown. On older trees, it is deeply furrowed and broken into irregularly shaped plates, usually purple-gray in color, but sometimes brown to reddish-brown. Bark is relatively thick at all ages, being 4 to 6 inches thick on mature butt trunks. Larch bark, which may be confused with that of Ponderosa pine, has a reddish-purple color under the scales in contrast to the yellow patches under the scales of Ponderosa pine.

Sapwood. The sapwood is thin (1/4 inch to 1 inch thick), nearly white to light pale brown, and may be slightly pitchy. One of the most distinguishable features is the sharp color contrast between the narrow band of sapwood and the heartwood.

Heartwood. The heartwood is hard, reddish-brown to dull brown in color. The contrast between heartwood and sapwood is distinct. At times, the log end may resemble a “target” with distinct bands of light and dark colored rings.

Knots. Knots are scattered, light reddish-brown in the center, surrounded by light tan or pale brown wood. Larch knots have a tendency to be clustered with several knots forming small bunions or bulges on the side of the log.

Foliage. Needles are borne in dense clusters on small raised bumps on the twigs. They are 1 to 1 1/2 inches long, thin, flexible, and light green in color. In the fall, they turn bright yellow and then drop off. This is the only conifer in Idaho that loses its needles.

A-1.25 Lodgepole Pine



Species. (*Pinus contorta*) Common name is Lodgepole Pine, also called jack pine, black pine, or simply “lodgepole”.

Bark. The bark on young trees is dark gray to almost black and very scaly. Bark on mature Lodgepole pine differs in northern and southern parts of the state. In northern Idaho, the mature bark is made up of narrow ridges, broken into almost square or rectangular plates with the ridges separated by deep furrows. The overall color is almost black to dark gray. Cutting length-wise into the bark reveals numerous, small white specks of pitch. In the southern part of Idaho mature Lodgepole pine bark is light brown or orange-brown to almost gray and is covered by thin, loose scales. Knocked-off scales reveal a greenish color where the scales were attached.

Sapwood. The sapwood is narrow, nearly white to pale yellow in color. Often there is no easily discernible difference between heartwood and sapwood, though the sapwood is usually somewhat lighter in color. Pitch exudation is conspicuous on the sapwood.

Heartwood. The heartwood is light yellowish white to pale yellow and may have a slight pink hue.

Knots. These are scattered and often have a dimpled appearance with small catfaces surrounding them.

Foliage. The yellow-green to light green needles are borne in bundles of two and are 1 to 3 1/2 inches long.

A-1.26 Ponderosa Pine



Species. (*Pinus ponderosa*) Common name is Ponderosa Pine, also called “P” pine, bull pine, yellow pine, and western yellow pine.

Bark. The bark on young trees (80 to 100 years old) is broken into ridges covered with small, thin platelets, dark reddish-brown to nearly black, and from 1/2 inch to 1 1/2 inches thick. Young trees with this dark bark are often called bull pine. On older trees the bark is often from 2 to 4 inches thick, divided into deep and irregular plates, sometimes 4 to 5 feet long and 12 to 18 inches wide. These larger plates are covered with thick, yellow-brown to orange-brown irregular platelets.

Sapwood. Young Ponderosa pine is 80 to 100 percent sapwood. In older growth, the sapwood is usually 2 to 12 inches thick. This sapwood is cream-colored, and pitch exudation on the sapwood is usually conspicuous.

Heartwood. The heartwood is yellowish to light reddish-brown and usually has a conspicuous brown center or pith. There is a definite pitchy odor.

Knots. Are scattered, bulging, and can be quite large. The knots are usually reddish-brown to a dark brown in color surrounded by cream-colored wood. The center of the knot is often hard and brittle.

Foliage. The needles of Ponderosa pine are usually borne in bundles of three (sometimes two to five), 5 to 11 inches long, and dark green in color.

A-1.27 White Pine



Species. (*Pinus monticola*) Common name is White Pine, also called Idaho white pine or western white pine.

Bark. The bark on young trees is usually smooth and light gray-green in color. On old trees, it is 3/4 inch to 1 1/2 inches thick, and is divided into small, nearly square plates by deep lengthwise and crosswise fissures covered by small, thin or closely oppressed purplish-gray scales.

Sapwood. The sapwood is whitish to a light cream in color, soft, and from 1/2 inch to 3 inches thick. A conspicuous exudation of pitch (resin) is generally visible in the sapwood on the log ends. In older decked logs, the sapwood may be almost white in color.

Heartwood. The heartwood is usually an off-white but may have a pale pink to light reddish-brown hue. The wood is soft, straight-grained, and has a slightly pitchy or resinous odor.

Knots. Knots are usually whorled around the tree in a single row with large areas in between the whorls containing no knots. The centers of the knots are pink in color; this is especially visible in the smaller knots.

Foliage. Needles are borne in bundles of five, 2 to 4 inches long, and blue-green in color.

A-1.28 Spruce

Species. (*Picea engelmanni*) Common name is Spruce, also called Engelmann spruce.

Bark. The bark is from 1/4 to 1/2-inch thick; usually light purplish-gray to orange-brown in color, and broken into larger, thin, loose scales.

Sapwood. The sapwood is 2 to 4 inches thick, pale yellow to pale yellow-brown in color, and may be slightly pitchy.

Heartwood. The heartwood is usually about the same color as the sapwood, sometimes slightly darker. As a rule, it is extremely difficult to differentiate between heartwood and sapwood.

Knots. Knots are generally scattered around the log and are about the same color as the heartwood on Spruce logs.

Foliage. The blue-green needles are borne singly and are usually about 1 inch long. They are moderately stiff and sharp-pointed; crushed needles have a pungent odor.

A-1.29 Grand fir

Species. (*Abies grandis*) Common name is Grand fir, also called white fir (the common name “white fir” is also used for *Abies concolor* whose native range in Idaho is the southeast corner of the state; for commercial scaling in Idaho, species identification as “grand fir” or “white fir” is used interchangeably for either species).

Bark. Young trees have smooth, gray-green bark with numerous pitch blisters. Older trees begin to develop a furrowed, rough bark, which is up to 2 inches thick and is dark gray-brown to purple-gray in color on mature trees. In southern Idaho trees, the bark is corky in texture and resembles Douglas fir bark.

Sapwood. The narrow sapwood, light cream to pale yellowish-brown, is not resinous; although some pitch from the inner bark may be present on the sapwood. It may be difficult to distinguish the sapwood from the heartwood.

Heartwood. The soft heartwood of Grand fir is not distinctively different in color from the sapwood, although it may be slightly darker. The summerwood portion of the annual rings may be faintly pinkish in color.

Knots. The absence of resin exudation from the sapwood on ends of logs and the similarity in color of sapwood and heartwood are marked features. A dark water core is sometimes present and growth rings are conspicuous.

Foliage. Grand fir needles are borne singly and those of the lower crown are arranged in flat rows along each side of the twig. They are about 1 to 2 inches long and are dark glossy green on the upper side with whitish streaks on the under side. Crushed needles give off a pleasant aromatic odor.

A-1.210 Alpine fir

Species. (*Abies lasiocarpa*) Common name is Alpine fir, also called subalpine fir or balsam fir.

Bark. Similar to a young Grand fir but with numerous horizontal rows of dark, almost black colored resin blisters. As the tree matures, the bark remains fairly smooth except in the lowest part of the trunk. The irregular shape in which Alpine fir grows is especially visible in the butt segment. Occasional mature trees may have furrowed bark extending most of its length.

Sapwood. The sapwood is thin, almost white, and slightly lighter-colored than the heartwood.

Heartwood. The heartwood is soft, coarse-grained, and light yellowish-white or tan in color.

Knots. Helpful as an identifying feature are yellow-colored knots and the evidence of down-turned limbs. Branches are small and scattered, hanging towards the ground instead of towards the sun as in most species. The wood is soft and has a pungent odor.

Foliage. Needles, borne singly, are massed and brush-like on the upper side of the twig. They are usually about 1/2 inch to 1 inch long, flexible, gray-green and dull on the upper surface.

A-1.3 MINOR COMMERCIAL SPECIES

A-1.31 Mountain Hemlock



Species. (*Tsuga mertensiana*) Common name is Hemlock; rarely, it is specifically identified as Mountain hemlock (for commercial scaling in Idaho, species identification as “Hemlock” is normally used for both mountain hemlock and western hemlock).

Bark. The bark is similar to western hemlock, dark reddish-brown to purple-brown but is usually more furrowed in appearance. When cut lengthwise the under-bark is a bright red streaked with purple. Most often, a distinguishing characteristic is the pronounced twist of the bark as it climbs the tree.

Sapwood. The sapwood is almost white in color and sometimes shows little to no contrast with the heartwood. Mountain hemlock is very slow growing compared to western hemlock.

Heartwood. The heartwood is very tight-grained compared to western hemlock, usually a pale tan or cream colored, but occasionally it may have a purplish cast. Usually there is little or no contrast between heartwood and sapwood. However, the absence of resin and lack of contrast between heartwood and sapwood are typical of both mountain and western hemlocks.

Knots. Knot appearance is similar in both mountain and western hemlocks. The knots of Mountain hemlock are scattered and hard, have a cream or light brown color, and do not commonly display the Western hemlock black ring appearance around the outside edge.

Foliage. The needles are semi-circular in cross sections, ½ to 1-inch long and pale blue-green on both surfaces.

A-1.32 Whitebark Pine



Species. (*Pinus albicaulis*) Common name is Whitebark Pine. This is a high mountain species that is rarely harvested; when encountered, it is often recorded under Lodgepole pine species designation.

Bark. The bark on young trees is usually smooth, thin, and light gray in color with a reddish hue. Older trees have bark that has broken into small narrow silvery-grey scales similar to lodgepole pine, with a reddish hue similar to spruce.

Sapwood. The sapwood is very similar to white pine, whitish to a light cream color, soft, and from 1/2 inch to 3 inches thick. A conspicuous exudation of pitch (resin) is generally visible in the sapwood on the log ends.

Heartwood. The heartwood is usually an off-white color but may have a pale pink to light reddish-brown hue. The wood is soft, and has a pitchy or resinous odor.

Knots. Knots are pinkish-purple in color, very similar to white pine.

Foliage. Needles are borne in bundles of five, 1 1/2 to 2 1/2 inches long, stout, rigid, and dark green in color.

A-1.33 Limber pine

Species. (*Pinus flexilis*) Common name is Limber pine. This is a high mountain species of southern Idaho areas; when encountered, it is often recorded under Lodgepole pine species designation.

Bark. The bark on young trees is usually smooth, thin, and light gray in color with a reddish hue. Older trees have bark that has broken into small narrow silvery-grey scales similar to lodgepole pine, except that they have a reddish hue. Whitebark pine and Limber pine cannot be readily differentiated by bark characteristics.

Sapwood. Pitch exudation is conspicuous in the pale, off-white colored sapwood.

Heartwood. The heartwood is light yellowish-tan to pale yellow in color.

Foliage. The dark green, stout, rigid needles are borne in bundles of five and are 1 to 3 1/2 inches long. The foliage of whitebark pine and Limber pine cannot be readily differentiated.

A-1.34 White fir

Species. (*Abies concolor*) Common name is White fir, may also be named grand fir (the common name “white fir” is also used for *Abies grandis*; for commercial scaling in Idaho, species identification as “grand fir” or “white fir” is used interchangeably for either species). In Idaho, the native range of *Abies concolor* is the southeast corner of the state. Hybrid varieties have been reported in some southern areas of the state (cross between *Abies grandis* and *Abies concolor*).

Bark. Young trees and the upper portions of older trees are very difficult to distinguish from grand fir; both have smooth, gray-green bark with numerous pitch blisters. Older trees begin to develop a furrowed, rough, corky bark resembling Douglas fir bark.

Sapwood. See Grand fir.

Heartwood. See Grand fir.

Knots. See Grand fir.

Foliage. Needles are about 1 inch long and are a dark glossy green. Instead of being arranged in flat rows along each side of the twig like Grand fir they wrap around the twig. The name “*concolor*” refers to the fact that both upper and lower needle surfaces are the same color. Crushed needles give off a pleasant aromatic odor.

A-1.4 SPECIES IDENTIFICATION CHART

Some general characteristics to aid in the process of species identification are shown in the chart below.

Species Identification Chart	Bark - scaly or plated (on mature trees)	Bark - deeply furrowed (on mature trees)	Bark - stringy & fibrous	Heartwood / Sapwood light-color, little contrast	Heartwood / Sapwood dark color, strong contrast	Knots – pinkish color	Knots – yellowish color	Pith - large & distinct	Pitchy sapwood	No pitch, sap or heartwood
Species										
White Pine	X			X		X			X	
Ponderosa Pine	X			X				X	X	
Lodgepole Pine	X			X					X	
Douglas Fir		X			X				X	
Larch	X				X				X	
Grand Fir (& White fir)		X		X						X
Hemlock		X		X						X
Alpine Fir				X			X			X
Spruce	X			X					x	
Cedar			X		X					
Whitebark & Limber Pines	X			X		X			X	

APPENDIX A-2 – CUBIC VOLUME TABLE

Cubic Foot Log Volumes											
<i>***Segment length = 8 Ft.***</i>											
Small End Dia.	Inches of Taper										
	0	1	2	3	4	5	6	7	8	9	10
2	0.2	0.3	0.4	0.6	0.9	1.2	1.5	1.9	2.3	2.7	3.2
3	0.4	0.5	0.7	1.0	1.3	1.6	2.0	2.4	2.8	3.3	3.9
4	0.7	0.9	1.1	1.4	1.7	2.1	2.5	3.0	3.5	4.0	4.6
5	1.1	1.3	1.6	1.9	2.3	2.7	3.2	3.7	4.2	4.8	5.5
6	1.6	1.9	2.2	2.6	3.0	3.4	3.9	4.5	5.1	5.7	6.4
7	2.1	2.5	2.8	3.3	3.7	4.2	4.8	5.3	6.0	6.7	7.4
8	2.8	3.2	3.6	4.0	4.5	5.1	5.7	6.3	7.0	7.7	8.5
9	3.5	3.9	4.4	4.9	5.5	6.0	6.7	7.4	8.1	8.8	9.6
10	4.4	4.8	5.3	5.9	6.5	7.1	7.8	8.5	9.2	10.1	10.9
11	5.3	5.8	6.3	6.9	7.5	8.2	8.9	9.7	10.5	11.4	12.3
12	6.3	6.8	7.4	8.1	8.7	9.4	10.2	11.0	11.9	12.8	13.7
13	7.4	8.0	8.6	9.3	10.0	10.8	11.6	12.4	13.3	14.2	15.2
14	8.6	9.2	9.9	10.6	11.3	12.2	13.0	13.9	14.8	15.8	16.8
15	9.8	10.5	11.2	12.0	12.8	13.6	14.5	15.5	16.4	17.5	18.5
16	11.2	11.9	12.7	13.5	14.3	15.2	16.1	17.1	18.2	19.2	20.3
17	12.6	13.4	14.2	15.0	15.9	16.9	17.8	18.9	19.9	21.1	22.2
18	14.1	14.9	15.8	16.7	17.6	18.6	19.6	20.7	21.8	23.0	24.2
19	15.8	16.6	17.5	18.4	19.4	20.4	21.5	22.6	23.8	25.0	26.2
20	17.5	18.3	19.3	20.3	21.3	22.4	23.5	24.6	25.8	27.1	28.4
21	19.2	20.2	21.2	22.2	23.3	24.4	25.5	26.7	28.0	29.3	30.6
22	21.1	22.1	23.1	24.2	25.3	26.5	27.7	28.9	30.2	31.5	32.9
23	23.1	24.1	25.2	26.3	27.4	28.6	29.9	31.2	32.5	33.9	35.3
24	25.1	26.2	27.3	28.5	29.7	30.9	32.2	33.5	34.9	36.3	37.8
25	27.3	28.4	29.5	30.7	32.0	33.3	34.6	36.0	37.4	38.9	40.4
26	29.5	30.7	31.9	33.1	34.4	35.7	37.1	38.5	40.0	41.5	43.0
27	31.8	33.0	34.3	35.5	36.9	38.2	39.7	41.1	42.6	44.2	45.8
28	34.2	35.5	36.7	38.1	39.4	40.9	42.3	43.8	45.4	47.0	48.6
29	36.7	38.0	39.3	40.7	42.1	43.6	45.1	46.6	48.2	49.8	51.5
30	39.3	40.6	42.0	43.4	44.9	46.4	47.9	49.5	51.1	52.8	54.5
31	41.9	43.3	44.7	46.2	47.7	49.2	50.8	52.5	54.1	55.9	57.6
32	44.7	46.1	47.6	49.1	50.6	52.2	53.8	55.5	57.2	59.0	60.8
33	47.5	49.0	50.5	52.0	53.6	55.3	56.9	58.7	60.4	62.2	64.1
34	50.4	51.9	53.5	55.1	56.7	58.4	60.1	61.9	63.7	65.6	67.5
35	53.4	55.0	56.6	58.2	59.9	61.6	63.4	65.2	67.1	69.0	70.9
36	56.5	58.1	59.8	61.5	63.2	64.9	66.8	68.6	70.5	72.5	74.4
37	59.7	61.4	63.0	64.8	66.5	68.3	70.2	72.1	74.0	76.0	78.1
38	63.0	64.7	66.4	68.2	70.0	71.8	73.7	75.7	77.7	79.7	81.8
39	66.4	68.1	69.9	71.7	73.5	75.4	77.4	79.3	81.4	83.4	85.6
40	69.8	71.6	73.4	75.2	77.1	79.1	81.1	83.1	85.2	87.3	89.4
41	73.3	75.2	77.0	78.9	80.9	82.8	84.9	86.9	89.1	91.2	93.4
42	77.0	78.8	80.7	82.7	84.6	86.7	88.7	90.9	93.0	95.2	97.5
43	80.7	82.6	84.5	86.5	88.5	90.6	92.7	94.9	97.1	99.3	101.6
44	84.5	86.4	88.4	90.4	92.5	94.6	96.8	99.0	101.2	103.5	105.9
45	88.4	90.3	92.4	94.4	96.6	98.7	100.9	103.2	105.5	107.8	110.2
46	92.3	94.4	96.4	98.5	100.7	102.9	105.2	107.4	109.8	112.2	114.6
47	96.4	98.5	100.6	102.7	104.9	107.2	109.5	111.8	114.2	116.6	119.1
48	100.5	102.6	104.8	107.0	109.3	111.5	113.9	116.3	118.7	121.1	123.7
49	104.8	106.9	109.1	111.4	113.7	116.0	118.4	120.8	123.3	125.8	128.3
50	109.1	111.3	113.5	115.8	118.2	120.5	123.0	125.4	127.9	130.5	133.1

Cubic Foot Log Volumes

Segment length = 9 Ft.

Small End Dia.	Inches of Taper										
	0	1	2	3	4	5	6	7	8	9	10
2	0.2	0.3	0.5	0.7	1.0	1.3	1.7	2.1	2.6	3.1	3.6
3	0.4	0.6	0.8	1.1	1.4	1.8	2.2	2.7	3.2	3.8	4.4
4	0.8	1.0	1.3	1.6	2.0	2.4	2.8	3.4	3.9	4.5	5.2
5	1.2	1.5	1.8	2.2	2.6	3.1	3.6	4.1	4.8	5.4	6.1
6	1.8	2.1	2.5	2.9	3.3	3.9	4.4	5.0	5.7	6.4	7.2
7	2.4	2.8	3.2	3.7	4.2	4.7	5.4	6.0	6.7	7.5	8.3
8	3.1	3.6	4.0	4.5	5.1	5.7	6.4	7.1	7.9	8.7	9.5
9	4.0	4.4	5.0	5.5	6.1	6.8	7.5	8.3	9.1	9.9	10.8
10	4.9	5.4	6.0	6.6	7.3	8.0	8.7	9.5	10.4	11.3	12.3
11	5.9	6.5	7.1	7.8	8.5	9.3	10.1	10.9	11.8	12.8	13.8
12	7.1	7.7	8.3	9.1	9.8	10.6	11.5	12.4	13.4	14.4	15.4
13	8.3	9.0	9.7	10.4	11.2	12.1	13.0	14.0	15.0	16.0	17.1
14	9.6	10.3	11.1	11.9	12.8	13.7	14.6	15.6	16.7	17.8	18.9
15	11.0	11.8	12.6	13.5	14.4	15.3	16.3	17.4	18.5	19.7	20.9
16	12.6	13.4	14.2	15.1	16.1	17.1	18.2	19.3	20.4	21.6	22.9
17	14.2	15.0	16.0	16.9	17.9	19.0	20.1	21.2	22.4	23.7	25.0
18	15.9	16.8	17.8	18.8	19.8	20.9	22.1	23.3	24.5	25.8	27.2
19	17.7	18.7	19.7	20.7	21.8	23.0	24.2	25.5	26.8	28.1	29.5
20	19.6	20.6	21.7	22.8	24.0	25.2	26.4	27.7	29.1	30.5	31.9
21	21.6	22.7	23.8	25.0	26.2	27.4	28.7	30.1	31.5	32.9	34.4
22	23.8	24.9	26.0	27.2	28.5	29.8	31.1	32.5	34.0	35.5	37.0
23	26.0	27.1	28.3	29.6	30.9	32.2	33.6	35.1	36.6	38.1	39.7
24	28.3	29.5	30.7	32.0	33.4	34.8	36.2	37.7	39.3	40.9	42.5
25	30.7	31.9	33.2	34.6	36.0	37.4	38.9	40.5	42.1	43.7	45.4
26	33.2	34.5	35.8	37.2	38.7	40.2	41.7	43.3	45.0	46.7	48.4
27	35.8	37.1	38.5	40.0	41.5	43.0	44.6	46.3	48.0	49.7	51.5
28	38.5	39.9	41.3	42.8	44.4	46.0	47.6	49.3	51.0	52.8	54.7
29	41.3	42.7	44.2	45.8	47.4	49.0	50.7	52.4	54.2	56.1	58.0
30	44.2	45.7	47.2	48.8	50.5	52.2	53.9	55.7	57.5	59.4	61.4
31	47.2	48.7	50.3	52.0	53.7	55.4	57.2	59.0	60.9	62.9	64.8
32	50.3	51.9	53.5	55.2	56.9	58.7	60.6	62.5	64.4	66.4	68.4
33	53.5	55.1	56.8	58.5	60.3	62.2	64.1	66.0	68.0	70.0	72.1
34	56.7	58.4	60.2	62.0	63.8	65.7	67.6	69.6	71.7	73.8	75.9
35	60.1	61.9	63.7	65.5	67.4	69.3	71.3	73.4	75.4	77.6	79.8
36	63.6	65.4	67.2	69.1	71.1	73.1	75.1	77.2	79.3	81.5	83.7
37	67.2	69.0	70.9	72.9	74.9	76.9	79.0	81.1	83.3	85.5	87.8
38	70.9	72.8	74.7	76.7	78.7	80.8	83.0	85.1	87.4	89.7	92.0
39	74.7	76.6	78.6	80.6	82.7	84.8	87.0	89.3	91.5	93.9	96.3
40	78.5	80.5	82.6	84.6	86.8	89.0	91.2	93.5	95.8	98.2	100.6
41	82.5	84.6	86.6	88.8	91.0	93.2	95.5	97.8	100.2	102.6	105.1
42	86.6	88.7	90.8	93.0	95.2	97.5	99.8	102.2	104.7	107.1	109.7
43	90.8	92.9	95.1	97.3	99.6	101.9	104.3	106.7	109.2	111.7	114.3
44	95.0	97.2	99.4	101.7	104.1	106.4	108.9	111.4	113.9	116.5	119.1
45	99.4	101.6	103.9	106.2	108.6	111.1	113.5	116.1	118.6	121.3	123.9
46	103.9	106.1	108.5	110.9	113.3	115.8	118.3	120.9	123.5	126.2	128.9
47	108.4	110.8	113.1	115.6	118.1	120.6	123.2	125.8	128.5	131.2	134.0
48	113.1	115.5	117.9	120.4	122.9	125.5	128.1	130.8	133.5	136.3	139.1
49	117.9	120.3	122.8	125.3	127.9	130.5	133.2	135.9	138.7	141.5	144.4
50	122.7	125.2	127.7	130.3	132.9	135.6	138.3	141.1	143.9	146.8	149.7

Cubic Foot Log Volumes
 Segment length = 10 Ft.

Small End Dia.	Inches of Taper										
	0	1	2	3	4	5	6	7	8	9	10
2	0.2	0.4	0.5	0.8	1.1	1.4	1.9	2.3	2.8	3.4	4.0
3	0.5	0.7	0.9	1.2	1.6	2.0	2.5	3.0	3.5	4.2	4.9
4	0.9	1.1	1.4	1.8	2.2	2.6	3.2	3.7	4.4	5.0	5.8
5	1.4	1.7	2.0	2.4	2.9	3.4	4.0	4.6	5.3	6.0	6.8
6	2.0	2.3	2.7	3.2	3.7	4.3	4.9	5.6	6.3	7.1	8.0
7	2.7	3.1	3.5	4.1	4.6	5.3	5.9	6.7	7.5	8.3	9.2
8	3.5	4.0	4.5	5.0	5.7	6.4	7.1	7.9	8.7	9.6	10.6
9	4.4	4.9	5.5	6.1	6.8	7.6	8.3	9.2	10.1	11.0	12.1
10	5.5	6.0	6.7	7.3	8.1	8.9	9.7	10.6	11.6	12.6	13.6
11	6.6	7.2	7.9	8.6	9.4	10.3	11.2	12.1	13.1	14.2	15.3
12	7.9	8.5	9.3	10.1	10.9	11.8	12.8	13.8	14.8	16.0	17.1
13	9.2	10.0	10.7	11.6	12.5	13.4	14.5	15.5	16.6	17.8	19.0
14	10.7	11.5	12.3	13.2	14.2	15.2	16.3	17.4	18.5	19.8	21.1
15	12.3	13.1	14.0	15.0	16.0	17.0	18.2	19.3	20.6	21.8	23.2
16	14.0	14.9	15.8	16.8	17.9	19.0	20.2	21.4	22.7	24.0	25.4
17	15.8	16.7	17.7	18.8	19.9	21.1	22.3	23.6	24.9	26.3	27.8
18	17.7	18.7	19.7	20.9	22.0	23.3	24.5	25.9	27.3	28.7	30.2
19	19.7	20.8	21.9	23.0	24.3	25.6	26.9	28.3	29.7	31.2	32.8
20	21.8	22.9	24.1	25.3	26.6	28.0	29.3	30.8	32.3	33.8	35.5
21	24.1	25.2	26.5	27.7	29.1	30.5	31.9	33.4	35.0	36.6	38.2
22	26.4	27.6	28.9	30.2	31.6	33.1	34.6	36.1	37.7	39.4	41.1
23	28.9	30.1	31.5	32.9	34.3	35.8	37.4	39.0	40.6	42.4	44.1
24	31.4	32.8	34.1	35.6	37.1	38.6	40.3	41.9	43.6	45.4	47.2
25	34.1	35.5	36.9	38.4	40.0	41.6	43.3	45.0	46.7	48.6	50.4
26	36.9	38.3	39.8	41.4	43.0	44.6	46.4	48.1	50.0	51.8	53.8
27	39.8	41.3	42.8	44.4	46.1	47.8	49.6	51.4	53.3	55.2	57.2
28	42.8	44.3	45.9	47.6	49.3	51.1	52.9	54.8	56.7	58.7	60.8
29	45.9	47.5	49.1	50.9	52.6	54.5	56.3	58.3	60.3	62.3	64.4
30	49.1	50.7	52.5	54.2	56.1	57.9	59.9	61.9	63.9	66.0	68.2
31	52.4	54.1	55.9	57.7	59.6	61.5	63.5	65.6	67.7	69.8	72.0
32	55.8	57.6	59.4	61.3	63.3	65.3	67.3	69.4	71.6	73.8	76.0
33	59.4	61.2	63.1	65.0	67.0	69.1	71.2	73.3	75.5	77.8	80.1
34	63.0	64.9	66.9	68.9	70.9	73.0	75.2	77.4	79.6	81.9	84.3
35	66.8	68.7	70.7	72.8	74.9	77.0	79.2	81.5	83.8	86.2	88.6
36	70.7	72.7	74.7	76.8	79.0	81.2	83.4	85.8	88.1	90.6	93.0
37	74.7	76.7	78.8	81.0	83.2	85.4	87.8	90.1	92.6	95.0	97.6
38	78.8	80.9	83.0	85.2	87.5	89.8	92.2	94.6	97.1	99.6	102.2
39	83.0	85.1	87.3	89.6	91.9	94.3	96.7	99.2	101.7	104.3	107.0
40	87.3	89.5	91.7	94.1	96.4	98.9	101.3	103.9	106.5	109.1	111.8
41	91.7	93.9	96.3	98.6	101.1	103.5	106.1	108.7	111.3	114.0	116.8
42	96.2	98.5	100.9	103.3	105.8	108.3	110.9	113.6	116.3	119.0	121.8
43	100.8	103.2	105.6	108.1	110.7	113.3	115.9	118.6	121.4	124.2	127.0
44	105.6	108.0	110.5	113.0	115.6	118.3	121.0	123.7	126.5	129.4	132.3
45	110.4	112.9	115.5	118.1	120.7	123.4	126.2	129.0	131.8	134.7	137.7
46	115.4	117.9	120.5	123.2	125.9	128.6	131.4	134.3	137.2	140.2	143.2
47	120.5	123.1	125.7	128.4	131.2	134.0	136.8	139.8	142.7	145.8	148.8
48	125.7	128.3	131.0	133.8	136.6	139.4	142.3	145.3	148.3	151.4	154.6
49	131.0	133.7	136.4	139.2	142.1	145.0	148.0	151.0	154.1	157.2	160.4
50	136.4	139.1	141.9	144.8	147.7	150.7	153.7	156.8	159.9	163.1	166.3

Cubic Foot Log Volumes
 Segment length = 11 Ft.

Small End Dia.	Inches of Taper										
	0	1	2	3	4	5	6	7	8	9	10
2	0.2	0.4	0.6	0.9	1.2	1.6	2.0	2.5	3.1	3.7	4.4
3	0.5	0.7	1.0	1.3	1.7	2.2	2.7	3.3	3.9	4.6	5.3
4	1.0	1.2	1.6	1.9	2.4	2.9	3.5	4.1	4.8	5.5	6.4
5	1.5	1.8	2.2	2.7	3.2	3.7	4.4	5.1	5.8	6.6	7.5
6	2.2	2.5	3.0	3.5	4.1	4.7	5.4	6.1	7.0	7.8	8.8
7	2.9	3.4	3.9	4.5	5.1	5.8	6.5	7.3	8.2	9.1	10.1
8	3.8	4.3	4.9	5.5	6.2	7.0	7.8	8.7	9.6	10.6	11.6
9	4.9	5.4	6.1	6.7	7.5	8.3	9.2	10.1	11.1	12.1	13.3
10	6.0	6.6	7.3	8.1	8.9	9.7	10.7	11.7	12.7	13.8	15.0
11	7.3	7.9	8.7	9.5	10.4	11.3	12.3	13.3	14.5	15.6	16.9
12	8.6	9.4	10.2	11.1	12.0	13.0	14.0	15.1	16.3	17.5	18.8
13	10.1	10.9	11.8	12.7	13.7	14.8	15.9	17.1	18.3	19.6	20.9
14	11.8	12.6	13.6	14.5	15.6	16.7	17.9	19.1	20.4	21.7	23.2
15	13.5	14.4	15.4	16.5	17.6	18.7	20.0	21.3	22.6	24.0	25.5
16	15.4	16.3	17.4	18.5	19.7	20.9	22.2	23.5	25.0	26.4	28.0
17	17.3	18.4	19.5	20.7	21.9	23.2	24.5	25.9	27.4	28.9	30.5
18	19.4	20.5	21.7	22.9	24.2	25.6	27.0	28.5	30.0	31.6	33.2
19	21.7	22.8	24.1	25.3	26.7	28.1	29.6	31.1	32.7	34.3	36.1
20	24.0	25.2	26.5	27.9	29.3	30.7	32.3	33.9	35.5	37.2	39.0
21	26.5	27.7	29.1	30.5	32.0	33.5	35.1	36.7	38.5	40.2	42.1
22	29.0	30.4	31.8	33.3	34.8	36.4	38.0	39.7	41.5	43.3	45.2
23	31.7	33.1	34.6	36.1	37.7	39.4	41.1	42.9	44.7	46.6	48.5
24	34.6	36.0	37.6	39.1	40.8	42.5	44.3	46.1	48.0	49.9	52.0
25	37.5	39.0	40.6	42.3	44.0	45.7	47.6	49.5	51.4	53.4	55.5
26	40.6	42.1	43.8	45.5	47.3	49.1	51.0	52.9	55.0	57.0	59.2
27	43.7	45.4	47.1	48.9	50.7	52.6	54.5	56.5	58.6	60.7	62.9
28	47.0	48.7	50.5	52.3	54.2	56.2	58.2	60.3	62.4	64.6	66.8
29	50.5	52.2	54.1	55.9	57.9	59.9	62.0	64.1	66.3	68.5	70.9
30	54.0	55.8	57.7	59.7	61.7	63.7	65.9	68.1	70.3	72.6	75.0
31	57.7	59.5	61.5	63.5	65.6	67.7	69.9	72.1	74.5	76.8	79.3
32	61.4	63.4	65.4	67.5	69.6	71.8	74.0	76.3	78.7	81.1	83.6
33	65.3	67.3	69.4	71.5	73.7	76.0	78.3	80.7	83.1	85.6	88.1
34	69.4	71.4	73.6	75.7	78.0	80.3	82.7	85.1	87.6	90.1	92.8
35	73.5	75.6	77.8	80.1	82.4	84.7	87.2	89.7	92.2	94.8	97.5
36	77.8	79.9	82.2	84.5	86.9	89.3	91.8	94.3	97.0	99.6	102.3
37	82.1	84.4	86.7	89.1	91.5	94.0	96.5	99.1	101.8	104.5	107.3
38	86.6	88.9	91.3	93.7	96.2	98.8	101.4	104.1	106.8	109.6	112.4
39	91.3	93.6	96.1	98.5	101.1	103.7	106.4	109.1	111.9	114.7	117.6
40	96.0	98.4	100.9	103.5	106.1	108.7	111.5	114.3	117.1	120.0	123.0
41	100.8	103.3	105.9	108.5	111.2	113.9	116.7	119.5	122.4	125.4	128.4
42	105.8	108.4	111.0	113.7	116.4	119.2	122.0	124.9	127.9	130.9	134.0
43	110.9	113.5	116.2	118.9	121.7	124.6	127.5	130.5	133.5	136.6	139.7
44	116.1	118.8	121.5	124.3	127.2	130.1	133.1	136.1	139.2	142.3	145.5
45	121.5	124.2	127.0	129.9	132.8	135.7	138.8	141.9	145.0	148.2	151.5
46	126.9	129.7	132.6	135.5	138.5	141.5	144.6	147.7	150.9	154.2	157.5
47	132.5	135.4	138.3	141.3	144.3	147.4	150.5	153.7	157.0	160.3	163.7
48	138.2	141.1	144.1	147.1	150.2	153.4	156.6	159.9	163.2	166.6	170.0
49	144.0	147.0	150.0	153.1	156.3	159.5	162.8	166.1	169.5	172.9	176.4
50	150.0	153.0	156.1	159.3	162.5	165.7	169.1	172.5	175.9	179.4	183.0

Cubic Foot Log Volumes
 ***Segment length = 12 Ft. ***

Small End Dia.	Inches of Taper										
	0	1	2	3	4	5	6	7	8	9	10
2	0.3	0.4	0.7	0.9	1.3	1.7	2.2	2.8	3.4	4.1	4.8
3	0.6	0.8	1.1	1.5	1.9	2.4	2.9	3.6	4.3	5.0	5.8
4	1.0	1.3	1.7	2.1	2.6	3.2	3.8	4.5	5.2	6.1	6.9
5	1.6	2.0	2.4	2.9	3.5	4.1	4.8	5.5	6.3	7.2	8.2
6	2.4	2.8	3.3	3.8	4.5	5.1	5.9	6.7	7.6	8.5	9.6
7	3.2	3.7	4.3	4.9	5.6	6.3	7.1	8.0	9.0	10.0	11.1
8	4.2	4.7	5.4	6.1	6.8	7.6	8.5	9.5	10.5	11.6	12.7
9	5.3	5.9	6.6	7.4	8.2	9.1	10.0	11.0	12.1	13.3	14.5
10	6.5	7.2	8.0	8.8	9.7	10.6	11.6	12.7	13.9	15.1	16.4
11	7.9	8.7	9.5	10.4	11.3	12.3	13.4	14.6	15.8	17.0	18.4
12	9.4	10.2	11.1	12.1	13.1	14.2	15.3	16.5	17.8	19.1	20.6
13	11.1	11.9	12.9	13.9	15.0	16.1	17.3	18.6	20.0	21.4	22.8
14	12.8	13.8	14.8	15.9	17.0	18.2	19.5	20.8	22.3	23.7	25.3
15	14.7	15.7	16.8	18.0	19.2	20.5	21.8	23.2	24.7	26.2	27.8
16	16.8	17.8	19.0	20.2	21.5	22.8	24.2	25.7	27.2	28.8	30.5
17	18.9	20.1	21.3	22.5	23.9	25.3	26.8	28.3	29.9	31.6	33.3
18	21.2	22.4	23.7	25.0	26.4	27.9	29.5	31.1	32.7	34.5	36.3
19	23.6	24.9	26.2	27.7	29.1	30.7	32.3	33.9	35.7	37.5	39.3
20	26.2	27.5	28.9	30.4	31.9	33.5	35.2	36.9	38.7	40.6	42.5
21	28.9	30.3	31.7	33.3	34.9	36.6	38.3	40.1	42.0	43.9	45.9
22	31.7	33.1	34.7	36.3	38.0	39.7	41.5	43.4	45.3	47.3	49.3
23	34.6	36.2	37.8	39.4	41.2	43.0	44.8	46.8	48.8	50.8	52.9
24	37.7	39.3	41.0	42.7	44.5	46.4	48.3	50.3	52.4	54.5	56.7
25	40.9	42.6	44.3	46.1	48.0	49.9	51.9	54.0	56.1	58.3	60.5
26	44.2	46.0	47.8	49.6	51.6	53.6	55.6	57.8	60.0	62.2	64.5
27	47.7	49.5	51.4	53.3	55.3	57.4	59.5	61.7	63.9	66.3	68.7
28	51.3	53.2	55.1	57.1	59.2	61.3	63.5	65.7	68.1	70.5	72.9
29	55.0	57.0	59.0	61.0	63.2	65.3	67.6	69.9	72.3	74.8	77.3
30	58.9	60.9	63.0	65.1	67.3	69.5	71.9	74.3	76.7	79.2	81.8
31	62.9	65.0	67.1	69.3	71.5	73.9	76.2	78.7	81.2	83.8	86.5
32	67.0	69.1	71.3	73.6	75.9	78.3	80.8	83.3	85.9	88.5	91.2
33	71.3	73.5	75.7	78.0	80.4	82.9	85.4	88.0	90.6	93.4	96.1
34	75.7	77.9	80.2	82.6	85.1	87.6	90.2	92.8	95.6	98.3	101.2
35	80.2	82.5	84.9	87.3	89.9	92.4	95.1	97.8	100.6	103.4	106.4
36	84.8	87.2	89.7	92.2	94.8	97.4	100.1	102.9	105.8	108.7	111.7
37	89.6	92.1	94.6	97.2	99.8	102.5	105.3	108.2	111.1	114.0	117.1
38	94.5	97.0	99.6	102.3	105.0	107.8	110.6	113.5	116.5	119.5	122.6
39	99.5	102.1	104.8	107.5	110.3	113.1	116.0	119.0	122.1	125.2	128.3
40	104.7	107.4	110.1	112.9	115.7	118.6	121.6	124.6	127.8	130.9	134.2
41	110.0	112.7	115.5	118.4	121.3	124.3	127.3	130.4	133.6	136.8	140.1
42	115.5	118.2	121.1	124.0	127.0	130.0	133.1	136.3	139.5	142.8	146.2
43	121.0	123.9	126.8	129.8	132.8	135.9	139.1	142.3	145.6	149.0	152.4
44	126.7	129.6	132.6	135.6	138.7	141.9	145.2	148.5	151.8	155.3	158.8
45	132.5	135.5	138.6	141.7	144.8	148.1	151.4	154.8	158.2	161.7	165.3
46	138.5	141.5	144.6	147.8	151.1	154.4	157.7	161.2	164.7	168.2	171.9
47	144.6	147.7	150.9	154.1	157.4	160.8	164.2	167.7	171.3	174.9	178.6
48	150.8	154.0	157.2	160.5	163.9	167.3	170.8	174.4	178.0	181.7	185.5
49	157.1	160.4	163.7	167.1	170.5	174.0	177.6	181.2	184.9	188.7	192.5
50	163.6	166.9	170.3	173.7	177.2	180.8	184.4	188.1	191.9	195.7	199.6

Cubic Foot Log Volumes
 Segment length = 13 Ft.

Small End Dia.	Inches of Taper										
	0	1	2	3	4	5	6	7	8	9	10
2	0.3	0.5	0.7	1.0	1.4	1.9	2.4	3.0	3.7	4.4	5.2
3	0.6	0.9	1.2	1.6	2.1	2.6	3.2	3.9	4.6	5.4	6.3
4	1.1	1.5	1.8	2.3	2.8	3.4	4.1	4.9	5.7	6.6	7.5
5	1.8	2.2	2.6	3.2	3.8	4.4	5.2	6.0	6.9	7.8	8.9
6	2.6	3.0	3.5	4.1	4.8	5.6	6.4	7.3	8.2	9.3	10.4
7	3.5	4.0	4.6	5.3	6.0	6.8	7.7	8.7	9.7	10.8	12.0
8	4.5	5.1	5.8	6.6	7.4	8.3	9.2	10.2	11.3	12.5	13.8
9	5.7	6.4	7.2	8.0	8.9	9.8	10.8	11.9	13.1	14.4	15.7
10	7.1	7.8	8.7	9.5	10.5	11.5	12.6	13.8	15.0	16.3	17.7
11	8.6	9.4	10.3	11.2	12.3	13.4	14.5	15.8	17.1	18.5	19.9
12	10.2	11.1	12.1	13.1	14.2	15.4	16.6	17.9	19.3	20.7	22.3
13	12.0	12.9	14.0	15.1	16.2	17.5	18.8	20.2	21.6	23.1	24.7
14	13.9	14.9	16.0	17.2	18.4	19.7	21.1	22.6	24.1	25.7	27.4
15	16.0	17.1	18.2	19.5	20.8	22.2	23.6	25.1	26.7	28.4	30.1
16	18.2	19.3	20.6	21.9	23.3	24.7	26.2	27.8	29.5	31.2	33.0
17	20.5	21.7	23.0	24.4	25.9	27.4	29.0	30.7	32.4	34.2	36.1
18	23.0	24.3	25.7	27.1	28.6	30.2	31.9	33.6	35.5	37.3	39.3
19	25.6	27.0	28.4	30.0	31.6	33.2	35.0	36.8	38.6	40.6	42.6
20	28.4	29.8	31.3	32.9	34.6	36.3	38.1	40.0	42.0	44.0	46.1
21	31.3	32.8	34.4	36.1	37.8	39.6	41.5	43.4	45.4	47.5	49.7
22	34.3	35.9	37.6	39.3	41.1	43.0	45.0	47.0	49.1	51.2	53.5
23	37.5	39.2	40.9	42.7	44.6	46.5	48.6	50.7	52.8	55.1	57.4
24	40.8	42.6	44.4	46.3	48.2	50.2	52.3	54.5	56.7	59.0	61.4
25	44.3	46.1	48.0	50.0	52.0	54.1	56.2	58.5	60.8	63.1	65.6
26	47.9	49.8	51.8	53.8	55.9	58.0	60.3	62.6	64.9	67.4	69.9
27	51.7	53.6	55.7	57.7	59.9	62.1	64.4	66.8	69.3	71.8	74.4
28	55.6	57.6	59.7	61.9	64.1	66.4	68.8	71.2	73.7	76.3	79.0
29	59.6	61.7	63.9	66.1	68.4	70.8	73.2	75.8	78.3	81.0	83.7
30	63.8	66.0	68.2	70.5	72.9	75.3	77.9	80.4	83.1	85.8	88.6
31	68.1	70.4	72.7	75.0	77.5	80.0	82.6	85.3	88.0	90.8	93.7
32	72.6	74.9	77.3	79.7	82.2	84.8	87.5	90.2	93.0	95.9	98.8
33	77.2	79.6	82.0	84.6	87.1	89.8	92.5	95.3	98.2	101.1	104.2
34	82.0	84.4	86.9	89.5	92.2	94.9	97.7	100.6	103.5	106.5	109.6
35	86.9	89.4	92.0	94.6	97.3	100.1	103.0	106.0	109.0	112.1	115.2
36	91.9	94.5	97.1	99.9	102.7	105.5	108.5	111.5	114.6	117.7	121.0
37	97.1	99.7	102.5	105.3	108.1	111.1	114.1	117.2	120.3	123.5	126.8
38	102.4	105.1	107.9	110.8	113.7	116.7	119.8	123.0	126.2	129.5	132.9
39	107.8	110.6	113.5	116.5	119.5	122.6	125.7	128.9	132.2	135.6	139.0
40	113.4	116.3	119.3	122.3	125.4	128.5	131.7	135.0	138.4	141.8	145.3
41	119.2	122.1	125.1	128.2	131.4	134.6	137.9	141.3	144.7	148.2	151.8
42	125.1	128.1	131.2	134.3	137.5	140.8	144.2	147.7	151.2	154.7	158.4
43	131.1	134.2	137.3	140.6	143.9	147.2	150.7	154.2	157.8	161.4	165.1
44	137.3	140.4	143.6	146.9	150.3	153.8	157.3	160.8	164.5	168.2	172.0
45	143.6	146.8	150.1	153.5	156.9	160.4	164.0	167.6	171.4	175.2	179.0
46	150.0	153.3	156.7	160.1	163.6	167.2	170.9	174.6	178.4	182.3	186.2
47	156.6	160.0	163.4	166.9	170.5	174.2	177.9	181.7	185.6	189.5	193.5
48	163.4	166.8	170.3	173.9	177.5	181.3	185.1	188.9	192.9	196.9	200.9
49	170.2	173.7	177.3	181.0	184.7	188.5	192.4	196.3	200.3	204.4	208.5
50	177.3	180.8	184.5	188.2	192.0	195.9	199.8	203.8	207.9	212.0	216.3

Cubic Foot Log Volumes
 Segment length = 14 Ft.

Small End Dia.	Inches of Taper										
	0	1	2	3	4	5	6	7	8	9	10
2	0.3	0.5	0.8	1.1	1.5	2.0	2.6	3.2	4.0	4.8	5.7
3	0.7	1.0	1.3	1.7	2.2	2.8	3.4	4.2	5.0	5.8	6.8
4	1.2	1.6	2.0	2.5	3.1	3.7	4.4	5.2	6.1	7.1	8.1
5	1.9	2.3	2.8	3.4	4.0	4.8	5.6	6.5	7.4	8.4	9.5
6	2.7	3.2	3.8	4.5	5.2	6.0	6.9	7.8	8.9	10.0	11.1
7	3.7	4.3	5.0	5.7	6.5	7.4	8.3	9.4	10.5	11.6	12.9
8	4.9	5.5	6.3	7.1	7.9	8.9	9.9	11.0	12.2	13.5	14.8
9	6.2	6.9	7.7	8.6	9.5	10.6	11.7	12.9	14.1	15.5	16.9
10	7.6	8.4	9.3	10.3	11.3	12.4	13.6	14.9	16.2	17.6	19.1
11	9.2	10.1	11.1	12.1	13.2	14.4	15.7	17.0	18.4	19.9	21.5
12	11.0	11.9	13.0	14.1	15.3	16.5	17.9	19.3	20.8	22.3	24.0
13	12.9	13.9	15.0	16.2	17.5	18.8	20.2	21.7	23.3	24.9	26.6
14	15.0	16.1	17.3	18.5	19.9	21.3	22.8	24.3	26.0	27.7	29.5
15	17.2	18.4	19.6	21.0	22.4	23.9	25.4	27.1	28.8	30.6	32.5
16	19.5	20.8	22.1	23.6	25.0	26.6	28.3	30.0	31.8	33.6	35.6
17	22.1	23.4	24.8	26.3	27.9	29.5	31.2	33.0	34.9	36.8	38.9
18	24.7	26.2	27.6	29.2	30.8	32.6	34.4	36.2	38.2	40.2	42.3
19	27.6	29.1	30.6	32.3	34.0	35.8	37.6	39.6	41.6	43.7	45.9
20	30.5	32.1	33.7	35.5	37.3	39.1	41.1	43.1	45.2	47.4	49.6
21	33.7	35.3	37.0	38.8	40.7	42.6	44.7	46.8	48.9	51.2	53.5
22	37.0	38.7	40.5	42.3	44.3	46.3	48.4	50.6	52.8	55.2	57.6
23	40.4	42.2	44.1	46.0	48.0	50.1	52.3	54.6	56.9	59.3	61.8
24	44.0	45.9	47.8	49.8	51.9	54.1	56.4	58.7	61.1	63.6	66.1
25	47.7	49.7	51.7	53.8	56.0	58.2	60.6	63.0	65.4	68.0	70.6
26	51.6	53.6	55.7	57.9	60.2	62.5	64.9	67.4	69.9	72.6	75.3
27	55.7	57.8	59.9	62.2	64.5	66.9	69.4	72.0	74.6	77.3	80.1
28	59.9	62.0	64.3	66.6	69.0	71.5	74.1	76.7	79.4	82.2	85.1
29	64.2	66.5	68.8	71.2	73.7	76.2	78.9	81.6	84.4	87.2	90.2
30	68.7	71.0	73.5	75.9	78.5	81.1	83.8	86.6	89.5	92.4	95.4
31	73.4	75.8	78.3	80.8	83.5	86.2	89.0	91.8	94.8	97.8	100.9
32	78.2	80.7	83.2	85.9	88.6	91.4	94.2	97.2	100.2	103.3	106.4
33	83.2	85.7	88.3	91.1	93.8	96.7	99.6	102.7	105.8	108.9	112.2
34	88.3	90.9	93.6	96.4	99.3	102.2	105.2	108.3	111.5	114.7	118.0
35	93.5	96.2	99.0	101.9	104.8	107.9	110.9	114.1	117.4	120.7	124.1
36	99.0	101.7	104.6	107.5	110.6	113.7	116.8	120.1	123.4	126.8	130.3
37	104.5	107.4	110.3	113.4	116.4	119.6	122.9	126.2	129.6	133.1	136.6
38	110.3	113.2	116.2	119.3	122.5	125.7	129.0	132.4	135.9	139.5	143.1
39	116.1	119.2	122.2	125.4	128.7	132.0	135.4	138.9	142.4	146.0	149.7
40	122.2	125.3	128.4	131.7	135.0	138.4	141.9	145.4	149.0	152.8	156.5
41	128.4	131.5	134.8	138.1	141.5	145.0	148.5	152.1	155.8	159.6	163.5
42	134.7	137.9	141.3	144.7	148.1	151.7	155.3	159.0	162.8	166.6	170.6
43	141.2	144.5	147.9	151.4	154.9	158.6	162.3	166.0	169.9	173.8	177.8
44	147.8	151.2	154.7	158.2	161.9	165.6	169.4	173.2	177.1	181.2	185.2
45	154.6	158.1	161.6	165.3	169.0	172.8	176.6	180.5	184.6	188.6	192.8
46	161.6	165.1	168.7	172.5	176.2	180.1	184.0	188.0	192.1	196.3	200.5
47	168.7	172.3	176.0	179.8	183.6	187.6	191.6	195.7	199.8	204.1	208.4
48	175.9	179.6	183.4	187.3	191.2	195.2	199.3	203.5	207.7	212.0	216.4
49	183.3	187.1	191.0	194.9	198.9	203.0	207.2	211.4	215.7	220.1	224.6
50	190.9	194.7	198.7	202.7	206.8	210.9	215.2	219.5	223.9	228.3	232.9

Cubic Foot Log Volumes
 ***Segment length = 15 Ft. ***

Small End Dia.	Inches of Taper										
	0	1	2	3	4	5	6	7	8	9	10
2	0.3	0.5	0.8	1.2	1.6	2.2	2.8	3.5	4.3	5.1	6.1
3	0.7	1.0	1.4	1.8	2.4	3.0	3.7	4.5	5.3	6.3	7.3
4	1.3	1.7	2.1	2.7	3.3	4.0	4.7	5.6	6.5	7.6	8.7
5	2.0	2.5	3.0	3.6	4.3	5.1	6.0	6.9	7.9	9.0	10.2
6	2.9	3.5	4.1	4.8	5.6	6.4	7.4	8.4	9.5	10.7	11.9
7	4.0	4.6	5.3	6.1	7.0	7.9	8.9	10.0	11.2	12.5	13.8
8	5.2	5.9	6.7	7.6	8.5	9.5	10.6	11.8	13.1	14.4	15.9
9	6.6	7.4	8.3	9.2	10.2	11.3	12.5	13.8	15.1	16.6	18.1
10	8.2	9.0	10.0	11.0	12.1	13.3	14.6	15.9	17.3	18.9	20.5
11	9.9	10.8	11.9	13.0	14.2	15.4	16.8	18.2	19.7	21.3	23.0
12	11.8	12.8	13.9	15.1	16.4	17.7	19.1	20.7	22.3	23.9	25.7
13	13.8	14.9	16.1	17.4	18.7	20.2	21.7	23.3	25.0	26.7	28.6
14	16.0	17.2	18.5	19.8	21.3	22.8	24.4	26.1	27.8	29.7	31.6
15	18.4	19.7	21.0	22.5	24.0	25.6	27.2	29.0	30.8	32.8	34.8
16	20.9	22.3	23.7	25.2	26.8	28.5	30.3	32.1	34.0	36.0	38.1
17	23.6	25.1	26.6	28.2	29.9	31.6	33.5	35.4	37.4	39.5	41.6
18	26.5	28.0	29.6	31.3	33.1	34.9	36.8	38.8	40.9	43.1	45.3
19	29.5	31.1	32.8	34.6	36.4	38.3	40.3	42.4	44.6	46.8	49.2
20	32.7	34.4	36.2	38.0	39.9	41.9	44.0	46.2	48.4	50.8	53.2
21	36.1	37.8	39.7	41.6	43.6	45.7	47.9	50.1	52.4	54.9	57.3
22	39.6	41.4	43.4	45.4	47.4	49.6	51.9	54.2	56.6	59.1	61.7
23	43.3	45.2	47.2	49.3	51.5	53.7	56.0	58.5	60.9	63.5	66.2
24	47.1	49.1	51.2	53.4	55.6	58.0	60.4	62.9	65.4	68.1	70.8
25	51.1	53.2	55.4	57.6	60.0	62.4	64.9	67.5	70.1	72.9	75.7
26	55.3	57.5	59.7	62.1	64.5	67.0	69.5	72.2	74.9	77.8	80.7
27	59.6	61.9	64.2	66.6	69.1	71.7	74.4	77.1	79.9	82.8	85.8
28	64.1	66.5	68.9	71.4	74.0	76.6	79.4	82.2	85.1	88.1	91.1
29	68.8	71.2	73.7	76.3	78.9	81.7	84.5	87.4	90.4	93.5	96.6
30	73.6	76.1	78.7	81.4	84.1	86.9	89.8	92.8	95.9	99.0	102.3
31	78.6	81.2	83.9	86.6	89.4	92.3	95.3	98.4	101.5	104.8	108.1
32	83.8	86.4	89.2	92.0	94.9	97.9	101.0	104.1	107.3	110.6	114.0
33	89.1	91.8	94.7	97.6	100.5	103.6	106.8	110.0	113.3	116.7	120.2
34	94.6	97.4	100.3	103.3	106.4	109.5	112.7	116.0	119.4	122.9	126.5
35	100.2	103.1	106.1	109.2	112.3	115.6	118.9	122.3	125.7	129.3	132.9
36	106.0	109.0	112.1	115.2	118.5	121.8	125.2	128.6	132.2	135.8	139.6
37	112.0	115.1	118.2	121.4	124.8	128.2	131.6	135.2	138.8	142.6	146.4
38	118.1	121.3	124.5	127.8	131.2	134.7	138.3	141.9	145.6	149.4	153.3
39	124.4	127.7	131.0	134.4	137.8	141.4	145.0	148.8	152.6	156.5	160.4
40	130.9	134.2	137.6	141.1	144.6	148.3	152.0	155.8	159.7	163.7	167.7
41	137.5	140.9	144.4	148.0	151.6	155.3	159.1	163.0	167.0	171.0	175.2
42	144.3	147.8	151.3	155.0	158.7	162.5	166.4	170.4	174.4	178.6	182.8
43	151.3	154.8	158.5	162.2	166.0	169.9	173.8	177.9	182.0	186.2	190.5
44	158.4	162.0	165.7	169.6	173.4	177.4	181.5	185.6	189.8	194.1	198.5
45	165.7	169.4	173.2	177.1	181.0	185.1	189.2	193.4	197.7	202.1	206.6
46	173.1	176.9	180.8	184.8	188.8	192.9	197.2	201.5	205.8	210.3	214.8
47	180.7	184.6	188.6	192.6	196.8	201.0	205.3	209.6	214.1	218.6	223.3
48	188.5	192.5	196.5	200.6	204.9	209.1	213.5	218.0	222.5	227.1	231.8
49	196.4	200.5	204.6	208.8	213.1	217.5	222.0	226.5	231.1	235.8	240.6
50	204.5	208.7	212.9	217.2	221.5	226.0	230.5	235.2	239.9	244.7	249.5

Cubic Foot Log Volumes
 ***Segment length = 16 Ft. ***

Small End Dia.	Inches of Taper										
	0	1	2	3	4	5	6	7	8	9	10
2	0.3	0.6	0.9	1.3	1.7	2.3	3.0	3.7	4.5	5.5	6.5
3	0.8	1.1	1.5	2.0	2.5	3.2	3.9	4.8	5.7	6.7	7.8
4	1.4	1.8	2.3	2.8	3.5	4.2	5.1	6.0	7.0	8.1	9.2
5	2.2	2.7	3.2	3.9	4.6	5.5	6.4	7.4	8.5	9.6	10.9
6	3.1	3.7	4.4	5.1	5.9	6.9	7.9	8.9	10.1	11.4	12.7
7	4.3	4.9	5.7	6.5	7.4	8.4	9.5	10.7	12.0	13.3	14.7
8	5.6	6.3	7.2	8.1	9.1	10.2	11.3	12.6	14.0	15.4	16.9
9	7.1	7.9	8.8	9.8	10.9	12.1	13.4	14.7	16.1	17.7	19.3
10	8.7	9.6	10.6	11.7	12.9	14.2	15.5	17.0	18.5	20.1	21.8
11	10.6	11.6	12.7	13.8	15.1	16.4	17.9	19.4	21.0	22.7	24.5
12	12.6	13.7	14.8	16.1	17.5	18.9	20.4	22.0	23.7	25.5	27.4
13	14.7	15.9	17.2	18.5	20.0	21.5	23.1	24.8	26.6	28.5	30.5
14	17.1	18.4	19.7	21.2	22.7	24.3	26.0	27.8	29.7	31.6	33.7
15	19.6	21.0	22.4	24.0	25.6	27.3	29.1	30.9	32.9	34.9	37.1
16	22.3	23.8	25.3	26.9	28.6	30.4	32.3	34.3	36.3	38.4	40.7
17	25.2	26.7	28.4	30.1	31.9	33.7	35.7	37.7	39.9	42.1	44.4
18	28.3	29.9	31.6	33.4	35.3	37.2	39.3	41.4	43.6	45.9	48.3
19	31.5	33.2	35.0	36.9	38.8	40.9	43.0	45.2	47.6	50.0	52.4
20	34.9	36.7	38.6	40.5	42.6	44.7	46.9	49.3	51.7	54.1	56.7
21	38.5	40.4	42.3	44.4	46.5	48.7	51.0	53.4	55.9	58.5	61.2
22	42.2	44.2	46.2	48.4	50.6	52.9	55.3	57.8	60.4	63.0	65.8
23	46.2	48.2	50.4	52.6	54.9	57.3	59.8	62.4	65.0	67.8	70.6
24	50.3	52.4	54.6	56.9	59.3	61.8	64.4	67.1	69.8	72.6	75.6
25	54.5	56.8	59.1	61.5	64.0	66.5	69.2	71.9	74.8	77.7	80.7
26	59.0	61.3	63.7	66.2	68.8	71.4	74.2	77.0	79.9	82.9	86.0
27	63.6	66.0	68.5	71.1	73.7	76.5	79.3	82.2	85.3	88.4	91.5
28	68.4	70.9	73.5	76.1	78.9	81.7	84.6	87.7	90.8	93.9	97.2
29	73.4	76.0	78.6	81.4	84.2	87.1	90.1	93.2	96.4	99.7	103.1
30	78.5	81.2	83.9	86.8	89.7	92.7	95.8	99.0	102.3	105.6	109.1
31	83.9	86.6	89.4	92.4	95.4	98.5	101.7	104.9	108.3	111.7	115.3
32	89.4	92.2	95.1	98.1	101.2	104.4	107.7	111.0	114.5	118.0	121.6
33	95.0	98.0	101.0	104.1	107.2	110.5	113.9	117.3	120.9	124.5	128.2
34	100.9	103.9	107.0	110.2	113.4	116.8	120.2	123.8	127.4	131.1	134.9
35	106.9	110.0	113.2	116.5	119.8	123.3	126.8	130.4	134.1	137.9	141.8
36	113.1	116.3	119.6	122.9	126.4	129.9	133.5	137.2	141.0	144.9	148.9
37	119.5	122.7	126.1	129.5	133.1	136.7	140.4	144.2	148.1	152.1	156.1
38	126.0	129.4	132.8	136.4	140.0	143.7	147.5	151.4	155.3	159.4	163.5
39	132.7	136.2	139.7	143.3	147.0	150.8	154.7	158.7	162.7	166.9	171.1
40	139.6	143.2	146.8	150.5	154.3	158.2	162.1	166.2	170.3	174.6	178.9
41	146.7	150.3	154.0	157.8	161.7	165.7	169.7	173.9	178.1	182.4	186.8
42	153.9	157.6	161.4	165.3	169.3	173.3	177.5	181.7	186.0	190.5	194.9
43	161.4	165.1	169.0	173.0	177.1	181.2	185.4	189.8	194.2	198.7	203.2
44	168.9	172.8	176.8	180.9	185.0	189.2	193.6	198.0	202.5	207.0	211.7
45	176.7	180.7	184.7	188.9	193.1	197.4	201.8	206.3	210.9	215.6	220.3
46	184.7	188.7	192.9	197.1	201.4	205.8	210.3	214.9	219.6	224.3	229.2
47	192.8	196.9	201.1	205.5	209.9	214.4	218.9	223.6	228.4	233.2	238.1
48	201.1	205.3	209.6	214.0	218.5	223.1	227.8	232.5	237.4	242.3	247.3
49	209.5	213.8	218.2	222.7	227.3	232.0	236.7	241.6	246.5	251.5	256.6
50	218.2	222.6	227.1	231.6	236.3	241.1	245.9	250.8	255.9	261.0	266.2

Cubic Foot Log Volumes
 Segment length = 17 Ft.

Small End Dia.	Inches of Taper										
	0	1	2	3	4	5	6	7	8	9	10
2	0.4	0.6	0.9	1.3	1.9	2.5	3.2	3.9	4.8	5.8	6.9
3	0.8	1.2	1.6	2.1	2.7	3.4	4.2	5.1	6.0	7.1	8.3
4	1.5	1.9	2.4	3.0	3.7	4.5	5.4	6.4	7.4	8.6	9.8
5	2.3	2.8	3.4	4.1	4.9	5.8	6.8	7.8	9.0	10.2	11.6
6	3.3	3.9	4.6	5.4	6.3	7.3	8.3	9.5	10.8	12.1	13.5
7	4.5	5.2	6.0	6.9	7.9	8.9	10.1	11.4	12.7	14.1	15.7
8	5.9	6.7	7.6	8.6	9.6	10.8	12.1	13.4	14.8	16.4	18.0
9	7.5	8.4	9.4	10.4	11.6	12.8	14.2	15.6	17.2	18.8	20.5
10	9.3	10.2	11.3	12.5	13.7	15.1	16.5	18.0	19.7	21.4	23.2
11	11.2	12.3	13.4	14.7	16.0	17.5	19.0	20.6	22.3	24.2	26.1
12	13.4	14.5	15.8	17.1	18.5	20.1	21.7	23.4	25.2	27.1	29.1
13	15.7	16.9	18.3	19.7	21.2	22.9	24.6	26.4	28.3	30.3	32.4
14	18.2	19.5	21.0	22.5	24.1	25.8	27.6	29.5	31.5	33.6	35.8
15	20.9	22.3	23.8	25.5	27.2	29.0	30.9	32.9	35.0	37.1	39.4
16	23.7	25.3	26.9	28.6	30.4	32.3	34.3	36.4	38.6	40.8	43.2
17	26.8	28.4	30.1	31.9	33.8	35.8	37.9	40.1	42.4	44.7	47.2
18	30.0	31.8	33.6	35.5	37.5	39.5	41.7	44.0	46.4	48.8	51.4
19	33.5	35.3	37.2	39.2	41.3	43.4	45.7	48.1	50.5	53.1	55.7
20	37.1	39.0	41.0	43.1	45.2	47.5	49.9	52.3	54.9	57.5	60.3
21	40.9	42.9	45.0	47.1	49.4	51.8	54.2	56.8	59.4	62.2	65.0
22	44.9	47.0	49.1	51.4	53.8	56.2	58.8	61.4	64.2	67.0	69.9
23	49.0	51.2	53.5	55.9	58.3	60.9	63.5	66.2	69.1	72.0	75.0
24	53.4	55.7	58.0	60.5	63.0	65.7	68.4	71.3	74.2	77.2	80.3
25	57.9	60.3	62.8	65.3	68.0	70.7	73.5	76.4	79.5	82.6	85.8
26	62.7	65.1	67.7	70.3	73.1	75.9	78.8	81.8	84.9	88.1	91.4
27	67.6	70.1	72.8	75.5	78.3	81.3	84.3	87.4	90.6	93.9	97.3
28	72.7	75.3	78.1	80.9	83.8	86.8	89.9	93.1	96.4	99.8	103.3
29	78.0	80.7	83.5	86.5	89.5	92.6	95.8	99.1	102.5	105.9	109.5
30	83.4	86.3	89.2	92.2	95.3	98.5	101.8	105.2	108.7	112.2	115.9
31	89.1	92.0	95.0	98.1	101.3	104.6	108.0	111.5	115.1	118.7	122.5
32	94.9	98.0	101.1	104.3	107.6	110.9	114.4	118.0	121.6	125.4	129.2
33	101.0	104.1	107.3	110.6	114.0	117.4	121.0	124.7	128.4	132.3	136.2
34	107.2	110.4	113.7	117.1	120.5	124.1	127.8	131.5	135.4	139.3	143.3
35	113.6	116.9	120.3	123.7	127.3	131.0	134.7	138.6	142.5	146.5	150.7
36	120.2	123.5	127.0	130.6	134.3	138.0	141.9	145.8	149.8	154.0	158.2
37	126.9	130.4	134.0	137.6	141.4	145.2	149.2	153.2	157.3	161.6	165.9
38	133.9	137.5	141.1	144.9	148.7	152.7	156.7	160.8	165.0	169.3	173.8
39	141.0	144.7	148.4	152.3	156.2	160.3	164.4	168.6	172.9	177.3	181.8
40	148.3	152.1	156.0	159.9	163.9	168.1	172.3	176.6	181.0	185.5	190.1
41	155.9	159.7	163.6	167.7	171.8	176.0	180.3	184.7	189.2	193.8	198.5
42	163.6	167.5	171.5	175.7	179.9	184.2	188.6	193.1	197.7	202.4	207.1
43	171.4	175.5	179.6	183.8	188.1	192.5	197.0	201.6	206.3	211.1	215.9
44	179.5	183.6	187.8	192.2	196.6	201.1	205.6	210.3	215.1	220.0	224.9
45	187.8	192.0	196.3	200.7	205.2	209.8	214.5	219.2	224.1	229.1	234.1
46	196.2	200.5	204.9	209.4	214.0	218.7	223.5	228.3	233.3	238.3	243.5
47	204.8	209.2	213.7	218.3	223.0	227.8	232.6	237.6	242.6	247.8	253.0
48	213.6	218.1	222.7	227.4	232.2	237.0	242.0	247.0	252.2	257.4	262.8
49	222.6	227.2	231.9	236.7	241.5	246.5	251.5	256.7	261.9	267.3	272.7
50	231.8	236.5	241.3	246.1	251.1	256.1	261.3	266.5	271.8	277.3	282.8

Cubic Foot Log Volumes
 Segment length = 18 Ft.

Small End Dia.	Inches of Taper										
	0	1	2	3	4	5	6	7	8	9	10
2	0.4	0.6	1.0	1.4	2.0	2.6	3.3	4.2	5.1	6.1	7.3
3	0.9	1.2	1.7	2.2	2.8	3.6	4.4	5.4	6.4	7.5	8.7
4	1.6	2.0	2.6	3.2	3.9	4.8	5.7	6.7	7.9	9.1	10.4
5	2.5	3.0	3.6	4.4	5.2	6.1	7.2	8.3	9.5	10.8	12.3
6	3.5	4.2	4.9	5.7	6.7	7.7	8.8	10.1	11.4	12.8	14.3
7	4.8	5.5	6.4	7.3	8.3	9.5	10.7	12.0	13.4	15.0	16.6
8	6.3	7.1	8.1	9.1	10.2	11.4	12.8	14.2	15.7	17.3	19.0
9	8.0	8.9	9.9	11.0	12.3	13.6	15.0	16.5	18.2	19.9	21.7
10	9.8	10.8	12.0	13.2	14.5	16.0	17.5	19.1	20.8	22.6	24.5
11	11.9	13.0	14.2	15.6	17.0	18.5	20.1	21.8	23.7	25.6	27.6
12	14.1	15.4	16.7	18.1	19.6	21.3	23.0	24.8	26.7	28.7	30.8
13	16.6	17.9	19.3	20.9	22.5	24.2	26.0	27.9	29.9	32.1	34.3
14	19.2	20.7	22.2	23.8	25.5	27.3	29.3	31.3	33.4	35.6	37.9
15	22.1	23.6	25.2	26.9	28.8	30.7	32.7	34.8	37.0	39.3	41.7
16	25.1	26.8	28.5	30.3	32.2	34.2	36.3	38.5	40.8	43.2	45.7
17	28.4	30.1	31.9	33.8	35.8	37.9	40.2	42.5	44.9	47.4	50.0
18	31.8	33.6	35.5	37.6	39.7	41.9	44.2	46.6	49.1	51.7	54.4
19	35.4	37.4	39.4	41.5	43.7	46.0	48.4	50.9	53.5	56.2	59.0
20	39.3	41.3	43.4	45.6	47.9	50.3	52.8	55.4	58.1	60.9	63.8
21	43.3	45.4	47.6	49.9	52.3	54.8	57.4	60.1	62.9	65.8	68.8
22	47.5	49.7	52.0	54.4	56.9	59.5	62.2	65.0	67.9	70.9	74.0
23	51.9	54.2	56.6	59.1	61.8	64.4	67.2	70.1	73.1	76.2	79.4
24	56.5	59.0	61.5	64.1	66.8	69.6	72.5	75.4	78.5	81.7	85.0
25	61.4	63.9	66.5	69.2	72.0	74.9	77.9	80.9	84.1	87.4	90.8
26	66.4	69.0	71.7	74.5	77.4	80.4	83.4	86.6	89.9	93.3	96.8
27	71.6	74.3	77.1	80.0	83.0	86.0	89.2	92.5	95.9	99.4	103.0
28	77.0	79.8	82.7	85.7	88.7	91.9	95.2	98.6	102.1	105.7	109.4
29	82.6	85.5	88.5	91.5	94.7	98.0	101.4	104.9	108.5	112.2	115.9
30	88.4	91.3	94.4	97.6	100.9	104.3	107.8	111.4	115.1	118.8	122.7
31	94.3	97.4	100.6	103.9	107.3	110.8	114.4	118.1	121.8	125.7	129.7
32	100.5	103.7	107.0	110.4	113.9	117.5	121.1	124.9	128.8	132.8	136.9
33	106.9	110.2	113.6	117.1	120.7	124.3	128.1	132.0	136.0	140.0	144.2
34	113.5	116.9	120.4	123.9	127.6	131.4	135.3	139.3	143.3	147.5	151.8
35	120.3	123.7	127.3	131.0	134.8	138.7	142.6	146.7	150.9	155.2	159.5
36	127.2	130.8	134.5	138.3	142.2	146.1	150.2	154.4	158.6	163.0	167.5
37	134.4	138.1	141.9	145.7	149.7	153.8	158.0	162.2	166.6	171.1	175.6
38	141.8	145.5	149.4	153.4	157.5	161.6	165.9	170.3	174.7	179.3	184.0
39	149.3	153.2	157.2	161.2	165.4	169.7	174.1	178.5	183.1	187.8	192.5
40	157.1	161.1	165.1	169.3	173.6	177.9	182.4	187.0	191.6	196.4	201.3
41	165.0	169.1	173.3	177.5	181.9	186.4	190.9	195.6	200.4	205.2	210.2
42	173.2	177.3	181.6	186.0	190.5	195.0	199.7	204.4	209.3	214.3	219.3
43	181.5	185.8	190.2	194.6	199.2	203.9	208.6	213.5	218.4	223.5	228.6
44	190.1	194.4	198.9	203.5	208.1	212.9	217.7	222.7	227.8	232.9	238.2
45	198.8	203.3	207.8	212.5	217.3	222.1	227.1	232.1	237.3	242.5	247.9
46	207.7	212.3	217.0	221.7	226.6	231.5	236.6	241.7	247.0	252.4	257.8
47	216.9	221.5	226.3	231.1	236.1	241.2	246.3	251.6	256.9	262.4	267.9
48	226.2	230.9	235.8	240.8	245.8	251.0	256.2	261.6	267.0	272.6	278.2
49	235.7	240.6	245.5	250.6	255.7	261.0	266.3	271.8	277.3	283.0	288.7
50	245.4	250.4	255.4	260.6	265.8	271.2	276.6	282.2	287.8	293.6	299.4

Cubic Foot Log Volumes
 Segment length = 19 Ft.

Small End Dia.	Inches of Taper										
	0	1	2	3	4	5	6	7	8	9	10
2	0.4	0.7	1.0	1.5	2.1	2.7	3.5	4.4	5.4	6.5	7.7
3	0.9	1.3	1.8	2.3	3.0	3.8	4.7	5.6	6.7	7.9	9.2
4	1.7	2.1	2.7	3.4	4.1	5.0	6.0	7.1	8.3	9.6	11.0
5	2.6	3.2	3.8	4.6	5.5	6.5	7.6	8.8	10.1	11.5	13.0
6	3.7	4.4	5.2	6.1	7.0	8.1	9.3	10.6	12.0	13.5	15.1
7	5.1	5.9	6.7	7.7	8.8	10.0	11.3	12.7	14.2	15.8	17.5
8	6.6	7.5	8.5	9.6	10.8	12.1	13.5	15.0	16.6	18.3	20.1
9	8.4	9.4	10.5	11.7	13.0	14.4	15.9	17.5	19.2	21.0	22.9
10	10.4	11.5	12.6	13.9	15.3	16.8	18.4	20.2	22.0	23.9	25.9
11	12.5	13.7	15.0	16.4	17.9	19.5	21.2	23.1	25.0	27.0	29.1
12	14.9	16.2	17.6	19.1	20.7	22.4	24.2	26.2	28.2	30.3	32.5
13	17.5	18.9	20.4	22.0	23.7	25.5	27.5	29.5	31.6	33.8	36.2
14	20.3	21.8	23.4	25.1	26.9	28.9	30.9	33.0	35.2	37.6	40.0
15	23.3	24.9	26.6	28.4	30.4	32.4	34.5	36.7	39.1	41.5	44.0
16	26.5	28.2	30.1	32.0	34.0	36.1	38.3	40.7	43.1	45.6	48.3
17	29.9	31.8	33.7	35.7	37.8	40.1	42.4	44.8	47.4	50.0	52.7
18	33.6	35.5	37.5	39.6	41.9	44.2	46.6	49.2	51.8	54.6	57.4
19	37.4	39.4	41.6	43.8	46.1	48.5	51.1	53.7	56.5	59.3	62.3
20	41.5	43.6	45.8	48.1	50.6	53.1	55.8	58.5	61.3	64.3	67.4
21	45.7	47.9	50.3	52.7	55.2	57.9	60.6	63.5	66.4	69.5	72.6
22	50.2	52.5	54.9	57.5	60.1	62.8	65.7	68.7	71.7	74.9	78.1
23	54.8	57.3	59.8	62.4	65.2	68.0	71.0	74.0	77.2	80.5	83.8
24	59.7	62.2	64.9	67.6	70.5	73.4	76.5	79.6	82.9	86.3	89.7
25	64.8	67.4	70.2	73.0	76.0	79.0	82.2	85.4	88.8	92.3	95.9
26	70.1	72.8	75.6	78.6	81.7	84.8	88.1	91.4	94.9	98.5	102.2
27	75.5	78.4	81.3	84.4	87.6	90.8	94.2	97.7	101.2	104.9	108.7
28	81.2	84.2	87.3	90.4	93.7	97.0	100.5	104.1	107.8	111.6	115.4
29	87.1	90.2	93.4	96.6	100.0	103.5	107.0	110.7	114.5	118.4	122.4
30	93.3	96.4	99.7	103.1	106.5	110.1	113.8	117.6	121.4	125.4	129.5
31	99.6	102.8	106.2	109.7	113.3	116.9	120.7	124.6	128.6	132.7	136.9
32	106.1	109.5	113.0	116.5	120.2	124.0	127.9	131.9	136.0	140.2	144.5
33	112.8	116.3	119.9	123.6	127.4	131.2	135.2	139.3	143.5	147.8	152.2
34	119.8	123.4	127.0	130.8	134.7	138.7	142.8	147.0	151.3	155.7	160.2
35	126.9	130.6	134.4	138.3	142.3	146.4	150.6	154.9	159.3	163.8	168.4
36	134.3	138.1	142.0	146.0	150.1	154.2	158.5	163.0	167.5	172.1	176.8
37	141.9	145.7	149.7	153.8	158.0	162.3	166.7	171.2	175.9	180.6	185.4
38	149.6	153.6	157.7	161.9	166.2	170.6	175.1	179.7	184.5	189.3	194.2
39	157.6	161.7	165.9	170.2	174.6	179.1	183.7	188.4	193.3	198.2	203.2
40	165.8	170.0	174.3	178.7	183.2	187.8	192.5	197.4	202.3	207.3	212.4
41	174.2	178.5	182.9	187.4	192.0	196.7	201.6	206.5	211.5	216.6	221.9
42	182.8	187.2	191.7	196.3	201.0	205.9	210.8	215.8	220.9	226.2	231.5
43	191.6	196.1	200.7	205.4	210.3	215.2	220.2	225.3	230.6	235.9	241.3
44	200.6	205.2	209.9	214.8	219.7	224.7	229.8	235.1	240.4	245.9	251.4
45	209.8	214.6	219.4	224.3	229.3	234.5	239.7	245.0	250.5	256.0	261.7
46	219.3	224.1	229.0	234.0	239.2	244.4	249.7	255.2	260.7	266.4	272.1
47	228.9	233.8	238.9	244.0	249.2	254.6	260.0	265.5	271.2	276.9	282.8
48	238.8	243.8	248.9	254.1	259.5	264.9	270.5	276.1	281.9	287.7	293.7
49	248.8	253.9	259.2	264.5	269.9	275.5	281.1	286.9	292.7	298.7	304.8
50	259.1	264.3	269.6	275.1	280.6	286.3	292.0	297.9	303.8	309.9	316.1

Cubic Foot Log Volumes
 Segment length = 20 Ft.

Small End Dia.	Inches of Taper										
	0	1	2	3	4	5	6	7	8	9	10
2	0.4	0.7	1.1	1.6	2.2	2.9	3.7	4.6	5.7	6.8	8.1
3	1.0	1.4	1.9	2.5	3.2	4.0	4.9	5.9	7.1	8.3	9.7
4	1.7	2.2	2.8	3.5	4.4	5.3	6.3	7.5	8.7	10.1	11.6
5	2.7	3.3	4.0	4.9	5.8	6.8	8.0	9.2	10.6	12.1	13.6
6	3.9	4.6	5.5	6.4	7.4	8.6	9.8	11.2	12.7	14.2	15.9
7	5.3	6.2	7.1	8.1	9.3	10.5	11.9	13.4	14.9	16.6	18.4
8	7.0	7.9	8.9	10.1	11.3	12.7	14.2	15.8	17.5	19.3	21.2
9	8.8	9.9	11.0	12.3	13.6	15.1	16.7	18.4	20.2	22.1	24.1
10	10.9	12.1	13.3	14.7	16.1	17.7	19.4	21.2	23.1	25.1	27.3
11	13.2	14.5	15.8	17.3	18.9	20.6	22.4	24.3	26.3	28.4	30.7
12	15.7	17.1	18.5	20.1	21.8	23.6	25.5	27.5	29.7	31.9	34.3
13	18.4	19.9	21.5	23.2	25.0	26.9	28.9	31.0	33.3	35.6	38.1
14	21.4	23.0	24.7	26.5	28.4	30.4	32.5	34.7	37.1	39.5	42.1
15	24.5	26.2	28.0	29.9	32.0	34.1	36.3	38.7	41.1	43.7	46.4
16	27.9	29.7	31.6	33.7	35.8	38.0	40.4	42.8	45.4	48.0	50.8
17	31.5	33.4	35.5	37.6	39.8	42.2	44.6	47.2	49.8	52.6	55.5
18	35.3	37.4	39.5	41.7	44.1	46.5	49.1	51.8	54.5	57.4	60.4
19	39.4	41.5	43.7	46.1	48.5	51.1	53.8	56.6	59.4	62.4	65.6
20	43.6	45.9	48.2	50.7	53.2	55.9	58.7	61.6	64.6	67.7	70.9
21	48.1	50.4	52.9	55.5	58.1	60.9	63.8	66.8	69.9	73.1	76.5
22	52.8	55.2	57.8	60.5	63.3	66.2	69.2	72.3	75.5	78.8	82.2
23	57.7	60.3	62.9	65.7	68.6	71.6	74.7	77.9	81.3	84.7	88.2
24	62.8	65.5	68.3	71.2	74.2	77.3	80.5	83.8	87.3	90.8	94.5
25	68.2	71.0	73.8	76.8	80.0	83.2	86.5	89.9	93.5	97.1	100.9
26	73.7	76.6	79.6	82.7	86.0	89.3	92.7	96.3	99.9	103.7	107.6
27	79.5	82.5	85.6	88.8	92.2	95.6	99.2	102.8	106.6	110.4	114.4
28	85.5	88.6	91.8	95.2	98.6	102.2	105.8	109.6	113.4	117.4	121.5
29	91.7	95.0	98.3	101.7	105.3	108.9	112.7	116.6	120.5	124.6	128.8
30	98.2	101.5	104.9	108.5	112.1	115.9	119.8	123.8	127.8	132.0	136.4
31	104.8	108.3	111.8	115.5	119.2	123.1	127.1	131.2	135.4	139.7	144.1
32	111.7	115.2	118.9	122.7	126.5	130.5	134.6	138.8	143.1	147.5	152.1
33	118.8	122.4	126.2	130.1	134.1	138.1	142.3	146.7	151.1	155.6	160.2
34	126.1	129.9	133.7	137.7	141.8	146.0	150.3	154.7	159.3	163.9	168.6
35	133.6	137.5	141.5	145.6	149.8	154.1	158.5	163.0	167.7	172.4	177.3
36	141.4	145.3	149.4	153.6	157.9	162.4	166.9	171.5	176.3	181.1	186.1
37	149.3	153.4	157.6	161.9	166.3	170.9	175.5	180.3	185.1	190.1	195.1
38	157.5	161.7	166.0	170.4	175.0	179.6	184.3	189.2	194.2	199.2	204.4
39	165.9	170.2	174.6	179.2	183.8	188.5	193.4	198.4	203.4	208.6	213.9
40	174.5	178.9	183.5	188.1	192.9	197.7	202.7	207.7	212.9	218.2	223.6
41	183.4	187.9	192.5	197.3	202.1	207.1	212.2	217.3	222.6	228.0	233.5
42	192.4	197.1	201.8	206.7	211.6	216.7	221.9	227.2	232.6	238.1	243.7
43	201.7	206.4	211.3	216.3	221.3	226.5	231.8	237.2	242.7	248.3	254.0
44	211.2	216.0	221.0	226.1	231.2	236.5	241.9	247.4	253.1	258.8	264.6
45	220.9	225.9	230.9	236.1	241.4	246.8	252.3	257.9	263.6	269.5	275.4
46	230.8	235.9	241.1	246.4	251.8	257.3	262.9	268.6	274.4	280.4	286.4
47	241.0	246.1	251.4	256.8	262.3	268.0	273.7	279.5	285.5	291.5	297.7
48	251.3	256.6	262.0	267.5	273.1	278.9	284.7	290.6	296.7	302.9	309.1
49	261.9	267.3	272.8	278.4	284.2	290.0	295.9	302.0	308.2	314.4	320.8
50	272.7	278.2	283.8	289.6	295.4	301.3	307.4	313.6	319.8	326.2	332.7

APPENDIX A-3 – SCRIBNER VOLUME TABLE

IDAHO SCRIBNER DECIMAL "C" VOLUME TABLE																	
Diam (inch)	Log Length (feet)																
	4	5	6	7	8	9	10	11	12	13	14	15	16	17	18	19	20
3										1	1	1	1	1	1	1	1
4					1	1	1	1	1	1	1	1	1	1	1	1	1
5		1	1	1	1	1	1	1	1	1	1	1	2	2	2	2	2
6		1	1	1	1	1	1	1	1	1	1	1	2	2	2	2	2
7	1	1	1	1	1	1	1	2	2	2	2	2	3	3	3	3	3
8	1	1	1	1	1	1	2	2	2	2	2	2	3	3	3	3	3
9	1	1	1	2	2	2	3	3	3	3	3	3	4	4	4	4	4
10	1	1	2	2	3	3	3	3	3	4	4	5	6	6	6	6	7
11	1	2	2	2	3	3	4	4	4	5	5	6	7	7	8	8	8
12	2	2	3	3	4	4	5	5	6	6	7	7	8	8	9	10	10
13	2	3	4	4	5	5	6	7	7	8	8	9	10	10	11	12	12
14	3	4	4	5	6	6	7	8	9	9	10	11	11	12	13	14	14
15	4	4	5	6	7	8	9	10	11	12	12	13	14	15	16	17	18
16	4	5	6	7	8	9	10	11	12	13	14	15	16	17	18	19	20
17	5	6	7	8	9	10	12	13	14	15	16	17	18	20	21	22	23
18	5	7	8	9	11	12	13	15	16	17	19	20	21	23	24	26	27
19	6	8	9	10	12	13	15	16	18	19	21	22	24	25	27	28	30
20	7	9	11	12	14	16	17	19	21	23	24	26	28	30	31	33	35
21	8	10	12	13	15	17	19	21	23	25	27	28	30	32	34	36	38
22	8	10	13	15	17	19	21	23	25	27	29	31	33	35	38	40	42
23	9	12	14	16	19	21	23	26	28	31	33	35	38	40	42	44	47
24	10	13	15	18	21	23	25	28	30	33	35	38	40	43	45	48	50
25	11	14	17	20	23	26	29	31	34	37	40	43	46	49	52	54	57
26	12	16	19	22	25	28	31	34	37	41	44	47	50	53	56	59	62
27	14	17	21	24	27	31	34	38	41	44	48	51	55	58	62	65	68
28	15	18	22	25	29	33	36	40	44	47	51	54	58	62	65	69	73
29	15	19	23	27	31	35	38	42	46	49	53	57	61	65	68	72	76
30	16	21	25	29	33	37	41	45	49	53	57	62	66	70	74	78	82
31	18	22	27	31	36	40	44	49	53	58	62	67	71	75	80	84	89
32	18	23	28	32	37	41	46	51	55	60	64	69	74	78	83	88	92
33	20	24	29	34	39	44	49	54	59	64	69	73	78	83	88	93	98
34	20	25	30	35	40	45	50	55	60	65	70	75	80	85	90	95	100
35	22	27	33	38	44	49	55	60	66	71	77	82	88	93	98	104	109
36	23	29	35	40	46	52	58	63	69	75	81	86	92	98	104	110	115
37	26	32	39	45	51	58	64	71	77	84	90	96	103	109	116	122	129
38	27	33	40	47	54	60	67	73	80	87	93	100	107	113	120	126	133
39	28	35	42	49	56	63	70	77	84	91	98	105	112	119	126	133	140
40	30	38	45	53	60	68	75	83	90	98	105	113	120	128	135	142	150

Diameter (in)	IDAHO SCRIBNER DECIMAL "C" VOLUME TABLE																
	Log Length (feet) -																
	4	5	6	7	8	9	10	11	12	13	14	15	16	17	18	19	20
41	32	39	48	56	64	72	79	87	95	103	111	119	127	135	143	151	159
42	33	42	50	59	67	76	84	92	101	109	117	126	134	143	151	160	168
43	35	43	52	61	70	79	87	96	105	113	122	131	140	148	157	166	174
44	37	46	56	65	74	83	93	102	111	120	129	139	148	157	166	176	185
45	38	47	57	66	76	85	95	104	114	123	133	143	152	161	171	180	190
46	39	49	59	69	79	89	99	109	119	129	139	149	159	169	178	188	198
47	41	52	62	72	83	93	104	114	124	134	145	155	166	176	186	196	207
48	43	54	65	76	86	97	108	119	130	140	151	162	173	184	194	205	216
49	45	56	67	79	90	101	112	124	135	146	157	168	180	191	202	214	225
50	47	58	70	82	94	105	117	129	140	152	164	175	187	199	211	222	234
51	48	61	73	85	97	110	122	134	146	158	170	183	195	207	219	231	243
52	50	63	76	89	101	114	127	139	152	165	177	190	202	215	228	240	253
53	52	66	79	92	105	118	132	145	158	171	184	197	210	224	237	250	263
54	54	68	82	96	109	123	137	150	164	177	191	205	218	232	246	260	273
55	56	71	85	99	113	127	142	156	170	184	198	212	227	241	255	269	283
56	59	73	88	103	118	132	147	162	176	191	206	220	235	250	264	279	294
57	61	76	91	107	122	137	152	167	183	198	213	228	244	259	274	289	304
58	63	79	95	110	126	142	158	174	189	205	221	237	252	268	284	300	315
59	65	81	98	114	131	147	163	180	196	212	229	245	261	278	294	310	327
60	67	84	101	118	135	152	169	186	203	220	237	253	270	287	304	321	338
61	70	87	105	123	140	158	175	193	210	228	245	263	280	298	315	332	350
62	72	90	108	127	145	163	181	199	217	235	253	271	289	307	325	344	362
63	74	93	112	131	149	168	187	205	224	243	261	280	299	317	336	354	373
64	77	96	116	135	154	174	193	213	232	251	270	290	309	329	348	368	387
65	79	99	119	139	159	179	199	219	239	259	279	299	319	339	358	378	398
66	82	103	123	144	164	185	206	226	247	268	288	309	329	350	370	391	412
67	85	106	127	148	170	191	212	233	254	275	297	318	339	360	381	402	423
68	87	109	131	153	175	197	219	240	262	284	306	328	350	371	393	415	437
69	90	113	135	158	180	203	226	248	271	294	316	339	361	384	406	429	452
70	93	116	139	163	186	209	232	256	279	302	325	349	372	395	419	442	465
71	96	120	144	167	192	215	240	263	287	311	335	359	383	407	430	454	478
72	98	123	148	173	197	222	247	271	296	321	345	370	395	419	444	468	493
73	101	127	152	178	203	229	254	280	305	330	356	381	406	432	457	482	508
74	104	130	157	183	209	236	261	288	314	340	366	393	418	445	471	497	523
75	107	134	161	188	215	242	269	296	323	350	377	404	430	458	484	511	538

APPENDIX A-4 – LENGTH DETERMINATION TABLE

SCALING LENGTH DETERMINATION TABLE							
Measured Log Length	Scaling Length	Butt Segment	Segment Length	Segment Length	Segment Length	Segment Length	Segment Length
8'1" - 8'8"	8						
8'9" - 9'8"	9						
9'9" - 10'8"	10						
10'9" - 11'8"	11						
11'9" - 12'8"	12						
12'9" - 13'8"	13						
13'9" - 14'8"	14						
14'9" - 15'8"	15						
15'9" - 16'8"	16						
16'9" - 17'8"	17						
17'9" - 18'8"	18						
18'9" - 19'8"	19						
19'9" - 20'8"	20						
20'9" - 22'2"	21	11	10				
22'3" - 23'2"	22	12	10				
23'3" - 24'2"	23	12	11				
24'3" - 25'2"	24	12	12				
25'3" - 26'2"	25	13	12				
26'3" - 27'2"	26	14	12				
27'3" - 28'2"	27	14	13				
28'3" - 29'2"	28	14	14				
29'3" - 30'2"	29	15	14				
30'3" - 31'2"	30	16	14				
31'3" - 32'2"	31	16	15				
32'3" - 33'2"	32	16	16				
33'3" - 34'2"	33	17	16				
34'3" - 35'2"	34	18	16				
35'3" - 36'2"	35	18	17				
36'3" - 37'2"	36	18	18				
37'3" - 38'2"	37	19	18				
38'3" - 39'2"	38	20	18				
39'3" - 40'2"	39	20	19				
40'3" - 41'2"	40	20	20				
41'3" - 42'8"	41	14	14	13			
42'9" - 43'8"	42	14	14	14			
43'9" - 44'8"	43	15	14	14			
44'9" - 45'8"	44	16	14	14			
45'9" - 46'8"	45	16	15	14			

SCALING LENGTH DETERMINATION TABLE							
Measured Log Length	Scaling Length	Butt Segment	Segment Length	Segment Length	Segment Length	Segment Length	Segment Length
46'9" - 47'8"	46	16	16	14			
47'9" - 48'8"	47	16	16	15			
48'9" - 49'8"	48	16	16	16			
49'9" - 50'8"	49	17	16	16			
50'9" - 51'8"	50	18	16	16			
51'9" - 52'8"	51	18	17	16			
52'9" - 53'8"	52	18	18	16			
53'9" - 54'8"	53	18	18	17			
54'9" - 55'8"	54	18	18	18			
55'9" - 56'8"	55	19	18	18			
56'9" - 57'8"	56	20	18	18			
57'9" - 58'8"	57	20	19	18			
58'9" - 59'8"	58	20	20	18			
59'9" - 60'8"	59	20	20	19			
60'9" - 61'8"	60	20	20	20			
61'9" - 63'2"	61	16	16	15	14		
63'3" - 64'2"	62	16	16	16	14		
64'3" - 65'2"	63	16	16	16	15		
65'3" - 66'2"	64	16	16	16	16		
66'3" - 67'2"	65	17	16	16	16		
67'3" - 68'2"	66	18	16	16	16		
68'3" - 69'2"	67	18	17	16	16		
69'3" - 70'2"	68	18	18	16	16		
70'3" - 71'2"	69	18	18	17	16		
71'3" - 72'2"	70	18	18	18	16		
72'3" - 73'2"	71	18	18	18	17		
73'3" - 74'2"	72	18	18	18	18		
74'3" - 75'2"	73	19	18	18	18		
75'3" - 76'2"	74	20	18	18	18		
76'3" - 77'2"	75	20	19	18	18		
77'3" - 78'2"	76	20	20	18	18		
78'3" - 79'2"	77	20	20	19	18		
79'3" - 80'2"	78	20	20	20	18		
80'3" - 81'2"	79	20	20	20	19		
81'3" - 82'2"	80	20	20	20	20		
82'3" - 83'8"	81	17	16	16	16	16	
83'9" - 84'8"	82	18	16	16	16	16	
84'9" - 85'8"	83	18	17	16	16	16	
85'9" - 86'8"	84	18	18	16	16	16	
86'9" - 87'8"	85	18	18	17	16	16	

SCALING LENGTH DETERMINATION TABLE							
Measured Log Length	Scaling Length	Butt Segment	Segment Length	Segment Length	Segment Length	Segment Length	Segment Length
87'9"-88'8"	86	18	18	18	16	16	
88'9"-89'8"	87	18	18	18	17	16	
89'9"-90'8"	88	18	18	18	18	16	
90'9"-91'8"	89	18	18	18	18	17	
91'9"-92'8"	90	18	18	18	18	18	
92'9"-93'8"	91	19	18	18	18	18	
93'9"-94'8"	92	20	18	18	18	18	
94'9"-95'8"	93	20	19	18	18	18	
95'9"-96'8"	94	20	20	18	18	18	
96'9"-97'8"	95	20	20	19	18	18	
97'9"-98'8"	96	20	20	20	18	18	
98'9"-99'8"	97	20	20	20	19	18	
99'9"-1 00'8"	98	20	20	20	20	18	
100'9"-101'8"	99	20	20	20	20	19	
101'9"-102'8"	100	20	20	20	20	20	
102'9"-104'2"	101	18	18	17	16	16	16
104'3"-105'2"	102	18	18	18	16	16	16
105'3"-106'2"	103	18	18	18	17	16	16
106'3"-107'2"	104	18	18	18	18	16	16
107'3"-108'2"	105	18	18	18	18	17	16
108'3"-109'2"	106	18	18	18	18	18	16
109'3"-110'2"	107	18	18	18	18	18	17
110'3"-111'2"	108	18	18	18	18	18	18
111'3"-112'2"	109	19	18	18	18	18	18
112'3"-113'2"	110	20	18	18	18	18	18
113'3"-114'2"	111	20	19	18	18	18	18
114'3"-115'2"	112	20	20	18	18	18	18
115'3"-116'2"	113	20	20	19	18	18	18
116'3"-117'2"	114	20	20	20	18	18	18
117'3"-118'2"	115	20	20	20	19	18	18
118'3"-119'2"	116	20	20	20	20	18	18
119'3"-120'2"	117	20	20	20	20	19	18
120'3"-121'2"	118	20	20	20	20	20	18
121'3"-122'2"	119	20	20	20	20	20	19
122'3"-123'2"	120	20	20	20	20	20	20

APPENDIX A-5 – TAPER TABLE

Standard tapers have been developed for determining midpoint diameters on multi-segment, butt-cut logs produced from timber growing in most areas of Idaho as well as neighboring states. For uniformity and consistency in determining gross scale of butt-cut logs, standard taper represents the average taper of different tree species growing within broad geographic areas.

Application of standard taper rules is based upon “point of origin” of timber growth (example: a log produced from a tree growing in Region 1 uses Region 1 taper rules, regardless of the location where it may be physically scaled). Certain log lengths, or some regions, have no prescribed standard taper and must use actual taper to determine midpoint diameters. Actual taper is best determined by making caliper measurements.

MIDPOINT TAPER ON MULTI-SEGMENT BUTT LOGS		
<p>Region 1 - North Idaho Area (North of the Salmon River, including all of Idaho county except that portion which is both south of the main Salmon river and east of the Little Salmon River. Also includes western Montana, and the northeastern Washington area bounded by the Snake River on the south, to the Columbia River, north to the Okanogan River, north to Canada)</p> <p>--- Midpoint taper(s) shall be a standard taper as follows:</p>		
Larch & Lodgepole Pine	21'-48'	Shall be 1-inch per segment.
Larch & Lodgepole Pine	49'-60'	Shall be 2-inch top segment, 1-inch remaining segment.
Cedar	21'-40'	Shall be 2-inches per segment.
All Other Species	21'-40'	Allow 1-inch taper on pieces with an odd top diameter; allow 2-inch taper on pieces with an even top diameter (Odd-Even Rule).
All Species (except Larch & Lodgepole Pine)	41'-60'	Take two measurements, small end and 16' up from the butt. The diameter at the 16' measurement point shall be determined by actual measure. Apply calculated taper distribution to determine scaling diameter of the second segment.
All Species	61' and longer	Take two measurements, small end and top of the second segment up from the butt. The top diameter of the second segment shall be determined by actual measure. Apply calculated taper distribution to top segment(s) and standard taper rule for the appropriate species to bottom segment.
<p>Region 2 - East-Central Idaho Area (Includes these counties: Lemhi, Custer, Butte, Bingham, Power, Oneida, Franklin, Bear Lake, Bannock, Caribou, and that portion of Bonneville lying south of the Snake river)</p> <p>--- All midpoint taper(s) shall be determined on the basis of actual taper.</p>		
<p>Region 3 - Eastern Idaho Area (All counties lying to the east and north of Region 2, and including all of the Targhee National Forest)</p> <p>--- Midpoint taper(s) shall be a standard or actual taper as follows:</p>		
Douglas Fir & Alpine Fir & Engelmann Spruce	21' - 40'	Shall be 2-inch standard taper.
Lodgepole Pine	21' - 31'	Shall be 1-inch standard taper
Lodgepole Pine	32' - 40'	Shall be 2-inch standard taper.
Any Species	41' and longer	Shall be actual taper.

MIDPOINT TAPER ON MULTI-SEGMENT BUTT LOGS

Region 4 - Southwest Idaho Area (South of the Salmon River, including that portion of Idaho county which is both south of the main Salmon river and east of the Little Salmon River. Includes all counties lying to the west of Region 2)

--- Midpoint taper(s) shall be a standard or actual taper as follows:

Larch	21'- 40'	Shall be 1-inch standard taper.
All Other Species	21'- 40'	Shall be 2-inch standard taper.
Any Species	41' and longer	Shall be actual taper.

Region 5 – Nevada-Utah-Wyoming Area (Adjoining states to the south or east of southern Idaho)

--- All midpoint taper(s) shall be determined on the basis of actual taper.

Region 6 – Southeast Washington & East Oregon Area (South of the Snake River and east of the foothills in the Cascade mountain range)

--- Midpoint taper(s) shall be a standard or actual taper as follows:

Larch	21'- 40'	Shall be 1-inch standard taper.
All Other Species	21'- 31'	Shall be 1-inch standard taper.
All Other Species	32'- 40'	Shall be 2-inch standard taper.
Any Species	41' and longer	Shall be actual taper.

Region 7 – All Other Areas (Includes logs produced from timber growing in any area other than Regions 1 through 6)

--- All midpoint taper(s) shall be determined on the basis of actual taper.

APPENDIX A-6 – COMMON ROTS OF IDAHO LOGS

A-6.1 GENERAL	111
A-6.2 TRUNK ROTS	112
A-6.21 Paint Rot (<i>Echinodontium tinctorium</i>)	112
A-6.22 Fomes or Pini Rot (<i>Phellinus pini</i>)	114
A-6.23 Red Ray or Anceps Rot (<i>Dichomitus squalens</i>)	117
A-6.24 Brown Top Rot (<i>Fomitopsis roseus</i>)	118
A-6.25 Quinine Rot (<i>Fomitopsis officinalis</i>)	118
A-6.26 Yellow Pitted Trunk Rot (<i>Hericium abietis</i>)	119
A-6.3 BUTT ROTS	120
A-6.31 Red-Brown Butt Rot (<i>Phaeolus schweinitzii</i>)	120
A-6.32 Feather Rot (<i>Perenniporia subacida</i>)	121
A-6.33 Weirii Butt Rot (<i>Phellinus weirii</i>)	121
A-6.34 Brown Pocket Rot of Cedar (<i>Postia sericeomollis</i>)	122
A-6.35 Red Root and Butt Rot (<i>Inonotus tomentosus</i>)	123
A-6.36 Annosus Root or Butt Rot (<i>Heterobasidion annosum</i>)	124
A-6.37 Big White Pocket Rot (<i>Phellinus nigrolimitatus</i>)	124
A-6.38 Shoestring Root Rot (<i>Armillaria ostoyae</i>)	125
A-6.39 Brown Cubical Rot (<i>Laetiporus sulphureus</i>)	125
A-6.4 SAP ROTS AND STAINS	126
A-6.41 Gray-Brown Sap Rot (<i>Cryptoporus volvatus</i>)	126
A-6.42 Pitted Sap Rot (<i>Trichaptum abietinum</i>)	126
A-6.43 Brown Pocket Sap Rot (<i>Lenzites saepiaria</i>)	127
A-6.44 Brown Crumbly Rot (<i>Fomitopsis pinicola</i>)	128
A-6.45 Blue and other Sap Stains	128

A-6.1 GENERAL

Much of the deductible volume loss in scaling is caused by the feeding activity of fungi, resulting in the decay or breakdown of wood cells. Fungi organisms have microscopic filaments that are able to penetrate, breakdown, and use wood cells as food. After this feeding activity and resulting decay of wood has progressed to an advanced stage, reproductive structures commonly known as “conks” develop on the decaying wood. In log scaling, these conks are sometimes helpful as indicators in determining extent of decay, but a scaler often recognizes the presence of rot by its appearance on the end of a log. Conks occasionally remain on logs, but generally are dislodged before the log reaches the landing where the scaler is working.

For the most part, rots of living trees are confined to the heartwood and dead sapwood around wounds. Most wood decay fungi do not invade living sapwood. On dead trees and logs, the reverse is true. The sapwood deteriorates rather rapidly while the heartwood is usually considerably more resistant to decay. Many decay fungi affect heartwood of living trees as well as the sapwood and heartwood of dead material. Some are important only as heart rot fungi, and others are known to cause decay in dead material only. On this basis, rots can be classified as heart rots and sap rots.

Many of the heart rot fungi are found only in the roots and the butt of a tree. These fungi generally enter the tree through the roots or through basal injuries, such as fire scars where dead sapwood is adjacent to heartwood. Other decay fungi are usually found in the upper or middle trunk. These fungi enter the tree through branch stubs, broken tops, or other injuries. Because of this localization in the tree, heart rots are frequently categorized as trunk rots or butt rots. The term “root rot” is also commonly used for butt rots that gain entrance to the tree through the roots.

The color and consistency of decayed wood also serves as a basis for classifying rots into two groups, the brown rots and white rots. Most of the brown rot fungi feed almost exclusively on the cellulose of wood cells and leave behind a brown, crumbly mass, usually made up of more or less cubical chunks. A few of the brown rot fungi break down the wood into a brownish, stringy or laminated residue. The white rot fungi feed on all components of wood cells and the resulting rots are more varied in appearance than the brown rots. Some have the decay localized in relatively small pockets in the wood, giving it a pitted or honeycombed appearance. Sometimes, firm and apparently sound wood may separate pockets of decay. Other white rot fungi break down the wood cells into a uniform white, mottled, spongy, or stringy residue.

Early stages of decay can often be recognized by definite discoloration of the wood before there is any noticeable change in its other properties. In the case of white rots, the strength properties of the wood may not be seriously affected in this early stage of decay. In the early stage of the brown rots, however, the wood may have suffered a serious decrease in strength properties, even though there is little or no evidence of change to the naked eye.

Diagrams and methods of deducting for defects due to various fungi and accompanying rots will be found on the following pages. *However, the scaler must bear in mind that no hard and fast rule can always be applied, inasmuch as the extent of damage to individual trees will vary with the age of the tree, the length of time that the fungus has been active in the tree, and the region in which the tree grew.* It cannot be over-emphasized that the scaler must consistently scale each log upon its own individual merits, regardless of the species being scaled or defects being considered. A prime requisite for any scaler is “good judgment” which is based upon experience and the observation of how various rots affect defective logs. This includes deciding if rot is in initial or advanced stages, recognition of external indicators to judge extent of decay, and knowledge of rot characteristics in specific stands of timber.

The exact number of wood-rotting fungi in Idaho is not known, but an estimate of 1,000 species would be quite conservative. Most of the rot that is encountered by the scaler, however, is caused by a very small number of fungi. The rots of major importance for log scaling in Idaho, and a category on sapwood stain, are arranged and categorized as trunk rots, butt rots, and sap rots.

TRUNK ROTS

1. **Paint Rot.** Caused by *Echinodontium tinctorium*
2. **Fomes or Pini Rot.** Caused by *Phellinus pini*
3. **Red Ray or Anceps Rot.** Caused by *Dichomitus squalens*
4. **Brown Top Rot.** Caused by *Fomitopsis roseus*
5. **Quinine Rot.** Caused by *Fomitopsis officinalis*
6. **Yellow Pitted Trunk Rot.** Caused by *Hericium abietis*

BUTT ROTS

7. **Red-Brown Butt Rot.** Caused by *Phaeolus schweinitzii*
8. **Feather Rot.** Caused by *Perenniporia subacida*
9. **Weirii Butt Rot.** Caused by *Phellinus weirii*
10. **Brown Pocket Rot of Cedar.** Caused by *Postia sericeomollis*
11. **Red Root and Butt Rot.** Caused by *Inonotus tomentosus*.
12. **Annosus Root or Butt Rot.** Caused by *Heterobasidion annosum*
13. **Big White Pocket Rot.** Caused by *Phellinus nigrolimitatus*
14. **Shoestring Root Rot.** Caused by *Armillaria ostoyae*
15. **Brown Cubical Rot.** Caused by *Laetiporus sulphureus*

SAP ROTS AND STAINS

16. **Gray-Brown Sap Rot.** Caused by *Cryptoporus volvatus*
17. **Pitted Sap Rot.** Caused by *Trichaptum abietinum*
18. **Brown Pocket Sap Rot.** Caused by *Lenzites saepiaria*
19. **Brown Crumbly Rot.** Caused by *Fomitopsis pinicola*
20. **Sap Stain or Blue Stain.** Caused by *Ceratocystis*, *Graphium*, and *Leptographium*

A-6.2 TRUNK ROTS

A-6.21 Paint Rot (*Echinodontium tinctorium*)

Caused by *Echinodontium Tinctorium*. This rot is also called “Indian paint” rot or brown stringy rot, and is the most common defect found in both Grand fir and Hemlock in Idaho.

Species Affected. Primarily Grand fir, White fir, and Western hemlock. Subalpine fir and Mountain hemlock are frequently affected. Engelmann spruce, Western larch, Douglas fir, and Western red cedar are occasional hosts. Paint rot is reported in a few other Idaho conifers. It does not occur in hardwoods.

Rot Description. Paint rot, which is of major importance as a trunk rot of living fir and Hemlock, usually enters the tree through branch stubs or frost cracks. Decay of slash is of little importance, as the fungus apparently does not invade dead trees and logs. The first visible evidence of decay in the heartwood is a faint yellowish discoloration. In this stage, separation of the wood along the annual rings tends to develop, especially after drying. As decay progresses, the color darkens, a definite ring shake develops, and orange or rusty-red streaks appear in the wood. In the late stages of decay, the wood breaks down into a brownish stringy mass. In larger trees, the rot may destroy the entire heartwood of the trunk down to the roots and may extend into the heartwood of larger branches. Infections of long standing may leave portions of the trunk virtually hollow. On ends of logs, the decay is usually seen as a ring, a solid circular core of discolored softened heartwood, or as a hollow lined with soft, Paint wood.

Indicators of Decay. Conks of *Echinodontium Tinctorium* are perennial, woody, and generally develop under branch stubs. The upper surface becomes blackened and extensively cracked. Coarse cream-colored to grayish spines form the under surface. The interior tissue of the conk, including the spines, is a distinctive orange or rusty-red color. Frequently the knots where conks develop show a similar orange or rusty-red discoloration cause by the build-up of fungous tissue in the later stages of decay. These are known as “paint knots”, and after the conks have fallen or have been knocked from the tree during logging operations, they provide a reliable indication of decay in the heartwood.

Whenever the butt log shows shake and stain, the log should be thoroughly inspected for the fruiting bodies of this rot or paint knots. Shake and stain are indicators of this defect. Because of the heavy water content of the extreme butts on Grand fir, White fir, and Hemlocks, the rot does not break down the wood fiber as quickly as it does in the upper portions of the tree.

Extent of Decay. For all species affected by *Echinodontium Tinctorium*, when nothing is evident to determine the overall extent of decay to the contrary, estimate that rot will extend 4 feet up (towards the top) and 6 feet down (towards the butt) from a conk or paint knot, and affect the entire area of the heartwood. The deduction most often is made by the length-cut method for the extent of the defect.

Figure A6-1 shows a 16-foot, 16-inch sed, 18-inch led, Grand fir log with a small dark stain and a little growth ring separation in the butt. Upon closer examination, a paint knot is discovered 10 feet up from the butt. It is estimated the rot will extend 4 feet up (towards the top) and 6 feet down (towards the butt) from the paint knot. With no 6-foot lumber remaining above or below the rot, the log is a cull sawlog.

Figure A6 - 1

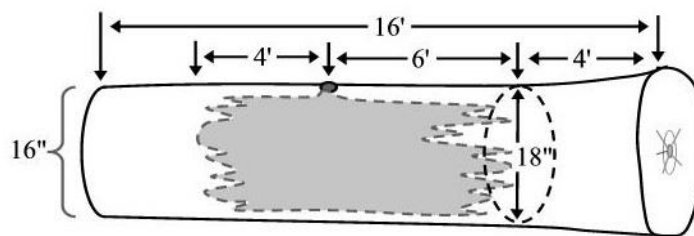

An exception to the length-cut approach may occur on logs where strong evidence exists that the overall extent of decay is contrary to the “4 feet up, 6 feet down” default rule. These situations are rare, but a scaler may occasionally encounter them.

Figure A6-2 is an example of this situation, the log shows no evidence of rot on the end, but has one, lone, paint knot located one foot from the log end. It is obvious that the rot is not affecting 4 feet up from the indicator, and it would be reasonable to assume the rot will not affect 6 feet down from the indicator. Using “good scaler judgment”, a pie-cut deduction of one-half of 2 feet, (one-foot length-cut) is made rather than an 8-foot length-cut. Gross volume is 15.9 cf, defect is 1.0 cf, net 14.9 cf. Scribner gross of 10 bds, defect 1 bd, net of 9 bds, (decimal “C”).

Figure A6 - 2

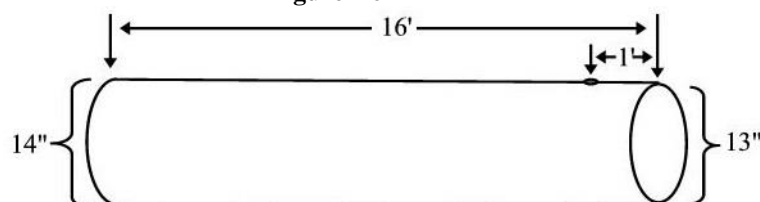

Use the exception to the length-cut approach only when careful examination of the log ends, and careful examination of the log's length for indicators of decay, reveals minimal or no rot. Do not use this approach when a paint knot is located 3 feet or more from the log end, or if more than one indicator knot is found on the log segment in question.

Indicators of paint rot are often difficult to find. Thoroughly examine suspected logs for knot indicators of this defect. They are often found around unusual swellings, in sucker knots, on logs with crook or sweep, and logs with frost check or ring shake defects. Even though log ends are sound, the presence of even one, small indicator of decay located near the middle of a log segment will often cull it, unless 6-foot lumber recovery is determined above or below the extent of decay.

Figure A6-3 shows a 16-foot, 15-inch sed, 16-inch led, Hemlock with a paint conk located 5 feet up from the large end. It is estimated the rot will extend up an additional 4 feet from the conk for a total of 9 feet. When defecting, lumber recovery must be in 2-foot multiples, the rot is extended one additional foot resulting in a 6-foot lumber length. Gross volume is 21.0 cf, defect is 13.1 cf, and net scale is the volume of a 6-foot, 15-inch log, which is 7.9 cf. Scribner gross of 14 bds, defect 9 bds and net of 5 bds).

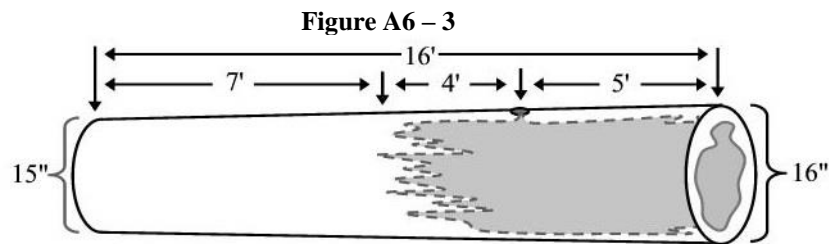

A-6.22 *Fomes* or *Pini* Rot (*Phellinus pini*)

Caused by *Phellinus Pini* (also called *Fomes Pini* in older literature). This rot is commonly referred to as *Pini* and may also be called conk rot, ring rot, red rot, honeycomb rot, white speck, or white pocket rot.

Species Affected. All Idaho conifers may be hosts. This rot is of particular importance in White pine, Ponderosa pine, Lodgepole pine, Western larch, Douglas fir, and Engelmann spruce.

Rot Description. *Fomes* rot is primarily a heart rot of living trees. Decay may continue in dead standing trees or in fallen trees, but it is not an important factor in the decay of slash. The fungus usually enters the tree through branch stubs and causes a trunk rot, but it occasionally enters through basal scars and causes a butt rot. In the early stages of decay, the wood shows a pinkish to purplish-red discoloration. As decay progresses, small, white, lens-shaped pockets develop parallel to the grain. The wood between these pockets is discolored but firm. On ends of logs, the discoloration and pockets are often localized in crescent-shaped areas or in more or less concentric rings. Frequently, however, the pockets are uniformly scattered throughout the decaying wood with no definite pattern of arrangement. A pronounced ring shake may develop as a result of the rapid deterioration of the springwood and the separation of the wood along the annual rings.

Indicators of Decay. The brownish, perennial conks of *Phellinus Pini* usually develop at branch stubs or on basal scars. They vary from thin and bracket-shaped to thick and hoof-like. The under surface and margin of growing conks is a bright yellowish-brown with large irregular pores, and the upper surface is dark brown to blackish with concentric zones and furrows. Interior tissue of the conks is yellowish-brown and firm. Older conks may be from several inches to as much as one foot in diameter, but they generally fall off before reaching that size. Brown punky knots, not to be confused with dead rotten knots, indicate decay in the heartwood. The location of punky knots may be indicated by conspicuous swellings commonly called "swollen knots". Where punky knots have healed over with no conspicuous swelling, chopping through the bark into the knot can reveal them.

Extent of Decay. For all species except White pine, when nothing is evident to determine the overall extent of decay to the contrary, estimate that rot will extend 4 feet up (towards the top) and 6 feet down (towards the butt) from a conk or punky knot, and affect the entire area of the heartwood. In most instances, the full diameter of the log is lost. The deduction most often is made by the length-cut method for the extent of the defect.

Figure A6-4 shows a 20-foot Western larch 14-inch sed, 15-inch led, with a single *fomes* conk located 8 feet up from the butt. There are no other visible indicators showing the extent of decay therefore, it is estimated the rot will extend 4 feet up (towards the top) and 6 feet down (towards the butt) from the conk. Since the rot affects the entire area of the heartwood the length-cut procedure is generally used. Measuring from the butt end to 4 feet above the conk will require a 12-foot length-cut. Gross scale is 23.0 cf, net scale is 9.2 cf. Defect is the difference between gross and net ($23.0 - 9.2 = 13.8$ cf defect). Scribner gross 14 bds, defect 8 bds, net is 6 bds, the volume of an 8-foot log.

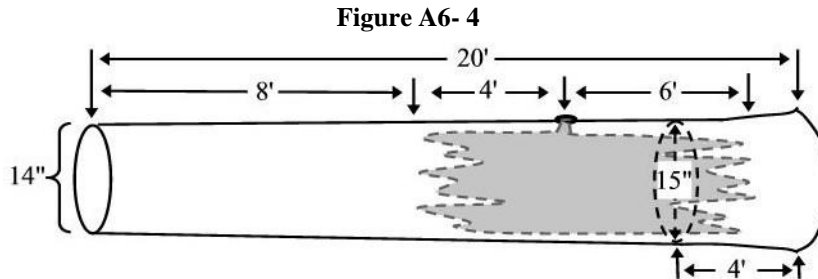

An exception to the length-cut approach may occur on logs with very thick sapwood. An example of this would be an old-growth, Ponderosa pine that may have sapwood as much as 12 inches thick, depending upon the age of the tree and the locality in which the tree grew. Instead of a length-cut, use the squared-defect deduction for the heartwood, plus deduction for any punky knot(s) associated with the defect, when it would leave net scale of 33-1/3% or better for the affected length.

Figure A6-5 shows a 12-foot old-growth Ponderosa pine, with a 36-inch sed, and 38-inch led. There is a *fomes* conk located 5 feet up from the butt or large end with 16 inches of rot visible on the large end, and 14 inches on the small end of the log. Due to very thick sapwood, the squared defect procedure is used.

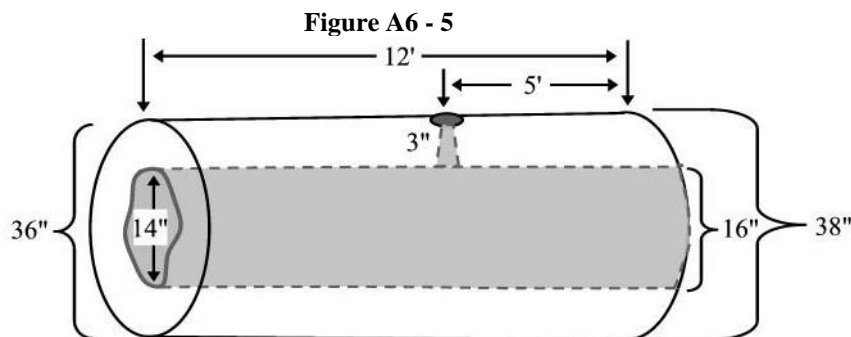

For cubic average $14'' + 16'' = 30 \div 2 = 15$ inches, using squared defect enter 15×15 for 12 feet = 18.8 cf. Since the length of the log segment is shorter than 16 feet, Scribner requires only the large end defect dimensions are used to calculate the deduction. 16×16 for 12' = 23 bds. An additional deduction for the conk knot may also be needed. The height of the conk is determined by subtracting the mid-point defect size of 16" (waste included) from 36" (the diameter) and dividing by 2 ($36 - 16 = 20 \div 2 = 10$). Remember the handheld programs automatically add 1-inch for waste for Scribner and not for cubic. The additional defect for the conk is entered as $3'' \times 9'' \times 6'$, for 1.1 cf and 2 bds. Gross scale of 89.7 cf, defect of 19.9 cf, and net of 69.8 cf. Scribner gross of 69 bds, 25 bds defect, 44 bds net.

In White pine species, when nothing is evident to determine the overall extent of decay to the contrary, estimate that rot will extend 2 feet up (towards the top) and 4 feet down (towards the butt) from a conk or punky knot, and affect one-half (1/2) of the area of the heartwood. When the rot has been developing for a long period of time, as in mature timber, the rot may extend further up and down from the indicator of decay. Since White pine has relatively thin sapwood, the loss for this defect is made by the pie-cut method – one-half (1/2) of the scaling cylinder for the length affected.

Figure A6-6 shows a 16-foot, 14-inch sed, and 16-inch led, White pine with a *fomes* conk located 7 feet up from the large end. It is estimated that rot will extend 2 feet up (towards the top) and 4 feet down (towards the butt) from the conk for total of 6 feet and will affect 1/2 of the cylinder. This leaves 7-foot lumber on the top end; lumber recovery lengths must be in 2-foot multiples, the defect is extended one-foot leaving a 6-foot lumber length. Using the pie-cut method: one-half of 10 feet is converted to a 5-foot length cut. Net scale would be 13.5 cubic feet or 8 decimal "C", the volume of an 11-foot, 14-inch log.

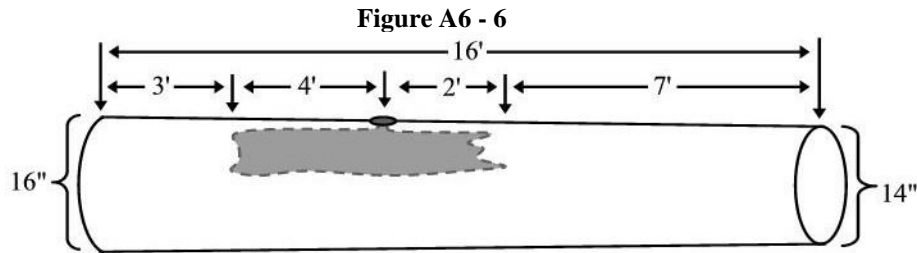

When the extent of decay from rot is determined to leave less than six feet merchantable lumber length, treat the defect as extending to the end of the log segment.

Figure A6-7 shows a 20-foot, 10-inch Western larch with a *fomes* conk located 11 feet up from the large end. It is estimated that rot will extend 4 feet up (towards the top) and 6 feet down (towards the butt) from the conk leaving only 5-foot lumber on each end of the log. Since 5-foot does not meet the minimum lumber length, the log is a cull sawlog.

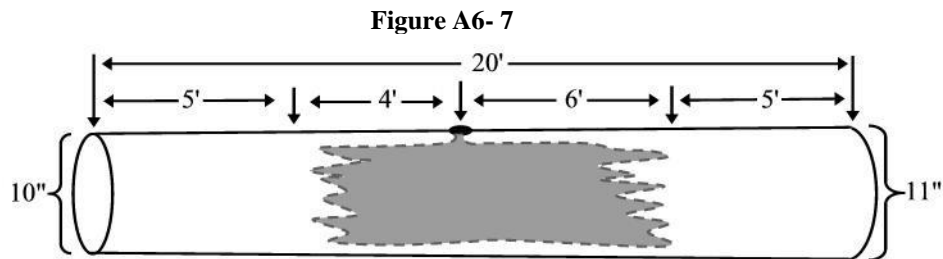

It is not uncommon for the ends of logs to show no visible signs of rot. A scaler should closely examine suspected logs for rot indicators away from the log ends. Chop swollen knots, depressions, or sucker limbs to reveal the brown, punky indicators of decay.

Figure A6-8 shows a 24-foot second-cut Douglas fir log, with diameter measurements of 14 inches on the small end and 17 inches on the large end. The log has a single *fomes* conk located 11 feet up from the butt or large end. It is estimated that rot will extend 4 feet up (towards the top) and 6 feet down (towards the butt) from the conk. Since the butt end does not have the minimum 6-foot lumber length remaining, it is culled for sawlog. The small end has a total of 9 feet remaining however, when defecting lumber lengths must be in 2-foot multiples. The defect must be extended an additional 1-foot, leaving 8-foot of the top segment merchantable. Gross volume for the 24-foot log would be 32.6 cf, defect is 22.7 cf, for a total net volume of 9.9 cf. Scribner gross of 21 bds, defect 15 bds and net of 6 bds.

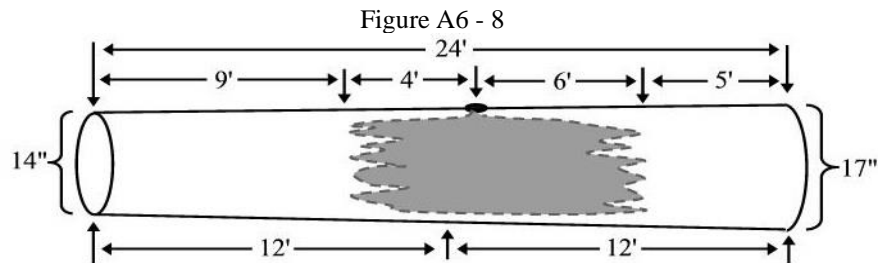

Occasionally, *fomes* rot may be visibly apparent on the log end(s), but careful examination of the log reveals no indicators of decay. Deduction is made by length-cut or pie-cut (or possibly the squared-defect method), using “good judgment” for determining extent of decay. It is important that the scaler, regardless of the species being scaled, consistently scale each log segment on its own merits.

Figure A6-9 shows a 16-foot, 17-inch sed, 18-inch led, White pine with *fomes* rot affecting one-third of 2 feet on the butt end. Using the pie-cut method: $1/3$ of 2' = .66 raises to 1 for a 1-foot length-cut. The gross scale is 26.7 cf, defect 1.7 cf, net scale is 25.0 cf. Scribner gross of 18 bds, defect 1 bd and net of 17 bds.

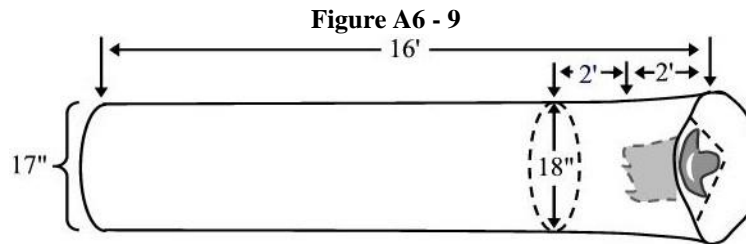
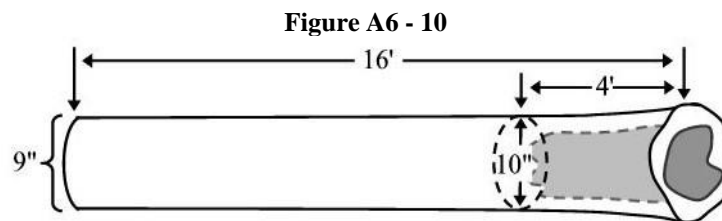

Figure A6-10 shows a 16-foot, 9-inch sed, 10-inch led, Lodgepole pine with *fomes* affecting the entire heartwood on the butt end. After careful examination of the log, no visible indicators such as conks, catfaces, scars, or swells were discovered. Due to the severity of the rot, it is estimated to extend up the log 3 to 4 feet requiring a 4-foot length-cut deduction. Gross scale of 7.9 cf, defect 2.0 cf, net of 5.9 cf. Scribner gross scale is 4 bds, defect is 1 bd, net scale is the volume of a 12-foot, 9-inch log which is 3 bds.



A-6.23 Red Ray or Anceps Rot (*Dichomitus squalens*)

Caused by *Dichomitus Squalens* (also called *Polyporus Anceps* in older literature). This rot is also called wagon wheel rot, red heart, or western red rot.

Species Affected. This is a heart rot primarily seen in Ponderosa pine and Lodgepole pine but also affects other Idaho conifers. It can continue decaying as a slash rot.

Rot Description. Red ray rot is common in living Ponderosa pine and Lodgepole pine, entering mainly through broken tops and dead branches. It causes a trunk rot in these species that also can continue to decay as a slash rot. In the early stages of decay the wood develops a reddish-brown discoloration. Later, small white pockets of advanced decay develop parallel to the grain. These pockets are usually poorly defined, have blunt or almost square ends, and tend to run together. Usually the wood between the pockets is considerably softer than the sound wood, and eventually the wood becomes a white spongy mass. In the heartwood, the rot typically develops in distinct radial zones from the center of the tree. This distinctive radial pattern on the ends of logs is characteristic of this rot. However, as decay progresses, the entire heartwood may be invaded and this radial pattern will not be apparent.

Indicators of Decay. The conks do not ordinarily develop on living trees, but are usually present on stumps, decaying logs, and slash. They are annual, white, crust-like, and bracket-shaped. Although rather tough, they usually deteriorate rapidly. On dead material, a conspicuous white mat of fungous tissue develops between the bark and the wood.

Extent of Decay. The extent of the rot column will vary with the size of the timber, and from one locality to another. In earlier stages of decay, the defect appears as a cylinder or hole. In advanced stages of decay, the defect affects the entire heartwood. Since conks do not ordinarily develop on living trees, indicators are normally lacking and the scaler must estimate extent of decay based upon rot appearance on the ends of logs.

On Ponderosa pine logs, evidence for extent of decay may sometimes show as a purplish discoloration in the heartwood of knots that is radial or spoke-shaped (“wagon wheel rot”). Rot is estimated to extend 4 feet beyond this type of indicator. On Lodgepole pine logs, evidence for extent of decay may sometimes be found by chopping through the thin sapwood to find rot in the heartwood.

Deduction for this defect is made by squared-defect or pie-cut method in early stages of decay, or most often by length-cut in advanced stages of decay.

Figure A6-11 shows a 16-foot, 12-inch sed, 13-inch led Lodgepole pine with 5 inches of red ray rot showing on the butt end. The rot is estimated to be in the early stages and will not extend beyond 4 feet on this log. Using the squared-defect method, enter a 5" x 5" x 4' for 0.7 cubic feet. Gross is 13.7 cf, defect 0.7 cf, net of 13.0 cf. Scribner gross volume is 8 bds, defect is 1 bd, and net volume is 7 bds.

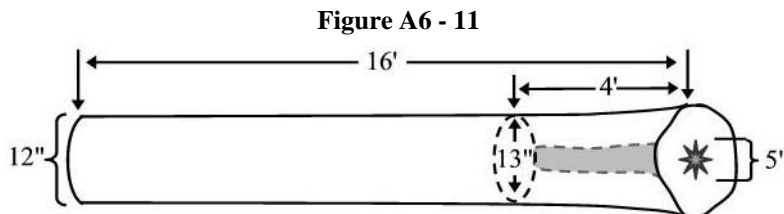
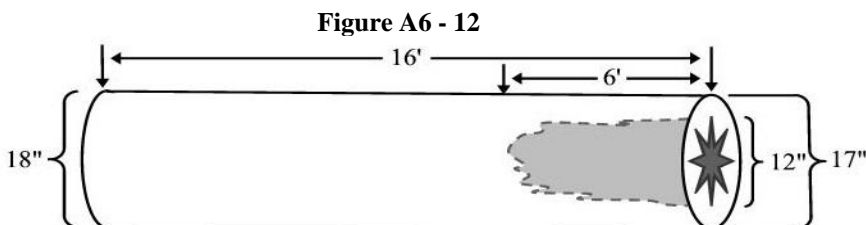

Figure A6-12 shows a 16-foot, 17-inch sed, 18-inch led, Ponderosa pine log with 12 inches of red ray rot visible in the small end. The rot is estimated to extend 6 feet down the log. Using the squared-defect method, if you enter a 12" x 12" x 6' for a deduction of 6.0 cf, for Scribner, one inch of waste was added to the height and width of the defect, 12" + 1" = 13" x 13" = 169 x 6' (length of the defect) = 1014 / 15 = 67.6 rounds to 70 or 7 bds (decimal "C"). Remember, Scribner is the driver, when the squared defect equals or exceeds the volume of the portion affected, you must use the length-cut method. In this instance a 6-foot, 17-inch log scales 60 bf, which is less than the squared defect deduction of 70 bf. Therefore, the proper defect deduction for this log would be a 6-foot length-cut. Cubic gross volume is 26.7 cf, defect is 10.0 cf, and net is 16.7 cf. Scribner gross volume is 18 bds, defect is 6 bds, and net would be 12 bds.



A-6.24 Brown Top Rot (*Fomitopsis roseus*)

Caused by *Fomitopsis Roseus* (also called *Fomes Roseus* in older literature). Sometimes called *Fomitopsis cajanderi*, red fomes rot, or rose conk.

Species Affected. Primarily seen in Douglas fir, Western larch, and Lodgepole pine, this may also be found in other conifers.

Rot Description. This heart rot generally enters the tree through broken tops, localizes in the top of the tree, and is often limited to the unmerchantable top portion. This top rot is most common in Douglas fir. The rot also occurs in stumps, dead trees, and stored logs. A yellowish-brown to dark brown discoloration develops in the early stage of decay. The advanced stage is characterized by the formation of irregular, crumbly, brown cubes. Thin whitish, or pale and rose-colored fungous tissue sometimes develops in the cracks between the cubes of decayed wood.

Indicators of Decay. The conks of *Fomitopsis Roseus* are perennial, woody, and bracket-like to hoof shaped. The upper surface is brown to black and is usually cracked and roughened. The under surface has small circular pores and is rose-colored, as is the inner tissue of the conks. Although old broken tops may indicate the presence of this rot, they are not a specific indication, as other decay fungi may also invade tops.

Extent of Decay. Brown top rot is usually confined to the top portion of the trunk and, in some cases, may require culling the log. In Lodgepole pine, this rot very often goes the full length of the trunk and necessitates culling the entire tree. Because this defect is generally confined to the top portion of the tree and affects the entire heartwood, the method of deduction most commonly used is a length-cut for the part affected.

A-6.25 Quinine Rot (*Fomitopsis officinalis*)

Caused by *Fomitopsis Officinalis* (also called *Fomes Laricis* in older literature). Also called brown trunk rot, or dry rot, or red-brown heart rot.

Species Affected. Douglas fir, Western larch, and Ponderosa pine are the most common hosts. It also occurs in White pine, Engelmann spruce, Lodgepole pine, Western hemlock, and true firs. Hardwoods are not affected.

Rot Description. This rot is one of the major heart rots of living western conifers and continues its decaying action in logs and stumps. The fungus generally enters the heartwood through broken tops and branch stubs, and the rot is common in the upper and middle portions of the trunk. When basal scars are invaded, decay occurs in the butt of the tree. A yellowish to light reddish-brown discoloration marks the early stage of decay. As decay progresses, the wood becomes softer and eventually breaks down into a crumbly mass of yellowish-brown to reddish-brown cubical chunks that are interwoven with extensive mats of whitish, resinous fungous tissue. These mats may become 1/4-inch thick and cover several square feet. On ends of logs, the early stages of decay appear in roughly circular areas of yellowish-brown to reddish discoloration. In the late stages, these circular areas show extensive radial and concentric cracks filled with white mats of fungous tissue.

Indicators of Decay. Conks of *Fomitopsis Officinalis* develop only after extensive decay in the heartwood. They are perennial, hard, and chalky; after many years of development, they tend to be long and cylindrical in shape. The tissue is white, chalky, and tastes extremely resinous and bitter. The outer layers of tissue usually become grayish or black and extensively cracked, while the under surface is white with small pores. Broken tops often indicate the presence of Quinine rot, although other decay fungi may invade top injuries.

Extent of Decay. The rot is quite extensive and the presence of a single conk may indicate the tree is a cull. Quinine fungus is most common as a trunk rot, but it sometimes occurs as a butt rot entering fire scars or cat faces. Methods used to deduct for this defect in advanced stages are to make a length-cut deduction, or when the defect appears as a cylinder or hole use the squared-defect method.

Figure A6-13 shows a 32-foot Douglas fir, 18 inches on the small end and 21 inches on the large end. The log shows quinine rot in the top end. Closer examination reveals a conk knot in each segment resulting in a cull sawlog. It is common for quinine rot to run in pockets with small unaffected areas between the pockets. Do not assume a few sound knots above or below a conk knot means the remaining portion of the log is sound. Gross volume is 68.3 cf, defect is 68.3 cf, net sawlog volume is 0 cf.

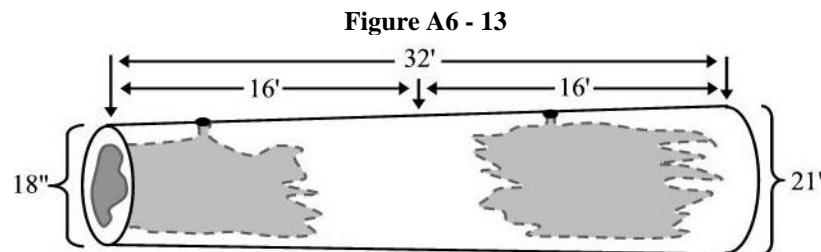

A-6.26 Yellow Pitted Trunk Rot (*Hericium abietis*)

Caused by *Hericium Abietis* (also known as *Hydnum Abietis* in older literature).

Species Affected. Western hemlock, Grand fir, Subalpine fir, and Engelmann spruce.

Rot Description. This rot occurs frequently in the heartwood of living true fir and hemlock and is common in stumps, snags, and fallen trees. It also continues to develop in stored logs. In the early stages of decay, the wood remains firm but develops a yellow or pale brownish discoloration and often appears mottled with darker spots. As decay progresses, elongated pockets develop parallel to the grain. These pockets may be empty or may be partially filled with whitish or yellowish fibers of decayed wood. The wood between the pockets is discolored but firm. On the ends of logs, the decay pattern is irregular. In the early stages, the rot appears as brownish discolored areas, roughly circular in outline. In the advanced stages of decay, the pockets are visible in the discolored areas.

Indicators of Decay. The white, coral-like, annual conks develop on living trees, stumps, slash, and on ends of recently cut logs. They are soft, extensively branched, and bear large numbers of pendant spines or teeth. Because of their soft, fragile consistency, these conks deteriorate very rapidly and are present as indicators for a relatively short period of time.

Extent of Decay. Yellow pitted trunk rot is generally confined to the bottom portion of the tree. Most common occurrence is in Hemlock and Grand fir in northern Idaho. Deduction for this defect is by the length-cut method.

A-6.3 BUTT ROTS

A-6.31 Red-Brown Butt Rot (*Phaeolus schweinitzii*)

Caused by *Phaeolus Schweinitzii* (also called *Polyporus Schweinitzii* in older literature). Commonly referred to as cubical butt rot or velvet-top fungus, this rot is also called stump rot or brown butt rot.

Species Affected. All Idaho conifers except Juniper and especially common in Douglas fir. It does not occur on hardwoods.

Rot Description. Red-brown butt rot is important as a root and butt rot of living trees. The rot may continue development in dead trees and stumps, but it is not a major factor in decay of slash. Entrance to the heartwood is most often gained through basal injuries, especially fire scars. The first visible evidence of decay is a pale yellowish or reddish-brown discoloration, usually extending in narrow spires ahead of the advanced decay. A serious weakening of the wood occurs, however, before any visual evidence of decay develops. In the advanced stage, the wood is reduced to a reddish-brown mass that cracks up into cubes and is easily crumbled into powder. A very thin layer of cream-colored fungous tissue often develops in the cracks between the cubes. On end sections of logs, this rot may appear as several isolated pockets of decay or as a single pocket ranging from a few inches to several feet in diameter. The decay can usually be traced to a cat-face at the base of the log.

Indicators of Decay. The annual conks of *Phaeolus Schweinitzii* generally develop on the duff around the base of decayed trees, although occasionally they develop on the butt of the tree. On trees, they are thin and bracket-like; growing on the ground, they are more or less circular, thin, and stalked. The upper surface is reddish-brown and velvety or plush-like with concentric zones. The under surface is olive green on fresh growing conks and dark reddish-brown on dead ones. Basal scars are so generally invaded by this fungus that they are quite reliable indicators of decay. When red-brown butt rot is present in a tree, it is almost always visible on the lower end of the butt log.

Extent of Decay. This rot generally extends from 2 to 24 feet up the trunk from the butt and is usually confined to the heartwood. *Phaeolus schweinitzii*, as previously noted, is quite common to Idaho conifers and, in advanced stages, affects the entire heartwood of the butt of the tree or log. Often this type of log has been long-butted above the swell of the butt, and deduction is made by using the squared-defect method. When the log has not been long-butted, the length-cut method may be more appropriate.

Figure A6-14 shows a 16-foot Douglas fir log with a small end diameter measurement of 20 inches, and a 22-inches on the large end. Rot in early stages of decay measures 12 inches and is estimated to extend four feet into the log. Using squared defect enter $12'' \times 12'' \times 4' = 4.0$ cf. Gross of 38.6 cf, net is 34.6 cf. Scribner gross is 28 bds, 5 bds defect, and 23 bds net.

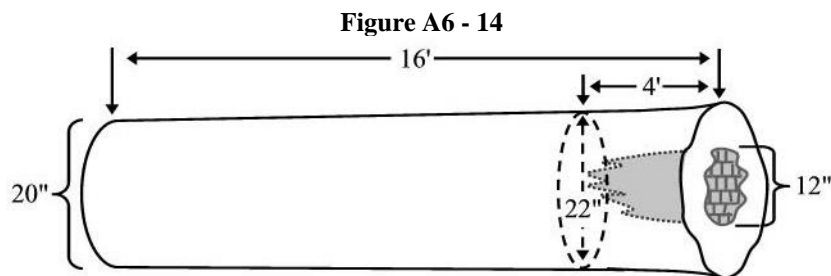
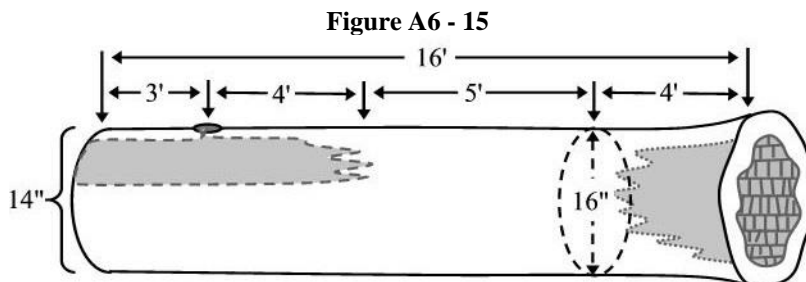
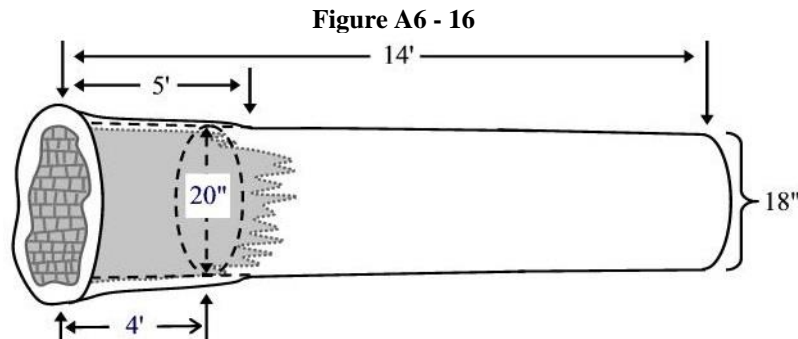

Figure A6-15 shows a 16-foot White pine with a small end diameter measurement of 14 inches, and a large end measurement of 16 inches. Two separate defects are illustrated. A *fomes* knot is three feet down from the top end of the log, and cubical butt rot is showing on the butt end of the log. The *fomes* knot indicates rot in one-half of a 7-foot section of the log.



Deductions for these defects are determined by the length-cut method for the butt rot and the pie-cut method for the *Fomes* rot. The butt rot affects the full scaling diameter of the butt for a 4-foot length-cut. The *Fomes* conk will affect 1/2 of 8 feet, leaving only 5 feet of sound material in the top one-half of the log. Since 5-foot lumber is not merchantable, the entire upper half-section is deducted as defect. A pie-cut of one-half of 12 feet equals an additional 6-foot length-cut deduction. The remaining bottom half of the log shows 12 feet of sound wood. Total deduction is 4' + 6' = 10'. Net scale of the log is 7.4 cf or 4 bds Scribner.

Figure A6-16 shows a 14-foot Western larch with a small end diameter measurement of 18 inches. The log has 16 inches of rot showing in the butt end. A scaler should bear in mind that the outside of a log can indicate what is inside. In the diagram, note the abnormal swell or bulge on the butt end; this is an indication of how far the rot will extend. The scaler determines a length-cut deduction, just above the swell.



The swell in the butt indicates rot will extend 5 feet. The scaler will need to make a 6-foot length-cut deduction, because the remaining lumber length recovery must be in multiples of two feet. The gross scale of the log is 27.6 cf, defect is 11.8 cf, and net is 15.8 cf. Scribner gross of 19 bds, defect 8 bds, net of 11 bds.

A-6.32 Feather Rot (*Perenniporia subacida*)

Caused by *Perenniporia subacida* (also called *Poria subacida* in older literature). Also known as spongy root rot, stringy butt rot, and white stringy rot.

Species Affected. Grand fir, Engelmann spruce, White pine, Ponderosa pine, Douglas fir, Western hemlock, and Western red cedar. Also found on hardwoods.

Rot Description. Feather rot is one of the most common slash rots on conifer wood in Idaho, being found in dead standing trees, stumps, fallen trees, and stored logs. In addition, it occurs frequently as a butt and root rot of living trees, especially in western white pine. Faint pinkish to brownish discoloration of the wood marks the early stages; as decay progresses, elongated whitish streaks appear in the springwood of the annual growth ring. These streaks enlarge and run together, and the wood separates easily at the annual rings. Black flecks often appear among the white fibers. As decay continues, the wood breaks down into a whitish stringy mass of soft, spongy, water-soaked material. In the advanced stages of decay, cream-colored mats of fungous tissue with golden brown flecks usually develop in the wood. On the ends of logs, this rot is roughly circular in outline; the white, stringy nature of the decayed wood and the fungous tissue serve to identify it.

Indicators of Decay. Conks of *Perenniporia subacida* are flat and crust-like with small circular pores. The perennial conks are cream to almost lemon yellow in color. Conks develop in root crotches of living trees and on the undersurface of dead material on the ground.

Extent of Decay. In old growth timber, the rot characteristically hollows out the center section and leaves a clear shell. In many instances, deduction is made by using the squared-defect method. When the entire cross section is affected for a portion of the scaling length, deduction is made by the length-cut method. This rot rarely extends beyond 16 feet in length and is confined to the butt log.

A-6.33 *Weirii* Butt Rot (*Phellinus weirii*)

Caused by *Phellinus weirii* (also called *Poria weirii* in older literature). This is sometimes called laminated root rot.

Species Affected. Common in Western red cedar and also occurs in Western hemlock, Douglas fir, Grand fir and other Idaho conifers.

Rot Description. This common butt rot in Western red cedar in Idaho enters the tree through basal injuries, particularly fire scars. It is a common rot in fallen trees and cull logs left in the woods. In the early stages, the wood shows a yellowish discoloration, which darkens as the wood becomes softer. The wood then begins to separate along the annual rings, and a definite ring shake develops. The thin layers of decayed wood usually have small, elliptical pits parallel to the grain. Brownish strands of fungous tissue also appear between the layers. On ends of logs, the rot may appear in crescent- or ring-shaped circular areas with conspicuous radial cracking. The thin layers of decayed wood can be readily pulled out of the log. In older infections, the butt may become hollow. These hollows are usually lined with the typical, laminated decayed wood. *Weirii* butt rot also occurs as a heart rot of other conifers and may kill young Douglas fir and Grand fir as a root rot.

Indicators of Decay. On living trees, the conks develop under roots, in root crotches, and in hollow butts. They are perennial, dark chocolate brown in color, flat and crust-like, and rather soft and light.

Extent of Decay. Although *Weirii* butt rot is usually confined to the butt log of western red cedar, it may extend up the trunk for 30 feet or more in severe decay.

Figure A6-17 shows a 30-foot butt-cut cedar, 20-inch scaling diameter, 24-inch large end diameter with *Weirii* butt rot extending its full length. Rot measurements are 7" on the small end and 15" on the butt end.

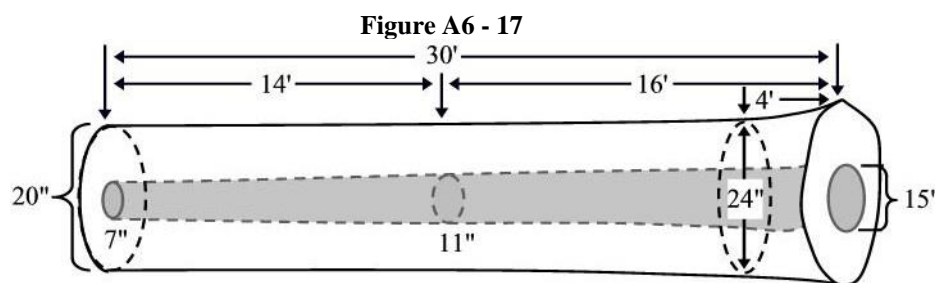

Using the squared-defect deduction method, proceed as follows:

- The size of the rot is averaged to determine the midpoint diameter of the rot
- $7'' + 15'' = 22''$ divided by 2 = 11" midpoint diameter of the rot
- Even though the top segment is less than 16 feet, cubic uses the average size of the defect
- $7'' + 11'' = 18''$ divided by 2 = 9"
- $9'' \times 9'' \times 14'$ is 7.9 cubic feet.

For Scribner, defect should be taken from the large end on the 14-foot segment. $11'' \times 11'' \times 14' = 13$ boards. The handheld program will add the 1-inch for waste.

- Gross cubic volume of the top log is 33.7 cf – 7.9 cf defect = 25.8 cf.
- Gross Scribner volume of the top log is 24 bds – 13 bds defect = 11 bds net.
- Since the scaling length of the butt segment is 16- to 20-feet, average the size of the defect
- $11'' + 15'' = 26''$ divided by 2 = 13" average defect size in butt segment
- $13'' \times 13'' \times 16'$ is 18.8 cf.
- For Scribner, the program will add the one inch for waste, $13'' + 1'' = 14''$

(A quick way to check the defect deduction can be made by using the scale stick. Check the "red" numbers for a 16- foot length with a 14-inch diameter, which is 21 bds defect.)

- Gross cubic volume of the butt log is 46.2 cf – 18.8 cf = 27.4 cf.
- Gross Scribner volume of the butt log is 33 bds – 21 bds defect = 12 bds net
- Cubic volume of the entire log is 79.9 cf, total defect is 26.7 cf, for a net scale of 53.2 cf.
- Scribner volume of the entire log is 57 bds, total defect 34 bds, and 23 bds net.

A-6.34 Brown Pocket Rot of Cedar (*Postia sericeomollis*)

Caused by *Postia Sericeomollis* (also called *Polyporus sericeomollis* or *Poria Asiatica* in older literature).

Species Affected. Common in living Western red cedar and as a slash rot in other conifers.

Rot Description. Although brown pocket rot in cedar is most commonly found in the butt, it may extend throughout the merchantable length of the tree. In the early stages of decay, a light brown discoloration appears; the wood becomes soft and loses its natural luster. In the advanced stages, the wood cracks extensively and breaks down into a fragile, crumbly mass of brown cubes; and whitish or cream-colored fungous tissue develops in the cracks. The decay first develops in isolated, well-defined pockets. In the butt of the tree, these pockets run together and often form solid cylinders of rot. On ends of logs, the

rot commonly appears in small scattered pockets, concentric ring-shaped areas, or as solid circular areas. Large hollows often develop in the butt of older trees.

Indicators of Decay. Conks of *Postia Sericeomollis* rarely, if ever, appear on living cedars, even when the decay is extensive and long established. Consequently, there is no specific indication of decay on the living tree. Conks develop on dead material and are abundant on slash of other conifers. They are white, thin and crust-like with small regular pores and have a very bitter taste.

Extent of Decay. In advanced stages of butt rot, the log may be treated in scaling by using the length-cut method above the point of butt swell. More commonly, when rot is showing in the center area of the heartwood, it is scaled out by applying the squared-defect deduction method.

Figure A6-18 illustrates a 16-foot cedar log with a small end diameter of 26 inches, and a large end measurement of 28 inches. The log has brown pocket rot extending the full length, measuring 12 inches on the small end and 16 inches on the large end. There is a sound core of wood that measures 7 inches on the small end.

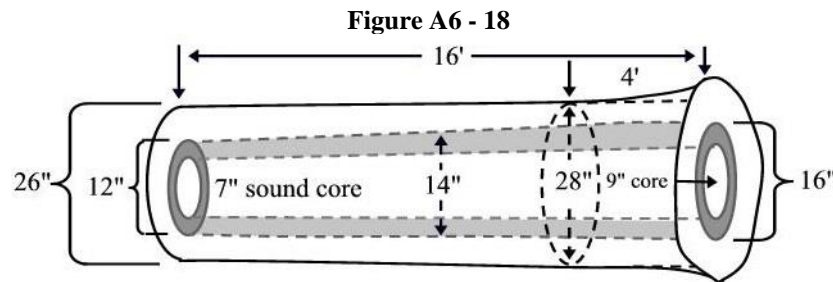

Using the multiple ring deduction method, proceed as follows:

- Enter the outside small end diameter of the rot and the large end outside diameter of the rot, 12-inches and 16-inches
 - Next, enter the small end diameter of the sound core and the large end diameter of the sound core, 7" and 9".
- Cubic gross volume is 63.7 cf, 16.5 cf defect, and 47.2 cf net. Scribner gross volume is 50 bds, 21 bds defect, and 29 bds net.

A-6.35 Red Root and Butt Rot (*Inonotus tomentosus*)

Caused by *Inonotus Tomentosus* (also called *Polyporus Tomentosus* in older literature). Commonly called honeycomb rot.

Species Affected. White pine and Ponderosa pine are the major hosts in Idaho. Engelmann spruce, Western larch, Lodgepole pine, Douglas fir, and Western hemlock are also decayed by this fungus.

Rot Description. Red root and butt rot is generally confined to the lower portion of the butt log, with the fungus entering the tree through basal scars or perhaps through injured roots. In the early stages of decay, the wood is discolored, dark reddish-brown, and firm. In the later stages, narrow, lens-shaped pockets develop parallel to the grain. These pockets are filled with white decayed wood and are separated by reddish-brown firm wood. The rot is important only in living trees and is of little consequence in decay of slash.

Indicators of Decay. Conks of *Inonotus Tomentosus* develop on the ground near the roots of a decayed tree or on the butt of the tree. Conks on the ground are stalked with a thin circular cap, and those on trees are usually thicker and more or less bracket-like. Both are yellowish-brown with a velvety or plush-like upper surface.

Extent of Decay. This rot is generally confined to the basal portion of the first log and rarely extends beyond 6 to 10 feet. Deduction for this defect should be made using the length-cut method, or by using the squared-defect deduction method.

Figure A6-19 shows a 16-foot Ponderosa pine, 18 inches small end diameter, 20 inches large end diameter, with 8 inches of red root rot estimated to extend 6 feet up from in the butt.

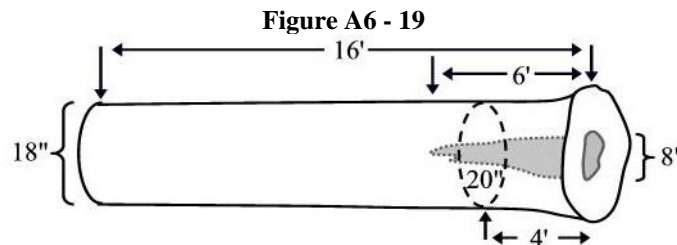

Using the squared-defect deduction method, proceed as follows:

- The size of the rot is 8 inches on the large end.
- $8'' \times 8'' \times 6' = 2.7$ cf of defect. Gross 31.6 cf, net of 28.9 cf.
- Scribner gross is 21 bds, 3 bds defect, and 18 bds net.

A-6.36 *Annosus* Root or Butt Rot (*Heterobasidion annosum*)

Caused by *Heterobasidion Annosum* (also called *Fomes Annosus* in older literature). This rot is also called white spongy rot, and black-spotted pocket rot.

Species Affected. All Idaho conifers.

Rot Description. *Heterobasidion Annosum* causes a root and butt rot of living trees and is a common slash rot of conifers. In the early stages of decay, the wood is firm and pinkish to reddish-brown in color. White pockets of decay appear in the discolored wood as decay progresses. These pockets are elongated parallel to the grain and frequently have black flecks in the center. The pockets enlarge and run together; the wood tends to separate at the annual rings, and a soft spongy mass of fibrous rotten wood with black flecks eventually results. In the early stages, the rot appears on the ends of butt logs as dark reddish-brown areas of discolored heartwood or as circular areas of whitish, spongy, decayed heartwood surrounded by a dark zone of early decay. Hollows may develop in older infections. The black specks and anise odor (licorice) together constitute the most reliable characteristics for identification.

Indicators of Decay. Conks of *Heterobasidion Annosum* are perennial and are generally inconspicuous, developing under logs and roots or in root crotches of living trees. The upper surface is cream-colored with small circular pores. Conks developing under logs or roots are commonly flat and cream-colored with a brownish-black margin. Resin flow may occur at the base of infected trees.

Extent of Decay. This rot is generally confined to the butt log. Deduction should be made in the same manner as for previously described butt rots; that is, by squared-defect method, or length-cut method.

A-6.37 Big White Pocket Rot (*Phellinus nigrolimitatus*)

Caused by *Phellinus nigrolimitatus* (also called *Fomes nigrolimitatus* in older literature). Also called white pocket rot.

Species Affected. Western larch, Engelmann spruce, White pine, Ponderosa pine, Western hemlock, Lodgepole pine, Western red cedar, and Douglas fir.

Rot Description. Big white pocket rot is common in fallen trees and cull logs and is occasionally found as a heart rot in the butt of living western red cedar. A reddish-brown discoloration develops in the early stages of decay. Later on, large irregularly shaped pockets appear in the discolored wood. These pockets, elongated roughly parallel to the grain, are usually filled with white fibrous, decayed wood and are separated by firm, apparently sound, reddish-brown wood. On the ends of logs, the large white pockets are conspicuous.

Indicators of Decay. Conks of *Phellinus nigrolimitatus* are perennial; they are generally not noticeable and develop as crust-like patches on the underside of fallen trees and cull logs left in the woods. They are dark reddish-brown in color; when broken, they show fine blackish lines running through the tissue. When the conks develop as brackets on the sides of fallen trees and logs, the upper surface is usually soft and spongy.

Extent of Decay. In determining the extent of decay for scaling purposes, this rot should be considered the same as trunk rot, using either the squared-defect or length-cut deduction methods.

A-6.38 Shoestring Root Rot (*Armillaria ostoyae*)

Caused by *Armillaria ostoyae* (also called *Armillaria mellea* in older literature).

Species Affected. Most conifers and hardwoods in Idaho are susceptible to shoestring root rot. It is particularly common on Grand fir, White pine, Ponderosa pine, and Douglas fir.

Rot Description. *Armillaria* causes the decay and death of sapwood in the roots and butts of living trees. Entering the tree through the roots and growing upward past the root collar, it often girdles the tree completely. In the early stages of decay, the wood appears water-soaked and shows a pale brownish discoloration. Eventually it becomes whitish, soft, and spongy or stringy with conspicuous narrow black zone lines running through the decayed wood. A white butt rot in the heartwood of older trees is also reported to be caused by *Armillaria*.

Indicators of Decay. The presence of shoestring root rot may be indicated by abundant resin flow on the bark of the butt portion of the tree. Removal of bark from the root collar of infected trees reveals the presence of white fans of fungous tissue in the cambium region between bark and wood. Long, narrow, whitish to black strands of fungous tissue may be present under the bark and in the duff around the base of infected trees. These strands, called "rhizomorphs," have given rise to the common name of shoestring root rot. In the fall, conks of *Armillaria* may develop at the base of infected trees and stumps; or they may develop on the ground from infected roots. The conks, which often grow in dense clusters, are honey-colored mushrooms with circular caps; the undersurfaces of the caps have radial gills.

Extent of Decay. Shoestring root rot usually extends up the trunk for only a few feet, generally one to four feet, but may extend to six feet in advanced stages of decay. Root rot begins as isolated pockets around the outer portions of the heartwood. As rot progresses, these pockets may grow together. Usually, the center area of the heartwood is not affected and this is an identifying feature of this rot. In advanced stages of decay, the entire heartwood is affected; a small core of sound wood may be present in the center. When the defect affects only a portion of the scaling cylinder, deductions are made by using the pie-cut defect deduction method. In advanced stages of decay, use the length-cut deduction method.

A-6.39 Brown Cubical Rot (*Laetiporus sulphureus*)

Caused by *Laetiporus sulphureus* (also called *Polyporus sulphureus* in older literature). This rot is sometimes called sulphur rot.

Species Affected. White pine, Grand fir, Western larch, Ponderosa pine, Douglas fir, Western hemlock, and Engelmann spruce.

Rot Description. *Laetiporus sulphureus* decays the heartwood of living conifers and usually causes a butt rot. The rot is commonly observed in stumps and fallen trees. In the early stages of this rot, a brownish discoloration is observed; and the advanced stage is very similar to that of Quinine rot. The wood becomes a brown, crumbly mass of more or less cubical chunks with conspicuous mats of white fungous tissue appearing in the cracks. On the ends of logs, the appearance of the rot is almost exactly like that of Quinine rot; the cubical structure of the brown decayed wood and the white mats are very noticeable. The rot column is generally circular in outline; and, in trees with long-established rot, hollow butts are common.

Indicators of Decay. Conks of *Laetiporus sulphureus*, often spreading profusely over a large area on the base of living trees, stumps, and fallen trees, and are annual, thin, and bracket-like. They are a bright orange on the upper surface and sulphur-yellow on the under surface, which has small circular pores. Fading out as the conk ages or is dried, the bright tones eventually become straw-colored or almost white; the conks deteriorate rapidly in the fall. Living trees are infected through basal wounds and dead branch stubs.

Extent of Decay. This rot is generally confined to the butt log and is one of the more common butt rots. This rot is usually conical in shape. Similar to red brown butt rot (*schweinitzii*) deductions are usually made by the length-cut method. Sometimes, application of the squared-defect deduction method is appropriate on logs that have been long-butted.

Figure A6-20 illustrates an 18-foot log, with a small end diameter of 22-inches, large end diameter of 24 inches. The butt displays brown cubical rot extending 6 feet up the log, and the top shows *Fomes* rot with a punk knot located 1-foot down from the end of the log. The extent of decay from the two rots leaves only a 5-foot section of sound wood in the middle of the log. Since 6-foot is minimum lumber length recovery, the entire log is a cull sawlog.

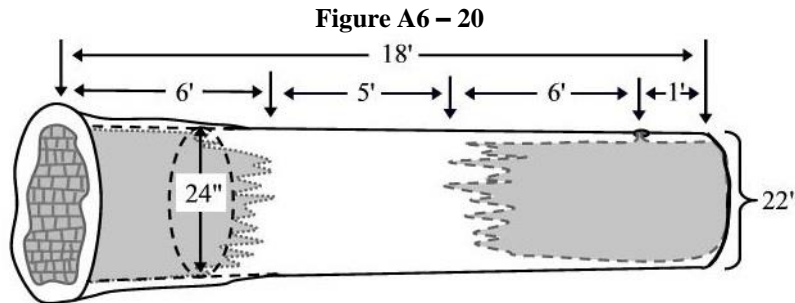

A-6.4 SAP ROTS AND STAINS

A-6.41 Gray-Brown Sap Rot (*Cryptoporus volvatus*)

Caused by *Cryptoporus volvatus* (also called *Polyporus volvatus* in older literature). This rot is commonly called pouch fungus.

Species Affected. Primarily Douglas fir and Grand fir, but may also be found in all Idaho conifers.

Rot Description. Gray sap rot develops very rapidly in dead standing trees, and is extremely common in fire-killed or bug-killed Douglas fir. It is also common in recently-cut stored logs, particularly grand fir logs and pulpwood. In early stages, this rot is generally superficial, being limited to the outer 1/4-inch of sapwood. Dark gray streaks and flecks appear in the wood, which remains quite firm. Later limited areas less than 1-inch wide and 10 inches long develop a very light brown cubical, crumbly decay, which occurs only as deep as the sapwood.

Indicators of Decay. Conks of *Cryptoporus volvatus* usually appear on trees the year after death occurs, often developing by the thousands over the entire trunk surface as well as on the larger branches. These conks indicate the rapid and extensive development of the decay in the newly-dead sapwood. Apparently, conks develop during one season, are quickly eaten by insects, and do not occur again on that particular tree. They are cream-colored and often resemble small eggs or pouch-like structures attached to the bark of a tree. Larger conks, up to two inches in diameter, are more or less hoof-shaped. The underside of the conk has a small circular hole near the base, opening into a cavity that frequently contains insects that spread the spores of the fungus.

Extent of Decay. This rot may affect all or just a portion of the sapwood. If the sapwood is broken down, deduction should be made using the diameter-cut method by measuring the sound core inside the affected area.

A-6.42 Pitted Sap Rot (*Trichaptum abietinum*)

Caused by *Trichaptum abietinum* (also called *Polyporus abietinus* in older literature). This rot is also called hollow pocket rot.

Species Affected. Virtually all conifers in Idaho with the possible exception of Junipers and Pacific yew.

Rot Description. Pitted sap rot attacks only dead material, and it occasionally decays dead sapwood on cat faces of living trees. It is one of the most common decay fungi on stumps, logs, and slash in the woods. It also develops on decked saw logs and pulpwood and has been reported to attack unseasoned wood after manufacture into lumber. *Trichaptum abietinum* does not cause heart rot of living trees, although heartwood on dead material may be decayed. The first evidence of decay is a yellowing and softening of the wood. Tiny empty pockets that are elongated parallel to the grain appear. As decay progresses, these pockets become larger and more numerous until the wood has a fragile, lace-like appearance. Pitted sap rot develops rapidly in wood that still has bark on it.

Indicators of Decay. Conks of *Trichaptum abietinum* usually develop abundantly on decaying material. They are flat and crust-like on the under surface of logs and slash; and they are thin and bracket-shaped on dead standing trees, stumps, and the upper surfaces of down material. The conks are gray with faint radial zones on the upper surface and purplish with large, irregular pores on the under surface. As the conks age, the purple color fades to a pale brown. On the sapwood at the ends of logs, the conks commonly appear in large numbers, sometimes completely covering it.

Extent of Decay. As conks develop readily on the bark over the entire surface area of the decaying sapwood, the distribution of the conks usually indicates the extent of decay. Sapwood of logs on which conks of *Trichaptum abietinum* appear is considered unsound and should be deducted for accordingly. Such logs are scaled by measuring the sound core inside the affected sapwood, using the diameter-cut deduction method.

Figure A6-21 shows a 32-foot Douglas fir butt log with a 16-inch small end diameter, and 20-inch large end diameter. This log was harvested in the north Idaho area. Therefore, the midpoint-scaling diameter for Scribner is determined on the basis of standard taper and is also 18-inches. The log has sap rot in both segments, extending to within 4 feet of the butt end. The sound core on the small end measures 11 inches, indicating sap rot penetration of 2-1/2 inches. Since each segment is scaled on its own individual merits, do not assume the rot penetrates the same depth on both segments. For the butt segment, the scaler will need to chop into the sapwood with a hatchet and measure the rot depth at midpoint. Check this depth in several places at midpoint to determine if the sap rot affects the entire circumference, or just a portion. In figure A6-21 the sap rot is 1 inch deep and affects the entire circumference at midpoint.

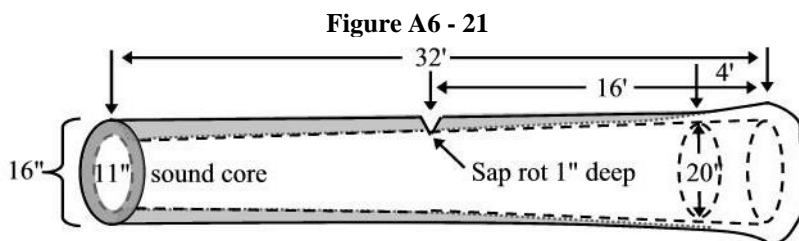

The top segment has a 16-inch sed, and 18-inch led for a gross volume of 25.3 cf or Scribner 16 bds. Using the diameter-cut method, measure the sound core inside the rotted sap, which is 11 inches. A 16-foot log with an 11" to 13" diameter scales 12.7 cf or Scribner of 7 bds. This is the net scale of the top segment.

The butt segment is given an 18-inch sed, to a 20-inch led, in accordance with the appropriate taper rules for a gross volume of 31.6 cubic feet or Scribner of 21 bds. A scaler must remember that defect deductions are calculated by using the standard taper diameter as a starting point. No defect adjustment is made if the actual midpoint diameter measurement is smaller or larger than standard taper. The sap rot penetrates 1 inch deep on the butt segment, to within 4 feet of the log end. Since 6-foot is required for minimum lumber length recovery, the sap rot defect is treated as extending the entire length of the segment. Sap rot penetration of 1 inch depth results in a sound core that is 2 inches smaller than the standard taper diameter, or a 16" to 18" sound core. A 16-foot log with a 16" to 18" diameter scales 25.3 cf or Scribner of 16 bds. This is the net scale of the butt segment.

Adding the segment volumes together, the gross scale of the log is 56.9 cf, defect of 18.9 cf, net of 38.0 cf. Scribner gross of 37 bds, defect is 14 bds, and net scale is 23 bds.

A-6.43 Brown Pocket Sap Rot (*Lenzites saepiaria*)

Caused by *Lenzites saepiaria*, *Trametes americana*, and *Trametes serialis*. Many other fungi cause a brown cubical sap rot but these listed are the most commonly found. This rot is also called brown cubical sap rot.

Species Affected. All commercial conifers in Idaho and some hardwoods.

Rot Description. *Lenzites saepiaria* and *Trametes serialis* are occasionally found on living trees, on dead sapwood under fire scars, and on other wounds. The decay first appears as a yellow to yellow-brown discoloration in the sapwood or outer heartwood. Advanced decay is characterized by a mass of crumbly, brown cubical wood that may or may not have thin mats of fungous tissue in the cracks in the wood. Decay on fallen trees, stumps, snags, and smaller material on the ground usually begins in the sapwood, which is rapidly destroyed, and progresses into the heartwood, which is also eventually decayed.

Indicators of Decay. Conks of these fungi are annual, tough, and persistent. *Lenzites saepiaria* conks are light to dark cinnamon brown, thin, and bracket-like, and have radial gills on the under surface. *Trametes americana*, which are similar, have large circular pores on the under surface. *Trametes serialis* conks are white, flat, and crust-like with large circular pores.

Extent of Decay. Brown sap rot indicates that the entire sapwood is unusable for lumber or pulp. Deduction is made by the diameter-cut method.

Figure A6-22 shows a 20-foot, 16-inch sed, 20-inch led log with 2 inches of sap rot extending the full length. Measure the sound core inside the sap rot to determine the appropriate diameter cut. Gross volume is 35.8 cf, defect 14.0 cf and net of 21.8 cf, which is the volume of 20-foot log with diameter measurements of 12” and 16”. Scribner gross is 20 bds, defect is 10 bds, and the net scale is the volume of a 20-foot, 12-inch log, which is 10 bds (decimal “C”).

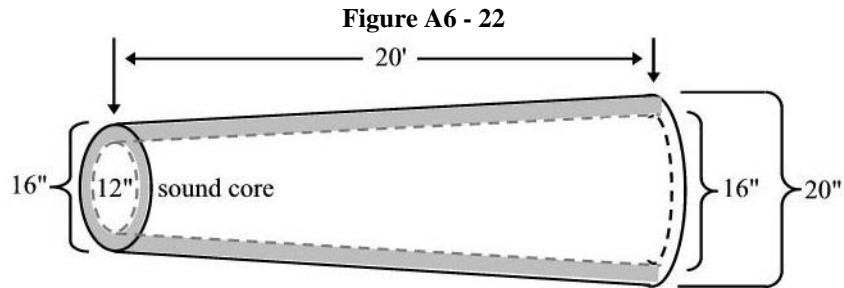

A-6.44 Brown Crumbly Rot (*Fomitopsis pinicola*)

Caused by *Fomitopsis pinicola* (also called *Fomes pinicola* in older literature). This rot is also called red belt fungus.

Species Affected. All Idaho conifers and some hardwoods.

Rot Description. This rot is probably the most important slash rot of conifers in Idaho. It occurs on dead standing trees, fallen trees, saw logs, and pulpwood in storage. The rot usually develops in the sapwood, which is decayed rapidly, and then progresses into the heartwood. It has been reported as an occasional heart rot in living trees, entering the heartwood through basal scars, but its major role is in decay of slash and stored logs. The early stage of decay is marked by a faint brownish discoloration. In the later stages, the wood is reduced to a yellowish-brown to reddish-brown mass of cubical chunks with white mats of fungous tissue developing in the cracks in the decayed wood. The sapwood of dead spruce and pine is destroyed quite rapidly; where logs of these species are kept in decks for long periods, the losses in higher grades of lumber or pulp yields may be considerable.

Indicators of Decay. Conks of *Fomitopsis pinicola* develop readily on dead standing and fallen trees and on stored logs. They are perennial, woody, and hoof-shaped to rather thin and bracket-like. The upper surface is crusted, gray to blackish, and often has a distinct reddish band around the margin. The under surface is smooth and cream-colored with very small, circular pores. Small, whitish, crust-like conks often develop extensively over the sapwood on ends of decaying stored logs.

Extent of Decay. Because this rot vigorously attacks sapwood, scaling is generally accomplished by scaling inside the affected sapwood, using the diameter-cut deduction method.

A-6.45 Blue and other Sap Stains

Blue stain is caused by a large number of fungi, including species of *Ceratocystis*, *Graphium*, and *Leptographium*. Sapwood of virtually all species may be stained to some extent, but White pine, Ponderosa pine, Lodgepole pine and Engelmann spruce are particularly susceptible. Contrary to their name “blue stains” can also be black, brown, or even red in color. Blue stains do not follow the annual rings; rather they follow rays inward from the cambium and are commonly wedge-shaped. Bark beetles carry and introduce most of the stain causing fungi found in logs.

Blue stain in logs is not considered a defect for which deduction is allowed, as sound or firm blue-stained lumber is merchantable. No deduction is made in scaling logs affected with blue stain, unless the sapwood is also broken down or rotten. In the latter case, the decay can be traced to some of the true wood-destroying fungi. The conditions favorable for the development of the bluing fungi - high moisture content and warm weather - are also highly favorable to the development of true wood-destroying fungi. Hence, logs attacked by bluing fungi may at the same time be attacked by various fungi that produce decay. In scaling blue-stained logs that have also been broken down or rotted in the sapwood, a deduction must be made. Such logs are net scaled to the average diameter inside the rotten sapwood, by using the diameter-cut deduction method.

The value of blue stained logs is often considerably less than logs that are not stained. Log scalers may be required to identify and record blue stained logs separately from those without stain.