

LCOS FX 10.5

User Manual

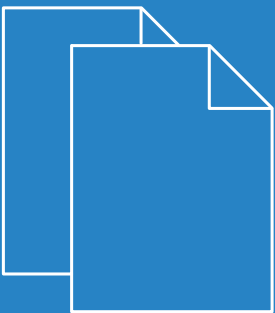

Contents

1 About This Manual.....	4
1.1 Target Audience.....	5
1.2 What is in this Manual.....	5
1.3 Conventions.....	5
1.4 Related Resources.....	6
2 Getting Started.....	7
2.1 Initial setup.....	7
2.2 Configuring the Internet Connection.....	12
2.2.1 Dial-up Connection.....	12
2.2.2 Cable or Router Connection with Dynamic IP Address.....	14
2.2.3 Static Connection with Static IP Address.....	14
2.3 Enabling Internet Access.....	15
2.3.1 Creating an Internet Object.....	15
2.3.2 Configuring Your Local Network Connection.....	15
2.3.3 Creating a Network Object.....	16
2.3.4 Configuring Firewall Rules for Internet Access.....	16
2.3.5 Activating the Desktop Configuration.....	16
3 User Interface.....	17
3.1 Web Client Components.....	17
3.1.1 Header.....	18
3.1.2 Navigation Pane.....	19
3.1.3 Desktop.....	19
3.1.4 Information panel.....	21
3.2 Icons and buttons.....	22
3.3 Firewall Rule Settings.....	24
3.3.1 Setting Up a Connection.....	24
3.3.2 Setting Up a Firewall Rule.....	24
3.4 Menu Reference.....	26
3.4.1 Firewall.....	26
3.4.2 Monitoring & Statistics.....	49
3.4.3 Network.....	63
3.4.4 Desktop.....	82
3.4.5 UTM.....	96
3.4.6 User Authentication.....	116
3.4.7 VPN.....	127
3.4.8 Certificate Management.....	142
3.4.9 Diagnostic Tools.....	149

Copyright

© 2020 LANCOM Systems GmbH, Würselen (Germany). All rights reserved.

While the information in this manual has been compiled with great care, it may not be deemed an assurance of product characteristics. LANCOM Systems shall be liable only to the degree specified in the terms of sale and delivery.

The reproduction and distribution of the documentation and software supplied with this product and the use of its contents is subject to written authorization from LANCOM Systems. We reserve the right to make any alterations that arise as the result of technical development.

Windows® and Microsoft® are registered trademarks of Microsoft, Corp.

LANCOM, LANCOM Systems, LCOS, LANcommunity and Hyper Integration are registered trademarks. All other names or descriptions used may be trademarks or registered trademarks of their owners. This document contains statements relating to future products and their attributes. LANCOM Systems reserves the right to change these without notice. No liability for technical errors and/or omissions.

This product contains separate open-source software components which are subject to their own licenses, in particular the General Public License (GPL). If the respective license demands, the source files for the corresponding software components will be provided on request. Please send an e-mail to gpl@lancom.de.

Products from LANCOM Systems include software developed by the "OpenSSL Project" for use in the "OpenSSL Toolkit" (www.openssl.org).

Products from LANCOM Systems include cryptographic software written by Eric Young (eay@cryptsoft.com).

Products from LANCOM Systems include software developed by the NetBSD Foundation, Inc. and its contributors.

Products from LANCOM Systems contain the LZMA SDK developed by Igor Pavlov.

LANCOM Systems GmbH

Adenauerstr. 20/B2

52146 Wuerselen

Germany

www.lancom-systems.com

1 About This Manual

LCOS FX is the operating system for the LANCOM R&S® Unified Firewalls and is part of the LANCOM operating systems family.

The LANCOM operating systems are the trusted basis for the entire LANCOM product portfolio. Each operating system embodies the LANCOM values of **security**, **reliability**, and **future viability**.

➤ **Maximum security for your networks**

as each LANCOM operating system is carefully maintained and developed in-house and with the accustomed quality. They are all guaranteed backdoor-free.

➤ **Reliability of the highest order**

as they receive regular Release Updates, Security Updates, and Major Releases over their entire product lifetime.

➤ **Future viability for your networks**

according to the LANCOM Lifecycle Policy, i. e. they are free of charge for all LANCOM products and come with major new features.

The LANCOM R&S® Unified Firewall User Manual describes the functionalities of LANCOM R&S® Unified Firewalls.

LANCOM R&S® Unified Firewalls integrate firewall, intrusion prevention, application control, web filtering, malware protection and many more functions in a single system.

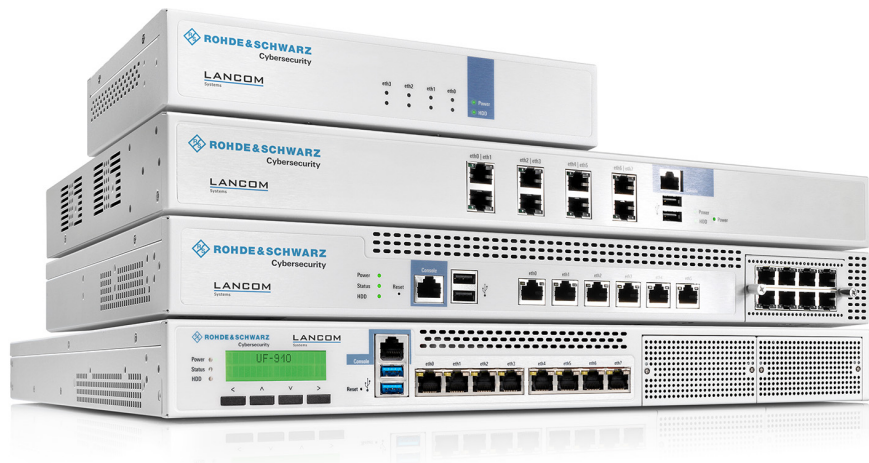

Figure 1: LANCOM R&S® Unified Firewalls

This document applies to all LANCOM R&S® Unified Firewall models.



There are license-based features that distinguish individual product models from one another. For more information about your specific model, see the information on the relevant data sheet.

See the topics below for further information about this document.

1.1 Target Audience

This manual is for the networking or computer technician responsible for installing and configuring LANCOM R&S® Unified Firewalls and employees that use the web client to define traffic filtering rules.

To use this document most effectively, you need to have the following knowledge and abilities depending on your responsibilities:

- > To install and configure the hardware, you must be familiar with telecommunications equipment and installation procedures. You need to be sufficiently trained and experienced in network and / or system administration.
- > To define filtering rules, you need to understand basic TCP/IP networking concepts.

1.2 What is in this Manual

The contents of this manual are designed to assist you in configuring LANCOM R&S® Unified Firewalls.

This document includes the following chapters:

- > [Getting Started](#) on page 7

Log on to your LANCOM R&S® Unified Firewall to set up the system for your network.

- > [User Interface](#) on page 17

The sections in this chapter describe the components of the user interface of LANCOM R&S® Unified Firewalls.

We are committed to providing documentation that meets your needs. To help us improve the documentation, send us any errors, suggestions, or comments via our support portal:

<https://support.lancom-systems.com/>.

When submitting your feedback, include the document title and the document date located on the title page.

1.3 Conventions

This chapter explains the typographic conventions and other notations used to represent information in this manual.

Elements of the web-based graphical user interface (GUI, or “web interface”) are indicated as follows:

Convention	Description
Graphical user interface elements	All names of graphical user interface elements on the screen, such as menu items, buttons, check boxes, dialog boxes, list names are displayed in bold typeface.
Top-level menu item > submenu element	A sequence of menu commands is indicated by greater than symbols between menu items and the whole sequence displayed in bold typeface. Select the submenu element from the top-level menu item.
[Keys]	Key names are enclosed in square brackets.
List options, literal text, filenames, commands, program code	List options, literal text, filenames, commands, coding samples and screen output are written in monospaced font.
Links	Links that you can click (e. g. references to other parts within this manual) are displayed in blue font.

Convention	Description
<i>References</i>	References to parts of the product documentation are displayed in italics.
<NAME> <SESSION_TIMEOUT>	Parameters and placeholders are capitalized in monospaced font. They are enclosed in angle brackets.
PDF file ZIP archive	File types are written in capital letters.

Notes

The following types of notes are used in this manual to indicate information that expands on or calls attention to a particular point:

-
-  This annotation provides additional information that can help make your work easier.

 -  This is a note. The content of a note provides important additional information regarding the use of the product or the product itself.

 -  This annotation contains safety-related information. Non-observance can damage LANCOM R&S[®] Unified Firewalls or put your network security at risk.

1.4 Related Resources

This section contains additional documents and further sources of information for LANCOM R&S[®] Unified Firewalls.

Refer to the following related documents and resources:

- > **Data Sheets** summarize the technical characteristics of the different LANCOM R&S[®] Unified Firewall hardware models.
- > **Release Notes** provide the latest information on each release of LCOS FX.

-
-  For further documentation, e. g. technical specifications, please visit our [product website](#).

2 Getting Started

This document provides all the required information on how to set up and configure your LANCOM R&S® Unified Firewall device.

To get started, please follow the steps described below.

! When first started after delivery or a new installation, your LANCOM R&S® Unified Firewall runs as a test version for 30 days. For more information, see [License](#) on page 41.

2.1 Initial setup

1. Remove the preinstalled LANCOM R&S® Unified Firewall device from the packaging.
2. Connect a patch cable to the port labeled **eth1** on the front of your LANCOM R&S® Unified Firewall device and the Ethernet port of your computer.
3. Connect a patch cable to the port labeled **eth0** on the front of your LANCOM R&S® Unified Firewall device and the LAN port of the device (e.g. your router, DSL or cable modem) that you received from your Internet access provider. Make sure this device is switched on.
4. Make sure the network adapter of your computer is set to “Automatically configure the IP address”.
5. Switch on your LANCOM R&S® Unified Firewall device.
6. Start a web browser on your computer.
7. Enter the following into the address bar of the browser: <https://192.168.1.254:3438>.
8. Create an exception for the certificate warning.

The LANCOM R&S® Unified Firewall login page appears.

9. On the login page of the LANCOM R&S® Unified Firewall web client, enter `admin` as **User Name** and the default **Password** `admin`.

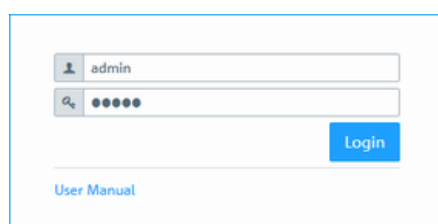

Figure 2: Login page of the LANCOM R&S® Unified Firewall web client

10. Click on **Login**.
11. After the first login with the default credentials, the system prompts you to accept the End User License Agreement (EULA) and then change the following two passwords:
 - > The password for the user `admin` – you need this password to login to the LANCOM R&S® Unified Firewall web client.
 - > The support password – the support password is the password used by the technical supporter to login to your LANCOM R&S® Unified Firewall. Keep it secure and protected from unauthorized access.

The new user password and support password must contain no less than eight and no more than 255 characters. You can use Latin letters, including German umlauts, as well as numbers and special characters. Do not use Cyrillic or other alphabets. You must use characters from at least three of the categories capital letters, lowercase letters, numbers, and special characters.

 This step is mandatory.

12. Click on **Accept & Login** to accept the new passwords and the EULA.

The setup wizard appears.

 With the exception of the language selection at the start of the setup wizard, you can cancel the wizard at any time with the **Cancel Wizard** button. After canceling the wizard, you can continue with a manual setup following the steps [Configuring the Internet Connection](#) on page 12 and [Enabling Internet Access](#) on page 15.

For most of the setup wizard, you can use the **Back** and **Next** buttons to navigate.

13. Select the language for the setup wizard and web client. You can switch the language of the web client later as required.



Figure 3: Welcome page of the setup wizard

14. To restore the configuration from a previous installation, click on **Select** to choose a backup file. Enter the associated backup password. Then click **Restore the backup and restart**.

The setup wizard is then closed, the configuration is restored from the backup, and the firewall restarts.

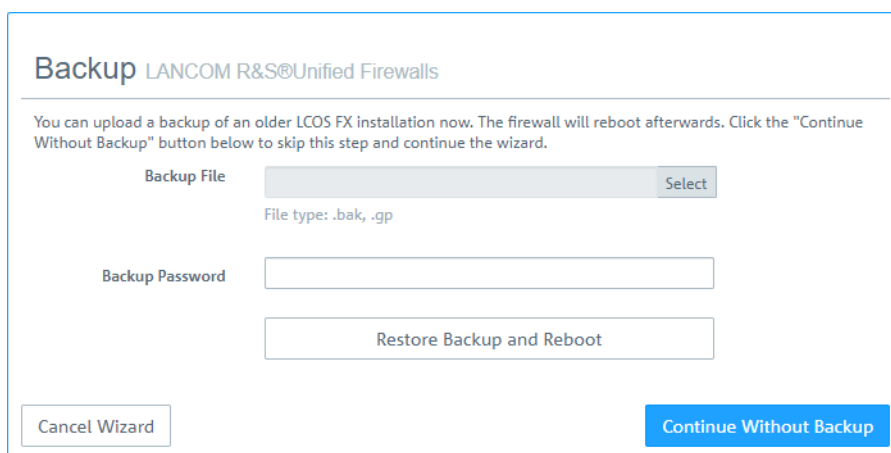

Figure 4: Optional: Restore a previous configuration from a backup

Alternatively, you can continue with a new installation with **Continue without backup**.

15. Configure the following general firewall settings:

Firewall hostname

Give your firewall a name to be used as the host name.

Time zone

The time zone is preset with the time zone currently set in the browser. Change this setting if necessary.

Send usage statistics

You can optionally allow information about the firewall's load and state to be recorded and sent to LANCOM Systems GmbH. No personal information or any of the firewall traffic will be transmitted.

 You can change this setting later. See also [General settings](#) on page 27.

Send crash reports

In the event of a crash, you can optionally allow general information about the system status, current system configuration and the occurring error to be transmitted to LANCOM Systems GmbH. The data is used solely for error analysis and is then deleted. No data is disclosed to any third parties.

 You can change this setting later. See also [General settings](#) on page 27.

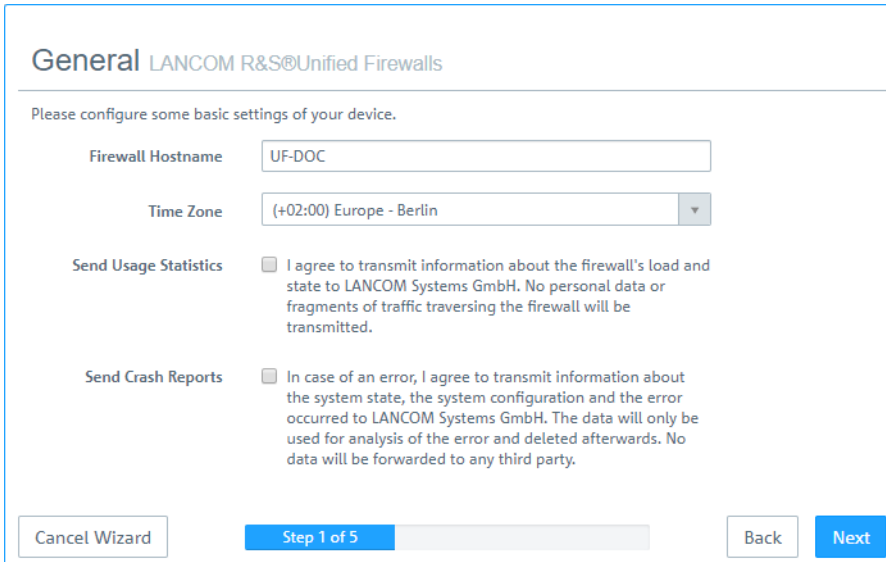



Figure 5: General settings of the firewall

- Set the **Internet interface** as the firewall port (default: **eth0**) that is connected to the device supplied by your Internet service provider. You then enter your option for **Internet access**:

 Depending on your selection, you can configure the relevant data.

DHCP

The IP address for this interface is obtained via DHCP.

Static configuration

Enter the **IP address with prefix length** (CIDR notation), the **default gateway** and the **DNS server**.

ADSL / SDSL

Enter the **username** and the **password** that you have received from your Internet service provider.

VDSL

Enter the **VLAN ID**, the **username** and the **password** that you have received from your Internet service provider.

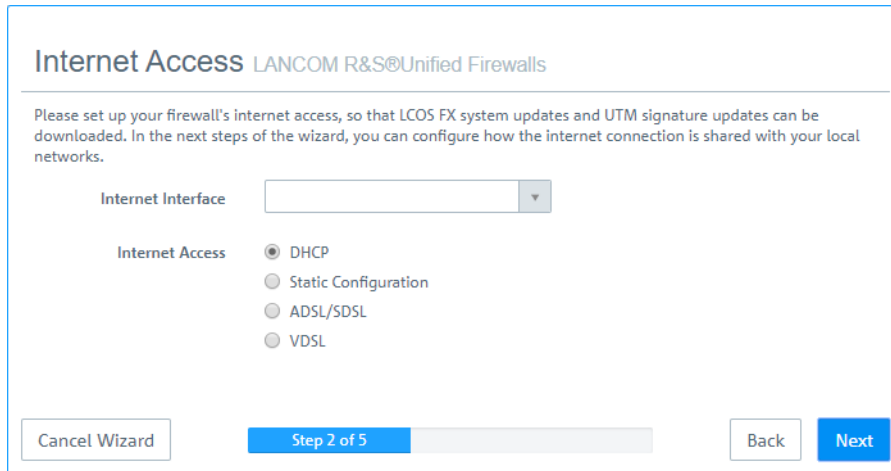

Figure 6: Internet access

- Here you configure the local network to which the firewall is (to be) connected. Each line corresponds to a network interface of the firewall (**Interface** column).

You can enable/disable an interface, depending on whether you want to use it or not (**Active** column). The Internet interface cannot be deactivated.

In the field **IP and prefix length**, enter the IP that the firewall should use on this interface, together with the prefix length (CIDR notation). If you leave the field blank, the firewall will not have an IP connection on this interface. If this is the case, you will be unable to use this interface to access the firewall and you cannot provide a DHCP server, web or mail access for clients connected via this interface. Each interface should have its own subnet.

To enable a DHCP server on an interface, select the appropriate checkbox **Enable DHCP server**. The DHCP pool depends on the firewall IP associated with this port and is preset to the largest continuous range available on the subnet.

You can permit typical Internet applications (**Web** and **Mail**) for clients connected to an interface by selecting the corresponding checkbox. **Web** allows clients to connect to the Internet via HTTP. **Mail** enables SMTP, POP3 and IMAP traffic. This includes the SSL/TLS versions of these protocols.

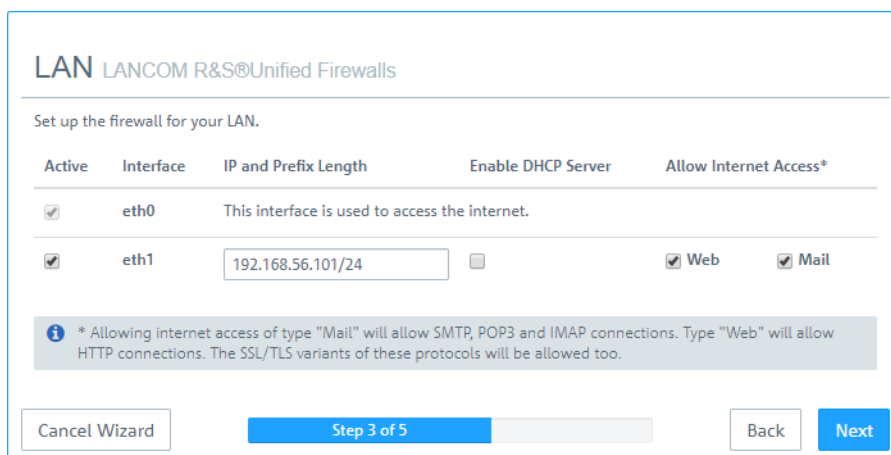



Figure 7: Local networks

- Select the security features **Anti-Malware**, **IDS/IPS** and/or **Content Filter**, which are to be activated. Depending on your device, not all features may be available.

 After being started for the first time, or following a re-installation, the LANCOM R&S® Unified Firewall runs for 30 days as a demo version. You cannot perform a backup during the trial period. At the end of the trial period, the firewall will retain your configuration. The UTM features will be disabled and you can no longer save any changes.

For more information, please see [License](#) on page 41.

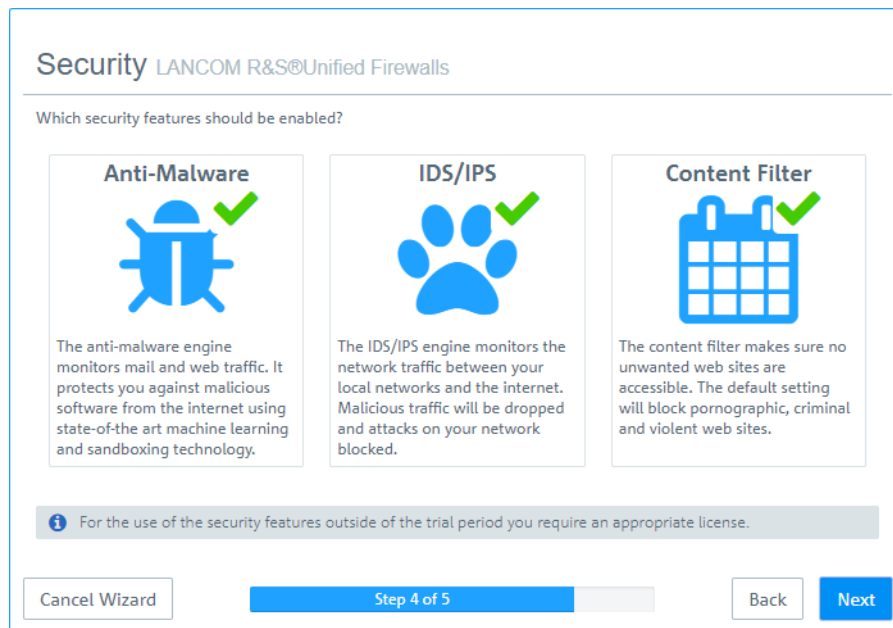

Figure 8: Security features

- Here you see a summary of your settings and, if necessary, you can go back and adjust them. Click **Finish** if everything is to your satisfaction.

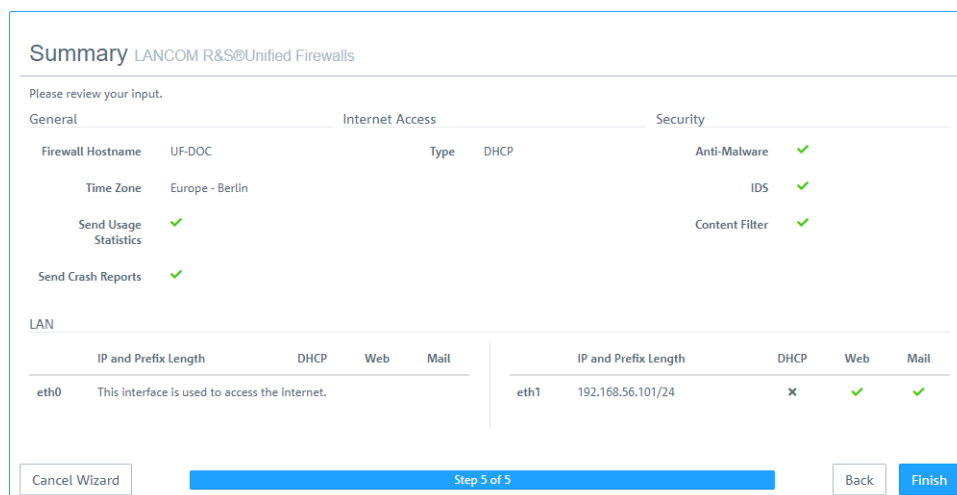

Figure 9: Summary of settings

- Wait for the setup wizard to finish. You will then see the links to use to access the web client after the setup wizard has completed. You can either click these links or click OK to go to the web client.

If you want to use the automatically generated certificate for the web proxy, download it and roll it out to your clients.

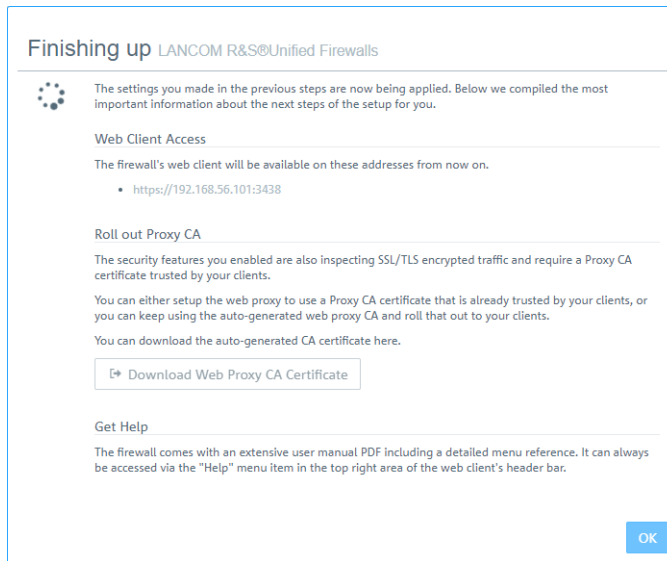



Figure 10: Finishing up

 If you want to use the setup wizard again, you will need to reset your firewall to its factory defaults. See also [Header](#) on page 18.

2.2 Configuring the Internet Connection

This chapter describes how you can configure your Internet connection.

1. Connect a patch cable to the **eth0** port on the front of your LANCOM R&S[®] Unified Firewall and to the LAN port of the device that you received from your provider to access the Internet (e. g. your router, DSL or cable modem).
2. In the navigation bar, go to **Network > Connections**.
The item list bar on the right of the navigation bar opens.
3. Click **»** in the upper right corner of the item list bar to see which network connection is assigned to which interface.
The item list bar expands.
4. Delete the default connection on eth0 by clicking  (Click to delete) in the last table column in the same row.
5. Depending on the type of your Internet access, proceed corresponding to one of the following three approaches:
 - > [Dial-up Connection](#)
 - > [Cable or Router Connection with Dynamic IP](#)
 - > [Static Internet Connection with Static IP](#)

2.2.1 Dial-up Connection

Configuring the network connection

Proceed with this step if you want to configure a PPTP connection. For PPPoE connections, this step does not apply.

1. To create a new network connection, click  (Create a new item) in the item list bar.
The **Network Connection** dialog opens. It allows you to configure a network connection.
2. Enter a name for your network connection in the **Name** field.
3. From the **Interface** drop-down list, select **eth0**.
4. From the **Type** drop-down list, select the **Static** menu item.
5. Enter the IP address and the subnet mask for the network connection in the **IP Addresses** field.

 This IP address is the client/NIC IP address you received from your provider.

6. Click  on the right to add your entry to the list of IP addresses.
7. Click **Create**.

The **Network Connection** dialog closes. The new interface is added to the list of available network connections in the item list bar.

Creating a PPP interface

1. Navigate to **Network > Interfaces > PPP Interfaces**.
2. To create a new PPP interface, click  (Create a new item) in the item list bar.
The **PPP Interface** dialog opens. It allows you to configure a PPP interface.
3. From the **Master Interface** drop-down list, select **eth0**.
4. Unless stated otherwise by your provider, leave the other settings on default value.
5. Click **Create**.

The **PPP Interface** dialog closes. The new interface is added to the list of available PPP interfaces in the item list bar.

Creating a PPP connection

1. Navigate to **Network > Connections > PPP Connections**.
2. To create a new PPP connection, click  (Create a new item) in the item list bar.
The **PPP Connection** dialog opens. It allows you to configure a PPP connection.
3. Enter a name for your PPP connection in the **Name** field.
4. From the **Interface** drop-down list, select the PPP interface you created under [Creating a PPP interface](#) on page 13.
5. From the **Type** drop-down list, select your connection type.
6. Enter the credentials predefined by your provider.

 If you are creating a PPTP connection, enter the IP address of the modem you received from your provider into the **PPTP Server IP** input field.

7. Unless stated otherwise by your provider, leave the other settings on default value.
8. Click **Create**.

The **PPP Connection** dialog closes. The new connection is added to the list of available PPP connections in the item list bar.

9. Click  **Activate** in the toolbar at the top of the desktop to apply your configuration changes.
You have configured your Internet connection.

2.2.2 Cable or Router Connection with Dynamic IP Address

1. Navigate to **Network > Connections > Network Connections**.
2. To create a new network connection, click  (Create a new item) in the item list bar.
The **Network Connection** dialog opens. It allows you to configure a network connection.
3. Enter a name for your network connection in the **Name** field.
4. From the **Interface** drop-down list, select **eth0**.
5. From the **Type** drop-down list, select the **DHCP** menu item.
6. Select the **Obtain DNS Server** check box
7. Select the **Obtain Domain** check box
8. Click **Create**.

The **Network Connection** dialog closes. The new connection is added to the list of available network connections in the item list bar.

9. Click  **Activate** in the toolbar at the top of the desktop to apply your configuration changes.
You have configured your Internet connection.

2.2.3 Static Connection with Static IP Address

Configuring the network connection

1. Navigate to **Network > Connections > Network Connections**.
2. To create a new network connection, click  (Create a new item) in the item list bar.
The **Network Connection** dialog opens. It allows you to configure a network connection.
3. Enter a name for your network connection in the **Name** field.
4. From the **Interface** drop-down list, select **eth0**.
5. From the **Type** drop-down list, select the **Static** menu item.
6. Enter the IP address and the subnet mask for your network connection in the **IP Addresses** field.

 You receive the IP address from your provider.

7. Click  on the right to add your entry to the list of IP addresses.

Configuring DNS settings

1. Go to the **WAN** tab in the **Network Connection** window.
2. Select the **Set Default Gateway** check box
3. Enter your default gateway IP address in the **Default Gateway** input field.
4. Click **Create**.

The **Network Connection** dialog closes. The new connection is added to the list of available network connections in the item list bar.

5. Navigate to **Network > DNS Settings**.

The **DNS Settings** dialog opens. You can use it to configure DNS settings for your LANCOM R&S® Unified Firewall.

6. Clear the **Acquire DNS server** check box.

You can now edit the **1. Nameserver/2. Nameserver** input field.

7. Enter the IP addresses of the DNS servers you received from your provider in the **1. Nameserver** and **2. Nameserver** input fields.
8. Click **Save** to store your settings.
The **DNS Settings** dialog closes.
9. Click **✓ Activate** in the toolbar at the top of the desktop to apply your configuration changes.

You have configured your Internet connection.

2.3 Enabling Internet Access

2.3.1 Creating an Internet Object

1. Navigate to **Desktop > Desktop Objects > Internet Objects**.
2. In the item list bar, click **+** (Create a new item) to create a new Internet object.
The **Internet Object** dialog opens. It allows you to configure an Internet object.
3. Under **Object Name**, enter a name for your Internet object.
4. From the **Connections** drop-down list, select your Internet connection.
You can find more information on creating an Internet connection under [Configuring the Internet Connection](#) on page 12.
5. Click **+** on the right to add your entry to the list of connections.
6. Click **Create**.

The **Internet Object** dialog closes. The new object is added to the list of available Internet objects in the item list bar.

For more information, see [Desktop Objects](#) on page 83.

2.3.2 Configuring Your Local Network Connection

1. Connect a patch cable to one of the ports labeled **ethX** (except **eth0** as it is used for the Internet connection) on the front of your LANCOM R&S[®] Unified Firewall device and to one of the Ethernet ports on your network switch.
2. Navigate to **Network > Connections > Network Connections**.
3. In the item list bar, click **+** (Create a new item) to create a new Internet connection.
The **Network Connection** dialog opens. It allows you to configure a network connection.
4. Enter a name for your network connection in the **Name** field.
5. Under **Interface**, select the port to which you have connected your network switch from the drop-down list.
6. From the **Type** drop-down list, select the **Static** type.
7. Under **IP Addresses**, enter the IP address of this connection in CIDR notation (IP address followed by a slash "/" and the number of bits set in the subnet mask, for example 192 . 168 . 50 . 1 / 24).
8. Click **+** on the right to add your entry to the list of IP addresses.
9. Click **Create**.

The **Network Connection** dialog closes.

2.3.3 Creating a Network Object

1. Navigate to **Desktop > Desktop Objects > Networks**.
2. To create a new network object, click  (Create a new item) in the item list bar.
The **Network** dialog opens. It allows you to configure a network object.
3. Enter a name for your network object in the **Name** field.
4. From the **Interface** drop-down list, select the network connection that you have created under [Configuring Your Local Network Connection](#) on page 15.
5. Under **Network IP**, enter the IP address of your local network.
6. Click **Create**.

The **Network** dialog closes. The new object is added to the list of available network objects in the item list bar.

For more information, see [Desktop Objects](#) on page 83.

2.3.4 Configuring Firewall Rules for Internet Access

1. Set up a connection between the network object (see [Creating a Network Object](#) on page 16) and the Internet object (see [Creating an Internet Object](#) on page 15) that you have just created:
 - a. Click the  button in the toolbar at the top of the desktop. The desktop objects which can be selected for this connection and possible connections between them are highlighted and marked by dotted circles and lines.
 - b. Select the network object as the source object of the connection by clicking the corresponding desktop object.
 - c. Select the Internet object as the target object of the connection by clicking the corresponding desktop object.

You are automatically forwarded to **Desktop > Desktop Connections**. The **Connection** editor panel opens.

Alternatively, you can click the  button in the circular menu of the source object on the desktop and then select the target object.

2. Set up a firewall rule with HTTP and/or HTTPS, depending on your needs:
 - a. The services that you can apply firewall rules to are displayed in the service selection list bar on the right side of the browser window. This list is divided into categories that combines similar services.
Into the **Filter** input field, enter `HTTP` or `HTTPS`. As you type in the input field, the web client reduces the list to show only those services and service groups that contain the characters you are typing.
To add **HTTP** and **HTTPS** from the **Internet** category, click .
 - b. Click **Create**.
The selected services are removed from the service selection list bar and are displayed in the table in the **Rules** tab.
 - c. The **Connection** dialog closes. The new desktop connection is added to the list of available desktop connections in the item list bar.

For more information, see [Firewall Rule Settings](#) on page 24.

2.3.5 Activating the Desktop Configuration

1. Click  **Activate** in the toolbar at the top of the desktop to apply your configuration changes.

The Internet access through your LANCOM R&S® Unified Firewall is activated.

3 User Interface

The sections in this chapter describe the components of the user interface of LANCOM R&S® Unified Firewalls.



The LANCOM R&S® Unified Firewall web client requires a minimum display resolution of 1024 x 786 pixels (XGA).

The following browser versions (or newer) are supported, with JavaScript enabled:

- > Google Chrome 10
- > Chromium 10
- > Mozilla Firefox 12

[Web Client Components](#) on page 17 provides an overview of the main components of the web client.

[Icons and buttons](#) on page 22 explains the meaning of the icons and buttons commonly used on the user interface and throughout this manual.

[Firewall Rule Settings](#) on page 24 describes how to set up a firewall rule for a connection between two desktop objects.

[Menu Reference](#) on page 26 reflects the arrangement of the menu items in the navigation bar on the left side of the user interface. For information on the available options, see the corresponding section.

3.1 Web Client Components

The web client of LANCOM R&S® Unified Firewalls uses a standard four-pane page layout with a common header area, a navigation pane on the left a main content pane (desktop) and an info area on the right.

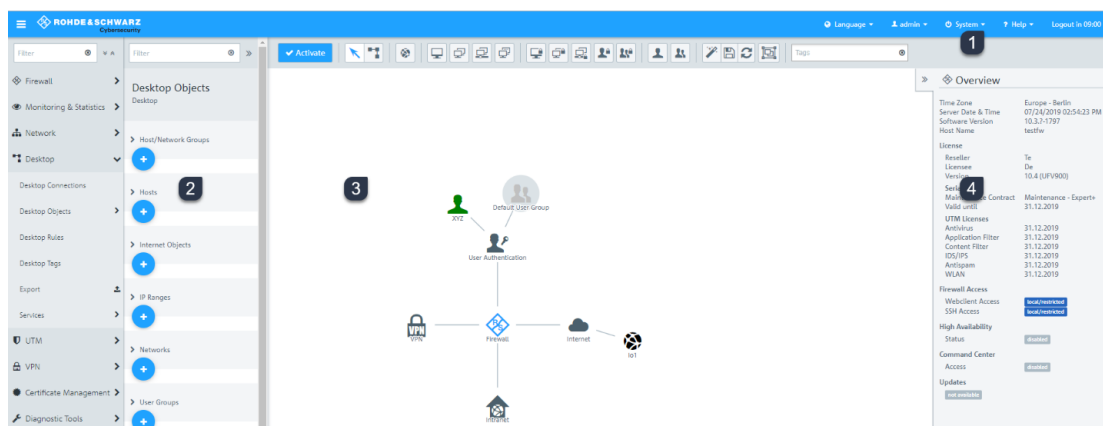

1. Header area
2. Navigation pane
3. Desktop
4. Info area

Figure 11: LANCOM R&S® Unified Firewall web client.

The following sections contain information about each area.

3.1.1 Header

The header (1) contains the following items (from left to right):



Figure 12: Header of the LANCOM R&S[®] Unified Firewall web client

1. ☰ button shows or hides the navigation bar.
2. Rohde & Schwarz[®] Cybersecurity GmbH logo.
3. Language menu that allows you to select the language of the web client.
4. User menu that allows you to quit the current session and return to the login page.
5. System menu with which you shut down or restart the LANCOM R&S[®] Unified Firewall, reset it to its factory settings, or choose a recovery point. When the firmware is updated, a recovery point is set automatically. If no logins take place for a certain time after the update, an error is assumed to exist and the previous version is reactivated according to your settings. See also [Updates Settings](#) on page 47.
6. A help menu with links to the PDF version of the LANCOM R&S[®] Unified Firewall User Manual.
7. Time remaining before the automatic logout from the web client.

The header also indicates that there are unsaved changes to the configuration, i.e. if you closed an editing window by pressing the [Esc] key. If you have closed an editing window by clicking the ✕ button in the upper right-hand corner of the window, there is no indication of any unsaved changes.

 The current version of the LANCOM R&S[®] Unified Firewall User Manual is also available on the login page. Click on the **User Manual** link to open the file.

About the automatic logout

You will be automatically logged out after 10 minutes of inactivity, i.e. if no HTTP requests are sent to the server. The timer restarts following any action, such as opening a dialog or saving settings or regularly updated logs (for example, the [Alert log](#) on page 54). Exceptions are background requests that do not restart the timer.

 If you change settings in a dialog, do not save your changes and leave the dialog open, you will automatically be logged out after 10 minutes.

Multiple administrators logged in

Multiple administrators can be logged in to the LANCOM R&S[®] Unified Firewall web client at the same time. However, only one of these administrators can have write access, i.e. make changes to the configuration. This is always the administrator who logged in first; the others all have read access only. If the administrator with write access then logs off, these privileges are passed on to the next administrator in line, i.e. who logged in earliest. This administrator receives a corresponding message.

When you log in, you will be informed that a session with write access is already active. If you have read permissions for the administrator settings, you will also see a list of the other administrators who are currently logged on. Also see [Administrators Settings](#) on page 26. If you log in with an account that already has another privileged session active, you can terminate that session and start a new one. This is useful if you just closed a browser window without logging off.

The header shows whether you have reduced privileges.



An administrator with write access is also informed in the header if additional administrators log in.







Clicking the warning will bring up the same warning message that was also displayed when you logged in.

3.1.2 Navigation Pane

The navigation pane (2) is on the left side of the web client. Depending on your selection in the first bar, a second bar is displayed to the right of the first one. The menu items in the left navigation bar provide access to the LANCOM R&S® Unified Firewall settings. The item list bar on the right is displayed when you select a menu item in the navigation bar. The item list bar is used to display information on the current desktop configuration.

Both bars contain a **Filter** input field at the top which helps you quickly find a particular menu item or item list entry. Each input field only works for the bar it is part of. As you type in one of the input fields, your LANCOM R&S® Unified Firewall reduces the corresponding list to show only those menu items or item list entries that contain the characters you are typing. Click  in the input field to delete the search string and display an unfiltered view of the bar.

You can expand all menus in the navigation bar at once by clicking  or collapse them by clicking  in the upper right corner of the navigation bar. Furthermore, you can hide the navigation bar by clicking  in the header area. For more information, see [Header](#) on page 18.

The information displayed in the item list bar depends on the menu item selected in the navigation bar and on how much information you desire to be displayed. You can unfold more detailed information by clicking  or reduce the amount of information presented by clicking  in the upper right corner of the item list bar.

See [Menu Reference](#) on page 26 for details on the options available in each view.

3.1.3 Desktop

The desktop (3) fills the main portion of the screen below the header area and to the right of the navigation pane. The highlighted nodes and connections depend on the item selected in the navigation pane or on the desktop.

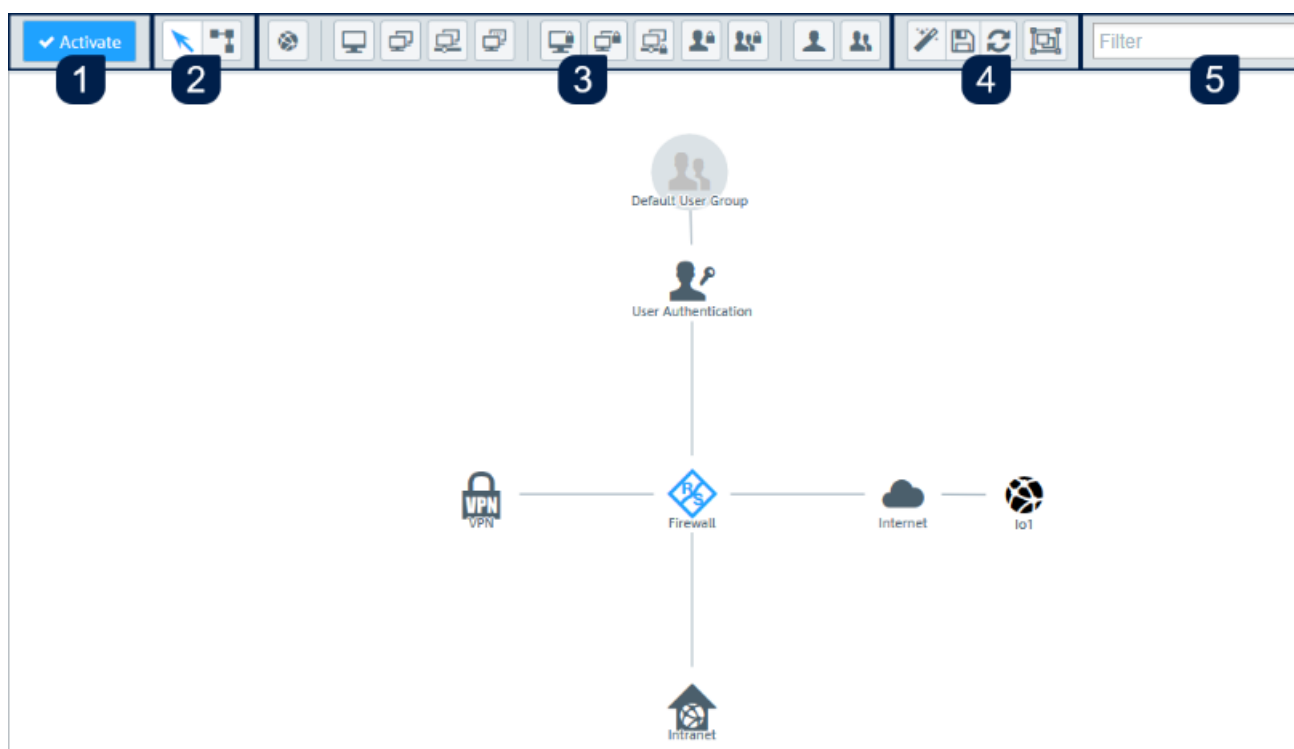

Figure 13: LANCOM R&S® Unified Firewall web client desktop.

On the desktop, you have an overview of your configured network. You can edit various settings in this pane or view the details of a configuration.

A toolbar at the top of the desktop provides quick access to frequently used functions (from left to right):

1. Confirmation button
2. Selection tool, connection tool
3. Tools for creating desktop objects
4. Tools for saving, restoring and arranging desktop objects
5. Filter/search tool

All toolbar buttons use mouse-over pop-up labels for easy identification.

For more information, see [Icons and buttons](#) on page 22.

Saving the system configuration (1)

If the system configuration changes, the  **Activate** button in the first section of the toolbar is highlighted, prompting you to update your configuration. Click this button to save your current desktop configuration changes and to activate them on your LANCOM R&S[®] Unified Firewall.

Selecting or connecting desktop objects (2)

Use the selection tool for all actions on the desktop, such as moving objects or selecting certain functions. With the connection tool, you can create or edit a connection between two desktop objects. For more information, see [Firewall Rule Settings](#) on page 24.

When you left-click a desktop object, several buttons appear in the circular menu, depending on the type of the desktop object. Use these buttons to adjust the settings for an existing object and to create or edit a connection between two existing objects. Furthermore, you can hide or display objects attached to another object, unpin an object from a specific location on the desktop or remove an object from the desktop.

Creating a desktop object (3)

To create a desktop object, click the respective button. An editor panel opens where you can enter the object's data.

Customizing the desktop layout (4)

You can customize the desktop layout by dragging the objects to the desired position where they are automatically pinned. You can save and restore your customized layout or arrange the objects automatically.

Finding desktop objects (5)

You can use the **Filter** input field at the end of the toolbar to quickly identify desktop objects based on the following criteria:

- > Name of the desktop object
- > Description
- > Tags
- > Interface used, including "any" and "Internet" interface
- > IP addresses, IP networks and IP ranges
- > User or user group names
- > Internet connections
- > IPsec and VPN SSL connection names
- > Local and remote networks used in IPsec connections

You can also filter for desktop connections, but due to the way the desktop works, connections can only be viewed indirectly by displaying the related desktop objects. Values that can be used for filtering:

- > Service name

- > Ports (for port ranges, a search is conducted in addition to the text filter to see whether the search string is a number and lies within the port range)
- > Protocol used (TCP, UDP, ICMP ...)
- > Activated DMZ, external IP address used for the DMZ
- > Activated proxy

Click in the input field to open a drop-down list with the names of the possible inputs. You can either select an element from the list to include it in the filter input, or search for a specific element. Pseudo elements are used to display the connections and are added to find connections with an activated proxy and DMZ. As you type your input into the search field, your LANCOM R&S® Unified Firewall will show only the drop-down list items that contain the characters you entered. You can add any number of entries to the filter input, all of which are combined with an “Or” operator. Input is not case sensitive.

Your LANCOM R&S® Unified Firewall limits the displayed desktop objects to those that match the selected filter criteria. Desktop nodes along the path from the **Firewall** root node to a node that matches the filter criteria are always displayed, even if intermediate objects do not match the search criteria.

Click on  in the input field to delete the search input and return to the unfiltered list view. Please refer to [Desktop Tags](#) on page 93 for further information.

3.1.4 Information panel

The information area (4) is located on the right-hand side of the desktop.

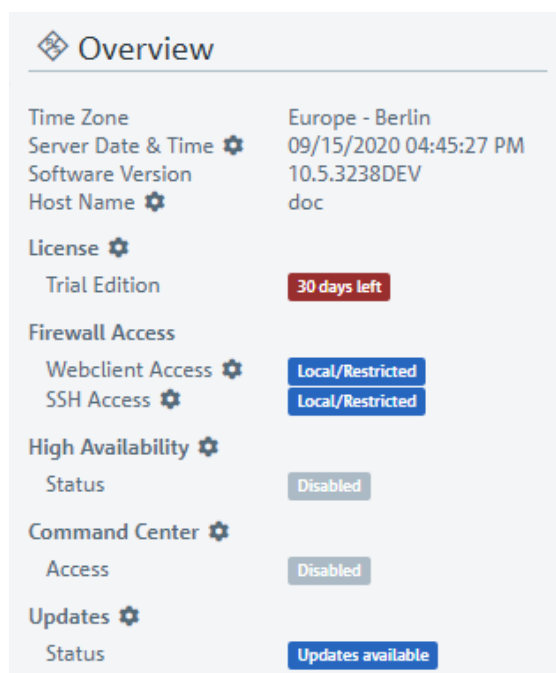



Figure 14: Information panel of the LANCOM R&S® Unified Firewall web client

After logging in, the information panel is visible and displays basic firewall information.

Select a desktop object to display its details in information panel, e.g.:

- > Description
- > Tags
- > IP addresses
- > Group members
- > Current VPN connections

The amount and type of information displayed differs for the different types of desktop objects (hosts, Internet objects, users, etc.). Dynamic information (e.g. the status of a VPN connection) is updated automatically.

You can click on entries with  to open a corresponding settings dialog.





















Click on  to minimize the information panel. Click on the **info** icon to show the information panel again.

























 If the information panel shows **not available** for marked objects, the logged in user does not have appropriate rights to view this information.

3.2 Icons and buttons

This section explains the icons and buttons used on the user interface and throughout this guide.

Hovering over the buttons with your mouse pointer will display pop-up labels for easy identification.

Icon / button	Description
	Show or hide the navigation bar.
	Move objects or select objects or features on the desktop.
	Create or edit a connection between two desktop objects.
	Create an Internet object.
	Create a host.
	Create a host group.
	Create a network.
	Create an IP pool.
	Create a VPN host.
	Create a VPN group.
	Create a VPN network.
	Create a VPN user.
	Create a VPN user group.
	Create a user.
	Create a user group.
	Reset all manual layout changes on the desktop and restore the default layout.
	Save the current desktop layout.
	Restore the last saved desktop layout. Restore a backup. Restore a certificate by importing a new certificate.
	Adjust the entire network to the desktop size.
	Highlights a menu item with settings that can be configured in the navigation bar. Highlights a table column containing actions available for a table entry.

Icon / button	Description
	Detach a desktop object to drag & drop it across the desktop together with its corresponding desktop node.
	View and edit the settings for a desktop object, list item, or table entry.
	Create a list item or table entry from a copy of an existing entry.
	Delete a desktop object or list entry from the system after confirming the security prompt. Permanently revoke a certificate.
	Delete a customized firewall rule from the system. Remove a firewall rule with a predefined service from the firewall rules table.
	Import a certificate or blacklist/whitelist from a file. Sign a certificate signing request.
	Export a certificate or blacklist/whitelist to a file.
	Import a backup from a file.
	Export a backup to a file.
	Create a list item in the object bar.
	Expand a menu item in the navigation bar to show child items. Expand a web filter category to show its subcategories. Expand a firewall-rule service category to show child services. Expand a statistic or table.
	Hide a menu item in the navigation bar to show child items. Hide the subcategories of a web filter category. Hide the child services in a firewall-rule service category. Hide a statistic or table.
	Expand detailed information in the object bar.
	Reduce information in the object bar.
	Collapse all menus in the navigation bar. Expand a desktop node to display its associated desktop objects.
	Expand all menus in the navigation bar. Collapse a desktop node to hide its associated desktop objects.
	Indicates that a certificate is still valid.
	Indicates that a certificate has expired.
	Verify a certificate.
	Temporary suspension of a certificate or CA.
	Reactivate a suspended certificate.
	Renew a certificate with changed validity.
	Close a pop-up window.
	Reset filter search criteria to show all results.

Icon / button	Description
	This marks all objects and settings that are managed by the LANCOM Management Cloud (LMC). These can be viewed with the web client, but cannot be edited. Objects managed by the LMC cannot be referenced. This means, for example, that an application filter profile created by the LMC cannot be used in a self-created desktop connection.

3.3 Firewall Rule Settings

This section describes how to create a firewall rule for a connection between two desktop objects.

3.3.1 Setting Up a Connection

To set up a connection between two desktop objects, proceed as follows::

1. Click the  button in the toolbar at the top of the desktop.

The desktop objects which can be selected for this connection and possible connections between them are highlighted and marked by dotted circles and lines.

2. Select the source object of the connection by clicking the corresponding desktop object.
3. Select the target object of the connection by clicking the corresponding desktop object.

The **Connection** editor panel opens, displaying, if applicable, existing firewall rules for this connection.

Alternatively, you can click the  button in the circular menu of the source object on the desktop and then select the target object.

3.3.2 Setting Up a Firewall Rule

To set up a firewall rule, proceed as follows::



1. In the **Rules** tab of the **Connection** editor panel, select at least one of the services to which you want to apply the firewall rule.

The services that are available for the connection are displayed in the service selection list bar on the right side of the browser window. The list bar is subdivided into categories of services which serve a similar purpose. You can collapse and expand the categories by clicking the corresponding icon.

For more information, see [Icons and buttons](#) on page 22.

The **Filter** input field at the top of the service selection list bar helps you quickly find a particular service or service group. As you type in the input field, your LANCOM R&S® Unified Firewall reduces the list to show only those services and service groups that contain the characters you are typing. Click  in the input field to delete the search string and display an unfiltered view of the list.

- a. There are two ways to add services to a firewall rule:

- > To add an individual service, click the  button in front of the corresponding service in the service selection list bar.
- > Click the  (Add filtered services) button directly below the header of a category to add all services belonging to that category at once.

The selected services are displayed in the table in the **Rules** tab.

- b. To adjust the settings of a firewall rule, click  (Click to edit this rule).

An editor panel for the particular service opens.

2. The editor panel displays the following information and allows you to configure the following elements of the firewall rule:
 - a. Under **Description**, you can enter additional information regarding the firewall rule for internal use.
 - b. In the **Ports / Protocols** tab, you can see which ports and protocols were defined to be used for the service. For more information, see [Services](#) on page 94.
 - c. In the **Schedule** tab, you can specify the time when the firewall rule is active. The tab provides the following options:
 - > Set specific times and weekdays using the sliders.
 - > Click **Always On** – the rule is always active.
 - > Click **Always Off** – the rule is always inactive.

- d. The **Advanced** settings tab provides the following options:

Input Field	Description
Proxy	For firewall rules with predefined services only if the predefined services allow a proxy (HTTP, HTTPS, FTP, SMTP, SMTPS, IMAP, IMAPS, POP3 or POP3S): Select this check box to activate the proxy for this rule. For firewall rules with user-defined services only: From the drop-down list, select a proxy for this rule. To delete a proxy, click ✕ to the right of the entry.
NAT / Masquerading	For NAT/masquerading, enter the desired direction (<i>bi-directional</i> , <i>left-to-right</i> or <i>right-to-left</i>) or deactivate (<i>Off</i>) the feature for this rule by selecting the respective radio button. The default setting depends on the source and target objects selected for the connection.
New source IP	Optional: If you have multiple outgoing IP addresses, specify the IP address to be used for Source NAT. If you do not specify the IP address, the system automatically chooses the main IP address of the outgoing interface.
Enable DMZ / Port Forwarding for this service	If the target of the firewall rule is a single host object, you can select this check box to enable DMZ and port forwarding for this rule.
External IP address	Optional: Specify the destination IP address of the traffic to be manipulated. The DMZ rule is only applied to this type of traffic. This IP address must be one of the IP addresses of the firewall.
External Port	Displays the original destination port of the traffic to be manipulated, depending on the port defined in the Ports / Protocols tab.
Destination IP address	Displays the new destination IP address of the traffic (after its manipulation).
Destination Port	Optional: Enter the destination port of the traffic (after its manipulation).

- e. The buttons at the bottom right of the editor panel allow you to confirm your changes to an existing rule (**OK**), reject the editing of an existing rule (**Cancel**) and discard your changes (**Reset**).

The configured rule is displayed in the table in the **Rules** tab. To delete a rule from the table, click the  button (Click to delete this rule) in the last column.

3. For more information on the **URL / Content Filter** and **Application Filter** tabs, see [Desktop Connections](#) on page 82
4. The buttons at the bottom right of the editor panel allow you to close (**Close**) the editor panel as long as no changes have been made and to save (**Save**) or to discard (**Reset**) your changes.
5. Click  **Activate** in the toolbar at the top of the desktop to apply your configuration changes.

For more information, see [Icons and buttons](#) on page 22.

3.4 Menu Reference

This reference chapter describes each menu item in the navigation bar on the left side of the browser window. The license acquired from LANCOM Systems determines which menu items are available on your LANCOM R&S® Unified Firewall. Features that are not included in your LANCOM R&S® Unified Firewall license are grayed out in the navigation bar.

Refer to the sections below for information on the options available in each view.

3.4.1 Firewall

Use the settings under  **Firewall** to configure your LANCOM R&S® Unified Firewall for your local environment. In addition, you can set up access to your LANCOM R&S® Unified Firewall from external networks or the Internet and connect your LANCOM R&S® Unified Firewall to an Command Center server.

Administrators

Use the **Administrators** settings to define administrators and their access to certain services.

You can find more information in the following sections.

Administrators Overview

Navigate to **Firewall > Administrators** to display a list of administrators that are currently defined in the system in the item list bar.

Click  above the list to add new administrators.

In the expanded view, the first table column displays the **Name** of the administrator. The **Admin** column shows one of the following status indicators:

- > Green – The administrator has been granted access to the web client.
- > Orange – The administrator has not been granted access to the web client.

The buttons in the last column allow you to view and to adjust the settings for an existing administrator. Furthermore, the buttons allow you to create an administrator based on a copy of an existing administrator or delete an administrator from the system.

For more information, see [Icons and buttons](#) on page 22

Administrators Settings

Under **Firewall > Administrators**, you can add a new or edit an existing administrator.

 You cannot delete or rename the default user `admin`. Furthermore, access rights of this user on the web client cannot be withdrawn.

The **Administrator** configuration dialog allows you to configure the following elements:

Input field	Description
Name	Enter a unique name for the administrator.
Description	Optional: Enter additional information regarding the administrator for internal use.

On the **Client Access** tab:

Input field	Description
Granting access	Select this check box to allow the administrator access to the web client.

Input field	Description
Password	For new administrators and only if the Granting access check box is selected: Enter a password and confirm it. For edited administrators and only if the Change check box is selected: Enter a password and confirm it.
Change	Optional and for edited administrators and only if the Granting access check box is selected: Select this check box to change the administrator's password.
Show Password	Optional and for new administrators and only if the Granting access check box is selected: Select this check box to verify the password. Optional and for edited administrators and only if the Change check box is selected: Select this check box to verify the password.
Require password change after next login	Optional and for new administrators and only if the Granting access check box is selected: Select this check box if you want to require the user to change the password after the next login. Optional and for edited administrators and only if the Change check box is selected: Select this check box if you want to require the user to change the password after the next login.

On the **Webclient Permissions** tab, you can specify what the administrator is allowed to do in specified areas of the web client.

You can choose between the following permissions by selecting the respective radio button:

- > **Forbidden** – The administrator has no access to the specified area of the web client.
- > **Read / Open** – The administrator can open and read the entities in the specified area of the web client but cannot change them.
- > **Write / Execute** – The administrator has full access to the entities in the specified area of the web client.

The buttons at the bottom right of the editor panel depend on whether you add a new administrator or edit an existing one. For a newly configured administrator, click **Create** to add it to the list of available administrators or **Cancel** to discard your changes. To edit an existing administrator, click **Save** to store the reconfigured administrator or **Reset** to discard your changes.

If you have modified these settings, use the buttons at the bottom right of the editor panel to confirm (**Save**) or to discard your changes (**Reset**). Otherwise, you can close the dialog (**Close**).

General settings

Navigate to **Firewall > General settings** to open an editing window where you can adjust some of the central settings for your LANCOM R&S® Unified Firewall.

In the **General settings** editing window you can modify the following parameters:

Input box	Description
Host name	Host name of the firewall.
Domain	Domain of the firewall. If the firewall is connected to an Active Directory, enter the corresponding Active Directory domain here.
Send usage statistics	Collect information about the load and the state of the firewall and send this to LANCOM Systems GmbH.  No personal information or any of the firewall traffic will be transmitted.
Send crash reports	In the event of an error, general information about the system status, the current system configuration and the error that occurred is transferred to LANCOM Systems GmbH.

Input box	Description
	 The data is used solely for error analysis and is then deleted. No data is disclosed to any third parties.

If you have made changes, you can use the buttons at the bottom right of the edit window to save them (**Save**) or discard them (**Reset**). Otherwise you can close the window (**Close**).

Backup

Your LANCOM R&S® Unified Firewall stores your settings in configuration files which are automatically created whenever settings are changed in the web client. The options under **Backup** allow you to schedule regular backups of the current system configuration, to back up the system configuration manually and to restore previous configurations.

 You can create backups at any time at the time a license is imported (i. e. not within the 30 day trial period).

For more detailed information on backups, see the following sections.

Automatic Backup Settings

The **Auto Backup** settings allow you to set up a connection to a remote backup server on which you want to store automatically created backups. Furthermore, this panel lets you schedule how often the firewall configuration is backed up automatically. There are no restrictions on the amount or interval of backup creation.

 Before you proceed, make sure that you set the time zone for your LANCOM R&S® Unified Firewall as described under *Time Settings* on page 46. Otherwise, the backups are created according to Europe - Berlin (CET/UTC +1) instead of the time specified by you in the automatic backup settings.

Navigate to **Firewall > Backup > Auto Backup** to open an editor panel to display and edit the settings for automatic backups.

The **Auto Backup** panel allows you to configure the following elements:

Input field	Description
Server Address	Enter the IP address of the remote backup server on which you want to store automatically created backups.
Username	Enter the name of the user on the remote backup server.
Password	Enter the user's password for the remote backup server if necessary.
Show Password	Optional: Select this check box to verify the user's password.
Server Type	Select the respective radio button to specify which network protocol is used to upload the backups to the server. This option is set to FTP by default, but you can adjust the settings to SCP if necessary.
Filename	Enter a name for automatically created backup files.
Encryption Password	Enter a password for the encryption of the backup files. The password can consist of up to 32 characters (allowed are letters of the English alphabet, integers and the special characters \ -] [/ . , ~ ! @ # \$ % ^ * () _ + : ? > < } {)
Show Encryption Password	Optional: Select this check box to verify the encryption password.
Options	Select the respective radio button to specify what is added to the filenames to distinguish the backups from each other. This option is set to Append current date to filename by default, but you can adjust the settings to the other value as necessary:

Input field	Description
	<ul style="list-style-type: none"> > Append current date to filename – The date and the time stamp of the creation of a backup is added to the filename (e. g. Backup_20171130-1527.gp). As these filenames never repeat, old backup files are never overwritten. > Max. file count – A number (backup number) is added to the filename. Specify the maximum number of backup files to be stored by entering an integer in the input field below this option. This option is set to 20 by default. Once the defined number is reached, counting starts anew and the oldest backup file is automatically overwritten.
Schedule	<p>Specify how often the firewall configuration is backed up automatically.</p> <p>Under Start, click the input field to set the date and time of the first backup to be created automatically. A pop-up window with a calendar and input fields for setting the date and time opens. You can enter a date in the MM/DD/YYYY format or choose a date from the calendar. You can also set a time by entering the time in the hh:mm:ss format.</p> <p>Under Interval and Unit, define how often the configuration is backed up automatically. Set the interval by entering a number or using the up and down arrows. This option is set to 1 by default. Then, select one of the unit options from the drop-down list. This option is set to days by default, but you can adjust the settings to one of the other values as necessary:</p> <ul style="list-style-type: none"> > Once > Hours > Days > Months <p>Click Add to add the schedule to the list.</p> <p>You can edit or delete individual entries in the list by clicking the corresponding button next to an entry. For more information, see Icons and buttons on page 22.</p> <hr/> <p> If you edit a schedule, a check mark appears on the right of the entry. You have to click the check mark before being able to save the settings of the certificate.</p>

To check the connection to the configured backup server, click the **Test Server Settings** button at the bottom left of the editor panel. The system tries to save a test file (file_name_test) on the backup server. If this test is successful, a text file is saved on the server and a pop-up window with a success message appears. You can delete this text file after the test.

If you have modified these settings, use the buttons at the bottom right of the editor panel to confirm (**Save**) or to discard your changes (**Reset**). Otherwise, you can close the dialog (**Close**).

Click  **Activate** in the toolbar at the top of the desktop to apply your configuration changes.

Backup Export

The **Export** settings allow you to create and export a manual backup of the current firewall configuration. Use this function, for example, to reload a configuration after a system update.

Navigate to **Firewall > Backup > Export** to open an editor panel to create and transfer a manual backup in GP file format to your computer so you can restore the configuration contained in it later if necessary.

The **Export** configuration dialog allows you to configure the following elements:

Input field	Description
Encryption Password	Enter a password for the encryption of the backup file and confirm it. The password can consist of up to 32 characters (allowed are letters of the English alphabet, integers and the special characters \-] [/ . , ~ ! @ # \$ % ^ * () _ + : ? > < } {).

Input field	Description
Show Password	Optional: Select this check box to verify the password.
Use auto backup password	Optional: Select this check box if you want to use the password for automatic backup file encryption (see Automatic Backup Settings on page 28) instead of inserting a new password.

If you want to export the backup file, click **Export**. Otherwise, click **Cancel** to close the editor panel.

Backup Import

Your LANCOM R&S® Unified Firewall allows you to upload a previously downloaded backup file to restore the system configuration (e. g. after a new installation).

Navigate to **Firewall > Backup > Import** to load and activate a firewall configuration from a backup file that was created earlier.

 To upload an automatically created backup file stored on the backup server, you first have to transfer the backup file from the backup server to your local disk.

The **Import** configuration dialog allows you to configure the following elements:

Input field	Description
Backup File	Click Select to open the local disk search. Select a backup file in GP file format to transfer from your local disk. Click Open to close the local disk search. The name of the backup file appears in the field.
Password	Enter the encryption password which you chose for the export of the file.
Show Password	Optional: Select this check box to verify the password.

If you want to import the backup file, click **Import**. Otherwise, click **Cancel** to close the editor panel.

If the upload was successful, a success message appears. Confirm that you want to reboot the system by clicking **Reboot**. The system restarts, logs you out and opens the LANCOM R&S® Unified Firewall login page. Enter your login credentials and click **Login**. The web client appears.

Command Center

LANCOM R&S® UF Command Center allows you to administrate multiple LANCOM R&S® Unified Firewalls devices in one application.

Navigate to **Firewall > Command Center** to open an editor panel to connect your LANCOM R&S® Unified Firewall to an LANCOM R&S® UF Command Center through a VPN connection.

 To establish the VPN connection, you need VPN certificates for all devices that were signed by the same certificate authority (CA). Therefore, it is advisable to manage the VPN CA and the VPN certificates on one site and then export and import the VPN certificates from there to the other sites.

For information on how to create, export and import certificates, see [Certificates](#) on page 144.

The **Command Center** configuration dialog allows you to configure the following elements:

Input field	Description
I/O	A slider switch indicates whether the connection to your LANCOM R&S® UF Command Center is active (I) or inactive (O). Click the slider switch to change the status of the connection. The connection to your LANCOM R&S® UF Command Center is deactivated by default.

Input field	Description
Host	Enter the host name or IP address under which your LANCOM R&S®UF Command Center is reachable from your LANCOM R&S®Unified Firewall.
Port	Enter the port number under which your LANCOM R&S®UF Command Center is reachable (usually port number 11940).
Command Center CA	From the drop-down list, select the CA that was used to sign the LANCOM R&S®UF Command Center certificate.
Firewall Certificate	From the drop-down list, select the VPN certificate for your LANCOM R&S®Unified Firewall.
Latitude/Longitude	Optional: Enter the grid coordinates of the location of your LANCOM R&S®Unified Firewall in decimal degrees, e. g. 53.555483. The grid coordinates are used to display your LANCOM R&S®Unified Firewall in a map in your LANCOM R&S®UF Command Center.

If you have modified these settings, use the buttons at the bottom right of the editor panel to confirm (**Save**) or to discard your changes (**Reset**). Otherwise, you can close the dialog (**Close**).

E-mail settings

The e-mail settings are necessary for using the notification system. You can use this to receive e-mail messages about specific types of notification, either immediately or regularly in an aggregated form. Further details are available under [Notification settings](#) on page 50.

Navigate to **Firewall > E-mail settings** to open an editing window where you can configure the sender and message encryption. Optionally, settings are available for a relay server if e-mails cannot be sent directly.

In the **E-mail settings** editing window you can adjust the following parameters:

Input box	Description
I/O	A slider button indicates whether the E-mail settings are enabled (1) or disabled (0). Click on the slider button to change this.
Sender address	Sender e-mail address of the firewall system.
Connection security	Choose one of the possible options <i>None</i> , <i>TLS</i> or <i>StartTLS</i> .
Validate remote certificate	If enabled, the firewall verifies the certificate of the destination server or relay.
S/MIME certificate	If this is specified, then the firewall encrypts all outgoing e-mails with the public key of the selected certificate.

On the **Relay** tab you can configure preset values for the following items:

Input box	Description
Server	The address of the e-mail server.
Port	The port used by the e-mail server.
User name	Name used by the firewall to log in to the e-mail server.
Password	Password used by the firewall to log in to the e-mail server.

You can test your settings by using the button **Send test mail**. A dialog opens where you can enter a **recipient address**. You then click the **send** button.

 If you are using a relay server, please note that the subsequent status message only tells you if the relay server accepted the e-mail. If the relay server is unable to deliver the message, this can only be seen on the relay server itself.

If you have made changes, you can use the buttons at the bottom right of the edit window to save them (**Save**) or discard them (**Reset**). Otherwise you can close the window (**Close**).

Executive Report

By navigating to **Firewall > Executive Report**, you can generate a report on your current desktop configuration and various statistics, and transfer these to your computer.

In the **Executive Report** window you can choose between the file formats PDF and HTML by selecting the appropriate radio button.

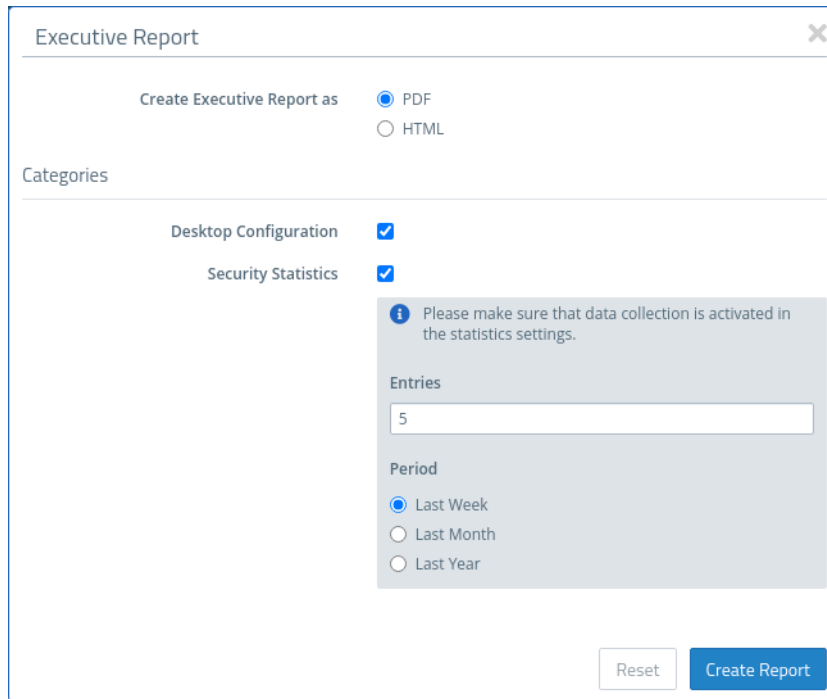



Figure 15: Executive Report – settings

In the **Categories** section you can configure the following elements:

Input box	Description
<p>Desktop configuration</p>	<p>The export file contains an image of the current desktop and a table with all of the configured firewall rules, including additional information such as NAT, DMZ, IP addresses of the host objects and the content of the description fields for the configured desktop objects and connections.</p> <hr/> <p> Desktop objects are only included if they are linked to other desktop objects.</p>
<p>Security statistics</p>	<p> In order for statistics to be generated, the value under Monitoring & Statistics > Settings must at least be set to "Create Statistics" for the event types.</p> <p>Contains the statistics that are also available under the menu item Monitoring & Statistics > Statistics > Overview, both as a graph and as a table:</p> <ul style="list-style-type: none"> > Blocked connections > Blocked content > Top viewed domains > Top blocked domains > Top traffic per source

Input box	Description
	If security statistics are activated, further settings are available: <ul style="list-style-type: none"><li data-bbox="694 315 1236 344">> Number of entries (this setting applies to the top lists only)<li data-bbox="694 349 1436 405">> Period, definition of the period to be recorded starting with the current point in time

Click on **Create Report** if you want to create and transfer the export file. Your settings are saved and a file name with a date prefix (YYYY-MM-DD_HH-mm) is suggested. Otherwise click **Reset** to reset the settings to the last saved settings.

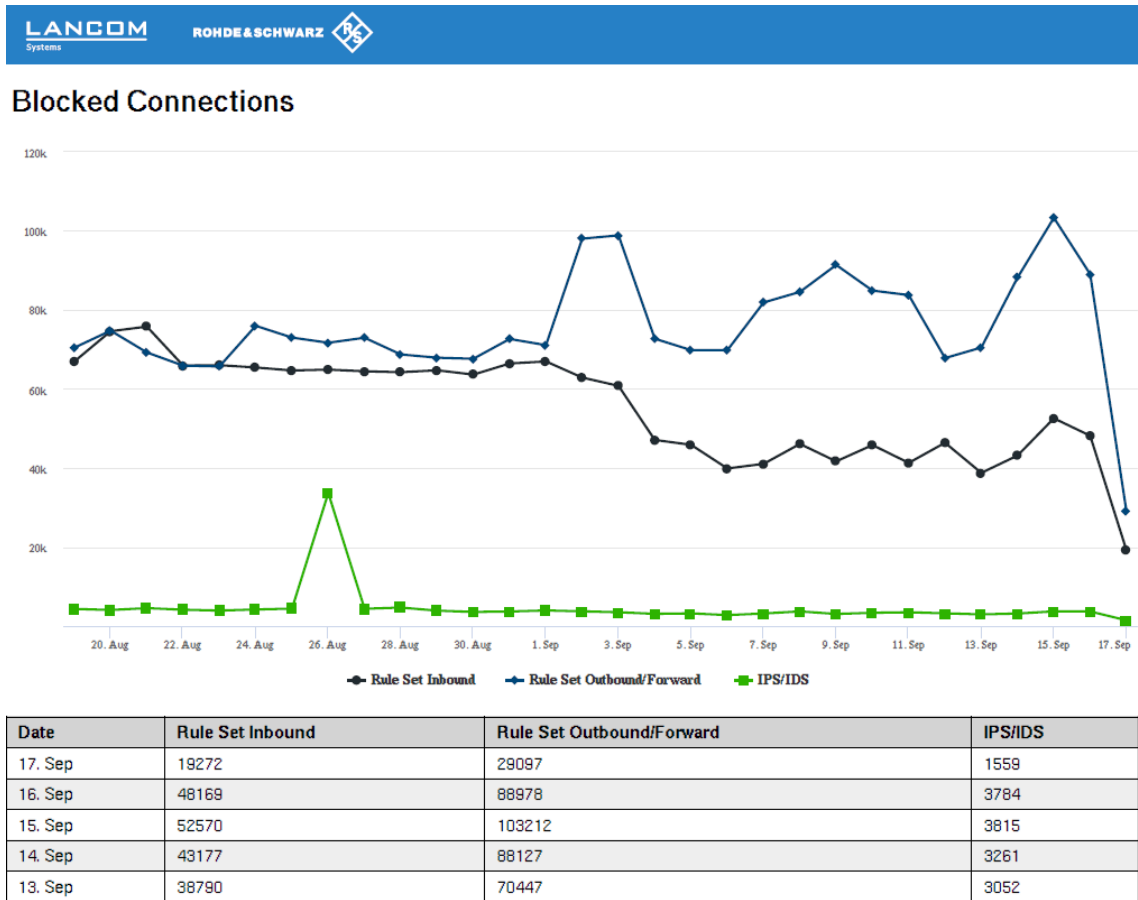
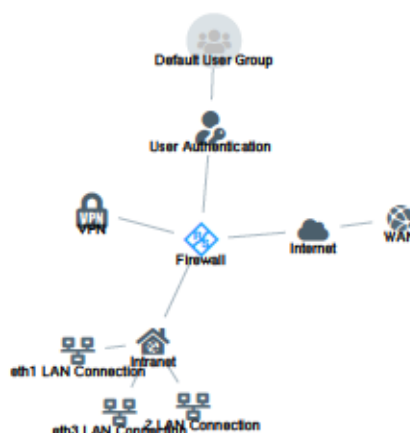

Figure 16: Sample from an Executive Report



Desktop Configuration



Source	Action	NAT	Destination	Service	Rule Settings	Connection Settings
eth2 LAN Connection 10.10.21.0/24	→	→	WAN eth0 WAN Connection	IMAP4 143 TCP	Proxy: IMAP4	Webfilter: Sex: Content Filter Kriminelles: Content Filter Werbung: Content Filter
	→	→		POP3s 995 TCP	Proxy: POP3S	
	→	→		SMTP 25 TCP	Proxy: SMTP	
	→	→		IMAP4s 993 TCP	Proxy: IMAP4S	
	→	→		POP3 110 TCP	Proxy: POP3	
	→	→		SMTPs 465 TCP	Proxy: SMTPS	
	→	→		HTTPS 443 TCP	Proxy: HTTPS	
	→	→		HTTP 80 TCP	Proxy: HTTP	
eth1 LAN Connection 10.10.20.0/24	→	→	WAN eth0 WAN Connection	HTTPS 443 TCP	Proxy: HTTPS	Webfilter: Sex: Content Filter Kriminelles: Content Filter Werbung: Content Filter
	→	→		HTTP 80 TCP	Proxy: HTTP	

Figure 17: Sample from an Executive Report

High Availability

The **Firewall > High Availability** configuration dialog allows you to connect two independent LANCOM R&S® Unified Firewall systems in a master/slave configuration through a dedicated interface. The so-called HA cluster provides failover. If the master device becomes unavailable, the standby device (slave) takes over its tasks.

The master and slave systems are connected via a Cluster Interconnect cable that allows them to communicate with one another and monitor the status of the paired system. The slave node's configuration is synced with the master node's configuration. Certain rules are applied to the slave device, that allow network communication with the master node only. If the slave system fails to detect a "heartbeat" signal from the master, it takes over the role of the master system (in the event of a power outage or hardware failure/shutdown).

⚠ In this case, the slave device removes specific blockades and sends a gratuitous ARP request. The switch connected to your LANCOM R&S® Unified Firewall must allow the ARP command. It may take several seconds for the client device in the network to update its ARP cache and for the new master to be reachable.

The following figure illustrates a typical network environment with a redundant master/slave configuration for High Availability.

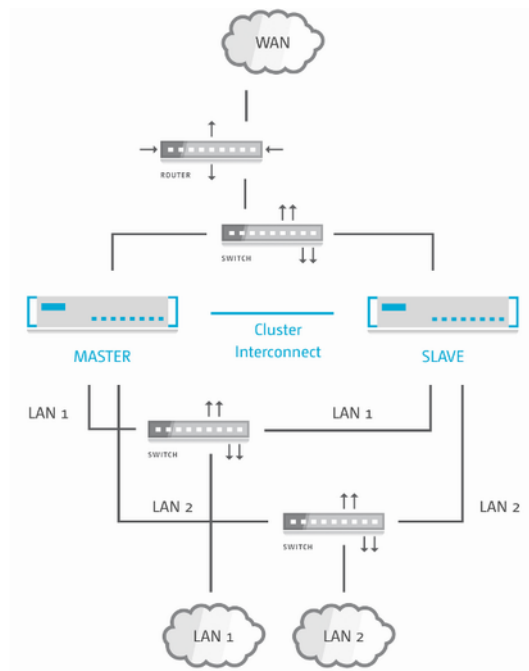

Figure 18: Sample network setup for High Availability.

! High Availability is not available for the LANCOM R&S® Unified Firewall models UF-50 and UF-100.

You can find more information regarding high availability in the following sections.

High Availability Settings

Use the **High Availability** settings to specify the connection parameters for the master/slave configuration.

The High Availability feature requires two identical systems of the same hardware type (for example UF-200 with UF-200 or UF-500 with UF-500) and software version. Furthermore, a free network interface (NIC) is required on both systems that is not in use by any other interface (like VLAN or bridge) or any network connection. For more information, see [Interfaces](#) on page 72 and [Network Connections](#) on page 63. You have to use the same NIC on both systems for cluster interconnection.



The master system synchronizes its initial configuration and any subsequent configuration changes to the slave system to ensure that the same configuration is used in the event of failure.

! High Availability can only be activated if no background processes, such as updates or backups, are running.

Navigate to **Firewall > High Availability** configure the high availability settings.

The **High Availability** configuration dialog allows you to configure the following elements:

Input field	Description
I/O	A slider switch indicates whether the High Availability feature is active (I) or inactive (O). By clicking the slider switch, you can toggle the state of High Availability. High Availability is deactivated by default.
Status	Displays the High Availability status of your LANCOM R&S® Unified Firewall. The following statuses are available:

Input field	Description
	<ul style="list-style-type: none"> > Disabled – High Availability is not enabled on the firewall. > No connection – High Availability is enabled on the firewall but the other firewall cannot be reached. > Not synced – High Availability is enabled on the firewall and the other firewall can be reached, but the configuration from the master system has not been synchronized to the standby (slave) system yet. > Synchronized and ready – High Availability is enabled on the firewall. The other firewall can be reached and is synchronized. > Updating – High Availability is enabled on the firewall. The other firewall can be reached. Both systems are being updated. <hr/> <p> The update process consists of multiple steps that can be tracked in Update Settings dialog and in the Info Area.</p>
Initial Role	<p>Select the respective radio button to specify the role which your LANCOM R&S® Unified Firewall is to play in the HA cluster:</p> <ul style="list-style-type: none"> > Master – The LANCOM R&S® Unified Firewall is active and synchronizes its configuration to the LANCOM R&S® Unified Firewall being the slave. > Slave – The LANCOM R&S® Unified Firewall is not active (i. e. it cannot be reached using the web client) but it receives the master configuration and is prepared for taking over.
HA Interface	<p>From the drop-down list, select the interface to be used for the HA cluster communication. This interface cannot be used for any other firewall services.</p> <hr/> <p> The same interface (NIC) must be used on both LANCOM R&S® Unified Firewall systems for Cluster Interconnection.</p>
Local IP	<p>Enter the IP address which you want to assign to the HA interface on the LANCOM R&S® Unified Firewall in CIDR notation (IP address followed by a slash “/” and the number of bits set in the subnet mask, e. g. 192 . 168 . 50 . 1 / 24).</p>
Remote IP	<p>Enter the IP address under which the LANCOM R&S® Unified Firewall can reach the other LANCOM R&S® Unified Firewall of the HA cluster.</p>

 **Local IP** and **Remote IP** must be in the same subnet. HA cluster communication is not supported for routed networks.

If you have modified these settings, use the buttons at the bottom right of the editor panel to confirm (**Save**) or to discard your changes (**Reset**). Otherwise, you can close the dialog (**Close**).

Click  **Activate** in the toolbar at the top of the desktop to apply your configuration changes.

 Before you connect the slave system to the master with the cluster interconnect cable and configure High Availability on the slave, the configuration of the master system must be complete and activated.

Connect the slave system with the same “WAN” and “LAN” network components as the master system (see [Figure 18: Sample network setup for High Availability](#), on page 36).

 Only the master system can be reached and configured using the web client.

If you want to change the High Availability configuration (for example to change the HA interface), first disable High Availability, then change the configuration. Then, turn High Availability back on with the new configuration.

To use both firewalls with your LANCOM R&S[®] UF Command Center, you need to configure them separately. When High Availability (HA) is enabled, the LANCOM R&S[®] UF Command Center settings are synchronized using the slave node to configure your LANCOM R&S[®] UF Command Center only once. For more information see [Command Center](#) on page 30

To make the HA feature work properly, the time settings of both firewalls need to be in sync. When you enable the HA feature, the settings are configured as follows:

1. The NTP client and server are activated on both firewalls.
2. Cluster link IP addresses are added to both nodes of the NTP server list.

You can find more information under [Time Settings](#) on page 46

To remove the slave system from the High Availability configuration and operate it as a standalone system, click the slider switch to deactivate the HA feature. The configuration settings of the slave node and the IP addresses of the network interface are set to default.

 It is possible that the default IP addresses of the slave node are in conflict with the IP addresses of the master node after the reset. For more information, see [Getting Started](#) on page 7. Contact our Support team to let them reconfigure the settings of the master node before deactivating the HA feature.

Operating the HA Features

In this chapter, you will receive information on how you can set up and operate the HA feature for your LANCOM R&S[®] Unified Firewall.

Initial Setup

To use the HA feature, you require a dedicated cluster link for firewall-to-firewall communication. This link is essential to make the HA feature work properly. Use a redundant interface, e. g. a bond interface that is provided through link aggregation.

 The following interfaces cannot be used as cluster links: VLAN, WLAN, PPP, Bridge interface

Use a switch to separate the cluster link to smoothly monitor the master node and the slave node through SNMP.

Synchronization

In this chapter, you will find information on how to sync the master node and the slave node with regards to the HA configuration, to connection tracking, to logs and statistics and on sync constraints.

Configuration

All configuration changes are synced with the slave node. During the synchronization and activation process, the HA feature is displayed as **Not in sync**. A role switch during the synchronization process can lead to data loss or loss of configuration changes.

Configuration changes are synced after a 15 second delay to prevent unnecessary activations in the slave node.

Click  **Activate** in the toolbar at the top of the desktop to start a full sync.

Connection Tracking

Connection-based protocols, as TCP, are tracked in the firewall. The tracking tables are automatically synced with the slave node. Therefore, connections remain after a role switch, e. g. during a downloading process.

Logs and Statistics

Your LANCOM R&S[®] Unified Firewall synchronizes the log and statistics databases between the master and slave system. Logs of the slave node are not stored, as the slave database only provides read permissions.

Constraints

The UTM features only save the status of connections through the firewall.

Example: The DPI engine stored meta data of packets that have already been analyzed until the connection ends.

Your LANCOM R&S® Unified Firewall does not synchronize this connection status, but stores it in the master node. After a role switch, all connections that have been analyzed by the UTM feature, are interrupted.

Example: A loss of meta data makes the DPI engine reject new packets of an older connection as unknown.

Role Switch

For the active-passive HA feature, LANCOM R&S® Unified Firewall provides the following roles:

> Master node

The master node actively processes network traffic. The master node is also responsible for forwarding all configuration and status changes to the slave node to ensure both systems are in sync.

> Slave node

The slave node is a passive node that is used as a hot-standby replacement that takes over the master's tasks if it is out of service. The slave node detects configuration and status changes and applies and activates them.

If the firewall does not work properly, e. g. due to hardware or kernel issues, the HA feature ensures a smooth feature failover by the slave. This prevents network downtimes. The failover is effected through Gratuitous ARP packets to all hosts in each broadcast domain of the firewall. These hosts acquire that the IP requests are responded by the new master node.

 Using the HA feature is useful if you want to supply your firewalls with new hardware without experiencing downtimes, e. g. for network modules or SSD disks.

Licensing

Your LANCOM R&S® Unified Firewall devices need to be digitally licensed for each device. If you have purchased two LANCOM R&S® Unified Firewall devices to use them in a HA environment, you will only receive one license. Both firewalls need to be configured and put into operation as HA clusters during the licensing process. Otherwise, the firewall might reject the license.

Updates

Installing an update in a HA environment can be effected with high reliability and without downtimes, even if the update fails.

 Create a backup of your configuration before initiating an update. For more information on updates, refer to [Updates Settings](#) on page 47.

The master node controls the update process as follows:

1. Downloading the update or upgrade

This step will be skipped if you have already downloaded the update or upgrade or if you have installed the upgraded firmware on the firewall manually, e. g. in an offline environment.

2. Synchronizing the update or upgrade with the slave node through the cluster link.

3. Installing the update on the slave node

The master node initiates the update or upgrade installation on the slave node. If an error occurs, the master node continues to work while the update process is being suspended. Contact our Support team to support you in case of downtimes.

4. Installing the update on the slave node

After installing the update on the slave node, it is installed on the master node.



Automatic updates are allowed when HA is enabled to prevent data loss or network downtimes as a successful role switch cannot be guaranteed after a failed installation of the update.

If both systems are not in sync, updates cannot be initiated.

Update with reboot

Most updates require a reboot after the installation. Rebooting the system in a HA environment triggers a role switch. We therefore recommend an administrator's assistance for the update process.

The master node controls the update process with reboot as follows:

1. Downloading the update
2. Synchronizing the update with the slave node through the cluster link.
3. Installing the update on the slave node
4. Restarting the slave node

The slave node restarts automatically after the installation.

5. Waiting for user confirmation

The web client prompts the administrator to proceed with the update process. Errors that occur prior to this step can be fixed. Contact our Support team if you need assistance.

6. Installing the update on the slave node
7. Restarting the master node

The master node automatically reboots after the installation. The role switch is effected on reboot.

Upgrade

To install an upgrade, your LANCOM R&S® Unified Firewall reboots. The reboot initiates the upgrade installation that provides the system with the latest version. An upgrade also initiates a role switch. We therefore recommend an administrator's assistance for the upgrade process.

The master node controls the upgrade process as follows:

1. Downloading the update or upgrade
2. Synchronizing the update or upgrade with the slave node through the cluster link.
3. Installing the update on the slave node
4. Upgrading the slave node

The slave node reboots and initiates the upgrade installation automatically.

5. Waiting for user confirmation

The web client prompts the administrator to proceed with the update process. Errors that occur on the slave node prior to this step can be fixed. Contact our Support team if you need assistance.

6. Installing the update on the master node
7. Upgrading the master node

The master node automatically reboots after the installation and initiates the upgrade installation automatically. The role switch is automatically effected upon reboot.

Synchronization

Prior to the installation of the update, your LANCOM R&S® Unified Firewall deactivates synchronization to ensure that the new version of the slave node is configured after reboot. All changes that you have made after the installation of the update has already started are applied after the update.

-
- ! During the upgrade, your LANCOM R&S® Unified Firewall synchronizes all logs and statistics from the old version and the new version.

Monitoring

If a device goes offline and is not able to reconnect, e. g. due to hardware issues, the administrator needs to react immediately and solve the issue or replace the defective device. A cluster that does not work properly is not able to prevent downtimes. It is therefore necessary to monitor the firewalls when HA is activated. This can be effected as follows:

- > Web client

You can monitor the HA feature in the *Info area* and in the HA menu (see *High Availability* on page 35). You can identify the firewall that is currently set as the master node from the local IP address.

- > SNMP

SNMP is the de-facto standard for monitoring the firewall. Refer to *SNMP Settings* on page 58 for more information on the firewall configuration and how to download the necessary MIB files. SNMP requests towards the firewall will help you to identify the firewall that is currently active by identifying the IP address of the cluster link.

-
- ! You can only monitor the slave node through the cluster link. To get access to this interface, use a switch as described in *Initial Setup* on page 38.

- > Remote Syslog Server

You can use a remote syslog server to monitor HA events as cluster messages are included in the syslogs. Role switches are clearly logged. You can get the master IP address from the logs as well.

-
- ! The logs for the slave node are not sent to the remote syslog server. The logs for the master node are sufficient for retrieving all necessary information.

- > Command Center

Use the LANCOM R&S® UF Command Center to monitor the HA status of several firewalls, including the license status and hardware resources.

License

The features provided by your LANCOM R&S® Unified Firewall software depend on the license you have purchased from your supplier.

The following features can be individually licensed with the purchased license file:

- > Anti-spam (UTM license)
- > Anti-virus (UTM license)
- > Application filter
- > Content filter
- > IDS/IPS (UTM license)
- > Wireless LAN

Navigate to **Firewall > License** to open the **License Manager**, which you can use to view the validity period of your LANCOM R&S® Unified Firewall license and additional feature licenses, or upload new licenses.

-
- ! After being started for the first time, or following a re-installation, the LANCOM R&S® Unified Firewall runs for 30 days as a demo version. You cannot perform a backup during the trial period. At the end of the trial period, the firewall will retain your configuration. The UTM features will be disabled and you can no longer save any changes.

The system checks the expiry dates of licenses in the license file at regular intervals. If a license expires or a trial period ends, all licensable features will be disabled until you upload a new license with the web client. After the license expires, web and mail traffic is blocked or forwarded by the LANCOM R&S[®] Unified Firewall without being filtered. In the first case, you will immediately see that you need to download a new license if your current license data has expired. If you operate the system in an unsecured mode after the license expires, you will only be notified on the LANCOM R&S[®] Unified Firewall user interface. You can configure this in the **License Manager**:

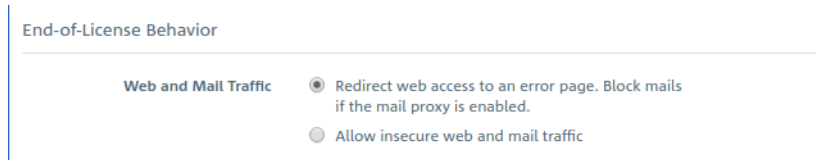

Figure 19: Configuring end-of-license behavior

! Regardless of how the end-of-license behavior is configured, features in the user interface are always disabled when the main license has expired.

After a feature license expires, the corresponding feature will be disabled. The settings dialog for this feature can still be opened. The dialog will indicate that the license has expired. If you try to make changes, an error message appears.

i The license information in the *information panel* of the web client appears in red as soon as the license expiry period is less than 30 days.

For an unlicensed LANCOM R&S[®] Unified Firewall, a temporary serial number is displayed in the information panel. This will be replaced by a valid license number after a license is purchased.

If the LANCOM R&S[®] Unified Firewall is installed on a virtual machine, the UUID of the virtual machine is displayed in the information panel.

Under **License Upload** you can upload a new license for your LANCOM R&S[®] Unified Firewall software. Please proceed as follows to do this:

1. Next to the **Select File** input field, click on **License File**.

The search function for the local data medium opens.

2. Select a license file in GPLF or LIC format.

! The new license must correspond to the version number of the LANCOM R&S[®] Unified Firewall software and hardware.

3. Click on **Open**.

The search function for the local data medium closes.

4. To upload the license file, click **Save**.

The license is uploaded. If the upload was successful, all licenses and related information will automatically be transferred to your LANCOM R&S[®] Unified Firewall and a success message is displayed.

5. Confirm that you want to log out by clicking **OK**.

You will be logged out. The login page of the firewall opens.

6. Enter your login credentials.

7. Click on **Login**.

The web client appears.

i You can also download the uploaded license again. To start the file download, simply click on the license file which is displayed as a link further up next to **Download**.

The **Details** tab shows you more detailed license information about your LANCOM R&S® Unified Firewall software, e.g. information about the UTM licenses. You can also see the maximum number of simultaneous VPN tunnels. If this number is reached, connection attempts of further IPsec clients or remote stations will be rejected.

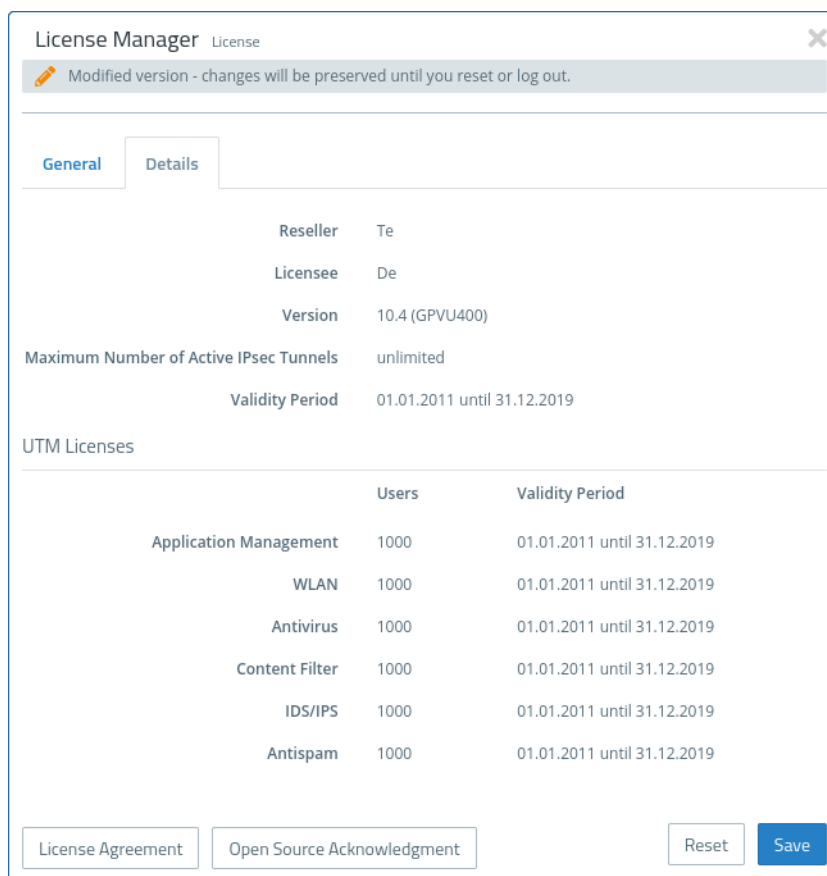

Figure 20: Example for detailed license information

LANCOM Management Cloud settings

These are the settings for the configuration and monitoring of your device via the LANCOM Management Cloud (LMC). Navigate to **Firewall > LMC Settings** to open an editing window where you can view and modify the settings for the LMC.

In the **LMC Settings** editing window you can adjust the following parameters:

Input box	Description
I/O	A slider button indicates whether firewall management via the LANCOM Management Cloud is enabled (I) or disabled (O). Click on the slider button to change the status of this option.
LMC domain	Enter the domain name for the LMC here. By default, the domain is set to the Public LMC for the first connection. If you wish to manage your device with your own Management Cloud ("Private Cloud" or "on-premises installation"), please enter your LMC domain.
Activation code	As an alternative to entering the serial number and the cloud PIN supplied with the device, it can also be assigned to a project in the LMC by means of an activation code. In the LMC go to Devices , click on Activation codes and then on Create activation code . This creates a temporary activation code. While it remains valid, this code can be used to activate any number of LANCOM devices, i.e. to transfer them to the LMC.

Firewall Access

The **Firewall Access** settings allow you to define how your LANCOM R&S® Unified Firewall can be accessed from external networks or the Internet. In addition, you can determine how your LANCOM R&S® Unified Firewall reacts, for example, to ping requests.

 The **Firewall Access** settings only apply to external access to your LANCOM R&S® Unified Firewall for defined users. Accessing your LANCOM R&S® Unified Firewall from the internal network is always possible.

Navigate to **Firewall > Firewall Access** to determine whether and how access from external networks or the Internet to your LANCOM R&S® Unified Firewall is allowed.

For more detailed information on the **Firewall Access** settings, see the following sections.

Ping Settings

The **Ping Settings** allow you to specify how your LANCOM R&S® Unified Firewall handles ICMP echo requests (ping) to the firewall from the internal network and the Internet.

Navigate to **Firewall > Firewall Access > Ping Settings** to open an editor panel to display and edit the ping settings.

Input field	Description
Ping (ICMP to Firewall)	<p>Select the respective radio button to specify how your LANCOM R&S® Unified Firewall handles ICMP echo requests to the firewall from the internal network and the Internet. The option is set to Allow by default, but you can adjust the settings to the other value as required:</p> <ul style="list-style-type: none"> > Deny – The LANCOM R&S® Unified Firewall does not respond to ICMP echo requests to the firewall from the internal network and the Internet. > Allow – The LANCOM R&S® Unified Firewall responds to ICMP commands to the firewall from the internal network and the Internet. <p> While blocking ICMP echo requests can improve the security of your LANCOM R&S® Unified Firewall, it also makes any troubleshooting in the network difficult. Therefore, if an error occurs in the network, we recommended setting this option to Allow before you start troubleshooting.</p>

If you modify the settings, click **Save** to store your changes or **Reset** to discard them. Otherwise, click **Close** to shut the editor panel.

Click  **Activate** in the toolbar at the top of the desktop to apply your configuration changes.





SSH Settings

The **SSH Settings** allow you to configure SSH access to your LANCOM R&S® Unified Firewall from the Internet.

Navigate to **Firewall > Firewall Access > SSH Settings** to open an editor panel to display and edit the SSH settings.

The **SSH Settings** panel allows you to configure the following elements:

Input field	Description
I/O	A slider switch indicates whether the SSH service is active (1) or inactive (0). By clicking the slider switch, you can toggle the state of the service. The SSH service is activated by default.
Port	Set the listening port by entering the port number. The default setting is port 22.
Password Authentication	Password authentication allows you to login to your LANCOM R&S® Unified Firewall via SSH using a password. Password authentication is activated by default.

Input field	Description
	<p> Password authentication can only be deactivated if at least one SSH public key is actively used for key authentication.</p>
<p>SSH Public Keys</p>	<p>This table displays the SSH public keys that are used to authenticate a user without a password. Click Add to open the SSH Key panel and add a new key.</p> <p>On this panel, you can define the following settings:</p> <ul style="list-style-type: none"> > In the Key field, enter or paste the SSH public key. > In the Title field, enter a name for the SSH public key. <hr/> <p> Your LANCOM R&S® Unified Firewall only support keys in Secure Shell (SSH) Public Key File Format.</p> <p>If you modify these settings, click Save to save your changes or Reset to discard them. Otherwise, click Close to close the editor panel.</p> <p>The SSH public key appears as a list entry (Fingerprint). You can edit or delete single entries in the list by clicking the corresponding button next to an entry. For more information, see Icons and buttons on page 22.</p> <hr/> <p> You can use these authentication methods (Password Authentication, SSH Public Keys) alone or in combination.</p>
<p>Access Restrictions</p>	<p>This table displays user-defined IP addresses or IP networks that can be allowed access to the LANCOM R&S® Unified Firewall (whitelist mode).</p> <p>Select the check box next to an entry to allow access.</p> <p>To add an IP address or network to the list, enter a Title and Source and click Add. The new entry is added to the list and is activated automatically.</p> <p>The following entries are predefined and cannot be removed:</p> <ul style="list-style-type: none"> > Local Networks represents the internal access and is activated by default. > Internet provides SSH access to the LANCOM R&S® Unified Firewall from the Internet. <hr/> <p> In certain circumstances, this may grant attackers access to your LANCOM R&S® Unified Firewall. Therefore, we do not recommend using this option as a permanent solution.</p> <ul style="list-style-type: none"> > VPN Tunnels <p>The following default entries include network sections for the customer support. These entries are deactivated by default.</p> <ul style="list-style-type: none"> > Rohde & Schwarz Internet Gateway > Rohde & Schwarz Cybersecurity Customer Support

If you modify the settings, click **Save** to store your changes or **Reset** to discard them. Otherwise, click **Close** to shut the editor panel.



Click  **Activate** in the toolbar at the top of the desktop to apply your configuration changes.

Webclient Settings

The **Webclient Settings** allow you to configure external web access to your LANCOM R&S® Unified Firewall from the Internet.

Navigate to **Firewall > Firewall Access > Webclient Settings** to open an editor panel to display and edit the webclient settings.

The **Webclient Settings** panel allows you to configure the following elements:

Input field	Description
Port	Set the listening port by entering the port number. The default setting is port 3438.
Webclient Certificate	<p>Select a webclient certificate that is used to verify the SSL connection.</p> <p> If you do not select a webclient certificate, an auto-generated, self-signed system certificate is used. The system certificate is not part of the certificate management. To avoid certificate warnings from your browser when connecting to the webclient, select a certificate that was signed by a CA trusted by your browser.</p>
Access Restrictions	<p>This table displays user-defined IP addresses or IP networks to allow access for these addresses only (whitelist mode).</p> <p>Enter a Title and Source. Click Add to add the IP address to the list.</p> <p>The following entries are read-only, but can be activated or deactivated.</p> <ul style="list-style-type: none"> > Local Networks represents the internal access and is activated by default. > Internet provides SSH access to the LANCOM R&S® Unified Firewall from the Internet. <p> In certain circumstances, this may grant attackers access to your LANCOM R&S® Unified Firewall. Therefore, we do not recommend using this option as a permanent solution.</p> <ul style="list-style-type: none"> > VPN Tunnels <p>The following default entries include network sections for the customer support. The entries are deactivated by default.</p> <ul style="list-style-type: none"> > Rohde & Schwarz Internet Gateway > Rohde & Schwarz Cybersecurity Customer Support <p>Optional: Clear the check box next to an entry to restrict access for it.</p> <p> The webclient access is the main access type to the server. You have to select at least one entry in the list of IP addresses.</p>

If you modify the settings, click **Save** to store your changes or **Reset** to discard them. Otherwise, click **Close** to shut the editor panel.

Click  **Activate** in the toolbar at the top of the desktop to apply your configuration changes.



Time Settings

Your LANCOM R&S® Unified Firewall works with time-sensitive rules. Furthermore, the system time is particularly important for services such as logging that rely on accurate timestamps. Therefore, it is necessary to set the date and time correctly.

Navigate to **Firewall > Time Settings** to open an editor panel to display and edit the system date and time settings.

The **Time Settings** configuration dialog allows you to configure the following elements:

Input field	Description
Time Zone	From the drop-down list, select one of the predefined time zones. The time zone is set to (+01:00) Europe - Berlin by default, but you can adjust the settings to one of the other values as necessary.
Current Time	Check the current system date (MM/DD/YYYY) and time (hh:mm:ss) of the LANCOM R&S® Unified Firewall.

Input field	Description
Date & Time	<p>Optional: Click the input field to set a new system date or time manually. A pop-up window with a calendar and input fields for changing the date and time opens. You can enter a date in the MM/DD/YYYY format or choose a date from the calendar. You can also set a new time by entering the time in the hh:mm:ss format.</p> <hr/> <p> To set the system time manually, NTP has to be disabled (in other words, the NTP Client check box must be cleared). Otherwise, the time will be reset automatically as soon as the system sends the next NTP request.</p>
NTP Client	<p>Optional: Select the check box to use remote network time protocol servers to set the system date and time automatically.</p>
NTP Servers	<p>Optional and only available if the NTP Client check box is selected: You can either use the predefined NTP servers or add your own NTP servers to the list.</p> <p>The standard NTP servers are: de.pool.ntp.org and europe.pool.ntp.org.</p> <p>You can add as many NTP servers as you like. Enter the IP address or the fully qualified domain name of an NTP server in the input field. Then, click Add to add the NTP server to the list.</p> <p>You can edit or delete individual entries in the list by clicking the corresponding button next to an entry. For more information, see Icons and buttons on page 22.</p> <hr/> <p> If you edit an NTP server, a check mark appears on the right of the entry. You have to click the check mark before being able to save the settings of the NTP server.</p> <hr/> <p> If more than one NTP server is configured, the LANCOM R&S® Unified Firewall automatically synchronizes the system clock with the server that transmits the best time signal.</p>
Serve as local NTP server	<p>Optional and only available if the NTP Client check box is selected: Select this check box if you want to make the system time of the LANCOM R&S® Unified Firewall available in the internal network. The LANCOM R&S® Unified Firewall then acts as an internal, local NTP server.</p>

If you modify the settings, click **Save** to save your changes or **Reset** to discard them. Otherwise, click **Close** to close the editor panel.

Click  **Activate** in the toolbar at the top of the desktop to apply your configuration changes.

Updates Settings

The editing window **Updates Settings** helps you to keep your LANCOM R&S® Unified Firewall up to date at all times. New versions of the LCOS FX operating systems, security updates and new features can be downloaded automatically from the update server and quickly and easily installed on the firewall. The update system has various ways to notify the system administrator of new updates. You can also view the history of imported updates.

Every LCOS FX update has a digital signature to prevent the installation of unauthorized or malicious updates on the firewall. Updates must have a valid signature in order to be displayed and installed.

Navigate to **Firewall > Updates Settings** to open an editing window where the available updates, additional information and their status are listed on the **Updates** tab.

Use the **Filter** input field to narrow down the results in the table below. As you type your search into the input field, your LANCOM R&S® Unified Firewall will only show those entries that contain the entered characters in the name, type or description. Click on  in the input field to delete the search input and return to the unfiltered list view.



The column headers in the list of updates contain the following information:

Column	Description
Name	Displays the names of the available updates.
Type	<p>Displays the type of update.</p> <p>The update system differentiates between four types of update:</p> <ul style="list-style-type: none"> > <i>Security</i> – contains enhancements regarding the security of the firewall. > <i>Recommended</i> – contains enhancements and optimizations in performance and stability. > <i>Hotfix</i> – contains enhancements to individual modules of the firewall, but also new features. > <i>Upgrade</i> – contains an upgrade to the next version of LCOS FX.
Description	<p>Displays a text box with more information about the update.</p> <p>Click on the text field to expand it and display further information about the update.</p>
Reboot	Indicates whether a system has to be restarted after a successful update.
Release Date	Shows the date when the update was released.
Status	<p>Distinguishes between new updates and updates that have already been installed.</p> <hr/> <p> An update can only be installed once.</p>
Action / Dependency	If all dependencies are met, the action Install is allowed. Otherwise, a list of dependencies is displayed. The listed updates should be installed to fulfill these dependencies.

You can manually update the list of the latest updates by clicking on **Refresh Updates List**.

Use the settings on the **Settings** tab to adjust the following parameters:

Input box	Description
Search for New Updates Automatically	Check this box to automatically refresh the list with the latest updates.
Interval	<p>Select the desired interval for updating the list from the drop-down menu. By default, this option is set to <i>Daily</i>. Possible values:</p> <ul style="list-style-type: none"> > <i>Hourly</i> > <i>Daily</i> > <i>Weekly</i>
Update Time	<p>Enter the date and time of the first automatic refresh of the updates list and the first automatic update. A pop-up window opens with a calendar and input fields for adjusting the date and time. You can enter the date in format <i>MM/DD/YYYY</i> or select a date in the selection window. You can also enter the new time in the format <i>hh:mm:ss</i>.</p> <hr/> <p> If you have activated the automatic installation of updates as described below, all subsequent updates will be carried out at the time specified here.</p>
Install Updates Automatically	Use the appropriate radio button to determine which updates are automatically installed on your LANCOM R&S® Unified Firewall. This feature is limited to security updates and recommended hotfixes. By default, this option is set to <i>None</i> , but you can change the settings to one of the other values if required.
Update Servers	<p>The default update server is:</p> <p>http://www.gateprotect.com/updateserver</p>

Input box	Description
	<p>You can add any number of update servers. Enter the URL of the update server into the input field and then click on Add. The server is added to the list.</p> <hr/> <p> If the URL contains a fully qualified domain name (FQDN), you need to configure the DNS settings. Otherwise, the FQDN cannot be resolved.</p> <p>You can edit or delete any entry in the list by clicking on the appropriate icon. Please refer to Icons and buttons on page 22 for further information.</p> <hr/> <p> When you edit an update server, a checkmark will appear to the right of the entry. You first have to confirm your change with this checkmark before you can save the update-server settings.</p>

Use the settings on the **Automatic Recovery** tab to adjust the following parameters:

Input box	Description
Automatic Recovery	<p>Check this box to perform an automatic recovery in case of an error. An error is assumed to have occurred if, following an update to a new firmware version, there is no authentication by an administrator, the LANCOM Management Cloud or the LANCOM R&S[®] UF Command Center within the time configured for the Timeout. In this case the previous firmware version is automatically restored.</p> <p>The recovery points can be displayed using the System menu.</p> <hr/> <p> A recovery is also possible in a high-availability scenario, although the recovery is limited to the main firewall only. The backup firewall can no longer be operated and must be installed anew.</p>
Timeout	Time limit in minutes after which the automatic recovery may be carried out.

The **History** tab shows the chronology of the LANCOM R&S[®] Unified Firewall updates.

If you change any settings, click **Save** to store your changes or **Reset** to discard them. Otherwise, click the **Close** button to quit the window and return to the overview of your configured network.

Click  **Activate** in the toolbar at the top of the desktop to apply your configuration changes.

 For information about installing system updates in a high availability configuration, see [Updates](#) on page 39.

3.4.2 Monitoring & Statistics

The  **Monitoring & Statistics** settings display detailed information about the traffic flowing through your LANCOM R&S[®] Unified Firewall. These settings allow you to set up remote SNMP and syslog servers to forward log messages generated by different message sources. You can furthermore configure how your LANCOM R&S[®] Unified Firewall should handle detected event types and for which event types statistics shall be recorded.

Statistics Settings

Navigate to **Monitoring & Statistics > Settings** to adjust the statistics settings.

You can furthermore configure how LANCOM R&S[®] Unified Firewall should handle detected event types and for which event types statistics shall be recorded. From the drop-down lists of event types, select one of the following options:

Mode	Description
Disabled	No data is collected for this event type.
Create Statistics	Event data is collected to create statistics.

Mode	Description
Send Raw Data to External Syslog	Data from occurring events is collected to create statistics and passed on to a configured external syslog server.
Save Raw Data Locally	Data from occurring events is collected to create statistics, passed on to a configured external syslog server and stored on the device.  This mode can cause the storage of the device to fill up rapidly.

Hover the mouse over the  next to the event type label to find an explanation of what graph a particular event is used for. Use the **All Event Types** drop-down list to set all event types simultaneously to the same mode.

If you have modified these settings, use the buttons at the bottom right of the editor panel to confirm (**Save**) or to discard (**Reset**). Otherwise, you can close the dialog (**Close**).

Click  **Activate** in the toolbar at the top of the desktop to apply your configuration changes.

Notification settings

The notification systems sends e-mail messages about specific types of notification, either immediately or regularly in an aggregated form. This requires an active e-mail function in which at least one sender is set. Security comes with the optional settings **Validate remote certificate** to verify the remote site before sending e-mail and **S/MIME certificate** to encrypt the outgoing mail. Further details are available under *E-mail settings* on page 31

Navigate to **Monitoring & statistics > Notification settings** to open an editing window where you can configure the following items:

Table 1: General

Input box	Description
I/O	A slider button indicates whether the notification settings are enabled (I) or disabled (O). Click on the slider button to change this.
Notification language	Set the language used in the notification e-mails. If the dialog is opened for the first time, the language is set to that used for the web client.
Subject template	Set the subject of the notification e-mails.
Recipients	List of recipient addresses where the notifications are sent. Click on  on the right-hand side to add your entry to the list.

In the **Aggregated notifications** editing window you can modify the following items:

Input box	Description
Aggregation interval	The events are collected and summarized in an e-mail at a specified interval. Enter the interval in minutes in which events are collected before they are sent as a message.
Max. number of notifications per mail	Here you specify how many events are combined in an e-mail. This determines how many mails are sent at the end of each aggregation interval. At the same time, this limits the maximum size of the e-mail.  If necessary, observe any spam guidelines of the recipient.

In the **Instant notifications** editing window you can modify the following items:

Input box	Description
Max. number of mails per hour	<p>In the occurrence of an event of a type flagged for Instant notification, an e-mail is sent to the recipient immediately. Depending on the settings in the Notification Types section and the events that occur, large numbers of e-mails could be sent in a short time. This could lead to them being blocked if provider policies at the receiving end are infringed. To avoid this, you can use this item to limit the number of instant notifications sent per hour.</p> <hr/> <p> All instant notifications are also sent in the next aggregated e-mail.</p>

In the **Notification types** editing window you can modify the following items:

Input box	Description
Filter	The displayed notification fields can be filtered by their name and set value.
Set for all selected notifications	All currently displayed notification fields are adjusted to the value set here. For example, to set all of the fields for IPSec to Instant , go to Filter and enter "ipsec", and you can change all of the IPSec-related notification fields to Instant .
Expected system restart	Notification when the system is restarted as expected.
Unexpected system restart	Notification when the system is restarted unexpectedly.
HA role switch	Notification when a role switch is performed in high availability mode.
Internet connection offline	Notification when disconnected from the Internet.
Backup Internet connection activated	Notification when the default Internet connection is disconnected and the backup connection takes over.
Internet connection online	Notification when connecting to the Internet.
Default Internet connection restored	Notification when the default Internet connection is in use again.
IPSec site-to-site tunnel online	Notification when an IPSec site-to-site tunnel is established.
IPSec site-to-site tunnel offline	Notification when an IPSec site-to-site tunnel is disconnected.

If you have made changes, you can use the buttons at the bottom right of the edit window to save them (**Save**) or discard them (**Reset**). Otherwise you can close the window (**Close**).

Connection Tracking

The **Connection Tracking** panel allows you to view and interact with the in-kernel connection tracking system to get a list of all active connections on your LANCOM R&S® Unified Firewall.

Navigate to **Monitoring & Statistics > Connection Tracking** to open an editor panel to view all connections tracked in the system.

The filter section allows you to narrow the list of results in the table below it. First, select one of the options in a drop-down list or type in one of the input fields. Then, click **Reload** to refresh the list to show only those entries that contain the selected option or the characters you have typed. Click **X** in the drop-down list or **⊗** in the input field to delete the selected option or the search string or click **Reset Filter** to delete all entries and display an unfiltered view of the list.

 Filter options are AND-connected.

The table columns of the currently active connections list contain the following information:

Column	Description
#	Displays a consecutive number for the table row.
Protocol	Displays the IP protocol type used by the connection. The type can either be TCP or UDP.
TTL	Displays the lifetime of the conntrack entry in seconds. Once this time span has elapsed, the entry is discarded.
TCP State	Displays the current state of the TCP connection. The TCP state can be as follows: <ul style="list-style-type: none"> > SYN_SENT > SYN_RECV > ESTABLISHED > FIN_WAIT > CLOSE_WAIT > LAST_ACK > TIME_WAIT > CLOSE > LISTEN
Source	Displays the source IP address and port of the connection request.
Destination	Displays the destination IP address and port of the connection request.
Packets	Displays the number of packets sent in the original direction for the given connection. In this case, original direction means from source to destination.
Bytes	Displays the number of bytes sent in the original direction for the given connection. In this case, original direction means from source to destination.
State	Displays the state of the connection in the original direction. In this case, original direction means from source to destination. The state can be one of the following: <ul style="list-style-type: none"> > ASSURED > ESTABLISHED - This connection has been established. > EXPECTED - This is an expected connection. There have not yet been any matching packets, but the firewall expects such packets soon. > FIXED_TIMEOUT > INVALID - This connection does not follow the expected behavior of a connection and is, therefore, considered invalid. > NEW - This connection is starting. > RELATED - This connection has already been expected. > SEEN_REPLY - The first answer packet from the destination was seen, but the handshake has not yet been completed. > UNREPLIED - An initial packet from the source was seen, but it has not yet been replied. > UNSET > UNTRACKED - This connection is not tracked.
State (Reply)	Displays the state of the connection in the reply direction. In this case, reply direction means from destination to source. The status can be one of the following: <ul style="list-style-type: none"> > ASSURED > ESTABLISHED - This connection has been established.

Column	Description
	<ul style="list-style-type: none"> > EXPECTED - This is an expected connection. There have not yet been any matching packets, but the firewall expects such packets soon. > FIXED_TIMEOUT > INVALID - This connection does not follow the expected behavior of a connection and is, therefore, considered invalid. > NEW - This connection is starting. > RELATED - This connection has already been expected. > SEEN_REPLY - The first answer packet from the source was seen, but the handshake has not yet been completed. > UNREPLIED - An initial packet from the source was seen, but it has not yet been replied. > UNSET > UNTRACKED - This connection is not tracked.
Source (Reply)	Displays the source IP address and port expected of the return packets (usually the same as under Destination).
Destination (Reply)	Displays the destination IP address and port expected of the return packets (usually the same as under Source).
Packets (Reply)	Displays the number of packets sent in the reply direction for the given connection. In this case, reply direction means from destination to source.
Bytes (Reply)	Displays the number of bytes sent in the reply direction for the given connection. In this case, reply direction means from destination to source.
Mark	Displays the connection mark. The mark is set by your LANCOM R&S [®] Unified Firewall.
Used	Displays the contrack <code>Use</code> field.

Click **Reload** to refresh the connections list in the table.

The **Close** button at the bottom of the editor panel allows you to shut the panel and return to the complete overview of your entire configured network.

Logs

Your LANCOM R&S[®] Unified Firewall stores records of system events, status information, errors and other communication in a log database. Navigate to **Monitoring & Statistics > Logs** to view the event logs. The **Logs** panels display the contents of the logs. In these logs, you can find technical details about the cause of a problem.

The logs are automatically reloaded to get the latest entries by default. You can disable the automatic reload to focus on older entries by clicking the **AUTORELOAD ON** slider switch. Click **Manual Reload** to update the item list bar manually. To enable automatic reload again, click the slider switch.

Use the filter options above the tables to reduce the list of results to items that include a certain search string. Toggle the options to specify search criteria in the input fields. The **Message** and **User** filters return all results that contain the input string. The remaining filter fields return exact matches only. The available options depend on the log type. With filter options set, the logs are always automatically reloaded.



To filter the contents of a log by a customized time range, click the **Time** input field. A new window opens where you can either select a predefined time range or enter a custom time range. Click **Custom** to open a calendar and drop-down list for changing the date and time. Set the date and time as desired. Click **Apply** to save your changes and to view the filtered log or click **Cancel** to discard your changes.

To view the complete logs again, click **Reset**, which deletes all search criteria, or click the **X** button on the right side of a selected drop-down list entry or the **⊕** button in the input fields.

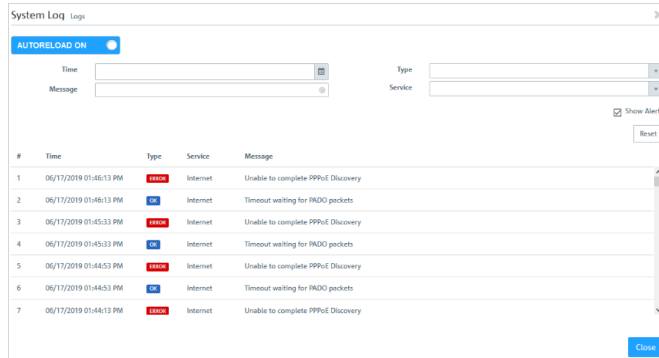

Figure 21: Sample filtered system log

The **Close** button at the bottom of the log panels allows you to shut the log panels and return to the complete overview of your configured network.

You can find more information regarding the event logs in the following sections.

Alert log

Navigate to **Monitoring & Statistics > Logs > Alert Log** to view the event logs for alerts and to set up display filters. In the **Alert Log** editing window, you can see what traffic is blocked by your LANCOM RGS® Unified Firewall or how traffic was transmitted through the firewall.

The column headers contain the following information:

Table 2: Filter types

Column	Description
Time	Timestamp of the log entry.
Category	Event category, which can be one of the following: <ul style="list-style-type: none"> > Application filter > Connection blocked > Connection finished > IDPS > Mail malware > Spam > Web filter allowed > Web filter blocked > Web malware
Message	The log message itself. If necessary, the  on the right-hand side of a message performs actions directly. For example, in the category IDPS messages about blocked services are displayed. These messages are displayed along with the signature ID that would be required in a rule to stop blocking this service. Exceptions can therefore be added directly from the log.

Filtering

You can use **More Filters** on the input field with different search criteria and options to narrow down the results. These filters relate to the time interval that you set under **Time**.

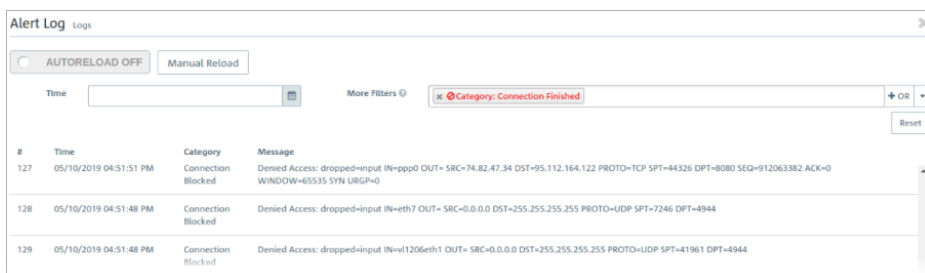

Figure 22: Alert log with applied filter

Proceed as follows to create a filter:

1. Click in the input field.

The web client displays suggested filters.

The available filter types, input formats and default values can be found in the [Filter types](#) table.

2. Select one of the suggested filters from the drop-down list, or enter any search text to receive further suggestions.

For each suggestion, you can specify whether to use this as an inclusion filter (+ / AND) or exclusion filter (/ AND-NOT).

After selection, the suggested filter is inserted into the input field as a search criterion.

The list of log messages is adapted to the search query. Matching log entries are highlighted.

Repeat the above steps until you have added the desired filter criteria to your query.

Only entries that match all filter criteria are displayed.

To delete a filter criterion in a search query, click on .

You can add multiple lines to your search by clicking on **+ OR** next to the input field. You can choose to insert a new blank line or to copy the last created line. Each line is a separate search query, which is ORed with the other lines.

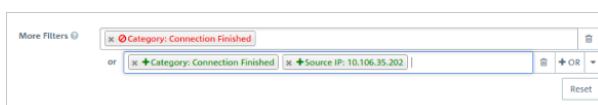

Figure 23: Combined filter query

Delete the line by clicking next to the line.

Filter types

Filter type	Input format	Default values	Subtypes
Text	Free text		Log entry Domain / URI (log entries from HTTP proxies, virus scanners and the URL / Content Filter)
Protocol	Free text	ICMP, TCP, UDP	

Filter type	Input format	Default values	Subtypes
		Transport protocols or protocols detected by the Application Filter	
Port	Numbers from 0 to 65535		TCP / UDP source or destination port of IPDS or firewall messages
IPv4	Valid IP address or parts thereof		Source or destination IP address of mail proxy, IDPS, application filter, or firewall messages
Category	Free text or selection from the More Filters drop-down list	<ul style="list-style-type: none"> > Application filter > Connection blocked > Connection finished > IDPS > Mail malware > Spam > Web filter allowed > Web filter blocked > Web malware 	

Audit Log

The **Audit Log** creates records about every configuration change made on your LANCOM R&S® Unified Firewall (e. g. updating the VPN settings), executed actions (e. g. importing a backup) and what caused the change or action. To display the logs, **Monitoring** permissions are necessary.. For more information on web client permissions, see [Administrators Settings](#) on page 26.



The table columns contain the following information:

Column	Description
Time	Time stamp of the log entry.
Action	Event log category, which can be one of the following: <ul style="list-style-type: none"> > Call – Executing a certain action (e. g. importing a backup) > Delete – Deleting a configuration element (e. g. deleting an expired IPsec connection) > Insert – Inserting a new configuration element (e. g. inserting a host group) > Update – Changing a configuration element (e. g. adjusting the antivirus settings)
User	Name of the user that created the entry, e. g. admin.
Message	The log entry itself. The message content depends on the Action type: <ul style="list-style-type: none"> > If the Action is Call, Message starts with the called endpoint. > If the Action is Delete, Message indicates the name and the internal type of the removed configuration element. > If the Action is Insert, Message indicates the name and the internal type of the new configuration element. It also contains the entire payload of the message that is used to create the configuration element and that contains the exact used settings. > If the Action is Update, Message indicates the name and the internal type of the modified configuration element. It also contains the exact changes for a specific path in italics. The path identifies the settings of a configuration element which have been changed.

System Log

The **System Log** displays a list of recent system events.

The table columns contain the following information:

Column	Description
Time	Time stamp of the log entry.
Type	Message type which can be one of the following: <ul style="list-style-type: none"> > OK – The service is working correctly. > Error – An error occurred. An error message is displayed.
Service	<p>Name of the service that created the entry. The following filters are available:</p> <ul style="list-style-type: none"> > Server – Firewall services, including kernel, DHCP server, DNS server, SNMP server and Wi-Fi access point messages > VPN – IPsec and SSL tunnels > Internet – NTP, DynDNS and DSL connection status > User – Terminal login, SSH login and super user actions (sudo) > Connections – Connections that were established successfully. These message are only stored if Connection Finished in the Monitoring & Statistics > Settings is set to Save Raw Data Locally. > Proxy – Messages regarding web and mail proxies > Updates – All messages regarding the firewall software > Appfilter – Application filter messages > IDPS – IDS/IPS messages > Alerts – Alerts related to security, irrespective of the generating engine (e. g. when the anti-malware engine detects a virus or when the IDS/IPS engine detects a thread) <hr/> <p> Alerts will only be shown in the Alerts category, even if they also belong to another category.</p> <p>Example: Appfilter generates an alert. The alert will only be shown in Alerts, but not in Appfilter.</p>
Message	<p>The log entry itself.</p> <p>Select Alerts in the Service column to filter IDS/IPS log messages.</p> <p>Tip: You can use log messages to add an IDS/IPS rule to the list of ignored rules on the Rules tab of the IDS/IPS editor panel. Click  in the respective IDS/IPS log message. A drop-down list opens. Select the Ignore rule entry. The IDS/IPS rule is automatically added to the list of ignored rules on the Rules tab of the IDS/IPS editor panel. For more information, see IDS/IPS on page 103.</p>

Select the **Show Alerts** check box to display alerts regardless of the selected service on top of the displayed log messages.

 Alerts can contain additional information about events to identify the source of an error.

Creating rules from the log

You can create rules for denied access attempts directly from the alert and system logs. The alert log (**Monitoring & Statistics > Logs > Alert Log**) is preferred, since you can filter directly for Connection Blocked entries.

To use this functionality, the firewall must be configured accordingly:

1. Under **Monitoring & Statistics > Settings**, the setting for **Blocked Forwarded Traffic** has to be set to **Save Raw Data Locally** in order for the firewall to access the necessary data.
2. An Internet connection has to be defined if there is no data traffic between internal networks on different interfaces of the firewall.

As soon as data traffic is blocked, entries of the "Connection Blocked" category should appear in the alert log.

On the right-hand side of each of these entries, the user can use the action menu to **Create a new rule**. A new dialog is then displayed where you can define a rule (with fewer options than the Connection dialog).

Range / input field	Description
Log information	Information about the selected entry is listed here. Example: Data should be sent from a host (192.168.3.3) on the internal network via the interface "eth3" using "ICMP" and sent to the destination 192.168.5.5.
Service	In the "Service" section, the user can decide whether to use a predefined or custom service or to create a new custom service. The only services to be displayed relate to the port and protocol corresponding to the blocked access. This example is ICMP with (port 0/No port) and the ICMP protocol. The newly created service takes on the same port and protocol settings. A user-defined name can be entered.
Source, Action and Destination	<p>Any missing data for creating the desktop connection must be entered in the lower area. Here, too, you decide whether the source and destination are existing desktop objects, or whether new desktop objects should be created. It is also possible to connect a new object to an existing one.</p> <p>The available desktop objects include all Internet objects and desktop objects with a matching IP address and interface. This can also apply to VPN desktop objects. Any available desktop object that is selected by default is the one that most closely matches the interface and the IP address. In our example, a host object with 192.168.3.3 and eth3 takes priority over a network object with 192.168.3.0/24. If there is no suitable desktop object for selection, an Internet object is used instead.</p> <p>If you want to create a new desktop object, you are limited to one host or network object to make creating a rule quick and easy. The interface and the IP address are preselected according to the blocked entry. All you have to enter is a name. For the interface you can, if necessary, choose from any of the available interfaces without restriction. The address must either match the blocked access attempt or at least be from a network that contains its IP address, e.g. 192.168.3.0/24, 192.168.0.0/16. Depending on the selected address, a host or a network object is created.</p> <p>After selecting the source and destination you can still, if necessary, change the type of access or the NAT by clicking on the corresponding icons, similar to the rules for a desktop connection. Typically, the access should be source-to-destination or two-way. As NAT is usually used to access an Internet address, NAT is always preselected in the direction of the Internet object. If no Internet object is selected, NAT is deactivated by default.</p>

After the rule is created, you can use the Log dialog to create further rules or you can close the dialog. If you have created new rules, you will be asked to activate the rules after closing the Log dialog.

SNMP Settings

SNMP (Simple Network Management Protocol) is a networking protocol that is used to offer and receive status information across a network. The participants of the SNMP-based information exchange are the SNMP manager (e. g. Nagios) and the SNMP clients (devices such as your LANCOM R&S® Unified Firewall that are meant to be monitored by the SNMP manager).

The SNMP manager requests, receives and monitors information. SNMP clients respond to information requests (e. g. "What is the current CPU load/memory usage of the device?"). Status information offered by managed devices is organized like a tree (the so-called Management Information Base, short *MIB*), with each leaf being a retrievable piece of information. Every single leaf can be addressed and requested individually via its own unique numeric address. A file containing a mapping of these numeric address snippets to meaningful names, and thereby a declaration of all information available

on a managed device, can be provided to the SNMP manager to increase human usability (e. g. `29577.1.1` represents `RSCS.SystemLoad.cpuLoad`).

The **SNMP Settings** allow you to configure the following elements:

Input field	Description
I/O	A slider switch indicates whether the SNMP is active (I) or inactive (O). Click the slider switch to change the status. SNMP is deactivated by default.
Listening IP	Optional: Enter a local IP address the service will be listening on. If you retain the pre-defined IP address <code>0.0.0.0</code> , requests will be accepted on all IP addresses.
Listening Port	Optional: Specify the port number the service will be listening on. The default port number is <code>161</code> .
Protocol Version	From the drop-down list, select the version of the SNMP protocol you want to use. Depending on the selected version, the following options are available. <code>v2c</code> is selected by default.
Community String	Only available if the selected Protocol Version is <code>v2c</code> : Enter the pre-shared key that every SNMP manager/client has to use to authenticate to the SNMP service of the access zone.
Show Community String	Only available if the selected Protocol Version is <code>v2c</code> : Select this check box to verify the pre-shared key.
Username	Only available if the selected Protocol Version is <code>v3</code> : Enter the username that every SNMP manager/client software has to use to identify to the SNMP service of the access zone.  The username is created and used by the SNMP service internally.
Authentication Protocol	Only available if the selected Protocol Version is <code>v3</code> : From the drop-down list, select the hashing algorithm that is used for authentication purposes. You can choose between <code>No Authentication</code> , <code>MD5</code> and <code>SHA</code> .
Authentication Password	Only available if the selected Protocol Version is <code>v3</code> and if the selected Authentication Protocol is <code>MD5</code> or <code>SHA</code> : Enter the password you want to use for authentication. The password must consist of at least eight characters.
Show Authentication Password	Optional and only available if the selected Protocol Version is <code>v3</code> and if the selected Authentication Protocol is <code>MD5</code> or <code>SHA</code> : Select this check box to verify the authentication password.
Privacy Protocol	Optional and only available if the selected Protocol Version is <code>v3</code> and if the selected Authentication Protocol is <code>MD5</code> or <code>SHA</code> : From the drop-down list, select the hashing algorithm that is used to encrypt the communication with the SNMP service. You can choose between the encryption algorithms <code>3DES</code> and <code>AES</code> . This option is set to <code>No Encryption</code> .
Privacy Password	Only available if the selected Protocol Version is <code>v3</code> , if the selected Authentication Protocol is <code>MD5</code> or <code>SHA</code> and if the selected Privacy Protocol is <code>3DES</code> or <code>AES</code> : Enter the password that is used to encrypt the communication with the SNMP service with the selected encryption algorithm.
Show Privacy Password	Optional and only available if the selected Protocol Version is <code>v3</code> , if the selected Authentication Protocol is <code>MD5</code> or <code>SHA</code> and if the selected Privacy Protocol is <code>3DES</code> or <code>AES</code> : Select this check box to verify the privacy password.
Location	Optional: Enter a fixed value which your LANCOM R&S® Unified Firewall returns for requests to certain Object Identifiers (OIDs) of the standard Management Information Base (MIB): <code>sysLocation</code> .
Contact	Optional: Enter a fixed value which your LANCOM R&S® Unified Firewall returns for requests to certain Object Identifiers (OIDs) of the standard Management Information Base (MIB): <code>sysContact</code> .

If you have modified these settings, use the buttons at the bottom right of the editor panel allow to confirm (**Save**) or to discard your changes (**Reset**). Otherwise, you can close the dialog (**Close**).

Click  **Activate** in the toolbar at the top of the desktop to apply your configuration changes.

Statistics

The **Statistics** panels contain graphics and tables. You can control several aspects of the presentation and data on these statistics.

The **Statistics** right is required to access the statistics and configure the settings related to them. For more information on web client permissions, see [Administrators Settings](#) on page 26.

 When analyzing the statistics and configuring the settings related to them, the administrator must comply with data security regulations.

There are two ways to access the individual statistics panels:

- You can use the links in the navigation bar to navigate to the detailed statistics panels, e. g. via **Monitoring & Statistics > Statistics > Blocked Connections**.
- You can click the **Details** link in the top right corner of one of the chart panels on the **Statistics** overview. The link forwards you to the detailed statistics panel for that chart. For more information, see [Overview](#) on page 61.

Working with statistics

There are two types of statistics:

- Counters are displayed as line charts on the **Blocked Connections** and **Blocked Content** statistics panels. The charts contain several counters each.
- Toplists provide a ranking for different events types and are displayed as a pie chart or an area chart, depending on the selected data period. Data for the `Day` period is displayed as a pie chart, while data for `Month` and `Year` is displayed as a stacked area chart.

A tabular display of the graphical data complements each statistics panel. In the case of counters, the data table always displays the same data as the chart. Each statistics element creates a column in the data table. In the case of toplist, the data table displays the values of the statistics elements.

The charts and tables in the statistics panels share common functions to adjust the data display and allow you to focus on the data you are most interested in:

- Under **Period** in the header area of the statistics panels, you can set the desired temporal scope of the data to be displayed. Use the buttons to toggle between the different data periods available. You can choose between `Day`, `Month` and `Year`. This option is set to `Day` by default.
- Toplists typically contain an input field in the header area of the panels. Use the **Entries** field to adjust the maximum number of items to be displayed in the chart. This option is set to 5 by default. You can enter a different value or use the up and down arrows in the input field to change the value.

 Regardless of the value set for the chart, the data table always displays up to 1,000 entries.

- You can collapse and expand charts and tables by clicking the corresponding icon in the header area of a chart or table to expand the table or hide unnecessary details. For more information, see [Icons and buttons](#) on page 22.
- Click  in the top right corner of a chart to access various export options (print view, PNG, JPEG, SVG, PDF, CSV and XLS) for the data displayed in the chart.

 If you use the XLS export function available for toplist charts, only the data used by that chart is exported, taking into account the value you have selected for the maximum number of toplist items.

- Line and area charts include a legend. The legend is color-coded and can be used as a filter for the chart. Click items in the legend below the chart to activate and deactivate them in the chart. If clicking has no effect and the legend item remains gray, data collection for the underlying event type was disabled in the statistics settings and, therefore, no data is available. For more information, see [Statistics Settings](#) on page 49.
- Tooltips provide details on specific points in the graphical statistics. Hover the cursor of your mouse over the chart to see the exact values for a specific point in time.

The sections below provide further information on the data available in the statistics overview, on each detailed statistics panel and on the settings.

Blocked Connections

The **Blocked Connections** configuration dialog allows you to configure the following elements:

Statistics Element (Event Type)	Description
Rule Set Inbound (Blocked Inbound Traffic)	Number of connections blocked by input rules
Rule Set Outbound/Forward (Blocked Forwarded Traffic)	Number of connections blocked by forwarding rules
IPS/IDS (IDPS Alert)	Number of IDS/IPS alerts. If the IDS/IPS mode is set to "IDS", "IPS Drop" or "IPS Reject", then this statistics element displays the number of dropped packets. For more information, see IDS/IPS on page 103.

Blocked Content

The **Blocked Content** configuration dialog allows you to configure the following elements:

Statistics Element (Event Type)	Description
Virus (Mail) (Malware Alert (Mail))	Number of viruses detected in e-mails
Virus (Other) (Malware Alert (HTTP and FTP))	Number of viruses detected in HTTP or FTP traffic
Spam (Spam Alert)	Number of spam e-mails detected
Web Access (Web Content Blocked)	Web access blocked by content filter
Appfilter (Appfilter Alert)	Number of alerts regarding blocked application-specific traffic

Overview

Navigate to **Monitoring & Statistics > Statistics > Overview** to view a summary of all available statistics charts. It can be considered a dashboard for **Statistics** and is intended to provide an initial answer to the most common questions regarding the events that your LANCOM R&S® Unified Firewall can detect.

The following special features apply only to this panel (diverging from the description of the individual statistics panels in [Statistics](#) on page 60):

- Under **Period** in the header area of the statistics window, you can define the desired time span to be used for all data displayed in charts.
- You can click the **Details** link in the top right corner of an individual chart panel to be forwarded to the detailed statistics panel for the respective chart.
- The number of entries for toplist charts is set to a fixed value of 5.

Top Domains Accessed

The **Top Domains Accessed** panel shows the web sites that have been accessed the most by local network users, if you enable your LANCOM R&S® Unified Firewall to collect this data and if you activate the **Web Content Allowed** event

type. These statistics are used to determine whether web-browsing habits match the company policy and the goals of the business.

Top Domains Blocked

The **Top Domains Blocked** panel shows the top websites that are blocked, if you enable your LANCOM R&S® Unified Firewall to collect this data, by activating the **Web Content Blocked** event type.

Top Data Traffic per Source

The **Top Traffic per Source** panel shows the traffic volume for the top data traffic sources if you allow your LANCOM R&S® Unified Firewall to collect this kind of data by enabling the **Connection Finished** event type.

Syslog Servers

Your LANCOM R&S® Unified Firewall can be used to configure multiple external syslog servers to forward log messages generated by different message sources for reporting purposes.

Syslog messages are sent in cleartext (not encrypted) usually via port number 514 and either via the User Datagram Protocol (UDP) or the Transmission Control Protocol (TCP) to the remote syslog server.

You can find more information regarding external syslog servers in the following sections.

Syslog Servers Overview

Navigate to **Monitoring & Statistics > Syslog Servers** to display a list of remote syslog servers that are currently defined in the system and displayed in the item list bar.

In the expanded view, the table displays the server address of the external syslog server which consists of the IP address and the port. For example, the server address `192.168.124.5:514` corresponds to the IP address `192.168.124.5` using the port number `514`. Furthermore, the protocol type used for the transmission of the text message is displayed. The buttons in the last column allow you to view and to adjust the settings for an existing external syslog server, create a new syslog server based on a copy of an existing syslog server or delete a syslog server from the system.

For more information, see [Icons and buttons](#) on page 22.

Syslog Servers Settings

The **Syslog Servers** settings allow you to specify connection details for multiple remote syslog servers to forward log messages generated by different message sources.

Under **Monitoring & Statistics > Syslog Servers**, you can add a new or edit an existing remote syslog server.

The **Syslog Servers** configuration dialog allows you to configure the following elements:

Input field	Description
Destination IP	Enter the IP address of the server.
Destination Port	Specify the port number to be used by entering an integer value.
Transport Protocol	From the drop-down list, select the protocol type you want to use.

The buttons at the bottom right of the editor panel depend on whether you add a new remote syslog server or edit an existing one. For a newly configured server, click **Create** to add the server to the list of available remote syslog servers or **Cancel** to discard your changes.

If you have modified these settings, use the buttons at the bottom right of the editor panel to confirm (**Save**) or to discard your changes (**Reset**). Otherwise, you can close the dialog (**Close**).

Click **✓ Activate** in the toolbar at the top of the desktop to apply your configuration changes.

3.4.3 Network

The  **Network** settings allow you to organize your network by configuring interfaces, connections, WLAN, routing policies and DHCP settings. Furthermore, you can set up the WAN access of your LANCOM R&S® Unified Firewall by configuring DNS settings, DynDNS accounts and QoS settings.

Connections

The **Desktop Connections** settings allow you to configure the network and PPP connections for your LANCOM R&S® Unified Firewall.

Network Connections

The **Network Connections** configuration dialog allows you to configure network connections. The system offers default connections for all available Ethernet interfaces.

You can find more information regarding the network connections in the following sections.

Network Connections Overview

Navigate to **Network > Connections > Network Connections** to display the list of network connections that are currently defined in the system and displayed in the item list bar.

In the expanded view, the first column of the table displays the **Name** of the network connection. The **Status** column shows one of the following status indicators:

- > Green – The network connection is enabled.
- > Gray – The network connection is disabled.
- > Red – The network connection is disconnected.

Furthermore, the **Interface** that the network connection is assigned to and the connection **Type** are displayed. The buttons in the last column allow you to view and to adjust the settings for an existing network connection, create a new connection based on a copy of an existing network connection or delete a network connection from the system.

For more information, see [Icons and buttons](#) on page 22.



Network Connections Settings

Use the **Network Connections** settings to configure custom network connections.





Under **Network > Connections > Network Connections**, you can add a new or edit an existing network connection.

The **Network Connection** panel displays the following information and allows you to configure the following elements:

Input field	Description
I/O	A slider switch indicates whether the network connection is active (I) or inactive (O). Click the slider switch to change the status of the connection. A new connection is active by default.
Name	Enter a name for the network connection.  If you leave this field empty, the name will be generated automatically from the selected interface and connection type.
Interface	From the drop-down list, select the interface that you want to assign to the connection. You may select an Ethernet, VLAN or bridge interface.
Type	From the drop-down list, select the connection type. This option is set to <i>Static</i> by default, but you can adjust the settings to one of the other values as necessary: <ul style="list-style-type: none"> > <i>Static</i> – This mode is used to specify a fixed IP address for the connection. > <i>DHCP</i> – This mode is used to assign IP addresses dynamically.



Input field	Description
	<p> Once you click Create to establish the network connection, you will no longer be able to change the connection type.</p> <p> The elements in the Network tab depend on the selected connection type.</p>
Used by	Displays the components that use the network connection.
Status	<p>Displays the status of the network connection.</p> <p>The status can be one of the following:</p> <ul style="list-style-type: none"> > <code>up</code> – The network connection is enabled. > <code>disabled</code> – The network connection is disabled. > <code>disconnected</code> – The network connection is disconnected.

On the **Network** tab:

Input field	Description
IP Addresses	<p>Assign one or multiple IP addresses to the network connection. Enter an IP address in CIDR notation (IP address followed by a slash “/” and the number of bits set in the subnet mask, e. g. 192.168.50.1/24). Click Add to add the IP address to the list.</p> <p>You can edit or delete individual entries in the list by clicking the corresponding button next to an entry. For more information, see Icons and buttons on page 22.</p> <p> If you edit an IP address, a check mark appears on the right of the entry. You have to click the check mark before being able to save the settings of the IP address.</p> <p>Click / to change the order of the IP addresses in the list.</p> <p> The IP address which is listed first in the list is used as the default source IP address for NAT and for IPsec connections.</p>
Obtain Gateway	Optional and only available if the selected connection Type is <code>DHCP</code> . Select this check box if you want your LANCOM R&S® Unified Firewall to obtain a gateway for the connection from the DHCP server.
Obtain DNS Server	Optional and only available if the selected connection Type is <code>DHCP</code> . Select this check box if you want your LANCOM R&S® Unified Firewall to obtain a DNS server for the connection.
Obtain Domain	Optional and only available if the selected connection Type is <code>DHCP</code> . Select this check box if you want your LANCOM R&S® Unified Firewall to obtain a domain for the connection from the DHCP server.
Obtained via DHCP	<p>Optional and only available if the selected connection Type is <code>DHCP</code>.</p> <p>Displays one of the following states:</p> <ul style="list-style-type: none"> > If the connection is working, the IP address is displayed. > <code>Connection not yet saved</code> – A new connection is being created. > <code>Failed</code> – The DHCP connection could not be established.

On the **WAN** tab:

Input field	Description
Set Default Gateway	Optional and only available if the selected connection Type is <code>Static</code> . Select this check box if you want to set a default gateway for the network connection.

Input field	Description
	<p> If you select <code>DHCP</code> as the connection type, this check box is always enabled and grayed out as the gateway is obtained from the DHCP server.</p>
Default Gateway	<p>Optional and only available if the selected connection Type is <code>Static</code>. Enter the default gateway for this connection.</p> <p> If you select <code>DHCP</code> as the connection type, this check box is always enabled and grayed out and displays the gateway that is obtained from the DHCP server.</p>
Time Restrictions	<p>Optional: Select this check box if you want to set a time limit for which the connection is enabled.</p> <p>Click Edit to open the Time Restriction editor panel which provides the following options:</p> <ul style="list-style-type: none"> > Set specific times and weekdays using the sliders. > Always On – The connection is always enabled. > Always Off – The connection is always disabled. <p>The buttons at the bottom right of the editor panel allow you to confirm your time limit changes (OK) and to discard your changes (Cancel). The editor panel closes and the chosen option is displayed on the left of the Edit button: <code>Restricted</code>, <code>Always On</code> or <code>Always Off</code>.</p>
Multi WAN Weight	<p>Specify how much of the Internet traffic is routed through this connection by entering a value from 1 to 256. The higher the set value, the higher the percentage of Internet traffic routed through the connection. Setting the same value for all connections results in equal traffic distribution across all connections.</p>
Desktop Object	<p>From the drop-down list, select an Internet object that is used in firewall rules for this WAN connection. For more information, see Internet Objects on page 85.</p>

On the **Failover** tab:

Input field	Description
Heartbeats	<p>Specify how you want to test the state of the connection by adding tests.</p> <p>The default settings contain a ping test with the Google server (8.8.8.8). Click Add to add another test to the list. For more information on configuring the reachability test, see Heartbeat Settings on page 66.</p> <p>You can edit or delete individual entries in the list by clicking the corresponding button next to an entry. For more information, see Icons and buttons on page 22.</p>
Use as backup connection	<p>Optional: Select this check box to configure this connection as a backup Internet connection.</p>
Backup connections	<p>Select any backup connection you wish to assign to the connection and specify its Priority. If the current connection fails, your LANCOM R&S® Unified Firewall switches to the available backup connection with the highest priority. Click Add to add the backup connection to the list.</p> <p>You can edit or delete individual entries in the list by clicking the corresponding button next to an entry. For more information, see Icons and buttons on page 22.</p> <p> If you edit a backup connection, a check mark appears on the right of the entry. You have to click the check mark before being able to save the settings of the backup connection.</p>

The buttons at the bottom right of the editor panel depend on whether you add a new network connection or edit an existing one. For a newly configured connection, click **Create** to add it to the list of available connections or **Cancel** to discard your changes. To edit an existing network connection, click **Save** to store the reconfigured connection or **Reset** to discard your changes. You can click **Close** to shut the editor panel as long as no changes have been made on it.

Click  **Activate** in the toolbar at the top of the desktop to apply your configuration changes.

Heartbeat Settings

The **Heartbeat** editor panel allows you to set up automatic heartbeat tests to check the connection state. In the editor panel, you can configure the following elements:

Input field	Description
Type	From the drop-down list, select the type of reachability test you want to run: <ul style="list-style-type: none"> > <code>ping</code> – This mode sends ping signals to the target. > <code>tcp_probe</code> – This mode tests the capacity of a TCP connection.
Timeout	Specify the timeout for the test in seconds.
Number of tries	Set the overall number of tries to be performed.
Number of successful tries	Set the number of successful tries required for a successful heartbeat.
Arguments	Specify the arguments to be used in the test, e. g. IP addresses that you want to ping.

 If you have created a backup Internet connection on the **Failover** tab and the automatic heartbeat test defines the state of the connection as `disconnected`, your LANCOM R&S® Unified Firewall automatically switches to the backup connection with the highest priority available.

The buttons at the bottom right of the editor panel allow you to confirm your changes to the heartbeat test (**OK**) and to run the connection test manually (**Test**). You can also reject (**Cancel**) your changes to the test, close the editor panel and return to the **Network Connection** editor panel. The specified test is displayed as an entry in the list under **Heartbeats** on the **Failover** tab.

PPP Connections

Use the **PPP Connections** settings to configure existing connections using the Point-to-Point Protocol and to add new connections.

You can find more information regarding PPP connections in the following sections.

PPP Connections Overview

Navigate to **Network > Connections > PPP Connections** to display a list of PPP connections that are currently defined in the system and displayed in the item list bar.

In the expanded view, the columns of the table display the **Name** of the connection and the **Type** of the connection and if it is **Active** or not. The buttons in the last column allow you to view and adjust the settings for an existing PPP connection, create a new connection based on a copy of an existing PPP connection or delete a PPP connection from the system.



For more information, see [Icons and buttons](#) on page 22.

PPP Connections Settings

Under **Network > Connections > PPP Connections**, you can add a new or edit an existing network connection.

The **PPP Connections** connection settings contain the following elements:

Input field	Description
I/O	A slider switch indicates whether the PPP connection is active (I) or inactive (O). Click the slider switch to change the status of the connection. New PPP connections are activated by default.
Name	Enter the name of the network connection.

Input field	Description
	If you leave this field empty, the name will be generated automatically from the selected interface and connection type.
Interface	Assign an interface to the connection. You can only select a PPP interface that is not being used by another connection.
Type	<p>From the drop-down list, select the connection type, depending on your Internet provider: <code>PPPoE</code> or <code>PPTP</code>. Use the <code>PPPoE</code> mode to connect using the Point-to-Point Protocol over Ethernet. PPPoE is typically used to share a broadband connection, such as a single DSL line or cable modem. Use the <code>PPTP</code> mode to connect using the Point-to-Point Tunneling Protocol.</p> <p> Once you click Create to establish the PPP connection, you will no longer be able to change the connection type.</p> <p> The elements in the Configuration tab depend on the selected connection type.</p>
Used by	Displays the components that use the PPP connection.
Status	Displays the status of the connection (<code>up</code> , <code>disconnected</code> or <code>disabled</code>).

On the **Configuration** tab:

Input field	Description
Auth. Method	<p>Select an authentication method for the connection, depending on your Internet service provider:</p> <ul style="list-style-type: none"> > <code>None</code> > <code>auto</code> - Automatically selects the authentication method which best matches the Internet service provider. > <code>pap-only</code> - password authentication > <code>chap-only</code> - handshake authentication > <code>ms-chap2</code> - handshake authentication for Microsoft
Username	Enter the username required to connect to your Internet service provider.
Password	Enter the password required to connect to your Internet service provider.
PPTP Server IP	If you chose PPTP as connection type, enter the IP address of the PPTP server.
MPPE	<p>If you chose PPTP as connection type, select the Microsoft Point-to-Point Encryption key length:</p> <ul style="list-style-type: none"> > <code>mppe-40</code> > <code>mppe-56</code> > <code>mppe-128</code>
Local IP	Optional: Enter your local IP address only if explicitly required by your Internet service provider.
Remote IP	Optional: Enter your remote IP address only if explicitly required by your Internet service provider.
AC Hardware Address	Optional: Enter the hardware MAC address of the Access Concentrator used by your Internet service provider. Only do so if your Internet service provider explicitly requires this.
Force disconnect	<p>Optional: Select this check box if you want to enforce a disconnect process at a specified time. To enter the time, use the <code>HH:MM:SS</code> format.</p> <p>Some Internet service providers force a disconnect at specific intervals (usually every 24 hours). With this setting enabled, your LANCOM R8S[®] Unified Firewall disconnects at a specific time thereby preventing the auto-disconnect from the Internet service provider. This allows you to control when the disconnect happens.</p>

On the **WAN** tab:

Input field	Description
Time Restrictions	Select this check box if you want to set a time limit for which the connection is enabled. Click Edit to open the Time Restrictions editor panel which provides the following options: <ul style="list-style-type: none"> > Set specific times and weekdays using the sliders. > Always On - The connection is always enabled. > Always Off - The connection is always disabled.
Multi WAN Weight	Specify how much of the Internet traffic is routed through this connection by entering a value from 1 to 256. The higher the set value, the higher the percentage of Internet traffic routed through the connection. Setting the same value for all connections results in equal traffic distribution across all connections.
Desktop Object	From the drop-down list, select an Internet object that is used in firewall rules for this connection. For more information, see Internet Objects on page 85.

On the **Failover** tab:

Input field	Description
Heartbeats	Specify how you want to test the state of the connection by adding ping tests. The default settings contain a ping test with the Google server (8.8.8.8). Click Add to add another test to the list. For more information on configuring the reachability test, see Heartbeat Settings on page 68. You can edit or delete individual entries in the list by clicking the corresponding button next to an entry. For more information, see Icons and buttons on page 22.
Use as backup connection	Select this check box to configure this connection as a backup Internet connection.
Backup connections	Select any backup connection you wish to assign to the connection and specify its Priority . If the current connection fails, your LANCOM R8S [®] Unified Firewall switches to the available backup connection with the highest priority. Click Add to add the backup connection to the list. You can edit or delete individual entries in the list by clicking the corresponding button next to an entry. For more information, see Icons and buttons on page 22.

Heartbeat Settings

The **Heartbeats** panel allows you to configure automatic heartbeat tests. The editor panel contains the following elements:

Input field	Description
Type	From the drop-down list, select the type of reachability test you want to run: <ul style="list-style-type: none"> > <code>ping</code> - This mode sends ping signals to the target. > <code>tcp_probe</code> - This mode tests the capacity of a TCP connection.
Timeout	Specify the timeout for the test in seconds.
Number of tries	Set the overall number of tries to be performed.
Number of successful tries	Set the number of successful tries required for a successful heartbeat.
Arguments	Specify the arguments to be used in the test, e. g. IP addresses that you want to ping.

Click **Test** to run the connection test manually. Click **OK** to save your settings and to return to the **Network Connection** panel.

The buttons at the bottom right of the editor panel depend on whether you add a new PPP connection or edit an existing one. For a newly configured connection, click **Create** to add it to the list of available PPP connections or **Cancel** to discard your changes. To edit an existing PPP connection, click **Save** to store the reconfigured connection or **Reset** to discard your changes. You can click **Close** to shut the editor panel as long as no changes have been made on it.

Click  **Activate** in the toolbar at the top of the desktop to apply your configuration changes.

DHCP Settings

Navigate to **Network > DHCP Settings** to configure the DHCP settings on your LANCOM R&S[®] Unified Firewall.

Input field	Description
I/O	A slider switch indicates whether DHCP is active (I) or inactive (O). Click the slider switch to change the status.
Operation Mode	Choose if you want to set up a DHCP server or a DHCP relay. The remaining fields on the screen depend on the chosen operation mode.

DHCP Server Settings

With the DHCP server running on your LANCOM R&S[®] Unified Firewall, you can assign IP addresses and transfer them to other configuration parameters (Gateway, DNS server, NTP server, etc.). Alternatively, it is possible to forward DHCP requests to an existing DHCP server on another network.

Configure the following elements for the DHCP server:



Input field	Description
Default Lease Time	Enter the default lease time (in seconds) to determine the amount of time that the IP address of a computer is valid.
Maximum Lease Time	Enter the maximum lease time (in seconds).
Prevent IP Conflicts	Select this check box to have the DHCP server ping an IP address to verify that it is not yet in use before assigning it to a new client.
Interfaces	This table displays all interfaces (Ethernet, VLAN and bridge) on which a static connection has been configured and their DHCP settings. Click  to open the DHCP Settings editor panel of the respective interface.

The **DHCP Settings** configuration dialog allows you to configure the following elements for an interface:

Input field	Description
I/O	A slider switch indicates whether the DHCP server is active (I) or inactive (O) for this interface. By clicking the slider switch, you can toggle the state of the DHCP server for this interface.

On the **General** tab:

Input field	Description
Network	From the drop-down list, select the subnet whose IP addresses are distributed by the DHCP server. By selecting the subnet, the Range Start IP and the Range End IP input fields are automatically prefilled with the respective IP range.
Range Start IP	If the prefilled start IP address does not meet your requirements, adjust the entry to specify the range of IP addresses that are distributed to the client computers.

Input field	Description
Range End IP	<p>If the prefilled end IP address does not meet your requirements, adjust the entry to specify the range of IP addresses that are distributed to the client computers.</p> <hr/> <p> Make sure that the permanent IP addresses are not within the IP address range of the DHCP server as permanent IP addresses are not excluded automatically during dynamic address assignment. Otherwise, addresses may be assigned twice.</p>
Lease Time	Specify the time (in minutes) that the IP address of a computer is valid. The default lease time is 60 minutes.
Gateway	If the prefilled gateway IP address to be pushed to the client does not meet your requirements, adjust the entry. The default gateway IP address is usually the IP address of your LANCOM R&S® Unified Firewall.
WINS server	Optional: If there is a WINS server in the network, use this input field to communicate it to the clients.
Preferred NTP server / Alternative NTP server	Optional: Clients may use NTP servers to determine the exact time. This is particularly important for user authentication via Windows servers.
Preferred DNS server / Alternative DNS server	If your LANCOM R&S® Unified Firewall does not carry out name resolution, enter internal DNS servers that are located in the network or the Internet. Otherwise, the clients are allocated the IP address of your LANCOM R&S® Unified Firewall as their DNS server.
DNS Search Domains	<p>Specify a DNS search domain that the DNS service uses to resolve host names that are not fully qualified domain names.</p> <p>Click  to add the DNS search domain to the list.</p> <p>You can edit or delete individual entries in the list by clicking the corresponding button next to an entry. For more information, see Icons and buttons on page 22.</p> <hr/> <p> If you edit an entry, a check box appears on the right of the entry. Activate the check box to apply your changes.</p>

On the **Static IP Addresses** tab:

Input field	Description
MAC Address / IP Address / Host Name	<p>Specify a static IP address for a host in the network by entering the host's MAC address and IP address. Additionally, you can enter the host name. Click Add to add the static IP address to the list.</p> <p>You can edit or delete individual entries in the list by clicking the corresponding button next to an entry. For more information, see Icons and buttons on page 22.</p> <hr/> <p> If you edit an entry, a check box appears on the right of the entry. Activate the check box to apply your changes.</p>
Add from ARP Cache	From the drop-down list, select the addresses that you want to add to the ARP cache.

Click **OK** to save your settings and to return to the **DHCP Settings** panel.

DHCP Relay Settings

A DHCP relay redirects incoming requests to a DHCP server to another network as DHCP requests cannot be routed.

Input field	Description
DHCP Server IP Address	Enter the IP address of the server to which the DHCP requests will be redirected.

Input field	Description
Relay through these interfaces	Select one or more interfaces from which DHCP requests will be forwarded. Also, select the interface that the DHCP server is connected to.

If you modify these settings, click **Save** to save your changes or **Reset** to discard them. Otherwise, click **Close** to close the editor panel.

Click  **Activate** in the toolbar at the top of the desktop to apply your configuration changes.

DNS Settings

Navigate to **Network > DNS Settings** to configure the DNS settings on your LANCOM R&S[®] Unified Firewall.

 Usually, the DNS server settings are provided by the WAN connection. You should have to configure the DNS server settings only if you cannot obtain them over the WAN connection.

The **DNS Settings** configuration dialog allows you to configure the following elements:

Input field	Description
Acquire DNS server	Select this check box to connect to a DNS server selected by the provider's router.  If you use several Internet lines from different providers, make sure that the DNS servers you use can be reached from all lines. If necessary, use public DNS servers on the Internet.
Nameserver	Specify an alternative DNS server by entering its IP address.

If you modify these settings, click **Save** to save your changes or **Reset** to discard them. Otherwise, click **Close** to close the editor panel.

Click  **Activate** in the toolbar at the top of the desktop to apply your configuration changes.

DynDNS Accounts

To connect to your LANCOM R&S[®] Unified Firewall from the external network, e. g. with a VPN connection, the IP address of your device has to be recognized on the Internet. Using dynamic DNS ("DynDNS"), your LANCOM R&S[®] Unified Firewall retrieves a fixed host name (e. g. `yourcompany.dyndns.org`) on the Internet, even if it has no fixed public IP address. This is accomplished by sending the current IP address to a DynDNS provider that maps it to a domain name so that the firewall is accessible using that domain name. If, for example, the IP address changes due to a DSL disconnect forced by your Internet service provider, the IP address is re-sent to the DynDNS provider. This behavior ensures that the dynamic DNS always points to the current IP address.

 To set up DynDNS on your LANCOM R&S[®] Unified Firewall, you require a configured DynDNS account with a DynDNS provider. For more information about dynamic DNS and to register for the dynamic DNS process, go to www.dyndns.org.

You can find more information regarding dynamic DNS accounts in the following sections.

DynDNS Accounts Overview

Navigate to **Network > DynDNS Accounts** to display a list of DynDNS accounts that are currently defined in the system and displayed in the item list bar.

In the expanded view, the columns of the table display the DynDNS account's **Hostname**, **Server Type** and **Status**. The buttons in the last column allow you to view and to adjust the settings for an existing DynDNS account, create a new account based on a copy of an existing account or delete an account from the system.

For more information, see [Icons and buttons](#) on page 22.

DynDNS Accounts Settings

Under **Network > DynDNS Accounts**, you can add a new or edit an existing DynDNS account for WAN access in general.

The **DynDNS Account** configuration dialog allows you to configure the following elements:

Input field	Description
I/O	A slider switch indicates whether the DynDNS account is active (I) or inactive (O). Click the slider switch to change the status of the DynDNS account. A new DynDNS account is activated by default.
Internet Connection	From the drop-down list, select the Internet connection used by this account.
Server Type	From the drop-down list of supported DynDNS services, select the type of server to be used.
Hostname	DynDNS services provide a domain name entry under their authority. Consequently, a registered host always has the suffix of the service provider (e. g. <code>yourname.dynamicdns.org</code>). Enter the entire host name into this input field.
Username	Enter the user name with which your account is registered with the DynDNS provider.
Password	Enter the password with which your account is registered with the DynDNS provider.
Show Password	Optional: Select this check box to verify the password.
Custom Server Address	Optional: Enter the address of the server if your DynDNS provider requires the definition of a different server address.
MX Record	Optional: If you want to use an MX record, enter its IP address or host name.
Wildcards	Optional: Select this check box to activate the use of wildcards in host names if you plan to use subdomains of your DynDNS account (Example: <code>*.yourname.dynamicdns.org</code> will resolve for any domain ending with <code>yourname.dynamicdns.org</code>).

The buttons at the bottom right of the editor panel depend on whether you add a new DynDNS account or edit an existing one. For a newly configured account, click **Create** to add the account to the list of available DynDNS accounts or **Cancel** to discard your changes. To edit an existing account, click **Save** to store the reconfigured account or **Reset** to discard your changes. You can click **Close** to shut the editor panel as long as no changes have been made on it.

Click **✓ Activate** in the toolbar at the top of the desktop to apply your configuration changes.

Interfaces

Navigate to **Network > Interfaces** to configure Ethernet, VLAN, Bridge, PPP and WLAN interfaces. The item list bar displays an overview of all interfaces, that are currently defined in the system.

Bond Interfaces

Use the **Bond Interfaces** settings to combine multiple physical Ethernet interfaces into one logical bond interface. Depending on its mode of operation, a bond interface offers the following two advantages:

- > Load balancing – A bond interface provides increased bandwidth by using all aggregated Ethernet interfaces in parallel to transmit data.
- > High availability – If one Ethernet interface fails, data can still be received and transmitted on the remaining Ethernet interfaces.

You can add as many bond interfaces as you like as long as there are available Ethernet interfaces that are not used by other interfaces or in any network connections.

You can find more information regarding bond interfaces in the following sections.

Bond Interfaces Overview

Navigate to **Network > Interfaces > Bond Interfaces** to display a list of bond interfaces that are currently defined in the system and displayed in the item list bar.

In the expanded view, the first column of the table displays the **Name** of the bond interfaces. The **Status** column shows one of the following status indicators:

- > Green – The bond interface is up.
- > Gray – The bond interface is disabled.

Furthermore, the webclient shows the **Ports** (i. e. Ethernet interfaces) that are assigned to the bond interface. The buttons in the last column allow you to view and to adjust the settings for an existing bond interface or to delete one from the system.

For more information, see [Icons and buttons](#) on page 22.

Bond Interfaces Settings

Use the **Bond Interfaces** settings to configure user-defined bond interfaces.

Under **Network > Interfaces > Bond Interfaces**, you can add a new or edit an existing bond interface.

The **Bond Interface** panel displays the following information and allows you to configure the following elements:

Input field	Description
I/O	A slider switch indicates whether the bond interface is active (I) or inactive (O). Click the slider switch to change the status of the bond interface. New bond interfaces are activated by default.
Name	Displays the name of the bond interface. The name is filled in automatically. Bond interfaces are numbered in the order they are created, starting with <code>bond0</code> .
Hardware Address	Displays the hardware address (MAC address) of the bond interface.
Used by	Display the network components (e. g. connections, other interfaces, etc.) that use the bond interface.
Mode	<p>From the drop-down list, select the mode of operation for the bond interface, specifying how the multiple Ethernet interfaces are to be aggregated.</p> <p>The option is set to <code>IEEE 802.1AX (LACP, Direct connection)</code> by default, but you can adjust the settings to the other values as necessary:</p> <ul style="list-style-type: none"> > <code>Balance - Round-Robin (Trunk, Direct connection)</code> – This mode provides load balancing and high availability. Packets are transmitted in sequential order from the first available aggregated Ethernet interface through the last, then continuing with the first aggregated Ethernet interface again. > <code>Active-Backup (Bridge, Direct connection)</code> – This mode provides high availability only. Data is transmitted and received by the active Ethernet interface (i. e. the first Ethernet interface in the list) only as long as it is not faulty. When the first Ethernet interface fails, the next Ethernet interface in the list is used to transmit and receive data. > <code>Balance - XOR (Trunk, Direct connection)</code> – This mode provides load balancing and high availability. Packets are transmitted on all Ethernet interfaces. A simple algorithm (layer2+3 XOR) is applied to decide which Ethernet interface is used to transmit the data. > <code>Broadcast (Trunk, Direct connection)</code> – This mode provides high availability only. Packets are transmitted simultaneously on all Ethernet interfaces. > <code>IEEE 802.1AX (LACP, Direct connection)</code> – This mode provides load balancing and high availability by using the LACP (Link Aggregation Control Protocol) standard. Packets are transmitted on all Ethernet interfaces. A simple algorithm (layer2+3 XOR) is applied to decide which Ethernet interface is used to transmit the data.

Input field	Description
	<ul style="list-style-type: none"> <li data-bbox="639 275 1441 394">> Balance - TLB (Bridge) – This mode provides load balancing and high availability. In addition to the simple selection algorithm (layer 2+3 XOR), the current load of the Ethernet interface is taken into account when deciding which Ethernet interface is to be used to transmit the data. <li data-bbox="639 394 1441 515">> Balance - ALB (Bridge) – This mode provides load balancing and high availability. Data is received using ARP negotiation. In addition to the simple selection algorithm (layer 2+3 XOR), the current load of the Ethernet interface is taken into account when deciding which Ethernet interface is to be used to transmit the data.
Ports	<p data-bbox="635 551 1441 611">Add the Ethernet interfaces that you want to aggregate into one logical link by clicking the input field. You can add as many available Ethernet interfaces as you like.</p> <hr data-bbox="635 629 1441 633"/> <p data-bbox="635 640 1441 701"> You can select only Ethernet interfaces that are not used by other interfaces or in any network connections.</p> <p data-bbox="635 712 1441 741">The selected Ethernet interfaces are displayed in a table at the bottom of the panel.</p> <p data-bbox="635 752 1441 790">To delete an element from the input field, click X to the left of the entry.</p>
MTU	<p data-bbox="635 804 1441 864">Set the maximum size of each packet (in bytes). The maximum transmission unit can be any integer from 64 to 16384.</p>

The buttons at the bottom right of the editor panel depend on whether you add a bond interface or edit an existing one. For a newly configured bond interface, click **Create** to add it to the list of available bond interfaces or **Cancel** to discard your changes. To edit an existing bond interface, click **Save** to save the reconfigured interface or **Reset** to discard your changes. You can click **Close** to shut the editor panel as long as no changes have been made on it.

Click  **Activate** in the toolbar at the top of the desktop to apply your configuration changes.

Bridge Interfaces

Use the **Bridge Interfaces** settings to connect two interfaces and their networks on Layer 2, forming a common broadcast domain.

You can find more information regarding bridge interfaces in the following sections.

Bridge Interfaces Overview

Navigate to **Network > Interfaces > Bridge Interfaces** to display a list of bridge interfaces that are currently defined in the system and displayed in the item list bar.

In the expanded view, the first table column displays the **Name** of the bridge interface. The **Status** column shows one of the following status indicators:

- > Green – The bridge interface is enabled.
- > Orange – The bridge interface is disabled.

Furthermore, the web client shows the **Ports** that are assigned to the bridge interface. The buttons in the last column allow you to view and to adjust the settings for an existing bridge interface, create a bridge interface based on a copy of an existing bridge interface or delete a bridge interface from the system.

For more information, see [Icons and buttons](#) on page 22.

Bridge Interfaces Settings

Use the **Bridge Interfaces** settings to configure custom bridge interfaces.

Under **Network > Interfaces > Bridge Interfaces**, you can add a new or edit an existing bridge interface.

The **Bridge Interface** panel displays the following information and allows you to configure the following elements:

Input field	Description
I/O	A slider switch indicates whether the bridge interface is active (I) or inactive (O). Click the slider switch to change the status of the bridge interface. New bridge interfaces are activated by default.
Name	Displays the name of the bridge interface. The name is generated automatically. Bridges are numbered in the order they are created, starting with <code>br0</code> .
Hardware Address	Displays the hardware address of the bridge interface.
Used by	Displays the network components (e. g. connections, other interfaces, etc.) that use the bridge interface.
Ports	<p>Add the ports that the interface will bridge by clicking the input field. You can select any number of VLAN interfaces or other bridge interfaces.</p> <p>To delete an element from the input field, click X to the left of the entry.</p> <p>The selected ports are displayed in a table at the bottom of the panel.</p> <hr/> <p> Bridges cannot be created using interfaces which are already used in another bridge.</p>
MTU	Set the maximum size of each packet (in bytes). The maximum transmission unit can be any integer from 64 to 16384.
Spanning Tree Protocol	Optional: Select this check box to enable the Spanning Tree Protocol. It is disabled by default.
Priority	Only available if Spanning Tree Protocol is enabled: Set the bridge priority. Enter a multiple of 4096 in the range of 4096 to 61440.
Hello Interval	Only available if Spanning Tree Protocol is enabled: Set the hello interval (in seconds). Enter any integer from 1 to 10.
Ports	<p>This table displays the ports selected in the bridge interface.</p> <p>If Spanning Tree Protocol is enabled, the buttons on the right of each entry allow you to configure the Priority and the Cost for the respective port, and to remove the port from the bridge interface.</p>

The buttons at the bottom right of the editor panel depend on whether you add a bridge interface or edit an existing one. For a newly configured bridge interface, click **Create** to add it to the list of available bridge interfaces or **Cancel** to discard your changes. To edit an existing bridge interface, click **Save** to store the reconfigured bridge or **Reset** to discard your changes. You can click **Close** to shut the editor panel as long as no changes have been made on it.

Click  **Activate** in the toolbar at the top of the desktop to apply your configuration changes.

Ethernet Interfaces

The physical **Ethernet Interfaces** receive the following default IP addresses: `192.168.x.254/24` (x being the number of the interface, i. e. the IP address of `eth0` is `192.168.0.254`).

You can find more information regarding Ethernet interfaces in the following sections.

Ethernet Interfaces Overview

Navigate to **Network > Interfaces > Ethernet Interfaces** to display a list of Ethernet interfaces that are currently defined in the system and displayed in the item list bar.

In the expanded view, the first table column displays the **Name** of the Ethernet interface. The **Status** column shows one of the following status indicators:

- > Green – The Ethernet interface is up.
- > Gray – The Ethernet interface is disabled.

Furthermore, the **Speed** of the Ethernet interface is displayed. The button in the last column allows you to view and to adjust the settings for an existing Ethernet interface.

For more information, see [Icons and buttons](#) on page 22.

Ethernet Interfaces Settings

Under **Network > Interfaces > Ethernet Interfaces**, you can display more detailed information on the available Ethernet interfaces and adjust the settings.

The **Ethernet Interface** panel displays the following information and allows you to configure the following elements:

Input field	Description
Name	Displays the name of the Ethernet interface, e. g. <code>eth0</code> .
Description	Displays a short description of the Ethernet interface.
Hardware Address	Displays the hardware address (Ethernet MAC address) of the Ethernet interface.
Used by	Displays the connection that is currently using the Ethernet interface.
Status	Displays the status of the Ethernet interface. The status can be one of the following: > <code>up</code> – The Ethernet interface is enabled. > <code>disabled</code> – The Ethernet interface is disabled.
Speed	Displays the speed (e. g. in Gbit/s) of the Ethernet interface.
Duplex	Displays the duplex mode of the Ethernet interface, e. g. <code>full</code> .
Type	Displays the type of wiring connected to the interface, e. g. <code>twisted pair</code> .
I/O	A slider switch indicates whether the Ethernet interface link is active (I) or inactive (O). Click the slider switch to change the status of the Ethernet interface link.
MTU	Set the maximum size of each packet (in bytes). The maximum transmission unit can be any integer from 64 to 16384.

If you modify the settings, click **Save** to save your changes or **Reset** to discard them. Otherwise, click **Close** to close the editor panel.

Click  **Activate** in the toolbar at the top of the desktop to apply your configuration changes.

PPP Interfaces

The **PPP Interfaces** settings allow you to create interfaces that use the point-to-point protocol.

You can find more information regarding PPP interfaces in the following sections.

PPP Interfaces Overview

Navigate to **Network > Interfaces > PPP Interfaces** to display a list of PPP interfaces that are currently defined in the system and displayed in the item list bar.

In the expanded view, the first column of the table displays the **Name** of the PPP interface. The **Status** column shows one of the following status indicators:

- > Green – The PPP interface is enabled.
- > Orange – The PPP interface is disabled.

Furthermore, the **Master Interface** that the PPP interface is associated with is displayed. The buttons in the last column allow you to view and to adjust the settings for an existing PPP interface, create a PPP interface based on a copy of an existing PPP interface or delete a PPP interface from the system.

For more information, see [Icons and buttons](#) on page 22.

PPP Interfaces Settings

Use the **PPP Interfaces** settings to configure custom PPP interfaces.

Under **Network > Interfaces > PPP Interfaces**, you can add a new or edit an existing PPP interface.

The **PPP Interfaces** configuration dialog allows you to configure the following elements:

Input field	Description
I/O	A slider switch indicates whether the PPP interface is active (I) or inactive (O). Click the slider switch to change the status of the PPP interface link. New PPP interfaces are activated by default.
Master Interface	From the drop-down list, select the Ethernet, VLAN or bridge interface that the PPP interface is associated with.
LCP Echo Interval	Specify at which interval (in seconds) your LANCOM R&S [®] Unified Firewall sends an echo request to the peer by entering an integer value from 1 to 1800.
LCP Echo Failure	Specify the number of LCP echo failures after which the peer is considered dead by entering an integer value from 0 to 64. If you enter 0, failures are ignored.
MTU	Set the maximum size of each packet (in bytes). The maximum transmission unit can be any integer from 64 to 16384.
MRU	Specify the maximum receive unit by entering an integer value from 128 to 16384.

The buttons at the bottom right of the editor panel depend on whether you add a new PPP interface or edit an existing one. For a newly configured PPP interface, click **Create** to add it to the list of available PPP interfaces or **Cancel** to discard your changes. To edit an existing PPP interface, click **Save** to store the reconfigured interface or **Reset** to discard your changes. You can click **Close** to shut the editor panel as long as no changes have been made on it.

Click  **Activate** in the toolbar at the top of the desktop to apply your configuration changes.

VLAN Interfaces

The **VLAN Interfaces** configuration dialog allows you to configure to add custom virtual local area network (VLAN) tags to all traffic to a given interface.

You can use this method to create “virtual interfaces” that allow you to put several logical network zones on one physical interface. When you associate a VLAN tag with a network interface, the tag is added to all outgoing packets that are sent through this virtual interface and stripped from the incoming packets that are received on this VLAN. You can associate several VLANs with each network interface. Packets with different tags can be processed and associated with the corresponding interface.

You can find more information regarding VLAN interfaces in the following sections.

VLAN Interfaces Overview

Navigate to **Network > Interfaces > VLAN Interfaces** to display a list of VLAN interfaces that are currently defined in the system and displayed in the item list bar.

In the expanded view, the first column of the table displays the **Name** of the VLAN interface. The **Status** column shows one of the following status indicators:

- > Green – The VLAN interface is enabled.
- > Orange – The VLAN interface is disabled.

Furthermore, the **Master Interface** that the VLAN is associated with and the **VLAN Tag** are displayed. The buttons in the last column allow you to view and to adjust the settings for an existing VLAN interface, create an interface based on a copy of an existing one or delete an interface from the system.

For more information, see [Icons and buttons](#) on page 22.

VLAN Interfaces Settings

Use the **VLAN Interfaces** settings to configure custom VLAN tags to be added to all traffic on a given interface.

Under **Network > Interfaces > VLAN Interfaces**, you can add a new or edit an existing VLAN interface.

The **VLAN Interface** panel displays the following information and allows you to configure the following elements:

Input field	Description
I/O	A slider switch indicates whether the VLAN interface is active (I) or inactive (O). Click the slider switch to change the status of the VLAN interface link. New VLAN interfaces are activated by default.
Name	Displays the name of the VLAN interface. The name is generated automatically and contains the VLAN Tag and the underlying Master Interface .
Hardware Address	For edited VLAN interfaces only: Displays the hardware address (MAC address) of the underlying Master Interface .
Used by	Displays the network components (e. g. connections, other interfaces, etc.) that use the VLAN interface.
Master Interface	For edited VLAN interfaces only: From the drop-down list, select the Ethernet or bridge interface that the VLAN interface is associated with. For edited VLAN interfaces only: Displays the Ethernet or bridge interface that is associated with the VLAN interface.
VLAN Tag	Enter the text content of the VLAN tag. The tag may contain any integer from 1 to 4094.
MTU	Set the maximum size of each packet (in bytes). The maximum transmission unit is limited to the MTU value of the underlying master interface.  Due to a kernel restriction, the maximum MTU value is limited by the MTU value of the underlying interface.

The buttons at the bottom right of the editor panel depend on whether you add a new VLAN interface or edit an existing one. For a newly configured VLAN interface, click **Create** to add it to the list of available VLAN interfaces or **Cancel** to discard your changes. To edit an existing VLAN interface, click **Save** to save the reconfigured VLAN interface or **Reset** to discard your changes. You can click **Close** to close the editor panel as long as no changes have been made on it.

Click  **Activate** in the toolbar at the top of the desktop to apply your configuration changes.

Quality of Service (QoS)

Under **Network > QoS** you can set up Quality of Service for your Internet connections, in other words, for the network and PPP connections for which you configured a default gateway.

Quality of Service (QoS) prioritizes the processing of queued network packets in your LANCOM R&S® Unified Firewall based on Type of Service (ToS) flags. This way, performance-critical applications like Voice over IP (RTP) can be prioritized.

A precondition for Quality of Service is that applications or devices (such as VoIP telephone systems) set the ToS field in IP data packets. Your LANCOM R&S® Unified Firewall then sorts the packets based on the value of the ToS field and assigns them to several queues with different priorities. Data packets from the queue with the highest priority are forwarded immediately. Data packets from queues with lower priority are only forwarded when all the queues with higher priority have been emptied.

QoS Settings

Navigate to **Network > QoS > QoS Settings** to open an editor panel to view, activate and adjust the Quality of Service settings.

The **QoS Settings** configuration dialog allows you to configure the following elements:

Input field	Description
I/O	A slider switch indicates whether Quality of Service is active (I) or inactive (O). Click the slider switch to change the status of QoS.
QoS Services	<p>Enter a Service for which you want to activate QoS. Specify the hexadecimal Value of the ToS field which defines the application or the device for the service.</p> <p>Click ⊕ to add the service to the list. You can edit or delete individual entries in the list by clicking the corresponding button next to an entry. For more information, see Icons and buttons on page 22.</p> <hr/> <p> If you edit an entry, a check box appears on the right of the entry. Activate the check box to apply your changes.</p> <p>Click ▲/▼ or drag and drop an entry to change the priority of the services. The service which is listed first in the list has the highest priority.</p>

If you modify these settings, click **Save** to save your changes or **Reset** to discard them. Otherwise, click **Close** to close the editor panel.

QoS Connections

The **Connections** configuration dialog allows you to configure Quality of Service connections.

 QoS connections are only established if Quality of Service is enabled for Internet connections. For more information, see [QoS Settings](#) on page 79.

You can find more information regarding QoS connections in the following sections.

QoS Connections Overview

Navigate to **Network > QoS > Connections** to display a list of QoS connections that are currently defined in the system and displayed in the item list bar.

In the expanded view, the columns of the table display the connection's name and the download and upload bandwidth thresholds. The buttons in the last column allow you to view and to adjust the settings for an existing QoS connection or to delete a connection from the system.

For more information, see [Icons and buttons](#) on page 22.

QoS Connections Settings

The **QoS Connection** configuration dialog allows you to configure the following elements for Quality of Service:

Input field	Description
Internet Connection	From the drop-down list, select the Internet connection you want to configure Quality of Service for.
Download Rate/Upload Rate	<p>To activate Quality of Service, enter the bandwidth thresholds that you want to reserve for QoS services for this connection. The input fields define the maximum download and upload bandwidth (in Kbit/s).</p> <p>If you set both values to 0, Quality of Service will not be used for this connection.</p>

If you have modified these settings, use the buttons at the bottom right of the editor panel to confirm (**Save**) or to discard your changes (**Reset**). Otherwise, you can close the dialog (**Close**).

Routing

Use the **Routing** settings to configure routing tables and routing rules.

The routing settings allow you to define custom routes that are used to reach devices on a given destination network.

 Routes between network objects are created automatically and hidden. You should not normally need to create routes unless you have an upstream router that requires special routes. To influence traffic between network objects, create a firewall rule as described under [Firewall Rule Settings](#) on page 24.

Routing Rules

Routing rules specify which packets are managed by which routing table. This allows for more differentiated routing as routing rules include more fields of the IP header in the routing decision, whereas routing tables only consider the destination IP address.

Routing Rules Overview

Navigate to **Network > Routing Rules** to display the list of routing rules that are currently defined on the system.

The plus button  above the filter settings allows you to add new routing rules.

The **Filter Settings** allow you to narrow down the list of results in the table to display only entries that include a certain search string. You can filter the contents by selecting the required options from the drop-down list and/or entering search strings in the respective input fields. Click **Apply** to make use of the selected filter options. The list of routing rules is adjusted to reflect your filter results. Click **Reset** to delete the selected filter options and display an unfiltered view of the list of routing rules.

The table columns of the routing rules list display the priority of the routing rule, the selectors that can be used to define which traffic should be routed where and whether it is a system rule or not. The buttons in the last column allow you to view and adjust the settings of a routing rule or to delete a rule from the system.

For more information, see [Icons and buttons](#) on page 22.

 System routing rules cannot be modified or deleted.

To close the **Routing Rules** panel, click  in the upper right corner of the panel.

Routing Rules Settings

Under **Network > Routing Rules**, you can add a new or edit an existing routing rule.

The **Routing Rule** configuration dialog allows you to configure the following elements:

Input field	Description
Priority	Set the priority of the routing rule by entering an integer value from 64 to 32767 for custom rules. The rules are sorted by priority in ascending order. This means the system runs through the rules list starting with the system rule with priority 0 until all selectors in a rule match the packet. The action of this rule is then carried out.
Source Subnet	Optional: Enter the IP address of the source subnet in CIDR notation (IP address followed by a slash "/" and the number of bits set in the subnet mask, e. g. 192.168.50.0/24).
Destination Subnet	Optional: Enter the IP address of the destination subnet in CIDR notation (IP address followed by a slash "/" and the number of bits set in the subnet mask, e. g. 192.168.50.0/24).

Input field	Description
Input Interface	Optional: Select one of the interfaces defined on your LANCOM R&S® Unified Firewall as the input interface.
Output Interface	Optional: Select one of the interfaces defined on your LANCOM R&S® Unified Firewall as the output interface.
TOS	Optional: Specify the Type of Service value by entering a hexadecimal number from 0 to FF.
Action	<p>Specify the rule action:</p> <ul style="list-style-type: none"> > Goto – Enter the Priority of another routing rule. If a packet matches the selectors in the rule, it goes to the rule with the specified goto priority. > Table – Enter the number of a routing table. If a packet matches the selectors in the rule, it runs through the specified routing table. If one of the routes in the table matches the packet, it is routed accordingly. Otherwise, the packet continues to run through the routing rules list. <p>This parameter is displayed in the Action Parameter table column of the routing rules list (for more information, see Routing Rules Overview on page 80).</p>



If you specify none of the selectors, the entire traffic matches the rule.

The buttons at the bottom right of the editor panel depend on whether you add a new routing rule or edit an existing one. For a newly configured routing rule, click **Create** to add the rule to the list of available routing rules or **Cancel** to reject the creation of the new rule. To edit an existing rule, click **Save** to store the reconfigured rule or **Reset** to discard your changes. You can click **Close** to shut the editor panel as long as no changes have been made on it.

Routing Tables

Routing tables route packets through the network based on the destination IP address.

You can find more information regarding routing tables in the following sections.

Routing Tables Overview

Navigate to **Network > Routing > Routing Tables** to display the list of routing tables that are currently defined in the system and displayed in the item list bar.

Clear the **Show configurable tables only** check box to display all tables on the system. Otherwise, only tables that can be edited are displayed.

The following tables are preset on the system:

- > Table 254 is the main routing table. You can add custom routes to this table. The entries are then adopted for all existing routing tables.
- > Table 255 contains local routes for all configured interfaces.
- > Tables 1 to 63 are reserved for the management of the Internet connections.
- > Tables 64 to 250 are reserved for routes with a source address and appear with a source IP address during the set-up of routes.
- > Table 293 is reserved for the transparent proxy.

In the expanded view, the columns of the table display the name of the routing table. The buttons in the last column allow you to view and adjust the settings of a routing table or to delete a table from the system.

For more information, see [Icons and buttons](#) on page 22.

Routing Tables Settings

The **Routing Tables** settings allow you to add a new or edit existing routing tables.

The **Routing Table** configuration dialog allows you to configure the following elements:

Input field	Description
Table Number	Enter an ID for the routing table. Custom routing tables receive the ID 512 or higher. You must configure routing rules pointing to custom routing tables, otherwise those tables are not used (see Routing Rules on page 80).
Routes	This table displays the custom routes that are specified in the routing table. Click Add to open the Edit Route panel and define a new route. You can edit or delete individual entries in the list by clicking the corresponding button next to an entry.

The **Edit Route** configuration dialog allows you to configure the following elements:

Input field	Description
Destination	Enter the IP address of the destination network in CIDR notation (IP address followed by a slash "/" and the number of bits set in the subnet mask, e. g. 192.168.50.0/24).
Interface	Select an interface for the route.
Gateway	Enter an IP address as the gateway for this route. Traffic from the source zone to the destination network will be routed using this gateway (rather than the standard gateway).
Type	Select the address type from the drop-down list.
Preferred Source	Only packets with the selected sender address will be routed.
Metric	Define the costs for the route. The value entered here concerns routing protocols. A higher metric means the route is considered costly and is less likely to be chosen.

Click **OK** to save your routing settings and to return to the **Routing Table** panel.

The buttons at the bottom right of the editor panel depend on whether you add a new routing table or edit an existing one. For a newly configured routing table, click **Create** to add the table to the list of available routing tables or **Cancel** to discard your changes. To edit an existing routing table, click **Save** to store the reconfigured table or **Reset** to discard your changes. You can click **Close** to shut the editor panel as long as no changes have been made on it.

3.4.4 Desktop

The  **Desktop** settings display a list of all available services and the firewall rules defined in the system.

Desktop Connections

Navigate to **Desktop > Desktop Connections** to display and edit the connections between various desktop objects that are defined on the system.

Desktop Connections Overview

In the expanded view, the columns of the table display the nodes of the desktop connection. The buttons in the last column allow you to view and to adjust the settings for an existing desktop connection, create a connection based on a copy of an existing desktop connection or delete a connection from the system.

For more information, see [Icons and buttons](#) on page 22.

 Copied desktop connections are always set up between the same nodes as the original.

Desktop connection settings

Editing a desktop connection opens the **Connection** window. Under **Description** you can enter additional information about the connection for internal use.

On the **Rules** tab you can adjust the rule set for the related connection. For more information about creating firewall rules see the section [Firewall Rule Settings](#) on page 24.

On the **URL / Content Filter** tab you can configure the URL/content filter for the related connection.

Input box	Description
Block all by default	Select this checkbox to add all of the URL filters that are currently defined in the system to the blacklist and to select all of the content filters.
Name	Shows the name of the URL/content filter.
URL Filter Black/White	Add the URLs of the respective filters to the blacklist or whitelist by clicking on the relevant checkboxes.
Content Filter	Select content filters by checking the respective boxes.
Schedule	Indicates whether the filter is always on, always off, or active when scheduled. To modify the schedule, clicking on the entry.

If you use application filters (see [Application Management](#) on page 99), you can activate or deactivate these for the selected desktop connection. In the **Application Filter** tab you set the **Mode** of the application filter to **Blacklist** or **Whitelists** or deactivate the application filter for each selected profile by selecting the corresponding option button. On the **Application Based Routing** tab you can add any configured [Routing Profiles](#).

If you change any settings, click **Save** to store your changes or **Reset** to discard them. Then click **Close** to quit the editing window.

Click **✓ Activate** in the toolbar at the top of the desktop to apply your configuration changes.

For more information on URL, content and application filters, see [URL/Content Filter](#) on page 109 and [Application Management](#) on page 99.

Desktop Objects

Use the **Desktop Objects** settings to organize your network by setting up single and group objects for hosts, users, networks, VPN and IP ranges. The created objects are displayed as nodes on the desktop and can be used as sources and/or destinations in connections to apply firewall rules.

The item list bar displays an overview of all desktop objects, subdivided into types of desktop objects, that are currently defined on the system. When you click an entry in the item list bar, the nodes of all desktop objects that this desktop tag is assigned to are highlighted on the desktop.

To create a desktop object, click the **+** button at the top of the respective section in the item list bar. Alternatively, click the respective desktop object icon in the toolbar at the top of the desktop.

For more information, see [Icons and buttons](#) on page 22.

The sections below provide further information on the various types of desktop objects.

Host/Network Groups

Create desktop objects for host and network groups that can be used to create connections between multiple hosts or networks and other desktop objects (such as VPN objects, etc.). Host and network groups can be used as sources and/or destinations to apply firewall rules and web filters to multiple computers.

Host/Network Groups Overview

Navigate to **Desktop > Desktop Objects > Host/Network Groups** to display the list of host and network group objects that are currently defined in the system and displayed in the item list bar.

In the expanded view, the first table column displays the **Name** of the host or network group object. The buttons in the last column allow you to view and to adjust the settings for an existing host or network group object, create an object based on a copy of an existing object or delete an object from the system.

For more information, see [Icons and buttons](#) on page 22.

Host/Network Groups Settings

The **Host / Network Group** settings allow you to configure the following elements:

Input field	Description
Name	Specify a name for the host or network group object.
Description	Optional: Enter additional information on the host or network group object for internal use.
Tags	Optional: From the drop-down list, select the desktop tags that you want to assign to the host or network group object. For more information, see Desktop Tags on page 93.
Color	Select the color to be used for this object on the desktop.
Hosts / Networks	<p>Specify the hosts or networks that you want to add to the host or network group object. Define the Name, whether login is allowed, the Interface, and the IP address of the host or network. Click Add to add a host or network to the list.</p> <p>You can edit or delete individual entries in the list by clicking the corresponding button next to an entry. For more information, see Icons and buttons on page 22.</p> <hr/> <p> If you edit an entry, a check box appears on the right of the entry. Activate the check box to apply your changes.</p>

The buttons at the bottom right of the editor panel depend on whether you add a new host or network group object or edit an existing object. For a newly configured object, click **Create** to add the object to the list of available host and network groups or **Cancel** to discard your changes. To edit an existing object, click **Save** to store the reconfigured object or **Reset** to discard your changes. You can click **Close** to shut the editor panel as long as no changes have been made on it.

Click  **Activate** in the toolbar at the top of the desktop to apply your configuration changes.

Hosts

Create a host object that can be used to create connections between the host and other desktop objects (such as VPN objects etc.). A host (for example a printer or a VoIP phone) can be assigned a dedicated IP address so that firewall rules can be specifically applied to it. For more information on creating firewall rules, see [Firewall Rule Settings](#) on page 24.

Hosts Overview

Navigate to **Desktop > Desktop Objects > Hosts** to display the list of host objects that are currently defined in the system and displayed in the item list bar.

In the expanded view, the columns of the table display the **Name** and the **IP** of the host object and to which interface it is connected. The buttons in the last column allow you to view and to adjust the settings for an existing host object, create an object based on a copy of an existing host object or delete an object from the system.

For more information, see [Icons and buttons](#) on page 22.

Hosts Settings

The **Host** configuration dialog allows you to configure the following elements:

Input field	Description
Name	Specify a name for the host object.
Description	Optional: Enter more information on how to use the host object internally.
Tags	Optional: From the drop-down list, select the desktop tags that you want to assign to the host object. For more information, see Desktop Tags on page 93.
Color	Select the color to be used for this object on the desktop.
Allow login	Select this check box to allow users to log in to your LANCOM R&S [®] Unified Firewall using the IP address range of this host object. This allows your LANCOM R&S [®] Unified Firewall to apply user-specific firewall rules to the user currently logged on.
Icon	Select an icon to represent the host on the desktop.
Interface	Select an interface that the host is connected to.
IP Address	Enter the IP address of the host object.

The buttons at the bottom right of the editor panel depend on whether you add a new host object or edit an existing object. For a newly configured object, click **Create** to add the object to the list of available host objects or **Cancel** to discard your changes. To edit an existing object, click **Save** to store the reconfigured object or **Reset** to discard your changes. You can click **Close** to shut the editor panel as long as no changes have been made on it.

Click  **Activate** in the toolbar at the top of the desktop to apply your configuration changes.

Internet Objects

Create Internet objects for your Internet connections. Internet objects are used to create connections between other desktop objects (such as VPN objects) and the Internet.

Internet Objects Overview

Navigate to **Desktop > Desktop Objects > Internet Objects** to display the list of Internet objects that are currently defined in the system and displayed in the item list bar.

In the expanded view, the first table column displays the **Object Name** of the Internet object. The buttons in the last column allow you to view and to adjust the settings for an existing Internet object, create an object based on a copy of an existing one or delete an Internet object from the system.

For more information, see [Icons and buttons](#) on page 22.

Internet Objects Settings

The **Internet Object** configuration dialog allows you to configure the following elements:

Input field	Description
Object Name	Specify a name for the Internet object.
Description	Optional: Enter additional information on the Internet object for internal use.
Tags	Optional: From the drop-down list, select the desktop tags that you want to assign to the Internet object. For more information, see Desktop Tags on page 93.
Color	Select the color to be used for this object on the desktop.
Connections	Select the Internet connection(s) that this object is part of. For more information, see Network Connections Settings on page 63.

The buttons at the bottom right of the editor panel depend on whether you add a new Internet object or edit an existing object. For a newly configured object, click **Create** to add the object to the list of available Internet objects or **Cancel**

to discard your changes. To edit an existing object, click **Save** to store the reconfigured object or **Reset** to discard your changes. You can click **Close** to shut the editor panel as long as no changes have been made on it.

Click **✔ Activate** in the toolbar at the top of the desktop to apply your configuration changes.

For more information on creating Internet objects, see [Enabling Internet Access](#) on page 15.

IP Ranges

Create an IP address range object to group hosts by indicating a start and end IP address. If a DHCP server is configured for the selected interface, you can also use the address range of the DHCP server.

IP Ranges Overview

Navigate to **Desktop > Desktop Objects > IP Ranges** to display the list of IP range objects that are currently defined in the system and displayed in the item list bar.

In the expanded view, the columns of the table display the **Object Name** of the IP range object, the **Interface** it is connected to, as well as its **Start IP** and **End IP**. The buttons in the last column allow you to view and to adjust the settings for an existing IP range object, create an object based on a copy of an existing IP range object or delete an object from the system.

For more information, see [Icons and buttons](#) on page 22.

IP Ranges Settings

The **IP Range** settings allow you to configure the following elements:

Input field	Description
Name	Specify a name for the IP range object.
Description	Optional: Enter additional information on the IP range object for internal use.
Tags	Optional: From the drop-down list, select the desktop tags that you want to assign to the IP range object. For more information, see Desktop Tags on page 93.
Color	Select the color to be used for this object on the desktop.
Allow login	Select this check box to allow the user to log in to your LANCOM R&S [®] Unified Firewall using the IP range of this object. This allows your LANCOM R&S [®] Unified Firewall to apply user-specific firewall rules to the user currently logged in.
Interface	Select an interface to assign it to the IP range object. Select any if you do not want to assign this object to a certain interface. This way, all interfaces will accept packets from the IP range of this object.
Start IP	Specify the start IP address of the IP range.
End IP	Specify the end IP address of the IP range.

If you want to use the IP address range of the DHCP server of the selected interface, click the **Use DHCP IP range** button at the bottom left of the editor panel.

The buttons at the bottom right of the editor panel depend on whether you add a new IP range object or edit an existing object. For a newly configured object, click **Create** to add the object to the list of available IP range objects or **Cancel** to discard your changes. To edit an existing object, click **Save** to store the reconfigured object or **Reset** to discard your changes. You can click **Close** to shut the editor panel as long as no changes have been made on it.

Click **✔ Activate** in the toolbar at the top of the desktop to apply your configuration changes.

Networks

Create a network object that can be used to create connections between the network and other desktop objects (such as VPN objects, etc.).

Networks Overview

Navigate to **Desktop > Desktop Objects > Networks** to display a list of network objects that are currently defined in the system and displayed in the item list bar.

In the expanded view, the columns of the table display the **Name** and the **IP** of the network objects and to which **Interface** it is connected. The buttons in the last column allow you to view and to adjust the settings for an existing network object, create an object based on a copy of an existing network object or delete an object from the system.

For more information, see [Icons and buttons](#) on page 22.

Networks Settings

The **Network** configuration dialog allows you to configure the following elements:

Input field	Description
Name	Enter a name for the network object.
Description	Optional: Enter additional information on the network object for internal use.
Tags	Optional: From the drop-down list, select the desktop tags that you want to assign to the network object. For more information, see Desktop Tags on page 93.
Color	Select the color to be used for this object on the desktop.
Allow login	Select this check box to allow the user to log in to your LANCOM R&S® Unified Firewall using the IP address of this network object. This setting allows your LANCOM R&S® Unified Firewall to apply user-specific firewall rules to the current user.
Interface	Select the interface that the network is connected to.
Network IP	Enter the IP address of the network in CIDR notation (IP address followed by a slash "/" and the number of bits set in the subnet mask, for example 192.168.50.0/24).

The buttons at the bottom right of the editor panel depend on whether you add a new network object or edit an existing object. For a newly configured object, click **Create** to add the object to the list of available network objects or **Cancel** to discard your changes. To edit an existing network, click **Save** to store the reconfigured network or **Reset** to discard your changes. You can click **Close** to shut the editor panel as long as no changes have been made on it.

Click  **Activate** in the toolbar at the top of the desktop to apply your configuration changes.

User Groups

Create desktop objects for user groups that can be used to create connections between multiple users and other desktop objects (such as VPN objects etc.) applying a common rule set to multiple users.

User Groups Overview

Navigate to **Desktop > Desktop Objects > User Groups** to display a list of user group objects that are currently defined in the system and displayed in the item list bar.

In the expanded view, the first table column displays the **Name** of the user group object. The buttons in the last column allow you to view and to adjust the settings for an existing user group object, create an object based on a copy of an existing one or delete a user group object from the system.

For more information, see [Icons and buttons](#) on page 22.

User Groups Settings

The **User Group** configuration dialog allows you to configure the following elements:

Input field	Description
Name	Specify a name for the user group object.

Input field	Description
Description	Optional: Enter more information on how to use the user group object for internal use.
Tags	Optional: From the drop-down list, select the desktop tags that you want to assign to the user group object. For more information, see Desktop Tags on page 93.
Color	Select the color to be used for this object on the desktop.
User	<p>Select the users you want to add to the user group.</p> <p>The left-hand list displays the users in the group. The right-hand list displays the users available in the system that are not part of the group.</p> <p>To add a user to the group, click <. Click << to add all available users at once.</p> <p>To remove a user from the group, click >. Click >> to remove all users at once.</p> <p>Use the Filter field to narrow down the list of users to display only entries that include a certain search string. Click ⊕ to display an unfiltered view of the list of users.</p> <hr/> <p> Users may belong to several groups.</p>

The buttons at the bottom right of the editor panel depend on whether you add a new user group or edit an existing group. For a newly configured group, click **Create** to add the group to the list of available user groups or **Cancel** to discard your changes. To edit an existing group, click **Save** to store the reconfigured group or **Reset** to discard your changes. You can click **Close** to shut the editor panel as long as no changes have been made on it.

Click **✓ Activate** in the toolbar at the top of the desktop to apply your configuration changes.

Users

Create desktop objects for users that can be used to display the users on the desktop and to create connections between the users and other desktop objects (such as VPN objects etc.).

 The menu **Desktop > Desktop Objects > Users** only serves to create desktop objects for users that already exist in the system. For information on how to add and manage users, see [User Authentication](#) on page 116.

Users Overview

Navigate to **Desktop > Desktop Objects > Users** to display a list of user objects that are currently defined in the system and displayed in the item list bar.

In the expanded view, the columns of the table display the user object's **Name** and the **User Name** related to it. The buttons in the last column allow you to view and to adjust the settings for an existing user object, create an object based on a copy of an existing user object or delete a user object from the system.

For more information, see [Icons and buttons](#) on page 22.

Users Settings

The **User** configuration dialog allows you to configure the following elements:

Input field	Description
Object Name	Specify a name for the user object.
Description	Optional: Enter additional information on the user object for internal use.
Tags	Optional: From the drop-down list, select the desktop tags that you want to assign to the user object. For more information, see Desktop Tags on page 93.
Color	Select the color to be used for this object on the desktop.

Input field	Description
User Name	Select the user to be used for the object.  Users may belong to several user objects.

The buttons at the bottom right of the editor panel depend on whether you add a new user object or edit an existing object. For a newly configured object, click **Create** to add the object to the list of available user objects or **Cancel** to discard your changes. To edit an existing object, click **Save** to store the reconfigured object or **Reset** to discard your changes. You can click **Close** to shut the editor panel as long as no changes have been made on it.

Click  **Activate** in the toolbar at the top of the desktop to apply your configuration changes.

VPN Groups

Create a VPN group object that can be used to create connections between multiple VPN connections and other desktop objects applying a common rule set to multiple VPN connections.

VPN Groups Overview



Navigate to **Desktop > Desktop Objects > VPN Groups** to display the list of VPN group objects that are currently defined in the system and displayed in the item list bar.

In the expanded view, the first table column displays the **Name** of the VPN user group object. The buttons in the last column allow you to view and to adjust the settings for an existing VPN user group object, create an object based on a copy of an existing one or delete a VPN user group object from the system.

For more information, see [Icons and buttons](#) on page 22.

Settings for VPN groups

The **VPN Group** settings allow you to adjust the following parameters:

Input box	Description
Name	Enter an name for the VPN group object here.
Description	Optional: Enter further information about the VPN group object for internal use.
Tags	Optional: From the drop-down list, select the desktop tags you want to assign to the VPN group object. Please refer to Desktop Tags on page 93 for further information.
Color	Select the color to use for this object on the desktop.
VPN Connections	Select the VPN connections you want to add to the VPN group. First select the Type of the VPN connection you want to add from the drop-down list. In the next field, select the desired connection from the drop-down list. In the case of IPSec connections, the last box lets you choose whether the connection should use all of the configured remote networks, or just a specific one. The desktop rules are then applied accordingly. Click on Add to add the connection to the list. You can edit or delete any entry in the lists by clicking on the appropriate icon. Please refer to Icons and buttons on page 22 for further information.  When you edit an entry, a checkmark will appear to the right of the entry. Click the checkmark to accept the change.  VPN connections can be assigned to multiple VPN groups.

The buttons available at the bottom right of the edit box depend on whether you are adding a new VPN group object or editing an existing object. For a new object, click **Create** to add it to the list of VPN group objects, or **Cancel** to

discard your changes. To edit an existing object, click **Save** to save the newly configured object, or **Reset** to discard your changes. If no changes have been made, you can click **Close** to close the editing window.

Click **✔ Activate** in the toolbar at the top of the desktop to apply your configuration changes.

VPN Hosts

Create a VPN host object that can be used to configure firewall rules for VPN Client-to-Site connections.

VPN Hosts Overview

Navigate to **Desktop > Desktop Objects > VPN Hosts** to display a list of VPN host objects that are currently defined in the system and displayed in the item list bar.

In the expanded view, the columns of the table display the **Name** of the VPN host object, the **Type** of VPN connection and the VPN connection that the VPN host belongs to. The buttons in the last column allow you to view and to adjust the settings for an existing VPN host object, create an object based on a copy of an existing VPN host object or delete an object from the system.

For more information, see [Icons and buttons](#) on page 22.

VPN Hosts Settings

The **VPN Host** configuration dialog allows you to configure the following elements:

Input field	Description
Name	Specify a name for the VPN host object.
Description	Optional: Enter additional information on the VPN host object for internal use.
Tags	Optional: From the drop-down list, select the desktop tags that you want to assign to the VPN host object. For more information, see Desktop Tags on page 93.
Color	Select the color to be used for this object on the desktop.
Icon	Select an icon to represent the VPN host object on the desktop.
VPN Connection Type	Select the type of VPN connection by clicking the respective radio button.
IPsec Connection / VPN-SSL Connection	This field depends on the selected VPN connection type. Select the connection you want to associate to the VPN host object from the drop-down list.

The buttons at the bottom right of the editor panel depend on whether you add a new VPN host object or edit an existing object. For a newly configured object, click **Create** to add the object to the list of available VPN host objects or **Cancel** to discard your changes. To edit an existing object, click **Save** to store the reconfigured object or **Reset** to discard your changes. You can click **Close** to shut the editor panel as long as no changes have been made on it.

Click **✔ Activate** in the toolbar at the top of the desktop to apply your configuration changes.

VPN Networks

Create a VPN network object that can be used to configure firewall rules for VPN Site-to-Site connections.

VPN Networks Overview

Navigate to **Desktop > Desktop Objects > VPN Networks** to display a list of VPN network objects that are currently defined in the system and displayed in the item list bar.

In the expanded view, the columns of the table display the **Name** of the VPN network object, the **Type** of VPN connection and the VPN connection that the VPN network belongs to. The buttons in the last column allow you to view and to adjust the settings for an existing VPN network object, create an object based on a copy of an existing VPN network object or delete an object from the system.

For more information, see [Icons and buttons](#) on page 22.

Settings for VPN networks

In the **VPN Network** editing window you can modify the following parameters:

Input box	Description
Name	Enter an name for the VPN network object here.
Description	Optional: Enter further information about the VPN network object for internal use.
Tags	Optional: From the drop-down list, select the desktop tags you want to assign to the VPN network object. Please refer to Desktop Tags on page 93 for further information.
Color	Select the color to use for this object on the desktop.
VPN Connection Type	Select the type of VPN connection by selecting the appropriate radio button.
IPsec Connection / VPN-SSL Connection	This field depends on the selected connection type. From the drop-down list, select the VPN connection you want to assign to the VPN network object.
Remote networks	If you have selected an IPsec connection, you can either use all of the configured remote networks or explicitly add the remote networks to be used.

The buttons available at the bottom right of the edit box depend on whether you are adding a new VPN network object or editing an existing object. For a new object, click **Create** to add it to the list of VPN network objects, or **Cancel** to discard your changes. To edit an existing object, click **Save** to save the newly configured object, or **Reset** to discard your changes. If no changes have been made, you can click **Close** to close the editing window.

Click  **Activate** in the toolbar at the top of the desktop to apply your configuration changes.

VPN User Groups

Create desktop objects for VPN user groups that can be used to create connections between multiple users and other desktop objects applying a common rule set to multiple VPN users. VPN user groups are displayed at the VPN node on the desktop.

VPN User Groups Overview

Navigate to **Desktop > Desktop Objects > VPN User Groups** to display a list of VPN user group objects that are currently defined in the system and displayed in the item list bar.

In the expanded view, the first table column displays the **Name** of the VPN user group object. The buttons in the last column allow you to view and to adjust the settings for an existing VPN user group object, create an object based on a copy of an existing one or delete a VPN user group object from the system.

For more information, see [Icons and buttons](#) on page 22.

VPN User Groups Settings

The **VPN User Group** configuration dialog allows you to configure the following elements:

Input field	Description
Name	Specify a name for the VPN user group.
Description	Optional: Enter additional information on the VPN user group object for internal use.
Tags	Optional: From the drop-down list, select the desktop tags that you want to assign to the VPN user group. For more information, see Desktop Tags on page 93.
Color	Select the color to be used for this object on the desktop.
User	Select the users you want to add to the VPN user group.

Input field	Description
	<p>The left-hand list displays the users in the group. The right-hand list displays the users available in the system that are not part of the group.</p> <p>To add a user to the group, click <. Click << to add all available users at once.</p> <p>To remove a user from the group, click >. Click >> to remove all users at once.</p> <p>Use the Filter field to narrow down the list of users to display only entries that include a certain search string. Click ⊕ to display an unfiltered view of the list of users.</p> <hr/> <p> Users may belong to several VPN user groups.</p>

The buttons at the bottom right of the editor panel depend on whether you add a new VPN user group or edit an existing group. For a newly configured group, click **Create** to add the group to the list of available VPN user groups or **Cancel** to discard your changes. To edit an existing group, click **Save** to store the reconfigured group or **Reset** to discard your changes. You can click **Close** to shut the editor panel as long as no changes have been made on it.

Click **✓ Activate** in the toolbar at the top of the desktop to apply your configuration changes.

VPN Users

Create desktop objects for users that can be used in VPN connections. VPN users are displayed at the VPN node on the desktop.

 The menu **Desktop > Desktop Objects > VPN Users** only serves to create desktop objects for users that already exist in the system. For information on how to add and manage users, see [User Authentication](#) on page 116.

VPN Users Overview

Navigate to **Desktop > Desktop Objects > VPN Users** to display a list of VPN user objects that are currently defined in the system and displayed in the item list bar.

In the expanded view, the columns of the table display the **Object Name** of the VPN user object and the **User Name**. The buttons in the last column allow you to view and to adjust the settings for an existing VPN user object, create an object based on a copy of an existing VPN user object or delete an object from the system.

For more information, see [Icons and buttons](#) on page 22.

VPN Users Settings

The **VPN User** settings allow you to configure the following elements:

Input field	Description
Object Name	Specify a name for the VPN user object.
Description	Optional: Enter additional information on the VPN user object for internal use.
Tags	Optional: From the drop-down list, select the desktop tags that you want to assign to the VPN user object. For more information, see Desktop Tags on page 93.
Color	Select the color to be used for this object on the desktop.
User Name	Select the user to be used for the VPN user object.
	<hr/> <p> Users may belong to multiple user objects.</p>

The buttons at the bottom right of the editor panel depend on whether you add a new VPN user object or edit an existing object. For a newly configured object, click **Create** to add the object to the list of available VPN user objects or **Cancel**

to discard your changes. To edit an existing object, click **Save** to store the reconfigured object or **Reset** to discard your changes. You can click **Close** to shut the editor panel as long as no changes have been made on it.

Click  **Activate** in the toolbar at the top of the desktop to apply your configuration changes.

Desktop Rules

Use the **Desktop Rules** settings to display and modify the rules which are used to manage network traffic. For more detailed information on firewall rules, see [Firewall Rule Settings](#) on page 24.

Navigate to **Desktop > Desktop Rules** to display the list of rules that are currently defined on the system.

The **Filter Settings** allow you to narrow down the list of rules to display only rules that include a certain search string. You can filter the contents by selecting the required options from the drop-down lists and/or entering search strings in the respective input fields. Click **Apply** to make use of the selected filter options. The list of firewall rules is adjusted to reflect your filter results. Click **Reset** to delete your selected filter options and display an unfiltered view of the list of rules.

The table columns of the rules list display the following information:

Column	Description
Object A	This column indicates the source object in the connection.
Direction	This column displays the direction in which the rule is applied.
Object B	This column indicates the destination object in the connection.
Service	This column displays the name of the service of the rule.

The buttons in the last column allow you to view and to adjust the settings for an existing rule. Click  and the **Connection** dialog opens. For more detailed information on how to create firewall rules and editing connections, see [Firewall Rule Settings](#) on page 24 and [Desktop Connections](#) on page 82.

To close the **Desktop Rules** panel and return to the desktop, click  in the upper right corner of the panel.

Desktop Tags

Under **Desktop Tags** you can create a list of tags that you can assign to any of the desktop objects, except to the **Firewall** root node and the main nodes (for example **Intranet**). You can use these tags to display a filtered desktop for a customized overview of your configured network. For more information, see [Desktop](#) on page 19.

 When restoring a backup from an LCOS FX version prior to 10.0, the layers and regions that were defined in the desktop configuration are converted to tags. All desktop objects which lie on a layer or region are tagged with the converted tags.

Desktop Tags Overview

Navigate to **Desktop > Desktop Tags** to display the list of desktop tags that are currently defined in the system and displayed in the item list bar.

In the expanded view, the first column of the table displays the **Name** of the desktop tag. The buttons in the last column allow you to view and adjust the settings for an existing desktop tag, create a tag based on a copy of an existing desktop tag or delete a tag from the system.

For more information, see [Icons and buttons](#) on page 22.

When you click an entry in the item list bar, the nodes of all desktop objects that this desktop tag is assigned to are highlighted on the desktop. When you click a desktop object node on the desktop with the **Desktop Tags** item list bar being open, the desktop tags that are assigned to this desktop object are highlighted in the item list bar.

Desktop Tags Settings

Under **Desktop > Desktop Tags**, you can add a new or edit an existing desktop tag.

The **Desktop Tag** configuration dialog allows you to configure the following elements:

Input field	Description
Name	Enter a name for the desktop tag.

The buttons at the bottom right of the editor panel depend on whether you add a new desktop tag or edit an existing one. For a newly configured desktop tag, click **Create** to add the tag to the list of available desktop tags or **Cancel** to discard your changes. To edit an existing desktop tag, click **Save** to store the reconfigured tag or **Reset** to discard your changes. You can click **Close** to shut the editor panel as long as no changes have been made on it.

Click **✓ Activate** in the toolbar at the top of the desktop to apply your configuration changes.

Services

Navigate to **Desktop > Services** to display a list of services and service groups that are currently defined in the system and displayed in the item list bar. Services are protocols or combinations of protocols and ports (if protocols use ports, such as TCP and UDP). When you click an entry in the item list bar, the nodes of all desktop objects that this desktop tag is assigned to are highlighted on the desktop. When you click an object on the desktop, the system highlights the services it uses in the list of services.

To create a user-defined service or a service group, click the **+** button at the top of the respective section in the item list bar.

For more information, see [Icons and buttons](#) on page 22.

The sections below provide further information on the various types of services and on service groups.

Predefined Services

Navigate to **Desktop > Services > Predefined Services** to display a list of predefined services that are currently defined in the system and displayed in the item list bar.

In the expanded view, the columns of the table display the **Name** of the service, indicate whether the service is used in a connection (green) or not (orange), and show the **Ports** used by the service.

The predefined services are available for use in custom firewall rules (see [Setting Up a Firewall Rule](#) on page 24).

Service Groups

Use the **Service Groups** settings to group predefined and user-defined services in a service group. This way, you can assign a similar set of rules to different connections without having to add each service individually.

Service Groups Overview

Navigate to **Desktop > Services > Service Groups** to display the list of service groups that are currently defined in the system and displayed in the item list bar.

In the expanded view, the table columns display the **Name** of the service group and the number of **Services** belonging to this group. The buttons in the last column allow you to view and to adjust the settings for an existing service group, create a new group based on a copy of an existing service group or delete a service group from the system.





For more information, see [Icons and buttons](#) on page 22.

Service Groups Settings

Use the **Service Groups** settings to configure service groups.

Under **Desktop > Services > Service Groups**, you can add a new or edit an existing service group.

The **Service Group** configuration dialog allows you to view and to configure the following elements:

Input field	Description
Name	Enter a name for the service group.
Services	<p>Along with the Service Group panel, a service selection list bar with all services that are currently defined on the system opens on the right side of the browser window. The list bar is subdivided into categories of services which serve a similar purpose. You can collapse and expand the categories by clicking the corresponding icon. For more information, see Icons and buttons on page 22.</p> <p>The Filter input field at the top of the service selection list bar helps you quickly find a particular service. As you type in the input field, your LANCOM R&S® Unified Firewall reduces the list to show only the services that contain the characters you are typing. Click  in the input field to delete the search string and display an unfiltered view of the list.</p> <p>To add an individual service to the service group, click  in front of the service in the service selection list bar. Click the  button directly below the header of a category to add all services belonging to that category at once.</p> <p>The services appear along with the ports and/or protocols assigned to them as entries in the list. To remove a service from the service group, click  next to the entry.</p> <hr/> <p> The Clear services button at the bottom left of the panel allows you to delete all services from the group at once.</p>

The buttons at the bottom right of the editor panel depend on whether you add a new service group or edit an existing group. For a newly configured service group, click **Create** to add the group to the list of available service groups or **Cancel** to reject the creation of a new service group. To edit an existing service group, click **Save** to store the reconfigured group or **Reset** to discard your changes. You can click **Close** to shut the editor panel as long as no changes have been made on it.

Click  **Activate** in the toolbar at the top of the desktop to apply your configuration changes.

The service groups defined here are available for use in custom firewall rules (see [Setting Up a Firewall Rule](#) on page 24 for further information).

User-defined Services

If you require a port or protocol that is not covered by any of the predefined services (see [Predefined Services](#) on page 94), you can create a custom service to be applied to a connection.

Navigate to **Desktop > Services > User-defined Services** to display the list of user-defined services that are currently defined in the system and displayed in the item list bar.

User-defined Services Overview

In the expanded view, the columns of the table display the **Name** of the service, indicate whether the service is used in a connection (green) or not (orange), and show the **Ports** and protocols used by the service. The buttons in the last column allow you to view and to adjust the settings of a user-defined service, create a service based on a copy of an existing user-defined service or delete a user-defined service from the system.

For more information, see [Icons and buttons](#) on page 22.

User-defined Services Settings

Under **Desktop > Services > User-defined Services**, you can add a new or edit an existing user-defined service.

The **User-defined Services** configuration dialog allows you to configure the following elements:

Input field	Description
Name	Enter a name for the user-defined service.
Ports / Protocols	<p>To extend the user-defined service to apply to traffic to certain ports/port ranges and/or protocols, click Add to open the Edit Service panel.</p> <p>On this panel, you can define the ports and protocols to be used:</p> <ul style="list-style-type: none"> > For TCP and UDP, specify individual ports or ranges to extend the service to apply to traffic being transmitted to a certain destination port. Use the Port From and To input fields to enter a value. The value can be any integer from 1 to 65535. <p>Port From and To form a port range. To enter an individual port, use the same value for both fields or leave To blank.</p> <ul style="list-style-type: none"> > Specify a protocol to apply the service to by selecting the corresponding check box <p>The buttons at the bottom right of the editor panel allow you to confirm your changes (OK) and to discard your changes (Cancel). The Edit Service panel shuts automatically.</p> <p>The specified ports/port ranges and/or the protocol appear as a list entry. You can edit or delete individual entries in the list by clicking the corresponding button next to an entry. For more information, see Icons and buttons on page 22.</p>

The buttons at the bottom right of the editor panel depend on whether you add a new user-defined service or edit an existing one. For a newly configured user-defined service, click **Create** to add it to the list of available services or **Cancel** to discard your changes. To edit an existing user-defined service, click **Save** to store the reconfigured service or **Reset** to discard your changes. You can click **Close** to shut the editor panel as long as no changes have been made on it.

Click  **Activate** in the toolbar at the top of the desktop to apply your configuration changes.

The user-defined services defined here are available for use in custom firewall rules (see [Setting Up a Firewall Rule](#) on page 24).

3.4.5 UTM

The  **UTM** settings allow you to create and edit application filter profiles, define URL/content filters and to configure antivirus, e-mail security settings, and proxies to protect your network.

Antivirus Settings

Your LANCOM R&S[®] Unified Firewall protects your internal network against computer viruses with an integrated Avira virus scanner.

 The virus scanner is included in the UTM license. When you boot your LANCOM R&S[®] Unified Firewall for the first time, the virus scanner runs as a test version for 30 days. When this period has expired, the virus scanner is deactivated automatically. For more information, see [License](#) on page 41.

Navigate to **UTM > Antivirus Settings** to open an editor panel to display, activate and adjust the antivirus settings for your web and e-mail proxy.

In the **Antivirus Settings** dialog you can view and configure the following information:

Input field	Description
License	This field displays the license information for your virus scanner.
Updates	This field shows the date on which the virus scanner tried to update last. Click Update now to update the virus scanner manually.
Last Successful Update	This field shows the time and date of the last successful update of the virus scanner.

Scanner

On the **Scanner** tab, you can activate or deactivate the virus scanner for e-mails, HTTP(s) and FTP and modify the antivirus settings.

Input field	Description
I/O	<p>A slider switch indicates whether the virus scanner is active (I) or inactive (O) for e-mails, HTTP(s) and FTP.</p> <p>Click the slider switch to change the status.</p> <p>This option is activated for all services by default.</p>
Enable Cloud Scan	<p>This check box is not selected by default. Activate the check box to allow the scanning of files on Avira Protection Cloud.</p> <p>If the local antivirus application does not identify a file as a threat but as a risk, the file is hashed and will be sent to the Avira Protection Cloud. If the hash is known, this information is sent back as a result. If the hash is unknown, the file is uploaded to the Avira Protection Cloud and checked.</p> <p> This comparison only happens if the local antivirus application assesses the file's risk class as sufficiently high.</p>
Scan archived files	<p>This check box is selected by default. Clear the check box if you do not want the virus scanner to check archived files for viruses.</p>
Block files if scan fails	<p>Activate this check box to block e-mails and the download of HTTP(S) and FTP files that the virus scanner could not check successfully.</p> <p>If an error occurs during the check, the e-mail will be blocked and the recipient will be informed. If you clear the check box, the recipient will receive a substitute e-mail with the original e-mail as an encrypted attachment, together with the password to decrypt it.</p>
Heuristic analysis	<p>Select the depth of the heuristic analysis from the drop-down list. Binary files are checked for code whose characteristics resemble those of viruses, or if they could cause any other kind of damage. In that way, virus sub-categories can be detected, even if they have no signature of their own.</p>

Whitelist

On the **Whitelists** tab, you can add trusted hosts and servers to a whitelist. Data transferred from these hosts via HTTP or FTP as well as e-mail addresses will not be checked for viruses.

Enter the IP address or domain name of the trusted host or server in the input field **Trusted HTTP / FTP Sources**.

-  The entries to display multiple entries using wildcard characters are different for HTTP(S)/FTP and e-mail.
- > For HTTP(S)/FTP: To unblock a domain "example.com" including all subdomains like "www.example.com", write ".example.com" with a dot at the beginning. To unblock only the domain "example.com" without subdomains, write "example.com" without a dot at the beginning.
 - > For e-mail:
 - > Entries with a dot at the beginning behave exactly like those for HTTP(S)/FTP.
 - > Entries starting with "*@" or "@" or without "@" in the text are only compared with the domain part of an e-mail address. The comparison must fit exactly. For instance, @test.de would match all addresses with @test.de, but not @subdomain.test.de, for example.
 - > A complete e-mail address only matches exactly this address.

Click  to add the host or server to the list.

You can edit or delete single entries in the list by clicking the corresponding button next to an entry. If you edit an entry, a check box will appear on the right of the entry. Click the check box to apply your changes. For more information, see [Icons and buttons](#) on page 22.

Click **↔ Export** to export your whitelist to the file system. Click **↩ Import** to import a whitelist.

On **Trusted Mail Addresses**, you can add trusted e-mail addresses by selecting one of the following options:

> **Sender**

All e-mails sent from this e-mail addresses will be excluded from the virus scanner.

> **Recipient**

All e-mails sent to these e-mail addresses will be excluded from the virus scanner.

> **Sender / Recipient**

All e-mails sent from OR sent to these e-mail addresses will be excluded from the virus scanner.

Click **+** to add the e-mail address to the list.

You can edit or delete single entries in the list by clicking the corresponding button next to an entry. If you edit an entry, a check box will appear on the right of the entry. Click the check box to apply your changes.

Updates

On the **Updates** tab, you can configure automatic updates for the virus scanner:

Input field	Description
<p>Update Servers</p>	<p>The default update server is: http://cybersecurity.rohde-schwarz.com/updateserver/av</p> <p>Add as many update servers as you wish. In the input field, enter the server’s URL and click +. The server will be added to the list.</p> <hr/> <p> The list of update servers is processed top-down. When an update server can be reached, the other servers will not be contacted during this update process.</p> <p>You can edit or delete single entries in the list by clicking the corresponding button next to an entry.</p> <p>If you edit an entry, a check box will appear on the right of the entry. Click the check box to apply your changes.</p> <p>For more information, see Icons and buttons on page 22.</p>
<p>Automatic Updates</p>	<p>Enter a date and time for the first automatic update of the virus scanner. You can enter a date in the MM/DD/YYYY format or choose a date from the calendar. Set a time using the format hh:mm:ss.</p> <p>Enter a Interval in hours, with which the virus scanner is to be updated. If you enter 0 h, the update is carried out immediately. Click + to add the update plan to the list.</p> <p>You can edit or delete single entries in the list by clicking the corresponding button next to an entry.</p> <p>If you edit an entry, a check box will appear on the right of the entry. Click the check box to apply your changes.</p> <p>For more information, see Icons and buttons on page 22.</p>

If you have modified these settings, use the buttons at the bottom right of the editor panel to confirm (**Save**) or to discard your changes (**Reset**). Otherwise, you can close the dialog (**Close**).

Click  **Activate** in the toolbar at the top of the desktop to apply your configuration changes.

 The antivirus settings for specific protocols (HTTP, FTP, e-mail) only apply if a proxy for the corresponding protocol is configured and active. To configure a proxy, navigate to the proxy settings and create/edit a firewall rule to activate the proxy for the corresponding protocol (see also [HTTP\(S\) Proxy Settings](#) on page 105 and [E-mail Security](#) on page 101).

Application Management

With application management, you can filter network traffic according to the behavior of the data stream. In this way, parts of an application—such as the chat feature in Skype—can be systematically filtered out even if they are encrypted.

 In some cases, for example with Skype, the Application Management filter can only classify applications after a certain number of packets have been exchanged. This means that there is no way to prevent the initial contact. However, all subsequent packets are then blocked.

Settings

The **Application Filter Settings** allow you to enable or disable filters in general.

Input box	Description
I/O	A slider button indicates whether application management is enabled (I) or disabled (O). Click on the slider button to change the status of this option. By default, application management is disabled.
License	Displays license information about your application filter. Please refer to License on page 41 for further information.
CA for SSL Interception	This certificate authority is used by the application filter to create pseudo certificates if SSL interception has been activated in the profile.

If you have made changes, you can use the buttons at the bottom right of the edit window to save them (**Save**) or discard them (**Reset**). Otherwise you can close the window (**Close**).

Click  **Activate** in the toolbar at the top of the desktop to apply your configuration changes.

Filter Profiles



Navigate to **UTM > Application Management > Filter Profiles** to display the list of Application Management filter profiles in the object bar.

In the expanded view, the table columns show the **Name** of the profile and the number of protocols and applications selected for it. Use the buttons in the last column to view and modify the settings for an existing application filter profile, create a new profile based on a copy of an existing profile, or delete a profile from the system.

Please refer to [Icons and buttons](#) on page 22 for further information.

The **Application Filter Profile** settings allow you to configure the following options:

Input box	Description
Profile Name	Enter a name for the filter profile.
SSL Interception	Set a check mark in the check box to activate SSL interception. SSL interception enables your LANCOM R&S [®] Unified Firewall to analyze incoming data traffic routed through SSL-encrypted connections and to apply the configured filter profile to it.

Input box	Description
Rules	<p>Select the protocols and applications you want to add to the profile. The protocols and applications are listed in the table by Category.</p> <p>Use the Filter input field to filter the list of protocols and applications and display only the entries that match your search input. Click  to show the unfiltered list of protocols and applications.</p> <p>Click the  button next to a category to view the protocols and applications that it contains, along with a brief description. You can select entire categories or individual protocols or applications by placing a checkmark in the appropriate box. Uncheck the box next to a category, protocol, or application to remove it from the Application Filter profile. To hide protocols and applications, click the  button next to the category.</p>

The buttons available at the bottom right of the edit box depend on whether you are adding a new filter profile or editing an existing profile. For a new profile, click **Create** to add it to the list of profiles, or **Cancel** to discard your changes.

If you have made changes, you can use the buttons at the bottom right of the edit window to save them (**Save**) or discard them (**Reset**). Otherwise you can close the window (**Close**).

Click  **Activate** in the toolbar at the top of the desktop to apply your configuration changes.

The filter profiles defined here can be used in user-defined firewall rules that blacklist the selected protocols and applications (further information is available under [Firewall](#) on page 26 and [Desktop connection settings](#) on page 83).



Routing Profiles

Navigate to **UTM > Application Management > Routing Profiles** to display the list of Routing Profiles in the object bar.

In the expanded view, the table columns show the **Name** of the profile and the number of protocols and applications selected for it. Use the buttons in the last column to view and modify the settings for an existing routing profile, create a new profile based on a copy of an existing profile, or delete a profile from the system.

Please refer to [Icons and buttons](#) on page 22 for further information.

Use the settings for **Routing Profiles** to configure the following options:

Input box	Description
Name	Enter a name for the routing profile.
Internet connection	Configures the Internet connection over which the traffic is to be routed.
Bypass proxy	Set a check mark in the check box to bypass the proxy. The traffic will then not be routed through the proxy. In particular, this makes it possible to exclude certain applications from the proxy, for example applications for mobile devices that enforce certificate pinning.
Bypass IPsec	Set a check mark in the check box to bypass an IPsec tunnel, meaning that the traffic is not routed through IPsec tunnels. Among other things, this feature can be used for branches that route all of their Internet traffic via IPsec to their headquarters. For certain trusted applications that need low latency, such as Microsoft Office 365, it often makes sense to exclude this traffic from being redirected to the headquarters.
Rules	<p>Select the protocols and applications you want to add to the profile. The protocols and applications are listed in the table by Category.</p> <p>Use the Filter input field to filter the list of protocols and applications and display only the entries that match your search input. Click  to show the unfiltered list of protocols and applications.</p> <p>Click the  button next to a category to view the protocols and applications that it contains, along with a brief description. You can select entire categories or individual protocols or applications by placing a checkmark in the appropriate box. Uncheck the box next to a category,</p>

Input box	Description
	protocol, or application to remove it from the Application Filter profile. To hide protocols and applications, click the ▼ button next to the category.

The buttons available at the bottom right of the edit box depend on whether you are adding a new router profile or editing an existing profile. For a new profile, click **Create** to add it to the list of profiles, or **Cancel** to discard your changes.

If you have made changes, you can use the buttons at the bottom right of the edit window to save them (**Save**) or discard them (**Reset**). Otherwise you can close the window (**Close**).

Click **✓ Activate** in the toolbar at the top of the desktop to apply your configuration changes.

The routing profiles defined here can be used in user-defined firewall rules to implement application-based routing. For more information, see [Firewall](#) on page 26 and [Desktop connection settings](#) on page 83.

E-mail Security

Navigate to **UTM > Email Security** to change the settings of your email and spam filters.

Antispam Settings

Configure your LANCOM R&S® Unified Firewall to protect your system from spam e-mail.







The spam filter is included in the UTM license. When you boot your LANCOM R&S® Unified Firewall for the first time, the spam filter runs as a test version for 30 days. When this period has expired, the spam filter is deactivated automatically. For more information on licenses, see [License](#) on page 41.

Navigate to **UTM > Email Security > Antispam Settings** to open an editor panel to display, activate and adjust the spam filter settings.

The **Antispam Settings** configuration dialog allows you to view and to configure the following elements:

Input field	Description
I/O	A slider switch indicates whether antispam is active (I) or inactive (O). Click the slider switch to change the status. This option is activated by default.
License	This field displays the license information for your spam filter.
Spam Detection	To select one of the following options, click the respective button: <ul style="list-style-type: none"> > Confirmed – E-mails that contain known and verified spam patterns are classified as spam. > Bulk – Complimentary to the Confirmed setting, e-mails sent by mail accounts that generally send mass e-mail are classified as spam (default). > Suspect – Complimentary to the Confirmed and Bulk setting, mails sent from accounts that generally send large of e-mails are classified as spam.
Spam Tag	To decide how you want to mark e-mails as spam, select one of the following options: <ul style="list-style-type: none"> > Header – The original e-mail is marked as spam in the mail header. > Subject – The original e-mail is marked as spam in the mail header. The subject is changed according to the formatting settings (default). > Attachment – An e-mail identified as spam is attached to a new e-mail that is marked as spam in the mail header and in the heading according to the formatting settings.
Subject Tag format	Define how you want to mark e-mails that are classified as spam. Enter an individual text to mark the subject of an e-mail. Use the following variables: %SUBJECT% (original subject of

Input field	Description
	the email), %SPAMCLASS% and %SPAMCLASSNUM% (category). Click  to mark the subject of an email according to the default settings (*****SPAM***** [%SUBJECT%]).
Mail Lists	<p>To create a blacklist and/or a whitelist, add any amount of e-mail addresses to the respective list. You can apply both lists at the same time. You can add e-mail addresses to both lists.</p> <ul style="list-style-type: none"> > To add e-mail addresses manually, enter an e-mail address into the input field and click Add. > You can also import email addresses from a text file. On the respective list, click  Import and open the desired file. By default, the maximum size of an import file is 1 Megabyte. Every line that is not empty adds an entry to the respective list. <p>To export an address list to your local disk as a text file, click  Export below the list.</p> <p>For more information, see Icons and buttons on page 22.</p> <hr/> <p> In every address list, you can add the following placeholders: * for words, ? for single characters.</p>

If you have modified these settings, use the buttons at the bottom right of the editor panel to confirm (**Save**) or to discard your changes (**Reset**). Otherwise, you can close the dialog (**Close**).

Click  **Activate** in the toolbar at the top of the desktop to apply your configuration changes.

 The antispam settings for the e-mail protocol only apply to traffic that corresponds to a rule of a proxy for the current protocol. Additionally, you have to activate the proxy as described in [Mail Filter Settings](#) on page 102.

Mail Filter Settings

To activate the mail proxy of your LANCOM R&S® Unified Firewall, navigate to **UTM > Email Security > Mail Filter Settings**. After you have activated the mail proxy, you can filter e-mails according to their target address. When these e-mails are filtered, they will not be forwarded to the recipient and/or mail server.

The **Mail Filter Settings** configuration dialog allows you to configure the following elements:

Input field	Description
I/O	A slider switch indicates whether the mail proxy is active (I) or inactive (O). Click the slider switch to change the status. This option is deactivated by default.
Filter Mode	Choose the option that contains the desired filter mode. If you select Blacklist (default), all e-mails contained in the blacklist (see below) will not be forwarded to the mail server. If you select Whitelists , only whitelist addresses (see below) will be forwarded to the mail server.
Action	<p>Select the button with the action you wish to be applied to the filtered e-mails. While Reject emails (default) rejects e-mails using an RFC-compliant answer, Delete emails discards unwanted e-mails and makes the sender believe that the e-mail was forwarded to the mail server.</p> <hr/> <p> The Delete emails option is NOT RFC-compliant. A faulty configuration may cause important e-mails to be deleted.</p>
Blacklist/Whitelists	<p>According to on the selected filter mode, you can add as many e-mail addresses to a blacklist or whitelist as you like.</p> <p>You can add e-mail addresses to both lists in the following ways:</p> <ul style="list-style-type: none"> > To add e-mail addresses manually, enter an e-mail address into the input field and click Add.

Input field	Description
	<p>➤ Alternatively, click Import to import e-mail addresses from a text file. By default, the maximum size of an import file is 1 Megabyte. Every line that is not empty adds an entry to the respective list.</p> <p>You can edit or delete individual entries in the list by clicking the corresponding button next to an entry.</p> <p>For more information, see Icons and buttons on page 22.</p> <p>To export the entire list of mail filters to your local disk as a text file, click Export below the list.</p> <hr/> <p> In every address list, you can add the following placeholders: * for words, ? for single characters.</p>

If you have modified these settings, use the buttons at the bottom right of the editor panel to confirm (**Save**) or to discard your changes (**Reset**). Otherwise, you can close the dialog (**Close**).

Click **Activate** in the toolbar at the top of the desktop to apply your configuration changes.

 The other mail filter, antispam and antivirus settings are only active if you activate the mail proxy. For more information, see [Antispam Settings](#) on page 101 and [Antivirus Settings](#) on page 96.

 If you use SSL inspection in both the mail filter and in firewall rules, you need to add your certification authority to the trust store of your LANCOM R&S[®] Unified Firewall and to your client devices.

IDS/IPS

The Intrusion Detection/Prevention System (“IDS/IPS”) maintains a database of known threats to protect the computers on your network from a wide range of hostile attack scenarios, to generate alerts when any such threats are detected, and to terminate communication from hostile sources. The network threat detection and prevention system is based on Suricata.

The threat database consists of an extensive rule set provided by ProofPoint. This rule set includes blacklisted IP addresses, patterns to recognize malware in communication links, patterns to scan networks, patterns to detect brute-force attacks and many more. In IDS mode, the IDS/IPS engine only generates alerts if the traffic matches one of the rules. In IPS mode, the IDS/IPS engine generates alerts and additionally blocks malicious traffic. Once you activate IDS/IPS, all rules are activated by default. If any of the services in the network are falsely blocked by the IDS/IPS, you can configure the IDS/IPS engine to ignore the rule that caused the false positive. For more information on the categories, see [FAQ Emerging Threats](#).

When enabled, the IDS/IPS engine continuously scans traffic on all interfaces.

 IDS/IPS is included in the UTM license. When you boot your LANCOM R&S[®] Unified Firewall for the first time, IDS/IPS runs as a test version for 30 days. When this period has expired, IDS/IPS is deactivated automatically. For further information on the licenses, see [License](#) on page 41.

Navigate to **UTM > IDS/IPS** to open a configuration dialog to display, activate and adjust the IDS/IPS settings.

The **IDS/IPS** configuration dialog allows you to configure the following elements:

Input field	Description
I/O	A slider switch indicates whether IDS/IPS is active (I) or inactive (O). Click the slider switch to toggle the state of IDS/IPS. IDS/IPS is deactivated by default.
IDS/IPS License	This field displays your license information for IDS/IPS.

Input field	Description
Mode	<p>Select the desired IDS/IPS mode by clicking the respective radio button. The following modes are available:</p> <ul style="list-style-type: none"> > IDS (log events) – This mode is used to only log events. It does not prompt any action. > IPS Drop (drop and log packets) – When an event is triggered, the packets which are related to this event are dropped without any response to the sender. A log entry is created. > IPS Reject (reject and log packets) – When an event is triggered, the packets which are related to this event are rejected. For TCP connections, your LANCOM R&S® Unified Firewall sends an RST packet to the source and creates a log entry (see also Logs on page 53).

Under **Rules** you can specify the IDS/IPS rules which you want to be ignored. You can add as many rules as you like.

Input field	Description
SID	<p>Enter the unique signature ID (SID) of a rule and click  to add the rule to the list. You can edit or delete individual entries in the list by clicking the corresponding button next to an entry. You can fetch a rule's SID from the respective log entry (see Logs on page 53).</p> <p>For more information, see Icons and buttons on page 22.</p>
Description	<p>Optional: In the input field, enter additional information regarding the IDS/IPS rule to be ignored. If you leave the text field blank, it will be automatically filled as soon as your LANCOM R&S® Unified Firewall finds a rule that matches the signature ID.</p>

Alternatively, you can add IDS/IPS rules which you want to be ignored by selecting the respective rules in the system log. For more information, see [System Log](#) on page 57.

The **Clear Ignored Rules** button at the bottom left of the panel allows you to delete all ignored IDS/IPS rules at once.

On the **Updates** tab, you can create profiles for automatic IDS/IPS updates:

Input field	Description
From	<p>Enter the date and time for the first automatic IDS/IPS update.</p> <p>You can enter a date in the MM/DD/YYYY format or choose a date from the calendar. Set a time using the hh:mm:ss format.</p>
Interval	<p>Specify the interval for IDS/IPS updates in hours. If you enter 0 hours, the update is carried out immediately.</p>

Click **Add** to add the profile to the list. You can edit or delete individual entries in the list by clicking the corresponding button next to an entry.

For more information, see [Icons and buttons](#) on page 22.

If you have modified these settings, use the buttons at the bottom right of the editor panel to confirm (**Save**) or to discard your changes (**Reset**). Otherwise, you can close the dialog (**Close**).

Click  **Activate** in the toolbar at the top of the desktop to apply your configuration changes.

Proxy

Under **UTM > Proxy**, you can manage your HTTP(S), mail and VoIP proxy settings.







HTTP(S) Proxy Settings

Your LANCOM R&S® Unified Firewall uses the Squid proxy. This proxy serves as an interface to the content filter and the antivirus scanner (see [URL/Content Filter](#) on page 109 and [Antivirus Settings](#) on page 96).

Under **UTM > Proxy > HTTP Proxy Settings**, you can configure the HTTP(S) proxy for your LANCOM R&S® Unified Firewall.

The HTTP(S) proxy serves as a man-in-the-middle. For this purpose, it establishes a connection to the web server, generates a pseudo certificate for the website using its own HTTP(S) Proxy CA, and uses this pseudo certificate to establish a connection to the browser. This way, the proxy can analyze the traffic, apply the URL/content filter and scan for viruses.

When the HTTP(S) proxy is active, make sure that the DNS server of your LANCOM R&S® Unified Firewall is able to correctly resolve the domains to be accessed. Furthermore, import the HTTP(S) Proxy CA of your LANCOM R&S® Unified Firewall as a trusted CA into the browsers of all clients.

Input field	Description
I/O	<p>A slider switch indicates whether the HTTP(S) proxy is active (I) or inactive (O). Click the slider switch to toggle the state of this service regardless of the configured proxy modes. The HTTP(S) proxy is deactivated by default.</p> <p> Activating or deactivating the HTTP(S) proxy will also activate or deactivate the FTP proxy.</p>
Plain HTTP Proxy	<p>To deactivate the HTTP proxy, select the "Disable Proxy" option.</p> <p>If you choose Transparent, your LANCOM R&S® Unified Firewall automatically forwards all requests which arrive on port 80 (HTTP) through the proxy (default setting). If you choose Intransparent, the HTTP proxy of your LANCOM R&S® Unified Firewall must explicitly be addressed on port 10080.</p>
HTTPS Proxy	<p>To deactivate the HTTPS proxy, select the Disable Proxy option.</p> <p> You can configure the HTTP(S) proxy independently from the HTTP proxy.</p> <p>If you select Transparent, your LANCOM R&S® Unified Firewall forwards all requests which arrive on port 443 (HTTPS) automatically through the proxy (default setting).</p> <p>If you choose Intransparent, the HTTP(S) proxy of R&S Unified Firewall must explicitly be addressed on port 10443.</p>
Proxy CA	<p>The CA is used by the HTTP(S) proxy to generate the pseudo certificates.</p> <p>Depending on the certificate type, the LANCOM R&S® Unified Firewall will make a proposal on which certificates are useful and which are not.</p> <p> The CA will only be shown if HTTPS Proxy is set to Transparent or Intransparent.</p>
Client Authentication	<p>Only available if Plain HTTP Proxy or HTTPS Proxy are set to Intransparent: Select this check box to enable HTTP(S) client authentication using the LANCOM R&S® Unified Firewall user management.</p> <p> When you enable Client Authentication, the FTP proxy will be disabled. In that case, a warning will be displayed.</p> <p> The proxy can only process HTTP data packets. If a program tries to transmit data packets of other protocols through this port, the packets are blocked.</p>
Whitelists	<p>You can define separate whitelists for individual domain groups.</p> <p>A domain group consists of a name, an optional description and a list of URLs (domains) that should be excluded from SSL interception, virus scanning and URL filtering. You can add any number of domains to a domain group. Enter a domain and click  to add it to the list.</p>

Input field	Description
	<p>Domains in the whitelist are accepted by the HTTP(S) proxy without analysis and become directly available to the users' browser. No certificates are created. This is necessary for services which employ strict Certificate Pinning, such as Windows Update (windowsupdate.com).</p> <p>You can edit or delete a domain group by clicking on the corresponding button next to an entry. Select or deselect the checkbox to the left of a domain group to enable or disable its use.</p> <p>For more information, see Icons and buttons on page 22.</p> <hr/> <p> To unblock a domain "example.com" including all subdomains like "www.example.com", write ".example.com" with a dot at the beginning. To unblock only the domain "example.com" without subdomains, write "example.com" without a dot at the beginning.</p>



If you have modified these settings, use the buttons at the bottom right of the editor panel to confirm (**Save**) or to discard your changes (**Reset**). Otherwise, you can close the dialog (**Close**).

Click  **Activate** in the toolbar at the top of the desktop to apply your configuration changes.

Mail Proxy Settings

With the Mail proxy, you can use your LANCOM R&S® Unified Firewall as a proxy for e-mails.

Under **UTM > Proxy > Mail Proxy Settings**, you can configure the mail proxy for your LANCOM R&S® Unified Firewall software:

Input field	Description
I/O	A slider switch indicates whether the mail proxy is active (I) or inactive (O). Click the slider switch to change the status. This option is activated by default.
Verify Server Certificates	Select this check box if you want the mail proxy of your LANCOM R&S® Unified Firewall to validate server certificates.
Use StartTLS (SMTP)	Select this check box to activate StartTLS for SMTP connections through the proxy.
Certificates	<p>Select the certificate type that you want to use for the mail proxy by selecting the respective radio button. The following options are available:</p> <ul style="list-style-type: none"> > Create certificates automatically Your LANCOM R&S® Unified Firewall creates pseudo certificates automatically for each mail server. > Select certificate Your LANCOM R&S® Unified Firewall uses a certificate for all servers. From the Proxy Certificate drop-down list, select a certificate. <hr/> <p> You can find more information on creating these certificates under Certificate Management on page 142.</p> <hr/> <p> Only non-CA certificates with a private key are allowed.</p>

If you have modified these settings, use the buttons at the bottom right of the editor panel to confirm (**Save**) or to discard your changes (**Reset**). Otherwise, you can close the dialog (**Close**).

Click  **Activate** in the toolbar at the top of the desktop to apply your configuration changes.

VoIP Proxy Settings

With the VoIP proxy, you can use your LANCOM R&S® Unified Firewall as proxy for VoIP connections.

Under **UTM > Proxy > VoIP Proxy Settings**, you can configure the VoIP proxy for your LANCOM R&S® Unified Firewall:

Input field	Description
Internal Net	From the drop-down list, select your local network interface that you want to use for phone calls.
Internet Connection	Select the Internet connection from the drop-down list which your LANCOM R&S® Unified Firewall uses to forward the VoIP connections.
Activate SIP Proxy	Select this check box if you want your LANCOM R&S® Unified Firewall to serve as VoIP proxy for the SIP. It can be reached on port 5060.
Forward data to an External SIP Proxy	Select this check box to forward VoIP data in the SIP to an external SIP proxy.
Address of External Proxy	Enter the IP address of the external SIP proxy.
Port	Enter the port of the external SIP proxy.

! To use the VoIP proxy, you have to enter the IP address of your LANCOM R&S® Unified Firewall with port 5060 in your VoIP devices. For further details, see the documentation of your VoIP terminal devices.

If you have modified these settings, use the buttons at the bottom right of the editor panel to confirm (**Save**) or to discard your changes (**Reset**). Otherwise, you can close the dialog (**Close**).

Click **✓ Activate** in the toolbar at the top of the desktop to apply your configuration changes.

Reverse Proxy

Under **UTM > Reverse Proxy** you can manage your backends, frontends and reverse proxy settings.

A reverse proxy is useful when a public website is hosted on your own network.

When the reverse proxy is active, the LANCOM R&S® Unified Firewall device accepts the website request from external networks (e. g. the Internet). Then, it will relay it according to your configuration to on or more of your internal web servers.

The LANCOM R&S® Unified Firewall reverse proxy allows you to host multiple domains on one IP address. Additionally, it provides load balancing and failover when you use multiple internal servers.

Reverse Proxy Settings

Use the **UTM > Reverse Proxy > Reverse Proxy Settings** to activate or deactivate the reverse proxy.

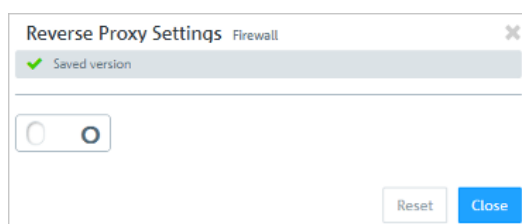

Figure 24: Reverse proxy settings

Input field	Description
I/O	A slider switch indicates whether the reverse proxy settings are active (I) or inactive (O). Click the slider switch to change the status of the reverse proxy. The reverse proxy is deactivated by default.

Backends

Navigate to **UTM > Reverse Proxy > Backends** to define at least one backend with one server. A backend consists of one or more internal web servers serving your website.

The **Reverse Proxy Backend** configuration dialog allows you to view and to configure the following elements:

Input field	Description
Name	Enter a name for the backend.
SSL	Select this check box to enable SSL. If SSL is enabled, the connection between the reverse proxy and the backend will be encrypted.
Server	Assign one or more servers to the backend. Enter a server address. Click ⊕ to add the server's IP address to the list.

The buttons at the bottom right of the editor panel allow you to cancel (**Cancel**) the process or to create (**Create**) a new backend.

Click ✓ **Activate** in the toolbar at the top of the desktop to apply your configuration changes.

Frontends

Navigate to **UTM > Reverse Proxy > Frontends** to configure your frontends.

 To configure a frontend, you have to define at least one backend with at least one server.

After having created a backend, you can create a frontend in the **Reverse Proxy Frontend**. Each configured frontend represents one website with its external IP address, port, domain and certificate (if SSL is enabled).

The **Reverse Proxy Frontend** configuration dialog allows you to view and to configure the following elements:

Input field	Description
I/O	A slider switch indicates whether the reverse proxy is active (1) or inactive (0). Click the slider switch to change the status of the reverse proxy. The reverse proxy is deactivated by default.
Domain or IP address	Enter the name of the domain or the IP address the frontend is assigned to.
Connection	Select a connection. You can choose a network connection and a PPP connection.
Port	Configure the external listen port for the reverse proxy, e. g. the port that is reachable from external networks.
SSL	Select this check box to enable SSL. If SSL is enabled, the reverse proxy will serve the website with SSL encryption, using the configured certificate for its authentication.
Certificate	Select a certificate with a private key. This option is only available if SSL is enabled.
Proxy Paths	Select a configured backend. Enter a URL path. The URL path has to be absolute, i. e. it has to start with / . You can now forward requests matching the URL parameters to the configured backend.
Blocked Paths	Blocks requests which match the URL parameter. Enter a URL path. The URL path has to be absolute, i. e. it has to start with / .

The buttons at the bottom right of the editor panel allow you to cancel (**Cancel**) the process or to create (**Create**) a new frontend.

Click ✓ **Activate** in the toolbar at the top of the desktop to apply your configuration changes.

URL/Content Filter

URL and content filters determine which websites are available to computers on the protected network.

The URL filter function of your LANCOM R&S® Unified Firewall checks Internet addresses (URLs) received in the HTTP traffic for allowed and/or not allowed terms according to their classification in the blacklists and whitelists.

A “blacklist” approach defines a list of sites to block, and grants access to all sites that have not been forbidden explicitly. For example, if the URL of a website is on a blacklist, access to this site is blocked. Therefore, with the category **Ordering** being blacklisted, the URL `http://www.amazon.de` is blocked.

A “whitelist” approach can be used to limit access to a list of sites that have specifically been approved for usage and block all others. For example, if the subcategory **Shopping** is on the blocking list but you want to allow access to the URL `http://www.amazon.de`, this URL must be entered into a whitelist.

If websites do not contain any verifiable terms in their URLs, a URL filter itself is not sufficient. Therefore, your LANCOM R&S® Unified Firewall also filters the HTTP data communication by the content of the websites. Similar to a search engine, the content filter searches websites available on the Internet, analyzes and categorizes them and compiles the results in a database.



 To use the URL and content filter, the HTTP proxy is essential. The HTTP data communication of a connection can only be filtered by URL lists and content if the HTTP proxy is activated for this connection in the rules editor.

The URL and content filters defined here are available for use in custom firewall rules (see [Firewall Rule Settings](#) on page 24 for more information).

You can find more information regarding URL and content filters in the following sections.

Settings for URL/content filter

Navigate to **UTM > URL/Content Filter > Settings** to configure the URL and content filter for your LANCOM R&S® Unified Firewall.

Input box	Description
Content Filter License	This field shows the license information for your content filter.
URLs	Set a checkmark here in order for sections following a ? (used to communicate variables in PHP) to be excluded from black and white lists
SafeSearch	Set this checkmark to configure the setting <code>SafeSearch=strict</code> to automatically configure the search engines Google, Bing, and Yahoo to keep adult content out of search results. Users cannot change this setting.  SafeSearch only works when the HTTPS proxy is active, since most search engine providers use encrypted HTTPS connections on their websites.
Override Mode for Categories	If a website has been blocked, you can control the behavior of your firewall here: <ul style="list-style-type: none"> > Disabled Do not allow overrides. > Allow Override If a webpage is blocked, you can override the Content Filter for a set period of time. Enter the duration in minutes for disabling the category profile of the Content Filter.  Only the current category of a URL/Content Filter profile is unblocked for a certain period. > Allow Override by Code If a website has been blocked, your users can override the Content Filter by entering a short numerical code. Specify the users who are allowed to manage the codes here. This

Input box	Description
	<p>can be from the perspective either of your LANCOM R&S® Unified Firewall local users (see User Authentication on page 116), LDAP users or LDAP groups.</p> <p>See Managing URL/content filter codes on page 111</p>

If you have made changes, you can use the buttons at the bottom right of the edit window to save them (**Save**) or discard them (**Reset**). Otherwise you can close the window (**Close**).

Click  **Activate** in the toolbar at the top of the desktop to apply your configuration changes.

URL/Content Filter Overview

Navigate to **UTM > URL/Content Filter > URL/Content Filter** to display a list of URL and content filters that are defined in the system.

In the expanded view, the columns of the table display the **Name** of the filter and the number of selected entries in content filters, blacklists and whitelists. The buttons in the last column allow you to view and to adjust the settings for existing content filters, create a filter based on a copy of an existing filter or delete a filter from the system.

For more information, see [Icons and buttons](#) on page 22.



Settings for a URL/content filter profile

These settings allow you to configure the following options:

Input box	Description
Name	Enter a name for the URL/content filter.
Override by user	<p>Check this box to allow overrides for this Content Filter profile. Depending on your settings, a code may have to be entered here. You can find out how to set the duration of this option or whether a code is required under Settings for URL/content filter on page 109. Learn more about managing the codes under Managing URL/content filter codes on page 111.</p> <hr/> <p> This option is only available for profiles that are non-standard profiles.</p>

Content filter



In the section **Content Filter** you specify which websites should be available to users on the network and which should be blocked.

Click the  button next to a category to show its subcategories. You select entire categories or individual sub-categories by checking the appropriate box. Remove the check mark next to a category or sub-category to remove it from the blacklist or whitelist. To hide the sub-categories, click the  button next to the category.

URL filter

In the **URL Filter** section you can define blacklist and/or whitelist filters for URLs.

Input box	Description
Blacklist / Whitelists	<p>You create a blacklist and/or a whitelist by adding any number of terms to the respective list. If both lists are used at the same time, the whitelist takes priority.</p> <p>Each list has two ways of adding terms:</p> <ul style="list-style-type: none"> > Search terms can be added manually by entering a term into the input field.

Input box	Description
	<p>➤ Alternatively, you can import search terms from a text file by clicking  Import and opening the file. By default, the maximum file size for imports is 1 megabyte. Each non-empty line of the selected text file is added to the corresponding list.</p> <p>You can edit or delete any entry in the list by clicking on the appropriate icon.</p> <p>Please refer to Icons and buttons on page 22 for further information.</p> <p>You can export a list of terms as a text file to the local hard drive by clicking on  Export under the corresponding list.</p> <hr/> <p> The terms used in the lists can include the following wildcards: * for whole words, ? for single characters.</p>

To create a **Blacklist** or **Whitelists**, you can either enter search terms directly or use regular expressions (RegEx).

RegEx	Description	Example
.	Wildcard for single characters	ho.me – e.g. home, hole
*	Any number of repetitions of the character	hom* – e.g. hom, homm
.*	Any number of characters	ho.*e – e.g. home, house
^	Start of a line	^home – home is at the beginning of the line only
\$	End of a line	home\$ – home is at the end of the line only

The buttons available at the bottom right of the edit box depend on whether you are adding a new URL/content filter or editing an existing one. For a newly configured URL/content filter, click **Create** to add it to the list of services, or **Cancel** to discard your changes.

If you have made changes, you can use the buttons at the bottom right of the edit window to save them (**Save**) or discard them (**Reset**). Otherwise you can close the window (**Close**).

Click  **Activate** in the toolbar at the top of the desktop to apply your configuration changes.

Managing URL/content filter codes

If a website has been blocked, your users can override the blocking mechanisms of the content filter—optionally by entering a short numerical code on the block page. The user has to be permitted to manage these codes and must be logged on to the LANCOM R&S[®] Unified Firewall. See [User Authentication](#) on page 116 (Login) and [Settings for URL/content filter](#) on page 109 (Definition of users).

The administrator must have entered the users authorized to set up codes in the configuration of the content filter under **Override Mode for Categories**. These users then connect via HTTPS to one of the local firewall interfaces. With the appropriate DNS configuration in the network, for example, simply enter https://firewall or the IP address (https://<IP address>) in the web browser. These web pages are created in a responsive design so that they adapt to the capabilities of the device and can also be operated from a smartphone. For example, if the administrator has set up an LDAP connection of the firewall to Active Directory, log on with the access data of your Windows account.

Once logged in to the firewall, the management interface is visible at the bottom left. This displays the active codes that have been set up previously. "Active" means that these codes are available for use, but not necessarily that they are currently being used.

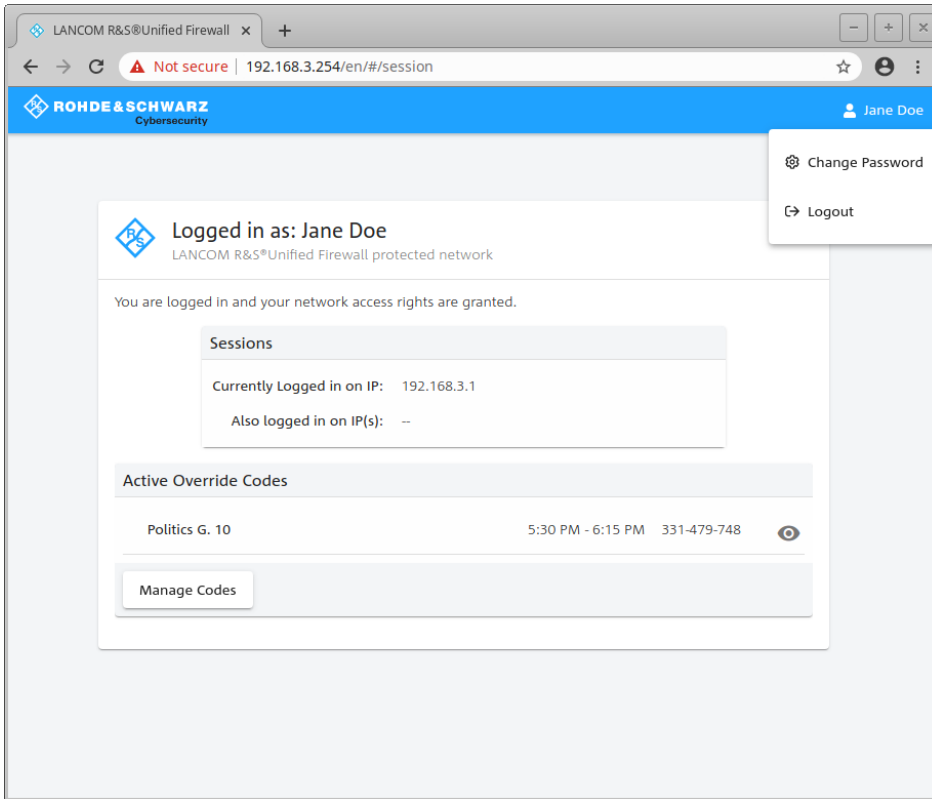

Figure 25: Override code: Accessing the management

If you click the eye symbol next to an active code, the code will be displayed as it will be shown to the intended users. Users can then enter the code on the block page.

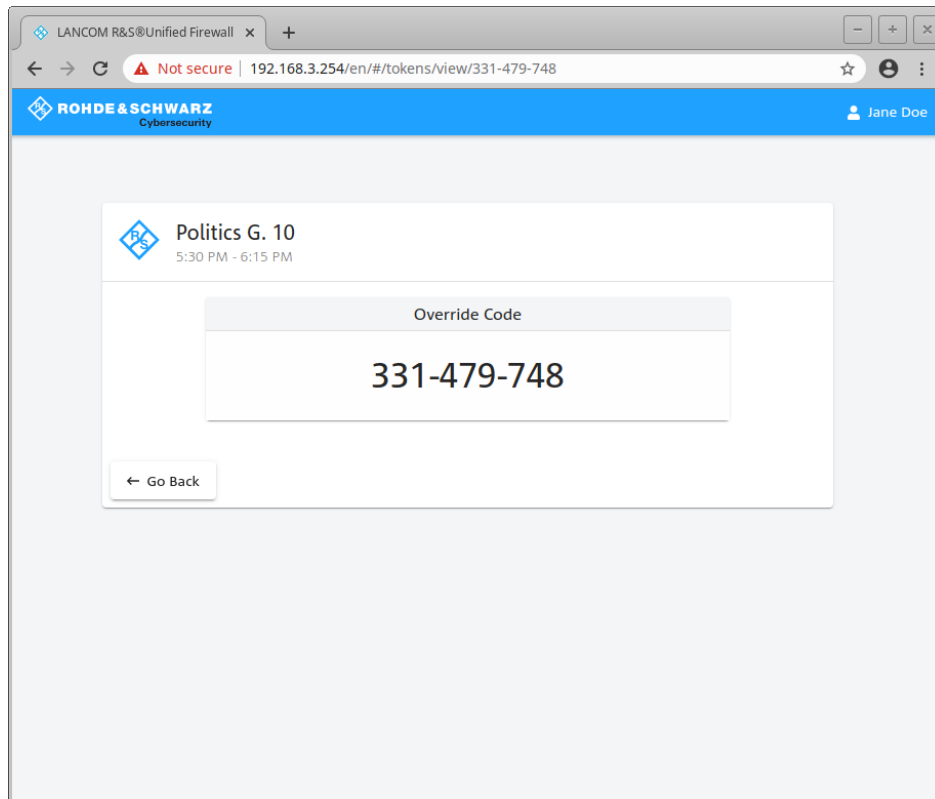

Figure 26: Override code: Presentation mode

The button **Manage codes** on the main page displays the interface for managing the codes. All of the codes are displayed here, including those that have expired and those ready for future use.

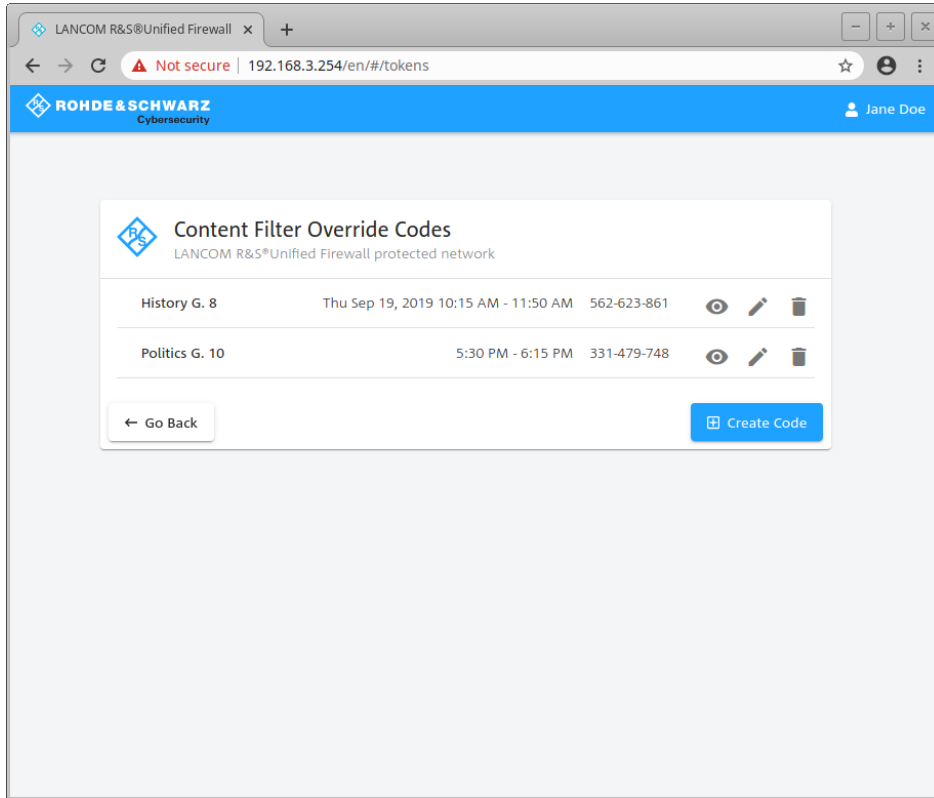

Figure 27: Override code: Management mode

You can use the icons to display a code in presentation mode (eye), edit it (pen) or delete it (trash can). New codes are generated by using the button **Create code**. You configure the following options here:

Input box	Description
Code Name	The name that refers to and is displayed with the code.
Code	The code itself. This cannot be changed.
Valid on	Date the code is valid.
Valid from	The time of day when the code becomes valid and can be used to bypass a filter.
Valid until	The time of day when the codes becomes invalid and can no longer be used to bypass a filter.

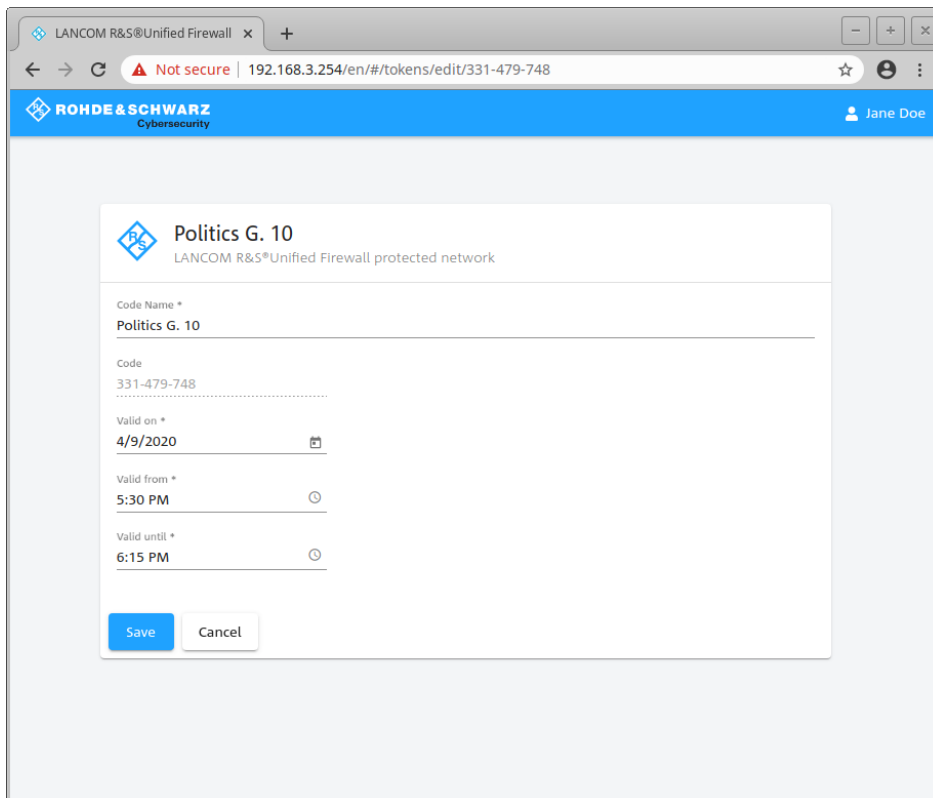

Figure 28: Override code: Create code

Save your new or changed code by clicking **Save**, or discard your entries with **Cancel**.

⚠ If you change a code's validity periods, this change does not apply to users who are already using this code. These overrides will end at their original end time. Users will then have to enter the code again to continue using the override.

A call to a blocked page is then displayed with a message on which a valid code can be entered.

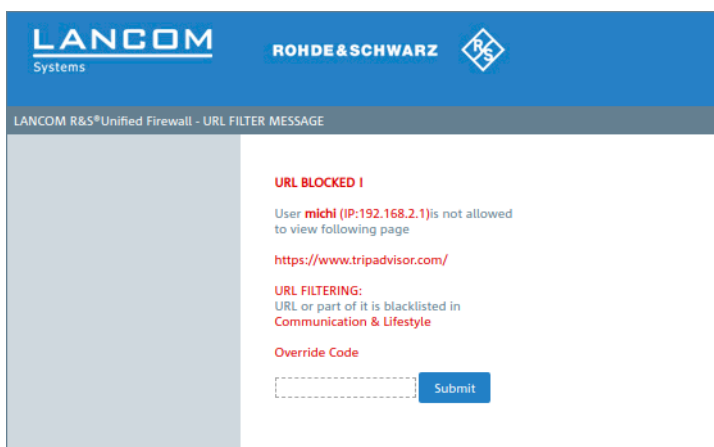

Figure 29: Override code: Blocked page notification

3.4.6 User Authentication

In the settings for **User Authentication** you set the list of users who are authorized to use your network resources (e.g. Internet access, content-filter override and VPN tunnels). You can use these settings to configure local users and connect your LANCOM R&S[®] Unified Firewall to an external directory service for accessing information about individual users and user groups. This allows you to create firewall rules not only for computers, but also for individual users. You can also provide VPN profiles for individual users of the LANCOM Advanced VPN Client.

Navigate to **User Authentication** to display the list of users available on the system in the object bar.

The following sections contain information about user authentication.

Technical background and preparations

The purpose of user authentication

User authentication can be used to assign firewall rules to users when they log in. Only one user can be logged in per IP address. If a user logs in from an IP address that is already being used for a session, the previously logged in user is logged out and the new user is logged in.

Logging in to the firewall

The LANCOM R&S[®] Unified Firewall operates a separate web server for the exclusive purpose of user logins. This receives the user name and password. A local user database created on your LANCOM R&S[®] Unified Firewall is used by an authentication service to verify the user name and password. If this login fails and a Microsoft Active Directory server or an OpenLDAP server are configured in the LANCOM R&S[®] Unified Firewall, the authentication service additionally contacts these directory servers via the Kerberos protocol and tries to authenticate the user. If authentication succeeds, the firewall rules for this user are assigned to the IP addresses where the request was sent from.

Users registered in the local database of your LANCOM R&S[®] Unified Firewall can change their passwords via the web server. The password can consist of up to 248 characters. Longer passwords can be accepted but are truncated automatically.

Some computers can be excluded from user authentication, for example terminal servers used by many users concurrently or servers that only administrators can login to. In these cases, the web server and authentication service do not accept user logins from the IP addresses of these computers.

Since all users of a terminal server have the same IP address, your LANCOM R&S[®] Unified Firewall cannot identify the individual users on the network. To get around this problem, Microsoft offers Remote Desktop IP virtualization for Server 2008 R2 and newer versions. With this application, each user gets their own IP address from a pool of IP addresses, similar to DHCP.

Authentication server

Your LANCOM R&S[®] Unified Firewall provides the option of local user administration, which is ideal for smaller organizations that do not use central user administration. The local user database can be used at any time. However, you can also use an external directory service such as the Microsoft Active Directory server or an OpenLDAP server. Both Microsoft Active Directory and OpenLDAP use the Kerberos protocol to verify login information provided by user authentication clients.

Active Directory groups

If you use a Microsoft Active Directory server for authentication, the Active Directory groups are also listed in the object bar under User Authentication. Active Directory groups are an effective way to set up and maintain security settings for individual users. For example, you can add Active Directory users to specific Active Directory groups and use your LANCOM R&S[®] Unified Firewall to set firewall rules for specific groups.

Logging in

There are three different ways to login to the LANCOM R&S® Unified Firewalls:

- > [Login via web browser](#)
- > [Login via the LANCOM R&S® Unified Firewall User Authentication Client](#)
- > [Login via the LANCOM R&S® Unified Firewall Single Sign-On Client](#)

Login via web browser

If users have been set up as desktop objects and firewall rules have been configured for them, using the landing page will enable them to act in compliance with the rules. Logging in is possible with any browser and is SSL encrypted.

Follow these steps to login to your LANCOM R&S® Unified Firewall by web browser:

1. Start a web browser.
2. Check that cookies are enabled.
3. Enter the IP address of your LANCOM R&S® Unified Firewall, e.g. `https://192.168.12.1` (default port 443) into the address bar.

A web site with the LANCOM R&S® Unified Firewall landing page is displayed.

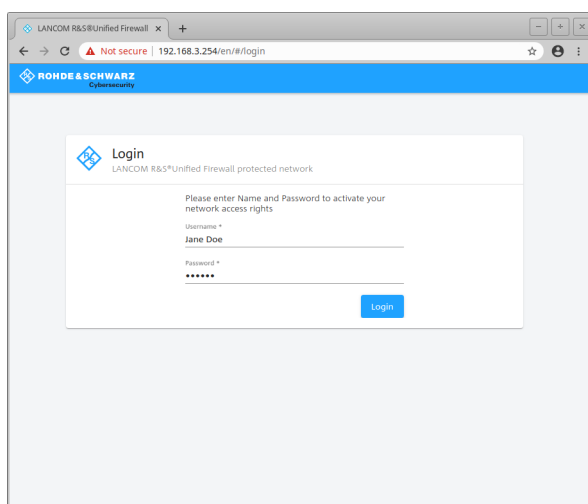

Figure 30: User authentication via web browser

4. Enter your username into the field **Name**.

⚠ If the user is an LDAP user, the login name of the user must exactly match the name in the user's sAMAccountName attribute. Otherwise, the name in the user-specific firewall rules will not match the name of the user logging in to the client, and the rules will not match.

5. Enter the **Password**.
6. Click on **Login**.

Authentication is performed.

⚡ For security reasons, the browser window used to log in must remain open throughout the session. Otherwise, the user is automatically logged out after one minute. This prevents unauthorized persons from gaining access to the firewall if a user forgets to log out.

Login via the LANCOM R&S® Unified Firewall User Authentication Client

The Windows-based LANCOM R&S® Unified Firewall User Authentication Client is located in the directory `UA_Client` on the USB flash drive.

Follow these steps to use the LANCOM R&S® Unified Firewall User Authentication Client to login to your LANCOM R&S® Unified Firewall:

1. Install the LANCOM R&S® Unified Firewall User Authentication Client.
2. Start the LANCOM R&S® Unified Firewall User Authentication Client.



Figure 31: LANCOM R&S® Unified Firewall User Authentication Client

3. Under **Server Address**, enter the IP address of your LANCOM R&S® Unified Firewall.
4. Enter your username into the field **User Name**.

⚠ If the user is an LDAP user, the login name of the user must exactly match the name in the user's `sAMAccountName` attribute. Otherwise, the name in the user-specific firewall rules will not match the name of the user logging in to the client, and the rules will not match.

5. Enter the **Password**.
6. Optional: Check the **Remember password** box to save the password for future logins.
7. Optional: Adjust the time window for the new connection under **Settings** by right-clicking on the icon in the notification area of the Windows task bar.

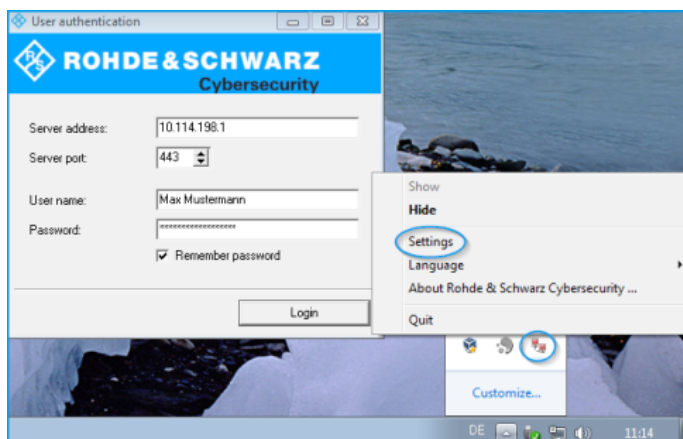

Figure 32: LANCOM R&S® Unified Firewall User Authentication Client settings

8. Click on **Login**.
Authentication is performed.



For security reasons we recommend that the LANCOM R&S® Unified Firewall User Authentication Client should always be updated to the latest available version. However, there is a compatibility mode that allows older versions of the LANCOM R&S® Unified Firewall User Authentication Client to work with LCOS FX of version 10 and higher. Please refer to [Settings](#) on page 124 for further information.

Login via the LANCOM R&S® Unified Firewall Single Sign-On Client

When using single sign-on (SSO), Active Directory domain users login to a Windows client. The rules configured on your LANCOM R&S® Unified Firewall that are relevant to these users are then applied automatically.

The following requirements must be met to operate SSO with a LANCOM R&S® Unified Firewall in an Active Directory environment:

1. Since Kerberos is time-based, make sure that for all SSO components (domain controller, Windows client and LANCOM R&S® Unified Firewall) are all set with the same time and the same NTP server.
2. Create the user `gpLogin`

In the user administration of Active Directory, a normal domain user needs to be created under "CN=Users". This user is then assigned a Service Principal Name (SPN), which is necessary to authenticate your LANCOM R&S® Unified Firewall at the server. The user does not need any special rights.

- a. Open the domain controller.

The screenshot shows the 'New Object - User' dialog box. The 'Create in' field is set to 'qa.local/Users'. The 'First name' field contains 'gpLogin'. The 'Last name' field is empty. The 'Full name' field contains 'gpLogin'. The 'User login name' field contains 'gpLogin/rsuf' and the domain dropdown is set to '@qa.local'. The 'User login name (pre-Windows 2000)' field contains 'QA\gpLogin'. At the bottom, there are buttons for '< Back', 'Next >', and 'Cancel'.

Figure 33: Create a user

- b. Under **First name** enter `gpLogin`.

This name makes it easier to find the user in the user overview later.

- c. Under **User login name** enter `gpLogin/<firewall name>`.

In the example above, the host name (<firewall name>) is that of your LANCOM R&S® Unified Firewall `rsuf`, hence the login name of the user is `gpLogin/rsuf`.

- d. Under **User login name (pre-Windows 2000)** enter `gpLogin`.

- e. Click on **Next**.

- f. Enter a password for the user and confirm this.

Figure 34: Enter a user password

- g. Check the **Password never expires** box.
 h. Click on **Next**.
 i. To check the details of the new user, click **Finish**.

This creates the user `gpLogin`.

3. Login with the user `gpLogin` to query the Active Directory.

In the input box **User Name** under **Authentication Server**, enter `gpLogin`.

4. Configure the Service Principal Name (SPN).

Assign an SPN to the newly created user so that your LANCOM R&S® Unified Firewall recognizes the domain controller as trustworthy. To do this, execute the following command on the domain controller: `setspn -A gpLogin/rsuf gpLogin`

5. Generate a Kerberos key

With the help of the LANCOM R&S® Unified Firewall Single Sign-On Client, a user login to the Windows domain can be redirected to your LANCOM R&S® Unified Firewall. Your LANCOM R&S® Unified Firewall uses the Kerberos key to check the forwarded information and activate the user-specific firewall rules. Proceed as follows to generate a Kerberos key:

- Login to your LANCOM R&S® Unified Firewall.
- Navigate to **User Authentication > LDAP/AP**.
- On the **Kerberos** tab, click the **Create Kerberos Key** button to generate the Kerberos key.

The Active Directory is queried to validate the specified AD user and to obtain relevant information such as the version number of the Kerberos key. Your LANCOM R&S® Unified Firewall can use this information to generate a valid Kerberos key locally.

6. Enable SSO on your LANCOM R&S® Unified Firewall

Proceed as follows to enable SSO on your LANCOM R&S® Unified Firewall:

- Set a checkmark in the **Active** check box on the **Kerberos** tab.
- Click **Save** to store your settings.

7. Prepare the Windows client.

The ZIP archive with the Windows Installer for the Single Sign-On Client can be found at:

<https://www.lancom-systems.de/downloads/>

There are three ways to install the LANCOM R&S® Unified Firewall Single Sign-On Client:

- > Copy the standalone application `UAClientSSO.exe` to the desired location.
- > Run the setup program `UAClientSSOSetup.exe` and install the standalone application `UAClientSSO.exe` to the following path:

`C:\Program Files\R&S Cybersecurity\UA Client\3.0\`

- > Install the client via the domain using the Microsoft installer `UAClientSSO.msi` in a group policy object (GPO).

 All of these methods install the independent application `UAClientSSO.exe` on the Windows PC. It can then be executed by specifying the following parameters:

- > Hostname of the LANCOM R&S® Unified Firewall (for further information see [Settings](#) on page 124).
- > IP address of the LANCOM R&S® Unified Firewall in the network of the client computer.

Example: Your LANCOM R&S® Unified Firewall has the hostname "rsuf". The IP address of the client computer on the network is 192.168.0.1. The target path for installing the LANCOM R&S® Unified Firewall Single Sign-On Client is therefore:



`C:\Program Files\R&S Cybersecurity\UA Client\3.0\UAClientSSO.exe rsuf 192.168.0.1.`

LDAP/AD

Here you can specify the connection parameters for the directory server used to manage the LDAP users on your network.



The tab **Authentication Server** allows you to specify which database type you want to use. You can use the local user database in the LANCOM R&S® Unified Firewall either independently or in combination with an external user database such as Microsoft Active Directory Server or the OpenLDAP server with Kerberos.

If you select `Microsoft Active Directory Server` you can configure the following items:

Input box	Description
Host	Enter the host name or the IP address of the directory server.  If you enter the host name of the directory server, you must configure the DNS settings. Otherwise, the name cannot be resolved.
Port	Enter the port number of the directory server to be used for communication. You can also select the port number with the up/down arrow.
User Name	Enter the name of a read-only user to retrieve the list of domain users from Active Directory. This input field must match the user attribute <code>sAMAccountName</code> . The user must be listed in "CN=Users". Please refer to Login via the LANCOM R&S® Unified Firewall Single Sign-On Client on page 119 for further information.
Password	Enter the password of the read-only user.  We recommend that you create a dedicated user for this purpose.
Domain Name	Enter the domain name of the Active Directory.
StartTLS	You can use the StartTLS protocol to secure the connection to the OpenLDAP or Microsoft Active Directory server. In this case, you also enter the Server CA to be used.

To check the settings configured for Microsoft Active Directory Server, click **Test AD Settings**.

If you select `OpenLDAP Server` you can configure the following items:

Input box	Description
Server Address	Enter the host name or the IP address of the directory server.  If you enter the host name of the directory server, you must configure the DNS settings. Otherwise, the name cannot be resolved.
Port	Enter the port number of the directory server to be used for communication. You can also select the port number with the up/down arrow.
User DN	Enter the user domain name of a read-only account.  You do not have to enter the complete user domain name. If you click Save , the system automatically adds the domain components from the Base DN entry.
Password	Enter the password of the read-only user.
Base DN	Enter a unique name (Base-DN) together with Relative Distinguished Names (RDN) separated by commas. For example, three domain components: <code>dc=ldap,dc=example,dc=com</code> specify the location in the directory where you want to start the directory search.
User Query	Optional: Specify the filter to be used to retrieve the list of users.
User ID	Optional: Set the attributes from which the user identifier is retrieved. The user name displayed in the web client is derived from this LDAP-user attribute. By default, the user identifier is taken from the attribute <code>sAMAccountName</code> .
User name	Optional: Set the attribute from which the user name is retrieved.
User group	Optional: Set the attribute from which the user group is retrieved.
User Primary Group	Optional: Set the attribute from which the user primary group is retrieved.
Mail Query	Optional: Specify the filter to be used to retrieve the e-mail list.
Mail Name	Optional: Set the attribute from which the e-mail name is retrieved.
Group Query	Optional: Specify the filter to be used to retrieve the list of groups.
Group Name	Optional: Set the attribute from which the e-mail name is retrieved.
Group ID	Optional: Set the attribute from which the group ID is retrieved.
Group Primary ID	Optional: Set the attribute from which the group primary ID is retrieved.
Group Parent	Optional: Set the attribute from which the parent group is retrieved.
StartTLS	You can use the StartTLS protocol to secure the connection to the OpenLDAP or Microsoft Active Directory server. In this case, you also enter the Server CA to be used.

If you click **Save**, the system adds default values to any optional fields which you have not filled.

If you want to operate single-sign-on with Kerberos, the username must be `gpLogin`. The host name and domain of your firewall is taken from the general settings. See [General settings](#) on page 27. Please refer to [Logging in](#) on page 117 for further information.

On tab **Kerberos**:

Input box	Description
Active	Select this checkbox to enable the Kerberos service.
Kerberos Key	Displays the service name, host name, and domain name for the userPrincipalName of the most recently created Kerberos key, also called a keytab. Please refer to Logging in on page 117 for further information.

External portal

With the external user portal, the administrator can allow individual or multiple users to have limited access to the firewall. This gives them the option to directly receive provided files or information. These may include the IPsec configuration required for the LANCOM Advanced VPN Client to establish a VPN connection to your LANCOM R&S[®] Unified Firewall.

The following steps are necessary for this:

- › Create a certificate for access via HTTPS.



For the external portal, a certificate from a trustworthy certification authority is recommended!

- › Create local users or configure access to a directory server (OpenLDAP or Microsoft Active Directory).
- › Create an IPsec client-to-site connection.
- › Configure the external portal under **User Authentication > External Portal > Settings**.
- › Create a new profile under **User authentication > External portal > VPN profiles** and assign the VPN connection to the users.

The users can then log in to the firewall using the configured address.

Settings

The **User Authentication Settings** for the external portal allow you to activate or deactivate user authentication for external users.

The external portal uses the reverse proxy system to provide web access, and the settings are analogous to the settings for a reverse-proxy front end, with the following differences:

- › SSL is always activated
- › No "Outlook Anywhere", proxy paths or blocked paths
- › A separate reverse-proxy back end is created for the external portal in the back end, but it is not included in the list of back ends.
- › Also, the settings for the external portal do not appear in the list of front ends, but they are treated like a front end when validating settings.

Navigate to **User Authentication > External Portal > Settings** to open an editing window where you can create the general settings for the user authentication.

In the **External Portal** editing window you can modify the following parameters:

Input box	Description
I/O	A slider button indicates whether the external portal is enabled (I) or disabled (O). You can change the status of the user authentication by clicking the slider button. User authentication is disabled by default.
Domain or IP address	Enter the name of the domain or the IP address assigned to the external portal.
Connection	Select a connection. You can choose both a network connection and a PPP connection.
Port	Configure the externally accessible listen port for the external portal.
SSL certificate	Select a certificate with a private key.

VPN profiles

The purpose of the VPN profiles is to create and provide the VPN configuration files for the configured users. The VPN configuration files are similar to the zip files that users receive when they create an IPsec connection using the export button, except that these configuration files are not password-protected.

In the **VPN Profiles** editing window you can adjust the following parameters:

Input box	Description
Name	Give the template a descriptive name.
IPsec connection	This item selects the IPsec connection that is to be provided to the user as a configuration file in the external portal.
Gateway	The LANCOM Advanced VPN Client connects to this address.
Remote certificate	Certificate of the remote site.
Key password	Enter the password used to decrypt the private key of the client certificate.
Transport password	Enter the password used to decrypt the p12 transport container.
Users	Specify the users to whom this profile should apply. Assigning several users to a single IPsec connection only functions properly in combination with XAuth or EAP. In the portal, users only see the profiles assigned to them.

Internal portal

The internal user portal enables firewall rules to be assigned to users when they log in. It is also used to provide and manage content-filter codes to allow exemptions/overrides.

Only one user can be logged in per IP address. If a user logs in from an IP address that is already being used for a session, the previously logged in user is logged out and the new user is logged in.

Settings

The **User Authentication Settings** for the internal portal allow you to activate or deactivate user authentication for internal users.

Navigate to **User Authentication > Internal Portal > Settings** to open an editing window where you can create the general settings for the user authentication.

In the **Internal Portal** editing window you can modify the following parameters:

Input box	Description
I/O	A slider button indicates whether the user authentication is enabled (1) or disabled (0). You can change the status of the user authentication by clicking the slider button. User authentication is disabled by default.
Log Logins	Activate this checkbox if you want to log every authentication on the LANCOM R&S® Unified Firewall. You can view the login events under Monitoring & Statistics > Logs > System Log .
Login Mode	Choose one of the following four options: <ul style="list-style-type: none"> > Single Login (deny new login) – No user can login from more than one IP address at a time. > Single Login (disconnect old login) – All previous logins are logged off when the user logs in from a different IP address. > Multiple Logins – Users can login from up to 254 different IP addresses simultaneously. > Multiple Logins (with warning in report) – Users can log in from up to 254 different IP addresses simultaneously, and alerts are displayed in the report.
Web Login Port	Specify the HTTPS port for the web login by navigating up/down using the arrow key or by entering the port number. The default is port 443.
Compatibility Mode	Enable this checkbox if you want to log in to the LANCOM R&S® Unified Firewall with user authentication clients older than version 3.0.0.

Input box	Description
	 Enabling this checkbox puts your network security at risk. Please refer to User Authentication on page 116 for further information.
Show Landing Page	Optional: Enable this checkbox to display a landing page when an unauthorized user attempts to access the Internet.

 Each individual IP address supports just one user login, even if the mode **Multiple Logins** is activated.

Wake-on-LAN

Start devices as soon as a user logs on to the internal portal in order to activate firewall rules.

In the **Wake on LAN** editing window you can modify the following parameters:

Input box	Description
User	Select a user in the left pane.
MAC address	Enter one or more MAC addresses in the right pane. As soon as the user logs in to the internal portal to activate firewall rules, wake-on-LAN packets are sent to this MAC address to start the corresponding device.

Click  **Export** to export your user MAC addresses to the file system. Click  **Import** to import user MAC addresses.

Users

Like computers, users and LDAP groups can be set up on the desktop as individual users or user groups.

You can then define rules for these desktop objects that are assigned to the users as soon as they log in. When a user logs in from a computer that certain rules are assigned to, the user is assigned the rules for this computer as well as their own user-specific rules. You can select users and LDAP groups from the local user database of your LANCOM R&S® Unified Firewall and from the OpenLDAP or Active Directory authentication server and add them to the user groups on the desktop. There is also a special **Default User Group** that can be selected on the desktop. Users cannot be added to this user group. It includes all of those users who can login but have not yet been set up as individual users or as members of another user group on the desktop. If a default user group has been set up on the desktop and you have assigned rules to it, users who are subsequently created on the Active Directory server are automatically added to this default user group. After logging in, these new users are automatically assigned the default rules without any further administrative work.

LDAP users

It is possible to connect your LANCOM R&S® Unified Firewall to an external directory server and access users using the Lightweight Directory Access Protocol (LDAP). These users can then be integrated into user-specific firewall rules.

You can also use LDAP to access directory services and to manage user data.

Connect to a directory server as described under [LDAP/AD](#) on page 121.

Navigate to **User Authentication > LDAP Users** to display the list of LDAP users on the directory server in the object bar.

To make the LDAP users listed here available for connections and group-specific firewall rules, the groups must be assigned to a user desktop object. Please refer to [User Groups](#) on page 87 for further information.

LDAP groups

It is possible to connect your LANCOM R&S® Unified Firewall to an external directory server and access user groups using the Lightweight Directory Access Protocol (LDAP). You can integrate these user groups into group-specific firewall rules.

You can also use LDAP to access directory services and to manage user data.

Connect to a directory server as described under [LDAP/AD](#) on page 121.

Navigate to **User Authentication > LDAP Groups** to display the list of LDAP groups on the directory server in the object bar.

To make the LDAP groups listed here available for connections and group-specific firewall rules, the groups must be assigned to a user-group desktop object. Please refer to [User Groups](#) on page 87 for further information.

Local users

Your LANCOM R&S® Unified Firewall offers local user administration for smaller installations without central administration. Use the settings under **Local User** to enter usernames and passwords. In this way you can define and manage users.

Navigate to **User Authentication > Local Users** to display the list of local users available on the system in the object bar.

In the expanded view, the table columns show the **Name** of the local user and also a **Description**, if one has been entered. Use the buttons in the last column to view and modify the settings of a local user, create a new user based on a copy of the existing local user, or delete a user from the system.

Please refer to [Icons and buttons](#) on page 22 for further information.

Under **User Authentication > Local Users** you can add a new user or edit an existing local user.

In the **Local User Authentication** editing window you can modify the following parameters:

Input box	Description
User Name	Specify a unique name for the local user. This name is the login name.  The user's login name must match the User Name (case sensitive). Otherwise, the name in the user-specific firewall rules will not match the name of the user logging in to the client, and the rules will not match.
Description	Optional: The information provided here is for internal use by the administrator only.
Password	Enter a password for the user and confirm this. The password must contain at least six characters.
Show Password	Optional: Set a check mark in the check box to verify the password.
Require password change after next login	Optional: If you check this box, the user will have to change their password after the next login. The web server will redirect the user from the login page to a page where the password can be changed.

The buttons available at the bottom right of the edit box depend on whether you are adding a new local user or editing an existing one. For a newly configured local user, click **Create** to add the new user to the list of local users, or **Cancel** to discard the entry.

If you have made changes, you can use the buttons at the bottom right of the edit window to save them (**Save**) or discard them (**Reset**). Otherwise you can close the window (**Close**).

The local users defined here are available for use in desktop objects such as the VPN users.

Unassigned users

Navigate to **User Authentication > Unassigned Users** to display LDAP users who are assigned to user objects on the desktop but can no longer be accessed on the directory service.

Example applications

In a Windows domain

If you operate a Windows domain, you can perform user authentication by means of the Windows domain controller.

Proceed as follows to enable user authentication by the Windows domain controller:

1. Navigate to **User Authentication > Settings**.
2. Click on **Authentication Server**.
3. Enter the data for your domain controller.

All users in the specified domain are displayed in the user list.

4. Drag the user icons onto the configuration desktop and assign rules to them.

To log in, users enter the URL including `https://` and the IP address of the firewall into the address bar of their browser. A login page is displayed. After a successful login, the firewall rules of the user are assigned to the specified IP addresses. When the browser window is closed, the session cookie expires and the rules are no longer valid.

Excluding the terminal server from user authentication

If you use a terminal server, you should exclude it from user authentication. Otherwise, all current users will be logged out when a new user logs in.

Proceed as follows to exclude the terminal server from user authentication.

1. Click the host group icon on the toolbar at the top of the desktop.
2. Uncheck the box in the **Login Allowed** column.

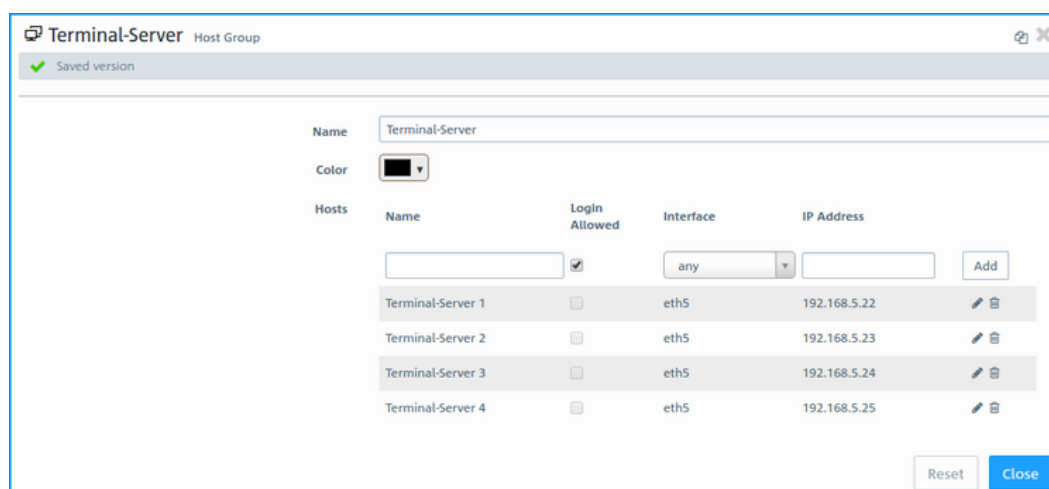

Figure 35: Object settings – terminal server

i If your users require authentication in the terminal server, you can activate Remote Desktop IP Virtualization in the terminal server. This assigns a unique IP address to each user during a session.

3.4.7 VPN

With the settings under **VPN** you can configure your LANCOM R&S® Unified Firewall as a Virtual Private Network server to provide client-to-site (C2S) VPN connections. This allows computers in another location to use IPSec and VPN-SSL to securely access resources on the local network. A *site-to-site* (S2S) VPN gateway can use IPSec and VPN-SSL to establish a secure communication channel between two remote networks via the Internet.

Client-to-site VPN connections

A client-to-site VPN connection provides access to the corporate network from the outside. Authentication is performed either via IPSec with issued certificates, by means of a PSK (pre-shared key), or via VPN-SSL with certificates.

Client-to-site connections over IPSec and VPN-SSL operate in one of two modes, depending on the client settings:

- In the *split-tunnel mode*, the only communication to pass through the firewall is that between the client and the internal network (e.g. a company network). Clients can reach devices in the internal network through the tunnel. For other destinations (e.g. the Internet), the packets are not routed by the LANCOM R&S[®] Unified Firewall.

Example: A user dials in to a corporate network remotely from a hotel's wireless network using a VPN software client. Split tunneling allows the user to connect to file servers, database servers, mail servers, and other company network resources through the VPN connection. If the user connects to Internet resources (websites, FTP sites, etc.), the connection request is sent directly through the hotel network gateway.

- In the *full-tunnel mode* all traffic is routed back to your LANCOM R&S[®] Unified Firewall, including communication with the Internet.

Full tunneling does not allow the user to access the Internet directly through hotel networks. All of the traffic sent by the client will be sent to the firewall while the VPN connection is active.

 C2S connections over IPSec are established using a normal VPN client, such as the LANCOM Advanced VPN Client. Please refer to [IPSec connection settings](#) on page 134 for further information.

 VPN-SSL C2S connections are established using a normal VPN client. Please refer to [VPN SSL connection settings](#) on page 139 for further information.

Site-to-site VPN connections

In the case of a site-to-site connection, two locations are connected via an encrypted tunnel to form a virtual network and they exchange data through this tunnel. The two locations can have fixed IP addresses. Authentication is performed either via IPSec with issued certificates, by means of a PSK (pre-shared key), or via VPN-SSL with certificates.

IPSec

Internet protocol security (IPSec) is a set of protocols that operates at the network layer or the link layer and secures the exchange of packets over untrusted networks (such as the Internet) by authenticating and encrypting each IP packet in a communication session. IPSec meets the highest security requirements.

VPN-SSL

VPN over SSL provides a fast and secure way to get a roadwarrior connected. The biggest advantage of VPN-SSL is that all traffic passes through a TCP or UDP port and, unlike IPSec, no other special protocols are required.

 Before setting up VPN connections, make sure that you have installed the necessary certificates as described in [Certificate Management](#) on page 142.

IPSec

The IPSec (Internet Protocol Security) suite operates on the network layer and uses the authentication and encryption of IP packets to secure communication in untrusted networks.

For a site-to-site connection over IPSec, you need two VPN-IPSec-enabled servers. For a client-to-site connection, you need separate client software.

Your LANCOM R&S[®] Unified Firewall is able to use the IPSec protocol suite to establish and operate secure connections. This is made possible by ESP in tunnel mode. The key exchange can be performed using either version 1 of the IKE

protocol or the newer IKEv2. You can chose between using pre-shared keys or X.509-standard certificates. IKEv1 also allows authentication via XAUTH. IKEv2 additionally supports authentication via EAP.

IPSec settings

You can enable IPSec and configure the settings under **VPN > IPSec > IPSec Settings**:

Table 3: General

Input box	Description
I/O	A slider button indicates whether IPSec is enabled (I) or disabled (O). Click on the slider button to change the status of this option.
Excluded interfaces	This selection list is used to select interfaces that should not be used by the IPSec service. If nothing is entered here, then all interfaces are excluded on the system, including those that are newly created or generated automatically. Usually, exception interfaces and IP addresses are required when all traffic is sent to the central office through an IPSec tunnel. In a case like this, you have to be careful to ensure that the local networks remain accessible. By default, IPSec has a higher priority than normal routes. Consequently, even packets destined for local area networks could be sent to the VPN tunnel instead. Under normal circumstances, the default setting which excludes all local interfaces means that the local networks can always be reached.
Excluded IP address	Enter the IP addresses in CIDR format. Under no circumstances will packets for these networks be routed to a tunnel, even if a tunnel is configured for the destination address. Click on ⊕ on the right-hand side to add your entry to the list of IP addresses.
Proxy ARP	If this option is enabled, the firewall will respond to ARP requests from local networks for virtual IP addresses for IPSec clients by sending its own MAC address.

Table 4: DHCP server

Input box	Description
Active	IPSec can use a DHCP server to assign virtual IP addresses to the connected IPSec clients. You can enable this function here. To use this for an IPSec connection, go to Virtual IP pool and select the option DHCP virtual IP pool .
IP address	Enter the IP address of the DHCP server. This can be either the address of a DHCP server or a broadcast address of a network.

Table 5: RADIUS server

Input box	Description
Active	In conjunction with EAP or XAUTH, IPSec can use the user management of a RADIUS server to authenticate the connection. Also, the RADIUS server can assign IP addresses to IPSec clients. To do this for an IPSec connection, go to Virtual IP pool and select the option RADIUS virtual IP pool . You can enable this function here.
IP address	IP address of the RADIUS server
Port	The port the RADIUS server.
Password	Password for accessing the RADIUS server.

If you have made changes, you can use the buttons at the bottom right of the edit window to save them (**Save**) or discard them (**Reset**). Otherwise you can close the window (**Close**).

Click  **Activate** in the toolbar at the top of the desktop to apply your configuration changes.

Security profiles

Under **VPN > IPSec > Security profiles** you will find a list of predefined profiles that you can extend with custom profiles.

 The predefined profiles cannot be edited or deleted.

 If used security profiles are changed, all related connections can be restarted in the extended list bar. Security profiles are selected in the templates and connections.



Click on  to add a new security profile.

Table 6: General settings

Input box	Description
Name	Give the security profile a descriptive name.
Used in	Indicates the IPSec connections currently using this profile.
Data compression	If you select data compression here, it will be activated for all connections using this profile. This saves bandwidth, but it also increases the CPU load.  If you enable data compression, it must also be activated at the remote site.

ISAKMP (IKE)

This tab is used to define security settings for the IKE phase. IKE defines how security parameters are negotiated and shared keys exchanged

Table 7: ISAKMP (IKE)

Input box	Description
IKE version	Select IKEv1 or IKEv2
Encryption algorithms	From the available encryption algorithms, select the ones you want to use from the list.
Authentication algorithms	From the available authentication algorithms, select the ones you want to use from the list.
DH groups	From the available Diffie-Hellman groups, select the ones you want to use from the list.
SA lifetime	Enter the SA lifetime in seconds.
Mobile IKE (IKEv2 only)	This option is available for IKEv2 only and allows you to change IP addresses without disconnecting.

 The encryption algorithms, authentication algorithms, and DH groups defined here are used in establishing the IPSec connection to negotiate an encryption-authentication combination with the remote site. The more entries are defined here, the higher the number of possible combinations.

 With IKEv1, the number of possible combinations is limited to just over 200. There is no limit with IKEv2.

IPSec (ESP)

Encapsulating Security Payload (ESP) provides mechanisms to ensure the authenticity, integrity and confidentiality of the transmitted IP packets. These settings thus determine the encryption and authentication algorithms used for the actual IP packets.

Table 8: IPSec (ESP)

Input box	Description
Encryption algorithms	From the available encryption algorithms, select the ones you want to use from the list.
Authentication algorithms	From the available authentication algorithms, select the ones you want to use from the list.
DH-Groups	From the available Diffie-Hellman groups, select the ones you want to use from the list.
SA lifetime	Enter the SA lifetime in seconds.

Click on **Create**.

The **Security profile** dialog closes. The new security profile is added to the list of available security profiles in the object bar.

Virtual IP pools

Virtual IP pools can be used to send IP address configurations to connected clients. The virtual IP pools are available for selection on the **Tunnel** tab of the templates and connections.

Under **VPN > IPSec > Virtual IP pools** you will find, on the one hand, the predefined and non-modifiable virtual IP pools for the DHCP and RADIUS servers, and on the other hand the **Default virtual IP pool** that you can modify. Alternatively you can click on  to add a new virtual IP pool.

 The predefined profiles cannot be edited or deleted.

Table 9: Virtual IP pool

Input box	Description
Name	Give the virtual IP pool a descriptive name.
Used in	Indicates the IPSec connections currently using this virtual IP pool.
IP pool	Network address from which IP addresses are sent to the clients.
Preferred DNS server	IP address of the preferred DNS server
Alternate DNS server	IP address of the alternative DNS server
Preferred WINS server	IP address of the preferred WINS server
Alternate WINS server	IP address of the alternative WINS server
DNS search domains	List of DNS search domains. Click on  on the right-hand side to add your entry to the list of DNS search domains.

Click on **Create**.

The **Virtual IP pool** dialog closes. The new pool is added to the list of available virtual IP pools in the object bar.

 If used virtual IP pools are changed, all related connections can be restarted in the extended list bar.

Templates

Connection templates are useful for pre-defining values for connections that are commonly used. Except for the template name, all values are optional and populate the various fields of a VPN connection created using this template.

Various templates have been predefined, such as the template "LANCOM Advanced VPN Client" to simplify IPSec connections with this client. The template "(empty)" is used if the values of an existing connection should be deleted.

 The predefined templates cannot be edited or deleted.

Under **VPN > IPSec > Templates** you can open the window **IPSec connection template**. Use the **IPSec connection template** windows to view and configure the following information:

Table 10: IPSec connection template

Input box	Description
Name	Give the template a descriptive name.
Security profile	Select one of the predefined security profiles.

On the **Connection** tab you can configure the presets for the following fields:

Table 11: Connection

Input box	Description
Connection	By optionally selecting a network or Internet connection, its IP addresses will be used for the IPSec connection.
Listening IP addresses	As an alternative to Connection , you can also enter user-specified IP addresses. If IP addresses are entered here, the Connection setting is ignored. If neither Connection nor Listening IP addresses are set, the IPSec service will automatically use one of the configured IP addresses of all connections.
Remote gateway	This address is necessary for the Initiate connection option in order to determine the address of the remote site.
Initiate connection	The firewall will connect to the address specified in the Remote gateway field.
Force NAT-T	NAT-T is usually set automatically if the connection requires it. If that mechanism fails, this option forces the use of NAT-T on a connection.

On the **Tunnels** tab you can configure the presets for the following fields:

Table 12: Tunnel

Input box	Description
Local networks	Local networks to be connected to the remote site.
Remote networks	Remote networks to connect to the local area networks.  All of the configured local networks are connected to all of the configured remote networks. For IKEv1 connections and IKEv2 connections with the option IKEv2 compatibility mode enabled, the maximum number of combinations is limited to 25. There is no limit for IKEv2 with the option IKEv2 compatibility mode disabled.
Virtual IP pool	The remote site is assigned an IP address from the configured IP pool.
IKEv2 compatibility mode	Instead of sending all configured local and remote networks through a single tunnel, a single tunnel is created for each connection between two networks (as with IKEv1). This option only applies to IKEv2 connections.

On the **Authentication** tab you can configure the presets for the following fields:

Table 13: Authentication

Input box	Description
Authentication type	Specify the authentication type. Possible values: <ul style="list-style-type: none"> > Certificate – authentication is based on a local and a remote certificate. > Certificate Authority – authentication is performed through a local and a remote certificate signed by the selected CA. > PSK (preshared key) – authentication is based on the entry of a password.
PSK (preshared key)	For authentication type PSK (preshared key) only – specify the required password here.
Local certificate	The certificate of the firewall for authentication. This must contain a private key.
Local identifier	If this field is empty, PSK authentication automatically uses the outgoing IP address of the firewall and, for certificate authentication, the distinguished name (DN) of the selected local certificate. <ul style="list-style-type: none"> > For PSK authentication, the following values are allowed: IP addresses, fully qualified domain names (FQDN), e-mail addresses (FQUN), and free text between quotation marks (""). > For certificate authentication, the following values are allowed: The distinguished name (DN) of the selected certificate, wildcard DN – all DN items must be present (in the correct order), but may be specified as a wildcard (e.g. CN=*) – any subject alternative names (SAN) of the selected certificate.
Extended Authentication	Enables the optional use of extended user authentication. Once you have selected a security profile, the following options are available: <ul style="list-style-type: none"> > No Extended Authentication – Do not perform extended authentication. > XAUTH (IKEv1) – Either the local user database or a RADIUS server is used (depending on whether or not RADIUS is active in the IPSec settings). > EAP First Round – An external RADIUS server is used, which must be enabled in the IPSec settings. The configuration for the RADIUS server is made in the IPSec settings. The settings in the Local section are used to authenticate the firewall at the remote terminal. The remote terminal only authenticates itself via EAP. > EAP Second Round – An external RADIUS server is used, which must be enabled in the IPSec settings. The configuration for the RADIUS server is made in the IPSec settings. The settings in the Local section are used to authenticate the firewall at the remote terminal. The remote party authenticates to the firewall using the PSK or a certificate and then performs EAP authentication. > EAP-TLS – Corresponds to the EAP First Round variant with the difference that a TLS certificate is used for EAP authentication. <div style="border: 1px solid #ccc; padding: 5px; margin-top: 10px;"> <p> > For IKEv1, the options No Extended Authentication and XAUTH (IKEv1) are available regardless of the authentication type.</p> <p>> For IKEv2 with certificate or PSK authentication, all options are available except XAUTH (IKEv1).</p> <p>> For IKEv2 with CA authentication, the options No Extended Authentication and EAP Second Round are available.</p> </div>
Remote certificate	Only with authentication type "Certificate": Certificate of the remote site.
Certificate authority	Only with authentication type "Certificate Authority": A CA whose signed certificates can be used for authentication.

Input box	Description
Remote identifier	<p>If this field is empty, PSK authentication automatically uses the IP address of the remote gateway (if set). For certificate authentication, the distinguished name (DN) of the selected remote certificate.</p> <ul style="list-style-type: none"> > For PSK authentication, the following values are allowed: IP addresses, fully qualified domain names (FQDN), e-mail addresses (FQUN), and free text between quotation marks (""). > For certificate authentication, the following values are allowed: The distinguished name (DN) of the selected certificate, wildcard DN – all DN items must be present (in the correct order), but may be specified as a wildcard (e.g. CN=*) – any subject alternative names (SAN) of the selected certificate.

Click on **Create**.

The **IPSec connection template** dialog closes. The new template is added to the list of available templates in the object bar.

IPSec connections

Your LANCOM R&S® Unified Firewall is able to provide remote clients with VPN access via IPSec (IPSec client-to-site) and to create a secure tunnel between two remote networks (IPSec site-to-site).

Overview of IPSec connections

Navigate to **VPN > IPSec > Connections** to display the list of IPSec connections available on the system in the object bar.

In the expanded view, the table columns display the **Name** and the **Status** of the IPSec connection. Furthermore, the columns indicate the authentication method chosen for this connection. Use the buttons in the last column to view and modify the settings for a IPSec connection or to delete a connection from the system.

Please refer to [Icons and buttons](#) on page 22 for further information.

IPSec connection settings

Under **VPN > IPSec > Connections** you can add an IPSec connection or edit an existing connection.

In the **Connection** editing window you can modify the following parameters:

Input box	Description
I/O	A slider button indicates whether the IPSec connection is enabled (I) or disabled (O). Click on the slider button to change the status of this connection. A new connection is enabled by default.
Name	Enter a unique name for this connection. This must consist of 1-63 alphanumeric characters and underscores.
Template	Optionally you can select one of the predefined templates. All settings are then taken from the template. Values that were not set in the template are reset. The template "(empty)" can be used to reset all values.
Security profile	Select one of the predefined security profiles.



On the **Connection** tab you can configure the presets for the following fields:

Table 14: Connection

Input box	Description
Connection	By optionally selecting a network or Internet connection, its IP addresses will be used for the IPSec connection.
Listening IP addresses	As an alternative to Connection , you can also enter user-specified IP addresses. Click on ⊕ on the right-hand side to add your entry to the list. If IP addresses are entered here, the Connection setting is ignored. If neither Connection nor Listening IP addresses are set, the IPSec service will automatically use one of the configured IP addresses of all connections.
Remote gateway	This address is necessary for the Initiate connection option in order to determine the address of the remote site.
Initiate connection	The firewall will connect to the address specified in the Remote gateway field.
Force NAT-T	NAT-T is usually set automatically if the connection requires it. If that mechanism fails, this option forces the use of NAT-T on a connection.

On the **Tunnels** tab you can configure the presets for the following fields:

Table 15: Tunnels

Input box	Description
Local networks	Local networks to be connected to the remote site. Click on ⊕ on the right-hand side to add your entry to the list.
Remote networks	Remote networks to connect to the local area networks. Click on ⊕ on the right-hand side to add your entry to the list.  All of the configured local networks are connected to all of the configured remote networks. For IKEv1 connections and IKEv2 connections with the option IKEv2 compatibility mode enabled, the maximum number of combinations is limited to 25. There is no limit for IKEv2 with the option IKEv2 compatibility mode disabled.
Virtual IP pool	The remote site is assigned an IP address from the configured IP pool.
Virtual IP	Assign a specific IP address to the remote site.  The options Remote networks , Virtual IP pool and Virtual IP should not be used together
IKEv2 compatibility mode	Instead of sending all configured local and remote networks through a single tunnel, a single tunnel is created for each connection between two networks (as with IKEv1). This option only applies to IKEv2 connections.

On the **Authentication** tab you can configure the presets for the following fields:

Table 16: Authentication

Input box	Description
Authentication type	Specify the authentication type. Possible values: <ul style="list-style-type: none"> > Certificate – authentication is based on a local and a remote certificate. > Certificate Authority – authentication is performed through a local and a remote certificate signed by the selected CA. > PSK (preshared key) – authentication is based on the entry of a password.
PSK (preshared key)	For authentication type PSK (preshared key) only – specify the required password here.
Local certificate	The certificate of the firewall for authentication. This must contain a private key.

Input box	Description
Local identifier	<p>If this field is empty, PSK authentication automatically uses the outgoing IP address of the firewall and, for certificate authentication the default is the distinguished name (DN) of the selected local certificate.</p> <ul style="list-style-type: none"> > For PSK authentication, the following values are allowed: IP addresses, fully qualified domain names (FQDN), e-mail addresses (FQUN), and free text between quotation marks (""). > For certificate authentication, the following values are allowed: The distinguished name (DN) of the selected certificate, wildcard DN – all DN items must be present (in the correct order), but may be specified as a wildcard (e.g. CN=*) – any subject alternative names (SAN) of the selected certificate.
Extended Authentication	<p>Enables the optional use of extended user authentication. Once you have selected a security profile, the following options are available:</p> <ul style="list-style-type: none"> > No Extended Authentication – Do not perform extended authentication. > XAUTH (IKEv1) – Either the local user database or a RADIUS server is used (depending on whether or not RADIUS is active in the IPSec settings). > EAP First Round – An external RADIUS server is used, which must be enabled in the IPSec settings. The configuration for the RADIUS server is made in the IPSec settings. The settings in the Local section are used to authenticate the firewall at the remote terminal. The remote terminal only authenticates itself via EAP. > EAP Second Round – An external RADIUS server is used, which must be enabled in the IPSec settings. The configuration for the RADIUS server is made in the IPSec settings. The settings in the Local section are used to authenticate the firewall at the remote terminal. The remote party authenticates to the firewall using the PSK or a certificate and then performs EAP authentication. > EAP-TLS – Corresponds to the EAP First Round variant with the difference that a TLS certificate is used for EAP authentication. <hr/> <p> > For IKEv1, the options No Extended Authentication and XAUTH (IKEv1) are available regardless of the authentication type.</p> <p>> For IKEv2 with certificate or PSK authentication, all options are available except XAUTH (IKEv1).</p> <p>> For IKEv2 with CA authentication, the options No Extended Authentication and EAP Second Round are available.</p>
Remote certificate	Only with authentication type "Certificate": Certificate of the remote site.
Certificate authority	Only with authentication type "Certificate Authority": A CA whose signed certificates can be used for authentication.
Remote identifier	<p>If this field is empty, PSK authentication automatically uses the IP address of the remote gateway (if set). For certificate authentication, the distinguished name (DN) of the selected remote certificate.</p> <ul style="list-style-type: none"> > For PSK authentication, the following values are allowed: IP addresses, fully qualified domain names (FQDN), e-mail addresses (FQUN), and free text between quotation marks (""). > For certificate authentication, the following values are allowed: The distinguished name (DN) of the selected certificate, wildcard DN – all DN items must be present (in the correct order), but may be specified as a wildcard (e.g. CN=*) – any subject alternative names (SAN) of the selected certificate.

The buttons available at the bottom right of the edit box depend on whether you are adding a new VPN IPSec connection or editing an existing connection. For a new network connection, click **Create** to add the connection to the list of available IPSec network connections, or **Cancel** to cancel the creation of a new network connection.

If you have made changes, you can use the buttons at the bottom right of the edit window to save them (**Save**) or discard them (**Reset**). Otherwise you can close the window (**Close**).

Click **✓ Activate** in the toolbar at the top of the desktop to apply your configuration changes.

Setting up an IKEv2 VPN connection with the LANCOM Advanced VPN Client

Scenario: The LANCOM R&S® Unified Firewall is connected directly to the Internet and has a public IPv4 address:

- A company wants its sales representatives to have access to the corporate network via an IKEv2 client-to-site connection.
- The notebooks used by the sales representatives have the LANCOM Advanced VPN Client installed on them.
- The company headquarters has a LANCOM R&S® Unified Firewall as a gateway with an Internet connection with the fixed public IP address 81.81.81.81.
- The local network at the headquarters has the IP address range 192.168.3.0/24.

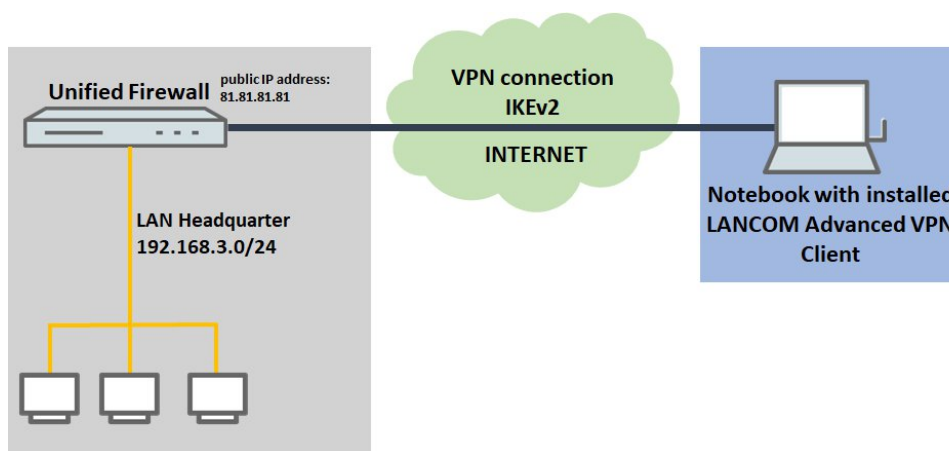

Among other scenarios, this is one of the scenarios explained in the [LANCOM Support Knowledge Base](#). Click on the following link for step-by-step instructions:

<https://support.lancom-systems.com/knowledge/pages/viewpage.action?pageId=37455360>

VPN-SSL

VPN over SSL provides a fast and secure way to get a roadwarrior connected. The biggest advantage of VPN-SSL is that all traffic passes through a TCP or UDP port and no other special protocols are required.

Your LANCOM R&S® Unified Firewall is able to offer VPN access to remote client computers (C2S, “client-to-site”), a secure connection between two remote networks (S2S, “site-to-site”), or by means of a bridge connection over the VPN-SSL protocol.

VPN SSL settings

Under **VPN > VPN SSL > VPN SSL Settings**, you can enable VPN-SSL and configure the general settings on your LANCOM R&S® Unified Firewall:

Input box	Description
I/O	A slider button indicates whether VPN SSL is enabled (I) or disabled (O). Click on the slider button to change the status of this option.
Host certificate	Select a host certificate that your LANCOM R&S® Unified Firewall uses for all VPN SSL connections.
DNS	Optional: Enter a DNS server to be used by clients for client-to-site connections.
WINS	Optional: Enter a WINS server to be used by clients for client-to-site connections.

Input box	Description
Timeout	Enter the timeout in seconds. The tunnel is disconnected if there is no data flow before the timeout expires. The default is 0. The tunnel is thus kept open permanently.
Log Level	Set the event log level here. For troubleshooting, event log level 5 is recommended.
Routes	<p>Enter routes for the VPN SSL tunnels to be created by the clients or the remote end of the connection. These routes will be used for all VPN SSL connections.</p> <p>Click on Add to add the route to the list. You can edit or delete any entry in the list by clicking on the appropriate icon.</p> <p>Please refer to <i>Icons and buttons</i> on page 22 for further information.</p> <hr/> <p> When you edit an entry, a checkmark will appear to the right of the entry. Click the checkmark to accept the change.</p>

On tab **Client-to-Site**:

Input box	Description
Protocol	Select the protocol with the appropriate radio button.
Port	<p>Specify the VPN SSL listening port to be used for incoming connections.</p> <hr/> <p> This port number also has to be specified in the client software.</p>
Address pool	Specify the address range from which IP addresses are assigned to clients. This address range must not overlap with your local networks.
Encryption algorithm	Use the drop-down list to select the encryption algorithm to use for C2S connections over VPN SSL.
Key renegotiation	To increase security, a VPN SSL connection renegotiates the session key while the connection is in progress. Enter the interval for key renegotiation in seconds.
Compression	Optional: Uncheck this box to disable LZO (Lempel-Ziv-Oberhumer, an algorithm for lossless data compression). This checkbox is enabled by default.

On tab **Site-to-Site**:

Input box	Description
Protocol	Select the protocol with the appropriate radio button.
Port	<p>Specify the VPN SSL listening port to be used for incoming connections.</p> <hr/> <p> The same port number must be specified at the remote end of the connection.</p>
Address pool	Specify the address range from which IP addresses are to be used for S2S connections. This address range must not overlap with your local networks.
Encryption algorithm	Use the drop-down list to select the encryption algorithm to use for S2S connections over VPN SSL.
Key renegotiation	To increase security, a VPN SSL connection renegotiates the session key while the connection is in progress. Enter the interval for key renegotiation in seconds.
Compression	Optional: Uncheck this box to disable LZO (Lempel-Ziv-Oberhumer, an algorithm for lossless data compression). This checkbox is enabled by default.

On the **Bridging** tab you specify the settings for the VPN SSL server connection:

Input box	Description
Protocol	Select the protocol with the appropriate radio button.
Port	Specify the number of the VPN SSL listening port to be used for bridging.  The same port number must be specified at the remote end of the connection.
Encryption algorithm	Use the drop-down list to select the encryption algorithm to use for bridging over VPN SSL.
Key renegotiation	To increase security, a VPN SSL connection renegotiates the session key while the connection is in progress. Enter the interval for key renegotiation in seconds.
Compression	Optional: Uncheck this box to disable LZO (Lempel-Ziv-Oberhumer, an algorithm for lossless data compression). This checkbox is enabled by default.

If you have made changes, you can use the buttons at the bottom right of the edit window to save them (**Save**) or discard them (**Reset**). Otherwise you can close the window (**Close**).

Click  **Activate** in the toolbar at the top of the desktop to apply your configuration changes.

VPN SSL connections

You can create and manage VPN SSL connections under **VPN > VPN SSL > VPN SSL Connections**.

Your LANCOM R&S[®] Unified Firewall is able to provide VPN access by means of VPN-SSL to remote clients (client-to-site) and to create a secure tunnel between two remote networks (site-to-site).

Overview of VPN SSL connections

Navigate to **VPN > VPN SSL > VPN SSL Connections** to display the list of VPN SSL connections available on the system in the object bar.

In the expanded view, the table columns display the **Name** of the VPN SSL connection, the **Certificate** used for the connection, as well as the **Type** and the **Status** of the connection. Use the buttons in the last column to view and modify the settings for a VPN SSL connection or to delete a connection from the system.



Please refer to [Icons and buttons](#) on page 22 for further information.

VPN SSL connection settings

Under **VPN > VPN SSL > VPN SSL Connections** you can add a VPN SSL connection or edit an existing connection.

With the settings under **VPN SSL Connections** you can adjust the following parameters:

Input box	Description
I/O	A slider button indicates whether the VPN SSL connection is enabled (I) or disabled (O). Click on the slider button to change the status of this connection. Newly created connections are enabled by default.
Name	Enter a unique name for this connection. The name has to consist of alphanumeric characters (i.e. letters excepting ä, ö, ü and ß, numbers and special characters).
Certificate	Select the server certificate for VPN SSL connections from the drop-down list.  The VPN certificate must be signed by the same Certificate Authority (CA) at all locations. It is therefore advisable to administer the VPN certification authority and the VPN certificates at one location and to export the VPN certificates from there to all other locations.
Connection type	Select the connection type and the function of the LANCOM R&S [®] Unified Firewall by selecting the appropriate radio button. You can choose from the following types:

Input box	Description
	<p>> Client-to-Site – A C2S connection is established (e.g. for full tunneling).</p> <p> This connection type can, for example, be used with the OpenVPN client, primarily to connect mobile clients to your local network.</p> <p>> Site-to-Site (Server) – An S2S connection is established with your LANCOM R&S® Unified Firewall acting as a server.</p> <p>> Site-to-Site (Client) – An S2S connection is established. Your LANCOM R&S® Unified Firewall acts as a client.</p> <p>> Bridge (Server) – A bridge server connection is established.</p> <p> You can create several bridge server connections; however, all connections must use the same bridge so that, for example, several locations can be combined into one network. No other settings are required.</p> <p>> Bridge (Client) – A bridge client connection is established.</p> <p> As soon as a connection has been established, an automatically generated TAP interface appears in the port list for the bridge. This TAP interface cannot be removed from the bridge, but it can be used in desktop connections like any other interface in order to help to define rules.</p>



The items displayed in the settings depend on the connection type selected:

You can configure the following items for client-to-site connections:

Input box	Description
Set default gateway	Check this box to use the VPN SSL tunnel as the default route (for example, for full tunneling).
Client IP	Optional: Enter the IP address where the client can be reached.
Additional remote networks	<p>The local area networks to which the client sets up connection routes must be specified in valid CIDR notation (IP address followed by a slash "/" and the number of bits specified in the subnet mask, e.g. 192.168.1.0/24).</p> <p>Click on Add to add a network to the list.</p> <p>You can edit or delete any entry in the list by clicking on the appropriate icon.</p> <p>Please refer to Icons and buttons on page 22 for further information.</p> <p> When you edit an entry, a checkmark will appear to the right of the entry. Click the checkmark to accept the change.</p>

For site-to-site connections where your LANCOM R&S® Unified Firewall acts as a server, you can configure the following items:

Input box	Description
Address pool	Specify the address range from which IP addresses will be used for this connection. The address range is specified in the VPN SSL settings. Please refer to VPN-SSL on page 137 for further information.
Remote IP	Optional: Enter the IP address of the remote end of the connection.
Remote Networks	<p>Specify the networks available at the remote end of the connection. Once the connection is successfully established, the server creates routes to these networks.</p> <p>Click on Add to add a network to the list.</p> <p>You can edit or delete any entry in the list by clicking on the appropriate icon.</p> <p>Please refer to Icons and buttons on page 22 for further information.</p>

Input box	Description
	 When you edit an entry, a checkmark will appear to the right of the entry. Click the checkmark to accept the change.
Additional Local Networks	<p>Specify any additional local networks. Once the connection is successfully established, the server creates routes to these networks.</p> <p>Click on Add to add a network to the list.</p> <p>You can edit or delete any entry in the list by clicking on the appropriate icon.</p> <p>Please refer to Icons and buttons on page 22 for further information.</p> <hr/>  When you edit an entry, a checkmark will appear to the right of the entry. Click the checkmark to accept the change.

For site-to-site connections where your LANCOM R&S® Unified Firewall acts as a client, you can configure the following items:

Input box	Description
Address pool	Specify the address range from which IP addresses will be used for this connection. The address range is specified in the VPN SSL settings. Please refer to VPN-SSL on page 137 for further information.
Remote Addresses	<p>Enter the IP address where the remote end of the connection can be reached.</p> <p>Click on Add to add a network to the list. If you add more than one network, an automatic failover will be triggered if the first network becomes unreachable. In this case, your LANCOM R&S® Unified Firewall will try to reach the other networks in the list one by one until a network is found.</p> <p>You can edit or delete any entry in the list by clicking on the appropriate icon.</p> <p>Please refer to Icons and buttons on page 22 for further information.</p> <hr/>  When you edit an entry, a checkmark will appear to the right of the entry. Click the checkmark to accept the change.
Remote Port	Enter the port number used at the remote end of this connection.
Try establishing connection for	Specify the timeout in minutes after which no further connection attempts will be made. If this option is set to 0, the connection attempts will continue without interruption.

You can configure the following items for bridge-server connections:

Input box	Description
Bridge	Select a bridge from the preconfigured bridges. Please refer to VPN-SSL on page 137 for further information.

You can configure the following items for bridge-client connections:

Input box	Description
Bridge	Select a bridge from the preconfigured bridges. Please refer to VPN-SSL on page 137 for further information.
Remote Addresses	<p>Enter the IP address where the remote end of the connection can be reached.</p> <p>Click on Add to add a network to the list. If you add more than one network, an automatic failover will be triggered if the first network becomes unreachable. In this case, your LANCOM R&S® Unified Firewall will try to reach the other networks in the list one by one until a network is found.</p> <p>You can edit or delete any entry in the list by clicking on the appropriate icon.</p>

Input box	Description
	Please refer to Icons and buttons on page 22 for further information.
	 When you edit an entry, a checkmark will appear to the right of the entry. Click the checkmark to accept the change.
Remote Port	Enter the port number used at the remote end of this connection.
Try establishing connection for	Specify the timeout in minutes after which no further connection attempts will be made. If this option is set to 0, the connection attempts will continue without interruption.

The buttons available at the bottom right of the edit box depend on whether you are adding a new VPN SSL connection or editing an existing connection. For a new connection, click **Create** to add the connection to the list of available VPN SSL connections, or **Cancel** to discard your changes.

If you have made changes, you can use the buttons at the bottom right of the edit window to save them (**Save**) or discard them (**Reset**). Otherwise you can close the window (**Close**).

Click  **Activate** in the toolbar at the top of the desktop to apply your configuration changes.

3.4.8 Certificate Management

The  **Certificate Management** settings allow you to control the certificates used by the web client, the built-in SSL proxy and the OpenVPN server, to create templates to ease the creation of certificates and to enable OCSP/CRL services.

Certificate Signing Requests

You can use your LANCOM R&S® Unified Firewall to create and export a Certificate Signing Request, e. g. to sign a certificate on another firewall.

Certificate Signing Requests Overview

Navigate to **Certificate Management > Certificate Requests** to display a list of Certificate Signing Requests that are currently defined in the system in the item list bar.

The buttons above the list allow you to create a new Certificate Signing Request and to sign a Certificate Signing Request.

In the expanded view, the first table column displays the **Common Name** of the Certificate Signing Request. The buttons in the last column allow you to view the settings for an existing Certificate Signing Request or delete a CSR from the system.





For more information, see [Icons and buttons](#) on page 22.

Certificate Signing Requests Settings

Under **Certificate Management > Certificate Requests**, you can add a new or edit an existing Certificate Signing Request.

The **Generate Certificate Request** settings allow you to configure the following elements (some fields are only displayed for certain certificate types):

Input field	Description
Type	From the drop-down list, select the certificate type you want to use for the Certificate Signing Request. The following three types are available: <ul style="list-style-type: none"> > Secondary CA > VPN Certificate > Webserver Certificate (R&S Cybersecurity UA Client) For more information, see Types of Certificates on page 146.

Input field	Description
Private Key Encryption	Decide whether to use the pre-selected RSA (Rivest-Shamir-Adleman) or the selectable DSA (Digital Signature Algorithm) as the encryption algorithm for the private key. Due to limitations of OpenVPN, DSA is not available for VPN certificates.  DSA with a private key size of 1024 bits or lower is not accepted by most clients.
Private Key Size	Decide whether to use the default value (2048 Bit) or to select a different bit length for the private key. Longer keys are more secure but they take longer to create.
Private Key Password	Enter a password to secure the private key.
Show Private Key Password	Optional: Select the check box below to make the password visible for verification.
Fill from Template	From the drop-down list, select a template to fill in the input fields regarding the Distinguished Name (see Templates on page 148). Alternatively, you can manually enter the information.
Common Name (CN)	Specify a name for the certificate.
Country (C)	Optional: Enter the two-letter code denoting the country.
State (ST)	Optional: Enter the name of the state.
City (L)	Optional: Enter the name of the city.
Organization (O)	Optional: Enter the name of the organization.
Organizational Unit (OU)	Optional: Enter the name of the unit within the organization.
Subject Alternative Name (SAN)	Optional: Enter as many custom subject alternative names (SAN) as you like for the certificate for specific usage and select the corresponding types from the drop-down list. Available types are: E-Mail , DNS , DirName , URI and IPv4 . Click  to put a subject alternative name (SAN) on the list. You can edit or delete individual entries in the list by clicking the corresponding button next to an entry. For more information, see Icons and buttons on page 22.  If you edit a subject alternative name (SAN), a check box appears on the right of the entry. You have to activate the check box before being able to save the settings of the certificate.
OCSP	Optional and only available for secondary CAs: Select the check box to activate validation via OCSP (Online Certificate Status Protocol) for the CA and for secondary certificates. For more information, see OCSP/CRL on page 147.
CRL	Optional and only available for secondary CAs: Select the respective check box to activate validation via CRL (Certificate Revocation List) for the secondary CA. For more information, see OCSP/CRL on page 147.
Addresses for OCSP Responder / CRL Download	Optional and only available for secondary CAs: Define base URLs for OCSP and CRL by entering a URL in the input field and clicking  . The actual URLs for the certificates are built from the base URL (protocol://hostname/) and are appended with <code>ocsp/<id-of-the-ca></code> for OCSP URLs and with <code>/crls/<id-of-the-ca>.crl</code> for the CRL download URL. The base URL has to point to the LANCOM RGS® Unified Firewall or to any host providing the CRL (when the CRL is mirrored). You can edit or delete individual entries in the list by clicking the corresponding button next to an entry. For more information, see Icons and buttons on page 22.  If you edit a URL, a check mark appears on the right of the entry. You have to click the check mark before being able to save the settings of the certificate. To activate the OCSP and CRL services, see OCSP/CRL on page 147.

The buttons at the bottom right of the editor panel allow you to generate a new certificate signing request and to add it to the list of available certificate signing requests or to reject (**Cancel**) the creation of the new certificate signing request.

After creating a Certificate Signing Request, you are prompted to store it in a local PEM file.

Signing a Certificate Signing Request

To sign a certificate signing request, proceed as follows:

1. Navigate to **Certificate Management > Certificate Requests**.

The list of certificate signing requests which are currently defined on the system opens.

2. In the item list header, click **➔** (Sign certificate request).

The **Sign Certificate Request** editor panel opens.

3. Click **Select File** next to the **Request File** input field.

The local disk search opens.

4. Select a certificate signing request file in PEM format from the local disk.

5. Click **Open**.

The local disk search closes.

6. Under **Validity**, define the initial period of time for which the new certificate should be considered valid. You can enter a date as MM/DD/YYYY (e. g. 04/20/2017) or use the date picker to set the validity period of the certificate.



The validity period of the certificate must not exceed the validity period of the signing CA.

7. Under **Signing CA**, select the certificate authority that you want to use to sign the new certificate from the drop-down list. This CA will be the parent CA that is used to verify or to revoke the certificate.

8. Under **CA Password**, enter the password for the private key of the signing CA. The password is necessary as the signing of the public key of the new certificate is done with the private key of the signing certificate authority.

9. Optional: Select the **Show CA Password** check box to verify the signing CA's password.

10. Click **Sign** to sign the certificate signing request.

The certificate signing request is signed.

After signing the certificate signing request, the system prompts you to save the certificate to the local disk. You can also export the certificate as described in [Certificates](#) on page 144.

Certificates

The **Certificates** configuration dialog allows you to manage the certificates used by the LANCOM R&S[®] Unified Firewall web client, the built-in SSL proxy and the OpenVPN server.

To secure encrypted connections, your LANCOM R&S[®] Unified Firewall uses digital certificates as per the X.509 standard.

The LANCOM R&S[®] Unified Firewall itself acts as a certification authority. Therefore, a so-called CA certificate is required. To centralize the management of the certificates, it is advisable to create a CA certificate on a central firewall and use it to sign every certificate used for the application directly. This is called a single-staged certification chain.

All certificates for applications have to be signed by the central firewall. If a certificate is needed for another firewall, you have to create a request on it. This request has to be signed by the central firewall. The signed request which you created has to be imported by the other firewalls to use it.

If the other firewalls require the ability to create certificates for mostly local purposes which are however recognized as valid to your whole organization, you can use multi-staged certification chains. Therefore, you need a so-called root CA certificate on your central firewall with which you sign the secondary CA certificates. You need to create requests for these secondary CA certificates on your other firewalls. After importing the signed CA certificates, the other firewalls

themselves are able to sign certificates for applications. To display these hierarchies clearly, your LANCOM R&S® Unified Firewall shows them in a tree view.

Certificates Overview

Navigate to **Certificate Management > Certificates** to display the list of certificates that are currently defined in the system in a tree of authorities in the item list bar.

The buttons above the list allow you to create a new certificate and to import a certificate from a file.

Upon first boot and after a reinstallation, there are four certificates created by default:

Name of the Certificate	Description
HTTPS Proxy CA	Certificate authority for the creation of subordinate certificates used by the HTTPS proxy.
HTTPS Proxy Initialization	Pre-configured certificate for the HTTPS proxy.
Mail Proxy CA	Certificate authority for the creation of subordinate certificates used by the mail proxy.
Mail Proxy Initialization	Pre-configured certificate for the mail proxy.

In the expanded view, the item list bar displays the name of the certificate and its dependency. The buttons behind the individual certificates show you the validity status and the type of each certificate. Click the buttons to view the details of each certificate, replace a certificate by importing a new certificate, export and verify a certificate, temporarily suspend or renew the validity of a certificate, and permanently revoke the certificate.

For more information, see [Icons and buttons](#) on page 22.



Certificate Settings

The **Certificates** manage the certificates used by your LANCOM R&S® Unified Firewall.

Click  above the list to add a new certificate.

The certificate settings allow you to configure the following elements (some fields are only displayed for certain certificate types):

Input field	Description
Type	From the drop-down list, select what kind of certificate to create. For more information, see Types of Certificates on page 146.
Signing CA	If you set the certificate type to <code>VPN Certificate</code> , <code>Webserver Certificate</code> , <code>Secondary CA</code> or <code>HTTPS Proxy CA</code> , you can select the certificate authority that you want to use to sign the new certificate. This CA will be the parent CA that is used to verify or to revoke the certificate.
Private Key Encryption	Decide whether to use the pre-selected <code>RSA</code> (Rivest-Shamir-Adleman) or the selectable <code>DSA</code> (Digital Signature Algorithm) as the encryption algorithm for the private key. (<code>DSA</code> is not available for VPN certificates due to limitations of OpenVPN.)  DSA with a private key size of 1024 bits or lower is not accepted by most clients.
Private Key Size	Decide whether to use the default value (2048 Bit) or to select a different bit length for the private key. Longer keys are more secure but they take longer to create.
Validity	Define the initial period of time for which the certificate should be considered valid. The input fields are pre-filled with the current date as the date issued and the same day one year later as the date of expiry. To define a different period of time, enter the new date in the following format: MM/DD/YYYY (e. g. 04/20/2017).
CA Password	Optional: Enter a password for the private key of the signing CA if the certificate type was set to <code>VPN Certificate</code> , <code>Webserver Certificate</code> , <code>Secondary CA</code> or <code>HTTPS</code>

Input field	Description
	Proxy CA. The password is necessary as the signing of the public key of the new certificate is done with the private key of the signing certificate authority.
Show CA Password	Optional: Select this check box to verify the signing CA's password.
Private Key Password	Optional: Enter a password to secure the private key.
Show Private Key Password	Optional: Select the check box to verify the password.
Fill from Template	From the drop-down list, select a template to fill in the input fields regarding the Distinguished Name (see Templates on page 148). Alternatively, you can manually enter the information.
Common Name (CN)	Specify a name for the certificate.
Country (C)	Optional: Enter the two-letter code denoting the country.
State (ST)	Optional: Enter the name of the state.
City (L)	Optional: Enter the name of the city.
Organization (O)	Optional: Enter the name of the organization.
Organizational Unit (OU)	Optional: Enter the name of the unit within the organization.
Subject Alternative Name	<p>Optional: Enter as many custom subject alternative names (SAN) as you like for the certificate for specific usage and select the corresponding types from the drop-down list. The following types are available: E-Mail, DNS, DirName, URI and IPv4. Click ⊕ to put a subject alternative name (SAN) on the list. You can edit or delete individual entries in the list by clicking the corresponding button next to an entry.</p> <p>For more information, see Icons and buttons on page 22.</p> <hr/> <p> If you edit a subject alternative name, a check mark appears on the right of the entry. You have to click the check mark before being able to save the settings of the certificate.</p>
OCSP	Optional and only available for CAs: Select the check box to activate validation via OCSP (Online Certificate Status Protocol) for the CA and for subordinate certificates. For more information, see OCSP/CRL on page 147.
CRL	Optional and only available for CAs: Select the check box to activate validation via CRL (Certificate Revocation List) for the CA. For more information, see OCSP/CRL on page 147.
Addresses for OCSP Responder / CRL Download	<p>Optional and only available for CAs: Define base URLs for OCSP and CRL by entering a URL in the input field and clicking ⊕. The actual URLs for the certificates are built from the base URL (protocol://hostname/) and are appended with ocspl/<id-of-the-ca> for OCSP URLs and with /crls/<id-of-the-ca>.crl for the CRL download URL. The base URL has to point to the firewall or to any host providing the CRL (when the CRL is mirrored).</p> <p>For more information, see Icons and buttons on page 22.</p> <p>You can edit or delete individual entries in the list by clicking the corresponding button next to an entry.</p> <hr/> <p> If you edit a URL, a check mark appears on the right of the entry. You have to click the check mark before being able to save the settings of the certificate.</p> <p>To activate OCSP and CRL services, see OCSP/CRL on page 147.</p>

The buttons at the bottom right of the editor panel allow you to create a new certificate and to add it to the list of available certificates or to reject (**Cancel**) the creation of the new certificate.

Types of Certificates

Your LANCOM R&S® Unified Firewall offers various certificate types to choose from when creating a certificate.

Certificate type	Description
VPN Certificate	Creates a certificate that is used to identify VPN clients and servers. A suitable parent CA has to be selected.
Webserver Certificate (UA client)	Creates a certificate that is used for webserver. A suitable parent CA has to be selected.
CA for VPN / Webserver Certificates	Creates a certificate authority that can directly sign VPN and webserver certificates. No subordinate authorities can be attached. This CA can become a subordinate authority itself by exporting a signing request and reimporting the newly signed public certificate, thus signing it externally.
CA with secondary CAs	Creates a certificate authority that can sign subordinate CAs and client certificates for VPN and webserver.
Secondary CA	Creates a subordinate CA that can be used to sign VPN and webserver certificates. A parent CA of the kind <code>CA with secondary CAs</code> has to be selected.

OCSP/CRL

Enable the OCSP and/or CRL services to allow clients to verify the validity of certificates issued by the central firewall.

If co-workers quit their job or a private key gets lost, the corresponding certificate must be blocked to assure the company's security. This has to be done on the firewall which issued the certificate. The deletion of the certificate on the issuing firewall always includes the revocation of the certificate. To make the status of a certificate accessible to other firewalls, your LANCOM R&S[®] Unified Firewall offers two distinct services:

- OCSP (Online Certificate Status Protocol) – The remote firewall requests the status of the certificate from the issuing firewall at the moment the certificate is needed.
- CRL (Certificate Revocation List) – The firewall is able to provide static revocation lists in predefined intervals which can be downloaded by remote firewalls. Then the application only has to check whether the current CRL lists the certificate as blocked.

To use OCSP and/or CRL, the services in general have to be activated once with the necessary settings. While creating or renewing a CA, you have to declare whether OCSP and/or CRL requests should be sent and under which addresses (URLs) these services should be offered. These options are stored in the certificates themselves, so applications or remote firewalls know where to check the status of a certificate. For more information, see [Certificates](#) on page 144.

The **OCSP/CRL** settings allow you to configure the following elements:

Input field	Description
I/O	A slider switch indicates whether the service is active (I) or inactive (O). Click the slider switch to toggle the state of both services individually. Both options are deactivated by default.
Allow access to OCSP / CRL service from Internet	Select this check box to allow access to the respective service from the Internet.
Port	Specify the port that is reachable from the Internet.
Validity Period	Specify the cache time (in hours) which is sent in the HTTP header to requesting firewalls. After this period has elapsed, new requests will be answered. The default cache time is set to 168 hours.
Update Interval	Specify the update interval in hours. The default interval is set to 48 hours.

If you modify these settings, click **Save** to save your changes or **Reset** to discard them. Otherwise, click **Close** to close the editor panel.

Click  **Activate** in the toolbar at the top of the desktop to apply your configuration changes.

Templates

To ease the creation of new certificates, you can use templates to prepopulate the input fields regarding the **Distinguished Name** and the **Subject Alternative Names**.

Templates Overview

Navigate to **Certificate Management > Templates** to display a list of templates in the item list bar that are currently defined in the system.

In the expanded view, the columns of the table display the name and the settings of the template. The buttons in the last column allow you to view and to adjust the settings for an existing template, create a new template based on a copy of an existing template or delete a template from the system.

For more information, see [Icons and buttons](#) on page 22.

Templates Settings

The **Templates** configuration dialog allows you to configure the following elements:

Input field	Description
Name	Specify a name for the template.
Country (C)	Optional: Enter the two-letter code denoting the country.
State (ST)	Optional: Enter the name of the state.
Location (L)	Optional: Enter the name of the city.
Organization (O)	Optional: Enter the name of the organization.
Organizational Unit (OU)	Optional: Enter the name of the unit within the organization.
Subject Alternative Names	<p>Optional: Enter as many custom subject alternative names (SAN) as you like for the certificate for specific usage and select the corresponding types from the drop-down list. The following types are available: E-Mail, DNS, DirName, URI and IPv4. Click Add to put a subject alternative name (SAN) on the list. You can edit or delete individual entries in the list by clicking the corresponding button next to an entry.</p> <p>For more information, see Icons and buttons on page 22.</p> <hr/> <p> If you edit a subject alternative name, a check mark appears on the right of the entry. You have to click the check mark before being able to save the settings of the certificate.</p>

The buttons at the bottom right of the editor panel depend on whether you add a new template or edit an existing one. For a newly configured template, click **Create** to add the template to the list of available templates or **Cancel** to discard your changes. To edit an existing template, click **Save** to store the reconfigured template or **Reset** to discard your changes.

Trusted Proxy CAs

Navigate to **Certificate Management > Trusted Proxy CAs** to display the list of custom and system certificate authorities that are currently defined in the system and displayed in the item list bar and that the SSL proxy trusts for external connections.

In the expanded view, the first column of the table displays the **Name** of the CA certificate. The buttons in the last column allow you to view the settings for an existing CA certificate or delete a CA certificate from the system.

For more information, see [Icons and buttons](#) on page 22.

To send a custom CA to your LANCOM R&S® Unified Firewall, click the  (Import) button in the item list header, select the desired PEM file and click **Import**. The imported custom certificate is added to the list of available trusted proxy CAs.

Click  **Activate** in the toolbar at the top of the desktop to apply your configuration changes.

3.4.9 Diagnostic Tools

Navigate to the  **Diagnostic Tools** menu to use diagnostic tools if communication problems occur between your LANCOM R&S® Unified Firewall and other devices .

Use the diagnostic tools to verify whether your LANCOM R&S® Unified Firewall can communicate with a computer or other device with a specific network address (`ping`), or to trace a message's route through the network (`tracert`).

 To allow diagnostic analysis between zones, a firewall rule with the ICMP protocol or the ICMP Ping application has to be active in the corresponding direction.

You can find more information regarding diagnostic tools in the following sections.

Ping

Navigate to **Diagnostic Tools > Ping** to use the `ping` command to check if your LANCOM R&S® Unified Firewall can communicate with a computer or other device at a specific network address.

Ping is a diagnostic tool that continuously sends ping signals to the target to check if it is able to receive data. Pinging can help you debug communication problems by verifying connectivity between your LANCOM R&S® Unified Firewall and the remote device.

The **Ping** configuration dialog allows you to configure the following elements:

Input field	Description
Destination	Enter a valid network address to ping.
Request Count	Select the number of ICMP echo request packets to be sent to the target. You can choose any integer from 1 to 10 from the drop-down list. The default number is set to 4.

Click **Run** to start pinging. The **Output** area displays the output of the `ping` command. If the other device responds to the ping, your LANCOM R&S® Unified Firewall can reach the device.

The **Close** button at the bottom of the panel allows you to shut the panel and return to the complete overview of your entire configured network.

Traceroute

Navigate to **Diagnostic Tools > Traceroute** to use the `tracert` command to track the path a message takes through the network.

Packets sent from your LANCOM R&S® Unified Firewall may pass through many other devices on the way to their final destination, which can make it difficult to figure out where problems are occurring if connectivity cannot be established. The `tracert` command allows you to trace the routes of your LANCOM R&S® Unified Firewall packets to a certain host.

The **Traceroute** settings allow you to configure the following **Parameters**:

Input field	Description
Destination	Enter the IP address of the final destination.
Max Hops	Enter the maximum number of nodes (routers or other devices) to be traversed on the way to the destination. The number is set to 30 by default, but you can enter any integer from 1 to 255. If the destination is not reached before this threshold, probe packets are discarded.

Click **Run** to start tracerouting. The **Output** area displays the list of gateways traversed along the way.

The **Close** button at the bottom of the panel allows you to shut the panel and return to the complete overview of your entire configured network.