

Culture and Capture of Fish in Chinese Reservoirs

Li Sifa and Xu Senlin

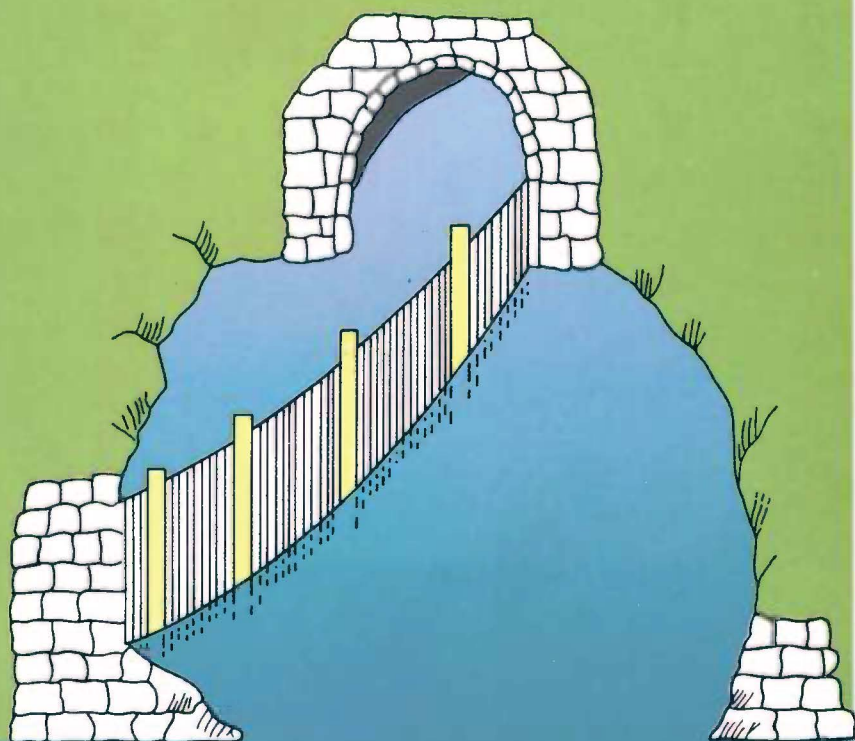

**SOUTHBOUND
INTERNATIONAL DEVELOPMENT RESEARCH CENTRE**

*Culture and
Capture of Fish in
Chinese Reservoirs*

Li Sifa and Xu Senlin

SOUTHBOUND

Penang

INTERNATIONAL DEVELOPMENT RESEARCH CENTRE

Ottawa

All rights reserved. No part of this publication may be reproduced, stored in a retrieval system, or transmitted, in any form or by any means, electronic, mechanical, photocopying, or otherwise, without the prior permission of the International Development Research Centre and Southbound Sdn. Bhd.

Copyright ©
International Development Research Centre and
Southbound Sdn. Bhd., 1995

Published in Malaysia by
Southbound Sdn. Bhd.
9 College Square
10250 Penang
Malaysia
ISBN 983-9054-11-2

Published in Canada by
International Development Research Centre
P.O. Box 8500
Ottawa, Ontario
Canada K1G 3H9
ISBN 0-88936-749-3

Printed by Jutaprint
54 Kajang Road
10150 Penang
Malaysia

Cover and book design
by Chin Mun Woh

Typeset by
TYPOGRAPHICS
in 10.5/16 pt.
Palatino

The designations employed and presentation of material in this publication do not imply the expression of any opinion whatsoever on the part of the International Development Research Centre and Southbound Sdn. Bhd. concerning the legal status of any country, territory, city or area of its authorities concerning the delimitation of its frontiers or boundaries.

Perpustakaan Negara Malaysia
Cataloguing-in-Publication Data

Li, Sifa

Culture & capture of fish in Chinese Reservoirs/Li Sifa & Xu Senlin

Bibliography: p. 123-125

ISBN 983-9054-11-2

1. Reservoirs — China. 2. Fish-culture — China. 3. Fisheries — China.
4. Freshwater fishes — China. I. Xu, Senlin. II. International Development
Research Centre (Canada). III. Title.

639.310951

Contents

Acknowledgements ix

Foreword ix

Preface xi

PART I. RESERVOIRS 1

CHAPTER 1

Hydrological and Physicochemical Characteristics of Reservoirs 2

Morphology 2

Common terminology and parameters 2

Types of reservoir 2

Classification by morphology 2

Classification by size 3

Hydrology 3

Water level, storage capacity, and surface area 3

Flow rate 6

Sedimentation 6

Physicochemical characteristics of reservoir water 6

Water temperature 6

Transparency 8

pH 9

Dissolved gases 9

Nutrients 10

CHAPTER 2

Natural Food Organisms 12

Phytoplankton 12

Zooplankton 13

Detritus and bacteria 16

Periphyton 16

Benthos 16

Aquatic Macrophytes 17

CHAPTER 3

Development of Fish Resources 19

Formation and development of the natural ichthyofauna 19

Riverine fishes 19

Lacustrine fishes 19

Migratory fishes 19

Manipulation of fish fauna in reservoirs 22

Dominant species 22

Development of fish fauna 22

Biology of economically important species 22

Silver carp 23

Bighead carp 23

Common carp 25

Crucian carp 25

Grass carp 25

Grass bream 26

<i>Black bream</i>	26
<i>Wuchang fish</i>	27
<i>Xenocyprinae</i>	27
<i>Mud carp</i>	28
<i>Elopichthys bambusa</i>	29
<i>Erythroculter ilishaeformis</i>	29
<i>Erythroculter mongolicus</i>	30
<i>Erythroculter dabryi</i>	30
<i>Snakehead</i>	30
<i>Mandarin fish</i>	30
<i>Catfish</i>	31
<i>Opsariichthys bidens</i>	31
<i>Pike (Esox reicherti)</i>	31
<i>Hemiculter leucisculus</i>	31

CHAPTER 4

Assessment of Fish Productivity in Reservoirs 32

Biological production process 32

Transformation of matter and energy in reservoirs 32

Biological production processes 32

Classification of trophic level of reservoir 33

Assessment of fish production 33

Factors influencing fish productivity 33

Environmental factors 34

Species composition and population structure 35

Human activity 35

Principal methods to evaluate fish productivity 35

Evaluation based on area of surface water 35

Vegetation and soil quality of catchment area 36

Morphoedaphic index (MEI) 36

Biomass of food organisms 36

Primary productivity 37

Factors to be considered when estimating fish productivity 38

PART II. FISH CULTURE IN RESERVOIRS 41

CHAPTER 5

Culture of Large-Size Fingerlings 42

Fingerling culture in cages 42

Advantages and disadvantages 42

Reservoir and site selection 43

Food sources 43

Flow rate of water 43

Installation of cages 44

Dimensions of cages 44

Fingerling production in cages 45

No-feeding culture 45

Feeding culture 46

Routine management 46

Timely cleaning 46

Inspection of cages 47

Prevention of losses because of floods and typhoons 47

Fingerling culture in coves	47
<i>Selection of coves</i>	48
Fishery concerns	48
Construction engineering concerns	48
<i>Design of coves</i>	48
Net-fenced coves	48
Dam-blocked coves	48
<i>Fingerling production in coves</i>	49
Predator elimination	49
Management	49
Escape	50
Harvest of fingerlings	51
Fingerling culture using barnyard grass and rice	51
Artificial propagation of reservoir populations of silver carp and bighead carp	51
<i>Maturation of brooder fish</i>	52
<i>Natural spawning grounds</i>	52
<i>Use of brooder population</i>	52
Artificial insemination	52
Transportation of brooders	53
Induced breeding and artificial insemination	54
Hatching	54

CHAPTER 6

Stocking 56

Stocking strategy 56

<i>Species selection</i>	56
<i>Stocking density and ratio</i>	57
Empirical method	58
Theoretical calculation	58
<i>Stocking size and quality of fingerlings</i>	59
<i>Stocking time and place</i>	61
<i>Transportation of fingerlings</i>	61
Modes of transportation	61
Factors affecting survival during transportation	63

Intensive culture in small reservoirs 63

<i>Silver carp and bighead carp as the principal species</i>	64
<i>Grass carp and common carp as the principal species</i>	64
<i>Integrated fish farming in small reservoirs</i>	65

Culture of food fish in net cages 65

<i>Culture of silver carp and bighead carp without artificial feeding</i>	65
<i>Culture of common carp and tilapia with feeding</i>	66
Culture of common carp	66
Culture of tilapia	66
Culture of luxury species	67

Fish culture in tailwater 67

<i>Fish culture in running water ponds</i>	67
Water source	67
Design of running water ponds	67
<i>Fish culture in irrigation canals</i>	68
Fixed cages	68
Floating or movable cages	68
<i>Culture of rainbow trout</i>	68

CHAPTER 7**Management of Natural Fish Resources 70****Control of predators and low-value species 70***Common predators and their impact 70*

Endanger stocked fishes 70

Lengthening the food chain and decreasing
fish productivity 71*Types of predators 71*

Pursuing predators 71

Ambushing predators 71

Parasitic predators 71

*Population dynamics of predators 72*Conditions favouring the development of
predators as the dominant species 72

General trends in predator populations 72

Control of predators 72

Eliminate the source 72

Destroy spawning conditions 73

Chemical control and catching 73

Control of small low-value fishes 74

Enhancement and protection 74*Transformation and enrichment of ichthyofaunal
populations 74*

Temperature 74

Salinity 75

Food 75

Improvement of spawning conditions 75

Protection of spawning grounds 75

Installation of artificial nests 76

*Increase natural food sources 76**Reasonable harvests 76*

Fishing intensity 77

Size limits 77

Control of fishing season 77

PART III. BARRIERS AND HARVEST TECHNIQUES 79**CHAPTER 8****Barriers 80****Types of barriers 80***Fence 80*

Bamboo (wooden) fence 80

Bamboo baskets 80

Wire fences 80

*Barrier nets 80**Electric screen 81***Design of barrier nets 82***Design principles 82*Selection of the section of the reservoir to
be impounded 82

Flow rate 82

Depth of the barrier net 83

Size and species of fish 83

Mesh size 83

Net twine 84

<i>Design procedures</i>	84
Survey of barrier site	84
Area of barrier net	84
Dimensions of nets	84
Twine consumption	85
Type and dimension of lines	85
Resistance of barrier net	85
Net weight of barrier net in the water	86
Floating and sinking forces of a barrier net	87
Applied forces on the head line and foot line	87
Applied forces on anchoring devices	88
<i>Installation of barrier net</i>	89
Cutting and stitching of net panels	89
Installation of floats and sinkers	89
Installation of cover net	89
Installation of bottom net	89
<i>Debris filter</i>	90
<i>Boat-passing device</i>	90
<i>Case study</i>	91
Primary design features	91
Efficiency	91
Electric screens	92
<i>Reactions to electrical stimulation</i>	92
Initial reaction	92
Directive reaction	92
Narcotic reaction	93
<i>Design of pulse screen</i>	93
Site selection	93
Geometrical and electrical parameters of electrode array	93
<i>Construction of LD-1 electric screen</i>	94
Insert type	94
Slanted strut type	94
Hanging type	94
<i>Operating experience</i>	94
CHAPTER 9	
Harvesting Pelagic Fish Species	95
Migration habits of silver carp and bighead carp	95
Joint fishing method	95
<i>Principles and practice</i>	95
<i>Types of fishing gear</i>	95
Driving gear	95
Blocking net	96
Fixed filter net	96
<i>Design and installation of principal fishing gear</i>	96
Blocking net	96
Trammel net	97
Fixed filter net	99
Dimensions of nets	101
Mesh size, twine thickness, and hanging coefficient	103
Installation of a fixed filter net	104
<i>Fishing methods</i>	104
Formulation of a fishing plan	105
Fishing techniques	106

Seine net	107
<i>Use and structure</i>	108
<i>Fishing method</i>	108
Shooting	108
Hauling	109
CHAPTER 10	
Harvesting Demersal Fish Species	110
Relevant biology of common carp	110
Gill net for common carp	110
<i>Net structure</i>	111
<i>Fishing method</i>	111
Shooting	111
Hauling	111
Motorized trawl	111
<i>Net structure</i>	111
Wing net	111
Cover net (square)	113
Body net and bag	113
Gusset and flapper	113
<i>Main parameters</i>	113
Estimation of pulling force	113
Determination of hanging coefficients	114
Horizontal and vertical spreading of the net opening	114
Buoyancy and weight of sinker line	114
Tension on tow line	114
<i>Fishing method</i>	116
CHAPTER 11	
Harvesting Predatory Species	118
Relevant biology of major predators	118
<i>Pelagic predators</i>	118
<i>Demersal predators</i>	118
Fishing gear and methods	118
<i>Polyethylene gill net for <i>Elopichthys bambusa</i></i>	118
Net structure	118
Installation methods	119
Fishing methods	119
<i>Cage weir</i>	119
Structure	120
Construction and installation	120
Fishing methods	120
References	123
List of Fish Species	126
List of Reservoirs	127

ACKNOWLEDGEMENTS

The authors wish to acknowledge the kind assistance and support of the International Development Research Centre (IDRC) in publishing this book; the encouragement of Dr. F Brian Davy, Associate Director (Fisheries), Agriculture, Food and Nutrition Sciences Division and Mr. Andrew MacNaughton, Program Officer, Regional Office for Southeast and East Asia, IDRC; the assistance of Mr. Zhou Enhua, Senior Technical Interpreter, Prof. Hu Heyong, and Prof. Xu Yating for translating the book; and Mrs. Sun Ling for typing the manuscript. We express our thanks to Dr. S De Silva and his wife, Celine, for their attention to the technical and English review of the manuscript. Finally, we thank Mr. Michael Graham for his painstaking editing of the final draft of the manuscript and accompanying illustrations.

FOREWORD

China produces more freshwater fish than any other country in the world, but most information on culture techniques has focused on the now-famous Chinese system of fish culture in ponds. In view of current predictions for the construction of new dams throughout Asia, reservoir fisheries hold considerable potential to increase fish production in this region.

Since the end of World War II, China has developed a considerable amount of knowledge about fish production in reservoirs. An estimated 1.44 x 10⁶ ha of reservoirs are used for fishery production in China, and average annual production is 214 kg/ha. In the post-war period, an extensive production system for reservoir fisheries has evolved. However, until now, much of this information has not been available in English.

The idea for this text originated from presentations made by Drs. Li Sifa and Xu Senlin during an IDRC-hosted workshop on reservoir fisheries. Drs. Li and Xu offered to make more of the Chinese information available in English by revising and translating their just-published Chinese text. A group of interpreters was hired to work with the authors to translate this text into English. The resulting text was edited to eliminate portions of the Chinese text that were already available in English. The final text is the culmination of several years of translation, editing, and revision. As part of this overall program, IDRC has also published two related publications on reservoir fisheries: *Reservoir Fishery Management and Development in Asia* (1988) and *Reservoir Fisheries of Asia* (1992).

I would like to particularly note the efforts of Dr. S De Silva in leading this program and working with Drs. Li and Xu on this text.

F Brian Davy
Executive Secretary
Strategy for International Fisheries
Research (SIFR)

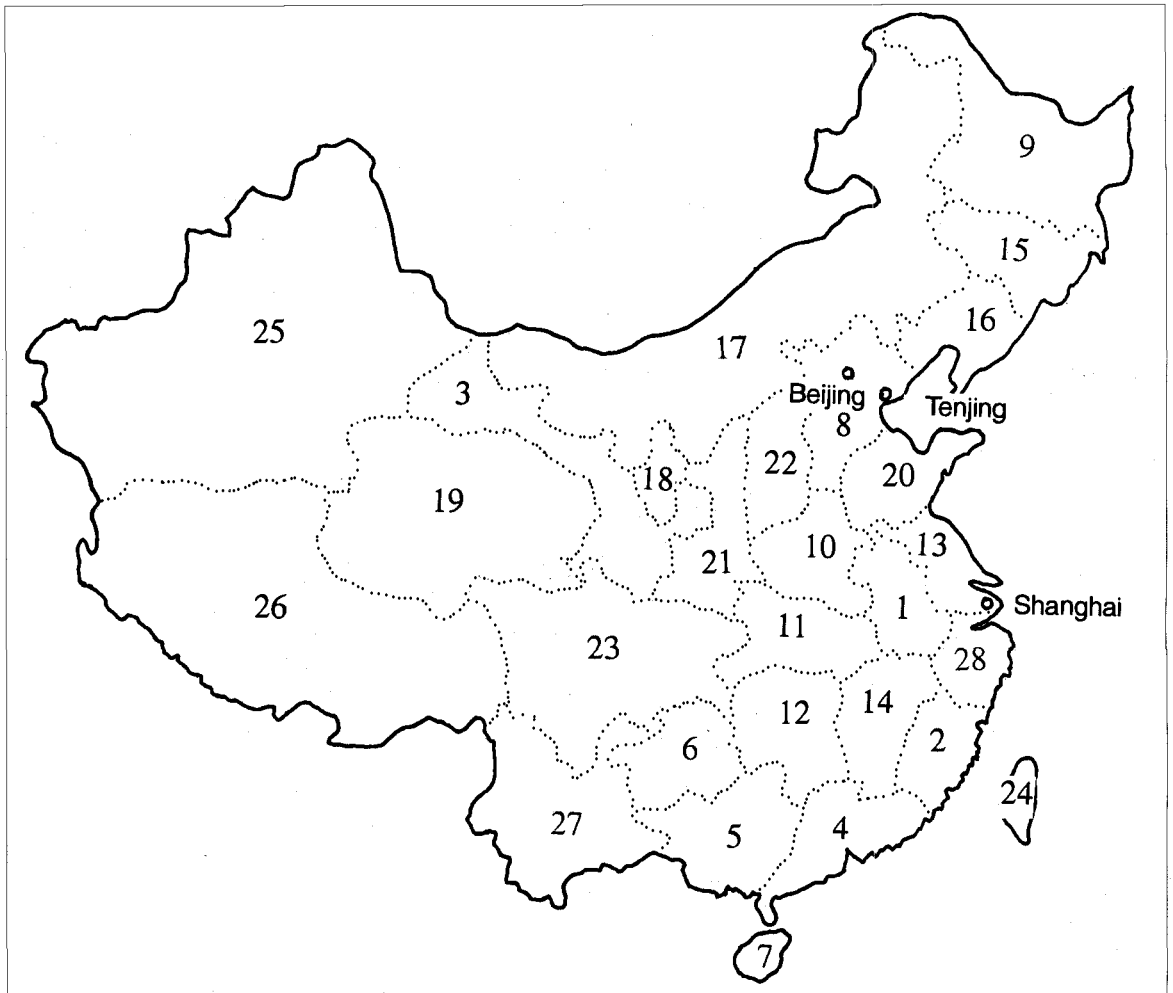

Figure 1. The administrative divisions of the People's Republic of China. The Provinces and Autonomous Regions are: (1) Anhui, (2) Fuji, (3) Gansu, (4) Guangdong, (5) Guangxi, (6) Guizhou, (7) Hainan, (8) Hebei, (9) Heilongjiang, (10) Henan, (11) Hubei, (12) Hunan, (13) Jiangsu, (14) Jiangxi, (15) Jiling, (16) Liaoling, (17) Neimeng, (18) Ningxia, (19) Qinghai, (20) Shangdong, (21) Shannxi, (22) Shanxi, (23) Sichuan, (24) Taiwan, (25) Xinjiang, (26) Xizang, (27) Yunan, and (28) Zhejiang. The Municipalities are: (1) Beijing, (2) Tenjing, and (3) Shanghai.

PREFACE

Reservoir fisheries involves the management of fish resources, fish culture, and fish capture. Reservoir fisheries is a new industry in China compared with pond fisheries, which is more than 3,000 years old, and lake fisheries, which is over 1,000 years old. Fish culture was first practiced in China in the Dongqianhu Reservoir, which was built in 744 in Zhejiang Province (see Figure 1). However, it is only within the last 30 years that fish farming in reservoirs has become popular.

The development of reservoir fisheries in China can be divided into three stages:

- Stage one (1949-1957). The reservoirs were primarily used to generate electricity for irrigation, but seldom for fish production. Small, simple, fishing gear was adopted to harvest the wild fish resources, but people lacked experience in fish culture in reservoirs. Although fish farming was practiced to some extent in reservoirs, many technical problems (e.g., fingerling supply, prevention of fish escape, harvest techniques, and management methods) remained unsolved.

- Stage two (1958-1978). This was the developmental stage of reservoir fisheries in China. From 1958 to 1965, the rapid development of water conservation for agricultural production led to the impoundment of many reservoirs of various sizes. These developments accelerated reservoir fisheries, and many important techniques were developed. Artificial breeding of silver carp and bighead carp, use of brooder resources to ensure seed supply, technologies to rear fingerlings in coves to solve the problem of land shortage for fingerling production, and successful application of combined fishing methods (e.g., blocking, driving, gill-netting, and seining) to overcome the difficulty of catching pelagic fish species were all introduced. Since the 1970s, cage culture for fingerling and food-fish production has been developed and techniques have been evolved to harvest demersal species (e.g., common carp), harvest and control predatory fish (e.g., *Elopichthys bambusa* and *Erythroculter* spp.), prevent fish escape by using fences and electric barriers, and properly use draw-down areas. During this period, a set of techniques was established to provide a solid foundation for further development of reservoir fisheries in China.

- Stage three (1979 to present). Better management systems were implemented in the reservoirs. The development of reservoir fisheries was recognized as an important strategy to maximize the use of water, land, natural food organisms, labour, and equipment and to integrate fisheries with irrigation, hydroelectricity generation, forestry, and fruit production.

Today, the water area in reservoirs is 2 million ha and accounts for 40% of the total inland water surface in China. Reservoir fisheries are therefore crucial to the development of freshwater fisheries in China. Although

an average fish yield of 376 kg/ha was achieved in Chinese reservoirs in 1993, this was much lower than the yield from lakes (526 kg/ha) and ponds (3,073 kg/ha). This lower production from reservoirs is due to: the use of only two-thirds of the available water area for fish culture, large variations in fish yield per unit area, and a shortage of fisheries technicians and the unpopularity of fish culture among fish farmers.

To increase fish production in reservoirs, increased priority must be given to: reasonable stocking rates of large-size fingerlings, installation of reliable and effective fish barriers, effective elimination of harmful organisms, enhancement of economic fishery resources, application of effective fishing gear and methods, development of cage and pen fish-culture based on local conditions, and development of integrated fish-farming systems (e.g., fish-livestock-forestry or fish-agriculture-livestock). If these aspects are better managed and implemented, there is great potential to develop reservoir fisheries in China.

Reservoir fisheries has reached an unprecedented stage of development in China in the last 10 years. For example, cage culture has been further developed because of the availability in reservoirs of deep, flowing water with a high oxygen content. In 1990, the total cage area in inland waters exceeded 5,330,000 m². On average, the fish yield from cage culture was 30 kg/m². In addition, intensive and semi-intensive culture are practiced in coves and can produce fish yields that approach the levels obtained from ponds. Irrigation channels are also used for fish culture.

World-wide, reservoir construction is increasing rapidly. Many countries project massive increases in their reservoir areas by the year 2000. These water bodies are one of the few sources of potential fish production in the world. At present, limited research and data are available on which to make sound planning and development decisions. However, many countries have recognized the potential for increased fish production from reservoirs.

This book was originally published in Chinese in 1988. With assistance and encouragement from the International Development Research Centre (IDRC), the book has been revised and translated into English. We hope that it will be useful not only to fisheries scientists but also to fish farmers engaged in reservoir fisheries.

Li Sifa,

Professor (Aquaculture)

Xu Senlin,

Associate Professor

(Fishing Techniques and Science)

Department of Aquaculture

Shanghai Fisheries University

Shanghai, 200090 China

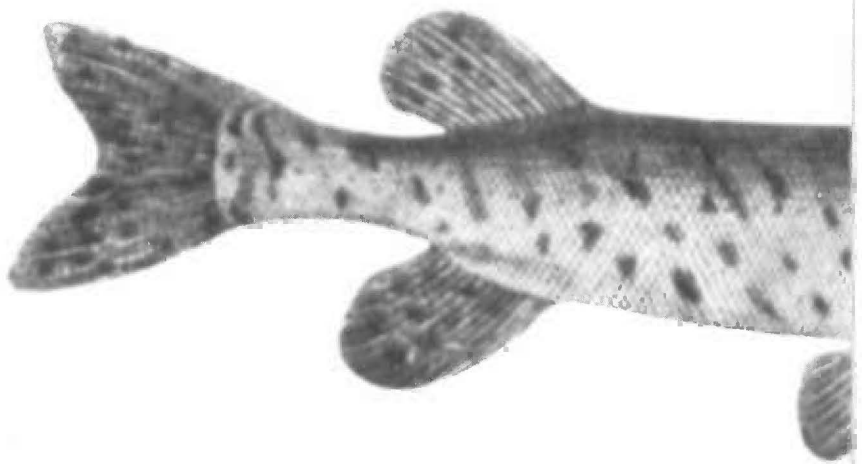

Reservoirs

For the purposes of flood control, hydroelectric power, irrigation, and navigation, a reservoir is a body of water that is created by an impounding dam and enclosed on two sides by natural banks. It is also known as an anthropogenic lake and includes impounded basins created in lowlands by raising banks or by digging in the food plains.

In general, the environmental conditions in reservoirs are intermediate between those in rivers and lakes. These differences are reflected in the morphology, hydrology, and physicochemical and biological conditions and greatly affect fish culture and capture fisheries in reservoirs.

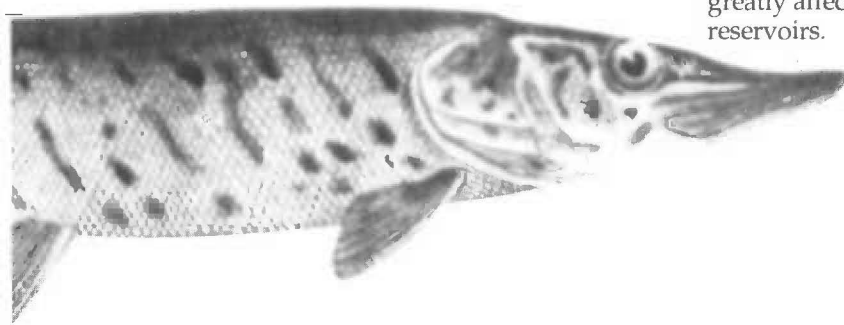

CHAPTER 1

Hydrological and Physicochemical Characteristics of Reservoirs

MORPHOLOGY

Common terminology and parameters

The most common parameters are defined as:

- Area (A)—the relative surface area at a certain water level (normally units are m^2 , ha, or km^2).
- Maximum length (L)—the distance between the two most distant points on the reservoir shore (units are m or km).

- Maximum width (W)—the maximum distance on the reservoir surface at right angles to the line of maximum length (units are m or km).

- Storage volume (V)—the water-storage capacity at a certain water level (units are m^3).

- Maximum depth (Z_m)—the maximum water depth at a certain water level (units are m).

- Mean depth (\bar{Z})—the ratio of storage volume to surface area at a certain water level ($\bar{Z} = V/A$).

- Shoreline development index (SDI)—the ratio of the shoreline length (l) to the circumference of a circle that is the same area as the reservoir. A circular reservoir would have an SDI of 1. As the shoreline becomes more irregular, the SDI increases ($SDI = l/(2\sqrt{\pi A}) = 0.2821(l/\sqrt{A})$).

- Water exchange ratio (P)—the ratio of the annual water flow (F) into the reservoir to the average storage volume (V) of the reservoir ($P = F/V$).

- Gradient ratio and water drop of reservoir bed—The gradient ratio is the ratio of the difference in elevation (i.e., height above sea level) between the upstream riverbed and the dam to the horizontal distance between these two points. The water drop is the difference between the water levels at two points in the original river stream.

- Backwater—After the reservoir is completed, backwater is created as the water level is increased. The confluent area is where the backwater meets the influx to the reservoir.

- Upstream, midstream, and lower reaches—These terms refer to the different regions in a reservoir where the water runs toward the dam (Figure 2).

- Littoral zone, sublittoral zone, and open-water area—The area around the reservoir shoreline where both emergent macrophytes and floating-leaf vegetation can grow is known as the littoral zone. The sublittoral zone is the area from the littoral zone to the deep areas where the submerged macrophytes can grow. The open-water area refers to the area outside the sublittoral zone (Figure 3).

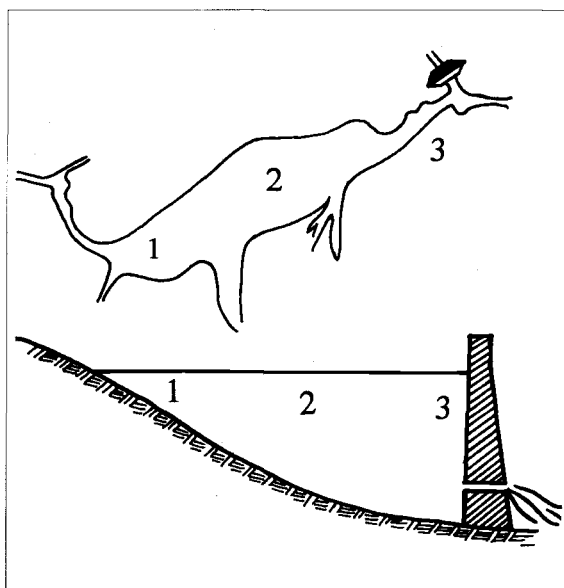

Figure 2. The upstream (1), midstream (2), and lower reaches (3) of a reservoir.

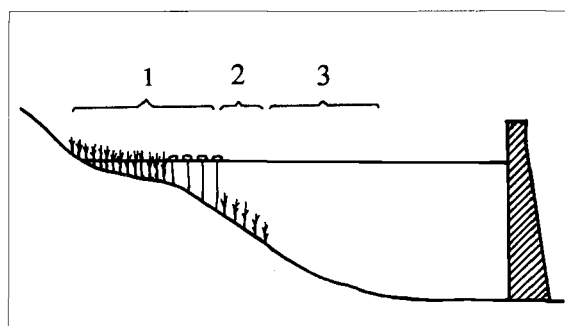

Figure 3. Lacustrine zonation of a reservoir: (1) littoral zone, (2) sublittoral zone, and (3) open-water area.

Types of reservoir

Classification by morphology

According to the local topography, the morphology of the reservoir bed, and the surface area, reservoirs are generally classified into four types.

- River-valley reservoirs (Figure 4A). These reservoirs are constructed along the valley of a stream and the impounding dam is built between the valleys. These reservoirs are usually surrounded by high mountains, have a high and precipitous bank slope ($30-40^\circ$), and have a long backwater (see Table 1). In addition, the reservoir length is much greater than the width, and

the bed slope and water drop are very large. The coves are deep and long and have many islands but little open water. Water depth varies from an average of 20-30 m to a maximum of 30-90 m. There is great variation in temperature between the upper and lower layers of water, and a thermocline usually develops. These reservoirs usually have poor exchange of nutrients and heat between the upper and lower layers. Moreover, they have fewer species of aquatic plants and benthos, but more abundant plankton. They also have few fish species. Examples of river-valley reservoirs are: Xinanjiang, Liujiaxia, Panqiao, Ansha, Changshouhu, and Meshan (the size and location of all reservoirs are given in the appendices).

- Plain-lake reservoirs (Figure 4B). These reservoirs are found in flat or water-logged areas surrounded by hills. Plain-lake reservoirs are characterized by a wide surface area, a large area of open water, a relatively regular shoreline, and few coves. Compared with river-valley reservoirs, the storage volume per unit area is small, but the surface area at the same storage capacity is large. Plain-lake reservoirs have a large drawdown area, are flat bottomed, and contain large amounts of silt. The maximum water depth is about 10 m, and there is not usually a thermocline because the water is effectively mixed. There is a rich diversity of aquatic organisms (both species composition and biomass), and the fish species are similar to those found in natural lakes located in the flatlands. Examples of plain-lake reservoirs are: Shushanhe, Xiashan, and Suyaha.

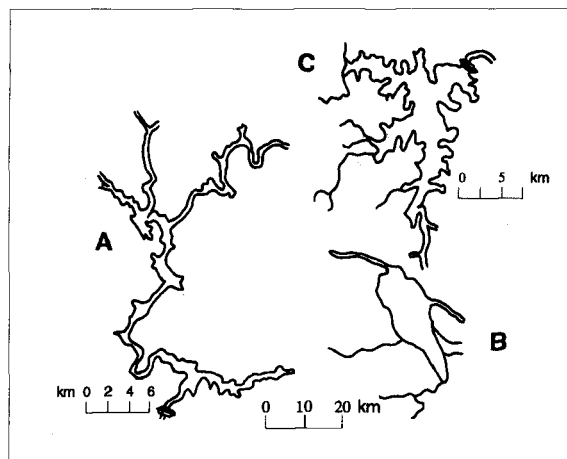

Figure 4. Types of reservoirs: (A) river-valley reservoir (Ansha), (B) plain-lake reservoir (Suyaha), and (C) hilly-lake reservoir (Nanwan).

- Hilly-lake reservoirs (Figure 4C). These reservoirs are usually constructed on rivers in hilly areas and are surrounded by hills that have a small slope. This type of reservoir is characterized by a more tortuous shoreline, more coves, an uneven bottom, and a short backwater. The open water generally lies in front of the dam, with a maximum water depth of 15-40 m. The thermocline is sometimes present, and the water is

usually fertile. Examples of hilly-lake reservoirs are Nanwan and Nanshahe.

- Hilly-pond reservoirs. These mini-reservoirs are constructed either on small streams or on low-lying land, specifically for agricultural irrigation. The mini-reservoirs are similar in shape to fish ponds.

Classification by size

Because they have different objectives, the water conservancy department and the fisheries department classify reservoirs differently on the basis of size. The water conservancy department classifies reservoirs based on storage capacity: large reservoirs (storage capacity exceeds 100 million m³), medium reservoirs (storage capacity 10-100 million m³), and small reservoirs [storage capacity 1-10 million m³ (type I), storage capacity less than 1 million m³ (type II)].

The fisheries department classifies reservoirs on the basis of surface area: huge reservoirs (surface area exceeds 6,670 ha), large reservoirs (surface area 670-6,670 ha), medium reservoirs (surface area 70-670 ha), small reservoirs (surface area less than 70 ha), and mini-reservoirs [surface area about 6-7 ha (pond type)].

HYDROLOGY

Water level, storage capacity, and surface area

Several parameters related to water level and storage capacity affect fishery production.

- Normal high water level. This is the normal level of water stored in the reservoir. This level is influenced by the hydrological characteristics of the reservoir and the demands of both industry and agriculture.

- Designated flood level. This level is determined by the type of reservoir and the predicted flood frequency. Generally, the safety of a hydraulic structure is calculated on the basis of the flow velocity of the water at a certain flood frequency. The structure should be able to withstand a flood that is much higher than the normal high water level. For example, if the flood level is calculated on the basis of the highest flood velocity over the past 100 years, it should be rechecked using the maximum flood velocity over the past 1,000 years.

- Average water level. This is the daily and annual water levels. The daily average water level is the mean value of several measurements taken during the day. The annual water level is the mean value over 12 months. Over a number of successive years, these yearly average water levels indicate the mean value of the average water level each year.

- Dead water level. This is the minimum water level. Water cannot be, or is not, discharged from the outlet channels below this level.

- Dead storage capacity. This includes a lower part used to store mud and sand, and an upper part in which a certain depth of water is maintained to ensure a water supply for irrigation, hydroelectric power, and

TABLE 1. Characteristics of the four different types of reservoirs.

	VALLEY-RIVER	HILLY-LAKE	PLAIN-LAKE	HILLY-POND
Surrounding geomorphology	high mountains	hilly area	plain or small hills	hills and table land
Bank slope	high and precipitous	moderate	small	relatively steep
Bed	very uneven; "U" shaped cross section	less uneven; cross section like a frying pan	flat; cross section like a plate	like a frying pan
Length of backwater	very long	moderate	very short	none
Gradient ratio of the original river	large	small	low	none
Tortuosity of shoreline	more tortuous, more coves	relatively tortuous	less tortuous, few coves	no coves
Maximum depth	over 50 m	30-40 m	about 10 m	less than 10 m
Mean depth	over 20 m	10-20 m	several metres	less than 10 m
Water fluctuation	fairly high	fairly high	fairly high	high
Thermocline	yes or no	yes or no	generally no	no
Area of open water	small and scattered	large and located at the front of the dam	large and concentrated	
Draw-down area	small	large	large	none
Natural fish productivity	fair	good	good	poor
Efficiency of fishery use	good	excellent	good	good

environmental sanitation. The upper limit of the water level is the dead water level.

- Designed storage capacity. This is the storage volume needed for irrigation, hydroelectric power, domestic use, and industrial and fishery production. The upper limit of the water level is the designed water level or the normal water storage level.

The water level of a reservoir is directly proportional to its storage capacity (Figure 5).

Considerable water-level fluctuation and water exchange is a characteristic of Chinese reservoirs. These variations are due to the catchment area, precipitation, evaporation, and the draw-down for usage. Water fluctuation is particularly great in reservoirs located in the monsoon areas because rainfall is more concentrated at certain times of the year. In general, rainfall decreases from the southeast to the northwest in China. The rainy season usually occurs in summer in most

places in China, but it is a little earlier in the southern and central areas compared with the north. Water resources are abundant in the reservoirs in the central and southern parts of China where the flood season usually occurs from late spring to early summer. However, water resources are less adequate in northern China where the flood season usually occurs during the hot summer. The dry season is generally from winter to spring in most reservoirs.

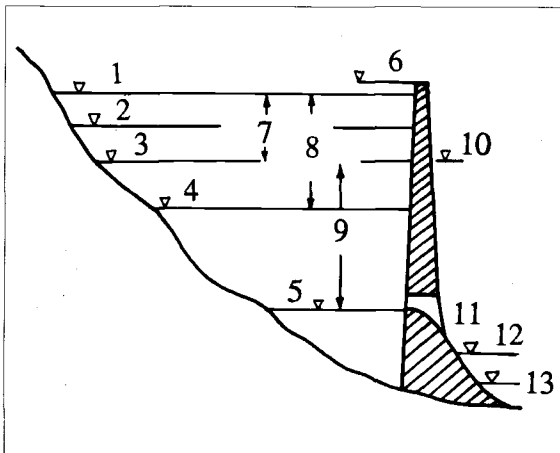

Figure 5. Different water levels and storage capacities: (1) checked flood level, (2) designed flood level, (3) normal water storage level, (4) limited flood level, (5) dead water level, (6) height of dam, (7) flood-adjustment storage capacity, (8) flood-prevention storage capacity, (9) constructed storage capacity, (10) bottom height of spillway, (11) outlet channel, (12) maximum tailwater level, and (13) normal tailwater level.

Fluctuations in water level are greatly affected by the use of the impoundment and the method of water manipulation. In reservoirs constructed primarily for flood prevention and hydroelectric power, the water level is usually decreased to the minimum level before the flood season. The level then increases to its maximum after the rainy season and gradually drops to its minimum in late winter or early spring. However, in reservoirs used mainly for irrigation purposes, the water level is gradually increased during and after the rainy season and reaches its maximum prior to the irrigation period. In reservoirs used principally for industrial production and domestic usage, fluctuations in water level are much lower although the level is usually lowest before the rainy season and then reaches its maximum.

Fluctuations in water level have negative effects on fish production:

- Fluctuations cause an irregular change in both surface area and storage capacity, which in turn influence the habitat, feeding ground, and spawning ground of fish species.
- Changes in water level produce large areas that are alternately flooded and exposed. This variation

limits growth of aquatic plants and animals. If the water level drops during the spawning season of fish, fish that lay adhesive eggs cannot spawn because of a lack of spawning nests, and eggs that are produced often die because of desiccation. This is particularly important for fish species that spawn in the littoral or sublittoral zone or spawn on stone and gravel. The area of a reservoir exposed to this cycle of flooding and drying can be very large (e.g., 8,000 ha in Nanwan Reservoir and 2,270 ha in Changshouhu Reservoir); therefore, the effects can be tremendous.

- Variations in water level place constraints on the construction and management of production bases for fingerlings around the reservoir.

- In reservoirs with large amounts of water exchange, losses of organic matter and nutritive salts limit increases in fish productivity.

However, fluctuations in water level also have advantages:

- When the water level increases, a large area of land is immersed and nutrients in the soil are released to the water, which enriches the water. When the water level decreases, the land is exposed to the air, which accelerates its mineralization and promotes further dissolution.

- When the cycle of drying and flooding is relatively long, some terrestrial plants (e.g., *Artemisia selengensis*, *Echinochloa crusgalli*, *Setaria viridis*, and *Polygonum lapathifolium*) will naturally grow in large quantities. These plants become feed or manure for fish and food organisms when they are submerged in the water. For example, the drying and flooding area in Changshouhu Reservoir is about 2,430 ha (50% of the total reservoir area). Many plants grow and develop in that area during the dry season (from August to March). There were about 30-34 million kg of plants (24 families, 66 genera, and 78 species) growing on this land.

- The lower water level in the winter makes fishing more profitable.

The disadvantages of fluctuations in water level can be modified, or, to some extent, overcome and used. For example, at the minimum water level from the late autumn to early winter, green fodder or other crops can be planted on the exposed area. The plants grown on this land can then be used as spawning sites, feed, or manure when they are immersed. During the spawning season, the water level should be increased to immerse the plants around the shoreline and provide suitable spawning grounds. It has been demonstrated that these practices directly or indirectly increase fish productivity in reservoirs.

Because of fluctuations in water level, it is difficult to calculate the surface area for fish culture. However, accurate calculation of the cultivated surface area is essential to develop a program to develop and manage the fishery resources and to analyze productivity. Based

on reservoir conditions, four methods are used to calculate the surface area for fish farming.

- Previous hydrological information is used to determine the annual average surface area at the normal water level over a period of 5-10 years. This is called the actual surface area.

- The surface area of the water at two-thirds of the designed storage capacity is calculated. This is called the checked surface area and is computed as: water level for fish culture = (designed water level - dead water level) \times two-thirds. This is called the two-thirds water level method. This calculation can be checked by subtracting the relevant surface area from the water level - surface area relationship curve.

- Using the same principle, one-half is used as the constant instead of two-thirds. The equation then becomes: water level for fish culture = (designed water level - dead water level) \times one-half. The surface area for fish farming is known as the calculated surface area.

- The area can also be calculated as: water level for fish culture = (designed water level - dead water level) \times one-half + dead water level. This area is comparatively smaller and is called the conservatively calculated surface area.

Because of errors in estimates of precipitation and variations in actual rainfall, there are differences between estimates of actual surface area, checked surface area, calculated surface area, and conservatively calculated surface area. If the difference is less than 10%, it is customary to use the checked surface area; however, if the difference is greater than 10% the calculation must be adjusted accordingly.

The surface area for fish culture in a reservoir is a very important parameter, and further study is needed to obtain a more objective and scientifically reliable method to calculate the actual surface area for fish culture.

Flow rate

Compared with rivers, the flow rate in reservoirs is rather slow after impoundment, but it is somewhat different from lakes, which are almost static. The flow rate in a reservoir depends on the degree of inflow and discharge and their interrelationship. The flow rate usually reaches its maximum during the flood season. At the inlets of the reservoir, the current may reach 0.2-2.0 m/s. At the mixed water zone, the current slows down, but can usually be measured in the water column. The flow rate at the dam depends on such factors as hydroelectric power, irrigation, and flood discharge. During the non-flood season, water flow in the entire reservoir is so slight that it can hardly be observed. The water is almost stagnant, except for wind and density currents.

As reservoir water is exchanged through regular and irregular filling and discharge, it becomes more conducive to the circulation of nutrients and to the even distribution of water temperature, dissolved

oxygen (DO), and various nutrients. These conditions favour the growth and propagation of fish and natural food organisms.

Because of the stimulation of water flow during the flood season and currents at some of the inlets, river-spawning fishes such as silver carp, bighead carp, grass carp, black carp, and mud carp can find their spawning grounds. This does not occur in natural lakes. In the same way, many phytophilous fishes, which spawn among plants upon which their eggs adhere, can use the weeds and drifting segments from upstream and bank areas during the flood season as a spawning substrate.

Sedimentation

Mud, sand, and suspended matter washed from the land during seasonal floods is deposited at the bottom of the reservoir. When the sediment is as high as the dam, the reservoir is "dead." Therefore, the life of a reservoir depends on the intensity of deposition of sediments and its dead storage capacity.

The intensity of deposition is closely related to the area, soil quality, and vegetation in the catchment area and to the biological processes that take place in inflowing solids. Generally, the speed of deposition is slow in reservoirs with good quality soil and vegetation. However, sedimentation is more serious in reservoirs with a catchment area with poor vegetation and poor soil quality. For example, one reservoir on the Huanghe River was designed in 1967 to have a storage capacity of 568 million m³ and a surface area of 11,330 ha. By 1971, the storage capacity had been reduced to 100 million m³ with a surface area of only 670-1,330 ha. In addition, its water surface had returned to the shape of the original river.

Slight sedimentation is conducive to the production of benthic organisms and aquatic plants. But, when sedimentation becomes excessive, survival of these species is adversely affected and the highly productive silt is covered by mineralized deposits. One advantage of sedimentation is that it helps to level the bottom of the reservoir, which is profitable for fishing. More trees can be planted in the catchment area to prevent soil erosion and avoid serious sedimentation.

PHYSICOCHEMICAL CHARACTERISTICS OF RESERVOIR WATER

Physicochemical conditions, which directly affect the growth, spawning, and migration of fish and bait organisms, are important environmental factors that affect fish productivity in the reservoir. The most important factors are water temperature, transparency, pH, dissolved gases, and inorganic salts.

Water temperature

Water temperature affects the metabolic rate of both fish and bait organisms as well as their feeding, growth, and spawning. Chinese carp are the principal species

cultured in the Chinese reservoirs, and the range of water temperature for their optimal growth is 20-32°C.

Overall, water temperature after impoundment is higher than in the original river. The higher water temperature improves the growth and propagation of fish and bait organisms. For example, the optimal water temperature (25-32°C) for the growth of Chinese carp was prolonged from 4 to 6 months after the completion of the Changshouhu Reservoir.

Water temperature is directly affected by latitude and height above sea level. In general, water temperatures in the north or at high elevations are lower than water temperatures in the south or at lower elevations. The length of the growing season varies in the same way (Figure 6).

Freezing usually occurs in reservoirs located north of the Changjiang River. For example, the Meishan and Foziling reservoirs in the Huaihe River Basin are frozen for about 1 month; whereas, the reservoirs in the northeast are usually frozen for 4-6 months. Although the period of freezing is comparatively longer in some large and medium reservoirs in the north, the fish seldom die because of a shortage of dissolved oxygen because the water is deep and the water continues to flow at the bottom. However, attention should be given to the overwintering safety of fish in large and medium reservoirs that have shallow water and little water flow.

Reservoirs always freeze first at shallow areas around the bank or in the coves. The ice generally melts first upstream and in tributaries, then at the middle and lower reaches and in areas of open water. Wind can sometimes pile ice against the dam (or barrier) and cause damage.

Water temperature changes from the surface water layer to the bottom water layer and creates homiothermic, cooling, warming, and thermocline layers (Figure 7). In the cooling layer, the water temperature decreases; whereas, in the warming layer, the temperature increases. In the homiothermic layer, water temperature remains constant, and in the thermocline water temperature decreases rapidly with depth (1°C per metre). The thermocline varies in thickness in different reservoirs and at different times during the period of stratification.

The vertical distribution and change in water temperature has a great effect on the productivity and habitat of natural organisms in the reservoirs. However, the effect varies from reservoir to reservoir. The difference in water temperature between the upper and lower layers is always less in shallow reservoirs. In these reservoirs, water is easily mixed; therefore, circulation is quickened and productivity is increased.

A thermocline usually develops in deep reservoirs. In Meishan Reservoir (maximum depth 70 m), the water temperature at the surface layer can reach 35°C in the hot summer (Figure 8). The thermocline normally appears at a depth of 8-23 m, and the temperature

difference is as high as 20°C. The average annual water temperature therefore remains at about 9°C at a water depth of over 20 m. A thermocline appears at a depth of 10 m in many reservoirs in northeast China.

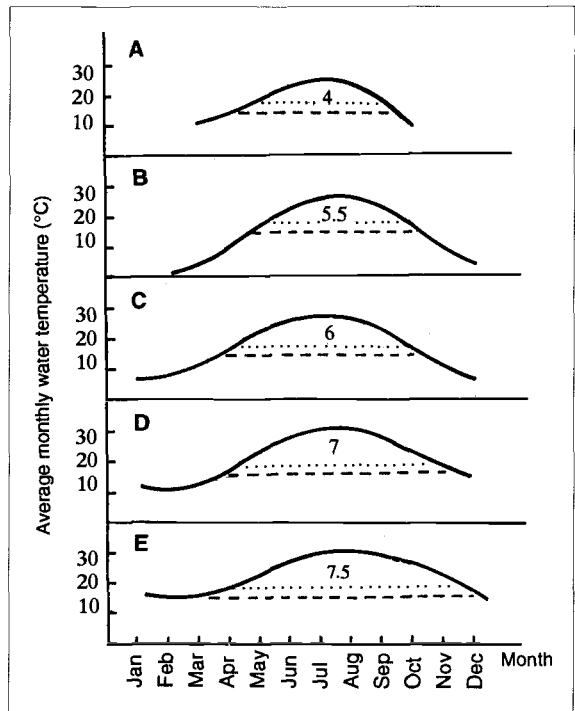

Figure 6. Growing season of fish in various Chinese reservoirs. The dotted line indicates months in which the water temperature is above 18°C and the dashed line indicates the months in which the water temperature is above 15°C. (A) Longtou Reservoir (45°N latitude), (B) Wangwo Reservoir (37°N latitude), (C) Shiquant Reservoir (33°N latitude), (D) Xinanjiang Reservoir (29°N latitude), and (E) Jinjiang Reservoir (22°N latitude).

In deep reservoirs, the difference in water temperature between the upper and lower layers is large because of the existence of a thermocline. In this case, the surface water is not mixed with the bottom water, and the nutrients deposited on the bottom are not released to the surface layer. The dissolved oxygen and warmer water at the surface do not mix with the bottom layer and the activity of aquatic organisms is reduced and reservoir productivity is lowered. In these reservoirs, the nutrients deposited on the bottom are not released to the surface water layer unless mixing occurs, or the water level is markedly reduced in summer.

Vertical changes in water temperature affect the movement and distribution of fish and in turn influence fishery production in deep reservoirs. In Xinanjiang Reservoir, common carp usually live at a depth of 1-15 m from April to August and 15-30 m from March to September. They seldom live at a depth of over 30 m because the water temperature is less than 13°C and the dissolved oxygen level is less than 1 mg/L.

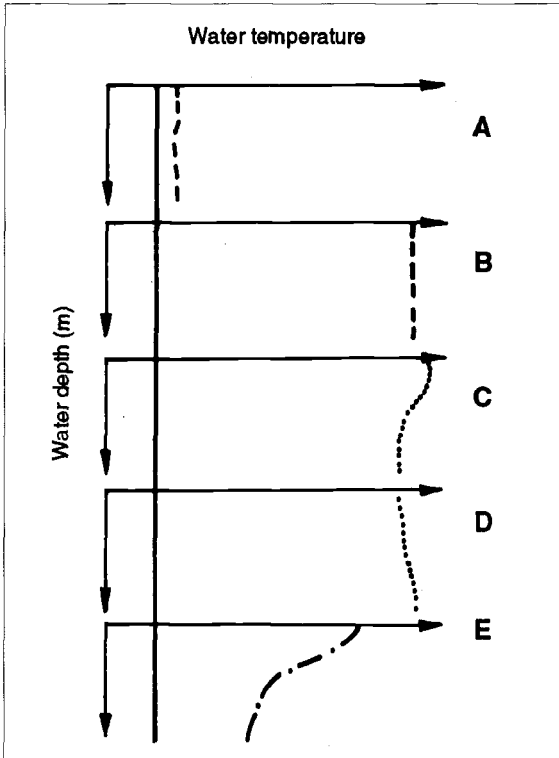

Figure 7. Vertical distribution of water temperature in reservoirs: (A, B) homiothermic layer, (C) cooling layer, and warming layer, and (E) thermocline.

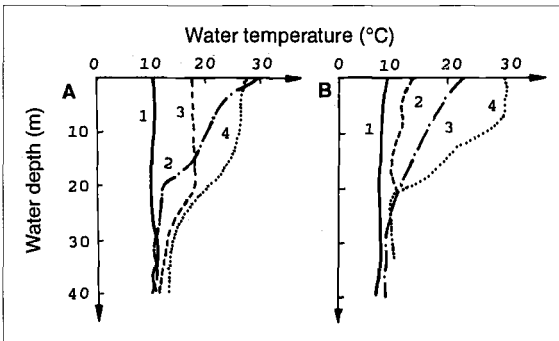

Figure 8. The vertical distribution of water temperature in two reservoirs: (A) Peiling Station of Xinanjiang Reservoir (1) March, (2) June, (3) September, and (4) December; (B) Meishan Station of Meishan Reservoir (1) February, (2) November, (3) May, and (4) August.

The vertical difference in water temperature in deep reservoirs is especially adverse to fishery production below the dam because the tailwater temperature from the turbines is only 10-18°C. For example, the maximum tailwater temperature at the Foziling and Xinanjiang Reservoirs is 14°C and 10-16°C, respectively. If low-temperature water is discharged throughout the year, the water below the dam can be used to culture cold-water fishes such as salmon and trout. For

example, rainbow trout are being successfully cultured below the dam of the Xinanjiang Reservoir. In addition, because spring comes later in the north, the tailwater can have a higher temperature than the water in fish ponds. The tailwater can be introduced into the ponds to induce early spawning of fish if the farm is constructed downstream of the dam. This type of operation has been practiced successfully at the Dachuang Fish Farm below the Liujiaxia Reservoir.

The larger the storage capacity, the more stable the water temperature. Compared with ponds in the same area, the average annual water temperature is higher in reservoirs and the difference between the maximum and minimum range of water temperature is also lower. Therefore, the growing period for fish is considerably longer in reservoirs.

Transparency

Transparency is a measure of the distance that light penetrates into the water. Transparency is closely related to plankton biomass, the amount of sandy clay, detritus, and organic matter suspended in the water, and the quantity of dissolved elements in the water. Therefore, transparency can be used empirically to estimate water fertility or the depth of the euphotic zone (the depth at which 99% of the surface radiation has been absorbed or dissipated).

Except when transparency is lowered because of flood water and runoff during the rainy season, the water transparency in reservoirs is usually high (1-3 m in the open water areas of large and medium reservoirs). For example, it is 0.75-2.35 m in Qinghe Reservoir, about 2.5 m in Liuxihe Reservoir, 1.5-2.1 m in Meishan Reservoir, and 1.1-1.4 m in Lingdon Reservoir (667 ha). There are very few fertile reservoirs with a transparency of less than 0.5 m in China (e.g., Qingshan Reservoir, 0.2-0.3 m).

Water transparency usually decreases after heavy rain. Water turbidity varies with runoff, sand content, and the size and shape of the reservoir. In small or mini-reservoirs, the water often becomes turbid throughout the reservoir because of flooding, but in large and medium reservoirs usually only the middle and lower layers become turbid.

During the flood season, when the turbid layer moves downstream, fish populations move downstream and sometimes collect in front of the dam. This is usually a good time to harvest fish. For example, 560 tonnes of silver carp and bighead carp were caught near the dams of the Xianghongdian and Xinanjiang Reservoirs during the flood season (23-29 April 1966). This fishing effort must be well timed because the fish will scatter soon after the water becomes turbid throughout the reservoir.

pH

The pH depends on the concentration of ionized carbon dioxide ($\text{pH} = 6.37 - \log \text{CO}_2 + \log \text{HCO}_3^-$). This indicates that the higher the CO_2 concentration, the lower the pH value.

Fish can tolerate a certain range of pH. The optimal pH value for common carp is 4.4-10.4. When the pH exceeds this range, the skin mucus and gills are destroyed and the fish die. In acidic water, the fish require less oxygen, but the interaction of haemoglobin with oxygen is reduced and the fish lose their physical balance and their metabolism and growth are affected.

Changes in pH not only affect the physical condition and survival of fish and aquatic organisms, they also directly affect the utilization and transfer of nutrients in the water. Weakly alkaline water is more favourable to the decomposition of organic matter and to the absorption and utilization of nutrients by plankton and aquatic macrophytes. However, acidic water does not aid decomposition of organic matter and causes some dissolved nutrients to be deposited as sediments that cannot be used by organisms (e.g., calcium deposited as CaCO_3). Therefore, weakly alkaline or neutral water (pH 7-9) is preferred for fish farming.

The pH value in reservoirs varies greatly because of differences in the pH of the soil and rivers and streams. In general, the pH of the soil decreases from north to south in China. The soils in the north and northeast are generally black, dark, calcareous, and brown soils. When the bases are saturated with available calcium, the water is slightly alkaline. The soils in the south are generally red and yellow in colour and the bases are unsaturated. Because of the higher temperatures, fast microbiological mineralization, more precipitation and erosion, the water in the southern reservoirs is usually weakly acidic or neutral. This is one reason why fishery productivity is comparatively low in southern reservoirs.

Dissolved gases

Many gases are dissolved in reservoir water, but oxygen and carbon dioxide are the most critical to fish. Although other toxic gases such as hydrogen sulphide, methane, and ammonia do exist in reservoir water, little information on their toxicity is available and they are of little importance because of regular exchange of water.

- Dissolved oxygen (DO) is essential to the metabolism of every organism living in the water. Fish absorb dissolved oxygen through their gills and require a certain amount of DO to sustain their life. When water temperature and other ecological conditions are suitable, fish usually have a high feeding intensity, fast growth, and have a low food coefficient when DO is over 5 mg/L. Fish feed poorly and have a high food coefficient when DO is less than 2 mg/L. Fish suffocate if DO drops below 1 mg/L (Table 2). High DO is

one of the most important factors needed to promote growth of fish in reservoirs.

Because the water is regularly exchanged at the considerable flow rate, DO content is usually adequate, constant, and evenly distributed in reservoirs. The oxygen content at the surface layer is 7-10 mg/L (He Zhihui and Li Yonghan 1983, Lu Quixiang *et al.* 1984).

There is little variation in DO between upstream and downstream locations, and DO content is similar at the surface and bottom layers of shallow reservoirs. But, the DO level at the surface is usually higher than that at the bottom of deep reservoirs. At Meishan Reservoir, DO at the upper, middle, and bottom water layers was 8, 6, and 5.5 mg/L, respectively, in summer. At a depth of 0-10 m, DO decreased by 1-1.5 mg/L per 5 m; at depths greater than 10 m, DO decreased 0.2 mg/L per 5 m.

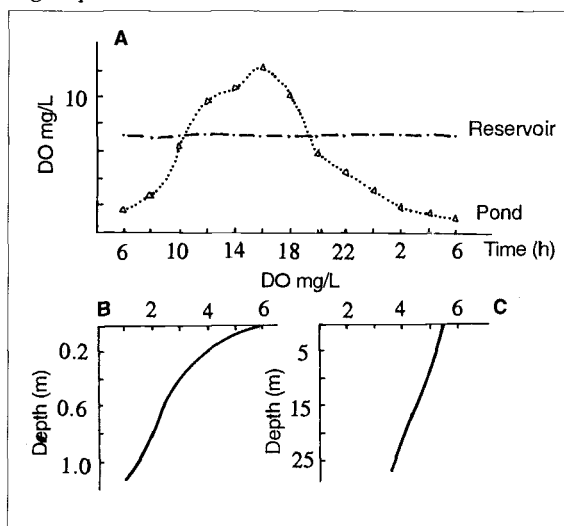

Figure 9. A comparison of DO content in reservoirs and ponds: (A) the diurnal change of DO at the surface of reservoirs and ponds; (B) the vertical change of DO in ponds; and (C) the vertical change of DO in reservoirs.

The dissolved oxygen content at the bottom is related to water flow in the reservoir. For example, in Xinanjiang Reservoir, the DO is as high as 11.3 mg/L at a water depth of 30 m in locations where there is an undercurrent, but DO is less than 1 mg/L at a depth of 18 m in places without water flow.

Compared with ponds, the higher DO in reservoirs has several advantages (Figure 9):

- The higher DO content can fully meet the physical demands of the fish.
- There is little diurnal variation of DO. For example, at Peiling Station in Xinanjiang Reservoir, the diurnal change of DO ranged from 7.09 to 7.84 mg/L within a depth of 10 m compared with a variation of 1-12 mg/L at the surface layer of a nearby fish pond. In the pond, the fish lacked sufficient DO one-third to one-half the time.

TABLE 2. Rates of oxygen consumption and levels of dissolved oxygen at which major Chinese carps suffocate

SPECIES	BODY WEIGHT (G)	WATER TEMPERATURE (°C)	O ₂ CONSUMPTION RATE PER HOUR (MG/G)	SUFFOCATION RANGE (MG/L)
Silver carp	5.20	27.7	0.33	0.72-0.34
Bighead carp	4.67-5.27	26.0-27.7	0.28-0.32	0.38-0.34
Grass carp	9.60	27.6	0.28	0.51-0.30
Black carp	1.31	27.6	0.40	0.89-0.63
Common carp	3.60	26.4-27.0	0.26-0.38	0.34-0.30
Crucian carp	3.32	26.4-27.0	0.26-0.38	0.13-0.11
Blunt snout bream	0.85	20.0	0.47	—

• There is little vertical change of DO. In ponds, although normally 1.5-3 m deep, the vertical variation of DO is so great that fish at the bottom often suffer serious DO depletion. As a result, all of the water cannot be fully used by the fish.

The concentration of carbon dioxide in reservoir water generally ranges from 2.0 to 12.0 mg/L. In contrast to oxygen, the concentration of CO₂ at the bottom is higher than at the surface. This is primarily due to the decomposition of organic matter, the respiration of animals, and the decomposition of carbonates.

Nutrients

Nitrates, phosphates, silicate, and iron are important nutrients required by fish and bait organisms in reservoirs. Inorganic nitrogen exists in the form NH⁴⁺, NO²⁻, and NO³⁻ in water. Inorganic nitrogen results mainly from runoff and therefore concentrations are highest in confluent areas and coves. Phosphorus is an important nutritive element for organisms and directly affects their growth. Unfortunately, phosphorus is in the lowest concentration of naturally available nutrients. Silicate is essential for diatom algae, one of the food sources required by silver carp and bighead carp as well as many species of zooplankton. In reservoirs, the dynamics of the SiO₂ concentration are linked with the growth of diatom algae. Iron is important for the production of blood and bone by the fish.

Because the soil and vegetation are different in the catchment area and the submerged area, the concentration of nutrients varies from reservoir to reservoir. Table 3 summarizes the nutrient contents of some Chinese reservoirs. These data are only indicative because the measuring methods were not standardized and the concentrations of nutrients varied depending on the age and development of the reservoir itself and the growth of phytoplankton (Figure 10). The concentration of nutrients is also affected by the hydrological conditions of the reservoirs. In general, they become richer after floods. Based on long-term observations,

the change in nutrient concentration in reservoirs may be divided into three stages:

• The high concentration stage usually occurs when the reservoir is initially completed because large areas of land are immersed, many plants decay, and a lot of organic and inorganic matter is dissolved in the water. At this time, the fertility of the water reaches its maximum.

• The relatively low concentration stage occurs several years after impoundment when almost all of the nutrients obtained during the initial stage are used up and the only supplements are from runoff.

• The stable concentration stage occurs when there is a continuous supply of nutrients from runoff. Additional organic matter is accumulated at the reservoir bottom (which becomes more flat) and the area that is dried and immersed becomes more stable as different populations develop.

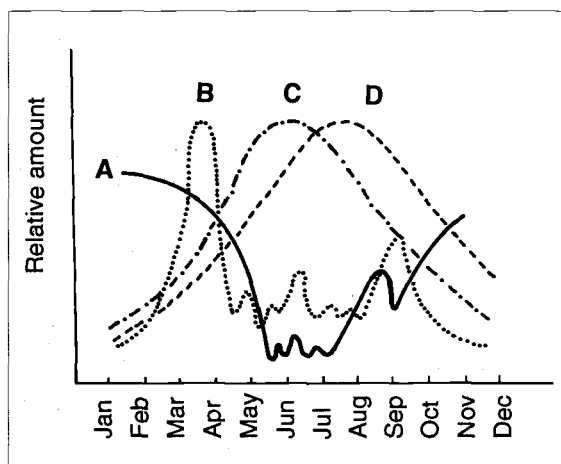

Figure 10. Seasonal changes in nutrients, phytoplankton, illumination, and water temperature in reservoirs: (A) nutrients, (B) phytoplankton, (C) illumination intensity, and (D) water temperature.

TABLE 3. Nutrient levels in some Chinese reservoirs

RESERVOIR	AREA (HA)	PH	HARDNESS (GERMAN DEGREES)	O ₂ USED BY ORGANIC MATTER (MG/L)	CONDUCTIVITY (µMHOS/CM)	MAIN IONS (MG/L)						NUTRIENTS (MG/L)							
						CA ⁺²	MG ⁺²	K ⁺ & NA ⁺	HCO ⁻³	CO ₃ ⁻²	SO ₄ ⁻²	CL ⁻	NH ⁺⁴	NO ⁻²	NO ⁻³	P ₂ O ₅	SiO ₂	TOTAL IRON	
Nanchengzi ^a	533	7.8-7.9	5.68-12.04			1.52-3.40							0.05-0.1	0.14-0.17	0.61-0.01				0.14-0.8 Fe ⁺³
Hekou ^b	1,200	9.4	31.53	6.12		11.6	130.0	1069.0	1190.0	405	244	697	0.252	0.002	0.016	0.56	3.90		0.46
Fenhe ^c	1,670	8.35	24.92	2.2		2.11	1.08	0.63	2.58	0.25	0.83	0.29	0.227	0.040	0.516	0.009	6.1		0.071
Liujiaxia ^d	10,670	8.45	8.75	2.4		10.9	11.1	12.8	177.4		20.9	10.9	0.11	0.007	0.333	0.03	6.5		0.023
Bailianhe ^e	4,000	7.8	21.56	5.1		10.2	3.2	8.5	59.8	0	6.2	0.7	0.40	0.008	0.060	0.036	1.80		0.048
Meichuan ^f	167		1.91	7.5	80.0							3.0	0.41	0.001	0.014	0.04			
Xinjiang ^g	4,000	7.0-8.4	2.0-4.0	2.5-4.5		8.62-18.59	1.0-10.0					1.0-8.0	0.02-0.06	0.0015-0.01	0.002-0.006	0.005-0.01	4.6-10.1		
Qingshan ^h	567	7.6-8.7		2.0-11.7	80.0-164.0	21.6-41.7					7.1-63.4	4.1-8.7		0.2	0.012	0.2-1.2			0.01-0.5 Fe ⁺³
Tumenzi ⁱ	930	7.2-8.4	0.28-0.54	2.67-21.2		0.28-6.85	0.49-3.38			0.88-36.28	2.37-1.87	0.08-0.15	0.003				0.06-11.8		0.0008-0.08 Fe ⁺³
Average of twelve reservoirs ^j	22-3,000	6.4-8.7	82.0-482.0	0.30-47.8	0.0002-14.8	0.33-1.79							0.0-0.348	0.001-0.008	0.008-0.952	0.011-0.275	0.02-15.5		0.001-1.204

^a Liu Yuming 1984
^b Zhang Xiaogang 1984
^c Li Zhenquan 1984
^d Guansu Fisheries Institute 1984
^e Hu Batong *et al.* 1993
^f Hubei Provincial Reservoir Investigation Team 1982
^g Lin *et al.* 1990
^h Xu Shencai and Wang Chongguan 1984
ⁱ Jie Yuhao and Li Bo 1987
^j Guangxi Fisheries Research Institute 1984

CHAPTER 2

Natural Food Organisms

Fish culture in reservoirs depends on the availability of natural food (e.g., plankton, detritus and bacteria, periphyton benthos, and aquatic macrophytes) (Figure 11). The species composition and biomass of the reservoir fauna and flora influence fish productivity. Therefore, it is necessary to study the sources of natural food and assess fish productivity when determining suitable stocking and survival levels for fish culture in reservoirs.

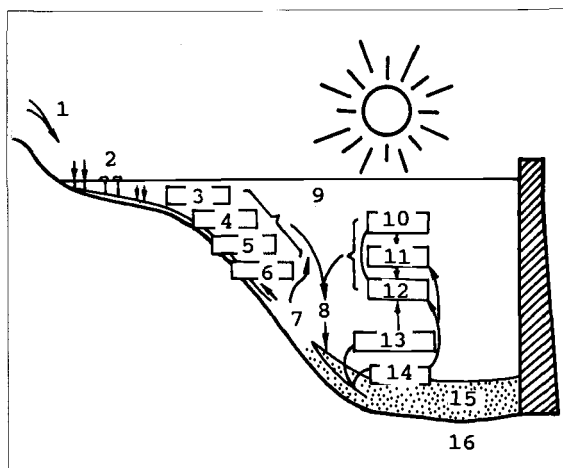

Figure 11. Sources of natural food in reservoirs: (1) detritus and nutrients, (2) littoral zone, (3) aquatic plants, (4) periphyton, (5) benthos, (6) fish, (7) nutrients, (8) detritus, (9) open water, (10) phytoplankton, (11) zooplankton, (12) fish, (13) invertebrates, (14) bacteria, (15) detritus, and (16) bottom.

After impoundment, the hydrological conditions in reservoirs change and, as a result, the species composition and biomass of natural organisms change. Species that originate in rivers either adapt to the new environment, become extinct, or are confined to the upper stream and confluent area. Organisms that originate in submerged ponds, ricefields, ditches, and lakes become part of the natural fauna and flora when the water level rises in a reservoir and survive or disappear depending on their degree of adaptation. In general, the faunal composition is richer in reservoirs than in rivers; however, the biomass of different species varies considerably.

PHYTOPLANKTON

After impoundment, the water level rises, water flow slows, transparency increases, and sunlight penetrates to greater depths. Organic matter is continuously

released from the submerged area and from aquatic plants, and the environment becomes more favourable for the growth and reproduction of phytoplankton. The number of species, and their biomass, increase significantly (Table 4). The formation of the phytoplankton community takes place rapidly and is usually completed when the water level rises to its designated height.

TABLE 4. Comparison of the plankton biomass in rivers and reservoirs^a

	PHYTOPLANKTON		ZOOPLANKTON	
	10 ³ /L	MG/L	No./L	MG/L
River	355	0.69	2,080	0.21
Reservoirs	800	0.75	12,640	1.07

^a All figures are averages from 17 rivers and 11 reservoirs in Guangxi, adopted from Guangxi Fisheries Research Institute (1984).

The species of phytoplankton are similar in southern and northern reservoirs. The common species are from the genera: *Melosira* and *Cyclotella* (Bacillariophyta); *Anabaena*, *Aphanizomenon*, and *Microcystis* (Cyanophyta); *Cryptomonas* and *Ceratium* (Pyrrophyta); and *Chlamydomonas*, *Eudorina*, and *Pediastrum* (Chlorophyta) (Figure 12). In terms of species and biomass of phytoplankton, diatoms and green algae are dominant.

Phytoplankton are not evenly distributed in reservoirs. Biomass is usually greater in the midstream to upstream areas, but lower at greater depths (Figure 13). In Dahuofang Reservoir in June 1963, the average phytoplankton density of the upper, middle, and bottom water layers in the upstream area was 886×10^3 /L; whereas, the average numbers in three different water layers in the middle and lower streams were 1978×10^3 /L and 521×10^3 /L, respectively. In Fenhe Reservoir, the levels of phytoplankton biomass at the upper, middle, and lower streams were 4.71 mg/L, 4.85 mg/L, and 3.91 mg/L, respectively (Li Zhenquan 1984).

In reservoirs, the longitudinal distribution of phytoplankton is closely related to water currents, turbidity, and the abundance of nutrients. For example,

diatoms, because of their heavier cell wall, tend to sink more quickly than other species. As a result, the phytoplankton biomass usually declines from the upstream to the downstream areas in reservoirs dominated by diatoms. If turbidity is relatively high upstream, the biomass of phytoplankton will be highest at midstream, and the biomass downstream will be low because some algae sink to the bottom and the nutrient concentration decreases as the depth increases.

The vertical distribution of phytoplankton biomass decreases from the surface to the bottom. The biomass concentration increases with depth until it reaches a peak at mid-depth (Figure 13B). Phytoplankton biomass also shows remarkable seasonal changes. The biomass is usually at its minimum in the winter and maximum in the summer or autumn (Figure 14).

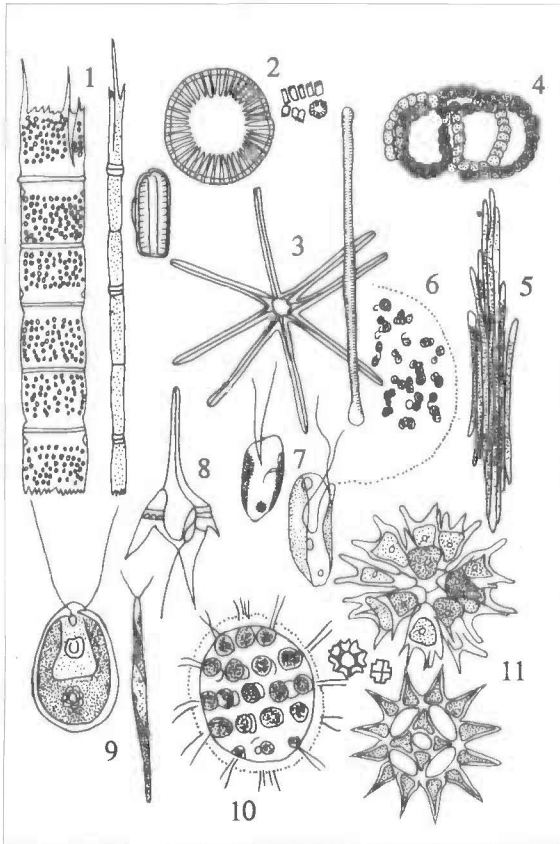

Figure 12. Common genera of phytoplankton in reservoirs: (1) *Melosira*, (2) *Cyclotella*, (3) *Asterionella*, (4) *Anabaena*, (5) *Aphanizomenon*, (6) *Microcystis*, (7) *Cryptomonas*, (8) *Ceratium*, (9) *Chlamydomonas*, (10) *Eudorina*, and (11) *Pediastrum*.

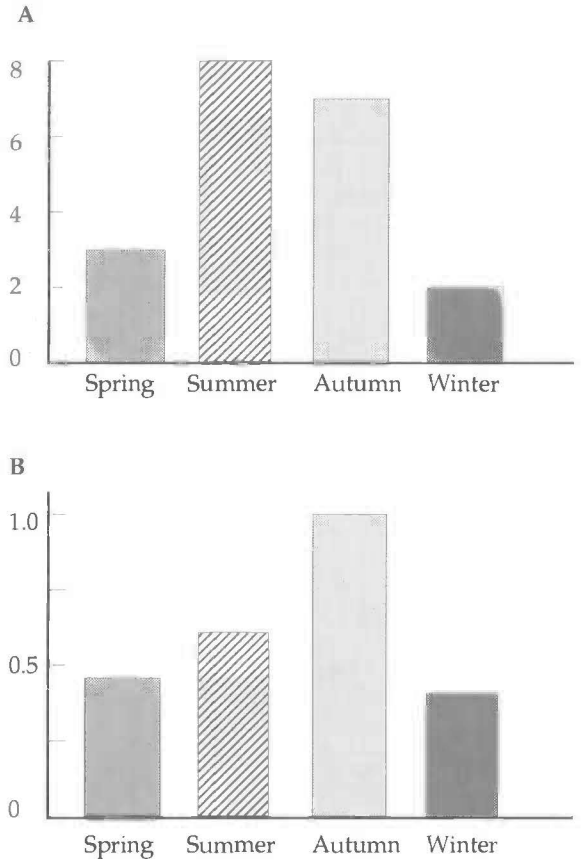

Figure 14. Seasonal changes (mg/L) in phytoplankton biomass in reservoirs: (A) Qinghe Reservoir (He Zhihui and Li Yonglian 1983); (B) Chengbihe Reservoir (Guangxi Fisheries Research Institute 1984).

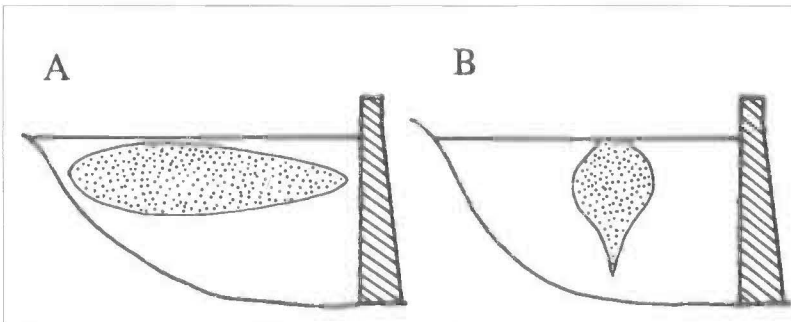

Figure 13. Distribution of phytoplankton in reservoirs: (A) longitudinal distribution, and (B) vertical distribution.

ZOOPLANKTON

In rivers, the biomass of zooplankton (e.g., infusorians, rotifers, cladocerans, and copepods) is very low because of the fast flow rate and lower organic matter content. After impoundment, the flow rate slows, more suspended matter sinks to the bottom, organic matter increases, and the transparency increases. Under these conditions, phytoplankton and bacteria

propagate quickly and stimulate the development of a zooplankton fauna.

Unlike the rapid formation of the phytoplankton community, it takes 2-4 years for the zooplankton community to develop and stabilize. Generally, zooplankton develop faster in reservoirs that have small fluctuations in water level and a lower number of aquatic macrophytes.

The common species of zooplankton belong to the genera: *Diaphanosoma*, *Bosmina*, *Bosminopsis*, *Ceriodaphnia*, *Macrocyclus*, *Brachionus*, *Asplanchna*, *Synchaeta*, *Lecane*, *Difflugia*, *Cucurbitella*, *Amoeba*, *Arcella*, and *Epistylis* (Figure 15). Protozoa are the most abundant, but have a low biomass. There are fewer species of *Rotifera*, *Cladocera*, and *Copepoda* but they form the largest part of the total biomass. On average, there are 10^2 - 10^3 zooplankton/L in reservoirs (maximum 10^4 /L) and the biomass level is about 1 mg/L. The Guangxi Fisheries Research Institute found that the maximum density of zooplankton was 3,618/L in Zhongdang Reservoir and that the minimum was 406/L in Guishi Reservoir. The highest biomass of zooplankton was 2.68 mg/L in Dushan Reservoir, and the lowest was 0.40 mg/L in Xijin Reservoir.

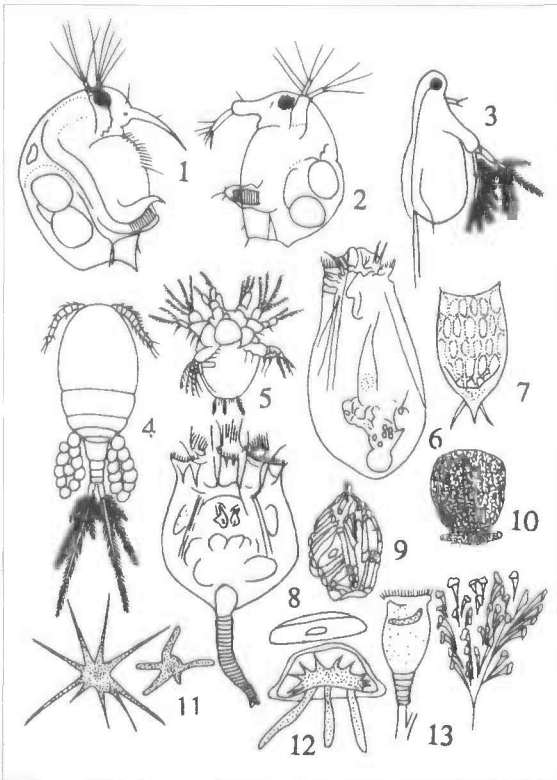

Figure 15. Genera of zooplankton commonly found in reservoirs: (1) *Bosmina*, (2) *Bosminopsis*, (3) *Diaphanosoma*, (4) *Macrocyclus*, (5) *Nauplius*, (6) *Asplanchna*, (7) *Lecane*, (8) *Brachionus*, (9) *Difflugia*, (10) *Cucurbitella*, (11) *Amoeba*, (12) *Arcella*, and (13) *Epistylis*.

The quantity and distribution of zooplankton depend on the phytoplankton biomass. This dependence can be seen in studies of the biomass of phytoplankton and zooplankton at the upper, middle, and lower reaches of Qinghe Reservoir in Liaoning Province (Table 5). Because most zooplankton species migrate vertically, their vertical distribution is greater than that of phytoplankton, and zooplankton continue to be abundant even at depths of 10-15 m in some reservoirs.

There are also seasonal changes in zooplankton biomass. Biomass is lowest in January and February when the water temperature is lowest. Biomass reaches a maximum in the summer and autumn. However, the peak of zooplankton production also depends on the location of the reservoir. For example, the sequence of zooplankton biomass in Chengbihe Reservoir is autumn > summer > spring > winter (Figure 16); in Qinghe Reservoir, the sequence is summer > autumn > spring > winter. Differences in geographic location and natural surroundings cause zooplankton biomass to vary greatly between reservoirs (Table 6).

In addition, turbidity affects zooplankton reproduction. As turbidity increases, zooplankton biomass declines. After heavy winds or a storm, the suspended mud and sand can cause high zooplankton mortality (for copepods, the mortality can be as high as 80-90%).

The density of phytoplankton is much higher than the density of zooplankton in reservoirs (e.g., phytoplankton 10^4 - 10^5 /L, zooplankton 10^2 - 10^3 /L). Phytoplankton are about a hundred times more plentiful in number and about 1-3 times greater in biomass. For example, in Qinghe Reservoir, from 1970 to 1979, the average biomass of phytoplankton was 5.97 mg/L compared with 1.95 mg/L for zooplankton (ratio 3:1) (He Zhihui and Li Yonghan 1983). Investigations by the Guangxi Fisheries Research Institute in 13 southern reservoirs in 1984 found that the average biomass ratio between phytoplankton and zooplankton was 1.2:1.

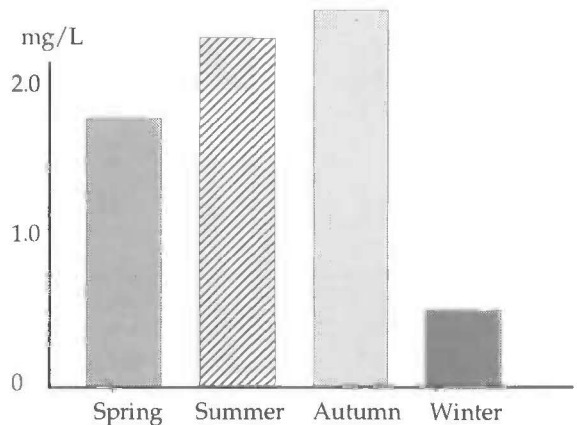

Figure 16. Seasonal changes in zooplankton biomass in Chengbihe Reservoir (Guangxi Fisheries Research Institute 1984).

TABLE 5. Seasonal changes in plankton biomass in Qinghe Reservoir (mg/L) (He Zhihui and Li Yonghan 1983)

SEASON	UPSTREAM			MIDSTREAM			LOWER STREAM			AVERAGE		
	PHYTO	ZOO	TOTAL	PHYTO	ZOO	TOTAL	PHYTO	ZOO	TOTAL	PHYTO	ZOO	TOTAL
Spring	4.25	1.38	5.63	3.73	0.63	4.36	2.20	1.03	3.23	2.73	1.13	3.86
Summer	13.75	3.40	17.15	19.25	7.10	26.35	2.35	2.75	5.10	7.88	3.78	11.66
Autumn	17.17	4.75	21.92	10.47	3.17	13.54	7.07	1.05	8.12	6.55	2.32	11.10
Winter	2.60	0.85	3.45	2.30	0.71	3.01	1.37	0.13	1.50	1.80	0.40	2.20
Average	9.44	2.60	12.04	8.94	2.90	11.84	3.25	1.24	4.49	5.37	1.84	7.21

Note: Phyto = phytoplankton, Zoo = zooplankton.

TABLE 6. Plankton biomass in some Chinese reservoirs

RESERVOIR	LOCATION (PROVINCE)	AREA (HA)	PHYTOPLANKTON		ZOOPLANKTON		SOURCE
			(MG/L)	(10 ³ /L)	(MG/L)	(NO./L)	
Longtou	Jilin	800	5.764	2,620	0.587	316	Zhang <i>et al.</i> 1981
Qinghe	Liaoning	3,000	5.97	—	1.95	—	He Zhihui and Li Yonghan 1983
Liujiaxia	Gansu	10,670	0.64	580	1.10	458	Guangxi Fisheries Research Institute 1984
Hekou	Shanxi	1,200	1.99	1,082.5	2.45	178	Zhang <i>et al.</i> 1981
Fenhe	Shanxi	1,670	4.24	—	1.15	—	Li Zhenquan 1984
Bailianhe	Hubei	4,000	—	3,919	—	2,996	Hu Batong <i>et al.</i> 1983
Xujiahe	Hubei	3,840	1.065	20.46	0.434	648	Hubei Provincial Reservoir Investigation Team 1982
Meichuan	Hubei	167	14.6	4,869	1.169	6,572	Hubei Provincial Reservoir Investigation Team 1982
Xinjiang	Zhejiang	40,000	8.05	134-184	1.22	1,521-2,185	Lin <i>et al.</i> 1990
Bantou	Fujian	333	—	25.45-43.8	—	150-1,770	Li Sifa 1975 (unpublished)
Tumenzi	Liaoling	930	0.95-2.24	69.6-138.1	0.656-1.254	1,291-2,286	Jie and Li 1987
Twelve Reservoirs	Guangxi	22-3,000	0.3123-4.1549	343-4,207	0.0185-4.134	15-26,114	Guangxi Fisheries Research Institute 1984

DETRITUS AND BACTERIA

Most detritus is nonliving organic particles, but there is some living material. There are two main sources of detritus: the bulk comes from plant debris and animal manure. Generally, 10-50% of the plant materials consumed by herbivorous animals is undigested and discharged as faeces or pseudofaeces. Faeces are a rich source of organic matter and bacteria.

Detritus includes the organic matter that is converted from the dead bodies of organisms by mechanical grinding and decomposition by heterotrophic bacteria and fungi. In the past, bacterial biomass was neglected in the consideration of the total biomass of natural organisms in water bodies. Therefore, its effect on nutrient and energy circulation in ecosystems was not appreciated. It is only in the last 20 years that the functions of detritus and bacteria in the aquatic ecosystem have been studied. It is now known that they not only play an important role in trophic dynamics, but are a nutritive source and important link in the food chain in reservoirs.

Based on size, detritus can be divided into three categories: macroparticle organic matter (diameter > 1mm), microparticle organic matter (diameter 0.5 μ m-1mm), and dissolved organic matter (diameter < 0.5 μ m). When plant fragments and manure are loaded into waters for a considerable time, nutrients leach out and leftover particles, through mechanical grinding, animal grazing, and decomposition by bacteria, are converted into small particles that can be grazed by organisms. These particles, which are the nutritive source for heterotrophic bacteria, are then further simplified.

In polluted water systems, the biomass of bacteria is proportional to the amount of organic matter in the water. The biomass increases as organic matter increases and declines when the organic matter is digested, or if little organic matter is added. Guangxi Fisheries Research Institute reported that the average number of bacteria in the upper, middle, and lower stream of Chengbihe Reservoir in 1983 was 500/L, 174 x 10⁴/L, and 100/L, respectively. The techniques for quantification of detritus and bacteria have not been perfected; therefore, the effect of detritus and bacteria on fish production needs further study. However, next to plankton, detritus and bacteria are the most important natural food resource in reservoirs.

PERIPHYTON

The layer of epiphytic algae that covers rocks and submerged tree branches is called periphyton and includes diatom algae (*Dinobryon* and *Cladophora*). In addition, *Rotifera* and *Vorticella* are also numerous. Periphyton is an excellent source of food for grazers such as *Xenocypris* spp. and mud carp.

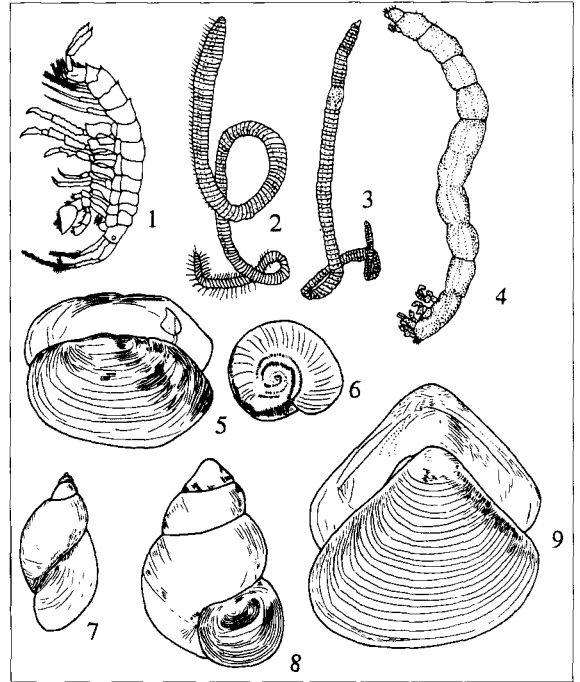

Figure 17. Benthic genera commonly found in Chinese reservoirs: (1)*Gammarus*, (2)*Branchiura*, (3)*Limnodrilus*, (4)*Chironomus*, (5)*Anodonta*, (6)*Gyaulus*, (7)*Lymnaea*, (8)*Bellamya*, and (9)*Corbicula*.

BENTHOS

Except in shallow plain-lake reservoirs and old reservoirs, benthic fauna and diversity are low (Table 7). This is because most reservoirs are deep, have fluctuating water levels, have heavy silt deposition, and the benthos reproduces poorly and has low mobility. During the early stages of impoundment, the benthos consists of both riverine species and species from the submerged area. After many years, changes in hydrological conditions mean that benthos that prefer running water are confined to the upper stream and are limited in number of species and in biomass. Benthos that prefer static water (e.g., chironomid larvae, oligochaetes, and molluscs) (Figure 17) become abundant in species number and biomass and gradually become the dominant species. Chironomids propagate most quickly and become the dominant species (80-90% of the total biomass of benthos in most reservoirs) because the adults can fly and lay eggs in the water more than six times during the summer. The larvae are planktonic and omnivorous. They can ingest food either by filtering or by swallowing. Chironomid larvae are also able to withstand low oxygen levels and poor water quality.

Oligochaetes are often next to chironomids in biomass (and are sometimes dominant). In Xianghongdian Reservoir and Meishan Reservoir,

tubificids account for most of the benthos. Because Tubificidae, unlike most other benthic species, can live in deep water, they are most abundant at depths of 40-50 m.

Molluscs are few or absent in deep reservoirs, but are relatively abundant in shallow reservoirs. For example, in the Gedalou and Yongxing Reservoirs, which have a water depth of about 1 m, the biomass of the clam *Cristaria plicata* was found to be 4,500 kg/ha and the snail *Corbicula fluminea* was 8,100 kg/ha.

Compared with plankton, the development of benthos in reservoirs is a long process that varies depending on hydrological and bottom conditions. The benthic fauna always develops faster in lake-type reservoirs, but more slowly in the river-type reservoirs. Sometimes, benthic populations never reach saturation because some of the original species from the river become extinct, and new species do not become established. However, some benthic species can be introduced to accelerate the development and reformation of benthic fauna.

AQUATIC MACROPHYTES

After impoundment, most of the original aquatic macrophytes and land plants in the submerged area are destroyed and new plants start to grow around the shoreline. Aquatic macrophytes develop first in inlet areas and coves where seeds first spread because of the water current. It takes a long time for aquatic macrophytes to become abundant; usually several years in small reservoirs and sometimes as long as 20 years in large reservoirs.

Because of extensive fluctuations in water level, steep banks, and erosion, aquatic macrophytic fauna are poor in species diversity and abundance. Most species are only found in the confluent area or shallow areas of coves. Common species include: *Vallisneria spiralis*, *Potamogeton crispus*, *Hydrilla verticillata*, *Ceratophyllum demersum*, *Pistia* spp., *Potamogeton malainus*, *Najas* spp., and *Eichhornia carassipes* (Figure 18). However, aquatic macrophytes are well developed in some old reservoirs such as Dongqianhu and in shallow reservoirs such as Ersheng and Qiaozijian.

TABLE 7. Benthic biomass in some Chinese reservoirs

RESERVOIRS	GROUP	DENSITY (No./M ²)	BIOMASS (G/M ²)	SOURCES
Liujiaxia	Chironomid larvae	120	0.242	Guangxi Fisheries Research Institute 1984
	Tubificidae	71	0.044	
	Aquatic insects	0.4	0.006	
Fenhe	Tubificidae	16	0.033	Li Zhenquan 1984
	Chironomid larvae	12	0.066	
	<i>Gammarus</i> spp.	1	0.001	
Xujiahe	Oligochaetes	285	0.042	Hubei Provincial Reservoir Investigation Team 1982
	Aquatic insects	68	0.0008	
Meichuan	Oligochaetes	20	0.0004	Hubei Provincial Reservoir Investigation Team 1982
Xianghongdian	Tubificidae	5,726	11.97	Anhui Fisheries Research Institute 1984
Twelve Reservoirs in Guangxi		144-800		Guangxi Fisheries Research Institute 1984
Tumenzi	Chironomid larvae	16-192	0.0006-0.224	Jie and Li 1987
	Oligochaetes	16-24	0.0005-0.65	

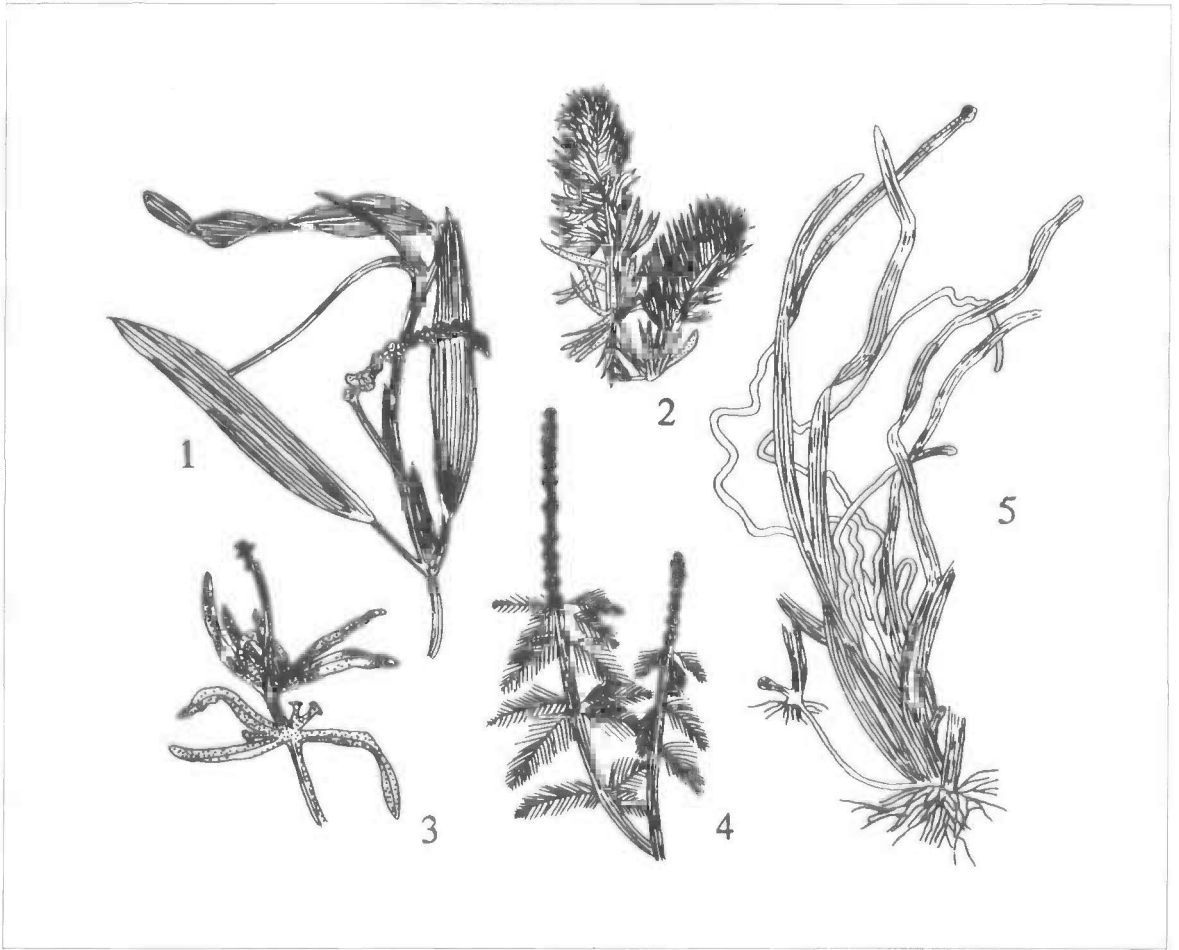

Figure 18. Common aquatic plants in Chinese reservoirs: (1) *Potamogeton malainus*, (2) *Ceratophyllum demersum*, (3) *Potamogeton crispus*, (4) *Myriophyllum spicatum*, and (5) *Vallisneria spiralis*.

CHAPTER 3

Development of Fish Resources

FORMATION AND DEVELOPMENT OF THE NATURAL ICHTHYOFAUNA

After impoundment there are major changes in fish fauna because of changes in the hydrological regime and biological conditions.

Riverine Fishes

As the original rivers disappear and water flow becomes almost static in newly built reservoirs, riverine species such as *Varicorhinus (Onychostoma)* spp. are forced to move to the upper reaches of the reservoir and may even disappear entirely.

Lacustrine Fishes

The newly created open-water environment provides lacustrine fish with a favourable habitat and an adequate food source; therefore, their numbers tend to increase. After impoundment, the large numbers of submerged plants serve as the spawning substrate for species such as common carp, crucian carp, and *Hemiculter leucisculus*. Because of the large water volume, low fish population density, limited interspecific and intraspecific competition, and fewer predators and harmful organisms, the offspring of these fish usually have a high survival rate, grow fast, and increase rapidly in number. Therefore, in many reservoirs, the species of fish that develop during the early impoundment stage can be continually captured for a number of years. For example, in Shuifeng Reservoir (impounded in 1942), common carp were continuously captured until 1962.

After a few years of impoundment, the terrestrial plants in the submerged area decay and there are more frequent fluctuations in water level, new populations of plants are not formed (or are less developed), and most phytophilous fishes have difficulty finding suitable spawning grounds and their larvae have problems finding suitable feeding areas. In the years when rainfall is abundant and water level fluctuations are minimal, spawning takes place readily. However, during dry periods when water levels vary considerably, spawning is not common. This may be the main reason why populations of common carp and crucian carp increase in the early stages of impoundment but decrease afterward and the generations that are produced in most years are weak. However, some fishes (e.g., *Hemiculter leucisculus* and *Pseudolaubuca sinensis*) that are not highly specific in their spawning conditions usually sustain a viable fishery.

In the case of common lacustrine predators [including *Erythroculter ilishaeformis*, *Erythroculter mongolicus*, *Elopichthys bambusa*, *Parasilurus asotus* (catfish), *Ophiocephalus argus* (snakehead), *Siniperca chuatsi* (mandarin fish), and *Esox reicherti* (pike)] spawning conditions are generally improved after impoundment; therefore, populations establish rapidly.

Fishes (e.g., silver carp, bighead carp, and grass carp) that migrate between rivers and lakes cannot move to the reservoirs because of dam construction. Fish captured in the submerged region after impoundment will not spawn naturally although they do reach maturity. In addition, the flow rate of the water is not adequate for hatching or for the survival of post-larvae. As a result, these species never develop large populations.

Migratory Fishes

Migratory fish [e.g., eel (*Anguilla japonica*), sturgeon (*Hilsa reevesii*), and *Coilia* spp.] cannot migrate from the lower stream into the reservoir because their migratory routes are disrupted. This leads to a decrease in population numbers and finally to their disappearance.

Generally, the succession of fish fauna in the reservoir after impoundment is: the dominant indigenous riverine fishes are replaced by lacustrine species, then omnivorous fishes, such as common carp and crucian carp, are replaced by planktivorous, detritivorous, and carnivorous fish. The principal fish species are changed significantly, and the new dominant fish population is much larger than the indigenous one.

Table 8 shows the fish species in the principal river systems, and Figure 19 illustrates species abundance in various river systems. There are greater numbers of fish species in the reservoirs constructed along the Changjiang River and the Zhujiang River Basin than there are in the reservoirs in the northwestern river systems. Similarly, there are more species in reservoirs at the middle and lower streams than upstream in the same river system, and in reservoirs in hilly areas compared with alpine areas.

The general dynamics of fish composition and population density are illustrated by Changshouhu Reservoir. This reservoir is located at the middle and lower reaches of the Longxi River, a branch of the Changjiang River, in Changshou County, Sichuan Province. It was built in 1955, with an average water surface of 4,470 ha, a maximum water depth of 40 m, and a mean depth of 10 m. Common carp and crucian carp were

TABLE 8. Number of fish species in four major river systems

FAMILY	ZHUJIANG		CHANGJIANG		HUANGHE		HEILONJIANG	
	SPP.	%	SPP.	%	SPP.	%	SPP.	%
Cyprinidae	167	44.2	141	49.8	84	54.9	59	52.2
Bagridae	23	6.0	19	6.7	6	3.9	4	3.5
Gobiidae	17	4.5	12	4.2	8	5.2	3	2.7
Cobitidae	28	7.4	19	6.7	18	11.8	—	—
Salmonidae	—	—	1	0.4	—	—	11	9.7
Homalopteridae	22	5.9	15	5.3	—	—	—	—
Salangidae	—	—	5	1.8	8	5.2	—	—
Acipenseridae	—	—	3	1.1	—	—	2	1.8
Others	121	32.0	68	24.0	29	19.0	34	30.1
TOTAL	378	100.0	283	100.0	153	100.0	113	100.0
Total Number of Families	49		37		27		23	

Source: Li Sifa 1993; data for the Zhujiang River (Feng Qixin 1987); the dash indicates few species or data not available.

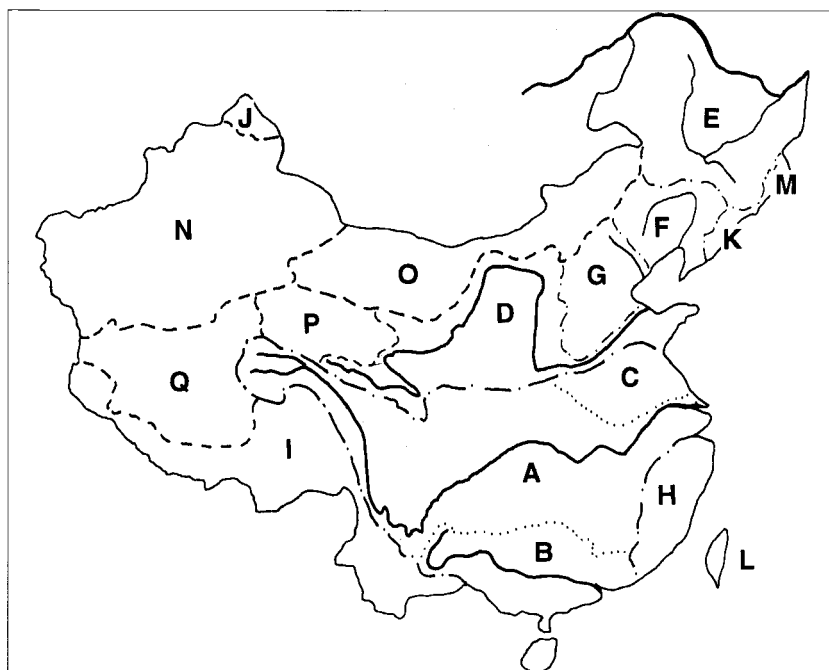

Figure 19. Diversity of fish species in different areas of China. High Diversity (more than 200 species): (A)Changjiang River; (B)Zhujiang River; (C) Huaihe River. Moderate Diversity (50-200 species): (D)Huanghe River; (E)Heilongjiang River; (F)Liaohe River; (G)Haihe River; (H)Southeast coastal region; (I)Southwest rivers outflow region; (J)Erqisi River; (K)Yalujiang River; (L)Taiwan; (M)Tumenjiang River. Low Diversity (fewer than 50 species): (N)Xingjiang endorheic region; (O)Gansu endorheic region; (P)Qinghai endorheic region; (Q)Xizhang endorheic region.

TABLE 9. Fish populations before and after construction of Changshouhu Reservoir

PERIOD	FISH SPECIES	MAJOR SPECIES
Before 1955 (year of impoundment)	Common carp, <i>Varicorhinus (Onychostoma) angustistomatus</i> , <i>Barbodes (Spinibarbus) sinensis</i> , <i>Sinilabeo rendahli</i> , <i>Procypris rabaudi</i> , catfish (<i>Parasilurus asotus</i>), <i>Mystus</i> spp., <i>Hemiculter leucisculus</i> , <i>Beaufortia leveretti</i> , etc. (about 20 species)	Common carp, <i>Barbodes (Spinibarbus) sinensis</i> , <i>Varicorhinus (Onychostoma) angustistomatus</i> , and <i>Hemiculter leucisculus</i>
1958-1961	Common carp, crucian carp, <i>Opsariichthys bidens</i> , <i>Varicorhinus</i> spp., <i>Hemiculter leucisculus</i> , <i>Procypris rabaudi</i> , catfish, <i>Mystus</i> spp., <i>Hypseleotris swinhonis</i> , <i>Erythroculter mongolicus</i> , <i>Pelteobagrus</i> spp., <i>Erythroculter ilishaeformis</i> , <i>Ancherythroculter kurematsui</i> , <i>Xenocypris</i> spp., <i>Squaliobarbus curriculus</i> , <i>Varicorhinus (Onychostoma) angustistomatus</i> , mandarin fish, <i>Rhodeus</i> spp., <i>Ctenogobius</i> spp., <i>Monopterus albus</i> , <i>Pseudorasbora parva</i> , <i>Pseudolaubuca sinensis</i> , <i>Beaufortia leveretti</i> , <i>Misgurnus anguillicaudatus</i> (loach), etc.	<i>Hemiculter leucisculus</i> , crucian carp, common carp, <i>Opsariichthys uncirostris</i> , <i>Ancherythroculter kurematsui</i> , and catfish
1962-1979	Common carp, crucian carp, <i>Procypris rabaudi</i> , <i>Opsariichthys bidens</i> , black carp, grass carp, <i>Squaliobarbus curriculus</i> , <i>Ochetobius elongatus</i> , <i>Xenocypris</i> spp., silver carp, bighead carp, <i>Barbodes (Spinibarbus) sinensis</i> , <i>Varicorhinus (Onychostoma) angustistomatus</i> , <i>Pseudorasbora parva</i> , <i>Parabramis pekinensis</i> , <i>Megalobrama terminalis</i> , <i>Ancherythroculter kurematsui</i> , <i>Hemiculter leucisculus</i> , <i>Rhodeus</i> spp., catfish, <i>Hypseleotris swinhonis</i> , <i>Cobitis</i> spp., <i>Beaufortia leveretti</i> , <i>Pelteobagrus</i> spp., <i>Leocassis</i> spp., <i>Mystus</i> spp., <i>Monopterus albus</i> , etc. (about 40 species)	Silver carp, bighead carp, <i>Erythroculter ilishaeformis</i> , <i>Megalobrama terminalis</i> , <i>Ochetobius elongatus</i> , <i>Parabramis pekinensis</i> , <i>Hemiculter leucisculus</i> , <i>Ancherythroculter kurematsui</i> , <i>Squaliobarbus curriculus</i> , etc.

stocked in 1958 and silver carp and bighead carp in 1960. The changes in fish composition in the reservoir are shown in Table 9.

After impoundment, the indigenous species (common carp, crucian carp, *Hemiculter leucisculus*, *Ancherythroculter kurematsui*, *Opsariichthys uncirostris*, *Opsariichthys bidens*, and catfish) flourished, particularly *Hemiculter leucisculus*. However, the population of *Hemiculter leucisculus* decreased remarkably soon after the stocking density of silver carp and bighead carp was increased. At the same time, those fishes that originally inhabited the Longxi River (e.g., *Varicorhinus simus*, *Barbodes sinensis*, *Sinilabeo rendahli*, and *Beaufortia leveretti*) gradually moved upstream and their populations declined in the reservoir.

Before the Longxi River was dammed, there were four major predatory species (*Opsariichthys bidens*, *Ancherythroculter kurematsui*, catfish, and *Mystus* spp.). After impoundment, *Opsariichthys bidens* developed rapidly and became the dominant predator during the

late 1950s. However, it was succeeded by *Ancherythroculter kurematsui* in the early 1960s and in the 1970s, *Erythroculter ilishaeformis* (which was artificially stocked) became the dominant predator. The composition of predatory fishes in Changshouhu Reservoir indicates that, with time, smaller predatory species are replaced by larger species.

After construction of the Changshouhu Reservoir in 1955, the number of fish species increased from 20 to 43 by 1982. *Ochetobius elongatus* is an interesting species. It occurs in the Changshouhu Reservoir but it did not exist in the Longxi River. Only one *Ochetobius elongatus* was captured in the reservoir in 1959, but by 1961 it comprised 20% of the total reservoir catch. Since then, the population has declined. The change in dominant fishes in Changshouhu Reservoir is summarized in Figure 20.

Species composition and yield are significantly changed after impoundment of reservoirs. If the fish fauna is allowed to develop naturally, the small,

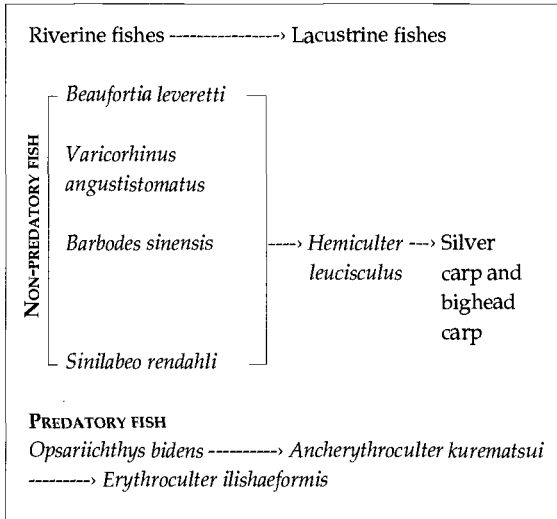

Figure 20. Change in dominant fish species in Changshouhu Reservoir.

adaptable, low-value fishes that have a short life cycle and simple spawning requirements would increase in number, followed by predatory fishes. However, high fish production has never been achieved in reservoirs dominated by small low-value fishes or predators. For example, in Xianghongdian Reservoir, the total catch from February to September 1983 was about 85,000 kg, of which the predators accounted for 56.6% (*Elopichthys bambusa* 17.2%, *Erythroculter* spp. 30.6%, and mandarin fish 7.7%); *Xenocypris* spp. 12.1%; and the stocked fishes (silver carp and bighead carp) 28.8%. On average, the fish yield was only 27.15 kg/ha.

MANIPULATION OF FISH FAUNA IN RESERVOIRS

The species of fish selected as the dominant ones in reservoirs should have a plentiful food supply, a short food chain, a high food conversion rate, and be economically important. The ideal fish fauna should consist of species that occupy different ecological niches. This maximizes the use of space and available productivity in the reservoir.

Dominant species

The dominant fish populations in reservoirs include:

- Silver and bighead carp, which are most suitable when cultured in reservoirs that are rich in plankton biomass.
- Common carp and crucian carp, which should preferably be reared in reservoirs with a great abundance of benthic organisms, but less plankton.
- Salinity- and alkalinity-tolerant fishes (e.g., crucian carp), which are reared in reservoirs that have high salinity and alkalinity.

Most reservoirs are rich in plankton, organic detritus, and bacteria. Because silver carp and bighead carp

are the most effective grazers, they are always selected for culture in Chinese reservoirs. Silver carp and bighead carp account for 96% of the total catch in Qingshan Reservoir. They typically account for 60-80% of the catch in other reservoirs.

Development of fish fauna

To accelerate a desirable change in fish composition and promote the growth of economically important fishes, it is necessary to start to regulate the fish populations before impoundment. Predators should be eliminated, and the culture of preferred fish species should be started. Before impoundment, these steps are recommended:

- Predators and small low-value fishes should be eliminated or captured in the rivers and other water bodies that are to be flooded.
- The capture of economically important species should be prohibited.
- Brood stock or fingerlings of important species should be transported into the ponds, lakes, and other water bodies that are to be submerged.
- Hatcheries should be set up to produce the fingerlings that are to be stocked in the reservoirs.
- The reservoir bottom should be graded or cleared. After impoundment, these steps are recommended:
- Artificial stocking should be carried out.
- Economically important fishes and food organisms adapted to the new environment should be introduced.
- Predators and small low-value fishes should be captured on a regular basis.
- Measures should be taken to protect the spawning grounds of the important fish species.

These measures can develop a highly productive fishery in a short time and gradually transform the fish composition in the reservoir to establish a sustained fishery. For example, Foziling Reservoir was built in 1954 and artificial stocking was initiated in 1956. The reservoir was drained for maintenance from 28 September to 7 October 1965. The fish composition at harvest showed that a desirable balance in species had been achieved (Table 10).

BIOLOGY OF ECONOMICALLY IMPORTANT SPECIES

Based on feeding habits and economic value, the fishes found in reservoirs can be categorized as: economically important, predatory, and small low-value fish.

The economically important fish are all high-value non-predatory fishes that grow quickly and are large. The major species cultured and protected in reservoir fisheries are: silver carp (*Hypophthalmichthys molitrix*), bighead carp (*Aristichthys nobilis*), common carp (*Cyprinus carpio*), crucian carp (*Carassius auratus*), grass bream (*Parabramis pekinensis*), Wuchang fish

(*Megalobrama amblycephala*), black bream (*Megalobrama terminalis*), grass carp (*Ctenopharyngodon idellus*), black carp (*Myllopharyngodon piceus*), mud carp (*Cirrhina molitorella*), *Xenocypris argentea*, *Plagiognathops microlepis*, *Distoichodon tumirostris*, *Hemibarbus maculatus*, *Hemibarbus labeo*, *Barbodes (Spinibarbus) sinensis*, *Leuciscus waleckii*, *Squaliobarbus curriculus*, *Sinilabeo decorus*, *Varicorhinus (Onychostoma) spp.*, *Coregonus spp.*, and *Tilapia spp.*

TABLE 10. Composition of catch in Foziling Reservoir after drainage

SPECIES	PERCENTAGE BY WEIGHT	PERCENTAGE BY NUMBER
Silver carp and bighead carp	44.53	5.77
Common carp	21.42	10.12
<i>Xenocypris</i> spp.	11.32	29.0
<i>Parabramis</i> spp. and <i>Megalobrama</i> spp.	10.08	39.52
Grass carp and black carp	8.5	2.10
<i>Elopichthys bambusa</i>	0.07	0.01

The predatory fishes grow quickly and reach a large size. They have good quality flesh and a high economic value. Because they are predators, they endanger the stocked fingerlings of cultivated fishes. The main predatory fishes are: *Elopichthys bambusa*, *Erythroculter mongolicus*, *Erythroculter ilishaeformis*, *Culter erythropterus*, *Erythroculter dabryi*, catfish (*Parasilurus asotus*), mandarin fish (*Siniperca chuatsi*), snakehead (*Ophiocephalus argus*), *Channa asiatica*, *Opsariichthys uncirostris*, *Opsariichthys uncirostris amurensis*, *Erythroculter oxycephaloides*, *Luciobrama macrocephalus*, *Esox reicherti*, *Hucho taimen*, and *Anguilla marmorata*.

The small, low-value fishes grow slowly and are generally of low economic value. They compete for food with the economically important fish and some eat the eggs and fry of other species. The main low-value fishes in reservoirs are: *Hemiculter leucisculus*, *Pseudolaubuca sinensis*, *Toxabramis swinhonis*, *Coilia brachygnathus*, *Saurogobio dabryi*, *Pseudobagrus fulvidraco*, *Rhodeus* spp., *Sarcocheilichthys sinensis*, *Hypseleotris swinhonis*, *Rhinogobius giurinus*, *Pseudorasbora parva*, *Gnathopogon* spp., *Macropodus chinensis*, and *Sinibrama macrops*.

There are more than one hundred fish species in Chinese reservoirs. Each locality has some indigenous fishes: e.g., mud carp is the dominant indigenous species in reservoirs in Guangdong Province and Guangxi Autonomous Region; *Sinilabeo decorus* occurs only in Guangxi; *Hypophthalmichthys harmandi* is only found in Songtao Reservoir on Hainan Island; crucian carp, *Pseudogobio vaillanti*, and *Gnathopogon chankaensis* are found only in some northeastern reservoirs; *Leuciscus waleckii* occurs exclusively in the reservoirs in the upstream reaches of the Huanghe River; and *Anguilla japonica*, *Anguilla marmorata*, and *Plectoglossus altivelis* are endemic to the reservoirs on the coast of Fujian, Zhejiang, and a few other provinces.

Silver carp

Silver carp (Figure 21) prefer to live on phytoplankton, but also ingest large amounts of zooplankton, detritus, and bacteria. Food conversion is good. Compared with its growth in lakes and ponds, the growth of silver carp in reservoirs varies in response to the abundance of natural food organisms (Table 11). Therefore, individual growth and fish production can be adjusted according to the source of natural food organisms, social demand, and economic efficiency.

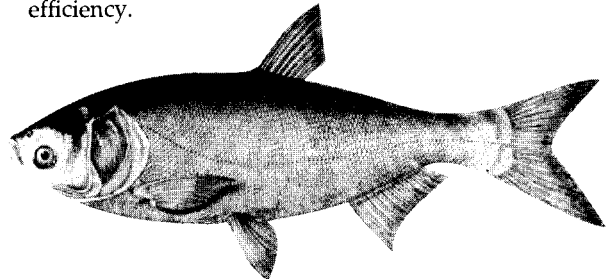

Figure 21. Silver carp (*Hypophthalmichthys molitrix*).

In most reservoirs, silver carp reach maturity at the age of 4+. The hydrology of reservoirs differs from rivers; therefore, although silver carp may spawn in some large-sized reservoirs, the eggs do not hatch and fry cannot survive. This is because there is little flowing water in the reservoir. As a result, silver carp do not develop naturally into a large population; however, the fishery can be developed through artificial stocking of fish raised in hatcheries.

Bighead carp

Bighead carp (Figure 22) are zooplankton feeders that also feed on a certain amount of phytoplankton, detritus, and bacteria. They have a high food conversion rate and grow quickly because they utilize both the primary and secondary production in a reservoir. Bighead carp are far more variable in reservoirs than silver carp (Table 12). In reservoirs, silver carp and bighead carp both move in schools, which makes harvesting easier.

TABLE 11. Mean weight (kg) of silver carp in various reservoirs

RESERVOIR	AGE ^a						SOURCE ^b
	1 ⁺	2 ⁺	3 ⁺	4 ⁺	5 ⁺	6 ⁺	
Xinjiang	—	1.90-2.00	2.00-4.25	2.50-6.05	3.95-6.50	4.40-6.80	1984 (140 fish)
Fuqiaohe	1.08	2.15	3.05	7.00	—	—	HPRIT 1982 ^c
Qinghe	0.30-0.60	1.00-1.75	1.50-2.90	3.10-4.60	5.00-6.70	6.00-9.90	Qin and Liang 1977
Chengbihe	—	1.51	2.23	4.30	—	—	GFRI 1984 ^d
Pohe	0.84	1.42	2.38	—	—	—	1973 (113 fish)
Dongzhang	—	0.55	1.70	2.35	—	—	1983 (5 fish)
Liujiaxia	—	0.93	1.38	1.80	—	—	1973 (8 fish)
Nanshahe	—	2.48	3.68	4.00	—	—	1973 (8 fish)
Qingshan	0.40-0.80	1.20-1.50	—	—	—	—	1972-1976 (200 fish)
Changtan	—	—	0.40	0.55	0.68	0.93	Chen 1984
Gaozhou	0.60	1.70	2.82	4.20	4.50	5.05	Li 1978
Hulukou	0.18-0.75	0.60-2.00	2.65-4.50	4.20-5.75	4.60-6.00	—	Leng <i>et al.</i> 1984

^a 1⁺ means that the fish had one annual ring and its second ring was taking shape; 2⁺ means the fish had two annual rings and its third was forming; and so on.

^b Where only the year is given, the source is Li Sifa (previously unpublished data).

^c Hubei Provincial Reservoir Investigation Team.

^d Guangxi Fisheries Research Institute.

TABLE 12. Mean weight (kg) of bighead carp in various reservoirs

RESERVOIR	AGE ^a						SOURCE ^b
	1 ⁺	2 ⁺	3 ⁺	4 ⁺	5 ⁺	6 ⁺	
Xinjiang	—	1.75-4.60	2.55-11.30	8.75-15.75	12.10-16.00	—	1984 (96 fish)
Fuqiaohe	1.82	4.07	6.75	14	—	—	HPRIT 1982 ^c
Chengbihe	1.42	3.79	4.85	7.23	13.17	18.32	1984
Pohe	2.09	2.98	4.23	8.25	—	—	1973 (85 fish)
Dongzhang	—	1.03	2.83	5.25	—	8.25	1984 (10 fish)
Qingshan	0.40-0.80	1.20-1.50	—	—	—	—	1972 (200 fish)
Changtan	—	0.38	0.55	0.78	1.24	2.05	Chen 1984
Gaozhou	0.80	2.71	5.20	7.50	10.10	12.30	Li 1978
Hulukou	0.30-1.28	1.18-5.10	5.10-10.15	11.23-13.75	12.25-17.25	—	Leng <i>et al.</i> 1984

^a 1⁺ means that the fish had one annual ring and its second ring was taking shape; 2⁺ means the fish had two annual rings and its third was forming; and so on.

^b Where only the year is given, the source is Li Sifa (previously unpublished data).

^c Hubei Provincial Reservoir Investigation Team.

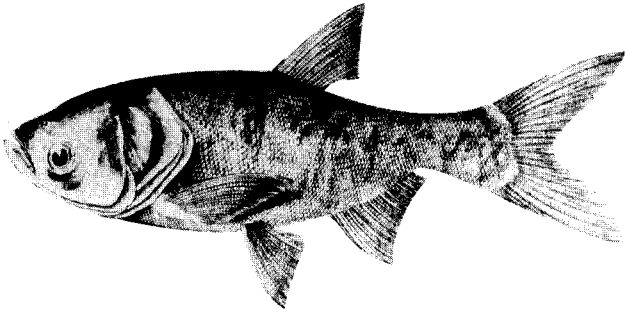

Figure 22. Bighead carp (*Aristichthys nobilis*).

Common carp

Common carp (Figure 23) are omnivorous and have a fast growth rate and good resistance to low temperatures, alkalinity, and low oxygen levels. They can survive at a pH of 5 to 9.8 and a dissolved oxygen concentration of 0.5 mg/L. Common carp reproduce easily, are widely distributed, and are one of the dominant species in reservoir fisheries in China. Table 13 shows the growth rate of common carp in some reservoirs.

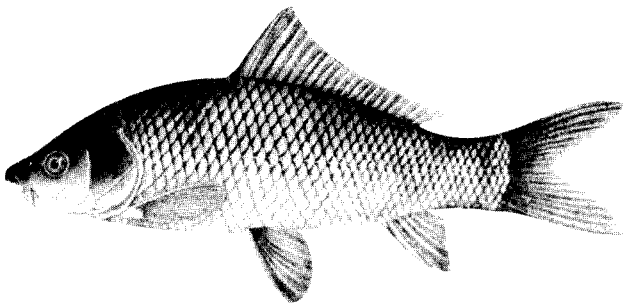

Figure 23. Common carp (*Cyprinus carpio*).

Crucian carp

Compared with common carp, crucian carp (Figure 24) have higher environmental tolerance. They can grow and spawn in alkaline waters, survive at a dissolved oxygen content of 0.1 mg/L, and maintain normal feeding and growth between 10 and 32°C. Crucian carp prefer to feed on zooplankton, benthic organisms, algae, tender aquatic grass, and detritus. Their reproductive rate is higher than common carp; therefore, their natural distribution is very wide. Crucian carp are the dominant species in northern reservoirs and account for more than 20-30% of total production.

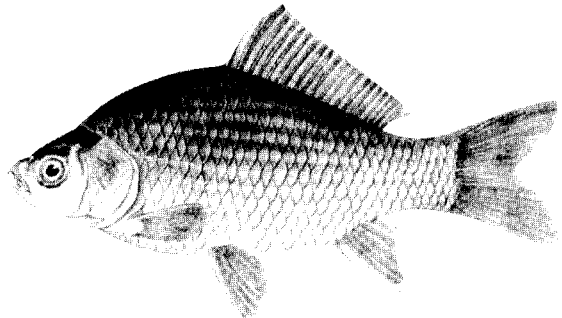

Figure 24. Crucian carp (*Carassius auratus*).

Grass carp

Grass carp (Figure 25) are herbivorous. They feed on zooplankton at the fry stage and on chironomids, algae, and *Lemma* spp. as juveniles. However, grass carp will feed completely on aquatic macrophytes after they reach 10 cm in body length. They usually occupy shallow submerged grassy areas or shorelines with an abundance of aquatic weeds. The spawning habits of grass carp are similar to silver carp and bighead carp.

TABLE 13. Mean weight (kg) of common carp in various reservoirs

RESERVOIR	AGE ^a					SOURCE ^b
	1 ⁺	2 ⁺	3 ⁺	4 ⁺	5 ⁺	
Gangnan	0.55	1.06	1.22	3.65	—	HFS 1972
Huangbizhuang	0.35	0.37	0.70	1.75	—	HFS 1972
Honglingjin	0.90	0.94	0.98	—	—	HFS 1972
Siweihe	0.27	0.48	0.92	—	—	GFRI 1984
Xinanjiang	0.36-0.59	0.39-1.65	0.93-2.75	1.65-3.29	2.25-3.49	Li Sifa (124 fish)
Hulukou	0.30-1.20	0.60-1.80	0.80-2.80	1.58	—	Leng <i>et al.</i> 1984

^a 1⁺ means that the fish had one annual ring and its second ring was taking shape; 2⁺ means the fish had two annual rings and its third was forming; and so on.

^bHFS (Hubei Fisheries School); GFRI (Guangxi Fisheries Research Institute); Li Sifa (previously unpublished data).

Grass carp are common in all the main rivers in China. Because of its herbivorous feeding habit, fast growth, and good flesh quality, it is traditionally cultured as one of the principal species. However, stocking of grass carp is limited by the sources of aquatic plants available in most reservoirs (Table 14).

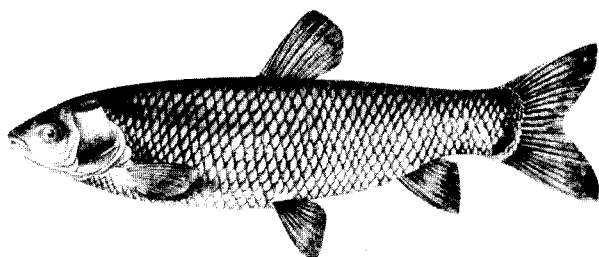

Figure 25. Grass carp (*Ctenopharyngodon idellus*).

Grass bream

Grass bream (Figure 26) is a medium-sized fish that is widely distributed in reservoirs. The adults feed mainly on aquatic weeds, but also ingest aquatic insect larvae and crustaceans when the source of aquatic weeds is inadequate. Grass bream prefer to live in the littoral zone of coves and spawn naturally in many reservoirs (although their eggs are semi-pelagic). Grass bream do not require such specific spawning conditions as silver carp and bighead carp; therefore, they can naturally reproduce in some reservoirs. Growth figures for grass bream are shown in Table 15.

Black bream

Black bream (Figure 27) can reach maturity and spawn naturally in reservoirs. Generally, they inhabit confluent areas and coves with gravel and boulder

TABLE 14. Mean weight (kg) of grass carp in various reservoirs

RESERVOIR	AGE ^a					SOURCE ^b
	1 ⁺	2 ⁺	3 ⁺	4 ⁺	5 ⁺	
Liujiaxia	0.2	1.3	4.6	—	—	1973
Pohe	3.6	5.8	—	—	—	1973
Hulukou	1.4-2.1	1.5-3.6	3.1-6.7	7.7-8.6	—	Leng <i>et al.</i> 1984

^a 1⁺ means that the fish had one annual ring and its second ring was taking shape; 2⁺ means the fish had two annual rings and its third was forming; and so on.

^b Where only the year is given, the source is Li Sifa (previously unpublished data).

TABLE 15. Mean weight (g) of grass bream in various reservoirs

RESERVOIR	AGE ^a					SOURCE
	1 ⁺	2 ⁺	3 ⁺	4 ⁺	5 ⁺	
Gangnan	225	360	475	—	—	HFS 1972 ^b
Huangbizhuang	50	495	735	750	—	HFS 1972
Twelve Reservoirs in Guangxi	85	195	350	600	935	GFRI 1984 ^c

^a 1⁺ means that the fish had one annual ring and its second ring was taking shape; 2⁺ means the fish had two annual rings and its third was forming; and so on.

^b Hubei Fisheries School.

^c Guangxi Fisheries Research Institute.

bottoms, large quantities of *Limnoperna lacustris*, and submerged plants. In the winter, black bream congregate in crevices to overwinter. They are an important economic species in many reservoirs because of their fast growth and good eating quality (Table 16).

Wuchang fish

Wuchang fish (Figure 28) are herbivorous, grow quickly, and mature early (they can spawn at 3 years of age). Artificial breeding is simple; therefore, a fingerling supply is readily available. Wuchang fish are one of the principal species cultured in the reservoirs.

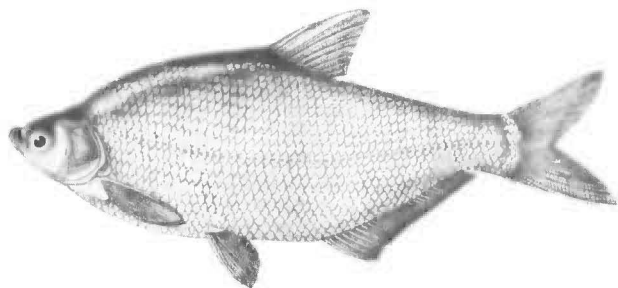

Figure 26. Grass bream (*Parabramis pekitensis*).

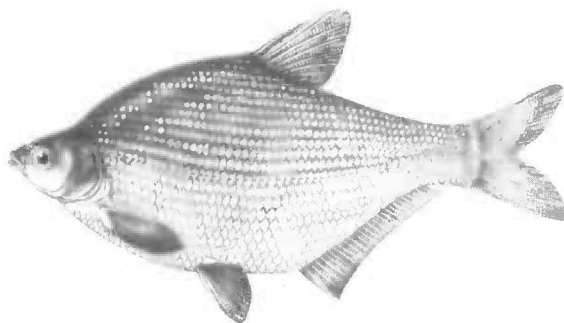

Figure 28. Wuchang fish (*Megalobrama amblycephala*).

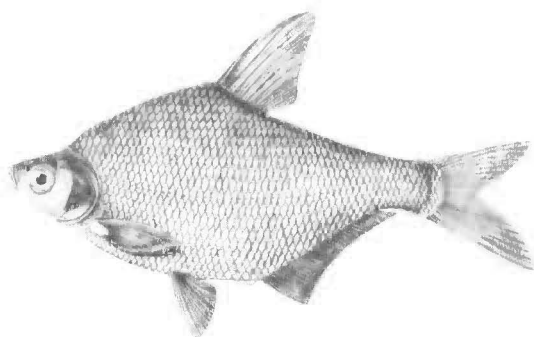

Figure 27. Black bream (*Megalobrama terminalis*).

Xenocyprinae

In China, the subfamily Xenocyprinae consists of nine species, of which only four are of economic importance: *Xenocypris argentea*, *Xenocypris davidi*, *Xenocypris microlepis*, and *Distoechodon tumirostris* (Figures 29-32). These four species prefer to live in currents in the middle and bottom layers of the reservoir and move in schools. The adults feed mainly on detritus and algae, which they scrap with the horny part of their lower jaw.

TABLE 16. Mean weight (kg) of black bream in Gutian and Nanwan reservoirs

RESERVOIR	AGE ^a						SOURCE ^b
	1 ⁺	2 ⁺	3 ⁺	4 ⁺	5 ⁺	6 ⁺	
Gutian	0.23	0.74	0.99	1.68	2.68	3.10	1975
Nanwan	0.30	0.70	—	—	—	—	1973

^a 1⁺ means that the fish had one annual ring and its second ring was taking shape; 2⁺ means the fish had two annual rings and its third was forming; and so on.

^b Year indicates source is Li Sifa (previously unpublished data).

TABLE 17. Mean weight (g) *Xenocypris davidi* in reservoirs

RESERVOIR	AGE ^a				SOURCE ^b
	1 ⁺	2 ⁺	3 ⁺	4 ⁺	
Xianghongdian	58-178	130-290	254-650	—	Zhu Guozhang 1986
Xinanjiang	53-100	120-280	175-425	425-775	1984 (98 fish)

^a 1⁺ means that the fish had one annual ring and its second ring was taking shape; 2⁺ means the fish had two annual rings and its third was forming; and so on.

^b Where only the year is given, the source is Li Sifa (previously unpublished data).

Xenocyprinae are medium- to small-sized fishes that grow at a moderate rate. Among them, *Distoichodon tumirostris* grows fastest and reaches a weight of 4 kg. The maximum body weight of *Xenocypris davidi* is 1 kg (Table 17); whereas, *Xenocypris microlepis* reaches 3 kg.

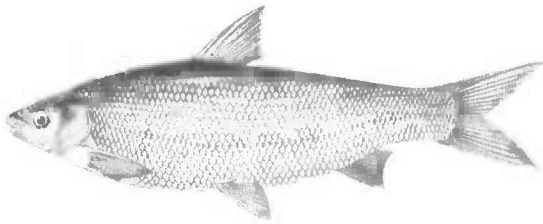
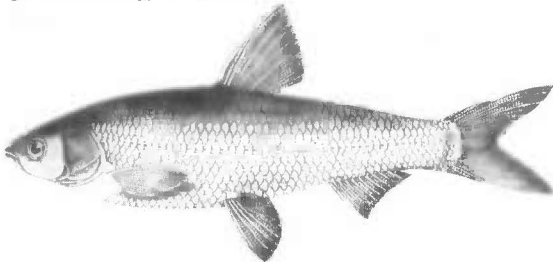
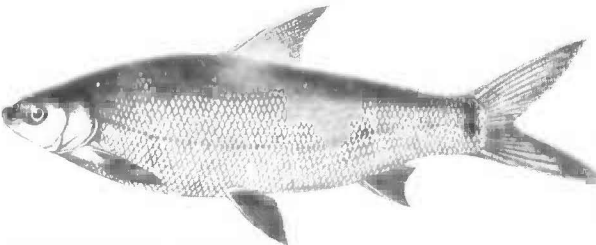
Figure 29. *Xenocypris davidi*.Figure 30. *Xenocypris argentea*.Figure 31. *Xenocypris microlepis*.

Because reservoirs are rich in detritus from runoff, and the hydrological conditions are generally suitable for the spawning of Xenocyprinae, this subfamily of fish can develop naturally into a dominant population. Although they have a small marketable size, they are a

major species for reservoir fishery production because they have a high biomass. For example, *Xenocypris davidi* accounted for 15% of the total production in Xiangang Reservoir, and *Xenocypris davidi* and *Xenocypris microlepis* accounted for 26-31% of the total production in Xianghongdian Reservoir from 1983 to 1985.

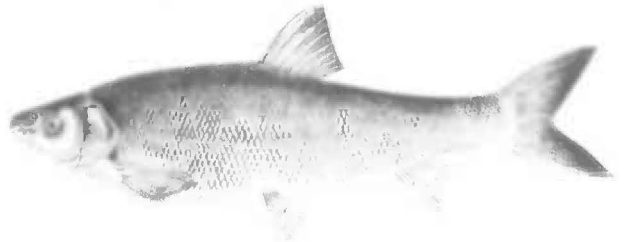
Figure 32. *Distoichodon tumirostris*.

Mud carp

Mud carp (Figure 33) are a dominant species in southern reservoirs. They feed mainly on epiphytic algae and detritus. Although they do not grow quickly (Table 18), they produce a lot of biomass. Pan-size mud carp have high consumer preference and usually reach marketable size in 2 years. However, they have poor tolerance of low temperatures and high mortality below 7°C. Genetic selection is being used to increase their resistance to low temperatures.

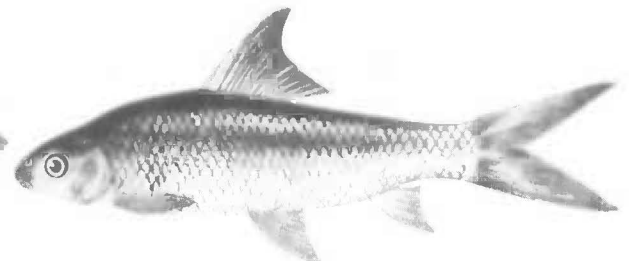
Figure 33. Mud carp (*Cirrhina molitorella*).

Mud carp spawn naturally in reservoirs, but do not naturally form a large enough population to sustain intensive fishing. Artificial stocking can be used to sus-

tain increased productivity in reservoirs. In Hanshan Reservoir, mud carp accounted for one-third as much production as silver carp and bighead carp; whereas, in Nanshan Reservoir mud carp comprised 12% of total production.

TABLE 18. Weight (g) of mud carp in Hanshan Reservoir

RESERVOIR	AGE ^a		SOURCE ^b
	1 ⁺	2 ⁺	
Hanshan	85	310	1984 (31 fish)

^a 1⁺ means that the fish had one annual ring and its second ring was taking shape; 2⁺ means the fish had two annual rings and its third was forming; and so on.

^b Year indicates source is Li Sifa (previously unpublished data).

Elopichthys bambusa

Elopichthys bambusa (Figure 34) starts to prey on other fishes at a body length of 1.4 cm. It is a typical predatory fish. It is shuttle shaped, has a long, sharp head, swims rapidly, and has a horny protuberance on the lower jaw that is well adapted for predation. *Elopichthys bambusa* inhabits the middle and upper water layers and attacks many other species. It will attack fish with a body length 26-30% of its own size.

Elopichthys bambusa feed rapidly, digest quickly, and have a high growth rate (Table 19). The largest specimen captured so far weighed 58 kg.

Elopichthys bambusa spawns under similar conditions as silver carp, bighead carp, and grass carp. Because it requires simple conditions for spawning, it can develop large populations in reservoirs. *Elopichthys bambusa* can seriously damage stocked fish; therefore, it is essential to minimize the possibility of their introduction when cultivated fishes are stocked. They should also be eliminated as completely as possible before impoundment.

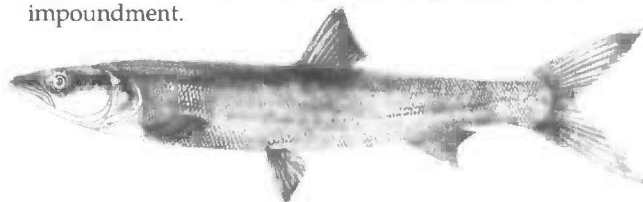

Figure 34. *Elopichthys bambusa*.

Erythroculter ilishaeformis

Erythroculter ilishaeformis (Figure 35) has a mouth that opens vertically upward and a well-developed lower jaw. It grows quickly to a large size (Table 20). The adults mostly feed on small fish and shrimp as well as insects, cladocerans, and copepods. *Erythroculter ilishaeformis* swim rapidly and prefer to search for food in the middle and upper layers of open waters. They are commonly distributed from south to north in China and are a major predator in reservoirs.

TABLE 19. Mean size (cm) and weight (kg) of *Elopichthys bambusa* in Kongwangshan Reservoir

	AGE ^{a,b}					
	1 ⁺	2 ⁺	3 ⁺	4 ⁺	5 ⁺	6 ⁺
Length	52.88	91.86	95.34	102.49	129.70	142.00
Weight	1.36	7.04	8.29	10.27	21.95	33.00

^a 1⁺ means that the fish had one annual ring and its second ring was taking shape; 2⁺ means the fish had two annual rings and its third was forming; and so on.

^b Source: Li Sifa (previously unpublished data).

TABLE 20. Mean weight (g) of *Erythroculter ilishaeformis* in Xinanjiang Reservoir

	AGE ^{a,b}								
	1 ⁺	2 ⁺	3 ⁺	4 ⁺	5 ⁺	6 ⁺	7 ⁺	8 ⁺	9 ⁺
Body weight	100-145	185-300	215-250	450-825	600-1650	1500-4150	2350-5200	4000-8200	6250-8350

^a 1⁺ means that the fish had one annual ring and its second ring was taking shape; 2⁺ means the fish had two annual rings and its third was forming; and so on.

^b Source: Li Sifa (previously unpublished data).

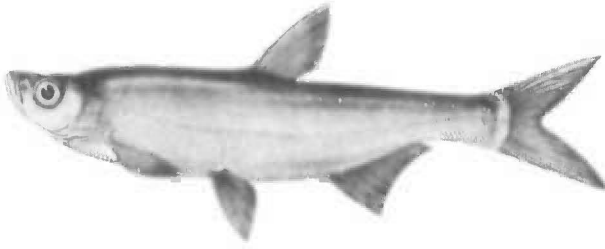

Figure 35. *Erythroculter ilishaeformis*.

Erythroculter mongolicus

Erythroculter mongolicus (Figure 36) is similar to *Erythroculter ilishaeformis* in morphology. It is medium-size (maximum body weight 4 kg), has a mouth that slants upward, and a red tail. Feeding and spawning habits are basically the same as *Erythroculter ilishaeformis*, but their growth is slower and they tend to move in schools (Table 21). *Erythroculter mongolicus* is common and is one of the main predators in Chinese reservoirs.

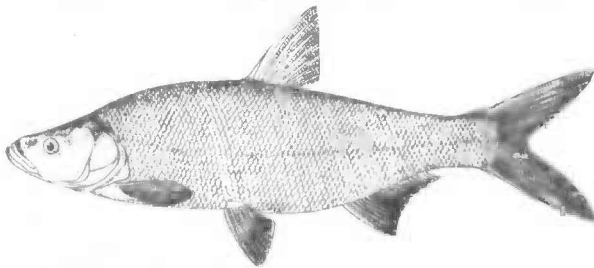

Figure 36. *Erythroculter mongolicus*.

Erythroculter dabryi

Erythroculter dabryi (Figure 37) is very similar in appearance to *Erythroculter ilishaeformis*, but its tail is greenish grey and there is a greater protuberance in front of the dorsal fins. Its feeding and spawning habits are also similar to *Erythroculter ilishaeformis*. *Erythroculter dabryi* rarely forms a dominant school in reservoirs.

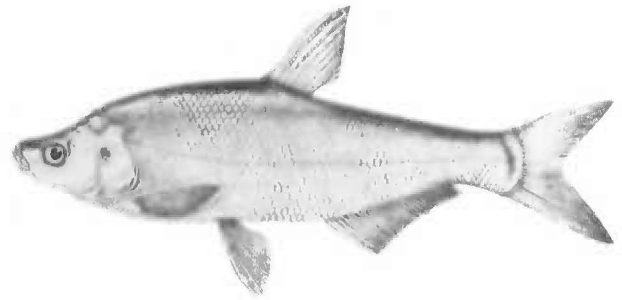

Figure 37. *Erythroculter dabryi*.

Snakehead

Snakehead (Figure 38) is a ferocious species that starts to feed on small fish when it reaches a body length of 8 cm. The snakehead eats fish, shrimp, and insects. Mature fish build nests among aquatic plants and lay eggs inside the nests. The eggs are pelagic. The snakehead is very adaptable and tolerates changes in water temperature and water quality and low oxygen levels.

The snakehead is widely distributed in Chinese reservoirs. After impoundment, snakehead originating from submerged ponds soon adapt themselves to the new water body. Because they use the submerged plants as spawning grounds and the numerous small fishes as food, the snakehead is the first predator to form a large population.

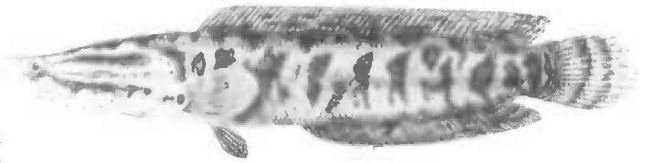

Figure 38. Snakehead (*Ophiocephalus argus*).

Mandarin fish

The mandarin fish (Figure 39) starts to predate on fry of other species at a body length of 8 mm. At a

TABLE 21. Mean weight (g) of *Erythroculter mongolicus* in various reservoirs

RESERVOIR	AGE ^{a,b}					
	1 ⁺	2 ⁺	3 ⁺	4 ⁺	5 ⁺	6 ⁺
Xinanjiang	70-155	105-500	105-1050	345-1380	465-1115	944-2600
Pohe	32	181	395	—	—	—

^a 1⁺ means that the fish had one annual ring and its second ring was taking shape; 2⁺ means the fish had two annual rings and its third was forming; and so on.

^b Source: Li Sifa (previously unpublished data).

body length of more than 10 cm, it hides on the bottom and lives mainly on small fish and shrimps. It grows quickly and normally reaches a body weight of 50-100 g in the first year and about 500 g in the second. The heaviest fish caught so far was 12 kg. Mandarin fish spawns in slow moving water, and the eggs are buoyant because they contain oil globules. It is widely distributed in Chinese reservoirs.

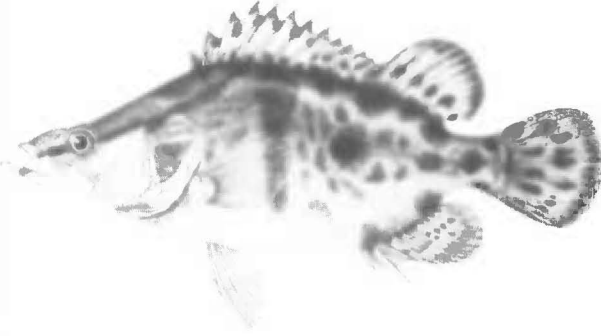

Figure 39. Mandarin fish (*Siniperca chuatsi*).

Catfish

Catfish (Figure 40) have a flat head, a big mouth, and two pair of barbels. Catfish usually hide during the day in the abundant aquatic weeds at the bottom. Juvenile catfish feed mainly on shrimp and aquatic insects; whereas, small fish are the major food for adults. Catfish lay large, sticky eggs in aquatic weeds. The population development of catfish is retarded if there is not a good source of aquatic weeds.

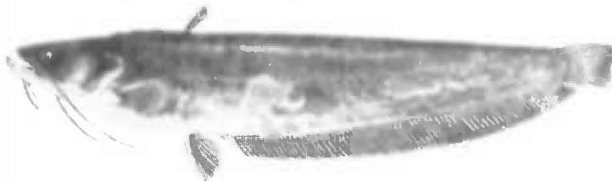

Figure 40. Catfish (*Parasilurus asotus*).

Opsariichthys bidens

Opsariichthys bidens (Figure 41) is a small-size fish that inhabits small streams. The adults prefer to feed on small fishes and insects. It has a large mouth that opens upward. Although small in size, its gape is so large that it can swallow fishes nearly half its body length. *Opsariichthys bidens* can form large populations in reservoirs because it reproduces quickly and is a strong predator of small-sized fishes stocked in reservoirs.

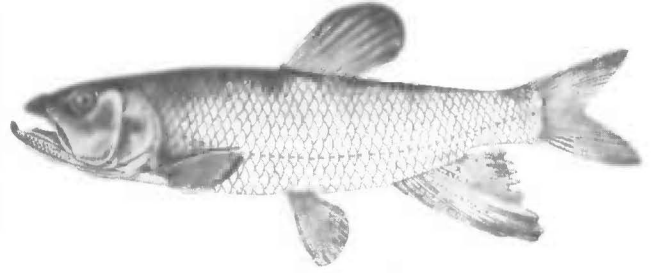

Figure 41. *Opsariichthys bidens*.

Pike (*Esox reicherti*)

Esox reicherti (Figure 42) is cylindrical and has a flat head. The upper and lower jaws are equipped with sharp teeth. The dorsal and lateral regions are covered with scattered black spots. The juveniles tend to school; whereas, the adults are solitary. *Esox reicherti* swim swiftly and rapidly and are voracious feeders, even in the winter. As well as eating fish, pike also feed on frogs and birds. *Esox reicherti* lays adhesive eggs on aquatic plants. However, spawning is affected by fluctuations in water levels.



Figure 42. Pike (*Esox reicherti*).

Hemiculter leucisculus

The body of *Hemiculter leucisculus* (Figure 43) is narrow and flat. The lateral line declines sharply at the pectoral fin, becomes parallel to the abdominal margin, and rises again in the tail region. *Hemiculter leucisculus* feeds mainly on macrozooplankton and aquatic insects. It often swallows the eggs of common carp and crucian carp during the spawning season. It can reproduce and grow in both running and lentic waters and is widely distributed throughout all parts of China except the north.

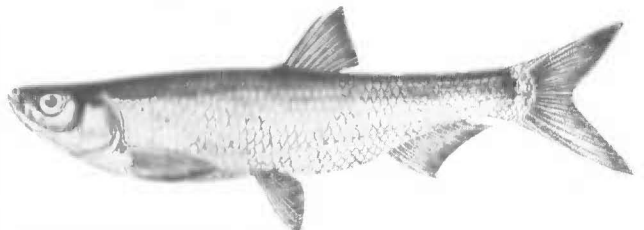

Figure 43. *Hemiculter leucisculus*.

Assessment of Fish Productivity in Reservoirs

BIOLOGICAL PRODUCTION PROCESS

Allochthonous and autochthonous nutrient sources sustain the ecological balance in any water body. Allochthonous sources include plant and dissolved matter from the catchment area; whereas, autochthonous sources are the plants within the water body (e.g., algae, bryophytes, and aquatic macrophytes). Compared with rivers, lakes, and ponds, both allochthonous and autochthonous inputs are important to reservoirs (Figure 44). During the early stages of water impoundment, allochthonous inputs are most important; whereas, autochthonous inputs become more important later. However, allochthonous sources continue to be the main source of nutrients and materials to sustain biological production in reservoirs.

Transformation of matter and energy in reservoirs

Biological production takes place in the water of reservoirs. Because of the continuous input of organic matter from the catchment area, water flow, and frequent water exchange, nutrients, food organisms, and even fish are lost from the system. This is called an "open recycling system" (Figure 45). In contrast, there is a lower inflow of nutrients from the outside and less decomposed organic matter is deposited at the bottom of ponds and lakes. As well, the water in ponds or lakes is seldom discharged; therefore, fewer nutrients and food organisms are lost. This is called a "closed internal recycling system."

Biological production processes

Biological production results from the integration of three ecosystems (the water body, the submerged area, and the catchment area). Biological production takes place in the water body of a reservoir, but primary production and fish productivity are significantly influenced by the land-water replacement system (draw-down area) and the land ecosystem (catchment area) (Figure 46). These systems not only provide the allochthonous inputs (e.g., detritus, bacteria, and nutrients, such as nitrogen, phosphorous, and silicon), but also affect the area, depth, storage capacity, morphology, shoreline development index, and physicochemical conditions of the reservoir. Because these factors influence the growth and reproduction of natural food organisms, it is essential to emphasize the importance of both the area that is periodically flooded and the catchment area to the development and management of reservoir fisheries.

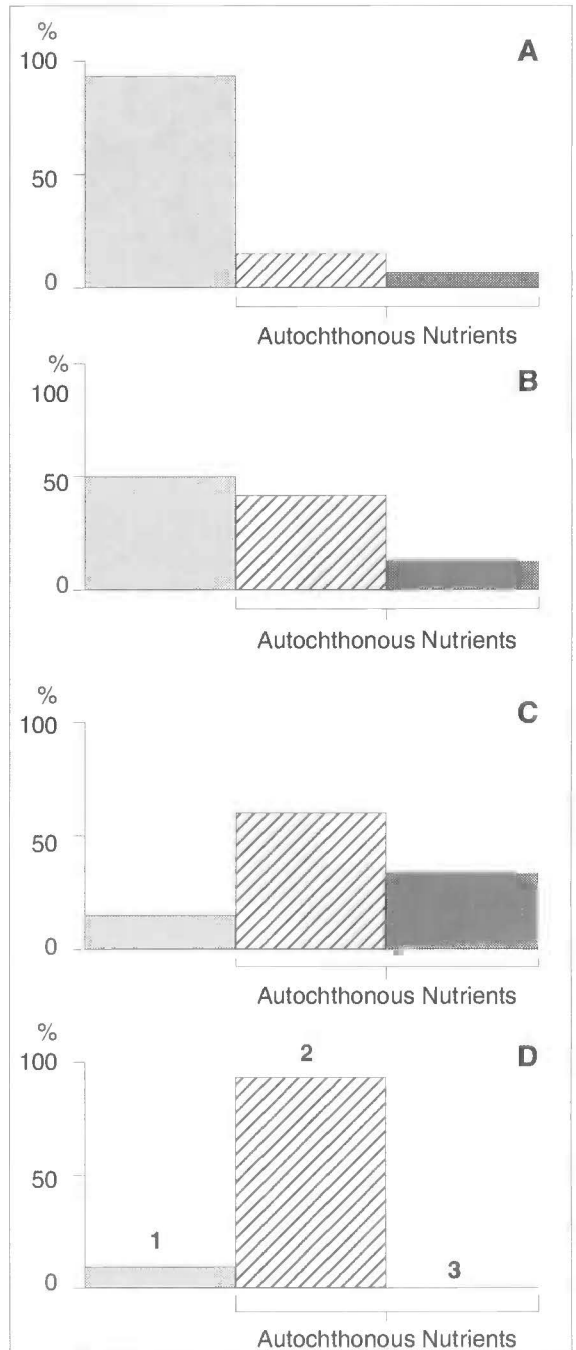

Figure 44. Comparison of the availability of trophic sources in four aquatic ecosystems (expressed as percentages of the total input): (A) river, (B) reservoir, (C) lake, (D) pond, (1) allochthonous, (2) phytoplankton, and (3) macrophytes.

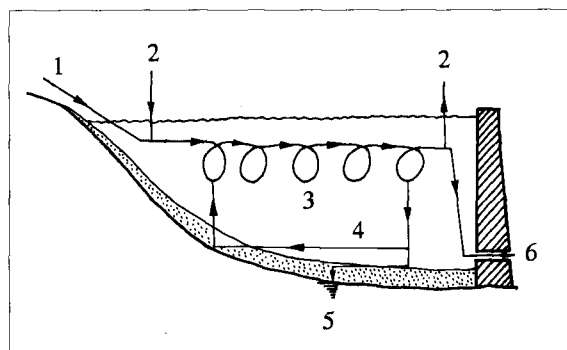

Figure 45. Open recycling system in reservoirs: (1) catchment area, (2) atmosphere, (3) circulation within reservoir, (4) surface sediment, (5) permanent sediment, and (6) outflow.

CLASSIFICATION OF TROPHIC LEVEL OF RESERVOIR

Various indicators, such as the concentration of the principal nutrients, morphological characteristics, biomass of phytoplankton, and biological production, have been studied to obtain correlations between fish productivity and trophic level. Based on the information collected so far, we have summarized the characteristics of reservoirs at different trophic levels, with special references to reservoir fish culture (Table 21).

ASSESSMENT OF FISH PRODUCTION

Potential fish production refers to production that could be achieved if all organisms and organic matter were converted into harvestable fish products. The actual biomass of fish caught from the fishery is known as the yield or fish production (fish production = fish productivity - standing crop of fish in reservoir).

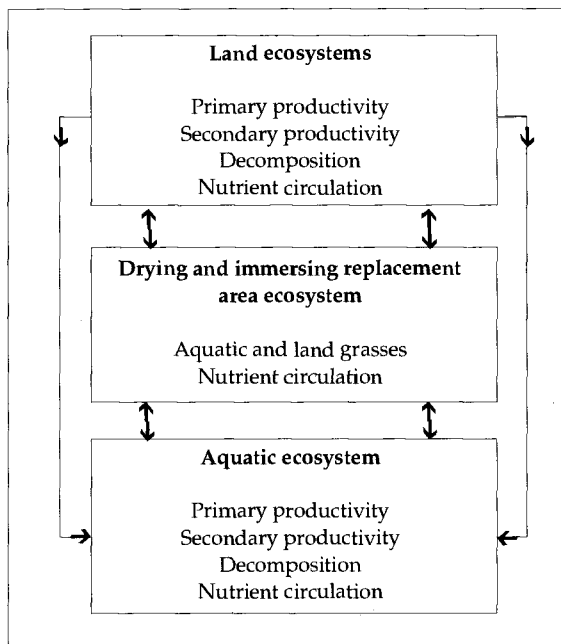

Figure 46. The relationships among the three ecosystems that contribute to the biological productivity of reservoirs. To improve the efficiency of energy conversion and the flow of matter from primary productivity to final production, it is important to understand each of the inputs and outputs of matter and energy in the reservoir ecosystem and to control their dynamics.

Factors influencing fish productivity

The yield of fish from reservoirs is closely related to the nonbiotic and biotic environments and to human activities.

TABLE 21. Characteristics of reservoirs

	CHARACTERISTICS	EUTROPHIC TYPE	HYPOTROPHIC TYPE	OLIGOTROPHIC TYPE
Morphology	Bank slope and bottom	Slight slope; small drop of bottom; shape similar to surface; large area of shallow water; no long narrow coves	Relatively steep; large drop of bottom; some large coves; larger area of shallow water	Very steep; large drop of bottom; shaped like lake with open water; long and narrow like a river; small open-water area; long, deep coves
	Morphological type	Most are lake-type reservoirs	Most are hilly-type reservoirs	Most are valley-type reservoirs
Catchment and submerged areas	Catchment area	Abundant vegetation; more fertile fields	Fair vegetation; most are hills and agricultural fields	Poor vegetation; most are sterile fields
	Submerged area	Most are agricultural fields	Most are hills and fields	Most are hills and low land
	Surroundings	Towns and villages	No towns, but some villages	Few people

Table 21 Continued on next page

Table 21 Continued from previous page

	CHARACTERISTICS	EUTROPHIC TYPE	HYPOTROPHIC TYPE	OLIGOTROPHIC TYPE
Hydrology	Average water depth (m)	2-5	7-10	10-20
	Maximum water depth (m)	7-10	Up to 20	Up to 80-100
	Water exchange	Little; relatively stable except during rainy season	More in both quantity and frequency	Almost year-round
	Water level fluctuation	Rises in spring; high in summer; maximum in autumn; lowest in winter. These reservoirs are primarily for flood prevention	Rises in later winter; high in spring; maximum in summer; drops to minimum level in autumn. These reservoirs are mainly for irrigation	High in the rainy season; low in winter. These reservoirs are mainly for hydroelectric power
Physical condition of water	Thermocline	No	Exists temporarily	Exists for a long time
	Transparency	Low	Fair	High
	Turbidity	Flood does not affect turbidity of major part of reservoir	Flood can affect turbidity of major part of reservoir	Very high during flood season
	Smell of bottom water	Generally no smell	Sulphur smell	Strong sulphur smell
Chemical condition of water	pH	7.5-8.5	6.8-7.5	Below 6.8
	Total N (mg/L)	~0.01	~0.05	~0.01
	Total P (mg/L)	~0.05	~0.03	Trace
	TDS	More	Moderate	Less
	O ₂ consumption of organic matter (mg/L)	~15	~10	~5
Natural food	Phytoplankton (10 ³ /L or mg/L)	1,000 or over 5	3-1,000 or 2-5	300 or below 2
	Zooplankton (No./L or mg/L)	2,000 or over 3	1,000-2,000 or 1-3	1,000 or below 1
	Organic detritus and bacteria	Abundant	Abundant	Poor or humus

Environmental factors

• Illumination and water temperature (climate). Solar irradiation provides the energy needed by plants for photosynthesis; whereas, water temperature affects the rates of both photosynthesis and metabolism. However, illumination and water temperature are dependent on the latitude and altitude. The climate in China is characterized by warm temperatures in the south and low temperatures in the north. The

difference in air temperature between the south and north is small in summer, but large in winter. The amount of accumulated heat is greater in the south, and the growing period is comparatively longer. This is the principal reason why fish production in southern reservoirs is higher than in northern reservoirs. At the same latitude, fish productivity in the east is higher than in the west because of the higher altitude and lower temperature in the west.

- **Nutrients.** The concentrations of nutrients change with the morphology, hydrology, soil quality, abundance of vegetation, population density of people, and economic conditions of the catchment area.

- **Food biomass.** Fish productivity depends on the species and biomass of natural organisms in the reservoir. However, not all natural organisms (e.g., bacteria, fungi, aquatic plants, plankton, and benthos) in the water can be fully converted into fish products and some are predators or competitors to fish.

Species composition and population structure

In accordance with the principles of energy flow between trophic levels, the greatest fish production from reservoirs is obtained from species with a short food chain (e.g., planktivorous and herbivorous fishes). However, fishes with similar feeding habits have variable food conversion rates. This is because some fish species consume more energy to sustain themselves. Therefore, fish productivity also depends on the feeding habits, position in the food chain, and energy-conversion efficiency of the fish. Generally, fish productivity in reservoirs dominated by carnivorous fish is lower than in reservoirs that contain primarily omnivorous or herbivorous fishes.

In addition, the same species of fish has different energy-conversion efficiency and food coefficient at each developmental stage or at different ages. In the young stages, most of the assimilated energy is converted into growth, but proportionally less energy is used for maintenance (respiration). However, as the fish grow older, the energy converted into growth is gradually reduced. Therefore, fish productivity is closely linked with the age structure of fish populations.

The fish faunal composition and population structure in highly productive reservoirs are characterized by: a diverse fish fauna; short food chain, rapid growth, and high reproduction rates of the major fish species; a significant diversity in ecological niches for major fish species; and an appropriate age structure of the major fish populations.

Human activity

Human activities have a great effect on fish productivity and can be adjusted through the alteration of environmental conditions and the control of living organisms.

Principal methods to evaluate fish productivity

Evaluation based on area of surface water

Usually, the larger the area of surface water, the shorter the shoreline per unit area. But the inflow of nutrients is directly proportional to the square of shoreline length, which implies that the larger the reservoir area, the lower the fish productivity. Based on a study of 8 large, 10 medium, and 16 small reservoirs in

Guangxi Autonomous Region, Chen (1984) found that the correlation between reservoir area and fish yield was $r = -0.5432$ ($p < 0.0001$) (Table 22). The data also indicated that fish productivity declined as reservoir area increased (Table 23). Moreover, it is difficult to stock and harvest in large reservoirs. This is one reason that surface area is used to evaluate fish productivity in reservoirs.

TABLE 22. Fish production in various reservoirs in Guangxi Autonomous Region

RESERVOIR	AREA (HA)	YIELD (KG/HA)	YEARS
Beisha	22	613.5	1968-1974
Beishi	47	177.0	1966-1976
Tielian	50	490.5	1973-1981
Yingling	84	61.5	1971-1980
Jiuyang	87	330.0	1970-1976
Dingbiao	100	73.5	1979-1982
Dingluo	101	54.0	1980-1982
Kangning	101	93.0	1971-1974; 1977-1980
Yimei	141	39.0	1971-1980
Tiantang	146	40.0	1971-1980
Dushan	147	39.0	1977-1980
Najiang	160	123.0	1971-1980
Xiyunjiang	233	87.0	1972-1980
Siweihe	257	3.0	1976; 1978-1979
Qingping	440	114.0	1958-1980
Zhongdang	473	21.0	1974; 1977-1982
Bameng	667	24.0	1976-1977; 1980
Lingdon	667	87.0	1965-1978
Linglong	800	16.0	1965-1980
Chengbihe	2,100	81.0	1975-1981
Qingshitan	2,180	69.0	1975-1980
Dawangtan	2,500	5.0	1976-1980
Guishi	3,000	34.5	1975-1981
TOTAL	14,503		
Average		54.0	

TABLE 23. Fish production in some well-managed reservoirs

RESERVOIR	AREA (HA)	YIELD (KG/HA)	YEARS
Xinjiang	40,000	75	1982-1984
Miyun	8,000	150	1972-1980
Shahe	1,370	225	1981-1984
Qingshan	567	600	1969-1983
Nanshahe	160	525	1966-1975
Xuantan	11	1,665	1983-1984

Vegetation and soil quality of catchment area

Allochthonous organic matter is the main energy source for biological production in reservoirs. However, the quantity of organic matter depends on the soil quality and vegetation of the catchment area. At present, there is no appropriate method for quantitative evaluation.

Morphoedaphic index (MEI)

Based on comparative studies of over 100 lakes and reservoirs in North America, Ryder (1965) developed a formula:

$$MEI = \frac{TDS (mg/L)}{Z (m)} \quad [1]$$

where: MEI is morphoedaphic index, TDS is total dissolved solids, and Z is average water depth.

It is difficult to measure TDS; therefore, conductivity (π , expressed as $\mu\Omega/cm$), which is directly proportional to TDS, is commonly adopted. According to Ryder and Henderson (1975), $TDS \approx 0.88\pi$. However, the slope of linear correlation between π and TDS varies between bodies of water. Therefore, these two factors must be measured separately to determine the ratio between them before conductivity can be used to estimate TDS.

The general relationship between fish productivity (Y_p) in kg/ha and morphoedaphic index (MEI) is:

$$Y_p = K \sqrt{MEI} \quad [2]$$

K is a variable that must be empirically measured. Based on the measurements for the Nasser Reservoir, Ryder and Henderson (1975) found that: TDS = 176 (mg/L), Z = 20.6 m, MEI = 8.5, and the potential fish yield (Y_p) = 39 kg/ha.

Jenkins (1982) reported that fish productivity in American reservoirs was highly correlated with MEI ($p = 0.0001$). Based on investigations in 14 reservoirs in Xiangyang, the Hubei Provincial Reservoir Investigation Team (1982) concluded that there was no significant relationship between fish productivity and conductivity. Similar results were obtained from 15 reservoirs in the Huanggang area of Hubei Province. This indicates that fish production in Chinese reservoirs is greatly affected by artificial stocking, fishing, and fishery management. In fact, MEI has little value in the evaluation of fish productivity where fish farming is practical. However, MEI can be used to obtain a rough estimate of fish productivity in new reservoirs before fish are stocked.

Biomass of food organisms

Fish productivity (Y_p) in reservoirs can also be estimated from:

$$Y_p = \frac{B (P/B) U_f}{K_f} \quad [3]$$

or

$$Y_p = \frac{P (U_f)}{K_f} \quad [4]$$

where: B = standing biomass of a particular food organism, P = production of a particular food organism, P/B = ratio of production to the standing biomass of a particular food organism, U_f = utilization ratio of a certain food by the fish, and K_f = food-conversion efficiency.

At least three parameters are needed to evaluate fish productivity based on the biomass of food organisms:

- Biomass of food organisms and P/B coefficient. The weight of a particular food organism that can be sampled or harvested by normal methods at any one

TABLE 24. The P/B coefficients of food organisms in various reservoirs

RESERVOIR AND LOCATION	PHYTOPLANKTON		ZOOPLANKTON		BENTHOS	
	RANGE	AVERAGE	RANGE	AVERAGE	RANGE	AVERAGE
Lake-type reservoirs in former USSR	10.5-112	55	1.8-30.6	16	1.1-25	4
Reservoirs in northeastern China	40-60	50	15-25	20	5-7	—
Reservoirs in central China	—	180	—	25	—	—
Lake-type reservoirs in North America, Europe, and Africa	8.9-358.6	113	0.5-44.0	14	0.6-25	4

time from a given area is called the standing biomass (B). The total weight of a particular food organism produced over a period of time (this includes both living and dead organisms as well as those consumed by fish or washed away in the water flow) is known as the production (P). The standing biomass can be measured; whereas, production cannot yet be measured directly, but can be estimated. The ratio of production to standing biomass is called the P/B coefficient. The higher the P/B coefficient, the higher the productivity of a certain food organism. For example, the P/B coefficient of the same species in the south is usually higher than in the north because the species has a longer growing period. The P/B coefficients of several major food organisms are shown in Table 24.

- Utilization rate of food organisms. This is the ratio of the biomass of the food organisms directly eaten by the fish to the total biomass of the food organisms. The ratio depends not only on the species of food organisms, but also on the size and density of grazers. The rate at which fish use food organisms in reservoirs is determined from empirical estimates in the laboratory because no reliable data are available. In stocked reservoirs, the utilization rates of phytoplankton, zooplankton, and benthos are estimated as 20-30%, 25-50%, and 20-50%, respectively. However, there is little information on the utilization rate of detritus and bacteria.

- Food coefficient. This is the amount of food consumed per unit gain in fish body weight. In reservoirs, the food coefficients of the main food organisms are: phytoplankton and aquatic plants 40-100, zooplankton 6-10, chironomid larvae and tubificids 5, clams 40, shrimp 9-14, and fish 5.

Based on these three parameters, it is possible to estimate fish productivity as shown in case studies A and B.

- Case study A. Based on 47 measurements in Qinghe Reservoir from 1970 to 1979, He Zhihui and Li Yonghan (1983) reported that the average plankton biomass was 6.6 mg/L and that of this, the zooplankton biomass was 2.3 mg/L during the growing period (April-October). The average water depth was 10 m, phytoplankton production was 660 kg/ha, and zooplankton production was 229.5 kg/ha. By taking the P/B coefficients of phytoplankton as 50 and of zooplankton as 20, the utilization rate is 20% for phytoplankton and 50% for zooplankton; whereas, the food coefficient is 30 for phytoplankton and 10 for zooplankton. The annual fish productivity that could be supported by phytoplankton can be estimated as:

$$\frac{660 (50) 20\%}{30} = 220.5 \text{ kg/ha} \quad [5]$$

The fish productivity that could be supported by zooplankton can be estimated as:

$$\frac{229.5 (20) 50\%}{10} = 229.5 \text{ kg/ha} \quad [6]$$

Therefore, the total fish productivity of silver carp and bighead carp that could be supported by plankton in Qinghe Reservoir is 450 kg/ha.

- Case study B. Based on investigations in Qinghe Reservoir from 1978 to 1979, Xie (1982) estimated the total standing crop of Tubificidae and chironomid larvae to be 29.25 kg/ha. If the P/B coefficient is assumed to be 3, the utilization rate 25%, and the food coefficient 5, the fish productivity of common carp and crucian carp would be:

$$\frac{29.25 (3) 25\%}{5} = 4.4 \text{ kg/ha} \quad [7]$$

However, the fish production of common carp and crucian carp is higher when molluscs and organic matter are also considered to be food sources.

Primary productivity

The productivity of silver carp and bighead carp can be estimated from primary productivity using the equations developed by Wang and Liang (1981).

- Silver carp

$$F_h = \frac{P_g (f) K (a) H_y}{E_h (C)} \quad [8]$$

- Bighead carp

$$F_a = \frac{P_g (f) K (a) A_r}{E_a (C)} \quad [9]$$

where: F = fish productivity (kg or tonnes), P_g = gross productivity of phytoplankton ($\text{g O}_2/\text{m}^2/\text{year}$), $f = (P_h/P_g)$ the ratio of net phytoplankton productivity to gross phytoplankton productivity (0.78), $K = \text{O}_2$ equivalent of heat (3.51 cal/mg O_2), $a =$ the maximum utilization of phytoplankton by fish (0.8), $C =$ raw fish-flesh equivalent of heat (1.2 kcal/g fresh fish), $H_y =$ relative stocking proportion of silver carp to the total stocking of both silver carp and bighead carp, $A_r =$ relative stocking proportion of bighead carp to the total stocking of both silver carp and bighead carp, $E_h =$ energy-conversion efficiency from phytoplankton to silver carp (39.18), and $E_a =$ energy-conversion efficiency from phytoplankton to bighead carp (22.69).

Because f , I , a , C , E_r and E_a are all constant in Equations [8] and [9], the equations can be simplified as: $F_h = 0.0466 H_y (P_g)$ and $F_a = 0.0804 A_r (P_g)$, in which

$H_y + A_r = 1$. At different ratios of H_y to A_r , F_h and F_a can be simply calculated based on the factors given in Table 25.

For example, the average daily productivity of phytoplankton measured with the light and dark bottle method (Zhang *et al.* 1981) in Longtou Reservoir (71 ha) was 3.55 g O₂/m² in 1978 and 6.48 g O₂/m² in 1979. It was calculated that the total productivity was 639 g O₂/m² in 1978 and 1,166 g O₂/m² in 1979 during the growing period of the fish (180 days). The average productivity of phytoplankton was assumed to be 902 g O₂/m²/year or 641 t O₂ for the whole reservoir.

When $H_y = 0.7$ and $A_r = 0.3$, the productivity of silver carp (F_h) and bighead carp (F_a) was estimated to be: $F_h = 0.0326 P_g = 0.0326 \times 641 = 20.90$ t; and $F_a = 0.0241 P_g = 0.0241 \times 641 = 15.45$ t.

Therefore, the total estimated productivity of silver carp and bighead carp is 36.35 t, and it could be higher if detritus and bacteria were considered as a food source.

Factors to be considered when estimating fish productivity

- Site selection, sampling, monitoring, and calculation of the standing crop of food organisms are the

basic steps used to evaluate fish productivity in reservoirs. The light and dark bottle method is reasonably accurate, but accuracy in converting the net production of oxygen into phytoplankton growth must be improved.

- The parameters used in the equations are hypothetical or experimental data obtained under specific conditions. In fact, these parameters vary with the particular conditions. Therefore, the values of fish productivity are only approximate.

- In a water body stocked with fish, the biomass of the food organisms that is monitored is actually the number of organisms that remain after the fish have fed. Because plankton reproduce rapidly and have a short life cycle, the portion consumed can be easily replaced by propagation. Therefore, standing fish production should be included in the evaluation of fish productivity.

- In reservoirs with artificial culture, natural factors that affect fish productivity cannot be easily quantified because the stocking of fingerlings and other management practices affect fish production. For example, many surveys in the Huanggang area in Hubei Province have shown little correlation between fish production (kg/ha) and primary productivity.

TABLE 25. Factors used to predict productivity of silver carp (F_h) and bighead carp (F_a) at different ratios of H_y and A_r

	$H_y = 0.7$ $A_r = 0.3$	$H_y = 0.6$ $A_r = 0.4$	$H_y = 0.5$ $A_r = 0.5$	$H_y = 0.4$ $A_r = 0.6$	$H_y = 0.3$ $A_r = 0.7$
F_h	0.0326 P_g	0.0280 P_g	0.0233 P_g	0.0186 P_g	0.0140 P_g
F_a	0.0241 P_g	0.0322 P_g	0.0402 P_g	0.0482 P_g	0.0563 P_g

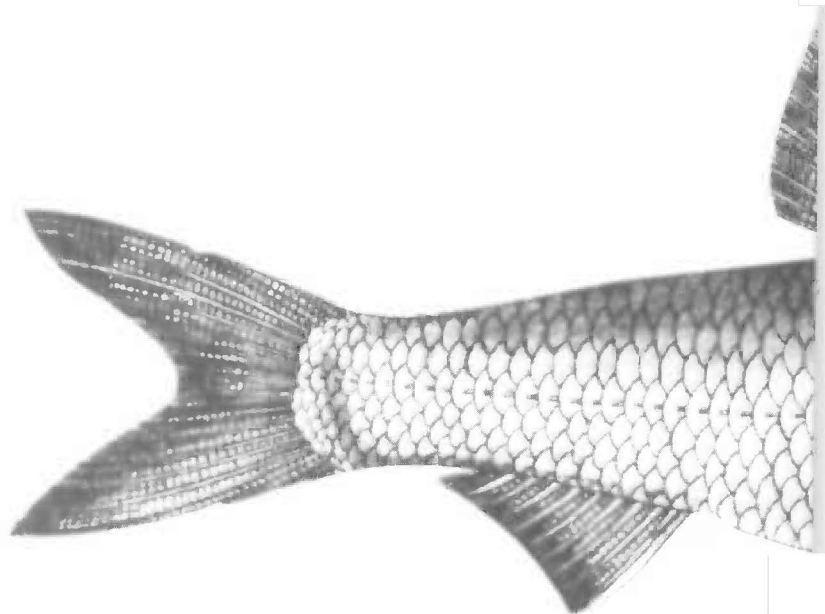

PART II

Fish Culture in Reservoirs

There are several patterns of fish culture in Chinese reservoirs: extensive culture, semi-intensive culture and intensive culture (including cage culture), and integrated fish farming. All patterns include: culture of large-size fingerlings, stocking, control of predators and trash fish, and prevention of escape.

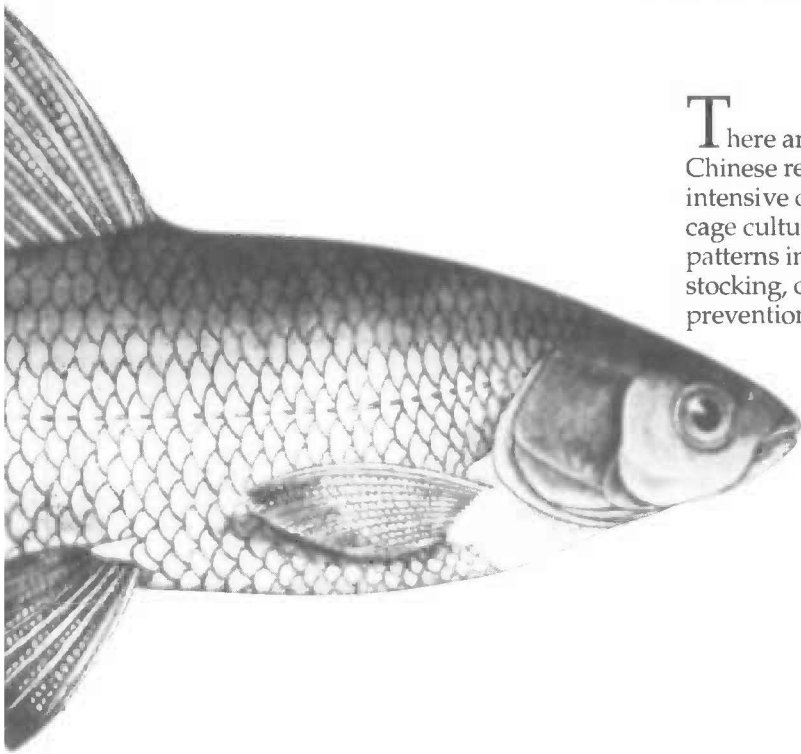

CHAPTER 5

Culture of Large-Size Fingerlings

Years of practice and experimentation have demonstrated that stocking of large-size fingerlings is a prerequisite for successful fish culture in reservoirs. Using traditional practices, a 1-ha pond produces only about 75,000 13-cm fingerlings. When fingerlings (3 cm total length, TL) are reared over the summer to 13-cm fingerlings, every 10,000 fingerlings consume 450 kg of commercial feed (e.g., rape cakes or barley) or 250 kg of bean cake, and 1,500 kg of manure. A 1,000-ha reservoir requires 1.5 million fingerlings at a stocking rate of 1,500 fingerlings/ha. To produce this number of fingerlings, more than 200 ha of fingerling ponds, 37,500-67,500 kg of commercial feed, and over 225,000 kg of manure are needed. Shortages of pond space, food, and manure are starting to limit the rearing of large-size fingerlings. To meet the increasing demands of reservoir fishery development, new technologies, such as fingerling production in coves and cages, have been developed to supplement production from traditional pond culture.

FINGERLING CULTURE IN CAGES

Cage culture was first developed in China in the 1970s. Since then, these practices have proved effective in producing an adequate number of large-size fingerlings for stocking and for production of table fish in reservoirs and have become an integral part of fish farming.

Fingerlings produced in ponds often have high mortality rates soon after stocking because they are injured during netting and transportation and do not adapt to the new environment. Fingerlings produced in cages have a higher survival rate and do not need to be transported. Therefore, cage culture of fingerlings is being rapidly developed. For example, only five cages

were used for a trial production in Dahuofang Reservoir in 1979. In 1980, the number of cages was increased to 240 and 15.3 million fingerlings were produced. The fingerlings were overwintered in cages under the ice and about 700,000 yearlings with a body weight of 50-350 g were produced. In 1981, the number of cages was increased to 650. The success of producing large-size fingerlings in cages has meant that this reservoir, which was formerly dominated by predators, has been transformed and quickly become a valuable fishery resource. In Fuqiaohe Reservoir, about 96% of the fingerlings stocked in 1978-1979 were produced from cages.

Advantages and disadvantages

There are several advantages to the use of cages to rear fingerlings:

- The water resources of reservoirs are better used and the space needed for pond construction is minimized.

- With proper management, water can be continuously exchanged to ensure the availability of natural food for silver carp and bighead carp, which reduces the input of food and manure.

- The stocking density and survival rate of fish are comparatively high in cages, and labour and production costs can be reduced. Table 26 shows the inputs into the various farming systems. For example, Sandaoling Reservoir is a hypotrophic reservoir with a phytoplankton biomass of 500,000/L. In 1980, 63 open-type cages with a total area of 2,268 m² were placed in the reservoir. Commercial feed was used because the water fertility was low. It was found that 30,000 10-cm fingerlings consumed 29 kg of rice bran at a cost of CNY32.89 (in 1980, CNY1 ≈ USD2). On average, the

TABLE 26. Inputs needed to produce fingerlings using different farming systems

	FOR 10,000 FINGERLINGS				FOR 100 KG OF FINGERLINGS			
	LAND (HA)	WATER SURFACE (HA)	FEED (KG)	LABOUR (DAY)	LAND (HA)	WATER SURFACE (HA)	FEED (KG)	LABOUR (DAY)
Cage	—	0.0007	—	5	—	0.0027	—	2
Cove	—	0.3333	400	14	—	0.1333	160	6
Pond	0.0333	0.1333	400	30	0.133	0.0267	160	12

yield in the cages was 200 fingerlings/m² with a production cost of CNY138 per 10,000 fingerlings. The revenue from cage culture was CNY5.5/m²; whereas, in ponds of 3.3 ha, the total production cost was CNY238 and net profit was CNY0.04/m². Based on the results from Fuqiaohe Reservoir, the quantity of fingerlings produced from 1 ha of cages is the same as can be reared from 12-50 ha of ponds or 30-130 ha of coves.

- Because of the continuous exchange of water, dissolved oxygen content and water quality are high. Consequently, fish can be stocked at high densities and the growth rates and food conversion ratio are high.

- It is easier to control competitors, predators, and the spawning of reared fish and is convenient to prevent and treat diseases.

- Harvesting of fingerlings is easier and there is less handling and injury. The survival rate is also increased because transportation is not necessary.

- Cages can be moved easily when necessary.

- Investment and production costs are low, but economic returns are high.

Cage culture also has some disadvantages:

- Fish production in cages depends on the ecological condition of the reservoirs. Cage culture of silver carp and bighead carp is not suitable for shallow reservoirs that are poor in natural food organisms, have a high fluctuation in water level, or have a swift current. In these cases, nomadic cage-farming techniques can be used to move the cages to places where conditions are favourable.

- It is labour-intensive to wash away the epiphytic organisms and dirt that become attached to the nets to permit free exchange of water.

- Some of the applied commercial feed may be wasted.

- Some animals (e.g., rats and crabs) can damage the nets and allow fish to escape.

Reservoir and site selection

The prerequisites for fast growth and high yield of fingerlings in cages are: abundant food, water of high quality, high levels of dissolved oxygen, and appropriate water temperature.

Food sources

If natural organisms are the main food source, fingerlings of silver carp and bighead carp will not grow well unless they are cultured in eutrophic reservoirs that have an abundance of plankton. For example, in hypotrophic reservoirs, at a stocking density of 200-300 fish/m², it is difficult to achieve a survival rate above 60% and to produce fingerlings that are 13 cm in length. However, in eutrophic reservoirs, these production targets can be achieved even at a density of 500-600 fish/m².

Experiments in 1979 showed that the phytoplankton biomass in Gangnan, Tuhe, and Henshling Reservoirs was 660,000/L, 808,000/L, and 1,840,000/L, respectively. The survival rate of silver carp and bighead carp fingerlings reared in 242 cages (about 6,670 m²) in these three reservoirs was 24.2%, 29.4%, and 46.6%, which indicates that the survival rate of fingerlings was directly proportional to the plankton biomass in the reservoir.

Because there are no standardized criteria for the trophic classification of reservoirs, the correlation between plankton biomass and fish production in cages needs further study. Table 27 shows the production of silver carp and bighead carp fingerlings in three reservoirs with different trophic levels.

Water fertility and plankton biomass vary in different regions of the same reservoir; therefore, fish production also varies. The site for cage culture should be carefully selected. Generally, cages should be located near towns, villages, large livestock farms, and abundant vegetation and at the confluent areas of reservoirs.

Flow rate of water

The water for cage culture should have an optimal flow rate of about 0.05-2.0 m/s to ensure good exchange of water. If the water flow is too rapid, the fish will consume more energy to maintain their position. If the water exchange is adequate, the dissolved oxygen content will be more or less the same inside and outside the cages (Table 28). In Bailianhe Reservoir, little difference in dissolved oxygen content was found inside and outside the cages with fish production at 70 kg/m². However, the plankton biomass inside the cage

TABLE 27. Correlation between plankton biomass and production of 13-cm silver carp and bighead carp in reservoirs with different trophic levels

TYPES OF RESERVOIR	PHYTOPLANKTON		ZOOPLANKTON		PRODUCTION	STOCKING DENSITY (FISH/M ²)
	(10 ³ /L)	(MG/L)	(NO./L)	(MG/L)		
Eutrophic	>1,000	>5	>2,000	>3	Good	300-600
Hypotrophic	300-1,000	2-5	1,000-2,000	1-3	Poor	100-300
Oligotrophic	<300	<2	1,000	<1	Very poor	—

was lower because of grazing by the fish. Table 29 shows the differences in plankton biomass inside and outside the cages in Bantou Reservoir.

Generally, the ratio of the area of cages to the natural water body should not be less than 1:60-100. Cages should be about 30 m apart.

TABLE 28. Oxygen concentration (mg/L) inside and outside cages in Bantou Reservoir

DATE	INSIDE CAGE			OUTSIDE CAGE
	CAGE I	CAGE II	CAGE III	
Morning of 22 Sept 1975	5.9	5.7	5.9	7.1
Afternoon of 27 Sept 1975	6.3	6.2	6.5	6.5

TABLE 29. Differences in plankton biomass inside and outside cages in Bantou Reservoir.

	RANGE	MEAN
Phytoplankton (10^3 /L)		
Inside Cage	74-324	205
Outside Cage	255-438	342
Zooplankton (No./L)		
Inside Cage	30-630	381
Outside Cage	150-1,770	698

Note: The stocking density of 13-cm silver carp and bighead carp was 108 fish/m².

Installation of cages

Cages usually consist of a frame, the netting, a float, a sinker or weight, and an anchor.

- **Frame.** The frame is used to support the soft cage body (net) and maintain its shape, and also as a float or operation platform. Cage frames are usually made of bamboo, wood, and polyethylene pipe (Table 30); however, metal pipes have also been used recently.

- **Netting.** The cage body is made from several pieces of net that are woven from polyamide (PA), polyethylene (PE), polypropylene, other synthetic materials, or wire. The material selected for the body of the cage should be selected carefully. At present, polyethylene is most commonly used because of its high tenacity, resistance to rotting, non-absorption of water, and low cost. However, polyethylene nets easily degenerate in the sun. Nylon netting is more costly

and fouling organisms are difficult to remove. Wire mesh allows good movement of water and little fouling, but is costly and rather heavy to handle.

TABLE 30. Materials used for cage frames

	BAMBOO	WOOD (FIR)	POLYETHYLENE PIPE
Diameter (cm)	>6	5-10	5-6
Duration (years)	2-3	3-5	6-8
Buoyancy	Moderate	Poor	High
Disadvantages	Leak	Sink after absorbing water	Expensive

- **Floats.** Many materials are used as floats (e.g., bamboo logs, glass bulbs, plastic, metal, and rubber). The main principle in choosing float material is to use light-weight material that has a high buoyancy per unit volume. Since the 1970s, plastic floats have been widely used because they are light, buoyant, and easy to produce.

- **Sinkers.** Many types of sinkers are used. Generally, ceramic sinkers are used because their smooth surface reduces wear and tear on the nets and ropes. If conditions permit, steel pipes (2-2.5 cm in diameter) can be used. Because steel pipes do not bend easily, they are commonly used both as the sinker and to maintain the shape and increase the effective volume of the cage. In practice, the most simple method is to use stones or prefabricated concrete as weights.

Dimensions of cages

- **Area.** The larger the cage area the lower the production cost. However, the relative exchange of water is also reduced, which lowers productivity compared with smaller cages when natural food organisms are used under the same conditions. Four sizes of cages are commonly used in commercial production: 100-120 m² (large size), 30-100 m² (medium size), 30 m² (small size), and 1-4 m² (mini size). If silver carp and bighead carp are reared on natural food organisms, the optimal cage sizes for fingerling production are 4 m x 4 m, 3 m x 4 m, and 3 m x 3 m; whereas, for yearling production, 6 m x 5 m and 6 m x 6 m are preferred. Cages of this size have good water exchange, abundant food supply, and can be conveniently managed.

- **Depth.** The netting required to make a cage of 20 m x 6 m x 3 m is 15.1% more than needed to make a cage of 20 m x 6 m x 2 m. Similarly, a cage that is 10 m

x 3 m x 3 m requires 23.2% more materials than a cage that is 10 m x 3 m x 2 m. However, if the cage is made too shallow, the space available to the fish becomes too small and the amount of natural food is reduced. Therefore, the depth of cages should be adjusted to local conditions to maximize fish production and minimize production costs.

No matter how deep the cage is, the bottom should be at least 0.5 m above the reservoir bed to maintain a proper exchange of water and to discharge fish faeces and waste food. When the fish depend on natural food sources, the depth of the cage in the water is determined by the vertical distribution of the plankton. Generally, photosynthesis reaches a maximum at a water depth of 0.5 m, and over 60% of primary productivity takes place in the first 3 m of water in reservoirs. As a result, the optimal depth for cages is 2-4 m.

The size of the fingerlings to be reared also affects cage depth and the management of the cages. For example, fingerlings normally live at a depth of 0.5-1.0 m and seldom move below 1.8 m; therefore, cages that are 1.5-2.0 m are deep enough. Yearlings live at a depth of more than 1.5 m; therefore, cages should be 2-3 m deep.

The cover net used to prevent the fish from jumping out of the cage is about 1 m in height. If it is too high, the net can be blown over by the wind, but if it is too low, silver carp can easily jump out.

- Shape. Whatever shape is adopted, the primary concern must be water exchange around the cage. The smaller the cage area, the better the water exchange and the higher the utilization of natural food.

Theoretically, round cages have a higher utilization rate and lower production costs, but they are more difficult to construct. The square-shape cage is always the least efficient. A rectangular-shape cage usually has a larger surface area exposed to the outside water than a square-shape cage, but a smaller exposure than an octagonal cage.

Rectangular cages are simple in structure and easy to install. The most common rectangular cages used in reservoir fish production have a width:length ratio of 1:1.2-1.5. The longer side of the cage should be placed toward the water current to ensure the best exchange of water.

- Mesh size. The mesh size of the netting used to make the cages should be chosen so that fish cannot escape, less material is used, and good water exchange is ensured. If the mesh size is too small, netting material is wasted and water flow is reduced; however, the fish cannot escape.

Based on experience at Xinanjiang Reservoir, the mesh size of cages can be calculated as: $a = 0.13 L$, where a = leg length of the mesh (cm) and L = length of silver carp (cm). For example, if 11.6-cm silver carp fingerlings are stocked, the mesh size ($2a$) should be

3 cm. For common carp of the same length, the mesh size of the cages could be larger because common carp have a broader girth. For common carp fingerlings (4-5 cm long), the mesh size ranges from 1.0 to 1.3 cm.

- During the culture period, the fish must be transferred to larger cages of suitable mesh size. This is important to increase fish growth, ensure uniform fish size, and increase fish production.

- Types of cages. There are two types of cages: open and closed. Open cages are normally better than closed ones because they are convenient to use, allow good light penetration and ventilation, and are low cost. The only disadvantage is that part of the wall is out of the water and disintegrates in the sun and can blow over.

Fingerling production in cages

No-feeding culture

This method of rearing silver carp and bighead carp fingerlings depends on natural food organisms. With good water exchange, the species composition and biomass of plankton influence the stocking density, proportion of the two fish species, their growth rate, and population biomass.

Hu Batong *et al.* (1983) stocked 4-cm silver carp at a density of 500 fish/m³ in cages in Bailianhe Reservoir. The reservoir was rich in plankton (average density of phytoplankton was 3.9 million/L and zooplankton was 2,996/L during June-August) and the fish grew to 13 cm in length after 70 days of rearing.

- Stocking density. Stocking density in cages is expressed either as the number of fish (fish/m² or fish/m³) or as the weight of the fish (kg/m² or kg/m³). The formula to calculate the stocking density is:

$$\text{Stocking density} = \frac{\text{Fish at transfer size (fish/kg)} \times \text{estimated fish productivity (kg/m}^2\text{)}}{\text{survival rate (\%)}} \quad [10]$$

For example, if the expected transfer size of silver carp is 13.2 cm and there are 44 fish per kilogram, the estimated fish productivity is 5 kg/m², and the survival rate is expected to be 80%, then the stocking density should be:

$$\text{Stocking density} = \frac{44 \text{ fish/kg (5 kg/m}^2\text{)}}{80\%} = 275 \text{ fish/m}^2 \quad [11]$$

The evaluation of silver carp and bighead carp productivity is reviewed in Chapter 4.

- Stocking proportion. Proper stocking proportion is an important technical consideration in the culture of silver carp and bighead carp fingerlings in cages using natural food sources. Both species are filter

feeders, but they have different feeding habits. Silver carp live mainly on phytoplankton, and bighead carp primarily on zooplankton. Because the feeding habits of these two species overlap, plankton of various sizes and types can be used efficiently when these fish are cultured together in the correct proportion.

However, the stocking proportion of silver carp and bighead carp varies because the species composition and biomass of the plankton differ between reservoirs. For example, there is no difference between polyculture and monoculture in Hedi Reservoir, but there are few reservoirs of this type in China. In most large- and medium-size reservoirs (e.g., Nanwan and Chengxi), bighead carp grow faster than silver carp and the stocking density of bighead carp should be higher. However, in some eutrophic reservoirs that are rich in phytoplankton biomass (e.g., Bailianhe and Helong Reservoirs), silver carp grow faster and should be stocked at a higher density.

Within large reservoirs, the stocking proportion of silver carp and bighead carp can differ between locations. For example, in Xinanjiang Reservoir, the stocking proportion of silver carp to bighead carp is 3:7 in the backwater zone of the main channels; either of the species can be reared as the major species in the larger tributaries; and the proportion should be adjusted to 2:8 in areas enriched with domestic sewage.

- Stocking of fingerlings. When fingerlings are transferred from ponds into cages, they must be conditioned because: the newly stocked fingerlings usually swim or jump along the cage wall in groups for the first 1-2 days; the level of dissolved oxygen is high and stable in reservoirs (therefore, fingerlings stocked in cages will have a higher rate of metabolism and require more food); the density of food organisms in reservoirs is much lower than in ponds; and the stocking density of fish is higher in cages. As a result, unhealthy fingerlings may starve to death.

The stocking size of juveniles for cage culture of large-size fingerlings ranges from 4 to 6 cm; therefore, the fish should be carefully sized and properly conditioned prior to stocking. For juveniles transported a long distance, the stocking density should be adjusted to account for their survival and health. If they are in good condition, direct stocking can be performed; otherwise, they should be temporarily stocked in another cage for 1-2 days so that dead, injured, or diseased fish can be removed.

Fingerlings should also be disinfected before they are stocked in cages to prevent the spread of disease. The methods commonly used to disinfect fingerlings are: bathing in a 3-4% salt (NaCl) solution for 5-10 min; bathing either in a malachite green solution (10 ppm) or in a potassium permanganate solution (10-20 ppm) for 10-15 min; or bathing in a 5% salt (NaCl) and 0.5% sodium bicarbonate (NaHCO₃) solution. The choice of

bathing solution is made according to water temperature and fish health.

Before the cages are stocked, they should be put in the water for several days to allow some epiphytic organisms to grow on the netting. This reduces injuries to the newly stocked fingerlings.

- Seasonal changes in production. Because plankton have seasonal peaks in biomass, fingerlings should be stocked at a time that enables them to fully utilize the plankton. If the growing period is long enough, double cropping of fingerlings is possible, particularly in reservoirs with two peaks of plankton production, one in spring and another in autumn. Generally, the fish are harvested in late October when the water temperature declines, plankton populations are reduced, and the fish are less active.

Feeding culture

If the natural food source is insufficient, commercial food must be provided. Fish such as grass carp, common carp, Wuchang fish, and tilapia can be reared on artificial food.

Routine management

Management is an important part of cultural practices. Successful fingerling production in cages depends on cage cleaning, prevention of fish escape, and careful examination of fish growth and behaviour.

Timely cleaning

Timely cleaning of cages ensures good exchange of water. Soon after cages are installed in the water, filamentous algae (e.g., *Spirogyra*, *Zygnema*, *Mongeotia*, and *Apanizomenon*), diatoms (e.g., *Synedra*, *Fragilaria*, and *Cymbella*), and other organisms as well as mud and sand become attached to the cages. For example, in Bantou Reservoir, a new cage was installed on 22 July and examined on 22 October 1975. There were 563-750 g of epiphytic organisms attached to each square metre of the cage wall (mesh size 2.4 cm).

The common cleaning methods are:

- Mechanical cleaning. Water sprayers or pumps can be used to clear dirt off cages using a high-pressure water spray. For example, an agricultural spray gun driven by a 2.2-kW diesel engine, with an inlet pipe of 2-3 m and outlet pipe of 2 m, but a 12-16 mm nozzle is installed at the mouth of the outlet pipe. This equipment is usually installed on a small boat and operated by 2 or 3 people. One person controls the spray gun, the others lift the cages. It takes only 15 min to completely wash a 50-m² cage.

- Biological cleaning. Omnivorous fish (e.g., bream, tilapia, *Distoechodon tumirostris*, and *Plagiognathops microlepis*) prefer to scrape epiphytic algae and ingest filamentous algae and organic detritus. Therefore, some of these fishes can be stocked to help remove the

epiphytic organisms and also increase the number of species reared and the production of the cages.

- Sun drying. Cages can be exposed to the air and sun to remove fouling organisms. However, the cage becomes fragile after long-term exposure to the sun, which reduces its durability.

Inspection of cages

Cages should be regularly checked for holes because fish can escape easily.

Prevention of losses because of floods and typhoons

The cage and mooring ropes should be frequently adjusted as the water level fluctuates, especially during floods and periods of irrigation. When heavy storms or floods occur, the water level will increase significantly; therefore, the mooring ropes should be loosened to prevent the cage from becoming completely submerged. During dry seasons, the anchor ropes should be tightened to maintain a suitable depth for fish growth as the water level drops. Alternatively, the cages can be moved to a safer place.

FINGERLING CULTURE IN COVES

Fish culture in coves makes use of areas that are alternately flooded and exposed. These areas are separated from the main part of the reservoir by a dam or barrier net and are used for the culture of fingerlings or food fish.

A cove blocked with a dam is called a dam-blocked cove (Figure 47). The dam is usually installed with a spillway, drainage, and culverts. This type of cove is a permanent small reservoir separated from the main reservoir; however, its water level is not affected by the main reservoir. Therefore, manure and food can be applied and predators can be easily and effectively eliminated.

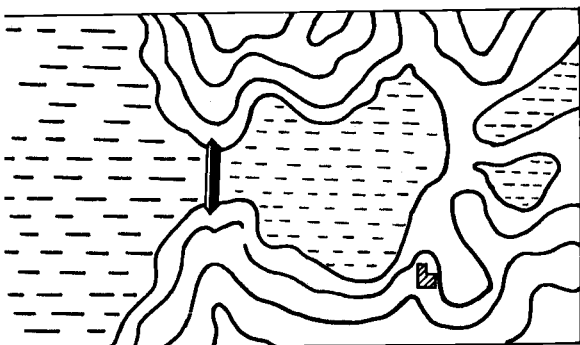

Figure 47. Dam-blocked cove.

A cove fenced with a net is called a net-fenced cove (Figure 48). Because the water in the cove is connected

to the main reservoir, small fish are able to move in and out and it is difficult to eliminate wild fish and predators. Generally, feeding and manuring are not practiced in net-fenced coves, and production is less intensive than in dam-blocked coves. However, the impounding net can be set or removed as needed.

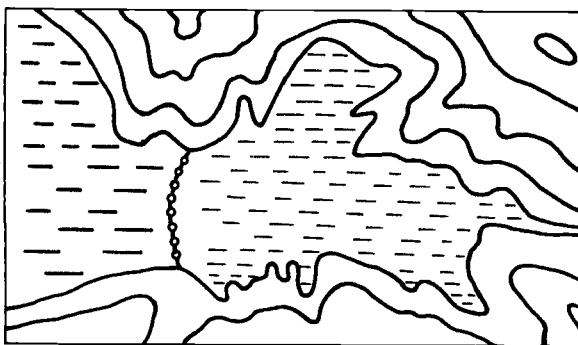

Figure 48. Net-fenced cove.

There are several advantages of fingerling culture in coves:

- reservoirs have well-developed shorelines and many coves, and the use of coves neither competes with agriculture for land nor affects the normal water storage and discharge of the reservoir;
- because coves are large, deep, and have good water quality, the fingerlings that are produced adapt easily to reservoir conditions, and they grow and survive better than fingerlings raised in ponds;
- coves usually have good quality water and abundant natural food sources; therefore, production costs are comparatively low because the fish seldom need to be supplied with commercial food and manure;
- compared with ponds, coves have more stable water temperatures and higher levels of accumulated heat and dissolved oxygen; and
- the investment per unit area of a dam-blocked cove is usually 50% less than the investment needed for ponds.

Fingerling production in coves has been practiced and improved since the 1960s. For example, since 1964 the area of dam-blocked and net-fenced coves in Xinanjiang Reservoir has increased to 287 and 1,000 ha, respectively, and is now the main base for fingerling production. In Shahezi Reservoir, 13 dam-blocked coves with a total water surface of 37.5 ha have been used since 1972, and fingerling production now supplies the total stocking program of the reservoir and has greatly increased fish production. By the end of 1981, there were about 700 ha of coves being used in Hubei Province to supply 20 million large-size fingerlings annually (about one-half of the fingerlings stocked in local reservoirs).

Selection of coves

Cove selection and natural conditions for fingerling production greatly affect the construction investment and production efficiency. Cove selection is based both on fishery and engineering concerns.

Fishery concerns

- The water should be fertile and free from industrial pollution. It is best to select coves adjacent to villages or agricultural fields for nutrient addition and labour and transportation.
- The water should be several metres deep (maximum 10 m). However, the water can be as deep as 20 m in net-fenced coves. The bottom of the cove should also be relatively flat.
- The coves should face south and have adequate sunlight.
- The catchment area should be large enough to ensure that there is sufficient inflow to enrich the fertility of the cove water and to provide inputs of fresh water.
- The optimal area for a dam-blocked cove is 3-7 ha; whereas, the best size for a net-fenced cove is 7-33 ha for fingerling culture and 30-60 ha for yearling production.

Construction engineering concerns

- The cove mouth should be narrow and the main water body wide. This means that the construction project is small, but the production area is large.
- The location for the dam or barrier net should be narrow and there should be a solid nonpermeable stratum at the dam site.
- The water flow at the barrier net should be less than 0.7 m/s during the flood season.
- The cove should not be on a main transportation passage.

Design of coves

Net-fenced coves

Within 30-50 m of the construction site of the net barrier, the cove bottom should be flat and have no large stones or tree stumps. The water depth should not exceed 20 m. If the barrier net is to be set up on a transportation route, the field of vision must be more than 300 m on both sides. There are many types of barrier nets. Their design is reviewed in Chapter 8.

Dam-blocked coves

Coves for fish farming are usually impounded using various earth dams. Dams can be made of soil with a central clay wall, a soil-stone mixture, or soil with a clay bottom. However, soil dams and the soil dams with a central clay wall are most commonly used in small reservoirs and coves. Soil dams are commonly used where there is a nonpermeable bed, or where the permeable bed is not deep, and soil is easily available.

A dam with a central clay wall is normally constructed where the permeable bed is not deep and sandy soil is readily available.

Soil dams (Figure 49A) are constructed using clay, loess, and sandy loam (50-70% sand and 30-50% loam). If the clay content exceeds 50-60%, the dam should be covered with a layer of sand to prevent leakage through cracks caused by freezing or drought. Soil dams with a central clay wall (Figure 49B) are made of more permeable materials (e.g., sandy soil) and have a central wall made of clay. The dam should be at least the same height as the normal high-water level in the main reservoir, and should be high enough to maintain a maximum water depth of 8-10 m (average 4-5 m).

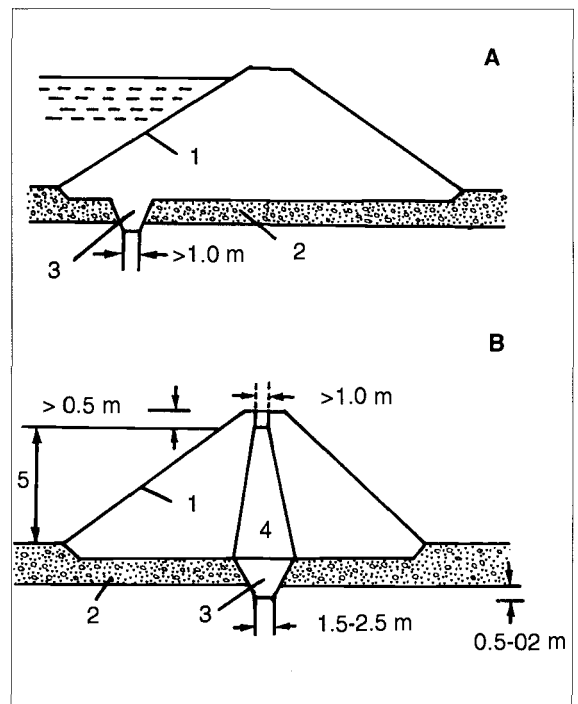

Figure 49. Soil dam (A) and soil dam with a central clay wall (B): (1) barrier wall, (2) permeable stratum, (3) nonpermeable stratum, (4) central wall, and (5) maximum water storage.

To minimize the effects of wave action and to ensure easy access, the top surface of the dam should be sufficiently wide, about 3 m for a 6-m dam, 3.5 m for a 7-8-m dam, and 4 m for a 9-10-m dam. The slope of the dam depends on soil quality and the height of the dam. A dam constructed with sandy soil should have a slight slope; whereas, a dam made of clay can have a relatively steep slope. The higher the dam, the less steep the slope, the more earthwork needed, and the longer the spillways and culverts needed. For cove dams up to 10-m high, the recommended inner (toward cove) slope is 1:1.5-2.0 and the outer slope (toward main reservoir) is 1:1.5. However, the slope of the base of the dam should be increased to 1:2-3.

The dam slope that faces extensive wave action should be covered with heavy stones, and the slope decreased to 1:1. To withstand normal waves, the slope should be protected with a 20-cm layer of small stones. It is not normally necessary to protect the inner dam slope from small waves and floods. The dam surface must be well compacted.

A spillway is essential. Its maximum overflow rate during the flood season is usually based on the catchment area and storage capacity. The width and height of the spillway are chosen to give the desired storage depth and to allow for passage of small boats. The cross-sectional area of the spillway is designed to match the inflow into the cove.

The site of the spillway is dictated by local conditions. If topographical conditions permit, the spillway should be constructed in a saddled-shaped place that is not too close to the dam. This prevents the dam from being damaged by runoff during floods. If the spillway must be built on the dam, the shore at one end of the dam is always chosen as the site for construction and is properly reinforced with stones to prevent collapse and leakage. Both the inner and outer slopes of the dam near the spillway must be protected with stones to withstand the turbulence created by water discharge. Depending on the velocity and flow rate of the flood water, fish barriers are installed either inside or at both ends of the spillway to prevent the escape of stocked fish and the entry of wild fish.

A culvert is commonly used to discharge water from coves to maintain the desired water level. The inner diameter of the culvert pipes is usually 30-50 cm, but this varies with storage capacity and the quantity of water to be discharged. The culvert must be placed on solid ground and be well sealed with cement at any joints to prevent leakage. In general, automated gates are installed to control the discharge of water from culverts. While the dam is being constructed, the cove bottom should be levelled and other engineering projects (e.g., fish ponds, manure storage tanks, and food-processing factories) should be carried out.

Fingerling production in coves

The main aspects of fingerling production in coves are: predator elimination, management, preventing the escape of fish, and harvesting.

Predator elimination

It is important to eliminate and control predators, wild fish, and other harmful organisms to increase the survival of stocked fingerlings. For example, in Litong Cove in Xinanjiang Reservoir, the survival rate of fingerlings was only 17% in 1974 because of the high abundance of *Opsariichthys* spp.; however, the rate in Xingwang Cove was 97% after thorough cleaning. The methods used to eliminate predators are described in Chapter 7.

In dam-blocked coves, predators must be eliminated before the cove is filled with water, and the entrance of wild fish must be prevented. If the predators are not eliminated, it is difficult to use chemical methods later. The bottom of dam-blocked coves should be cleared every year before filling. The water should be added just before the fish are stocked to prevent the growth of weeds, which not only consume nutrients but provide hiding sites for predators.

Net-fenced coves are generally larger and deeper, and small wild fish can move in and out freely. Therefore, it is comparatively more difficult to eliminate predators. The common method used is a combination of blocking, gill netting, and filtering or electric fishing, but the result is unsatisfactory (see Chapter 7).

Management

The system of fingerling culture in Chinese reservoirs is a multiple-layer system that includes: fry, fingerling, and food fish grown in fingerling ponds, dam-blocked coves, cages (or net-fenced coves), and the main water body of reservoirs. A model of this system is shown in Figure 50.

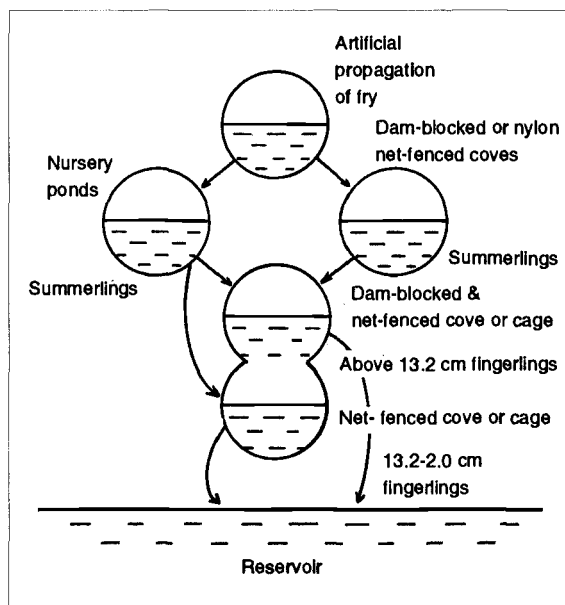

Figure 50. Model of the multiple-layer system used for fingerling culture in reservoirs.

- Dam-blocked coves. Before stocking, the water must be fertilized. In Xinanjiang Reservoir, the water is fertilized by adding organic manure (animal manure, night soil, and plant residues) 1-2 weeks before the fingerlings are stocked. During the entire production period, commercial feed is placed on feeding platforms (one platform/10,000 fingerlings) located in the shallow areas along the bank. As the fingerlings grow, the number of feeding platforms can be reduced and gradually moved to deeper water.

The optimal stocking density is 52,500-60,000 fish/ha in dam-blocked coves. If silver carp fingerlings are the major species, up to 20% bighead carp can be included. A few grass carp can also be introduced.

If the cove has a relatively stable water level and is skilfully managed, the survival rate of fingerlings can reach 80% in dam-blocked coves. For example, in Xuyuan Cove No. 1 in Xinanjiang Reservoir, yearlings were stocked in 1972. At the end of the year, 701.9×10^3 fingerlings with a body length of 12 cm were produced. Total production was 12,358 kg, and the survival rate was 84.7% (on average, 2,648 kg/ha and 150,420 fingerlings/ha). Feeding and manuring were practiced in a dam-blocked cove (5.33 ha) in Mingshan Reservoir in 1975 and 440×10^3 fingerlings over 13 cm in body length were produced with an average yield of 82,500 fish/ha and a survival rate of 49%.

Dam-blocked coves can also be used to rear fry to juveniles. One method uses the whole cove; in another, a corner (<1 ha) of the cove is enclosed with a nylon net. In the second method, the fish are allowed to move freely to the larger space after they reach a certain size.

- Net-fenced coves. Fish culture in net-fenced coves is usually practiced without any additions of food or manure. The fish depend on natural food sources, and it is difficult to eliminate predators; therefore, net-fenced coves are used mainly to culture fingerlings or yearlings at low density. It is difficult to harvest fish and record production in net-fenced coves. In addition, the growth and survival rate of the newly stocked

fingerlings are often affected by fish populations established in previous years.

The mesh size of the impounding net is selected according to the size of the fingerlings or yearlings that are to be stocked. The mesh size, twine dimensions, and inlet and outlet areas of a cove in Xinanjiang Reservoir are shown in Table 31. This net-fenced cove had a transparency of 0.5-5 m, phytoplankton density of 1.45×10^6 /L, and zooplankton density of 1,200-1,900/L.

Net-fenced coves are often used, in combination with a dam-blocked cove, as one of the stages in fingerling production. In Changshouhu Reservoir, the coves are blocked with nylon nets (mesh size 1-2 cm) before the floods in summer. Grass and other plants that grow during the dry season are used as fertilizer. As the water level increases, the grass and plants are submerged and decay and large quantities of plankton are produced. Fingerlings (4.0-6.6 cm) produced in the dam-blocked coves are stocked into the net-fenced coves for 3-4 months of culture. When the fingerlings grow to a body length of 13-16.5 cm in November or December, they are allowed to move into the main reservoir by removing the barrier net.

Escape

For successful fingerling production, it is important to design and build proper facilities to prevent fish escape. The design and management of facilities to prevent escape from coves are similar to those used in large reservoirs (see Chapter 8).

TABLE 31. Mesh size of barrier net in relation to the fingerling size of silver carp and bighead carp in the net-fenced cove in Xinanjiang Reservoir

	FINGERLING SIZE			
	1-YEAR-OLD	1-YEAR-OLD	1-YEAR-OLD	2-YEAR-OLD
Size of impounding mesh (cm)	0.8-1.3	1.3-1.8	3.0-3.5	4.0-5.0
Dimension of polyethylene twine ^a	0.21/3x2	0.21/3x2	0.21/3x3	0.21/3x3,3x4
Rearing duration (months)	Jul-Nov	Jul-Nov	Dec-May	May-Dec
Stocking size (cm)	5.0-5.6	6.6-8.3	11.6-13.2	16.5-19.8
Desired rearing size (cm)	11.6-13.2	13.2-16.5	16.5-19.8	0.25-0.5 kg
Silver carp: Bighead carp ratio	7:3	7:3	6:4	6:4
Stocking density (fish/ha)	45,000	37,500-45,000	7,500-15,000	3,000-7,500

^a Throughout the text, dimensions of twine are described in a standard format. The first number (0.21 in this case) is the diameter of the twine in millimetres. The second and third numbers are the number of pieces of this twine that are woven together to form two strands. These two strands are then made into the final rope.

Harvest of fingerlings

Harvest of fingerlings is easy in ponds, but is more difficult in coves because they have deeper water and have uneven bottoms. Several methods are common.

- Attracting the fish. Fish are normally fed from a feeding platform during the production period. In early autumn (from mid- or late September to early October in the middle and lower reaches of Changjiang River), when the water temperature starts to decline, the fingerlings still have a high feeding rate. At this time, they can be attracted to the platforms and caught with filter nets. Catching rates are as high as 90%.

Normally, the fish are fed from the platform for 1 or 2 days before the harvest. A filter net is set up a day earlier, 30-50 m away from the feeding platform. The following morning, the platform (full of food) is gently removed to the preset filter net. At the same time, feed is placed on the net to attract as many fish as possible. The filter net is lifted quickly when there are adequate numbers of fingerlings. Another practical method is to set up the filter net under the feeding platform and lift the net out of the water as soon as the fingerlings swim over it. However, this method must be performed in several locations if the water area is large and there are many fingerlings.

After this harvesting method has been repeated several times, the fingerlings will develop a conditioned reflex to the feeding platform and net and will not approach them. If this happens, the harvest should be stopped for 1-2 weeks.

- Combined fishing method. After September and October, the water temperature and feeding rates drop, and the filter net method usually gives unsatisfactory results. The fingerlings must then be harvested using a combined fishing method of blocking, chasing, and trapping. This is similar to the joint fishing method (Chapter 9), but no gill net is used.

- Netting. In coves with a relatively flat bottom, fingerlings can be driven to one end of the cove and harvested with a net. If possible, the cove should be drained to a depth of 1-2 m, which increases harvesting efficiency.

Because the harvesting of fingerlings in coves is not completely developed, considerable numbers of fingerlings can escape. Large-size fingerlings that remain in the cove have a negative influence on the small-size fish and reduce fingerling production. Therefore, large-size fingerlings that remain must be harvested when predators are eliminated during the dry season.

The only way to harvest fingerlings in the net-fenced coves is to use the joint fishing method, or simply allow the fingerlings to move freely into the large reservoirs. This makes it impossible to monitor how many fingerlings are stocked. However, in some reservoirs, samples are randomly collected at specific sites to roughly calculate the fingerling biomass. Production

efficiency is then evaluated based on the harvest the following year.

FINGERLING CULTURE USING BARNYARD GRASS AND RICE

Observations made by the Nanjing Geography Institute confirm that the silt in highly fertile lakes and ponds contains 0.66-2.66% organic matter, 0.056-0.67% inorganic N, 0.079-0.73% inorganic P, and 1.7-4.6% K. To use these nutrients in ponds and lakes, barnyard grass (*Echinochea crusgalli*) and rice are often cultivated. The yield of barnyard grass is 90-135 × 10³ kg/ha.

The growing season of barnyard grass in the Changjiang River basin is normally from March to November. However, the grass is planted to suit fingerling production. Barnyard grass seeds are normally sown in late March or early April, and juvenile fish are stocked in May or June.

The barnyard grass is fully submerged when the pond is filled. The decomposing grass releases nutrients to accelerate the propagation of plankton. Organic detritus and bacterial aggregates are eaten by the silver carp and bighead carp. Alternatively, the grass can be submerged in increments. In this way, the grass keeps growing while the water is added. The barnyard grass is usually submerged in water at the ear-bearing or flowering stage. If grass carp are to be reared as the major species, the grass should be fully submerged when the fingerlings are stocked. The dissolved oxygen content is always insufficient soon after the barnyard grass is submerged. As a result, it is important to prevent suffocation by using an aerator.

Compared with fingerling production in ponds, practice has shown that the use of barnyard grass or rice can save food and manure, increase the transfer size of the fingerlings, and decrease production costs. The method has been successfully practiced in Changshouhu Reservoir and Zhanghe Reservoir. In 1983, 3.8 ha of ponds in Zhanghe Reservoir produced 270 × 10³ kg of barnyard grass, which was used to produce 9,000 kg of fingerlings (>10 cm) at an average yield of 2,460 kg/ha.

ARTIFICIAL PROPAGATION OF RESERVOIR POPULATIONS OF SILVER CARP AND BIGHEAD CARP

Silver carp, bighead carp, grass carp, and mud carp reach maturity in most reservoirs, but natural spawning only takes place in a few reservoirs that have favourable spawning grounds (e.g., Xinanjiang and Changshouhu Reservoirs). In addition, few reservoirs have suitable hatching environments. Silver carp, bighead carp, and grass carp eggs usually take about 70 hours to hatch at a water temperature of 22-25°C. At a water-flow rate of 0.5-2.0 m/s, the fry often naturally travel up to 200 km

from the spawning grounds before they hatch. The eggs cannot travel such long distances in most reservoirs and as a result usually sink and die. It is estimated that the survival rate from the egg to fingerling stage is only 1/480,000. This implies that one brooder fish with the fecundity of 500×10^3 eggs will only produce one offspring that lives until the fingerling stage. Therefore, it is not worth protecting the natural spawning of these fish. However, it is useful to carry out artificial propagation using mature broodstock collected directly from the reservoirs. Because the fish are readily available, production is high. Brooder ponds are not needed; therefore, labour, food, and manure are saved and production costs are much lower.

This practice is now being used for fry production in many reservoirs. For example, artificial propagation was initiated in 1960 in Changshouhu Reservoir and 12.96, 10.58, and 67.71 million eggs were obtained in 1963, 1964, and 1965 respectively; in Xinanjiang Reservoir, 100-200 million silver carp and bighead carp fry have been produced annually since 1965; about 53 million fry were produced in the upper reach of Dahuofang Reservoir from June to August 1971; in reservoirs in the Yintai area of Shandong Province, about 188.3 million eggs and 40 million fry were produced from 1972 to 1974; and in Meishan, Xianghongdian, and Foziling Reservoirs in Anhui Province about 50% of fry were obtained through artificial breeding.

However, there are disadvantages to the use of brooder fish from reservoirs for fry production because breeding and hatching are less certain than breeding in ponds. This is because production relies on the hydrological conditions of the reservoirs. Practical operations in Xinanjiang Reservoir proved that these disadvantages can be overcome if hydrological changes and the maturity and spawning behaviour of the brooders are carefully studied.

Maturation of brooder fish

Gonad development of mature silver carp and bighead carp in reservoirs is similar to that in ponds. Most fish reach stage II or III, and a few reach stage IV before overwintering. Gonads develop slowly in winter, but more quickly after March. Generally, the fish reach late stage IV in mid-May in the south and in early June in the north. They are ready to migrate upstream for spawning as soon as the water level rises in the reservoir. The gonads of unspawned brooders start to degenerate in mid- to late July.

However, there are some differences between ponds and reservoirs. The gonad development of brooders grown in reservoirs is more variable, as is the time and degree of their maturity. But, the maturation coefficient of gonads at stage IV is higher in reservoirs (17-23%) compared with brooders cultured in ponds (17-20%), and their abdomens are relatively larger, but not as soft.

Natural spawning grounds

Investigations of spawning grounds at Shigao Beach in Changshouhu Reservoir and Jiuli and Jintan Beaches in Xinanjiang Reservoir have shown that the spawning grounds for silver carp, bighead carp, grass carp, and black carp have several common characteristics:

- The bottom is gravel or sand,
- There are great fluctuations in water level (the water level can rise 3-5 m within several hours, thus forming a migration area),
- The water level continuously rises for over 12 h, has a flow rate of 0.5-2.0 m/s, and eddy currents,
- The water becomes turbid after storms because of rotten leaves, mud, or soil (transparency < 30 cm), and
- The water temperature is 20-28°C.

Before the spawning season, the gonads of the brooder fish gradually start to mature as the water temperature rises. The fish start to migrate upstream for spawning, but many live in groups in the deeper streams in the upper reaches or confluent area before the flood season starts. When the rainy season begins and the water level rises, the mature brooders travel rapidly upstream for spawning. However, the number of brooder fish that migrate to the spawning grounds is related to the duration of the rise in water level, water depth, and velocity. In general, silver carp spawn early and bighead carp spawn later. Whenever spawning conditions are available on the spawning ground, natural breeding will take place. The spawning season in reservoirs is from mid-May to mid-July, which is a little later than that in rivers. Female fish discharge their eggs at one time, but the males discharge milt several times. As soon as spawning is complete, the fish move downstream to the coves and actively feed.

Use of brooder population

Artificial insemination

In reservoirs, it is rare to catch brooders that are ready for stripping. However, brooder fish caught in, or near, the spawning ground can be used for artificial induction.

Catching and selection of brooders is based on detailed investigations of maturity age, size, gonad development, spawning migration of brooders, and the conditions of spawning grounds. Brood fish are generally caught upstream in late spring or early summer when they are migrating upstream; however, they are sometimes caught in groups near dam inlets in some reservoirs. Brooders can also be caught in the middle or lower reaches of the reservoir if the water level rises slowly and the brooders become scattered. The brooders caught upstream are the best for breeding; those caught in the middle reaches of the reservoir are the least suitable.

It is better to use a fixed filter net to catch brooders (see Chapter 9 for a description of net types). Fixed

filter nets have a high catch rate, which allows for good selection, and results in few injuries, which increases the spawning rate (Table 32). The main disadvantage to this type of net is that, because of its size, it is difficult to operate in small coves that have uneven bottoms and are shallow. Seine nets and power-driven lift nets are more flexible in their operation than filter nets and result in few injuries to the fish.

A trammel net is simple to operate and can be adapted to suit a variety of topographical conditions. Therefore, it can be used as supplementary fishing gear to catch brooder fish. Because the net usually causes serious injury to the brooders and, therefore, a low spawning rate, the net should be set up and hauled every hour to avoid unnecessary injury to the fish (Table 33).

During the catching of brooders, fluctuations in water level affect the spawning rate. In general, spawning rates are highest when water levels are rising. At other times, the fish will hardly spawn or refuse to spawn completely. Therefore, the timing of the capture of brooders is critical.

The brooders selected for breeding should be mature, have a bright body colour (i.e., silver carp should be silver-white and bighead carp dark grey), and have no injuries. In addition, their genital openings should be slightly red and protuberant and their abdomens smooth and soft. If the fish is turned upside down, the posterior part of the abdomen drops down and the ribs on both sides can be seen. Spawning must be induced on newly caught brooders because the spawning rate decreases with the time that the fish are held in captivity.

TABLE 33. Spawning rate in relation to harvest time of brooders caught in a trammel net in Xinanjiang Reservoir

HARVEST TIME	NO. OF FISH INDUCED	SPAWNING RATE (%)
Fish harvested soon after being caught in net	6	50
Fish harvested morning after being caught in net	12	6

Transportation of brooders

Brooder fish can be transported in several ways. The fish can be pulled by a boat. In this case, the lower jaws of the brooders are tied with a rope, and the fish are hung over the side or stern of the boat and slowly pulled through the water. The brooders can also be placed in a cage with a cover net and slowly pulled by a boat. This method is suitable for large-scale transportation and results in less injury to the brooders. These two methods can only be used for short-distance transportation in the reservoir. If long-distance transportation is required, techniques such as oxygenated nylon bags must be used.

TABLE 32. Relationship between fishing gear and spawning, fertilization, and hatching rates

RESERVOIR	YEAR	FISHING GEAR	FISH	NO. INDUCED	NO. SPAWNED	FERTILIZATION RATE (%)	HATCHING RATE (%)
Xinanjiang	1965	Trammel net	SC+BH	224	111	28.0	44.5
		Filter net		36	16	65.0	85.1
	1966	Trammel net	SC+BH	35	13	No data	35.0
		Filter net		141	78	No data	45.6
Gaozhou	1965	Seine net	BH	5	4	89.0	85.0
		Fishing stakes		10	2	38.0	15.0

Note: SC silver carp; BH bighead carp.

Induced breeding and artificial insemination

The common inducing agents and dosages for breeding silver carp and bighead carp are as follows: PG (pituitary gland) 0.5-1 pituitary of silver carp or bighead carp per kilogram of body weight with one injection; HCG (human chorionic gonadotropin) 4 mg/kg body weight with one injection; and LRH-A (luteinizing releasing hormone — analogous) 2 µg/kg of body weight (first injection) and 20 µg/kg body weight (second injection) at an interval of 24 h. LRH-A is particularly effective for bighead carp, and results in a spawning rate of over 80%. The injection dosage can be slightly reduced for brooders caught on the spawning ground. However, the dosage should be increased for brooders that are injured or are less mature.

Because it is troublesome to transport brooders, the most practical method is to perform artificial insemination on the spot. Two methods are used.

- Breeding in cages. Cages for breeding are temporarily formed between two boats using bamboo or fir. The cages are 4-5 m x 2 m x 3 m and the mesh size is 5 cm. Each cage should be stocked with 10 male and 5-6 female silver carp; or 6 male and 4-5 female bighead carp. The cages must be well covered.

- Breeding by hanging brooders in water. A rope is fixed on a leeward bank of the cove that is facing the sun. Generally, one end of the rope is fixed to the bank and the other end is anchored in the water. Floats are installed on the main rope at a distance of 2-3 m apart. One brooder is tied to a rope at each float for natural spawning. The rope that is holding the brooder should not be too long, otherwise, the brooders may injure themselves on the cove bottom.

Whatever the method used, breeding must be carried out as soon as the brooders are harvested, otherwise, their spawning rate will be reduced. Unlike brooders in ponds, fish from reservoirs do not have an obvious estrus.

To improve breeding efficiency, it is critical to control the effective time for artificial insemination. The effective time depends on: the induced agents and their dosages, water temperature, climate, and the harvesting site of the brooders. Because the inducing agents and dosages are known, effective breeding is adjusted based on regular monitoring of water temperature. The correlation between the effective time and water temperature is shown in Table 34. When the effective time is reached, the estrus of brooders should be carefully observed. If the chasing of brooders is observed, the fish should be harvested from the cages and checked. As soon as eggs start to flow, artificial insemination must be carried out immediately. Otherwise, the eggs may become overripe, and the fertilization rate will be reduced.

Hatching

To make upstream field production of eggs and fry more convenient in reservoirs where the fry and fingerling farms are far away, several types of boats have been developed to both transport and hatch fish eggs. The eggs are hatched while they are being transported.

TABLE 34. Correlation between water temperature and effective time

WATER TEMPERATURE (°C)	EFFECTIVE TIME (h)
20-21	17
22-23	15
24-25	13
26-27	11
28-30	10

In Xinanjiang Reservoir, two concrete boats (each with a tonnage of 30 t) are positioned like a catamaran. They hold 170 hatching jars, each with a capacity of 132 L, as well as other facilities such as pumps and water-storage tanks. The water-storage tank is located

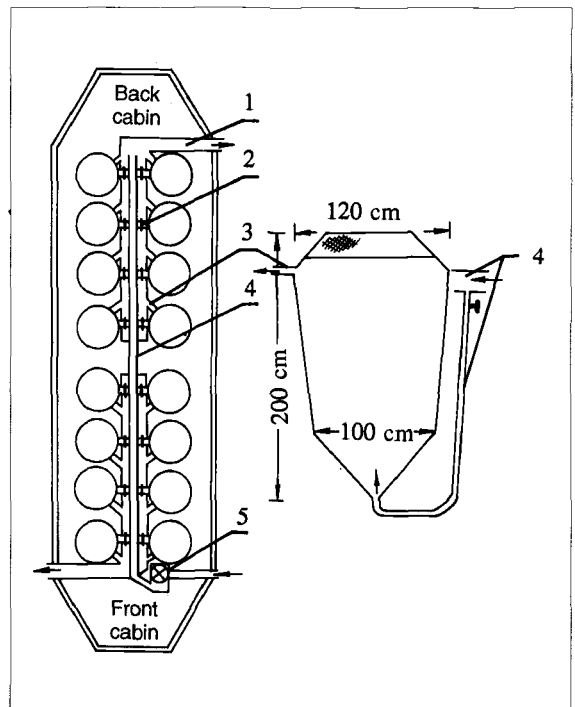

Figure 51. Diagram of boat used to incubate and hatch eggs in Changshouhu Reservoir: (1) drainage trough, (2) valve, (3) drainage pipe, (4) water-filling pipe, and (5) pump.

1 m above the hatching jars and water flow is controlled by valves. Each hatching jar can be stocked with 500×10^3 silver carp or bighead carp eggs, and total production from one batch is about 40 million fry.

In Changshouhu Reservoir, a wooden hatching boat with a tonnage of 60 t holds 16 hatching baskets, with a total volume of 25 t, that can hold 50-70 million eggs (Figure 51). In Meishan Reservoir, the hatching boat is made of two wooden hulls, each with a tonnage of 6 t, and four iron hatching circulators (Figure 52). The inner and outer diameters of the circulators are 0.5 and 1.5 m, respectively, their width is 0.5 m, and their central depth is 0.9 m. Their capacity is 1.1 m^3 and they hold 1.8-2.2 million eggs.

However, the eggs are usually transported to the hatching farm by hand in medium and small reservoirs. The eggs can only be transported in canvas baskets or oxygenated nylon bags after they have fully absorbed water.

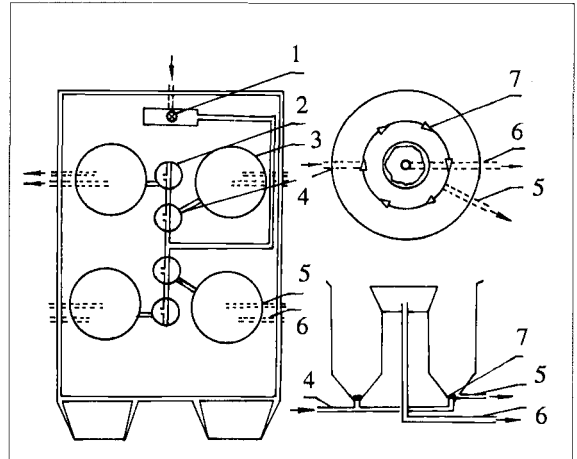

Figure 52. Diagram of boat used to hatch and incubate eggs in Meishan Reservoir: (1) pump, (2) water-storage tank, (3) incubator, (4) water-filling pipe, (5) drainage pipe, (6) hatching outlet, and (7) sprayer.

CHAPTER 6

Stocking

Fish production in reservoirs depends on: the environment, the species of fish, and management techniques. Appropriate stocking involves fish selection and stocking and comprehensive farming techniques. Although natural conditions differ between reservoirs, the basic principles of stocking can be adopted in most reservoirs.

STOCKING STRATEGY

Species selection

The main consideration in species selection should be to make full use of all food resources and ecological niches. The fish that are selected should have fast growth, high economic value, abundant natural food, and an easily available and reliable supply of fry. Moreover, they should not harm other economically important fish species.

The most common species stocked in Chinese reservoirs are: bighead carp, silver carp, grass carp, Wuchang fish, common carp, crucian carp, and *Xenocypris* spp. The biological characteristics and productivity of these species suit the biological production system in most reservoirs (Figure 53).

species in Chinese reservoirs. In this way, primary production is effectively converted into fish production through the shortest food chain, which is a special characteristic of reservoir fish culture in China.

Grass carp and Wuchang fish are herbivorous species in the second trophic level. Grass carp, in particular, are less susceptible to diseases in reservoirs than in pond culture. Because aquatic plants develop slowly and productivity is low in reservoirs, these two species are only stocked as secondary species. However, their stocking rate and standing crop must be controlled, or they will limit the reproduction of aquatic plants. Comparatively speaking, Wuchang fish are less dangerous to natural reproduction of aquatic plants because they consume less.

Common carp and crucian carp grow quickly, have a high economic value, and have a readily available source of food in reservoirs. These species spawn naturally; therefore, their population can be sustained if their spawning grounds are protected. It is not necessary to stock these species unless the reservoirs have poor spawning conditions.

Among the detritivorous fishes, mud carp are the main species cultured in southern China. Attempts are

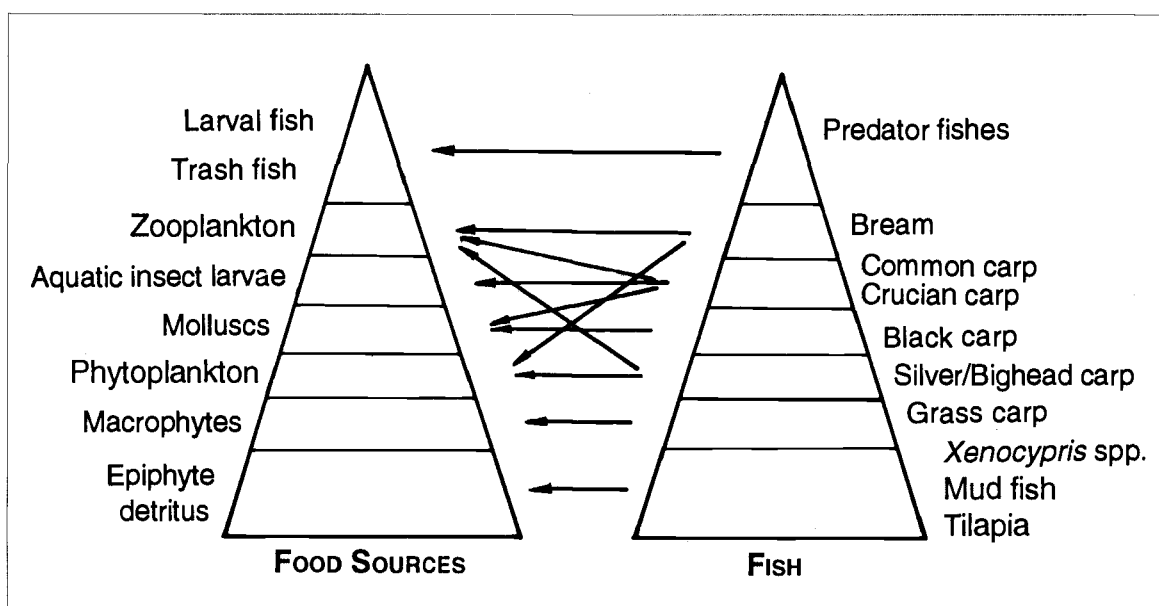

Figure 53. Stocked species of fish and their natural food sources in reservoirs.

Plankton, organic detritus, and bacteria are the most abundant natural food sources in reservoirs. Silver carp and bighead carp, planktivores in the second and third trophic levels, are commonly stocked as the principal

now being made to select strains of mud carp that have better resistance to low temperature to be able to extend cultivation to the north. *Xenocypris microlepis* mainly feeds on humus, organic detritus, and algae.

Because it can be bred and reared easily, it is one of the main species propagated in reservoirs. Most Chinese reservoirs provide environments conducive to the growth of food organisms for *Xenocypris microlepis*; therefore, good harvests can be expected. In addition, ecological conditions favour spawning in most reservoirs; therefore, more emphasis should be placed on the introduction and protection of this indigenous species. However, stocking should be conducted annually if conditions for natural spawning are unavailable.

Eels can grow well in reservoirs. Because of a shortage in fingerling supply, it is only stocked occasionally in reservoirs. However, eels could become an important species in reservoirs if artificial breeding and production were successfully developed. Sturgeon could also become an important species in reservoirs if problems related to artificial breeding and fry supply were solved. Information is available in the former Soviet Union and the United States. For example, there are about 20 sturgeon hatcheries in Russia, with an annual production of several million juveniles (2-3 g), and production from natural sources is now being replaced by cultured varieties. In some hilly reservoirs that have a short photoperiod and either cold water or cold spring water sources, rainbow trout could be cultured as the main species.

The selection of major and secondary fish species should suit the conditions of each reservoir. However, consideration should be given not only to the species stocked, their density, and food availability, but also to the optimal use of space and time.

Most Chinese reservoirs are stocked with silver carp and bighead carp mixed with secondary species (e.g., grass carp, black carp, and common carp). However, some reservoirs are stocked with omnivorous fishes because they are rich in aquatic plants and benthic organisms. Some reservoirs in southern China, for example, Hanshan Reservoir, are mostly stocked with mud carp because there is an abundance of vegetation in the catchment area and many plant fragments flow into the reservoirs. However, reservoirs in the plains, which tend to be shallow, have less grass, and are turbulent, are primarily stocked with common carp and crucian carp.

If fishes with different habitat preferences are selected, the shallow area along the shoreline, the open water area, the upper, middle, and lower reaches, and the surface, middle, and bottom layers of the reservoir should be fully used. This system is known as the "stereo fish-farming system."

Comparatively speaking, the economic value of mandarin fish, *Erythroculter* spp., and other predatory fishes is much higher than that of stocked species. However, few reservoirs in China stock predatory species because they have a long food chain and, therefore, low productivity. As living standards in China improve, the consumers are showing a greater demand for high-quality fish. In addition, more attention is

being given to developing sport fishing. In general, the best species for sport fishing are the large- and medium-size varieties. Therefore, it is expected that the culture and proliferation of predators with a high economic or recreational value will be included in reservoir fish-farming programs.

Stocking density and ratio

The ratio between the utilization rate of the food source by the fish species and the reproductive rate of the food organism will determine the maximum stocking density. For example, from 1966 to 1975, the fish yield (kg/ha) in Nanshahe Reservoir was directly proportional to the stocking density (fish/ha): $Y = 122.1 + 0.1140 X$ ($r = 0.7631$), where Y = fish yield and X = stocking density (Figure 54).

However, as the stocking density increases, production rises, but catchable size is reduced (Figure 55). To rear fish to the desired marketable size in a short period, stocking density must be controlled to balance fish production, harvest size, and crop turnover.

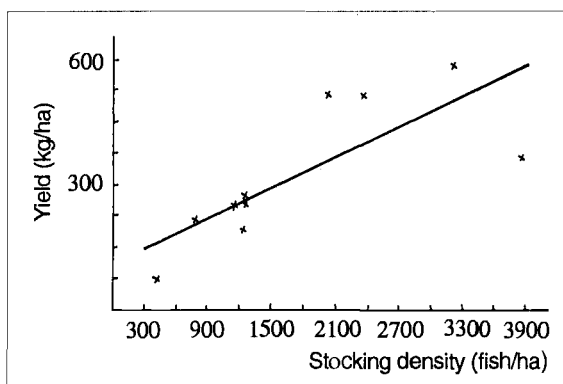

Figure 54. Relationship between fish yield and stocking density in Nanshahe Reservoir.

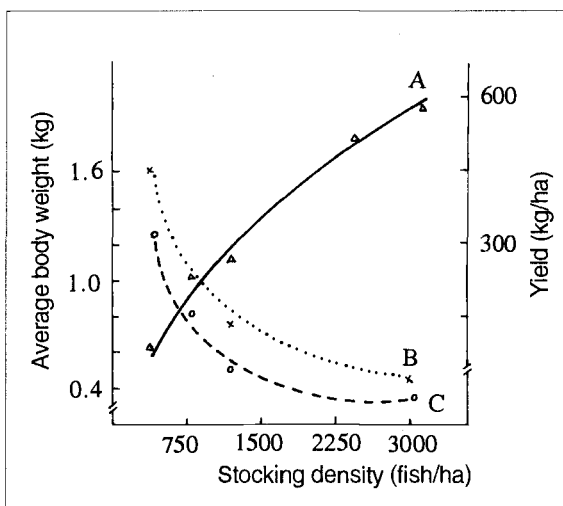

Figure 55. Relationship between stocking density, yield, and average body weight of bighead carp and silver carp in Nanshahe Reservoir: (A) total yield, (B) bighead carp, and (C) silver carp.

TABLE 35. Stocking density and production of silver carp and bighead carp in Qingshan Reservoir (1963-1965)

YEAR	FISH/HA	STOCKING		KG/HA	HARVEST		
		SILVER (%)	BIGHEAD (%)		SILVER (%)	BIGHEAD (%)	OTHER (%)
1963	885	71.8	28.2	332.5	31.4	40.4	28.2
1964	2,055	62.7	37.3	514.5	36.7	37.9	25.4
1965	1,065	51.5	48.5	607.5	34.1	53.9	12.0

When species are polycultured in the correct proportion, they will live compatibly and maximize the utilization of various food sources without affecting the reproductive rate and mutual balance among different food organisms. In addition, all species will reach the desired size in a given period of time.

Because most Chinese reservoirs are stocked mainly with silver carp and bighead carp, they account for most of the total production. It is very important to establish an appropriate stocking ratio between these two species based on the conditions in each reservoir. In Qingshan Reservoir, since common carp were replaced by silver carp and bighead carp, the stocking ratio has been adjusted every year. The initial stocking ratio of silver carp to bighead carp was 85:15; whereas, the current ratio is 30:70. The stocking ratio must be adjusted in accordance with water fertility and the composition of food organisms.

Except in a few medium or small eutrophic reservoirs, the individual growth and mass production of bighead carp are greater than for silver carp. For example, from 1963 to 1965, the stocking rate of silver carp was higher than that of bighead carp, but production of silver carp was lower in Qingshan Reservoir (Table 35).

Annual production of silver carp in intensively cultured ponds has been reported to be as high as 4,500 kg/ha; whereas, bighead carp production was only 25-33% of this amount. The reasons may be that: the ratio between zooplankton and phytoplankton biomass is higher in reservoirs (1:1-1:3) than that in ponds (1:3-1:5); even at the same size, bighead carp consume less oxygen per hour than silver carp (0.28-0.32:0.33 mg/g for 4.7-5.3 g fingerlings (Table 2); and bighead carp (22.69) have a higher conversion efficiency of phytoplankton than silver carp (39.18) (Wang and Liang 1981). In actual practice, the stocking density and species ratio are based on practical experience, although a theoretical basis is being developed.

Empirical method

The growth of each species is quantified from an analysis of the harvest. Fast growth of a species indicates an abundance of food in the reservoir and suggests a need to increase the stocking density of all species or to raise the stocking proportion of the fast-

growing species the following year. However, slow growth of a species shows insufficient food in the reservoir and indicates a need to reduce the stocking density and species ratio the next year. Stocking density and species ratio are adjusted until results are maximized.

Comparative studies on stocking density, growth rate, and harvest of silver carp and bighead carp showed that the combined average yield of these two species was about 646.5 kg/ha in Qingshan Reservoir from 1972 to 1976. Over this period, silver carp and bighead carp were the major species and were mixed with other species. Both species were stocked at a minimum size of 13.2 cm and the stocking density of the two species together was 1,500 fish/ha (ratio 3-4:7-6). One year later, the body weights of silver carp exceeded 0.5 kg, and bighead carp exceeded 0.75 kg. Yearly turnover of the two species is adopted in this reservoir because it gives the best yield.

Based on over 30 years of practical experience with fish production in Qingshan, Dongfeng, and Nanshahe Reservoirs, a reference table has been developed to show the correlations between different trophic levels, reservoir size, stocking density, species proportion, and expected yield (Table 36). However, figures in this table must be adjusted to match fish growth and the availability of natural food.

Theoretical calculation

The theoretical relationship between stocking density, fish productivity, harvest size, and return rate is:

$$d = \frac{F}{WS} \quad [13]$$

where d = annual stocking density (fish/ha), F = annual fish productivity (kg/ha), W = average harvesting size (kg), and S = return rate (%). For example, if $F = 500$ kg/ha, $W = 0.5$ kg, and $S = 20\%$, $d = 500 / (0.5 \times 0.2)$ or 5,000 fish/ha.

It should be noted that the return rate (number harvested/number stocked \times 100) of the stocked fish is usually highest in the first year after impoundment. Therefore, the initial stocking density should be as high as possible. For example, Pohe Reservoir (1,330 ha) was completed in 1970, and 4.47×10^6 summerlings (about 3 cm) were stocked in 8 ha of ponds in 1969.

After one year of rearing, the fingerlings reached a body length of 13 cm and were released into the reservoir. In 1971, 20,500 kg of fish were harvested. Among the stocked species, the body weights were: silver carp 0.5-1.0 kg, bighead carp 2.5-3.0 kg, and grass carp 1.5-2.0 kg, and an abundant population developed rapidly. Similarly, Tieshan Reservoir (2,670 ha) was completed in April 1982, and from April 1982 to March 1983, 9.40×10^6 fingerlings (3,525 fish/ha) were stocked. The fish were harvested from late 1983 to January 1984 and the total catch was 520×10^3 kg after just 1 year.

Although the stocking density in Gaozhou Reservoir was 70% higher than that of Qingshan Reservoir, the average return rate was 7.7% in Gaozhou and 8.3% in Qingshan (Table 37).

Experiments on stocking efficiency of various sizes of bighead carp fingerlings were conducted in Dongfeng Reservoir from 1975 to 1977 (Chen 1982). Fingerlings were stocked from January to February 1975, and the results are shown in Table 38.

Experiments have shown that the return rate of stocking 14.7-cm bighead carp fingerlings is two times

TABLE 36. Reference table showing correlation between different trophic levels, reservoir size, stocking density, species proportion, and expected yield in different types of reservoirs

SIZE OF RESERVOIRS (HA)	TROPIC LEVEL	STOCKING PROPORTION (%)			STOCKING DENSITY (FISH/HA)	FISH YIELD (KG/HA)
		BH & SC	GC, WF & CC	MC		
Small (<70)	Eutrophic	45	40	15	3,000-7,500	750-3,000
	Hypotrophic	35	30	35		
	Oligotrophic	10-15	10-15	70-85		
Medium (70-670)	Eutrophic	45	40	15	1,500-3,000	450-750
	Hypotrophic	50	30	20		
	Oligotrophic	40	20	40		
Large (670-6,670)	Eutrophic	50	35	15	750-1,500	225-450
	Hypotrophic	50	30	20		
	Oligotrophic	40	20	40		
Super (>6,670)	Eutrophic	55	30	15	450-750	150-225
	Hypotrophic	55	25	20		
	Oligotrophic	40	20	40		

Note: BH = bighead carp; SC = silver carp; GC = grass carp; CC = common carp; WF = blunt snout bream; MC = mud carp.

Stocking size and quality of fingerlings

The stocking of large, healthy fingerlings ensures fast growth, high survival, high fish production, and improved economic gain. However, the importance of stocking large-size fingerlings is sometimes overlooked in some reservoirs. Lack of knowledge or inadequate attention to rearing conditions and technologies for large-size fingerling production results in low production. The significance of stocking large-size fingerlings in reservoirs must be emphasized. For example, the fingerlings stocked in Gaozhou Reservoir from 1960 to 1971 were only 5-8 cm; whereas, 13-cm fingerlings were stocked in Qingshan Reservoir from 1961 to 1971.

higher than stocking 11.6-cm fingerlings and four times higher than stocking 9.1-cm fingerlings. In addition, weight gain and economic efficiency are much higher, and growth rate is faster (Figure 56).

The Hydrobiology Research Institute measured the monthly gain in body weight of various-size fingerlings of silver carp and bighead carp in Donghu Lake in Hubei Province. The absolute gain in body weight of large-size fingerlings was much higher than for small-size fingerlings (Figure 57).

Cao Fukang *et al.* (1976) found that 90% of the silver carp and bighead carp fingerlings that were preyed on by *Erythroculter ilishaeformis* were less than

13 cm in body length in Dongfeng Reservoir. Zhu Zhirong *et al.* (1976) also found that in Donghu Lake, silver carp and bighead carp longer than 13 cm were rarely attacked by predators (e.g., *Erythroculter ilishaeformis* and *Erythroculter mongolicus*) shorter than 50 cm. As well, for management of resources, fence barriers with a gape of 1 cm and barrier nets with a mesh size of 3 cm prevent silver carp and bighead carp fingerlings that are longer than 13.2 cm from escaping, and also maintain a good exchange of water. In reservoirs south of the Changjiang River, 13-cm silver carp and bighead carp stocked at the proper density, can exceed 0.5 kg in the year they are stocked; whereas, in the northeast and northwest, they can exceed 0.75 kg the following year.

TABLE 37. Comparison of stocking size and production in Qingshan and Gaozhou Reservoirs (adapted from Li Changchun 1984)

	QINGSHAN (1961-1971)	GAOZHOU (1960-1971)
Total stocked (x 10 ³ fish)	6,523	11,010
Total density (fish/ha)	16,320	27,510
Stocking size of SC, BH (cm)	13.2	5-8.3
Total production (x 10 ³ kg)	2,625	1,760
Total yield (kg/ha)	5,610	442.5
Maximum annual yield (kg/ha)	868.5	67.5
Size of fish at harvest (kg) 2-year-old silver carp	0.9-1.0	0.25-0.60
Bighead carp	1.0-2.0	0.40-0.75

Note: SC = silver carp; BH = bighead carp

TABLE 38. Yearly return rate (%) and weight increment of populations resulting from different stocking sizes of bighead carp in Dongfeng Reservoir (Chen 1982)

	AVERAGE STOCKING SIZE (CM)		
	9.1	11.6	14.7
1975	5.29	6.18	18.22
1976	10.77	19.93	39.63
1977	0.30	11.90	16.81
Total return rate in 3 years	16.36	38.01	74.66
Weight increment of population	3.79	10.24	13.55

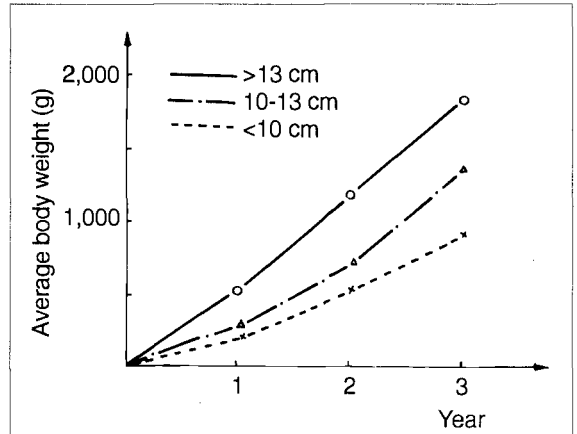

Figure 56. Weight gain of various sizes of bighead carp fingerlings in Dongfeng Reservoir (based on data from Chen 1982).

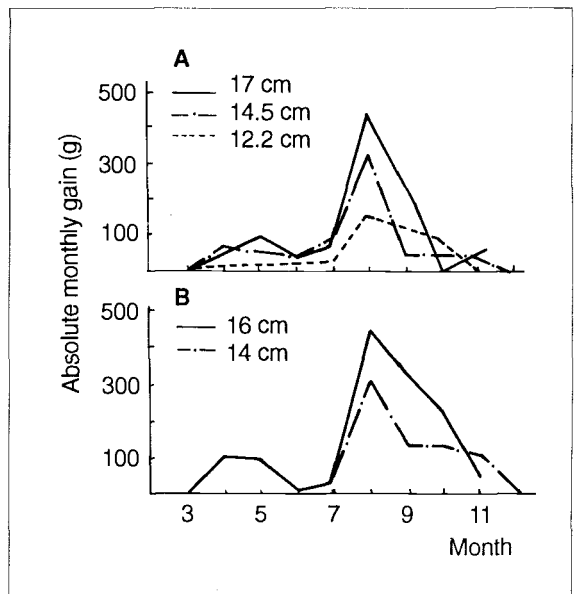

Figure 57. Absolute monthly gain in body weight of silver carp (A) and bighead carp (B) in Donghu Lake (Hydrobiology Research Institute of Hubei Province 1975).

In general, the stocking of fingerlings larger than 13 cm ensures better results; however, stocking of large-size fingerlings is not always better. The production of large-size fingerlings requires more ponds, coves, and cages, and uses more manure and food. As a result, production turnover is longer and the economic efficiency may not be reasonable. It is not practical to stock fingerlings larger than 16 cm in most reservoirs because of constraints in present technology and the high cost of producing very large fingerlings.

A stocking size of more than 13 cm is not absolute. For example, in the first year after impoundment when the predatory fishes and small low-value fishes are less abundant, but natural food resources are high, the stocking of small-size fingerlings (3 cm) can give good production. For example, in Jiaokou Reservoir (263 ha),

water impoundment started on 20 May 1973, and 640,000 summerlings of silver carp, bighead carp, grass carp, and common carp were stocked on 3 June 1973. After 1 year, about 50,000 kg of fish were harvested, silver carp reached a body weight of 0.55-0.7 kg, bighead carp reached a body weight of 0.75-0.9 kg, and the return rate was 20%.

Regardless of size, the fingerlings used for reservoir stocking must be in good condition. The common criteria adopted to visually identify high-quality fingerlings are shown in Table 39. Fingerlings with a certain body length should also reach a corresponding body weight. If the fingerlings reach a certain length, but are under weight, they are considered to be of poor quality. Table 40 shows the correlation between the total length and body weight of healthy fingerlings. At a body length of 13.2 cm for normal stocking in reservoirs, every kilogram should contain 44 silver carp, 42 bighead carp, 48 grass carp, 26 common carp, and 40 blunt-snout bream.

TABLE 39. Criteria used to identify high-quality fingerlings

GOOD QUALITY	POOR QUALITY
<i>Observation inside container</i>	
Jump strongly without opening gill covers	Jump weakly with opened gill covers
Small head, dorsal part with thick muscles	Big head, dorsal part with few muscles
Bright-coloured skin, complete scales and fin rays	Dark-coloured skin, with incomplete scales and fin rays
No injuries	Injuries
Uniform size	Different sizes
<i>Observation in pond</i>	
Swim actively in groups	Swim alone slowly
Response to any fright	No response to fright
Feed well	Feed poor
Surface only in the centre of the pond	Surface around the side of the pond

Stocking time and place

Fingerlings are usually stocked in late winter or early spring. Stocking is performed in January in the Changjiang River Basin, but it is carried out before or after the winter freeze north of the Huanghe River.

Stocking in late winter or early spring when the water temperature is low has many advantages:

- Fish are less active; therefore, injuries caused during netting and transportation are minimized,
- Predatory fish are usually less active at low temperatures; therefore, adverse effects on newly stocked fingerlings are minimized,
- Winter is the dry season; therefore, few fish escape because there is little water exchange, and
- Earlier stocking ensures earlier utilization of food organisms in the spring and a longer growing period.

Stocking should not be done from April to October when floods occur frequently and predators are very active. In addition, stocking of fingerlings is not usually done on windy, snowy, or very cold days to avoid any unexpected losses.

The places selected for stocking should be shallow, upstream coves that have plenty of sunlight and are sheltered from the wind. Stocking must not be carried out near outlets or spillways, in leeward coves, or in the central part of the reservoir, otherwise, the newly stocked fish may either escape or die because they are not well adapted to the new environment.

Stocking of diseased fishes is prohibited. It is better to disinfect or immunize the fingerlings prior to stocking.

Transportation of fingerlings

Because the fingerlings must always be transported from the nursery ponds, coves, or cages to the stocking site, transportation is an indispensable link in reservoir fish farming.

Modes of transportation

- Oxygenated plastic bags. Fingerlings that are packed in oxygenated plastic bags can be transported by train, plane, truck, or ship because the bags have a small volume, hold many fish, are convenient to carry, and the survival rate of the fingerlings is high.

Plastic bags are made of 0.05-0.18 mm polyethylene film. The bags are 70-80 cm in length and 40-45 cm in width and have a capacity of 20 L (5-8 kg of water). The water should be filtered to reduce the oxygen consumption because of the decomposition of organic matter during transportation. It is safer to place the plastic bags inside cardboard, wooden, or plastic boxes during transportation. The number of fish that can be carried in the plastic bags depends on the duration of transportation, temperature, and fish size and quality. Table 41 shows the correlation between carrying capacity and transportation time at a water temperature of 25°C. When the water temperature is high and the water contains organic matter, it is effective to add 2,000 IU of penicillin per litre of water to prevent the deterioration of water quality.

TABLE 40. Correlation between total length and body weight of healthy fingerlings^a

SILVER CARP			BIGHEAD CARP			GRASS CARP			BLUNT-SNOUT BREAM		
TL (CM)	BW (G)	FISH/ (KG)	TL (CM)	BW (G)	FISH/ (KG)	TL (CM)	BW (G)	FISH/ (KG)	TL (CM)	BW (G)	FISH/ (KG)
16.5	45.5	22	16.5	50.0	20	19.5	88.9	12	13.2	25.0	40
16.2	41.6	24	16.2	45.5	22	19.1	82.8	12	12.9	23.8	42
15.8	38.4	26	15.8	41.6	24	18.8	80.0	12	12.5	21.9	46
15.5	35.6	28	15.5	38.5	26	17.5	64.1	16	12.2	17.2	58
15.2	33.3	30	15.2	35.6	28	17.2	55.6	18	11.9	14.4	70
14.9	31.3	32	14.9	33.3	30	16.2	45.3	22	11.6	12.8	76
14.5	29.4	34	14.5	31.3	32	14.9	32.8	30	11.2	12.2	82
14.2	27.8	36	14.2	29.4	34	14.5	31.3	32	10.9	11.3	88
13.9	26.3	38	13.9	27.8	36	14.2	29.4	34	10.6	10.2	98
13.5	25.0	40	13.5	26.6	38	13.9	27.2	37	10.2	9.4	106
13.2	22.8	44	13.2	23.8	42	13.5	25.0	40	9.9	8.3	120
12.9	20.8	48	12.9	22.7	44	13.2	20.9	48	9.6	7.7	130
12.5	18.4	54	12.5	21.7	46	12.9	20.0	52	9.2	7.0	142
12.2	16.6	60	12.2	19.2	52	12.5	17.2	58	8.8	5.9	168
11.9	15.6	64	11.9	17.2	58	12.2	16.9	60	8.6	4.4	228
11.6	14.3	70	11.6	15.6	64	11.9	15.6	66	8.3	4.2	238
11.2	13.4	74	11.2	14.4	70	11.6	14.3	70	7.9	4.1	244
10.9	12.2	82	10.9	13.2	76	11.2	12.5	80	7.6	3.9	256
10.6	11.3	88	10.6	12.2	82	10.9	11.8	84	7.3	3.4	288
10.2	10.3	96	10.2	10.9	92	10.6	10.8	92	6.9	3.1	320
9.9	9.6	104	9.9	10.2	98	10.2	10.0	100	6.6	2.9	350
9.6	9.1	110	9.6	9.7	104	9.9	9.3	108			
9.2	8.6	116	9.2	9.1	110	9.6	9.0	112			
8.9	8.1	124	8.9	8.5	118	9.2	8.1	124			
8.6	7.4	136	8.6	7.7	130	8.9	7.4	134			
8.3	6.6	150	8.3	7.0	142	8.6	6.9	144			
7.9	6.3	160	7.9	6.5	154	8.3	6.6	152			
7.6	5.9	172	7.6	6.0	166	7.9	6.3	160			
7.3	5.3	190	7.3	5.4	184	7.6	5.9	170			
6.9	4.9	204	6.9	5.0	200	7.3	5.3	190			
6.6	4.2	240	6.6	4.3	230	6.9	5.0	200			

^a Adapted from Liu Jiankang and He Biwu (1992). Units have been converted to metric and some data have been modified.

TABLE 41. Correlation between carrying capacity in a plastic bag and transportation time at a water temperature of 25°C

TRANSPORTATION DURATION (H)	CARRYING CAPACITY (FISH/BAG)		
	SUMMERLING (x 1000)	FINGERLING (3 CM)	FRY (8.3-10 CM)
10-11	150-180	2,500-3,000	300-500
15-20	100-120	1,500-2,000	—
20-25	70-80	1,200-1,500	—
25-30	50-60	800-1,000	—

When the fingerlings arrive at their destination, they should be acclimated because: after long-distance transportation the fish need some time to recover from the high concentration of carbon dioxide; and they need time to adapt to the difference in water temperature between the container and reservoir. The difference in water temperature should not be over 5°C for fingerlings and 2°C for fry. For temporary acclimation, the fish are placed in a large container (e.g., fish basket) and fresh water from the reservoir is gradually added until the temperature in the container is similar to the reservoir.

Plastic bags can also be used to transport food fish and brooders. In 1984, 452 silver carp with an average

body weight of 0.6 kg were transported by the authors from Shanghai to Sunde, Guangdong Province, with a survival rate of 100%.

- Baskets and canvas tubs. Fingerlings in unsealed containers (e.g., wooden baskets, canvas tubs, and fish baskets) can also be transported short distances by truck, train, plane, and ship. However, it is necessary to oxygenate the water by such means as splashing the water by hand, which is very labour intensive.

Factors affecting survival during transportation

Several factors affect the survival rate of fingerlings during transportation.

- Dissolved oxygen. There must be sufficient oxygen to ensure successful transportation. Therefore, the stocking density in the container should be determined by the dissolved oxygen content in the water and the oxygen consumption rate, which varies with species, size, and water temperature. Ye Yezhuo *et al.* (1960) reported that the hourly oxygen consumption rate of silver carp summerlings in the summer was 0.35-0.64 mg/g, that the rate for 13-cm fingerlings was 0.14-0.33 mg/g, that the rate for bighead carp summerlings was 0.37-0.43 mg/g, and that the rate for bighead carp fingerlings was 0.28-0.32 mg/g. In winter, the oxygen consumption rates of various fish are only about one-sixth the rates in the summer.

- Water temperature. Fish activity is closely related to water temperature. The higher the water temperature, the greater the activity. Silver carp, in particular, are susceptible to injury in small transportation containers. This is why fish are always transported at a lower temperature.

- Water quality. Fish continuously release carbon dioxide, mucus, and faeces during transportation. Discharged organic matter decomposes, uses oxygen, and lowers water quality. Fishes are likely to become paralyzed when the carbon dioxide concentration exceeds 100 mg/L. Therefore, the water used to transport fish must have little organic matter; water from ponds and tap water are not suitable.

- Fish health. Prior to transportation, extra care should be taken to ensure that the fish are healthy. Fish that are to be transported are conditioned two or three times to force them to secrete large amounts of mucus and faeces. This reduces the release of pollutants during transportation and makes the fish stronger so that they can adapt to the changes in their environment and better tolerate handling.

INTENSIVE CULTURE IN SMALL RESERVOIRS

Small reservoirs are used mainly for irrigation, are constructed in hilly areas, and depend on small rivers and streams for their source of water. They include minireservoir types I and II as well as pond-type reservoirs. Small reservoirs account for 98% of the number and 26% of the surface area of reservoirs in China.

Because they are numerous and widely distributed, they play important roles in agricultural production and fish farming. Their use has accelerated reforms in agricultural production and increased the supply of animal protein in the rural areas, particularly in the hills.

Fish culture can be practiced in the small reservoirs as intensively as in ponds because:

- The area is comparatively small (less than one to several hectares) and is easy to manage, especially for the private sector,

- The water is relatively shallow (about 10 m), which is conducive to growth of fish and food organisms,

- The natural fish resource in small reservoirs is poor, usually consisting of crucian carp, *Pseudorasbora parva*, *Hemiculter leucisculus*, loach, and *Monopterus albus*, and

- There are few predators (e.g., snakehead) in small reservoirs.

However, there are some difficulties:

- Because of the relatively small capacity of the reservoir, fluctuations in water depth are high. When water is required for irrigation, especially during the dry season, the water level may become extremely low or the reservoir may dry up. During the rainy season, the water may overflow. These constant water exchanges drastically change the physicochemical conditions of the water and reduce the production of food organisms,

- Fish production must also depend entirely on artificial stocking because natural fish resources are poor, and

- Small reservoirs usually have a small catchment area; therefore, the allochthonous input is inadequate. After several years of fish farming, internal nutrients are almost totally exploited and the water becomes less fertile. To achieve a high and stable fish yield, it is necessary to supply nutrients and energy to these water bodies on a continuous basis.

Compared with large and medium reservoirs, the ecological conditions for fish species in small reservoirs can be easily controlled because the reservoirs are small and located adjacent to villages. It is possible to adopt intensive culture techniques (e.g., high stocking density, application of food and manure, and carefully controlled harvesting and stocking).

There is great potential for intensive fish culture in small reservoirs. For example, fish production steadily increased in small reservoirs in Luxian County, Sichuan Province, when integrated fish farming was adopted. In the Yibin area, average fish yield increased from 75.75 kg/ha in 1979 to 217.5 kg/ha in 1984, and production from aquaculture accounted for 60-70% of the total value of the output from the reservoirs (Du Yunlong, Fisheries Bureau, Chongqing City, Sichuan Province, personal communication).

In intensively cultured reservoirs, the choice of species and their density and proportion must be based on the supply of manure, the trophic level of the reservoir, and management capabilities. In eutrophic reservoirs, if the supply of manure is adequate, silver carp and bighead carp can be stocked as the principal species with some grass carp and a small number of common carp and crucian carp. In hypotrophic or oligotrophic reservoirs, the major species should be grass carp or common carp mixed with some silver carp or bighead carp. If a large amount of grass and pelleted food is supplied, a high yield can be obtained.

Silver carp and bighead carp as the principal species

Meishan Reservoir is usually stocked with 40% silver carp, 40% bighead carp, 10% grass carp, and 10% common carp and the edges of the reservoir are used to cultivate grass through the application of organic and inorganic manure or silt. Since 1978, an average fish yield of 1,650 kg/ha has been achieved (Gui Jicai and Rao Guichun 1984). Similarly, the production of fish has also increased from 360 to 960 kg/ha because of the input of manure to Sixing Reservoir (Chen Shouben 1986). In Dujiashan Reservoir, the average fish yield was only 165 kg/ha before 1981, but it was increased to 600 kg/ha in 1983 through the application of inorganic fertilizer.

In Xuantan Reservoir, the average stocking density was 9,750 fish/ha from 1979 to 1982, and the species composition was grass carp 8.46%, silver carp 81.85%, and bighead carp 9.69%. To increase the food sources

for grass carp, barnyard grass (*Echinochloa crusgalli*), rye grass (*Lolium pereme*), sudan grass (*Sorghum sudanense*), and elephant grass (*Pennisetum purpureum*) were cultivated on the slopes of the reservoir. Based on the principle that one grass carp can support three silver carp, grass that was grown on the slopes of the reservoir was added to the water. This increased the production of grass carp several fold, increased the nutrients and plankton biomass, and enhanced the production of both silver carp and bighead carp. The changes in water quality and fish production before and after the application of grass to Xuantan Reservoir are shown in Table 42.

Grass carp and common carp as the principal species

Mafu Reservoir is rich in aquatic weeds but not fertile. Therefore, grass carp and common carp are stocked as the principal species and mixed with a small number of silver carp and bighead carp. The results are satisfactory. Generally, small reservoirs are poor in aquatic plant resources, but land grasses can be planted on the waste land around the reservoir. A 1-ha field produces 150,000 kg of grass in the Yibin area, and, on average, the production cost of every 100 kg of grass is CNY0.40. In commercial fish production, 100 kg of grass produces 1.5 kg of grass carp and 1 kg of silver carp or bighead carp, with a value of CNY5. Consequently, the economic value was increased 10-15 times (Du Yunlong, Fisheries Bureau, Chongqing City, Sichuan Province, personal communication). With the rapid development of fish farming in rural areas and the

TABLE 42. Water quality (mg/L) and fish production (kg/ha) before and after the application of grass (Xuantan Reservoir) (Zhang 1986)

	GRASS	NH ₄	NO ₃	NO ₂	P ₂ O ₅	SiO ₂	PHYTO- PLANKTON	ZOO- PLANKTON
	APPLICATION							
Water Quality								
1979	No	0.286	0.007	0.204	0.046	4.14	10.23	2.61
1980-1983 (average)	Yes	0.435	0.011	0.305	0.066	5.40	15.03	4.11
Fish Production								
	SILVER CARP	BIGHEAD CARP	GRASS CARP	TOTAL FISH YIELD ^a				
1976-1979 (average)	745.5	45.2	12.0	1,215				
1980-1983 (average)	1,083.3	192.8	113.3	2,100				

^a Includes silver carp, bighead carp, grass carp, and some other minor species.

increased demand for high-quality fish, pelleted feed is now used to rear grass carp, Wuchang fish, and common carp in small reservoirs.

Integrated fish farming in small reservoirs

Use of the techniques of intensive pond culture and soil and water conservation in combination with the integration of fisheries with pearl culture, livestock and poultry farming, forage grass production, and horticulture can turn reservoirs into well-managed enterprises that produce not only fish, but pearls, livestock, and poultry. Integrated fish farming is a positive way to develop and use the resources available in small reservoirs. These practices increase fish production (Table 43) as well as the number of species reared and the output of good quality fish (Table 44).

There is always competition between fish culture and irrigation in small reservoirs. However, the water supply for agriculture must be the first priority. The management of water supply is normally based on the principle of the three constants: constant irrigation area,

constant irrigation time, and constant water level for fish farming. If the reservoir must be drained during the dry season, the fish are transported elsewhere and restocked when water is available.

CULTURE OF FOOD FISH IN NET CAGES

Culture of silver carp and bighead carp without artificial feeding

This simple practice requires a small investment, provides a quick return, and is appropriate in fertile reservoirs. Experiments on rearing market-size fish in net cages were initiated in 1977 in Foziling Reservoir. It became a commercial operation after 1980, and in the first year of operation, 82,598 kg of market-size silver carp and bighead carp were harvested from 138 cages at a profit of CNY21,599. On average, the production cost was less than CNY0.60/kg of fish (Wei Kelong 1982). The total production from the reservoir in 1986 increased to 271,500 kg and food fish reared in cages accounted for 42.9% of the total (Zhu Wenbo 1987). In Panjiakou Reservoir, the total cage area

TABLE 43. Effect of application of food and manure on fish production in reservoirs in Zhejiang Province (1985) (Lu Dingyan 1986)

RESERVOIR	AREA (HA)	AVERAGE YIELD (KG/HA)		FOOD AND MANURE USED (KG/HA)		
		BEFORE USE	AFTER USE	MANURE	FINE FOOD	GREEN FODDER
Xiangyang	4.77	145.5	2,598	32,445	3,217.5	22,560
Fengchkou	2.66	159.0	4,167	36,435	5,989.5	31,754
Guanmenchong	1.87	54.0	4,844	47,820	9,453.0	38,282

TABLE 44. Percentages of various fish used in small reservoirs that practice integrated fish farming

RESERVOIR	AREA (HA)	CULTURE SYSTEM	GC	SC	BH	TI	CC	CrC	BSB	AVG. YIELD (KG/HA)
Xiangyang, Fengchkou, and Guanmenchong	1.87-4.77	Grazing species (e.g., grass carp) reared as major species	35	20	18	10	7	6	4	3,607
Shishankou	13.0	Filter-feeding species (e.g., silver carp) reared as major species	6	61	15	5	9	2	2	1,521
Wagou	8.93	Both filter-feeding and grazing species reared as major species	18	37	6	10	11	6	12	2,581

Note: GC grass carp, SC silver carp, BH bighead carp, TI tilapia, CC common carp, CrC crucian carp, and BSB blunt-snout bream.

increased from 29,348 m² in 1988, to 32,684 m² in 1989, to 60,697 m² in 1990. In 1990, the fingerling yield was 6.5 kg/m², and the yield of market-size fish was 10.8 kg/m² (Gu and Fong 1992).

The success of the experiment in Foziling Reservoir indicates that the critical factors in rearing silver carp and bighead carp in cages without any artificial feeding are:

- All the cages must be properly located to ensure an adequate source of natural food organisms, a slight water flow, and a long photoperiod. The water depth should be 5-8 m. The catchment area for the reservoir should be covered with trees, vegetation, villages, and agricultural fields.

- Large-size fingerlings should be used. In Foziling Reservoir, the stocking size in the grow-out cages is 150 g, and 0.6- to 0.7-kg fish can be produced by the end of the same year.

- Stocking density varies with water quality and fingerling supply. An acceptable density is 20-50 fingerlings/m³ of water.

- Cage size affects yield. In Foziling Reservoir, fish production in 8 m x 4 m x 2 m cages is higher than in 15 m x 8 m x 4 m cages. Average fish production in the smaller cages is 14.6 kg/m² or 7.5 kg/m³ and in the larger cages is 6 kg/m² or 1.5 kg/m³.

- The cage netting should be cleaned frequently to ensure free exchange of water, and the cage lines should be adjusted regularly to maintain the shape of the cages.

Culture of common carp and tilapia with feeding

This is intensive aquaculture at a high stocking density that usually involves monoculture of species such as common carp, tilapia, and grass carp. Cage culture of common carp was started in 1981 in both Bailianhe and Huiting Reservoirs. The dimensions of the experimental cages were 4 m x 4 m x 2 m with a mesh size of 3 cm. Stocking size was over 75 g at a stocking density of 130-150 fish/m². Fish were fed with pelleted feed containing 30% crude protein (the ratio of plant to animal protein was 1:4) for 4 months. Common carp reached a body weight of 0.6 kg. The average yield was more than 62 kg/m² with a production cost of CNY0.92/kg of fish (the food cost was 60% of the total expenditure).

Culture of common carp

Wu *et al.* (1987) reported that in 1986, Liu Anping privately set up six closed, floating, cages in Huanglongtan Reservoir. The dimensions of the cages were 5 m x 4 m x 2 m with a mesh size of 3 cm. The stocking size of common carp fingerlings ranged from 30-69 g (average 50.7 g) at a stocking density of 153 fish/m². After 235 days, the average size was 770 g, and the gross yield was 77.8 kg/m². The average food conversion rate was 1.91. The production cost was CNY2.32/kg and food accounted for 50% of the cost and fingerlings 38%. The ratio between the input costs and output value was 1:1.72.

The pellets used to rear the carp contained 30.1% crude protein, 13.9% crude fat, and 12.9% carbohydrate. The essential amino acids in the pellets were: threonine 1.20%, methionine 0.68%, valine 1.62%, isoleucine 1.34%, leucine 2.40%, phenylalanine 1.56%, lysine 1.50%, histidine 0.81%, and arginine 2.45%. The pellets also contained additives to promote fish growth. The monthly ration of pellets is shown in Table 45.

In northern China, the growing period for fish (when the temperature is above 15°C) is comparatively short (e.g., 110-140 days in Jilin Province). However, a high rate of production of common carp can be achieved if the operation is properly managed. Liu Rui *et al.* (1986) reported that 40 floating cages were installed for common carp culture in Songhuahu, Xingxingshao, and Kalun Reservoirs. The average stocking size was 46.5 g, the harvest size was 330.6 g, and the average survival rate was 66.7%. The average net yield was 50.3 kg/m², with an average food conversion rate in the three reservoirs of 2.13.

In small reservoirs or coves where farming is carried out in cages, intensive culture exploits the superiority of the ecological conditions. Therefore, productivity of the reservoir or cove can be increased if fish faeces and waste food are fully utilized.

Culture of tilapia

Yang Qinfang *et al.* (1987) reported on the cage culture of *Oreochromis niloticus* in Shishantou Reservoir. Fifteen closed, fixed cages (7 m x 4 m x 2.3 m, mesh size 1.5 cm) were first operated in 1986. The average stocking size of fingerlings was 22.7 g in nine cages and 15.6 g in six cages. The average stocking

TABLE 45. Monthly ration of pellets used in cage culture of common carp in Huanglongtan Reservoir

	APR	MAY	JUN	JUL	AUG	SEPT	OCT	NOV
Daily feeding rate (% of body weight per day)	1.2-1.6	2.0-2.8	3.2-4.0	4.0-5.0	3.8-5.2	2.2-3.8	1.2-2.0	0.6-1.2
Percentage of total input	1.6	5.3	11.5	19.7	24.8	20.8	11.1	5.2

density was 87 fish/m². During the first 2 months, the fish were fed rice, wheat bran, and rape-seed cake. This was gradually replaced by pellet feed (at a daily feeding rate of 3–6% of body weight). After 138 days, the mean size of the tilapia was 230.7 g, with an average yield of 1,753 kg/m² and a survival rate of 87.4%. Using this method, 2.18 kg of pelleted food, 0.82 kg of fine powdered food, and 0.67 kg of green fodder (*Spirodela polyrhiza*) were required to produce 1 kg of market-size fish. The pellets contained 29.1% crude protein, 6.0% crude fat, and 5.7% carbohydrate. The ratio between input and output was 1:1.4.

Minicages (1–4 m²) have been developed recently. The major species are common carp and tilapia. Wen Changchun *et al.* (1993) reported that the average yield (202 cages, 347 m² in total) of common carp was 187.8 kg/m² in Xiangyansan Reservoir.

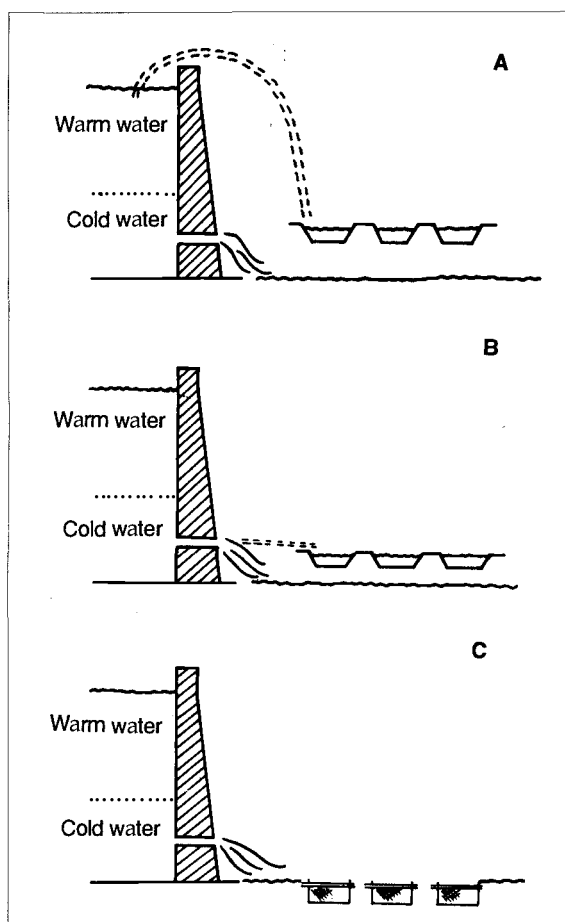

Figure 58. Fish culture in the running water systems of reservoirs: (A) pond culture using the warm surface water, (B) pond culture using the cold bottom water, and (C) cage culture using the cold bottom water.

Culture of luxury species

Cage culture of luxury species (e.g., eel and mandarin fish) has developed rapidly in recent years. The yield of eels reached 40 kg/m² in Xinanjiang Reservoir

in 1992, and the total production of mandarin fish was 75,000 kg in Fuqiaohe Reservoir.

FISH CULTURE IN TAILWATER

The water for power generation and irrigation can be used for fish farming. This multiple use of reservoir water (reservoir water—power generating—fish farming—agricultural irrigation) is illustrated in Figure 58. Each use of the water occurs at a lower level than the previous use.

Fish culture in running water ponds

Water source

The running water ponds should be constructed below the dam because filling and draining are convenient. The water can be obtained from the surface of the reservoir through siphonage (e.g., in Longtou Reservoir) or from the bottom through underground channels (e.g., in Qingshan Reservoir). However, it is best to use surface water because it is warmer. The bottom water has a lower oxygen level and must be exposed to the air or oxygenated before it can be used.

Design of running water ponds

Running water ponds are small water bodies used for intensive fish culture. The design of the pond must allow for free exchange and flow of pond water, convenient discharge of wastes, and even distribution of fish in the pond. In addition, the pond must be arranged to make efficient use of land and filling and discharge easy. Therefore, the area, shape, and irrigation system of the running water ponds must be specifically designed to suit local conditions.

At present, running water ponds are rectangular, round, or elliptical in shape. Rectangular ponds make the best use of land, but wastes tend to accumulate in the corners and are not easily discharged. Round ponds have no corners, but they cost more and make less efficient use of the land. Elliptical ponds combine the advantages of rectangular and round ponds. In Qingshan Reservoir, all running water ponds are elliptical, are 7 m × 4 m, and have an area of 24 m². Their average water depth is 0.85 m and they have a capacity of about 20.4 m³ (Figure 59).

Fish production in running water ponds depends on the dissolved oxygen level in the water, which in turn is determined by the oxygen content and flow rate of the water in the reservoir. In general, the dissolved oxygen content should be above 5 mg/L and the water should be changed once every 20–30 min. To prevent the fish from expending too much energy to swim against the water current, the water flow in ponds is usually controlled at about 0.2 m/s.

Because a small volume of water is used and there is a continuous flow of water, food and fish faeces are discharged from running water ponds. To make use of these wastes, a waste-utilization pond is constructed at the main outlet. This is an effective way to reduce

production costs and increase fish production. The waste-utilization pond, which can store, discharge, and be refilled with waste water from the running water ponds, is usually stocked with omnivorous fishes (e.g., common carp and tilapia) that have fast growth rates and strong resistance to disease.

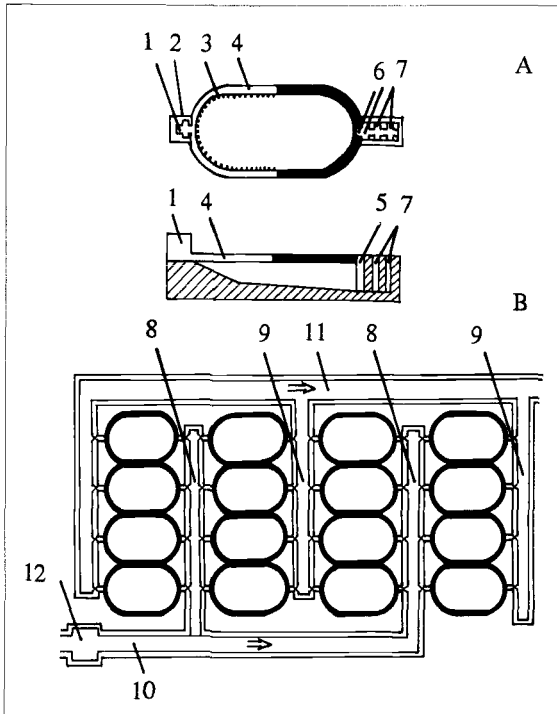

Figure 59. Elliptical running water ponds in Qingshan Reservoir: (A) details of individual pond and (B) layout of ponds; (1) water inlet, (2) water gate, (3) water inlet, (4) water inlet channel, (5) fish screen, (6) sewage outlet, (7) water outlet gate, (8) branch channel for water inlet, (9) branch channel for water outlet, (10) general channel for water inlet, (11) general channel for water outlet, and (12) pond for water intake.

Running water ponds are mainly stocked with herbivorous species because grass is easily available in the hilly areas, and these fish are better adapted to environments with a high dissolved oxygen level. The stocking size should be relatively high (optimal size about 50 g). The stocking density practiced in Qingshan Reservoir is 100 fish/m³. After stocking, the fish are first fed with tender grass, which is gradually supplemented with commercial feed. The fish grow to 0.7-1.0 kg after 6-7 months of culture and have a survival rate of about 45%. In 1979-1980, the average yield of grass carp from the running ponds (400 m²) was 31.7 kg/m³ in Qingshan Reservoir.

Fish culture in irrigation canals

Most irrigation channels in reservoirs can be used for fish culture because they have adequate water quality and supply, a moderate and stable flow rate

(less than 0.2 m/s), and a fish barrier. The species that are reared are grass carp, Wuchang fish, common carp, and black carp. The wire cages should not affect the water flow in the channels. The velocity of the water and shape of the irrigation channels affect the type of cages that are placed in the channel. Apart from the normal requirement of water quality, the water should not be too turbid (less than 15-20 g/L) or the mud and sand will block the gills of fish and fish will suffocate. This practice is common in Sichuan Province, where the total area of wire cages was about 25,000 m² in 1987. There are two types of cages.

Fixed cages

These wire cages are 30-200 m² and are suitable for shallow irrigation channels (less than 3 m) and small fluctuations in water level (below 1-2 m). The cage bottom is made of concrete, and the enclosure is made of diamond-shaped metal mesh (11-13 mm). The enclosure is supported by galvanized steel pipes and is fixed to one side of the irrigation channel. The metal mesh provides good aeration and filtration, high strength and resistance to decay, is a poor substrate for epiphytic organisms such as algae and molluscs, and it is not easily damaged by predators. The top of the cage should also be covered with a piece of polyethylene netting.

Floating or movable cages

These cages are normally installed in deep channels (more than 3 m), where there are large fluctuations in water level, and where construction is impossible unless the water flow is curtailed. The cages, which are either open or closed, are made of steel pipes or angle iron and metal mesh. They are either fixed to the channel bottom or supported by floats and move with fluctuations in water level.

No matter what type of cage is used in the irrigation channels, the dimensions and installation site must be adjusted according to the flow rate and speed of the water current. The flow rate inside the cage must be controlled at about 0.05-0.2 m/s. The cage is usually painted with an antirust paint and then with another layer of oil-based paint or enamel to make it rust-proof (Din Jiashou and Hu Fuliang 1986, Liu Hanyuan 1988).

Culture of rainbow trout

The optimal water temperature for culture of rainbow trout is 7-20°C. In most deep reservoirs, the temperature of the tailwater from the bottom layer is less than 15°C. For example, there is a 3 km cold-water stream behind the dam of the Xinanjiang Reservoir. The annual water temperature ranges from 9 to 20.4°C and, on average, the monthly temperature is 10.1-16.2°C. There is an abundance of shrimp and wild fish; therefore, the tailwater is an ideal place to culture rainbow trout.

To make use of the tailwater from the reservoir for the culture of rainbow trout, the water can be introduced into running water ponds or into cages installed directly in the tailwater stream. Farming of rainbow

trout in cages has been practiced successfully in Xinanjiang Reservoir since 1980. Trout farming would become even more promising if a less expensive food source could be obtained.

Management of Natural Fish Resources

Traditionally, fish are stocked every year and harvested after they reach a certain weight in a given period. These fish are called stocked species. Species that grow and spawn naturally and are harvested later are called natural economic species and include common carp, crucian carp, *Xenocypris* spp., and *Spinibarbus* spp.

CONTROL OF PREDATORS AND LOW-VALUE SPECIES

Predatory fishes are one of the main reasons for the low survival and production of stocked fish in most Chinese reservoirs. Low-value fishes are all small-size fish with a low economic value. Although the small low-value species compete with commercial species for food, they are also forage fish for the predators and cushion the effect of the predators on stocked fish. In addition, some low-value species consume eggs and fry of commercial species. However, low-value species play a role in maintaining balance in the aquatic ecosystem.

Common predators and their impact

The common predatory species in Chinese reservoirs are: *Elopichthys bambusa*, *Erythroculter ilishaeformis*, *Erythroculter mongolicus*, *Culter brevicauda*, *Siniperca chuatsi* (mandarin fish), *Ophiocephalus argus* (snakehead), *Parasilurus asotus* (catfish), *Opsariichthys* spp., *Esox reicherti* (pike), and *Hucho taimen*. Predators harm fish culture in two ways.

Endanger stocked fishes

In unstocked waters, the predators live mainly on the low-value fishes; whereas, in reservoirs with an intensive stocking program, the predators consume both small low-value species and stocked fingerlings. In fact, fingerlings of silver carp, bighead carp, and grass carp become the main prey species when they are small and abundant (particularly at the time of stocking). This is because the fingerlings have not yet developed a defence response and move slowly in schools (Table 46).

Predatory fishes can create great losses in reservoir fish culture unless they are properly controlled. For example, Fuqiaohe Reservoir had been intensively stocked since 1960 with fry collected from the Changjiang River. In 1966, annual production was 845,000 kg (average 420 kg/ha). *Elopichthys bambusa* fry were accidentally introduced with carp fry. This predator propagated naturally and its population increased rapidly. Stocked fingerlings were preyed on and fish production declined to 49,500 kg (24.8 kg/ha) in 1975. However, the yield recovered rapidly to 300,000 kg in 1980 when the predator was eliminated (Tang *et al.* 1992). In Tangquan Reservoir, fish production showed no obvious increase in spite of intensive stocking because of an abundant population of *Opsariichthys* spp. The water depth was dropped to its minimum level and the reservoir treated with rotenone. Since then, fish culture in the reservoir has improved.

TABLE 46. Stomach contents of common predatory fish species in reservoirs

	BL (CM)	BW (KG)	NO. EXAMINED	PREDATORS		PREY		
				EMPTY STOMACHS (%)	STOMACHS WITH PREY (%)	NO. OF FISH IN STOMACH	SC+BH (%)	OTHER (%)
<i>Elopichthys bambusa</i>	43.5-109.5	1.2-10.78	30	33	67	27	41.5	58.5
<i>Erythroculter ilishaeformis</i>	44.0-73.0	1.32-3.8	12	25	75	10	33.3	66.7
<i>Erythroculter mongolicus</i>	15.0-63.0	0.10-2.50	472	39	61	298	17.4	82.6
Mandarin fish	20.0-40.0	0.70-1.25	79	41	59	53	62.0	38.0
Catfish	29.5-66.0	0.17-2.60	76	16	84	38	15.7	84.3

Note: BL body length, BW body weight, SC silver carp, and BH bighead carp.

Lengthening the food chain and decreasing fish productivity

When predators become abundant, the trophic dynamics of the reservoir change. More links are added to the food chain from primary to final production, and fish productivity is lowered. There are many examples of low fish production in reservoirs dominated by predatory species (e.g., Mozitan, Fuqiaohe, Gaozhou, and Shishankou Reservoirs). In 1983, fish production in Xianghongdian Reservoir was 109,000 kg and *Erythroculter* spp., *Elopichthys bambusa*, and mandarin fish constituted 60.2% of the yield; however, the production in Shishankou Reservoir in 1972 was only 24,000 kg, and *Erythroculter* spp. accounted for 90% of the yield. Therefore, high fish production can only be achieved in reservoirs in which the stocked species is the principal species and there are few predators.

Types of predators

Based on feeding patterns and habitat preferences, there are two types of predators.

Pursuing predators

These pelagic predators obtain food by pursuing and catching prey using speed and strength. They normally live in the upper and middle water layers. These predators usually pursue and catch the prey from behind and swallow them head first or tail first. Based on their size and habitat preferences, they can be further subdivided into three groups.

- Large-size predators. *Elopichthys bambusa* is a typical large predator that has a strong pursuing ability and is exclusively piscivorous. The upper and lower jaws of *Elopichthys bambusa* are well-developed and its mouth is large enough to swallow prey that is 26.5-31.4% of its body length. It is widely distributed from the Heilongjiang River in the north to the Zhujiang River in the south. This species propagates naturally and its pelagic eggs are found in most large- and medium-size reservoirs. Although its survival rate is low, small populations can cause harm to reservoir fish culture.

- Medium-size predators. This group consists mainly of *Erythroculter ilishaeformis*, *Erythroculter mongolicus*, and *Culter brevicauda*. *Erythroculter* spp. are commonly distributed in reservoirs in the Changjiang River Basin and in Dahuofang Reservoir in the northeast because they are introduced with the natural fry transported from the Changjiang River. *Culter brevicauda* is commonly found in the reservoirs (e.g., Qinghe, Caihe, and Nanchengzi) in the Liaohe River system in northeast China.

- *Erythroculter* spp. differ from *Elopichthys bambusa* because their diets are not very specific during the fry and juvenile stages. For example, *Erythroculter ilishaeformis* and *Erythroculter mongolicus* become

completely piscivorous only when the body length exceeds 25 cm. Their mouth is comparatively small. *Erythroculter mongolicus* smaller than 50 cm in length are unable to consume bighead carp larger than 13.2 cm (Zhu Zhirong *et al.* 1976). Therefore, intensive fishing should be used to control the age and size composition of *Erythroculter* spp. and large-size fingerlings (longer than 13 cm) should be stocked to minimize the predatory effect. Che Yuchun (1978) reported that *Culter brevicauda* were able to prey on fish that were 14.3-21.7% of their body length. *Culter brevicauda* is small and seldom grows to more than 35 cm in body length. Therefore, only fish smaller than 7 cm are susceptible, and the harmful effects can be minimized by stocking large-size fingerlings.

- Small predators. *Opsariichthys* spp. are small-size predators with a large mouth. They can eat fish that are 25-44% of their body length. They prefer to travel in schools and live in streams with a sand or gravel bottom. In small reservoirs in the North and Northeast (e.g., Tangquan), *Opsariichthys* spp. has become a dominant species and seriously endangers smaller stocked fish.

Ambushing predators

Predators that ambush are slow moving and live on the bottom. They usually attack the head or sides of the prey and swallow them head first. This type of predator includes catfish, snakehead, mandarin fish, and pike. Studies in Qingshan Reservoir (Cao Fukang *et al.* 1976) showed that silver carp and bighead carp fingerlings accounted for 50% of the food consumed by mandarin fish and 6% and 4% of the food consumed by catfish. Because these predatory fish have lower fecundity, special breeding habits, and restricted spawning conditions in reservoirs, their populations are low. Therefore, except in the early stages of impoundment, they are not as serious a problem for stocked fish as pursuing predators.

The ambushing species include: snakehead, which is commonly distributed in the plain reservoirs that have abundant aquatic weeds (e.g., Tuanjie, Xipaozi, and Qiaozijian Reservoirs), catfish, which are common in reservoirs in hilly areas (e.g., Longfengshan Reservoir), and mandarin fish, which are common in reservoirs that are located in hilly areas and have a rocky bottom (e.g., Xiangang Reservoir).

Parasitic predators

This group is represented by *Lampetra* spp., which live on the blood and flesh of the host fish. Although sea lampreys cause tremendous losses of fish in the Great Lakes of North America, *Lampetra japonica* and two other species are only found in the Heilongjiang River Basin in China. Their influence on fisheries needs further study.

Population dynamics of predators

Conditions favouring the development of predators as the dominant species

- Spawning conditions. Snakehead and mandarin fish require aquatic weeds for spawning; whereas, *Elopichthys bambusa* require spawning grounds with a slight current. For example, in Gaozhou Reservoir, the spawning ground of *Elopichthys bambusa* is located in the confluent area of the upstream rivers. In other reservoirs, the spawning ground is where the larger streams flow into the reservoir. Spawning of *Elopichthys bambusa* takes place from April to June in large- or medium-size reservoirs that have a fairly strong current. However, this species cannot spawn in medium or small reservoirs that have no strong water current or flood conditions.

- Abundant forage fish. Rapid propagation of snakehead, particularly at the early stages of impoundment, not only relates to the abundance of macrophytes and the improvement of spawning conditions, but also depends on the early reproduction of *Hemiculter leucisculus* and *Xenocypris* spp., which have a short life cycle, high fecundity, strong adaptability, and provide an abundant food base for the predators. When predators exist, stocking of small-size fingerlings effectively supplies more live forage fish for the predators.

- Interspecific competition. Two species cannot occupy the same ecological niche. Therefore, if two species of predators try to dominate the same niche at the same time, one will be eliminated. For example, *Erythroculter ilishaeformis* and *Erythroculter mongolicus* cannot become dominant at the same time. In general, the species that have favourable spawning conditions, a better food supply, and are not properly controlled by fishing, will be better able to compete and be more likely to become dominant.

Because there are diverse ecological conditions in large reservoirs, if one species of predator becomes dominant, others will be forced to change their niche. However, they will not become extinct. For example, in 1983, the total catch was 108,500 kg in Xianghongdian Reservoir, and of this, *Erythroculter* spp. constituted 38%, *Elopichthys bambusa* 15%, and mandarin fish 7%. When *Elopichthys bambusa* becomes the dominant species, *Erythroculter* spp. are forced to leave the open areas and to occupy either the littoral areas or coves. Although snakehead, mandarin fish, and catfish are all bottom predators, one species cannot totally eliminate the others because they all have slightly different habitat preferences.

General trends in predator populations

The benthic demersal predators develop first in newly impounded reservoirs. Many macrophytes are submerged and small low-value fish with strong adaptability and a short life cycle grow quickly. This provides

the bottom predators with an environment conducive to their living, spawning, and feeding. For example, Xinanjiang Reservoir was constructed in 1959 and the production of snakehead accounted for 60% of the total catch (105,000 kg) in 1960. The production of catfish and snakehead was 20-30% of the total catch in Gaozhou Reservoir in 1960, the year when it was constructed.

Pelagic predators are likely to be well-developed 3-5 years after impoundment. By this time, nearly all the submerged macrophytes have decayed and new populations of aquatic plants are less abundant. The populations of benthic demersal predators therefore decline and are replaced by pelagic species. Because *Culter* spp. and *Erythroculter* spp. reach maturity early and have a high reproductive capacity, they are usually the first to become dominant. However, if *Elopichthys bambusa* existed in the original submerged region or enters with the stocked fingerlings, they will dominate after several generations because they grow faster and spawn earlier than the other species. However, it takes a considerable time for *Elopichthys bambusa* to form large schools because they reach maturity later. The dominant predators found immediately after impoundment are always small and will be gradually replaced by medium- and large-size predators.

A decline in one predatory species because of fishing usually favours the others. In Chengxi Reservoir, *Erythroculter mongolicus* soon became dominant when *Elopichthys bambusa* was almost eliminated. Therefore, efforts are required to control the other predators when one of the species is being harvested.

Examples of the sequence of change of the dominant predators in some Chinese reservoirs are shown in Figure 60. These sequences are further condensed into the models shown in Figure 61.

Control of predators

A good understanding of the population dynamics of the predators helps to control predators and their harmful effects. As a result, a reasonable stocking program can be developed. There are four principal measures for predator control.

Eliminate the source

The submerged region in the preimpoundment area should be thoroughly cleared of predatory fish. Therefore, investigations on the ichthyofauna and composition of predators should be conducted prior to impoundment to obtain sufficient information to eliminate or catch the predators. During artificial stocking, efforts must be made to ensure that known predators are not introduced. When new species of fish are introduced into a reservoir, serious consideration should be given to the fact that they may become predators in the new environment.

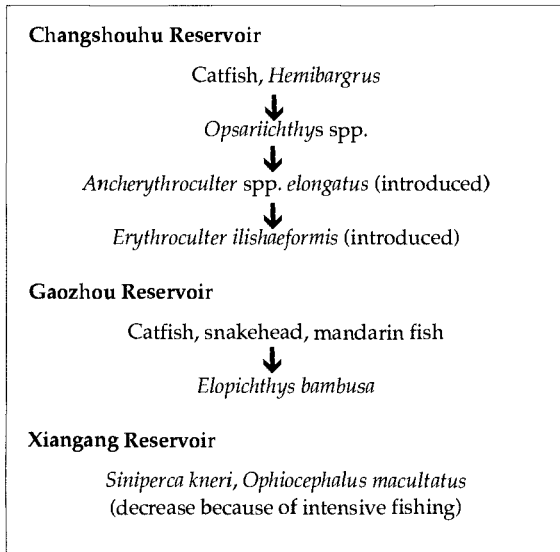

Destroy spawning conditions

Several measures are commonly used to control the spawning activities of predators. Migration routes for spawning predators should be obstructed with nets. In this way, not only are brooders eliminated but their spawning is controlled. Predators can be eliminated from the spawning grounds by using various fishing gear, nets, electric fishing, and hooks. Attention should also be paid to the elimination of predator eggs attached to stems and leaves of plants and floating objects along the reservoir bank. Generally, artificial nests are provided in the spawning ground and removed after the fish spawn.

Chemical control and catching

Chemicals (e.g., rotenone) can be used to control predators. Different fishing gear and methods are also used depending on the habitat preferences of the predator. When efforts are made to eliminate the dominant predator, attention must be paid to predicting and

Figure 60. Sequence of change in dominant predators.

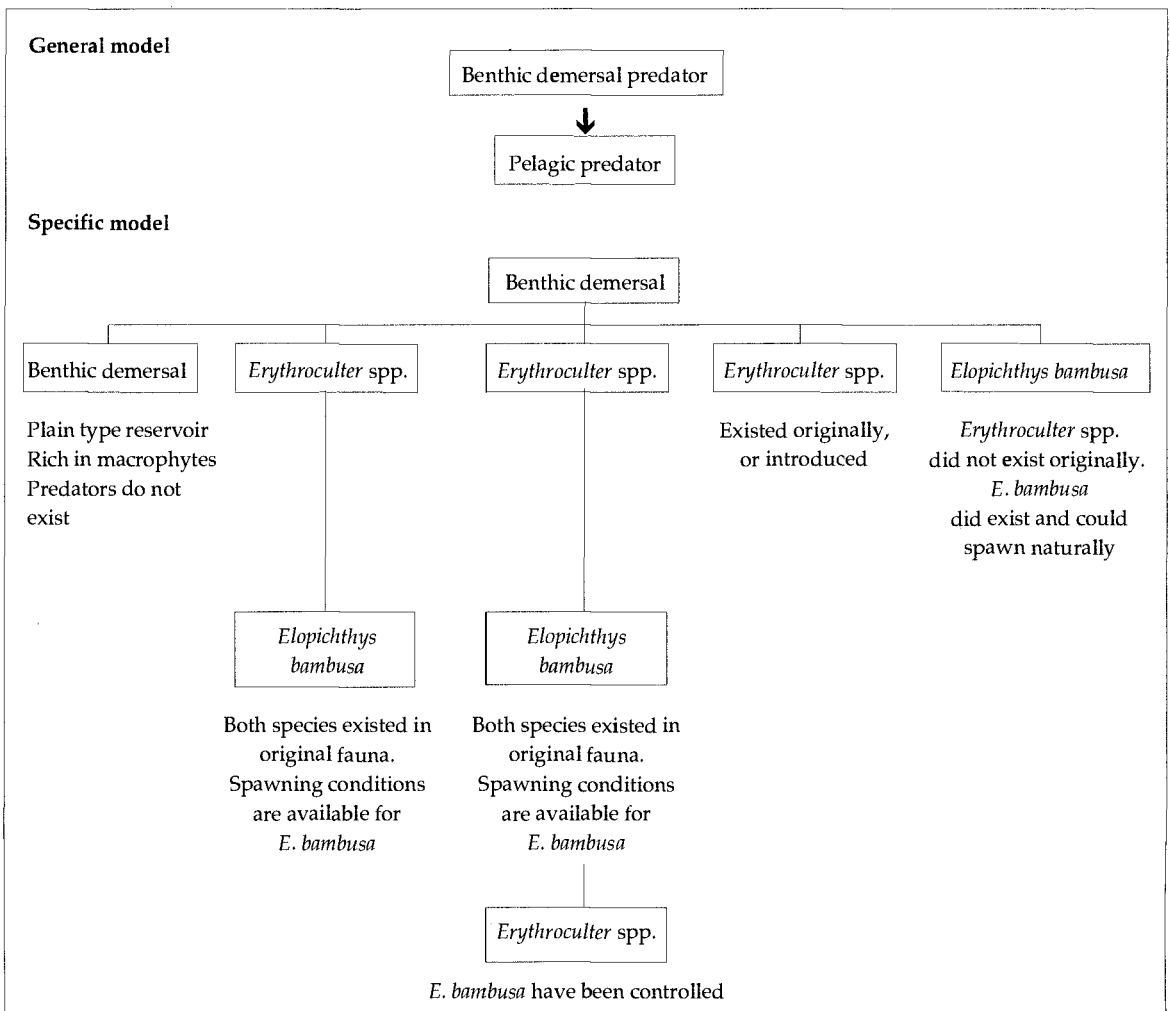

Figure 61. Models of change in predator populations.

monitoring the other predator species that may become dominant.

It should be noted that predators are not always harmful to commercial fish because their adverse effects can be reversed under certain conditions. For example, *Erythroculter dabryi* and *Culter erythropterus* are small-size predators that are only able to prey on silver carp and bighead carp fingerlings with a body length of 5-6 cm. Therefore, these two predators will cause no harm if the stocked fingerlings exceed 13 cm in body length. Under these conditions, they prey on small low-value fishes that compete for food with the stocked fish.

Control of small low-value fishes

The common small low-value fishes found in Chinese reservoirs are: *Hemiculter leucisculus*, *Pseudolaubuca sinensis*, *Toxabramis swinhonis*, *Saurogobio dabryi*, *Rhodeus* spp., *Hypseleotris swinhonis*, *Rhinogobius* spp., and *Gnathopogon* spp. These fish compete with economic fishes and are characterized by early maturity, high reproductivity, a short life cycle, and a simple age structure. Therefore, the population dynamics of these low-value fish are more variable. Three main factors limit their development: food availability, predator stress, and fishing intensity.

Hemiculter leucisculus, the most common low-value fish in Chinese reservoirs, live mainly on cladocerans, plant debris, and phytoplankton. They usually mature in two years (10 cm length and 15 g in body weight). Their relative fecundity is high (330-1,430 eggs/g body weight) and they spawn in batches. *Hemiculter leucisculus* spawn under a variety of conditions from slight upstream currents to shallow regions near the reservoir bank. The eggs are semipelagic and hatch either in the water column or on the sandy bottom. *Hemiculter leucisculus* prefer to swim in schools during the spawning and overwintering periods. Their age structure is simple, and 3-year-old fish are dominant. Their biological characteristics and population structure are adapted to the relatively stable breeding conditions, but not to stable food resources and variable stress from predators. If fishing intensity is increased, or predators increase, *Hemiculter leucisculus* will decrease rapidly.

Hemiculter leucisculus is an important forage fish for predators such as *Erythroculter ilishaeformis*, *Erythroculter mongolicus*, and mandarin fish. Therefore, their existence can, to some extent, reduce the effects of predators on stocked fishes. However, they grow slowly and have a low economic value. Because they compete with silver carp and bighead carp for food, it is necessary to regulate their population by fishing.

ENHANCEMENT AND PROTECTION

Transformation and enrichment of ichthyofaunal populations

In China, more than one hundred species of fish grow naturally in the large- and medium-size reservoirs. However, natural development of the fish fauna takes place very slowly because the fish fauna is not varied enough to make full use of all the food sources and ecological niches available in the reservoirs. The fish species composition is relatively poor in the hilly reservoirs with shallow, swift streams or where the number of indigenous species in the river are low. For example, there are only 17 fish species in the Liujixia Reservoir on the main stream of the Huanghe River. Of these species, 12 are indigenous and the rest are stocked. Generally, reservoirs built in the plain area have more fish species than reservoirs in hilly areas, and large reservoirs have more species than medium and small reservoirs.

Fish productivity has not been fully exploited in many reservoirs because fish species composition is inadequate. Some of the existing species also have a low economic value; therefore, they should be replaced by species with higher economic value and a better rate of food utilization to increase fish productivity. Other species do not reach a population size that permits harvesting.

One of the main strategies used to improve and enrich the ichthyofaunal composition is to introduce new species that will survive and naturally develop a sustainable population. Several factors must be considered when the introduction and acclimation of new species is planned.

Temperature

Water temperature differs greatly from south to north in China. Generally, fish that grow and spawn at a water temperature lower than 20°C are called cold water fishes. Fish that can grow and propagate above 20°C are known as warm water fishes. For example, the optimal temperature for growth of common carp is 25-28°C, and its growth is adversely affected when the temperature is above 29°C or below 19°C. Fish that grow and spawn at a water temperature greater than 24°C are called tropical fishes. The optimal temperature for growth of tilapia is 25-35°C, but they can survive below 10°C. As a result, before any new species is introduced, it is necessary to know whether the new species is eurythermal or stenothermal, and its upper and lower lethal temperature limits.

Salinity

The growth of fish and aquatic organisms is affected by salinity concentration and composition. Fish are either osmoconformers or osmoregulators. The salinity content of the body of osmoconformers varies with the salinity of the surrounding water (e.g., some anadromous fishes); whereas, osmoregulators always maintain a constant osmolarity in their body (e.g., some freshwater and marine fishes). With respect to salinity tolerance, fishes are usually divided into euryhaline and stenohaline species.

In general, salinity is not high in the Chinese reservoirs; however, attention should be given to salinity in reservoirs located in the west or northwest, where salinity may exceed 5‰. For example, in Hekou Reservoir, the composition of the indigenous species included crucian carp, *Pseudorasbora parva*, and *Hypseleotris swinhonis*. Although new species (e.g., common carp, silver carp, bighead carp, grass carp, and bream) were introduced, silver carp and bighead carp did not flourish, mainly because of the high salinity and alkalinity. In the last 10 years, the surface area of Hekou Reservoir has decreased from 1200 to 400-460 ha because of reduced rainfall, salinity has increased to 3.75‰, alkalinity to 92.4% German degrees, and pH to 9.4. Consequently, silver carp, bighead carp, grass carp, and bream cannot survive. Common carp, which once dominated the reservoir, have been replaced by crucian carp. The fish species that exist now are crucian carp, common carp, *Pseudorasbora parva*, *Hypseleotris swinhonis*, and *Hemiculter leucisculus*. Because crucian carp has the strongest tolerance to salinity, it has become the dominant species (Zhang Xiaogang 1984).

Food

Interspecific competition is based on the availability of food and nutrients. When new species are introduced, the original food sources and niches are further divided between the indigenous and newly stocked fishes. The exotic species can neither survive nor develop unless their feeding habits and habitats are different from those of the indigenous species, or they are stronger competitors.

Therefore, prior to introduction, it is important to carefully investigate the biological characteristics of the introduced species and ecological conditions of the reservoirs. The exotic species to be introduced should have a high economic value, have a strong ability to adapt to the new environment, have the ability to make full use of the space and food available, and be able to sustain their life cycles.

There are several examples of introductions of exotic species that were low cost and produced quick

returns after 2 or 3 years using simple operations. For example, Wuchang fish were introduced into Shangtun Reservoir and have reproduced naturally to form a large population. Wuchang fish are now the main species harvested. *Xenocypris microlepis* was accidentally introduced into Taoyuanhe Reservoir and now represents 8% of the total catch. This species has now been introduced into many reservoirs. Pond smelt (*Hypomesus olidus*) were introduced into Tumenzi Reservoir in 1984, and produced 5,900 kg in 1986. Pond smelt have also been introduced successfully into Heping, Guanmen, and Jindou Reservoirs. In Hebei Province, pond smelt have been introduced into 32 reservoirs (28,000 ha) and annual production now exceeds 1,000 tonnes. Ice fish (*Hemisalanx branchystralis*) were introduced into Dianchi Lake in 1979 and production reached 1,500 tonnes in 1983. In Henan Province, ice fish were introduced into Beiguishan Reservoir and 110 tonnes were harvested (an increase in yield of 21 kg/ha). Over 20 years ago, grass carp, silver carp, and bighead carp were introduced from the Changjiang and Heilongjiang Rivers into the former Soviet Union. Production of these three Chinese carps now accounts for one-quarter of the total inland fish production.

Improvement of spawning conditions

Spawning conditions are improved for economic species to ensure normal spawning, hatching, and growth of fish.

Protection of spawning grounds

Natural spawning grounds can be destroyed in numerous ways (e.g., hydrological changes, drought, sediments, damage to spawning substrates, industrial pollution, and abundant predators). Therefore, proper measures must be adopted to preserve the spawning grounds of important species.

Common carp and crucian carp are economically important species in Chinese reservoirs. However, their production can be affected by changes in the condition of the reservoir bottom, difficulties in harvesting, and a poor spawning environment. Because common carp and crucian carp are adaptable, they can develop into a large population if spawning conditions are favourable. The essential condition for their spawning is a substrate for attachment of eggs. They will not spawn if spawning nests are not available. In reservoirs, the main factor that influences spawning conditions for common carp and crucian carp is water level. During the spawning season, if the water level rises and a large area around the reservoir edge is submerged for a sufficient time, the brooders can find spawning nests. If the water level is stable or declines slowly after

spawning, the eggs stick to the nests (which are kept moist), the eggs hatch successfully, and the fish reach the juvenile stage. In many reservoirs, common carp and crucian carp produce large populations in years when hydrological conditions favour spawning. After 2 or 3 years, this generation of fish will become a large school that can sustain several years of harvest. Therefore, it is very profitable to control and adjust fluctuations in water level to create conducive spawning conditions for both species.

Xenocypris spp. naturally reproduce well. During the spawning season (April-June), they migrate and spawn in flooded confluent areas that have a gravel bottom. If the water level fluctuates and the spawning ground is exposed during the spawning season, or the spawning ground is destroyed by excessive sediments, their production will be seriously affected. For example, the *Xenocypris* populations, which once dominated most of the reservoirs in Hebei Province, are now very scarce because of adverse conditions during the spawning season.

To ensure spawning of these economic fishes, fishing is forbidden one month before and after spawning and some of the principal spawning grounds are protected from fishing. During the closed period, fishing and the collection of aquatic weeds are both banned.

Installation of artificial nests

If natural spawning grounds are destroyed, or the water level cannot be controlled to meet the needs for spawning, artificial nests can be used to improve spawning conditions and protect the fish resources.

Artificial nests are made of various materials such as water hyacinth (*Pistia stratiotes*), water lettuce (*Eichhornia crassipes*), bunch grass (*Myriophyllum ussuriensis*), other aquatic plants, land grass, and even the fibrous roots of poplar. In addition, synthetic materials can be used. However, several points should be taken into account during the construction and installation of artificial nests.

The materials used to make fish nests must be fresh and clean because the attraction to brooders and the laying of eggs are directly proportional to the quality of the nest materials. Materials (e.g., *Vallisneria spiralis*) that decay or rot easily must not be used.

Artificial nests should be provided when the fish are fully mature and hydrological conditions favour spawning. If the nests are provided too early, they may become covered with deposits of clay and sand, they may rot, or they can be used by small low-value fishes that spawn early. Therefore, it is important to know the spawning time based on previous records and changes in hydrological conditions. Generally, the best season to install nests is in the spring when the water temperature rises above 18°C and there is a slight water flow to stimulate spawning.

Predation of fish eggs should also be controlled. The main predators of fish eggs are: *Hemiculter* spp., *Pseudobagrus* spp., and *Culter brevicauda*. Observation and control of the predators must be continuous. One option is to place the nests in water bodies where there are few predators; another is to transfer the nests containing newly spawned eggs into coves that have been cleared of predators with chemicals or are protected with a fine-mesh net. The newly hatched fry are best cultured in coves before they are released into the reservoirs. Most reservoirs have extensive fluctuations in water level; therefore, floating frames are often used to suspend the nests.

Increase natural food sources

In newly built reservoirs, some food organisms, especially benthic organisms, are not introduced naturally, or reproduce slowly over long periods. As a result, the reservoirs are dominated by chironomids and tubificids that reproduce easily, but have few snails, clams, shrimps, and crabs.

More success has been achieved outside China in the introduction of exotic organisms. In the former Soviet Union, from 1971 to 1975, about 540 million food organisms were introduced into 28 reservoirs and 24 lakes. For example, opossum shrimp and *Gammarus* from the Yenisei River and the lower reaches of the Heilongjiang River were introduced sequentially into the Northbirsk and Classnor Reservoirs; similarly, opossum shrimp and other organisms from the Dilipo River and the lower reaches of the Bug River were introduced into reservoirs in the Volga system. Opossum shrimp have become the main food source for sturgeon, perch, and bream in the Volga and Zimluong Rivers and the Kuibyshev Reservoir. By 1975, fish production in these reservoirs had increased by 4,100 tonnes. Aquatic animals have been introduced in some Chinese reservoirs. For example, snails were introduced into Dongfeng Reservoir to promote the growth of common carp.

Reasonable harvests

Fishing should be used to adjust the fish composition and to control the age structure of various fish populations. Even if appropriate strategies of stocking and enhancement are practiced, fish production cannot be increased if fishing is performed improperly. Therefore, the adjustment and utilization of the fish resource must be performed scientifically to achieve sustainable fish production. Controlled harvesting is important to protect and enhance fishery resources in reservoirs.

The concept of a reasonable harvest includes: fishing intensity, size limits, and control of the fishing season.

Fishing intensity

Fishing intensity is simply the amount harvested. Generally, over-fishing will reduce the size and age of the fish caught, and finally decrease production. At the same time, it will also decrease the standing population and, consequently, the food and space in the reservoir are underutilized. However, under-fishing will stunt fish growth and slow down the recruitment of juveniles because of overpopulation. Fishes that are over-populated usually consume most of their energy for maintenance, and do not grow very much. Figure 62 is a model that shows the effect of fishing intensity on fish populations. The thin-line triangular frame indicates the theoretical age structure of a fish population, in which the average annual mortality is assumed to be 50%; whereas, the dark-line trapezium frame shows the possible age structure of the fish population at three different fishing pressures. Figure 62 indicates that rational fishing can ensure a proper standing biomass and relatively fast growth of the fish population during the entire production period. This ensures a high increment in fish growth, a large portion of market-size fish, and an adequate and stable recruitment of juveniles.

To have a reasonable proportion among various economic species, fishing intensity should be worked out to determine which species should be intensively harvested and which should not. For example, if one species of fish grows very quickly, this indicates that the food source is rich, but that the number stocked or natural recruitment is inadequate. In this case, this species should be stocked in larger numbers, harvested less often, and better protected. Otherwise, fishing intensity should be increased to reduce fish density.

The predicted yield of a stocked species is equal to: stocking density x return rate (%) x size at harvest. For example, in Qingshan Reservoir, 8 million fingerlings of silver carp and bighead carp were annually stocked at the end of a year and the return rate was 40% in the second year with an average harvest size of 0.6 kg. The return rate was 10% in the third year with an average harvest size of 1.0 kg.

Yield in second year = 8,000,000 x 40% x 0.6 = 192,000 kg.

Yield in third year = 8,000,000 x 10% x 1.0 = 80,000 kg.

Total production = 272,000 kg.

Size limits

The size at harvest depends on the growth of the fish, market demand, fishing conditions, and yield. In most of the reservoirs, the accepted harvest sizes are: silver carp ≥ 1 kg, bighead carp ≥ 1 kg, grass carp ≥ 1 kg, black carp ≥ 1 kg, bream ≥ 0.25 kg, crucian carp > 50 g, and *Erythroculter* spp. 0.25-0.5 kg.

Control of fishing season

In biological terms, the capture season for stocked fish should be the time when the fish reach the maximum size and capture activities have the least deleterious effect on fish spawning. The fish biomass should equal the carrying capacity of the reservoir. If fish density is reduced at the correct time, it will promote the growth of small-size fishes. In economic terms, the harvesting should be compatible to market demands, and harvest operations must have a high production efficiency.

Harvesting usually takes place in the winter in China. However, if joint fishing on a large scale cannot be performed in the winter, the fish can be harvested in the spring when they migrate for spawning and feeding, or in the summer rainy season when they are more active. Harvesting in the winter can usually meet the production target in medium and small reservoirs. However, because of the depth, large water surface, and larger numbers of fish in large reservoirs, harvests in both spring and summer are also needed. These two harvests also thin stocks and better match fish populations to available food resources. Naturally spawning fish are harvested mainly in spring and autumn. Predatory fishes must be harvested all year round, especially during their spawning seasons.

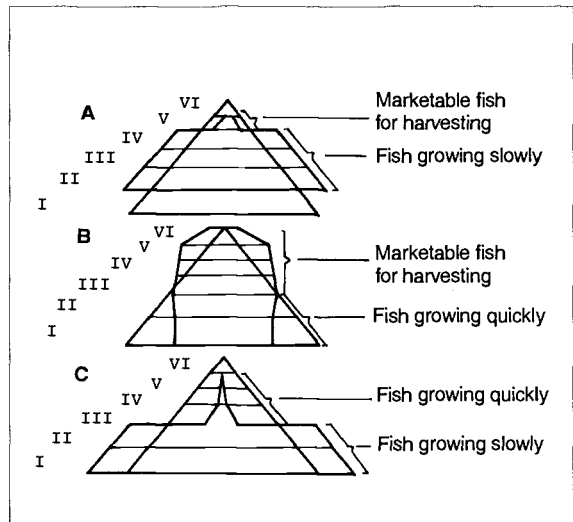
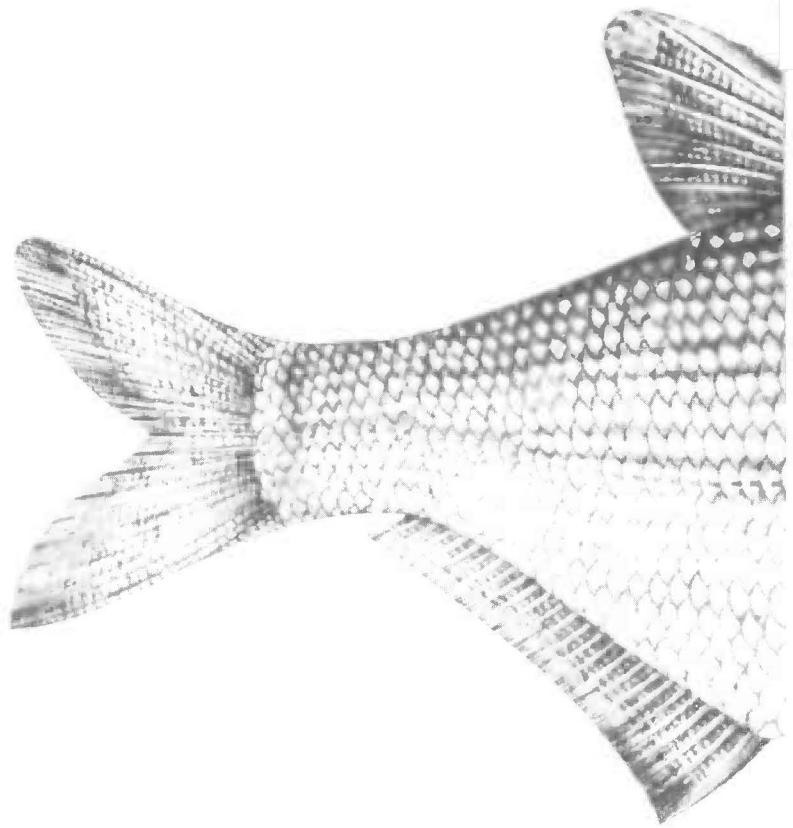

Figure 62. Effects of different fishing pressures on dynamics of fish populations: (A) under-fishing, (B) reasonable fishing, (C) over-fishing. I to VI represent age groups (modified from Bennett 1962).



Barriers and Harvest Techniques

The barrier is part of a system that prevents fish from escaping from reservoirs. It is an important component of fish culture in medium and large reservoirs.

The economic and social benefits of reservoir fisheries management not only depend on the techniques of fish culture and enhancement of natural fish resources, but also on the harvest techniques. Because the water is deep and the bottom uneven, fishing techniques in reservoirs are rather different from those used in other inland waters.

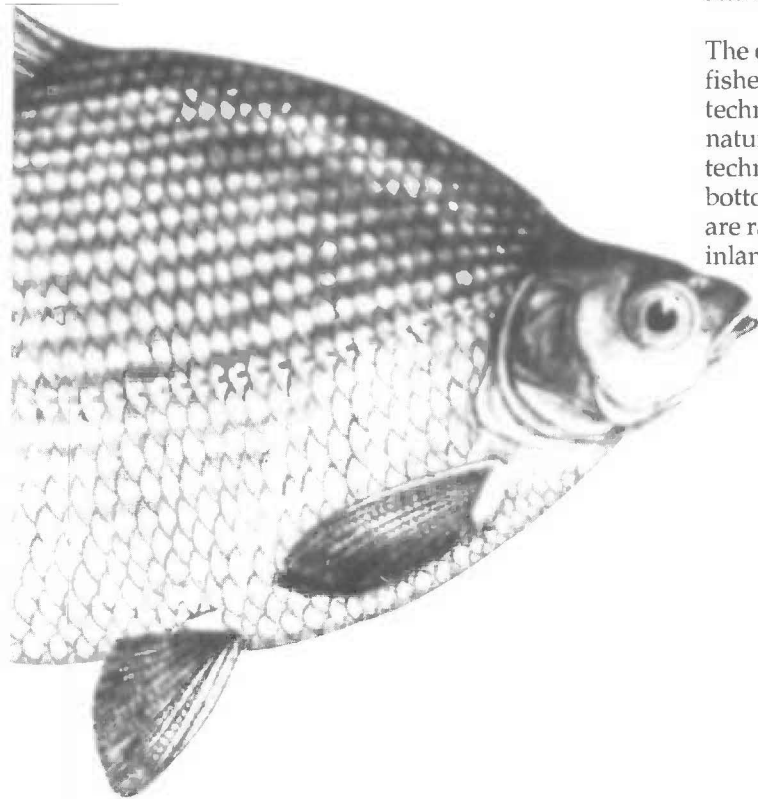

CHAPTER 8

Barriers

Barriers are used to prevent fish from escaping from large- and medium-size reservoirs. The function and morphometry of reservoirs vary and barrier facilities must be designed accordingly. However, all fish barriers must tolerate floods, and prevent fish escape.

TYPES OF BARRIERS

Fence barriers and barrier nets are commonly used in the Chinese reservoirs. In some small and hilly reservoirs, the graded culvert inlets are simply blocked with baskets. In the 1980s, electric screens were adopted in the spillways of small, hilly reservoirs. They can be used when the water flow is comparatively slow.

Fence

Fences are classified on the basis of the material used for their construction.

Bamboo (wooden) fence

- Use. These fences are usually installed at the culvert inlet of medium and small reservoirs that are shallow, have slow water flow, and little drifting matter.

- Structure. The bamboo (wooden) fence is usually made of bamboo or wooden sticks that are 3-cm wide. The bamboo or wooden sticks are fixed on a rectangular wooden frame. The dimensions of the frame are adjusted to match the section to be blocked. A supporting cement frame is constructed with a 10-cm slot to support the bamboo (wooden) fence. The fence must fit tightly into the cement frame (Figure 63).

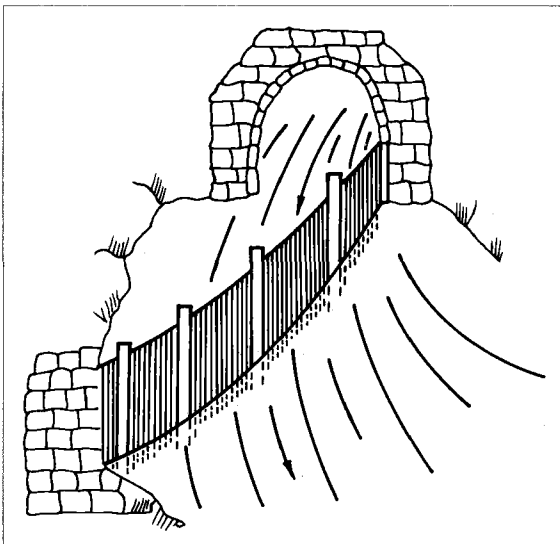

Figure 63. Structure of a bamboo (wooden) fence.

- Efficiency. The bamboo (wooden) fences are widely used in Chinese reservoirs because they are simple, made of easily available raw materials, and are easy to manage. They are sometimes replaced by wire fences. Because culvert mouths are shallow and the water flow is slow, bamboo (wooden) fences usually give good results. However, they can be destroyed by the runoff from heavy storms because they are relatively weak.

Bamboo baskets

- Use. Baskets are easily installed at the graded culvert inlets of small reservoirs.

- Structure. The basket is usually made of bamboo sticks. Its dimensions are dictated by the diameter of the culvert and the volume of flow. The baskets are normally installed at the inlet and effectively prevent the escape of fish.

- Efficiency. The bamboo baskets are designed specifically as a barrier at the culvert inlets. They have a simple structure and are easily managed. However, baskets are easily destroyed if the inlet is blocked by drifting debris.

Wire fences

- Use. Wire fences are usually installed in the spillway or external part of the discharge channel of large and medium reservoirs. Wire fences are used in Dongzhang and Gaozhou Reservoirs.

- Structure. The wire fence, also known as a filtering barrier, is set at an angle to the water flow. It is made of iron wire (3-5 mm diameter). The ready-made fence is fixed on the sloping concrete base. Two spacings are used between the iron wires. A spacing of 3.5 cm is used to block adult fish; a spacing of 1-1.4 cm is used to prevent escape of fingerlings (Figure 64).

- Efficiency. Because wire fences are made of metal, they can withstand a strong water flow. They are strong and effectively stop fish from escaping. Wire fences do not affect water flow, but they require a high investment, and the adults and fingerlings that are blocked are often injured or killed.

Barrier nets

- Use. Barrier nets are used to prevent fish escapes from large and medium reservoirs. They can be used for various spans and water depths when the water flow is less than 1 m/s.

- Structure. A barrier net consists of various nets (the main net, auxiliary net, cover net, and bottom net) and supports (head line, foot line, main head line, main

foot line, and iron chains). Barrier nets can be made of polyamide (PA), polyethylene (PE), and a new synthetic material [PE + polyvinyl alcohol (PVA)]. Several methods are used to hold the nets in the water: anchors, piles, and weights. Barrier nets made of PE + PVA and held by weights are most commonly used for commercial production. The barrier nets are held in position by weights on the bottom and banks of the reservoir. When the barrier net is pushed by the water flow, the force is transferred through the main head and foot lines and equally spread to the weights on both sides of the banks. This design gives the net good resistance to flood waters. A large-span barrier net with multiple functions was designed by the authors in 1986 for Taipingghu Reservoir. This barrier includes an impounding net, a filtering net, and a double-platform device to allow boats to pass through the barrier, and can be used both to block and capture fish (Figure 65).

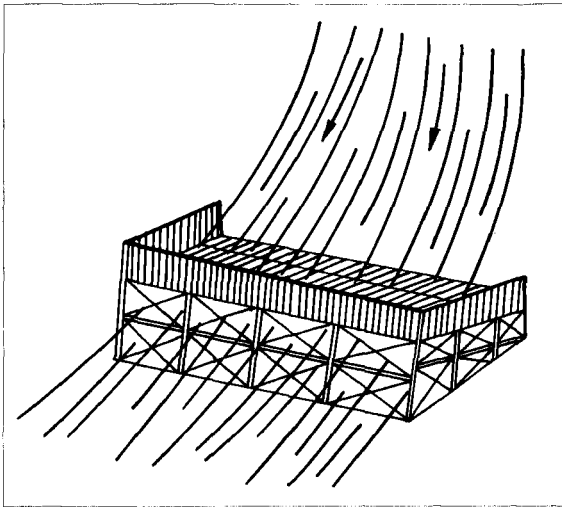

Figure 64. Structure of a wire fence.

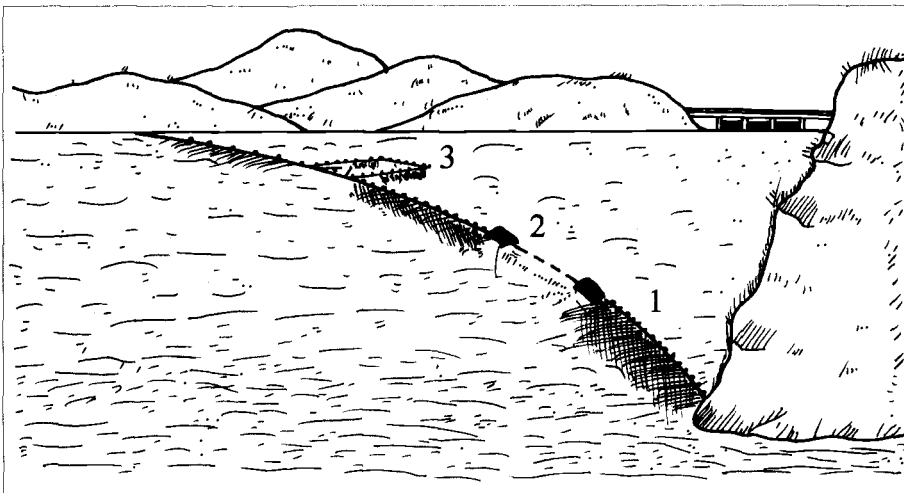

Figure 65. Barrier net operated in Taipingghu Reservoir: (1) barrier net, (2) double-platform device to allow passage of boats, and (3) fixed filtering net.

- Efficiency. Barrier nets are effective and widely used for reservoir fisheries in China. An improved design has increased flood resistance, the physical characteristics of the nets have been improved, and the buoyancy of the nets has been reduced through the use of PE + PVA for the netting material. A cover net and a bottom net have been attached to the head line and foot line, respectively, to ensure more complete blockage and to increase the efficiency of both blocking and fishing. The boat-passing device allows boats to safely and quickly pass, which increases both the social and economic efficiency of the barrier net.

This type of barrier net has been installed and successfully operated in many Chinese reservoirs [e.g., Dongzhang Reservoir (1983), Qixi Reservoir (1984), Tuohu Reservoir (1985), Taipingghu Reservoir (1986), and Qianhu and Sifangghu Reservoirs (1987)]. In these reservoirs, the maximum span is 2,000 m and maximum water depth is 55 m.

Electric screen

- Use. Electric screens are most efficient in spillways of medium and small reservoirs that have a water flow of less than 0.7 m/s for adult fish, and a flow of less than 0.5 m/s for fingerlings.

- Structure. Electric screens use an electric field produced by electrodes in the water to prevent fish escape. Three types of current are used: alternating current, direct current, and pulse current. The electrical supply is either twin phase or single phase. The electrodes are arranged in single rows, double rows, or multiple rows. The most common electric screens in small reservoirs have a single row of electrodes and use single-phase electricity (Figure 66). The screens can be installed in several ways. They can be buried if the reservoir can be drained, they can be hung in deeper, undrainable reservoirs, and they can be floated in deeper, wider reservoirs.

- Efficiency. Electric screens have been used in reservoirs since the early 1960s in China. They were first successfully operated in the Yangmeiling Reservoir. Since the mid-1970s, electric screens with pulse currents have been developed and applied in many medium and small reservoirs. Generally, electric screens are unaffected by floating debris, use little electricity, and are safe and

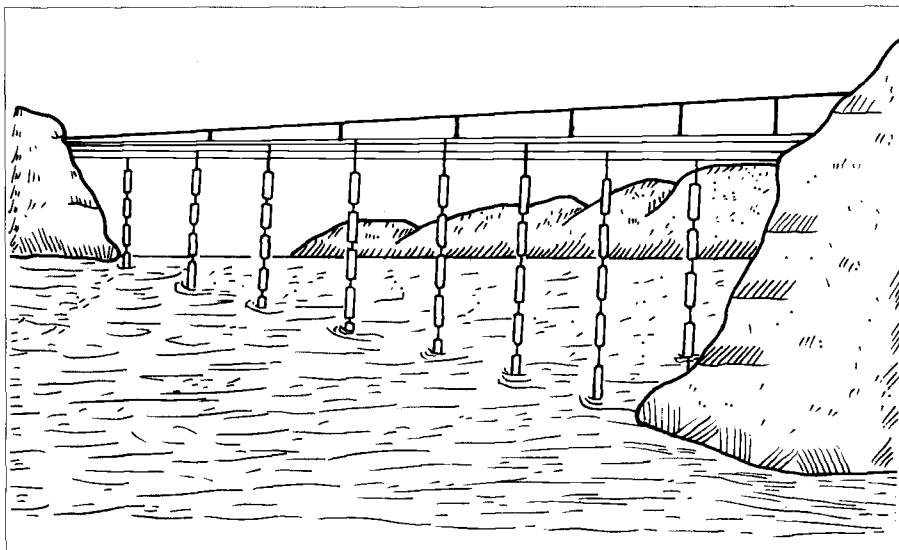

Figure 66. Electric screen with a single row of electrodes and single-phase electricity.

simple to maintain. Electric screens are now being widely used in medium and small reservoirs in hilly areas.

DESIGN OF BARRIER NETS

The overall design of barrier nets includes: the design and construction of the net itself, methods to fix the net in position, filters to remove floating debris, and a device to allow boats to pass.

Design principles

Design principles include: the selection of the section of the reservoir to be impounded, the speed of water flow, the height of the barrier net, the size and species of fish to be blocked, and the mesh size.

Selection of the section of the reservoir to be impounded

The choice of location is the most important factor in the design of a barrier net because it determines the force to be applied to the net, its operational efficiency, and the type of construction and investment needed. When the site is selected, consideration should be given first to the effects of water velocity. The primary principle is to ensure that the maximum flow is less than the velocity that can be endured by the fish (the swimming velocity limit of the fish). If the flow rate is beyond this limit, fish will be swept against the barrier net. However, if the designed water velocity for the barrier net is much less than the swimming velocity of the fish, the net will be unnecessarily large and costly. Therefore, it is most practical to select a location with a small cross section and control the flow rate.

It is also necessary to consider the bottom geology, topography, and cover. A clay or sandy clay bottom is preferred when weights, anchors, or piles are to be

used to fix the barrier net. The slopes on the sides should be slight and the bottom flat and free of obstacles. It is also important to limit the discharge of rubbish and debris and, if necessary, to allow for easy and safe passage of boats.

The barrier net must have no adverse effects on the hydraulic engineering of the reservoir. For this reason, the net is usually located far from the dam. The minimum distance from the barrier net to the dam

should be 5-10 times the water depth at the barrier net. For example, the maximum water depth at the barrier net is 30 m in Dongzhang Reservoir, and the net is located 150 m away from the main dam.

Flow rate

The water flow at the barrier site not only affects the efficiency of fish blocking, it is the most important parameter affecting the resistance of the barrier net in the water. This resistance is directly related to the tolerance of the net to floods and to the forces that are applied to the anchors and weights.

The flow rate at the site of the barrier can be calculated as:

$$V = Q/S \quad [14]$$

where V = flow rate at the site of the barrier (m/s), Q = maximum discharge capacity at the 1-in-50-year flood level (m^3/s), and S = cross-sectional area of the barrier net (m^2).

The swimming velocity of fish varies with species, morphology, spawning season, growth, and water temperature. Tables 47 and 48 show the maximum swimming velocities of various fish species.

Based on the swimming speed of the various fish species, the maximum allowable flow rate at the barrier net can be calculated. Silver carp are the most sensitive stocked species and always escape before the other species. If the barrier net can effectively prevent silver carp from escaping, all the other species will be retained. Therefore, the swimming velocity limit of silver carp is usually used to determine the maximum allowable flow rate at the barrier net. Generally, the swimming velocity limit of silver carp is 0.7 m/s; therefore, the maximum flow rate must be about 0.7 m/s.

TABLE 47. Maximum swimming velocity of some freshwater fishes^a

SPECIES	BODY LENGTH (CM)	MAXIMUM SWIMMING VELOCITY (M/S)
Silver carp	23-25	0.9
Common carp	20-25	1.0
Crucian carp	15-20	0.8
Wuchang fish	10-17	0.6
Grass carp	18-20	0.8
<i>Erythroculter</i> spp.	20-25	0.9
Snakehead	30-60	1.0
Catfish	30-60	1.1

^a Limits were measured by having the experimental fish swim against a water current in a straight glass tank. Measurements made by Sea and River Control Headquarters, Hebei Survey and Design Institute, Hubei Bureau of Aquatic Products and Hydrobiology, Academia Sinica.

TABLE 48. Sustained swimming speed of several freshwater fishes^a

SPECIES	BODY LENGTH (CM)	WATER TEMPERATURE (°C)	SUSTAINED SWIMMING SPEED (M/S)
Silver carp	40-50	22	0.9-1.0
Bighead carp	40-50	22	0.8
Black carp	26-30	19.5-23.0	0.6-0.94
	40-58		1.25-1.31
Grass carp	24-27		1.02
	30-40		1.27
Common carp	37-41		1.16
	40-59		1.11
Bream	26-27		1.03
	36-40		1.17
Crucian carp	21.5-23.0		0.91-0.94

^a The sustained swimming speed is the speed at which the fish swam against the water current for more than 30 min. Measurements made by Sea and River Control Headquarters, Hebei Survey and Design Institute, Hebei Bureau of Aquatic Products and Hydrobiology, Academia Sinica.

Depth of the barrier net

The barrier net should be as deep as the maximum predicted flood-water level. The total depth of the barrier net is equal to the depth of the net from the bottom of the reservoir to its maximum height on the bank. This depth is determined by the predicted flood level at a certain frequency. If the flood level is predicted to occur once every 100 years, the frequency is 1%. If the flood occurs once every 50 or 20 years, the frequency is

2% and 5%, respectively. The hydrological and hydraulic records of the reservoir are used to predict the frequency of occurrence of floods.

Size and species of fish

In stocked reservoirs, all economic fishes should be controlled. Because the ichthyofauna includes various species that differ in size, morphology, growth, spawning season, and physical characteristics, the problem can become quite complicated. To simplify matters, silver carp and bighead carp are often selected as the representative species. In large and medium reservoirs, silver carp and bighead carp over 0.5 kg in weight are the principal species to be controlled. In small reservoirs, silver carp and bighead carp over 0.25 kg are the primary species to be blocked, and in coves and minireservoirs used for fingerling production, silver carp and bighead carp that are 13.2 cm long are the major species to be controlled.

Mesh size

The mesh size of the barrier net depends on the size of the species to be retained. The mesh size not only directly affects the retention efficiency of the barrier net, it determines the resistance of the barrier in the water and the quantity of twine that is required.

Based on detailed studies during the design and construction of the barrier nets in large and medium reservoirs, the authors have established a correlation between fish size and mesh size of the barrier net based on measurements of silver carp and bighead carp (Table 49).

TABLE 49. Correlation between size of silver carp and bighead carp and the mesh size of a barrier net

FISH SIZE	MESH SIZE (MM)
Fingerlings above 13.2 cm	> 25
Juvenile fish above 0.25 kg	50-60
Adult fish above 0.5 kg	80-100
Adult fish above 1 kg	100-120
Adult fish above 2.5 kg	120-140

The barrier net in large and medium reservoirs must be strong enough to withstand a certain degree of flooding. At the same time, the amount of material and cost can be reduced by using two different mesh sizes according to the water depth. The principle is that a small mesh is used in the middle and upper parts of the net; whereas, a large mesh is used for the lower and bottom parts of the net. For example, the total height of the barrier net in Dongzhang Reservoir is 34 m; however, the upper 20 m of netting has a mesh size of 50 mm and the bottom 14 m has a mesh size of

60 mm. The barrier net in Qixi Reservoir is 32 m in height and uses mesh sizes of 60 mm, 70 mm, and 80 mm at different depths.

Net twine

The choice of net twine is directly related to its operational efficiency and cost. Barrier nets are made mainly of polyethylene twine, which has a high resistance to rot and sunshine and is strong and inexpensive. The polyethylene fibre has a specific gravity of 0.94-0.96, which makes it buoyant. When the water level is lowered, the excess portion of net floats on the water and deteriorates if exposed to the sun for a long time. In addition, the portion of the net floating on the water catches floating debris, which not only affects the filtration rate, but shortens the life of the net. Floating nets are more of a problem in reservoirs with a lot of boat traffic because management of the barrier net is more difficult.

To solve this technical problem, a new synthetic material (PE + PVA) was developed for nets. Polyethylene (PE) and polyvinyl alcohol (PVA) is mixed at a ratio of 2:1. The structure of the net twine is (23/3x3+29/3x1)x3. Because PVA has a specific gravity of 1.26-1.30, the specific gravity of the new type of net twine is equal to or greater than 1. Nets made of this synthetic material sink when they are soaked for more than 24 h. These nets have been used successfully in Dongzhang and Qixi Reservoirs and in Tuohu Lake. Any excess net left above the water surface sinks automatically when the water level drops. The physical and mechanical characteristics of PE + PVA and PE twine are shown in Table 50.

Design procedures

Survey of barrier site

After the barrier site is selected, the water depth and topography should be surveyed to ensure accurate design and smooth construction of the barrier net. At this time, working diagrams of the cross section of the location of the net should be drawn (Figure 67).

Measurements should be made, and rechecked, both above and below the water surface to obtain data on water depth. A working diagram is used to calculate the area to be impounded and to decide on the size of netting to be used.

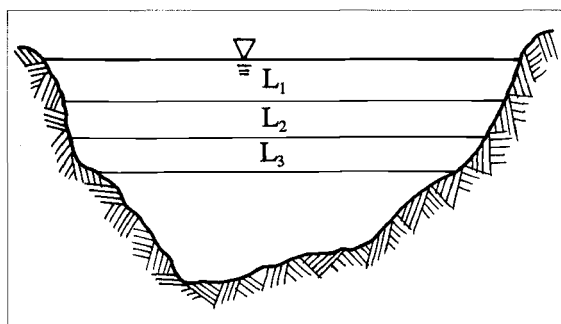

Figure 67. Working diagram of the cross section of the location of a barrier net.

Area of barrier net

The theory of suspended cables is used to calculate the area of the barrier net:

$$L/L' = 0.95; H/H' = 0.95; \text{ and } S' = L' \times H' \quad [15]$$

where L = actual width of the section to be impounded (m), H = actual water depth of the section to be impounded (m), L' = actual length of the barrier net (m), H' = actual height of the barrier net (m), and S = area of the barrier net (m^2).

Dimensions of nets

A barrier net is composed of the main net, the cover net, the bottom net, and the selvedge strip. The main net is the primary section that prevents the escape of fish. The selvedge strip is woven out of thick twine and is used to reinforce the edges of the main net. The cover net is usually attached to the head line to prevent fish from jumping over the net, and is normally woven from polyethylene so that it floats. The bottom net is made of the same material as the main net and is designed to prevent fish from escaping below the foot line. Because of their large size, barrier nets are usually made in sections for easier handling and installation.

The theory of hanging nets is used to calculate the dimensions of the mesh used in the barrier net. The ratio $E_1/E_2 = 0.64-0.66/0.75-0.77$ is usually used to calculate mesh dimensions; however, the dimensions of each section of the barrier net can be calculated from:

$$L_o = L_1/E_1; m = L_o/2a; H_o = H_1/E_2; \text{ and } n = H_o/2a \quad [16]$$

TABLE 50. Comparison between the twisted (PE + PVA) twine and PE twine

MATERIAL	SPECIFICATION	DIAMETER (MM)	WEIGHT (G/M)	BREAKING STRENGTH (KG)	ELONGATION AT BREAKING POINT (%)
PE + PVA	(23/6+29/3)x3	1.53	1.025	36.57	15.1
PE	23/9x3	1.75	1.220	40.00	23-30
PE	23/7x3	1.55	0.950	31.00	23-30

where E_1 = horizontal hanging coefficient, E_2 = vertical hanging coefficient, H_o = stretched depth of net (m), L_o = stretched length of net (m), $2a$ = mesh size (mm), m = number of horizontal lines in the net, and n = number of vertical lines in the net.

Twine consumption

After the size of the mesh is calculated for each section of the net, the amount of twine needed to make the net can be calculated from:

$$G = \frac{(2a + cd)}{500} C_h (N) \quad [17]$$

where G = twine needed to make net (g or kg), $2a$ = mesh size (mm), d = twine diameter (mm), c = consumption coefficient of different knots (braiding knot 14-15, sheath bend 16-18, double sheath bend 24-25, and double twist sheath bend 32), C_h = twine weight per metre (g/m), and N = total number of meshes ($m \times n$ in Equation 16).

The amount of twine needed for each section of the net is calculated separately. Examples of material requirements for the components of a barrier net are shown in Table 51.

Type and dimension of lines

A barrier net has many lines. The main head line and main foot line support the load on the barrier net. In addition, there are head lines, foot lines, cork lines, sinker lines, bolch lines, reinforcing lines, cover-net lines, and bottom-net lines. The positions of these lines are shown in Figure 68.

Steel wires are usually used for the main head line and main foot line because they sustain the whole load on the barrier net and must withstand the forces applied during floods. The other lines are made of polyethylene. The diameter and length of the lines used depend on the size of the barrier net and the forces applied during floods. The characteristics of the different lines used in barrier nets designed by the authors and installed in some large and medium reservoirs are shown in Table 52.

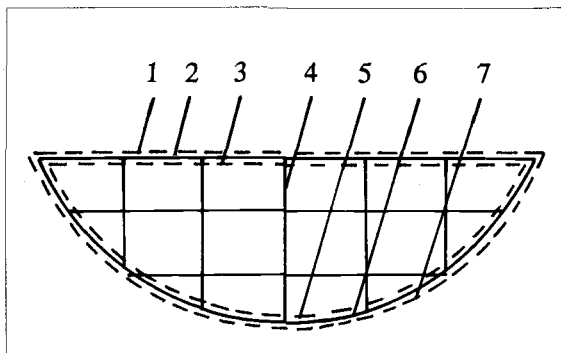

Figure 68. Positions of lines in a barrier net: (1) main head line, (2) head line, (3) bolch line for cork line, (4) reinforcing line, (5) bolch line for sinker line, (6) foot line, and (7) main foot line.

Resistance of barrier net

The total resistance of a barrier net includes the resistance of the net, lines, and floats.

- Net resistance. When set in flowing water, the barrier net stretches in an arch-shape. The resistance at each part of the barrier net is not the same because the different parts of the net are at different angles to the flow of the water. To simplify the calculation, the net is assumed to be at 90° to the flow of the water. In this case, the resistance can be calculated as:

$$R_w = 180 \frac{d}{a} S V^2 \quad [18]$$

where R_w = resistance of net (kg), d = diameter of twine used in the net (mm), a = length of a bar (mm) (a bar is equal to half the stretched mesh length), S = net area after hanging (m²), and V = flow rate of water (m/s).

- Line resistance. The resistance of lines includes most lines used in the barrier net. Because the main foot line, sinker line, and foot line sit on the reservoir bottom, their resistance is not calculated. The formula used to calculate the resistance of lines is:

$$R_l = K_o L d V^2 \quad [19]$$

TABLE 51. Materials required to make the component nets for a barrier net (mesh size 50 mm, all material PE + PVA, 9 x 3)

COMPONENT	NUMBER REQUIRED	LENGTH X WIDTH (M)	MESH NUMBERS (LENGTH X WIDTH)	TOTAL NUMBER OF MESH	TWINE NEEDED (MG)
I ₁₋₆	6	52.63 x 4.22	1,620 x 111 x 6	1,078,920	182 ^a
I ₇	1	31.58 x 4.22	972 x 111	107,892	
II ₁	1	49.47 x 10.53	1,523 x 277	421,871	
II ₂₋₆	5	52.63 x 10.53	1,620 x 277 x 5	2,243,700	414 ^b
II ₇	1	5.26 x 10.53	162 x 277	44,874	

^a For all I components.

^b For all II components.

TABLE 52. Characteristics of the various lines used in barrier nets installed in large and medium reservoirs

LINES	MATERIAL	DIAMETER (MM)	BREAKING STRENGTH (KG)	WEIGHT PER METRE OF LINE (KG/M)
Main head line	Steel wire	9.3-11.5	6,420	0.45
Main foot line	Steel wire	9.3	4,110	0.288
Head and foot lines	PE	10-12	1,360	0.079
Reinforcing line	PE	8-10	1,100	0.055
Bolch lines and lines for cover and bottom nets	PE	6	430	0.021

where R_l = resistance of lines (kg), L = length of lines (m), d = diameter of lines (m), V = flow rate of water (m/s), and K_o = coefficient of resistance of lines.

According to the parabola theory, the coefficient of resistance (K_o) can be found from Figure 69 as the ratio of sag (f) to the length of the head line (L).

$$K_o = f (f/L) \quad [20]$$

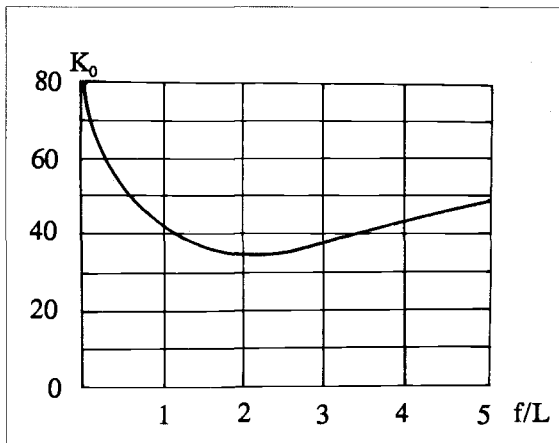

Figure 69. Coefficients of resistance (K_o) of lines.

• **Float resistance.** The floats of a barrier net are made of spherical polyethylene plastics. Their resistance in the water can be calculated as:

$$R_f = K_o S V^2 \quad [21]$$

where R_f = resistance of all floats (kg), S = float area (central axial section) (m^2), V = flow rate of water (m/s), and K_o = coefficient of resistance.

The coefficient of resistance of the floats (K_o) is shown in Figure 70. The Reynolds number (Re) is calculated as:

$$Re = \frac{VL}{\mu} \quad [22]$$

where V = speed, L = plate length in the direction of the water flow, and μ = kinetic viscosity coefficient (acceptable $\mu = 0.01$). In general, when the floats are 1-30 cm in diameter and the flow rate is 0.1-1.0 m/s, K_o is approximately equal to 25.

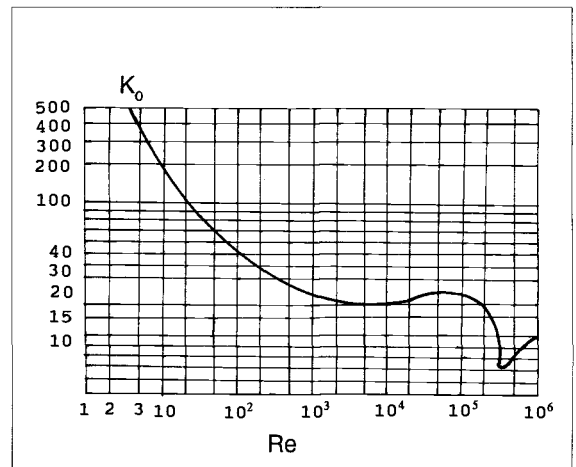

Figure 70. Coefficient of resistance of floats. Ordinate is K_o and abscissa is Reynolds number (Re).

• **Total resistance.** The total resistance of a barrier net (R_t) is the sum of the resistance of all the net, the lines, and the floats. Most of the resistance comes from the net.

$$R_t = R_w + R_l + R_f \quad [23]$$

Net weight of barrier net in the water

After the total dry weight of the barrier net is calculated, its total wet weight can be computed as:

$$G_w = G_n (q_n) + G_l (q_l) \quad [24]$$

where G_w = weight of a barrier net in the water (kg), G_n = total dry weight of netting (kg), G_l = total dry weight of lines (kg), q_n = sinking rate of line materials [$q_n = (r - 1)/r$], r = specific gravity of net material, q_l = sinking

rate of line materials [$q_1 = (r_1 - 1)/r_1$], and r_1 = specific gravity of the line materials.

The sinking rates (q_1) of commonly used netting and line materials are: polyethylene (PE) $q_1 = -0.0526$ (floating), polyamide (PA) $q_1 = 0.1228$, synthetic material (PE + PVA) $q_1 = 0.0566$ (estimated), and wire lines $q_1 = 0.866$.

Floating and sinking forces of a barrier net

Under water, two applied forces act on the barrier net: F_1 pulls the head line down, F_2 lifts the foot line up (Figure 71). To overcome these two forces, the barrier net should have appropriate floats and weights to retain its normal shape in the water.

The floating and sinking forces can be calculated from Figure 72 in which the abscissa is G_w/R and the ordinate is H/h (G_w = weight of barrier net in water, R = resistance of barrier net, H = water depth at site of net, and h = height of barrier net).

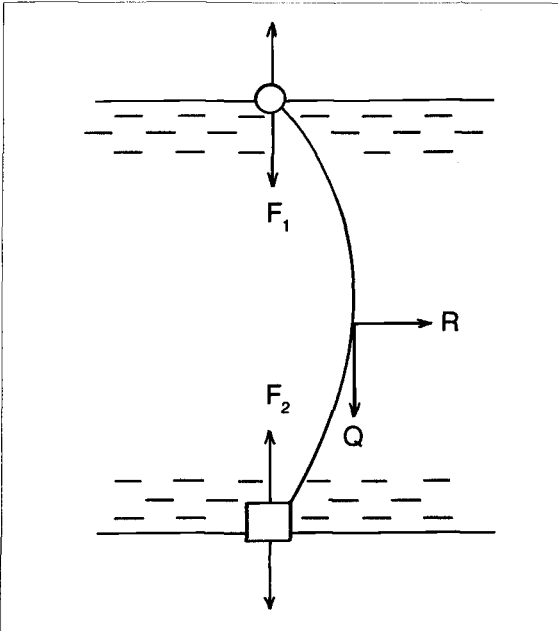

Figure 71. The applied forces on the longitudinal section of a barrier net: F_1 = sinking force, F_2 = floating force, R = resistance of net in horizontal direction, and Q = resistance of net in vertical direction.

Figure 72 can be used to calculate F_1 and F_2 based on the ratios F_1/R and F_2/R when the resistance of a barrier net is known. The values of F_1 and F_2 are the minimum floating and sinking forces required to maintain the position and shape of the barrier net. In the actual calculation of floating and sinking forces to be used, the force applied to the barrier net by weather, floating debris, and schools of fish must also be considered. As a result, additional floating and sinking forces must be included. Usually, the forces are increased by a factor of 1.5-2.

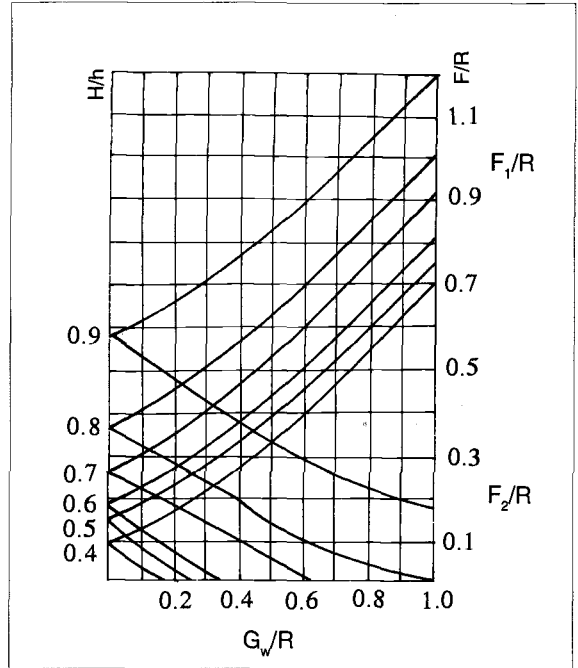

Figure 72. Correlation curves of H/h and F/R : H = water depth at site of net, h = height of barrier net, $F = F_1 + F_2$ (sinking + floating forces), and R = resistance of net in horizontal direction.

Based on the total sinking and floating forces that are calculated, the number and size of sinkers and floats can be worked out. However, it must be remembered that the combined weight of all weights, anchors, and iron chains must be included in the calculation of the sinking force.

Applied forces on the head line and foot line

• Head line. The applied force at each end of the head line can be analyzed and calculated using the theory of suspended cables (Figure 73). When the sag (f) is relatively small, the horizontal tension (T_o) of two hanging points and the tangential tension (T) can be calculated as:

$$T_o = (QL)/(8f) \quad [25]$$

$$T = \sqrt{T_o^2 + (\frac{Q}{2})^2} \quad [26]$$

where L = length of line (m), Q = component forces of line tension in the same opposite direction to the water flow, which is half the barrier net resistance ($Q = R_n/2$, kg), T_o = component force of line tension perpendicular to the direction of water flow (kg), and T = tangential tension of the symmetric applied forces (i.e., tension on the head line, kg).

• Foot line. The applied force on the foot line is usually smaller than the force on the head line. However, to simplify the design, the forces are often

assumed to be equal, and wires of the same dimension are used for both lines.

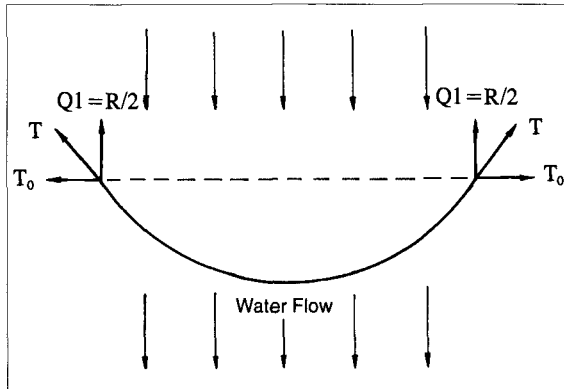

Figure 73. Applied force on head line (see text for details).

Applied forces on anchoring devices

Barrier nets are fixed in place with piles, anchors, and concrete blocks. Piles are most commonly used for barrier nets at the spillways of small reservoirs that are shallow and have slow water flow. The others are used for barrier nets in large and medium reservoirs. The anchoring devices in the water have two functions: they sustain the normal shape of a barrier net and prevent the barrier net from moving.

- Piles. The size and depth of the piles must be calculated. The size of the piles is calculated from:

$$\text{Round pile: } d = \sqrt[3]{\frac{W_{\max}}{0.1 [\sigma]}} \quad [27]$$

$$\text{Square pile: } a = \sqrt{\frac{W_{\max}}{[\sigma]}} \quad [28]$$

where d = minimum diameter of round pile (cm), a = length of side of square pile (cm), $[\sigma]$ = acceptable bending stress (kg/cm²), and W_{\max} = maximum bending moment of the pile (kg · cm).

The acceptable bending stress is the maximum stretching force or compressive force sustained per unit area of a pile. The $[\sigma]$ values of various materials are given in Table 53.

TABLE 53. The values of $[\sigma]$ for various materials

MATERIAL	ACCEPTABLE BENDING STRESS (KG/CM ²)	
	STRETCH	COMPRESSION
Pine tree	70-100	100-120
Fir tree	70	100
Tung tree	90-100	130-150
Wire	1,400	1,400
Concrete	1-7	10-90

The depth that the piles should be inserted into the reservoir bottom can be calculated from:

$$h = \cot(45^\circ + \frac{\beta}{2}) \sqrt{\frac{5R}{4dr}} \quad [29]$$

where h = insertion depth of pile into the bottom (m), R = loading on pile (kg), d = diameter of pile (cm), r = weight per volume of bottom soil (kg/m³), and β = friction angle (natural angle of reservoir bottom). The values of β and r for various types of water-saturated reservoir bottoms are given in Table 54.

TABLE 54. Values of β and r for various types of water-saturated reservoir bottoms

SOIL TYPE	β (DEGREES)	r (KG/M ³)
Muddy clay	15	1,800
Sandy silt	20	1,900
Silt clay	20	1,800
Pure sand	22	2,000
Medium and coarse sand	25	2,000
Muddy sand	25	1,900
Gravel and small stones	27	2,000

- Anchors. The barrier net is fixed in the water by the anchors, primarily based on their tractional force. The maximum traction of an anchor is calculated as:

$$H_{\max} = KG \quad [30]$$

where H_{\max} = maximum traction of the anchor (kg), G = weight of the anchor (kg), and K = coefficient of tractive resistance of the anchor (5-6 on a sandy bottom and 10-12 on a clay bottom).

In practice, the total traction of all anchors must be equal to or greater than the drag of the barrier net. Based on this principle, the weight and numbers of anchors used can be calculated according to the calculated drag of the barrier net.

- Volume of concrete weights. The weights placed in the water are made of concrete. There are usually two parts: an upper part in the shape of a truncated cone and a lower cylinder-shaped part (Figure 74). Their volume can be calculated from:

$$\text{Upper part: } V_1 = \frac{h_1}{3}(S_1 + S_2 + \sqrt{S_1 S_2}) \quad [31]$$

$$\text{Lower part: } V_2 = S_2 h_2 \quad [32]$$

where h_1 and h_2 = the partial heights of the weight (m), S_1 and S_2 = the cross-sectional areas of the upper and

lower sections (m^2), and V_1 and V_2 = the partial volumes of the upper and lower sections (m^3).

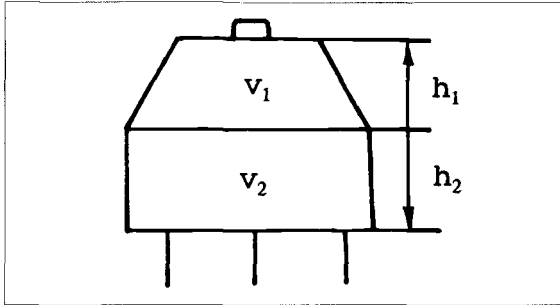

Figure 74. The concrete weights used to hold barrier nets in position.

From the weight per unit volume of concrete ($r = 2.5 \text{ t/m}^3$), the total weight can be calculated as:

$$G = (V_1 + V_2) r \quad [33]$$

where G = total weight (t). The weight and number of concrete weights depend on the design of the barrier net.

- Applied force on bank weights. Two bank weights are set in fixed points on each side of the reservoir. Their weight is determined from the applied force on these two fixed points, which equals the resultant force exerted by the head and foot lines. After the magnitude and direction of the forces on the head line and foot line have been calculated, the resultant force (T) on the bank weights can be calculated as:

$$T = \sqrt{T_h + T_f + 2T_h (T_f \cos \alpha)} \quad [34]$$

where T = the tension on bank weights (t); T_h = the tension on head line (t), T_f = the tension on foot line (t), and α = the angle between the head line and foot line.

Installation of barrier net

The art of making a barrier net includes the cutting and stitching of net panels and the installation of floats and sinkers, the cover net, and the bottom net.

Cutting and stitching of net panels

Because the topography of the bottom at the site of the barrier net is irregular, the net at the foot line must be designed to match the topography of the bottom and the slopes of the reservoir banks. Therefore, based on the cross section of the barrier site, the net panels must be cut to match the actual features of the bottom.

Each part of the barrier net is made from many small panels because the whole barrier net is too large to be made in one piece. These panels are stitched together to make the final design. To maintain the strength of the barrier net, the panels in the main net are always knitted together, and the stitching line and

mesh size are the same as used in the main net panels. If two pieces of net of different length are to be joined, they are carefully knitted together to ensure that they are joined evenly along their length.

Installation of floats and sinkers

Floats are installed on the main head line, the head line, and the bolch line for the cork line, nets, and floats. A polyethylene rope (0.23/12x3) is passed through each mesh opening in the cork line selvedge strip, and the barrier net is tied onto the head line. When the barrier net is set up, the head line is fixed to the main head line (wire) by specially made shackles set at a distance of 2 m. The final step is to attach the floats. The distance between the floats, and the number of floats, are determined from the calculations related to the design of the net (Figure 75).

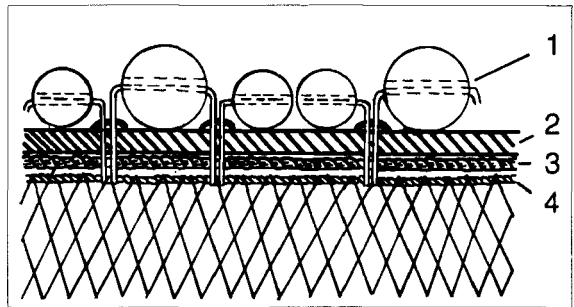

Figure 75. Installation of floats: (1) float, (2) main head line, (3) head line, and (4) bolch line.

Sinkers are installed on the main foot line, the foot line, and the bolch line for the lead line, nets, and iron chains. During installation, the foot line is first passed through all the mesh openings in the lead-line selvedge strip and the net tied onto the foot line. When the barrier net is ready for final installation, the foot line is fixed to the main foot line (wire) using specially made shackles (Figure 76). The iron chains are then tied onto the sinker line with double-strand twine. The size and weight of the iron chains are determined from the design calculations.

Installation of cover net

The cover net is made in a long strip from several pieces of net. During installation, the selvedge strips are fixed to the head line of the barrier net. Plastic floats, each with a buoyancy of 30 g, are installed every 0.75 m along the upper selvedge strips of the cover net (Figure 77).

Installation of bottom net

The bottom net is made of the same materials as the main net. During installation, two bolch lines are passed through the marginal mesh in the upper and lower selvedge strips. One line is fastened with a double-strand synthetic line (PE + PVA) (0.22/9 x 3) to the

main net, 0.5 m above the foot line. They are fixed by one knot every 0.5 m. Another bolch line is fastened to the bottom net line, and lead sinkers (0.4 kg each) are fixed between these two lines, at a distance of 0.75 m. The number of sinkers is based on the overall design of the barrier net.

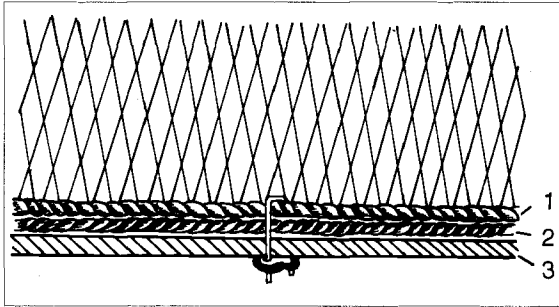

Figure 76. Installation of sinkers: (1) bolch line, (2) foot line, and (3) main foot line.

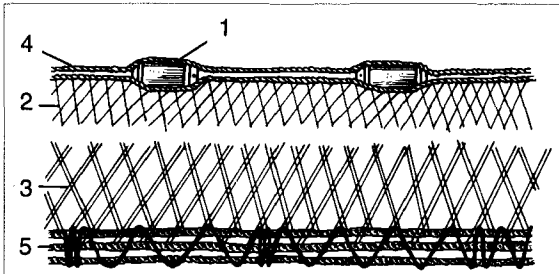

Figure 77. Installation of cover net: (1) float, (2) upper selvedge strips of cover net, (3) lower selvedge strips of cover net, (4) head line, and (5) bolch line.

Debris filter

During the rainy season, terrestrial grasses, aquatic weeds, and tree branches drift toward the sluice. Because of the way that the barrier net is constructed, it catches plenty of flotsam, which affects its filtering efficiency and can break the netting and even destroy the entire barrier net. Therefore, before the barrier net is constructed, it is important to install a debris filter.

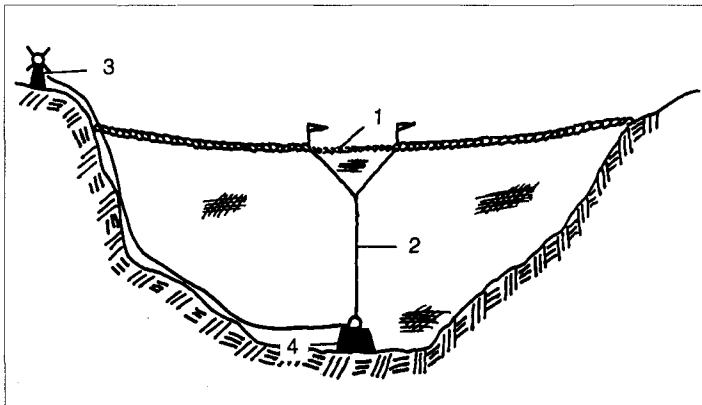

Figure 78. A boat-passing device: (1) boat passage, (2) lead rope, (3) winch, and (4) weight.

The filter usually includes a net or rope set 100-200 m upstream of the barrier net. The actual location of the filter is determined by the morphology of the reservoir and the kinds and distribution of material in the water.

The filter net is normally made of the polyethylene twine because it floats. The calculations of impounding width and netting dimension are often worked out in relation to the barrier net. However, the mesh size should be more than 100 mm and its height 1-1.5 m. A filter net is installed in the same way as a barrier net. Floats and sinkers are used to make the net hang vertically in the water, and the two ends of the net are normally fixed to the bank. If the flow rate is too high, anchors or weights are placed in the water to hold the middle portion of the net.

Boat-passing device

There is a lot of vessel traffic in reservoirs. Therefore, all barrier nets constructed on main transportation routes must include a specially designed boat-passing device. A lead rope is fixed to the head line of the barrier net. The other end of the rope is attached to a winch on the bank. The rope passes through a pulley fixed to a weight at the bottom of the reservoir (Figure 78).

When the winch is turned, the head line in the middle portion of the barrier net is pulled down by the lead rope. When the boat has passed over the barrier net, the winch is released and the head line quickly floats up and resets the net. The key to the operation of the boat-passing device is to ensure that the weight stays in its original position and operates properly. The position of the weight directly affects the capacity and traction force of the winch. Under normal conditions, the distance between the weight and the barrier net is directly proportional to the traction force needed from the winch. Therefore, the closer the weight is to the barrier net, the smaller the traction force required from the winch.

Boat-passing devices constructed in small reservoirs

or coves are simpler. Because the boats in these water bodies do not have motors and are small, it is unnecessary to install a winch on the bank and weights on the bottom. In this case, two small wooden boats (each 1-tonne capacity) are fixed on the sides of the boat-passing entrance. Each boat has a manual winch and the lead rope is tied to a stone (15-20 kg) hanging on the head line of the barrier net. Whenever a boat comes, the lead rope is loosened and the stones pull the head line down to form a boat passage. The lead rope should be lifted as soon as the boat has passed to allow the net to reset to its original position (Figure 79).

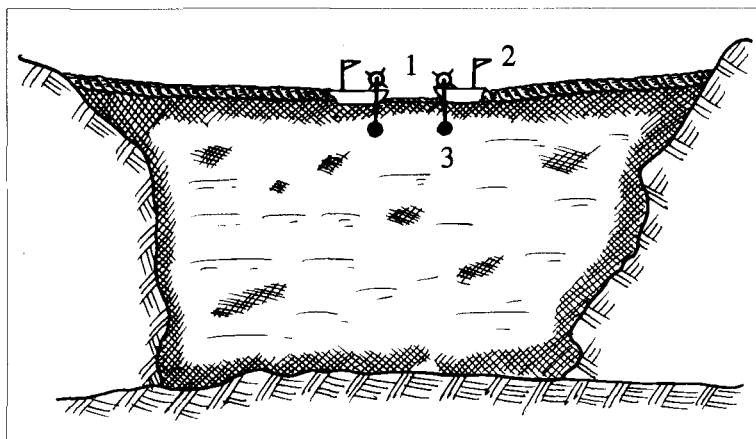

Figure 79. Simplified boat-passing device: (1) boat passage, (2) small boat, and (3) heavy stone.

Although the boat-passing device that uses a winch and a weight is quite efficient, it is difficult to repair. The linking system can only be repaired after the weight is lifted out of the water. The authors have designed a system that can be fully controlled from above the water. This double-platform electric lifting device solves the difficulty of repairing the system. The double-platform electric lifting device comprises double cylindrical platforms, an electromagnetic-brake, electric motors, and a control panel. This device has worked well in Taipingghu Reservoir. It is safe, fast, and reliable and is convenient to maintain.

Case study

Taipingghu Reservoir is a valley-type reservoir with a surface area of 2,722 km², a length of over 50 km, and a maximum width of 4 km. The average annual flow capacity is 2,770 million m³, and the water level is controlled at 117 m during the flood season. The area used for fish culture is 8,670 ha, which makes it the largest culture operation in Anhui Province. About 2 million Chinese carp fingerlings are stocked into the reservoir yearly.

Primary design features

A special large-span barrier net with several functions was designed in 1986 for Taipingghu Reservoir. The net included an impounding net, filter net, and double-platform device for passage of boats.

The main body of the barrier net is 450 m in length and 70 m in height. The net is made of synthetic material (PE+PVA) and includes various nets and several lines and chains (Table 55). The barrier net is used to block silver carp, bighead carp, and grass carp that are more than 0.5 kg in weight. The position of the barrier is fixed by the weights placed on the bottom and the bank.

The filter net is designed to catch fish and prevent their escape. It is simply built, convenient to operate,

low cost, and highly efficient (Xu 1983). This rectangular filtering net is 50 m x 20 m x 15 m. Because fish retreat against the flow of the water when they are blocked, they enter the filtering net and are caught. The fixed filter net includes a body net (including bottom netting, side-wing netting, and back-side netting), a funnel-shaped net, and a cover net (including side-cover netting, back-side netting, and funnel-shaped netting). The body net and funnel-shaped net are made of polyethylene twine (PA 210D/8x3-10x3), mesh size 80-100 mm; the remainder is made of polyethylene twine (PE 0.23/4x3), mesh size 100 mm. The opening of

the filter net should face downstream to catch retreating fish. The filter net cannot be operated during floods.

TABLE 55. Characteristics of the barrier net in Taipingghu Reservoir

Mesh size	80, 90, and 100 mm
Maximum flow rate	3,690 m ³ /s
Area of the net	16,834 m ²
Total resistance of the net (in the water)	9,165 kg
Total weight of the net (in the water)	522.9 kg
Total length of head line	439 m
Total length of foot line	475 m
Floating force	5,214 kg
Sinking force	4,765 kg
Applied force on head line and foot line	4,510 kg
Applied force on bank weights	8,883 kg
Size of each weight on bottom of reservoir	265 kg

A double-platform electric lifting device was installed. The operation platforms are two iron cylinders (1.0 m x 2.0 m) made of 2.5-mm iron plate. This design of boat-passing device has proven to be quick to operate, highly efficient, convenient to maintain, and safe (Table 56).

Efficiency

Installation of the barrier net was completed in October 1986, and the net has been in operation since then. The net efficiently blocks fish. The barrier net is about 2,000 m from the dam. In the past, more than 200 farmers fished by various means and produced several hundred thousand kilograms annually. Since construction of the barrier net, fish resources downstream

have been greatly reduced. All fishing operations were transferred upstream of the barrier net and farmers no longer fished downstream. This indicates the effectiveness of the barrier net.

TABLE 56. Parameters of the boat-passing device installed in Taipinghu Reservoir

Boat passage	30 x 3.5 m
Loading on platform (single)	1,000 kg
Hoist capacity (one)	2.2 kW
Pulling force of hoist	500 kg
Linear velocity of the hoist (on average)	12 m/min
Time needed for one operation	12 s
Maximum loading of the excess-loading protection device	800 kg
Total weight of double cylindrical platform	697.54 kg
Buoyancy calculation of double cylindrical platform	2.44 kg

The total catch from the fixed-filter net from early November to early December 1986 reached 8,000 kg, which was equivalent to the total annual production by the fishing team. More than ten species of fish, including silver carp, bighead carp, bream, common carp, grass carp, and *Erythroculter* spp., were caught, and the maximum size of the fish was 20-25 kg. The largest catch was 2,500 kg.

The boat-passing device allows easy movement of boats through the barrier net. On average, 20 boats pass through the barrier net every day. These boats include a tourist ship (320 HP), various size motorized boats, and different rafts (30-50 m in length). It only takes 12 s to operate the device.

Similar barrier nets are now operated in many Chinese reservoirs (e.g., Dongzhang, Qixi, Tuohu, Taipinghu, Qianhu, and Sifanghu Reservoirs). These nets were designed and installed by the authors. In

these reservoirs, the maximum span is 2,000 m and the maximum water depth is 70 m. Comparative data on these nets are given in Table 57.

ELECTRIC SCREENS

Electric screens were first operated in Yangmeiling Reservoir in 1966. In the late 1970s, electric screens that used pulses of electrical current were installed in the small reservoirs in the Minbei area of Fujian Province. After many years of experimentation, these pulse screens have been found to be effective, especially in reservoirs with a low flow rate.

Experiments have shown that the pulse of electricity has a greater stimulatory effect on fish. However, the duration of this effect is short after the power is shut off. In addition, the use of a pulse saves energy and minimizes the size of the power unit. These pulse electric screens are now widely adopted in small, hilly reservoirs. To date, more than 100 electric screens have been installed in China. The longest is 300 m and encloses an area of 5,800 m².

Reactions to electrical stimulation

Fish usually react when they are stimulated by an electric field. However, their reactions vary depending on the type and intensity of the electrical current, the position of the fish, and their size. The reactions of fish to electrical stimulation can be divided into three stages.

Initial reaction

The earliest response of fish to the minimum intensity of the electrical current is called the initial reaction. When the intensity of the electric field is increased, the fish are frightened and start to swim uneasily. At this stage, the fish can predict the direction of the current, and they attempt to swim to a place with a relatively low electric field. Electric screening, electric driving, and electric leading of fishes use these principles.

Directive reaction

When the intensity of the electric field is increased, the fish jump violently. In a field of direct current or direct-pulse current, fish always move to the anode

TABLE 57. Comparative data on barrier nets

RESERVOIR	CULTURE AREA (HA)	YEAR INSTALLED	BARRIER NET		AVERAGE YIELD		IMPROVEMENT
			LENGTH (M)	DEPTH (M)	BEFORE NET (KG/HA)	AFTER NET (KG/HA)	
Dongzhang	800	1983	348	34	15	225	15
Qixi	533	1984	377	32	—	—	—
Tuohu	4,000	1985	2,000	6	24	125	5.2
Taipinghu	8,670	1986	450	70	57	138	2.4
Qianhu	4,000	1987	1,900	6	22	67	3
Sifanghu	667	1987	400	6	—	—	—

(electro-taxis); whereas, in a field of alternating current, fish move to a position parallel to the electric potential to minimize electrical stimulation.

Narcotic reaction

When the intensity of the electric field is continuously increased, the fish become narcotized, stiff, and finally lose their balance and die. This reaction of the fish should be avoided during electro-fencing and driving.

Design of pulse screen

Site selection

Site selection for a pulse screen effects blocking efficiency. The average flow rate of water in the impounding section must be less than the maximum swimming velocity of the fish. Studies on the swimming speed of silver carp and bighead carp in the laboratory showed that the flow rate for large fish (over 30 cm) must be less than 0.7 m/s, and that the flow rate for small fish (over 10 cm) must be less than 0.5 m/s. The electric screen should be installed in a large area on the spillway to give the fish enough space to retreat when they are stimulated by the electric field. In this way, the blocking efficiency can be raised. In addition, the electric fence should be positioned at an angle of 40°-60° to the direction of water flow to maximize the efficiency of the electric field.

Geometrical and electrical parameters of electrode array

The pulse screen commonly used in reservoirs is Model LD-1 (Figure 80, Zhong Weiguo 1990). The electrodes are arranged vertically in a single row at different spacing and supplied with various voltages. This screen has a simple design, an extended electric field, and consumes little power; however, the enclosure efficiency of the electric field is poor. The main parameters of the electrode array are: radius (r), spacing (d),

and type of electrodes. These parameters affect the characteristics of the electric field.

Figure 80 shows the wiring connections to the electrodes of the LD-1 electric fish screen. Suitable dimensions and the electrical characteristics of this fish screen are given in Table 58. The ratio of the distance d_1 to d_2 varies with the fish species and the method of voltage division. Two types of divided voltage are used, either equal voltage on each section or unequal voltage ($V_1 = V_3 = V/4$ and $V_2 = V/2$). The ratio d_1/d_2 is shown in Table 59.

The LD-1 screen can also be used to stop fish from moving upstream, but the parameters must be changed. Table 60 shows the electrode parameters of the electric screens constructed in four reservoirs in northern Fujian Province (Zhong Weiguo 1990).

TABLE 58 Dimensions and characteristics of an LD-1 electric fish screen (Zhong Weiguo 1990)

	$D = \frac{D_1 + D_2}{2}$ (m)	TOTAL VOLTAGE (V)		
		D/r _o	AC PEAK VOLTAGE	
Small fish	1.5-2.0	50-65	220	450-600
Large fish	2.0-2.5	65-80	220	600-800

TABLE 59. Ratio of d_1 to d_2 for different voltage types (Zhong Weiguo 1990)

	EQUAL SECTION VOLTAGE	UNEQUAL SECTION VOLTAGE
Small fish	1.20-1.35	0.83-0.74
Large fish	1.35-1.50	0.74-0.67

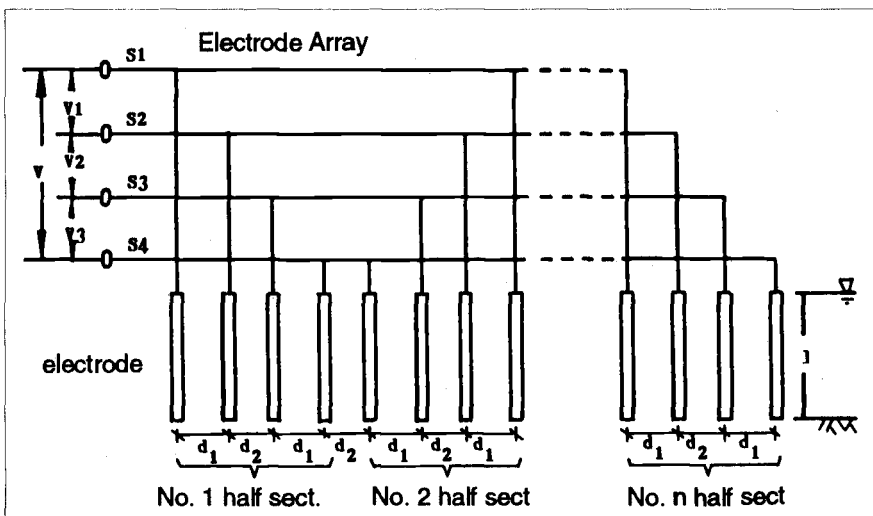

Figure 80. Configuration of the electrode array of an LD-1 electric fish screen ($V =$ total voltage, $V_{1-3} =$ voltage between electrodes).

TABLE 60. Parameters of electric screens constructed in four reservoirs in northern Fujian Province

RESERVOIR	SPACING (D) (CM)	RADIUS OF ELECTRODE (R) (CM)	D/R	REMARKS
Dingxi	300	7	85.5	For blocking large fish
Dongfeng	290	7.8	74.3	For blocking large fish
Guanting	150	5	60	For blocking small fish
Qingqiao	150	5	60	For blocking small fish

Construction of LD-1 electric screen

Three forms of the LD-1 electric screen have been designed for the varied conditions in reservoirs.

Insert type

The construction of the insert type is very simple. It is ready for use after each electrode is inserted into a hole in a base block. It is well suited to shallow water, and is easy to construct when the bottom is dry. The base blocks should be heavy enough to support the electrodes and prevent them from being turned over. The electrode array should be located at the funnel area of the spillway to make it easy for the fish to turn back.

Slanted-strut type

An array of slanted struts is usually set on the inner lip of the reservoir dam where water flows out. The cost of this system is lower than the insert type of array.

Hanging type

The insert and slanted-strut screens are not suitable for some large reservoirs because the flow rate of the water is high and the water is too deep. In the hanging screen, two wires are suspended across the spillway. The main top wire bears the total load of the electrode array and is suspended from piers on the bank or from land anchors on mountain slopes. The lower wire is held in a horizontal position by vertical bridles and uniformly separates the electrodes. The lower end of each electrode is tied to a heavy weight laid on the bottom. The weight prevents movement due to water flow and holds the electrode in the proper position. To reduce the load and total quantity of

material, and to ease construction, each electrode is made of several steel pipes (0.5 m long, 0.5 m apart) (Figure 81). The length of the electrode is determined by the depth at which the fish swim. A length of 15 m has been found to be sufficient to reach bottom fish. The screen must be carefully designed to ensure safety because the hanging screens are large, costly, and very heavy. The longest hanging screen in China is 300 m in length and reaches a maximum depth of nearly 50 m. Its maximum discharge capacity is about 1,500 m³/s and its blocking cross section is 5,800 m².

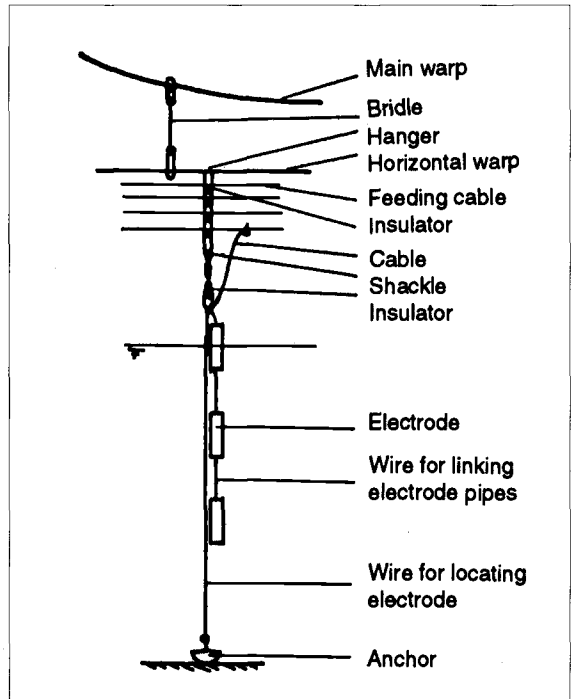

Figure 81. Construction details of a hanging electric screen (Zhong Weiguo 1990).

Operating experience

Fish have been observed jumping, turning back, and swimming away at a distance of 3-5 m from a screen during its operation. Sometimes large schools of fish have been blocked, and they were observed to swim in front of the screen for about 10 h. In medium and small reservoirs, fish have not been observed to escape after an electric fence has been installed. However, in large reservoirs, some fish stay in the gaps between the screen and the dam and are lost when the gates are opened. Electric fish screens are a powerful tool to prevent fish losses and to advance the development of reservoir fisheries. There have been some accidents with large-scale electric fish screens; therefore, management, maintenance, design, construction, staff training, and development are very important.

Harvesting Pelagic Fish Species

Chinese reservoirs are primarily stocked with silver carp and bighead carp; therefore, harvest methods for these species are pivotal to the development of reservoir fisheries in China. Since the late 1960s, seines and trawl nets have been operated in reservoirs. A fishing method that combines blocking, driving, gill-netting, and seining has been developed based on an understanding of the habits of silver carp and bighead carp. This technology has, to some extent, solved the technical problems of harvesting pelagic species and has laid the foundation for the further development of reservoir fisheries.

MIGRATION HABITS OF SILVER CARP AND BIGHEAD CARP

Like most other species stocked in reservoirs, silver carp and bighead carp school. However, their movements vary depending on the developmental stage of the fish and on environmental conditions. Annual movements of silver carp and bighead carp can be classified into the three types of migration: spawning, overwintering, and feeding. An understanding of the migration behaviour of fish schools helps locate suitable fishing grounds.

Silver carp and bighead carp naturally reach maturity in some reservoirs. In May or June, a large number of brooders, which are stimulated by the increasing water level and runoff, migrate upstream and spawn in groups in shallow areas. These are good fishing grounds. In addition, the brooders sometimes aggregate adjacent to the outlets of irrigation channels that have a slight water flow. These locations also present good opportunities for harvests.

Water temperature is an important environmental factor that stimulates overwintering migration of fish. The optimum water temperature for silver carp and bighead carp is between 12 and 30°C; below 12°C, the fish are ready to overwinter. Under normal conditions, they do not feed until spring. During the overwintering period, silver carp and bighead carp usually inhabit deeper water and become sluggish. Therefore, the efficiency of harvesting is low because the fish are less sensitive to the operation of fishing nets, particularly in larger and deeper reservoirs. However, in some medium and small reservoirs that have flat bottoms, harvest occurs principally in the winter.

Under normal conditions, silver carp and bighead carp overwinter from January to March. During the remainder of the year, they feed heavily and always aggregate in groups to feed in places where plankton are abundant. These locations are good fishing grounds.

JOINT FISHING METHOD

The joint fishing method, which combines blocking, driving, gill netting, and seining, is a large-scale operation used specifically to catch silver carp and bighead carp. This fishing method was developed in the mid-1960s and has been constantly improved. It is now widely applied in most of the large and medium reservoirs in China.

Principles and practice

The joint fishing method is a large-scale operation that uses three or more types of fishing gear. The fish are first blocked and then chased into a fixed filter net for harvesting.

The method has several operational characteristics:

- Several types of fishing gear are jointly operated in the same water body. In this way, the fishing gear can be used for different functions and passive fishing gear can be turned into active gear. The joint fishing method can be applied and adapted to reservoirs with complicated bottom topography, large surface areas, and scattered fish populations.

- In actual operation, the blocking and driving operations are conducted simultaneously with capture so that all of the silver carp and bighead carp are forced to aggregate in a certain place and are caught. The joint fishing method is such a large-scale operation that it can be used for a fishing area ranging from a hundred to thousands of hectares.

- The joint fishing method also captures some grass carp, bream, *Elopichthys bambusa*, and *Erythroculter* spp. Moreover, some bottom fishes, such as common carp and crucian carp, can also be harvested using this method.

- Because it is a large-scale operation, the method involves a lot of gear, boats, and labour and investment is high. It is used in large and medium reservoirs.

Types of fishing gear

The joint fishing method uses several types of fishing gear.

Driving gear

The driving gear includes the net- and non-net driving gear. They give the best results when they are used jointly; however, they can be used separately.

- Net-driving gear. Net-driving gear is mostly gill nets, such as trammel nets, frame gill nets, and simple gill nets. But, beach seines are sometimes used to drive fish in shallow, flat-bottom lacustrine reservoirs. The

trammel net is used mainly to drive the fish schools. The frame gill net and simple gill net are the most common fishing gear for capture, but are not popular for driving operations. When operated in combination with trammel nets, the driving effect is greatly increased and other species can also be caught.

- Non-net driving gear. The commonly used devices include white boards, air curtains, and electricity. White boards tied to ropes are towed by a motor boat back and forth in the fishing ground to drive the fish. This is the simplest of the non-net driving gear. The white boards are made of wood and are 400 mm x 50 mm x 5 mm in size. The white boards are tied at a distance of 1-1.5 m to a manila rope that is 18-20 mm in diameter (Figure 82). An iron, lead, or stone weight (3-5 kg) is attached to the end of the rope. The fish are driven in a given direction by the swaying white boards. The results are best when the fish are driven from shallow to deep water. When the boat is driven 200-500 m, the area should be blocked with an impounding net to prevent the return of the fish.

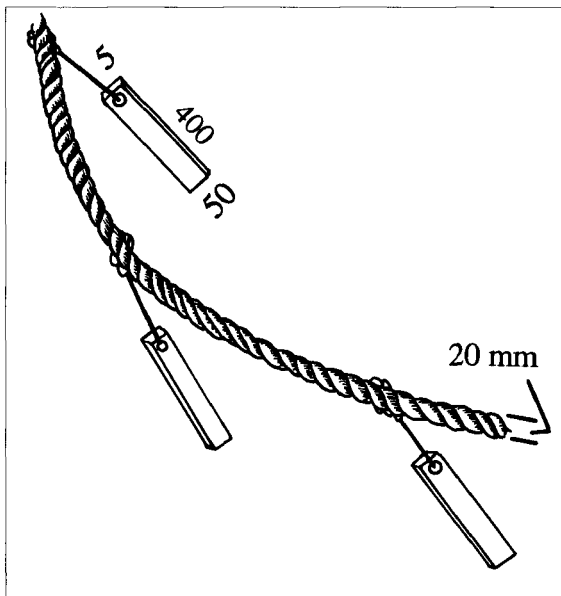

Figure 82. Structure of the white boards (not to scale).

A compressor is used to introduce air into the water through several tubes to form an air curtain. The fish are frightened by the bubble sound and low frequency oscillations and move rapidly in the desired direction. This device includes an engine-driven compressor that forces compressed air into a steel manifold (8 m in length and 20 cm in diameter) and then through nine rubber pipes (8 mm in diameter). The rubber pipes are held in place with wire and weighted with iron sinkers. The rubber pipes should be 3-5 m longer than the water depth of the fishing ground to ensure that all pipes reach the bottom during the operation (Figure 83).

Electricity can also be used to drive fish. Fish are forced by the electric field to move rapidly toward the planned harvest area. Compared with net driving, electricity requires less investment and labour. However, its effect is not as predictable as other methods, particularly in large reservoirs. Therefore, electric driving is operated in combination with netting. This method requires further improvement.

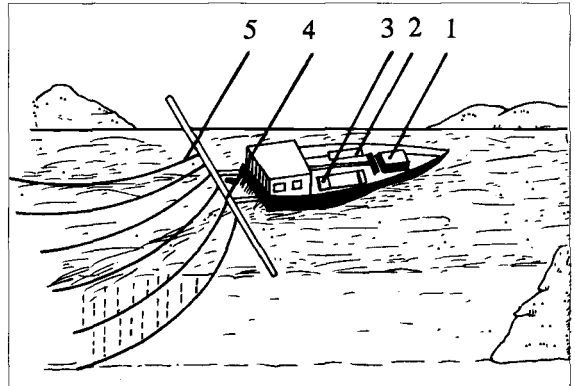

Figure 83. Operation of the air curtain: (1) engine, (2) air compressor, (3) air receiver, (4) steel manifold, and (5) rubber pipe.

Blocking net

This is one of the main fishing devices used in joint fishing. It has several functions. At the start of the harvest, all escape routes are blocked with blocking nets to form an enclosure. Blocking nets are usually set in combination with trammel nets and other fishing gear to force the fish to aggregate in the enclosure. When blocking nets are accompanied by fixed filter nets, they can prevent fish from returning and guide the fish toward the fixed filter net where they are caught. If the mesh size and twine diameter of the net are designed to suit the morphology of *Elopichthys bambusa*, the net can be used to block fish and to eliminate predators.

Fixed filter net

In the joint fishing method, the fixed filter net is the final chamber used to harvest the fish. It is usually set at a specific location on the fishing ground. The fish are driven by the trammel nets, blocking nets, and other fishing gear and are forced to the filter net for harvesting.

Design and installation of principal fishing gear

Blocking net

This net is ribbon-shaped and made of a single layer of netting (Figure 84).

- Mesh size. The mesh size of the blocking net should not allow harvest-size silver carp and bighead carp to pass through. For example, the minimum harvest size of these two species is set at 2.5 kg in

Xinanjiang Reservoir. The mesh size of a gill net needed to capture such fish is 120-140 mm; therefore, the optimal mesh size of the blocking net would be about 100-120 mm. The entanglement of fish in the mesh of the blocking net should be avoided to improve fishing efficiency.

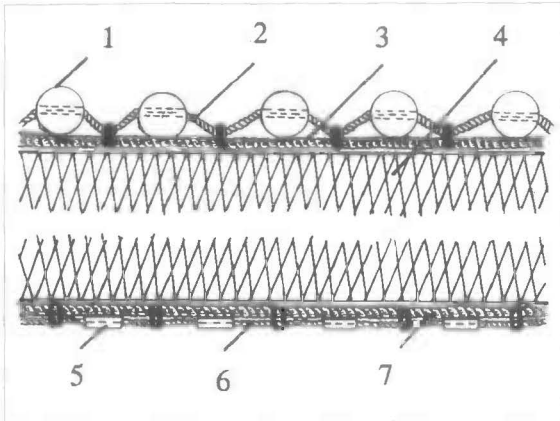

Figure 84. Structure of a blocking net: (1) float, (2) cork line, (3) head line, (4) netting, (5) sinker, (6) lead line, and (7) foot line.

- **Twine materials.** The twine materials must have enough strength to withstand various external forces, prolong their use, and increase their efficiency. Polyamide twine (210^D/6x3, D = denier) and polyethylene twine (0.23/6x3) are both used to make the blocking nets; however, because of its lower cost, polyethylene twine is most commonly used.

- **Hanging coefficient.** The acceptable horizontal and vertical hanging coefficients of blocking nets operated in reservoirs are: $E_1 = 0.60-0.65$ and $E_2 = 0.76-0.80$, respectively.

- **Height and length.** The height of the blocking net depends on the water depth in the fishing ground. Generally, the net should be designed to easily reach from the water surface to the reservoir bottom. The height of the blocking net must be adjusted to match the water depth. In commercial operations, a main net is used in conjunction with auxiliary nets of different heights to match the average and maximum water depths. For example, the maximum water depth in Dongzhang Reservoir is 32 m (near the dam), the average depth is 15 m, and the depth upstream is only several metres. Based on these conditions, the main and auxiliary blocking nets are designed with different dimensions. The height of the main net is 20 m, which is a little larger than the average water depth, and the auxiliary blocking net is used to supplement the main one. In the deeper waters, they are operated jointly; whereas, in coves and other shallow waters, the auxiliary net can be used independently. The heights of the two auxiliary nets are 10 m and 15 m.

- The length of a blocking net is dictated by the maximum width of the fishing ground. At least three

pieces of netting are normally used. Each piece consists of many sections, and each section is usually 50 m long. For very large operations, several dozen sections of netting are joined.

- **Buoyancy and sinking forces.** The blocking net must have a certain buoyancy and sinking force to ensure net stability. These forces are normally calculated with reference to a set gill net. However, higher coefficients of both buoyancy and sinking force are adopted. The buoyancy of a polyamide blocking net should be 0.60-0.65 times the total weight of the net in the air, and the sinking force should be 1-1.2 times the buoyancy of the floats. The buoyancy of a polyethylene blocking net is usually designed to be 0.55-0.70 times the total weight of the net in the air, and the sinking force is 1.2-1.5 times the buoyancy. The blocking net is supported by PVC foam plastic floats with buoyancy of 300-400 g per float. The drum-shaped ceramic sinkers that are normally used have a weight of 50-100 g per sinker.

- **Lines.** The blocking net consists of a head line, foot line, cork line, lead line, and breast line. Polyethylene rope (6-7 mm diameter) or palm rope (8-9 mm diameter) is commonly used. Because most reservoirs have uneven bottoms, the foot line sometimes does not fit well and some fish escape. To prevent the escape of fish under the foot line, the length of the foot line should be 5-10% longer than the head line.

- **Installation.** Blocking nets are installed in a similar way to gill nets.

Trammel net

A trammel net is a special type of gill net. It has two wide-meshed outer nets and one fine-meshed inner net. All three nets are fixed to the head and foot lines. The outer nets are made of thick twine, and the inner net is made of thin twine. The hanging coefficient of the outer netting is $E_1^2 + E_2^2 = 1$ and of the inner webbing $E_1^2 + E_2^2 < 1$. The structure of a trammel net is illustrated in Figure 85.

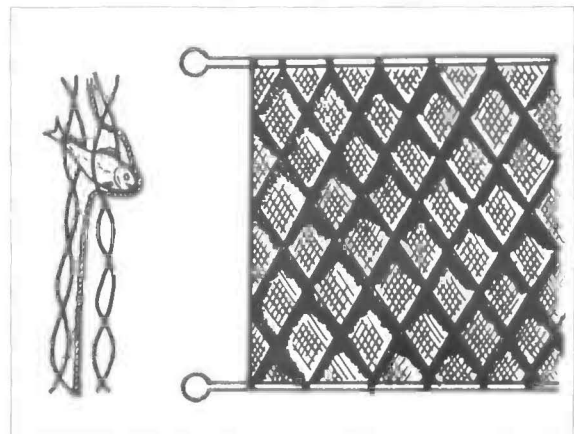

Figure 85. Structure of a trammel net.

• Mesh size. The mesh size of the inner net is 10-20% smaller than the mesh size of a gill net used to catch fish of the same size. The correlation between the mesh size of the trammel net and the average body length and weight of the fish to be harvested can be calculated as:

$$a = K_1 L \quad [35]$$

or

$$a = K_2 \sqrt[3]{G} \quad [36]$$

where a = bar length of gill net (mm), L = average body length of fish (mm), G = average body weight of fish (g), K_1 = coefficient of fish body shape (Table 62), and K_2 = coefficient of fish body weight (Table 62).

TABLE 62. Coefficients of body shape and weight of freshwater fishes^a

SPECIES	K_1	K_2
Black carp	0.126-0.128	5.00-5.30
Grass carp	0.120-0.127	4.80-5.30
Silver carp	0.152-0.170	5.50-6.31
Bighead carp	0.163-0.180	5.80-6.46
Common carp	0.150-0.160	5.40-6.10
Crucian carp	0.160-0.180	6.10-6.60
Perch	0.130	
Wuchang fish	0.143-0.145	
<i>Elopichthys bambusa</i>		4.30-5.00
Trout	0.350	

^a This table is adapted from information from the Shanghai Fisheries University, the Fujian Provincial Fisheries Research Institute, the Hunan Provincial Fisheries Research Institute, and from other information from outside China.

• The mesh size of the outer net depends mainly on practical experience. However, the mesh sizes of both the outer and inner nets must be properly matched. If they are not in the correct proportion, efficiency of

the net is reduced, fewer fish species are caught, and yield is decreased. Usually, the mesh size of the outer net is about five times larger than the mesh size of the inner net. A mesh of 400-700 mm for the outer net and 80-140 mm for the inner net is commonly used.

• Twine material. The trammel net is usually made of polyamide-twist twine or polyamide filament. These two materials have good fishing efficiency, but different characteristics. For example, a trammel net made from twist twine has a small volume, is easy to operate, and lasts longer (about 5 years), but it easily catches drifting material, which increases its resistance and affects operations. A trammel net made of filament has a better capture rate, faster stretching of the mesh, and little resistance in the water, but it is large in volume, inconvenient to store, and lasts only 1-2 years.

• The capture efficiency of a trammel net is directly affected by the thickness of the twine. The catching efficiency of the net, therefore, can be maximized by appropriate selection of twine thickness. The most important parameter of a trammel net is the ratio of twine diameter (d) to mesh size (a). Acceptable d/a ratios of trammel nets are given in Table 63.

• Hanging coefficient. According to the theory of gill nets, the optimal hanging coefficient gives a geometric shape to the mesh that is similar to the cross section of the fish to be caught. The hanging coefficient of a gill net is calculated as (Figure 86):

$$E_1 = \frac{n}{\sqrt{m^2 + n^2}} \quad [37]$$

where E_1 = horizontal hanging coefficient, n = sectional width of body of fish to be entangled (m), and m = sectional height of body of fish to be entangled (m).

The fishing principle of the trammel net is to catch fish by entanglement. To have sufficient netting to create a small bag, the horizontal hanging and vertical hanging coefficients of the inner netting should be 10-25% smaller than the theoretical hanging coefficients of a gill net. The correlation and common ranges of these two hanging coefficients are: inner webbing $E_1^2 +$

TABLE 63. Acceptable d/a ratios of trammel nets made of two types of polyamide (PA)^a

TYPE	MATERIAL AND DIMENSION	MESH SIZE (MM)	TWINE DIAMETER (MM)	RATIO (D/A)
Large mesh	PA 210 ^P /7x3	400-500	0.98	0.008-0.01
Small mesh	PA 210 ^P /2x3	80-120	0.47	0.004-0.005
Large mesh	PA filament	400-500	0.15-0.25	0.002-0.003
Small mesh	PA filament	80-120	0.50-0.55	0.004-0.006

^a All data adapted from Shanghai Fisheries University.

$E_2^2 < 1$ ($E_1/E_2 = 0.35-0.40/0.60-0.70$) and outer webbing
 $E_1^2 + E_2^2 = 1$ ($E_1/E_2 = 0.50-0.60/0.80-0.87$).

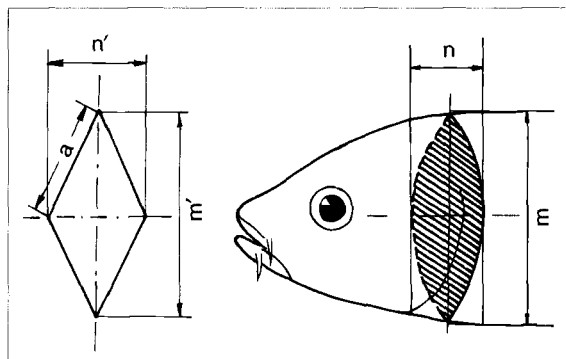

Figure 86. Cross section of body of fish to be entangled compared with size of mesh: n' = width of mesh with fixed horizontal and vertical hanging coefficients, m' = height of mesh with fixed horizontal and vertical hanging coefficients, n = sectional width of body of fish to be entangled, m = sectional height of body of fish to be entangled, and a = bar.

Because the inner nets have smaller hanging coefficients, the area of the inner net is 1/3-1/2 times larger than the outer net. Empirical analysis shows that the optimal value of the ratio of the inner to the outer net is 1.5-1.8. The fabricated ratio of the net is the product of stretched length times stretched width.

- Length and height. The length of the trammel net depends on the size of the fishing area. However, the ease of handling, installation, and maintenance must

be considered when determining the length of the net. In commercial production, each piece of netting is usually 50 m. The height of the net depends on the depth of the water and depth of the layer of water inhabited by the silver carp and bighead carp. Research has shown that the capture rate was 37% at a water depth of less than 5 m, 50% at a depth of 5-10 m, and 13% at a depth of more than 10 m. These data indicate that silver carp and bighead carp prefer to live in the water that is less than 20 m deep. Therefore, the trammel net is usually designed to be no more than 12 m in height. Dimensions of typical trammel nets are given in Table 64.

Fixed filter net

Fixed filter nets are made of several nets of different sizes and are installed with ropes, floats, sinkers, and other accessories. Fixed filter nets look like a dustpan and they are sometimes known as dustpan filter nets (Figure 87). The fixed filter net consists of a leader (funnel-shaped net), cage body (including bottom, back-wall, and side-wall nets), and cover net. However, these nets have been modified in some areas by expanding the leading net and adding a flapper net to prevent fish from escaping and to continuously lead the fish into the filter net. The inner funnel-shaped net is not fixed to the bottom net. It is attached using a triangular-shaped net, which provides an elevated floor to the funnel. In some other areas, the back-wall net has an opening that leads to a round harvesting chamber (15-20 m long) to reduce the damage caused by the fish to the cage walls. It is also easier to catch the fish in the

TABLE 64. Materials and dimensions of the trammel nets operated in Longwanshan and Guanchang Reservoirs

NETTING	MATERIAL AND DIMENSION	MESH SIZE (MM)	E_1/E_2	NET SIZE (MESH)		NET SIZE AFTER HANGING (M)		NO. OF PIECES	TOTAL WT. (KG)
				L	W	L	H		
1. Large Mesh	PA filament d=0.50 mm	500	0.6/0.8	166	20	50	8	2	1.70
Small Mesh	PA filament d=0.25 mm	120	0.35/0.6	1,190	111	50	8	1	4.1
2. Large Mesh	PA filament d=0.55 mm	500	0.6/0.8	166	15	50	6	2	1.51
Small Mesh	PA filament d=0.30 mm	120	0.35/0.6	1,190	84	50	6	1	2
3. Large Mesh	PA twine 210 ^P /7x3	500	0.6/0.8	166	15	50	6	2	3
Small Mesh	PA twine 210 ^P /3x2	120	0.35/0.6	1,190	84	50	6	1	3.81

Note: PA polyamide, L length, W width, and H height.

harvesting chamber. There are many types of fixed filter nets, but they can be classified into three types.

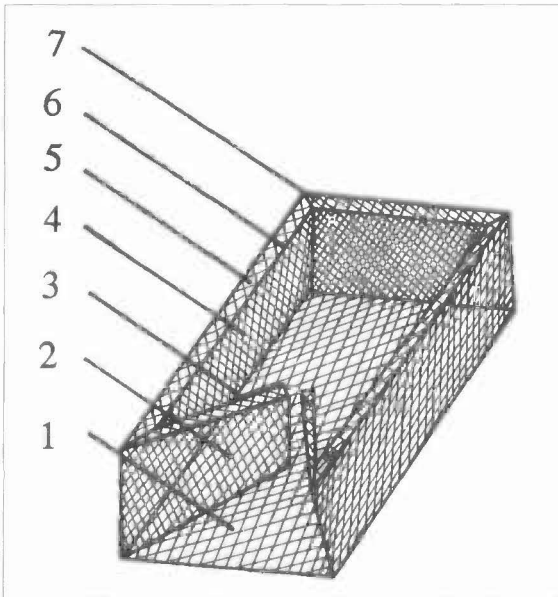

Figure 87. Structure of a fixed filter net: (1) bottom net, (2) funnel-shaped net, (3) funnel-shaped cover net, (4) side-wall cover net, (5) side-wall net, (6) back-wall net, and (7) back-wall cover net.

- Rectangular fixed filter nets. These are the most common and have a rectangular bottom (Figure 88). Compared with the other filter nets, they have a simple structure, are easy to install, and convenient to operate. The materials used in a rectangular fixed filter net are described in Table 65.

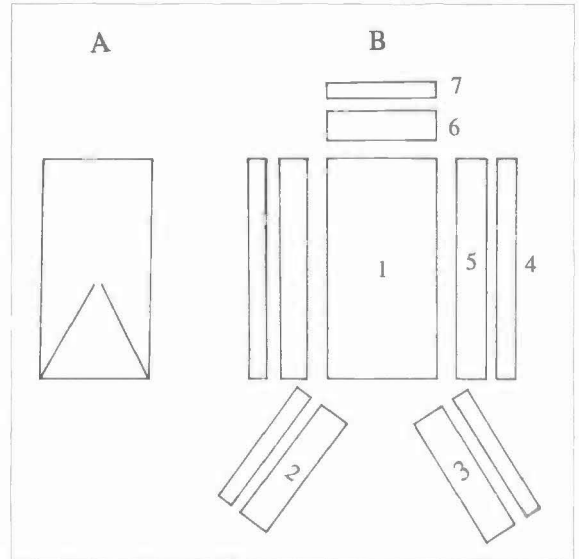

Figure 88. Structure of a rectangular fixed filter net: (A) plan view, (B) schematic drawing of netting, (1) bottom net, (2) funnel-shaped net, (3) cover net for funnel, (4) side-wall cover net, (5) side-wall net, (6) back-wall net, and (7) back-wall cover net.

- Trapezoidal fixed filter net. The cage body is made from a bottom net, two side-wall nets, and a cover net. Both the bottom and cover nets are the shape of an isosceles trapezoid. The materials used for all nets are the same, but the mesh sizes are different. The funnel-shaped net includes both an inner and outer net. The inner net extends inside the cage body and is called a non-return net. The flapper net is made from a trapezoidal net; whereas, the cod end is a rectangular cage connected to the back-wall net (Figure 89).

TABLE 65. Materials and dimensions of rectangular fixed filter net (24 m x 45 m x 16 m) designed by the authors

NETTING	MATERIAL	HANGING COEFFICIENT		MESH SIZE (MM)	LENGTH (M)			HEIGHT (M)			WEIGHT (KG)
		E ₁	E ₂		L ₀	L	N (MESH)	H ₀	H	M (MESH)	
Bottom	Nylon 210 ^P /9x3	0.75	0.50	120	60	45	500	48	24	400	41
Side-wall	Nylon 210 ^P /9x3	0.75	front 0.53 back 0.87	120	60	45	500	30	front 16 back 26.1	250	52
Back-wall	Nylon 210 ^P /12x3	0.375	0.81	80	64	24	800	32	25.9	400	65
Funnel-shaped	Nylon 210 ^P /9x3	0.638	0.81	100	40	25.5	400	20	16	200	30
Side cover	PE 0.24/4x3	0.75	0.80	100	60	45	600	2	1.6	20	3.1
Back cover	PE 0.24/4x3	0.60	0.80	100	40	24	400	2	1.6	20	1.1

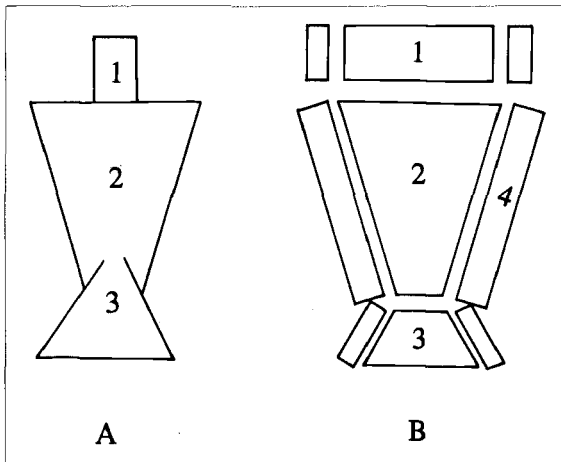

Figure 89. Structure of a trapezoidal fixed filter net: (A) plan view, (1) cod end, (2) cage body, and (3) flapper; (B) schematic drawing, (1) cod end, (2) back-wall net, (3) bottom net, and (4) side-wall net.

- Rhombus fixed filter net. This net has the same basic components as the other nets (Figure 90).

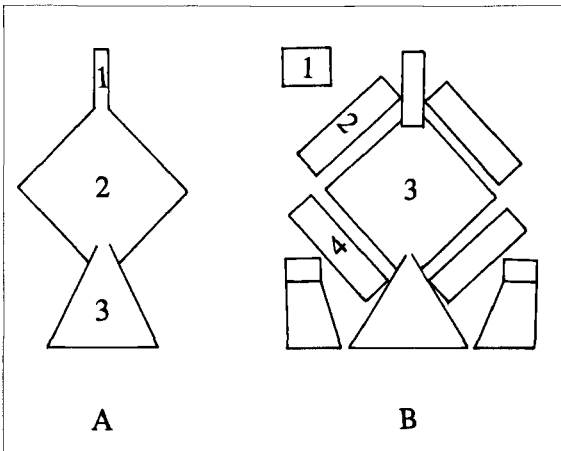

Figure 90. Structure of a rhombus fixed filter net: (A) plan view, (1) cod end, (2) cage body, and (3) flapper; (B) schematic drawing, (1) cod end, (2) back-wall net, (3) bottom net, and (4) front-wall net.

Dimensions of nets

The dimensions of the nets used for the various components are determined by the reservoir topography, depth of fishing area, and the population density and habitat preferences of the fish. Attention must also be paid to the convenience of both transportation and installation. The overall size of the fixed filter net varies with the particular conditions in different reservoirs. For example, year-round fishing is possible in large reservoirs where there are more fishing grounds and the water level is variable. Therefore, the dimensions of the fixed filter net should be adjusted to match

local conditions. In small reservoirs, large-scale fishing is only performed several times a year. Because the locations for the fixed filter nets are more or less the same and fluctuations in water level are small, specific fixed filter nets can be used for commercial production. The dimensions of the various component parts are reviewed in this section.

- Bottom net. Length and width are the primary parameters. In practice, the optimal ratio between length and width of the bottom net is 2:1. For example, if the water is deeper than 30 m in the fishing ground, the acceptable length should be 80 m and the width 40 m. If the water depth is about 20 m in depth, the length should be 40 m and the width 20 m. In huge reservoirs where fish populations are abundant (200,000-300,000 kg fish/haul), the capacity of the fixed filter net must be increased, and the ratio between length and width should be 3:1. For example, the largest fixed filter net in Xinanjiang Reservoir is 90 m long and 30 m wide.

- Side-wall net. The length of the side-wall net is equal to the length of the bottom net, and its height is equal to the overall height of the fixed filter net. Practice has shown that silver carp and bighead carp populations live mostly in water up to 20 m deep; therefore, the height of the side-wall net should be less than 20 m. The correlation between the dimensions of the fixed filter net and the water depth of the fishing ground is shown in Table 66.

- Back-wall net. When there is no attached cod end, the back-wall net is the final location for the fish caught in the net. When the fish are harvested, they struggle and create a large force on the back-wall net; therefore, the twine must be thick enough to tolerate this additional force. The net must also be strong enough to hold the maximum catch in one haul. The length of the back-wall net equals the width of the bottom net and its height is equal to the height of the side-wall nets. In practice, the length and height of the back-wall net are usually both designed to be somewhat larger.

- Funnel-shaped net (or leader). This net is both the inlet to the net and a guide that leads the fish into the fixed filter net. Practical experience has shown that the dimensions, design, and installation of the funnel-shaped net directly affect catching efficiency. Its height after installation is equal to the height of the side-wall net. Its length and the angle between the two panels (2θ) are closely related to the length of the bottom and side-wall nets (Figure 91).

In Figure 91, the angle (θ) is the angle between the side panels of the funnel-shaped net and the direction that the fish enter the cage net. Whenever the position of the funnel-shaped net is changed, the angle θ changes, which directly affects the leading efficiency of the net. To determine the best angle for the funnel-shaped net, comparative experiments were conducted at four positions (Figure 92).

TABLE 66. Correlation between the dimensions of a fixed filter net and the water depth of the fishing ground

RESERVOIR	WATER DEPTH AT OPERATION (M)	DIMENSION OF BOTTOM NET		HEIGHT OF SIDE-WALL NET (M)	
		LENGTH (M) L	WIDTH (M) W	H	L:W:H
Medium and large reservoirs	20	40	20	10	4:2:1
	30	80	40	20	4:2:1
Xinanjiang Reservoir	20	60	20	10	6:2:1
	30	90	30	20	9:3:2

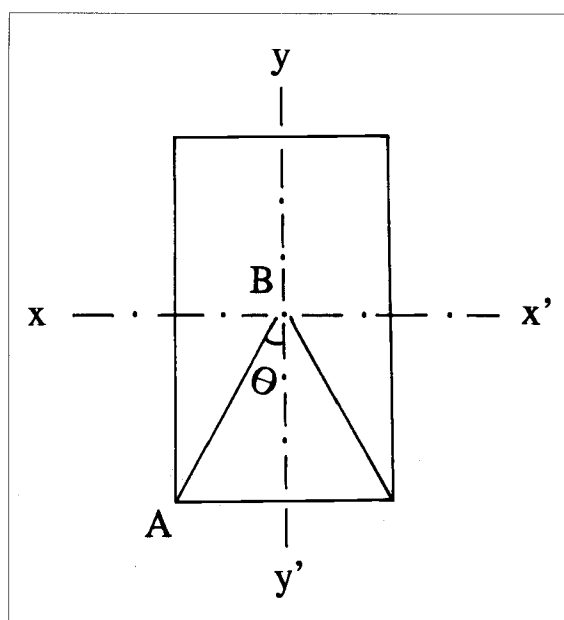

Figure 91. Plan view of a fixed filter net (θ = angle between the side panels of the funnel-shaped net and the direction the fish enter the net).

When $\theta = 90^\circ$, the funnel-shaped net is at a right angle to the path of the fish. In this case, most of the fish turn back soon after they reach the net, and only a few fish enter the cage. When $\theta = 60^\circ$, the number of fish entering the cage is increased remarkably and the number of fish that turn back is considerably reduced. When $\theta = 30^\circ$, most of the fish move naturally into the cage and few turn back. When $\theta = 0^\circ$, the walls of the funnel are parallel. In this case, they do not guide the fish.

These experiments showed that the angle $2\theta = 60^\circ$ is best. If the angle is too small, the length of the funnel-shaped net is considerably increased and the amount of netting inside the cage body becomes excessive. This reduces the effective volume of the cage body. As a result, an angle of $50\text{--}60^\circ$ is usually chosen as the

range of 2θ in the fixed filter net. It can be extrapolated that the length of the funnel-shaped net is about half the length of the bottom net. The length of the funnel-shaped net can be calculated from:

$$AB = \sqrt{BC^2 + AC^2} \quad [38]$$

where AB = length of the funnel-shaped net after installation, BC = half the width of the bottom net after installation, and AC = half the length of the bottom net after installation.

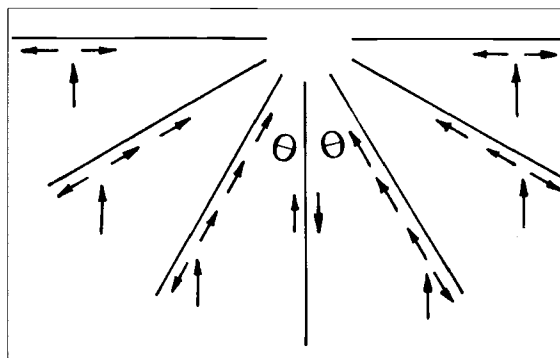

Figure 92. Optimal angle for the funnel-shaped net.

When the ratio between the length and width of a fixed filter net is 2:1, the length of the funnel-shaped net must be designed on the basis of these conditions: the length of the funnel-shaped net is about half of the length of the bottom net after installation, the angle (2θ) between the two side panels of the funnel should be $50\text{--}60^\circ$, and after the angle θ is determined, the length and width of the bottom net after installation can be calculated.

• Cover net. After they enter the cage, silver carp and bighead carp always swim back and forth along the sides of the nets and try to escape. Therefore, it is necessary to put a cover net on the side-wall nets and funnel-shaped net to prevent escape. The length of the cover net is equal to the length or width of the side-

wall net, back-wall net, and the funnel-shaped net; the width is 1.5-2 m. In some areas of Hunan Province, the cage body is covered with a large cover net that is the same size as the bottom net. Although this effectively prevents fish escape, it takes more material and considerably increases the cost.

• **Flapper.** The main function of the flapper (Figure 93) is to prevent, during hauling, the escape of fish that aggregate at the inlet of the fixed filter net. The flapper also gives better fishing results when the water is deeper than the height of the fixed filter net. The length and width of the flapper are calculated as:

Length (see Figure 93):

$$\sin \alpha = (H' - H)/l \quad [39]$$

$$\text{or } l = (H' - H)/\sin \alpha \quad [40]$$

where l = length of the flapper (m), H = height of the fixed filter net (m), H' = maximum operational depth of the fixed filter net (adjustable water depth of the entrance net) (m), and α = angle between the flapper and the horizontal plane (acceptable = 30°).

Width (see Figure 93):

The flapper is a trapezoid. The width of the top is the same as the width of the fixed filter net, but the width of the bottom is calculated as:

$$b' = \frac{2l}{\tan \beta} + b \quad [41]$$

where b' = bottom width of flapper (m), b = top width of flapper (m), and β = the angle between the side line and the bottom line (when $2\theta = 60^\circ$, $\beta = 60^\circ$).

Mesh size, twine thickness, and hanging coefficient

All the netting in the fixed filter net is made from polyamide twine because it has a high specific gravity and sinks in the water. A fixed filter net made from polyamide twine can be easily stretched and maintains its shape well. Sometimes, the wall and funnel-shaped nets are made of polyethylene to reduce costs or because of a shortage of polyamide. In this case, the capture efficiency may be reduced. The bottom net cannot be made of polyethylene twine because it floats.

Mesh size and twine thickness vary from place to place. However, the determination of mesh size (a_g) should be based on the principle that the mesh should be smaller than the mesh (a_g) used for a gill net for the same fish species. The mesh sizes for the different nettings should be: bottom and side-wall nets $a = (0.80-0.85) a_g$, funnel-shaped and cover nets $a = (0.70-0.75) a_g$, and back-wall net $a = (0.50-0.55) a_g$.

Twine thickness depends on the force applied to the parts of the fixed filter net. Acceptable thicknesses

are: funnel-shaped and side-wall — polyamide twine, 210^D/9 x 3 or polyethylene twine, 0.25/10 x 3; back-wall — polyamide twine, 210^D/12 x 3 or polyethylene twine, 0.25/12 x 3; cover — polyamide twine, 210^D/3 x 3 or polyethylene twine, 0.25/4 x 3; and bottom — polyamide twine, 210^D/9 x 3.

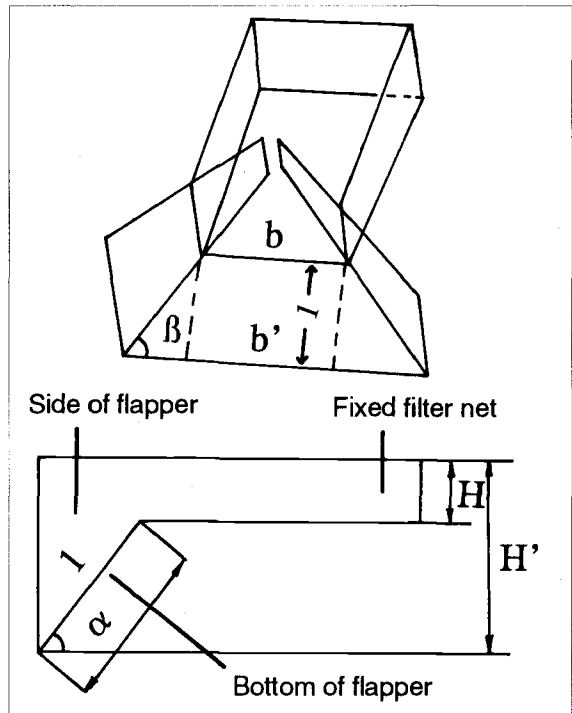

Figure 93. Position of the flapper: β = angle between the side and the bottom line of the flapper, b' = width of bottom line of the flapper (m), b = width of top line of the flapper (m), l = length of the flapper (m), H = height of the fixed filter net, H' = adjustable maximum water depth of the fixed filter net (m), and α = the angle between the flapper and horizontal plane.

Because the nettings used for the various parts of a fixed filter net have different functions, their hanging coefficients vary accordingly. The bottom and side-wall nets enclose and gather the fish. They must be designed with enough elasticity to tolerate the additional force exerted by the fish during hauling. Acceptable hanging coefficients of the bottom net and side-wall net are: $E_1 = 0.70-0.75$ and $E_2 = 0.50-0.60$. The funnel-shaped net guides the fish into the cage body. To ensure that the netting stretches in the water, this net is designed with hanging coefficients of $E_1 = 0.60-0.70$ and $E_2 = 0.75-0.80$. The back-wall net is the final chamber and it must endure the maximum impact. To maintain the highest elasticity of the netting in the water, smaller hanging coefficients are adopted, $E_1 = 0.40-0.45$ and $E_2 = 0.70-0.75$. Twine thicknesses, mesh sizes, and hanging coefficients of the netting used for the various parts of a fixed filter net are shown in Table 67.

TABLE 67. Parameters of the netting used for the parts of a fixed filter net

	TWINE MATERIAL	MESH SIZE (MM)	HANGING COEFFICIENT		REMARKS
			E ₁	E ₂	
Bottom Net	Nylon, 210 ^D /9x3	120-150	0.70-0.75	0.50-0.60	E ₂ indicates hanging coefficient (width)
Side-Wall Net	Nylon, 210 ^D /9x3 or PE 0.25/10x3	120-150	0.70-0.75	0.50-0.60	E ₂ indicates hanging coefficient (height)
Funnel-Shaped Net	Nylon, 210 ^D /9x3 or PE 0.25/10x3	100-110	0.60-0.70	0.75-0.80	—
Back-Wall Net	Nylon, 210 ^D /12x3 or PE 0.25/12x3	80	0.40-0.45	0.70-0.75	—

Note: PE polyethylene.

Installation of a fixed filter net

• Head and foot lines. The cork-line selvage strips of the back-wall, side-wall, and funnel-shaped nets are attached with two polyethylene lines (diameter 8-9 mm) that are the bolch lines for the float line and head line. The front selvage strip of the bottom net holds two lines that are the same diameter as the head line. The sides and back of the bottom net are also fitted with bolch lines, and the side-wall nets are supported by breast bolch lines. The sides of the funnel-shaped net are held in place by four breast bolch lines and two foot lines. All these lines are made of 4-mm polyethylene. The bolch line for the cover net is made of 3-mm polyethylene. The lengths of the lines are dictated by the lengths of the pieces of netting after they are hung. However, the foot line for the funnel-shaped net should be 5% longer. The positions of the various lines in the fixed filter net are illustrated in Figure 94.

• Ropes and accessories. Fixed filter nets also include 4-6 anchor ropes made of 12-mm polyethylene (length 100-150 m) and 4-6 iron anchors (each 15-20 kg), a 60-80 cm iron bar (3 kg), and a bamboo buoy (80-100 cm in length). All floats used in the fixed filter net are made of plastic foam balls. The buoyancy of the floats should gradually increase from the net opening to the back-wall net. The side-wall net and the funnel-shaped net are supported by floats (three floats/m) as is the back-wall net (five floats/m). In addition, 6-8 large plastic floats are attached to each corner of the net and to the inner ends of the funnel-shaped net.

• Net installation. When the pieces of the netting that make up the fixed filter net are joined, the sewing or stitching twines should be strong enough to withstand the impact from the fish. The normal twines used are nylon (210^D/15 x 3) and polyethylene (0.25/15 x 3). After stitching, the various lines and floats are

installed. Finally, a bamboo buoy is tied on the upper part of the net opening between both the sides of the funnel-shaped net, and an iron bar is fixed on the bottom net at the lower part of the net opening.

The size of the mouth of the funnel-shaped net and its connection to the bottom net affect catching efficiency. In practice, the mouth is 60-80 cm wide with an optimal angle (θ) of 50° - 60°.

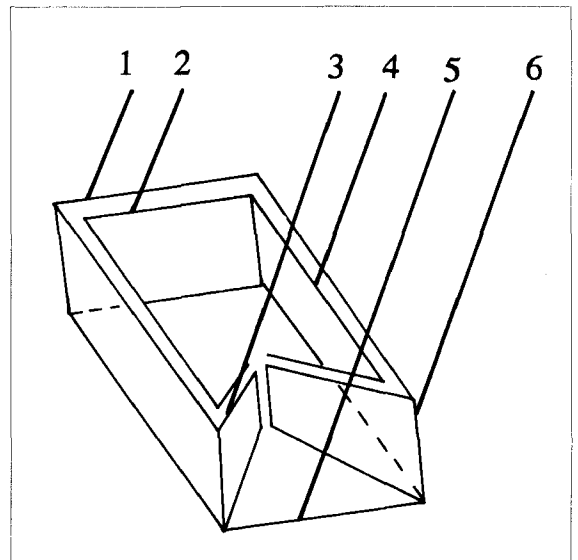

Figure 94. Positions of lines in a fixed filter net: (1) head line of back-wall net, (2) bolch line of cover net, (3) head line of funnel-shaped net, (4) head line of side-wall net, (5) breast line, and (6) bolch line of net inlet.

Fishing methods

The joint fishing method requires adequate fishing gear, boats, and workers. In large reservoirs (667-3,333

ha), the method requires 1,000-2,000 m of blocking net, 40-60 pieces of trammel net, one fixed filter net, one motorized boat (29.4-44.1 kW), 1-2 transportation boats, and about 30 workers. Additional fishing gear, boats, and workers are required for reservoirs larger than 6,667 ha. The joint fishing method includes both the formulation of a fishing plan and various fishing techniques.

Formulation of a fishing plan

- Survey fishing ground. The fishing grounds should be surveyed to determine the shape, water depth, bottom topography, soil quality, water transparency of the reservoir, and habits of the fish. Experience has shown that good fishing grounds have several common characteristics. (1) The tributaries of the original river were narrow, but were 2-3 km in length prior to impoundment. After impoundment, there are many coves that are 10-22 m in depth. (2) The locations of submerged towns, which have agricultural fields, a suitable depth of water, fertile bottoms, and abundant food organisms, attract fish populations. (3) Places where a small stream ran in a valley where there were villages and agricultural fields. In these locations, schools of fish feed when the water level rises during the wet summer season. When the water level declines during the dry winter season, the fish move to the deeper spots in the valley, which become good fishing grounds. (4) Coves in medium and small reservoirs, and that are deep and 2-5 km in length, are usually good shelters for schools of fish. The fish tend to aggregate in the morning and evening. These coves are also used by the fish to overwinter. (5) In the spring and summer rainy seasons, upstream areas of reservoirs that have a swift water current over a reasonable distance and surface area are favourable spawning grounds for silver carp and bighead carp. These sites provide good opportunities to catch these two fish species.

- Fish detection. Effective fish detection ensures fishing success. Fish detection is based on practical experience in reservoirs. Electronic fish detectors have been used in some reservoirs, but the results have not been satisfactory. The most practical ways to detect fish schools are to observe where the fish jump and to listen to the sounds made by the fish to be able to predict the species, biomass, and migration of schools.

Economic fish species have different ecological preferences, and the splashes and sounds caused by jumping fish are also different. In addition, the fish are affected by many factors (water temperature, air temperature, wind direction and force, and clear or rainy days). All these factors must be considered to make an accurate prediction. Several methods have been used to detect fish in Xinanjiang Reservoir.

(1) Jumping of fish — In reservoirs, silver carp and bighead carp have different jumping practices. When

silver carp school, they start to jump, but bighead carp seldom jump out of the water. However, bighead carp usually live with silver carp and can, therefore, be predicted at the same time as silver carp. In the spring and winter, they prefer gullies, coves, and other areas that have full sunlight and are sheltered from the wind. Jumping fish can be observed in the early morning or at dusk.

Changes in weather directly affect the jumping of fish. Movement of silver carp and bighead carp increases when the air temperature rises. Schools of fish move downward when the temperature of the surface water decreases after a storm. When the weather clears, they move to the water surface and make loud sounds by breathing through their mouths. Silver carp jump more often than bighead carp, and small fish jump more than large fish. If bighead carp are found to be jumping, it can be predicted that the fish school is a large one. If the jumping fishes are of a uniform size, it indicates that a good fishing ground has been selected and that the fish school is large. However, if the jumping fishes are of different sizes, it indicates that the school is small and includes fish of miscellaneous sizes that are difficult to catch.

The jumping of fish should be observed continuously at specific locations. Careful observation helps predict whether the fish belong to a mobile or resident fish school. If the school of fish moves rapidly forward after jumping, it suggests that this is a mobile fish population that must be further pursued and observed before it is harvested.

(2) Sounds made by the jumping fish — The species composition of the fish school can be predicted from the sounds that the fish make when they jump. Silver carp actively leap out of the water and beat the surface with their tail. They produce a small splash when they leap. Bighead carp do not fully expose their tail when they jump. They produce a very large splash when they leap. Common carp completely clear the water surface when they jump and make little sound when they return. *Elopichthys bambusa* and *Erythroculter* spp. are predatory fishes, and because they move violently, they make a loud sound when they jump. In addition, silver carp and bighead carp prefer to swim against the water current and wind, and schools usually form on the windward side of the reservoir. Fish do not jump at all when the wind is above 13.9-17.2 m/min.

(3) Water colour and bubbles — When the weather is clear and there is no wind or only a gentle breeze, the surface of the water may ripple and have an ashy-black colour. This indicates a school of silver carp and bighead carp. Sometimes, large round air bubbles rise continuously from the water. If the time interval between two bubbles is long and their position in the water moves forward, this can also indicate the presence of a school of silver carp and bighead carp.

(4) Fish faeces — Fish faeces are also an indicator of schools of fish. If there is a large quantity of fresh faeces floating on the water surface, it indicates that there must be a large school of silver carp and bighead carp nearby. The fish school is usually located on the windward side of the location of the faeces.

- Determination of time of harvest. Based on the surveys of fishing grounds, the location and timing of the harvest are determined. Generally, one haul (harvest) per year is used in small reservoirs and in the coves of large reservoirs. In practice, blocking nets or trammel nets are first installed in the shallow water areas and the schools of fish are gradually driven toward a fixed filter net that is installed in deeper water. However, in larger reservoirs, and in some medium-size reservoirs, it is necessary to divide the reservoir into several fishing grounds and to harvest several times. This reduces the need for more fishing gear, boats, and workers.

- Site for fixed filter net. After the fishing ground has been chosen, the site for the fixed filter net must be selected. In general, deeper locations with a flat bottom and no obstacles and that are convenient for both shooting and hauling should be chosen. However, the deepest water areas near the dam, which in large reservoirs can be up to 100 m deep, should not be selected. It is more practical to locate the fixed filter net where the water depth is similar to the height of the net. The blocking nets and trammel nets are used to gradually drive the schools of fish into the filter net.

- Driving scope and method. After the site for the fixed filter net has been selected, the next task is to work out the range and method that will be used to drive the fish. This choice depends on the reservoir topography, water surface, and the number of nets, boats, and workers involved. The optimal length of the driving area is 300-500 m. But, the distance between each driving or gill net (the fish passage) is variable. The nets are usually operated from large to small and from long to short. In large reservoirs, the length of a driving area is 400-500 m and the width of fish passage is 50-60 m. In small reservoirs, the driving area is 250-300 m and the fish passage is 20-40 m wide.

The driving method that uses a trammel net consists of both crosswise and longitudinal driving. Crosswise driving means that the driving net is parallel to the blocking net; in longitudinal driving, the net is perpendicular to the blocking net. The choice of driving method depends on the particular conditions of the fishing ground. The longitudinal driving method is used commonly for the first drive over a large water surface because it is a faster method. The crosswise driving method is used in fishing areas where better driving efficiency is required. When the schools of fish aggregate at the entrance of the fixed filter net, the driving method should be selected on the basis of prevailing conditions. A joint fishing method is shown in Figure 95.

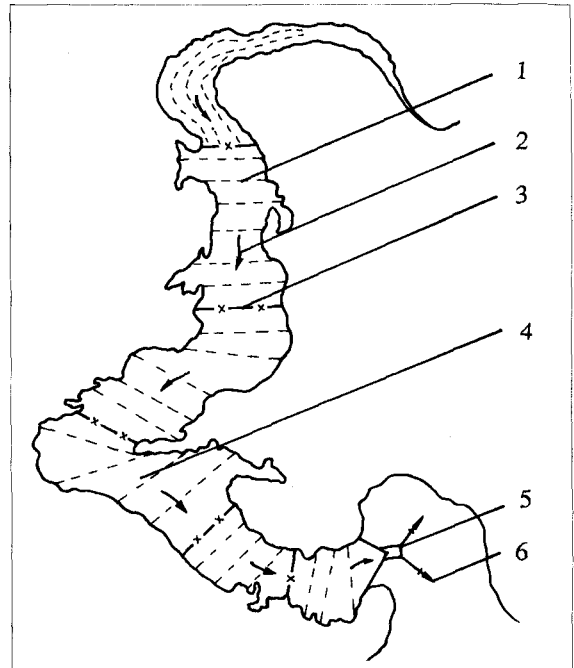

Figure 95. The joint fishing method: (1) driving fishing net, (2) driving direction, (3) blocking net, (4) driving area, (5) fixed filter net, and (6) anchor.

Fishing techniques

Effective application of the joint fishing method requires organization and unified action.

- Blocking. Blocking is the basis of the joint fishing method because fishing success cannot be assured unless the shoals are effectively blocked. The site for the blocking nets should have a flat bottom and no obstacles. The first blocking net is usually set at dusk. The other blocking nets are placed near the fixed filter net to block the fish and guide them into the fixed filter net. The blocking net must be properly designed. In particular, its foot line must be well fitted to the reservoir bottom to avoid fish escapes. The blocking net is always constructed before the fixed filter net. The blocking net should retain the shape of an arc in the water. In this way, the length of the net can be readjusted after the fixed filter net is positioned. All blocking nets must be long enough to reach both sides of the bank no matter where they are installed on the fishing ground.

The blocking net is set using small rowboats. However, in large reservoirs (water surface more than 1000 m wide) motorized boats are used to set the nets to save time and reduce labour. During hauling, one person is responsible for collecting the cork line, one person for the foot line, and three to five people for the netting. Because the blocking net is tall and heavy, manual pulling of nets is very labour intensive. To improve working conditions and increase labour efficiency, mechanical net haulers are now used in some large reservoirs.

- **Driving.** The driving operation is essential to success. Fish can be driven to the desired enclosure by using driving nets or non-net methods. In practice, a trammel net is generally used to drive the fish and, for common carp, is sometimes combined with the gill net. The larger the fish population, the greater the number of trammel nets used, the shorter the time of driving, and the better the driving efficiency. Normally, fish are driven from the coastal areas to the centre of the reservoir and from shallow areas to deeper areas. Both floating and submerged nets are used to force the fish to move toward the fixed filter net. The fishing ground is usually divided into many sections to improve driving performance.

There are two ways of placing the driving nets. In the transverse method, two or more trammel nets are set between the blocking net and the fixed filter net. These trammel nets are parallel to each other and to the fixed filter net and guide the fish into the fixed filter net. In the longitudinal method, trammel nets are set perpendicular to the blocking net and guide the fish to the fixed filter net (Figure 96).

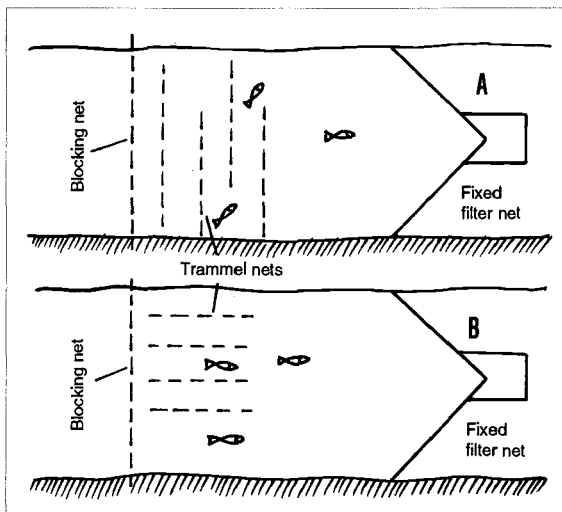

Figure 96. Methods of placing the driving nets: (A) transverse method, and (B) longitudinal method.

In large water bodies, towed white boards are often used to drive the fish. If driving nets and towed white boards are used together, the fish can be driven more efficiently. The white boards should not be used when the school of fish has aggregated near the fixed filter net.

- **Gill netting and seining.** These are the final steps in the joint fishing method. Most fish are caught in the fixed filter net; however, some become entangled in the trammel nets. Therefore, the trammel net can be used for both driving and fish capture, but it is more difficult and time-consuming to remove large quantities of fish from the trammel net. The trammel net should be used mainly to drive the fish.

The fixed filter net is usually located in the deep-water area of the fishing ground. In some cases, filter nets are placed along the routes where the fish must pass. The fixed filter net is always set after the blocking net.

During the operation, the fixed filter net must be managed by a skilful operator to maintain the shape of the fixed filter net and the blocking efficiency of the blocking nets. Especially during heavy winds, it is necessary to watch carefully the net position and the shape of the net opening. The fishing nets must be continually adjusted. In addition, records must be kept on the status and quantity of fish entering the fixed filter net. If too many fish are caught inside the fixed filter net, the net may be damaged. It is essential to make timely reports and to harvest the fish before they become too concentrated in the net.

When enough fish have entered the fixed filter net, they must be collected quickly. Before collection, the funnel-shaped net must be closed. The hauling procedure depends on the quantity of fish in the net. Under normal conditions, the fishes should be collected before the netting of the fixed filter net is lifted. However, if there are few fish, they can be collected while the net is being lifted.

At the start of hauling, the fish transportation boat is located outside the back-wall net and the cork line is lifted out of the water and hung on one side of the boat. The movable stitching margin between the bolch line of the bottom net opening and the bolch line for the float line of the barrier net is then untied to separate the fixed filter net from the barrier net. In sequence, the bottom, funnel-shaped, and side-wall nets are gradually hauled onto the boat. All the nets should be put in order while they are collected to ensure smooth shooting at the next harvest. The operation should be done quickly and steadily to avoid rapid movement and the escape of fish. When the bottom net and side-wall net of the fixed filter net are collected and the bottom selvedge strip of the back-wall net is just out of the water surface, a pocket is formed on the back-wall net where the fishes are concentrated (Figure 97). The fish are then hooked and drawn into the boat. Meanwhile, the netting of the back-wall net is hauled slowly until all of the netting is on deck. At the same time, the barrier net, trammel nets, and small anchors are collected.

SEINE NET

Seine nets operated from motorized boats are used to catch silver carp and bighead carp in reservoirs. These nets are flexible, highly mechanized, require a low investment, and produce good yields. Seine nets have been used in some reservoirs in Anhui, Jilin, Hebei, Hubei, and Guangdong Provinces. The operation of the seine net has been mechanized in Songhuahu Reservoir by using a power block for hauling. This has

reduced the time needed for each haul, increased fish production, decreased labour requirements and production costs, and increased the economic efficiency of the operation. For example, in Miyun Reservoir, a seine net has been used as the principal fishing gear since 1974. The annual catch is 1.5 million kg, or double the yield in previous years. Similar results have been achieved in Mingshan, Gaozhou, and Foziling Reservoirs (Wei Kelong 1983).



Figure 97. Collection of fish from a fixed filter net.

Use and structure

When a school of fish is located, a ribbon-shaped net is quickly set in a circle around the fish using motorized boats. After the fish have been encircled, the purse line is tightened, which gradually encloses the bottom of the net. The fish in the bunt are then collected (Figure 98).

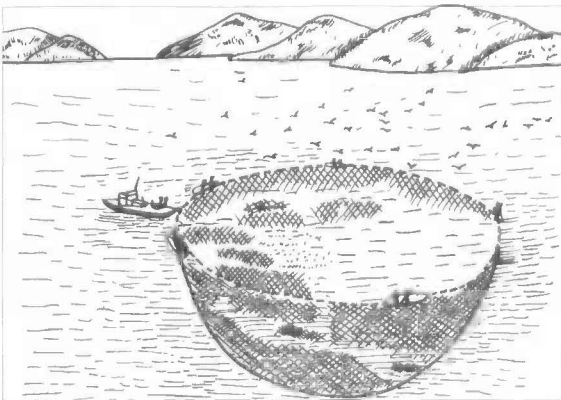

Figure 98. Operation of a seine net.

A seine net has no cod end and is a purse-ring type net that is composed of netting, pursing devices, and accessories.

- **Netting.** There is a wing net and a bunt. The wing net forms a circular enclosure and forces the fish to enter the bunt. The wing net is usually made up of several pieces of netting. The bunt is either at the centre or one end of the wing net. Because the bunt is where the fish are finally collected, its twine must be

strong enough to withstand the weight of the fish. Moreover, the mesh size must be smaller and the netting used longitudinally (with the run of the knots) to raise the tensile strength and operating height of the net. The netting used for the wing net is used against the direction of the knots because it is made from thinner twine and has a larger mesh size. To reinforce the selvedge strength of the whole net, cork line and lead line selvedge strips are strengthened with a row of mesh made of the thick twine.

- **Pursing devices.** The seine net with rings is characterized by pursing devices. The lines include a head line, foot line, float line, lead line, ring line, purse line, bridle, and tow rope. The pursing devices include a ring line, purse line, and purse rings and are used to close the bottom of the net to prevent the escape of fish. One end of the ring line is tied to the foot line and the other is connected to the purse ring. The ring line passes the retrieving force to the foot line and separates the foot line from the purse ring to avoid tangling. The purse ring is usually made of iron. Not only can it draw in the foot line rapidly and close the bottom of the net, it can be used as a sinker. The purse line can be made of synthetic fibres, wire, or cotton. However, a swivel must be installed between the purse ring and purse line to avoid twisting. The dimensions of seine nets used in two reservoirs are given in Table 68.

- **Accessories.** The accessories used with a seine net include floats, sinkers, shackles, and swivels. The floats are usually made of ball-shaped plastic foam and the sinkers of lead. The shackles are used to link the wires.

Fishing method

Before the net is shot, the net platform should be cleared and the net checked. The seine net should be arranged carefully. First, the foot line (including the lead line and purse rings) should be placed to port and the float line to starboard. The netting should be laid between the float line and lead line, the purse rings should be arranged in sequence, and the purse line must pass through all the purse rings.

Shooting

A motorized boat and several small boats move toward the fishing ground. In preparation for shooting, one end of the bridle is connected to the purse line, which is held by the leading boat. Another 3-4 boats, which are used to arrange the net, are tied to the motor boat. The motorized boat moves upwind at full speed to form a circle and enclose the fish. The four small boats are evenly distributed around the net enclosure to reset the net and frighten the fish. When the motorized boat meets the leading boat, the net end on the leading boat is transferred rapidly to the motorized boat. This is the complete process, which usually takes 5-10 minutes.

TABLE 68. Dimensions of seine nets operated in Shonghuahu and Foziling Reservoirs

		SHONGHUAHU	FOZILING
Length (m)	Head line	600	315
	Foot line	600	300
Depth (m)	Central part	40	27
	Both ends	26	21
Net depth/net length		1/15	1/11.7
Hanging coefficient	Wing net	head line 0.50	head line 0.55
		foot line 0.53	foot line 0.55
	Middle part	0.50	0.53
	Bunt	0.50	0.55
Mesh size (mm)	Wing net	100	110
	Middle part	100	110
	Bunt	100	110

Hauling

First, both ends of the purse line are untied and attached to the hoist. At the same time, the workers on the boats pull in the netting until the purse rings are in sight (Figure 99). While retrieving the purse lines, the workers on the four small boats pull on the head line. When the purse line is wound completely onto the hoist, all purse rings must be collected and the rest of the head line retrieved quickly. The netting is then collected on the leading boat and the purse line is unloaded from the hoist. Finally, the purse rings are passed in sequence onto the leading boat. During hauling, some of the fish can be taken into the small boats.

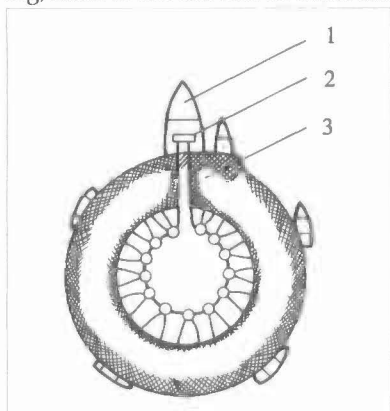

Figure 99. Hauling a seine net: (1) motorized boat, (2) hauling machine, and (3) seine net.

When all of the net has been collected, the purse line and seine net must be properly stowed. The last step is to collect the fish caught in the net. Under normal conditions, winding of the purse line requires 7 min and

hauling about 30 min. The time needed to collect the fish depends on the catch. The steps in the operation of the net are shown in Figure 100.

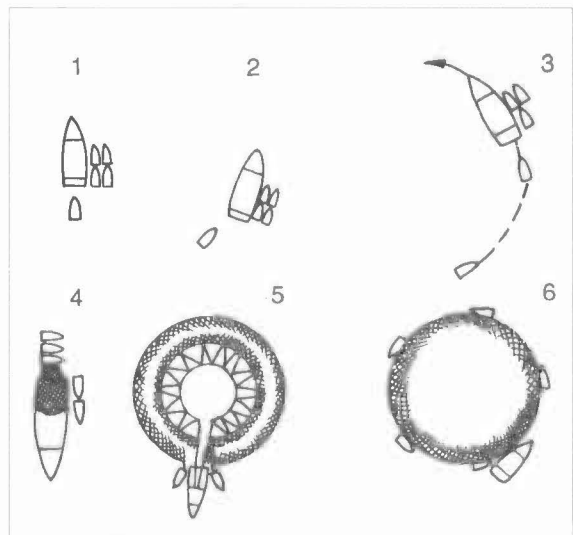

Figure 100. Operation of a seine net: (1) discovery of fish and preparation for shooting the net, (2) tying the net to the lead boat and starting shooting, (3) continuation of shooting while small boats start to work, (4) shooting completed and winding of purse line starts, (5) continuation of winding of purse line and collection of net on leading boat, and (6) the seine net is completely collected and stowed.

CHAPTER 10

Harvesting Demersal Fish Species

The common demersal fish species (common carp, crucian carp, mud carp, mandarin fish, and catfish) in reservoirs account for an important part of the total fishery resource. In the past, attempts were made to raise the production of stocked fish, but little attention was given to the development and utilization of the demersal fish species that spawn naturally. Rapid development of reservoir fisheries, and increased demands for high quality species, has made it important to conduct research to develop this resource and to solve problems related to fishing for demersal species.

Many types of fishing gear and methods are used for commercial capture of demersal species. However, not all give good results. In the early 1970s, a round single-layer gill net was used to catch common carp in Songhuahu Reservoir. Since then, a variable-depth gill net for common carp has been developed from this design and is now used in Xinanjiang Reservoir. This new gill net improved results, especially during the spawning and overwintering seasons. Trawl nets pulled by a 44.1-kW catamaran were first used to catch common carp (and other species) in Qinghe and Shuifeng Reservoirs and have produced good yields since 1981. The average yield of common carp, crucian carp, and

catfish was 74 kg/day during the experimental stage. In 1982, trammel nets were used by the Zhejiang Provincial Freshwater Fisheries Research Institute to harvest common carp. The daily catch of common carp was 87 kg/boat during the spawning season; whereas, the maximum catch was 68 kg/day in the autumn.

RELEVANT BIOLOGY OF COMMON CARP

Information collected from Xinanjiang Reservoir indicates the vertical and horizontal distribution of common carp throughout the year (Table 69).

GILL NET FOR COMMON CARP

A gill net made of polyamide is designed specially to catch common carp. This net is made from thin twine, has slack netting, and is very effective. Because the net is fan-shaped and has a long foot line, it is also called a skirt-net. This polyamide net has been used for more than 10 years primarily to harvest common carp, but it is also effective for other fish species. When it is operated, the buoyancy of the net is adjusted to regulate its operating depth in the water according to the depth of the common carp during the different months of the year.

TABLE 69. Annual vertical and horizontal distribution of common carp in Xinanjiang Reservoir

MONTH	VERTICAL DISTRIBUTION (M)	HORIZONTAL DISTRIBUTION
January	15-30	More abundant in deeper open water, few along coastline
February	15-30	More abundant in deeper open water, few along coastline
March	0-20	Distribution is changed considerably if the water rises early
April	0-10	Distribution is changed considerably if the water rises early
May	0-10	Distribution is changed considerably if the water rises early
June	0-10	Distribution is changed considerably if the water rises early
July	0-20	Fish more scattered and evenly distributed in the reservoir
August	0-20	Fish more scattered and evenly distributed in the reservoir
September	10-30	More abundant in deeper open water, few along coastline
October	15-30	More abundant in deeper open water, few along coastline
November	15-30	More abundant in deeper open water, few along coastline
December	15-30	More abundant in deeper open water, few along coastline

Net structure

The common carp net is a single-layer gill net made from polyamide twine. An experimental common carp net was operated by the authors in Gutian Reservoir in 1974 (Table 70). The net can be woven vertically or horizontally. In operation, the horizontally woven net is slacker in the water, can be easily repaired on location, but has less volume. The vertically woven net is more easily unrolled and operated because it is woven in the direction of the applied force. Moreover, it is stronger and more durable.

The net is made of polyamide filaments. It is best to use thin polyamide monofilament if it is strong enough. An acceptable net can be made from polyamide (0.20-0.30 mm diameter). Because the water temperature is low and fish move sluggishly in northeastern China in the winter, it is practical to use the thinner polyamide monofilament to make the common carp net.

All lines are made of polyethylene twine (0.25/8x3 or 0.25/6x3). In general, the foot line is 30% longer than the head line so that the shape of the bottom of the net can be maintained. More fish are caught in the bottom part of the net than in the upper part. The hauling speed of the head line and foot line should be controlled carefully to ensure that the net is retrieved evenly.

The buoyancy and sinking forces required for this net are less than for other fishing nets because the common carp gill net is comparatively light and has some slack. As a result, large common carp can be caught with the gill net. In general, one piece of common carp gill net is installed with 0.5 kg lead sinkers so that the sinking force is just slightly greater than the buoyancy of the floats.

Fishing method

Shooting

Stones are tied onto the foot line before the net is thrown into the water. If the net is cast near the shore, wooden piles are used to fix the two ends of the net instead of stone sinkers. Three people are required to

operate a boat with 1,500-2,000 m common carp gill net. The buoys are attached to the float line, and the length of the buoy line is primarily determined by the operational depth of the gill net (Figure 101).

Hauling

The hauling time depends on the size of the catch. During hauling, one person is responsible for the head line and another for the foot line. The buoys and sinkers should be removed as the net is hauled. A third person collects the fish caught in the net. If the capture rate is high, the shooting and hauling can be continued over several days.

MOTORIZED TRAWL

Motorized trawling is a common fishing method that gives good results. A trawl towed by a catamaran has been used to catch common carp, crucian carp, and other demersal species in Qinghe and Shuifeng Reservoirs. The maximum production of one haul was over 5,000 kg of common carp and crucian carp within 1 h in Qinghe Reservoir. In Dashahe and Henggang Reservoirs, 20-30% of the total production is obtained from a trawl used to catch mud carp, common carp, crucian carp, and bream.

Net Structure

This type of trawl net has wings. The type, material, quality, and dimension of each portion of the net depends on the living habits of fish to be caught, the environmental conditions of the fishing ground, and operating methods. The trawl net includes a wing net, cover net, body net, and bag (Figure 102). Sometimes, either two pieces of triangular net (gussets) are attached between the bosom and the bell of the body net, or a flapper is installed between the body net and the bag to spread the opening of the net and to prevent the escape of fish.

Wing net

The wing net spreads the opening of the net and, in turn, increases the sweeping area. It can also prevent the escape of fish at the net opening and guide fish into the net. The length of wing net has a direct effect on the effective sweeping area. The fishing scope can be increased by using a trawl with longer wings; however, water resistance is increased. An acceptable length of the wing is about half the length of the body net. A trawl net with short wings has low water resistance, fast operational speed, and increased

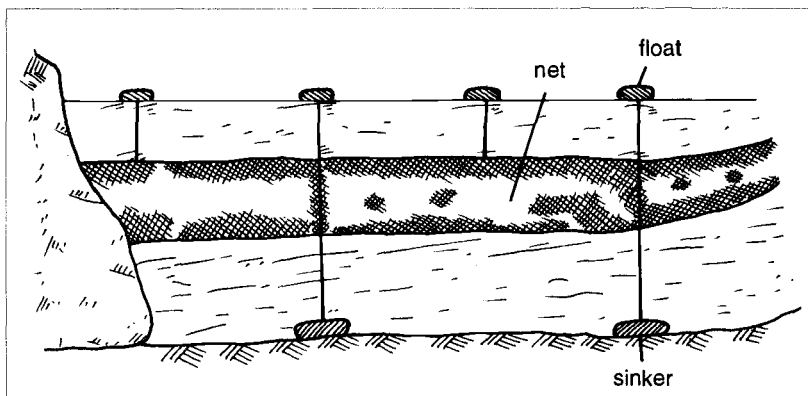

Figure 101. The common carp gill net.

TABLE 70. Dimensions of common carp gill nets with mesh sizes of 150 and 160 mm

	QUANTITY	MATERIAL AND DIMENSION	MESH SIZE	NETTING MESH			AFTER HANGING			
				LENGTH (MM)	WIDTH (MM)	HANGING COEFFICIENT (E_1/E_2)	LENGTH (M)	DEPTH (M)	LENGTH (M)	LINE WEIGHT (KG)
Netting	1	PA filament d = 0.3	150	1,100	30	0.30 (upper)/0.90	50 (upper)	4.05	—	1.35
						0.39 (lower)/0.90	64 (lower)	4.05		
Netting	1	PA filament d = 0.3	160	1,050	30	0.30 (upper)/0.90	50(upper)	4.30	—	1.36
						0.39 (lower)/0.90	64 (lower)	4.30		
Bolch line for float line	1	PE twine 0.25/8x3	—	—	—	—	—	—	52	0.05
Bolch line for lead line	1	PE twine 0.25/6x3	—	—	—	—	—	—	67	0.06
Cork line	1	PE twine 0.25/6x3	—	—	—	—	—	—	52	0.05
Lead line	1	PE twine 0.25/4x3	—	—	—	—	—	—	67	0.03
Float	51 per line	Plastic (4 cm x 1 cm x 1 cm)	—	—	—	—	—	—	—	—
Sinker	176 per line	Lead (25 cm x 4 cm x 2 mm)	—	—	—	—	—	—	—	0.53

Note: PA polyamide, PE polyethylene.

catch per haul. To reduce water resistance and save net material, part of the wing net can be made with a larger mesh size. The depth of the back portion of the wing net directly affects the vertical depth of the trawl mouth during operation; therefore, it must be sized carefully.

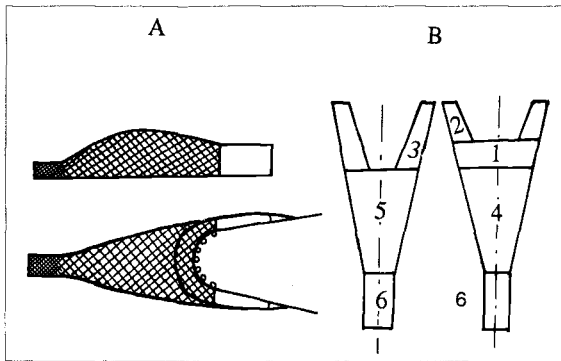

Figure 102. Structure of a trawl net with wings: (A) upper — side view, lower — plan view; (B) sectional view; (1) cover net, (2) upper wing net, (3) lower wing net, (4) bosom, (5) belly, and (6) bag.

Cover net (square)

The cover net prevents the escape of fish with strong swimming ability before they enter the mouth of the net. The cover net can also increase the vertical depth and horizontal opening of the wings. Practical experience has shown that the catching rate of a trawl can be increased if the length of the cover net is increased. The length of the cover net also directly affects the spread of the net opening. During construction, both sides of the cover net are sewed to the back portion of the lower wing net, then the inner netting of the cover net is stitched to the front margin of the bosom.

Body net and bag

If the body net and bag are an appropriate length, the net is stable in the water and the fish are led into the body net and finally into the bag. Increases in body net length can improve the stability of the net in the water; however, the increase in the resistance of the net in the water should not exceed the capacity of the trawler. Both the body net and the bag are cone-shaped. The body net is usually made up of a bosom, a belly, and two side nets. The bag is made of two pieces of rectangular netting. The body net should be designed to taper at a proper degree to lead the fish into the bag and limit their escape.

Gusset and flapper

Gussets are attached to both sides of the body net to spread the opening and improve the strength of the wing net. The gussets are usually 10-20 m in length. The flapper is designed to block the retreat of fish. As a result, the length of the body net can be reduced if a flapper is installed. The flapper is made of one or two

pieces of trapezoid-shaped net sewed in a cone shape. The opening of the flapper is equal to the girth of the bag, and it is about one-third to one-half the length of the bag.

Main parameters

Estimation of pulling force

The effective towing force during the operation is the pulling force, which should be equal to or larger than the resistance of the trawler and trawl net:

$$T > R_n + R_t \quad [42]$$

where T = effective pulling force of trawler at a certain speed (kg), R_n = resistance of the net during operation (kg), and R_t = resistance of the trawler during operation (kg).

According to the design of the propeller and the resistance of the vessel, curves of $T = f(v)$ and $R = f(v)$ can be drawn. The pulling force of the trawler is estimated from field surveys. Based on data on the trawl nets operated in China and elsewhere, if the vessel has a capacity of less than 294 kW, the pulling force can be calculated as: at low speed the pulling force is 2-5 kg, at moderate speed the pulling force is 5-9 kg, and at full speed the pulling force is 10-14 kg. The pulling force of small trawlers is increased by 20-25% if there is a tail wind, and is about 60% higher against the wind.

Several terms are used to describe the dimensions of a trawl net: the dimension of the trawl is the volume of the trawl net; the length of the head line is the distance from one end of the wing net to the other end; the number of mesh at the net opening is the girth of the bosom net; and the netting area is the total net area at assumed hanging coefficients of $E_1 = 0.5$ and $E_2 = 0.87$.

The dimension of the trawl is commonly expressed as head line length times stretched girth of net opening over mesh number of body opening. For example, the dimension of the trawl used in Shuifeng Reservoir is 35.5 m x 84 m/840 mesh, and it is operated with a 294-kW vessel.

In general, two principles dictate the mesh size of a trawl. First is fishing efficiency. The flow of water through the net is directly proportional to the mesh size of the trawl. Therefore, the larger the mesh size, the better the flow and the lower the resistance. Second, the mesh should be small enough that the fish are not easily gill-netted in the mesh because this slows down the operational speed and affects fishing efficiency. Mesh size is usually determined with reference to the mesh size of the gill net (a_g): for the bag $a_{bag} = (0.75-0.85) a_g$, for the body net $a_{body} = (1.20-1.50) a_g$, and for the wing net and cover net $a_{w/c} = (1.85-2.00) a_g$.

The selection of twine thickness is related to strength and abrasion resistance and to fish production and availability of materials. Because it is difficult to accurately calculate the load on each part of the trawl, the

thickness of the twine is based primarily on experience. The ratio between twine diameter (d) and mesh size (a) of different parts is: for the bag $d_{bag} = (0.06-0.07) a_{bag}$, for the body net $d_{body} = (0.03-0.06) a_{body}$ and for the wing net and cover net $d_{w/c} = (0.02-0.03) a_{w/c}$.

Determination of hanging coefficients

Hanging coefficients are closely related to the shape of the mesh and the net and directly affect the filtration rate of the net. They are also related to the operational area of the net and the strength of the twine. As a result, when the hanging coefficients are properly selected, the direction of the stress on the mesh will ensure proper function of each part of the net and help maintain the shape of the net.

The hanging coefficients of the various components have been determined from years of practical experience: for the float line of the wing net $E = 0.71-0.75$, for the middle head line of the net opening $E = 0.45-0.50$, for the lead line of the wing net $u = 0.95-0.97$, for the middle foot line of the net opening $E = 0.35-0.40$, and for the strengthening rope of the body net $E = 0.95-0.98$.

Horizontal and vertical spreading of the net opening

The shape of the opening of a trawl is determined by the horizontal and vertical expansion of the mouth of the net and affects the fishing efficiency of the net. During operations, the width of the net opening is determined by the horizontal distance between the wings, which in turn is related to the horizontal distance between the two trawlers, the length of the towing line, towing speed, and the mesh size.

During operation, the shorter the distance between the two trawlers, the smaller the net opening and the narrower the net mouth. The width of the net opening must be adjusted to suit the species to be caught and the conditions of the fishing ground. It is best to have a larger net opening to catch demersal fish species, but excessive expansion of the net opening causes the foot line to sink into the mud. Generally, the optimal horizontal distance between the two trawlers is 150-250 m. Towing speed also affects the net opening. Practical experience has shown that a towing speed of 5 km/h is effective for crucian carp and 8 km/h is effective for common carp.

The vertical height of the net opening is the vertical distance between the middle of the head line and the middle of the foot line; whereas, the demersal trawl is the vertical depth from the bottom of the reservoir to the middle of the head line.

Buoyancy and weight of sinker line

The buoyancy of the trawl net is calculated as:

$$F = \sigma_y + T_y - P_y \tag{43}$$

where F = buoyancy required (kg), σ_y = sinking force caused by the weight of the net (kg), T_y = sinking force caused by the tension on the head line (kg), and P_y = lifting force due to both water resistance and net weight (kg).

The buoyancy (F) and its distribution in the trawl are usually determined by practical experience. The buoyancy is usually allocated as 30% to the middle head line and 70% to the wing nets. The principle is to distribute the buoyancy along the head line so that it gradually increases from the end of the wing net to the middle of the head line at the net opening.

The demersal trawls operated in reservoirs usually use lead line instead of sinkers. If a lead line with plastic bobbins is used, it is not necessary to install the bobbins in the leg. The weight of the lead line is determined by the power of the main engine of the trawler (Table 71).

Tension on tow line

If the power of the main engine is N_i and the towing force needed to overcome net resistance is T_{net} , then:

$$T_{net} = t N_i \frac{(1 - V^2)}{V_{max}^2} \tag{44}$$

$$T_{tow\ line} = \frac{T_{net}}{2 \cos \alpha \cos \beta} \tag{45}$$

where $T_{tow\ line}$ = tension in tow line (kg), t = capacity of main engine (kg) per 0.735 kW, V = speed of the trawler (m/s), α = angle between the tow line and the midship line of the trawler (Figure 103), and β = angle between the tow line and the horizontal plane (Figure 103).

TABLE 71. Distribution of lead line weight in a bottom trawl

CAPACITY OF THE MAIN ENGINE (kW)	WEIGHT OF LEAD LINE (KG)			
	TOTAL	AT NET OPENING	AT WING NET	AT LEG
14.7	50-70	5-7.5	(15-20) x 2	(10-15) x 2
29.4	165-175	15-20	(40-50) x 2	(25-30) x 2
44.1	225-240	30	(60-65) x 2	(35-37.5) x 2

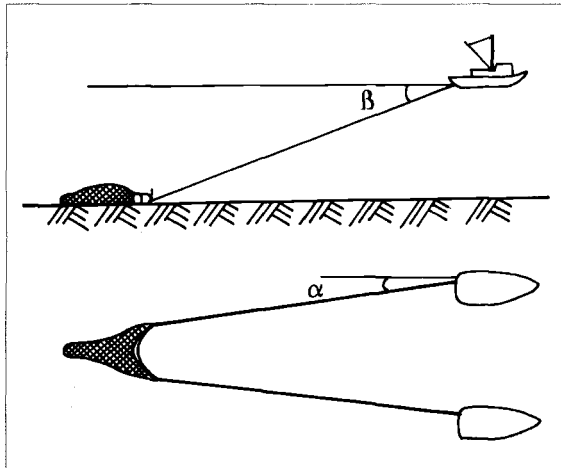

Figure 103. Analysis of the applied force of the tow line: β = the angle between the tow line and the horizontal plane, and α = the angle between the tow line and the midship line of the trawler.

The structure of the demersal trawl operated by a 58.5-kW trawler in Shuifeng Reservoir is illustrated in Figure 104. Its dimensions are given in Table 72. The dimensions of the four-panel trawl operated by the 14.7-kW trawlers in Dashahe Reservoir are given in Table 73.

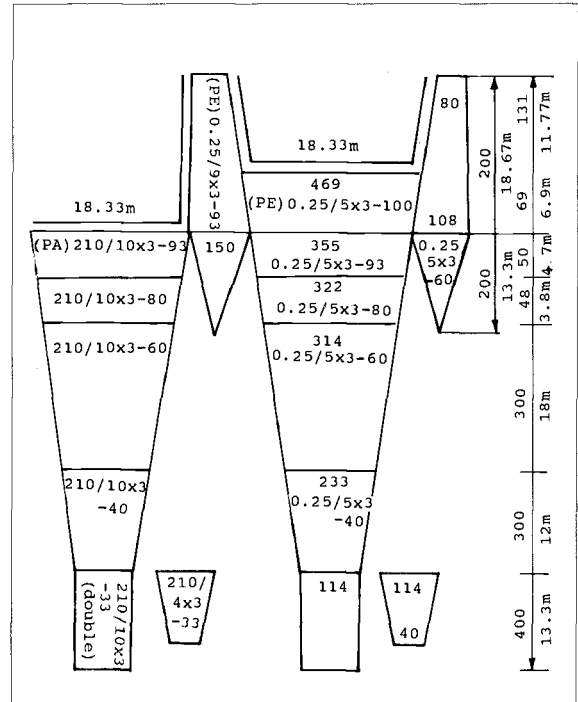

Figure 104. Dimensions of the components of the bottom trawl operated by a 58.5-kW trawler in Shuifeng Reservoir.

TABLE 72. Dimensions of lines and accessories of the demersal trawl operated in Shuifeng Reservoir

ITEM	QUANTITY	MATERIAL AND DIMENSION (MM)
Cork line	1	Steel wire wrapped with nylon threads, d = 5
Lead line	1	Steel wire passing through both plastic sinkers and mats, d = 6
Strengthening line of the gusset	4	White PE line, d = 10-15
Strengthening line of bossom and belly	2	Abaca rope, d = 15-20
Upper bridle	2	Steel wire, d = 6
Lower bridle	2	Steel wire, d = 6
Towing warp	1	Abaca rope, d = 26.5. Steel wire, d = 6
Bag line	1	Steel wire, d = 6
Floats	27	Hard plastic, d = 200
Sinkers		Replaced by lead line
Danlenoes	2	
Slip hook	1	
Shackles	4 large, 10 small	

Note: D diameter, PE polyethylene.

TABLE 73. Dimensions of lines and accessories of the four-panel trawl operated in Dashahe Reservoir

	QUANTITY	MATERIAL AND DIMENSIONS (MM)	LENGTH(M)	REMARKS
Cork line	1	PE, d = 8	25.40	Leg (20 m)
Bolch line for float line	1	PE, d = 5-6	25.60	
Lead line	1	Combination rope, d = 35	28.21	Steel wire, d = 9 mm
Bolch line for lead line	1	PE, d = 5-6	28.21	
Stapling line	1	PE, d = 8-10	60	
Bridle	2	Steel wire, d = 9	6	3 m for each bridle
Towing warp	2	Combination rope, d = 35	150	Steel wire, d = 9 mm
Floats	38	Foam plastics in ball shape, d = 100		
Bobbins	20	Wood, 120 (d = 4-6)		
Danlenoes	2	Iron, 500 (d = 5)		
Shackles	10	Iron, small size		
Guy clip	14	Iron, small size		
Sinker	40	Lead, 80 mm long		Total weight 17 kg

Note: D diameter, PE polyethylene.

Fishing method

The trawl is always operated in reservoirs by two equally powered trawlers (Figure 105). Normally, there is a crew of 12-14 on the two trawlers. One person is the fishing master for the overall organization of production and the adjustment of the fishing gear as necessary; six or seven people are responsible for the fishing operation (shooting and hauling); four people navigate and maintain the trawlers; and two people are responsible for accommodations, but also assist with fishing when needed.

Before shooting, the wing net, body net, and bag should be carefully laid out on the stern of the net boat. At the fishing ground, the two trawlers come close together and the tow line of the auxiliary boat is connected to the bridle. The trawlers then move slowly and place the bag, body net, and wing nets into the water. The two trawlers should move at the same speed. When the towing line has been shot 10 m, the speed is moderated to check the shape of the net in the water. The trawlers then attain full speed and shoot the tow line to expand the horizontal distance between the two trawlers.

During towing, the horizontal distance between the two trawlers should be 150-250 m. The tow line should be 15-20 times longer than the depth of the water. The towing speed is usually 5-8 km/h and each haul lasts about 1-2 h, but the time varies with the fishing ground, depth, and catch. If the estimated catch is high, the towing speed and horizontal distance between the two trawlers should be reduced to avoid breakage of the net.

During the hauling operation, the two trawlers stop moving and retrieve the tow line. When the bridle is out of the water, the wing net end should be pulled onto the deck until the connecting device between the tow line and the bridle is on the auxiliary trawler. At the same time, the tow lines are fully retrieved. The whole trawl is lifted onto the deck of the main trawler. First, the boom is used to lift the wing net sections. The body net and bag are lifted by the crew when the lead line is on deck. Then the boom is used to move the bag with the catch onto the front deck, the bag line is untied, and the fish are poured onto the deck. The bag is then returned to the stern deck, and the trawl net is prepared for its next use.

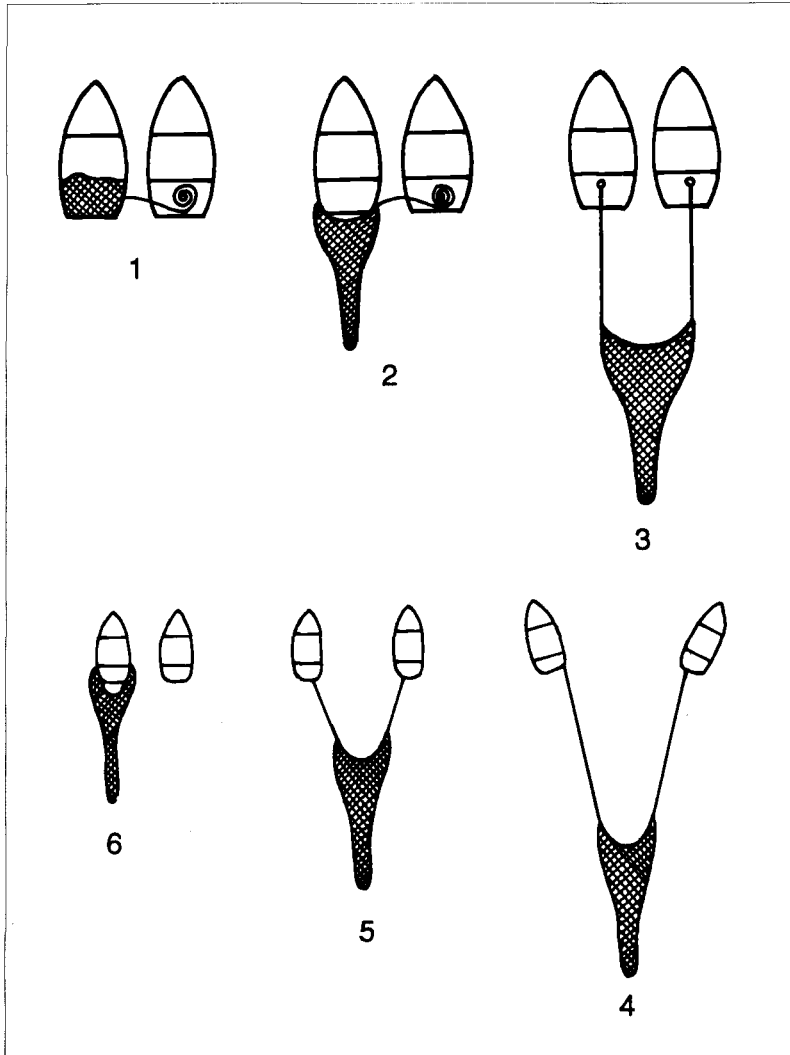

Figure 105. Operation of a demersal trawl in reservoirs: (1) two trawlers come close together to prepare for shooting, (2) two trawlers move at low speed and shooting starts, (3) shooting of tow line is stopped at 10 m and shape of net in the water is checked (speed of boat is relatively slow), (4) after the net is fully opened in the water, the two trawlers move at full speed to shoot the net (the towing of the net starts when the tow lines are fully loosened), (5) the two trawlers come close together for hauling, and the tow line is retrieved until the end of the bridle, and (6) the bag is lifted onto the main trawler and the fish are collected.

CHAPTER 11

Harvesting Predatory Species

The predatory or piscivorous species include *Elopichthys bambusa*, *Erythroculter ilishaeformis*, mandarin fish, catfish, and snakehead. Additional attention is being paid to the control of predators because they now pose a more serious threat to artificial stocking and natural proliferation programs in reservoirs. If predators are uncontrolled they will decrease the number of stocked fish and retard the development of reservoir fisheries. To maximize the use of large and medium reservoirs and to promote the development of the fishery resource, it is essential to reduce predator populations, especially *Elopichthys bambusa* and *Erythroculter* spp. An effective measure is to strengthen fishing intensity during the spawning season using specific fishing gear.

RELEVANT BIOLOGY OF MAJOR PREDATORS

There are both pelagic and demersal species of predators.

Pelagic predators

Typical pelagic predators in reservoirs are *Elopichthys bambusa*, *Erythroculter ilishaeformis*, and *Erythroculter mongolicus*, which live all year in the upper water layer and are strong, fast swimmers. *Elopichthys bambusa* usually inhabit the upper 2 m of the water and hide very quickly when frightened. *Erythroculter ilishaeformis* live in the middle and upper layers and are very active. *Erythroculter mongolicus* usually live in groups in the middle and upper layers and are strong swimmers.

Demersal predators

The demersal predators, which live at the bottom of the reservoir include mandarin fish, catfish, and snakehead. In comparison with pelagic predators, demersal predators are more sluggish. Mandarin fish live in rocks near the bank, tree roots, or other shelters. They prefer deeper areas during the day and move to the shallow areas at night. Because mandarin fish move slowly, especially during the spawning season, they are easy to catch when attracted to a light at night. Snakehead build nests before spawning and are serial spawners. Both male and female brooders care for the young until the offspring reach the juvenile stage. They are usually fished during the spawning season. Summer and autumn are the best times for fishing because most snakehead live in aquatic weeds. Catfish live in deeper water and overwinter in mud. Catfish usually live within aquatic plants near the bottom during the

daytime, but move to shallow water to feed at night. Therefore, they can be caught using spears near the bank at night.

FISHING GEAR AND METHODS

Fishing gear has been greatly improved over the last few years. During the spawning season, fishing gear and methods are adopted to catch *Elopichthys bambusa* and *Erythroculter* spp. Some gear is designed to exploit the anadromous migratory behaviour of the predators. Predator schools can be controlled or eliminated by blocking their migration routes and destroying their spawning grounds. In actual practice, both specific fishing gear and other fishing means are combined for periodic and year-round fishing. Specific fishing gear and methods have been developed to catch demersal predators, e.g., gill nets for mandarin fish and *Culter alburnus*, hooks for mandarin fish, line for catfish and *Pseudobagrus fulvidraco*, scoop nets for *Culter alburnus*, and spears. Most of these methods are designed for small-scale operations. Electricity is also used in some areas to harvest catfish, snakehead, *Pseudobagrus fulvidraco*, and other predators.

Polyethylene gill net for *Elopichthys bambusa*

This special net is used to catch *Elopichthys bambusa*. Although the main function of the net is to entangle the fish, it is also used to block and enclose schools of fish to increase fishing efficiency.

Net structure

The polyethylene gill net is ribbon-shaped and its structure is similar to that of an ordinary gill net. Because *Elopichthys bambusa* is a good swimmer, the selection of materials, hanging coefficient, and installation techniques are somewhat different from other gill nets. Each piece of net is usually 50 m long; however, several pieces of netting can be joined to suit the width of the water body. The height is adapted to suit local conditions. The nets commonly used by the authors are 50 m x 6 m, 50 m x 8 m, 50 m x 10 m, and 50 m x 12 m.

The net is made of polyethylene threads. Depending on the weight of *Elopichthys bambusa* to be caught, three sizes of polyethylene twine (0.25/7x3, 0.25/8x3, and 0.25/9x3) are used. The mesh size (2a) is determined by the age composition and the maximum girth of *Elopichthys bambusa* to be caught. The common mesh sizes are 80, 100, 120, 140, and 150 mm. The hanging coefficients are between those for the gill net and

barrier net. Acceptable hanging coefficients are: horizontal hanging coefficient, $E_1 = 0.38-0.45$; vertical hanging coefficient, $E_2 = 0.89-0.93$.

Both the head and foot lines are made of 6-8 mm polyethylene, and the foot line should be 15-20% longer than the head line. To stiffen the foot line, one palm rope is usually attached to the foot line. Spherical plastic floats with a buoyancy of 400 g and cylindrical lead sinkers are normally used. Total buoyancy and sinking forces are greater than for an ordinary gill net, but are similar to those of a barrier net. In general, 26 plastic floats and 5-10 kg of sinkers are installed on one piece (50 m) of net.

Installation methods

A net with a mesh size of 150 mm is used to illustrate installation methods.

- **Floats.** Installation of floats includes netting and bolch lines for the float line, cork line, and floats. First, a polyethylene rope (0.25/20x3) is used as a bolch line for the float line and is passed through the first row of mesh in the cork line selvedge strip. A 6-mm polyethylene line is then used as a cork line to join the 26 plastic floats. Depending on the desired hanging coefficient, a polyethylene line (0.25/10x3) is used to tie the cork line to the bolch line. There should be two mesh beneath every float and 34 mesh (2 m) between floats. In addition, the cork line and the bolch line for the float line are fixed with two knots at a distance of 1 m, and two mesh are left beneath the two knots.

- **Sinkers.** The installation of sinkers includes the netting, foot line, sinkers, and palm rope. First, a polyethylene rope (0.25/10x3) is passed through the first row of mesh of the lead-line selvedge strip.

Polyethylene line (0.25/6x3 or 0.25/8x3) is then used to tie the netting to the bolch line for the foot line to achieve the desired hanging coefficient. At the same time, each sinker is fixed at a distance of 40 cm. There should be two mesh above each lead sinker, and four mesh between sinkers, which are fixed by a single knot every two mesh. To prevent entanglement of the lead sinkers in the net, an 8-mm palm rope is often attached to the foot line.

Fishing methods

The net is usually placed on the migration route to catch the brooders and stop their spawning. Three kinds of net position are used depending on the morphology and flow rate of the reservoir.

- **Blocking migration route.** The net is positioned across the migration route to catch predators as they migrate upstream (Figure 106). During the rainy season this method produces good results. After the net is set, it is not necessary to remove it repeatedly. The fish that are caught can be harvested at fixed times. The daily catch can reach hundreds of kilograms, but special care is needed to avoid damage caused by boats or rafts. Experience has shown that this method is most suitable in areas with a slow current. If there is a swift current, the net has a lot of drag and is difficult to anchor.

- **Fishing in coves.** To catch *Elopichthys bambusa* in coves or along banks of coves with a slow current, a polyethylene gill net is often strung to block the cove entrance or enclose a specific area. The central portion of the net must be reinforced with anchors or stones. The net is set in the evening, and the fish are harvested the following morning.

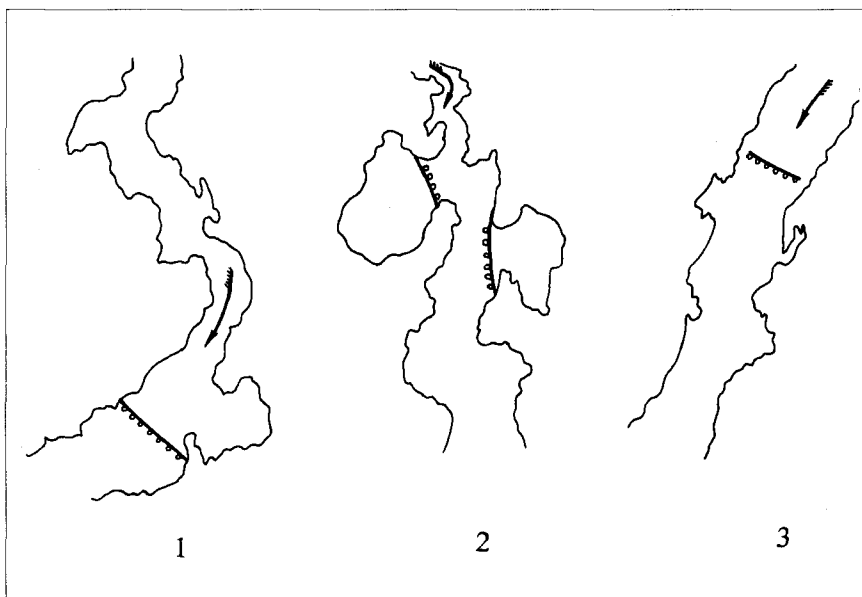

Figure 106. Uses of the polyethylene gill net: (1) blocking the river stream, (2) fishing in coves, and (3) fishing with a drift net.

- **Fishing with drift nets.** In areas with a swift current, drift nets are used for fishing. The polyethylene net is positioned upstream on the migration route of the fish and allowed to drift downstream with the water current. As it drifts, fish moving upstream become entangled in the net.

Cage weir

The cage weir is made of several polyethylene nets that form a cage and a fishing trap. Its structure is based on traditional fishing gear (e.g., labyrinth or weir).

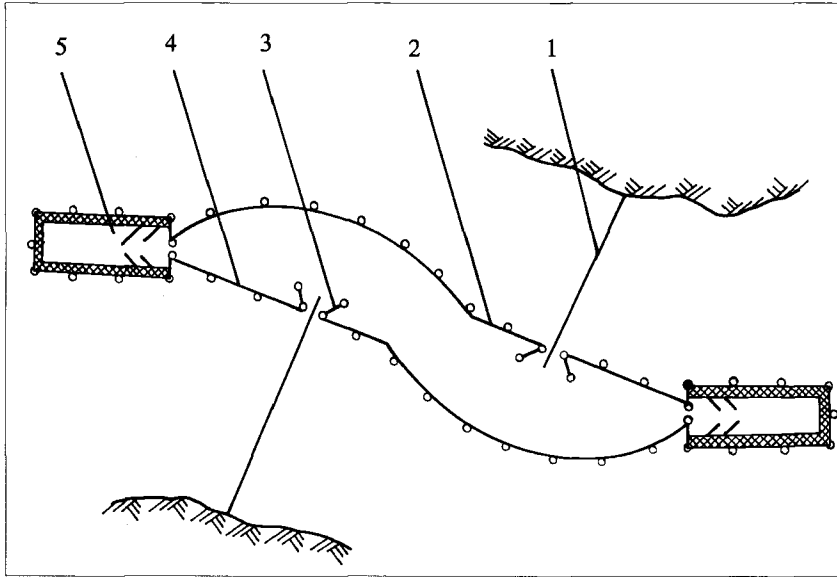

Figure 107. Layout of a cage weir: (1) leader, (2) big-wall net, (3) non-return net, (4) small-wall net, and (5) harvesting cage.

Structure

The cage weir includes a leader, big-wall net, small-wall net, harvesting cage, and non-return net (Figure 107). The leader is used to block the fish and lead them into the weir. The length of the leader varies with the size of the reservoir, and it should be higher than the depth of the water. One end of the leader is tied to the bank and the other is joined to the cage weir at the entrance. Both sides of the cage weir have a leader and there are two 1-m entrances for the fish.

The big-wall net is made of polyethylene netting in the shape of an arc. One end of the big-wall net is connected to the harvesting cage inlet and the other end is fixed adjacent to the leader. The big-wall net is three times as long as the small-wall net and it should be higher than the depth of the water. The small-wall net is similar to the big-wall net in both structure and height, but it is much shorter. The small-wall net and the big-wall net form a 1-m entrance for the fish. The nonreturn net prevents the escape of captured fish. It is 3 m in length and is connected to both the big-wall and small-wall nets at an angle of 60°.

Each harvesting cage is made of five pieces of rectangular netting and a cover net. The inner side of the cage has a 1-m inlet, which should be well tied to the small-wall net and big-wall net. To prevent the escape of fish caught in the cage, two funnel-shaped nets are located about 8-10 m apart. The width of the first funnel is 25 cm; the second is 15 cm. The wall of the harvesting cage is usually made from polyethylene twine (0.23/3x3) and has a mesh size of 3 cm. The cage bottom, however, is normally made from nylon. In general, the cage should be 40-50 m in length, 5-10 m

in width, and be about 1 m higher than the depth of the water. The leader, wall nets, and nonreturn nets are all made from polyethylene twine (0.23/3x3) and have a mesh size of 3-4 cm.

Construction and installation

The cage weir is commonly located at the upstream entrance of streams where the water surface is narrow and the water about 3-6 m deep (Figure 108). When the fishing ground is selected, the bamboo piles are driven into the bottom to give the desired shape. The netting is hung on these

piles. The hanging coefficient of the head line is about 0.5; the coefficient of the foot line is 0.6-0.65. Polyethylene ropes (0.4-0.6 cm in diameter) are used. The head lines of the different nets are supported with 8-10 cm plastic floats, and the foot line is fixed to the bottom with stone sinkers. A cover net should be attached to the upper parts of the harvesting cage. Leaders are constructed from each bank to the cage weir. They are spaced about 20-30 m apart. The small-wall net and the big-wall net, particularly the harvesting cage, should be placed in deeper water.

Fishing methods

The cage weir is usually operated from April to September. Production and the species caught vary with changes in water temperature and rainfall. Generally, cage weirs are constructed before the water temperature rises in early April and the fish start to move upstream to feed and spawn.

Cage weirs work best in the flood season. Daily management is critical for safe operation because reservoir conditions can be changeable and severe. To ensure the safety of cage weirs, the strength and the depth of the piles must be sufficient to tolerate strong water currents. Drifting materials that catch on the leader must also be removed frequently. When a storm is predicted, the mouth of the nonreturn net should be closed and the piles should be checked and reinforced if necessary.

The operation of the cage weir makes use of the fact that fish swim against the water current. The leader blocks fish that are swimming upstream and guides them into the weir and finally into the harvest cage. Fish are usually removed 1-2 times a day depending on capture rate. During harvest, one small boat

(500 kg) and two operators are needed. The net is hauled in and shot out immediately to force the fish from the mouth of the nonreturn net into the cage. This operation is repeated several times to concentrate the fish in a relatively small area. They are removed with a scoop net. The cage must be reset after each harvest. However, stocked fish under the marketable size should be released back into the reservoir. In terms of production and the fish species, there are three peak periods.

In early April when the water temperature increases, various fish species start feeding, their swimming is strengthened, and they migrate from deeper water to shallower coves and upstream areas in the reservoir. As a result, mandarin fish, catfish, snakehead, and other predators are the first to be caught in mid-April. Later, common carp, crucian carp, and *Hemibarbus maculatus* start to spawn and gradually move toward the reservoir banks and migrate upstream to places where vegetation is available. Early May is the first peak for the capture of brooders in cages.

During the rainy season (June-July), the water level increases and the upstream water current is strong. That is the spawning season of *Erythroculter* spp. and they migrate upstream (particularly *Erythroculter mongolicus*). As the rainfall increases, runoff increases and more fish are caught. This is the second peak for capture. For example, the average daily production from a cage weir in Shahe Reservoir in 1982 was 46 kg, but one day in mid-July when the daily rainfall reached 152 mm, daily production increased to more than 1,000 kg (of which 615 kg was *Erythroculter mongolicus*).

In August, the water level in the reservoir is more or less stable and most fish have completed their spawning. The capture of fish in the cage weir essentially ends. However, at this time, the reservoir is rich in

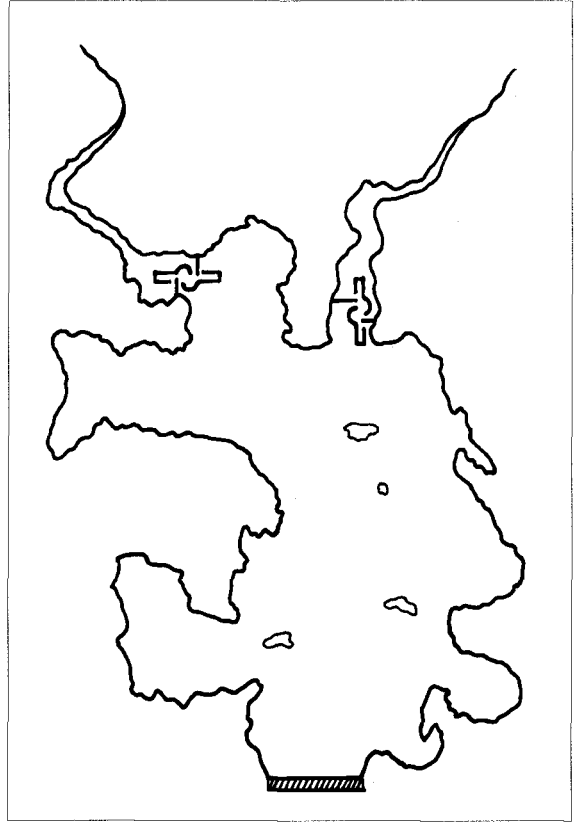

Figure 108. Position of cage weirs in reservoirs.

plankton and organic matter, which promote the growth of silver carp and bighead carp. Some silver carp and bighead carp are caught in the cage weir, which represents the third peak of capture.

REFERENCES

- Academia Sinica Hydrobiology Institute. 1976. *The fishes of Changjiang River*. Science Press, 278 pages (In Chinese).
- Anhui Fisheries Research Institute. 1984. Fisheries food resources of Xianghongdian Reservoir (Unpublished, in Chinese).
- Bennett, G.W. 1962. *Management of artificial lakes and ponds*. Reinhold Publishing Corporation, New York, New York.
- Cao Fukang, Huang Kaiguang, and Zhu Zhengzong. 1976. Fisheries and its utilisation in Qingshan Reservoir. *Chinese Journal of Zoology Sinica* 3: 31-35 (In Chinese).
- Che Yuchun. 1978. Biology of *Culter erythropterus* in Shangtun Reservoir. *Freshwater Fisheries* 4: 16-21 (In Chinese).
- Chen Defu. 1982. Review of the techniques to increase fish production in Dongfeng Reservoir. *Freshwater Fisheries* 5: 6-13 (In Chinese).
- Cheng Jingliang. 1982. Fishing of common carp by the variable-depth trammel net in reservoirs. *Reservoir Fisheries* 3: 44-48 (In Chinese).
- Chen Shouben. 1986. Relationship between manure application and water quality in small reservoirs with semi-intensive culture. *Reservoir Fisheries* 1: 12-15 (In Chinese).
- Chen Zhenyu. 1984. Preliminary study of fisheries potential in reservoirs in Guangxi Autonomous Region. In *Report on the Inland Fisheries Resources in Guangxi Autonomous Region*, pages 479-484. Guangxi Fisheries Research Institute, Guangxi (In Chinese).
- Din Jiashou and Hu Fuliang. 1986. Metal cage fish culture in channels. *Reservoir Fisheries* 6: 10-12 (In Chinese).
- FAO. 1975. *Catalogue of Small-Scale Fishing Gear*. Published by arrangement with the Food and Agriculture Organization of the United Nations. Fishing News Books Ltd., Osney Mead, Oxford.
- Feng Qixin. 1987. Artificial enhancement and its economic analysis for riverine fishes in Zhujiang Delta. *Freshwater Fisheries* 10: 21-23 (In Chinese).
- Guangxi Fisheries Research Institute. 1984. *Investigation of inland fisheries resources in the Guangxi Zhuang Autonomous Region*. Fisheries Research Institute of Guangxi Zhuang Autonomous Region, 645 pages (In Chinese).
- Guansu Fisheries Research Institute. 1984. Investigations of fisheries resources and utilization in Liujiaxia Reservoir. *Reservoir Fisheries* 5: 33-41 (In Chinese).
- Gui Jicai and Rao Guichun. 1984. Some experience on achieving high fish production in reservoirs. *Reservoir Fisheries* 2: 25 (In Chinese).
- Gu Lin and Fong Shangyang. 1992. The effects and culture of silver carp and bighead carp with cages in Panjiakou Reservoir. *Reservoir Fisheries* 1: 33-35 (In Chinese).
- He Zihui and Li Yonghan. 1983. Studies on the plankton in Qinghe Reservoir. *Acta Hydrobiologica Sinica* 8(1): 71-84 (In Chinese with English abstract).
- Hu Batong, Qian Wanmei, and Xi Shaoren. 1983. Studies on stocking density of silver carp fingerlings cultured in cages in Bailianhe Reservoir. *Journal of Fisheries of China* 7(1): 45-54 (In Chinese with English abstract).
- Hubei Fisheries School. 1972. Reservoir fisheries teaching material for fisheries technical school (In Chinese).
- Hubei Provincial Reservoir Investigation Team. 1982. Investigations on fisheries productivity in reservoirs of Hubei Province. *Reservoir Fisheries* 4: 10-45 (In Chinese).
- Hydrobiology Research Institute of Hubei Province. 1975. Experiments on the increase of fish production and its analysis in the East Lake of Wuchang. *Acta Hydrobiologica Sinica* 6(1): 5-15 (In Chinese with English abstract).
- Jenkins, R.M. 1982. The morphoedaphic index and reservoir fish production. *Transactions of the American Fisheries Society*, 111: 133-140.
- Jie Yuhao and Li Bo. 1987. Investigations of fisheries biology in Tumenzi Reservoir. *Reservoir Fisheries*, 1: 1-16 (In Chinese).

- Leng Yongzi, He Litai, and Wei Qinghe. 1984. Population biology and estimation of biomass of *Coreius heterodon* in the upstream of Changjiang River after the damming of Guozhouba Dam. *Freshwater Fisheries* 5: 21-25 (In Chinese).
- Li Changchun. 1984. *Culture and capture fisheries in reservoirs* (Second Edition). Chinese Science Press, Beijing, 310 pages (In Chinese).
- Li Sifa, ed. 1978. Statistical analysis of return rate of silver carp and bighead carp in Qingshan Reservoir. *Chinese Journal of Zoology* (3): 13-16 (In Chinese with English abstract).
- Li Sifa. 1993. A review of freshwater fish genetic conservation research and practices in China. In K.L. Main and E. Reynolds, eds., *Selective Breeding of Fishes in Asia and the United States*, pages 48-59. The Ocean Institute.
- Li Zhenquan, ed. 1984. Investigation report on the fisheries resources of Fenhe Reservoir. *Reservoir Fisheries* 4: 11-17 (In Chinese).
- Lin Songguan, Wu Qi, Xu Qiban, and Shi Feiyao. 1990. Investigations of fisheries resources and fisheries planning in Chunan County. In *Fisheries Science and Technology of Xinanjiang Reservoir*, pages 98-114, Fisheries Bureau of Chunan County (In Chinese).
- Liu Hanyuan. 1988. Running water fish culture in wire cages and its structure. *Reservoir Fisheries* 1: 30-32 (In Chinese).
- Liu Jiankang and He Biwu, eds. 1992. *Cultivation of the Chinese freshwater fishes* (Third Edition). Science Press, Beijing, 750 pages (In Chinese).
- Liu Rui, Zhuo Zhongwu, and Wang Yuwen. 1986. Common carp cage culture techniques in northern China. *Reservoir Fisheries* 1: 14-17 (In Chinese).
- Liu Yuming. 1984. Fisheries resources and utilization in Nanchengzi Reservoir. *Reservoir Fisheries* 2: 49-52 (In Chinese).
- Lu Dingyan. 1986. Study of the comprehensive utilization and development of small-sized reservoirs. *Reservoir Fisheries* 5: 2-8 (In Chinese).
- Lu Quixiang, Huang Mufang, Wang Jincan, and Huang Wenlan. 1979. Analysis of the factors that increase fish yield in Henggang Reservoir, Guangdong Province. *Fisheries Information in Science and Technology* 8: 6-8 (In Chinese).
- Qin Kejing and Liang Zaochun. 1977. A survey on the approach to increase the fish yield of Qinghe Reservoir based on the age-growth of silver carp. *Chinese Journal of Zoology* 3: 30-33 (In Chinese).
- Ryder, R.A. 1965. A method for estimating the potential fish production of north-temperate lakes. *Transactions of the American Fisheries Society* 94: 214-218.
- Ryder R.A. and H.F. Henderson. 1975. Estimations of potential fish yield for the Nasser Reservoir, Arab Republic of Egypt. *Journal of the Fisheries Research Board of Canada* 32: 3127-3151.
- Tang Gangsheng, Yuan Zhanpeng, and Liu Boping. 1992. Management of the fisheries of Fuqiaohe Reservoir, Hubei Province, China. In S. S. de Silva, ed., *Reservoir Fisheries of Asia*, pages 149-154. Proceedings of the 2nd Asian Reservoir Fisheries Workshop held in Hangzhou, China, 15-19 October 1990. International Development Research Centre, Ottawa.
- Wang Ji and Liang Yanling. 1981. An estimate of the potential productivity and stocking rate of fingerlings of silver and bighead carps in Donghu Lake by means of phytoplankton production. *Journal of Fisheries of China* 5(4): 343-350 (In Chinese with English abstract).
- Wei Kelong. 1982. Cage fish culture and its economic efficiency in Foziling reservoir. *Freshwater Fisheries* 3: 28-29 (In Chinese).
- Wei Kelong. 1983. Installation and application of a seine net in Foziling Reservoir. *Reservoir Fisheries* 1: 50-53 (In Chinese).
- Wen Changchun, Zhan Xueshi, and Chang Guangfu. 1993. Summary of techniques to use small-volume and high-density cages for fish culture in large areas. *Reservoir Fisheries* 3: 3-6 (In Chinese).
- Wu Zunlin, Li Bei, Zao Jianli, Ye Fei, and Wu Shanjin. 1987. Review of high production of common carp cultured in cages in Huanglongtan Reservoir. *Reservoir Fisheries* 6: 4-7 (In Chinese).
- Xie Zuohuan. 1982. Benthos of Qinghe Reservoir. *Liaoning Fisheries* 2: 32-34 (In Chinese).
- Xu Sengcai and Wang Chongguan. 1984. Investigation of fisheries resources and utilization of Qingshan Reservoir (Unpublished, in Chinese).
- Xu Senlin. 1983. *Capture of Freshwater Fisheries*. Agriculture Press, Beijing, 307 pages (In Chinese).

- Xu Senlin. 1983. Design and installation of a barrier net in Taipinghu Reservoir. *Reservoir Fisheries* 1: 27-36 (In Chinese).
- Xu Senlin. 1985. Design and installation of a barrier net in Dongzhang Reservoir. *Reservoir Fisheries* 1: 42-46 (In Chinese).
- Xu Senlin, Guo Dade, Yang Xinfan, Zhang Heisheng, and Zu Dean. 1986. Experimental report on the elimination of *Elopichthys bambusa* in Longwanshan Reservoir. *Reservoir Fisheries* (1): 27-31 (In Chinese).
- Yang Qinfang, Guo Heqing, and Jiang Lichun. 1987. Report on high production of tilapia cultured in cages. *Reservoir Fisheries* 5: 6-9 (In Chinese).
- Yang Qinfang and Guo Heqing. 1986. Study of technical measures for higher fish production in small-sized reservoirs with intensive culture. *Reservoir Fisheries* 5: 9-15 (In Chinese).
- Ye Yezhou, Tan Zhenxiao, and Chen Chuncai. 1960. Causes of fish death during overwintering and safety measures. *Chinese Journal of Zoology*. 5: 215-219 (In Chinese).
- Zhang Houxian. 1986. Review on the fish farming strategies in small-sized reservoirs with a yield of 2250 kg/ha. *Freshwater Fisheries* 1: 16-19 (In Chinese).
- Zhang Laifa, Wang Aimin, and Zhao Jinli. 1981. A study on primary productivity of phytoplankton, biomass of plankton and fish productivity of silver carp and bighead carp in Longtou Reservoir. *Journal of Fisheries of China* 5(2): 171-177 (In Chinese with English abstract).
- Zhang Xiaogang. 1984. Preliminary study on the effects of water quality on the fisheries in Hekou Reservoir. *Reservoir Fisheries* (3): 52-56 (In Chinese).
- Zhong Weiguo. 1990. Model LD-1 electric fishing screen used in reservoir fisheries in China. In I.G. Cowx, ed., *Developments in Electric Fishing*. Fishing News Books Ltd., Osney Mead, Oxford, 297 pages.
- Zhou Yinjia. 1982. Experimental report on the introduction of rainbow trout in Xinanjiang Reservoir. *Freshwater Fisheries* 2: 1-3 (In Chinese).
- Zhu Guozhang. 1986. *Xenocypris* spp. and their utilization in Xianghongdian Reservoir. *Reservoir Fisheries* 6: 5-8 (In Chinese).
- Zhu Wenbo. 1987. Foziling Reservoir farm in progress. *Reservoir Fisheries* 5: 32-33 (In Chinese).
- Zhu Zhirong (Chu Chi-Rong), Lin Yung-Tai, and Fang Rong-Lu. 1976. On the food habit of *Erythroculter mongolicus* and *E. ilishaeformis* in lake Tung-Hu, Wuchang, and the problem of their population control. *Acta Hydrobiologica Sinica* 6(1): 36-52 (In Chinese with English abstract).

LIST OF FISH SPECIES

(Line indicates that there is no common name in English for the species.)

COMMON NAME	SCIENTIFIC NAME	COMMON NAME	SCIENTIFIC NAME
Chinese sturgeon	<i>Acipenser sinensis</i>	—	<i>Luciobrama macrocephalus</i>
—	<i>Ancherythroculter</i>	Fight fish	<i>Macropodus chinensis</i>
—	<i>kurematsui</i>	River shad	<i>Macrura</i> spp.
—	<i>Ancherythroculter wangi</i>	Blunt-snout bream,	<i>Megalobrama amblycephala</i>
River eel	<i>Anguilla japonica</i>	Wuchang fish	
Marbled eel	<i>Anguilla marmorata</i>	Black bream	<i>Megalobrama terminalis</i>
Bighead carp	<i>Aristichthys nobilis</i>	Oriental weatherfish	<i>Misgurnus anguillicaudatus</i>
—	<i>Barbodes (Spinibarbus)</i>	Ricefield eel	<i>Monopterus albus</i>
—	<i>sinensis</i>	Black carp	<i>Mylopharyngodon piceus</i>
—	<i>Beaufortia leveretti</i>	—	<i>Mystus</i> spp.
Crucian carp	<i>Carassius auratus auratus</i>	—	<i>Ochetobius elongatus</i>
Crucian carp	<i>Carassius carassius</i>	Rainbow trout	<i>Oncorhynchus mykiss</i>
—	<i>Channa argus</i>		<i>(Salmo gairdneri)</i>
—	<i>Channa asiatica</i>	Snakehead	<i>Ophiocephalus argus</i>
Mud carp	<i>Cirrhina molitorella</i>	Horse mouth fish	<i>Opsariichthys bidens</i>
Taper-tail anchovy	<i>Coilia brachygnathus</i>	Piscivorous chub	<i>Opsariichthys uncirostris</i>
White fish	<i>Coregonus</i> spp.	Horse mouth fish	<i>Opsariichthys uncirostris</i>
Grass carp	<i>Ctenopharyngodon idellus</i>		<i>amurensis</i>
Pope's goby	<i>Ctenogobius cliffordpopei</i>	Tilapia	<i>Oreochromis</i> spp.
—	<i>Culter alburnus</i>	Grass bream	<i>Parabramis pekinensis</i>
—	<i>Culter brevicauda</i>	Catfish	<i>Parasilurus asotus</i>
—	<i>Culter erythropterus</i>	Yellow catfish	<i>Pelteobagrus fulvidraco</i>
Common carp	<i>Cyprinus carpio</i>	—	<i>Pelteobagrus</i> spp.
Spined loach	<i>Cobitis</i> spp.	—	<i>Plagiognathops microlepis</i>
—	<i>Distoechodon tumirostris</i>	Ayus	<i>Plectoglossus altivelis</i>
Yellow-cheek carp	<i>Elopichthys bambusa</i>	Rock carp	<i>Procypris rabaudi</i>
Blue tail	<i>Erythroculter dabryi</i>	—	<i>Pseudobagrus fulvidraco</i>
Vertical mouth	<i>Erythroculter ilishaeformis</i>	—	<i>Pseudogobio vaillanti</i>
Red tail	<i>Erythroculter mongolicus</i>	—	<i>Pseudolaubuca sinensis</i>
—	<i>Erythroculter oxycephaloides</i>	Top-mouth gudgeon	<i>Pseudorasbora parva</i>
—	<i>Erythroculter</i>	Bar-cheek goby	<i>Rhinogobius giurinus</i>
	<i>pseudobrevicauda</i>	Bitterling	<i>Rhodeus</i> spp.
Amur pike	<i>Esox reicherti</i>	Chinese fat minnow	<i>Sarcocheilichthys sinensis</i>
Gudgeon	<i>Gnathopogon</i> spp.	Long-nose gudgeon	<i>Saugobio dabryi</i>
—	<i>Gnathopogon chankaensis</i>	Oriental sheatfish	<i>Silurus asotus</i>
Skin carp	<i>Hemibarbus labeo</i>	—	<i>Sinilabeo decorus</i>
—	<i>Hemibarbus maculatus</i>	—	<i>Sinilabeo rendahli</i>
—	<i>Hemiculter leucisculus</i>	—	<i>Sinibrama macrops</i>
Icefish	<i>Hemisalanx branchyrostralis</i>	Mandarin fish	<i>Siniperca chuatsi</i>
Sturgeon	<i>Hilsa reevesii</i>	Spotted mandarin fish	<i>Siniperca schezer</i>
Taimen	<i>Hucho taimen</i>	—	<i>Spinibarbus sinensis</i>
Pond smelt	<i>Hypomesus olidus</i>	—	<i>Squaliobarbus curriculus</i>
Large-scale silver carp	<i>Hypophthalmichthys</i>	—	<i>Toxabramis swinhonis</i>
	<i>harmandi</i>	—	<i>Varicorhinus</i>
Silver carp	<i>Hypophthalmichthys</i>	—	<i>(Onychostoma) simus</i>
—	<i>molitrix</i>	—	<i>Varicorhinus (Onychostoma)</i>
—	<i>Hypseleotris swinhonis</i>		<i>angustistomatus</i>
Yalu River lamprey	<i>Lampetra morii</i>	Small-scale fish	<i>Xenocypris argentea</i>
—	<i>Leocassis</i> spp.	Yellow-tail fish	<i>Xenocypris davidi</i>
—	<i>Leuciscus waleckii</i>	—	<i>Xenocypris microlepis</i>

LIST OF RESERVOIRS

NAME	AREA (HA)	PROVINCE	NAME	AREA (HA)	PROVINCE
Ansha	4,670	Sichuan	Jindou	200	Shangdong
Bailianhe	4,000	Hubei	Jinjiang	1,110	Guangdong
Bameng	667	Guangxi	Jiuyang	87	Guangxi
Bantou	333	Fujian	Kalun	330	Jiling
Beiguishan	5,330	Henan	Kangning	—	—
Beisha	22	Guangxi	Kongwangshan	—	—
Beishi	47	Guangxi	Lingdon	667	Guangxi
Caihe	1,780	Liaoning	Linglong	800	Guangxi
Changshouhu	4,670	Shichuan	Liujiaxia	10,700	Gansu
Changtan	2,000	Zhejiang	Liuxihe	1,330	Guangdong
Chengbihe	2,100	Guangxi	Longfengshan	—	Heilongjiang
Chengxi	533	Anhui	Longtou	71	Jilin
Dahuofang	5,000	Liaoning	Longwanshan	—	Jiangsu
Dashahe	667	Guangdong	Mafu	7	Fujian
Dawangtan	2,500	Guangxi	Meichuan	167	Hubei
Dingbiao	100	Guangxi	Meishan	10	Jiangxi
Dingluo	101	Guangxi	Meshan	5,000	Anhui
Dingxi	133	Fujian	Mingshan	667	Hubei
Dongfeng	160	Zhejiang	Miyun	8,000	Beijing
Dongqianhu	2,000	Zhejiang	Mozitan	570	Anhui
Dongzhang	1,000	Fujian	Najiang	160	Guangxi
Dujiashan	23	Shaanxi	Nanchengzi	533	Liaoling
Dushan	147	Guangxi	Nanshahe	160	Shanxi
Ersheng	547	Jiangsu	Nanshan	3,800	Guangdong
Fengchkou	3	Zhejiang	Nanwan	5,670	Henan
Fenhe	1,670	Shanxi	Panjiakou	700	Hebei
Foziling	2,000	Anhui	Panqiao	970	Jiangxi
Fuqiaohe	1,330	Hubei	Pohe	1,330	Henan
Gangnan	3,380	Hebei	Qianhu	4,000	Anhui
Gaozhou	4,000	Guangdong	Qiaozijian	467	Anhui
Gedalou	—	Liaoning	Qinghe	3,000	Liaoning
Guanchang	70	Jiangsu	Qingping	400	Guangxi
Guanmen	30	Liaoning	Qingqiao	100	Fujian
Guanmenchong	2	Zhejiang	Qingshan	567	Zhejiang
Guanting	7,080	Beijing	Qingshitan	2,180	Guangxi
Guishi	3,000	Guangxi	Qixi	533	Hujian
Gutian	866	Fujian	Sandaoling	—	Liaoning
Hanshan	47	Guangxi	Shahe	1,470	Jiangsu
Hedi	10,670	Guangdong	Shahezi	—	—
Hekou	1,200	Shanxi	Shangtun	467	Liaoning
Helong	—	Jilin	Shangyansan	—	Heilongjiang
Heiwuwan	560	Hubei	Shiquant	—	Shanxi
Henggang	—	Guangdong	Shishankou	2,400	Henan
Henshling	—	Hubei	Shishantou	13	Jiangsu
Heping	127	Liaoning	Shonghuahu	—	—
Honglingjin	—	Hebei	Shuifeng	—	Liaoning
Huangbizhuang	3,333	Hebei	Shushanhe	1,530	Anhui
Huanglongtan	642	Hubei	Sifanghu	667	Anhui
Huiting	1,310	Hubei	Siweihe	246	Guangxi
Hulukou	300	Sichuan			
Jiaokou	263	Zhejiang			

Continued next page

Continued from previous page

NAME	AREA (HA)	PROVINCE	NAME	AREA (HA)	PROVINCE
Sixing	16	Liaoning	Xijin	13,090	Guangxi
Songhuahu	3,330	Jilin	Xinanjiang	40,000	Zhejiang
Songtao	10,000	Hainan	Xinfu	7	Sichuan
Suyahe	14,670	Henan	Xingxingshao	1,000	Jilin
Taipinghu	8,670	Anhui	Xinlicheng	4,500	Jilin
Tangquan	38	Hebei	Xipaozi	3,000	Liaoning
Taoyuanhe	—	Hebei	Xiyunjiang	223	Guangxi
Tiantang	146	Guangxi	Xuantan	1	Sichuan
Tielian	50	Guangxi	Xujahe	3,840	Hubei
Tieshan	3,000	Hunan	Yangmeiling	140	Zhejiang
Tuanjie	500	Liaoning	Yimei	—	—
Tuhe	—	Hubei	Yingling	84	Guangxi
Tumenzi	930	Liaoning	Yongxing	—	Liaoning
Tuohu	4,000	Anhui	Zhanghe	6,000	Hubei
Wagou	9	Jiangsu	Zhongdang	473	Guangxi
Wangwo	70	Shandong			
Xiangang	953	Guangdong	Classnor	210,000	Former USSR
Xianghongdian	4,000	Anhui	Kuibyshev	645,000	Former USSR
Xiangyang	5	Zhejiang	Nasser	308,700	Egypt
Xiangyansan	1,000	Heilongjiang	Northbirsk	547,000	Former USSR
Xiashan	7,470	Shandong			

China produces more freshwater fish than any other country in the world, but most information on culture techniques has so far focused on the now-famous Chinese system of fish culture in ponds. In view of current predictions for the construction of new reservoirs throughout Asia, reservoir fisheries hold considerable potential to increase fish production in this region. However, until now, much of this information has not been available in English. This book is one of the first focusing on the culture and capture of fishes in Chinese reservoirs.

It covers the following topics:

- Hydrological and physicochemical characteristics of reservoirs
- Natural food organisms
- Development of fish resources
- Assessment of fish productivity in reservoirs
- Culture of large-size fingerlings
- Stocking
- Management of natural fish resources
- Barriers and harvest techniques



ISBN 983-9054-11-2 (SOUTHBOUND)
ISBN 0-88936-749-3 (IDRC)