



# FILSTAR XP

FILSTAR XP-S



FILSTAR XP-M



FILSTAR XP-XL



FILSTAR XP-L



User Guide  
Notice d'utilisation  
Guía de uso

# IMPORTANT SAFETY INSTRUCTIONS

## WARNING –

To guard against injury, basic safety precautions should be observed, including the following:

### A. READ & FOLLOW ALL SAFETY INSTRUCTIONS

**B. DANGER** – To avoid possible electric shock, special care should be taken since water is employed in the use of aquarium equipment. For each of the following situations, do not attempt repairs by yourself; return the filter to an authorized dealer for service or discard the filter.

1. This filter is designed for indoor use only.
2. If the filter falls into the water, DON'T reach for it! First unplug it and then retrieve it. If electrical components of the filter get wet, unplug the immediately.
3. Carefully examine the filter after installation. It should not be plugged in if there is water on parts not intended to be wet.
4. Do not operate any filter if it has a damaged cord, plug, if it is malfunctioning or has been dropped or damaged in any manner.
5. To avoid the possibility of the filter plug or receptacle getting wet, position aquarium stand and tank to one side of a wall-mounted receptacle to prevent water from dripping onto the receptacle or plug. A "drip loop", shown in the figure at the top of the page, should be arranged by the user for each cord connecting an aquarium filter to a receptacle. The "drip

loop" is that part of the cord below the level of the receptacle, (or the connector if an extension cord is used), to prevent water traveling along the cord and coming in contact with the receptacle. If the plug or receptacle does get wet, DON'T unplug the cord.

Disconnect the fuse or circuit breaker that supplies power to the filter. Then unplug and examine for presence of water in the receptacle.

- C. Close supervision is necessary when any filter is used by or near children.
- D. To avoid injury, do not touch moving parts.
- E. Always unplug a filter from the outlet when not in use before putting on or taking off parts, and before cleaning. Never yank cord to pull plug from outlet. Grasp the plug and pull to disconnect.
- F. Do not use the filter for any other purpose than intended use. The use of attachments not recommended or sold by the filter manufacturer may cause an unsafe condition.
- G. Do not install or store the filter where it will be exposed to the weather or to temperatures below freezing.
- H. Make sure a filter mounted on a tank is securely installed before operating it.
- I. Read and observe all the important notices on the filter.
- J. If an extension cord is necessary, a cord with a proper rating should be used. A cord rated for less amps or watts than the filter rating may overheat. Care should be taken to arrange the cord so that it will not be tripped over or pulled.
- K. **Maintenance:**
  - Disconnect the power supply to all equipment in the

aquarium before putting your hands in the water

- Do not carry the filter using the handle or the pipes
- Do not force the handle when it is closed
- The rotor is lubricated by water, it is therefore essential never to operate with a dry filter, this would cause the rotor to wear rapidly

**L. Warning:** This product contains a chemical known to the State of California to cause cancer or birth defects or other reproductive harm.

### M. SAVE THESE INSTRUCTIONS

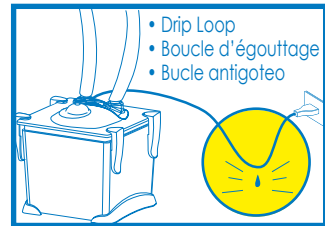

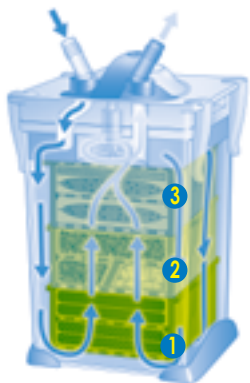

## FILTRATION MEDIA

The API® range contains all the filtration media you are likely to need for personalizing your installation and keeping your aquarium in perfect balance. You can modify the filtration media to adapt the system to your aquarium, while being careful to always respect the following filtration order:

- 1 **Mechanical filtration for waste particles:** Foam, pad
- 2 **Biological filtration for aquarium's balance:** BIO-CHEM STARS®, ceramic rings
- 3 **Chemical filtration for crystal clear water:** API® BIO-CHEM ZORB®, NITRA-ZORB®, PHOS-ZORB®, SUPER ACTIVATED CARBON

Some filter models have additional compartments that allow you to increase the filtration capacity by adding additional biological or chemical filtration media.

### MECHANICAL FILTRATION

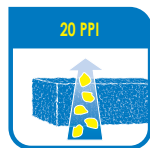

**FOAM 20 PPI**

- Filters large waste particles (food remains, plant remains...)
- First filtration step
- Replace every 3 months

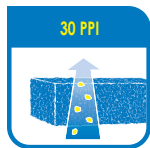

**FOAM 30 PPI\***

- Filters small waste particles (food remains, small gravel excrements...)
- Use after foam for large waste particles
- Replace every 3 months



**MICRO-FILTRATION PAD**

- Captures the finest particles
- Replace every month



**PROGRESSIVE MICRO-FILTRATION\***

- Captures the final filtration waste
- Very effective after a major servicing of the aquarium
- Replace every time you change the water or at least monthly

### BIOLOGICAL FILTRATION



**BIO-CHEM STARS®**

- Establish an optimal and long-lasting biological balance
- House massive quantities of bacteria
- Long-lasting effectiveness

### CHEMICAL FILTRATION



**BIO-CHEM ZORB®**

- Makes the water crystal clear
- Eliminates bad odors
- Absorbs toxic waste
- Fast acting
- Replace every 2 months



**PHOS ZORB®\***

- Limits the growth of algae due to the presence of phosphates
- Eliminates phosphates and silicates
- Encourages the growth of corals
- Replace every month



**NITRA ZORB®\***

- Limits the growth of algae due to the presence of nitrates
- Protects fish from pollution peaks
- Can be recharged 10 times
- Replace after 10 recharges



**SUPER ACTIVATED CARBON\***

- Clarifies the water
- Reduces bad odors
- Absorbs toxic waste
- Replace every month



**ZEOLITE AMMONIA REMOVER\***

- Removes deadly ammonia, the #1 killer of tropical fish
- Replace every 2 months



### MIX YOUR MEDIA AS YOU WISH

- A **MICRO-FILTRATION** or **PROGRESSIVE MICRO-FILTRATION**
- B **BIO-CHEM ZORB®** and/or **NITRA-ZORB®, PHOS-ZORB®, SUPER ACTIVATED CARBON** or **ZEOLITE AMMONIA REMOVER** according to the needs of your aquarium.
- C **BIO-CHEM STARS®**  
 XP-S: 8 - 10 stars  
 XP-M: 15 - 20 stars  
 XP-L: 30 - 35 stars  
 XP-XL: 50 - 55 stars
- D **FOAM 30 PPI**
- E **FOAM 20 PPI**

### FILTER MEDIA INSTALLATION



1. Remove the API® BIO-CHEM ZORB® from the plastic bag and rinse it until the water is clear.



2. Remove the BIO-CHEM STARS® and/or the ceramic rings from their plastic bags and rinse them.

For optimal filtration effectiveness, we recommend filling the additional compartments of your filter with a biological filtration substrate (ceramic rings or BIO-CHEM STARS®), or with a chemical filtration media, to adapt your system to the precise needs of your aquarium.

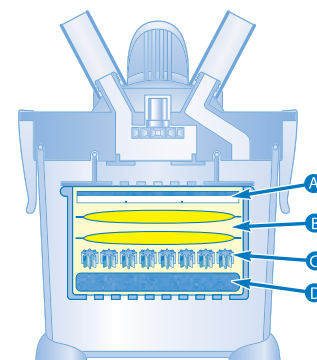

XP-S

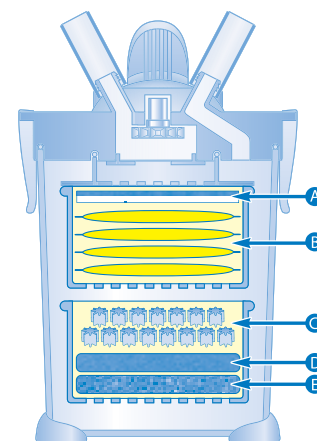

XP-M

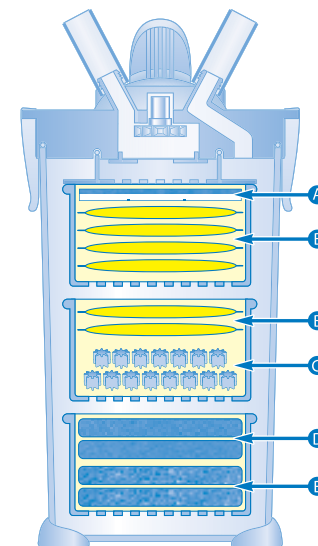

XP-L

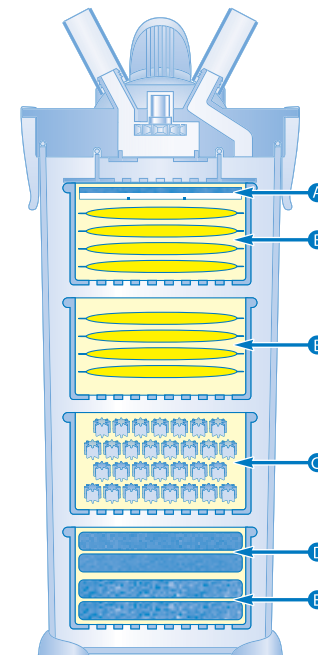

XP-XL

## EN INTRODUCTION

Congratulations!

You are now the owner of the finest canister filter available, the API® FILSTAR XP. Extremely powerful, unbelievably easy to use and maintain, and so silent it can be used in any room in the house.

The FILSTAR XP Canister Filter offers several set-up options, making it adaptable to fit your individual needs, and includes features that set it apart from all other canister filters:

- **Easy Start-Up – One-time, self-priming system:** Primes in seconds, without hand-pumping or manual siphoning
- **Maximum Capacity:** Large baskets hold API® filter media products
- **Unique Anti-Airlock System:** Prevents overheating and eliminates the need for re-priming
- **Bypass-Free Circulation:** Ensures complete water flow through filter media, not around it
- **Quick-Disconnect with a self-locking water shutoff system:** Prevents leaking during maintenance
- **Long-lasting, heavy-gauge construction:** Stands up to the rigors of everyday use
- **Easy Access:** Gives immediate access to media baskets, impeller, and shaft
- **Large Rubber Base:** Keeps filter in place and completely dampens vibration

Various API® media products are available, enabling you to customize your filtration system to meet your own particular aquatic requirements. Some of these media are included with the filter (API® BIO-CHEM ZORB®, advanced filtration media for exceptional water quality and fish health; FOAM 20 removes coarse debris; FOAM 30 for removal of finer debris; MICRO-FILTRATION PADS for ultra-fine filtration & polishing...)\*. All you have to do is drop the pouch into the media basket – it's that simple.

Thank you for purchasing a FILSTAR XP. You'll soon see the difference the FILSTAR XP'S advanced filtration system makes in creating a cleaner, healthier environment for your fish.

\* The exact contents of the box can vary depending on the filter model

PARTS



1. FILSTAR XP FILTER
2. Quick disconnect valve
3. API® BIO-CHEM ZORB®
4. API® BIO-CHEM STARS® (5 each)
5. Flexible tubing (2 each)

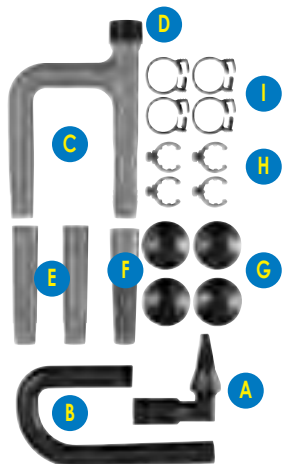

6. Accessories:
  - A. Goose neck
  - B. Outlet pipe
  - C. Inlet pipe
  - D. Inlet pipe cap
  - E. Inlet pipe 3" (8 cm) extension (2 each)
  - F. Inlet strainer
  - G. Suction cups (4 each)
  - H. Suction cup clamps (4 each)
  - I. Flexible tubing clamps (4 each)

BEFORE YOU BEGIN

Read all safety instructions in this booklet before beginning.

In the directions:

- "Inlet" refers to water going INTO the FILSTAR XP Filter
- "Outlet" is water coming OUT of the FILSTAR XP Filter and back into your aquarium

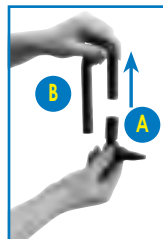

1. Connect Goose neck A to Outlet pipe B.

2. Make sure the filter is a minimum of 24" (60 cm) to a maximum of 55" (140 cm) BELOW the water level of the aquarium. The filter will need to sit on a level surface.

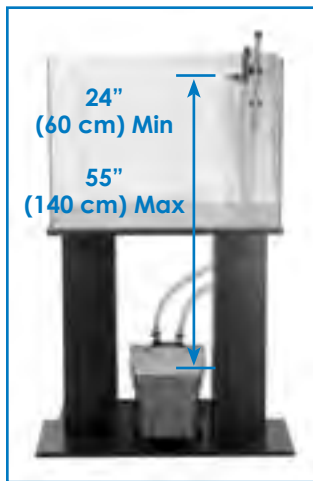

3. Take a look at your aquarium and decide where you want to place the inlet and outlet pipes and the FILSTAR Filter.
4. Make sure the hoses will be long enough and won't be stretched after installation.

For USA and Canada

If a part is missing or damaged, please do not return the filter to the store. Call our Technical Service Department at 1-800-847-0659 or visit our website: [www.apifishcare.com](http://www.apifishcare.com) Other countries: please ask your retailer.

INLET PIPE ASSEMBLY

1. This is the set-up that flows water into the filter.

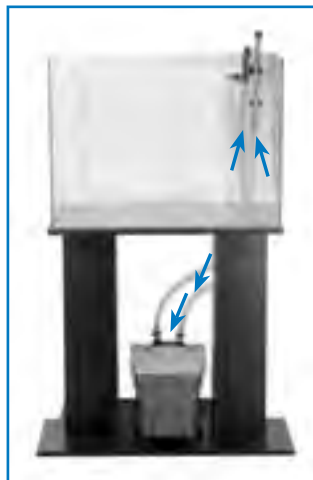

2. You will want the Inlet Strainer F on the Inlet Pipe C to be about 4" (10 cm) from the gravel bed.

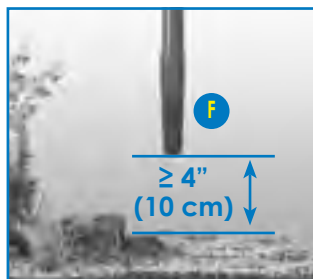

3. Choose the number of E pieces according to the depth of your aquarium.

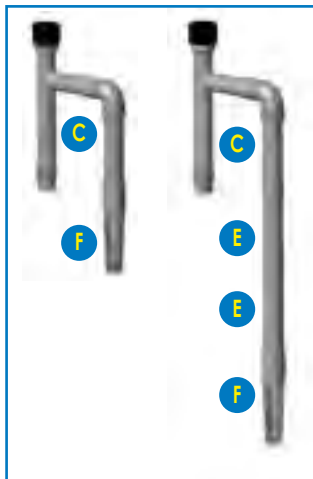

4. The Flexible Tubing 5 should be pushed on the Inlet Pipe C 2" (5 cm) and secured with a Flexible Tubing Clamp I.

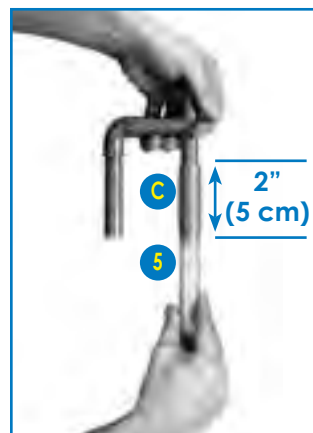

5. Attach 2 each Suction Cup Clamps H with 2 each Suction Cups G to the Inlet Pipe C so that it can be secured to the aquarium.



CONNECTION TO THE FILTER

1. The inlet connection on the filter is marked by the drawing and by the same color of the accessories one (light grey).



2. Measure the flexible tubing that is attached to the Inlet Assembly, mark with a pen.



3. Add 4" (10 cm) to this mark and cut.



Note: It is very important NOT to cut the tubing too short. If the tubing is cut too short it creates tension on the quick disconnect valve, and the filter may leak. Additionally, leaving the tubing too long may prevent the filter from priming and greatly reduce the waterflow.

4. Push the tube onto the water inlet of the Quick Disconnect Valve. This inlet connection on the filter is marked by the drawing and by the light grey color. Secure the Flexible Tubing with a Flexible Tubing Clamp.



**OULET PIPE ASSEMBLY**

1. This is the set-up that returns water back to the aquarium.

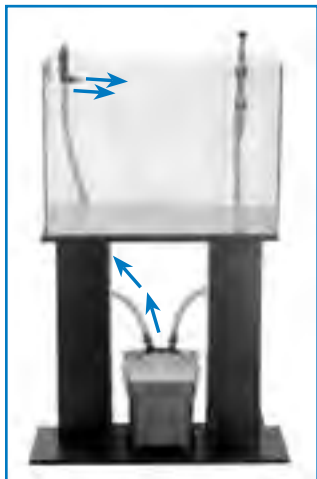

2. The outlet connection on the filter is marked by the drawing  and by the same color of the accessories one (dark grey).

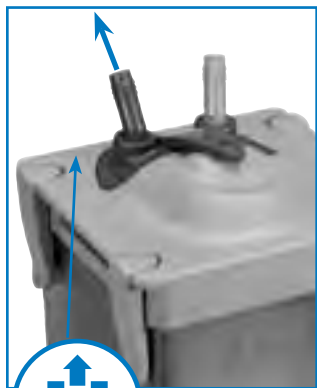

3. The Flexible Tubing **5** should be pushed onto the Outlet Pipe **B** 2" (5 cm) and secured with a Flexible Tubing Clamp **A**.

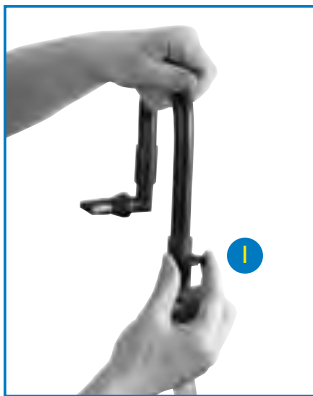
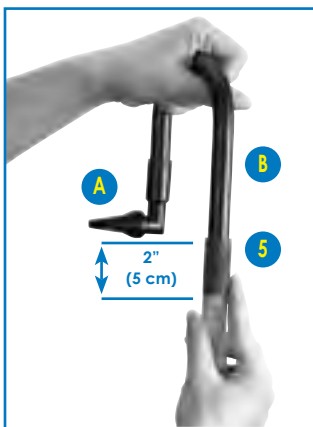

4. Attach two each Suction Cup Clamps **H** with two each Suction Cups **G** to the Outlet Pipe so that it can be secured in the aquarium.



**CONNECTING TO THE FILTER**

1. Follow the procedure described on page 7 to measure and cut your tubing.
2. Push the tube onto the water outlet of the Quick Disconnect Valve. This outlet connection on the filter is marked by the  drawing and by the dark grey color. Secure the Flexible Tubing with a Flexible Tubing Clamp.



**PRIMING THE FILTER**

1. When you have finished assembling your filter, lift the lever on the Quick Disconnect Valve.



2. Remove the Inlet Pipe Cap **D**.

3. Pour water in until the tube in between the Inlet Pipe Assembly and the Quick Disconnect Valve is full of water.

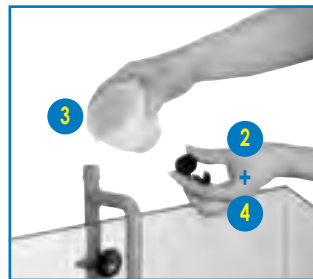

4. Replace the Inlet Cap securely.

5. Make sure the Quick Disconnect Valve is fully seated in the Blue Motor Housing and then push the lever down.



6. The canister should begin to fill with water and air should be forced out through the tubing.

7. Allow 2 minutes for the filter and tubing to fill completely and plug in the power cord.

Once the unit is primed and plugged in, the water should start to pump into the tank and drain back out into the canister. If it does not, consult the Trouble Shooting on this page.

**Plugging in the power cord:** To avoid the possibility of the electric plug getting wet, a "drip-loop", should be arranged by the user. See Safety Instructions on page 2 for more information on the drip-loop.

**NOTE:** If water does come into contact with the receptacle or the plug, turn the power supply off at the circuit box. DO NOT unplug the cord until the power supply is off.

**CLEANING & MAINTENANCE**

Regular cleaning, maintenance and replacement of the API® media is necessary in order to assure continued trouble free operation of your filter.

As a general rule:

- **Every month**
  - Change 1/4 of the aquarium water
- **Every 2 months**
  - Rinse the foam of the filter
  - Replace the API® BIO-CHEM ZORB®

With more experience, you will adapt these instructions to the specific needs of your aquarium.

**If the flow of water through your filter begins to decrease or stops, it is most likely due to dirty or clogged filter media, and should be cleaned immediately.**

1. Unplug the power cord from the electrical outlet.

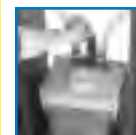

2. Lift up on the Quick Disconnect Valve.

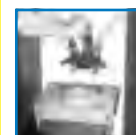

3. Gently disengage the Quick Disconnect Valve from the top of the Blue Motor Housing.



4. Carry the filter to the sink using the handles molded into the Blue Motor Housing. Do not carry the filter by the clamps on the canister, this could damage the filter.

5. Release the 4 clamps and remove the Blue Motor Housing. Remove the media baskets from the canister and empty out the water. Rinse or change the filtration media.

Note: The micro-filtration pad collects very fine particles and is difficult to rinse clean. It is recommended to replace this pad at every cleaning.

If you are using a bio-media such as BIO-CHEM STARS® or ceramic rings, rinse them lightly with water from the aquarium, **NOT TAP WATER.**

6. Rinse the canister, baskets and impeller.



7. Replace the filtration media in the baskets and the baskets in the canister. Replace the housing unit, secure the 4 clamps and

return the empty filter to its position under the aquarium.

8. Replace the Quick Disconnect Valve and push the lever down. Water should begin to fill the canister automatically.
9. Wait for 2 minutes and plug in the power cord.

**TROUBLE SHOOTING**

**There is slow, reduced or no water flow**

- Make sure that the filtration media is clean. If not, rinse it or change it
- Make sure the power cord is plugged in.
- Make sure the filter is at least 24" (60 cm) below the water level
- Make sure that the lever on the Quick-Disconnect is fully in the down/closed position
- Make sure that the Inlet Pipe Cap (H) used in the initial set-up is on tight and that all parts are properly fitted
- Make sure that the hoses are not kinked or clogged
- Make sure that the strainer is not clogged

**Filter leaks from the main seal**

- Check to make sure that all four clamps are properly closed
- Make sure the filter is no more than 55" (140 cm) below the water level. If it is deeper, raise the filter
- Make sure the O-ring is not damaged or twisted
- Make sure there is no gravel or other solid object between the canister and the O-ring
- Check the top edge of the filter for any chips, or cracks

**Water is leaking from where the power cord passes out of the motor housing**

- Make sure the filter is no more than 55" (140 cm) below the water level. If it is deeper, raise the filter
- Check the hoses and make sure they have not been cut too short or stretched too far creating tension on the Quick-Disconnect. If the hoses have been cut to short, change them

**The filter is noisy**

- Unplug the filter and wait two minutes. It allows the air to pass through the filter
- Clean the filter as described in the Cleaning Section

**Air has entered the filter**

- Make sure that no air stone or bubbling ornaments are located in the aquarium below or near the inlet pipe strainer
- Check to make sure that all four clamps are properly closed
- Make sure that the Inlet Pipe Cap (H) used in the initial set-up is on tight and that all inlet and outlet parts are properly fitted
- Make sure that the Flexible Tubing Clamps are in place and securely fitted

**GUARANTEE****2 YEAR LIMITED WARRANTY**

The product that you have purchased is warranted against defects of material and workmanship for two (2) years after the date of purchase. Our responsibility and liability is limited to replacing any such defective product.

This warranty does not cover or apply to improper use or installation, failure to follow or comply with the enclosed instructions, normal wear of parts or if the product has been tampered with or altered.

To obtain performance under this warranty, you must follow these instructions:

- 1) Do not return this product to the place of purchase: doing so may delay the processing of your claim.
- 2) To obtain warranty service, please call our Technical Service Department toll-free at 1-800-847-0659 to obtain a return authorization number. At this time, our technical service representative may be able to assist you in correcting the problem.
- 3) Pack the filter carefully.
- 4) Enclose a brief description of the defect or malfunction with your name and mailing address.
- 5) Enclose a copy of your purchase receipt.
- 6) Enclose \$10.00 for shipping and handling. Please pay by check or money order.
- 7) Send your filter to:  
Mars Fishcare North America, Inc.  
Attention: Warranty  
50 East Hamilton Street  
Chalfont, PA 18914
- 8) Mark the box with the return authorization number given to you on the phone.
- 9) Allow 30 days for the return of your filter.

No representative has any authority to change or enlarge the above warranty or our liability. This warranty gives you specific legal rights and you also may have other rights which vary from state to state. These warranties do not cover any damage caused by accident, misuse, shipment or other than ordinary consumer use. **WE EXCLUDE AND ARE NOT RESPONSIBLE FOR ANY CONSEQUENTIAL DAMAGES (SUCH A DAMAGE TO OR LOSS OF FISH, ANIMATE MATTER OR PERSONAL PROPERTY) NOR FOR ANY IMPLIED WARRANTY THAT RELATES TO OUR PRODUCT.** Some states do not allow the exclusion or limitation of incidental or consequential damages, so the above limitation or exclusion may not apply to you.

**GARANTIE****GARANTIE LIMITÉE 2 ANS**

Cet appareil est garanti contre les défauts de matériel ou de main d'œuvre pour une période de deux (2) ans à partir de la date d'achat par l'utilisateur. Cette garantie ne couvre pas les dommages pouvant résulter d'influences extérieures, d'une mauvaise manipulation ou d'un bricolage non autorisé.

Suivez les instructions suivantes pour faire jouer la garantie : ne pas retourner cet appareil dans le magasin où il a été acheté au risque de retarder le suivi de la réclamation. Pour obtenir le Service Garantie, contacter notre Service Technique au numéro gratuit suivant : 1-800-847-0659 pour obtenir un numéro d'autorisation. Dès lors notre Service Technique sera en mesure de vous aider à résoudre votre problème. Emballer le filtre avec précaution. Joindre un courrier décrivant la panne ou le défaut en précisant votre nom et adresse. Joindre une copie de votre preuve d'achat. Joindre un chèque (ou un ordre de règlement) d'un montant de \$10.00 pour couvrir les frais d'envoi et de suivi. Envoyer le filtre à l'adresse suivante : Mars Fishcare North America, Inc., Attention : Warranty, 50 East Hamilton Street, Chalfont, PA 18914. Indiquer sur la boîte le numéro d'autorisation communiqué au téléphone par notre Service Technique. Patienter 30 jours avant le retour du filtre. Aucun représentant n'est habilité à modifier ou élargir la garantie ci-dessus ou notre responsabilité. Cette garantie vous offre des droits spécifiques et vous pouvez aussi bénéficier d'autres droits qui peuvent varier d'un état à un autre. Cette garantie ne couvre pas les dommages pouvant résulter d'un accident, d'un mauvais usage, d'un transport ou de toute manipulation autre que celle prévue dans le cas d'une utilisation normale de l'appareil. **AUCUN AUTRE RECOURS N'EST POSSIBLE CONTRE NOUS, EN PARTICULIER, NOUS N'ACCEPTONS AUCUNE RESPONSABILITE POUR LES DOMMAGES POUVANT ETRE CAUSES PAR L'EMPLOI DE CET APPAREIL (TELS QUE LA PERTE DE POISSONS OU DES DOMMAGES PERSONNELS).** Certains états excluent ces limitations de recours en cas de dommages accidentels ou conséquents, de telle sorte que la garantie décrite ci-dessus peut ne pas s'appliquer à votre cas.

**GARANTIA****GARANTIA LIMITADA DE 2 AÑOS**

El producto que ha adquirido está garantizado contra defectos de materiales o mano de obra por el periodo de dos (2) años a partir de la fecha de compra. Esta garantía no cubre ni es pertinente en caso de uso o instalación incorrecto, falta de observación o cumplimiento de las instrucciones adjuntas o si el producto ha sido indebidamente manipulado o alterado.

Para obtener el reconocimiento de esta garantía, debe de seguir las siguientes instrucciones : No devuelva el producto al lugar donde lo compro : ya que esto retrasaría el proceso. Para obtener servicio tecnico de garanta llamar al Departamento Tecnico, el telefono es 1-800-847-0659, totalmente gratuito. Nuestros tecnicos podran ayudarles con sus problemas. Para obtener el reconocimiento de esta garantía, debe empaclar cuidadosamente el producto, adjuntar el recibo de compra original, una nota describiendo el defecto o mal funcionamiento, junto con \$ 10.00 para franqueo y envío, y devolverlo a nuestro distribuidor en Estados Unidos : Mars Fishcare North America, Inc., 50 East Hamilton Street, Chalfont, PA 18914, Attn: Warranty. Ningun representante tiene autoridad para modificar o ampliar la garantía precedentemente descrita o nuestra responsabilidad. La presente garantía le otorga derechos legales específicos, además de otros derechos que usted pueda tener y que varían de un estado a otro. **QUEDAN EXCLUIDO Y NO ASUMINOS NINGUNA RESPONSABILIDAD EN CUANTO A DANOS CONSIGUIENTES (TALES COMO EL DANO O LA PERDIDA DE PECES, MATERIAS AMMADAS O PROPIEDAD PERSONAL) NI DANOS INCIDENTALES QUE SE ORIGINEN DE LA VIOLACION DE UNA GARANTIA EXPLICITA, ESCRITA O IMPLICADA O RELACIONADA CON NUESTRO PRODUCTO.** Algunos estados no admiten la exclusion o la limitación de daños incidentales o consiguientes, de manera que la limitación o exclusion anteriormente indicadas pueden no ser pertinentes en su caso.

Distributed by

**Mars Fishcare North America, Inc.**50 E. Hamilton St.  
Chalfont, PA 18914  
USA**1-800-847-0659****www.apifishcare.com**

®/™/® Trademarks of Mars Fishcare North America, Inc.  
No binding photos • Photos non contractuelles  
• fotos no obligatorias