



Water Today - The Magazine

UNITING THE VIBRANT WORLD OF WATER

FORWARD OSMOSIS: APPLICATIONS & RECENT DEVELOPMENT & CHENNAI EXPO SPECIAL

**WATER TODAY'S
WATER EXPO
DELHI**

24 - 26 JUNE 2020
PRAGATI MAIDAN, DELHI

www.waterex.biz

REDEFINING WATER
EXHIBITIONS IN SOUTH ASIA

**WATER TODAY'S
WATER EXPO
BANGLADESH**

4th Edition

10 - 12 SEPTEMBER 2020
GULNAKSHA, INTERNATIONAL
CONVENTION CITY
BASHUNDHARA (ICCB), DHAKA

www.bangladeshwaterexpo.biz

**WATER TODAY'S
WATER EXPO
CHENNAI**

15th Edition

4- 6 MARCH 2021
CHENNAI TRADE CENTRE
NANDAMBAKKAM, CHENNAI

www.waterexpo.biz

GAIN ACCESS TO THE HIGHLY
BUOYANT MARKETS IN ASIA
THROUGH WATER EXPO AND EXPLORE
THE BUSINESS OPPORTUNITIES

QUALITY PURIFIES.



The efficient and sustainable treatment of water plays a decisive role in many industries. As one of the world's leading manufacturers of products for liquid purification, we have been offering our customers customized solutions for almost 80 years and are consistently developing our premium technologies. The proven **Lewatit®** ion exchange resins selectively remove ions from water and other liquid media and optimally complement each other with **Lewabrane®** reverse osmosis membrane elements. **Bayoxide®** iron oxide adsorbers bind impurities quickly, specifically, and reliably, and round off our product portfolio of solutions for water treatment. The quality of LANXESS allows us to keep our future clean. lpt.lanxess.com

X Lewatit® **X Lewabrane®** **X Bayoxide®**

LANXESS India Private Limited
Liquid Purification Technologies Business Unit,
LANXESS House, Plot Nos A162-164, Road No. 27, MIDC, Wagle Estate,
Thane, Maharashtra, India - 400604. Tel: 91 22 2587 1000
Email: s.pakash@lanxess.com

QUALITY WORKS.

LANXESS
Energizing Chemistry



Watermaster

CLEAN, SAFE AND WELL-FUNCTIONING WATERS

**ONE MACHINE FOR ALL SHALLOW WATER WORK
THE AMPHIBIOUS MULTIPURPOSE WATERMASTER
CLEANS AND MAINTAINS RIVERS, LAKES AND CANALS**

Dharsan Dredging & Constructions Pvt. Ltd.,
An authorized Indian agency, Wholesale Dealer & After Sales and Services, Technical Partner of Watermaster Classic IV & V Multipurpose, Amphibian, Self Propelled, Portable, Robotic, Versatile Shallow Water Dredgers, Originally manufactured by M/s Aquamec Ltd., Finland.

Postal Address:
M/s Dharsan Dredging & Constructions Pvt. Ltd.,
329A/1, Grace Cottage,
New Colony Second Street,
Chengalpattu - 603003,
Kancheepuram District,
Tamilnadu, INDIA.

Contact Numbers:
Tel: +91 44 2742 0074
Fax: +91 44 2742 0833
Mob: +91 94453 90683
Mob: +91 94453 90584
Mob: +91 90360 88339

Our Emails are:
dharsandredging@yahoo.com
dharsandredging2012@gmail.com
jesudossarumairaj6661@hotmail.com
asharaj2k7@gmail.com

Reprint & Permissions

All rights reserved. Without the written permission of the publisher, reproduction / republishing / reprinting of this magazine, in whole or in part, are strictly prohibited. To acquire permission write to info@watertoday.org

The Publishers and the Editors do not necessarily, individually or collectively, identify themselves with the views expressed in this magazine. The views expressed are those of the authors only. The Magazine also does not claim any responsibility for information contained in the advertisements. The magazine assumes no liability or accountability of any kind in connection with the information thereof.

Editor
Naina Shah
editor@watertoday.org

Resident Editor
Hemlatha Govindaraj
editor@watertoday.org

Senior Designer
N. Sirajudeen
siraj@watertoday.org

Circulation
subscribe@watertoday.org

Advertisement & Sales
info@watertoday.org

Corporate offices and academic institutions looking to order for bulk subscriptions, please contact us on +91 44 4291 6900 or write to us at subscribe@watertoday.org

Submissions

We inspire and encourage perspective authors to write articles, case studies, technical papers and application stories on water and wastewater industry and follow Water Today's Author's guidelines before submitting manuscripts. Write to us at editor@watertoday.org to obtain Author's Guideline.

Head Offices:

WATER TODAY Pvt. Ltd.
3d, III Floor Bhagheeratha Residency,
124, Marshall's Road, Egmore,
Chennai - 600 008, TN, India
Tel : +91 - 44 - 42916900
Email : info@watertoday.org
Web: www.watertoday.org

Regional Offices:

C - Wing 201, 2nd Floor,
Kohinoor Apartments, Ranade
Road, Dadar West
Mumbai - 400028,
Maharashtra, India



www.watertoday.org

www.watertoday.org

Printed & Published by S. Shanmugam on behalf of WATER TODAY PVT. LTD.

Printed at Dawood Graphics, No. 63, Muthu Street, Royapettah, Chennai - 600014, Tamil Nadu, India.

Published at 3D, IIIrd Floor Bhagheeratha Residency, 124, Marshall's Road, Egmore, Chennai - 600 008 Tamil Nadu, India

UNITING THE VIBRANT WORLD OF WATER - TO PROVIDE A PROACTIVE PLATFORM FOR THE WATER INDUSTRY TO CONVERGE AND WORK TOGETHER IN ACHIEVING SOLUTIONS TO GLOBAL WATER PROBLEMS.



Submersible Pumps

AQUA GROUP

Pumps you can rely on



Booster Pumps



A COMPLETE RANGE OF PUMPS FOR BUILDING SERVICES



Submersible Sewage Pumps

Sewage Pumps with Cutter

Construction Dewatering Pumps

Multistage High Pressure Pumps

Hydro Pneumatic System

Water Transfer System

Solar Pumps

k **krishna**
engineering

22, Red Hills Road, Ram Nagar, Ambattur,
Chennai - 600 053. Tamil Nadu.
Ph: 87544 77118, 73580 71710

www.krishnaengineering.com

Regulars

Masthead	4	Editorial Calendar 2020-2021.....	192
Water Wire.....	10	Subscription Form.....	193
Launch Pad.....	22	Classifieds.....	194
Product Zone.....	24	Ad. Index.....	199
Event Zone.....	26	Editor's Note.....	202

CHENNAI EXPO SPECIAL 2020

WATMAN 2020.....	30	Exhibitors List.....	34
Water Career.....	32	Exhibitor Profiles.....	38



EPTEX
ENVIRONMENT PROTECTION TECHNOLOGY EXHIBITION

24th 25th 26th JUNE 2020
PRAGATI MAIDAN, DELHI

AN INTERNATIONAL Exhibition ON ENVIRONMENT TECHNOLOGY, Equipments & Allied Industries

Organized by WATER TODAY PVT. LTD.
For More Details: info@eptex.biz | www.eptex.biz



AKSHARA
WATER TREATMENT
ISO 9001:2015 Certified

Office: Tower India Complex,
No. 208, near Police Station,
Erode Road, Perundurai-638052,
Erode Dist. Tamilnadu, India
Ph. No : 91 99422 14111, 63817 57410
E-Mail: annazld7@gmail.com
Website: aksharawatertreatment.com

Factory: Kandhampalayam Pirivu,
Erode Road, Perundurai-638052,
Erode Dist. Tamilnadu, India
**OUR AWT
MANPOWER
250 & ABOVE
EMPLOYEES**

OUR MANUFACTURING PLANT

- ♦ Textile Industry Waste Water Plant
- ♦ ATFD
- ♦ Plastic Industry Waste Water Plant
- ♦ Drinking Water Plant
- ♦ Milk Industry Waste Water Plant
- ♦ Sewage Treatment Plant
- ♦ Multiple Effect Evaporator
- ♦ DM Plant
- ♦ Forced Circulation Evaporator
- ♦ Sludge Paddle Dryer



ATFD & MEE



Sludge Paddle Dryer-BKS



Sludge Paddle Dryer
Veerapandi CETP



Aeration Tank



RO Plant Erection



RO Plant



ATFD-MALLOW



Engineering Works



Secondary Clarifier



RO Plant-SRG



200KLD ZLD Plant

Specialized in ZLD Plant
Our Product - ETP, UF, RO, NF, MEE, ATFD, Sludge Dryer, STP and DM Plant.
Our Service - TNPCB all work and ZLD Plant Operation & Maintenance



Dear Readers,

Days of hard work and networking of the highest calibre, a day to remember – it's not often that we manage to surprise ourselves, but success can do that to you.

While Water Today opens its 14th edition of the Water Expo 2020, concurrently the WATMAN International Conference, we have the pleasure to host top officials and participants from across India and the world – Government officials, Municipal Administration Authorities, IAS officers, Water Board officials, Researchers, International Researchers to name a few at both the annual events.

A comprehensive coverage of our exhibiting participants awaits you inside, but the fact of the matter is that both events have grown in stature and relevance since their inception.

The idea of the WATMAN Conference theme – Sustainable Water and Wastewater Management Solutions for a Better Future was thought over much brainstorming sessions. Naturally, with the amount of water produced and being lost to leakage and improper management, water is a topic that strikes a chord with the people, the various governing bodies in the country and across the world. Hence, shouldn't there be an event showcasing and recognising the upgraded technologies and processes?

Bringing together India and international business executives, political decisions makers and leading researchers, Water Expo 2020 is a showcase for the most advanced technologies and solutions globally. I am confident that you will benefit from the exciting range of topics as well as the technological and business solutions that are presented in this event.

A comprehensive coverage of our exhibiting participants awaits you inside, but the fact of the matter is that the event has grown in stature and relevance since its inception. As Water Today continues to build a successful legacy, we step into 2020 with new opportunities in our vision. We look forward to the new challenges awaiting us.

With Best Regards,

S Shanmugam
Managing Director & Publisher – Water Today Pvt. Ltd.

VASUDHA AQUA

Why waste when you can reuse?

Greywater System and Rainwater Harvesting System for Household, Retail and Commercial Spaces.

Greywater is wastewater from your daily use - washing, cleaning, and bathing (except for the water from the toilet) In a world where fresh, clean water has become a precious commodity, Grey water Recycling can help you reduce your water bills as well as your water footprint. Vasudha Aqua is here to pave your way.



Water treatment using gravity and in real-time



Fit-and-forget design that needs no intervention



No storage tank and pump needed



No need of harsh chemicals



Treated water for reuse for all purposes other than drinking and cooking



Interested to conserve water in your home with our Greywater System?
Call us today to know more!

+91 93840 95796 / 98400 92566

sales@vasudhaaqua.com www.vasudhaaqua.com VasudhaAqua.Ch

Metro Water signs MoU with IWA

According to an official, Metro Water has become the first utility in the country to sign an MoU with the International Water Association (IWA). “The MoU will help the Metro Water to function towards making the city water-wise by adopting circular economy principles in water management,” the official said.

He added that the objective of the agreement was to provide training and education for water professionals, apart from encouraging knowledge development and research to promote positive changes in water management. Metro Water managing director TN Hariharan and executive director of the International Water Association Kalanity Vairavamoorthy signed the MoU at the Metro Water headquarters recently.

IWA is an international body headquartered in the United Kingdom, which has members in 140 countries. The main objective of the association is to develop research and projects focused on solutions for water and wastewater management.

With the Metro Water joining the International Water Association, the city’s water manager could work in concurrence with the association and take part in the workshops organised by IWA.

Varanasi to get new lease of life with new sewage treatment plants

Varanasi - a historical city regarded as the spiritual capital of India. It draws Hindu pilgrims who bathe in the Ganga River’s water and perform funeral rites. The city’s growing population and a huge influx of visitors has led to sewage generation which is much higher than its existing treatment capacity. Varanasi generates about 300 million litres per day sewage.

Under the Namami Gange programme, the National Mission for Clean Ganga has taken up several projects for the treatment of sewer. Work is in full swing to tap major drains flowing into the river and divert them to sewage treatment plants (STPs). The existing treatment capacity of sewage in Varanasi has been boosted with the inauguration of 140 MLD sewage treatment plant (STP) at Dinapur, built at a cost of Rs. 235.53 crore. The project funded by JICA is the first and the largest sewage treatment project to be implemented under the Namami Gange mission. The treatment plant uses green power from sewage (biogas) to significantly reduce the carbon footprint apart from lowering the operational cost. The 50 MLD STPs being constructed in Ramana will bolster the existing sewage treatment capacity of the city and take it up to 412 MLD which is adequate to meet the sewage treatment demand till 2035. This will stop untreated sewage from flowing into the Ganga at Varanasi. Out of 23 drains, 20 have already been tapped. The remaining 3, including Assi are being tapped through Ramana STP project.

The growing population of Patna is leading to an increased outflow of domestic wastewater

The existing sewage treatment plants in Patna have long outlived their utility; the old sewer lines are choked, and the untreated water flows into Ganga.

In order to revamp the sewage management system in the city, NMCG has approved 11 projects worth over Rs 3,500 crore that will involve laying down 1,140 km of sewerage lines and create sewage treatment capacity of 350 MLD. This would cover the sewage treatment requirements of the city up to 2035 when its sewage generation is estimated to be 320 MLD.

Yogendra Kumar, Executive Engineer, Bihar Urban Infrastructure Development Corporation Ltd (BUIDCO) said, “In Patna, sewage is not allowed to flow directly into Ganga. We are working to connect every household with a sewerage system. The household wastewater will be diverted to the main hole and then to an STP. The wastewater will be treated through SBR (Sequencing Batch Reactors) technology and used for irrigation purposes after chlorination”. Work on most projects under Namami Gange scheme in Patna is in the final stages. Beur and Karmalichak STPs will together treat 80 million litres of wastewater per day through a sewerage network of 277 kilometres. The estimated cost of the Karmalichak STP is about Rs. 77 crore and the Beur STP will cost Rs. 68 crore. Work on two other sewage plants, 60 MLD STP in Saidpur Pahari and another 60 MLD STP at Pahari, is also near completion.

On ‘Mann Ki Baat’, Prime Minister Modi Urges People To Conserve Water

Addressing the nation in the first edition of ‘Mann Ki Baat’ in 2020, Prime Minister Narendra Modi urged people to make a determined effort to conserve water. During the radio programme, PM Modi appreciated the on-going efforts across the country in this area and highlighted that people from all sections of society have wholeheartedly contributed towards the efforts of water conservation.

While reminding people to focus on employing innovative methods to deal with water stress PM Modi called upon them to share the stories of their efforts through pictures and videos with the hashtag ‘#jalshakti4India’ in order to inspire others. He said, “Today, the entire nation is eager to listen to the tales of our Jal Shakti champions. I request you to share your efforts or of those around you towards water conservation, through stories, pictures and videos.” The Prime Minister noted that ponds and tanks have been constructed in various areas and gave examples of water conservation efforts from Rajasthan, Uttar Pradesh, Uttarakhand, and Tamil Nadu.



FUSION MACHINE RENTALS YOU CAN DEPEND ON

MAKE SURE YOUR NEXT RENTAL IS READY FOR THE JOB AHEAD

Having the right equipment for the job is just as important as having the right pipe, fittings and fabrications. That’s why McElroy India offers a wide range of Polyethylene and Polypropylene pipe fusion machines and productivity equipment for either sale or rent. McElroy India’s rental is a certified program which ensures the rental fleets perform to McElroy’s expectations as well as yours.



McElroy India 8/4, Whitley Layout, Whitefield, Bangalore 560066, India



MCELROY INDIA OFFERS FUSION EQUIPMENT RENTALS FOR:

- Small Diameter (16mm to 180mm)
- Medium Diameter (63mm to 340mm)
- Large Diameter (225mm to 1200mm)
- Mechanical/HVAC/Plumbing Applications
- Productivity Tools
- Quality Assurance Accessories

TO LEARN MORE, CONTACT:

Bharath Rajarao, Regional Director:
bharathrrao@mcelroy.com: 9845519914
Haricharan Kumar, Sales Manager (Central India):
hkumar@mcelroy.com: 9844373409
Syed Fahad, Sales Manager (North India):
sfahad@mcelroy.com: 7795651747

Bursts reduced as game-changing DNS system addresses 'lost' air valves

In response to what is a serious industry-wide issue whereby the location of hundreds of thousands of air valves is not known, Designed Network Solutions (DNS) have introduced a new Critical Air Valve Monitoring System. According to DNS, the 'disappearance' of air valves means that across UK networks, some water companies have no idea if these valves are operational or fit for purpose – allowing expensive burst events and high levels of leakage to continue, unabated. The new DNS Critical Air Valve Monitoring System can log (at least) two main parameters:

Pressure within the main - and then alarms if the pressure drops to below 0.2Bar because at this point the air valve is at risk of opening. It also monitors the air valve environment and whether it is operating within atmospheric conditions, or if the air valve is submerged and therefore poses a significant contamination risk. Designed Network Solutions' (DNS) Director, Craig Stanners said: "For far too long, engineers have been unable to properly maintain air valves or address serious issues such as contamination, water quality, transient and water hammer; simply because they don't have access to the right information. Now, with a proper Air Valve Monitoring System, they can carry out their work far more efficiently, reducing surge and transient events – first because they'll know what's actually in the network – and secondly, because they'll be notified by an alarm to advise when an air valve is not working as it should be".

City of Houston Chooses VTScaDa Software for 400 MGD Water Purification Plant Expansion



To help meet the growing drinking water demands for the fourth largest city in the US, the utility is expanding the NEWPP to 400 MGD, making this one of the largest active capital water projects in the US at a cost of \$1.4 billion. When completed, it will occupy acres and include twin 108" diameter water mains. The selection was made by the City of Houston consultant, in collaboration with the Houston Waterworks Team, a joint venture between CDM Smith and Jacobs Engineering (formerly CH2M). After an extended evaluation of features, licensing, and support, the team chose VTScaDa from a short-list of four leading SCADA products. VTScaDa is a software used around the world in industries such as water and wastewater, oil and gas, power generation, broadcasting, and marine solutions. The expanded system is scheduled for completion in 2024.

Grundfos inaugurates digital lab in Asia-Pacific region

Global pump manufacturer Grundfos has inaugurated its digital lab in Singapore – the first of its kind by the industry leader in Asia-Pacific – as a strategic initiative to drive greater adoption of intelligent water solutions in the region. The lab will showcase Grundfos' range of iSOLUTIONS products, which leverage intelligent technology to deliver optimal performance, greater energy efficiency and reliability. These products are used for a wide range of applications across sectors – from water distribution and wastewater treatment by water utilities, pressure boosting and heating, ventilation and air conditioning in commercial buildings, to industrial applications such as washing, cleaning and industrial cooling.

Key solutions on showcase included the Grundfos SMART Digital XL DDA and DDE dosing pumps, which enable accurate chemical dosage across numerous production processes including drinking water, wastewater treatment, and industrial processing, reducing chemical consumption by 5 to 19 percent. Kim Jensen, Regional Managing Director of Grundfos Asia Pacific region, said that establishing a dedicated lab in the region is a demonstration of the company's confidence in Asia-Pacific's digitalization potential, as well as recognition of Singapore as the hub for this digital transformation, thanks to its Smart Nation ambitions. Asia-Pacific is poised for digital growth – by 2021, approximately 60% of the region's GDP will come from products and services created through digital transformation.

Mitsubishi Electric Develops AI-based Aeration Control Technology for Biological Wastewater Treatment

Mitsubishi Electric Corporation has announced the development of aeration control technology to reduce the electric power consumption for supplying air (aeration) to biological reactors which is essential for biological wastewater treatment. By leveraging the company's Maisart® artificial-intelligence (AI) technologies, the system accurately predicts the quality (ammonia concentration) of the water flowing into the reactor over the following few hours. The control of aeration levels at individual section of the reactor will achieve approximately 10% reduction in the total amount of aeration, compared to the conventional methods. This will lead to a reduction in the power consumption of biological wastewater treatment plants, which consume about 7 billion kWh of electricity annually, equivalent to about 0.7% of total electric power consumption in Japan. The company is currently verifying the stability and effectiveness of this technology with the cooperation of domestic wastewater treatment plants, and is aiming to commercialise operation control systems using the new technology within fiscal year ending in March 2021.

System Engitech Pvt. Ltd.

ASME Certified | ISO 9001 - 2015 Certified

We are glad to introduce our organisation System Engitech Pvt Ltd that specializes in the business of Manufacturing and Supplying of wide range of Chemical & Pharmaceutical Process Equipment and ETP Equipment. We are also dealing in Turnkey projects. It has been more than two and half decades of successful journey from a humble beginning in 1993.

- We have been accredited by ASME for the manufacture and repair of pressure vessels under 'U' Stamp, 'NB' Stamp and 'R' Stamp certifications
- System Engitech is an ISO 9001:2015 company.

We Design, Manufacture and Supply of CHEMICAL & PHARMACEUTICAL PROCESS EQUIPMENT



We Design, Manufacture and Supply of EFFLUENT TREATMENT PLANT (ETP) EQUIPMENT

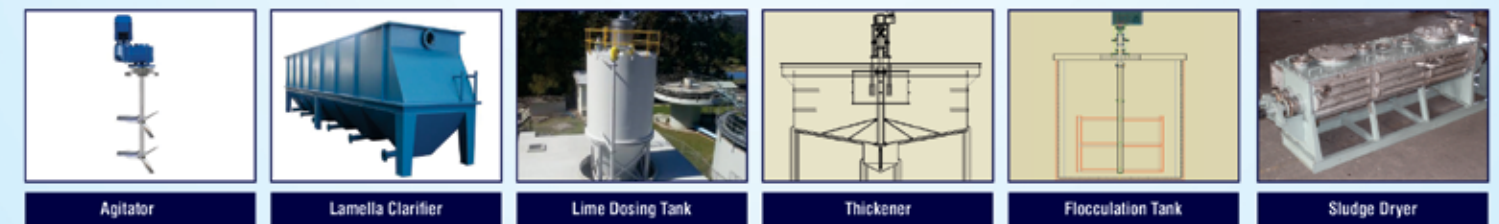

We Offer:

- Turnkey projects for Chemical & Petrochemical Industries
- Turnkey projects for Pharmaceutical Industries
- Manufacturing Equipment for ETP, STP & WTP



Registered office and Manufacturing Unit -1

Plot No. 4311/C, Road No. 4, Near Sagar Hotel,
Sachin GIDC, Surat - 394230, Gujarat, India
Email: sales@systemengitech.com
Mobile: +91 97261 41929 / 99253 41929

Sales and Service Support

Email: sales@systemengitech.com
Mobile: +91 97278 41929

www.systemengitech.com

Haya Water to Launch First PPP Project for Sewage Treatment Plant



In line with Oman’s increasing focus on enabling public private partnerships, Haya Water is preparing to launch its first Public Private Partnership (PPP) project in 2020 for a sewage treatment plant and associated infrastructure. Mid of 2019, Haya Water had signed a contract with KPMG for “preparing and implementing the PPP framework” for Haya Water’s wastewater projects. According to the release of the Oman PPP Law, the newly established Public Authority for Partnerships and Privatisation (PAPP) has approved the feasibility study for the project, thus clearing the way for the procurement process. This project is expected to be one of the first Sewage Treatment Plant (STP) projects in the Sultanate of Oman to be procured under the Oman PPP Law which was published in 2019. The proposed PPP Project package would include the design, financing, construction and operation of the Misfah Sewage Treatment Plant (STP) in the Wilayat of Basher with an average daily sewage treatment capacity of 40,000 m³/day and the design, finance and build of a 18km pipeline from the proposed Misfah STP to the existing STP at Al Ansab for the off-take of the Treated Effluent (TE). Located in the Al Misfah area, along the Ansab - Murayat road and in close vicinity to the Oman Cement Company plant, the Misfah STP is expected to divert all the tanker traffic currently served by the Al Ansab STP. Haya Water would be off-taker for the TE.0

Equitable access to water and sanitation still a challenge for Europe

According to the latest information from the WHO/UNICEF Joint Monitoring Programme for Water Supply, Sanitation and Hygiene (JMP), equitable access to water and sanitation is still a challenge for Europe. 31 million people in Europe do not have access to basic sanitation, 48 million people do not have piped water at home, and more than 300,000 people still practice open defecation, mainly in the countryside. The findings were generated through self-assessment by 11 countries: Armenia, Azerbaijan, Bulgaria, France, Hungary, North Macedonia, Moldova, Portugal, Serbia, Spain and Ukraine, and are available in the report the Human Rights to Water and Sanitation in Practice: Findings and lessons learned from the work on equitable access to water and sanitation under the Protocol on Water and Health in the pan-European region.

Intelligent Water Systems Challenge launches for third year

The Intelligent Water Systems Challenge is back for a third year to challenge participants to use innovation and data to help solve some of the most difficult issues facing water utilities. The goal is to demonstrate the value of intelligent water systems to utilities and foster adoption of smart water technologies, as well as give students, professionals, and technology experts the opportunity to showcase their talents and innovation with a focus on leveraging data using the tools to help utilities make better decisions.

The 2020 Intelligent Water Systems Challenge will run from January 15 to October 5, 2020. Scenarios will focus on collection systems, wastewater treatment systems, drinking water treatment systems, source water/watershed, and distribution networks. Teams with innovative solutions will be invited to present their results in person at WEFTEC 2020 in New Orleans for final judging. The winning team will receive a cash award of \$10,000 (\$\$13,483.70). The Challenge hosted by LIFT, a joint effort by The Water Research Foundation and the Water Environment Federation, is also supported by the American Water Works Association, BlueTech Research, Cleveland Water Alliance, IEEE Smart Cities TAC, Imagine H2O, International Society of Automation, and Smart Water Networks Forum.

Intelligent Water Systems Challenge launches for third year

The Intelligent Water Systems Challenge is back for a third year to challenge participants to use innovation and data to help solve some of the most difficult issues facing water utilities. The goal is to demonstrate the value of intelligent water systems to utilities and foster adoption of smart water technologies, as well as give students, professionals, and technology experts the opportunity to showcase their talents and innovation with a focus on leveraging data using the tools to help utilities make better decisions.

The 2020 Intelligent Water Systems Challenge will run from January 15 to October 5, 2020. Scenarios will focus on collection systems, wastewater treatment systems, drinking water treatment systems, source water/watershed, and distribution networks. Teams with innovative solutions will be invited to present their results in person at WEFTEC 2020 in New Orleans for final judging. The winning team will receive a cash award of \$10,000 (\$\$13,483.70). The Challenge hosted by LIFT, a joint effort by The Water Research Foundation and the Water Environment Federation, is also supported by the American Water Works Association, BlueTech Research, Cleveland Water Alliance, IEEE Smart Cities TAC, Imagine H2O, International Society of Automation, and Smart Water Networks Forum.

TWIN LOBE / TRI LOBE AIR BLOWER

High Quality Product

High Quality Acoustic Enclosure/ Noise Canopy

High Quality Manufacturing Process

High Quality Internal Components

Acme Air Equipments Co. Pvt. Ltd., designs & manufactures high quality Rotary Lobe Air Blowers. Some of the Company features are :

- Rich & Quality Experience of 30 years in Pressure & Vacuum Applications
- Strong After Sales Services
- Customized Solutions
- Approved with Major PMC/EPC/LST Companies in India
- Experience of Working with Reputed PMC/EPC/LSTK Multinational Companies
- Supplied to Wastewater Treatment Plants, Textile, Cement, Power, Fertilizer, Pharmaceuticals, Steel, Oil & Gas, Chemical/Petrochemicals, Food & Dairy, etc.

TWIN LOBE / TRI LOBE ROTARY AIR BLOWERS FEATURES:

- Max. Capacity: 18,315 m³/hr.
- Max. Differential Pressure: 1.0 kg/cm²
- Rated for Continuous Duty
- Rugged Construction
- High Performance Guaranteed
- Long Life of Blower
- High Quality Internal Components

LANXESS digitises its global asset base

LANXESS is driving forward the digitisation of its production. The specialty chemicals company has implemented a self-service analytics system for time-series data in many areas of its global plant fleet. Almost two thirds of its roughly 120 plants were equipped with the self-service analysis platform TrendMiner from Software AG, including all major production sites in Germany, Belgium, the U.S. and India. Only smaller plants with less complex processes are not yet covered by the implementation.

With TrendMiner, production employees can autonomously analyse manufacturing processes and measurement data, detect patterns and trends in these data, and thus detect production irregularities. Typical applications include capacity increase, predictive maintenance, improvement of product quality or more efficient raw material and energy use.

Jörg Hellwig, Chief Digital Officer of LANXESS, emphasises the economic advantages for LANXESS. “The use of data analytics tools in production is a clear business case. Tests with TrendMiner have proven this. With the successful roll-out, LANXESS is now leveraging the optimisation potential throughout the Group.” Sanjay Brahmawar, CEO of Software AG, underlines the good cooperation. “We are thrilled with the outcome of the successful roll-out of TrendMiner to offer LANXESS end to end capabilities to drive their digital automation. Their openness and trust were the perfect basis for our intensive cooperation.”

China Water Environment Eyes \$500 Million IPO in Hong Kong

China Water Environment Group Ltd., backed by the nation’s state-owned investment holding company, is considering an initial public offering in Hong Kong that could raise more than \$500 million (\$674.8 million), according to people familiar with the matter. The water treatment company is working with advisers on a listing that could take place as soon as in the second half of this year, said the people, declining to be identified as the information is not public.

China Water Environment Group, founded in 2013, runs underground wastewater treatment plants across 19 cities in the country including Beijing and Shanghai, according to its website. State Development & Investment Corp. bought into China Water Environment Group last year and is now the biggest shareholder with a 43% stake. Citic Private Equity Funds Management Co. is the second-biggest shareholder. China Water Environment could be joining other Chinese firms in eyeing sizable Hong Kong listings this year, such as bottled water giant Nongfu Spring Co., which is looking to raise at least \$1 billion (\$1.3 billion), and lender China Bohai Bank Co. which is planning an IPO that could raise over \$2 billion (\$2.7 billion).

Quality at the core of Danfoss’ new digital displacement assembly facility



A new assembly line has been commissioned at Danfoss’s global Digital Displacement manufacturing and R&D facility near Edinburgh in Scotland – which will bring a new approach to precision assembly. The fully flexible facility has been custom designed from the ground up to assemble a new generation of Digital Displacement® pumps for off-highway and industrial customers. Production has already begun, with the first customer pumps rolling off the line in August 2019.

“This new area is unique in Danfoss,” says Dominika Babalska, Head of Operations, Digital Displacement, at the Edinburgh site. Rather than building a large, fixed production line, we have taken a modular approach allowing the shop floor to grow naturally together with customers’ needs. “Every pump that rolls off will have been quality assured at each step and is fully traceable from start to finish,” Dominika says. Central to this is a step-by-step production process built around five modular workstations. These have been developed to ensure the system has an unambiguous and clear process which can be followed easily – yet can be modified and changed as customer demand increases and volume ramps up.

Germans protest against Tesla Gigafactory

Around 250 Germans protested in the outskirts of Berlin where electric car startup Tesla is planning to build a gigafactory, saying its construction will endanger water supply and wildlife in the area. The U.S. carmaker announced plans last November to build its first European car factory in Gruenheide, in the eastern state of Brandenburg. Politicians, unions and industry groups have welcomed the move, saying it will bring jobs to the region, but environmental concerns drove hundreds of locals to the streets on Saturday. “We are here, we are loud, because Tesla is stealing our water,” protesters called. The protest came after a Brandenburg water association warned against “extensive and serious problems with the drinking water supply and wastewater disposal” for the proposed factory.



The carrier media of the future for most compact, efficient biological water and waste water treatment systems...

~ 5,500 m²/m³

Transchip 3.0

- Surface Area - 5500 m²/m³, 6 to 14 times higher than conventional media
- Removal Performance – 10 BOD
- Clogging – Anti clogging design
- Process Stability – Highly stable
- Savings in construction costs – 50%.
- Ease in upgradation – Very easy, can upgrade to 5 times the load
- Energy savings – About 30 to 50% due to parabolic design and low mixing requirement
- Savings in transportation costs – Yes, it occupies less space per m² and per m³
- Durability – 20 years guaranteed life...
- Reactor load rate – 3-6% of tank volume for STP

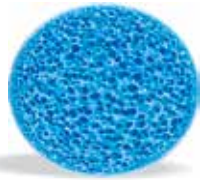

Conventional media

- Surface Area - 400 to 500 m² per m³
- Removal Performance – 30 BOD
- Clogging – Yes, frequently
- Process Stability – Not stable
- Savings in construction costs – Not much compared to ASP
- Ease in upgradation – Easy
- Energy savings – Not much
- Savings in transportation costs – No
- Durability – 3 to 5 years
- Reactor load rate – 30-40 % of tank volume for STP



Our Valued Customers

- TATA BSL Ltd. • Bhushan Power Ltd. • Hindistan Unilever Ltd. • NTPC – Leachate treatment plant
- Himedia Laboratories Pvt. Ltd. • Manipal University • Eesavyasa Technologies Pvt. Ltd.
- Bhushan Steel Ltd. • Sun Pharmaceutical Industries Ltd. • Ionex Envirotech Pvt. Ltd.
- Deknomet Systems Pvt. Ltd • Jyoti Hydrotech Pvt. Ltd. • Navkiran Techno Feeds • Shubham Inc



Transcend Cleantec Pvt. Ltd.
S No 37/2, Shed no 463/1, Near Joshi Transformer, Narhe, Taluka Haveli, Pune-411041

+91- (0)- 8669190129

info@transcendcleantec.com

www.transcendcleantec.com

Evoqua Technology Selected for Upgrade of PA Wastewater Treatment Plant



Evoqua Water Technologies, along with Nittany Engineering & Associates and sales partner Riordan Materials Corporation, recently completed the upgrade of the Bellefonte Borough Authority (BBA) Wastewater Treatment Plant located in Centre County, Pennsylvania. The treatment plant, which serves customers from both the Bellefonte Borough and surrounding townships, has a maximum capacity of 3.2 million gallons per day (MGD). The plant's effluent is discharged to Spring Creek, which is arguably one of the finest wild trout streams in Pennsylvania.

The innovative BioMag system infuses magnetite – fine, fully oxidized, iron ore particles – into biological floc, enhancing secondary clarification. The system increases settling rates, capacity, performance and stability, and meets enhanced nutrient removal (ENR) permits. For the BBA, the BioMag system was incorporated into the existing plant providing excellent clarification performance at high clarifier loadings and lower ammonia emissions. As a result, the plant includes a 41% organic capacity increase to treat higher future influent loadings, a significantly improved sludge treatment process with cleaner, better screened biosolids, and better odor control.

During the construction process, the complexity of the project increased with record rainfalls. The success of this project was a result of the thorough evaluation of treatment options to provide the lowest capital and operational costs for the plant, while providing the best effluent quality when compared to other treatment technologies available.

Energy recovery wins \$16.6 million of Water Awards

Energy Recovery, Inc. has announced total awards of \$16.6 million (\$22.3 million) to supply PX® Pressure Exchangers® (PX) and related equipment and services to multiple desalination facilities in the Middle East. The awards include Energy Recovery's first contract to support the conversion of a mega-project (>50,000 cubic metres per day) thermal desalination facility to more cost-efficient seawater reverse osmosis (SWRO) desalination technology.

“These awards cap a record-breaking year for Energy Recovery, and we are pleased to see a trend we have long anticipated – the conversion of thermal desalination capacity to large-scale SWRO facilities – move from our pipeline to our backlog,” said Robert Mao, Energy Recovery Chairman and Interim President and Chief Executive Officer. “Much of the Middle East's installed capacity is thermal desalination, which was largely built before technologies like the PX greatly improved the economics of SWRO. As older thermal desalination facilities reach the end of their useful life, owners and operators are evaluating the path forward. These facilities are needed to maintain current water supply, so they cannot be decommissioned without a replacement plan. Longer-term, the current thermal capacity of more than 20 million cubic metres per day creates an additional layer of growth potential for Energy Recovery.”

PUB seeks to boost rainfall forecasting capabilities with radar technology

National water agency PUB has developed a rainfall monitoring and prediction system capable of providing early heavy rainfall warnings, enhancing its response time to potential flash floods that may occur across Singapore. The system merges the rainfall monitoring capability of X-band radars – which are typically used for localised weather monitoring, as well as air traffic control and maritime vessel navigation – with a nowcast model that forecasts the movement, growth and decay of rainclouds, enabling it to produce forecasts 30 minutes ahead of a rainfall event. It augments the data that PUB currently receives from the Meteorological Service Singapore for rainfall alerts.

In 2016, PUB started working with the Hydroinformatics Institute Pte Ltd, as well as industrial electronics firm Furuno Singapore Pte Ltd, to develop a system that can provide quantitative rainfall forecast data. Three X-band radars – which are compact and suited for monitoring rainfall within short ranges of 30-50km – were installed in the northern, eastern and western parts of Singapore. Since their implementation in end-2018, the system has been able to produce 30-minute rainfall forecasts with an accuracy of 65%.

ESTD 2013
 “Indian Innovation - Changes the Global Economics”

“INSTANT SOLVENT SOFTNER”

(Softwater without Chemicals)

THE POWER OF WATER CONVERSION TECHNOLOGY

इसका पानी CLEAR WATER WITHOUT CHEMICALS

100% ECO-FRIENDLY GREEN PRODUCT

STOPS HARD WATER SCALE AND CORROSION

ONE TIME INVESTMENT FOR LIFE TIME PROFITS

SAVE WATER , ENERGY (or) FUEL & MONEY

REDUCES EXPENDITURE ON ENERGY CONSUMPTION

SUITABLE TO ALL INDUSTRIES WHEREVER WATER IS USED

VIRTUALLY MAINTENANCE FREE FOR ALMOST LIFE TIME

* SIGNIFICANT HIGHLIGHTS *

MORE WATER OUT FLOW FOR LESS ENERGY CONSUMPTION

IMPROVES LIFE TIME & PERFORMANCE OF ANY EQUIPMENT

EASY TO INSTALL WITHOUT ANY ALTERATION TO THE EXISTING PIPELINE

REMOVES THE EXISTING SCALES & NO FURTHER SCALES IN PIPELINE

KEEPS COOLING TOWERS, CONDENSERS CLEAN AND SCALE FREE

LESS CHEMICAL, SALT, ACID TO CLEAN THE SCALES IN PIPELINE

“इसका पानी”

PARHSAKTHY POWER TECHNOLOGIES PVT LTD

HYDERABAD - 500062 ,INDIA, Ph:+91-9100966001 / 002 / 019 , www.parahsakthy.com , salesandservice@parahsakthy.com

CEMENT INDUSTRIES

OIL REFINERIES

PHARMA INDUSTRIES

COOLING TOWERS

AIR COMPRESSORS

www.watertoday.org

Water Today - The Magazine | February 2020 21

Trump Administration issues WOTUS replacement

At an event at the Colorado Springs Pioneers Museum, U.S. EPA Region 8 Regional Administrator Gregory Sopkin and Lt. Col. Robin Scott, Deputy Commander of the U.S. Army Corps of Engineers (USACE)-Albuquerque District, announced the changes. According to a statement by the EPA, “The rule provides a new, clear definition for ‘waters of the United States’ (WOTUS) — delivering on President Trump’s promise to finalize a revised definition for “waters of the United States” that protects the nation’s navigable waters from pollution and will result in economic growth across the country.”

Critics argue the changes will set the U.S. further back, repealing protections guaranteed by the Clean Water Act. “This is not just undoing the clean water rule promulgated by the Obama administration. This is going back to the lowest level of protection we’ve seen in the last 50 years,” Collin O’Mara, president and CEO of the National Wildlife Federation, told The Hill. “This is a staggering rollback.”

EPA Administrator Andrew Wheeler said the new Navigable Waters Protection Rule “strikes the proper balance between Washington and the states in managing land and water resources while protecting our nation’s navigable waters, and it does so within the authority Congress provided.”

SUEZ renews contract to operate one of the largest wastewater recycling plants in the US

West Basin Municipal Water District has renewed its contract with SUEZ to operate and maintain the Edward C. Little Facility in El Segundo, CA, and its three satellite plants. The five-year renewal, worth a total of c. €67 million, began January 1, 2020 and runs through the end of 2024.

The Edward C. Little facility is one of the largest water recycling operations of its kind in the United States, producing about 150 000 m3 of water every day and conserving water resources in one of the nation’s most drought-prone regions. From 1994 to date, SUEZ has thus helped West Basin produce more than 750 million m3 of recycled water.

The facility produces five different qualities of custom-made recycled water to meet the specific needs of West Basin’s municipal, commercial and industrial customers (gardens watering, irrigation, supplying industrial boilers and cooling towers and indirect drinking water). Edward C. Little also produces 45 000 m3 of barrier water every day for aquifers replenishment that protects South Bay’s coastal groundwater reservoirs from seawater intrusion from the Pacific Ocean.

Rotork actuators help deliver fresh water

Rotork’s electric and pneumatic actuators have been installed at two sites in Germany with 39 GT pneumatic piston actuators and 13 CK modular electric actuators to be used at two municipal water works which supply the town of Lohr am Main, in Bavaria and surrounding areas.

At both sites water is extracted from six springs and two deep wells while the treatment takes place at seven waterworks. The actuators, which have been installed on butterfly and gate valves ranging from 2-12 in, are being used to drive isolation valves on the water stream to allow filtering, storage and distribution to take place. Underground containers with capacity for 5,500 m³ store the treated water before it is distributed through a pipeline network which is around 180 km long.

Rotork’s GT range of single and double-acting pneumatic piston actuators offer torques from 2.4 to 15,300 Nm and air pressure of 2 to 10 bar and is suitable for use in hazardous areas. The watertight CK range actuators are suitable for all valves in non-hazardous locations and can operate under the stress of high temperatures and strong vibrations by using separately mounted controls.

Oil-catching sponge could be solution for 100 billion barrels of oil-contaminated wastewater generated every year

Drilling and fracking for oil under the seabed produces 100 billion barrels of oil-contaminated wastewater every year by releasing tiny oil droplets into the surrounding water. Most efforts to remove oil from water focus on removing large oil slicks from industrial spills but these aren’t suitable for removing tiny droplets. Instead, scientists are looking for new ways to clean the water.

Now, researchers at the University of Toronto (U of T) and Imperial College London have developed a sponge that removes over 90% of oil microdroplets from wastewater within ten minutes.

After capturing oil from wastewater, the sponge can be treated with a solvent, which releases the oil from the sponge. The oil can then be recycled; the sponge, ready to be used again.

The sponge improves upon a previous concept: lead author Dr. Pavani Cherukupally, now of Imperial’s Department of Chemical Engineering, had developed an early version of the sponge during her Ph.D. at the U of T. Although the previous sponge removed more than 95% of the oil in the samples tested, it took three hours to do so — far longer than would be useful in industry.

“JOYAM Water Saving Re Circulation System For Vacuum Pump.”

Re-Usage of contaminated water



LIQUID RING RE-CIRCULATION SYSTEM

JOYAM TWIN LOBE ROOTS BLOWERS

For more information visit our website: www.joyam.in

Address:

CIN No. U93000GJ2007PTC051969

Joyam Engineers & Consultants Pvt. Ltd.

704 B, Mahalay, Opp. Hotel President, Near Swastik Cross Roads, Navrangpura, Ahmedabad - 380009. Gujarat

O: +91 79 26569533, 26560333, M: +91 97277 27115 Email: joyam@joyam.in, Website: www.joyam.in

ROMEMBRA



ROMEMBRA™ is a reverse-osmosis membrane element, developed using Toray's advanced polymer technology. The extensive lineup is used in a variety of applications. Potable & industrial water production through desalination of seawater & brackish water, wastewater reclamation from treated effluent, recovery of valuables in various industries, and concentration & separation applications of food industries.

Toray Industries, Inc.
Code: A100

NOV Mono Sludge Cake Pumps

NOV Mono has designed and manufactured its largest W Range progressing cavity pumps ever built. The four pumps have been ordered for two major wastewater treatment plant upgrade projects, and at 11-metres long they will have double the size and double the capacity of pumps normally used for this type of sludge cake application. The pumps will be used in a duty/standby configuration on a Cake Reception and Buffer Silo unit. This unit will house four feeder channels to transfer sludge cake from the silos into the specially-designed, 4-metre long hoppers of the W Range pumps. Injection points have been included in the hoppers so that additional material can be blended in to create the required degree of dry solids sludge.



NOV Mono
Ref Code: A101

E.2 Pump-Less Volute (PLV) Kit



The E.2 Series are energy-efficient, Dry Motor circulators designed for a wide range of applications. They include a permanently lubricated mechanical seal that can be replaced quickly and easily. Featuring improved durability and enhanced protection against leakage and water damage to electrical components, the key design elements of the E.2 Series include:

- New water slinger to protect motor against water intrusion
- Larger, stainless steel shaft
- Sealed, permanently lubricated bearings
- Bellows-style mechanical seal with silicon carbide wear surfaces

Armstrong Fluid Technology
Ref Code: A102

BA100K

The compact, dry self-priming dewatering and sewage pump has a capacity of over 190 m³/hour (836 US GPM) and a maximum head of 22 mwc (73 ft.). This is not only due to the large free passage of 82 mm (3.23"); the unit is driven by a single-cylinder diesel engine with a calculated maximum fuel consumption of 1.75 litre/hour.

Featured characteristics of the DriveOn® Technology include:

- Service interval of 1500 operational hours
- 65% less maintenance to the diesel engine
- 25% savings in engine oil

BBA Pumps
Ref Code: A103

For more details on products contact info@watertoday.org



Mechanical VACUUM EVAPORATORS for Effluent Treatment with NO STEAM, NO BOILERS & NO HEAD ACHE!!!

- NO Steam
- NO Boiler
- NO Pollution
- Fully Automatic
- Skid Mounted



- NO Choking
- NO Fouling
- Auto Descaling
- Very Compact
- Least OPEX (25P/Lit)*

Treat Your Emulsified Water (Coolant Oil, Lubricants, Soap...) at your Premises..!

Very Suitable For High TDS Effluent Water..!!

Treat Your Existing RO REJECT WATER TOO

Recover up to 97% of Pure Water @ <150ppm TDS...!!

Very Suitable for Chemical, Pharma, Textile, Leather, Automobile...!!

Lowest Process Cost (25paise/Lit) approx.

Recover NOT ONLY WATER...but ALSO ENERGY SPENT...!!

Very Energy Efficient than STEAM MECHANICAL EVAPORATORS...!!



Lombardyne Enviro Techniques
- Heat Pump Operated Vacuum Evaporators

5/8, First Floor, Jaya Complex, T.V.S. Nagar Thadagam Road
Coimbatore, Tamilnadu - 641 025.
Mob: 0091-99529 64323 | Email: sales@lombardyneenviro.com
Web: www.lombardyneenviro.com

FIP Instrumentation & Monitoring

Key Features

- Single and dual parameter monitors
- Efficient and cost-effective solution
- Useful combinations of output options
- Guided calibration procedure
- No need for instruction manual
- Mistake free setting
- Long Distance visible screen
- Leading-edge alert message
- More info displayed



Glynwed Pipe System (Asia)
Ref. Code: BO 100

WWR series

The WWR series by Alfaa UV, an ISO 9001:2000 certified company and a leader in its field. Alfaa UV has been disinfecting water for pharmaceutical, food, beverage, and other industrial applications to the highest standard. This same commitment to disinfection has prompted Alfaa to develop the WWR series to address the growing need for a reliable & environmentally responsible way to disinfect and reuse wastewater in these water starved times.



Alfaa UV
Ref. Code: BO 102

SCP-TP Process Controller

The SCP-TP Controller is designed to complement a dual solenoid control valve and can switch easily between settings for level control, upstream and downstream pressure management, flow control and position control. The SCP-TP also offers ON/OFF control and can be configured with a 4 – 20mA control motor such as the Singer 420 DC pilot mounted control motor. The SCP-TP is equipped with easy to use digital input controls and user selectable digital output alarms. Added features such as data logging, which logs all sensor feedback and set-point data as well as trending graphs, can be used for system analysis for water loss prevention and overall system pressure management.



Singer Valve
Ref. Code: BO 101

IN-Line And End-Suction Pumps

This product platform exceeds the requirements of the updated 2015 ErP regulations with a Minimum Efficiency Index (MEI) rating of 0.4 and provides significantly improved energy savings of up to 23 percent. Additionally, its expanded and optimised hydraulic coverage makes this new series suitable for a much broader range of industrial applications. e-series pumps can be supplied with an optional Xylem Hydrovar variable speed drive. The motor-mounted, space-saving Hydrovar is 'plug-and-play' and automatically adjusts operating speeds to optimise pumping system efficiency. As a result, it can provide up to an additional 70 percent reduction in energy costs depending on the application.



Xylem
Ref. Code: BO 104

Merit Flow

Booster Pump



Model: 75 GPD



Model: 100 GPD



NO COMPLAINTS



Model: 130 GPD



Model: 300 GPD

DISTRIBUTOR



VATTEN PURE INDIA LLP
7AA, Tiry Sector, Thira-Va-Ka Industrial Estate,
Ekattathaval, Chennai 600 033
Phone: 044 2525 1578, Mob: +91 95000 30580/3/4
Email: vattentpure@gmail.com | www.vattentpureindia.com



PURE INDIA
42, East Sathisandam Road, (Opp) Adayar Arundha Bhavan
R.S.Puram, Coimbatore - 641 002
Ph: +91 422 420 6202; Mob: 99422 38428 | 99885 88188
Email: perindia202@gmail.com, info@pureindia.co.in
Web: www.pureindia.co.in



SMART WATER SOLUTION
No. 3, Elango Sali Teyyanpet, Chennai 600 018, Tamil Nadu, India
Ph: 044 - 4205 0202, 4231 8282 | Mob: +91 90417 46567
Email: smartwatersolution@gmail.com



Aqua Clear Tech Water Solution
No. 93, South Marud Street, South Gate, Madurai-625001, Tamil Nadu, India
0432-4382994, 9900922001, 9944522894
aquaclear2008@gmail.com

ASIA WATER 2020



31 Mar – 02 Apr 2020
Kuala Lumpur, Malaysia

ASIAWATER 2020 is making its 11th edition on 31st March - 2nd April 2020 at the Kuala Lumpur Convention Center (KLCC). This sought after exhibition provides a sea of trade opportunities for players from every sector in the water industry to elevate their business further and strengthen networking among each other. This 3-day exhibition will be accompanied by free-to-attend conferences, technology seminars, and presentations from industry experts discussing the prospects, latest technologies, current and future issues whirling around the water and wastewater industry.

For more information log on to; <https://www.asiawater.org/>

OZWATER 2020



05-07 MAY 2020
Adelaide, Australia

Ozwater is the Australian Water Association's annual international water conference and trade exhibition attracting 3,500+ water professionals from Australia and abroad every year. The theme for Ozwater'20 is Thirst for Action and represents the need for continued action to meet the Sustainable Development Goals and the growing demands being placed on water from an environment, population and industrial perspective. It also reflects the Australian and global water sector's desire to be a leader in delivering a sustainable water future.

For more information log on to; <http://www.ozwater.org/>



YOUR TRUSTED SUPPLY CHAIN PARTNER FOR ENTIRE RANGE OF WATER TREATMENT CHEMICAL NEEDS.

STP/ETP/ZLD

- ◆ PAC: Powder & Liquid
- ◆ Zetag range of Polyelectrolytes (Anionic & Cationic) for STP, ETP
- ◆ Triwat – Decoloring Aid, Deoiling Aid and coagulation Aid
- ◆ Biopolymers for biological system – SBR, MBR
- ◆ Defoamer –Water & Silicone based
- ◆ Sludge Dewatering Polyelectrolytes
- ◆ RO Antiscalants
- ◆ MEE Antiscalants

DESALINATION/WTP

- ◆ Magnafloc LT 27 – Food Grade Polyelectrolyte for Drinking Water and Sugar Industry
- ◆ Magnafloc LT 7991 – Coagulation Aid
- ◆ RO Antiscalants
- ◆ RO Cleaning Chemicals
- ◆ Dewatering Polyelectrolytes

MINING/M-SAND

- ◆ Magnafloc range for ore beneficiation, thickeners and settlers
- ◆ Rheomax range for thickeners & tailing management
- ◆ Powder Flocculants for Alumina Refinery
- ◆ Organic Pellet Binder for Pellet Plants
- ◆ Super Absorbent Polymer (SAP)
- ◆ Dust suppressor

INDUSTRIAL WATER TREATMENT

- ◆ Cooling Tower/Boiler Water Treatment Chemicals
- ◆ EDTA
- ◆ Biocides-Oxidizing & Non Oxidizing
- ◆ Scale Inhibitors & Corrosion Inhibitors
- ◆ Deposit Control Agents
- ◆ Fuel Oil Additives
- ◆ Oxygen Scavenger
- ◆ Methane Sulfonic Acid

Triveni Global Pvt Ltd.

“Sai Kripa”, 51/26, 5th Street, Padmanabha Nagar, Adyar, Chennai - 600 020. Tamilnadu INDIA.
Telephone: +91-44-4260 7199 / 4211 5153.
Mobile: +91-99529 95769 (Manoj)
+91-98867 72211 (Akhilesh)
Email: vns@triveniglobal.com
akhilesh@triveniglobal.com

+91-99529 95777



Visit us: www.triveniglobal.com

10th ANNUAL SWAN CONFERENCE



SWAN, the Smart Water Networks Forum is the leading global hub for the smart water sector. A UK-based non-profit, SWAN brings together leading international water utilities, solution providers, academics, investors, regulators, and other industry experts to accelerate the awareness and adoption of “smart,” data-driven solutions in water and wastewater networks worldwide. SWAN Members receive full access to all SWAN research reports, regional workshops, webinars, select free passes to the SWAN 10th Annual Conference, global networking and speaking opportunities, marketing exposure, as well as the opportunity to take a lead role in advancing the water sector.

For more information log on to; <https://www.swan-2020.com/>

INDO WATER EXPO & FORUM 2020



INDO WATER 2020 is the biggest Expo & Forum for the fast growing water, wastewater and recycling technology in Indonesia. This show will bring together over 10,000 industry professionals and experts also over 550 exhibitors from 30 countries. It is proven platform for industry professionals to get updated on the latest trends and developments and to build valuable partnerships. It is also where water supply & sewerage companies, consultants, contractors, industrial wastewater treatment professionals and decision makers look for cost-effective solutions and technology.

For more information log on to; <http://www.indowater.com/>



- RO Membranes made with OVAY(Patented Technology) Membrane Sheet
 - RO Membrane 4040 comes with bigger active surface area to provide better flux
 - Stabilized rejection of 99.5%
 - Successfully tested in High TDS applications
- Higher flow and low pressure are the key factors of the Membrane Sheet
- Each RO Membrane is certified and stamped with WQA



Authorized Stockist for India: Membrane House, New Delhi
 Mail us at: Sanjay.khurana@membranehouse.com | Call us at: +91-9810667711

WATMAN 2020

WATMAN 2020 International Conference

To be held on 13th & 14th February 2020 at Chennai Trade Centre

The theme of WATMAN 2020 International Conference

Sustainable Water and Wastewater

Management Solutions for a Better Future

will focus on a diverse range of issues confronting in the water & wastewater industry.

AGENDA

Sessions		DAY 01 – 13 th February 2020
Session I		Decentralized Water Recycling Potentials
Session II		Latest Trends & Technologies in Desalination
Session III		Expanding Horizons in Industrial Effluent Treatment
Session IV		Reduce, Reuse and Recycle for a Sustainable Development in Future
Sessions		DAY 02 – 14 th February 2020
Session I		Cost-Effective Solutions for Wastewater Recycle & Reuse Technologies
Session II		IoT & AI in Water Management Solutions & Planning for a Sustainable Future
Session III		Industrial Wastewater Management: Recent Trends & Analysis
Session IV		Water Harvesting and Water Audit





C.R.I. FLUID SYSTEMS
Pumping trust. Worldwide.



One Stop Pumping Solutions...

- Ultrafiltration
- Demineralization
- Reverse Osmosis
- STP/ETP

- Municipal Wastewater
- Aqua Culture
- Water & Wastewater Treatment
- Mixtures of High Viscous Liquids





C.R.I. PUMPS PRIVATE LIMITED

Regd. Office : 7/46-1, Keeranatham Road, Saravanampatty, Coimbatore - 641 035, Tamilnadu, INDIA.
Phone : +91-422-7117000, Fax : +91-422-7117005, E-mail : bcsmt@cripumps.com www.crigroups.com

WATER CAREER 2020

Water Career is a One-Stop Database Source of talented Water & Wastewater Professionals

Water Career is the Human Resource Management division of Water Today Pvt. Ltd. Water Career is the largest and fastest growing talent pool of database of water and wastewater professionals. Water industry is a niche market with full of opportunities, we are the only company in India offering exclusive HR recruitment solutions to water and wastewater industries.

We believe in offering the best of potential and talented professionals to satisfy your requirements to attain your goals and objectives. We have a list of highly proficient profiles spanning across various categories, functions and expertise levels to cater the growing demand of Water and Wastewater Industries.

Water Today offers guidance to candidates for navigating the complex terrain of this industry. We can help you to find a job that is right for you. A world of diversified job opportunities awaits you.

Register with Water Career

We also promote specific vacancies in this field and attract response from a focused audience, through our various marketing initiatives such as print magazine, web portal, direct marketing & exhibitions. To register with Water Career, write to us at careers@watertoday.org, info@watertoday.org



WE BRING YOU NATURE'S MOST PRECIOUS GIFT...OZONE

Pioneers of Ozone Generation & Ozone Application Technology in India Servicing the Nation Since 1991



MAJOR APPLICATIONS

MUNICIPAL DRINKING WATER TREATMENT

WASTE WATER TREATMENT

PHARMACEUTICAL WATER TREATMENT

COOLING TOWER WATER TREATMENT

MUNICIPAL SEWAGE WATER TREATMENT

BOTTLED WATER TREATMENT

Ozonetek Limited

No. 98 Landons Road, Chennai 600010, India

Tel: +91 44 3511 4719

Email: info@ozonetek.com | kpatel@ozonetek.com

Web: www.ozonetek.com

Exhibitors List

ABS Watertech India Pvt Ltd
 Aguaclan Water Purifiers Private Limited
 Air O Water
 Akash Blowers Pvt. Ltd.
 All India Association Of Industries (AIAI)
 AMM Aqua Pure Systems
 Anandi Specialities & Services (P) Ltd
 Anji Engineering Solutions Private Limited
 Annamalayar Bottling Systems
 Antichem Equipments
 Aqua Natural Plus
 Aqua Revolutions
 Aquamec Ltd.
 Asahi Filter Fabrics Pvt. Ltd.
 Asahi Kasei Corporation
 Asian Print Systems
 Atharva Energy
 Automation Connect
 Ben And Gaws Private Limited
 Bio Cleaner Inc
 Bionics Enviro Tech
 BKS Engineers
 Blowchenn Machines
 Bluemoon Fibre Tech India Pvt. Ltd.
 Blufox Eco ventures LLP
 Bluwat Chemicals Co. Ltd
 Canadian Crystalline Water India Ltd.,
 Cauvery Electronics Consultants
 CEID Consultants & Engg Pvt Ltd
 CentPro Engineering Pvt.Ltd
 Chennai Bottling Systems
 CPC Water Treatment Solution Pvt Ltd
 Deah2o.com
 Deerfos Membranes Co.Ltd
 Devki Publication & Advertising
 Dharsan Dredging & Constructions Pvt. Ltd.

Dunamis Machines
 Earth Fokus
 ECO FRESH CARBON
 ECOgreen Cleantech Pvt Ltd
 Elite Automations
 Environment Protection Technology Exhibition (EPTEx)
 Evergreen Technologies
 Evoqua Water Technologies
 e-Water Mission India Pvt. Ltd.
 Ezzi Hardware
 Flui-Tec Instruments & Controls
 Global Water Intelligence / Media Analytics Ltd.
 Green Concept Technology India Pvt Ltd
 Green Tech Enviro Systems
 Greenrich Grow India Private Limited
 H2obazaar.com
 Hanna Equipments (India) Pvt. Ltd.
 Hatco Systems
 Hilda Automation
 Hydro Pure Technologies
 Hydropedia Pvt Ltd
 Indian Desalination Association (IDA)
 Indian Environmental Association (IEA)
 Indo American Water Systems
 Innovation Filter Systems Private Limited
 Ishan Paryavaran Pvt Ltd
 Jet Vacuum Systems Private Limited
 JimTrade.com A Division of Jupiter Infomedia Ltd
 Jumo India Pvt. Ltd.
 Kaveri Plasto Container Pvt. Ltd.
 Kaveri Water Storage Tanks
 Keerthi Pumps
 Kilburn Engineering Ltd
 Kitten Enterprises Pvt Ltd
 Klenz Chemicals
 Komter Equipments Private Limited

WATER & WASTE WATER TREATMENT SOLUTIONS



Fixed Aerators



Floating Aerators



Diffused Aerators

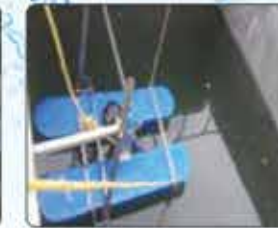

Biological Pretreatment



Tubular Membrane Filter



SWRO



Polishing RO



Diffusers with Retrievable Grid



Belt Press



Screw Press



FORWARD OSMOSIS



DISC RO



STP - Wet Land Technologies



TFM



Diffused Aeration

We Do Designing, Construction & Supply ZLD Systems With MEE, Bio-ETP, TFM, FO And RO Systems

WE DEAL WITH FOLLOWING SECTORS

- API & Pharma
- STP
- Distilleries
- Food industries
- Engineering

WE ALSO DO

- Tailor made solutions to handle water & waste waters
- Optimization, improvement & renovation of ZLD systems
- Water auditing
- Treatability studies
- Pilot plant studies

OUR TECHNOLOGY PARTNERS



OUR MAJOR CLIENTS



H.N-9-96, Ramaraju Nagar, Muthangi (Vill) Patancheru (MD), Sangareddy -502300 Telangana, india.
 Mobile: +91 90100 56902, 98493 66021, Email: sespvltld@outlook.com, Web: www.sesltd.co.in

Exhibitors List

Kontakt Engineers	Rammy Trade Solutions Pvt. Ltd.
Krishna Industrial Services	Rostfrei Steels Private Limited
Krofta Engineering Limited	RV Associates
KSSR Enterprises	S.ABBAS & CO
KWS Evaporators Pvt. Ltd.	Saravana Chem Dyes
Kymik Engineering Pvt. Ltd	Smaart Water Solution
Lansen Chem	Smart Aqua Technologies
LANXESS India Private Limited	Snow Wash & Co
Lexcru Water Tech Pv. Ltd	Sophisticated Industrial Materials Analytic Labs Pvt. Ltd.
Liquidsky	Spectra Plast India Pvt Ltd
Machine Factory	Spectralab Instruments Pvt Ltd.
Madras Chamber of Commerce and Industry (MCCI)	Spicos Media Communication
Madras Hardtools Pvt. Ltd	Spray Engineering Devices Limited
Marcus Blowin	Surplus Management Inc / Water Surplus
Maxwell Additives Private Limited	Tamilnadu Water Treatment Equipment Sellers Association - TWTESA
Membrane Engineering Pvt Limited	TenderTiger.com
Membrane House	Toshio Technology Pvt Ltd
Merit Flow	Trade4india.com
MICBAC india	Transcend Cleantec Pvt. Ltd.
Microtek Technologies	Ultra watech Systems
Mirai Co., Ltd	Vasthi Instruments Pvt Ltd.
Nachiket Engineering Pvt. Ltd	Vatten Pure India LLP
NetGlo Corporation	Venus Marketing & Enterprise
Nishu Enterprise	Vivek Flowtek System
Nivedhan Water Solutions Pvt Ltd	Vontron Membrane Technology co. Ltd.
Noble Trade Centre	Wasser Chemicals And Systems Private Limited
Nollet	Water Career
Nolta India Pvt Ltd	Water Quality Association (WQA)
Oasis Water Systems	Water Today Pvt. Ltd.
Ozone Engineers	Water Treatment Association of India
Permionics Membranes Pvt. Ltd.	Water World
Pet Plast India Inc	Xylem Inc
Pipeco Tanks	Yaha Water Systems Pvt Ltd
PPI Systems	Zero Mass Water
Pure N Safe Water Technologies Pvt. Ltd	Zhejiang Dayuan Pump Industrial Co.,Ltd
Raisunsoft Solutions (P) Ltd	



BIONICS ENVIRO TECH™

An ISO 9001 : 2015 CERTIFIED COMPANY

SCIENTIFIC MANUFACTURER OF NANOZYME CULTURE FOR
EFFLUENT TREATMENT PLANT (ETP), SEWAGE TREATMENT PLANT (STP)
COD & BOD REDUCTION, SLUDGE LESS PROCESS BY NANOZYME BIO-CULTURE™

Bionics Enviro Tech: Bionics Enviro Tech is an industry world leader in the field of biological waste water treatment By Manufacturing Nanzoyme bio culture and implementing in all industries. With presence in all states, Bionics Enviro tech with Strong research & Development and a passion for innovation is offering purely Nanzoyme technologies with wide range of solutions mainly focused on COD, BOD Reduction, Zero Sludge process, Zero Pollutant load in directed at addressing waste water challenges in all industries effluent treatment Plants (ETP), Sewage treatment plants (STP), Common Treatment plants(CETP) and Anaerobic Digester (AD) of any scale, any sector across the world with track record.

Executive Director: Dr.M. Parameswari Sasikumar, Executive director Ph.D., Agriculture Science with specialization in industrial waste water treatment heads the research and development of the company. Dr. M. Parameswari has more than 20 years of experience in university and industrial research, monitoring of industrial effluent treatment plants. She has published Doctoral research in dye industries effluent in to difference research journals international 20 research articles and national 16 research articles and also published research papers in international and national conference and seminar 35 papers.

BIONICS TECHNOLOGIES
(BIONICS GROUP OF COMPANIES)
NANOZYME TREATS WASTEWATER

INDUSTRIES WE SERVE:

- Dye & Textile Industries
- Pharmaceutical Industries
- Paper And Pulp Industries
- Tanneries And Leather
- Milk & Dairy Industries
- Food Processing Industries
- Breweries, Wine, Alcohol Plant
- Chemical Industries
- Municipal Sewage Water

MERITS OF USING NANOZYME:

- Sludge less process (Zero Sludge)
- Avoid Chemical Uses
- Low Cost Treatment Technology,
- Reduction of aeration Time & Blowers
- Reduction of >50% of Electricity Usage
- Degradation of Organic Pollutants & Heavy Metals
- Digest the suspended and floating organic debris.

NANOZYME APPLICATION:

- Aeration Tank
- Anaerobic Digester –UASBR
- MBR (Membrane Bioreactor)
- Collection and Equalization Tank
- Common Effluent Treatment Plants (CETP)
- Effluent Treatment Plants (ETP)
- Sewage Treatment Plants (STP)

98 % COD & BOD REDUCTION

ZERO SLUDGE

COLOUR & ODOR REMOVAL

DISSOLVED OXYGEN (DO)(4 to 11)

MLSS & TSS REDUCTION

COD & BOD REDUCTION, SLUDGE LESS PROCESS

AERATION TANK EFFLUENT TREATMENT PLANTS (ETP/CETP):	
NANOZYME-BET-ETP-7001	< 500 COD
NANOZYME-BET-ETP-7002	500-2000COD
NANOZYME-BET-ETP-7003	>2000 COD

SEWAGE TREATMENT PLANTS (STP/CSTP)
NANOZYME-BET-STP-9011
NANOZYME-BET-STP-9012
NANOZYME-BET-STP-9013

ANAEROBIC CULTURE:
NANOZYME BET-ANA-9001
NANOZYME BET-ANA-9002
NANOZYME BET-ANA-9003

NANOZYME APPLICATION DOSAGE (20 Kg / 100 KLD)		
NANOZYME	Day of Dosage	Nanozyme Application Dosage (600 liters)
1 st Dosage	1 st Day	50 liters
2 nd Dosage	3 rd Day	50 liters
3 rd Dosage	5 th Day	50 liters
4 th Dosage	7 th Day	30 liters
5 th Dosage	Alternated days	30 liters

HEAD OFFICE

2/185, Ramnagar, Vaikalmedu, Perundurai Main Road, Erode-638052.

CHENNAI OFFICE

No. 43, Mahindra World City, Chennai - 603004. Tamilnadu
(0) 90950 00090, (0) 90951 00090
(0) 95663 76690, (0) 82202 27745

drparams2014@gmail.com
info@bionicsenviro.com
kshasikumar@hotmail.com

www.bionicsenviro.com

TAMILNADU ANDHRA PRADESH KARNATAKA MAHARAstra GUJARAT DELHI
MADHYA PRADESH UTTAR PRADESH PUNJAB & ALL OTHER STATES



ABS Watertech India Pvt Ltd

ABS WATERTECH INDIA PVT LTD is pleased to introduce ourselves as one of the leading supplier in PAN INDIA & South –Asian countries for all kinds of Water and Waste Water treatment Plants & chemicals. We are in the market since last 15 years and our excellent business with many Govt., Semi-Govt., private sectors & Exporters to Srilanka, OMAN & QUITAR with repute and supplying the materials with their utmost satisfaction.

The Companies we represent are

- BWA – WATER ADDITIVES
(NSF certified products such as Antiscalants (Flocon / Belclene range), Corrosion Inhibitor (Belcor range), Desalination Chemicals (Belgard, Belsperse, Belite)
- WALCHEM (Auto Controller & Monitoring Systems)

Our Products & Services:

Water & Waste Water Management

Waste Water Treatment Plant – Design, Erection and Commissioning of Industrial RO, ETP, STP, WTP, Domestic RO Plants, AMC, Operation and Maintenance of Treatment Plants, etc.,

Utility Plant Water Treatment Management

HVAC – Process units, Cooling Tower Water, EVAPCO – Closed Loop CT, Chillers, Boilers, Desalination System, Swimming pool, ETP, STP, RO Treatment Chemicals.

Address: : # 6 / 17, First Floor, 2nd Cross Street, Defence Officers Colony, Guindy, Chennai –600 032.
Phone: +91-44-22310124 / 22322025, Mobile: 9841018391 / 729968600
Email: marketing@absgroups.co.in, abswatertech2009@yahoo.com, Web: www.abswatertech.co.in
Contact Person: Mr. M. Venkateshkumar



Aguaclan Water Purifiers Private Limited

AGUACLAN - Asia's No 1 Stainless Steel Dual Technology Water Purifiers, which was founded by Mr.C Guruswamy who has been bred in the water purifying industry for over a decade and has his roots firmly fixed in the fields of filtering, Super cleaning and liquid purification for more than 25 years. Accompanied by a group of passionate and highly self driven individuals, we strive to bring safe and clean water to every person.

We proudly present our wide range of water purification system - Water Purifier/ Water Coolers/ Water Dispenser/ RO Systems/ATM water vending machine and STP solutions. Our mission is to provide clean and healthy drinking water so as to hinder the water borne disease. Being on the verge of water crisis, clean water has become a distant dream for many people and we wanted to change this for the better. We could not find any better way to put this other than our motto "WE CARE WHAT YOU DRINK". The change may be small but the change is imminent and we invite you to be a part of it.

Why choose us: Our products are tailor made and you always have the liberty to customize the products as per your needs. We believe in the process that everything starts with the customers and ends with the customers.

You can customize from our below list of purification methods:

Spun Filter(Pre-Filter), Activated Carbon Filter(Pre Filter), Antiscalant (Increases the Life of Ro membranes), Sediment Filter, RO, TDS Stabilizer(maintains mineral level in water), Post Carbon, Alkaline (maintains PH), UV(Ultra-Violet) treatment, Ozonisation.

We are an organization who strongly recommend Eco-Friendly products. So we only manufacture Stainless Steel Eco-friendly Products. With no doubt and objection you can purchase our products for your requirement.

Address: 4/104- G, Cheran Co-Operative Industrial Estate, Somayampalayam Post, Coimbatore -641108.
Mobile: +91 84899 79595, Email: hr@aguaclan.com, Web: www.aguaclan.com
Contact Person: Mr. S.Karunya - HR



A3S Enviro Provides Integrated Solutions for Wastewater Treatment

Product Range

- Sewage Treatment Plant
- Effluent Treatment Plant
- Water Treatment Plant
- Water Treatment Chemicals
- Electro Coagulation Plant
- Air Pollution
- Recycling Plant - ZLD
- Fire Fighting Solutions

Advanced Waste Water Treatment Plant



Recent Projects



Looking for Channel Partners in Other States & Nepal

A3S ENVIRO & CONSULTANT

Office: Plot No. 11 F, Ground Floor, UMA Path Ram Nagar, Sodala, Jaipur Rajasthan 302019
Factory: Plot No. 11/OE/221, Ring Road Project, Muhana, Sanganer, Jaipur, Rajasthan- 302029
Mobile : +91-97851 20189 Email : info@a3senviro.com, Web: www.a3senviro.com



Air-O-Water

Roxy Exports Limited, which specializes in the manufacturing of electrical panels and communication equipment, introduced Atmospheric Water Generators in India under the name Air-O-Water.

The Air-O-Water is exactly like nature's way of producing water from the moisture in the air. The Air-O-Water uses a one-of-a-kind, reliable and adaptable technology which creates water from the humidity in the air, giving you fresh, bacteria-free, pure drinking water. Moreover, this water is completely untouched by contaminants in the ground or any other surfaces, unlike piped water.

This Air-O-Water technology has a global presence and is widely used for retrieving water from the environment and its purification. The patents owned by Air2Water contain 156 claims on various technologies including re-circulation, UV & Ozone sterilization and air filtration.

Address: 3rd Floor, Titanic Building, Tex Centre Complex, Chandivali Farm Road, Andheri-East, Mumbai-400072, Maharashtra
 Mobile: +91 99876 72726
 Email: yatin@airowater.com, Web: www.airowater.com
 Contact Person: Mr. Yatin Nandwani - Head-Marketing



Akash Blowers Pvt. Ltd.

AKASH Blowers is having the capacity to produce 600+ machines in a month & specialized in various lines of high quality Roots Type Air Blowers, Vacuum Boosters and Acoustic Hoods on a very economical price tag. We are having the manufacturing experience of 10000+ blowers & counting. We have extensive all-round facilities which include in-house design, production, manufacturing, quality control, inspection and after sales service.

Address: Plot No.1710, Modern Industrial Area, Part- B, Bahadurgarh, Haryana-124507
 Mobile: +91 99995 64644
 Email: mukesh@akashblowers.com
 Web: www.akashblowers.com
 Contact Person: Mr. Mukesh Sharma - Marketing Director

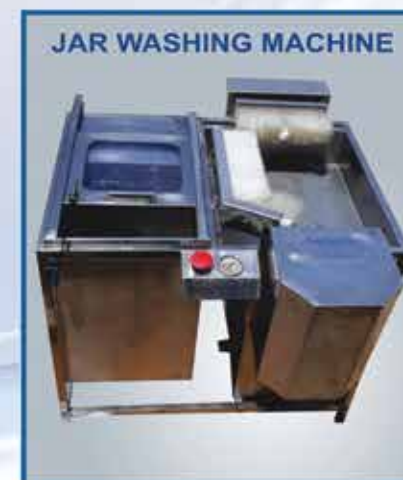

AQUA SAFE PLUS

No. T218, Sidco Women's Industrial Park, Kattur, Vellianur Post, Thirumullaivoyal, Chennai - 600 062. T.N. INDIA.

+ 91 81489 47967
 + 91 95511 65286

aquasafeplus.in@gmail.com
 project@aquasafeplus.com

www.aquasafeplus.com

BETTER
 LIVING
 THROUGH
 TECHNOLOGY



All India Association of Industries (AIAI)

All India Association of Industries (AIAI), established in 1956 in Mumbai has been serving trade and industry for over 50 years. The AIAI, with its core mission being 'building bridges of prosperity through industry', has over 1500 members and through its affiliates it represents over 50,000 industries. Nearly 70 percent of its members arise from the SME sector. AIAI represents its members effectively on various national and regional level panels and also with financial institutions on economic, trade and fiscal issues, among other things.

AIAI organizes seminars, workshops, trade exhibitions, B2B meetings, takes trade delegations overseas, and promotes domestic and internationally trade, investment and technology transfer through networking activities. It has signed agreements for cooperation with more than 200 international trade bodies and chambers of commerce covering most of the Industrial world. This promotes bilateral trade.

Address: 6th Floor, New Excelsior Bldg, A K Nayak Marg, Fort, Mumbai.
 Phone: 91-22-2201 9265/9160, Fax:91-22-2201 9764/9760
 Email: info@aiaiindia.com
 Web: www.aiaiindia.com
 Contact: Ms. Rupa Naik - Executive Director



AMM Aqua Pure Systems

We, AMM Aqua Pure Systems AN ISO9001 ; 2015 certified company began our journey in 2008 and we provide complete RO plant for Automatic bottling solutions industry manufacturer, supplier, and exporter of RO packaged Water Treatment Plant, Sea Water Desalination Plant, Bottle Filling Machine, Jar Washing and Filling Machine many more. We take end-to-end responsibility - planning, integrating and managing, quality, discharge and environmental fronts. By creating quantifiable benefits for our customers. We are counted amongst the Renowned manufacturers and suppliers of a wide range of water purifiers and all kinds of water treatment plants bottling machines. These are requirement, commercial, Industrial in all over India as well complete water processing plant with residential areas. We Export Production-30-40% of our total production in Sri Lanka, UK, Kenya US Uganda, and South Africa.

Product & Services:

Manufactures and exporters suppliers of RO Plant Bottling Machines, Sea Water Desalination Plant ISI packaged drinking Water Treatment Plant automatic filling machine our range 30 bpm to 100 bpm same automatic Bottle Filling Machine range 20 bpm automatic bubble top Washing and filling Machine range 200 bph to 500 bph manual bubble top Washing machine complete water processing plant with pre filtration Ro plants, post filtration ss sand, carbon fillers, UV System ,SS storage tank , and Ozonator conveyors and Roller Convey , our products the company undertakes turnkey projects from concepts to commissioning IN All kind of water processing machines sales and service , machine spares

Office Address: No.118 M.S Nagar 1st Street, Kundrathur Road Porur, Chennai-600116
 Phone: 044-4856 3820
 Mobile: +91 96000 91991, 91504 51388
 Email: ammaquapuresystem2008@gmail.com
 Web: www.ammaquapuresystems.in, www.waterbottlingplants.com
 Contact Person: Mr. A. Manikandan - MD

Factory Address:
 3/559 B, Kundrathur Road,
 Madhanandhapuram, Porur,
 Chennai- 600116, TamilNadu,



TW ULTRA FILTRATION MEMBRANES STREAM SERIES

Membranes Made in India for India

Ultrafiltration(UF) is a pressure-driven membrane based separation process to remove suspended solids, bacteria, virus, endotoxins and other pathogens to produce water with very high purity and low silt density.

Why Theway Membranes?

- Made in India
- Ready availability
- Excellent after sales service and support
- Customisable membranes to replace existing membranes (One-to-one replacement possible)
- Over 300 existing satisfied customers
- Unrivalled pricing

Merits of Theway UF Membranes

- Increased flux
- Increased Hydrophilicity
- Exceptional service life
- Higher resistance to fouling
- Higher resistance to scaling
- Lower pressure requirement
- Wide range of MWCOs
- Superior mechanical strength
- Finer and sharper pore size distribution
- Premium chemical resistance



Membrane Area (m ²)	8	12	20	35	40	60	55	80	95	145
---------------------------------	---	----	----	----	----	----	----	----	----	-----

Retrofit (Models)	DUPONT (DOW SFP 2860 DOW SFP2660)	NORIT/PENTAIR (NORIT/PENTAIR X FLOW AQUAFLEX 20, 40,55,64, 30GA 40,55, 64, SEARLEX 4055,64)	GE (SUEZ ZW1500)	HYDRANAUTICS (HYDRACAP 40A, 50A, HYDRACAP MAX 40, 60,80)	HYFLUX (K000, K2000)	KOCH (TARGA)
-------------------	---	---	---------------------	---	-------------------------	-----------------

THEWAY MEMBRANES

No.29, Yadaval Street, SIDCO Indl. Estate, Ambattur, Chennai 600 098, India
 Ph: +91 44 48502060 / +91 73974 98660, +91 73974 98658, +91 98407 60857
 Email: mail@thewaymembranes.com
 Web: www.thewaymembranes.com



Anandi Specialities & Services (P) Ltd.

We take immense pleasure in introducing to you Anandi Specialities & services and BePure Tech Pvt. Ltd. having 28 years of experience in water treatment sector.

Our is a leading manufacturer and wholesale distributor of water treatment and commercial water purification systems. Since its inception, ANANDI SPECIALITIES & SERVICES AND BE PURE has offered a wide range of pre-engineered as well as custom engineered solutions for all water purification needs.

By providing O&M services to various industrial/Commercial sectors, we have treated water from waste water and and recycle back to process thereby reducing extraction of precious ground water .

Our objective is to satisfy each customer with the most technologically advanced, cost effective, latest and innovative solutions.

Vision:

“Our vision is to reach out to all the water purification needs in the globe and develop the most innovative solutions with unmatched quality, for them

Address:175, V-Mall, Western Express Highway Near Sai Dham,
Thakur complex Kandivali-e, Mumbai-400101
Phone: +91 22 4297 4397, Mobile: 8104476560
Email: sales@saitreat.com, Web: www.saitreat.com
Contact Person: Mr. Harshal - Barde Technical Sales Manager



Anji Engineering Solutions Private Limited

ANJI Engineering Solutions Pvt Ltd (AES), a top solutions provider in the fields of HVAC, Acoustics & Vibration, Lighting and others has emerged as one of top companies in their area in INDIA in a short period , and has gained the confidence of prominent clients and consultants, who are looking for reliable and quality products and service. The company which was started couple of years ago with two employees is now an ISO 9001 : 2015 certified company, with independent departments, headed by qualified staff spear heading each activity and is trusted by their customers for the quality and reliability of their products and services.

Address: Door No:5, Sri Sundaram Flat, Morrison 3rd Street, Alandur- Chennai - 600 016
Phone: +91 44 2231 2989
Email: accounts@anji-es.com
Web: www.anji-es.com
Contact Person: Mr. K. G. Muralidharan - Managing Director

TURNKEY PROJECTS FOR ENVIRONMENT MANAGEMENT

Waste Water Treatment Plants

- Zero Liquid Discharge (ZLD) Plants
- Activated Sludge Biological Treatment
- Diffused Aeration system for Bio Plant
- Bio Sludge Disposal System
- Anaerobic Treatment Plants
- Advanced Oxidation Plant
- Wet Air Oxidation Plants
- MBR & MBBR ETP Plants
- UF & RO Plants



Air Pollution Control Plants

- Venturi Scrubbers & Packed Towers
- Exhaust System Vent Scrubbers
- Ammonia & Solvent Recovery Plants
- Odour Control System & Bio Scrubbers
- Organic Fumes Adsorption Plant
- Catalytic NOx Control System
- ACID Fume Scrubbing Systems



Chemical Waste Incinerators

- Solid & Liquid Waste Incinerators
- Organic Fumes & Waste Gas Incinerators
- Rotary Kiln Incinerators
- Drum Pyrolysis
- Bio Sludge Disposal System
- Flue Gas Treatment for Incinerator
- Air Pollution Control for Incinerator

Our strength

- Experienced team of Chemical Engineers
- Core competence in process and detailed engineering
- Long term and trustworthy services
- Motivated and results-driven achievers and team leaders.
- Strong organizational and team building skills combined with the ability to work under various situations to achieve deadlines.
- Significant experience of executing turnkey projects all over India and China.
- Highly efficient in a fast-paced environment while coordinating with numerous time-sensitive projects.
- Effective time management and prioritizing abilities.
- Total commitment to customer satisfaction.

Parth Projects & Construction Pvt. Ltd.

875/8 Parth House, Gidc Makarpura, Baroda 390010, INDIA
Phone: 0265 2653199 / 2633199 | Cell No. +91 93762 53199
Email: info@parthprojects.com | web: www.parthprojects.com





Annamalayar Bottling Systems

We, ABS Annamalayar Bottling Systems AN ISO9001; 2015 certified company began our journey in 2008. We provide complete RO plant for Automatic bottling solutions industry manufacturer, supplier, and, exporter of RO packaged Water Treatment Plant, bottle filling machine, jar washing filling machine and many more. With the experience of being a strong contender for continuous 10 years in the same industry through AMM Aqua Pure Systems, we are looking to scale up our business to new heights with ABS Annamalayar Botting Systems.

We take end-to-end responsibility - planning, integrating and managing, quality, discharge and environmental fronts. By creating *quantifiable benefits for our customers. We are counted amongs the Renowned manufacturers and suppliers of a wide range of water purifiers and all kinds of water treatment plants bottling machines These are requirement, commercial, Industrial as well complete water processing plant with residential areas. We export approx 20-40% of our total production to Dubai, Tanzania, Uganda, Kenya, Ethiopia, Saudi Arabia, USA and Sri Lanka.

Product & Services: Manufactures & exporters, suppliers of Ro plant bottling machines ISI packaged drinking Water Treatment Plant automatic filling machine our range 30 bpm to 100 bpm same automatic Bottle Filling Machine range 20 bpm automatic bubble top Washing and filling Machine range 200 bph to 500 bph manual bubble top Washing machine complete water processing plant with pre filtration Ro plants, post filtration ss sand, carbon fillers, UV System, SS storage tank, and Ozonator conveyors and Roller Convey, our company undertakes turnkey projects from concepts to commissioning All king of water processing machines sales and service.

Address: No.118, Kundrathur Main Road, MS Nagar 1st Street, Porur, Chennai-600116 Tamilnadu, India

Phone: 044-4856 3820, Mobile: 88709 50175, 96000 91991

Email: annamalayarbottlingsystems@gmail.com, Web: www.annamalayarbottlingsystems.com

Contact Person: Mr. A.Senthil Murugan - Managing Directo



Antichem Equipments

We are pleased to introduce ourselves as one of the leading manufacturers of Non-Metallic and Metallic Pumps in India since 2005 From Salem, TamilNadu. Our Product range includes solid injection moulded Polypropylene (PP) and polymer lined pumps with lining materials: PPH, PVDF, FEP, PFA and Investment Casting (CF8M) for Metallic pumps and also (Cast Steel, SS-304, SS-316L, Alloy 20, Hastalloy-B, Hastalloy -C, And CD4MCU and Etc... Which is Under Trade Brand ANTICHEM

The application range covers highly corrosive acids, alkalis, solvents and other corrosive fluids used in the Chemical Process, Petrochemical process, Refinery, Power Generation, Food Processing, Oil Extraction, Bulk Drug Manufacturing, Effluent Treatment, Steel and similar core Industrial sectors Marketing and distribution is handled Via Multiple Sales and Independent Distributors cross India. 25 Years of experiences providing solutions for liquid transport need ensure high quality of standards. We are certified to ISO 9001: 2015.

Address: Reg. Office : 930/5, Iyyappachettiyar Kadu, Alagapuram Pudur, White Field, Salem-636016, Tamil Nadu.

Mobile: +91 96004 60088, 995262 7277

Email: santhosh@antichem.net, sales@antichem.net, Web: www.antichem.net

Contact Person: Mr. Manikandan .V.P - Director

GOLDFINCH™ offers ...

Optimized Operating Cost for your Concentration/ Water Extraction Solution using...

FORWARD OSMOSIS TECHNOLOGY....

In association with **Aquaporin A/S, Denmark**



Lab Facilities



HFFO Membrane



Typical FO Skid

Applications

- Pre-concentration of wastewater before Evaporation
- Recovery and concentration of valuables
- Leachate treatment
- Water Extraction for process reuse while reducing volume of wastewater

Advantages

- Lower membrane fouling
- Lower energy consumption, lower operating Cost
- Better retention of solutes

We provide FO solutions integrated with Innovative Draw regeneration for high TDS wastewater

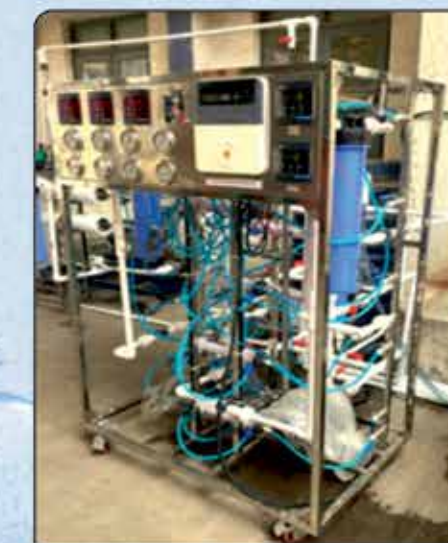

Industrial Pilot Plant

Goldfinch is a leading company with more than 3 decades of experience providing cost effective solutions in industrial wastewater treatment and ZLD projects. **GOLDFINCH™** provides a one-stop solution with its wide range state of art offerings.

GOLDFINCH ENGINEERING SYSTEMS PVT. LTD.

Plot No.A-288, Road No. 16Z, Opposite Agriculture Bus stop, Thane Industrial area, MIDC (Wagle Estate), Thane (W) 400604

Tel: 91 22 2580 1529/21/46

• Website : www.goldfinchengg.com • E-mail : mktg@goldfinchengg.com

Aqua Natural Plus

AQUA NATURAL PLUS is an ISO 9001:2008 Certified Company based at Chennai and leading manufacturing of Mineral Water water plant project related machineries. We install entire Mineral Water/Packaged Drinking water plant (fully Automatic as well as Semi Automatic) on turnkey basis. We provide end to end services right from plant design to getting ISI license. We also provide Marketing help to customers to sell their products in the market. We supply and install entire project as per Indian Standard Specifications IS 14543:2004

RO Plant:

- Water Treatment / Purification Plant
- Bottle Rinsing, Filling and Capping Machine Automatic 20 Liter Jar Washing
- Pouch Packaging Machine Cup / Glass Rinsing
- Filling And Sealing Machine
- Blow Moulding Machine (For Making Pet Bottles)
- "ISI" Mark Consultancy & Laboratory Supply

Address: Corporate Office: No. 140A, TV Chari Street, Venkatapuram, Ambattur, Chennai - 600 053. Phone: 044 - 4321 0501 / 2657 0501
 Email: aquanaturalplus2012@gmail.com, Web: www.aquanaturalplusindia.com
 Contact Person: Mr. K.Rajeshkumar-Managing Director - 97870 51351



Aqua Revolutions

Aqua Revolutions was started as a industry on Oct 2008 by Mr.Raja Kathirvel, Chennai, Tamil Nadu, and India to manufacture and supply water and waste water treatment plants to various industries.

Aqua Revolutions Produced and Supplied High Quality water& waste treatment machineries to various industries by outsourcing most of the processes. Sewage treatment plants are the major customers. We also have developed Innovative technology of their business in the field of Waste water and sewage treatment plant water manufacturing.

AQUA REVOLUTIONS can provide Quality Water Treatment Solutions to companies in Chennai, In Tamil Nadu and many places in South India, and elsewhere, exclusively in the Reverse Osmosis based systems. We understand how increased competitiveness, environmental awareness and stringent health and safety regulations have critically impacted on the commercial aspects in Water production, use and Conservation to minimize losses and maximize profits. Besides a Standard Product Folio we can also offer Custom-built Plants & equipments. We combine professional expertise with attention to detail to specifically ensure that the system and solutions designed, supplied or maintained by us operate safely, efficiently and effectively.

Address: Plot No-42& 43, Karpagam Nagar, Thirumudivakkam, Chennai-44
 Phone: 044-65516386, Mob: +91 98423 64193, 94442 44193, 87788 06700
 Email: sales@quarevolution.in, aquarevolutions@gmail.com
 Web: www.aquarevolution.in
 Contact Person: Mr. Raja Kathirvel - Chief Executive





Industrial Membranes

L8040
L4040
L4021

IMPORTERS
Leading Distributors & Supplier of
OTAYO®
Ideal For Ro Plant Managers & Operators
Seeking Consistency, High Performance, Long Element Life,
Increase Productivity, High Water Quality.



RO Plants

RAMMY TRADE SOLUTIONS PVT LTD
 1,Jyyasamy School Street, Nehru Nagar, Chrompet, Chennai-600 044
 Mob: +91 98403 11650, 98846 13936. Email: info@rammyindia.com

Mumbai: B-2/102, Mohan Regency, Adharwadi, Kalyan West-421301 Maharashtra, India.
 Mob: +91 99303 30576 CIN:U52390MH2015PTC261659

Bengaluru: Shop No. 3 & 4,3 BM-312, 3rd Main Road, Kasturi Nager,
 Bengaluru 560 016. Ph: 81230 11369

Watermaster

Aquamec Ltd.

Watermaster | Aquamec Ltd.

Cleaner, safer and better functioning waters with fewer machines and less money - The Amphibious Multipurpose Watermaster Dredger does the work of many separate machines.

Multipurpose Watermaster can take out polluted sediments and excess siltation from waterways by suction dredging. It can remove trash and invasive aquatic vegetation by excavating and raking. It can reinforce shorelines by pile driving to prevent erosion and to enhance functionality and the safety of urban areas. Watermaster can also help in the building, maintaining and developing of water infrastructure, such as marinas, piers and flood-walls.

We at Watermaster/Aquamec create and supply smart ecological solutions for heavy-duty works in shallow waters. Our mission is to offer the most versatile, most mobile and most reliable amphibious dredging vessels on the market. The strong Watermaster Classic V is the pinnacle of our continuous development and innovation work. It offers an unprecedented combination of mobility and heavy duty dredging capacity.

Hundreds of amphibious multipurpose Watermaster dredgers are currently solving shallow water projects in over 70 countries worldwide.

Authorized Distributor and Services Dealer in India:
M/s Dharsan Dredging And Constructions Pvt. Ltd.
329A/1, Grace Cottage, New Colony 2nd Street,
Chengalpattu - 603003, Tamilnadu.
Phone: +91 44 27420074, Fax: +91 44 27420833
Mobile: 9445390683, 9445390584.

Email: dharsandredging@yahoo.com,
dharsandredging2010@gmail.com,
jesudossarumairaj6661@gmail.com

Address: P.O. Box 260, 27801 Säkylä, Finland

Phone: +358 10 402 6400, Fax: +358 10 402 6422

Email: watermaster@watermaster.fi, Web: www.watermaster.fi



Asahi Filter Fabrics Pvt. Ltd.

Asahi Filter Fabrics Pvt. Ltd., have been established in 1992, in order to meet the needs of Customers in Filtration Media. We supply Non-woven and Woven Filter media for all air/gas filtration applications in all the industries.

Our Company in 1994 have set up our own manufacturing facilities in Chennai to fabricate and sew our full range of filters. Our close liaison with raw material suppliers ensure that the very latest fibers and finishes are available.

A full range of custom manufactured filter bags available in both Non-woven & woven filter media for all types of bag housing including pulsejet, mechanical shake and reverse flow cleaning systems.

We assist in choosing the most suitable material and offer solutions to many kinds of technical filtering conditions in Filtration processes.

We cater to Foundries, Cement Industry, Lead Industry, Pharma Industry, Food Processing Industry, Oil Industry, ETP Plants etc., for their specific process application.

Address: 365-C, IInd Floor, Mahakavi Bharathi Nagar, Vysarpadi, Chennai - 600 039

Mobile: .9841279062

Email: asahifab@gmail.com, Web: www.asahifab.com

Contact Person: Mr. S.B. Harikrishnan



INDIA'S PREMIUM DOSING PUMPS



INDIA'S FIRST pH/ORP CONTROL DOSING PUMP

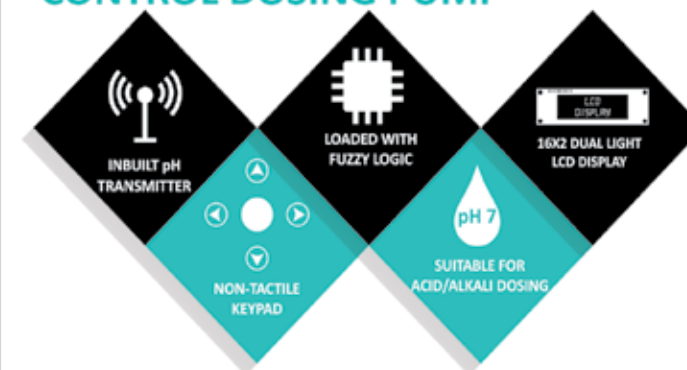

Mechanically actuated Diaphragm Metering Pump



Available in 100,200,300 and 400 LPH



Sr. No. 273, Near Vitthal Mandir, Bhatewara Nagar, Hinjawadi, Pune - 411 057, Maharashtra (India)

www.initiativeengineering.com | +91 20 2293 2122, +91 788 788 7533 | info@initiativeengineering.com

AsahiKASEI

Asahi Kasei India Pvt Ltd

- Asahi Kasei is a leading company of MF/UF membranes manufacture for water treatment such as drinking water, waste water treatment and desalination.
- Asahi Kasei successfully developed and employed TIPS (Thermal Induced Phase Separation) PVDF membranes for outstanding physical strength and chemical resistance which realized long-term operational reliability.
- As proven track record, there are over 800 drinking water plants employing Microza in the United States and there are all of major Singapore Newater plants (sewage effluent recycle plants) employing Microza.
- With more than 30 years experiences in water industries, Asahi Kasei Microza has been operating successfully over 2,000 sites all over the world.

Microza UF/MF Introduction

Type	UNA-620AB	UNA-620A	UHS-620A
Material	Pressurized	Pressurized	Submerged
Configuration	TIPS-PVDF	TIPS-PVDF	TIPS-PVDF
Flow Direction	Hollow fiber	Hollow fiber	Hollow fiber
Pore Size	Outside-In	Outside-In	Outside-In
Membrane Area	0.1 um	0.1 um	0.08 um
	65 m ²	50 m ²	50 m ²

Address: The Capital, Office No: 1502-B, 15th Floor, Plot No. C70, G-Block, Bandra Kurla Complex, Bandra (East) Mumbai-400051, India Phone: 020-67235815, Mobile: 99306 60454
 Email: asif@om-asahi-kasei.in, Web: <https://www.asahi-kasei.co.jp/membrane/microza/index.html>
 Contact Person: Mr. Mohammad Asif Ahmad

LINX

Asian Print Sytems

Asian print systems is an organization promoting LINX model industrial inkjet printers in Tamilnadu, Pondicherry & Kerala. Our industrial LINX inkjet printers are renowned for their ease of use, reliability and one time investment on their plants/units.

LINX model inkjet is the best in class industrial coding and marking solutions. You can rest assured that we have this industrial printer to meet your specific requirements.

Address: Plot No-4,Vellalar Street, School Road, Aynambakkam,Chennai-600 095.
 Phone: +91 72001 20004, Mobile: +91 95000 02806.
 Email: asianprintsytms@gmail.com
 Contact Person: Mr. Suresh Govinda - Partner

wipro water



Wipro Water offers solutions ranging from raw water treatment to waste water recycling and reuse including zero liquid discharge (ZLD). Our 360-degree capabilities range from consulting to product design, project management, manufacturing, installation, operations and maintenance. Custom designed to suit challenging local water sources, our solutions meet dynamic business requirements.



500+
global
customers



350+
projects
executed



25+
industry
segments



wipowater.in



rashmi.sagare@wipro.com



+91 75068 66787



1st floor, Venus Building, TTC MIDC Area, Thane – Belapur Road, Airoli, Navi Mumbai - 400708



Atharva Energy

Our products are used in virtually every industry, worldwide: aerospace engineering, automotive engineering, chemical and process industries, electrical resistance heating, oil and gas extraction industries, petrochemical processing, pollution control and waste processing, power generation, thermal processing and heat treatment.

Our Corporate Strategy :

We intend to be a major player in our key businesses, and to offer our customers State-of-the-Art products and services.

We focus on:

- Long term availability of our products
- Sustainable growth based on an adequate profit
- Solid financial basis
- Long term customer and suppliers relationship
- Readiness for continuous change
- Professional and human competence of our partners and employees

Our 10 Principles:

- We want to be among the leading solution providers for North India industries.
- Our core businesses are pneumatics, hydraulics, Water & Waste Water environmental technology.
- Our core competences are engineering, logistics and services.
- The motto, "Enriching your success", describes our target of supporting our customers with high competence, availability, service beyond average and flexibility on their way to market success.
- We want to be present all over India with uniform branding.

Address: G-22, Vardhman Star Mall, Sector-19, Near Badkhal Metro Station, NH-2, Faridabad Pincode : 121001 Haryana (India)
 Mobile: 91-93126 93904
 Email: atharvaenergy@yahoo.in, Web: www.atharvaenergy.com



Automation Connect

AutomationConnect is India first End to End B2B Portal exclusively for Industrial Automation conceived and headed by an industrial automation pioneer & veteran. The portal is the Automation Exchange Platform for industrial automation ecosystem comprising of Automation endusers (manufacturing industries), Automation vendors, OEMs, System Integrators, Consultants, Automation Technology experts, Automation students and many more who are related to automation. AutomationConnect are Online Media partners to leading event organizers and Online Media publishers to PR firms, consultants, Automation association bodies.

Automation Connect is a dedicated Automation Exchange and caters to:

- End User Industry who use Automation extensively for their Production, Monitoring & Control and Data Acquisition requirements. Industries like Automotive, water, Steel, Paper, Cement, Sugar, Oil & Gas, Ports, Material Handling, Textiles, Rubber & Plastics, Pharmaceuticals, Food & Beverages, Chemicals, Metals, Power, Printing/Packaging etc can look for automation providers.
- Automation Vendors who manufacture and/or distribute Automation products to the industry can showcase their products & solutions.
- OEMs who use Automation products extensively to manufacture equipment for the industry can look for providers.
- Systems Integrators who offer Automation Solutions to the industry by integrating automation products can showcase their business
- Consultants who are involved in design and engineering as well as those who would be influencing decisions of appropriate automation technology to end users industry mentioned above can look for clients by their presence
- Automation Technology Experts who contribute to the development of newer technologies can showcase their expertise

Address: 27/14, Josier Street, Nungambakkam, Chennai 600034
 Phone: 044-28266227, Mobile: +91-9940184440
 Email: aparna@automationconnect.com, Web: www.automationconnect.com
 Contact Person: Aparna Gopalakrishnan – Director

FILTER ELEMENTS FOR ALL YOUR FILTRATION NEEDS!



FILTER CARTRIDGES

- Spun
- Wound
- High Flow
- Pleated Polypropylene
- Hydrophobic PTFE
- Hydrophilic PTFE, PES, Nylon 66



BAG FILTERS

- Absolute
- Needled Felt PE
- Needled Felt PO
- Extended Life
- Oil Adsorption
- Mesh
- Tie-on
- Custom Bags



FILTER HOUSINGS

- Cartridge Housings
- Bag Housings
- High Flow Housings
- PP Housings
- Strainers
- Custom Housings

APPLICATIONS

- Trap filtration
- Waste water rejection
- Pre-filtration
- Haze removal
- Bacteria removal
- Sparging
- Clarification
- Precipitate removal
- Impurity removal

Kitten Enterprises Pvt. Ltd.

W407, Rabale MIDC, Near Golden Garage
 Navi Mumbai 400701 INDIA
 +91.22.2764.6464 | +91.865.500.9090
 advt@kitten.co.in | www.kitten.co.in





Ben And Gaws Private Limited

BEN & GAWS PVT. LTD, has grown to become one of the most preferred privately-owned engineering company by manufacturing superior and innovative 'bolted panel' liquid storage tanks, grain storage silos and material handling equipment for different industries like grain milling, seed plants, breweries, ethanol plants, fire fighting, rainwater harvesting, industrial and domestic water treatment, oil & gas, power plants, other manufacturing and Processing plants etc. Our engineering and technical expertise combined with exceptional qualities and continuous focus on customer satisfaction put us at the forefront of these verticals. BEN & GAWS follows latest German standard for designing, product development and manufacturing, as an alternative it also offers latest American and Indian standards depending on end-user's requirement, location and nature of application. Partnering reputed European as well as top Indian designing institutions and organizations, we are relentlessly developing and improving our products to suit all possible applications at all possible weather conditions and locations.

Our mission: Our mission is to meet the needs of the end-users accurately and to provide unparalleled quality of material and reliable after-sales service to ensure headache free operation of the supplied equipment and solutions in long run.

Safety Statement: The safety at workplace and health of our employees are our outmost priorities.

Quality Statement: Delivering work of the highest quality is essential when constructing infrastructure assets that must stand the test of time. Our quality leaders are skilled in their craft and provide governance and assurance across all projects.

Advantages:

- 1. 50 Years life expectancy
- 2. Brute Strength
- 3. Cost Effective
- 4. No Corrosive even in harshest environment
- 5. Zero leakage

Address: E-48/9 Okhla Industrial Area New Delhi 110020
 Mobiul: 9899264560/9899264567
 Email: madhu.gupta@bengaws.com, Web: www.bengaws.com
 Contact Person: Ms. Madhu Gupta -Regional Sales Head

BioCleaner

Bio Cleaner Inc.

BioCleaner is a technology-driven company that provides a U.S. patented technology that cleans Industrial, commercial and agricultural wastewater and cost-effective biological solutions to treat all types of organic waste in the residential, industrial and municipal sectors. We also have systems that can clean open waters like rivers and lakes.

We are currently looking for distributors and partners in India.

BioCleaner is headquartered in Monterey Park, California.

Address: U.S. Commercial Service, Chennai
 Phone: 044-28574477
 Email: Office.Chennai@trade.gov, Web: www.buyusa.gov/india



FILTRAN FABRICS

Solution for filtration

MANUFACTURER OF INDUSTRIAL FABRICS

GERMAN TECHNOLOGY
WITH INDIAN MAKE

About us: FILTRAN FABRIC is the first Indian company to make filter cloths with German technology. We offer a variety of filter cloths for various applications. Since our company is located at cotton city of south India Tirupur. We are able to produce International standard fabrics with low manufacturing cost. We have our R&D team for testing and choosing suitable filter fabrics for suitable application.

Quality Policy: We Are committed to providing customers with services of the highest possible level of quality. In order to achieve this. We are continually improving processes, products and services, meeting and exceeding customer satisfaction at all times.

Products

- Filter Press Cloth
- Centrifuge Bags
- Nutsche Filters
- Fluid Bed Dryer Bags
- Sparkler Filter Pads
- Disc Filter Bags
- Vacuum Belt Filters
- Rotary Vacuum Drum Filter Cloths
- Filter Papers

Industry we serve

- Pharma
- Chemical
- Oil and Fats
- Ceramics and Granites
- Mining
- Waste Water and effluent Treatments
- Dyes and pigments
- Food and beverages
- Other process Industries

Why Choose us ?

Filtran Fabrics staffs are having decades of experience in solid liquid separation which helps to create right filter fabrics for your application. We are register supplier for Top filter press and process equipment manufacturer in India and Asian countries through which we can guide to choose right machinery for your application . We have our Technical team to visit your premises for any day any time any where for your filtration Challenge

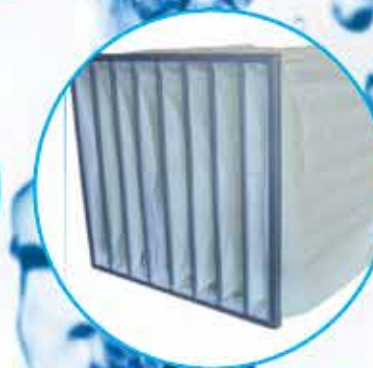
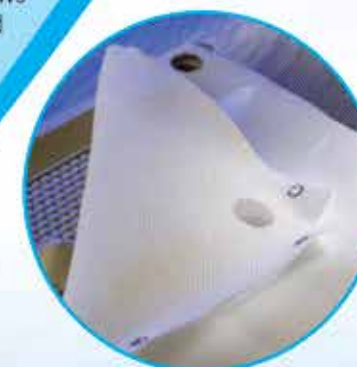

FILTRAN FABRICS

Solution for filtration

21/A, Tirupur Cotton and Spinning Mills Compound, P N Road, Tirupur - 641 602 , Tamil Nadu, India
 Mobile: 91 77081 11511, 99452 57419, Email: info@filtranfabrics.com, filtranfabrics@gmail.com, Web: www.filtranfabrics.com



Bionics Enviro Tech

About Bionics Enviro Tech: Bionics Enviro Tech is an industry world leader in the field of biological waste water treatment By Manufacturing Nanozyme bioculture and implementing in all industries. With presence in all states, Bionics Enviro tech with Strong research & Development and a passion for innovation is offering purely Nanozyme technologies with wide range of solutions mainly focused on COD, BOD Reduction, Zero Sludge process, Zero Pollutant load in directed at addressing waste water challenges in all industries effluent treatment Plants (ETP), Sewage treatment plants (STP), Common Treatment plants(CETP) and Anaerobic Digester (AD) of any scale, any sector across the world with track record.

About Executive Director: Dr.M. Parameswari Sasikumar,Ph.D., Agriculture Science with specialization in industrial waste water treatment heads the research and development of the company. More than 20 years of experience in university and industrial research.

Effluent Treatment Plants (ETP/CETP): Aeration Tank - Nanozyme-BET-ETP-7003 >2000 Cod

Anaerobic Culture: Nanozyme BET-ANA-9003. **Sewage Treatment Plants (STP/CSTP):** Nanozyme-BET-STP-9013

Merits Of Using Nanozyme

Parameters	% Of Reduction	Parameters	% Of Reduction
Odor Removal	100%	Avoid Chemical	100%
Colour Removal	100%	Increases Dissolved Oxygen (DO)	Min 3-Max 6
Sludge Degradation	Zero Sludge	Save Electricity & Reduce Aeration Time.	50-70%
Chemical Oxygen Demond(COD)	95-100%	Degradation Of Organic Pollutants & Heavy Metals	70-90%
Biological Oxygen Demond (BOD)	95-100%		

Address: 2/185, Ramnagar, Vaaikalmedu, Perundurur Main Road, Erode-638052.

Mobile: +91 90950 00090, 95663 76690 | Email: drparams2014@gmail.com, Web: www.bionicsenviro.com

Contact Person: Dr. M. Parameswari -Ph.D., (Agri.) / Executive director



BKS Engineers

BKS Engineers is one of the leading manufacturers and exporters of different type of FILTER PRESS like Plate & Frame, Recessed chamber, Membrane, Stainless steel & phosphor bronze etc. in Electro Hydraulics, Semiautomatic, Fully automatic with PLC based to cater various process industries for separation of liquid solids, de-watering etc. We have proven track record in handling the projects in Effluent Treatment plants, Sewage treatment plants & Waste water treatment plants, Ceramic, Insulators, Chemical, Dyes & Pigments, Pharmaceuticals, Bulk Drugs, Paper, Paint etc

Products: • Filter Press • Filter Cloths • Filter Plates & Progressive Cavity Pumps

Address: 42/A-3, Saradha Mill Road, Muthaiya Nagar, Podanur Coimbatore, Tamil Nadu, India - 641023

Phone: +91-422-2679611/ +91 9363361189 / +91 9894954818

Email: vbabbu@bksengineers.com, contact@bksengineers.com, Web: www.bksengineers.com

Contact Persion: Mr. Babbu.V, C.E.O

Factory: 10/7, Sundarapuram Main Road, Madukarai, Coimbatore – 641 105

K-PACK Systems Private Limited – ISO 9001: 2008

Leading manufacturer of wastewater treatment solutions focused on performance and flexibility designed to yield clean water, recover energy and resource recovery



Products



Complete Sewage Treatment Solutions

We provide end to end Solutions for all your Sewage Related issues. Our new Advanced Membrane Bio-Reactor

Benefits of K-Pack MBR:

- Better COD/BOD reduction compared to ASP, MBBR, FAB and others.
- Lower sludge production
- Higher nutrient removal compared to conventional process.
- Lower footprint
- Better treated water quality



Specialists in waste water treatment with over 27 years experience in the field.



Unit No-004, Embassy Square, Ground Floor No.148, Infantry Road, Bangalore-560001, India
Mobile: +91 9591 97 4580 / +91 9886 20 2940
Email: info@kpack.in • Web: www.kpack.in

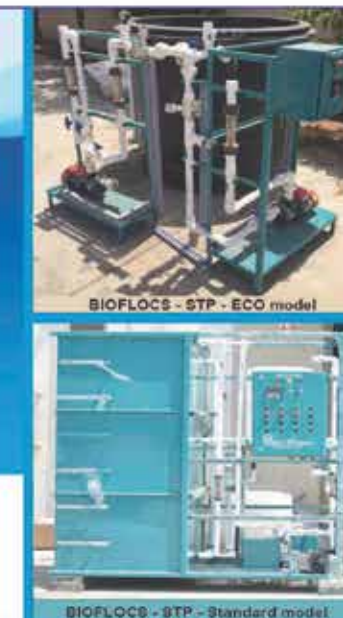

What we do

- Effluent Treatment Plant
- Oil Water Separators Sewage
- Sewage Water Treatment Plant
- Waste Water Treatment
- Water Treatment
- Serve all Industries

Water Treatment Companies & EPCs

WHY US

- We have 27 years Experience of Working with 400+ Clients across Industries in Indian and Global Markets
- We have Successfully Completed 2500+ Installations
- Tie ups with Multiple Reputed International Firms
- Provide Tailor Made Solutions
- Client Experience and Satisfaction is a Key Goal



K - Pack Systems Pvt. Ltd | ISO 9001:2008
Unit No-004, Embassy Square, Ground Floor, No.148, Infantry Road, Bangalore-560001, India • Mobile: +91 9591 97 4580 / +91 9886 20 2940
Email : sales@kpack.in, Web : www.kpack.in



Blowchenn Machines

We are one of the leading manufacturers of semi automatic and automatic stretch blow moulding machines in India. A team of experts with vast experience in blowing, mould making and design came together and with their combined experience designed and manufactured a series of blow moulding machines with leading technology, aimed at providing the optimized solution for the industry. Our machines are designed to provide perfect blowing with minimum wastage and optimum power consumption. Our vast industry experience and domain knowledge has translated into a series of machines with robust construction, simple layout and design which will ensure long life and maintenance free, trouble free performance. Based on our continuous improvement program, our machines are constantly update to incorporate the latest technology. This will enable our customers to have a competitive advantage in the bottle blowing industry. Located at Chennai a port city and commercial hub of south India, we are strategically located to ship our products all over the world with minimum freight cost and lead time.

No. 129, Sidco Industrial Estate, Vichoor Village,
Manali New Town Chennai - 600103
Mobile: 9840775206
Email: blowchenn@yahoo.com, Web: www.blowchenn.com
Contact Person: Mr. V. Ganapathy - CEO



Bluemoon Fibre Tech India Pvt Ltd

Overview

- Incepted in 2003 and Rebranded in 2011 as “Bluemoon Fibre Tech India Private Limited” in Chennai
- A dedicated plant for GRP/FRP filament wound Pipes under subsidiary as “Bluemoon Composite Private Limited”
- ISO 9001:2015 certified
- Registered as Micro Industry under MSME.

Products

- Manufacturer of FRP, GRP, GRE and PP-FRP products
- Range of Products
 - GRE Pipes (Epoxy Based & Polyester Based)
 - Gratings
 - Storage and Dosing Tanks
 - Structural Profiles
 - Scrubber and Exhaust System
 - Cable Trays
- Range of Services
 - Corrosion Resistance Lining
 - Design and Installation of Structural Profiles
 - Installation & Commissioning of Pipes & Fittings
 - Design and Installation of Scrubber and Odour Control Systems

Applications

- Aeration Pipes
- Dosing Tanks (Acid and Alkali)
- Preparation Tanks
- Chemical Feed Pipes
- Settling Tanks (Primary and Secondary)
- RO Reject Tanks
- Effluent Drain Pipes
- Measuring Tanks (Acid and Alkali)
- Separation Tanks

Bluemoon Fibre Tech India Pvt Ltd

Unit-1: #49, SIDCO Women Industrial Park, Kattur,
Thirumullaivoyal, Chennai – 600 062.
Email: info@bluemoonfibre.com Web: www.bluemoonfibretch.com
Contact Person: Mr. Dhinesh Kumar – Sr. Manager Mobile: +91-988 4118 822



Nisan Scientific Process Equipments Pvt. Ltd

An ISO 9001: 2015 Certified Company

The Complete Place For Your Process Industry Demands



Unit I : R-587/1, MIDC, TTC Inds Area, Rabale,
Navi Mumbai - 400701, India.
Unit II : R-465, MIDC, TTC Inds Area, Rabale,
Navi Mumbai - 400701, India.

Tel - 022-20873317 | 022-20871219 | 022-20872260
Email: sales@nisanprocess.com | marketing@nisanprocess.com
Web: www.nisanprocess.com



Blufox Eco Ventures LLP

Blufox is the leading supplier of Water treatment & Waste Water Treatment equipments in India. We are the supplier of MBR Membranes & Ultrafiltration Membranes in India. Also we are the mfg. of the MBR Based Sewage Treatment Plants & Effluent Waste Water Treatment Plants. Blufox is also known for Zero Liquide Discharge(ZLD) Technology across India with its latest innovative technologies with less foot prints / zero chemicals/ No RO Plants / NO ETPs & No Evaporators.

Description:MS-FSF MBR modules are made with reinforced hollow fibre PVDF membranes. The Hollow Fibres have tensile strength with excellent chemical resistance.0.1 Micron pore size provides superior rejection rate of TSS , bacteria, viruses. Compared with conventional treatment, FSF MBR module produce extremely high quality permeate, Due to high mixed liquor suspended solids (MLSS).FSF-MBR can greatly reduce the over all treatment plant foot print and operation cost.

Features:

- High hydrophilic PVDF membrane
- Reinforced hollow fibre membranes
- Reduce treatment plant footprint
- Long service life
- Consistent and stable flux performance
- Energy Saving due to low operating pressure

Applications:

- Municipal Sewage Water Treatment & Reuse
- Ideal Green Building Projects which needing water Reuse
- Landfill Waste Water Treatment
- Industrial Waste Water Treatment
- Textile Waste Water Treatment

Address: 801, Valentina Business Hub, Near Shell Petrol Pump, L.P. Savani Road, Surat - 395009 (Gujarat)

Mobile: +91 99245 68279, Mail: blufox.ecoventures@gmail.com, Web: www.eco-energy.in

Contact Person: Mr. Nilesh Kothari - Partner



Bluwat Chemicals Co. Ltd

Bluwat Chemicals is a professional supplier of water treatment chemicals in China. We provide our customers both traditional and innovative products to ensure optimum control in a wide variety of applications, which including treatment of drinking water, waste water, process water. We are trying our best to be the professional manufacturer and service supplier to reduce your treatment cost.

Bluwat chemicals produce BWD-1 Water Decoloring Agent, Polyacrylamide/PAM, PHPA, Polyaluminium Chloride, Polydadmac, Polyamine, BWG Bio-cleaning agent, etc. Our products are exporting to more than 80 countries, mainly used in water treatment industry, paper industry, mining industry, oil & gas drilling and sugar industry, etc.. Our BWD Water Decoloring Agent are specially used for color removal and COD reduction for textile & dyestuff wastewater, paper wastewater and other industries.

Address: No. 16 Yongning Rd, Yixing Chemical Industrial Park, Jiangsu, China, Yixing 214200

Mobiul: 0086-13961555590, Email: leo.zhou@bluwat.com.cn,

Web:www.bluwat.com.cn

Contact Person: Mr. Leo

A SIMPLE & ROBUST FILTRATION SYSTEM

AUTO BACK WASH FILTER For water & waste water filtration



Applications

- Side stream filtration (Sea/River/Canal)
- Condenser / Nozzle protection
- Intake water filtration
- Membrane protection
- Nozzle protection
- Desalination Plants.

Features

- Online filtration, no personal intervention is required
- Units are capable to handle very high flow rates with less footprint
- Water wastage is < 1%
- Consistency in outlet water quality
- Energy efficient technology
- Uniform cleaning
- Plug & Play Technology
- No extra pump required for Backflushing
- Stand by filter not required



SHARPLEX FILTERS (INDIA) PVT. LTD.

R-664, T.T.C. Industrial Area, Thane - Belapur Road, Rabale, MIDC, Navi Mumbai - 400701, India

Tel : +91-91-3692 1232/39, +91-22-27696339/6322/6325, E-mail : sales@sharplexfilters.com

www.sharplex.com



Canadian Crystalline Water India Ltd.,

CANADIAN CRYSTALLINE WATER INDIA LTD., with over four decades of commitment to quality in developing and delivering indigenous cost effective solutions in Water and waste water treatment, we have been pronounced globally as pioneers in the industry. Since 1969 CANADIAN CRYSTALLINE has been involved in delivering custom made solutions addressing the following needs:

- Process water for Industries.
- Drinking water supply at all needy places.
- Urban sanitation,
- General water treatment, Process Water Treatment and Desalination.
- Waste water treatment, Effluent Treatment, Effluent Recycling and Zero Discharge Plants.

CANADIAN CRYSTALLINE is also involved in driving the market towards innovative bottled water projects. Cold Press Juice Plants, Alkaline Water and Soft Drink Plants. We Manufacture, Supply, Install and Commission complete range Machineries required for Bottled Water Industry like Water Processing Equipments, PET Bottle Blowing Machines, Rinsing, Filling Capping Machine, required labeling and packaging machineries. Owning a 97% market share in Indian bottled water brands, CANADIAN CRYSTALLINE is an authority in bottled water projects and have spearheaded such projects globally, successfully installing over 7000 plants world wide.

With a 350 strong work force our corporate headquarters functions from a four storied, 15,000 sq. ft. "CANADIAN CRYSTALLINE Towers" in Chennai where all data transfer and communication systems are in place. The CANADIAN CRYSTALLINE factory is located 12 Km near Chennai city manufacturing a wide range of equipments. The company employs the best of engineering skills with excellent infrastructure to manufacture quality products.

Address: Eashwaran Towers No.149, Poonamallee High Road, Kilpauk, CHENNAI - 600 010. INDIA.
 Phone: +91 44 2836 2461/ 69 & 98410 97973, Mobile: +91 98410 72306
 Email: info@canadiancrystalline.net, Web: www.canadianclear.com

Cauvery Electronics Consultants

We are specialized in design and manufacturing of CECON Ozonators in Chennai, India. The company is headed by Dr R. Narayanan, who holds a Ph.D from IIT Mumbai. He also has over 25 years of industrial experience.

Our product range includes:

1. CECON Air Cooled Ozonators (2 – 20 GPH)
2. CECON Water Cooled Ozonators (25 – 300 GPH)
3. CECON Ozonation Systems for STP, ETP, Swimming Pools, RO Plants Etc
4. CECON Ozonator Accessories – Venturi Injector, Ozone Leak Monitor Etc

Please refer to our website www.ceconozonators.com for more details.

We can supply, install and maintain our CECON Ozonation Systems all over India. Customers may contact us for their specific requirements

Address: 13, Link Road, Maduvankarai, Guindy, Chennai – 600032.
 Phone: 98400 95297, 97909 43153, 99406 76930
 Email: cecon1987@gmail.com



We Manufacture Side Channel Blower, Turbine Blower, Ring Blower, Regenerative Blower, Twin Lobe Roots Blower, Centrifugal Blower and Rotary High Vacuum Pump.



INDUSTRIAL BLOWERS

- Ring / Turbine Blower
- Side Channel / Regenerative Blowers
- Twin Lobe Rotary Blower
- Centrifugal Blower
- Turbo Vacuum Pump
- Rotary Vacuum Pump
- Diaphragm Vacuum Pump

APPLICATION:

- Aquaculture Aeration / Fish & shrimp Farming
- Jacuzzi & Swimming pool Aeration
- Waste water Treatment plant
- Compact ETP & STP

98215 01735

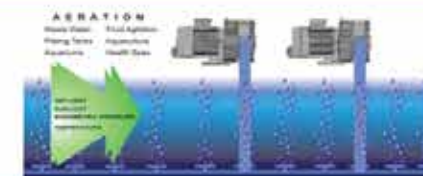

Gala No: G-13, M.K.Industrial Estate, Sonawala Cross Road, No: 2,Gorepoan (East), Mumbai: 400063., Phone: 26852842,
 Mobile: +91 98215 01735, 98925 93910, 98204 49467, 98215 01735
 Email: tbmhy1980@rediffmail.com, info@turboblower.in, h_vec@yahoo.com,
 Web: www.turboblower.in, www.ringblower.in, www.hipavacairsystems.com



CEID Consultants and Engineering Pvt Ltd

CEID Consultants and Engineering Pvt Ltd, is a Turnkey EPC company which provides complete solution for Setting up Biogas Bottling and Bio fertiliser plant. Ceid Installed the India's First Biogas Bottling plant in the year 2008 and also has installed the India's biggest biogas Bottling and Bio fertiliser plant in Gujarat. The plant handles 240 tons waste per day and produces 6000 Kg of CBG and 40 tons of solid fertiliser per day. CEID Plants are PLC SCADA controlled fully automatic plants.

All the plants operate on CSTR (Continuous Stirrer Tank Reactor) Technology and can handle multi feed like Cowdung, press mud, vegetable waste, Flower waste, Spent wash, Napier Grass, Coffee waste, Agro waste etc.. As on date CEID has successfully installed 24 projects across various states in India and currently doing 27 projects in 9 states in India. CEID is doing projects for North Delhi Municipal Corporation, East Delhi Municipal Corporation, South Delhi Municipal Corporation and Greater Chennai Corporation.

Address: 2Nd Floor Markfed Building, Opp. Pnb Main Branch,
Vir Haqiqat Rai Chowk, Abohar - 152116 Punjab India.
Phone: +91 1634-500005, Mobile +91-98033-39824
Email: ceidbiogas@gmail.com, Web: www.ceidconsultants.com



CentPro Engineering Pvt.Ltd



With reference to our discussion, we are glad to introduce our organization CentPro Engineering Pvt. Ltd. that specializes in the business of manufacturing and providing turnkey solutions in leading chemical technology and process equipment. CentPro Engineering Pvt. Ltd is a Pune, India based company with well-equipped manufacturing facility in Bhosari MIDC, Pune, India.

Process Design & Engineering

Capabilities for an efficient and robust design for all kind of process equipment and pressure vessels. Extensive Experience and competency in design compliance with national and international codes like,

- ASME Section VIII Div-1&2
- TEMA Standard
- API-650/620
- PD 5500
- IS 2825

Material Handling Capability

- Stainless Steel: SS304, SS304L, SS316, SS316L, SS316Ti
- Exotic Material:: SS Duplex, Super Duplex, Hastelloy, Inconel, Incoloy, SS904L (UNS N08904)
- Carbon Steel : SA-516 Grade 60, SA-516 Grade 60, LTCS
- Explosion Bonded materials with various material combinations.

Our Product Domain:

- Evaporation Plants
- Turnkey Plants
- Water and waste water treatment plants
- Distillation Plants
- Caustic Recovery Plants
- Process Equipment (All type)
- Zero Liquid Discharge Plants

Industries we cater to:

- Chemical
- Textile
- Pharma
- Dyes
- Petrochemical
- Automobile
- Food

Address: 306 Vishal Ventilla, Magarpatta rd, Hadapsar, Pune MH India – 411 013 Mobile:+91 913810 32727,
Email: satish.lagad@centpro.com, Web:www.centpro.com Contact Person: Mr. Satish Lagad



LIQUID FILTER - MELTBLOWN FILTER

Manufacturing for OEMs

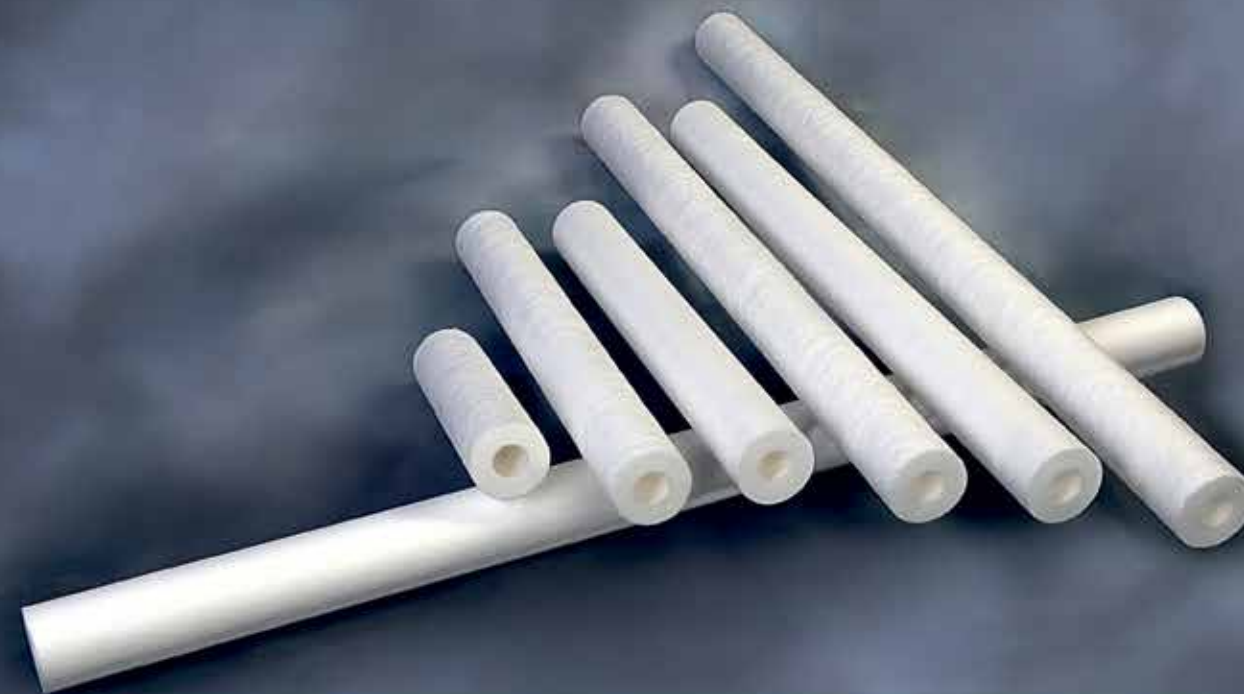

QUALITY IS OUR RESPONSIBILITY

INDIA'S NO.1 MELTBLOWN FILTER MANUFACTURER

BEST QUALITY FILTER.

100% PURE POLYPROPYLENE.

MANUFACTURING DOMESTIC & INDUSTRIAL FILTERS.
AVAILABLE IN 10"/20"/30"/40"/50" & JUMBO SIZES.

Beijing Liquid Filter New Material Technology (I) Private Limited

www.beijingfiltration.com

prakash.tripathi@beijingfiltration.com

+91-98995 04508



Chennai Bottling Systems

We provide complete bottling solutions for packaged drinking water plants all over India, and we give customized solutions for packaged drinking water plants. We strive to provide best of class technology to reduce man power and complete automation. The company is committed to quality products and environmental safety.

Product Profile

Manufactures and exporters of automatic bottle filling machines ranges from 30 bpm to 100 bpm, automatic bubble top bottle filling machines ranges from 60 bph to 300 bph bottle blowing machines, semi-automatic auto drop pet bottle blowing machines 800 bph, shrink tunnels, conveyor systems, complete water processing plants with pre filtration RO plants, post filtrations ozonator, semi and automatic shrink wrapping machines. In addition to offering broad range of products, the company undertakes turnkey projects from concepts to commissioning.

Address: No,20/18, Karumari Amman 4th Street, Natesan Nagar, Ayanambakkam Chennai -600 095.
 Mobile: +91 98408 55231
 Email: chennaibottlingsystems@gmail.com
 Contact Person: Mr. R.Murugan - Proprietor



CPC Water Treatment Solution Pvt Ltd

CPC emerged in 2010 with a clear motive of providing solutions & services in the field of instrumentation and to exhibit a clear differentiation in the market for providing amicable & affordable instrumentation and automation solution. The three verticals has built up an enviable reputation and carved a place of pride venturing into the field of water and waste water treatment and Renewable energy management. It is the determination to transform every challenge into opportunity to seize every opportunity to ensure growth. A highly applauded and awarded group of Companies.

- CPC PROCESS CONTROL INSTRUMENTATION
- CPC WATER TREATMENT SOLUTION PVT LTD
- CPC GREEN ENERGY ENGINEERING PVT LTD

The pride of CPC itself for having tremendous amount of talent and a dedicated work force and its philosophy is to create value for client's satisfaction through a culture of continuous service and solutions.

Our Strength: The manufacturing Of CPC envisions is to play an indispensable role in a global supply chain. Manufacturing strategy to produce a superior quality product suitable functionality, structural integrity, and conformance to established industry standards and practices which provides consistency of product quality, optimum availability, and superior customer service, while maintaining efficiency of operations and profitability necessary to continue product improvement and customer satisfaction

Our Network: Business operations and the network spread across the southern part of India having Chennai as head quarter and factory. Sales and service support offices at Hyderabad and Bangalore. Our network is further expanded globally with sales support partners located at Dubai for Middle-east and Egypt Region & at Malaysia for Asia pacific Region.

Address: No: 7A, IIInd Floor, School Road, Secretariat Colony, Ambattur OT, Chennai-600 053.
 Mobile: +91 98419 08345 Email: cpc@pcinfo.in, Web: www.pcinfo.in
 Contact Person: Mr. Dharmendra Kumar - CEO

PARTH WATER SOLUTION

ISO 9001:2015

Manufacturer of:

- S.S Vessels
- S.S Membrane Housing
- S.S Filter Housing
- S.S R.O Skid
- E.T.P Plant
- S.T.P Plant
- W.T.P Plant
- D.M Plant
- Water-Cooler
- Chiller Plant
- S.S Storage Tank
- R.O Plant
- Ozonator
- U.V Systems
- All type of S.S & M.S fabrication



PARTH WATER SOLUTION

W-6, Sector-11, Noida - 201301 (U.P), INDIA

Mobile: +91 98713 39355, 96439 27355, Email: parthwater03@gmail.com, Web: www.parthro.com



Dealh2o.com

Dealh2o.com, an exclusive B2B division of Water Today Pvt. Ltd., is an ecommerce platform for simple and easy way to buy & sell water and wastewater related products across India. Our initiative aims to propagate healthy living and improving the lifestyle with a common goal - Profit with Responsibility.

Dealh2o.com is a platform to bridge the gap between the manufacturer / importers and the retail buyers without any bias agenda. Dealh2o.com proposes various business opportunities in niche marketplace:

- a licensed privilege via franchisee model
- reach manufacturers & importers via our seller model
- complete access new products & technology with perfect pricing via buyer model.

Whether it is domestic, industrial, commercial or technical, Dealh2o.com helps to bring the entire category under one umbrella.

Address: 3D, III Floor Bhagheeratha Residency,
124, Marshall's Road, Egmore, Chennai - 600 008
Phone: 044 42916900
Email: info@watertoday.org
Website: www.dealh2o.com, www.watertoday.org



Deerfos Membranes Co. Ltd.

DEERFOS MEMBRANES Institute is leading the development of various creative membrane products. As a part of water treatment business, we have developed Hollow Fiber UF (Ultra-Filtration) , MBR(Membrane Bio Reactor) Membranes by using PVDF(Polyvinylidene fluoride) with pure domestic technology into high strength Even membrane and we'd like to advance into global market as well as domestic market. We have a Manufacturing process from the production of UF & MBR membrane to the manufacture of end product module. We are involved in handling large amount of water treatment such as Industrial dirty water, wastewater and rain water with small space and cost; besides, we manufacture and sell eco- friendly membrane that purifies, separates and enriches liquid material by taking advantage of perfect removal function of fine solid matter particles, bacteria and pathogenic microorganism.

Certificate & Patent:

ISO 9001, ISO 14001 certification acquired "Korea Standard Certification NET(New Excellent Technology)" certification acquired "NSF" Certification acquired

Patent Registration:

- "Highly porous membrane using that and preparing method thereof"
- "Manufacturing-method separation-film having elevation durability"
- "Hollow fiber membrane module and preparing method theses of"
- "High performance hollow fiber membrane using that and preparing method thereof"

Address: Kaico Deer Abrasive (P) Ltd, Plot No. 479, Phase-1,
Industrial Estate, Barhi, Sonipat. Sonipat -131001. India
Mobile: 093103 86228
Email: satpathy@deerfos.com, Web: www.dfmem.com
Contact Person: Mr. Bhabesh Satpathy - Business Head



Flow Star Engineering Pvt. Ltd.

Manufacturer of Variable area Rotameters



Flow Star Engineering Pvt. Ltd.

Plot No. 7F/2, Northern India Complex, 20/3, Mathura Road Faridabad - 121005, Haryana, India
Phone: 0129-4069661 | 4069662 | 4065661 | 4060669, Mobile: +91-98999 77324 | 98181 76380
Email: fsepl@flowstar.co.in | Web: www.flowstar.co.in

ifttrade.com
Innovative Food Technologies

Devki Publication & Advertising

IFT Trade Online B2b Portal for Food & Drink industry. IFT Trade providing a platform to Small, Medium & large businesses. Our Client is Manufacturers, Exporters, Suppliers, Importers, Wholesalers, Traders and Distributors of Food & Drink industry. Our aim is to provide single platform of Food & Drink industry business listing across India and global scale.

Our Monthly B2b food & drink industry magazine is also focus on food & drink industry. We offer the Indian Food N Drink industry a platform to promote business globally with our online b2b portal & print edition of magazine

Address: E-514 2nd Floor Gali No -9 Shanti Marg, Delhi - 110092, India
Mobile: +91 95558 44144
Email: viren@ifttrade.com, Web: www.ifttrade.com
Contact Person: Mr. Viren Singh - Marketing Manager



Dharsan Dredging & Constructions Pvt Ltd

Dharsan Dredging & Constructions Pvt Ltd is an authorized Indian agency for after sales & services wholesale dealer and O&M partner for Watermaster Multipurpose Amphibian Dredgers From Aquamec Ltd., Finland. We are professionals providing turnkey, high-quality dredging solutions regardless of the project size. Mr. J. Arumai Raj is founder of the company and has over 38 years' experience in this field. We also manufacture self unloading hopper barges and related marine utility crafts to cater services in shallow waters and city drain to support Watermaster Multipurpose Dredging.

Address: 329A/1, Grace Cottage New Colony 2nd Street, Chengalpattu 603003, Tamil Nadu India
Phone: +9144 2742 0074, 2742 0833, Mobile : +91 94453 90683, 94453 90584, 90360 88339
Email: dharsandredging@yahoo.com, dharsandredging2010@gmail.com,
Web: www.dharsandredging.com
Contact Person: Mr. J.Arumai Raj - President



100%
NATURAL
WATER

MANUFACTURES & IMPORTERS OF :
RO CABINETS, RO HOUSING, INLINE FILTERS
MEMBRANE HOUSING, RO PUMP, RO MEMBRANES,
SOLENOID VALVES & QC FITTINGS



Smart Logon Ki Smart Pasand



BAJRANG IMPEX PVT LTD.
BELIEVING IN RELATIONSHIP

Khasra. No.110/11, Firmi Road, Partap Farm, Near Kurkure Factory Mundka, New Delhi 110041



Dunamis Machines

Machinery manufacturer founded in 1999 which has dedicated itself to manufacture and supply of machineries for the beverage industry.

Product Basket:

- PET Bottle Blow Molding Machines with Accessories
- PET Bottle Rinsing, Filling and Capping Machines

Major Benefits for buying Fully Automatic PET Bottle Blow Moulding Machines from Dunamis Machines

- We have introduced Air Recovery System so the total connecting load for the machine with accessories is only 28 H.P. for giving an output of 2000 BPH
- Book type mould closing technology reduces the blowing cost to only 6 paisa

Dunamis Machines focus is on achieving International quality standards, cost effectiveness and adherence to committed delivery schedule in order to achieve total customer satisfaction. The manufacturing facility comprises of Assembly Units, Fabrication Shops and Testing Units. The Assembly shop is equipped with the necessary Machines, Tools & Components, Materials, etc... for efficient production. We devote ourselves to technical research in order to build up a good reputation & brand equity. A Dedicated service team is always ready to attend to the needs of our esteemed customers. Our company ensures global quality and easily serviceability

Vision: Empowering Packaging Automation

Address: No.4/516C, Edapalayam, Upparapalayam Road, Alamathi, Red Hills,
(Near NDDDB Semen Station) Chennai -600052, Tamilnadu, India.
Mobile: +91 99413 51557, 93822 22360, 90804 73814
Email: info@dunamismachines.in, info@dunamismachines.com
Web: www.dunamismachines.in, www.dunamismachines.com



Earth Fokus

There is no doubt that we care for the earth but preventing water scarcity cannot be accomplished simply through goodwill. We need to help prevent this crisis and do our part towards the preservation of freshwater bodies. We had our humble beginning in the year 2017, with the objective to work on conserving the environment. What started as a home project took off into a start-up.

Our name speaks to our belief of environmental conservation.

At Earth Fokus, we develop sustainable solutions for problems that affect our environment. The technology we design will not just support our surroundings but also equip the future for self-sustenance. By focusing on creating products that utilize non renewable energy, Earth Fokus commits to initiating a revolution.

Our solutions are based on 5 simple steps:

- 1) Identifying the problem
- 2) Analyzing the problem
- 3) Ideating several viable solutions
- 4) Research & Development, and
- 5) Choosing the best solution.

Our designs are not just motivated by functionality but also by modern designs which are efficient. And budget-friendly!

Address:3, South Avenue, Rajiv Gandhi Nagar, 2nd Street VGP NRI Layout Panayur, Chennai - 600119
Mobile: 91 9941302507
Email:shakeel@earthfokus.com, Web: www.earthfokus.com
Contact Person: Mr.Mohammed Shakeel

CALICUT
0495 2703297

CHENNAI
044 24845342 / 2484 8694

SECUNDERABAD
040 27701730



RV ASSOCIATES
contactrvassociates@gmail.com

Our Products also include

- FRP Composite Pressure Vessel
- FRP Membrane Housing
- UV Sterilisers
- Micron Filter Housing & Cartridges
- Rotameters
- UF Panels & Solenoid Valves
- Activated Carbon Resin

Accessories such as LPS, HPS,
Pressure Gauges, Floaty
and Level Switches





Eco Fresh Carbon

ECO FRESH CARBON is one of the prime manufacturer and exporter of Coconut shell based steam activated carbon. Our company started in the year 2008, and have gone through so many researches in the field of activated carbon. We achieved upto the level of 100 CTC super carbon , and supplied to our various customers across the globe. We concentrate more on Quality side as well as timely delivery. So we follow the motto of "RIGHT QUALITY AT THE RIGHT TIME".

Our products are high porous and high activity activated carbon manufactured by steam process of activation from chosen coconut shell charcoal. Our well equipped QC department has various latest testing equipments as per ASTM norms & we strictly follow ASTM procedures for all testing.

Water Treatment: ACTIVATED CARBON is widely used in the treatment of municipal ,industrial waste water , sewage water and process liquids which contain a wide range of organic and inorganic pollutants . Activated carbon adsorbs these pollutants from the waste in aliquid phase, acting as the optimum purification solution.

We can able to Supply

MESH SIZE	4x8	8x30	12x30
	6x12	12x40	8x16
IODINE VALUE	600 IV – 1300 IV		

Address: H - 15 , Thamirapathi Colony, Thiyagaraja Nagar, Maharaja Nagar(POST), Tirunelveli – 627 011 Tamil Nadu.
 Mobile: +91-9789776151
 Email: david@ecofreshcarbon.com, Web: www.ecofreshcarbon.com
 Contact Person: Mr. J. James David - Director



Ecogreen Cleantech Pvt Ltd

Eco Green Clean tech Pvt Ltd ., founded by Shri D.N. Nirranjan Kani, a second generation entrepreneur from the VVD family, is a professionally managed company recognized as one of India's leading manufacturers and exporters of activated carbon. Eco Green Clean tech Pvt Ltd. is a manufacturer and exporter of virgin & specialty Eco Green Clean tech Pvt Ltd . They are manufactured out of coconut shell & wood charcoals by steam activation. Various grades of our products are currently being used in many applications.

Vision: We strive to provide solutions for Clean Air & Pure Water for a Healthier Lifestyle.

Address: Ecogreen Cleantech Pvt Ltd (Formely Adsorbent Carbons Pvt Ltd) Chennai - 600 010
 Mobile: +91 89396 78435
 Email: ecogreen@carbons.in, Web: www.eco-green.co
 Contact Person: Mr. T Tamilvendan - Team Leader



+91 9894629087
 www.saravanachemdyes.com



Ultra Filtration Membrane

Inge - Our Patented Multibore® UF membrane combines seven individual capillaries in a highly robust fiber. The capillaries have an internal diameter of 0.9 mm or 1.5 mm. Our T-Rack® system require up to 70 percent less space than a conventional rack system.



Water Treatment Chemicals

With our Cutting-Edge expertise in water treatment chemicals BASF provides most advanced chemical solutions that delivers cost savings but also operate the process at peak efficiency.



Industrial Pumps

Ebara is the leader in developing energy-saving pumps that help reduce industrial energy consumption. With its wide range of series, Ebara has got reliable pumps for all popular industries.



Resins

Purolite - the leading manufacturer of quality ion exchange, catalyst, adsorbent and specialty high-performance resins is the only company that focuses 100% of its resources on the development and production of resin technology.

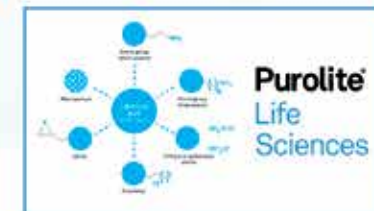

With our wide range of dosing systems our proven design principles guarantee a high standard of quality and precision that delivers reliable, accurate performance under the toughest conditions.



Water Solutions



Elite Automations

Elite Automation was founded by Mr.Edwin B.E., in the year 2013 at Porur Chennai and Established with the Vision and Mission of dedication, sincerity and commitment to deliver superior quality products in the field of Automatic Water Bottle Filling Machine from 30BPM to 90 BPM.

Elite Automation is managed by a team of young, enthusiastic, self motivated professional with extensive knowledge in Instrumentation Engineering we work with process industries and grow along with them, to achieve operational excellence and improve efficiency with reduced cost and hence preferred by high end industries.

Elite automation focuses in the field of automatic bottle filling machine – Design, Manufacturing, Engineering, Supply and Commissioning towards complete customer satisfaction.

Salient Features:

1. Machine capacity various from 30BPM to 90BPM.
2. No Bottle - No filling - No capping - No wastage.
3. Variable speed through frequency drive.
4. Single phase machine available.

Address: No. 7, Kuppuswamy Naicker Street,. Arumuga Nagar,
Chinna Porur,. Chennai - 600116. Tamil Nadu, India.
Phone: 044 - 2476 3742. Mobile: +91 93810 38630 .
Email: eliteautomation1972@gmail.com
Contact Person: Mr.Edwin

Environment Protection Technology Exhibition (EPTEx)

Environment Protection Technology Exhibition (EPTEx) is a division of Water Today Pvt. Ltd. EPTEx is an International Exhibition on Environment Technology, Equipments & Allied Industries. Environment is the basic element requisite for a sustainable growth, development and economic efficiency of any country. Knowing the significance of each element, Water Today has identified the needs of the events and has developed a more integrated approach to provide business and networking platforms through exhibitions to industry professionals and experts who can converge and move forward towards a common goal – Profit with Responsibility.

Address: 3D, III Floor Bhagheeratha Residency,
124, Marshall's Road, Egmore, Chennai - 600 008
Phone: 044 42916900
Email: info@eptex.biz.
Website: www.eptex.biz



KALPAKA CHEMICALS P. LTD. **KALPAKA**TM
4/133 X, Muthammal Colony 3rd Street,
Tuticorin - 628002. TamilNadu, INDIA.
Enriching Nature



KALBONTM
activated carbon
Enriching Nature

KALBON GAQ	Granules for Water Treatment
KALBON GAU	Granules for Gold Recovery
KALBON GFL	Granules for Domestic Water Filters
KALBON GSP	Granules for Syrup Solution
KALBON GVP	Granules for Air and Gas Purification
KALBON PET	Powder for Industrial Effluent Treatment
KALBON GCF	Granules for Cigarette Filters
KALBON JULIA	Wood based Powder Activated Carbon / Granules for waste water treatment
KALBON ANTHRACITE	Granules for Dual Media Filter
KALBON COAL	Granules for waste water
KALBON SILVER	Silver Impregnated Carbon for Potable Water Filters

Ph. : 91-461-2345638 / 2347669 Mobile : 91 98430 72936
E-Mail : marketing@kalpakachemicals.com; ganesan@kalbonusa.com

www.kalpakachemicals.com www.activatedcarbonexpoters.com



Evergreen Technologies

EVERGREEN TECHNOLOGIES established in 2002 is an ISO 9001 : 2015 Certified Company and a Leading Player in “Bottled Water” Industry. With 1000 of Customers in India and Transnational, We are a Vertically Integrated and Professionally Managed Organization led by a Dynamic Team of Qualified Technocrats. We have Designed, Manufactured, Erected and Commissioned “BOTTLED WATER” Purification / Treatment Plants of varying sizes starting from 1000 LPH to 50000 LPH on Turn Key Basis. We have well experienced Engineers, Technicians, Chemist, Microbiologists and Other Related Professionals. These Employees are Sufficiently Qualified and have been Groomed to be Specialists in their Respective Departments.

We offer BOTTLED WATER PROJECTS on Turn Key Basis, Including Water Purification System, Automatic PET Bottle & Jar Filling Machine, PET Stretch Blow Moulding, Pouch Packing Machine & Quality Control Laboratory as per WHO / BIS / ISO / SLS - (Srilankan Standards).

We offer Consultancy Services for establishing Turn Key Bottled Water Project.

Address: No. 5/1, Pillayar Koil Street, Essa Pallavaram, Chennai – 600 043, Tamilnadu, India.
 Phone: 044 2264 2788/ 2264 2799 / 2264 0799, Mobile: +91 98411 62411
 Email: info@evergreentechnologies.in
 Web: www.evergreentechnologies.in
 Contact Person: A.Thamaraiselvan



Evoqua Water Technologies

Evoqua Water Technologies is a leading provider of mission-critical water and wastewater treatment solutions, offering a broad portfolio of products, services and expertise to support industrial, municipal and recreational customers who value water. Evoqua has worked to protect water, the environment and its employees for more than 100 years, earning a reputation for quality, safety and reliability around the world. The company operates in more than 160 locations across ten countries. Serving more than 38,000 customers and 200,000 installations worldwide, our employees are united by a common purpose: Transforming Water. Enriching Life.

Evoqua is headquartered in Pittsburgh, Pennsylvania.

Address: U.S. Commercial Service, Chennai
 Phone: 044-28574477
 Email: Office.Chennai@trade.gov, Web: www.buyusa.gov/india



We are Specialist in Packaged Type
STP & ETP Plant
 are you searching for unique
WASTE WATER TREATMENT PLANT
SOLUTIONS

We Call it As “Bloom Box”
 It consisting of Acoustic Enclosure for Noise Reduction
 It consisting of Methane Perfroated Sheet for Odor Reduction

Trust us for every drop

We Offer Complete Solution for the Treatment of
 Any type of Industrial Effluent on Basis of
 Zero Liquid Discharge Technology:

Other Projects:

- Effluent Treatment Plant With ZLD System
- Sewage Treatment Plant
- Ultra-filtration System
- Multi Stage Reverse Osmosis System
- Sea Water Reverse Osmosis System for High TDS
- Nano Filtration System for Lower Rejection
- Highly Efficient and Cost Effective Evaporation System
- Softener Plant & DM Plant



We Also Take Care Of Operation & Maintenance Services



GRAM ENVOSOLUTION PVT. LTD.
 303, 3rd Floor, SP Arcade Sarojini Street,
 Ramnagar, Coimbatore - 641009 TN INDIA

☎ 0422-4378596
 ☎ 96007 72583
 ✉ info@getsenviro.com
 🌐 www.getsenviro.com



Branches: •Chennai •Madurai •Trichy •Andhra Pradesh

Sales Enquiry No. +91 9003826461
 Service Enquiry No. +91 9003826464



e-Water Mission India Pvt. Ltd

Greetings from e-Water Mission India Pvt. Ltd !!!

WATER & WASTE WATER ENGINEERING, TREATMENT & MANAGEMENT SOLUTIONS...

e-Water Mission India Pvt. Ltd are committed to a cleaner and greener environment and developing progressive technology for meeting the requirements of new and existing plants and industries for environmental sustainability without compromising that of future generation, EARTH & HEART are one soul. We are continuously striving to provide technological solutions and performance excellence to our Customers with service excellence and sustainable solutions. We continuously working for "Supply of advanced products & Services with good quality with competitive cost, we have been enjoying good trust from our customers and achieved continued and stable growth".

e-Water Mission India Pvt. Ltd. is providing solutions for the treatment of wastewater, industrial water, process water.

Our Services (Simple Solution for Complex Problem):

1. Unique Technologies in: Sludge Handling: Sludge Dewatering Screw Press, Drum Filter, Low Temperature Dryers
2. Primary Treatment: Three phase separator's, Low space clarifiers
3. Zero Liquid Discharge plant: Vacuum Evaporator, MEE
4. Biological Treatment: MBBR, SBR, ASP
5. High Strength Waste: Anaerobic C.S.T.R.; Contact Digester
6. Speciality Chemicals: Decolorizer, Defoamer, Dewatering polyelectrolyte, Heavy metal removal, Coagulants & Flocculants, etc
7. Services: Customized Solution: Primary Treatment, Bio-culture development, plant audit / improvement, Legal / Technical Services

Address: Regd. Office no. 4, Surya Tower, Opp. Reliance Smart, Erandwane, Pune (MH), India. 411 004

Mobile: +91 98223 97213, 98225 99823

Email: : info.ewatermission@gmail.com, Sales.ewatermission@gmail.com; Web: www.ewatermission.com

Contact Person: Mr. Vijay Wakchaure



Ezzi Hardware

We are the Leading Manufacturer, Dealer, Stockists of PP and Metal valves, Fittings and other accessories for both Industrial and Domestic purpose. Since 2001, Ezzi Hardware has become one of the most leading and trusted company for providing valves, fitting and other accessories for both domestic and industrial purpose in and around Chennai, Tamil Nadu and India. We also manufactures own products as per the requirements of our customers. We have a wide distribution network that has enabled us to carve a niche and ensure our clients get timely delivery of products at competitive prices. We pledge to be a good and responsible corporate citizen in the communities where we live and work. We offer a quality range of Valves and Fitting For both Domestic & Industrial Purpose, We provide some of products like Ball valve, Diaphragm Valve, Foot valve, Flow Indicator, Strainers, Fittings & accessories. Apart from these we offer quality products from many leading brands like PATH, CRI valves, INTERFITINDIA, GOLDEN, ASTRAL CORZAN & our own products . Our products are used in following industries:

- Water Treatment Plants
- Thermal Power
- Manufacturing Industries
- Aeronautics
- Mining
- Petrochemical
- Marine Sector
- Refinery
- Energy
- Construction
- Railway
- Water Stations
- Boiler industry
- Oil & Gas

Address: #36/1, Sembudoss St Parrys, Chennai- 600001

Phone: 044-25268865, Mobile: 9884031489

Email: sales@ezzihardware.com, ezzihardware@gmail.com, Web: www.ezzihardware.com

Contact Person: Mr. Dawood Hirani - MD



Pon Pure Chemicals Group
catalyzing your growth

Complete Water Treatment Solutions- "For Water Intensive Industries"



SEAMLESS WATER SOLUTIONS

- ▲ Raw Water - Coagulants / Flocculants / Disinfectant
- ▲ ETP - STP - Biocide / De-odorant / De-Oiling Polymers / Defoamers
 - ▲ Coagulant / Flocculant / Dewatering Aid / Decolorant
 - ▲ BOD COD Reducers
 - ▲ MEE / MED Chemicals
- ▲ Membrane Chemicals - Antiscalant / Cleaners / Preservative
- ▲ Cooling Water & Boiler Water Treatment
- ▲ Specialized Application - Lime Dolomite substitute / Environment Friendly Biocides .

No. 32, H Black, 15th Main Road, Anna Nagar, Chennai - 600 040. Tamil Nadu, India
Toll Free: 1800 274 1113 | Phone: 044-2616 1803/809 | Mobile: +91 94433 38507
mgrspl@pure-chemical.com | www.pure-chemical.com



Flui-Tec Instruments & Controls

Flui-Tec is proud to introduce its range of high quality performance equipments to solve almost any level, flow, pressure & process metering task, however challenging.

The company is looking forward with confidence to a future of continuous innovation & ever increasing standards of performance. The products are manufactured to ISO 9001 quality standards, thus guaranteeing consistently excellent product quality, which is maintained in the field by an efficient & responsive after-sales service. Flui-Tec's commitment to service is driven by our belief that every customer must be a satisfied customer. Flui-Tec will call on its unique blend of tradition & innovation to help you join the ever growing list of satisfied customers.

Product & Services: Liquid & Powder Level Switches, Level Transmitters, Flow meters & Flow Switches, Pressure transmitters & Pressure switches, Temperature transmitters & Temperature switches, Moisture Sensors & On Line & Table Top Analysers for Water & Waste water.

Water Meter Various Types: Magnetic Mechanical Class B & Class C meters, Water meters Blue Tooth Enabled & Water meters with LORA devices.

Address: 95/90, SOWJANYA, 2nd Floor, 19th Main, Rajajinagar 1st N Block, Bangalore - 560 010, Karnataka, India
 Phone: +080-23575492/93/41712590, Fax: +080-23575491
 Email: fluitec@eth.net, info@flui-tec.com
 Web: www.flui-tec.com
 Contact Person: Mr.Raju



Global Water Intelligence / Media Analytics Ltd.

Global Water Intelligence publishes newsletters, reports, and market intelligence platforms providing analysis and strategic data on the international water market. Its flagship publication, the monthly industry journal Global Water Intelligence Magazine, has established itself as the market-leading publication for developers, suppliers, financiers, governments, utilities and municipalities seeking information and analysis on water projects with an element of private sector participation. GWI tracks the bidding status of all new desalination, reuse, and public-private partnership projects, giving you a chance to get involved. Every month, our locally-based water and financial journalists bring you in-depth analysis of the industry, market profiles and need-to-know news stories to keep your business ahead of the competition. To find out more about GWI's market intelligence, please visit www.globalwaterintel.com/products-and-services. You can sign-up for free access to GWI articles, take a free trial of Water Desalination Report, or schedule your demo of our GWI WateData or DesalData platforms.

Address: Media Analytics Ltd., Suite C, Kingsmead House, Oxpens Road, Oxford OX1 1XX, UK
 Phone: +44 (0) 1865 204208, Fax: +44 (0) 1865 204209
 Email: sales@globalwaterintel.com, Web: www.globalwaterintel.com

SIGMA TECHNOLOGIES



Our Products

- ▲ Sewage Treatment Plant
- ▲ Effluent Treatment Plant
- ▲ Wastewater Treatment Plant
- ▲ Scrubbers & Dust Collector
- ▲ Water treatment Equipments
- ▲ Operation & Maintenance (AMC)
- ▲ Ultra Violet (UV) Treatment & Ozonator
- ▲ Diffusers
- ▲ Oil Skimmers
- ▲ Ultra Filtration (UF)
- ▲ Water treatment Plant
- ▲ Reverse Osmosis (RO) Plant
- ▲ Pollution Control Equipments

No.15, Venugopal Nagar Main Road, Thirumullaivoyal, Chennai –600 062.
 Mobile: +91 99437 89314, Email: sigmatotechnologies1@gmail.com
 Web: www.sigmatechnologies.in



Green Concept Technology India Pvt Ltd



We are the International representative for Innovative Water & Waste Water Treatment and Recycling Technologies from Europe, Japan and Singapore.

Aqua-life, Poland - Innovative technology for Seawater Desalination and Industrial Water Recycling System.

Power: 3.1kw/m³ of permeate

TDS Handle up to: 35,000 to 1,00,000 ppm

Recovery: 35% min to 95% Max. With single stage RO.

We are the authorized dealer of India, Srilanka, Bangladesh & Maldives

Eco-Oxidizer™- Advanced Oxidation Process: Treating all types of Industrial Effluent without coagulation & oxidation chemicals.

Eco oxidizer can handle up to 300,000 ppm of COD

Applications: Textiles removal of Colour, Hardness, High COD/BOD, Cyanide, High TSS, Heavy metals, Ammonia, H₂S,

SWRS –ZERO waste concept, Europe-For solid waste management handling equipment. High speed of composting technology (16-24 Hrs only) and completely eliminates Odour, Leachate and Landfill cost.

Applications: For municipal waste, Food waste, Medical waste, STP and Landfill.

Address: SF No. 170, Door No: 6/163, Rangasamuthiram, Panikkam Patti (Post) Palladam. Thirupur.641664.

Mobiul: +91 98943 22277, Email: gct.aqua@gmail.com, www.greenconcepttechnology.com

Contact Person: Mr. Vijayakumar-Director



Green Tech Enviro Systems

Water and Waste water Solution Innovative solutions to improve efficiency, energy recovery, water recycling and sustainability

Green Tech is Technology Company established in the year 2007 for the execution of turnkey projects in Water, wastewater, sewage treatment plants & recycling of the same. Green Tech has international synergetic partners in the field of water & waste water engineering field and has been promoted by experienced technocrats having more than two decades of onsite and abroad experiences with team of engineers, Technical experts involved in most economical and advance technical solutions for water, wastewater, sewage treatment plants & recycling of the same as a turnkey services including process design and Optimization, engineering procurement and construction management, pilot testing, fabrication, installation, Commissioning, operation and maintenance as well as Design-Build-Own-Operate (DBOO) solutions.

Green Tech have a large clientele base in India and abroad around 500 clients covering more than 1000 numbers of various equipment and successfully completed more than 100 turnkey industrial water treatment, effluent treatment and sewage treatment plants with capacity ranging from 10 Cum/day to 50000 Cum/day for various industrial sectors like power plants, sugar, fertilizer, paper, pharmaceutical, distillery, confectionery, electroplating, chemical textile, leather etc.,

System Division

- Dyeing effluent recycling plant with evaporator
- Reverse osmosis plant
- Industrial waste water treatments
- Recycling of waste water treatment plants
- Pilot skids for conducting on field trials and etc
- Water treatment plants
- Municipal waste water treatment plants
- Membrane desalination treatment plants
- Membrane bio-reactor
- SBR /MBBR based sewage treatment plant

Address: No: 14-A, Galaxy Road, East Ayanambakkam, Chennai – 600 095, Tamilnadu – India.

Mobile: +91 9444040050, Email: karthik@greentechenviro.net, Web: greentechenviro.net

Contact Person: Mr. Karthianathan - Proprietor



RAVIRAJ INDUSTRIES



RAVIRAJ INDUSTRIES is a Leading Designers, Manufacturers, Suppliers & Installers of all types of Equipments and Systems for Water Treatment Plant, Waste Water Treatment Plant, Waste Water Recycling Plant, Sewage Treatment Plant, Effluent Treatment plant, R.O. Plant, Fabrication Work for other Systems



Our Products

- Clarifier, Clariflocculator, Thickener
- Lamella Clarifier, HRSCC, Grit Separator
- Flash Mixer, Agitator, Fixed Aerator and Static Mixer
- Filter-PSF, ACF, DMF, MMF
- Packaged Sewage & Effluent Treatment Plant
- Pressure Vessels, Reactors, Heat Exchanger
- Mechanical Bar Screen & Other Equipments
- SS, MS, Lead Lining / Bonding, FRP / Lined Vessels & Equipments



106, SIDCO INDUSTRIAL ESTATE, AMBATTUR, CHENNAI – 600 098.

TELEPHONE-044 43111 660 (M) 09841811636 & (M) 09710431118

E- MAIL: madhu@rri.co.in, snmanivan@rri.co.in, Web: www.rri.co.in, www.clarifier.co.in



Greenrich Grow India Private Limited

Greenrich Grow India Private Limited is into providing Eco-friendly Waste Management & Environmental Solutions by converting the Food Waste into Organic Manure / Planting Media without the support of electricity or mechanical energy in the brand name MyGreenBin. My Green Bin has come up with a unique solution to this by formulating the organic waste into extremely effective bio-fertilizers, a project initiated by leading Environmentalist, Architect and Project management consultant.

We are in this industry of waste management since 2010. We have designed, patterned and moulded fibre glass bins, which is more authentic since it has good quality of aeration to prevent bad odour. We are the pioneer in giving the best range of products in Aerobic Composting for Home, Community, Institutions and Bulk Waste Generators. We provide micro solutions where waste is composted at SOURCE from 1 ltr to 1 Ton per day, to the ever growing problem of waste piling up in the cities, thereby making the environment green by encouraging organic farming and re-establishing the Eco System by Nourishing the Soil with high Microbial content of Compost. We are specialized in providing Onsite solutions for Biodegradable Waste and have successful installation records of setting up Bulk Digesting Units for huge Bulk waste generators. More than the commercial viability, the social responsibility urge initiated us to promote on mass scale.

Aerobic Composters @ MyGreenBin Hassle free, easy to use, easy to maintain and easy to convert your organic waste to organic manure.

- Greenrich Home Composters - Ideal for Home composting for family of 3 - 15 members, available capacities 20 ltrs, 25 ltrs, 50 ltrs, 120 ltrs. One set of Composter will digest 1 ltr – 6 ltrs of waste per day
- Greenrich Community Composters - Ideal for Community composting for 15 - 80 Families, available capacities 250 ltrs, 400 ltrs, 600 ltrs, 800 ltrs & 1000 ltrs. One set of Composter will digest 15 ltrs – 80 ltrs of waste per day

Address: # 31 A, First Floor, Chockanathar II Street, Maduravoyal, Chennai – 600095
 Phone: 044 2378 1844, Mobile: +91 95000 90619, 95000 90679,
 Email: solutions@mygreenbin.in, Web: www.mygreenbin.in

H2O BAZAAR

H2Obazaar.com

H2obazaar.com a unique e-market place for water and wastewater industry is transforming as a leading B2B Website in its category. One can find enormous business resources and information like new products, emerging technologies and exciting business opportunities in the water and wastewater markets. H2obazaar.com strives as an endeavor to empower your business through the world-wide-web, connecting you to national and international Manufactures, Suppliers and Buyers.

We work as a neutral platform bringing together global buyers and sellers, while providing you an opportunity to expand your business. Our business solutions to the South-East Asian water industry include the likes of a wide array of online services, directory services, our monthly Magazine (Water Today -The Magazine) and our International exhibitions. Through offering these solutions for the last 13 years, we have helped all our customers to reach their target audience. Our portal is an ideal forum for buyers and sellers across the globe to interact and conduct business smoothly and effectively. H2obazaar.com offers an integrated business solution to take your business to a new height. Our customized services are aimed at complete promotion of your business at all levels. In addition to your presence on our platform, we also promote your URL, further enabling buyers and sellers to find you in the most efficient and quickest way possible.

Address: 3D, III Floor, Bhageeratha Residency, 124 Marshall's Road, Egmore, Chennai - 600 008
 Phone: +91 44 42916900
 Email: info@watertoday.org,
 Web: www.h2obazaar.com

PROFLEX®

Tube Diffuser, Coarse Diffuser, Disc Diffuser, Wide Band Diffuser
 Commitment to quality Commitment to customers



TECPRO ENERGY SYSTEMS

Office: 21 E, North High Court Colony, Villivakkam, Chennai - 600 049, Tamil Nadu
 Tel +91 04426171621/627 & Mob : 9382667076, 9500029191 , 8220230911
 Email: cbj@tecproind.com tecprodiffuser1@gmail.com

Website: www.tecproenergysystems.in, www.tecproind.com, www.diffuseraerationsystem.com



Hanna Equipments (India) Pvt. Ltd.

HANNA Instruments is a world leader in the manufacture of analytical instrumentation. Headquartered in USA, HANNA has a global presence in 43 countries worldwide, offering more than 3,000 products to a wide range of industries. Our products include pH meters, Titrator, Photometers, COD Meters and many more. These products are useful in all the major industries like Agriculture, Aquaculture, Food & Dairy, Water Treatment etc.

Perpetual Innovation.

HANNA's research and development teams continuously challenge themselves to improve existing technologies and invent new testing techniques. These efforts have led to HANNA revolutionizing the world of testing.

- World's first tablet size multiparameter for pH/EC/DO analysis
- World's first pH electrode HALO with Bluetooth Technology
- World's first single parameter line of auto titrators.

Hanna Equipments (India) Pvt. Ltd. is the local face of Hanna Instruments in the INDIA. It operates from its Navi Mumbai headquarters to foster better relationships with its Indian customers and offer expert local support. HANNA Equipment's' mission is to supply its customers with practical, affordable solutions for their testing needs.

Address: 3/4/5/6, Aum sai, First Floor, (Above Corporation Bank),
Plot: 23 C, Sector - 7, kharghar, Navi Mumbai - 410 210
Phone: +91-22-27746554 / 55 / 56, Mobile: +91 70457921 78/64
Email: marketing@hannainst.in, Web: www.hannainst.in
Contact Person: Mr. Kondiba Shivaji Metkari - Business Manager



Hatco Systems

HATCO SYSTEMS is the proprietor concern run by Technocrat Entrepreneur with two decades of experience in water and water line products established on 2006 handling various projects across India. 100% eco friendly products knowing environmental needs and mass controlling the pollution in water for various industries. HATCO SYSTEMS offers total water solution right from Design, to Erection & Commissioning of Water treatment plants and associates with Consultants, Architects, Builders, All type of Industrials, Hospitals, Hotels, Schools, Colleges, Shopping complex, and OEMs. HATCO SYSTEMS offer complete range of water treatment products, like Sand Filters, Activated Carbon Filters, Softeners, Iron Removal Filters, DM Plants, Ultra Filtration Plants, Reverse Osmosis Plants, UVs, Ozonators, Packaged Drinking Water Plants, Waste Water Treatment Plants, Oil Removal Plants, Effluent Treatment Plants, Evaporators, Sewage Treatment Plants, Swimming Pools and Domestic Water plants. Also offers Pumping Systems, Booster Systems and Hydro-pneumatic Systems.

HATCO SYSTEMS newly launches NANO products from Germany such as resin, absorber, media and chemicals. Highlighted products which reduce brine, Back wash, No regent chemicals environmentally friendly products WIDE APPLICATION. HATCO SYSTEMS also tied up with world famous FLAGSHIP companies for microbial products and Aerators, Aspiration Aerators, Micro bubble generators to meet waste water segment to treat in high standard level and minimize the chemical consumption and power. HATCO SYSTEMS has sales network team to find out the exact requirement of client and give proper solution through our engineering team. HATCO has its own team of servicing is always available to attend to all your service calls solve all the problems in the plants. We also undertake AMC and O&M. HATCO SYSTEMS has manufacturing facilities in Chennai with engineering back round to manufacture high quality standard of products. We offer wide range of water management systems and complete package of Zero % discharge systems in the main land of the Industries. We are also offering technical consultancy to OEMs that are at par with the industrial standards.

Address: No.23/105, Ashoka Nagar, Arumbakkam, Chennai- 600106, Ph: 044-23631840, Mobile: +91-98412 93450
Email: hatcomahesh@gmail.com, Web: www.hatcosystems.com, www.indiamart.com/hatcosystems, Contact Person: Mr.C. Mahesh



HYDRO PRESS INDUSTRIES

PROVEN PERFORMANCE
TOTAL RELIABILITY

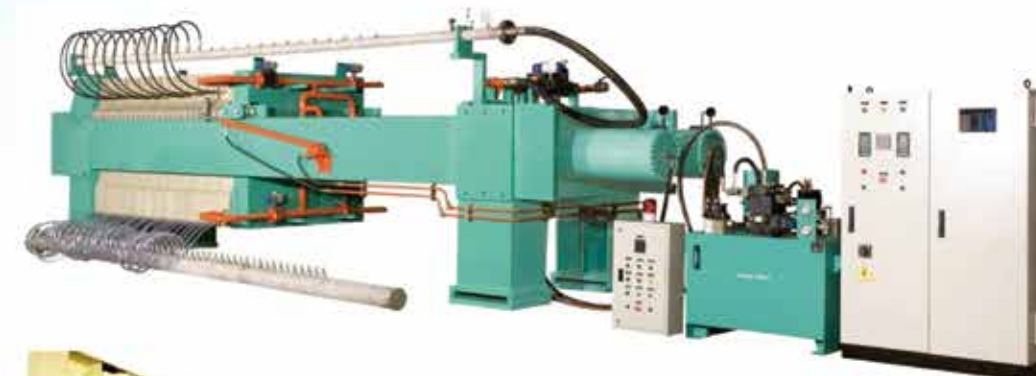

QUALITY FILTER PRESSES FOR FILTERING NEEDS

PP FILTER PRESS, MANUAL FILTER PRESS, MEMBRANE FILTER PRESS, GELATIN FILTER PRESS, FULLY
AUTOMATIC FILTER PRESS, SEMI AUTOMATIC FILTER PRESS, BEAM FILTER PRESS,
CAST IRON FILTER PRESS, SS FILTER PRESS AND SPECIAL FILTER PRESS,

HYDRO PRESS INDUSTRIES

BKG Group company

No. 3/170, A-4, Sivasakthi Colony, Industrial Estate Post, Coimbatore - 641021.
Phone: 0422-2674489, Telefax: 0422-2672102, Web: www.hydropressindustries.com, Email: hydropress@eth.net



Hilda Automation

Entire Product Range:

- Filling machines. (for Water, Juice, Milk, Yoghurt/Dahi, Jelly/Jam/Ketchup/ Oil,
- Sealing machines. (Pre-cut Al.Foil type & Laminated Film type)
- Shrink Sleeve Applicator (100BPM & 200BPM) (Body & Neck Sleeving)
- Labelling machines (Single side, Front & Back, Wrap Around & BOPP-Hot melt)
- Shrink Tunnel
- Shrink Wrapping machines.(Fully Automatic & Semi Automatic)

Address: R-810/811 T.T.C Industrial Area,
MIDC Thane Belapur Road, Rabale Navi Mumbai 400701
Phone: 22-2764 1585, 2764 2396, Mobile: 9930109050
Email: sofia@hildaautomation.in, Web: www.hildaautomation.in
Contact Person: Mrs. Sofiya Shaikh - Sales & Marketing Head



Hydro Pure Technologies

Specialized in Zero Liquid Discharge Systems, Sewage Treatment Plants, Effluent Treatment Plants, Disc RO Membrane Systems, Pharma Grade Ultra Pure Water Systems, Fully Automatic Ultra Filtration systems, Clarifier Mechanism, SS316 Heavy Cartridge Filter Housings, Heavy Single And Multi Bag filter Housings, Pressure Vessels, Spares and Specialty Chemicals.

Product Range: HYDRO PURE TECHNOLOGIES offers one of the most comprehensive range of process equipment used in different stages of treatment systems across industries such as.

- | | | |
|---|---|-----------------------------|
| • Bar Screen | • Mechanical Bar Screen | • Oil Skimmer |
| • Fixed Aerator | • Floating Aerator | • Diffused Aeration System |
| • Slow Speed Floating Aerator | • Agitator / Flash Mixer / Flocculation | • Clarifier |
| • Lamella Clarifier | • Clarisettler | • Clariflocculator |
| • Sludge Thickener | • Pressure Sand Filter / Multi Grade Filter / DMF | • Activated Carbon Filter |
| • Water Softner | • HRSCC (High Rate Solid Contact Clarifier) | • Auto Gravity Filter |
| • Ultra Filtration Systems | • Nano Filtration Systems | • Electro Coagulation Plant |
| • Effluent Treatment Plant | • Packaged Sewage Treatment Plant | |
| • Reverse Osmosis for drinking Water and effluent recycling | | |
| • Salt Recovery Plants for textile dye both using nano filtration | | |

Address: Head Office: 57-D, Annai Flats, 1St Floor, Balaji Nagar 1St Street,
Ags.colony, Keelkattalai, Chennai-600117
Phone: +91-9363073749, Mobile: +91 99401 73749
Email: kyadav.hpt@gmail.com, Web: www.hpt.co.in
Contact Person: Mr. A.B.V.N.Sairam Yadav - Director

Works: Plot No:9, Thirumalai Nagar,
R.S. No:175/3, 175/4, 175/5&6,
Chellappampalayam, Chittode, Erode-638102
Mobile: +91 766771515, Email: info.hpt@gmail.com,
Web:www.hpt.co.in



INFINITE BENEFITS... WHEN TECHNOLOGY MEETS SERVICE

an Environmental
Legal Compliance
data management software.

ZLD ZERO LIQUID DISCHARGE

- No WW disposal
- Valuable salt recovery
- Water recovery/ reuse
- Compliance with environmental regulation



To monitor, maintain, meet compliance of all the applicable environmental parameters set by local, state and central government authorities

MBR MEMBRANE BIOREACTORS

- High quality effluent
- Independent HRT and SRT
- Small footprint
- Low sludge production
- Consistent performance



SAM ENVIRO

SAM Enviro F-20, MIDC, AMBAD, Nashik-422 010, MAH. India

Phone : +91 253 2383551 +91 253 2381587 , Cell : 8275016305 Mail : info@samenviro.com , samsales@samenviro.com

Website : www.samconetp.com , www.accurateenviro.in

LinkedIn Instagram Facebook /samenviro

Turnkey solutions for water, waste water treatment & recycling



Hydropedia Pvt. Ltd.

We are leading manufacturer of S.S. Victaulic Clamp & Float Sensor. "Hydropedia Pvt. Ltd." is an eminent entity involved in manufacturing and trading a wide range of Water Treatment Plant such as RO plant, Softener Plant, Effluent treatment plant, Sewage treatment plant, Sea water desalination plant, Packaged Drinking Plant, Swimming pool filtration system, Diffusers, Robotic Cleaning, Water treatment Chemicals etc. Offered products are highly appraised for their durability, high strength, fine finish, rust resistance, etc. & also with designing, Installation and Service, we have gained a noteworthy position across the national market.

Address: : FF-04, Shiv Plaza, Opp. Navjivan Hotel, Gadhpur Road, Sarthana Jakatnaka, Surat, Gujarat-395006
 Mobile: +91 7600980607, +91 6354041081
 Email: hydropediapl@gmail.com, Web: www.hydropediapl.com
 Contact Person: Mr. Himen Chopda – Director



Indian Desalination Association (IDA)

Indian Desalination Association is a regional Affiliate of International Desalination Association formed in 1991 with the objective of development and promotion of water desalination and water purification system as a part of integrated water management. InDA provides an interface for disseminating and exchanging information. Besides, InDA facilitates periodical meeting of policy makers, suppliers, manufactures, users and academicians for synergistic interactions through conferences, discussion meets etc. Presently InDA has more than 220 Life Members and 20 corporate members. The website contains detailed information.

In all its affairs InDA, will be guided by the policy of maintaining neutrality, democracy and improving the quality of life of he general population.

Address : C/o. Desalination Division, Bhabha Atomic Research Centre, Mumbai- 400085
 Telephone : 022 25594619 , 25594647, Fax : 022 25505151
 Email : secy@gmail.com, Web : www.indaindia.org
 Contact Person : Dr.P.K.Tewari (President), Dr.S.Prabhakar (Vice President)



TECHNOMAX ENTERPRISES (I) PVT LTD.

Customized Water Treatment Solutions For Industry, Municipal & Irrigation.....

- ❖ MICROKLIN
- ❖ T-QUA
- ❖ MEMBRANE SYSTEM
- ❖ FILTRATION SYSTEM
- ❖ TECHNO-TREAT
- ❖ ECOTAP



Auto-Clean Disc Filter



Auto-Clean Brush Filter



Reverse Osmosis System



Eco-Tap Water Saver



Fully Automatic Water Filtration system

Reduce.... Recycle & Reuse....

E-mail: technomax@technomax.co.in
 Tele: 27795966 / 27790789



Indian Environmental Association (IEA)

The Indian Environmental Association (IEA) was formed in the year 1996 for the benefits of environmental professionals. Today, the IEA has about members spread all over India and the members include Engineers, Scientists, Planners, State Pollution Control Boards, Operators, Non-Government organizations etc.

The IEA has chapters in India. We also have an NRI chapter in the USA, which communicates with us via e-mail. The IEA is a recognized Member Association of the Water Environment Federation (WEF), USA and enjoys all the benefits and assistance from them. The IEA is governed by the Board of Directors, which changes every two years.

Typical programs of the Association include annual conference, topical mid-year conferences, seminars on current issues as well as training programs on air pollution, CETPs, hazardous wastes, membrane technologies, CRZ issues, etc. The IEA has assumed the role of "opinion builder and watchdog" on issues related to environment and development. It is achieved by arranging various Round Table discussions. Five Round Tables were held so far on the following themes. At the end of each Round Table, recommendations of the Round Table were sent to the concerned authorities including Ministry of Environment and Forest, the Government of India, New Delhi, Industry Associations, Member Associations of Industrial Estates, etc. for their consideration and action.

Address : No. C/O Aquachem Enviro Engineers Pvt. Ltd.
5th and 6th Floor Sunvision Classic Commercial Building
Hanuman Raod Vile Parle (East) Mumbai-400 057
Phone: 91-022-26119768/ 82 Fax : 91-022-2610 3618
Email: aquachem@vsnl.com



Indo American Water Systems

FILTERS INDIA: Filters India is a sister concern of Indo American Water Systems established in the year 2005. We own and operate a manufacturing facility of water treatment systems, Domestic RO membranes, and PP wound filter cartridges under brand names of 'PROFILT' & 'BAYWOUND' at Vizianagaram. Our Credentials extend beyond experience, expertise and components to ensure highest quality of our products. We have a group of well trained technicians whose innovative skills are exemplary and ensure quality of our products.

Products We Offer

- RO Membranes
- Ion- Exchange Resins
- FRP Vessels
- Bag Filters
- Anti Scalant Chemicals
- Cooling Tower / Boiler / ETP Chemicals.
- Activated Carbons
- Membrane Housings
- Filter Cartridges
- Upvc Multi Cartridge Housings
- Disinfectants

Address: 26-1-59/B, Main Road, Dasannapeta, Vizianagaram-535 002, Andhrapradesh.
Mobile: 96408 38332
Email: jalanidhi1@yahoo.co.in
Web: www.filtersindia.in
Contact Person: Mr. Karthik

Kaveri®

WATER STORAGE TANKS

Available capacity upto 20,000 Litres



DOUBLE LAYER ♦ TRIPLE LAYER ♦ ISI MARK



Website : www.kaveritanks.com ♦ email : kaveriplasto@gmail.com ♦ enquiry@kaveritanks.com

Kaveri® TANKS
Totally tough. Totally dependable.



Innovation Filter Systems Private Limited

With close to 20 years of experience in the design and manufacture of high performance filtration and separation systems, we supply critical equipment to some of the leading names in the most demanding industries all over the world.

Our filtration and separation technology is widely used at leading worldwide companies and in major development projects, all requiring a guarantee of equipment performance. We serve worldwide markets with innovative value adding solutions such as Industrial Filtration, Impurity removal, Customised filtration solutions and Oil skimming solutions.

We have a track record of producing high quality products backed by a commitment to total customer service, and a wealth of in-house manufacturing and value-adding designing solutions.

Our technical application teams also have considerable expertise in applied filtration technology, thus ensuring most of our products are market leading innovations. We have joined hands with Friess GmbH and able to make Tube Type Oil Skimmers in India with design same as Friess GmbH. Also we have joint collaboration with Transor Filter GmbH for production of "Make in India" filtration systems with German standards.

Address: "Plot No. 7, Gat No. 281/1, Kasar-Amboli, Tal. Mulshi, Dist. Pune, 412115
 Mobile: +91 74474 01618
 Email: ifs@innovationfilter.com, Web: www.innovationfilter.net
 Contact Person: Mr. Chinmay Joshi



Ishan Paryavaran Pvt Ltd

The company ISHAN PARYAVARAN PVT, Ltd, thanks to its long-lasting conceptual work, makes up one of the strongest Waste water treatment companies that is concerned with the Design, development, production and the delivery of water treatment equipment, focused especially on the branch of waste water treatment and water treatment. Basically deals in Etp's, STP's, Dm plants The company ISHAN PARYAVARAN, Ltd gains a dominant position in Indian perhaps in the northern regions market due to its big proficiency and its products are evaluated even abroad, to where it exports successfully. The company Ishan paryavaran, Ltd works with a very strong developmental department, cooperates with colleges, remarkable specialists of the branch of waste water and water treatment. That is why the most of the products are designed to meet newer demands in fast moving technology

HISTORY: The history of the company goes back to the beginning of the 1988's as Ishan Engineers, when its current owners began to develop and deliver equipment for waste water treatment. They used fully their experience of around 27 years, by establishing a new company with the target of becoming a strong player in the market. The main strengths of ISHAN PARYAVARN, Ltd are: high-quality technical products and a comprehensive range of services in the branch of waste water and water treatment. The company adapts quickly to the requirements of the pollution control board legalization. As a result of this we Satisfactory stands as largest amount of network both in India and abroad. We have touched around 350+ satisfied customers in a short span. We at Ishan not only provide waste water treatment products but our sister concern ISHAN CONSULTANTS also helps valued customers for undertaking annual contracts to operate and maintain various plants, thus extending its activities with production, delivery and assembly of water treatment systems for various industry. It follows with the experience of nearly ten years of tradition and collaboration of coworkers in this branch. Production activity is aimed at supply of equipments at the highest level with efficiency.

Address: Plot No 357 Phase 1 Industrial Area, Panchkula, Haryana - 134109 India
 Phone: +91 93575 30009, Email: ishanppl@gmail.com, Web: www.ishanparyavaran.co.in
 Contact Person: Mr Jagdeep Bhardwaj - Managing Director

PRECISION DESIGN & ENGINEERED

MULTI-DISC SCREW PRESS

for consistent lifecycle performance



OPERATIONAL CONVENIENCE



LOW LIFECYCLE COST



ROBUST ENGINEERING



ODOURLESS

TECHNICAL COMPARISON

Process	Transcend Cleantec Multi-Disc Screw Press	Centrifuge	Belt Press	Filter Press
DIRECT FEED FROM 'AERATION TANK'	✓	X	X	X
ELIMINATES THICKENER	✓	X	X	X
HANDLES LOW SLUDGE CONCENTRATION	✓	X	X	X
CONTINUOUS OPERATION	✓	X	X	X
AREA REQUIREMENT	■	■	■	■
LABOR REQUIREMENT	■	■	■	■
NOISE	■	■	■	■
POWER CONSUMPTION	■	■	■	■
BREAKDOWN MAINTENANCE	■	■	■	■
OPEX	■	■	■	■

WE ARE TRUSTED BY

- Amul • Atul • Warangal Municipal Corporation • Brookfield Realty • Ceat • Karsara
- Jammu Municipal Corporation • Kohima Municipal Corporation • Kwan • Panchshil Realty
- Narsapur Municipal Corporation • Satya-Deeptha Pharmaceuticals • Saint Gobain • Soffitel Malt
- WTE Infra • Kohler • Vadodara Municipal Corporation • Sudarshan Chemicals • Symbiotec

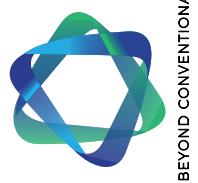

BEYOND CONVENTIONAL

Transcend Cleantec Pvt. Ltd.

S No 37/2, Shed no 463/1, Near Joshi Transformer, Narhe, Taluka Haveli, Pune-411041

+91- (0)- 8669190129

info@transcendcleantec.com

www.transcendcleantec.com



Jet Vacuum Systems Private Limited

Valued among our customers across the world for manufacturing and exporting a broad array of optimum quality Ejector Systems & Condensers, Jet Vacuum Systems Pvt. Ltd. came into existence in the year 2007 at Vadodara, Gujarat. We offer a wide range of Steam Jet Ejector, Multi Effect Evaporators, Thermo Compressor, Water Jet Ejector etc. Appreciated for their high performance, rugged construction, low maintenance, minimum energy consumption and longer severing life, the offered range is used in pharmaceuticals & drug industry, fine chemicals, textile industry, paper industry, evaporation and lab application in chemical industry.

On-time delivery of the offered range of ejector systems has helped us in winning the trust of our valuable customers. With our large production and storage capacity, we have been able to take bulk orders. By conducting various quality assurance procedures, we assure that the premium quality of the offered range is never compromised. We have appointed a team of experts and set up a huge infrastructure facility to meet the precise needs of our valuable customers in the most efficient manner. We also follow customer centric approach and transparency in all the business dealings, to meet the utmost satisfaction of our customers in the most efficient manner.

Address: Plot- 5/5A/6, Shah Industrial Park, R. S. No. 588, Savli,
Manjusar Road, Village Manjusar, Tal- Savli Vadodara - 391775, Gujarat, India
Phone: 08046036317
Website: www.jetvacuum.in
Contact Person: Mr.Pranay Bidwalkar -Director

JimTrade.com A Division of Jupiter Infomedia Ltd

Jimtrade is India's Largest Business Directory. It's a B 2 B directory and provides information about Indian Manufacturers to the suppliers. You will get 5,00,000+ product profiles from 21 major industries classified in 20,000+ product categories.

Address: 336, Laxmi Plaza, Laxmi Industrial Estate, New Link Road,
Andheri West, Mumbai - 400053
Phone: 022 - 61979000
Email: tradefair@jupiterinfomedia.com
Web: www.jupiterinfomedia.com
Contact Person: Ms. Shilpa Rathod

Floating oil problems? Try Vens Hydroluft's Skimmers today!

Belt Skimmers



Tube Skimmers



Disc Skimmer

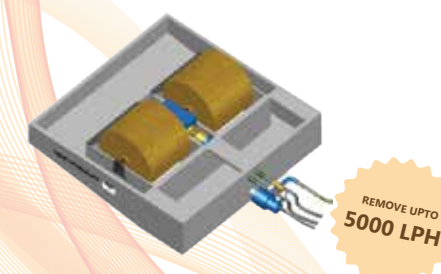
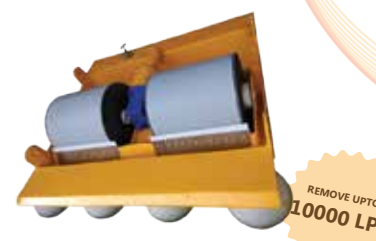
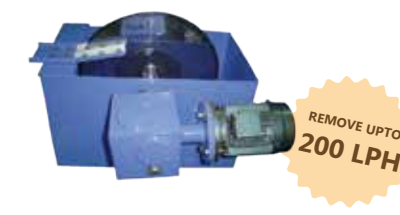

Floating Skimmers

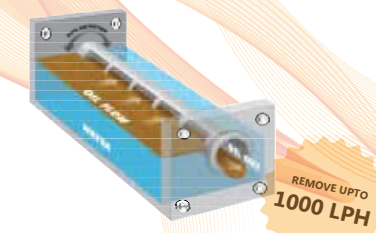

APPLICATIONS

- Effluent Treatment (ETP)
- Sewage Treatment (STP)
- Waste Water Treatment (WWTP)
- Pharmaceuticals
- Oil Industries
- CNC Machines

29 Yadaval Street, Sidco Ind. Estate, Pattaravakkam, Ambattur, Chennai, India 600098
Phone : 044-26250963, 26248852, 26231136, Fax: 044-42189346
Email : venshydro@gmail.com, sales@skimmer.co.in, Website : www.skimmer.co.in





JUMO India Private Limited

JUMO India Pvt. Ltd. is a 100 % subsidiary of JUMO GmbH & Co. KG. Our parent company M/s JUMO GmbH & Co, Germany is one of the leading manufacturer of process Control Instrumentation which is established for last 70 years. JUMO products are premium & field proven as a key instrument for keeping product quality and high efficiency production in various process and industries. In addition, JUMO products have excellent durability, easy operability as well as reliability and high accuracy.

Looking at the excellent response for the entire product range in the India, the Indian subsidiary was formed in August 2008. Main aim is to support Indian market with wide variety of offerings in field control instruments. All the instruments supplied through INDIA are manufactured as a complete assembly at our state of the art facility in Fulda, Germany.

JUMO offers comprehensive portfolio of measurement, control and recording technology. Our range of products includes devices for measurement of Temperature, Pressure, Humidity, Level & carrying out Liquid Analysis. In addition to measurement, our automation portfolio offers vast range of products from simple panel indicators to PLC. As a producer for sensor and automation solutions JUMO offers optimal components for water and wastewater. Other than sensors and devices for the most important parameters of liquid analysis, the JUMO products proven and also innovated solutions for water treatment, the tasks include measuring and controlling Pressure, Level, Flow and Temperature. Equipping water, process and wastewater treatment plants with high -quality measurement and control components will be an area to which increased attention will be paid within the framework of industry 4.0. Here, increased demands towards operational safety as well as ecological and economic aspect play just as much part as the trend towards a wastewater-free water cycle (ZLD- Zero Liquid Discharge)

Address: # 33/200, Ground Floor, NS Iyengar Street, Nehru Nagar, Behind Sheshadripuram College, Bangalore – 560020
 Mobile: +91 9632411899
 Email: Prakash.rao@jumo.net, Web: www.jumo.net
 Contact Person: P.M Prakash Rao - Director



Kaveri Plasto Container Pvt Ltd

KAVERI PLASTO CONTAINER PVT LTD, BANGALORE Manufacturer, Supplier & Exporter of Brand KAVERI Plastic Water Storage Tanks other Rotational/Blow Molded products. Manufacturing capacity is 60 to 20,000 Ltrs Water Storage Tanks an ISO 9001:2015 certified & ISI mark license (In range of 200 to 10,000 Ltrs). Brand KAVERI Water Storage Tanks is registered at various prestigious department Like NSIC, MES, Karnataka State Police Housing Corporation Ltd. CPWD, BSF etc. We have commercial tanks like Double Layer, Triple Layer, House Hold drums, Loft tanks, Sump tanks, Chemical containers, Industrial containers, Chemical Drums, Heavy Duty Plastic Pallets, Processing Trolleys. Brand KAVERI delivering brilliant products & service since 1990 as most trusted company. Our products have been used in various applications domestic, commercial, Industrial, warehouse & manufacturing.

Custom built products: We execute other jobs like automobile parts, Underground products, Chemical Lab`s products . We can develop any type of new products in to Rotational moulding.

Quality: We only purchase FDA approved raw material from ISO Certified companies. That can maintain high quality standards of raw material. The Vendours provide Test Certificates for each consignment that confirm to IS 12701:1996 Standards. Highly experience & technically qualified team in manufacturing Water Storage Tanks which conduct Type Tests on finished tanks to confirm IS 12701:1996 Standards. As ISO Certified firm, our strict Quality policy is to certify our products are delivered high quality only. Which builds confidence into our dealers & channel Partners to support END customers with durable quality at affordable prices.

Support: We lead Sales & Support shoulder to Shoulder to satisfy END Customers. Our Technical team support`s and provides solution for their requirements. We invest in technologies to upgrade a value chain in the industry, grows with clear synergies of markets and clients.

Address: Plot No 19G, Bidadi Industrial Area, Sector-1, Bidadi, Ramanagara Taluk, Karnataka-562109.
 Mobile: +91 9448283052, Email: kaveriplasto@gmail.com, Web: www.kaveritanks.com
 Contact Person: Mr. Rajesh Jain

Time to CHANGE for BETTER... RO Panels & Water ATMs



ROCon 11 (ABS Body)



ROCon 11 GSM (Metal Body)



RO 11 Easy

KEY FEATURES

- Microcontroller Based Software Technology with Complete RO Logic Pre-programmed
- RO Control Panels with GSM Connectivity, Pressure Transmitter, Temperature Sensor, PH Sensor, Level Sensors Connection Available.
- Provision to connect Raw Water Pump, High Pressure Pump, HPS, LPS, Auto MPV, Flush Solenoid Valve, Dosing Pump, Two Flow sensors etc
- Protection from Dryrun, Overload, Low Voltage & High Voltage for RWP and HPP
- **MODEL OPTIONS:** Panel RO 11 / RO 13 / RO 33 Universal / RO 33 DOL & Star Delta upto 20 Hp.

GET REAL TIME REPORTS ON DISPLAY

For RO Control Panel:

- RWP & HPP Current
- Conductivity / TDS
- Flow Rate
- Plant Run Hours
- Voltage etc.

For Water ATMs:

- Number of Coins Collected
- Number of Card Swipes
- Total Card Recharges
- Total Amount Collected
- Total Volume Dispensed etc.



WATER ATM DISPENSERS: Any Time Water Systems

- Smart Card Based Water ATM
- Single /MultiCoin Based Water ATM
- Smart Card & MultiCoin Combo Water ATM
- Water ATMs with Multiple Tap Connection, Battery Backup, GSM facility, Separate Taps for Normal & Chilled Water Available

Place Your Orders Today !

Contact: +91 98230 12102

Pisoli, Pune - 411048 ✉ khyatee.india@gmail.com

www.khyatee.in

SUBMERSIBLE AUTOMATION



KDP 99 Series (MS)

MANUFACTURED BY



Winner of DST - LOCKHEED MARTIN INDIA INNOVATION GROWTH AWARD 2013

An ISO 9001:2015 Certified Company





Kaveri Water Storage Tanks

Product: - Water Tanks for Drinking Water Application.

Brand KAVERI is a Bangalore based manufacturer of WATER STORAGE TANKS since last 30 years. Are Mission to deliver Quality and Service. We understand Drinking Water storage application and that's why we manufacture tanks that are tested by recognised third party agencies for its typical application and are safe for use of drinking water. Kaveri tanks are available in a wide range of sizes; colours and applications.

Size Range: 200 Ltrs to 20,000 Ltrs for Storage application.

Colours available: Outer Black, Blue, Yellow and White. Natural for Indoor application.

Product Range:

- a. Water Tanks: Double Layer, Triple Layer, ISI Mark (Embossed) Tanks.
- b. Chemical Tanks: CST Model (Full lid Open) – Single Layer; WST Model - Single Layer and Double Layer.

Application: Water Storage Tanks, Chemical Storage Tanks, storage of Raw Water, RO Units, Water Treatment Plants etc.

Brand KAVERI is an ISO 9001:2015 certified company and has an ISI mark license issued by Bureau of Indian Standards (In range of 200 to 10,000 Ltrs). Our Water Storage Tanks are registered with various persitgeous department Like NSIC, MES, Karnataka State Police Housing Corporation Ltd. CPWD, BSF etc. Our product is one of the most trusted in terms of Rotational (Roto) Storage Containers/Tanks. And has deployed in a wide range of applications in domestic, commercial, Industrial, Warehouse and manufacturing facilities.

Address: Plot No 44, 3rd Road, Jigani Indl Area, Jigani, Bangalore South - 560201
 Mobile: +91 9448283052, Email: kaveriplasto@gmail.com, Web: www.kaveritanks.com
 Contact Person: Mr. Rajesh Jain



Keerthi Pumps

We Keerthi Pumps, is an ISO 9001-2015 certified, AEO & MSME company specialized in the manufacturing of non-standard and standard pumps in iron and special steel constructions, We cater a wide range of products with more than 350 models specific to the requirements of all industrial sectors such as Fire Fighting, Paper, Petrochemicals, Sugar, Fertilizer, Desalination, Air Conditioning, Bulk Water Supplies, Dewatering, Mining etc., We manufacture to International standards & specifications and export products to USA, Africa, Middle East, Singapore, Bangladesh, Nepal and other countries for more than 10 years. Our products are being marketed in the brand name KEERTHI.

We are following the below mentioned International standards in our products and process.

KEERTHI PUMPS DESIGN STANDARDS.

- WATER PUMPS - DIN 24255 & AMP; EN 733
- ANSI CHEMICAL PROCESS PUMPS - ANSI B 73.1
- MIXED FLOW PUMPS - DIN 24256
- AXIAL FLOW – TYPE KAF
- HORIZONTAL SPLIT CASING – TYPE HS
- SLURRY/ SEWAGE PUMPS - DIN 24256
- VERTICAL PUMPS- TYPE VO
- CHEMICAL PROCESS PUMPS - DIN 24256 & AMP; ISO 2858
- PULP AND PAPER STOCK PUMPS - DIN 24256
- FIRE PUMPS - DIN 24255 & AMP; EN 733
- DEWATERINGPUMP – TYPE DWA
- MULTISTAGE CENTRIFUGAL PUMPS
- AIRCONDITION PUMPS - DIN 24255 & AMP; EN 733

KEERTHI PUMPS FLANGE STANDARDS.

- WATER PUMPS - DIN ND 16 & AMP; OPTIONAL ANSI B 16.5
- PULP AND PAPER STOCK PUMPS - ANSI B 16.5
- ANSI CHEMICAL PROCESS PUMPS - ANSI B 16.5
- MIXED FLOW PUMPS - ANSIB 16.5&BS 10TABLED

Adress: 1/514, Anna Nagar, Avinashi Road, Neelambur(PO), Coimbatore - 641062,
 Mobile: +91 7540082622, 623, 624, 625, Email: keerthipumps@gmail.com, marketing@keerthipumps.com, Web:www.keerthipumps.com
 Contact Person: Mr. Saravanan-General Manager

SOLUTION FOR EVERY APPLICATION



Head Office : Unit 1, 601/D, Wifi Park, Road No. 1, Above Satkar Grand, Opp. Aplab Co., Wagle Industrial Estate, MIDC, Thane - 400604.
Sales Enquiry No. : 9167202692 / 022 - 2582 8400
E-mail : sales@toshiopumps.com **Website :** www.toshiopumps.com





Kilburn Engineering Limited

KILBURN is one of the leading company in manufacturing of various types of dryers in India. We have been manufacturing & supplying various types of Dryers since last 40 years to various customers in India as well as abroad. The Dryers being manufactured are of different designs and for various products. KILBURN offers various types of dryers as following,

- Sludge Dryer
- Rotary Dryer, Rotary Kiln, Rotary Cooler, Rotary Calciner
- Paddle Dryer, Paddle Cooler
- Fluidized Bed Dryer & Cooler
- Vibrating Fluidized Bed Dryer & Cooler
- Spin Flash Dryer, Flash Dryer
- Converised Dryer, Band Dryer

Pilot plant facility is also available at KILBURN R&D centre for testing of material to ensure optimum sizing of dryer.

Address: Plot No.6, MIDC- Saravali, Kalyan-Bhiwandi Road, Tal.- Bhiwandi, Dist.- Thane 421 311
 Mobile: +91 93204 12191
 Email: pramod_patil@kilburnengg.com, Web: www.kilburnengg.com
 Contact Person: Mr. Pramod Patil



Kitten Enterprises Pvt. Ltd

Since 1995, Kitten Enterprises Pvt. Ltd. has offered solutions for purity to the food and beverage, pharmaceutical, chemical, microelectronics, oil and gas, industrial manufacturing, power generation, water and automotive industries. Based in Navi Mumbai - Maharashtra and with a new plant in Ahmedabad - Gujarat, Kitten provides innovative and cost-effective products for companies that need to compete in the aggressive global market.

Today, we manufacture a wide range of products: filter elements, housings and complete systems. All products are designed to reach maximum purity standards at the highest quality requirements. We listen to our customers' needs and strive to satisfy every requirement with every order.

We produce elements and housings to global standards such as PED 2014/68/EDU and our quality system is certified to ISO-9001:2015. When customers require customized solutions, our design staff listens to their requirements and develops individually tailored systems, housings and even filtration elements.

Kitten is also certified to affix the CE marking on our products for the European Community. With these achievements, we have become the preferred supplier for many high value companies. For 25 years now, Kitten has provided quality filtration products to industries all over India and the world. Our success is based on our solid technical expertise and superior customer service. Our goal is to exceed our customers' expectations in providing solutions to their filtration needs.

Visit our stand - E12 to discuss your filtration requirements and let us know how Kitten can help you keep your products and processes clean. Our goal is to be your global partner for purity!

Address: W 407, Rabale MIDC, Near Golden Garage, Navi Mumbai-400701 INDIA
 Phone: 022 2764 6464, Mobile: +91 86550 09090
 Email: advt@kitten.co.in, Web: www.kitten.co.in
 Contact Person: Mr. Danish Kazi



Mini Dose Solution Pumps

Budh Vihar, Delhi

Manufacturers and wholesalers an extensive array of Dosing Pumps, AC Stabilizers, and much more. These products are designed by experienced professionals using best material. In addition to this, these products are highly admired for their long lasting, lightweight, defect-free nature and high strength.



DIAPHRAGM DOSING PUMP



DOSING PUMP



ELECTRONIC DOSING PUMP



PLUNGER PUMP



MOTORISED DOSING PUMP



N.R.V.+ FOOTVALVE, PAIP



DIAPHRAGM



Screw Pump



Office: 0-1/58B, Budh Vihar Phase-1, New Delhi-110086
 Factory: I-218 Sector 5, DSIDC Industrial Area, Bawana, New Delhi- 110039 India
 Mobile: +91 9911565551/52/53, 93128 15051, 91366 37070
 Email: minidosesolutionpumps@gmail.com | akvminidose@gmail.com | info@dosingpump.co.in | mdsp@dosingpump.co.in
 Web: www.minidosesolutionpumps.com | www.minidosesolutionpumps.in | www.dosingpump.co.in | www.minidose.in



Klenz Chemicals

Since 2018, Klenz chemicals aiming at providing complete and reliable solutions for the water treatment plants and operating systems. Backed by a pioneering heritage, our innovative products and sustainable technologies are designed to meet the growing demands on waste water treatment, while making return of investment (ROI) easier.

Klenz chemicals products make a significant contribution to saving energy, improving performance and enhancing standards of unit operations in the waste water treatments. Klenz chemicals manufactures a wide spectrum of polymer based :

- | | | | |
|------------------------------|--------------------------------|---------------------|----------------------------|
| 1. RO Antiscalants | 2. Ph Booster | 3. Membrane Cleaner | 4. Boiler Chemicals |
| 5. Evaporator Chemicals | 6. ETP Chemicals | 7. STP Chemicals | 8. Cooling Tower Chemicals |
| 9. Tanery Effluent Chemicals | 10. Textile Effluent Chemicals | | |

Address: HO: 26, Sakthi Colony, Ramakrishnapuram, Ganapathy, Couimbatore – 641006.
 Works: 17/1E, Rathinagiri Road, Vilankurichi, Saravanampatti(P.o.), Coimbatore 641035.
 Mobile: +91 97900 90900, Email: thiru@klenzchemicals.in
 Web: www.klenzchemicals.in
 Contact Person: Mr. G. Thiruvnkadam



Komter Equipments Pvt Limited

KOMTER EQUIPMENTS PVT LIMITED is dealing with design, manufacture and distribution of Lubricated and Non-lubricated reciprocating low & high pressure compressors, Vacuum Pumps to Rotary Screw Compressors and Pressure boosters. Our quality compressors offer pioneering design, high impact technology and unmatched durability. Our world class products and solutions help customers achieve continuous improvements in efficiency and productivity in a wide range of industry segments including general engineering, automotive, manufacturing and process industries, construction, food and beverage, entertainment and so on.

We are dedicated to continual R & D in our product, which helps us to grow faster & fulfil our customer and dealer requirements. We are innovative, flexible and committed to our customer's requirement.

Our relationship with customers doesn't end after you receive our products, our Dedicated service network, comprehensive service and after market support allows you to protects our products throughout the lifecycle .

Address: 1/164, Perumal Koil Street Bhudhur Billage & Post,
 Sholavaram, Chennai - 600067 Phone: +91-9791276720
 E-mail: info@komter.in, komtermfg@gmail.com
 www.komter.in

Corporate office:
 Komter Equipments Private Limited
 No PC 5/2, Bharathi Salai, Above Agraharam Hotel,
 Mogappair West, Chennai - 600037



Manufacturer of :

- ◆ PP Sediment Melt Blown Filter Cartridge
- ◆ Orange Surface PP Melt Blown Filter Cartridges
- ◆ Grooved Surface PP Melt Blown Filter Cartridge
- ◆ PP Sediment String Wound Filter Cartridge
- ◆ Available End Caps:- 222, 226, Flat Gasket & Fin
- ◆ Melt Blown Cartridge With PP Core



www.silverfiltration.com

SILVER FILTRATION

Manufacturer of Melt Blown & Wound Filter Cartridge

Survey No.211, Plot No.6,
 Nr. Ravi Technoforge,
 Essen Road, Veraval (Shapar),
 Rajkot - 360024 (Gujarat) INDIA

+91 2827 294004
 +91 98256 79888 /
 + 91 99793 87938
 sales@silverfiltration.com





Kontakt Engineers

Modular Solar Roof Top Waste Water Treatment : We have developed for the first time Modular Solar Roof Top Waste Water Treatment / ETP & STP mounted on prefab structure using algae

Advantages:

- 1 Ground Space is not required – can be mounted on Roof Top (Any Type)
- 2 Reduction in operation cost – 90%
- 3 RO rejects evaporation can be done
- 4 Nutrient removal including ammonia
- 5 BOD & COD reduction
- 6 PH Correction
- 7 No – Fossil Fuel
- 8 No – Maintenance,
- 9 No – Ariation
- 10 No – Mechanical Moving Part except pump.

Address: SS2, 1ST Main Road, Sidco Industrial Estate, Ambattur, Chennai – 600058.

Mobile: +91 73580 40733 / 98400 52556

Email: vinodbomb@gmail.com

Web: Kontaktengineers.co.in

Contact Person: Mr. Vinod Bomb - Proprietor



Krishna Industrial Services

Our company KIS (Krishna Industrial Services) was established in the year 1992 by A.Hariharan, Proprietor. He is a chemistry graduate from R.K.M Vivekanandha college and has a 3 years work experience in manufacturer of ion exchange resins in unit at gummudipoondi. The company started doing trading activities in laboratory Glasswares, Chemicals and instruments. Then in 1994 resale of acids and chemicals was ventured. Supplies were made to SSIS,MSUS and collected a good client base., The company also had a sister concern in the name of vikaash chemicals for manufacturing pharmaceutical excipients.

As we had a good customer association with pharmaceutical formulation units in the Tamilnadu, Kerala & Karnataka ion exchange india Ltd.,(IEIL) appointed us as a stockiest for pharma grade resin in the year 2004. In 2009 we got associated with thermax for trading their water treatment resins. In the year 2011, the company got associated with aquanomics systems limited (ASL) a group company of IEIL and started selling products of ASL and became a house for complete range of water treatment components and chemicals it also started a group of company in the name of Ananth's Aqua Associates for servicing OEMS with resins, chemicals, Vessels, Valves, Membranes, Pumps, Dosing pump, Media, Carbon and many more. In the year 2012 the company got associated with Georg Fischer a switzerland Company, for stocking their UPVC pipes & fittings and became their exclusive stockist for south india In 2013 The child company Krishna aqua services is born for domestic water purifiers and plans for a good satisfactory customers with prompt service and emerging as KIS Group and is aiming for a yearly turnover of 50 crores by 2015.

Address: No.705, 28th Street, Korattur, Chennai – 600 080

Phone: 044 2687 2974, 2687 0234

Mobile: 94444 52708, 96000 01653

Email: saleskisgroup@gmail.com, aharriharan68@gmail.com

Contact Person: Mr A.Hariharan



LEXCRU[®]

WATER PURIFICATION

MADE IN INDIA
BEST MEMBRANE MANUFACTURER
AWARDED BY WATER DIGEST
IN ASSOCIATION WITH
UNESCO & ASSOCHAM



India's
First Manufacturer of
Membrane Sheet



Lexpure[®]

LCM[®]
INDUSTRIAL

Cruze[®]

LEXCRU WATER TECH PVT. LTD.

D- 601/602, Six Floor, Saral Icon, Near. Hotel Flora, Opp. Reliance Petrol Pump, S. P Ring Road,
Vastral - 302418, Ahmedabad, Gujarat, INDIA.

M. : +91 9624007888 | email : sales@lexcru.com | web : www.lexcru.com



KROFTA

Krofta Engineering Limited

Krofta - The name synonymous with DAF world over - has been supplying the most efficient DAF units to all sectors of industry since 1955. Over 1000 installations in India and more than 10,000 globally.

Today KROFTA supplies complete solutions for your water and waste water/sewage problems. The Krofta systems comprise of: DAF Systems (Supercell, Megacell, Sedicell, Minicell, Unicell), Belt Filter Press, CPI/TPI, Lamella Clarifiers, Continuous Sand Filters - No stopping for Backwash, Membrane Systems, Ultra Filtration & R.O., Pressure Sand Filters, Activated Carbon Filters, Aeration Systems (Fixed aerators, Floating surface aerators, Diffused aeration), Sedimentation Clarifiers, Softeners, Activated Sludge Process (SAF, MBBR, Extended aerator), Disinfection (chlorination, Ozonation, UV), We also manufacture Tilted Plate Interceptors and Corrugated Plate Interceptors Krofta backs up its technology with excellent after-sales services.

Address: Durga Bhavan A-68, FIEE Complex, Okhla Industrial Area Phase – II New Delhi – 110 020.
 Phone: +91-11-47242500
 Email: krofta@kroftaengineering.com, Web: www.kroftaengineering.com
 Contact Person: M.P. Jain - Group President

KSSR

KSSR Enterprises

Preevol Technics are engaged in manufacturing and exporting of industrial pressure pumps for various purpose in Industries. Our Triplex plunger pumps provide complete pumping solution and are known for their out standing Performance. The pumps designed by us are highly sophisticated and have been certified as an ISO 9001-2000 for their quality. We are having range up to 60m3/hr@1000 Kg/ Cm2. This pump can be use for high pressure jetting application, RO application, boiler, feed spraying, hydro testing, car washing and many more etc.

Address: No:2B, Lalitha Nagar,1st Street Annex, Madhanandapuram, Porur, Chennai-600125
 Mobile: +91 95000 27705, 96770 23659
 Email: sales@highpressureplungerpumps.com
 Web: www.highpressureplungerpumps.com, www.preevolplungerpumps.com
 Contact Person: Mr.Bhrimatt – Managing Director, Mr.T.S.Sridhar- Chief Executive



J M FILTRATION TECHNOLOGY

MANUFACTURERS | DESIGNERS | CONSULTANTS

ISO 9001 : 2015 COMPANY







INDUSTRIAL & COMMERCIAL

- Reverse Osmosis Plants
- Package Drinking Plants
- Ultra filtration Plants
- Water Vending Machine
- Water Softener Plants
- Demineralization Plants
- Zero Liquid Discharge Plants
- Sewage Treatment Plants
- Effluent Treatment Plants



We Provide Engineered solutions in Stainless Steel 304 & 316

Regd. Office: B-101, First Floor, Raj Chamber, Near Kothla Stand, Ahmednagar - 414 001. Maharashtra (India)
 Works: Plot No. 1, Survey No. 273/3, Behind Videocon Company, Burhannagar, Ahmednagar - 414 002. Maharashtra (India)
 Contact: +91 98906 49199 / +91 93706 49199 | E-Mail: jmfiltrationindia@gmail.com | Web: www.jmft.in



KWS Evaporators Pvt. Ltd.

We are glad to introduce us as one of the leading manufacturer of Multiple effect Evaporators in INDIA. Our business is run by team of technocrats who have very good experience in their respective field of operations. We manufacture different type of evaporators such as Falling film, Forced circulation, Natural Circulation and Pan Evaporators, Chiller Crystallizers, Basket Centrifuges and Pusher Centrifuges etc.

We design, fabricate, erect and commission the evaporators as per our client requirements and are highly energy efficient and reliable from the operational point of view.

For effluent treatment where ever the zero discharge norms of TNPCB have to be met, the only choice is to go for the multiple effect evaporators followed by Crystallizers. Here the main object to reduce the outflow from the effluent treatment plant and recover water and salt in pure form in order to reuse it in the process. We have manufactured and commissioned more than 100 plants for this application.

Address: #79, 11th Cross Street, 5th Main Road
HIG -2, Nolambur Phase-I, Chennai 600 037, India
Mobile: 94440 61899
Email: saviyasathu@gmail.com
Web: www.kwsevaporators.com
Contact Person: Mr. Saviyasathu



Kymik Engineering Pvt. Ltd.

KYMIK Engineering is the only Manufacturers, Exporter & Turnkey Project Solution provider, for all your Storage Requirement. KYMIK has been set up by qualified professionals with considerable experience in the Liquid Storage Industry

All our Storage Tanks are Custom made as per clients requirement and specification.

Storage Tank We Manufacture:

1. Bolted Panel Tank (3 Kl to 5000 Kl).
2. Zinc-Aluminum Tank (3 Kl to 5000 Kl).
3. GI Panel Tank (FM 4020 Compliance).
4. Fusion Bond Coated Tank.

Why Kymik Storage Tank: Kymik is undoubtedly your preferred choice for all your Storage Requirement. The Entire team of Kymik is Efficient & Effective to deliver optimum solutions. We work with honesty and integrity without compromising on the Quality & Production Cost.

Kymik's Tank Application: Water Tank, STP Tank, WWTP Tank, DM Water Tank, Fire Water Tank, Drinking Water Tank, Rain Water Tank, Fish Farming Tank, Aeration Tank, Industrial Water Tank.

Kymik'S International Presence: Bhutan, Nepal, Sri Lanka, Nigeria, Philippines Thailand, Myanmar Middle East.

Address: 632, SomDutt Chamber II, Bhikaji Cama Place New Delhi 66. INDIA
Phone: +91 11 4142 0505, Mobile: +91 97172 88404
E-mail: sroy@kymik.com, sales@kymik.com, Web: www.kymik.com
Contact Person: Mr. Saptarshi Roy Contact Person: Mr. Saptarshi Roy

PLACON FILTERS PVT. LTD.

Here Is The Answer.....for Your All Filtration Needs Under One Roof



Group Of Company
**MSK ENTERPRISES
PLACON ENGINEERING**
Corporate Office: No.306, Old No.254 GST Road, Upstair Sangeetha Mobile Show Room, Chromepet, Chennai - 600 044,
PH: 91-44-22388900, 42876741, Mobile: 9283649940, 9381904027, 9551912272
Web: www.placonfilters.co.in, www.placonfilter.com
Factory: MSK Enterprises, No.9 Narshimman Sreet, Nakalkeni, Chrompet, Chennai 600 044
Ph: 91-44-22388900, 42876741



Lansen Chem

LANSEN CHEM, established in 2004, is a leading manufacturer of coagulants & flocculants, textile dyeing auxiliaries in China, with decades of experience in production, R&D, and application service.

LANSEN provides customers wide range of water treatment chemicals, main product range comprises: water decoloring agent (DCDA polymer), polydadmac, polyamine, polyacrylamide, PAC, ACH, etc. Our annual production capacity is 100,000 tons.

Our company passed the certification of ISO9001, 14001, NSF and SGS. Our plant is located in Yixing, Jiangsu, China, 200km from Shanghai. For more information, please visit website is www.lansenchem.com.cn.

Address: No.23, Shuguang Road, Guan Lin Chemical Industry Park,
Guanlin Town, Yixing, Jiangsu, China Yixing - 214258
Mobiul: 0086-13861509095 Email: susan.shi@lansenchem.com.cn,
Web: www.lansenchem.com.cn.
Contact Person: Ms. Susan shi



LANXESS India Private Limited

LANXESS is a major global solution provider for liquid purification with almost 80 years of experience in water treatment and purification applications. With Lewatit® ion exchange resins, Bayoxide® iron oxide adsorbers, and Lewabrane® RO membrane elements, LANXESS holds a leading position in the development and production of three premium separation technologies for water purification, desalination, and process stream treatment. Production sites are located in Leverkusen, Bitterfeld, and Krefeld, Germany, and in Jhagadia, India. Our high-performance products are used in numerous industries to treat and purify water and other liquid media – industrial process water treatment, food processing solution purification, and wastewater treatment being the best-known fields of application. Energy suppliers use our products for the production of boiler feed water and steam, for condensate polishing, and water treatment in cooling towers.

Lewabrane® RO membrane elements are available for all water types, such as seawater, brackish water, and low-salinity water, for use in industrial and potable water applications. Apart from unique polyamide membrane chemistry, which provides the user with stable salt rejection and flow performance at changing feed conditions, a novel feed spacer technology has been implemented. The alternating strands design (ASD) offers a feed channel with improved feed water distribution and lower fouling tendencies. All Lewabrane® products are compliant with NSF/ANSI Standard 61.

The comprehensive design software LewaPlus® can calculate Lewabrane® RO and Lewatit® ion exchange (IX) arrays within the same software platform. It allows the designer to simultaneously optimize both the RO and IX configuration, which is unique in the industry.

The most important brands & products:

- Lewatit® ion exchange resins
- Bayoxide® iron oxide adsorbers
- Lewabrane® RO membrane elements
- LewaPlus® calculation and design software

Address: Plot No: A 162-164, Road No 27, MIDC, Wagle Estate, Thane (W) - 400604, Maharashtra,
Phone: +91 22 2587 1000 (Board), Fax: +91 22 25871287
Email: infoindia@lanxess.com, Web: www.lanxessindia.com, www.lpt.lanxess.com Contact Person: Mr. Prakash Shanmugam

SINGLE BORE / MULTIBORE ULTRA FILTRATION MEMBRANES

High Mechanical Strength
Reduced Foot Print

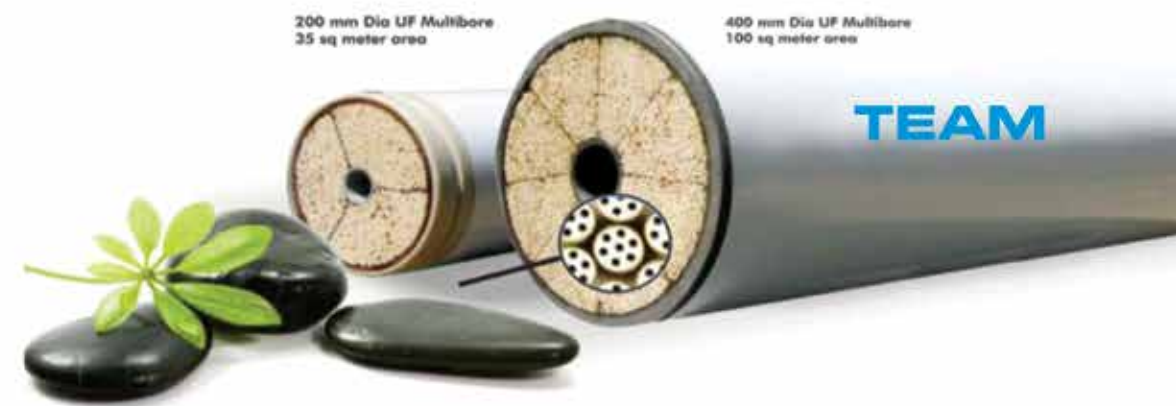

UF Applications

- Boiler Feed Water – Colloidal Silica Removal
- Pre – treatment R/O – Reduction of SDI
- Drinking Water – Removal of pathogens, bacteria
- Treated sewage – TSS / Turbidity / SDI Reduction
- Process Effluent Recycling – TSS / Turbidity / SDI Reduction
- CT Blow down Recycling – TSS / Microbes / SDI Reduction
- Pre – treatment to desalination – SDI Reduction
- Brine Clarification – Chlor-Alkali - TSS / Turbidity Reduction

Advantages of MHT UF Membranes

- Low Operating Pressure (0.5 to 0.8 Bar)
- High Performance anti-fouling Characteristics
- Operation in Dead End / Cross Flow modes
- MWCO range 10KD / 100KD
- Same UF feed pump used for Forward Flush A&B
- Reduces Foot Print with 100m² membranes
- Elimination of Pre-coat Filters (Brine Clarification)
- Lower Power Consumption

MEMBRANE HITEC

Division of Titanium Equipment and Anode Manufacturing Company Ltd

Team House, GST Road, Vandalur, Chennai - 600 048, India. Ph: +91-44-66799595, Fax: +91-44-22750771

Email: membranehitec@draoholdings.com

Website: www.membranehitec.com

Member - Dr.Rao's Group of Companies



Lexcru Water Tech Pvt. Ltd.

LEXCRU Water Tech Pvt. Ltd. is one of the most recognized and trusted brands globally for Water Purifiers such as Reverse Osmosis (RO)/Ultra Filtration/NANO Filtration and Water Purification components including RO Booster Pumps, RO membranes and filters.

Today LEXCRU's product range includes a complete collection of water purification components such as RO Systems, Bracket, Filter Wounds, Housing, Membrane and Pump among others.

Its competitive industry prices and constant technological innovation. Lexcru's most popular product, the RO booster pump known for its 'silent pump', limited power and an average a lifespan of more than two years was recently awarded the "Best Water Pump (Domestic)" award for third time running by the Water Digest Awards in association with UNESCO and ASSOCHAM in 2018-19. The company also received the 'Best Water Membrane Manufacturer' award at the same event.

Guided by their vision to provide safe potable water to all, LEXCRU ensures that their are available at competitive industry prices. LEXCRU is one of the few Indian companies to have its products approved by the CE, ROHS and FDA.

In a nutshell, it can be said that LEXCRU Water Tech Pvt. Ltd. has become a global force to reckon with in the OEM water purification industry.

Address: 601/602 Saral Icon, Opp. Reliance Petrol Pump, Sardar Patel Ring Road, Vastral, Ahmedabad, Gujarat 382418, INDIA
 Mobile: + 91 96240 07888
 Email: sales@lexcru.com, Web: www.lexcru.com
 Contact Person: Mr. Mayur Raval



LiquidSky

LiquidSky licences and supports the latest technologies to build a better world. With a focus on water, we bring to India, technologies that: Treat industrial waste water, cleaning and reuse through zero liquid discharge:

Replace traditional Multiple Effect Evaporators with compact skid mounted units with a 25 year lifecycle. Our equipments are manufactured to the highest quality standards, using super duplex material, which allows us to tackle the most aggressive waste water, and ensure a long life of our equipments. Very low maintenance and a long life make our equipments much cheaper on a lifecycle cost, compared to traditional evaporators.

We recover 95% of the wastewater in pure distillate form which can be recycled back to the production process. The 5% concentrate is treated in a vacuum concentrator and turned into solid sludge which can be taken away by a waste disposal company.

Address: 43/1, D2 Block , Telco Road, MIDC Chinchwad, Pune - 411019 India
 Mobile: 8550993368, Email: nayanit@liquidsky.org, Web: www.liquidsky.org
 Contact Person: Mr. Nayanit Shastri - AGM - Sales

A REFLECTION OF PURITY



Guddi Plastcon, the name with a mission to design, develop and produce a range of products for water & waste water treatment is a well established & recognised organisation formed in the year 1988 and have been pioneers since then.

The leading OEM's of the international and the Indian market have acknowledged Guddi Plastcon as the most reliable source of suppliers that deal in components for water & waste water treatment.

Not only does Guddi Plastcon manufacture the premium quality products but also promises to make it available at the most competitive prices with quick delivery time.

OUR PRODUCTS

Plastic Filter Nozzles



Under Drain Collection Systems For Sand Gravity Filters



Plastic Media For Bio-tower



Distribution & Collection Systems



Bottom Collection Systems



Multi Port Valves



Tower Packing & Hallow Balls



GUDDI PLASTCON PVT. LTD.
 For Water Treatment And Conditioning Equipments

B - 214/215, Kanara Business Centre, Behind Everest Garden Building, Laxmi Nagar, Ghatkopar (E), Mumbai-400 077, India.
 Tel: +91-22-61579393 | Fax: +91-22-61579393.
 Email: gplast@bom5.vsnl.net.in | sales@guddiindia.com
 website: www.guddiindia.com



Machine Factory

We, M/s. Machine Factory, Have Great Pleasure To Introduce Ourselves As One Of The Leading Manufacturer of PET Bottle Blow Moulding Machine and PET & Plastic Shredder Machines Based In Redhills, Chennai, India. We Have Emerged With A Reputation For The Quality Products As Well As Prompt Service. Since, we have our Own Factory to Manufacture the Accessories & Necessary Parts of the Blow Machines; we can capable to vend the machineries in better Competitive rates to our Customers. We have a team of highly trained and experienced professionals to manufacture machineries and who are working hard to maintain the Sales & Service throughout the year. We have the huge Ware House facility to keep the Machineries for Demo to prove the quality to our Customers. We Guarantee Competitive Rates Along With Excellent & Quality Products. Delighted customers are key to our success & we strive to achieve this key every second. We offer our Machine in both standard and Customized Specifications to meet customer requirements. Our machines are designed with at most care to eliminate all limitations of the existing Machinery. We develop PET bottle blow machine that build tangible long-term value. Machine Factory is a wide leader in complete machine line solutions. We focus on bottle blowing machine quality and product durability for enhanced hygiene to ensure optimum quality of our product to the consumer.

Address: No. 5, Haroon Ullasa Nagar, Pulli Line, Redhills,
Chennai-600052, Tamil Nadu, India
Mobile: +91 95000 04117
Email: gmsnowwash@gmail.com, Web:www.snowwash.net
Contact Person: Ms. Firoze Nisha - General Manager



Madras Chamber of Commerce and Industry

The Madras Chamber of Commerce & Industry (MCCI) is one of the premier industrial promotion organizations in Southern India and is currently into its 184th year of service to trade and industry. Established in 1836, the Madras Chamber is the oldest chamber of commerce and industry in Tamil Nadu and is one of the five promoter chambers of the Associated Chambers of Commerce & Industry of India (ASSOCHAM), New Delhi.

The Madras Chamber has been an integral part of the growth of commerce and industry in the southern region. Almost all leading industries and businesses in Tamil Nadu, family owned enterprises, publicly traded companies, multinational corporations and SMEs are our members. It would not be an exaggeration to say that a large proportion of industrial investment in Tamil Nadu is accounted for by the members of MCCI.

Over the decades, the Chamber has been a responsible and credible voice of trade and industry and has worked closely with the State and Central Government on various issues.

The Chamber has been a pioneer in bringing new initiatives such as a Centre for Vocational Training and Skill Development, Sustainable Chennai Forum, Start-up Entrepreneurial Eco System (SEE), Food For Thought (FFTs), Women Directors Forum among others.

Leveraging the knowledge and resource bases of various expert committees, the Madras Chamber plays a formidable role in policy making and advocacy in addition to providing the services such as Arbitration services, networking opportunities to promote business through various meetings, workshops, round tables, visit of overseas delegations, trade facilitation and B2B linkages.

Address: Karumuttu Centre, I Floor, 634, Anna Salai, Nandanam, Chennai 600 035
Phone: 044-24349452/24349871
Email: madraschamber@madraschamber.in, Web:www.madraschamber.in
Contact Person: K.Saraswathi - Secretary General

AUTOMATIC SELF - CLEANING FILTERS

- ROTARY BRUSH TYPE
- PISTON OPERATED TYPE
- SCRAPER TYPE
- MULTIPLEX TYPE
- AUTO BACK FLUSHING TYPE

APPLICATION:

FILTRATION OF SEA WATER, RIVER WATER, EFFLUENT WATER,
BLACK LIQUOR, COOLING WATER & ANY FREE FLOWING LIQUIDS

CLARITY : 5 MICRON AND ABOVE

MATERIAL : S.S., DUPLEX, HASTELLOY, TITANIUM, C.S, PTFE LINED ETC.

FLOW RATE : UPTO 3000 M³/ Hr IN SINGLE UNIT

Distinctive Features of "Clearsep™ SELF-CLEANING FILTERS"

NO CONSUMABLES
DISPOSAL ISSUES
OPENING OF THE FILTER
OPERATOR INTERVENTION
DIRTY SURROUNDINGS



For AUTOMATIC SELF-CLEANING FILTERS And Other

CLEAN-IN-PLACE & ECO FRIENDLY

FILTRATION EQUIPMENT AND SYSTEM, Please contact



CLEARSEP TECHNOLOGIES (I) PVT. LTD.,
AN ISO 9001:2015 CERTIFIED COMPANY

No. 616, Corporate Centre, Nirmal Lifestyle, LBS Marg,
Mulund (W), Mumbai - 400 080. INDIA
Ph: +91 22 2562 2323, Fax: +91 2562 2626,
Email: info@clearsep.com, URL: www.clearsep.in

"CLEARSEP" & The Logo Are
Registered Trademarks Of
Clearsep Technologies (I) Pvt. Ltd.,
Mumbai, INDIA



Madras Hardtools Pvt. Ltd

Madras Hardtools Pvt. Ltd. is an ISO 9001:2008 certified company established in 1972 having their head quarters in Chennai. Distributor in South India for “Usha Martin” make Wire Ropes & Wires. Having factory-cum-warehouse at Puduvoil on NH5, before Gummidipoondi. Manufacturing of Mech. spliced and Hand spliced Wire Rope Slings and Lifting Equipments, Polyester Web Slings, Distributor for “YOKE” for the Master Link, Assemblies, and Hooks etc. and Channel Partner for Crosby Products. Best equipped company in India possessing 3000 Ton USA National make Hydraulic Press & 300 Ton Test Bed and admitted as a member of AWRF, USA & ISSA, U.K. Producer of Green Power by Windmills & Solar Power Systems.

MHT PET DIVISION: Manufacturing of PET Preforms, PET Bottles, HDPE Caps. Machineries presently available with them are the state-of-the-art-Technology of L&T/Toshiba make injection moulding Machines-5 Nos. with Chillers & Dehumidifiers and Precision 16/24/32 cavity Moulds. Also blowing machines of capacity 200ml to 20Ltr. Importing PET Resins from China & Taiwan to sell locally. Proposed to manufacture Preforms for soft drinks like Juice, Soda, Pharma, etc. Erected 630 KW HT Line & 200 KWp solar power system to supply uninterrupted power supply for Injection moulding Machines.

AWARDS: The company have bagged MOITA (Market of India Trade Awards) Chennai Edition 2019 Super Star recognition in Industrial Supply Category & ZEE Business Dare to Dream Awards Session 2 in association with SAP - Company of the Year – Manufacturing.

Address: Office: No.1, Perianna Maistry Street, Broadway, Chennai - 600001
 Fac: No.62, Durainallore Village, Puduvoil, Thiruvallur Dist - 601206.
 Mobile: +91 98400 70053, 98400 66046, 98400 64831
 Email: info@madrashardtools.com/abl@madrashardtools.com, Web: www.madrashardtools.com
 Contact Person: Mr. B. Ali Akbar, Director / Huzefa A. Lehry, Director / Pravashapati



Marcus Blowin

Packaging Automation Through Robotics:

Your Gateway to Productivity for Automatic Bottling System and Your packaging partner, from conception to commercialization, Marcus Blowin is one of the pioneers in PET blow moulding technology. We have been developing tailor-made solutions in Automation Robotics for about nine years and along the way have accumulated expertise in design and production of packaging for foods & beverages.

Our Blowing Machines have High Productivity, Low Power Consumption, Easy Operation, Low maintenance costs, Precise and Programmable controls with Human Machine Interface (HMI), Low cost of Blowing, operator safety, secondary compression to eliminate parting line. Machine construction materials that are reliable and the best combination you can get in the PET world.

Marcus Blowin Says” 24/7 Customer Service is our Top Priority “

Address: 55, MGR Nagar, Trichy Main Road, Singanallur, Coimbatore - 641005, Tamil Nadu.
 Mobile: +91 95004 12345
 Email: info@marcusblowin.com, Web: www.marcusblowin.com
 Contact Person: Mr. Jayaprakash Kanesan - CEO



**WE HAVE FABRICATION
 SETUP AND DOING
 MANUFACTURING FOR OEM**
 MANUFACTURER & SUPPLIER OF
**WATER & WASTEWATER TREATMENT PLANTS
 EQUIPMENTS WITH PROPER FUNCTIONAL
 INFRASTRUCTURE & HIGHLY EXPERIENCED
 PROFESSIONAL TEAM.**

OUR PRODUCTS

- Mix Beds
- Softeners
- Agitators
- MBBR Tanks
- Tube Settlers
- Headers
- RO Plants & UF Plants
- Dosing Systems
- Pressure Sand Filter
- Multi Grade Filter
- Dual Media Filter
- Activated Carbon Filter
- Lamella Clarifiers
- Chemical Dosing Tanks
- DM Plants Tanks
- Process & Storage Tanks
- Settling Tanks & Dosing Tanks
- Interconnecting Piping - MS/SS/MSRL



**NEW EDGE
 TECHNOLOGIES**

Office:
 E/13, Dwarka Platinum, Sector 7, Indrayani Nagar, Bhosari, Pune - 411 026. Mobile: 84079 07700, 98608 63030
 Email: newedgetechnologies01@gmail.com, info@newedgetechnologies.com
 Web: www.newedgetechnologies.com

Works:
 Gat No. 79 Wagheshwar Colony, Next to CNG Pump, Moshi Road, Pune - 412105.



Maxwell Additives Private Limited

Nature Of Business: Maxwell Additives Pvt. Ltd. is a leading Chemicals manufacturer since 1988. SUJAL, OLKLIN & KLINMAN are our registered brands in Water Treatment Chemicals. Our uniqueness in the manufacturing of speciality chemicals that is Organophosphates, Polymers & Benzalkonium Chloride makes us a gem in this market. PHOSPHOMAN, POLYMAN & DEBAC are our registered brands in Speciality Chemicals. We are also growing in cleaners & sanitizers range. KLINMAN, OLKLIN & DEBAC are our registered brands in Cleaning. Recently launched Hygiene & Disinfectants products range.

Mission: We continuously serve in the field of cleanliness drive which is very much inevitable for healthy and hazard-free life with unique class of best quality.

Goal: Our Goal is to give the best quality products, at an affordable price, to keep our human folks as well as environment clean, safe and healthy. By virtue of this, the company has been able to source the products at very competitive prices and can supply the same with guaranteed specifications and delivery commitments.

Address: E/94, Sardar Industrial Estate, Road No.2, Ajwa Road,
Vadodara- 390019, Gujarat, India Phone: +91 265-2513595/ 2516773, 63549 18204
Email: sales1@maxwelladditives.com, admin@maxwelladditives.com
Web: www.maxwelladditives.com
Contact Person: Mr. Daxesh Soni -General Manager Marketing



Membrane Engineering Pvt Ltd

Membrane Group aims to improve the quality of life and the efficiency of your processes by providing State-of-the-Art Water and Wastewater Treatment Components. With over 30 years of experience, Membrane Group has been supplying Systems for both Pure Water as well as Wastewater Components to Industries and Companies around the world. It's always our ambition to add value to our customers by providing them with technologies and systems that help them recycle maximum amount of wastewater. In India, we represent the following Global Leaders for their complete range of Water & waste water treatment components:

- 1) LG Chem - Complete Range of Reverse Osmosis Membranes
- 2) MEMSTAR USA- Complete Range of Ultra Filtration Membranes
- 3) MITSUBISHI CHEMICALS, JAPAN - Membrane Bio Reactor Systems
- 4) KURITA, JAPAN - Specialized Water Treatment Chemicals
- 5) PENTAIR - CodeLine Housings, Structural Tanks, Filtration Solutions, Valves etc
- 6) AQUAPORIN, Denmark - Forward Osmosis Membranes

Together, we are committed to minimizing water wastage by recycling every drop of water.

Address: Plot 56, Functional Industrial Estate, Opp D.T.C. Bus Depot
Patparganj, Delhi - 110092, Delhi, India
Mobile: +91 9910379135, 93191 92466
Email: support01@membranegroupindia.com, Web: www.membranegroupindia.com



Collaborating with the Future

Introducing Superior Performance Aquaporin Inside[®] Forward Osmosis Technology

Perfect For:

- Effluent with High COD Load
- Automotive and Electroplating Waste
- Evaporator condensate dewatering
- Dairy wastewater Concentration
- Product Extraction



Curious how it works?

Test your applications for FO feasibility at our Lab Trial Facility



Pure Water is associated with Aquaporin- Danish water technology company, to promote innovative Forward Osmosis Membrane Technology solutions in India.

Pure Water Enterprises Pvt. Ltd.

A-331/Antop Hill Warehouse Complex, VIT College Road,
Wadala East, Mumbai-400037



+91-22-24175662, +91-22-24175663



info@purewaterent.net



7506795491



www.purewaterent.net



Membrane House

Hunan Ovay Technology Co Ltd (OVAY) is located in Zhuzhou, Hunan. The registered capital of Ovay is 100 Millions. Ovay Focuses on Researching , Manufacturing and Marketing of RO, NF, UF and MF Membrane material & Elements. It is one of the limited enterprises that have the capacity to manufacture the dry membranes at global scale.

Ovay has a high-tech elite team composed by several PhDs, Masters and Overseas Talents to look after its own one research and development centre along with two high-tech industrial Units as well. Ovay hosted or participated in 3 national projects, 1 CAS project and 1 school-enterprises project. Until now Ovay owned 16 national patents that include 10 invention patents and published several scientific papers in renewed core periodicals at home and abroad.

After long term technical reserve, there are more than 40 kinds of self- developed RO Membrane products that have been widely recognised in the trade and the performance reaches the international advanced level. Cooperation project of Ovay and Domestic well known university filled with technical gap and break up monopoly in hollow fibre Ultra Filtration Membrane and Hollow fibre Micro Filtration membrane products by Foreign Companies.

Address: Membrane House, New Delhi
 Phone: +91 98106 67711, Email: Sanjay.khurana@membranehouse.com

Merit Flow

Meritflow is a upcoming brand in India selling RO Booster Pump.

The range of RO pump available are 75 GPD, 100 GPD, 150 GPD and 300 GPD. Meritflow is manufacturing in India which is having complete infrastructure to manufacture DC motors and diaphragm pumps.

The plant is managed by the well experienced team including design, development, testing and manufacturing. The plant infrastructure involves motor production, pump production, injection moulding division etc. The dealers of Meritflow brand are Vatten pure India LLP - Chennai, Smart Water Solutions - Chennai, Pure India - Coimbatore, Aqua Clear Tech Solutions - Madurai

Vatten Pure India Llp
 74A, Tiny Sector, Thiru-Vi-Ka Industrial Estate,
 Ekkattuthangal, Chennai 600 033
 Phone: 044 2225 1578, Mob:+91 95000 30582/3/4
 Email: vattenpure@gmail.com | www.vattenpureindia.com

Pure India
 # 42, East Sambandam Road, (Opp) Adayar Ananda Bhavan
 R.S.Puram, Coimbatore - 641 002
 Ph: +91 422 420 6262, Mob: 98422 38428 | 85085 88188
 Email: pureindiacbe2@gmail.com, info@pureindiacbe.com
 Web: www.pureindiacbe.com

Smart Water Solution
 No. 3, Elango Salai Teynampet, Chennai 600 018, Tamil Nadu, India
 Ph: 044 - 4205 6262, 4231 6262 | Mob: +91 98417 46567
 Email: smartwatersolution@gmail.com

Aqua Clear Tech Water Solution
 No. 93, South Marret Street, South Gate, Madurai-625001,
 Tamil Nadu, India 0452-4382994, 9080922281, 9944522994
 aquaclear2008@gmail.com

AQUASOL

Analyzing Waters Anytime... Anywhere...



- ◆ Simple, Easy To Follow Procedures
- ◆ Based On International Standards
- ◆ Rapid, Accurate And Reliable Results
- ◆ Low Cost, Compact & Portable
- ◆ No need of a Trained resources
- ◆ Available in single and Multiparameter pack



Our range encompasses all known water parameters.

Acidity Alkalinity Amine Ammonium Arsenic Bromine
 Calcium Hardness Carbon Dioxide Chloride Chlorine Chlorine Dioxide
 Chloroscope Chromate Copper Dissolved Oxygen Fluoride
 Hydrazine Hydrogen Peroxide Iron Molybdate Nitrate Nitrite
 Orthophosphate pH Phosphonate Silica Sulphate Sulphite
 Tannin Total Hardness Turbidity Zinc

Our Other Product Range

AQUASOL
 Analyze Waters
 Any time... Anywhere...
 Easy to use water testing systems



www.rakiro.net

BACTASLYDE
 Detect Bacteria Easily
 Anytime... Anywhere...
 Microbe detection device



ChekNsee
 Power to see the Invisible Danger
 Drinking water test kit



WATREAT
 Complete Water Solution
 Increase the Performance of
 Your RO System



RAKIRO BIOTECH SYSTEMS PVT LTD
 An ISO 9001 : 2015 Company





MICBAC India

MICBAC India is one of the largest manufacturers and global supplier of high-quality Activated carbon used in a growing range of Waste water treatment industry, Water filtration, Oil refineries, Air purification, Gold recovery, food and pharmaceutical industry. Further more, As MICBAC India expanded and evolved, we have extended our production line to Activated Carbon briquettes, Anthracite Filter Media, Manganese DiOxide Filter media, Filter Media Sand as well as Hard Coke.

We have an annual production capacity of 20,000 Metric tonnes including Wood based Activated Carbon, Coal based Activated Carbon and Coconut Shell based Activated Carbon. We are always ready with humongous stock and ready to take bulk orders 24x7. Having significant production capabilities and supply capability, We can transport 1000 M.T to any country at any point of time and ensure regular and uninterrupted availability of consistent quality products for our customers. Our strict quality assurance procedures ensure that the delivered product meets and exceeds the specified requirements with excellent customer service, each and every time.

We have the vision to be the most respected, dynamic and sustainable in global Activated Carbon business, our leadership strives every day to ensure that we are an effective partner to our customers, developing and delivering product consistently and responsibly for your needs.

With a passion for innovation, MICBAC India has also concentrated on research and development to ensure the company retains its flexibility to accommodate custom solutions and evolving industry demands.

Address: C/314 Loharuka Green Oasis, Kaikhali, Kolkata - 700052
 Mobile: +91 99377 77702, 82688 88827
 Email: micbac.india@gmail.com, Web: www.micbacindia.com
 Contact Person: Mr. Niranjana Gupta - CEO

Microtek Technologies

Warm Greetings from Microtek Technologies!!!

We take pleasure to inform you that We are Exclusive Distributor for ,Hach Company India, USA(A Div. of DHR Holding India Pvt Ltd.) USA who are Pacesetters in Manufacturing of Analytical and Lab/Online water analysis like:

Full range of wet chemistry analysis:- Benchtop/ Portable pH, DO, ISE, Conductivity Meter, Turbidity Lab BOD, COD Colorimeters, Spectrophotometer etc. Includes online analyzers for the measurement of pH, DO, Conductivity, Turbidity, BOD, COD Analyzer etc.

Titration Systems, Reagents, Standards, Microbiology, Test Kits & Test Strips

TOC Analyzers: for Ultra-Pure Water & Waste Water Applications.

Services for all lab instruments: We, at Microtek Technologies, are very focused on the kind of market segments we target and hence we are growing at a fast pace. This company is owned and run by complete technocrats who have 10 years of experience in this field. We have a wide range of instruments which cater to Research Institutes, Pharmaceuticals, Chemical Industries, Biotechnology, Life Sciences, Universities, Power Plants, Food Industries etc.

While providing the best of equipments to our customers, we cater to service required by our customers in regards to installations, breakdowns if any and hence we have put a Service team in place to cater to these needs.

Address: 22, 2nd St., Aravind Nagar, Madambakkam, Chennai-600 126
 Mobile: +91 98404 14789
 Email: rajan@mkteck.com, Web: www.mkteck.com
 Contact Person: Mr. S. Rajan-Proprietor



Mineral Water
INDUSTRY BUSINESS

How to start?
Where to start?

Cost of Investment & Profit Returns

Standards for Building & Infrastructure

Machinery Required

Rules & Regulations

License / Certification

Bank Loans / Subsidy / Schemes

We assist you
What we do...

Source/Site selection | Building Design and Planning | Execution | Site construction monitoring | Periodical site visit & advises

Guidelines & support

Project Report | Bank Loan | Govt. subsidy | Pollution control board | Ground water authority | FSSAI license & other related activities

Lab installation | Training for Quality control person (on site) | Instrument calibration and certification | Product standardization | Self life studies | sample testing co-ordination

Documentation | Paper compilation | ISI application preparation
 Document preparation - submission
 Filing and Follow-ups | Pre inspection - Audit | Inspection co-ordination | File & record maintenance | Periodical factory visits & Audits

EVERGREEN TECHNOLOGIES
 Committed to quality

★ PACKAGED DRINKING WATER AS PER SLS STANDARD

Reg: No.5/1, Pillayar Kovil Street, Essa Pallavaram, Chennai - 600 043, Tamilnadu, India.
 Corporate Address: No.1, Pallavaram - Thoragakkam Radial Road, Chennai - 600043

Mobile: 98411 62411, Tel: 91-44-22642788, Fax: 91-44-22642799, Web: www.evergreentechnologies.in, Email: info@evergreentechnologies.in





NetGlo Corporation

NetGlo is a U.S. based IT company specializing in process management systems. Our IT platforms have been supplied to multinational companies such as Kellogg's, Grupo Bimbo, Texas Instruments and Verizon. We distinguish ourselves by providing aggressive financial paybacks to our customers – in some instances providing a payback in less than six months. NetGlo is visiting India to identify opportunities to work with water distribution agencies to deploy water monitoring, management and waste reduction IT systems.

NetGlo is headquartered in Highland, Maryland.

Address: U.S. Commercial Service, Chennai
 Phone: 044-28574477
 Email: Office.Chennai@trade.gov, Web: www.buyusa.gov/india



Nishu Enterprise

Nishu Enterprise was established way back in the early 90s as manufacturer of Water Treatment Plants. The Company was founded on the philosophy to lead product development through technology and innovation. Little wonder, the Company saw expansion as it entered areas of turnkey execution & total system approach by applying its extensive know-how, innovative product development & commitment to superior services.

Involvement & Innovation: At Nishu, we don't have off-the-shelf solutions. We listen to the client's requirements, analyze their water source, improvise a treatment technique, engineer the plant and produce an advance purification system to meet the exact required specifications. Our forte lies in the ability to draw on all available techniques and assure you the most objective recommendation and provide you a one-stop solution.

Our Mission: To convert the available source of water to the specific quality of water required by: Industries: For process/Pharma/Utilities Individual & Community: For personal hygiene (cleaning, washing) and health (drinking, cooking). Environment & Life: To treat industrial effluent and give back the environmentally chemical-free water. This is achieved by superior engineering and innovation coupled with stringent quality control practices to provide the best purification system you can rely

Customized Solutions: Unlike other water treatment manufacturers, we at Nishu don't have quick-fix solutions. We believe each water problem is unique and that is why each water solution has to be unique. A thorough understanding of your water problem, a systematic approach to the solution and a meticulously thought-through the design of treatment plant is the method Nishu follows to ensure you get the quantity and quality of water you require. Tell us your water problems. Tell us your water requirements. We'll bridge the gap effectively.

Address: Gala No.5/1, Bldg. No.6, Parshwanath Industrial, Opp. Golden Chariot Hotel,
 Western Express Hwy, Bhut Pada, Vasai East, Vasai, Maharashtra 401208
 Mobile: +91 98201 42424, 98206 32212, 96735 92033, 877 952 0712 / 976 941 8842
 Email: nishuab@gmail.com, Web: www.nishuwater.com, www.nishuenterprise.com

 Since 2002

Harshal Aqua Inc.

D-126, Vivekanand Indi. Estate, Opp. Vijay Petrol Pump, Nr. Rakhial Cross Road, Rakial, Ahmedabad-23, Gujarat, India,
 Ph: +91 94273 02874, +91 97254 42237, Email: harshal_aqua@yahoo.co.in, Web: www.harshalaqua.com



Nivedhan Water Solutions Pvt Ltd

Established in Nivedhan Water Solutions 2003 is one of the fastest developing brand of Nivedhan Water Solutions Pvt. Ltd. in Chennai involved the marketing and servicing of Reverse Osmosis technology based water purification systems, SOFTENERS, and IRON REMOVAL PLANTS. Within the short span of 11 years, its possible for us to set up 7 branches in South Chennai and 3 Branches in North Chennai and obtain a strong customer base of nearly 30,000 households, Hospitals, Schools, Collages, Hostels and Restaurants.

Our Aqua Cure Systems brand products are available in 4 Models, shapes, colors and are fitted with high quality imported raw materials. In early 2009 we have been accredited with ISO 9001:2015 by BSCIS Certification Pvt. Ltd. for our commitment to achieve complete customer satisfaction by means of supplying quality products to all our customers, timely response to customer needs and providing prompt service guarantee.

Recently we have launched 5 more products in our another brand of Odrops to fulfill the people's dream of getting pure water to protect their family from water borne diseases

MISSION STATEMENT: We Strive to provide "Superior Quality Water Purifiers" to our Customers for residential applications. We focus on continuous and strict "Quality Standards to ensure High Quality, Reliable, Effective, RO Water Purifiers" that is easy to use, install and maintain.

Address: No 29 E, 1st Floor, Medavakkam Main Road,
(OPP to Keelkattalai Bus stand) Keelkattalai, 600117,
Mobile: +91 99412 25588,
Email: nivedhanwatersolutions_acs@yahoo.com
Web: www.nivedhanwatersolutions.com
Contact Person: Mr. T S Prabhakaran-Director



Noble Trade Centre

Noble trade centre, a company estd in the year 2002 dedicatedly works under the visionary guidance of our mentor Mr. Saifee F. Gheewala. His extensive experience and endeavor to understand the industrial needs of the clients has helped the organization to carve a niche for itself in the domain, Our complete efforts towards the clients satisfaction enables us in being ahead of our competitors.

Product Details:

Located at Chennai, NOBLE TRADE CENTRE is one of the most trusted names for dealing distributing and supplying a wide variety of industrial equipments that are known for their high standards, functionality and durability. The range includes Industrial Valves, Victaulic Couplings and DI Fittings.

Address: 52, Sembudoss Street, Chennai - 600 001.
Phone: 44-25223786 Mobile: 9381052346/9025070010
Email: ntsaif@hotmail.com, Web: www.nobletradecentre.com
Contact Person: Mr. Murtaza S Gheewala

॥ : ऐश्वर्यम् : ॥

RO DOR Housing
Opaque / Transparent

Reusable Openable
Inline Cartridge

Jumbo
GAC 10" - 20"

Jumbo
Hosing 10" - 20"

Jumbo
Softener

Bag Filter
Assembly

Aishwarya Marketing Co.
FIRST IN THE LONG RUN

Corporate House :
'AISHWARYAM', 7, River View Banglow,
Nr. Parsi Sanatorium, Ashram Road, Ahmedabad 380009.
Phone : 079-26589950/60 Mobile : +91 9429622299/ 88
e-mail : filterhousing@yahoo.co.in ♦ www.waterfilter.co.in



Nollet

Nollet is a registered company of prominent Water Treatment equipment provider concern. Our concern has being in the market since 2013,at Chennai. We have established in 2018 as a big Trader in this particular sector. The products offered for both Domestic and Industrial applications. We are mainly focusing on the future requirement of customized water ATM machine and water dispensers in wide ranges. And also we have import and trade the carbon products like inline and etc. for water treatment applications. Our concern engineers are specialist in Automation of RO System and Filtration Plants. We also are doing the customized projects in industries according to their comfortable usage and their requirement. We back boned by skilled team of engineers in this Water Treatment field industries. And we have the network through over the Tamil nadu with our trained professionals.

The goal of our company is to have customer service that is not just the best but legendary. There is a spiritual aspect to our lives - when we give, we receive - when a business do something good for somebody, that somebody feels good about them!

We see our customers as invited guests to the party, and we are the hosts. It's our job every day to make every important aspect of the customer experience a little bit better.

Address: No 5/2-1, Bharathi Salai, Mogappair West, Chennai-600037. Tamilnadu, India.
 Phone: +91 9677050885, 9865228631
 Email: info@nolletro.com, Web: www.nollet.in
 Contact Person: Mr. N.sivalingam -Partner | A. Tamilarasan- Partner

NOLTA

Nolta India Pvt Ltd

Nolta India Pvt. Ltd. offers its customers simple solutions to complex problems concerning machine and pump connections. The company develop specific products for protection and management, maintenance-free operation and remote monitoring of machines and pumps. Complex machines and pump solutions require specialized knowledge and, as your partner, we make information about our products available to both manufacturers and end users. Under the name of our water technology brand, NIVA, we offer high-quality float switches and level controls for various applications.

Address: 400 , Best Sky Tower, Netaji Subhash Place, Pitam pura, New Delhi - 110034
 Phone: +91-11-47074110, Mobile: +91 99102 39059
 Email: rohit@nolta.co.in, Web: www.nolta.co.in
 Contact Person: Mr. Rohit Kumar

AQUASSTAR

water treatments



swimming pools

IMPORTERS & WHOLE SALERS OF WATER TREATMENT PRODUCTS SINCE 1984

OUR RANGE OF PRODUCTS



JTP SUBMERSIBLE PUMP



HQB SUBMERSIBLE PUMP



HJ SUBMERSIBLE PUMP



MINI DEWATER PUMP



DEWATER PUMP



AUTO TIMER



TESTING KIT



WATER PUMP



PG SERIES BLOWER



TAKATSUKI AIR PUMP



HJB AIR PUMP



ACO AIR PUMP



OXY MEDICAL AIR PUMP



TAIWAN AIRMAC AIR PUMP

AIR PUMPS,BLOWERS 2w TO 20Hp
AIR DIFFUSERS,AERO TUBES,
JAPAN TAKATSUKI HIBLOW AIR PUMPS
TAIWAN AIRMAC AIR PUMPS,
SUBMERSIBLE WATER PUMPS 2w to 5Hp,
CIRCULATION PUMPS WITH PRE FILTERS
OXY MAGNETIZERS,POND FILTERS
UV STERILIZERS,OZONISERS,
WATER CHILLERS & HEATERS
WATER TESTERS & WATER TEST KITS
OXY SAND FILTERS 400to1500mm Dia,
CATRIDGE FILTERS,POND FILTERS
OXY SWIMMING POOL FILTERS,
POOL&POND CLEANING ACCESSORIES,
UNDERWATER LIGHTS & FOUNTAINS
FOUNTAIN PUMPS & NOZZLES
FILTER MATERIALS, CARBON, ZEOLITES
AQUARIUM & AQUACULTURE PRODUCTS

FOR MORE DETAILS,PLEASE VISIT

www.airpump.in www.pondfilter.in www.oxypools.com

Aquasstar No5, West mada Street,kolathur,Chennai-600099

E-mail : aquasstar@yahoo.com,ph : 9840026078,044 25567887



Oasis Water Systems

We would like to introduce "Oasis Water Systems" as one of the leading concern in representing the excellence in manufacturing water filtration and purification products, a renowned establishment in Chennai since 2001, we own two branches and one manufacturing unit. Our company specializes in selling reverse osmosis RO and Iron removal plant as well as providing the repair services to filters of any brands. There is a professional team of engineers and RO professionals working within our company. At oasis water systems, our passion for ensuring the highest standard of quality, environmental safety and energy conservation has resulted in developing a high product range for water purification. We manufacture large water filters suitable for domestic use, hotels, resorts, villas, apartments, factories, ice plants, educational institutions, hospitals etc., our manufacturing facilities are equipped with most modern quality control and testing facilities and we lay emphasis in providing total customer satisfaction through ethical business practices.

Address: Oasis Water Systems, No 1 Venugopal St, Mogappair East, Chennai- 37
 Phone: 044-43572111, Mobile: +91 98849 32111, 880710 1111
 Email: oasisstechchennai@gmail.com
 Contact Person: Mr.J,Jose Stalin - Proprietor



Ozone Engineers

We Believe In Supply Quality Products In The Best Prices

OZONE ENGINEERS is One of the leading manufacturers and Exporters of Ozone Generators, Oxygen Concentrators, Ozone accessories and allied product based in Coimbatore Tamil Nadu. We manufacture Ozone Generators from 500 mg to 1 KG machine for various water and Air applications. Since last 7 years we are catering to more than 300 OEM'S, Corporates clients and Government sectors all over India and overseas. By focusing on the continuous improvement of Engineering research, customer satisfaction, top quality products, clean manufacturing practices and best after sales services we are having good number of regular clients with us.

We manufacture the lowest cost, highest quality ozone products by utilizing diverse application expertise to serve multiple markets while maintaining the optimum balance of innovation, quality, cost, safety and ozone efficiency.

OXYGEN Concentrator: In 2018 we launched our Industrial Oxygen Concentrator OxyNxtGen™ in two models of 5 LPM & 10 LPM (ONG-Series) and supplying to many customers with good satisfactory results.

Ozone Generator Ranges :

IAE Series - 2 gm/hr to 10 gm/hr | Built-in Oil free Air Compressor.
 IA Series - 2 gm/hr to 5 gm/hr | With Display | Built-in Oil free Air Compressor.
 EO Series - 5 gm/hr to 30 gm/hr | Air Cooled System | External Oxygen Source.
 WO Series - 10 gm/hr to 1 kg/hr | Water Cooled System | External Oxygen Source.
 IO Series - 10 gm/hr to 150gm/hr | Water Cooled System | Inbuilt Oxygen Source.
 SD Series - Skid System Integrated | Ozonator | Oxygen | Ozone Injection | System with Ozone Contact Tank

Address: S.F No. 504, Sivalapuri Amman Nagar, Nallampalayam Road, Sanganoor, Coimbatore – 641027, Tamilnadu, INDIA.
 Phone : +91 850 850 55 66, Email : sales@ozoneengineers.com, marketing@ozoneengineers.com, Web: www.ozoneengineers.com
 Contact Person: Mr. Mr. P.V.S Krishnan - 96599 66033, Mr. V. Kumar - 95855 18239

H₂O BAZAAR

(A Division of Water Today Pvt Ltd)

**Building Network
for Business!**

**World's leading B2B portal catering
to the requirements
of Water and Wastewater industry!**



**For everything you want to
buy and sell in the
water business log on to
www.h2obazaar.com**

**Your search
ends here!**



Permionics Membranes Pvt. Ltd.

We provides end-to-end solutions in water treatment, wastewater treatment, and effluent recycle. The domain expertise & experience gathered over past four decade gives us edge over competition so as to provide tailor made optimized solutions to various industries, commercial, rural, hospitality, defense establishments and the urban sector in order to help them reduce, reuse or recycle Water, Waste water & Effluent.

Permionics has been the pioneer of Membrane technology in India. Permionics has the unique distinction of being the FIRST & ONLY company in India till date to indigenously manufacture Reverse Osmosis (RO), Ultra-Filtration(Ultrafiltration), Nano-Filtration Membranes for various process-specific applications and Waste Water Recycling, Zero Liquid Discharge, Purified Water, Desalination of Sea Water and USP purified water system.

Address: 3/29, 4/19, B.I.D.C., Gorwa Estate, Vadodara -390 016, Gujarat, India.

Mobile: +91 89054 04459

Email: dipesh@permionics.com, Web: www.permionics.com

Contact Person: Mr. Dipesh Benkar



Pet Plast India Inc

We, "PET PLAST INDIA INC." an ISO 9001:2008 company, are one of the eminent business entities engaged in manufacturing, supplying and exporting a wide range of PET/PP/PC Blowing Machines (Fully auto and Semi auto) and its required Ancillaries. We also take projects on turnkey bases for PET Bottles making Plant. Available in customized form, our machines are used by several manufacturing companies in making of packaged drinking water, household chemicals, pharmaceuticals, edible oils, liquor, hare care, pesticide etc.

Strategically located in the machinery manufacturing hub of Faridabad, Haryana, we are catering to the ever-changing needs of the industry by innovating on a continuous basis. Backed by expert manpower, we are also offering PET Bottle Designing Services on a turnkey basis and offer detailed guidance to the clients for choosing the right product as well.

Address: Plot No. 10 , Astal Road, Near Maruti Nandan Dharam Kanta,

Bhakri Pali Road, Faridabad, Haryana , 121004

Phone: 0129 6590 003, Mobile: +91 93111 01292, 85058 18882

Email: mail@petplastindia.com, bdm@petplastindia.com

Web: www.petplastindia.com

Contact Person: Mr. Dhiraj Taneja - Managing Director



ENVIRO ENGINEERING

TECHNOLOGY GROUP

AN ISO 9001 -2010CERTIFIED COMPANY

Enviro is now offering Design, Engineering, Manufacturing and Exporter of all Kind of WTP/ STP/ETP Systems and Equipment
Enviro Valves and Beliefs are Aligned with Responsibility Towards Business

PARTIAL LIST OF OUR PRODUCT:

- ✦ MECHANICAL BAR SCREENS (CORSE / FINE/STEP)
- ✦ AGITATOR / FLASH MIXER
- ✦ FLOCCULATORS
- ✦ OIL REMOVAL SYSTEM
- ✦ DAF SYSTEM
- ✦ AERATOR (FLOATING / FIXED)
- ✦ CLARIFIERS (FULL BRIDGE / HALF BRIDGE)
- ✦ CLARIFLOCCUALTOR (FIXED / MOVING BRIDGE)
- ✦ THICKNERS
- ✦ FILTERS
- ✦ UF SKID
- ✦ RO SKID
- ✦ FILTERPRESS (PLATE / BELT)
- ✦ DRIVE HEADS



225, Pazhandhandalam Main Road, Poonthandalam, (Near Thirumudivakkam SIDCO), Chennai – 600069, Tamilnadu, India.

Phone: 044-6555 2884 / 65552994 | Mobile: 95000 00581 | 9962200700

Email: seles@enviroengineering.net, enviroengg@rediffmail.com | Web: www.enviroengineering.net, www.enviroengineering.co.in



Pipeco Tanks

We introduce ourselves as PIPECO Tank, a Company specializes in design, development and production of GRP Water Tanks. Located in Chennai, South India, Gimhae, South Korea our large-scale Plant and Research Center are dedicated to ongoing development and production to lead the industry. Our advanced technology has received ISO, WRAS (UK), BSEN (UK), PSB (SINGAPORE) Certificates and is garnering world acclaim.

In addition, with a corporate ideology rooted in placing our customers first, we base our Management and Product Development upon this foundation of trust, contribution to technological innovation, quality improvement and added enhancement. In order to carry out such customer-oriented management, we constantly keep in mind the priorities of stringent quality management and environmental protection. In following, We adopted ISO product quality and environmental management standards from the very beginning and our efforts to grow as an environmental friendly company along with our customer are never ending.

Excellent in clean & Hygienic and Non-leakage. GRP Sectional Water Storage Tank Please find our Credentials enclosed for your kind consideration and will be pleased to make a Presentation on our Products at your Office on a mutual convenient date and time so that we may obtain Brand Approval for our Products. We look forward to catering to your needs and we assure you of our best attention and services always,

Address: Pipeco Tanks Metro Towers – Rear block, No.115, Poonamalee High Road Chennai – 600084, Tamilnadu, India.
 Phone: 044-66444444, Mobile: +91 98846 88855
 Email: shafi@pipecotanks.com, Web: www.pipecotanks.com
 Contact Person: Mr. K M Shafi Mohammed

Factory Address: PIPECO TANKS
 No.3/95A, Gangai Koil Street,
 Redhills, Chennai – 52.

PPI Pumps Pvt. Ltd / PPI Systems

PPI Pumps Pvt. Ltd. is one of the leading vacuum pump manufacturers, exporters and suppliers in India providing vacuum pumps of different sizes and capacities like Liquid Ring Vacuum Pump for paper and sugar mills, Single Cone Vacuum Pump for process Industries & Power Plants, Close Couple Vacuum Pump for Plastic Industries and Breweries bottlinear Plant, Two Stage Vacuum Pumps for Chemicals and Pharmaceutical Process Industries, Twin Lobe Roots Blower and Chemical Process Pump for Cement, Fertilizer & Effluent Treatment Plants along with all types of pump spares parts from ISO 9001: 2008 certified company having modern infrastructure for vacuum pumps manufacturing process. Quality pumps of different types and size following the international standards are our core expertise to meet the client's expectations and satisfaction. Inquiries are appreciable if you are looking for any kind of vacuum pump, Nash vacuum pump or Nash pump, water ring vacuum pump.

Address: Green Space- A, Phase-1, G.I.D.C. Estate Vatwa, Ahmedabad - 382445
 Mobile: +91 93777 50175
 Email: ashwin@ppipumps.com, Web: www.ppipumps.com
 Contact Person: Mr. Ashwin Shah

Pack Tech Systems & Equipments



Since 1999



Premix Carbonator with Chilling Plant for soft drink beverage



Pasteurizer for beverage and milk.



RO Plant for water treatment



Water / Juice PET bottling Machine - Rinser, Filler and Capper



Gravity filler for distillery



20 ltr bubble top jar / Unibloc rinsing, filling and capping system



Hygienic SS monobloc pump

- We are manufacturers and suppliers of Automatic bottling machinery for Glass and PET bottles. Our product includes
- Glass Bottle Washer
 - Carbonators
 - Pasteuriser
 - Glass bottle Filler/crowner for juice, milk, carbonated soft drinks
 - Uniblock Rinser/Filler/Capper for PET bottles
 - SS/EP Slat chain, belt, Roller conveyors for packing industries.
 - PET bottle Cooling, Warmer tunnel
 - Sleeve shrink tunnel.

THESE MACHINERY ARE WIDELY APPRECIATED FOR THEIR STURDY CONSTRUCTION, RELIABILITY AND OPTIMUM PERFORMANCE.

Pack Tech Systems & Equipments

Manufactures of : Bottling Machineries & Packing Machineries

No : 292, 293, SIDCO Women Industrial Park,
 Kattur Village, Thirumullaivoyal, Chennai - 600062.

Ph : 044 26366292 / 93. Mobile : 9444087991.

Email : packtech99@yahoo.co.in / Web : www.packtech99.com



Pure N Safe Water Technologies Pvt. Ltd.



Pure N Safe Water Technology Pvt. Ltd. is ISO 9001:2015 & ISO 14001:2015, NSF certified and has been at the forefront of innovation since 2011. We have been awarded various organization for best innovation products in different product categories during last few years.

Mission: "To provide total water treatment solutions by combining the best practices, technologies and infrastructure available globally and then in-house researched & developed optimally which are cost effective, reliable and "Pure and Safe".

Products: Our products are built as per international standards. This gives us advantage to have presence in other countries apart from Indian Market. Our group company is in Singapore and associates in Europe facilitate new technology and product development for global market including India. Pure N Safe water technologies Pvt. Ltd provides entire spectrum of water & Wastewater treatment products.

Specialty Filtration Media:	• Iron Removal	• Fluoride Removal	• Arsenic Removal
	• Nitrate Removal	• Heavy Metal	• Radio Nuclei Removal
POE (Point Of Entry Products):	• Sand Filters (Filtration up to 3 Microns)	• UF Systems.	• Water Conditioners
	• Specialty Filtrations units	• Softeners	
	• Reverse Osmosis (RO) Purifiers.	• Components – Membranes, FRP Vessels, Multiple Valves, Pumps.	
POU (Point Of Use):	• Residential RO units	• UF + UV Purifiers.	• Non – Electric Purifiers. Softeners.
	• Water Conditioners.	• Gravity Filters including removal of Arsenic and Fluoride.	
	• Components – Membranes, Pumps, SMPS, UV, Inline Filters, SV.		

Address: J-7 Udyog Nagar Industrial Area, Rohtak Road, Nangloi. New Delhi-110041
 Phone: +91-01141106124/125, +91-8744052931, +91-8744052933 Email: info@purensafe.com, Web: www.purensafe.com
 Contact Person: Mr. Umesh Agarwal- Managing Director



Raisunsoft Solutions Pvt Ltd

Raisunsoft Solutions Pvt Ltd a CAD/CAM/CAE Solutions provider. Our vision is to help customers to Implement Solutions and Technologies that Reduce Time, Improve Quality and Increase Profitability. The solutions we offer futuristic technologies of Rule-based Design, Discrete Event Simulation, Mixed Reality, IOT, Virtual Reality, Augmented Reality, Artificial intelligence our hardware solution from most advanced 2D CAD Mouse and 3D Space Mouse with world fastest CAD Workstation with 5.1 and we also help our customers to Build World class Customer Experience Centres. We provide Engineering Process Automation Services, by developing Software modules. Our solution for water treatment plants is from Technical Data sheet to final Construction drawings and Bill of Quantities. Our User-friendly solution is developed with high degree of accuracy in commonly used user-friendly platforms such as CAD/Office Excel/Data base etc. Our solution generates pre-audited engineering documents, consistent engineering deliverables with high quality accurate BOQs of Civil, Mechanical, Piping and associated electrical and instrument BOQs. This gives us a minimum of 60% savings in Engineering manhour efforts.

Viswa Esurvey Jal Suite manoeuvre seamlessly through the field data, drafting, designing and producing quality final output drawings with high precision, minimizing the time to a greater extent. Our solutions are specially designed to accomplish water distribution and pipe line works. Hydraulic design is made simple without compromising on the accuracy and quality. Generation of optimized Longitudinal section is a gem by its own, while considering all the given constrains for design and actual site requirements. production of final drawings is customised in a unique way to achieve the submittals with minimal time and resources with a single click in our solution. Viswa Esurvey Jal suite ensures above 70% productivity gain in each of the project.

Address: No.2/136, Ground Floor, 8th Street Jayalakshmi Nagar, Kattupakkam Chennai 600 056, India.
 Mobile: +91 86808 07771
 Email: sales@raisunsoft.com, Web: www.raisunsoft.com
 Contact Person: Mr. Subramani.V

Manufacturers and Exporters of Water treatment Chemicals & Polymers

Polymer

- Polymaleic Acid
- Acrylic Maleic Co-polymer
- Acrylic AMPS copolymer
- Acrylic Ter polymer
- Poly DADMAC
- Acrylic Acid Homopolymer
- Acrylic acid SHP Co-polymer
- Acrylic acid AMPS, SHP or HPA Terpolymer

Formulation Chemicals for Cooling System

- Antiscalant
- Biodispersent
- Chiling plant anticorrosive
- Corrosion inhibitor
- Antiscalant cum Corrosion inhibitor
- Antiscalant cum Antifouling agent

Formulation Chemical For Bolier

- Alikinty builder
- Oxygen scavenger
- Steam side chemical
- Antiscalant cum scale inhibitor
- Fule. Additive
- All in one chemical
- Scale softner
- Antiscalant
- Fireside chemical
- Descalent

Biocide

- Quaternary Ammonium Compound Based Chemical
- Sodium Dimethyl Di Thio Carmabamet Compound Based
- Dichlorophin based
- Isothiozoline based
- DBNPA

Private Labeling Facility

"Envichem is also engaged in contract manufacturing of chemicals on Private Label basis."

"Envichem welcomes various water treatment manufacturing companies for making the chemicals on their brands and formulations."

Formulation chemical for RO

- Antiscalant
- Membrane descalent acidic base
- Antiscalant for high silica
- Membrane desclent alkaine based

Sugar Process Chemical

Polymer similar to Accumer Series Available

Envichem

Proven Science, Trusted Chemistry

Envichem Speciality Chemicals & Polymers Pvt Ltd

Factory : Gat No.107A, At post- Pirangut, Taluka – Mulshi, Pune – 412115. (Mah) India.

Mkt. Office : 304, 4th Floor, Datar Complex, Karvenagar, Near Pegasus Health Club, Pune, Maharashtra 411052

☎ 99226 39100, 98500 66616 ✉ Email : envichem.in@gmail.com 🌐 www.envichem.in

Pride Controls & Systems Pvt Ltd

No.240, Tiny Sector, Ambattur Industrial Estate, Chennai - 600 058, Tamil Nadu, India.

☎ +91 44 - 485 79196
 ✉ sales@pridecontrols.com



PRIDE RANGE OF INDUSTRIAL FLOWMETERS

www.pridecontrols.com



Rammy Trade Solutions Pvt Ltd

RAMMY Trade Solutions Pvt Ltd is a Registered Dealer, Manufacturer and Importers of quality RO Components for Water and Waste Water Treatment Plants with Registered Office at Mumbai and branches in Chennai & Bangalore.

We have a resident representative located in China to carry out Inspection and Import Operation.

Product at a Glance:

- Otayo Domestic RO Membrane
- Celny Low TDS RO Membrane
- Yaxsi Self Priming Pumps
- Yaxsi Smart SMPS
- RO Antiscalants
- Otayo Industrial Membrane
- Celny Plus Nano Membranes
- Yaxsi Booster Pumps
- Otayo Spun Filters

We are a fast growing Company with Sound Value system. We have a team of experienced Technical Professionals who have long experience and knowledge in Factory Operations, Audit Sourcing, Inspections, Projects Commissioning across various Industries in India and overseas besides work experience in China

This company is known for its high ethical standards and has a Vision to provide High Quality products to Customers. We are committed to continuous improvement and our Quality Management System provides a framework for measuring and improving our products and performance on a continuous basis..

Address: No No 1, Plot No 213 / Door No 24, 2nd Main Road, Venkataraman Nagar, Hastinapuram, Chennai-600044
 Phone: 044 48573710, Mobile : +91 9840311650, 9884613936
 Email: info@rammyindia.com, Web: www.rammytradesolutions.com
 Contact Person : Mr.M.S.Madhavan / N.Ramaswamy



Rostfrei Steels Pvt. Ltd.

ROSTFREI STEELS PVT. LTD. an ISO 9001:2015 and having FM4020 Approved products with its excellent service, product quality and proven track record, has established itself as the premier OEM manufacturer and turnkey service-provider of LIQUID STORAGE TANKS & SOLID STORAGE SILOS. Our products range from highly customised ZINCALUME and GLASS-FUSED-TO-STEEL Tanks and Silos best fit for storage of seeds, grains, pure water, waste-water, oil, chemicals, molasses, Biogas digesters etc. ROSTFREI has executed more than 8000 installations in approximately 25 countries worldwide.

ROSTFREI has earned a reputation of providing expert multifarious services to our venerated clientele that includes designing, manufacturing, supply, installation, erection and completion of various types of liquid tanks used for numerous types of applications. Rostfrei Steels offers the comprehensive services for tanks & silos in the sector of water infrastructure, solid waste management, agricultural infrastructure. We complement these services with wide ranging assistance in optimization of operation of new or rehabilitated water plants, private and government water schemes. We offer solutions from concept to commissioning and go the extra mile by holding the hand of the customer till Operations & Maintenance of the tanks.

Our Products:

- Liquid Storage Tanks
- Hopper Bottom Silo
- Biogas Digester Tanks
- Zincalume Tanks
- Flat Bottom Silo
- Glass Fused Steel Tanks
- Material Handling Equipments
- Grain Storage Silos
- Fittings & Accessories

Positioning of Tanks:

- Overhead Tank
- On the ground Tank
- Elevated Tank
- In the Basement
- Semi-Underground Tank

Address : Plot no: 211, 2nd floor, Okhla Industrial Area, Phase 3, Delhi- 110020
 Phone: 011-4661 1000, Mobile: 98842 39165, Email: kkalra@rostfreisteels.com, mkt.south@rostfreisteels.com, www.rostfreisteels.com
 Contact Person: Mr. Kapil Kalra (Director), Mr. A. Venkatesan - Regional Manager South Chennai



Water & Wastewater Treatment Technology

- ▲ Water & Wastewater Treatment Plants & Chemicals.
- ▲ Wastewater Recycling Plants
- ▲ Packages STP / WTP / ETP
- ▲ Dosing Systems
- ▲ Biological Treatment



Vapi Office: F-6, Plot No. 32/B, Near Amidhara Complex, N.H. 8, 1st Phase, G.I.D.C., Vapi - 396 195.
 Mobile: 99137 57482, 99793 00789, Email: aaradhyaviretech@gmail.com Web: www.aaradhyaviretech.com

M/s SRI KAMATCHIAMMAN TRADERS



Group of SRI KAMATCHIAMMAN CHEMICAL INDIA PVT LTD SRI KAMATCHIAMMAN LABORATORY

PROJECTS



RAW WATER TREATMENT CHEMICALS



RO MEMBRANE TREATMENT CHEMICALS



SEWAGE TREATMENT PLANT CHEMICALS



EFFLUENT TREATMENT PLANT CHEMICALS



RO ANTISCALENT

OUR SERVICES

- LIME POWDER
- POLY ELECTROLYTE
- ETHYLENE DI AMMONIUM TETRA ACETIC ACID(EDTA)
- SODIUM TRI POLY PHOSPHATE (STPP)
- SODIUM LAURYL SULPHATE (SLS)
- ALUMINIUM SULPHATE
- RO ANTI SCALENT (KOCH)
- EVOPORATE ANTI SCALENT
- SILICON DE-FOAMER
- CARTRIDGE FILTER (SPUN TYPE)
- BAG FILTER
- FERROUS SULPHATE
- SODIUM META BI SULPHATE
- CITRIC ACID
- TRI SODIUM PHOSPHATE(TSP)
- COLOR REMOVING CHEMICALS(MG CHEM)
- RO ANTI SCALENT (MG CAM)
- BIO-SIDE
- BLUE BLACK HOUSING
- CARTRIDGE FILTER (WOUND TYPE)
- WATER TREATMENT LABORATORY

ENVIROMENTAL WATER TREATMENT

- LABORATORY DIVISION
- CHEMICAL DIVISION
- EQUIPMENT & MACHINERY
- WATER TREATMENT
- O & M SERVICE
- CONSULTANT SERVICES

SRI KAMATCHIAMMAN TRADERS

No.105, New Pallipalayam Road, Near Gowri Theater, B.Komarapalayam - 638183, Namakkal (Dt)
 Mob: +91 99423 90075, 98427 26033 | Email: kat.chemical2012@gmail.com | www.srikamatchiammantraders.com



RV Associates

RV Associates is a super store for Water & Waste Water Treatment Plant accessories. We have been offering quality accessories and service since 1995 from our offices in Chennai, Secunderabad & Calicut. We can be contacted through e-mail : contactrvassociates@gmail.com / rvassociateshyd@gmail.com / rvassociatescalicut@gmail.com

Our product range includes e-Dose Metering Pumps, Manual & Auto Multiport valves, Aster range of Rotameters, Conductivity, pH ORP, DO, Chlorine meters, Aster RO, UF, STP, ETP Control panels, commercial range of Membranes from Otao and Dazzle range of underwater lights for swimming pools.

We also offer custom-built panels for motors of more than 10 HP rating. Watch out for the launch of our Nutra range of Dosing Pumps for auto pH correction, flow based dosing and motorised dosing pumps for large dosing flows.

Address : B4, Pandian Avenue, New Market Street,
Choolaimedu, Chennai - 600094
Phone: 24845342 / 24848694, Mobile: +91 98400 38428.
Email: rvassociateschennai@gmail.com
Web: www.indiamart.com/rvassociates
Contact : Mr.Ramasubramanian - Proprietor



S.ABBAS & CO

S. ABBAS & CO. was founded in the year 1979 by Late Mr. ABBAS FIDAHUSEIN. We are in the business of Valves, Water Meters, Flow Meters, Pipes and Fittings. In the last three decades we have grown and established our company in the market through good quality of materials service and Goodwill of our esteemed customers.

We are AUTHORISED DISTRIBUTOR of **FEDREL** Flow Meters (M/s V.A VALVES, JALANDHAR, INDIA); we have been awarded ISO 9001 -2000 by TUV Germany in the year 2005. Our Association with **FEDREL** Flow Meters, Jalandhar is for more than 5 years and they are one of the finest manufacturers of all complete range of Flow & Water Meters in India, they are manufacturing Flow Meters & Water Meter since 2007.

Over the years **FEDREL** has become a Synonymous name for Flow & Water Meters. Today **FEDREL** offers a wide range of Domestic & Industrial mechanical water meter, Turbine, Oval Gear, Electromagnetic, Ultrasonic, Vortex Steam, BTU, AMR, Pressure Transmitter and Ultrasonic Level Transmitter Metering Solutions for measuring and transferring fluids, lubricants and fuels. These solutions are not only Robust and Dependable but also easy to use.

FEDREL Approvals: CE (Conformity of Europe), ISO (International Standard Organization), IP-68 (Ingress Protection), ISI (Bureau of Indian Standards), FCRI (Fluid Control Research Institute), DJB (Delhi Jal Board), MCGM (Municipal Corporation of Greater Mumbai), SITARC (Scientific and Industrial Testing & Research Center) and many more.

Address: Address: 88, (old no.46), Sembudoss Street Chennai – 600 001
Phone: 044 – 2522 2280, 2522 8525, Mobile: 988 444 2859
Email: alivalves@vsnl.net, Web: www.alivalves.com
Contact Person: Mr. Ali Asgar Abbas - Partner



BIRM A8006

IRON AND MANGANESE REMOVAL MEDIA



PHYSICAL PROPERTIES

Color	: Black
Bulk Density	: 36 -38 lbs./ ct. ft.
Mesh Size	: 12X50
Specific Gravity	: 2.0 gm/cc
Effective Size	: 0.48 mm
Uniformity Coefficient	: 2.7

Uses:
BIRM Filter Media is used to remove Iron and Manganese content from the water source.

Advantages:

- Under ideal conditions, chemical are not required for maintenance and hence, low maintenance cost.
- Efficiency of iron removal is extremely high.
- Cost of labor is negligible.
- Maintenance is very easy periodic backwash is only required for smooth functioning.
- Extremely durable with long shelf life and product life.
- Widely used in water treatment plants in all arena's including domestic, commercial and industrial.

Application:

Widely used in Water treatment plants in all arena's including domestic, commercial and industrial

VARHAN CONSTRUCTION SERVICES PVT LTD

9, Pushpavanam Apartment, #43, 3rd Main Road, Gandhi Nagar,
Adyar, Chennai, Tamil Nadu 600020 | Phone: 044 - 24454204
Email: info@varhanservices.com | Web: www.varhanservices.com

avcon[®]
Pioneer Spirit in Valve Automation

A designer who saw 55 years back future in Solenoid Valves to give you Quality product at affordable price.



"Fit & Forget" Products

Solenoid valves suitable for almost all applications.
2-way solenoid valves 6mm to 200mm for all Industrial Electric Supply.
3-way solenoid valves are available from 15 mm to 40 mm.

Our Other Most Popular Range of Products :

Angle Seated & Straight Patterned Pneumatic Valves, Ball & Butterfly Valves with Pneumatic & Electric Actuators, Gas Regulation & Control Products & Gas Trains, Pneumatic & Electric Control Valves
***Ask for the literature mentioning model number :**



Manufactured by:
AVCON CONTROLS PVT. LTD.
Plot No.65, Road No.13, MIDC Marol, Andheri (East),
Mumbai-400 093. Email - avcon@avconcontrols.com

Tel.No. +91 22 2834 9134, 2836 6298 Fax. +91 22 2821 6917/ 3298.

Offices at : Contact No. :
Chennai : +91 44 40282503 • Coimbatore : +91 422 2314527 • Bangalore : +91 08042911261
Hyderabad : +91 40 30916849 • Kolkata : +91 33 22302471 • New Delhi : +91 11 26460811
Pune : +91 20 2712 0776 • Baroda : 8980806375

www.avconcontrols.com



Saravana Chem Dyes

Saravana Chem Dyes is one of the leading distributions of water treatment chemicals and equipments in South India having head quarters at Erode, Tamilnadu, India. The company was setup in 1983 and driven by experienced team with prompt and professional service. Our proud partners are,

- **INGE** - Multibore ultrafiltration membrane.
- **BASF/SOLENIS** - RO Antiscalants/ Flocculant / Coagulant / Speciality chemicals/ Sugar Processing Chemicals / Cooling & Boiler Treatment Chemicals
- **PUROLITE RESIN** - Iron Removal/ Fluoride Removal/ Heavy Metals removal/ Removal of Arsenic/ Removal of traces of Oil/ Industrial softening/demineralization.
- **EBARA** - Fluid transfer Pumps for all sort of Industry with 100 years experience.
- **PROMINENT** - Metering Pumps and Acid transfer Pump.
- **ECOTEC STP SYSTEMS** - Affordable sewage treatment plant with very low operation cost.

Our Key Strengths:

- 35 Years in service
- Fully equipped Water Quality Laboratory
- Trained sales and Service Team

Address: 25, Veerabhathra Street - II, Sathy Road, Erode, Tamilnadu- 638 003, India.
 Phone: 424 2255975, Mobile: +91 98946 29082, 98946 29087
 Email: tech@saravanachemdyes.com, Web: www.saravanachemdyes.com

Branch Offices:
 Tirupur, Chennai & Bangalore.



Smart Water Solution

India's Fastest Growing Manufacturer of Booster Pumps, RO Adapter & Spun / Housing.

Booster Pumps: We manufacture Booster Pumps, which has noise-free operations without any kind of vibration. Easy to install and highly durable, these are manufactured using precision engineered components. Also, these pumps can sustain constant pressure and can be availed with in-built voltage controller for maximum reliability.

RO Adapter: We are the leading Manufacturers & Supplier of RO Adapter Delivering Complete Satisfaction with 6 Months Replacement Warranty Our RO Adapter presents complete safety device for all other electric parts in water purifier.

Spun / Housing: We manufacture these by utilizing high grade raw material, sourced from the most trusted vendors. These products are highly demanded among the clients due to their effectiveness & promptness. Made of high quality polypropylene filter media, Filter Cartridge is designed cost-efficiently to catch particulate suspended solids in the water sources. It reduces Sand, Slit, Dirt and Rust particles. It can be used as a pre-treatment for residential water treatment systems.

Address: No. 3, Elango Salai Teynampet, Chennai 600 018, Tamil Nadu, India
 Phone: 044 4205 6262 I Mobile: +91 89034 42902
 Email: smartwatersolution@gmail.com
 Caontact Person: Mr. S. Saravanan



EBARA MACHINERY INDIA PRIVATE LIMITED

902, Bhumiiraj Costarica, Sector 18, Sanpada, 400705 Navi Mumbai, Maharashtra, India
 Phone +91 22 48782222
 standardpumps@emi.ebara.com

Looking ahead, going beyond expectations



ULTRAFILTRATION PRODUCTS FROM

S & C INVOTEK

FILTRATION PRODUCTS: LIQUID, AIR & GAS

YOUR CHALLENGE IN LIQUID FILTRATION



Liquid Bag, Strainer Filters
 No matter what your filtration requirements, we have the solution. Food, Pharma, Bio, Cosmetics, Water Treatment, Paint, Varnishes, Beverages, Ink, Coolant, SPM's Pre R.O. Washing Machines, Hydoil, Edible Oil, Coconut Oil

Talk to Dr. Filter on
 09844035677, 09980775677 (24 Hrs.)

Hi Technology Filter Bags for various High & Low Viscous Liquids



Stitched with Metal Ring Neck, Welded Bags with PP Neck in all Micron Rating

Filtronix

Mesh Type Strainers



S & C INVOTEK

TOWARDS PROGRESSIVE ENGINEERING
 FILTRATION PRODUCTS: LIQUID, AIR & GAS

#3776, 13th Cross, 30th Main, BSK 2nd Stage, Bangalore 560 070, Karnataka, India.
 Ph: 080-26697112, 080-26797001, 26690191

Fax: 080-26793748
 Email: info@invotekfilters.com / sales@invotekfilters.com
 marketing@invotekfilters.com
 Visit: www.invotekfilters.com



smart Aqua Technologies

smart is leading suppliers and manufacturers of all kind of filtration products under one roof. Our products are used in many of the countries with satisfactory. We are importing and manufacturing the filtration products FOR AIR, WATER, OIL, FUEL, GAS AND ALL OTHER Critical application of Filters. Our products are:

1. Filter cartridges, Filter bags in SS, PP, Rubber, Glass Fibre, and Needle Felt & Cotton. Cartridge Filter, Bag Filter & Basket Filter Housings in SS, UPVC & PP.
2. PRE, HEPA, Turbine, Paint Booth, Automobile, Hydraulic, Gas, Oil Filters Centrifuge bags and dust collectors.
3. Pleated Filter Cartridges PP, PTFE & PVDF different model like 222 fin, code 7, Code 3 & code 8 fin etc.,
4. Strainers in PP, SS, MS for Water & oil application
5. MBBR packing Materials
6. All kinds of RO, Water Treatment Chemicals & Swimming Pool Chemicals.
7. Turnkey Project of RO Plants, WTP Plants & STP Plants

SMART is the answer for all your Filtration needs under one roof

Address: No: 21A, Kumaran Enclave, 14th Cross Street New Colony, Chrompet, Chennai – 600 044.
 Ph: 9382382318, 9381904028, 9382382312, 044 – 42808146, 044 – 22414608.
 Email: rajkumar.smartaqua@gmail.com, sales.smartaqua@gmail.com
 Web: www.smartaquatech.com



Snow Wash & Co

We, M/s. Snow Wash & Co., is an industry leader within the manufacturer of FMCG Products. We are manufacturing Complete Set of Home Care Products such as, Detergent Powder, Liquid Detergent, Dish Wash Liquid, Floor Cleaner, Glass Cleaner, Toilet Cleaner, Bathroom Cleaner, Fabric Conditioner, Multi Purpose Cleaner & Etc., We have gained a reputation for quality and efficiency. Competitively priced Although quality is never compromised we are able to offer prices to meet almost any budget. We offer an accurate and accelerated response to customer requirements through an honest and open attitude to business coupled with an enthusiastic professionalism that all staffs are committed too. We incorporate our current standard stock items and customer requested formulations, all formulated by our in house laboratory chemist and testing facilities. As well as offering high performance products, our Sales Team, backed up by our Head Office are experienced and thoroughly trained and therefore ideally suited to offer a range of support services including Material Safety Data Sheet training (which is compliant with the latest chemical regulations), product training, site surveys and even direct delivery on a national basis to all sites if required. We are an ISO 9001 accredited cleaning products manufacturing company. We promote and do Own label design Enabling your company name to appear on the products.

Address: No. 5, Haroon Ullasa Nagar, Pulli Line, Redhills, Chennai-600052, Tamil Nadu, India
 Mobile: +91 95000 04117
 Email: gmsnowwash@gmail.com, Web: www.snowwash.net
 Contact Person: Ms. Firoze Nisha - General Manager

Water Filter Cartridge

GELTRON



Candle Characteristics:

- Specially designed as per BIS standard.
- Manufactured in an ISO9001:2015 setup.
- Food grade certified.
- Imported High strength polypropylene Yarn used.
- Manufactured on fully automatic imported machines.
- Available in 5 Micron as well as 1 Micron option.
- Multi Layered Depth Filter design for filtration as well as longer life.
- Can be cleaned by back flushing water hence less service cost.
- Hygienically packed in a completely sealed bag.

GELTRON TECHNO SYSTEMS PVT. LTD.

Gadson House, Plot 9, Road 2, Sector 19, New Panvel, 410206 New Mumbai. Mah, India
 Phone: 91 22-27453474/8080985473
 Email: marketing@gadsonindia.com | Web: www.gadsonindia.com

A GADSON GROUP COMPANY

LEADERS IN QUALITY WATER PURIFIER COMPONENTS...

ANYBODY CAN GIVE SUGGEST TO BUY A WATER PURIFIER, BUT ONLY AN EXPERT WILL ADVISE THE SUITABLE ONE...!



RO Plant 1000 LPH



No. 3, Elango Salai Teynampet, Chennai 600 018, Tamil Nadu, India

Phone: 044 - 4205 6262, 4231 6262, Mobile: +91 98417 46567, Email: smartwatersolution@gmail.com



Sophisticated Industrial Materials Analytic Labs Pvt. Ltd.

Incorporated in the year 1988, SIMA LABS is offering EPC services in the field of environment management & control; and testing services in the field of environment, life-sciences, pharmaceuticals, food products & building material. In the field of water and waste water treatment we have experience of more than 1000 successful turnkey projects of ETP / STP / WTP / CETP / ZLD / Recycling Plants in diverse sectors like automobile, steel, mines, bio-refineries, breweries, distilleries, real estate, government universities, ranging from capacities of 100 m³/day to 1000 m³/day. We also take up annual maintenance contracts of our installations. The company has treated more than a 300 million liters* of waste water cumulatively over its 3 decades of existence.

On the analytical testing and research front we are a NABL, MoEF, BIS, FSSAI accredited with fully equipped laboratories in New Delhi, Haridwar, Jammu .

Our laboratory and project team is supported by 15 marketing offices spread all across the length and breadth of India.

Address: A-3/7, Mayapuri Industrial Area, Phase – II, New Delhi - 110064
 Mobile: +91-98109-90527
 Email: aseem@simalab.co.in, Web: www.simalab.com, www.simalab.net
 Contact Person: Mr. Aseem Shrivatsa



Spectra Plast India Pvt Ltd

Spectraplast is a 15 year old company specialized in supplying customized conveyor solution to the food & bottling industry. We provide complete turnkey solution as well as spares and service support for the bottling and beverage industry.

We are the largest conveyor component manufacturers in India with sales network in 5 metros cities and exporting to 25 countries around the globe.

We also manufacture PP tanks for effluent treatment plant, welding rod manufacturing plant and other chemical applications.

Address: Site No:56, Sri subaganesh Industrial Estate, Kuppepalayam (PO), Annur (Tk) Coimbatore-641107
 Phone: 0422 – 2975529 / 2975872, Mobile: +91 90039 40423
 Email: sales@spectraplast.in, Web: www.spectraplast.in
 Contact Person: Mr. M.g.muthukrishnan



A.S. POWER SOLUTIONS

ISO 9001 - 2015

Tiruchirappalli City Corporation Class A Contractor..

PLC & SCADA

- Engineering Design, Supply, Installation, Erection Testing & Commissioning of Level, Flow, Pressure pH, TDS Actuator & Pump Remote/Local control by SCADA System
- Automatic Meter Reading (AMR)
- SCADA Data Encryption Web page
- VFD Pump Control Remote Mode
- Real Time data Monitoring,
- Control & Logging



ELECTRO MECHANICAL

- Supply, Erection, Testing, Commissioning & Servicing all type of VT & HSC Pump Set
- Corrocoating work for improving Pump Efficiency
- Supply & Laying of All Types of Pipes
- Radial Arm Flushing for Collector well
- All Type of Pipeline Leak Work
- Supply all types of Valves & Repair work
- Operation & Maintenance of HT & LT Pumping Station



Engineer Visioning A New World



V.STALIN B.E., (Managing Director)
 No. 3, Karthikeyan Garden Thiruvanaikovil Trichy - 620005
 M: 90941 84906 88701 01121 E: aspowersolutions15@gmail.com W: www.aspowerpvt.com

CORROCOAT



Products

- PHT Triplex
- Plunger Pumps
- Simplex Plunger Pumps
- Jacketted Triplex Plunger Pumps
- High Pressure Plunger pumps
- High Pressure Jet Cleaning Pumps
- High pressure inbuild Gear Pumps

Applications

- High Pressure Water Jetting
- Dust Suppression
- Spraying
- Salt Water Injection
- Hydrostatic Testing
- Corrosive Chemicals
- Cryogenic Liquids
- Boiler Feed
- Vehicle Wash
- Reverse Osmosis
- Injection
- Conveyance of Clean Water
- Slurries, Oils, Viscos Liquids
- Handling even high temperatures

KSSR ENTERPRISES



No:2B, Lalitha Nagar, 1st Street Annex, Madhanandapuram, Porur, Chennai-600125
 Mobile: +91 95000 27705, 98400 64659, 98400 62854. Email: sales@highpressureplungerpumps.com
 Web: www.kssrplungerpumps.com, www.highpressureplungerpumps.com, www.preevolplungerpumps.com



Spectralab Instruments Pvt. Ltd.

Spectralab Instruments Pvt. Ltd. is ISO 9001: 2015 manufacturing company having its facility at Rabale Navi Mumbai. We are in the manufacturing of sophisticated Analytical / Laboratory instruments for more than three decades. We have a strong R&D team & stringent quality checks throughout Quality Control department. Further we have a well-developed analytical lab for application development & support. We cater in the field of Water & Waste Water, Food, Pharma, Oil & other chemical industries in their QC & R&D Departments & also in the academic & research fields.

Food & Pharma: Potentiometric Titrator, Karl Fischer Titrator, Coulometric Karl Fischer Titrator, Kjeldahl Nitrogen Analyzer, Melting Point, Melting Range

Pollution Monitoring Instruments: COD Digestion Apparatus, COD Titrator, BOD Monitor, Thermoreactor, Handy Sampler, Composite Sampler, pH Meter, pH, Conductivity – TDS Meter, DO Meter, Conductivity Meter, pH ION Meter, Fluoride Meter

General Instruments: Multipoint Magnetic Stirrer, Mini Cooling system, DFR, Ultrasonic Cleaning Bath.

Water & Waste Water Samplers: Aquamatic (U.K.) programmable vacuum sampler to collect repeatable and accurate effluents samples. They are certified by MCERTS standard (UK) and also international standard for waste water samplers, ISO 5667-10. Portable, wall mounted or stationary systems, refrigerated and non-refrigerated versions available. Proper sample collection, tracking and preservation techniques are employed to meet regulatory and project specific requirements.

Sample extraction can be time based or triggered by external sources such as flow meters, level sensors, pH meters, PLC's etc. for project specific applications. All products meet relevant standards & Compliances to GLP, IEC, ASTM, APHA, IP/BP/USP with validation, Calibration, Traceability & Documentation.

Address: W – 446, Rabale MIDC, Rabale, Navi Mumbai, Rabale - 400701, India, Mobile: 09323035530
Email: marketing@spectralab.biz, Web: www.spectralab.biz, Contact Person: Mr. Vishwas Kulkarni



Spicos Media Communication

SPICOS has established itself as a one of the leading publishing house in India after publishing more than thirty five editions of SPICOS magazines (SPICOS Bi-Annual (Jan-Feb & May-June) having its focus on: Chemical, Fertilizer, Oil & Gas, Petrochemical, Pharmaceutical, Process & Water Industry, SPICOS Bi-Annual (May-June, CPHL PMECH Special & Nov-Dec) having its focus on: Pharmaceuticals, Food Processing & packaging Industry and SPICOS Quarterly (Jan., April, July & Oct. having its focus on Automation, Instrumentation, Electrical, Electronics, Hydraulics, Pneumatics, Material Handling, Power & Solar Industry with many new features, listings and content presented in a whole new way since 2010.

Address: Lily Annexe Building No.6, Office No.9, B / H. Hotel Mina Intl.
S.V.Road, Jogeshwari West, Mumbai 400102
Phone: 22-2679 1535, 2679 5531, Mobile: 91-93232 22080
Email: spicoscommunication2010@gmail.com, info@spicos.com
Web: www.spicos.com
Contact Person: Mr. Salman Ansari - CEO

STAR PET INDUSTRIES

Manufacturer of: Machinery for Pet Blow Moulding, Filling, Sealing, Pharmaceutical, Water, Food & Beverage Industry.



Plot no.101/3, Post Kasarvadavli, Waghbil, Ghodbunder Road, Thane(W) - 400607.

Mobile: +91 99205 17535, 99676 82100, Email: arunrajendran_666@gmail.com, arunrajendran_666@yahoo.co.in, starpet_industries@yahoo.com
Contact Person: Mr. S. Rajendran

CONSULTANCY & PROFESSIONAL SERVICES:

- ▶ Study for viable & feasible projects
- ▶ DPR preparation for MSW of townships
- ▶ DPR preparation of Sewage scheme of Township.
- ▶ DPR preparation for Effluent Industrial areas
- ▶ Environment clearance for projects
- ▶ Detailed engineering for Pollution control systems
- ▶ Environment Audit reports



ECO-FRIENDLY CHEMICAL FREE DM PLANT 1000 LPH

MANUFACTURER & PLANT INSTALLATIONS:

- ▶ ETP, CETP's, ZLD Plant & STP.
- ▶ RO plants for HIGH TDS and Hardness water.
- ▶ Eco-Friendly Chemical Free DM Plant.
- ▶ Eco-Friendly Chemical Free Silica Free DM Plant (For High Pressure Boiler Feed water).
- ▶ Air Pollution Control System.
- ▶ Process Fume control System.
- ▶ Drinking water filtration plants for remote area
- ▶ and/or in case natural calamities

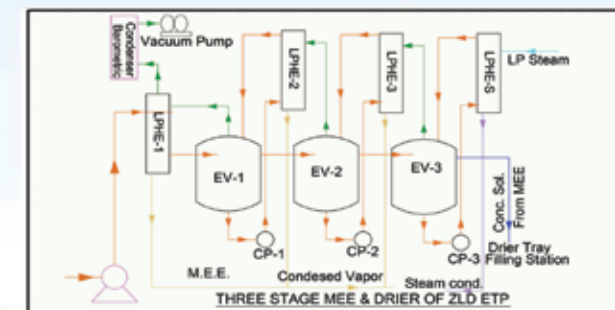

Zero Liquid Discharge (ZLD) ETP



RANS CONCEPT DEVELOPERS

Company in Industrial Environment Management & Pollution control Field
* ETP * CETP * STP * ZLD * MEE * DRIER * EFCF DM PLANT * APCS * SCRUBBER
B-IV/ 04 B, KESHAVPURAM, NEW DELHI-35. 9312634070 / 9555154080
Web: www.conceptenviro.com; Email : ransdevelopers@gmail.com



Spray Engineering Devices Limited

Spray Engineering Devices Limited (SED) having Head Office at Mohali, Punjab and three manufacturing facilities at Baddi (Himachal Pradesh) is pioneer in the field of Evaporation, Heat Exchanger, Condensation and Crystallization. Established in 1992 from a modest start of manufacturing of spray nozzles, SED today has established its existence in more than 40 countries by providing innovative technological solutions for sugar & allied industries. SED has emerged as one of the fastest growing technology driven company, striving to provide world class integrated energy efficient equipment and solutions for entire sugar sector across the globe. SED has revolutionized the water sector by providing most efficient water recovery and recycling solutions through low temperature evaporation technology based on MVR system. This patented technology is operating without use of heat i.e. boiler, steam, cooling water etc. eliminating use of Fossil & Non-Fossil Fuel Boiler, Condenser & Cooling Tower units etc. The technology is highly efficient and eco-friendly for concentration of any type of industrial effluents or domestic wastewater. It recovers upto 99% high quality clean water by concentrating wastewater/effluent and reducing its mass/volume to negligible providing environment friendly solution. This multiple low temperature evaporator is running successfully and performing excellently in more than 50 plants globally from last 3 years on various applications in water sector. The recovered clear water is recycled back to the process and there is no need of pre and post treatment of the water.

BENEFITS OF LOW TEMPERATURE EVAPORATOR:

- Upto 99% clean water recovery and recycling
- No heat rejection unit
- Lowest foot-print area
- Wide applicability
- Low capital cost
- No external heat source requirement
- Minimal electric power demand
- High quality product
- Automated operation
- Minimum operational and maintenance cost

Address: C - 82, Industrial Area, Phase-VII, Mohali – 160055, Punjab, India.
 Mobile: +91 99883 41451, Email: lalit.handa@sprayengineering.com, www.sprayengineering.com
 Contact Person: Mr. Lalit Handa



Surplus Management, Inc. / WaterSurplus

WaterSurplus was founded over thirty years ago as the creator of a global marketplace where buyers and sellers come together and generate value by redeploying surplus water treatment equipment. Through the years, the capabilities of WaterSurplus have expanded beyond surplus equipment to include the sale of new equipment and components; engineering and design services and custom turn-key equipment solutions. Our core expertise lies in reverse osmosis equipment and RO membranes, ion exchange resin and media filtration. Areas of focus include water reuse, potable water, beverage and general industrial applications. Today, WaterSurplus continues to develop and commercialize intellectual property and offers unique water treatment solutions across industries and around the world.

WaterSurplus has done business in India for several years and we are making a push to significantly increase our presence in the Indian market. We are looking for water treatment professionals with knowledge of their local markets who can take advantage of our inventory and assistance to better serve the needs of their customers. We are also looking for end users and municipal (governmental) agencies who can benefit equally from our offerings.

WaterSurplus is headquartered in Loves Park, Illinois.

Address: U.S. Commercial Service, Chennai
 Phone: 044-28574477
 Email: Office.Chennai@trade.gov, Web: www.buyusa.gov/india

QUALITY Chemical Group



Alum (Non Ferric / Ferric / Liquid)	Iodised Salt
Antiscalant (Chemical Base / Organic)	Lime Powder
Calcium Hypochlorite - 60%	Manganese Sulphate
Carbon Black	Nitric Acid
Caustic Soda Flakes	Poly Aluminium Chloride (Powder / Liquid)
Chlorine Tablets	Poly Electrolyte (Cationic / Anionic)
Chlorine Water	Soda Ash
Citric Acid	Sodium Bi Carbonate
D.A.P	Sodium Lauryl Sulphate
Defoamer	Sodium Meta Bi Sulphide
EDTA Di Sodium (Pure / Commercial)	Sodium Tri Poly Phosphate
Ferric Chloride	Sulphamic Acid
Hydrochloric Acid	Sulphuric Acid
All S.T.P, E.T.P, Swimming, Boiler Water, Cooling Water, R.O Treatment Chemicals & Lab Equipments	T.C.C.A - 90%

PH Meters / T.D.S Meters / D.O Meters / Salinity Meters / Spectro Meters & Test Kits Available

Old No. 24, New No. 80, Nyniappa Naicken Street, Park Town, Chennai 600 003
 Tamil Nadu | INDIA
 +91-44-4262-4861
 +91-98407-14007
 admin@qualitychemicalgroup.com
 QualityChemicalGroup.com



LiquoStore Contracting: LiquoStore



Kymik Engineering is an ISO 9001 certified company engaged in Design, Manufacturing and Installation of Liquid Storage Tanks.

- Zinc-Aluminum Tank. (3 KI—800 KI).
- FM 4020 Compliance Tank.
- Waster Water, STP, ETP, WWTP Tank.
- Fire Water Tank.
- Industrial Water Storage Tank

KYMIK ENGINEERING PVT. LTD.
 Off: 632 SomDutt Chamber II, Bhikaji Cama Place, New Delhi 66, INDIA
 Fac: Plot No 1552, Binode Danga, Domohani, Paschim Burdwan WB- 713334
 M: +91 9717288404 | Mail: sroy@kymik.com | W: www.kymik.com
 T: +91-8130385451 | Tel: +91 11 4142 0505

For Complete Storage Solution, Get Connected to Us.
LiquoStore Contracting:
 Off: 503 Ansal Chamber II, Bhikaji Cama Place, New Delhi - 66, INDIA
 Hp: +91 8130385451 +91 97172 88404 Ph: 011- 2616 3278
 Www.liquostore.com Mail: roy@liquostore.com
 Globally: Sri Lanka, UAE, Bhutan, Nepal, Thailand, Myanmar



Tamilnadu Water Treatment Equipment Sellers Association - TWTESA

The association of TAMILNADU WATER TREATMENT EQUIPMENT SELLERS ASSOCIATION- TWTESA is formally established in 2016 in Chennai with 9 members who all are from through over TAMILNADU. The prime objective of the association is to promote and encourage the WATER Industry field by providing individual motivation, supportive confidence, technical seminars and marketing seminars to association members. Bring the Quality Products and Quality Technician to the field is a main achievement of the association. And also the member's life will be secured by necessary insurance and need full activities. Through over Tamilnadu the retailers of the RO Industry will take together and make a good network with them for easy communication about field knowledge and also to solve their legal issues by association with their unity.

Address: 3/119, Nakkiren Street, Mogappair East, Chennai- 600 037
 Phone: +91 96003 46900, 96003 40661
 Email: tn.wtesa@gmail.com,
 Web: www.twtesa.in



TenderTiger.com

Products/Services : TenderTiger.com Tracks more than 10 Million+ Tenders, RFP, RFQ, Auctions, EOI from around the world annually published by 10K's of Buyers such that Suppliers can find new Business opportunities to sell their products & services.

Supplier can access Global Tender & projects information published by government departments, PSUs, Corporate, Institutes, Educational trusts etc through email service across India, Africa, Asia, Middle East, Europe, SAARC countries and other parts of Globe as well.

We also help buyers in automating his purchase & sales using tools like eRFQ, eTendering, Reverse Auction, Forward Auction, eAuction, Indent Management, Contract Management, etc. We endeavour to make procurement simple, fast, transparent & economical. We offer end to end eProcurement solution & services through different portals.

Other than Tenders Information we can help our clients to provide Liaison services, Subcontracting services, JV/Consortium, Tender Result services & more.. For more details please contact on +91-9825079334.

Address: B/704, Wallstreet-2, Ellis Bridge, Opp. Orient Club, Ahmedabad, Gujarat.
 Mobile: +91-9825079334
 Email: amitb@TenderTiger.com, Web: www.tendertiger.com
 Contact Person: Mr. Amit Bhanushali-CEO



Zero Liquid Discharge Wastewater Treatment Solutions, Spares, Revamps & Up gradation



ROUND DISC RO WITH 90-95% RECOVERY



MULTIPLE EFFECT EVAPORATOR



AGITATED THIN FILM DRYER



SLUDGE DEWATERING



ANAEROBIC BAFFLED REACTOR



TUBE SETTLER



LAMELLA CLARIFIER

Industries Serviced: Textiles, Breweries, Pharma, Dyes, Chemicals, Starch, Pesticides, etc

NIRTECH PVT. LTD.

A 2/2, Jai Ambe Industrial Estate, Pimpas, Mumbai Nashik Highway, Bhiwandi 421311, Maharashtra.
 Mobile: +91 83693 45173 | +91 83693 45178 | +91 99204 63699
 Email: rohan@nirtech.in | nirtech@gmail.com | Web: www.nirtech.in



Air and Water Cooled Blower

SHANTI BLOWERS

Roots Blower Manufacture



SHANTI BLOWER

41 Modern Industrial Estate, Phase - I, Bahadrugarh, Haryana, India - 124507
 Phone: +91-92688 22202 | 93554 92657
 Email: shantiblowers@gmail.com, Web: www.shantiblowers.com



Toshio Technology Private Limited

At Toshio, we strive to be the industry leader in wastewater pumps and equipment segment. Company offers complete pumping solution for sewage, effluent and dewatering applications. Products are designed to operate in tough conditions to pump water with solid particles.

With decade of experience, Toshio specializes in non-clog submersible pumps manufacturing, service and continues to invest in the fluid dynamic design, motor efficiency enhancement and R&D of various metal alloys. Toshio follows stringent quality standards to ensure uniformly high quality products.

The success of Toshio brand has been based on unyielding commitment and attitude to technical excellence and unparalleled dedication to customer service. Our honesty and integrity have further contributed dedicated to a long term sustainable relationship with all our customers.

Toshio creates and fabricates stainless steel radial pumps and weight boosting frameworks for applications including drinking and process water. With regards to pressure driven productivity, unwavering quality and quality, our pumps and frameworks are among the best on the planet.

Address: Unit 1, 601 /D Wifi Park Road No 1, Above Satkar Grand,
Wagla Eastete Thane 400604, Maharashtra india
Mobile: 9167226980, Email: sales@toshiopumps.com, service@toshiopumps.com
Web: www.toshiopumps.com



Trade4india.com

Titan Aeration Company (P) Ltd. (formerly Global Sourcing Corp.) established in 1997 with a vision to source and implement trade4india.com offers you an opportunity to choose from thousands of India's businesses from various industries. It is most sought after by Importers, Large Trading Houses, Trade Associations, Indenting Agents, and Manufacturers looking for information on Indian business. It is also available at all Indian embassies and consulates, World Trade Organizations' libraries, thus making it the most comprehensive reference tool for enhancing new business opportunities. On www.trade4india.com the data is current and updated. It is easier and faster for users to explore the entire Exporters & Manufacturers database from their own computer.

Address: No. 5, Old Market, Ramesh Nagar, New Delhi 110015
Phone: 011-2543 7674
Email: expo@trade4india.com
Contact Person: Mr. Vikram Sachdeva - Project Manager

'MEMBRANE AUTOPSY'

THE ONLY
3rd party laboratory in India
FOR NF, RO, MBR & UF MEMBRANE AUTOPSY

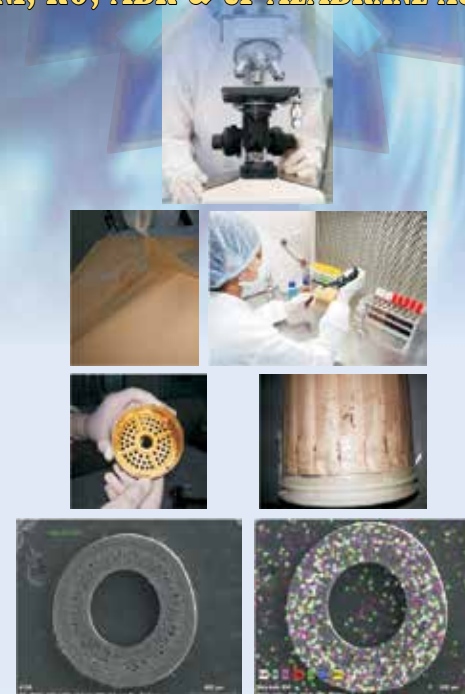

- Dissection of a Fouled Membrane Element, to reveal the Membrane Leaves and Spacer Material
- Chemical, Microbiological Examination
- Identification of the Key Foulants
- Documentation through Photographs
- SEM and EDI
- Comments, Solutions & Recommendations



ISO 9001:2015 Certified
ISO / IEC 17025:2005 Accredited Lab

NILAY, 23, PRATHAMESH PARK, BANER-BALEWADI ROAD
BANER, PUNE-411045
TEL: 91-8237014627 / 8237014628
lab@vipanan.com • www.vipanan.co



CHEM-FERT
C H E M I C A L S

SPECIALTY AND COMMODITY PRODUCTS

- Sodium Bromide
- Sodium Hydroxide
- Sodium Carbonate
- Sodium Bicarbonate
- Sodium hypochlorite
- Sodium Sulphite
- Sodium Meta Bisulphite
- Calcium Bromide
- Calcium Hydroxide
- Calcium Chloride
- Potassium Bromide
- Potassium Hydroxide
- Potassium Chloride
- Potassium Carbonate
- Baryte
- Lime
- Oxygen Scavenger

WATER TREATMENT CHEMICALS

- Water Treatment Chemicals
- Corrosion Inhibitor
- Scale Inhibitor
- Scale Remover
- Biocide
- Dispersant
- Defoamer

BOILER WATER TREATMENT CHEMICALS

- pH Booster
- Oxygen Scavenger
- Antiscalant

RO WATER TREATMENT CHEMICALS

- Antiscalant
- Membrane Cleaning Chemicals
- Biocides

ETP CHEMICALS

- Color Removal
- Poly Electrolyte Non Ionic
- Polyelectrolyte Cationic
- Polyelectrolyte Anionic.
- Alum
- Poly
- Enzymes for BOD

320, Shivam Industrial Park, Near Parikh Packaging,
Opp Sarvoday Hotel, Vasna Chacharwadi Gam, Moraiya
Char Rasta, Near Changodar, Ahmedabad, Gujarat, 382213
Mobile: +91 74900 00334 | Email: md.cfc@chemfertchemicals.com

Web: www.chemfertchemicals.com



Transcend Cleantec Pvt. Ltd.

We are Indian company located at Pune with operations spread all over India. Our company focuses on newer area of providing solutions to customers to enhance their productivity & operational efficiency. We have team of seasoned experts in the area of business development, process & project execution. We work in the area of Sludge treatment, Sludge Dewatering, Diffused Aeration System & Membrane Bio reactors.

Transcend Cleantec Pvt. Ltd., is representing exclusively Trislot N V for filter element in India. MUTAG GmbH – Germany. Innovum GmbH

- End Clients:**
- HPCL Mittal Energy Ltd.
 - JBG Petrochemicals Ltd.
 - Nuclear Power Company India Ltd.
 - Divi's lab, etc
 - Hindustan Petro Chemicals Ltd – Vizag
- Haldia Petrochemicals Ltd.
 - Nagarjuna Fertilisers Ltd.
 - Srf Ltd.
 - Indian Oil & chemicals Ltd. Panipat Refineries
- Reliance Ind. Ltd.
 - Essar Ltd. – Mumbai
 - Gujarat Agrochemicals Ltd.
- End Clients:**
- Gujarat Ambuja Exports Ltd - starch
 - Riddhi Siddhi Strach India Ltd.
 - Skol Breweries Ltd.
- Vijaynagar Biotec India Pvt. Ltd.
 - United Breweries Ltd. - Maharashtra
 - United Breweries Ltd. - Namibia
- Cargil India Ltd.
- OEM's:**
- Larsen & Toubro Ltd.
 - Godrej Ind. Ltd.
 - Alfa Laval Ltd.
 - Praj Ind. Ltd.

Licensors: Haldor Topsue, UOP, EIL, Chevron, Axens, Technip, Flour, Bechtel etc.

Address: S No. 37/2, Shed no. 463/1, Narhe, Taluka Haveli, Pune - 411041
 Mobile: 0091 8669190129, Email: info@transcendcleantec.com, Web: www.transcendcleantec.com



Ultra water Systems

Since establishment in the year 2007, Ultra Water Systems has been one of the prominent organizations involved in manufacturing, exporting, trader, importer, Service Provider and providing complete working solutions related to Water Treatment Plants, Associated Accessories, Bottling, Filling and Packaging Plants. Our range is widely appreciated by our clients all over for features like robust construction, easy operation and low maintenance.

Our range can be customized according to client's needs and we offer customization on various parameters like capacity, raw material used and dimensions. We are the fastest and largest growing integrated water solution provider in the country backed by a vast manufacturing unit and dedicated manpower, working constantly to ensure maximum client satisfaction.

Address: No 16,17, Venkateshwar Nagar, Main Road, Water Canal Road
 Korattur, Chennai- 600076, Tamil Nadu, India
 Phone: 9380508440
 Email: sales@ultrawatech.com, Web: www.ultrawatech.com
 Contact Person: Mr. Karikalan U – Director

MANUFACTURERS OF CUSTOMIZED VESSELS

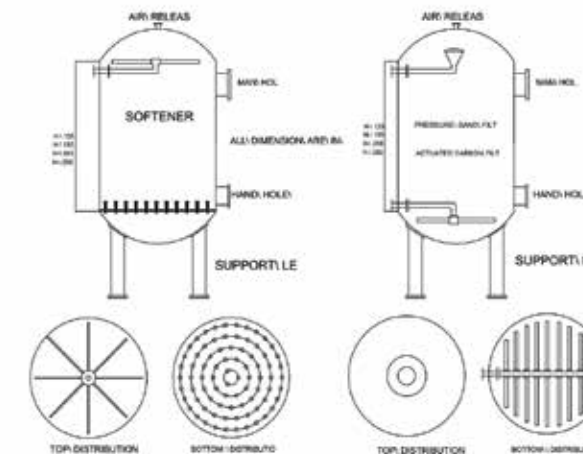

Leading Manufacturers of Customized Vessels with Distribution Systems as well as Modular Water, Sewage and Effluent Treatment Plants.

Specifications:

- MOC: SS/MS/CS/MSRL • VALVES: Butterfly/Diaphragm/Ball • PIPING: MS/UPVC/SS

Water Treatment Engineers

Microvision Group, 264, Kathwada GIDC, Opp. New GEB Substation, Ahmedabad - 382 430 Ph: +91 99252 42841
 Email: sushil.malhotra@mvisionprojects.com | Web: www.mvisionprojects.com



Minerva Engineering and Management Consultants

Power and Desalination Plant Consultancy Service Provider

SERVICES OFFERED

- Feasibility studies
 - Inspection services
 - Pre-bid engineering services
 - Detailed engineering services
 - Lenders Technical Advisory
 - Project management and general engineering services
 - Witnessing performance tests
- Site supervision
 - Life assessment studies
 - Basic and system engineering
 - Commissioning assistance
 - Plant efficiency improvement studies

MEMC can offer the services from Concept to Commissioning of Power & Desalination Plant

DETAILS OF ACTIVITIES PERFORMED

- Design review
 - Civil detail engineering
 - Bill of Material preparation
 - Piping stress and surge analysis
 - Procurement / EPC specifications
 - Piping isometrics, support drawings
 - Control & Instrumentation engineering
 - Electrical system studies, SLDs, sizing calculations
 - Design basis report (system wise sizing calculation)
 - Heat balance, water balance, salt balance, process flow diagram, P&IDs
- As built drawings
 - Plot plan / overall layout
 - Equipment and piping layouts
 - Cost estimate/financial modeling
 - Cable layouts, cable schedule/BOM
 - Feasibility report/detail project reports



Old No. 21/5, New No. 8/5 VTC Complex, Aziz Nagar Main Road, Kodambakkam, Chennai - 600 024 Tamil Nadu India
 Mobile: +91 99946 33377, +91 98410 08696, Email: m.gajapathy@minervaemc.com, venkatesh.r@minervaemc.com

Vasthi Instruments Private Limited

VASTHI INSTRUMENTS PRIVATE LIMITED company which deals in the business in our major products like Water Quality Analyzers, Stack Emission monitoring system, CEMS, Gas analyzers & Detectors, Dew point meters and Air Quality Monitoring Systems & etc... It is one of the most leading manufacturing company and service provider in all over INDIA. We are the manufacturer of high -tech environmental monitoring equipment, analytical instruments, industrial process and industrial safety products. We have integrated fields including microelectronics, tele communication, software, electrical and electrical engineering and other area of technology. We trade with many corporate customers, including domestic and foreign also.

VASTHI in a very short span has become one of the most leading company which we supplied with very higher corporate companies. We have the following products for Water quality monitoring systems.

1. Online COD Analyzer
2. Online BOD Analyzer
3. Online TSS Analyzer
4. Online PH & ORP Analyzer
5. Online COD,BOD,TSS,ORP & PH Analyzer for ETP & STP analyzer'
6. Ammonia-Nitrogen water quality online Automatic Analyzer

Address: Plot no.21&22, Block no.24, Phase-4 Auto nagar, Guntur, Andhra Pradesh-522 001
 Mobile: +91 73827 08685, 7337418685
 Email: mounika@vasthi.com, Web: ww.vasthi.com
 Contact Person: Ms. M. Mounika



Vatten Pure India LLP

Vatten Pure India LLP, a very young Indian Water Industry Company. We have 4 branches in major cities like Chennai, Ghaziabad, Bangalore and Ahmadabad with a great support from our valued Customers. We ensure to provide high quality Water Purifier Parts, Water Plants and RO Units at affordable Prices. Our customer service and support is not an afterthought, but a way of life, integrity and quality are built into each one of our products for customer satisfaction.

Vatten Pure India LLP procures the product directly from the manufacturers to ensure the products are genuine and the quality required. Also, we engaged to create a brand to our customers on the specific product groups.

Vatter Pure India LLP offers a wide range of Water Purifier parts in Domestic and Commercial segment, RO Plant for various requirements such as WTP, Vending Machines, specialized Plants etc. Also, we are part of a manufacturing company, producing Booster Pump, Fittings & Inline in wide range and supplying the same to our customers in their Brand NAME.

We offer wide range of Domestic RO Spares, Commercial RO Spares, Domestic & Industrial Plant at affordable price.

Also, we are manufacturer of RO Fittings, all models of Booster Pumps and importer of RO Spares.

We have branch in Chennai & Ahmadabad. Please visit our website to get complete details.

Address: 74A, Tiny Sector, Thiru-Vi-Ka Industrial Estate, Ekkattuthangal, Chennai – 600 033
 Phone: 044 2225 1578 Mobile: 95000 30582/3/4
 Email: vattenpure@gmail.com, Web: www.vattenpureindia.com
 Contact Person: Mr. Lakshmikandan - Branch Head

ADYAR WATER SOLUTION

ISO 9001: 2015 Certified Company



Products and Services

•Water Treatment Plant & Equipments Manufacturing

•Lab Equipments

No.14, Saraswathi Nagar 4th Street, Okkiayam Thoraipakkam, Thoraipakkam, Chennai 600097.
 Mobile: +91 98400 49975 , Email: adyarwatersolution@gmail.com

Mr. T.Abdul Masthan: +91 94449 93057

Madurai Branch: 94449 93056, 87544 81270, 87544 21272



IDEAL OZONE SOLUTIONS

MANUFACTURER OF OZONATORS & OZONE PLANTS



Ozonator Ranges
 1gr/hr to 500 gr/hr

Newly Designed
 Compact eco Series
 OZONE GENERATORS
 for Mineral water Plant
 PET BOTTLE FILLING LINE

8, Chakravarthy Nagar, Ayanavaram, Chennai - 600023

Tel : 91 - 44 -26223623, Mobile : 91-9840209789

E-mail: idealozonesolutions@yahoo.com, Web: www.idealozonesolutions.com



Venus Marketing & Enterprise

Jalco is formed by experts from water treatment industry and the top management team has over 20 years of experience in the industry. Jalco team caters to the wide gamut of customers in the water industry and has suitable products for all types of customers.

Jalco houses world class products drawn from some of the best manufacturing companies across the country. With Jalco, you can be sure that the products you buy are not only cost effective and efficient but also superior in quality and performance. All the products sold by Jalco are manufactured conforming to environment regulations and are absolutely safe.

Jalco is a Chennai based Water Solutions company. The company is backed by a team of water experts with over 3 decades of experience in water treatment industry. Jalco has wide range of products in various capacities for residential, commercial and industrial segments. We deal with entire range of products needed for water purification and water treatment industry. Jalco has accessories and spare parts for all water purification products right from small domestic RO purifiers to large industrial RO units. Jalco also undertakes turnkey water treatment plant installation and sewage treatment plants for customers of all sizes and types.

The company has experienced professionals in all departments' namely sales, service, customer care and after sales service. With Jalco you can be sure of a long lasting relationship and high quality service.

Address: 10 Periyar Pathai Road, Padmanabha Nagar, Choolaimedu (Near 100ft Road), Chennai - 600 094.
 Phone: 044 - 4287 7279, Mobile: +91 91769 67477, 98407 67427
 Email: chjalco@gmail.com, venusmarketingchennai@gmail.com
 Web: www.venusjalco.com



Vivek Flowtek System

We are leading manufacturer of Solenoid Valve. We have very well equipment for precision machining work and well equipped testing lab facility to provide you best quality product.

Applications:

- Textile Processing Machinery, Food Machinery, Packaging Machinery, Blow Machines, Liquid Filling Machines, Chemical Plants, Water Treatment, Sugar Machinery, Cement Machinery, Pumps, Irrigation, Combustion Equipment, Heat Exchanger, Air Dryer, Pollution Controls, Laundry Equipments and where dependable ON/OFF type control is required.
- Hope, the above will get an opportunity to work with your esteemed organization and prove our excellence to build a long term relation for the future.

Address: 197/198, Laxminagar, Sidsar Road, Bhavnagar - 364002
 Mobile: +91 73835 35353
 Email: vekflowteksystems@gmail.com, Web: www.vivekflowteksystem.com
 Contact Person: Mr. Ashish B Dharaiya - Proprietor

Universal Poly Pack

An Innovative Packing Machine People

- Manufacturers – Exports of : An ISO 9002 Certified Company
- An ISO Certified Company
 - Approved by Weight and measures – Government of India
 - In Operations since 1989

We Specialize on Packaging Machines and turn key projects like

- Mineral Water projects
- Carbonated water projects
- Fruit Drink projects
- Spices and masala Projects
- Milk Projects
- Snack Food projects and custom build machines

Specialized in Packaging and Bottling machines like Fully Automatic and semi Automatic pouch packaging, Blister packaging, Vaccum forming, Shrink Wrapping, Stretch Wrapping, Vaccum-Flushing- Sealing, Powder Filling, Liquid and Cream Filling, Powder and Granular Filling, PET Stretch Blow Moulding, Bottling and Labelling, Conveying systems and machines..



No: 12/4B, Venkata Subba Reddy Street, Mettu Street 5th Cross Street, Athipet, Ambattur, Chennai - 600058, Tamilnadu, India.
 Phone: 044-2635 8050, 2635 9707, Mob: +91 98400 19923, 94440 06863
 Email: uk@universalpolypack.com, uppack@yahoo.com, Web: www.universalpolypack.com

Dishita Automation & Solutions

We are Manufacturer and Service provider of Filling Machine, Cosmetic Packaging Machine, Bopp Labelling Machine, Filling Machine Maintenance Services



Bottle BOPP Labeling Machine



Juice Filling Machine



Cup Rinsing Filling Sealing Machine



Jar 20 Ltr Washing Filling Capping Machine



Mineral Water Filling Machine



RO PLANT

We are Specialist in

- Conveyors
- Curd Filling Sealing Machine
- Oil Filling Capping Machine
- Shrink Wrapping Machine
- Sleeve Applicator With Tunnel
- Special Purpose Machine
- Cosmetic Creams Filling Sealing Capping Machine

Gala No. 1, Dahidule Compound, Near Sai Nath Dairy Yadav Nagar, Kherani Road, Sakinaka, Mumbai- 400072, Maharashtra, India
Mobile: 098927 34521, Email: dusithaantony@gmail.com

VONTRON Vontron Membrane Technology co. Ltd.

In the past 20 glorious years, VONTRON has successfully survived from the tough competition in the RO membrane industry, we have gratefully experienced the stable growth not only in terms of revenue but also in terms of the market shares both China and the world. In the glorious past, VONTRON has successfully incorporated personal value into our businesses value, and incorporated the enterprise value into the society value.

In the foreseeable future as VONTRON expand our capabilities to do more for our customers, we are shifting our focus on merely business growth to take more social responsibilities.

“Environmental Sustainable” is not our slogan, but our principle. VONTRON undertake the mission as making the world cleaner, safer and healthier, protecting people and vital water resources.

In this glorious age, to embark on a journey of success we have to possess the quality of diligent, foresight and strategy. We endeavor to be one of the most competitive companies in the industry with emphasis on efficiency in operations and reliability for customers. We are single minded and ready to write a new chapter for China's world-class manufacture.

We thank you for your constant support and cooperation. Wish you be happy and prosperous!

Address: 1518, Liyang Avenue, Guiyang State High-tech Industrial Development Zone, Guiyang, Guizhou, China
Mobile: +91 97316 87614
Email: gairfan@vontron.com, sales@vontron.com



Wasser Chemicals And Systems Private Limited

We are pleased to introduce ourselves as one of the leading manufacturers and suppliers of wide range of chemicals for various water treatments, effluent, process treatment applications and standard package treatment plants. The company is promoted and managed by a team of techno commercial experts with a combined experience of over 75 years in industrial water treatment and management. The company has been certified for **ISO 9001-2015** for manufacturing and supply of chemicals for water and wastewater treatment and also for laboratory testing of water, effluent and air by **American Global Standards (US)**. The company manufactures the following top quality products and solutions as given below:

- Raw Water Treatment Chemicals
- Boiler Water Treatment Chemicals
- Cooling Water Treatment Chemicals
- Process Chemicals – Paper, Sugar & Textile
- Polyelectrolytes / Flocculants
- Effluent /Sewage Treatment Chemicals
- R.O. Membrane Treatment Chemicals
- Deodorant for Various Applications
- Defoamers/Decolourants
- Biocultures -Aerobic & Anaerobic
- Descaling Chemicals
- Evaporator Antiscalant
- Water Treatment Equipment & Accessories
- Basic Chemicals for Water Treatment Applications
- Fuel Additives / Fire Side Chemicals
- Laboratory Glassware & Chemicals
- Air & Stack Monitoring
- Water & Waste Water Analysis
- “WASSERCHECK” Easy Water Testing kits
- Operation & Maintenance Service (RO / STP/ETP)

Address: Flat No – 5, 1st Floor, Door No. HIG – I – 61, Mogappair West Main Road, Chennai – 600037
Phone: 044-4212 8766, 2653 3364, Fax 044-26533365, Mobile: +91 94449 04464, 94449 04463
Email: info@wasserchem.com, wasserchem08@bsnl.in
Web: www.wasserchem.com, Contact Person: Mr. P.B. Saseedharan



Vatten Pure
India LLP

We deal with...



Vatten Pure India LLP

74A, Tiny Sector, Thiru-vi-Ka Industrial Estate, Ekkattuthangal, Chennai - 600 032.

Phone: 044-2225 1578 / 94444 86098 / 95000 30582/3/4

E-mail : vattenpure@gmail.com



WASSER CHEMICALS & SYSTEMS PRIVATE LIMITED



Manufacturers of :

- Raw Water Treatment Chemicals
- Boiler Water Treatment Chemicals
- Cooling Water Treatment Chemicals
- Chiller Water Treatment Chemicals
- Process Chemicals : Paper, Sugar, Textile
- Biocultures – Aerobic & Anaerobic
- Effluent /Sewage treatment Chemicals
- R.O.Membrane Treatment Chemicals
- Decolorants for Effluents
- Evaporator Antiscalant / Descalants
- Deodorant for Various applications
- Bio Reeducation programme
- Bio Remediation programme
- Air & Stack Monitoring
- Water Testing kits complete range
- O & M / AMC SERVICES

TOTAL SOLUTIONS FOR WATER, EFFLUENT, PROCESS & AIR
Looking For Dealers At Chittagong Area For Promoting Our Products.
Interested Parties May Contact The Given Mail Ids

Regd. Office: Flat No.5, 1st Floor, HIG -I-61, Mugappair West Main Road, Chennai -37. INDIA

Ph: 044- 4212 8766, 2653 3364, Fax : 044-2653 3365, Helpline: 94449 04464 E-mail: wasserchem@vsnl.net / wasserchem08@bsnl.in, Web: www.wasserchem.com

Water Career

Water Today a knowledge sharing and resource partner for major companies in the Water and Wastewater Industry helps job aspirants find the right job in this very niche Industry. Water Today offers a thorough and professional guidance to candidates enabling them to tread this complex terrain to land in their dream job. Water Today offers a world of diversified job opportunities for individuals aspiring to explore and tap in the Water and Wastewater markets.

Water and wastewater related industries are growing at an exponential rate every year. What the industry suffers from is the dearth of qualified professionals. However, the fact remains that a number of job openings await the right personnel in the water and wastewater industries all over the world.

Registering with Water Today offers a world of exciting career opportunities for job aspirants.

Address: No.3D, III Floor, Bhageeratha Residency,
124 Marshall's Road, Egmore, Chennai 600 008
Phone: +91 44 42916919
Email: info@watertoday.org, muzammil@watertoday.org



Water Quality Association (WQA)

The Water Quality Association (WQA) is a not-for-profit association for the residential commercial, and industrial water treatment industry. WQA represents more than 2,500 member companies around the globe. Our membership is comprised of equipment manufacturers, suppliers, dealers and distributors of water quality improvement products and services. WQA proudly serves as an educator of water treatment professionals, certifier of water treatment products, public information resource and voice of the water quality improvement industry.

About WQA Product Certification
Certified Products Have a "Leg Up" in the Marketplace

Finding quality products in a marketplace flooded with options can be challenging. How can you tell if a product is safe, reliable, durable and capable of meeting the claims made on its packaging and literature? WQA's Certified Product Listings are available to help connect consumers with water treatment products that have been tested and certified to industry standards. WQA's Gold Seal Product Certification Program ensures that the product is constructed or formulated from safe materials, the claims listed on the packaging are backed by test data, and the product will hold up under normal usage conditions.

WQA maintains a complete listing of all products and components that have earned the Gold Seal and Sustainability Marks. Only products that pass the rigorous testing requirements of industry standards, pass annual manufacturing facility audits, and comply with WQA's Certification Schemes can be found in this listing For Further information about ANSI/ NSF standards or Membership in different countries around the world contact :

Address: Water Quality Association International Headquarters & Laboratory
4151 Naperville Road Lisle, Illinois 60532-3696 USA
Phone: +91 9899627270, Email: Vgupta@wqa.org, Web: www.wqa.org
Contact Person: Dr. Vaneet Gupta



MSI BIOTECH

- Effective Biotech Tools for Waste Management
- Bio-Cultures & Probiotics for Waste Water Treatment
- Enzymes for Odour Control during Waste Water Treatment
- Micronutrients for Waste Water Treatment
- Effective Biotechnological Tool - (Consortium of Enzymes & Bacteria)
- Aerobic & Anaerobic Biocultures
- Odour Control Probiotics
- Nutrients for the Biomass
- Taylor made Bio-cultures



99436 26076 | 80156 70885
info@msibiotech.com | msibiotech2009@gmail.com
www.msibiotech.com



Packaged UF



Custom Built RO



Pre-Engineered RO



Tertiary Treatment



Water Treatment, Effluent Recycle

- Pre order Consultancy
- Design, Engineering and Supply
- Spares and Components
- Site Services



Custom Built UF

Memtec Engineering Pvt. Ltd, A-2, 303, Tushar Residency, Rahatani Road, Pimple Saudagar,
Pune – 4111027, Maharashtra.
Email : sales@memtecengg.com Phone : +91 9970141481
Web : www.memtecwater.com; www.ultrafiltrationplants.com



Water Today Pvt. Ltd.

Established in 2005, Water Today is India's leading knowledge sharing platform providers catering to the Water and Wastewater Industry. Our goal is to provide proactive platform where the water industry can converge and move forward towards a common goal in solving Global Water Problems. Through our publication, we bring together professionals, researchers and leaders and disseminate the common issues of water problems by applying technologies and implementing policies and programs that benefit humanity as a whole.

With over a decade of experience, Water Today has successfully benchmarked WATER EXPO in India with the maximum footfalls, contented exhibitors, repetitive participants and increasing qualitative visitor ship, making it the most prominent and the largest International event in South East Asia. Water Today has embarked on various initiatives in creating awareness, disseminating knowledge, and provided interactive platform for OEMs, project companies & system integrator in identifying the potential business interests.

Address: No.3D, 3rd Floor, Bhageeratha Residency,
124 Marshall's Road, Egmore, Chennai 600 008
Phone: +91 44 42916900
Email: info@watertoday.org Web: www.watertoday.org

Water Treatment Association of India

"Water Treatment Association of India" registered Under Section 8 of Companies Act 2013. This new Association will usher in a new horizon in the annals of Water Industry and provide impetus to the members of the Association at All India and State Levels.

Main Objectives:

To encourage qualitative and ethical practices amongst manufacturers, suppliers, traders, retailers and importers in the field of water treatment.

To provide a platform to enable the voice of the Water Treatment Industry to reach the government.

To provide training on latest technologies, practices, alternative techniques, market practices, statutory updates on Central/State Laws concerning Water/Pollution/Environment, latest Court Judgments etc.

To create an exclusive Data Bank covering all relevant materials concerning the Water Treatment Industry, across the world.

Address: No.3D, 3rd Floor, Bhageeratha Residency,
124 Marshall's Road, Egmore, Chennai 600 008
Phone: +91 44 42916900
Email: info@watertoday.org Web: www.watertoday.org



J.S. Air Compressor

Sales, Service & Spares for Air Compressor

We are introducing ourselves as a leading air compressor seller. we are selling all kinds of compressor like air compressor, Pet compressor, High Volume compressor, oil free compressor and Vacuum pumps, Air Dryer, Chiller & Pet Machines

Products

- ▲ Pet Compressor
- ▲ High Pressure Pet Compressor
- ▲ Pet Blowing Machine
- ▲ Single Stage Air Compressor
- ▲ Two Stage Air Compressor
- ▲ Two Stage Three Cylinder Air Compressor
- ▲ High Pressure Three Cylinder Air Compressor
- ▲ High Pressure Refrigerated Air Dryer
- ▲ Chiller (1 ton to 10 ton)



J.S. Air Compressor

🏠 No: 10/37, Valli Kollai Medu, Thiruverkadu Main Road, Thiruverkadu, Chennai - 600 077.
📞 97890 74652, 90031 10378 ✉ jsaircompressor@gmail.com 🌐 www.jsaircompressor.com



CHENNAI CHLORO SYSTEM

CHENNAI CHLORO SYSTEM is one of the leading manufacturers of gas Chlorination system, Chlorine Evaporator Systems (Electrically Heated). Comprehensive Chlorine Tonner Leak Absorption / Neutralization System and Chlorine Safety Equipment in India. Chlorinator is a device to provide a continuous and constant supply supply of metered Chlorine in the safest possible manner. Chlorinator find application in Drinking Water, Cooling Water Waste Water Treatment, Chemicals & Fertilizers, Refineries, Petrochemicals, Sugar, Steel, Textile & Paper Pulp Industries, Pharmaceutical Formulation Aquaculture Units, Pesticides & Food Industries, Corporations & Water Boards and other industrial Applications. Gas Chlorination Systems is Classified into two types namely Vacuum-feed Type and Gravity-feed Type of Gas Chlorination Systems with capacities ranging form 100 Gms/hr to 200 Kgs/hr can be provided. Depending upon the client's requirements, the mode of operation gas chlorinator is Automatic and Semi Automatic can be also provided.

- Vacuum Feed Type Chlorination System - Frame Mounted / Floor Mounted / Wall Mounted / Cylinder / Tonner Mounted.
- Gravity Feed Type Chlorination system.



Frame Mounted Vacuum Feed Gas Chlorinator

Floor Mounted Vacuum Feed Gas Chlorinator

Wall Mounted Gas Chlorinator

Tonner Mounted Gas Chlorinator

Electrical Heated Chlorine Evaporator



Chlorine Leak Absorption System



FRP Hood for Chlorine Tonner



Emergency Kit- A/ B



Chlorine Gas Leak Detector



Self Contained Air Breathing Apparatus

OFFICE & FACTORY

44, Thiruvalluvar Street, Ramapuram, Ambattur, Chennai - 600 053.
Phone: 044 - 26243644, Fax: 044 - 26243644, Mobile: +91 98941 23145, 97911 29941
Email: chennaichloro@rediffmail.com, chennaichlorosystem@gmail.com
chennaichloro@ymail.com, Web: www.chennaichloro.com

REGISTERED OFFICE

68, 4th Cross Street, Thiruthanigai Nagar, Pudur, Ambattur, Chennai - 600 053.
Mobile: +91 90439 23025, 90439 23547

Water World

The company was formed as a proprietary concern by Mr. B. Ali Akbar in September 1999 to produce & supply of purified packaged drinking water under the brand “Fresh Water” with “Reverse Osmosis” process at Puduvoil, before Gummidipoondi, on NH5 just 40km away from Chennai City registered with FSSAI & BIS and Member of CII (Confederation of Indian Industry). It has also been registered under MSME development Act, 2006. Mr. Ali Akbar is a well-known industrialist and the Managing Director of Madras Hardtools Private Limited, a company in existence for about a half century. He is also a member of various notorious clubs like Chennai Cosmopolitan, Gymkhana, Boat Club, Chennai Cricket Club, First City Club, Country Club, Alumni Club (Anna University), Lovedable Club, Hindustan Chamber of Commerce and Andhra Chamber of Commerce.

Installed Capacity: The installed capacity of the plant is 2,40,000 liters per day and is presently producing 1,20,000 litres per day. The company is selling 20 ltrs, 12 ltrs, 2 ltrs, 1 ltr, 500ml and 300 ml bottles. A full-fledged QC lab has been set up with all modern facilities to test quality of water.

Process: The Water purification is effected by a state-of-art ‘Reverse Osmosis’ process which is one of the best methods in the industry today and which is acclaimed by the IBWA (International Bottled Water Association) as a method that can “remove most chemical and microbiological contaminants”.

The Technical Team: Mr. Prabash Pathi who is Plant in-charge has been in Water processing and purifying industry for more than 15 years with rich experience gained in this field. He is being assisted by two micro biologists, two lab assistants, two plant operators and 20 workers.

Address: Office: No.1, Perianna Maistry Street, Broadway, Chennai - 600001
 Fac: No.62, Durainallore Village, Puduvoil, Thiruvallur Dist - 601206.
 Mobile: +91 98400 70053, 98400 66046, 98400 64831
 Email: info@madrashardtools.com/abl@madrashardtools.com, Web: www.freshwaterindia.com
 Contact Person: Mr. B. Ali Akbar | Huzefa A. Lehry | Pravashapati



Xylem, Inc.

Xylem is a leading water technology company committed to “solving water” by creating innovative and smart technology solutions to meet the world’s water, wastewater and energy needs.

In a world of ever-growing challenges, Xylem delivers innovative water technology solutions throughout the cycle of water. Our technological strength across the life cycle of water is second-to-none. From collection and distribution to reuse and return to nature, our highly efficient water technologies, industrial pumps and application solutions not only use less energy and reduce life-cycle costs, but also promote sustainability.

Our Products and Services: Xylem offers a portfolio of products and systems designed to effectively meet the demands and challenges of transporting, treating, testing water and wastewater. From pumps to smarter aeration to advanced filtration to chemical-free disinfection to monitoring & control solutions, Xylem’s experts evaluate the varying needs of customers and help them find the right solutions for their application. Through the brands that have been trusted for decades, Xylem offers hundreds of solutions backed by a comprehensive, integrated portfolio of services designed to ensure that water and wastewater equipment keeps running at its best.

Xylem is headquartered in Rye Brook, New York.

Address: U.S. Commercial Service, Chennai
 Phone: 044-28574477
 Email: Office.Chennai@trade.gov, Web: www.buyusa.gov/india

PRODUCTS

- Bio Electricity & Bio CNG
- Bio Sulphur Power
- Liquid Bio Fertilizer
- Bio Carbon Dioxide
- Solid Bio Fertilizer
- Carbon Credits

2nd Floor, MARKFED Building, Opp. PNB Main Branch, Vir Haqiqat Rai Chowk, Abohar, Pin - 152116, District Fazilka (Punjab) INDIA
 Phone: +91-1634-500005, Mob: +91 96267 99344, 90233 69888
 Email: ceidbiogas@gmail.com, dipak_791@yahoo.co.in., Web: www.ceidconsultants.com

Our Company Specializes in Manufacturing, Supplying, Erection and Commissioning of

- ▶ Effluent Treatment plant
- ▶ Sewage Treatment Plant
- ▶ Fumes Scrubber

Environmental consultancy services

- ▶ MPCB Consent to Establish, Operate & Renewal of Consent to Operate.
- ▶ MPCB -ON LINE Legal Services like – Water Cess, Hazardous waste annual report, Environment statement report (Form – V)

Environmental analytical Testing Laboratory

ADITI ENTERPRISES
 ETP, STP Manufacturers – Turnkey Projects & Environment Consultant.
 Work / Office – Plot No. A-20, Satpur Nashik - 422007
 Call-0253-2303351, Mob-9423194387, 9403380865
 Email: vasant.kare79@gmail.com, info@aditienterprises.in, Web: www.aditienterprises.in

Features & Benefits

- High Grade SS304 Chambers
- Superior Quality Genuine Quartz
- Power Supply
- Lower Prices, Easy Availability, Best Performance

NEW INNOVATIVE PRODUCT

- RPMD (Remote Performances Monitoring Device)
- Micro Processor Plug & Play Control Panel
- SMS/GPRS Data Available
- ERP Tools (Web Based App) Available
- Historical Data Storage Facility Available

Dealership Inquiry Solicited

6/144, Sundernagar, Naran Pura Char Rasta, Naranpura, Ahmedabad - 380 013.
 Tel: +91 079 2749 3670, Mobile: +91 98256 11492, 98250 50032
 Email: bharatc483@gmail.com, gayatri2016@yahoo.com
 Web: www.gayatri-enterprise.in



Yaha Water Systems Private Ltd

YAHA Water Systems provides comprehensive solutions for Water and Waste Water Treatment, Sea/River Water Intake & Distribution Systems, Industrial Cooling Water and Process Water Treatment.

We pride ourselves on having an average experience of 45+ years in Conceptualising, Designing, Integrating and Delivering Sustainable, Customer-Centric Water Engineering Solutions. Cooling Water System, Drinking Water Plants, Intake Water Systems and Under Drain Systems for Rapid Gravity Filters are the water filter systems we supply to our customers.

Efficient, reliable and sustainable engineered solutions to enable recycle and reuse of water is our forte. Use of promising technology coupled with state-of-the-art equipment and products provides a level of quality standards that are high in performance and reliability. Safe drinking water for homes and communities, industrial waste water treatment, water treatment to meet quality requirements for any industry process, recycling and recovering water for reuse, reducing waste and pollution and protecting the environment by crafting products that pioneer the 'Recycling and Reuse' of water are few of the processes that Yaha Water Systems excels at. Water is a precious commodity and several steps need to be taken to save water. At Yaha Water Systems we are encouraged by the thought of recycling and reusing water and have therefore created systems that ensure the same.

Address: 305, Sai Commercial Complex, Govandi, Mumbai 400088.
 Mobile: +91 9820143117, 9373102241, 9740299300,
 Email: sudhirm@yahawater.in, santoshl@yahawater.in, siddarams@yahawater.in
 Web: www.yahawater.in



Zero Mass Water

Zero Mass Water's SOURCE Hydropanels are a proprietary technology that produces high quality drinking water from only sunlight and air.

SOURCE Hydropanels are a category-defining technology that can produce water in climates ranging from arid desert to tropical rainforest by combining highly adsorbent hygroscopic material with solar thermal and PV technologies. SOURCE Hydropanels are the only available air-to-water technology that can operate completely off-grid and that can produce water from air with as little as 10% Relative Humidity.

We are currently looking for commercial and government partnerships to execute and deliver largescale drinking-water projects in India, particularly where:

- Water scarcity and contamination creates challenges for rural and peri-urban communities that cannot be solved by traditional water infrastructure.
- Commercial entities require a sustainable and renewable alternative to bottled water.

Zero Mass Water is headquartered in Scottsdale, Arizona.

Address: U.S. Commercial Service, Chennai
 Phone: 044-28574477
 Email: Office.Chennai@trade.gov, Web: www.buyusa.gov/india



THE COMPLETE PIPING SOLUTION

PIPES | VALVES | FITTINGS | ACCESSORIES

**MANUFACTURER OF PP/HDPE/MDPE PIPES,
 PLASTIC VALVES AND COMPLETE
 PIPING SYSTEMS**



QUALITY | RELIABILITY | PERFECTION



Aerochem Piping Private Limited
 CIN : U25209GJ2006PTC049420
 Plot No. 258, Road No. 1/B, Phase I, Kathwada GIDC,
 Ahmedabad-382 430, Gujarat, INDIA. Phone : +91-79-2970 1347
 E-mail : info@aeropipes.in Website : www.aeropipes.in



PARTH POLY VALVES PRIVATE LIMITED
 CIN : U25200GJ2010PTC059985
 109, Mona Industrial Estate, Opp. Anil Starch Mill, Naroda
 Road, Ahmedabad - 380 025, Gujarat, INDIA.
 Phone: +91-79-2220 0198, 2220 0809 Fax: +91-79-2220 0179
 E-mail: sales@parthvalves.com Website: www.parthvalves.com

**IS COLOR,
 COD & SLUDGE
 IN EFFLUENT
 WATER TROUBLING
 YOU?
 WE PROVIDE
 YOU SOLUTIONS**

Advanced KROFTA SEDICELL

For Reduction of TSS, COLOR, COD & BOD &

KROFTA BELT FILTER PRESS

SPECIALLY DESIGNED FOR DEWATERING SLUDGE



Highlights Daf & Belt Filter Press

- Small Footprint
- Ease of installation
- High Hydraulic loading rate
- High solids consistency
- Color removal
- High clarification efficiency
- Compact
- Minimal operator supervision
- Minimal power requirement
- Over 10000 Global installations
- Over 2000 installations in India in all industrial sectors

Few Valued Clients from various industries





Krofta Engineering Limited

Durga Bhavan, A-68 FIEE Complex, Okhla Industrial Area Ph-II,
 New Delhi-110020 • Tel.: +91 11 47242500 • Fax: +91 11 41607026
 Email: krofta@kroftaengineering.com • Website : www.kroftaengineering.com



Zhejiang Dayuan Pump Industrial Co.,Ltd

Founded in 1990, Zhejiang Dayuan Pumps Industrial Co., Ltd. is located in Zeguo Town, Wenling City – the home of water pump in China. With RMB 62.8 million Yuan of registered capitals, the company professionally devotes to R&D, manufacturing, and sales of agricultural water pumps, domestic water pumps, pumps for engineering construction, single and three-phase pipeline shield circulation electric pumps of GPD and GP series, NP and HP central air-conditioning pumps, chemical engineering shield pumps, and marine pumps. It possesses 250mu of industrial park and above 1,300 staffs, with about RMB 1 billion Yuan of business income in water pump.

Address: Danya Industrial Area Zeguo, Taizhou, Zhejiang, China, Taizhou - 317500
 Mobile: 0086-15088995301, sale15@dayuan.com, Web: www.cnpumps.com
 Contact Person: Mr. Eric



Microscience

Microscience in the Waste Water Management: Microscience was established 15 years ago after having experience of handling analytical instrumentations dealt with reputed imported instruments catering to the Research Institutes, Universities and Industries but to the recognition of the environmental challenges faced by various industries Microscience became specialized to deal with Process and monitoring equipment's both online & offline systems, In addition Microscience has a team of technicians to treat waste water generated in the Industries, hotels, hostels etc., and successfully running STP'S WTP'S Etc., Our Products: Hach Co USA., Spectrophotometer, BOD Track, COD Systems, Turbidity Meters, DO Meters, PH/TDS/COND ETC.,

MICROSCIENCE in the Solid Waste Management: Microscience along with an Excel Industries from Mumbai, which is a long-standing pioneer in the field of Municipal Solid Waste Management in India. Over a span of 25 years we have developed and perfected a cost-effective and efficient method for the treatment and processing of municipal solid waste. Comprising of a mix of innovative, products processes and proprietary equipment, our systems are extremely effective for waste management of various capacities.

Applications: Proper treatment of Organic Waste using Bioculum converts it into a rich source of stable organic manure that can be used as a Bio Organic enricher.

Bioculum is suitable for treating and composting all kinds of organic wastes generated by:Hotels, Canteens, Restaurants, Slaughterhouses Municipalities, Food Processing Units, Households, Agriculture Operation etc., Turn your Garbage into Bio Manure in 10 days & 2 days

Our Products: ORGANIC WASTE CONVERTER, OWC-30, 60,130,300 & 500 Bioneer: 50,100,200,300&400 Single & Dual Shredder Machines

Address: 281-9th Etn, Gandhipuram, Coimbatore-641 012
 Mobile: +91 9042000915, 9488412470, Email: microsciencecebe@gmail.com
 Contact Person: Mr. William G.Peter - Chief Executive.



Water Management towards Zero liquid discharge: Saril Solution's are designed towards sustainable solutions. Reclaiming, Recycling around the application and Reduce the effluent produced a zero liquid discharge Plant Water audits and water management services.

Saril Solution's offer three levels of treatability trials Lab trials , In-house facilities and at clients place Optimisation of scheme , Operational costs combines multiple trials and numerous analytical requirements into one package with best technologies.

1. Hospital waste water treatment
2. Grey water treatment
3. Organic waste to Gas- energy and fertilizer

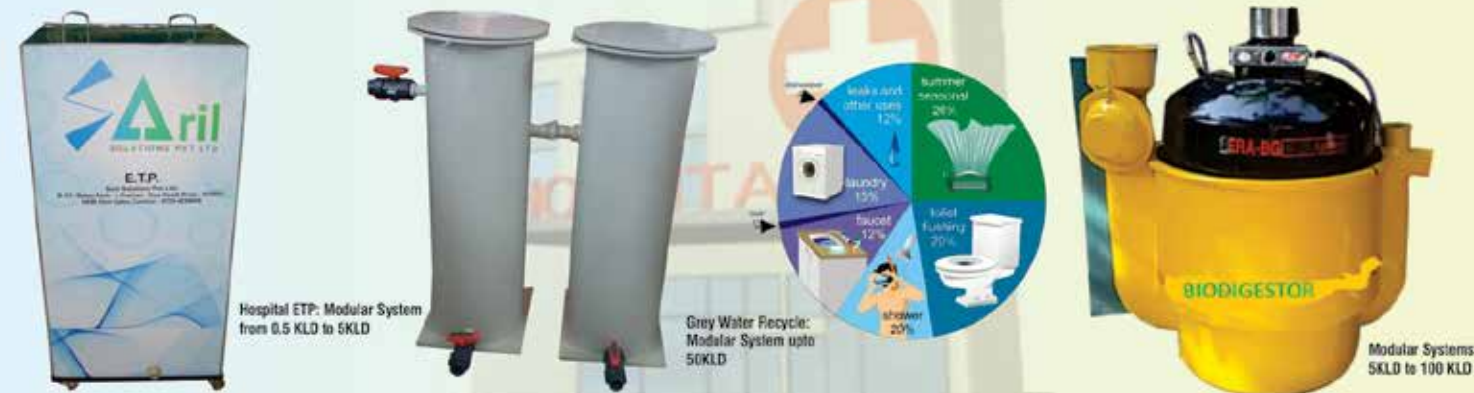

SARIL SOLUTIONS PVT LTD

Building 4/7, Ratan Park-I, Pashan-Sus Road, Pune -411021
 Mobile: +91 87903 887171 | Email: sudeepnigam9@gmail.com | www.sarilsolutions.com

airowater™
 Making water from air

Make Water out of Air! | **4 step Purification Process**

with Superior Ozonation technology for Oxygen-rich water

Visit **airowater.com** to know more

Toll free 1800-270-5050

PATENTED

© AirOWaterTechnology @AirOWater @AirOWater © Roxy Exports Ltd.

Largest & Reliable Range of BUSINESS DATA CD'S

Data CD's related to
"Water & Waste Water Treatment"

- Chemical & Chemical Products**
- Indian Exporters & Manufacturers
 - Indian Importers & Buyers
 - International Buyers & Sellers

- Pharma, Pharmaceutical Products**
- Indian Exporters & Manufacturers
 - Indian Importers & Buyers
 - International Buyers & Sellers

- Chemical Plant Machinery**
- Indian Companies
 - International Companies

- Pharmaceutical Machinery**
- Indian Companies
 - International Companies

- Agro Chemicals**
- Indian Manufacturers, Exporters & Importers
 - International Buyers & Sellers

- Herbal & Ayurvedics Products**
- Indian Manufacturers, Exporters & Importers
 - International Buyers & Sellers

Agro Chemicals

- Indian Manufacturers, Exporters & Importers
- International Buyers & Sellers

Inks, Dyes & Printing Material

- Indian Manufacturers, Exporters & Importers
- International Buyers & Sellers

Paints & Allied Products

- Indian Manufacturers, Exporters & Importers
- International Buyers & Sellers

Petroleum & Petrochemical Products

- Indian Exporters & Manufacturers
- Indian Importers & Buyers
- International Buyers & Sellers

Soaps & Detergents

- Indian Manufacturers, Exporters & Importers
- International Buyers & Sellers

Cosmetic & Beauty Products

- Indian Manufacturers, Exporters & Importers
- International Buyers & Sellers

Water Treatment, Plants & Chemicals

Environment & Pollution Control

Also Available Data CD's related to Other Industries

Unique Features:

1. Product Wise categorization
2. Easy to Use Interface
3. All CD's are Regularly Updated (Updates Available on Payment Basis)
4. Full Information
 - Company Name
 - Contact Person
 - Website Url
 - Address
 - Country
 - Job Description (Profile)
 - Contact Numbers
 - Email Id

Send your Order & Queries to :

Digital Trade Network (Data CD Division)
5. Old Market, Ramesh Nagar, New Delhi-110015 Ph : 91-11-2643767/445830027
Email : datacd@tradeindia.com, vikram_0017@rediffmail.com Web: http://datacd.tradeindia.com
Contact : Vikram Sachdeva (91-9811740658)



KAMAKSHI CONSULTANCY
Plumbing & Fire Fighting Consultants



We Design for the

- Drainage System
- Water Supply System
- Rainwater Harvesting System
- Hot Water Supply & Return System
- Water Treatment Systems

For the Following Buildings:

- Factory Building,
- Schools & colleges,
- Hospitals,
- Theaters, Mall Complexes,
- Residential High Rise Buildings,
- Town Ship Projects,
- Resorts etc.

We Support The Client In The Cost Estimation, Fixing The Contractor And Technical Support During Execution At Site.

Will Prepare The Tender Documents & Bill Of Quantities And Technical Specifications And Support The Client For The Entire Plumbing & Fire Fighting Works.

22, New Colony, 1st Street (Near Pallikaranai Bus Stand Behind Veerathamam Koil) Pallikaranai, Chennai - 600 100
Phone: 044-48591959, Mobile: 86959 67070, 9551295280
Email: thiyaga_maga@yahoo.co.in
Web: www.kamakshiconsultancy.com



Bio-Medical Liquid Waste Treatment Plant

(ES Ventures Group)

MINI EFFLUENT TREATMENT PLANTS (WITH OPTION OF WASHING BAY):

- Manual Liquid Waste Treatment System At The Point Of Its Generation
- Liquid Waste Water Gets Collected Directly Into Waste Water Unit Having Level Indicator To Avoid Over-Filling
- Level Indicators For Waste Water & Sodium Hypochloride
- Manual Draining Of Treated Waste Through Drain To Sewage Line
- Treats All Types Of Infected Body Fluids Such As Blood, Urine & Sputum As Per Bio-Medical Waste Management Rules 2016



25 LPD - 5000 LPD
As Per CPCB Norms

PARISUDH ECO CONCEPTS PRIVATE LIMITED

2/1063, MANTHURUTHI, KANJIKODE WEST (P.O), PUDUSSERY, PALAKKAD, PIN: 678623.
Mob: +91 9446040470, 8001854470, 8301853470
Email: parisudh.ecoconcepts@gmail.com www.parisudhecoconcepts.com
Office Address : 2/307, KRS COMPLEX, KOOTTUPATHA, PALAKKAD - 678 007 GSTIN : 32AAECP3246N1ZB



Advanced Composites Private Ltd.
We Manufacture Reverse Osmosis (RO) Pressure Vessels And Composite Pressure Vessels



Plot Nos. 77, 78, 89, 90, Bicholim Industrial Estate
Bicholim - 403 529. Goa, India
Mobile: +91-98221 27203, Web: www.acplgoa.com

A-1 Aqua Services
ISO 9001:2015

9-9-61/1, Ramalayam Street
Khammam 507001 Telangana State

**Water Treatment Systems,
20" Slime and Jumbo Filters
Manufacturers.**



Cont: 96031 18447, 95159 60119



EPTEX

ENVIRONMENT PROTECTION TECHNOLOGY EXHIBITION

24th 25th 26th

JUNE 2020
PRAGATI MAIDAN, DELHI

An International Exhibition on
Environment Technology, Equipments
& Allied Industries

Organized by WATER TODAY PVT. LTD.
For More Details: info@eptex.biz | www.eptex.biz

NATHANZ CHEMICALS PVT LTD

"Nathanz Chemicals Private Limited" is one of the reliable and foremost Manufacturers, Exporters and Suppliers of supreme quality **GARUDA BRAND COAGULANTS**. The Products we are offering to our customers are formulated using the Utmost quality raw material and highly developed technology in accordance with the Global Standards.

Aluminium Sulphate (ALUM) Non Ferric Grade

Available in: Slab /Lumps / Powder (Coarse , Fine & Super Fine) / Liquids



NATHANZ CHEMICALS PVT LTD,

89/9B, Kalitheerthal Kuppam, Madagadipet Post, Pondicherry – 605107, India.

Phone: 98409 60834, Email: ncplglobal@yahoo.in, Web: indiamart.com/nathanz-chemicals/



VayuJal Technologies Pvt. Ltd. develops Atmospheric Water Generators (AWGs) to combat the problem at the global level and to provide affordable, clean and healthy water to everyone facing a water shortage or a water contamination problem, through environmentally sustainable technological solutions.

30, 100, 400, 1000, 2000 LPD Unit Available



100 -Liters per Day Unit

VayuJal Technologies Private Limited

01FA, First Floor, IIT Madras Research Park, Kanagam Road, Tharamani,
Chennai, TamilNadu, India 600113
Phone: +91 89390 17761, 98408 71968
Email: ramesh@vayujal.in, info@vayujal.in, Web: www.vayujal.com

ALTASORZ GREEN TECHNOLOGIES PVT.LTD.
AltaSorZ Water Management Solutions



- Rain water Harvesting
- Watershed Management
- Waste water Recycling
- Waterless Urinal Solutions
- Sanitation Solution



Products:

- Altazyme Zero -Waterless urinal Solution
- Altazyme STP-Bioculture/Biochemcicla for Sewage Treatment Plant
- Altazyme ETP-Bioculture/Biochemical for Effluent Treatment Plant
- Altasorz Low Maintenance Biotoilets

**WATER IS THE MOST IMPORTANT RESOURCE TODAY.
DONT WASTE IT!!!**

CONTACT US TO SAVE WATER.TO BE WATER EFFICIENT!!

No. 986/c, Near Mahalaxmi Mandir, Swargate, Pune-02
Mobile: +91 9970306335 | Email: altasorz@gmail.com
www.altasorz.com

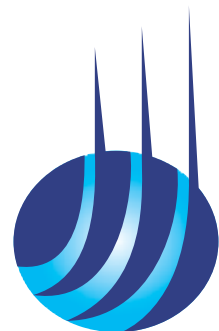

JimTrade.com

India's Largest Business Directory

Indian Products • Suppliers Directory • Trade Fairs

One Directory, Infinite Opportunities!

FREE ACCESS TO **5,00,000+** PRODUCT PROFILES FROM INDIAN MANUFACTURERS



(A division of Jupiter Infomedia Ltd.)

336, Laxmi Plaza, Laxmi Industrial Estate, New Link Road, Andheri (West), Mumbai – 400053, India.

• Tel: 91-22-61979000, 26341691 • Email: cs@jimtrade.com



SUN ENGINEERING SERVICES

AN ISO 9001:2015 COMPANY

MANUFACTURER AND SUPPLIER OF A WIDE RANGE OF PRODUCTS

- ▲ Automatic Chlorinator System
- ▲ Chlorinator Accessories
- ▲ Cylinder Mounted Chlorinator
- ▲ Chlorine Vaporizer System
- ▲ Telescopic Sludge Valve
- ▲ Chlorination System
- ▲ Chlorinator Safety Equipment
- ▲ Hypochlorite Dosing System
- ▲ Emergency Eyewash Shower

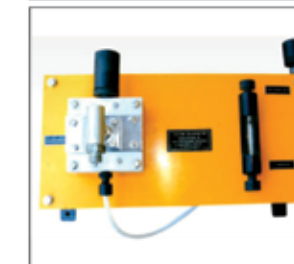
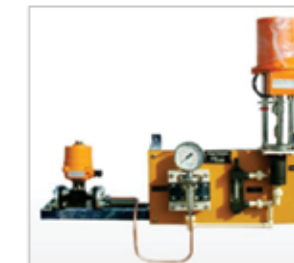

SUN ENGINEERING SERVICES

No. 173, Nilkanth Shopping Center, Opposite of Variya Vidyalaya, Nana Chiloda, Char Rasta, Ahmedabad, Gujarat, India - 382 330.
Mobile: +91-9427048552 / 9638534208, Email: sunengineering72@gmail.com, Web: www.sunengineeringservices.com, www.sunengineeringservices.in



Aqua New Generation®

An ISO 9001: 2015 Certified company
(Quality Approved by DGS & D GOVT OF INDIA)

Feel the Purity



Commencing Erection & Installation :-

- Pressure Sand Filter
- Activated Carbon Filter
- Softner
- D. M. Plant
- R. O. Plants
- Micron Filter
- U. V. System
- Ozonators
- Pet Blow Machine
- SS Tank
- SS Water Cooler
- Mineral Water Plant
- Automatic Bottling Plant
- Swimming Pool Equipment
- STP, ETP & Spares...

ANG PRODUCT - RANGE, QUALITY - AVAILABILITY
DOMESTIC, INDUSTRIAL & COMMERCIALS

Whole Sales - Retail - Service - AMC



H. O No 5: Gandhi Street, Vivekanandha Nagar, M. K. Kottai, Trichy - 620011 B. O: Nagapattinam, Kumbakonam, Coimbatore

Head Operations: + 91 - 90033 01163 | + 91 - 91595 01163 | aquanewgeneration@gmail.com | www.aquanewgeneration.com

WATER TODAY'S WATER EXPO BANGLADESH

10th, 11th & 12th SEPTEMBER 2020
INTERNATIONAL CONVENTION CITY
BASHUNDHARA, DHAKA

BE A PART OF THE LARGEST INTERNATIONAL
WATER EVENT IN BANGLADESH

www.bangladeshwaterexpo.biz



► POWER TO WIN GLOBAL TENDERS

TenderTiger Services

- Tender Alerts (eMail/web)
- Access Tender Documents
- Minutes of Pre Bid Meeting
- Corrigendum/Addendum Alerts
- Find JV/Consortium Partner
- Tender Submission Assistance
- Digital Certificate for eBidding
- Attending Tender Opening
- Find Sub contractors
- Supplier Enlistment Support
- Promoting your Company

Tiger has a long tail for business

- 5,000+ Newspapers are tracked
- 10,000+ Buyers websites crawled
- 50,000+ Listed Govt. Agencies
- 2 Million+ New Tenders
- 1 Million+ Registered users

View your First Tender on
TenderTiger App, **Absolutely Free**



www.tendertiger.com/apprequest.aspx



► FOR THOSE WHO STILL PROCURE OFFLINE

Credentials

- Reverse Auction/Forward Auction/RFQ/eTendering
- Clients Served worldwide : 450+
- e-Procurements events : 75000+
- Global bidders trained : 10,000+
- Transactions enabled worth : USD 10 Billion+
- Products/Services/Contracts sourced : 15000+
- Audit Trail/Auction MIS
- Property auctions
- Scrap/Recyclables
- License/NPA
- SMRA/CCA auctions
- Dutch/Qty + rate

abcProcure.com, AuctionTiger.net, CertificateTiger.com, OneTender.com, ProjectsTiger.com, SupplierTiger.com

e-Procurement Technologies Ltd.

Ahmedabad – 380 006, Gujarat (INDIA), | **Mobile:** +91 93745 19764, +91 9727773437, + 91 8140401117
Fax: +91-79 4027 0516, sales@TenderTiger.com | **Website :** www.TenderTiger.com

Reach to your prospective buyers by advertising in the SPICOS Magazines.

SPICOS Quarterly
Pub: (Jan.--March, April-June, July--Sept. Oct. & Dec.)

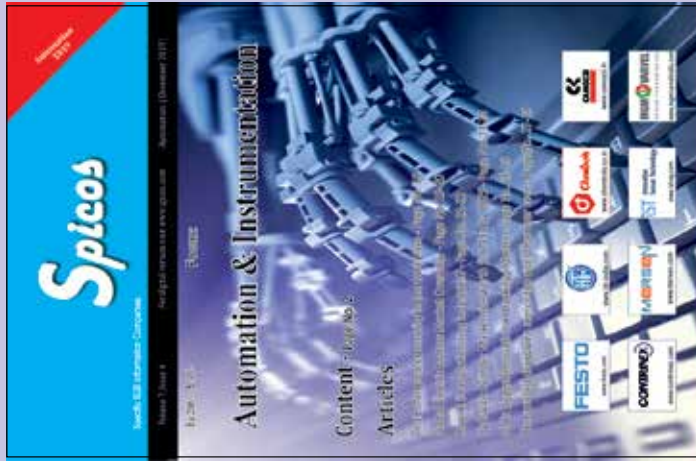

Focus : Automation, Instrumentation, Electrical, Electronics, Hydraulics, Pneumatics, Material Handling, Power & Solar Industry

SPICOS Quarterly
Pub: (Dec. - March, April - July, Aug. - Nov. & Chemtech Special Edition)



Focus: Chemical, Fertilizer, Oil & Gas, Petrochemical, Pharmaceutical, Process & Water Industry

SPICOS Quarterly
Pub: (Dec. - Feb, March - May, June - Aug & Sept. - Nov.)



Focus: Electrical, Electronics, Power & Solar Industry

SPICOS Quarterly
Pub: (March-June, July - Oct., (PMECH Special) Nov.- Feb.)



Focus: Pharmaceutical, Food Processing & Packaging Industry.

For further details , please contact us on :

Mob : 91-932322080 / 91-98694-67694 • Tel : 91-22-62364588 / 26791535

Email : salman@spicos.com & spicoscommunication2010@gmail.com

Website : www.spicos.com

Online B2b Portal for Food & Drink Industry

**INDIA
 MOST
 EFFECTIVE
 DIGITAL
 MEDIA
 PLATFORM**

Releasing B2b
 Monthly Magazine

Food & Drink
 Industry Magazine
 Feb - 2020

**REGISTER AT
 WWW.IFTTRADE.COM**

Editorial Calendar 2020 - 2021

Issue	Topic
Feb'2020	Chennai Expo Special
Mar'2020	A Review of Aerobic Technologies for the Treatment of Wastewater
Apr 2020	New Techniques & Trends in Filtration Systems and Separation Technologies
May 2020	Water Pages 2020
Jun 2020	ZLD Solutions for Industrial Wastewater Treatment & Delhi Expo Special
Jul 2020	Industry trends in Pumps, Valves & Automation Process Control
Aug 2020	Recent Developments in the Application of MBR, MBBR, SBR, SBBR, Technologies
Sep 2020	IoT & AI: The Future of Water Sector & Bangladesh Expo Special
Oct 2020	Current Scenario in Biological & Chemical Wastewater Treatment
Nov 2020	Sewage Treatment Systems in Smart Cities
Dec 2020	The State of Industrial Wastewater
Jan 2021	Advancements in Membrane Filtration Techniques

Water Today - The Magazine

3D, III Floor Bhagheeratha Residency, 124, Marshall's Road, Egmore, Chennai-600 008.
 Email: info@watertoday.org, www.watertoday.org | www.waterexpo.biz | www.h2obazaar.com



Water Today - The Magazine

UNITING THE VIBRANT WORLD OF WATER

Water Today™ - is a leading information and marketing platform, focusing on the water and wastewater industry. A Monthly publication, Water Today publishes technical articles, case studies, national and international news, and updates on products and services available in the water and wastewater market.

Yes, I Would like to subscribe to water Today - The Magazine

SUBSCRIPTION RATES

Period	Rates		Tick
	INR	USD	
1 Year (12 Issues)	2200	700	<input type="text"/>
2 Year (24 Issues)	4400	1400	<input type="text"/>

Name Ms./Mr./Dr. _____ Designations _____

Company / Organisations _____

Address _____

City _____ Pin Code _____ State _____ Country _____

Email _____ Phone _____ Fax _____ Mobile _____

What is your organization's function? (please tick)

- Manufacturers Distributors / Agents Consultants
 End Users Services & Maintenance Other (Please Specify

If Manufacturer / OEM please specify your product _____

If End User please specify your industry _____

About your Business / Professional interest (please tick)

- Water Treatment Pumps & Motors Boilers Swimming Pools
 Pipes & Valves Effluent Treatment Cooling Towers Other Specify _____

Payment Details

Amount _____ Cheque / DD No. _____ Dated _____ Bank _____

All payments should be made in favor of WATER TODAY PVT LTD' payable at Chennai. Please add Rs. 100/- for outstation cheques.

Date _____

Signature _____

3D, III Floor Bhagheeratha Residency, 124, Marshall's Road, Egmore, Chennai-600 008. Phone: 044 42916900, Email: subscribe@watertoday.org, Web: www.watertoday.org

Rootech Services

- Manufacturer Of Rootech Roots Blowers & Roots Pumps
- Rootech Is The Right Solution For Roots Blowers & Roots Pumps
- Indepth Subject Knowledge & Strong Hold On Product Technology
- Believe In Delivering User Friendly Product
- Prompt Pre & Post Customer Care /support
- Experienced Team Is Ready To Assist You For Any Query Subject To Roots Blowers & Roots Pumps
- 100% Dry Air 10 M3 To 10000 M3/hr Working Pressure: 0.6 Kg/cm2 (air Cooled) Ultimate Pressure: 1.0 Kg/cm2
- 100% Dry Air For Aquaculture Application
(Our Aqua design blowers rated for continuous operation 24x7. Oil & Grease chambers separated from air chamber so that in case of oil seal failure, oil will not mix with air chamber and in result no mortality loss to prawn seeds and prawns)
- Roots pumps 100%-dry pumping & vacuum up to .001 torr with back up pump



ROOTECH SERVICES (DELHI)
Plot No :110/7 Near Vardhman Dharam Kanta (Firmi Road)Mundka , Delhi - 110041

ROOTECH SERVICES (HARYANA)
Computer Palace, New nazafgarh Road, Near Shiv Chowk, Bahadurgarh, Haryana-124507.
Mobile: +91-9215006007, 9215006070, Email: rootechservices@gmail.com

WWW.ROOTECH.IN

Hari Ions India Pvt. Ltd.



- Water Treatment Plant
- Sewage Treatment Plant
- Effluent Treatment Plant
- Swimming Pool & Spare

Hari Ions India Pvt. Ltd.
Plot No: A-127, 2nd Floor, Sewak Park,
Near Dwarka Morh Metro Stand, New Delhi, India
Mobile: +91 98911 68190 | 98919 59562
Email: hariionsindia@gmail.com, info@hariionsindia.com
Web: www.hariionsindia.com

AQUA-XL Water Analysing Kits



- Easy to use
- Analysis based on standard methods.
- Saves time
- Reliable & accurate
- Cost effective
- Portable & User friendly

Our Various Parameters

▲ Total Hardness	▲ Tannin	▲ Copper
▲ Calcium Hardness	▲ Chromate	▲ Fluoride
▲ Acidity Hardness	▲ Zinc	▲ Total Iron/Hydrazine
▲ Sulphite	▲ Iodine	▲ Molybdate
▲ Alkalinity	▲ Ozone & PH	▲ Chromium
▲ Nitrite	▲ Hydrogen Sulphide	▲ Ammonia
▲ Chloride	▲ Formaldehyde	▲ OAC
▲ Free Chlorine	▲ Soluble Iron	▲ COD
▲ Dissolved Oxygen	▲ Bromine	▲ Sulphate
▲ Hydrogen Peroxide	▲ Phosphate	▲ Chlorine
▲ Amine	▲ Silica	▲ Chlorine Dioxide
▲ Carbon Dioxide	▲ Nitrate	▲ Phosphorate

AQUA VISION
Gala No. 1 C/o. Vinod Mahatre Niwas, Tukaram Wadi, Managaoon,
Behind Lalit Kanta, Kalyan - Shil Road, Dombivli (E) - 421 204
Mobile: +91 77363 01097, 93201 58020
Email: aqua_vision2005@yahoo.com

Bac'ta Cult Bioculture

Aeration Tank & Anaerobic Tank Quick & Hassle Free Commissioning



- Increase Strong & Healthy MLSS
- Removal of Filamentous Bacteria from Aeration Tank
- Increase COD/BOD Degradation
- FAT, OIL & GREASE Degradation Increase
- Odour Free Biological System
- Ammonical Nitrogen Reduction
- Reduce Sludge Carryover in Clarifier

Bioculture for ETP/STP

Amalgam Biotech
Division of Amalgam Engineering
201, Vastushilpa Building, Veerbhadra Nagar, Baner, Pune- 411045
Mob: +91 90238 82028 | 72760 20758
Email: sales@amalgambiotceh.com | Web: www.amalgambiotceh.com

AVIGHNA CLARITEC™

ENSURING OF EXCELLENCE AND INNOVATION BUILT INTO EVERY DESIGN

AVIGHNA CLARITEC™ Offers Wide Range of Products:

- ▲ Clarifier / Thickener (Centrally Driven & Peripheral Driven)
- ▲ Clariflocculator (Centrally Driven & Peripheral Driven)
- ▲ Turn Table Mechanism (Slewing Ring)
- ▲ Detritor Mechanism
- ▲ Drive Head Mechanism
- ▲ Centre Mechanism
- ▲ Flash Mixer
- ▲ Flocculator
- ▲ Rake Arm (Scraper)
- ▲ Lifting Device Unit



Factory No. 1 : Plot No. 263, Sudama Ind. Estate, Rambaug, Upvan, Thane (W) 400606.
Factory No. 2: Plot No. F-68, Additional MIDC, Anand Nagar, Ambernath (E) 421506
Mobile: +91 75069 39369 | Phone: 022 - 2585 6927
Email: info@avighnaclaritec.com | avighnaclaritec@gmail.com, Web: www.avighnaclaritec.com

BMR TECPACK

PRODUCTS:

- Water & Waste Water
- Food And Beverages
- Chemicals
- Industrials Valves
- Industrial Gear Boxes

•Latest Technology
•Reliable
•Effective
•Timely Execution

CONSULTANCY SERVICES

- Counseling and expert advice on viability of project.
- Project report and detailed project Plan.
- Design of project lay out.
- Installation testing and commissioning of the machineries.
- Detailed technical specifications of the various machines and other utilities required.
- Trial runs, Fine-tuning and commencement of commercial production.

#14A, 1st Floor, Athipal Main Road, Ambatur Ind. Estate, Chennai - 58
Phone: 044 2624 7050 | Mob: +91 99620 47050 | 99620 54060
Email: sales@bmrtecpack.com | rameshkumar@bmrtecpack.com
www.bmrtecpack.com

Jashun Chemicals

SUPPLIER OF WATER TREATMENT PLANTS & FACILITY CHEMICALS
No 7 Nellikuppam Main Road, Keerapakkam, Chennai-600127
PH: 044-27477550/9790727399/8610929594
Email: jashunchemicals@gmail.com, Web: jashunchemicals.in

SUPPLY FOR

- All Water Treatment Plans & Equipment's
- All Water Treatment Chemicals
- All Filter Media
- Pebbles
- Silix
- Green Sand
- Anthoxide
- Mno2
- Activated Corban
- Facilities Chemicals



AM Ozonics Pvt Ltd

Ozone Generator using world class Technology with inhouse R&D and Testing facility from AM Ozonics Pvt Ltd.

Features:

- Most advanced technology used worldwide.
- IP – 55 rated to work in moist and dusty environment
- Enclosed electrode to prevent sparking and ozone leakage
- High barrier quartz dielectric used to give higher electrode life
- SS 316L electrode housing gives consistent high ozone output.
- Oil immersed high voltage transformer for zero breakdowns
- ELCB protection with optional LOTO facility.
- Ozone contactor & mixing systems.
- Advanced oxidation system also provided
- Resonance inverter technology using latest IGBT to give high ozone concentration at low power requirements.
- Protection provided : Sparking protection, Over temperature protection, Cooling water failure protection, Oxygen flow failure protection.
- Optional accessories: Dissolved ozone sensor, Ambient Ozone leak detection system, Ozone analyser, Ozone destructor.

DESIGNED, MANUFACTURED AND SERVICED BY AM OZONICS PVT LTD
Head Office: 321, Hammersmith Industrial Estate, off Sitaladevi Temple Road, Mahim (West) Mumbai - 400 016.
Works & Office: E6 /110 Bhumi World Pimpas Village Mumbai Nashik Highway Bhiwandi - 421 311.
Tel : 2522672471 / 72 / 73, Mobile: +91 91670 69304
Email: ozonics@gmail.com | Web: www.amozonics.in

Few of our completed work



Packaged Sewage treatment plant



Paint booth effluent treatment plant

Wastewater Management & Treatment

Green Energy & Water Conservation

Wastewater Engineering

Laboratory & Analytical Services

Environmental Impact Assessment & Environmental Clearance

Water Engineering & Treatment

Legal Compliance & Environmental Audits

Air Pollution Control & Monitoring





Shivnagari Apartment, A Wing, Flat No.10, Third Floor, Opp. Saibaba Mandir, Sasanenagar, Hadapsar, Pune - 411 028. Phone: +91-20-26825505, Mobile: +91-98509 57232. Email: envirotech08@gmail.com, Web: www.envirotechsystems.in, www.envirotechpune.com

Your Solution Partner in Environmental Problems

TULSION ENGINEERING

Manufacturing And Supplying A Wide Range Of Bottle And Jar Machines. Our Range Includes Jar Making Machine, Bottle Moulds And Bottle Making Machine.

Sagar Industrial Estate 4-A, Gala No. Q-16, Near Quality Hardware, Dhumal Nagar, Valiv East, Valiv, Vasai-401208, Maharashtra, India. Mobile: 9320235535 | Email: tulsionengineering@gmail.com | www.indiamart.com/tulsionengineeringmumbai

DELHI WATER EXPO

WATER TODAY'S WATER EXPO DELHI

24th 25th 26th JUNE 2020 PRAGATI MAIDAN, NEW DELHI

The Largest & Premium Annual Exhibition in South Asia



For booking: info@watertoday.org log on to www.waterex.biz

WATER TODAY'S WATER EXPO BANGLADESH

10th, 11th & 12th OCTOBER 2020 INTERNATIONAL CONVENTION CITY BASHUNDHARA, DHAKA



BE A PART OF THE LARGEST INTERNATIONAL WATER EVENT IN BANGLADESH

www.bangladeshwaterexpo.biz

SUPER PLAST COMPANY UNIT II
An ISO 9001:2008 Certified Company

We are leading manufacturer of "Water Treatment spares" & "P.V.C. Cooling Tower Components".

PRODUCTS

- WATER / WASTE WATER TREATMENT PRODUCTS
- COOLING TOWER COMPONENTS
- BIO DECK MEDIA
- MBBR MEDIA
- TUBE DECK MEDIA
- EXTERIOR LOUVERS FINS FOR BUILDING
- PVC SOFT PROFILE
- PVC TRANSPARENT PROFILE
- HDPE & ABC PIPES & PROFILES
- INSULATION EXPANSION SECTION & PROFILES



Gala no 1 to 7, 104 to 106 Haridwar Industrial Estate, Bldg No 2 D K.T. Industrial Park, Village - Goraipada Vasai (East) Thane - 401 208. Tel: 0250- 2450060 / 70 / 0003, Mobile: 09821139407, 08452841407. Email: superpst@rediffmail.com, superpst@yahoo.in, Web: www.superplast.in

REHAL ENGINEERING WORKS

Design, Engineering & Manufacturing of ETP, STP & WTP

- Clarifiers • Clariflocculators • Recirculating Clarifier
- Thickner • High Rate Solid Contact Clarifier (HRSCC)
- Surface Aerators: Fixed & Floating • Agitators
- Flash Mixers • Flocculator • Trash Racks Screen
- Submerged Mechanical Screen • Curved Rotary Bar Screen
- Lamella Clarifier • Tube Settlers • Grit Separators • Detritor
- Oil Skimmer • Pressure Filters



Sharad Industrial Estate, F - 26, Lake Road, Bhandup (W), Mumbai - 400078. Phone: 022 - 2595 1642, Telefax : 022 - 2595 2659. Email: rehaleng@yahoo.com, rehaleng@mtnl.net.in

An Advanced Sewage Water Treatment Concept: 3R Technology



**Effluent Water Quality
by E - Ionization
Process**

- > No Smell
- > No Noise
- > No Chemicals
- > No big Space Req.
- > Compact Size
- > Single Button Start.
- > Easily Expandable.



Pranjali
Shop No. J-13, Nandanvan - 4, Opp. Aangan Part Plot,
Near Chandan, Farm Satellite road, Ahmedbad,
Gujarat - 380 015, India
Mobile: +91 9426177749,
E-mail: info@pranjaliwater.com

RAVE
RAVE FILTRATION SYSTEM

Importers and Bulk suppliers of all types and kind of

- > Filter cartridges in PP wound, PP Melt Blown, Pleated and of SS,
- > Filter Housings : PP, SS and UPVC suitable for single cartridge and multi cartridges,
- > FRP Vessels, Multiport Valves, Resin and Media Pressure Guage, Rotameters, Conductivity meters
- > Dosing pumps, Control Panels
- > High Pressure Pump and Membranes
- > Skid Mounted RO Plants



204/C-15, Acharya Niketan, Mayur Vihar, Ph-I, Delhi-110091,
Telefax: 011 - 22751478 / 22792750, Mob: 09811102134
E-mail: ravefs@vsnl.net, ravefs@yahoo.co.in, Website:www.indiamart.com/ravefiltrationsystems

H₂O BAZAAR
(A Division of Water Today Pvt Ltd)

**Building Network
for Business!**

**World's leading
B2B portal catering
to the requirements
of Water and
Wastewater
industry!**



**Your search ends here!
For everything you want to
buy and sell in the
water business log on to
www.h2obazaar.com**

Company Name	Page No.	Company Name	Page No.
A1-Aqua Services	183	Bionics Enviro Tech	37
A3S Enviro & Consultants	39	BMR Tech Pack	194
Aaradhya Enviro Tech	147	CEID Consultants and Engineering Pvt Ltd	177
Acme Air Equipments Company Pvt. Ltd.	15	Chem Fert Chemicals	163
Adhunika Enterprises	9	Chennai Chloro System	175
Aditi Enterprises	177	Clearsep Technologies (I) Pvt Ltd	121
Advanced composites Pvt ltd	183	Creative Concepts Advertising Pvt Ltd (Avcon)	149
Adyar Water Solution	167	CRI Pumps Pvt ltd	31
Air o water	181	Devki Publication & Advertising	191
Aishwarya Marketing Company	135	Dharsan Dredging & Construction Pvt. Ltd.	3
Akshara Water treatment	7	Dishita Automation	169
Algo Fluid Systems Pvt Ltd	131	Ebara Machinery india Pvt Ltd	151
Altasorz Technologies Pvt ltd	185	Envichem Speciality Chemicals And Polymers	145
AM Ozonics Pvt Ltd	195	Enviro Engineering	141
Amalgam Engineering	195	Envirotech Systems	196
Aqua New Generation	187	Evergreen Technologies	129
Aqua Safe Plus	41	Filtran Fabrics	57
Aqua Vision	195	Flow Star Engineering Pvt. Ltd.	71
Aquasstar	137	Gatson Group Company	153
AS Power Solutions	155	Gayatri Enterprise	177
Avighna Claritec	194	Geofluid Processors Private Limited	Back Inner
Bajrang Impex	73	Goldfinch Engineering Systems Pvt Ltd	47
Beijing Liquid Filter New Material Technology (I) Pvt Ltd.	67	GRAM Envo Solutions Pvt Ltd	81

Company Name	Page No.	Company Name	Page No.
Guddi Plastcon Pvt Ltd	119	Lexcru Water Tech Pvt. Ltd.	111
H2O Bazaar	139	Lombardyne Enviro Techniques	23
Hari Ions India Pvt Ltd	194	McELROY	11
Harshal Aqua Inc	133	Membrane Hitec	117
Hydro Press Industries	91	Membrane House	29
Ideal Ozone Solutions	167	Memtec Engineering PVt Ltd	173
Initiative Engineering	51	Merit Flow	25
J.S. Air Compressor	175	Minerva Engineering & Management Consultants	165
Jashun Chemicals	197	Mini Dose Solution Pumps	107
Jashun Chemicals	195	MSI Biotech PVt Ltd	173
Jim Trade	186	Nathanz Chemicals Pvt Ltd	185
JM Filtration Technology	113	New Edge Solution	123
Joyam Engineers	21	Nirtech Pvt Ltd	161
Kalpaka Chemicals Pvt Ltd	79	Nisan Scientific Process Equipments (P) Ltd	61
Kamkshi Consultancy	183	Ozonetek Limited	33
Kaveri Water Storage Tanks	97 & Back Cover	Pack Tech Systems	143
Khyatee Electronics Pvt Ltd	103	Parahsakthy Power Technologies Pvt Ltd	19
Kitten Enterprises Pvt Ltd	55	Parisudh Eco solution	183
Kpack Systems Pvt Ltd	59	Parth Poly Valves Pvt Ltd	179
Krishna Engineering	5	Parth Projects & Construction Pvt. Ltd.	45
Krofta Engineering Limited	179	Parth water Solutions	69
KSSR Enterprises	155	Placon Filters Pvt Ltd	115
Kymik Engineering Pvt Ltd	159	Pon Pure Chemicals Group	83
LANXESS India Private Limited	Front Inner	Pranjal	198

Company Name	Page No.	Company Name	Page No.
Pride Controls & Systems Pvt Ltd	145	Star Pet Industries	157
Pure Water Enterprises Pvt Ltd	125	Sun Engineering Services	187
Rakiro Biotech Systems Pvt Ltd	127	Super Plast Company	197
Rammy Trade Solutions Pvt Ltd	49	System EngiTech	13
Rans Concept Developers	157	Technomax Enterprise I Pvt Ltd	95
Rave Filtration	198	Tecpro Energy Systems	89
Ravi Acids & Chemicals	159	Tender Tiger	189
Raviraj Industries	87	Theway Membranes	43
Rehal Engineering Works	197	Toshio Technology Pvt Ltd	105
Rootech Services	194	Trade4india	182
RV Associates	75	Transcend Cleantec Pvt. Ltd.	17 & 99
S & C Invotek	151	Triveni Global Pvt Ltd	27
Sam Enviro	93	Tulsion Engineering	196
Saravana Chem Dyes	77	Turbo Blowers Manufacturer	65
Saril Solutions pvt ltd	181	Universal Poly Pack	169
Shanti Blowers	161	Varhan Construction Services Pvt Ltd	149
Sharplex Filters (India) Pvt Ltd	63	Vatten Pure India LLP	171
Sigma Technologies	85	VayuJal Technologies Private Limited	185
Silver Water Technologies	109	Vens Hydroluft	101
Smaart Water Solution	153	Vipanan Analytical Technologies LLP	163
Southern Ecologic & service	35	Wasser Chemicals & Systems Private Limited	171
SPICOS Media Communication	190	Water Treatment Engineers	165
Sri kamatchiamman Chemicals India Pvt Ltd	147	Wipro Water	53



Editor's Note

Welcome to Water Expo 2020,

The world is experiencing dramatic changes. Global warming, the accelerated growth of the world population and scarcity of water and energy resources are all contributing to the growing need for immediate and sustainable solutions.

The conservation and judicious use of water, a precious and integral element, stands at the heart of these solutions. Every active industry, including the energy industry, is in need of advanced water technologies to power tomorrow's solutions.

The answer lies in smart management of resources including comprehensive information gathering, data analysis and the providing of rapid responses that are precise, reliable and economical. During Water Expo 2020, we will examine some of the challenges and special benefits unique to the realm of investments in water solutions. We'll also take a look at some new business models that can connect brilliant ideas to available funding.

I look forward to spending time with you at Water Expo 2020, where you will have the opportunity to meet innovative entrepreneurs, local and international investors and government officials. Additionally, we will brainstorm solutions to current challenges and plan cooperative ventures for the future.

Water Today's Water Expo 2020 serves as a full-service help center for international investors interested in investigating direct investment and joint ventures in India. The Expo provides as a platform to potential investors and serves as a resource for investment related information.

Naina Shah
Naina Shah
Editor

Published & Printed by S. Shanmugam on behalf of WATER TODAY PVT. LTD.
Published at 3D, IIIrd Floor Bhagheeratha Residency, 124, Marshall's Road, Egmore, Chennai - 600 008 Tamil Nadu, India
Printed at Dawood Graphics, No. 63, Muthu Street, Royapettah, Chennai - 600014, Tamil Nadu, India.



Knowledge Partner...

Fluid Filtration, Separation, Purification, Disinfection & Pumping Technologies

H₂O -
The Essence of Life

Polymeric &
Non-Polymeric
Filter Vessels

Activated Carbon -
Granular, Powder,
Pellet

Closed Reactor
UV System

Open Channel
UV System

Fluid Process Filtration
Systems & Products

Automatic Self
Cleaning Filters Disc /
Screen Assembly

Reverse Osmosis (RO) Membranes

Grooved-End Flexible
Pipe Couplings

RO Pressure Vessels

Ion Pure CEDI

Membrane Bioreactor
(MBR)

Water, Wastewater
& Industrial Pumps

Ion Exchange Resins



Geofluid Processors Private Limited

112, Building No.2, Mittal Industrial Estate,
Andheri Kurla Road, Marol, Andheri (E), Mumbai - 400 059.

+91-22- 6155 5888 +91-22-6155 5800
info@geofluid.com www.geofluid.com

Kaveri®



WATER STORAGE TANKS

Available capacity upto 20,000 Litres



DOUBLE LAYER ♦ TRIPLE LAYER ♦ ISI MARK

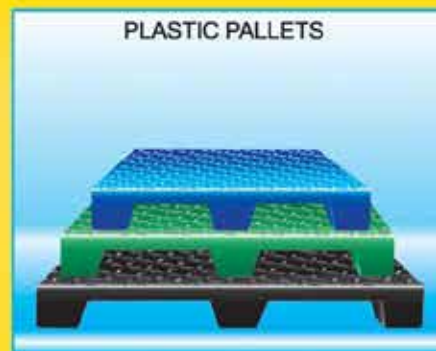

Website : www.kaveritanks.com ♦ email : enquiry@kaveriplasto.com

Kaveri® TANKS

Totally tough. Totally dependable.