



Philips Lighting Catalogue **2015/16**



PHILIPS

Philips
Lighting Catalogue
2015/16





Philips delivers innovation that matters to you

A technology company that cares about people.

From the very first light bulbs and radios, we've had one message at the heart of our company – our mission to improve people's lives through innovation that matters.

We don't just invent; we entertain, we enlighten, we solve. We are a technology company that cares about people.

It's in our DNA, and it's time to let it shine.

Terms and Conditions

All illustrations, information and specifications presented and referred to herein are believed to be correct at the time of publication. All measurements shown in millimetres unless otherwise stated. All Trade prices are excluding GST.

Attachments to some products are optional and available at additional cost.

Philips Lighting reserves the right to make changes from time to time without notice or obligation in the specifications, design, colour or materials. Philips Lighting reserves the right to change and discontinue products.

Additional details and specifications are available from Philips Lighting on request. Or refer to product content online at www.philips.co.nz/lighting

All due care has been taken to ensure that technical details listed in this guide are correct, however should any errors be found, Philips Lighting reserves the right to make alterations without notice.

A number of the products in this catalogue are available on indent ordering – please check with the customer service team for details.

Contact Philips Customer Service:

Ph: 0800 4 LIGHT

Fax: 0800 160 875

nz.lighting@philips.com

www.philips.co.nz/lighting

Standard Product Warranties

The warranty period starts on the date of purchase by the end user or electrical contractor. The below table summarises the standard warranty period for Philips lighting products.

Product Group	Product	Standard Warranty Period
Lamps:	GLS	3 months
	Halogen	1 year
	CFL-i, TL, CFL-ni, CDM, Cosmopolis	1 year
	CFLi Tornado 12W, 15W, 20W, 24W, Warm White (EnergyStar rated)	2 years
	LEDbulb range, My Ambiance Range, Hue Range	2 years
	Master LED Range	3 years
	PrimaVision CDM, PV/DV Xtreme CPO/SON/CDO	5 years
Gear/Components/Controls:	Driver HFP3, HFR, Occuswitch, Occuplus, Actilume, Master TL+ appropriate Philips drivers, Actilume Controls + appropriate Philips drivers	3 years
Professional Luminaires:	Conventional	1 year
	LED	3 years
Consumer Luminaires:	Roomstylers, Outerstylers, Ecomoods, Aquafit, Kidsplace, myLiving (non-LED)	1 year
	StarSpot LED, Oyster LED, Friends of Hue Range, LED Desk Lights	2 years
	Ledino LED Ranges, Living Colours, myBathroom LED Aquafit, Value Range	3 years

Terms and conditions:

- The warranty period (excluding GLS and halogen) is based on a burning time of maximum 4000 hours per year for indoor/outdoor applications and 500 hours/year for Sports applications, and switching cycles in accordance with IEC norms.
- The warranty period for GLS and halogen is based on a burning time of maximum 1000 hours per year.
- The warranty of eHID products are excluded from lightning strike damage except PV/DV Xtreme which has internal lightning strike protection.
- This warranty only covers Products applied within their "intended" or "normal" use as defined by:
 - Operating conditions are in accordance with the information on the Product and its packaging; and
 - Ambient temperature never exceeds the operating temperature range of -20degC to +45degC; and
 - Relative humidity in the installation never exceeds 80% RH, or never exceeds the IP rating of the Product if any is provided; and
 - Products are operated in an open luminaire, with minimum 10mm air around the body of the Products; and
 - Products are not subjected to more than total of 20,000 fast switches (time between "on" and "off" is less than 10 minutes); and
 - The electrical installation in which the Product operates is not subjected to voltage fluctuations in a range exceeding 230V +/- 10%.
- Products should be used within their specified tolerances in applications (e.g. temperature, water ingress and other extreme conditions, Indoor/outdoor, up-lighting/downlighting, etc.) and according to application guidelines. The warranty becomes void for defects caused by misapplication of the product.
- Products have to be properly installed and operated in accordance with the manufacturer instructions and guidelines.
- Philips recommends customers ensure their lighting installation is subject to a regular maintenance program by a qualified electrical contractor.
- The warranty will also be voided should the customer fail to appropriately maintain their installation (eg. changing lamps or replacement of components at end of life), and according to the product specifications.
- The product specification is used as the reference in assessing the justification of a warranty claim. If no product specification is available for LED luminaires, a failure can be defined as a non-functioning product or in the event that 50% of the products do not meet a minimum lumen maintenance of 70%.
- Information on extended warranties for products is available on request.
- For end-users who are consumers within the meaning of the Consumer Guarantee Act, 1993 this warranty is in addition to and does not replace your statutory rights and protections.

Contents

1 Introduction

■ Your Lighting Partner	1.0
-------------------------	-----

2 Professional Luminaires

■ Recessed	2.2
------------	-----

■ Surface & Suspended	2.14
-----------------------	------

■ Battens	2.25
-----------	------

■ WaterProof Battens	2.32
----------------------	------

■ Industrial Highbay	2.38
----------------------	------

■ Industrial Lowbay	2.45
---------------------	------

■ Downlights	2.51
--------------	------

■ Floodlighting Professional	2.63
------------------------------	------

■ Floodlighting General	2.69
-------------------------	------

■ Amenity	2.75
-----------	------

■ Sensors	2.81
-----------	------

3 Consumer Luminaires

■ LED Value 'Halo' Downlight	3.3
------------------------------	-----

■ Essential LED	3.6
-----------------	-----

■ Starspot	3.9
------------	-----



















■ LED Dyna	3.13
------------	------

■ Ledino	3.14
----------	------

■ myLiving	3.20
------------	------

■ RoomStylers	3.24
---------------	------

■ Heritage Refined	3.34
--------------------	------

 Vibrant Expressions	3.38
 Kidsplace	3.44
 Aquafit LED	3.48
 Aquafit	3.54
 Outerstylers	3.62
 myGarden	3.70
 LED Desk Lamps	3.74
 Living Colors	3.78
.....	
4 Connected Lighting	
 Hue	4.2
.....	
5 Lamps	
 General Lamps	5.2
 Halogen	5.6
 Fluorescent Lamps • Linear Tubes	5.18
 Fluorescent Lamps • Compact Non-Integrated	5.38
 Fluorescent Lamps • Compact Integrated (CFLi)	5.46
 LED	5.50
 High Intensity Discharge	5.68
 Special Lamps	5.91
.....	
6 Lighting Controls	
.....	
 Stand Alone Controls	6.2
.....	
7 Electronic Control Gear	7.0
.....	
8 Technical Data	8.0
.....	
9 Glossary of Terminology	9.0
.....	

Product Overview

PROFESSIONAL LUMINAIRES

RECESSED 2.2

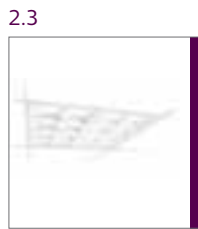

2.3
PowerBalance 2.0



2.5
SmartPanel LED



2.7
Coreview 2



2.9
CoreLine LED

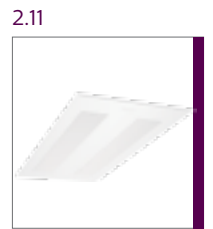

2.11
SmartBright LED Troffer

2.12



Sereno TBS
528/869

SURFACE & SUSPENDED 2.14



2.14
SmartBalance LED



2.16
Lumistone LED



2.18
Celino LED



2.20
CoreLine LED Surface Mount



2.22
CoreLine Trunking

2.23



Clean Room - Teardrop LED CR385



2.23
Clean Room - LED Hygeia CR418

BATTENS 2.25



2.25
GreenPerform LED Batten - Trunkable



2.25
GreenPerform LED Batten - Standalone



2.26
Core Range



2.28
SmartBright LED Gen 2



2.30
Modella

2.31



e-batten™ TMS 150

WATERPROOF

2.32

2.32



Pacific LED Waterproof

2.34



CoreLine Waterproof

2.36

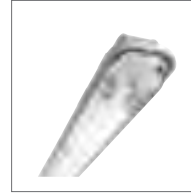

Pacific TCW216

2.37



TCW060 Under-verandah TL-D

INDUSTRIAL HIGHBAY

2.38

2.38



GreenPerform Highbay Gen2

2.40



Greenup Highbay

2.44



T5 Highbay

INDUSTRIAL LOWBAY

2.45

2.45



Mini 300 Gen2

2.47



Mini 500 Gen 2

2.49



Smartbay LED Lowbay

DOWNLIGHTS

2.51

2.51



Luxspace Gen III

2.54



Luxspace Gen III IP54

2.56



Luxspace Gen III Wall-Wash

2.58



Greenspace III / Greenspace Power

2.60

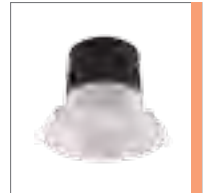

SmartBright Next Gen LED

2.61



SmartBright Surface

PROFESSIONAL FLOODLIGHTING

2.63

2.63

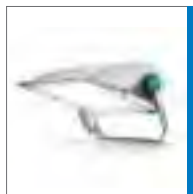

OptiVision

2.65



Tango LED Spec Grade

2.67



Tango G2 LED

FLOODLIGHTING
GENERAL

2.69

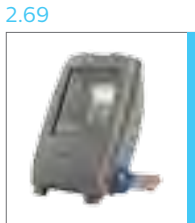

SmartBright LED Flood



Tango HID



ConTempo HID

AMENITY

2.75



Metro LED



Metro Lantern



Coreline Wallmount



Mini Vandalite LED



Italia - PL4520

2.80



Italia - PL4700

SENSORS

2.81

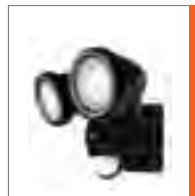

Twin Motion LED Sensor

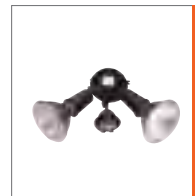

Sensor Lights - QHF560

CONSUMER LUMINAIRES

LED VALUE
'HALO'
DOWNLIGHTS

3.3



61021/31 & 61025/31



61022/31 & 61026/31



61023/27 & 61027/40



61024/27 & 61028/40

ESSENTIAL LED

3.6

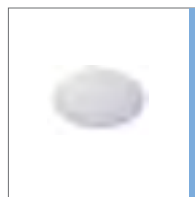

31814



31815



31816



31817

LED STAR SPOT

3.9

3.10



56240/31

3.10



56242/31

3.10



56244/31

LED DYNA

3.11

3.12

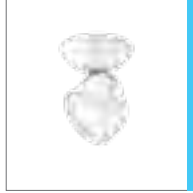

53235/31

3.12

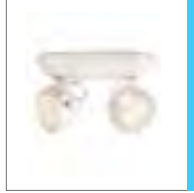

56242/31

3.12



53231/31

3.13



67413/31

LEDINO

3.14

3.16

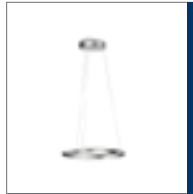

69055/48

3.16



69053/48

3.16



69049/48

3.17



69064/90

3.17



69064/99

3.17



69070/31

3.18



69072/31

3.18



69074

3.18



69080/99

3.19



69082/99

3.19



69084/99

3.19



69089/29

myLiving

3.20

3.22



40755

3.22

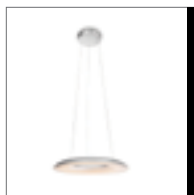

40902

3.22



31126

3.23



31132

3.23



31133

ROOMSTYLERS

3.24

3.26



QPG300

3.26



QPG301

3.26



QCG301

3.27



QCG301

3.27



FWG301

3.27



FCG300

3.28

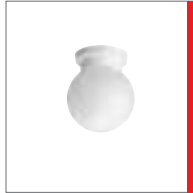

QCG304

3.28



FWG300

3.28



FWG300

3.29



QPG303

3.29



QPG303

3.29



QPG303

3.30



QPG304

3.30



QPG304

3.30



QPG304

3.31



FCG310

3.31



FCG311

3.31



FCG312

3.32



FCG313

3.32

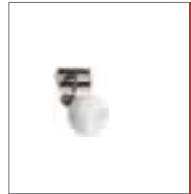

FCG307

3.32



FCG308

3.33



FCG309

3.33



FCG323

3.33



FCG324

HERITAGE
REFINED

3.34

3.36

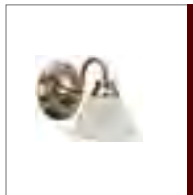

37712

3.36



37710

3.36

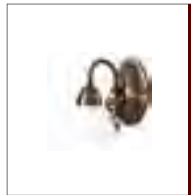

37934

3.37



37932

3.37



37933

VIBRANT EXPRESSIONS

3.38



41055



41055



41055

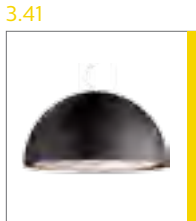

40380



40380



60201



60201



60202



60202



60200



60200

KIDSPPLACE

3.44

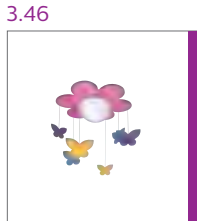

QCG314



QCG316

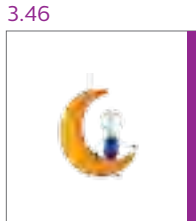

FPG301



QPG308



QPG315



FPG302

AQUAFIT LED

3.48



32208



32209

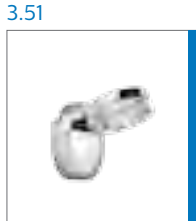

34208



34212

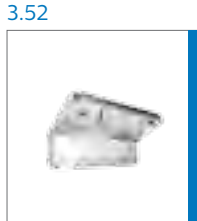

34213

AQUAFIT

3.54



QCZ800



QCZ802



QCZ806

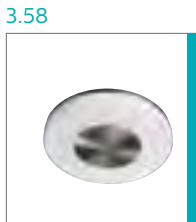

FCZ300

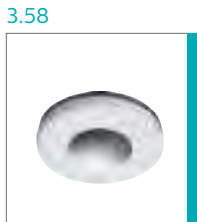

FCZ300

3.58



32047

3.59



32048

3.59



32049

3.59



32029

3.60



32030

3.60

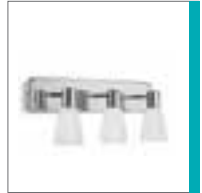

32031

3.60



FWZ301

OUTERSTYLERS

3.62

3.64



ECB300

3.64



ECB300

3.64

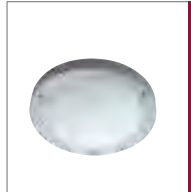

ECB300

3.65



EWS300

3.65



EWS300

3.65



EWS300

3.66



EWP300

3.66



EWP300

3.66



17104

3.67



17104

3.67

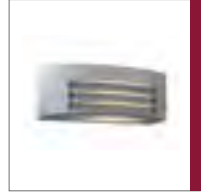

17105

3.67

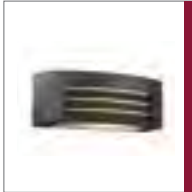

17105

3.68



01465

3.68



01465

3.68



17205

3.69



17204

MYGARDEN

3.70

3.72



17273

3.72



17273

3.72



17287

3.73



17287

LED DESK LAMPS

3.74

3.75

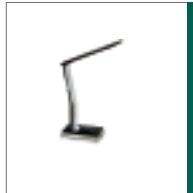

Eyecare Black

3.75



Eyecare White

3.75



CAP White

3.76



CAP Black

LIVING COLORS

3.78

3.80

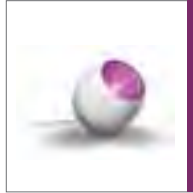

Micro-White

3.80



Micro-Black

3.80



Iris-White

3.81



Iris-Black

HUE CONNECTED LIGHTING

HUE

4.0

4.4



E27 3 Piece

4.4



E27 Single

4.4



Lightstrip 3m

4.5



Bloom Extension

LAMPS

GENERAL LAMPS

5.2

5.2



Practitone Tubular

5.3



Floodlight PAR38

5.4



Reflector Ring Mirror

5.4



Reflector Standard Floodline

HALOGEN

5.6

5.7



Masterline ES Dichroic

5.8



Brilliantline Pro Dichroic

5.9



Essential Plus Dichroic

5.10



Masterline 111

5.11



Essential Twistline Dichroic

5.12



Essential Capsule LV

5.13



Eco Halogen Capsule MV

5.14



EcoClassic A55

5.15



EcoClassic Candle

5.16



EcoClassic Lustre

5.17



Plusline Pro

LINEAR TUBES
5.18

5.19



Master TL5 High Efficiency ECO

5.20



Master TL5 High Output ECO

5.21

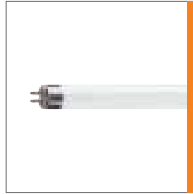

Master TL5 High Efficiency

5.22

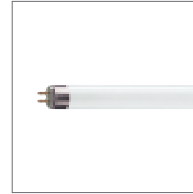

Master TL5 High Output

5.23



Master TL5 HO Xtra

5.24

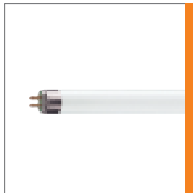

Master TL5 HO TOP

5.25

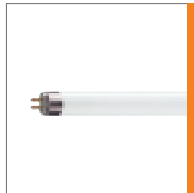

Master TL5 HO 90 Deluxe

5.26

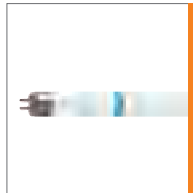

Master TL5 HE Secura

5.27

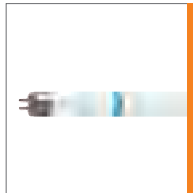

Master TL5 HO Secura

5.28

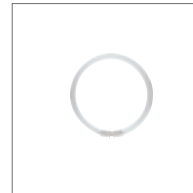

Master TL5 Circular

5.29



Master TL-D ALTO

5.30



Master TL-D ECO

5.31



Master TL-D Super 80

5.32



Master TL-D Xtreme

5.33



Master TL-D 90 De Luxe/Graphica

5.34



Master TL-D Secura

5.34



Master TL-D Flood Pro

5.35



TL-D Standard Colours

5.35

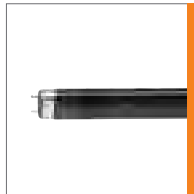

Blacklight Blue (BLB)

5.36



TL-E Circular Super 80

5.36



TL Miniature

5.37



TL-X XL Instant Start

5.37



Starter Switches

COMPACT NON-INTEGRATED
5.38

5.38



Master PL-R Eco

5.39



PL-C 2-PIN

5.40



PL-C 4-PIN

5.40



Master PL-L 4-PIN

5.41



PL-S 2-PIN

5.41



Master PL-S 4-PIN

5.42



Master PL-T 2-PIN

5.42

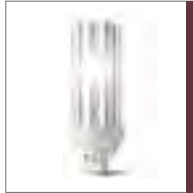

Master PL-T 4-PIN

5.43



Master PL-T TOP
4-PIN

5.44



PL-Q 2-PIN &
4-PIN Quadrant

COMPACT
INTEGRATED

5.46



Tornado

5.48



Genie

5.48



Ambiance PAR38

5.49



Ecotone High
Lumen Twister

LED LAMPS

5.50

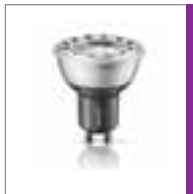

LEDspot Mains
Voltage GU10

5.54

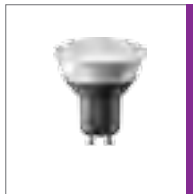

LEDspot Mains
Voltage GU10

5.55



LEDspot Low
Voltage MR16 - ND

5.56



LEDspot Low
Voltage MR16 - D

5.58



LEDbulb 10-60W
- D

5.59



LEDbulb - ND

5.60



Master LEDbulb
A60

5.61



Master LEDbulb
A67

5.62



LED Lustre Lamp

5.64



LED Decorative
Candle - D

5.64



LED Decorative
Candle - ND

5.65

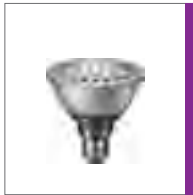

LEDspot PAR

5.66



LEDspot AR111 - D

5.67



TLED LED Tubes

HIGH INTENSITY
DISCHARGE

5.68



Master CDM-T
Evolution

5.68



Master CDM-T

5.69

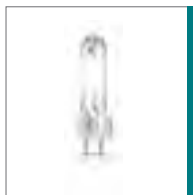

Master CDM-T Elite

5.70

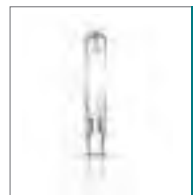

Master CDM-TC
Evolution

5.70



Master CDM-T/TC
Warm

5.71



CDM-T/TC Fresh

5.72



Master CDM-TC Elite

5.73



Master CDM-TD

5.73



Master CDM-T Elite Medium Wattage

5.74



Master CDM-R Mini

5.75



Master CDM-R Mini Elite

5.75

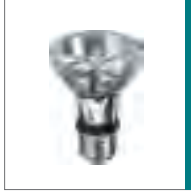

Master CDM-R PAR 20 Elite

5.76



Master CDM-R PAR 30

5.76



Master CDM-R PAR 30 Elite

5.77



CDM-R 111

5.78



CosmoPolis Outdoor

5.79



CDO-TT & CDO-ET Elliptical

5.80



HPI-T Quartz Metal Halide

5.81



HPI Plus Quartz Metal Halide

5.83



Universal Operating Ovoid

5.83



Universal Operating MHNasc

5.84

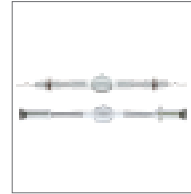

ArenaVision/OptiVision Lamps

5.85



ArenaVision/OptiVision Lamps

5.86



Sodium Lamps

5.87



SON-T

5.87



SON-T PIA

5.88



High Pressure Tubular Agro

5.88



SON-H

5.89



Mercury - High Pressure Ovoid

5.90

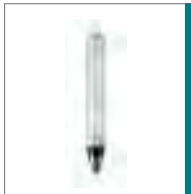

SOX

5.90



Master SOX-E

SPECIAL LAMPS

5.91



UV - Blacklight Blue

LIGHTING CONTROLS

STAND ALONE
CONTROLS

6.2

6.2

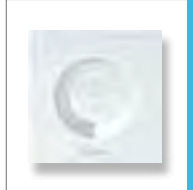

ToBeTouched

6.2



ToBeTouched

6.2



ToBeTouched

6.3



OccuSwitch DALI

6.4



Occuswitch –
LRM1070

ELECTRONIC CONTROL GEAR

ELECTRONIC
CONTROL GEAR

7.0

7.2



HF-Ri TD

7.4



HF Regulator
1-10V-D

7.5



HF Performer III

7.6



HF-Performer
Intelligent

7.7



HID-PrimaVision
Mini

7.8



HID-AspiraVision
and PrimaVision

7.9



HID PrimaVision
Medium Wattage

7.10



HID PrimaVision
Xtreme for CPO

7.11



ET-S Halogen
Transformer





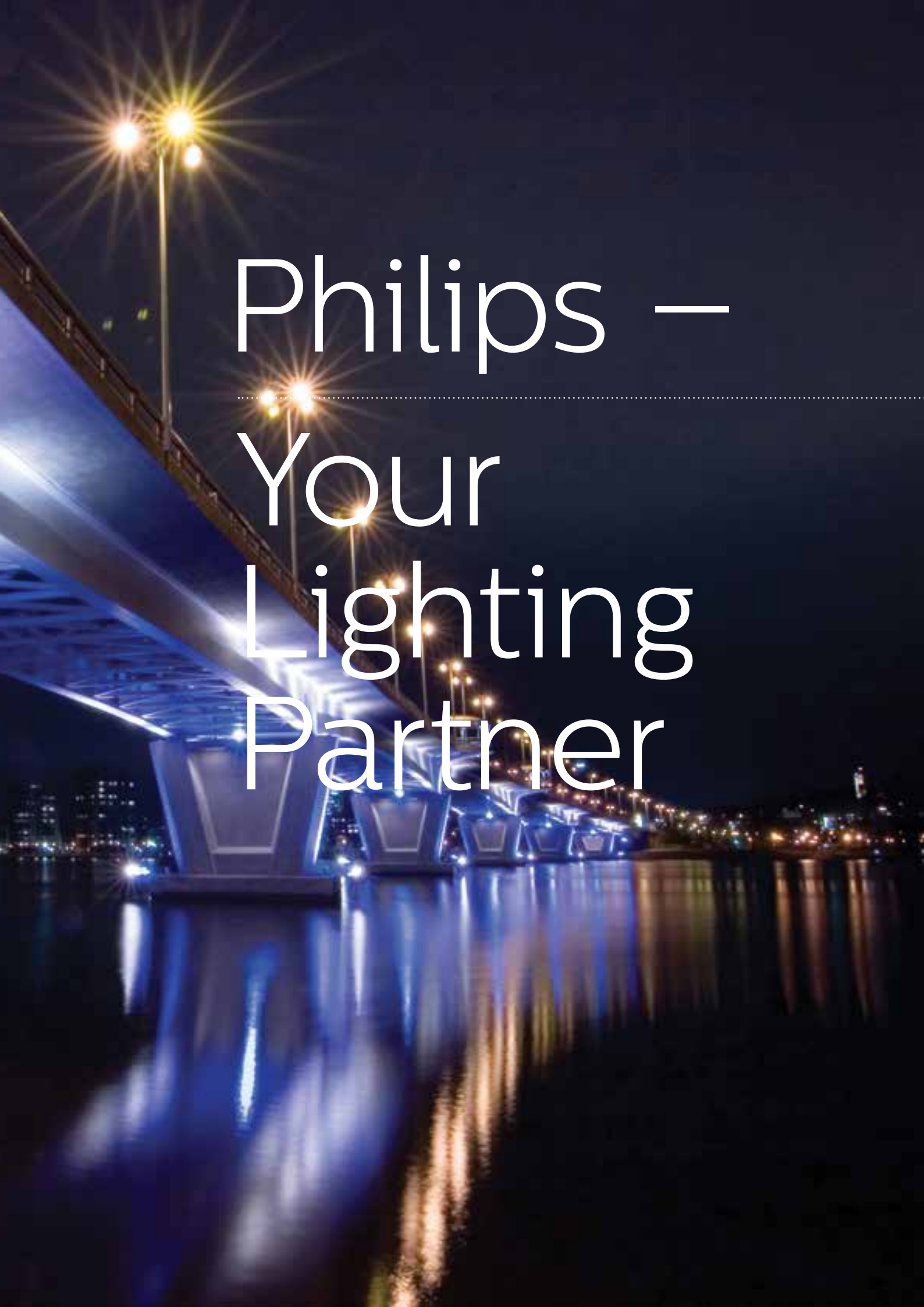

Philips –
Your
Lighting
Partner

Philips Companies



Dynalite

Philips Dynalite is synonymous with the creation of sophisticated, simple, reliable and energy-efficient lighting control solutions for a wide range of industry sectors, including residential, custom installation, offices, retail, hospitality and public spaces. An industry leading innovator for over 20 years, Philips Dynalite is the solution of choice for a wide range of 'smart home', energy management and architectural lighting control applications. Philips Dynalite solutions blend high-level functionality with dramatic aesthetic sustainability to enable and enhance our lives.

Phone: 0800 4 LIGHT
Email: nz.lighting@philips.com
Website: www.philips.com/dynalite



ColorKinetics

Philips ColorKinetics transforms environments through dynamic and innovative uses of light. Our award-winning LED lighting systems, lighting controllers, and custom lighting solutions reinvent light as a highly efficient, long lasting, environmentally friendly, and inherently digital source of illumination.

Phone: 0800 4 LIGHT
Email: nz.lighting@philips.com
Website: www.colorkinetics.com



Selecon

The passion for performance is the philosophy behind every luminaire manufactured by Philips Selecon. We offer lighting designers the tools to light the 'theatre of life' utilising innovative materials and design principals, and the latest lamp sources including LED, metal halide and tungsten halogen. Our luminaires are designed for entertainment applications, theatres, themed environments, convention centres, retail applications, museums and art galleries.

Where our light falls experiences are made.
Website: www.seleconlight.com





Philips – Your Lighting Partner

As the world's leader in Lighting, Philips is driving the switch to energy-efficient lighting solutions. Philips provides a unique combination of advanced technologies, which include LED systems, lamps, drivers, optics, luminaires, lighting controls and accessories, as well as the supporting tools to help you apply them.

Here are a few examples of how we can work with you and support the New Zealand lighting industry.



Design and Project Support

The Philips Lighting projects team can provide consultation, guidance, and support with projects featuring lighting. This includes solutions for office, retail, industrial, commercial, institutional, sports facilities, city beautification and more.

Our experienced team can help you at every step of the way with lighting project management.

- Latest technology and innovations
- Energy efficient and sustainable lighting
- Total cost of ownership tools and comparisons
- Lighting design featuring the latest software
- Pricing and delivery
- After sales support



Online Training

Looking for in-depth personal training? – Try our Philips Lighting online training course.

Start with the fundamentals, and work your way through luminaires, lamps, and gear products, covering technologies, benefits and applications. The Philips Lighting University aims to grow your lighting knowledge at your own pace in a lively interactive environment.

Sustainability

By 2050 it is estimated there will be 9 billion people living on Earth. Sustainable development for Philips means enabling all mankind to live healthy and well within the ecological carrying capacity of our planet.

Philips has a long sustainability history stretching all the way back to our founding fathers. In 1994 we launched our first program and set sustainability targets for our own operations. In 1998, we launched our first EcoVision program focused on operations and products showing energy saving characteristics and minimising hazardous materials in products and packaging. We also started to focus on sustainability in our supply chain in 2003. In 2010 we extended our scope further by including the social dimension of products and solutions, which is now reflected in our renewed company vision stating that we strive to make the world healthier and more sustainable through innovation. Our goal is to improve the lives of 3 billion people a year by 2025.



Philips Online

By its very nature, a printed catalogue like this represents the situation at a given moment in time.

For the very latest details on our extensive range of innovative lighting solutions and products, please check our website at www.philips.co.nz/lighting

- eCatalogue
- New products
- Project planners
- Application information and trends
- Case studies



Lighting Hub iPad app



facebook.com/philiphomeinspirations



Innovations in Light



@PhilipsLight

In addition, sign up for our e-newsletters via the Philips website for the latest in Philips' news and product innovations.



A photograph of a modern office interior, viewed from a low angle looking up at the ceiling. The ceiling features a grid of recessed lighting fixtures, some of which are illuminated, casting a warm glow. The lighting fixtures are arranged in a grid pattern, and the overall scene is bathed in a soft, ambient light. The text "Professional Luminaires" is overlaid in white, sans-serif font, centered on the image. A horizontal dotted line is positioned above the text.

Professional Luminaires







PowerBalance 2.0

The latest LED office luminaires can achieve energy savings of up to 55% compared to conventional Philips T5 fittings, as well as reduced operational costs. At Philips, we've designed our PowerBalance luminaire with all the above factors in mind. Combined with a rated lifetime of up to 50,000 hrs @ L70, the PowerBalance offers impressive energy savings resulting in reduced operational costs, trumping its conventional T5 predecessors.



Features and Benefits

- Advanced LED technology, offering very high efficiency and long lifetime.
- Smart Pyramid Optics (SPO), ensuring excellent light control.
- Choice of 4 lumen packages with 4000K colour temperature, ideal for office applications.
- System efficacy of up to 125lm/W.
- Comes standard with Dali (PSD) dimming drivers and Flex and Plug excluding 25/S



Product ID	L (mm)	W (mm)	H (mm)
W300L1200	1197	297	75
W600L600	597	597	75

Dimensions in mm (Nominal)

POWERBALANCE 2.0			
Family name	PowerBalance 2.0	Driver	Integrated DALI driver
Model	RC600B	Dimmable	Compatible with DALI controllers
Lumen/ Watt	20W/ 2500lm 26W/ 3100lm 29W/ 3500lm 36W/ 4000lm	Installation	T-rail recessed mounting
Correlated Colour Temperature (CCT)	4000K 3000K (available on request)	IP rating	IP20
Colour Rendering Index (CRI)	≥80	Weight	6.5Kg
Flex and Plug	Yes	Colour of housing	Housing: post-painted steel. Optics: plastic
Lifetime (L70)	50,000hrs	Application	Offices, Healthcare, Department stores
Unified Glare Ratio (UGR)	15 (average)	Accessories	Plaster mounting kit Seismic Restraint Kit available on request
Optics	Smart Pyramid Optics (SPO)		



PowerBalance 2.0 continued

DESCRIPTION	TRADE PRICE
RC600B LED25S/840 PSU W30L120	\$385.00
RC600B LED25S/840 PSU W60L60	\$385.00
RC600B LED31S/840 PSD W30L120 CAU	\$412.50
RC600B LED31S/840 PSD W60L60 CAU	\$412.50
RC600B LED35S/840 PSD W30L120 CAU	\$412.50
RC600B LED35S/840 PSD W60L60 CAU	\$412.50
RC600B LED40S/840 PSD W30L120 CAU	\$412.50
RC600B LED40S/840 PSD W60L60 CAU	\$412.50



SmartPanel LED 2.0

Philips SmartPanel is an affordable LED lighting solution for general office areas, providing energy savings of up to 30% compared with similar output Philips T5 fittings.

With its ultra-slim design, Philips SmartPanel is suitable for both recessed and suspended applications to cater to all tastes and trends. Featuring a side-lit LED and high quality light guide, Smart Panel creates a uniform and clean look for any office application.

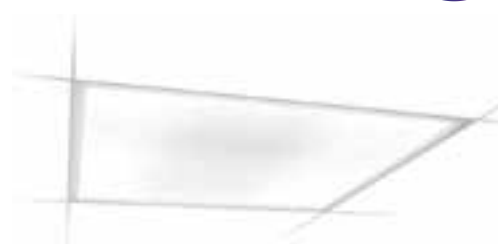

Features and Benefits

- High System efficacy: 80lm/W for neutral white 4000K.
- Improved working environment: High colour rendering (CRI \geq 80); Excellent lighting uniformity.
- Slim housing design: 14mm for housing height. 55mm with the driver height considered.

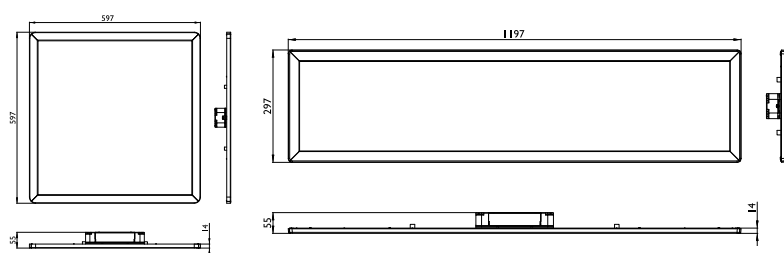

Product ID	L (mm)	W (mm)	H (mm)
RC160V Square	597	597	14/55
RC160V Rectangle	1197	297	14/55
Dimensions in mm (Nominal)			(H – including driver)

SMARTPANEL LED

Family name	RC160V
Lumen/Watt	2600lm/31W 3400lm/40W
Colour temp	Warm white 3000K / Neutral white 4000K
Colour Rendering Index (CRI)	\geq 80
Flex and Plug	Available on request
Lifetime (L70)	50,000 hrs
UGR	\leq 23
Louvre/Optics	Light guide with diffuser
Driver	Integrated driver

*specifications may vary between models

Dimmable	PSD option is compatible with DALI controllers
Installation	T-rail recessed mounting Suspended: Individual; suspended mounting with steel-wire-suspension kit (optional) with power cord
Classification/IP rating	IP20
Weight (kg)	4.2 kg
Colour/Materials	Housing: Steel with plastic frame Light guide: PMMA Driver housing: Polycarbonate Trim Colour: White
Application	General lighting, Offices, Schools
Accessories	Suspension mounting kit (RC160Z SMS PSU/ RC160Z SMS PSD) Surface mounting kit (RC160Z MB-SURF SQR/ RC160Z MB-SURF REC) Plaster mounting kit Seismic Restraint Kit available on request



SmartPanel LED 2.0 continued

DESCRIPTION	TRADE PRICE
RC160V LED25S/840 PSU W60L60	\$247.50
RC160V LED34S/840 PSU W60L60	\$258.50
RC160V LED34S/840 PSD W60L60	\$324.50
RC160V LED25S/840 PSU W30L120	\$286.00
RC160V LED34S/840 PSU W30L120	\$302.50
RC160V LED34S/840 PSD W30L120	\$352.00
RC160Z SMS PSU	\$44.00
RC160Z SMS PSD	\$44.00



Coreview 2

The new Philips Coreview 2 indirect is a functional LED Luminaire designed for general lighting in office spaces. With the latest LED technology, it offers considerable savings in energy costs* while still delivering the required light output. The indirect lighting from the Coreview 2 adds to the visual comfort of working environments without compromising on light quality or efficiency.



*Compared to traditional Philips fluorescent troffers

Features and Benefits

- Indirect light source that offers a soft and uniform light.
- High system efficacy of 85 lm/W.
- Great performance & reliability - CRI >80, SDCM 4, 50,000hrs L70.
- Simple design - Elegant appearance available in 600x600, 1200x300 & 1200x600 options.

Applications

- Open plan offices
- Cell offices
- Meeting and training rooms

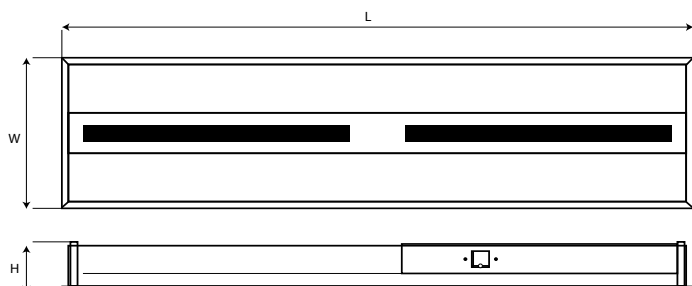

Product ID	L (mm)	W (mm)	H (mm)
RC420B LED 35/S W30L120	1197	297	121
RC420B LED 35/S W60L60	597	597	121
RC420B LED 35/S W60L120	1197	597	121
RC420B LED 50/S W60L120	1197	597	121

Dimensions in mm (Nominal)

COREVIEW 2

Type	RC420B
Power	44W for 3800 lm 56W for 4900 lm
Luminous flux	RC420 35/S W30 L120 (3800 lumens) RC420 35/S W60 L60 (3800 lumens) RC420 35/S W60 L120 (3800 lumens) RC420 50/S W60 L120 (4900 lumens)
Correlated colour temperature	4000K (3000K available on request)
Colour Rendering Index (CRI)	≥80
Lifetime (L70)	50,000 hrs
Driver	Integrated
Mains voltage	100-240V/50-60HZ

Dimmable	Option available on request
Material	Housing frame: Steel Optical lens: PMMA
Colour	White
Optical cover	Light guide with diffuser
IP	20
Flex & Plug	Yes



Coreview 2 continued

DESCRIPTION	TRADE PRICE
RC420B LED 35/S W30L120	\$245.00
RC420B LED 35/S W60L60	\$245.00
RC420B LED 35/S W60L120	\$400.00
RC420B LED 50/S W60L120	\$400.00



CoreLine LED

CoreLine LED is a stylish range of high output LED luminaires suitable for general office and retail lighting applications. With a longlife LED platform, you can directly replace a conventional TL8 and TL5 fluorescent system and enjoy lower maintenance costs.



Features and Benefits

- Up to 90 lm/W system efficacy with significant energy savings over traditional TL8 and TL5 systems.
- Comfortable light with minimal glare creates an improved working environment.
- Easy to install.
- Long lifetime, Lumen maintenance of 50,000 hours (L70).

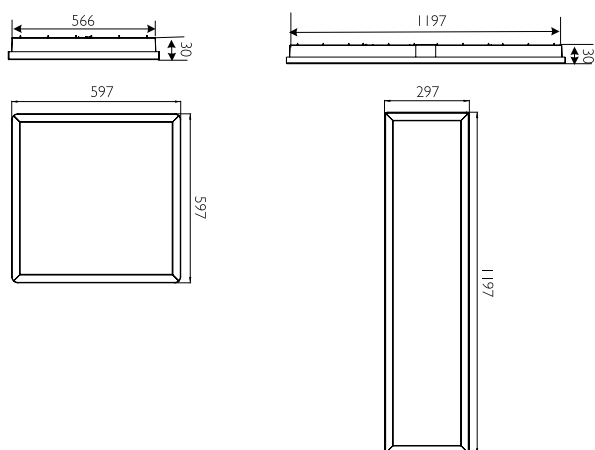

Product ID	L (mm)	W (mm)	H (mm)
RC100C Rectangle	1197	297	30
RC100C Square	597	597	30

Dimensions in mm (Nominal)

CORELINE LED

Family Name	Coreline	Installation	T-rail recessed mounting
Model	RC100C - Recessed ver.	Classification/IP rating	IP20
Lumen/ Watt	2600lm/31W 3700lm/41W	Weight (kg)	3.0
Lamp Colour	4000K (3000K available on request)	Colour/Materials	Housing: Steel Light cover: Polycarbonate Driver box: Steel
Colour Rendering Index (CRI)	≥80	Application	General lighting, Office, Corridors, Retail
Lifetime (L70)	50,000 Hours	Accessories	Plaster ceiling kits Seismic Restraint Kit available on request
UGR	19 - square version 22 - rectangle version		
Louvre/Optics	Light guide with diffuser		
Driver	Integrated driver		
Dimmable	DALI or 0 - 10v options		



CoreLine LED continued

DESCRIPTION	TRADE PRICE
RC100C LED25S/840 PSU W30L120 SM4	\$258.50
RC100C LED25S/840 PSU W60L60 SM4	\$258.50
RC100C LED35S/840 PSU W30L120 SM4	\$309.38
RC100C LED35S/840 PSU W60L60 SM4	\$309.38
RC100C LED35S/840 PSD W30L120 SM4	\$426.25
RC100C LED35S/840 PSD W60L60 SM4	\$426.25



SmartBright LED Troffer

When you need to provide energy efficient and reliable LED lighting on a budget, the range of SmartBright LED Troffers is the perfect solution.

The unobtrusive, elegant design blends seamlessly into any commercial décor. The SmartBright Troffer can be used in a range of indoor applications, including offices and administration areas.

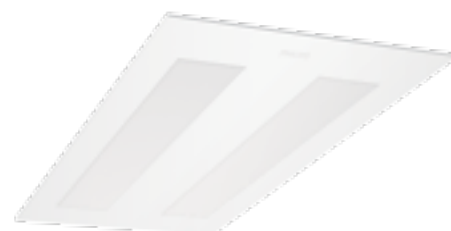

Features

- Up to 90 lm/W system efficacy with significant energy savings that gives up to 50% energy saving when compared to a conventional Philips traditional TL8 or TL5 system.
- CRI 80 provides good colour consistency that's easy on the eye.
- Entry level LED pricing makes this the perfect fit when budgets are tight and TCO is short.
- The simple design is suitable for offices and a variety of commercial applications. The traditional 1200 x 600, 600 x 600 and 1200 x 300mm sizes suit most Tee-rail ceiling grids.

- 25,000hrs @ L70
- 4600, 2200 lumens
- 4000K
- T-Rail ceilings
- CRI ≥80

Applications

- Offices
- Education
- General commercial applications
- Accessory - Seismic Restraint Kit available on request. PHSEKIT

DESCRIPTION	TRADE PRICE
RC0888 LED23S/840 PSU W60L60 PLS	\$214.50
RC0888 LED23S/840 PSU W30L120 PLS	\$214.50
RC0888 IED46S/840 PSU W60L120 PLS	\$324.50

Product ID	W (mm)	H (mm)
RC0888 LED23S/840 PSU W60L60 PLS	597	597
RC0888 LED23S/840 PSU W30L120 PLS	1197	297
RC0888 IED46S/840 PSU W60L120 PLS	1197	597

Dimensions in mm (Nominal)

Sereno TBS 528

The Philips TBS 528 is a range of recessed TL5 luminaires that feature superior optics with Philips patented 3 Dimensional Omni-directional Luminance Control (OLC). This feature provides excellent performance in terms of efficiency, uniformity and glare.



Main Applications:

- Conference rooms, Retail and department stores, Schools, Childcare services.
- Service Areas (Restaurant, Cafes) Reception and public service areas.
- General Office areas and corridors .

Optic:

- M8: Micro comfort optic, Matt finish, LOR up to 64%.

Main Features:

- Quick external connection without having to remove louvres.
- Easy replacement of lamps, only have to remove 1 reflector by means of V-clips (NEW).
- Ultra Flat only 47mm deep .
- Perforated infill panel to match the look and feel of suspended tiles.
- Actilume model offers integrated controls to offer even greater efficiency.

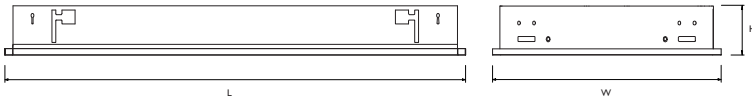

Product ID	L (mm)	W (mm)	H (mm)
3 x TL5-14W	595	595	47
2 x TL5-28W	1195	295	47
2 x TL5-28W WV	1195	595	47
3 x TL5-28W	1195	595	47

Dimensions in mm (Nominal)

Sereno TBS 528 continued

TBS528			
Family name	TBS528	Louvre/Optics	TBS528 – Micro Comfort Optic – Matt Finish
Lamp types	3 x 14W 2 x 28W 2 x 28W WV 3 x 28W	Gear/Ballast	HFP – High Frequency Performer
Lamps included	No (available on request)	Dimmable	DALI/Actilume on request
Flex and Plug	No (available on request)	Installation	T-rail recessed mounting
Office compliant/ UGR	17	Classification/IP rating	IP20
		Colour/Materials	Housing: Post painted sheet steel in white
		Accessories	Plaster mounting kit Seismic Restraint Kit available on request

SHORTCODE	DESCRIPTION	TRADE PRICE
TBS528228M8V2	TBS528 2xTL5-28W HFP M8 FU IPP 2	\$335.53
TBS528228M8WV2	TBS528 2xTL5-28W HFP WV M8 FU IPP 2	\$419.27
TBS528314M8V2	TBS528 3xTL5-14W HFP M8 FU IPP 2	\$319.94
TBS528328M8V2	TBS528 3xTL5-28W HFP M8 FU IPP 2	\$427.35



SmartBalance LED

SmartBalance is clearly the next step in surface-mounted and suspended luminaires for the specification market. It not only offers increased energy efficiency compared to similar Philips T5 fittings, but is also visually appealing without being intrusive. And its design helps to minimize clutter on the ceiling and meets all relevant office norms.



Features and Benefits

- Perfect combination of innovative design and performance.
- Energy efficacy of up to 90 lm/W.
- Compact, lightweight and unobtrusive.
- Office compliant – UGR 19 and two levels of L65, namely 1500/3000 cd/m².
- Aesthetic and novel design with visually better ceiling integration.
- Wireless DALI-controllable lighting options available.
- Direct and indirect lighting options available to create the right light levels for visual comfort and performance.
- Connect up to 3 luminaires with coupling accessories.

SM480C



Product ID	L (mm)	W (mm)	H (mm)
SM480C	1340	240	52
SP480P/ SP482P	1340	240	50
Dimensions in mm (Nominal)		(H – including driver)	

SP480P/SP482P

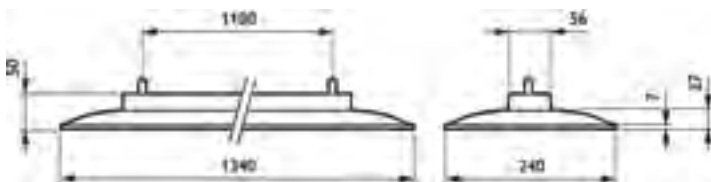



SmartBalance LED continued

SMARTBALANCE LED		Driver	Integrated driver
Family name	SmartBalance	Dimmable	Fixed output and DALI compatible
Model	SM480C - Surface SP480P - Suspended SP482P - Direct/Indirect Suspended	Installation	Surface and Suspended mounting
Lumen/Watt	ACC-MLO: 3500lm/ 40W AC/PC-MLO: 3000lm/ 41W Dir/Indir: 4050lm/ 48W	IP rating	IP40
Correlated Colour Temperature (CCT)	3000K, 4000K	Weight	SM480C - 4.5kg SP480P - 4.65kg SP482P - 4.55kg
Colour Rendering Index (CRI)	80	Colour of housing	White, Silver
Lifetime (L70)	50,000hrs	Application	Retail, Hospitality, Offices, Schools
Unified Glare Ratio (UGR)	19	Accessories	Coupling pieces (SP480Z CP WH, SP480Z CP SI)
Optics	AC-MLO: OLC micro-lens optic made of acrylic cover ACC-MLO: OLC micro-lens optic made of clear acrylic cover PC-MLO: OLC micro-lens optic made of polycarbonate		

DESCRIPTION	TRADE PRICE
SM480C LED30S/830 PSD W24L134 AC-MLO PI	\$800.00
SM480C LED30S/840 PSD W24L134 AC-MLO PI	\$800.00
SM480C LED35S/830 PSD W24L134 ACC-MLO PI	\$800.00
SM480C LED35S/840 PSD W24L134 ACC-MLO PI	\$800.00
SP480P LED30S/830 PSD W24L134 AC-MLO SM2	\$820.00
SP480P LED30S/840 PSD W24L134 AC-MLO SM2	\$820.00
SP480P LED35S/830 PSD ACC-MLO SM2 PI	\$820.00
SP480P LED35S/840 PSD ACC-MLO SM2 PI	\$820.00
SP482P LED40S/840 PSD W24L134 AC-MLO SM2	\$850.00
SP482P LED40S/830 PSD W24L134 AC-MLO SM2	\$850.00
SP482P LED40S/830 PSD ACC-MLO SM2 PI	\$850.00
SP482P LED40S/840 PSD ACC-MLO SM2 PI	\$850.00

DESCRIPTION	TRADE PRICE
SM480C LED30S/830 PSD W24L134 PC-MLO PI	\$820.00
SM480C LED30S/840 PSD W24L134 PC-MLO PI	\$820.00
SP480P LED30S/840 PSD PC-MLO SM2 PI SI	\$895.00
SP482P LED40S/830 PSD W24L134 PC-MLO SM2	\$895.00
SP482P LED40S/840 PSD W24L134 PC-MLO SM2	\$895.00



LumiStone LED

LumiStone is a LED luminaire consisting of two smaller ellipses rather than the traditional single voluminous piece. The ellipses have soft curvatures and resemble smooth stones found in nature. The flexible light effects created with direct and indirect light make LumiStone the perfect choice for inspiring lighting designs. Thanks to its cutting edge LED technology, LumiStone is also energy efficient.



Features and Benefits

- Inspiring design with elliptical modules.
- Creates a truly inspiring environment with appealing design and indirect lighting.
- Up to 50% energy savings compared to a functional Philips T5 luminaire.
- Many variations thanks to innovative mounting options.
- Choice of direct and direct/indirect lighting.
- Office compliant for use in all office spaces.

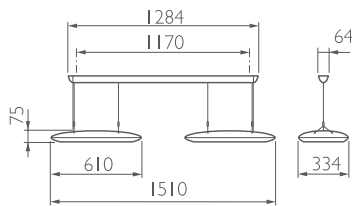

Product ID	L (mm)	W (mm)	H (mm)
SP524P/ SP526P	1510	334	75

Dimensions in mm (Nominal)



LumiStone LED continued

LUMISTONE LED			
Family name	LumiStone	Driver	Integrated driver
Model	SP524P - Direct SP526P - Direct/ Indirect	Dimmable	Fixed output and DALI compatible
Lumen/Watt	SP524P - Direct 4000lm/ 40W (3000K) 4000lm/ 38W (4000K) SP526P - Direct/ Indirect 3000lm/ 31W (3000K) 3000lm/ 29W (4000K)	Installation	Suspended mounting
Correlated Colour Temperature (CCT)	3000K, 4000K	IP rating	IP40
Colour Rendering Index (CRI)	≥80	Weight	SP524P - 6.15kg SP526P - 6.25kg
Lifetime (L70)	50,000hrs	Colour of housing	White
Unified Glare Ratio (UGR)	19	Application	Retail, Hospitality, Offices
Optics	Poly-carbonate LED cup	Accessories	Coupling pieces (SP480Z CP WH, SP480Z CP SI)
		Suspension Height - min/max	Between 20 and 150 cm from ceiling bar, cable stored in bar

DESCRIPTION	TRADE PRICE
SP520P 2xLED15S/830 PSD-E SMTT GR	\$1,000.00
SP520P 2xLED15S/830 PSD-E SMTT WH	\$1,000.00
SP520P 2xLED15S/840 PSD-E SMTT GR	\$1,000.00
SP520P 2xLED15S/840 PSD-E SMTT WH	\$1,000.00
SP522P 2xLED20S/830 PSD-E SMTT GR	\$1,075.00
SP522P 2xLED20S/830 PSD-E SMTT WH	\$1,075.00
SP522P 2xLED20S/840 PSD-E SMTT GR	\$1,075.00
SP522P 2xLED20S/840 PSD-E SMTT WH	\$1,075.00
SP524P 2xLED15S/830 PSD DCB GR	\$1,000.00
SP524P 2xLED15S/830 PSD DCB WH	\$1,000.00
SP524P 2xLED15S/840 PSD DCB GR	\$1,000.00
SP524P 2xLED15S/840 PSD DCB WH	\$1,000.00
SP526P 2xLED20S/830 PSD DCB GR	\$1,075.00
SP526P 2xLED20S/830 PSD DCB WH	\$1,075.00
SP526P 2xLED20S/840 PSD DCB GR	\$1,075.00
SP526P 2xLED20S/840 PSD DCB WH	\$1,075.00



Celino LED

Celino LED is a complete luminaire range that reflects the market trend towards miniaturisation and architectural integration, while delivering a significant advance in optical performance. Made of natural anodised aluminium, the housing of Celino LED is a mere 71mm wide and has die cast-aluminium end caps.



Features and Benefits

- Compliance with latest office - lighting norm.
- Complete luminaire range that reflects the trend to miniaturisation and architectural integration.
- Excellent optical performance: optical covers for optimum visual comfort and efficiency.
- Inspiring: aesthetical and novel design with visually better ceiling integration.
- Comfort: spacious and pleasant environment with comfortable lighting appearance.
- Efficient: high efficacy achieved with optics innovation.
- Luminaires can be coupled together to provide a continuous line (use ZPS680 coupler).

BCS680 W17L122

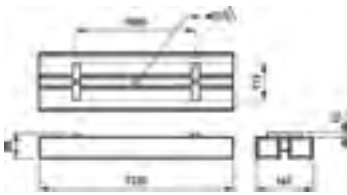

BPS680 W17L122

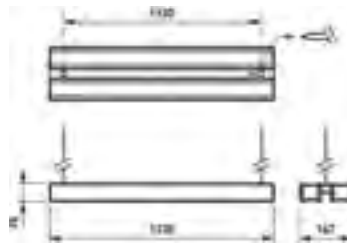

BCS680 W7L120

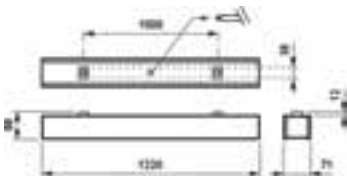

BPS680 W7L120

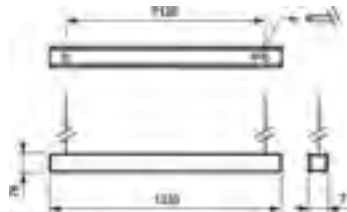

Product ID	L (mm)	W (mm)	H (mm)
BCS680 W7L120	1220	71	88
BPS680 W7L120	1220	71	76
BCS680 W17L122	1220	167	88
BPS680 W17L122	1220	167	76

Dimensions in mm (Nominal)



Celino LED continued

CELINO LED		Driver	Integrated driver
Family name	Celino LED	Dimmable	Fixed output and DALI compatible
Model	BCS680 – Surface BPS680 – Suspended	Installation	Surface and Suspended mounting Continuous Line option available on request
Lumen/Watt	LED 24: LIN-PC 2400lm/32W MLO-PC 1950lm/32W O-PC 2150lm/32W LED 48: LIN-PC 4200lm/50W MLO-PC 3400lm/50W O-PC 3750lm/50W	IP rating	IP40
Correlated Colour Temperature (CCT)	3000K, 4000K	Weight	W7L120 – 4.2kg W17L120 – 7.8kg
Colour Rendering Index (CRI)	≥80	Colour of housing	Housing: natural anodised aluminium, End caps: die-cast aluminium
Lifetime (L70)	50,000hrs	Application	Retail, Hospitality, Offices, Healthcare
Unified Glare Ratio (UGR)	19		
Optics	LIN-PC: OLC micro-lens optic in polycarbonate cover MLO-PC: OLC micro-lens optic in polycarbonate cover O – PC		

DESCRIPTION	TRADE PRICE
BCS680 C LED24/840 PSU W7L120 LIN-PC	\$360.00
BCS680 C LED24/840 PSU W7L120 MLO-PC	\$380.00
BCS680 C LED24/840 PSU W7L120 O-PC	\$360.00
BCS680 C LED48/840 PSU W17L120 LIN-PC	\$650.00
BCS680 C LED48/840 PSU W17L120 MLO-PC	\$700.00
BCS680 C LED48/840 PSU W17L120 O-PC	\$650.00
BPS680 C LED24/840 PSU W7L120 LIN-PC	\$380.00
BPS680 C LED24/840 PSU W7L120 MLO-PC	\$400.00
BPS680 C LED24/840 PSU W7L120 O-PC	\$380.00
BPS680 C LED48/840 PSU W17L120 LIN-PC	\$700.00
BPS680 C LED48/840 PSU W17L120 MLO-PC	\$720.00
BPS680 C LED48/840 PSU W17L120 O-PC	\$700.00
ZPS680 COUPLER GD	\$20.00



CoreLine LED (Surface Mount)

CoreLine LED is a stylish range of high output LED luminaires suitable for general office and retail lighting applications. With a longlife LED platform, you can directly replace a conventional Philips TL8 and TL5 fluorescent system and enjoy lower maintenance costs.



Features and Benefits

- Up to 90 lm/W system efficacy with significant energy savings over traditional Philips TL8 and TL5 systems.
- Comfortable light with minimal glare creates an improved working environment.
- Easy to install.
- Long lifetime LED Lumen maintenance of 50,000 hours (L70).

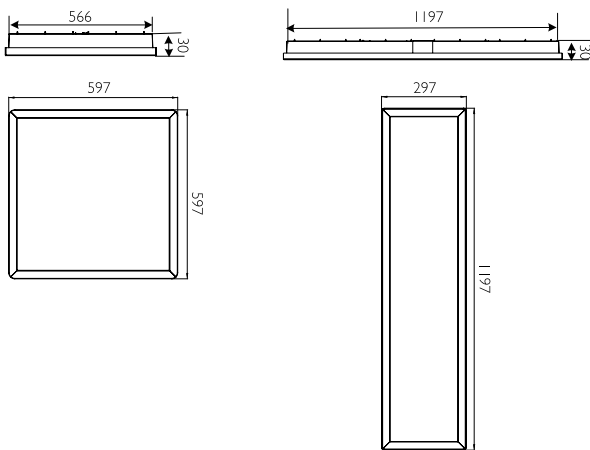

Product ID	L (mm)	W (mm)	H (mm)
SM100C Rectangle	1197	197	40
SM100C Square	597	597	40

Dimensions in mm (Nominal)

CORELINE LED (SURFACE MOUNT)

Family Name	Coreline	Installation	Surface Mounted
Model	SM100C - Surface Mounted Version	Classification/IP rating	IP20
Lumen/ Watt	2600lm/31W 3700lm/41W	Weight (kg)	4.4
Lamp Colour	4000K (3000K available on request)	Colour/Materials	Housing: Steel Light cover: Polycarbonate Driver box: Steel
Colour Rendering Index (CRI)	≥80	Application	General lighting, Office, Corridors, Retail
Lifetime (L70)	50,000 Hours	Accessories	Plaster ceiling kits Suspension kit
UGR	19 - square ver 22 - rectangle ver		
Louvre/Optics	Light guide with diffuser		
Driver	Integrated driver		
Dimmable	DALI or 0 - 10v options		



CoreLine LED (Surface Mount) continued

DESCRIPTION	TRADE PRICE
SM100C LED25S/840 PSU W60L60	\$291.50
SM100C LED25S/840 PSU W20L120	\$291.50
SM100C LED35S/840 PSU W60L60	\$309.38
SM100C LED35S/840 PSU W20L120	\$309.38
SM100C LED35S/840 PSD W60L60	\$426.25
SM100C LED35S/840 PSD W20L120	\$426.25
RC100C Suspension Sets	\$75.00



CoreLine Trunking

CoreLine Trunking solution offers a continuous line of light, creating uniformity across the intended space. The product is easy to install, with a simple starter pack per line of light, and easy access via a clever mount and clip device. The product is available in multiple lumen packages and lengths, as well as DALI dimmable option. The latest LED technology now means we can achieve 100 lm/w system efficacy, whilst achieving long lifetime of up to 50,000 hours (L70). This product is suitable for many applications, especially retail and industry application.



Features and Benefits

- Up to 54% more efficient than average conventional Philips Trunking systems, with 100 lm/W system efficiency.
- Functional design with 4 dedicated beam shapes (Wide, Narrow, Medium, Double Asymmetric).
- Dimmable (DALI) for even more energy savings potential.
- Comfortable light with up to 8000 lumens per 1.7m.
- Highlights merchandise with a 'sparkling' effect.
- One volume architecture for fast installation.

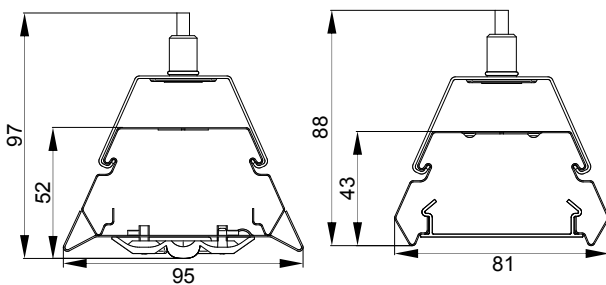

Product ID	Depth (mm)	Height (mm)	Length (mm)
LL120X	95	97	3450
LL121X	95	97	1725

Dimensions in mm (Nominal)

CORELINE TRUNKING

Family Name	CoreLine Trunking	Installation	Surface/ Suspension Wire
Model	LL120X - 3.4m LL121X - 1.7m	IP rating	IP20
Lumen/ Watt	4500 lm / 45W (1.7m) 9000 lm / 90W (3.4m) 8000 lm / 80W (1.7m) 16,000 lm / 160W (3.4m)	Weight	3400mm - 7.5kg 1700mm - 4.5kg
CCT	4000K (3000K available on request)	Colour of housing	White
Colour Rendering Index (CRI)	>80	Application	Industry, Retail
Flex and Plug	5 or 7 wire connection	Accessories	Surface/ Suspension Mounting Bracket Starter Kit per aisle of light - Incl. starting and end cap, connector to mains, and first suspension Alternative accessories on request
Lifetime (L70)	50,000hrs	Suspension Height - min/max	3m/ 12m
Unified Glare Ratio (UGR)	n/a	Maximum Run Length	NA
Optics	NB/ MB/ WB/ DA30		
Driver	Philips Xitanium Driver		
Dimmable	PSU (Fixed), or PSD (Dali)		

*Price on application.



Clean Room LED

The Philips Cleanroom range of LED luminaires are designed specifically for facilities where hygiene is of prime importance. They're dust free and easy to clean, and meet the relevant lighting requirements and norms.

Teardrop LED CR385

The Philips Teardrop LED CR385 is suitable for 10 to 1000 Class cleanroom facilities. Using the latest LED technology, the Teardrop delivers energy performance beyond fluorescent options. With the Teardrop LED CR385 you can expect up to 50,000 hours of maintenance-free operation.



LED Hygeia CR418

The new Hygeia CR418 has a streamlined shape that minimises dust gathering and disturbed airflow. It incorporates the latest Philips LED Line platform technology for outstanding energy efficiency and light performance. The low operational cost over the total lifetime of the luminaire means the CR418 provides you with an excellent return on investment. It's lighter than previous models too, making it quick and easy to install.



Features and Benefits

- Suitable for 1000 to 10,000 class cleanrooms for CR385 model or 1000 to 100,000 for CR418 models.
- Greater than 90 lumens per watt.
- Easy to install.
- 50,000 hours (L70).
- IP40 with smooth,easy to clean surface.
- Simple shapes that help minimise the disturbed airflow and duct gathering.

Model	Length (mm)	Width (mm)	Height (mm)
CR385	1200	60	110
CR418B	1198	148	65
CR418C	1200	150	65

Dimensions in mm (Nominal)



Clean Room LED continued

CLEAN ROOM LED				
Family Name	Cleanroom Teardrop Cleanroom Hygeia		Optics	High Transmisson PMMA
Lumen/Watt	1880lm/20W	CR385C LED20	Driver	Xitanium LED driver
	3725lm/40W	CR385C LED40	Dimmable	N
	2655lm/40W	CR385C LED40Y	Installation	Surface and Recessed
	3800lm/40W	CR418B LED40	IP Rating	IP40
	7200lm/80W	CR418B LED80	Weight	2.6kg 4.5kg
	4700lm/80W	CR418B LED80Y	Colour of Housing	White
	3800lm/40W	CR418C LED40	Application	Electronic, Pharmaceutical, Healthcare, Food and Beverage
	7200lm/80W	CR418C LED80	Accessories	Nil
	4700lm/80W	CR418C LED80Y		
Colour Rendering Index (CRI)	≥80 Yellow > 520nm			
Flex and plug	No			
Lifetime (L70)	50,000hrs			
United Glare Ration (UGR)	N/A			

DESCRIPTION	TRADE PRICE
RECESSED	
CR418B LED40/NW	\$250.00
CR418B LED80/NW	\$330.00
SURFACE	
CR418C LED40/NW	\$250.00
CR418C LED80/NW	\$330.00
TEARDROP	
CR385C LED20/NW	\$140.00
CR385C LED40/NW	\$160.00



GreenPerform LED Batten

The Philips GreenPerform LED Batten is a high quality LED batten that's at home in a variety of applications, from warehouses to corridors and storage spaces. The high system efficacy delivers significant energy savings of up to 50% as compared to conventional Philips T8 battens. The reliable and robust housing structure maximises the durability and contributes to the GreenPerform's long lifetime. With its flexible optics and mounting accessories, the GreenPerform LED Batten is suitable for symmetrical, asymmetrical, direct and indirect lighting applications.



Trunkable (diffused option shown)



Standalone (clear option shown)

Features and Benefits

- High system efficacy.
- Easy to install.
- Quality lighting with 100lm/W.
- Good colour uniformity and colour rendering index of 80.
- 50,000 hour lifetime @L70.

Applications

- Industry
- Corridors
- Supermarkets
- Storerooms
- Commercial

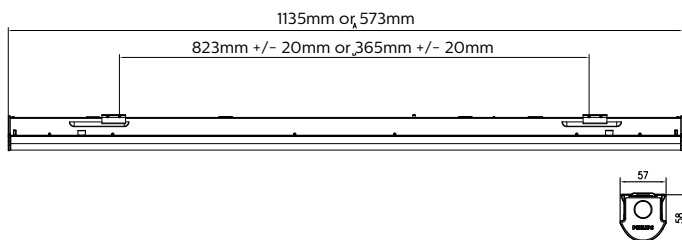

Product ID	L (mm)	H (mm)	W(mm)
BN208C (Standalone)	0.573mm	58mm	57mm
BN208C (Standalone)	1,135mm	58mm	57mm
BN209C (Trunkable)	1,135mm	58mm	57mm

Dimensions in mm (Nominal)

SHORTCODE	DESCRIPTION	TRADE PRICE
LEDBT4012S	BN208C LED40/NW L1200 S	\$247.50
LEDBT4012F	BN208C LED40/NW L1200 FR	\$258.50
LEDBT2012S	BN208C LED20/NW L1200 S	\$236.50
LEDBT2012S	BN208C LED20/NW L1200 FR	\$236.50
LEDBT206S	BN208C LED20/NW L600 S	\$192.50
LEDBT206F	BN208C LED20/NW L600 FR	\$192.50
LEDBT106S	BN208C LED10/NW L600 S	\$170.50
LEDBT106F	BN208C LED10/NW L600 FR	\$170.50
LEDBTT4012S	BN209C LED40/NW L1200 S	\$258.50
LEDBTT4012F	BN209C LED40/NW L1200 FR	\$258.50
LEDBTT2012S	BN209C LED20/NW L1200 S	\$236.50
LEDBTT2012F	BN209C LED20/NW L1200 FR	\$236.50

SHORTCODE	DESCRIPTION	TRADE PRICE
BY208Z MB-A	BY208Z MB-A	\$7.15
BY208Z MB-S	BY208Z MB-S	\$7.15
BY209Z MB-A	BY209Z MB-A	\$7.15
BY209Z MB-S	BY209Z MB-S	\$7.15
BY208Z SP	BY208Z SP	\$21.45
BY208Z TB	BY208Z TB	\$6.05
BY208Z C600-P	BY208Z C600-P	\$12.65
BY208Z C-2	BY208Z C-2	\$9.35
BY208Z C200-P	BY208Z C200-P	\$10.45



Core Range LED Batten

The Core Range LED batten combines the technology of the successful Greenperform batten range with the addition of 58W replacement models.

Using between 20 – 60W of power, there is up to 60% energy savings when compared to traditional Philips TL-D Fluorescent lamps. The Core Range has been developed for the New Zealand 58W market and provides both the contractor and end user with a wider range of options for general lighting needs.



Features and Benefits

- Designed for the NZ market.
- Choice of models for greater flexibility.
- Energy savings of up to 45% compared to Philips 2x 58W battens.
- Long lifetime - Up to 40,000 hrs @L70.

Applications

- Industry
- Corridors
- Supermarkets
- Storerooms
- Commercial

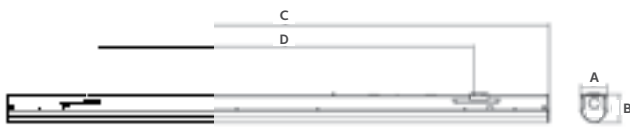

Dimension	A	B	C	D
2000/4000 lumen	57mm	58mm	1170mm	828+/-20mm
6000 lumen	57mm	58mm	1420mm	1126+/-20mm

Dimensions in mm (Nominal)

CORE RANGE LED BATTEN

Family Name	Core Range LED Battens
Lumen/Watt	2000 lm @ 4 FT 4000 lm @ 4 FT 6000 lm @ 5 FT
Temperature (CCT)	NW 4000/ CW 6500
Index (CRI)	≥80
Lifetime (L70)	40,000hrs
PF	>90
Input voltage	220-240V 50/60 HZ

Optics	Clear/Frost
Dimmable	NA
Installation	Surfaced (clips in pack) Standalone/Trunkable
Colour of Housing	White
Application	General/Commercial lighting



Core Range LED Batten continued

SHORTCODE	DESCRIPTION	TRADE PRICE
BN188LED40CWL1200C	BN188C LED40 CW ACC L1200 BR	\$145.00
BN188LED40NWL1200C	BN188C LED40 NW ACC L1200 BR	\$145.00
BN188LED60CWL1500C	BN188C LED60 CW ACC L1500 BR	\$195.00
BN188LED60NWL1500C	BN188C LED60 NW ACC L1500 BR	\$195.00
BN188LED40CWL1200OP	BN188C LED40 CW ACF L1200 BR	\$145.00
BN188LED40NWL1200OP	BN188C LED40 NW ACF L1200 BR	\$145.00
BN188LED60CWL1500OP	BN188C LED60 CW ACF L1500 BR	\$195.00
BN188LED60NWL1500OP	BN188C LED60 NW ACF L1500 BR	\$195.00
CORE RANGE LED BATTENS TRUNKABLE		
BN189LED40CWL1200C	BN189C LED40 CW ACC L1200 BR	\$145.00
BN189LED40NWL1200C	BN189C LED40 NW ACC L1200 BR	\$145.00
BN189LED60CWL1500C	BN189C LED60 CW ACC L1500 BR	\$195.00
BN189LED60NWL1500C	BN189C LED60 NW ACC L1500 BR	\$195.00
BN189LED40CWL1200OP	BN189C LED40 CW ACF L1200 BR	\$145.00
BN189LED40NWL1200OP	BN189C LED40 NW ACF L1200 BR	\$145.00
BN189LED60CWL1500OP	BN189C LED60 CW ACF L1500 BR	\$195.00
BN189LED60NWL1500OP	BN189C LED60 NW ACF L1500 BR	\$195.00



SmartBright LED Batten Gen2

SmartBright LED Batten G2 is an affordable replacement for Philips T5 indirect and direct lighting solutions, such as pelmet or cove lighting. The product comes in a variety of lengths, and an excellent lifetime of up to 30,000 hours (L70).



Features and Benefits

- Patented glass diffuser: Good heat conduction, no embrittlement, no yellowing.
- Long life time: 30,000 hours (L70).
- High energy-efficiency : 79 lm/W.
- Slim and narrow end cap designed for cove and shelf lighting.
- 5 lengths, 3 colours, flexible, mix and match.
- Kit includes 2-wire power supply, joiner cable, mounting clips.

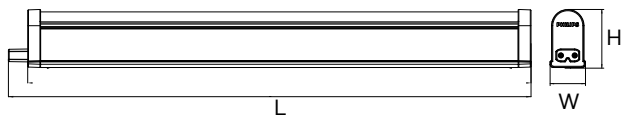

Product ID	Length (mm)	Height (mm)	Width (mm)
BN066C LED12/L1200	1185	36	22
BN066C LED10/L1000	999.5	36	22
BN066C LED9/L900	885	36	22
BN066C LED6/L600	585	36	22
BN066C LED3/L300	325	36	22

Dimensions in mm (Nominal)

SMARTBRIGHT LED BATTEN GEN2

Family Name	SmartBright LED Batten Gen2
Model	BN066C
Lumen/ Watt	1108lm / 14W 967lm / 12W 836lm / 10.8W 555lm / 7W 311lm / 4W
CCT	3000K, 4000K, 6500K
Colour Rendering Index (CRI)	≥80
Lifetime (L70)	30,000 Hrs
Abutted	Max 10 Pieces joined end to end
Optics	Diffused Glass

Driver	Integrated
Dimmable	PSU (Fixed)
Installation	Surface Mounted
IP rating	IP20
Colour of housing	White
Application	Shop Window, Cove, Shelf, Convenience Store, Freezer
Accessories	Mounting brackets, Connection cable, Hard wire cable

Flex & 2 Pin plug to order separately



SmartBright LED Batten Gen2 continued

SHORTCODE	DESCRIPTION	TRADE PRICE
BN066LED3WW300	BN066C LED3/WW L300 KIT	\$85.00
BN066LED3NW300	BN066C LED3/NW L300 KIT	\$85.00
BN066LED6WW600	BN066C LED6/WW L600 KIT	\$90.00
BN066LED6NW600	BN066C LED6/NW L600 KIT	\$90.00
BN066LED9WW900	BN066C LED9/WW L900 KIT	\$95.00
BN066LED9NW900	BN066C LED9/NW L900 KIT	\$95.00
BN066LED10WW1000	BN066C LED10/WW L1000 KIT	\$99.00
BN066LED10NW1000	BN066C LED10/NW L1000 KIT	\$99.00
BN066LED12WW1200	BN066C LED12/WW L1200 KIT	\$99.00
BN066LED12NW1200	BN066C LED12/NW L1200 KIT	\$99.00
BN066 Power Cable	ZCH086 CCPA CAU	\$7.95

Modella TCS125

The Philips TCS125 Modella is a luminaire designed for both TL-D and TL-5 linear fluorescent lamps. It comes with an aesthetic, unique design which perfectly harmonises with most interiors. It also comes with smooth, easy to clean opal covers. The covers are suspendable on the endcaps for easy lamp replacement without tools. Emergency and Dimming options available on request.



Features and Benefits

- Takes twin TL-D and TL-5 Linear fluorescent lamps.
- Contemporary slim design 63mm body depth.
- Compliments most interiors.
- Surface mounted via keyholes.
- Housing, white powder painted steel.
- IP20 Class I.
- Comes standard with HFP electronic ballasts..
- Emergency and dimming options available on request.

Applications

- Corridors, staircases
- Small offices
- Schools, Childcare Centres
- Service Areas (restaurants, cafés)
- Supermarkets
- General open plan offices

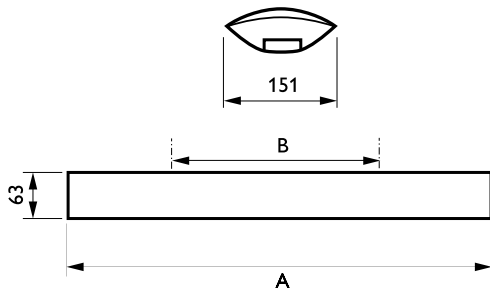

Product ID	A	B
TCS125 2xTL-D18W	680	450
TCS125 2xTL5-28W	1242	882
TCS125 2xTL5-35W	1542	1182
TCS125 2xTL5-49W	1542	1182
TCS125 2xTL5-54W	1242	882

Dimensions in mm

SHORTCODE	DESCRIPTION	IP RATING	TRADE PRICE
TCS1252180840	TCS125 2xTL-D18W/840 HFP SH O	IP20	\$206.66
TCS1252280840	TCS125 2xTL5-28W/840 HFP SH O	IP20	\$268.62
TCS1252350840	TCS125 2xTL5-35W/840 HFP SH O	IP20	\$268.62
TCS1252490840	TCS125 2xTL5-49W/840 HFP SH O	IP20	\$272.25
TCS1252540840	TCS125 2xTL5-54W/840 HFP SH O	IP20	\$289.19

* Lamps included in fitting

e-batten™ TMS 150

Philips fluorescent electronic battens are lightweight and a breeze to install. They're energy efficient, providing you with the perfect solution for virtually any commercial environment.

The TMS 150 range comes in T8 models, the new quality European HFPIII programme start ballasts ensure superior performance and extended lamp life.

You can adapt the new Philips e-Battens to a variety of environments using an extensive range of attachments that include prismatic diffusers, industrial reflectors and wire guards.

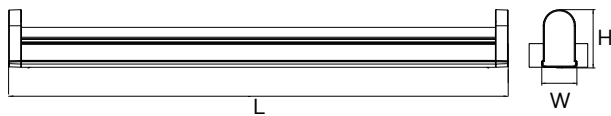

Product ID	L	W	H
TMS150 118W Single Bare Batten	610	54	90
TMS150 218W Twin Bare Batten	610	103	90
TMS150 136W Single Bare Batten	1220	54	90
TMS150 236W Twin Bare Batten	1220	103	90
TMS150 158W Single Bare batten	1520	54	90
TMS150 258W Twin Bare batten	1520	103	90

Dimensions in mm

SHORTCODE	DESCRIPTION	IP RATING	TRADE PRICE
TMS150118HFP	TMS150 1xTL-D18W HF-PCR F 220-240V 50/60Hz	IP20	\$102.80
TMS150136HFP	TMS150 1xTL-D36W HF-P F 220-240V 50/60Hz	IP20	\$114.35
TMS150158HFP	TMS150 1xTL-D58W HF-P F 220-240V 50/60Hz	IP20	\$125.90
TMS150218HFP	TMS150 2xTL-D18W HF-PCR F 220-240V 50/60Hz	IP20	\$114.35
TMS150236HFP	TMS150 2xTL-D36W HF-P F 220-240V 50/60Hz	IP20	\$125.90
TMS150258HFP	TMS150 2xTL-D58W HF-P F 220-240V 50/60Hz	IP20	\$137.45
GMS150118P	GMS150 118 P		\$42.00
GMS150136P	GMS150 136 P		\$58.33
GMS150158P	GMS150 158 P		\$63.00
GMS150218P	GMS150 218 P		\$55.44
GMS150236P	GMS150 236 P		\$71.61
GMS150258P	GMS150 258 P		\$78.54
GMS150236WG	GMS150 236 WG		\$103.95
GMS150258WG	GMS150 258 WG		\$115.50
GMS150236R	GMS150 236 R		\$40.43
GMS150258R	GMS150 258 R		\$48.51
GMS150136 RA	GMS150 136 R A		\$33.50
GMS150158 RA	GMS150 158 R A		\$40.43

* Order lamps separately

* Wire Guard comes with backing plate and end caps.



Pacific LED Waterproof

Pacific LED Waterproof batten is a high performance luminaire, replacing traditional Philips fluorescent fittings with comparable lumen outputs - Pacific LED will save up to 50% energy, and lasts up to 50,000 hours (L70). Further savings can be achieved through DALI dimming, and comes in a variety of lengths and beam angles. There is also a chemical resistance option, and multiple wiring options.



Features and Benefits

- Point-to-point replacement of high performance TL-D waterproof luminaires up to 2 x 58W.
- Dimmable (DALI) for even more savings potential.
- Low maintenance cost due to high system lifetime.
- Multiple Beam angles, lengths, and wiring connections.
- Easy to install and maintain.
- Suitable for use in freezers down to minus 30°C.

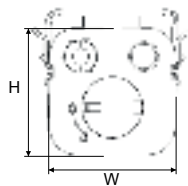
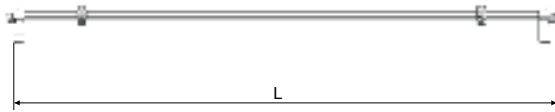

Model	W (mm)	H (mm)	L (mm)
2ft	96	96	721
4ft	96	96	1342
5ft	96	96	1642

Dimensions in mm (Nominal)

PACIFIC LED WATERPROOF BATTEN

Family Name	Pacific LED G3	Installation	Surface Mounted
Model	WT460C - Standalone Version WT461C - Chemical Resistance Version	IP rating	IP66
Lumen/ Watt	6400lm/ 64W 4200lm/ 39W 3500lm/ 28W 2300lm/ 24W	IK Rating	IK08
CCT	4000K	Weight	1500mm - 3.9kg 1200mm - 3.4kg 600mm - 1.7kg
Colour Rendering Index (CRI)	≥80	Colour of housing	Clear with light grey
Flex and Plug	No	Application	Industry, F&B, Parking, Semi Outdoor, Under Canopy, Freezers
Lifetime (L70)	50,000hrs	Accessories	Flexible ceiling bracket, Suspension Hooks, Ceiling clips, Cable glands, End cap 3 or 5 pole connector, Polycarbonate tube
Unified Glare Ratio (UGR)	22		
Optics	NB, WB, VWB		
Driver	Philips Xitanium Driver		
Dimmable	PSD (DALI), PSU (Fixed)		



Pacific LED Waterproof continued

DESCRIPTION	TRADE PRICE
WT460C LED23S/840 PSU WB L700	\$330.00
WT460C LED23S/840 PSU WB L1300	\$412.50
WT460C LED23S/840 PSU VWB L1300	\$440.00
WT460C LED42S/840 PSU WB L1300	\$412.50
WT460C LED42S/840 PSU VWB L1300	\$440.00
WT460C LED35S/840 PSU WB L1600	\$504.90
WT460C LED35S/840 PSU VWB L1600	\$517.00
WT460C LED64S/840 PSU WB L1600	\$504.90
WT460C LED64S/840 PSU VWB L1600	\$517.00

CHEMICAL RESISTANT VERSION	
WT461C LED23S/840 PSU WB L700	\$385.00
WT461C LED23S/840 PSU WB L1300	\$495.00
WT461C LED42S/840 PSU WB L1300	\$506.00
WT461C LED64S/840 PSU WB L1600	\$605.00



CoreLine Waterproof

CoreLine Waterproof LED can be a direct replacement for traditional Philips fluorescent waterproof luminaires, in terms of light performance, installation flexibility and length. With a similar look and feel to traditional battens, this diffused luminaire will last up to 50,000 hours (L70), hence reducing maintenance costs.



Features and Benefits

- Up to 50% lower energy consumption compared to Philips TL-D.
- Reliable LED technology – maintenance free.
- Direct substitute to conventional waterproofs in light performance, installation flexibility & length.
- Substitute available for 2X18W/1X36W/2X36W/1X58W/2X58W TL-D.
- Sleek design to create traditional look and feel.
- Wide-beam light distribution.
- Diffuser with optical element ensures visual comfort.
- Ceiling-mounted bracket and suspension hooks included; installation can be made vandal-proof by additional screw fixation of mounting brackets.
- EL3 Emergency option compliant to AS/NZS 2293.
- Central cable entry and through wiring possible.

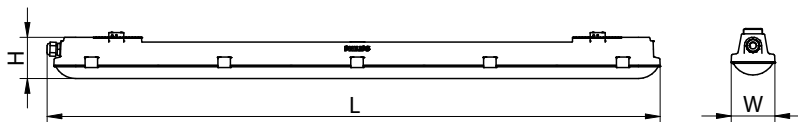

Model	W (mm)	H (mm)	L (mm)
2ft	87	82	661
4ft	87	82	1223
5ft	87	82	1504

Dimensions in mm (Nominal)



CoreLine Waterproof continued

CORELINE WATERPROOF BATTEN			
Family Name	CoreLine Waterproof Batten	Installation	Surface Mounted, Suspension Hook
Model	WT120C - Standalone version	IP rating	IP65
Lumen/ Watt	6000lm/ 57W 4000lm/ 41W 3400lm/ 29W 2200lm/ 23W 1800lm/ 19W	IK Rating	IK08
CCT	4000K	Weight	1500mm - 1.82kg 1200mm - 1.53kg 600mm - 1kg
Colour Rendering Index (CRI)	≥80	Colour of housing	Light Grey
Lifetime (L70)	50,000hrs	Application	Industry, F&B, Parking, Semi Outdoor, Under Canopy
Unified Glare Ratio (UGR)	23	Accessories (Included)	Mounting bracket (2pcs), suspension hook (2pcs), anti-vandal screws (2pcs), grommet (2pcs), cable gland (2pcs)
Optics	Symmetrical wide beam		
Driver	Philips titanium driver		
Dimmable	PSU fixed output		

SHORTCODE	DESCRIPTION	TRADE PRICE
WT120LED18SL70	WT120C LED18S/840 PSU L600	\$214.50
WT120LED22SL120	WT120C LED22S/840 PSU L1200	\$247.50
WT120LED40SL120	WT120C LED40S/840 PSU L1200	\$247.50
WT120LED34SL150	WT120C LED34S/840 PSU L1500	\$385.00
WT120LED60SL150	WT120C LED60S/840 PSU L1500	\$385.00
	WT120C LED60S/840 PSU L1500 EL3	\$715.00

Pacific TCW216

This waterproof luminaire has been designed to make installation easier and faster than ever before. NZ's first NO CLIP waterproof luminaire. Higher output means you can use less fittings for the same amount of light. Dimmable and emergency options available on request.



Features and Benefits

- Dust and moisture protected IP66.
- Impact protected .
- Fibre-glass reinforced polyester housing .
- Clear polycarbonate prismatic cover.
- Acrylic Cover options available on request.
- Fused connection block (FU).

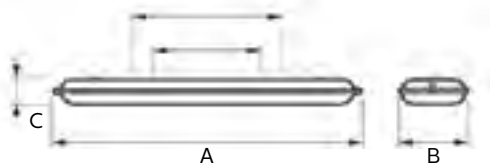

Product ID	A	B	C
2x18w	690	140	92
1x18w	690	100	92
2x36/28/54w	1300	140	92
1x36/28/54w	1300	100	92
2x58/35/49w	1600	140	92
1x58/35/49w	1600	100	92

Dimensions in mm (Nominal)

SHORTCODE	DESCRIPTION	IP RATING	TRADE PRICE
TCW216218E	TCW216 2xTL-D18W HFP PI IT	IP65	\$143.75
TCW216136E	TCW216 1xTL-D36W HFP FU SI	IP65	\$133.58
TCW216236E	TCW216 2xTL-D36W HFP FU SI	IP65	\$155.36
TCW216158E	TCW216 1xTL-D58W HFP FU SI	IP65	\$140.12
TCW216258E	TCW216 2xTL-D58W HFP FU SI	IP65	\$182.88
TCW216228E	TCW216 2xTL5-28W HFP PI	IP65	\$232.32
TCW216235E	TCW216 2xTL5-35W HFP PI	IP65	\$264.00
TCW216249E	TCW216 2xTL5-49W HFP PI	IP65	\$275.88
TCW216254E	TCW216 2xTL5-54W HFP PI	IP65	\$297.66
TCW216258EM	TCW216 2xTL-D58W FU Emerg Maint	IP65	\$440.00
GCW216218	GCW216 2 18 Polycarbonate Cover		\$41.58
GCW216136	GCW216 1 36 Polycarbonate Cover		\$49.83
GCW216236	GCW216 2 36 Polycarbonate Cover		\$54.65
GCW216158	GCW216 1 58 Polycarbonate Cover		\$54.65
GCW216258	GCW216 2 58 Polycarbonate Cover		\$60.98
GCW215218	GCW215 2 18 Acrylic Cover		\$39.92
GCW215136	GCW215 1 36 Acrylic Cover		\$38.53
GCW215236	GCW215 2 36 Acrylic Cover		\$39.22
GCW215158	GCW215 1 58 Acrylic Cover		\$40.19
GCW215258	GCW215 2 58 Acrylic Cover		\$41.09

* Order lamps separately

TCW060 Under-verandah TL-D

The Philips TCW060 range is a cost effective under verandah fitting suitable for many projects or replacment fit outs where budgets are constrained. It offers all the usual specifications at an affordable price.



Features and Benefits

- Ambient temperature: -5 to +25 °C.
- Materials: Polycarbonate housing, Polycarbonate (UV-resistant) cover, Polycarbonate clips (one extra clip included), White painted (RAL9003) steel gear tray with maintenance position, Stainless steel ceiling clips.
- Electronic HFP gear included 220V / 50Hz.
- Class I, IP65, IK08.

Applications

- Parking lots
- Warehouses
- Industry

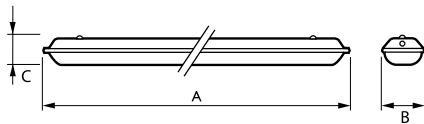

	L	W	H
Product ID	A	B	C
TCW060258HFPFU	1570	136	90
TCW060158HFPFU	1570	86	90
TCW060236HFPFU	1270	136	90
TCW060136HFPFU	1270	86	90

Dimensions in mm (Nominal)

SHORTCODE	DESCRIPTION	TRADE PRICE
TCW060258HFPFU	TCW060 2x58w HFP FU	\$170.50
TCW060158HFPFU	TCW060 1x58w HFP FU	\$134.75
TCW060236HFPFU	TCW060 2x36w HFP FU	\$154.00
TCW060136HFPFU	TCW060 1x36w HFP FU	\$132.00



GreenPerform Highbay Gen2

Ideal for factories, warehouses, distribution centres, and light industrial. Philips GreenPerform LED highbay Gen2 is designed to replace 250W and 400W Philips MH highbays, offering up to 60% energy savings, whilst delivering a long lifetime, in often hard to reach areas. The Gen2 version sees a reduction in glare by up to 20%, as well as a wide variety of light outputs, from 9,000 lm, all the way up to 24,000 lm.



Features and Benefits

- Energy-efficient: System efficacy >100lm/W, 1:1 replacement of 400/250W HPI
- Comfortable light: increase to CRI 85 for all colour temperatures.
- Optimal lighting effects: new light platform & optical design reduces glare by 20%.
- Versatile applications: multiple mounting options (hook/pipe/ bracket).
- Advanced control interface: 1 - 10V / DALI dimming option integrated for solution selling (selected models only).
- Robust & Reliable: IP65 protection and 50,000 (L70) hours system life time.
- Wide Industry Application: Available in both Tempered Glass Cover and PC Cover which makes the GreenPerform Highbay suitable for the food industry.
- Easy to Install: Equipped with 3m long power cord & IP65 connector.
- Weight: Max 9.5 kg.

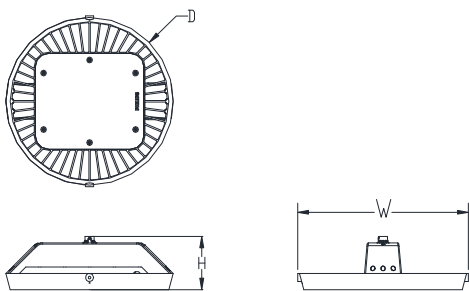

Model	W (mm)	D (mm)	H (mm)
BY687P	530	ø520	165
BY688P	466	ø457	158
BY689P	374	ø366	153

Dimensions in mm (Nominal)

GREENPERFORM HIGHBAY GEN2

Family name	GreenPerform Highbay Gen2	Driver	Philips Xitanium LED Driver
Lumen/Watt	BY687P - 240W, 200W (Big size) BY688P - 160W, 140W (Medium size) BY689P - 100W, 90W (Small size)	Dimmable	PSU (Fixed), PSR (1-10V selected), PSD (Dali selected)
Lamp Colour	24,000lm/ 240W 20,000lm/ 200W 16,000lm/ 160W 14,000lm/ 140W 10,000lm/ 100W 9,000lm/ 90W	Installation	Hook/ Pole/ Bracket
CCT	4000K (6500K available on request)	IP rating	IP65
Colour Rendering Index (CRI)	≥85	IK Rating	IK07
Wiring	IP65 Connector	Weight	BY687P - 9.5kg BY688P - 7kg BY689P - 5kg
Lifetime (L70)	50,000hrs	Colour of housing	Silvery grey, high quality die-cast aluminium
Unified Glare Ratio (UGR)	25	Application	Industry, Commercial & Convention
Optics	WB, NB, HRO	Accessories	Mounting Bracket Hook To be ordered separately



GreenPerform Highbay Gen2 continued

SMALL	
BY689P LED90/NW PSU S-NB	\$440.00
BY689P LED90/NW PSU S-WB	\$440.00
BY689P LED100 L3000/NW PSU S-NB	\$462.00
BY689P LED100 L3000/NW PSU S-WB	\$462.00
BY689P LED100 L3000/NW PSU S-HRO	\$462.00
BY689P LED100 L3000/NW PSU S-WB PC	\$462.00
BY689P LED100 L3000/NW PSU S-NB PC	\$462.00
BY689P LED100 L3000/NW PSU S-HRO PC	\$462.00
BY619Z Horizontal Bracket	\$55.00
BY619Z MB	\$27.50
Mounting Hook	\$6.60
MEDIUM	
BY688P LED140/NW PSU S-NB	\$522.40
BY688P LED140/NW PSU S-WB	\$522.40
BY688P LED 140/NW PSR S-NB	\$550.00
BY688P LED 140/NW PSR S-WB	\$550.00
BY688P LED 140/NW PSD S-NB	\$550.00
BY688P LED 140/NW PSD S-WB	\$550.00
BY688P LED160 L3000/NW PSU S-HRO	\$550.00
BY688P LED160 L3000/NW PSU S-NB	\$550.00
BY688P LED160 L3000/NW PSU S-WB	\$550.00
BY688P LED160 L3000/NW PSU S-WB PC	\$550.00
BY688P LED160 L3000/NW PSU S-NB PC	\$550.00
BY688P LED160 L3000/NW PSU S-HRO PC	\$550.00
BY618Z Horizontal Bracket	\$66.00
BY618Z MB	\$33.00
Mounting Hook	\$6.60

LARGE	
BY687P LED200/NW PSR S-WB L3000	\$792.00
BY687P LED200/NW PSR S-NB L3000	\$792.00
BY687P LED200/NW PSR S-HRO L3000	\$792.00
BY687P LED200 L3000/NW PSR S-WB PC	\$825.00
BY687P LED200 L3000/NW PSR S-NB PC	\$825.00
BY687P LED200 L3000/NW PSR S-HRO PC	\$825.00
BY687P LED240/NW PSR S-WB L3000	\$852.50
BY687P LED240/NW PSR S-NB L3000	\$852.50
BY687P LED240/NW PSR S-HRO L3000	\$852.50
BY687P LED240 L3000/NW PSR S-NB PC	\$852.50
BY687P LED240 L3000/NW PSR S-HRO PC	\$852.50
BY687P LED240 L3000/NW PSR S-WB PC	\$852.50
BY617Z MB	\$44.00
MOUNTING HOOK	\$6.60

GreenPerform Highbay Accessories

BY689 90/100watt	
BY619Z Horizontal Bracket	Ceiling
BY619Z MB	Wall
MOUNTING HOOK	Ceiling
BY688 140/160watt	
BY618Z Horizontal Bracket	Ceiling
BY618Z MB	Wall
MOUNTING HOOK	Ceiling
BY687 200/240watt	
BY617Z MB	Wall
MOUNTING HOOK	Ceiling

All GP LED Highbays require one of the above in order to suspend or attach to a wall or ceiling



Greenup LED Highbay

The Philips Greenup Highbay range includes models with an integrated wireless solution that combines controller, sensor and luminaire into one. This enables warehouse developers and facility managers to achieve excellent light quality with energy savings compared to traditional Philips MH high-bays. The light output can also be optimised for workspaces, allowing users to function without overstraining, thus achieving a safe environment.

The GreenUp Highbay incorporates long lifetime LED lighting and the global standard for Zigbee control to achieve an easy-to-use and reliable network-controlled solution.



Features and Benefits

- Optimal results with professional optic.
- Easy installation with quick and easy power connection.
- Energy savings of 75% vs HID 400W system; and 30% vs T5 HO 4x54W system.
- Efficient heat dissipation.
- Occupancy and daylight detection options.
- Connected lighting with mesh network and wireless zoning options.
- 50,000 hrs (L70) lifetime.

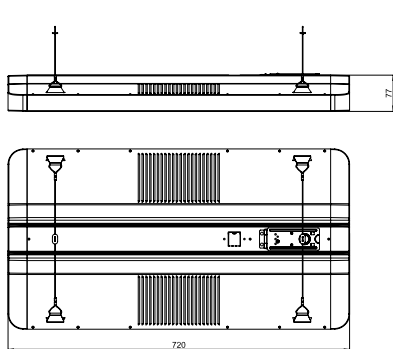

BY500P LED200

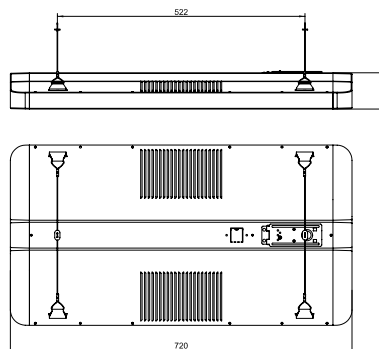

BY500P LED140

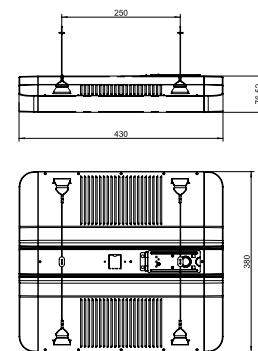

BY500P LED100

Model	W (mm)	H (mm)	L (mm)
BY500P LED 200	380	77	720
BY500P LED140	380	77	720
BY500P LED100	380	77	440



Greenup LED Highbay continued

SHORTCODE	DESCRIPTION	TRADE PRICE
Fixed Output (PSU)		
BY550P LED100/NW PSU HRO	BY550100nwhro	\$385.00
BY550P LED100/NW PSU WB	BY550100nwwb	\$385.00
BY550P LED100/NW PSU NB	BY550100nwnb	\$385.00
BY550P LED140/NW PSU NB	BY550140nwnb	\$467.50
BY550P LED140/NW PSU WB	BY550140nwwb	\$467.50
BY550P LED140/NW PSU HRO	BY550140nwhro	\$467.50
BY550P LED200/NW PSU HRO	BY550200nwhro	\$522.50
BY550P LED200/NW PSU NB	BY550200nwnb	\$522.50
BY550P LED200/NW PSU WB	BY550200nwwb	\$522.50
Intelligent Controls (PSD/ACW2)		
BY550P LED100/NW PSD HRO	BY550100nwhroD	\$440.00
BY550P LED100/NW PSD NB	BY550100nwnbD	\$440.00
BY550P LED100/NW PSD WB	BY550100nwwbD	\$440.00
BY550P LED140/NW PSD HRO	BY550140nwhroD	\$522.50
BY550P LED140/NW PSD NB	BY550140nwnbD	\$522.50
BY550P LED140/NW PSD WB	BY550140nwwbD	\$522.50
BY550P LED200/NW PSD HRO	BY550200nwhroD	\$577.50
BY550P LED200/NW PSD NB	BY550200nwnbD	\$577.50
BY550P LED200/NW PSD WB	BY550200nwwbD	\$577.50
BY550X LED100/NW ACW2 IS HRO	BY550X100nwhro	\$544.50
BY550X LED100/NW ACW2 IS NB	BY550X100nwnb	\$544.50
BY550X LED100/NW ACW2 IS WB	BY550X100nwwb	\$544.50
BY550X LED140/NW ACW2 IS HRO	BY550X140nwhro	\$632.50
BY550X LED140/NW ACW2 IS NB	BY550X140nwnb	\$632.50
BY550X LED140/NW ACW2 IS WB	BY550X140nwwb	\$632.50
BY550X LED200/NW ACW2 IS HRO	BY550X200nwhro	\$731.50
BY550X LED200/NW ACW2 IS NB	BY550X200nwnb	\$731.50
BY550X LED200/NW ACW2 IS WB	BY550X200nwwb	\$731.50



Intelligent Range

Solution A : Economical layout

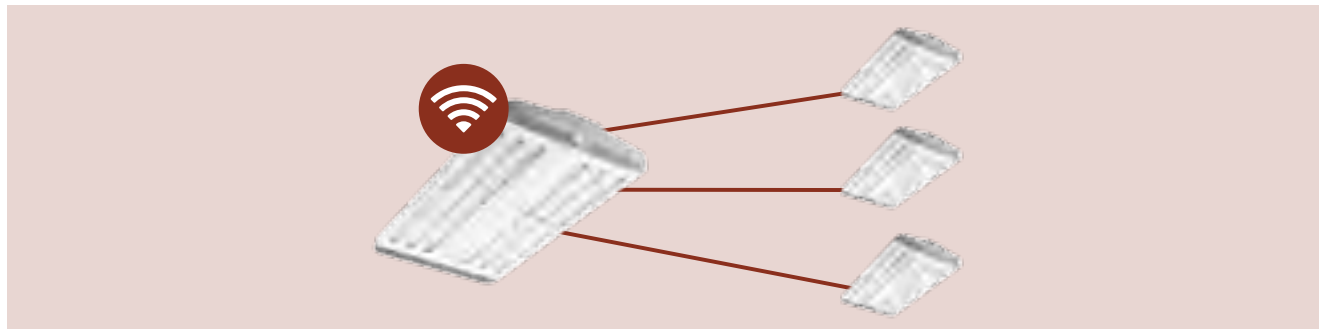

- 1 The most economical layout plan, with several luminaires forming a wireless connected unit
- 2 Connects BY550X and BY550P Dali
- 3 1 set of BY550X as master, and 1 to 3 sets of BY550P Dali as slave, forming a wireless connected unit
- 4 Grouping and re-zoning can be achieved without changing the physical connection between the units

1 master luminaire connected to slave luminaires

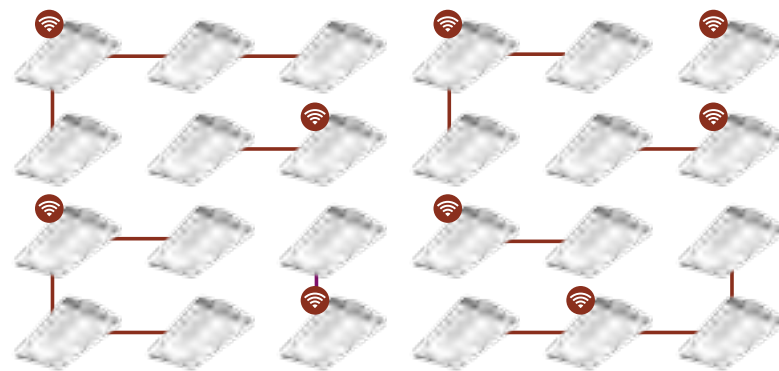

Solution B : Combinational layout



- 1 Incorporates wireless luminaires, standalone sensors, wireless terminals and Zigbee controls woven in a connected lighting network.
- 2 Grouping and re-zoning can be achieved without changing the physical connection between the units

Master luminaire connected to slave luminaires, standalone sensor and wireless panels

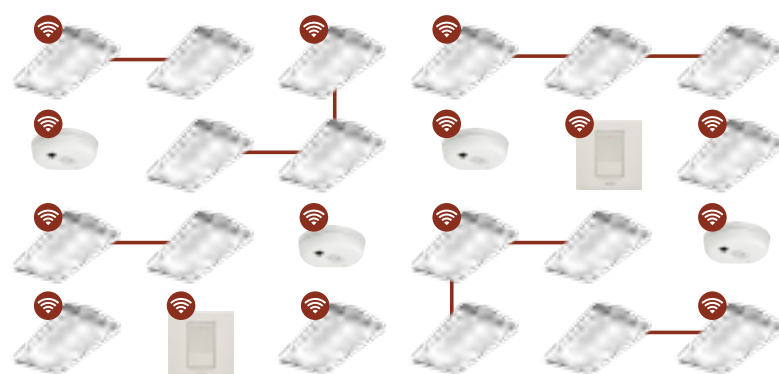



Intelligent Range continued

Application mode

Upon powering up after initial installation, the system will be turned on automatically and ActiLume controller will run on OOTB mode. After programming the required zone(s), Actilume controller will run in OP mode, and the default settings (mode 10) will be triggered into normal operating mode.

OP mode	Economic		Comfort		Safe
Mode	06	08	07	09	10
Motion Detect	on	on	on	on	on
Daylight harvesting	off	off	off	off	on
Hold time (min)	2	2	5	5	5
Background	10	10	20	20	10
Prolong time (min)	0	255	5	255	30
Power on / off	off	on	off	on	on

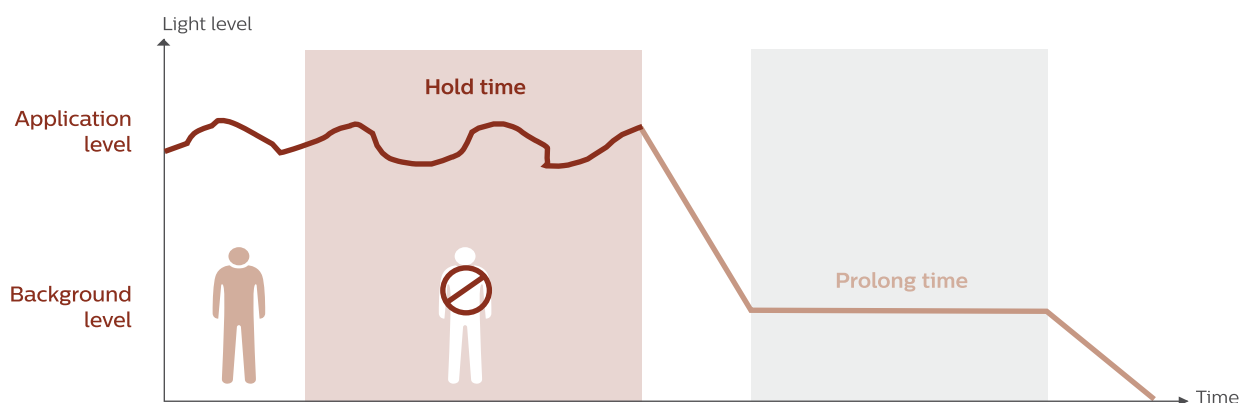

Installation and commissioning

- 1 Controls are built into the luminaire, eliminating the need for re-wiring. Installation is as easy as a plug-and-play luminaire installation.
- 2 Systems commissioning can be performed via IRT9090/01
- 3 Grouping can be set based on one single luminaire or a zone of networked luminaires.
- 4 Settings can be adjusted and programmed by users easily, without the need for on-site technicians' support

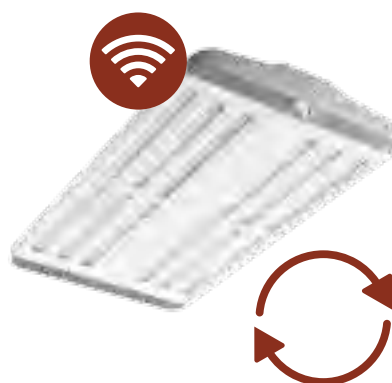

Systems installation

IR remote for commissioning

PC for wireless commissioning

T5 Highbay

High ceiling and large floor spaces aren't a problem with the Philips TPS150 T5 Highbay luminaires. The high reflectance medium beam reflector is suitable for a variety of mounting heights from 6 metres and above.

The amalgam-controlled operation of the 54W TOP lamps provides superior light output across a wide ambient temperature range. Plus you have the option of Philips long-life xtra lamps for those hard-to-reach ceiling spaces.



Product ID	W (mm)	L (mm)
TPS150/4x54(4x28)	502	1170

SHORTCODE	DESCRIPTION	IP RATING	TRADE PRICE
TPS1504x54WK*	TPS150 4xTL5 HO 54W Kombi	IP20	\$340.72
ZPS150PC	ZPS150 PC	n/a	\$87.23
ZPS150PM	ZPS150 PM	n/a	\$57.75

* Lamps included with fitting



Mini 300 Gen2

Designed for petrol-station canopies and low-bay applications, Mini 300 Gen2 is an ultra-efficient retrofit fixture that offers outstanding light quality, effective thermal management, and a very long lifespan.

Reduced maintenance, replacement and energy cost means a short payback period, making Mini 300 LED Gen2 a shining example of how businesses can save money by opting for green products. A movement detector combined with a daylight sensor enables further energy savings. Our Mini 300 LED gen2 app gives users control in ways that are simply not possible with other luminaires – for instance, reading status and managing lighting from the floor by laptop or Smartphone via Bluetooth.



Features and Benefits

- Wireless management via Bluetooth from Smartphone or laptop.
- Scheduler build in the luminaire to customize your settings.
- Status and settings can be read from the floor (no more lift is needed to change settings of luminaire.).
- Instant LED light, long lifetime for lower maintenance cost.
- Retrofit solution of 250W & 400W HPI Lowbays or 250W & 315W CDM (Mini300).
- Movement detector unit and daylight sensor combined for even more energy savings.
- Very low weight makes it easy to install (only one person needed).
- Plug & Play.
- Master & Slave to reduce number of luminaires with sensor (lower investment cost).
- Energy savings up to 85% compared to HPI systems.

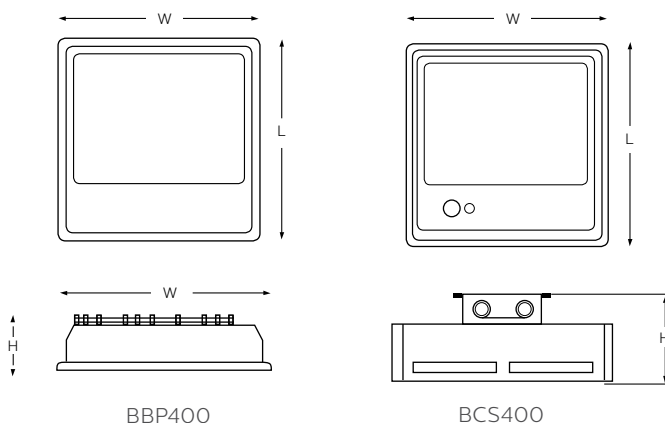

Model	Width (mm)	Length (mm)	Height (mm)
BBP400 (Recessed)	350	350	102
BCS400 (Surface)	378	373	152

Dimensions in mm (Nominal)



Mini 300 Gen2 continued

MINI 300 GEN2			
Family Name	Mini 300 G2	Dimmable	PSD (Dali)
Model	BBP400 - Recessed BCS400 - Surface Mounted	Installation	Recessed/ Surface Mounted
Lumens	4,900 - 15,100	IP rating	IP65
Lumen/Watt	100 - 111	Weight	BBP400 - 9.1kg BCS400 - 8.6kg
CCT	5700K/4000K available on request	Colour of housing	White - High quality die-casting aluminium
Colour Rendering Index (CRI)	68	Application	Petrol Stations, Industry, Warehouse, Public Areas
Lifetime (L70)	50,000 hrs	Accessories	Ceiling Mounting Frame
Unified Glare Ratio (UGR)	22-25	SMART Options	Motion Detection Unit, Daylight Sensor, Scheduler Mode, Bluetooth, Master vs Slave units
Optics	PRM, PRW, PAM, A		
Driver	Philips Xitanium LED Driver		

Price on application.



Mini 500 Gen2

The Philips Mini 500 LED is an intuitive under-canopy light that ensures optimal visual conditions while enabling energy savings. The luminaire's precision control optics enables light to be distributed where it is needed the most. Its integrated components and long life LED technology make this an easy to install, low maintenance solution.



Features and Benefits

- Solid die-cast housing design ensures long fixture lifetime.
- Up to 60% energy saving compared to traditional Philips HID lamp solutions.
- A range of precision control optics direct the light to where it is needed
- Wide range of options:
 - Basic On/OFF
 - Basic Dimming-PSR/Dali
 - Intelligent Version -PSD AC D2 IS
 - Surface/Recessed & Side entry pole
- AC D2 IS option incorporates presence and daylight sensing enabling maximum energy efficiency gains.

Applications

- Under canopy
- Industrial low bay

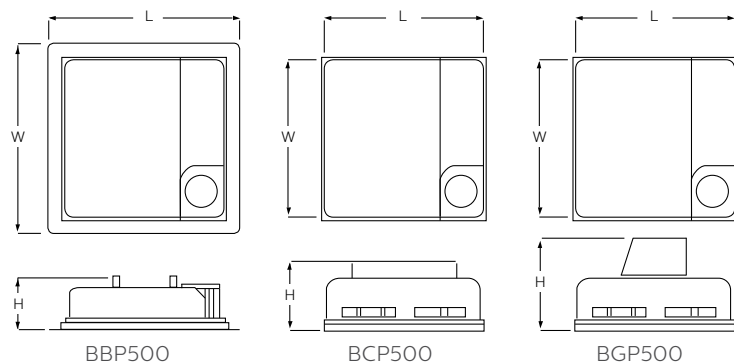

Model	Width (mm)	Length (mm)	Height (mm)
BBP500	400	400	111
BCP500	335	335	147
BGP500	335	335	194

Dimensions in mm (Nominal)

MINI 500 GEN2

Family Name	Mini 500 Gen2
Model	BBP-Recessed BCP500-Surface BGP500-Pole
Lumen/ Watt	11,000/100W
Colour Rendering Index (CRI)	≥85
Lifetime (L70)	50,000 hrs
Lamp Colour	4000K/6000K
Optics	S-WB,S-MB,A-WB
Driver	Philips Xitanium LED Driver

Dimmable	PSR, PSD
Installation	Recessed/Surface/Pole
IP rating	IP65
Weight	BBP,BCP 8.1kg BGP 7.2kg
Colour of housing	White
SMART Options	Motion Detection, Daylight Sensor, Programmable



Mini 500 Gen2 continued

DESCRIPTION	TRADE PRICE
RECESSED	
BBP500 LED110/NW PSU S-MB	\$687.50
BBP500 LED110/NW PSU S-WB	\$687.50
BBP500 LED110/NW PSU A-WB	\$687.50
BBP500 LED110/NW PSR S-WB	\$764.50
BBP500 LED110/NW PSR S-MB	\$764.50
BBP500 LED110/NW PSR A-WB	\$764.50
BBP500 LED110/NW PSD ACD2 IS S-WB	\$880.00
BBP500 LED110/NW PSD ACD2 IS S-MB	\$880.00
BBP500 LED110/NW PSD ACD2 IS A-WB	\$880.00
SURFACE	
BGP500 LED110/NW PSU A-WB	\$764.50
BGP500 LED110/NW PSU S-WB	\$764.50
BGP500 LED110/NW PSU S-MB	\$764.50
BGP500 LED110/NW PSR A-WB	\$825.00
BGP500 LED110/NW PSR S-MB	\$825.00
BGP500 LED110/NW PSR S-WB	\$825.00
BGP500 LED110/NW PSD ACD2 IS A-WB	\$880.00
BGP500 LED110/NW PSD ACD2 IS S-MB	\$880.00
BGP500 LED110/NW PSD ACD2 IS S-WB	\$880.00
POLE MOUNT	
BGP500 LED110/NW PSU A-WB	\$764.50



Smartbay LED Lowbay

SmartBay, Philips family of LED lowbays, delivers up to 45% energy savings when compared to traditional Philips HID fittings by adopting a state of the art LED platform and optical design.

The SmartBay has very good colour rendering (CRI 80), and good glare management to meet the requirements for various applications including industrial, retail and public spaces.

Designed as a 1 for 1 replacement for Philips HPI or CDM metal halide fittings, and with a 50,000 hour lifetime @ L70, the SmartBay is a true fit and forget solution that offers a high system efficiency of 95 lumens per watt. The SmartBay range comes in 3 wattages and 2 physical sizes and can be used for new or retrofit applications.



Features and Benefits

- Energy-efficiency: system efficacy > 95 lm/W, 1:1 replacement of Philips CDM or HPI, saving up to 69% energy.
- Comfortable light: CRI >85, UGR<19 (with reflector), offering a comfortable lighting experience .
- Super long life: 50,000 hours system lifetime (L70).
- Versatile applications : more than 5 mounting options and accessories, flexible for versatile indoor installations .

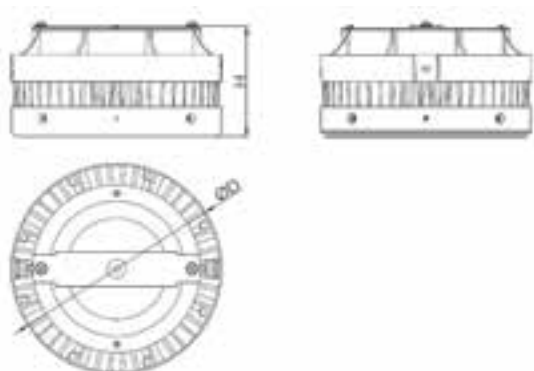

Model	D (mm)	H (mm)
BY268P	250	132mm
BY269P	150	102mm

Dimensions in mm (Nominal)

SMARTBAY LOWBAY

Family Name	SmartBay Lowbay
Model	BY268P - Big Size BY269P - Small Size
Lumen/ Watt	8,200 lm/ 85W 5,800 lm/ 60W 3,800 lm/ 40W
CCT	3000K, 4000K, 6500K
Colour Rendering Index (CRI)	≥85
Lifetime (L70)	50,000 hrs
Unified Glare Ratio (UGR)	22-25
Optics	WB, NB (Needs reflector)
Driver	Philips Xitanium LED Driver

Dimmable	PSU (Fixed)
Installation	Hook/ Pole/ Bracket
IP rating	IP40
Weight	BY268P - 4.5kg BY269P - 2.5kg
Colour of housing	Silvery grey (Pantone 429U)
Application	Industry, Supermarket, Public Area, Shopping Mall
Accessories	Mounting Bracket, Reflector, Hook, Chain Kit, Pipe Kit



Smartbay LED Lowbay continued

SHORTCODE	DESCRIPTION	TRADE PRICE
BY268L804K	BY268P LED80/NW PSU	\$500.50
BY268L803K	BY268P LED80/WW PSU	\$500.50
BY268L604K	BY268P LED60/NW PSU	\$456.50
BY268L603K	BY268P LED60/WW PSU	\$456.50
BY269L404K	BY269P LED40/NW PSU	\$264.00
BY269L403K	BY269P LED40/WW PSU	\$264.00
BY268MB	BY268Z MB	\$16.50
BY269MB	BY269Z MB	\$13.75
BY268Chain Kit	BY268Z SM C	\$49.50
BY268Pipe Kit	BY268Z SM P	\$35.75
BY268Hook Kit	BY268Z Hook	\$22.00
BY268Ref	BY268Z RL	\$115.50
BY269Ref	BY269Z RL	\$60.50



LuxSpace Gen III

Our highly energy-efficient LuxSpace family has now received a major upgrade, in the form of an improved system efficacy. The extremely low power consumption of this LED solution results in significant energy savings compared with traditional CFL downlights. There is also a range of different sizes and outputs, and an array of different accessories, ensuring maximum flexibility in customising the right light effect for your application. Best of all, this family of luminaires delivers specification grade performance, including a DALI dimming system, IP54 ingress protection (front part) and better glare control than ever before. These innovative downlights are ideal for applications in offices, shops, hotels and hospitals where an energy efficient general lighting solution is needed.



Features and Benefits

- Features the latest LED technology to deliver high system efficacy, resulting in up to 80% energy savings compared with conventional Philips CFL downlights.
- Realises specification grade standards in visual comfort, performance and consistent colour rendering:
 - Better colour rendering: CRI80;
 - Better colour consistency: SDCM3
- Provides more flexibility with a full range and different accessories.
- Compact curved design gives the luminaire a professional look.

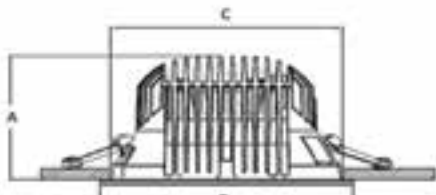

Product ID	A (mm)	B (mm)	C (mm) cut out
Micro - DN478	71	ø137	ø125
Mini - DN488/ DN489	88.5	ø163	ø150
Compact - DN486/ DN487	88.5	ø163	ø150
Compact Power - DN498/ DN499	119.5	ø218	ø200

Dimensions in mm (Nominal)

LUXSPACE GEN III			
Family name	LuxSpace Gen III	Correlated Colour Temperature (CCT)	3000K, 4000K
Model	UGR 22 Range Micro - DN478 Mini - DN488 Compact - DN486 Compact Power - DN498 UGR 19 Range Mini - DN489 Compact - DN487 Compact Power - DN499	Colour Rendering Index (CRI)	80
Lumen/ Watt	3000K Micro - 8.5W/ 600lm Mini - 12W/ 960lm Compact - 18W/ 1450lm Compact Power - 23W/ 1900lm 4000K Micro - 8.5W/ 640lm Mini - 12W/ 1000lm Compact - 18W/ 1500lm Compact Power - 23W/ 2000lm	Flex and Plug	No
		Lifetime (L70)	50,000hrs
		Unified Glare Ratio (UGR)	19, 22
		Driver	Fixed/DALI available on request



LuxSpace Gen III continued

DESCRIPTION	TRADE PRICE	DESCRIPTION	TRADE PRICE
Micro		Compact (continued)	
DN478 1xDLED-3000 PSU-E C WH	\$192.50	DN487 1xDLED-3000 PSU-E C WH	\$346.50
DN478 1xDLED-3000 PSU-E M WH	\$192.50	DN487 1xDLED-3000 PSU-E M WH	\$346.50
DN478 1xDLED-3000 PSD-E C WH	\$203.50	DN487 1xDLED-3000 PSD-E C WH	\$385.00
DN478 1xDLED-3000 PSD-E M WH	\$203.50	DN487 1xDLED-3000 PSD-E M WH	\$385.00
DN478 1xDLED-4000 PSU-E C WH	\$192.50	DN487 1xDLED-4000 PSU-E C WH	\$346.50
DN478 1xDLED-4000 PSU-E M WH	\$192.50	DN487 1xDLED-4000 PSU-E M WH	\$346.50
DN478 1xDLED-4000 PSD-E C WH	\$242.00	DN487 1xDLED-4000 PSD-E C WH	\$385.00
DN478 1xDLED-4000 PSD-E M WH	\$242.00	DN487 1xDLED-4000 PSD-E M WH	\$385.00
Mini		Compact Power	
DN488 1xDLED-3000 PSU-E C WH	\$275.00	DN498 1xDLED-3000 PSU-E C WH	\$385.00
DN488 1xDLED-3000 PSU-E M WH	\$275.00	DN498 1xDLED-3000 PSU-E M WH	\$385.00
DN488 1xDLED-3000 PSD-E C WH	\$330.00	DN498 1xDLED-3000 PSD-E C WH	\$429.00
DN488 1xDLED-3000 PSD-E M WH	\$330.00	DN498 1xDLED-3000 PSD-E M WH	\$429.00
DN488 1xDLED-4000 PSU-E C WH	\$275.00	DN498 1xDLED-4000 PSU-E C WH	\$385.00
DN488 1xDLED-4000 PSU-E M WH	\$275.00	DN498 1xDLED-4000 PSU-E M WH	\$385.00
DN488 1xDLED-4000 PSD-E C WH	\$330.00	DN498 1xDLED-4000 PSD-E C WH	\$429.00
DN488 1xDLED-4000 PSD-E M WH	\$330.00	DN498 1xDLED-4000 PSD-E M WH	\$429.00
DN489 1xDLED-3000 PSU-E C WH	\$297.00	DN499 1xDLED-3000 PSU-E C WH	\$401.50
DN489 1xDLED-3000 PSU-E M WH	\$297.00	DN499 1xDLED-3000 PSU-E M WH	\$401.50
DN489 1xDLED-3000 PSD-E C WH	\$346.50	DN499 1xDLED-3000 PSD-E C WH	\$440.00
DN489 1xDLED-3000 PSD-E M WH	\$346.50	DN499 1xDLED-3000 PSD-E M WH	\$440.00
DN489 1xDLED-4000 PSU-E C WH	\$297.00	DN499 1xDLED-4000 PSU-E C WH	\$401.50
DN489 1xDLED-4000 PSU-E M WH	\$297.00	DN499 1xDLED-4000 PSU-E M WH	\$401.50
DN489 1xDLED-4000 PSD-E C WH	\$346.50	DN499 1xDLED-4000 PSD-E C WH	\$440.00
DN489 1xDLED-4000 PSD-E M WH	\$346.50	DN499 1xDLED-4000 PSD-E M WH	\$440.00
Compact		Power	
DN486 1xDLED-3000 PSU-E C WH	\$330.00	DN496 1xDLED-3000 PSU-E C WH	\$412.50
DN486 1xDLED-3000 PSU-E M WH	\$330.00	DN496 1xDLED-3000 PSU-E M WH	\$412.50
DN486 1xDLED-3000 PSD-E C WH	\$374.00	DN496 1xDLED-4000 PSU-E C WH	\$412.50
DN486 1xDLED-3000 PSD-E M WH	\$374.00	DN496 1xDLED-4000 PSU-E M WH	\$412.50
DN486 1xDLED-4000 PSU-E C WH	\$330.00	DN497 1xDLED-3000 PSU-E C WH	\$429.00
DN486 1xDLED-4000 PSU-E M WH	\$330.00	DN497 1xDLED-3000 PSU-E M WH	\$429.00
DN486 1xDLED-4000 PSD-E C WH	\$374.00	DN497 1xDLED-4000 PSU-E C WH	\$429.00
DN486 1xDLED-4000 PSD-E M WH	\$374.00	DN497 1xDLED-4000 PSU-E M WH	\$429.00



LuxSpace Gen III – Accessories



Drop glass frosted middle
SG-FRC



Embedded frosted
middle
GF-HR



Drop glass mattel bezel
SG-HR-FR



White adaptor ring
CFRM WH



Drop glass opal finish
SG-O



Grey adaptor ring
CFRM GR



Embedded frosted glass
GF



LuxSpace Gen III – IP54

Our highly energy-efficient LuxSpace family has now received a major upgrade, in the form of an improved system efficacy. The extremely low power consumption of this LED solution results in significant energy savings compared with traditional CFL downlights. There is also a range of different sizes and outputs, and an array of different accessories, ensuring maximum flexibility in customising the right light effect for your application. Best of all, this family of luminaires delivers specification grade performance, including a DALI dimming system, IP54 ingress protection (front part) and better glare control than ever before. These innovative downlights are ideal for applications in offices, shops, hotels and hospitals where an energy efficient general lighting solution is needed.



Features and Benefits

- Features the latest LED technology to deliver high system efficacy, resulting in up to 80% energy savings compared with conventional Philips CFL downlights.
- Realises specification grade standards in visual comfort, performance and consistent colour rendering:
 - Better colour rendering: CRI80;
 - Better colour consistency. SDCM3
- Provides more flexibility with a full range and different accessories.
- Compact curved design gives the luminaire a professional look.

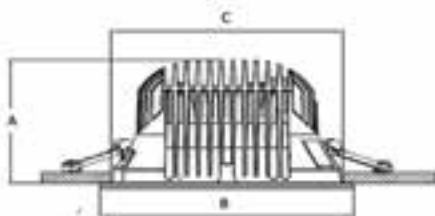

Product ID	A (mm)	B (mm)	C (mm) cut out
Micro - DN478 PG	71	ø137	ø125
Mini - DN488 PG	88.5	ø163	ø150
Compact Power - DN498 PG	119.5	ø218	ø200

Dimensions in mm (Nominal)



LuxSpace Gen III - IP54 continued

LUXSPACE GEN III - IP54	
Family name	LuxSpace Gen III - IP54
Model	Micro - DN478 PG Mini - DN488 PG Compact Power - DN498 PG
Lumen/ Watt	3000K Micro - 7W/ 600lm Mini - 10W/ 960lm Compact Power -20W/ 1900lm 4000K Micro - 7W/ 640lm Mini - 10W/ 1000lm Compact Power -20W/ 2000lm
Correlated Colour Temperature (CCT)	3000K, 4000K
Colour Rendering Index (CRI)	≥80
Flex and Plug	No
Lifetime (L70)	50,000hrs
Unified Glare Ratio (UGR)	22
Driver	External Fixed driver
Dimmable	DALI available on request
Installation	Recessed mounting with flexible spring clips
IP rating	IP54 (front cover only)
Colour of housing	White
Application	Retail, Hospitality, Offices
Accessories	Adaptor ring (White/Grey)
Reflector	Glossy

DESCRIPTION	TRADE PRICE
MICRO	
DN478 1xDLED-3000 PSU-E C WH PG	\$203.50
DN478 1xDLED-4000 PSU-E C WH PG	\$203.50
MINI	
DN488 1xDLED-3000 PSU-E C WH PG	\$286.00
DN488 1xDLED-4000 PSU-E C WH PG	\$286.00
COMPACT POWER	
DN498 1xDLED-3000 PSU-E C WH PG	\$396.00
DN498 1xDLED-4000 PSU-E C WH PG	\$396.00



LuxSpace Gen III Wall-wash

Our highly energy-efficient LuxSpace family has now received a major upgrade, in the form of an improved system efficacy. The extremely low power consumption of this LED solution results in significant energy savings compared with traditional CFL downlights. There is also a range of different sizes and outputs, and an array of different accessories, ensuring maximum flexibility in customising the right light effect for your application. Best of all, this family of luminaires delivers specification grade performance, including a DALI dimming system, IP54 ingress protection (front part) and better glare control than ever before. These innovative downlights are ideal for applications in offices, shops, hotels and hospitals where an energy efficient general lighting solution is needed.



Features and Benefits

- Features the latest LED technology to deliver high system efficacy, resulting in up to 80% energy savings compared with conventional Philips CFL downlights.
- Realises specification grade standards in visual comfort, performance and consistent colour rendering:
 - Better colour rendering: CRI80;
 - Better colour consistency. SDCM
- Provides more flexibility with a full range and different accessories.
- Compact curved design gives the luminaire a professional look.
- Internal reflector that provides an even wash of light against a wall.

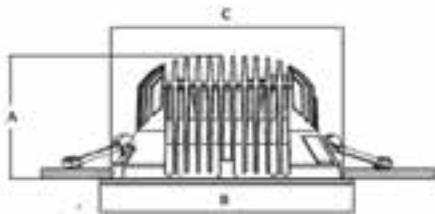

Product ID	A (mm)	B (mm)	C (mm)
Mini - DN488 M-A	88.5	ø163	ø150
Compact Power - DN498 M-A	119.5	ø218	ø200

Dimensions in mm (Nominal)



LuxSpace Gen III Wall-wash continued

LUXSPACE GEN III WALL-WASH	
Family name	LuxSpace Gen III Wall-wash
Model	Mini - DN488 M-A Compact Power - DN498 M-A
Lumen/ Watt	3000K Mini - 12W/ 960lm Compact Power -23W/ 1900lm 4000K Mini - 12W/ 1000lm Compact Power -23W/ 2000lm
Correlated Colour Temperature (CCT)	3000K, 4000K
Colour Rendering Index (CRI)	≥80
Flex and Plug	No
Lifetime (L70)	50,000hrs
Unified Glare Ratio (UGR)	22
Driver	External Fixed Driver
Dimmable	DALI available on request
Installation	Recessed mounting with flexible spring clips
IP rating	IP20
Colour of housing	White
Application	Retail, Hospitality, Offices
Accessories	Adaptor ring (White/Grey)
Reflector	Matt

DESCRIPTION	TRADE PRICE
MINI	
DN488 1xDLED-3000 PSU-E M-A WH	\$286.00
DN488 1xDLED-3000 PSD-E M-A WH	\$341.00
DN488 1xDLED-4000 PSU-E M-A WH	\$286.00
DN488 1xDLED-4000 PSD-E M-A WH	\$341.00
COMPACT POWER	
DN498 1xDLED-3000 PSU-E M-A WH	\$396.00
DN498 1xDLED-3000 PSD-E M-A WH	\$434.50
DN498 1xDLED-4000 PSU-E M-A WH	\$396.00
DN498 1xDLED-4000 PSD-E M-A WH	\$434.50



Greenspace III / Greenspace Power

GreenSpace III is your energy efficient, cost-effective LED downlight solution with a high system efficacy. In fact, you can expect up to 73% more energy savings compared to conventional Philips compact fluorescent downlights. The GreenSpace III is the perfect retrofit solution, delivering quality lighting that is diffused and uniform. The compact, elegant design can be used across a variety of applications, including offices, shops and hotels.



Features and Benefits

- The latest LED technology delivers high system efficacy, resulting in up to 73% energy savings compared to traditional Philips CFL downlights.
- 50,000 hour lifetime @L70.
- A comprehensive range provides a greater flexibility of choices.
- Improved PMMA material creates a higher diffusion rate for uniform, diffused lighting effect.
- Light efficacy of more than 90 lm/W.

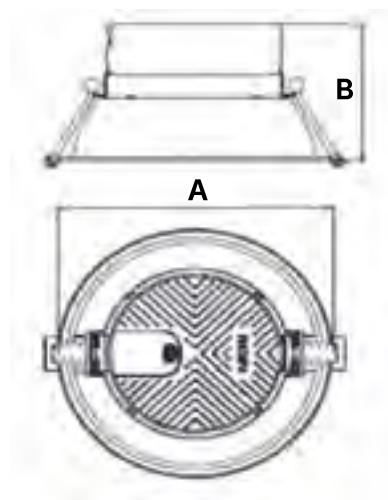

Greenspace III

Product ID	Width (mm) A	Height (mm) B	Cut-out (mm)
DN280B (White)	139	96	ø105 - 110
DN281B (White)	187	103	ø150 - 155
DN282B/DN283B (White/Aluminium)	234	117	ø200 - 205
DN280B (Aluminium)	121	94	ø105 - 110
DN281B (Aluminium)	170	103	ø150 - 155
DN280Z Adaptor Ring (White)	138		
DN281Z Adaptor Ring (White)	185		
DN282Z/DN283Z Adaptor Ring (White)	249		

Dimensions in mm

Greenspace Power

Product ID	Width (mm) A	Height (mm) B	Cut-out (mm)
DN284B 3500 lumen	234	113	150 - 155
DN284B 4500 lumen	234	117	ø150 - 155
DN285B 3500 lumen	294	158	ø200 - 205
DN285B 4500 lumen	294	163	200 - 205

Dimensions in mm



Greenspace III / Greenspace Power continued

DESCRIPTION	TRADE PRICE
DN280B 1xDLED-3000 PSU WH CAU	\$115.50
DN280B 1xDLED-4000 PSU WH CAU	\$115.50
DN281B 1xDLED-3000 PSU WH CAU	\$144.38
DN281B 1xDLED-4000 PSU WH CAU	\$144.38
DN282B 1xDLED-3000 PSU WH CAU	\$202.13
DN282B 1xDLED-4000 PSU WH CAU	\$202.13
DN283B 1xDLED-3000 PSU WH CAU	\$242.00
DN283B 1xDLED-4000 PSU WH CAU	\$242.00
DN280B 1xDLED-3000 PSU ALU G CAU	\$115.50
DN280B 1xDLED-4000 PSU ALU G CAU	\$115.50
DN281B 1xDLED-3000 PSU ALU PR CAU	\$144.38
DN281B 1xDLED-4000 PSU ALU PR CAU	\$144.38
DN281B 1xDLED-3000 PSU ALU G CAU	\$144.38
DN281B 1xDLED-4000 PSU ALU G CAU	\$144.38
DN282B 1xDLED-3000 PSU ALU G CAU	\$202.13
DN282B 1xDLED-4000 PSU ALU G CAU	\$202.13
DN283B 1xDLED-3000 PSU ALU G CAU	\$242.00
DN283B 1xDLED-4000 PSU ALU G CAU	\$242.00
DN283B 1xDLED-3000 PSU ALU G CAU	\$242.00
DN280Z AD Adaptor ring	\$27.50
DN281Z AD Adaptor ring	\$27.50
DN282Z AD Adaptor ring	\$27.50
DN283Z AD Adaptor ring	\$27.50
DN285B-10 1xDLED-4000 PSU WH	\$319.00
DN285B-10 1xDLED-3500 PSU WH	\$319.00
DN285B-10 1xDLED-3000 PSU WH	\$319.00
DN284B-10 1xDLED-4000 PSU WH	\$302.50
DN284B-10 1xDLED-3500 PSU WH	\$302.50
DN285B-8 1xDLED-3000 PSU WH	\$313.50
DN285B-8 1xDLED-4000 PSU WH	\$313.50
DN285B-8 1xDLED-3500 PSU WH	\$313.50
DN284B-10 1xDLED-3000 PSU WH	\$302.50
DN284B-8 1xDLED-4000 PSU WH	\$302.50
DN284B-8 1xDLED-3500 PSU WH	\$302.50
DN284B-8 1xDLED-3000 PSU WH	\$302.50



SmartBright Next Gen LED

With a lifetime of up to 25,000 hours, and IC rated, the latest SmartBright family ticks the boxes for domestic installations.

Using only 8W of power, there is up to 80% energy savings when compared to traditional Philips incandescent lamps. The SmartBright range is the obvious choice for endusers, contractors and landlords where budgets need to be met and quality is a must.



Features and Benefits

- Leading brand, with the assurance of quality.
- Ergonomically designed for easy application.
- Leading-edge technology creates a perfect experience.

Applications

- General lighting
- Residential
- Hospitality
- Retail
- Apartments
- Motels / Hotels

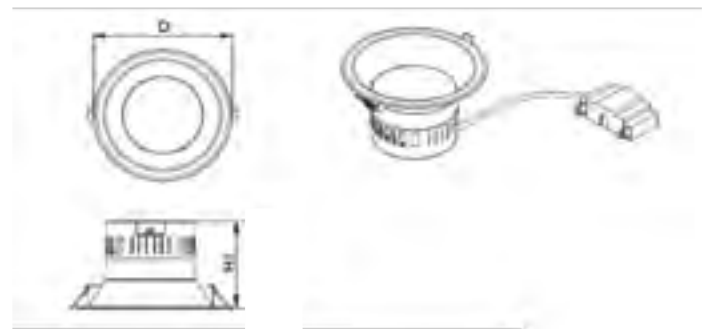

DESCRIPTION	SHORTCODE	TRADE PRICE
DN030B 1xDLED/830 WH	DN030TB	\$54.95
DN031B 1xDLED/830 WH	DN031TB	\$65.95

Product ID	D (mm)	H1 (mm)	Cut-out (mm)
DN030B	123	95	105
DN031B	142	105	125

Dimensions in mm (Nominal)



SmartBright Surface

Looking for a splash of style for your commercial environment? The new SmartBright LED Surface provides the aesthetics while going easy on energy. In fact, with outstanding efficacy of up to 85 lm/W, the SmartBright LED Surface can save you as much as 60% energy over a traditional Philips CFLi system.

The sleek, elegant design is perfectly at home in shops, restaurants and public areas. It's surface mounted, making it a breeze to install. There's no need to cut any large holes in the ceiling.



Features and Benefits

- Surface-mounted, so no need to cut large holes in the ceiling.
- Outstanding efficacy reaching 85 lm/W can save 60% more energy than a Philips CFLi system.
- High CRI (83) and SDCM (5).
- Streamlined profile suits a range of retail and hospitality environments and public areas.
- Made to the consistent Philips standard of quality, meeting the AS/NZ 60598 standard.
- Available in white or black.
- Surface or suspended mounting.
- 25,000 hrs (L70) lifetime.

Applications

- Hospitality
- Retail
- Public areas including foyers and hallways

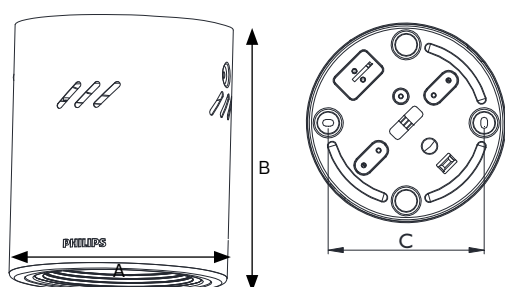

Lumens	Product ID	A	B	C
		Diameter (mm)	H (mm)	
600	SM050C	Ø133*	157	104
800	SM051C	Ø133*	157	104
1200	SM052C	Ø171*	198	140
1500	SM053C	Ø171*	198	140

Dimensions in mm (Nominal)



SmartBright Surface continued

DESCRIPTION	TRADE PRICE
SM050C 1xSLED/830 WH	\$125.00
SM050C 1xSLED/840 WH	\$125.00
SM051C 1xSLED/830 WH	\$145.00
SM051C 1xSLED/840 WH	\$145.00
SM052C 1xSLED/830 WH	\$165.00
SM052C 1xSLED/840 WH	\$165.00
SM053C 1xSLED/830 WH	\$185.00
SM053C 1xSLED/840 WH	\$185.00
SM050C 1xSLED/830 BK	\$125.00
SM050C 1xSLED/840 BK	\$125.00
SM051C 1xSLED/830 BK	\$145.00
SM051C 1xSLED/840 BK	\$145.00
SM052C 1xSLED/830 BK	\$165.00
SM052C 1xSLED/840 BK	\$165.00
SM053C 1xSLED/830 BK	\$185.00
SM053C 1xSLED/840 BK	\$185.00

OptiVision

An asymmetric luminaire for floodlighting that combines a compact design with very high efficiency. It provides excellent spill-light control and limitation of glare and upward leakage of light. It accommodates metal-halide lamps for good colour rendering or high-pressure sodium lamps for economical operation. Available with narrow, medium and wide beams.



Features and Benefits

- Excellent spill-light control; limitation of glare and upward leakage of light is secured by asymmetric optics that achieve peak intensity at 60° and a sharp cut-off of light at 80°.
- Housing dust proof and waterproof to IP65; no internal cleaning required.
- Integrated protractor scale for aiming.
- The compact, low-weight luminaire, together with the low drag factor, enables savings on mast costs.
- Specially designed heat fins to provide optimal working conditions for lamp and reflector system.

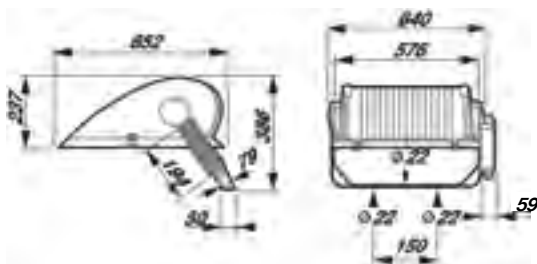

Product ID	L (mm)	W (mm)	H (mm)
MVP507	652	640	237

OPTIVISION			
Family Name	OptiVision	Control Gear	Open gear tray or gear tray in IP56 box
Model	MVP507	Installation	Floodlight mounting bracket
Lamp Type	HPI-T, SON-T, MHN-LA	IP rating	IP65
Wattage	1000W (HPI-T) 1000W (SON-T), 1kW, 2kW (MHN-LA)	Weight	17.3kg (excluding gear)
Lamp Colour	4200K/5600K	Colour of housing	Silver
Colour Rendering Index (CRI)	80/90 (MHN-LA)	Application	Sports Facilities / Industrial Areas / Car Parks
Flex and Plug	No	Accessories	NA
Optics	NB, MB, WB		

OptiVision continued

DESCRIPTION	TRADE PRICE
MVP507 1xSON-T 1000W WB Requires HPIT 1000 or SONT 1000 lamp	\$1,799.03
MVP507 MHN-LA1000W/842 230V WB SI Lamp Included	\$1,981.98
MVP507 MHN-LA2000W/842 400V MB SI SL Lamp Included	\$2,286.90
MVP507 MHN-LA2000W/842 400V NB SI SL Lamp Included	\$2,286.90
MVP507 MHN-LA2000W/842 400V WB SI SL Lamp Included	\$2,286.90
Control Gear for Optivision Floodlight	
SONT1000 30m (HPS-1KO-AN06880)	\$605.00
SONT1000 70m (HPS-1KO-AN06891)	\$715.00
SONT1000 30m IP56 (HPS-1KO-AN06905)	\$902.00
SONT1000 70m IP56 (HPS-1KO-AN06913)	\$990.00
HPIT1000 100m (MHA1KO-AN06882)	\$495.00
HPIT1000 100m IP56 (MHA1KO-AN06897)	\$825.00
MHN-LA 1000W Geartray MHD1KO-AMO4997	\$500.94
MHN-LA1KW IP56 W/P Box (MHD1KO-AM06156)	\$880.00
MHN-LA 2000w Geartray (MHH1K8-CUO4993)	\$698.28
MHN-LA2KW IP56 W/P Box (MHH1K8-CU05594)	\$872.85



Tango LED Specification Grade

Tango LED is a general purpose LED floodlighting luminaire for various lighting applications, such as area lighting, billboard, façade, industry areas close to the sea (BVP283 model), and other general applications. The Tango LED floodlight incorporates an LED light source, optical system, heat sink and driver into one compact housing. Its specially designed heat sink incorporates aesthetics and functionality whilst ensuring reliability and long lifetime. Tango LED takes advantage of all of these features and provides energy savings and a longer lifetime, bringing area lighting into a new era.



Features and Benefits

- Energy saving: system efficacy reaches 90 lm/W, which gives more than 40% of energy saving when compared to conventional Philips floodlights.
- Free from lamp replacement: Lifetime reaches 50,000 hours at L70.
- Low maintenance cost: IP65 housing ensures low maintenance with no need for internal cleaning, resulting in a lower total cost of ownership.
- Good reliability: Painted non-corrosive die-cast aluminium housing and galvanised steel bracket gives extra strength when the luminaire is installed in a rough environment.
- Special marine coated paint for BVP283 makes this model especially suitable for use in areas close to the sea.
- Easy installation and maintenance: Universal “U” shape mounting bracket.

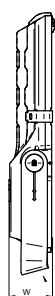
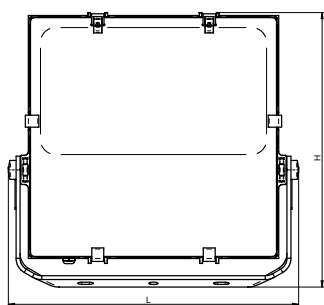

Model	L (mm)	W (mm)	H (mm)
BVP361	433	74	572
BVP363	587	74	572
BVP283	655	60	480

Dimensions in mm (Nominal)



Tango LED Specification Grade continued

TANGO LED		Optics	WB, MB, NB (BVP363 and BVP283 only)
Family Name	Tango LED	Driver	Integrated driver
Model	BVP361, BVP363, BVP283	Surge Protection	10kV
Lumens	BVP361 (5,300/10,400/15,500 lumen), BVP363 (17,500/21,000/24,500/28,000 lumens), BVP283 (21,000, 24,500, 28,000, 32,000, 34,000lm)	Installation	Universal Bracket
Wattage	BVP361 (55W, 105W, 155W), BVP363 (175W, 210W, 245W, 280W). BVP283 (210W, 245W, 280W, 315W, 335W)	Weight	BVP361 (10.5kg), BVP363 (16kg), BVP283 (13kg)
Lamp Colour	3000K, 4000K, 5700K	Colour of housing	Grey Aluminium
Colour Rendering Index (CRI)	75	Application	Area lighting, billboard, façade, industry area, and other general applications.
Flex	1.5m Flex		
Lifetime (L70)	50,000 hrs		
Classifications	IP65, IK07, Class I		

DESCRIPTION	TRADE PRICE
BVP361	
BVP361 LED53/NW 55W 220-240V AWB V	\$792.00
BVP361 LED53/NW 55W 220-240V SWB V	\$792.00
BVP361 LED104/NW 105W 220-240V AWB V	\$979.00
BVP361 LED104/NW 105W 220-240V SWB V	\$979.00
BVP361 LED155/NW 155W 220-240V AWB V	\$1,284.80
BVP361 LED155/NW 155W 220-240V SWB V	\$1,284.80
BVP363	
BVP363 LED175/NW 175W 220-240V AWB V	\$1,320.00
BVP363 LED175/NW 175W 220-240V NB V	\$1,320.00
BVP363 LED175/NW 175W 220-240V SWB V	\$1,320.00
BVP363 LED210/NW 210W 220-240V AWB V	\$1,430.00
BVP363 LED210/NW 210W 220-240V NB V	\$1,430.00
BVP363 LED210/NW 210W 220-240V SWB V	\$1,430.00
BVP363 LED245/NW 245W 220-240V AWB V	\$1,626.90
BVP363 LED245/NW 245W 220-240V NB V	\$1,626.90
BVP363 LED245/NW 245W 220-240V SWB V	\$1,626.90
BVP363 LED280/NW 280W 220-240V AWB V	\$1,760.00
BVP363 LED280/NW 280W 220-240V NB V	\$1,760.00
BVP363 LED280/NW 280W 220-240V SWB V	\$1,760.00

DESCRIPTION	TRADE PRICE
BVP283	
BVP283 LED210/NW 210W 220-240V SWB	\$1,430.00
BVP283 LED210/NW 210W 220-240V AWB	\$1,430.00
BVP283 LED245/NW 245W 220-240V SWB	\$1,626.90
BVP283 LED245/NW 245W 220-240V AWB	\$1,626.90
BVP283 LED280/NW 280W 220-240V AWB	\$1,760.00
BVP283 LED280/NW 280W 220-240V SWB	\$1,760.00
BVP283 LED320/NW 315W 220-240V AWB	\$1,980.00
BVP283 LED320/NW 315W 220-240V SWB	\$1,980.00
BVP283 LED340/NW 335W 220-240V AWB	\$1,980.00
BVP283 LED340/NW 335W 220-240V SWB	\$1,980.00



Tango G2 LED

Tango G2 LED is a general purpose mid-power LED floodlighting luminaire suitable for various lighting applications, including area lighting, billboard, façade, and other general applications. Similar to the Tango LED floodlight, the Tango G2 LED floodlight incorporates a mid-power LED light source, optical system, heat sink and driver into an even smaller and lighter compact housing. Its specially designed heat sink incorporates aesthetics and functionality whilst ensuring reliability and long lifetime. Tango LED takes advantage of all of these features and provides an affordable energy efficient floodlighting solution.



Features and Benefits

- Energy saving: system efficacy reaches 100 lm/W which gives an energy saving of more than 40% when compared to conventional Philips floodlights.
- No need for lamp replacement: thanks to a lifetime that reaches 50,000 hours at L70.
- Low maintenance: IP65 housing ensures low maintenance with no need for internal cleaning, resulting in a lower total cost of ownership.
- Flexibility on lighting application: the symmetrical wide beam covers most lighting applications.
- Long-lasting: painted, non-corrosive die-cast aluminium housing and galvanised steel bracket gives extra strength when the luminaire is installed in harsh environments.
- Easy installation and maintenance: with a universal “U” shape mounting bracket and 1.5m long tail, the Tango G2 is easy to install.

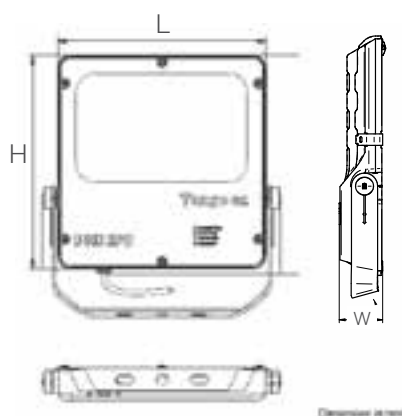

Product ID	L (mm)	W (mm)	H (mm)
BVP281	412	64	454
BVP282	655	60	480

Dimensions in mm (Nominal)



Tango G2 LED continued

TANGO G2 LED			
Family Name	Tango G2 LED	Optics	SWB
Model	BVP281, BVP282	Driver	Integrated driver
Lumens	BVP281 (4,000lm, 8000lm, 12,000lm), BVP282 (16,000, 20,000lm)	Surge Protection	10kV
Wattage	BVP281 (40W, 80W, 120W), BVP282 (160W, 200W)	Installation	Universal Bracket
Lamp Colour	4000K, 6500K	Weight	BVP281 (6.5kg), BVP282 (11.8kg)
Colour Rendering Index (CRI)	≥80	Colour of housing	Grey Aluminium
Flex	1.5m Flex	Application	Area lighting, bill board, façade, industry area, and other general applications.
Lifetime (L70)	50,000 hrs	Accessories	N/A
Classifications	IP65, IK07, Class I		

SHORTCODE	DESCRIPTION	TRADE PRICE
BVP281LED40SWB	BVP281 LED40/NW 40W 220-240V SWB	\$550.00
BVP281LED80SWB	BVP281 LED80/NW 80W 220-240V SWB	\$650.00
BVP281LED120SWB	BVP281 LED120/NW 120W 220-240V SWB	\$750.00
BVP282LED160SWB	BVP282 LED160/NW 160W 220-240V SWB	\$800.00
BVP282LED200SWB	BVP282 LED200/NW 200W 220-240V SWB	\$850.00



SmartBright LED Flood

The SmartBright LED Flood is the durable, long-lasting replacement for halogen and low wattage HID Floodlights.

It's the perfect solution for outdoor areas that require low to mid level illumination. The SmartBright LED Flood is equally at home in industrial, general sports, security and signage applications.

It's built to last, with a solid aluminium die-cast housing, tempered glass and true IP65 rated waterproof design. It comes with a 3 year Warranty and a 30,000 hour (L70) rated lifetime. The 6KV surge protection means the SmartBright LED Flood can handle unpredictable fluctuations in power.



Features and Benefits

- Waterproof and durable. Truly waterproof IP65 rating, with aluminium die cast body and tempered glass to withstand extreme weather.
- Reassurance of quality. Made to the consistent Philips standard of quality.
- Long-lasting. 30,000 hour lifetime @L70.
- Available in grey or black.
- 6KV surge protection to withstand power fluctuation.

Applications

- Industry
- Signage / Billboards
- General Sports
- Security
- Rural - Farming

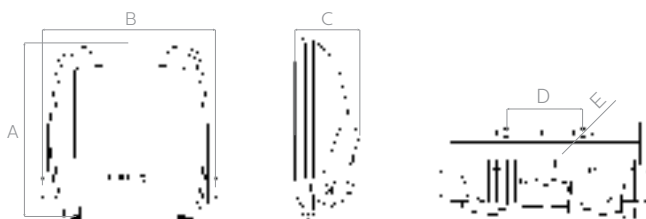

Model	A	B	C	D	E (Ø)
20W	185	170	65	80	6.2
30W	292	348	95	100	13.8
50W	292	348	95	100	13.8
75W	355	320	122	120	13.8

Dimensions in mm (Nominal)



SmartBright LED Flood continued

SHORTCODE	DESCRIPTION	TRADE PRICE
BVP10020NWGR	BVP100 LED20/NW 20W 220-240V 50/60Hz GREY	\$181.50
BVP10020NWBK	BVP100 LED20/NW 20W 220-240V 50/60Hz BLACK	\$181.50
BVP10030NWGR	BVP100 LED30/NW 30W 220-240V 50/60Hz GREY	\$269.50
BVP10030NWBK	BVP100 LED30/NW 30W 220-240V 50/60Hz BLACK	\$269.50
BVP10050NWGR	BVP100 LED50/NW 50W 220-240V 50/60Hz GREY	\$412.50
BVP10050NWBK	BVP100 LED50/NW 50W 220-240V 50/60Hz BLACK	\$412.50
BVP10075NWGR	BVP100 LED75/NW 75W 220-240V 50/60Hz GREY	\$493.90
BVP10075NWBK	BVP100 LED75/NW 75W 220-240V 50/60Hz BLACK	\$493.90

Tango HID

Compact, sturdy floodlight complete with integral gear, particularly suited for general floodlighting using metal halide or high-pressure sodium lamps. All-weather construction designed for simple cleaning and speedy servicing, and very reliable.



Features and Benefits

- High-grade symmetrical or asymmetrical reflector projects a highly efficient light beam.
- Wall, ceiling and surface mountings with wide range of adjustments for both down and up lighting.
- Quick, easy access to lamp and gear, without affecting beam adjustment, through hinged front window with quick-release clips.
- Housing dustproof and jetproof; no internal cleaning required.

MMF383, SMF383

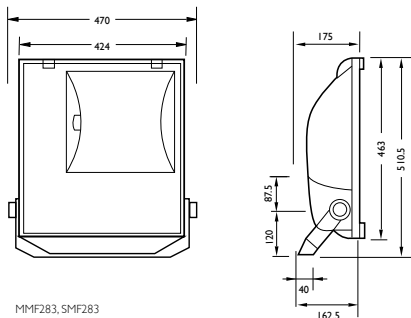

MMF283, SMF283

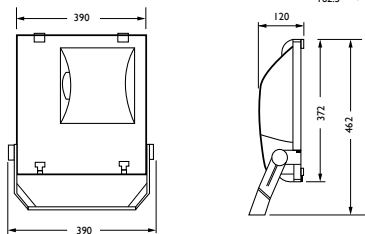

Product ID	L (mm)	W (mm)	H (mm)
MMF383, SMF383	470	175	510
MMF283, SMF283	390	120	462

Dimensions in mm (Nominal)

TANGO HID

Family Name	Tango HID	Control Gear	Conventional
Model	Tango 2 (SMF283, MMF283), Tango 3 (SMF383, MMF383)	Installation	Universal Bracket
Lamp Types	MHN-TD, HPI-T, SON-T Included	IP rating	IP65
Wattages	70W, 150W, 250W, 400W	Weight	Tango 2 (7.6-9kg) Tango 3 (12.5 -14kg)
Lamp Colour	MHN-TD (4200K), HPI-T (4500K), SON-T (2000K)	Colour of housing	Black
Colour Rendering Index (CRI)	MHN-TD (80) , HPI-T (65) , SON-T (25)	Application	Area Lighting / Billboard / Façade / Industrial Areas / Other General
Optics	Symmetrical, Asymmetrical		

Tango HID continued

DESCRIPTION	TRADE PRICE
MMF383 HPI-T+400w 240v 50Hz AK	\$667.01
MMF383 HPI-T400w 240v 50Hz SK	\$627.63
MMF383 HPI-T250w 240v 50Hz SK	\$627.63
MMF283 MHN-TD150w Tango SK 240v 50Hz	\$512.46
MMF283 MHN-TD70w Tango SK 240v 50Hz	\$409.10

ConTempo HID

The ConTempo floodlight has a registered design that blends well with contemporary outdoor environments. It has a rugged pressure die-casted aluminium housing with corrosion resistant powder coating. ConTempo also features an integrated energy saving copper ballast, electronic semi-parallel ignitor and capacitor.



Features and Benefits

- Rugged pressure die-casted aluminium housing with corrosion resistant powder coating.
- Integrated energy saving copper ballast, electronic semi-parallel ignitor and capacitor.
- Custom-designed peened anodised reflector for efficient symmetric and asymmetric optics.
- Hinged toughened glass cover for easy operation.
- Rigorously tested for dust and water ingress protection.
- Ergonomic installation and maintenance mechanisms.

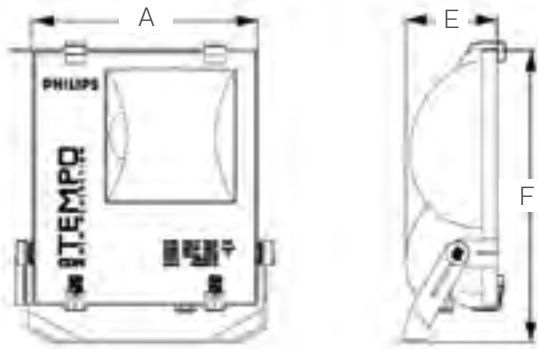

Product ID	A (mm)	E (mm)	F (mm)
RVP250	363	117	424
RVP350	460	137	476

Dimensions in mm (Nominal)

CONTEMPO HID

Family Name	ConTempo HID	Control Gear	Conventional
Model	RVP250/350	Installation	Stirup Bracket
Lamp Type	MHN-TD, HPI-T, SON-T Included	IP rating	IP65
Wattages	70W, 150W, 250W, 400W	Weight	RVP250 (4.7kg) , RVP350 (9.4kg)
Lamp Colour	MHN-TD (4200K), HPI-T (4500K), SON-T (2000K)	Colour of housing	Grey
Colour Rendering Index (CRI)	MHN-TD (80) , HPI-T (65) , SON-T (25)	Application	Area Lighting / Billboard / Façade / Industrial Areas / Other General
Optics	Symmetrical		

ConTempo HID continued

SHORTCODE	DESCRIPTION	TRADE PRICE
RVP350 HPI-T400W	RVP350 HPI-T400W K IC 240V 50Hz S SP	\$391.31
RVP250 MHN-TD150W	RVP250 MHN-TD150W K IC 240V 50Hz S SP	\$377.34
RVP350 SON-T400W	RVP350 SON-T400W K IC 240V 50Hz S SP	\$426.56
RVP250 SON-T70W	RVP250 SON-T70W K IC 240V 50Hz S SP	\$177.49



Metro LED

The Metro LED luminaire builds on the continued success of the conventional Metro fitting by offering an energy efficient light source for conveyor lighting, general mining lighting, residential streets, areas requiring security, footpaths, access ways and industrial lighting estates. Designed with die-cast aluminium housing and polycarbonate cover, it provides vibration, dust and heat resistant capabilities to meet harsh application environments. It uses the Philips LEDGINE LED platform to ensure long lifetime and reliability and offers significant energy savings when compared with conventional lamp systems.



Features and Benefits

- Up to 70% energy savings compared to conventional HID Metro with 70W High Pressure Sodium lamp.
- Ergonomic curve-shaped housing.
- Vibration, dust and heat resistant.
- High quality cool and neutral white light with high colour consistency.

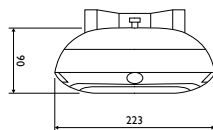
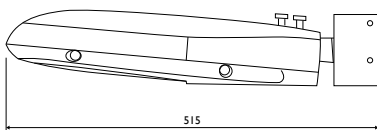

Model	Length (mm)	Width (mm)	Height (mm)
BGS007	515	223	90

Dimensions in mm (Nominal)

METRO LED			
Family Name	Metro LED	Driver	Integrated driver
Model	BGS007	Surge protection	10kV
Lumen/ Watt	2000 lm / 20W	Installation	Standard Metro mounting bracket (supplied)
Lamp Colour	4000K	Weight	3.5kg
Colour Rendering Index (CRI)	70 ± 5	Colour of housing	Grey
Flex cable	Yes - 3m	Application	General Mining areas / Conveyor Belts / Security Lighting
Lifetime (L70)	50,000 hrs	Accessories	NA
Classifications	IP65, IK06, Class I		
Optics	Symmetrical Beam		

DESCRIPTION	SHORTCODE	TRADE PRICE
BGS007 LED17/NW 20W 220-240V SMBV	MetroLED20W	\$467.00

Metro Lantern

The Philips Metro Lantern can be used for many applications such as mines, pathways and security lighting.

Quick and easy lamp replacement is carried out by simple removal of the twist-lock bowl.

IP55 rated with integral control gear. Comes complete with bracket / pole assembly.



Features and Benefits

- Lamp support spring to reduce lamp vibration.
- Polycarbonate bowl to reduce vandalism and shock.
- Choice of HPLN 80 or 50N 70 lamp e gear.

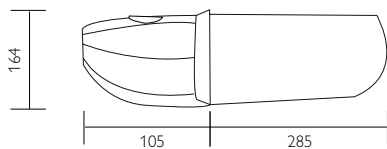

Dimensions in mm

SHORTCODE	DESCRIPTION	TRADE PRICE
METRO50	HGC 007 HPLN80 K HD	\$207.90
METRO70	HGC 007 SON70I K HD	\$231.00

* Lamps included in fitting



Coreline Wallmount

The elegant design looks good across a variety of applications, including hallways, stairways and garages. The homogenous soft lighting effect is easy on the eye – and it's easy on energy too. In fact, the Coreline Wallmount is up to 55% more energy efficient than traditional Philips luminaires with PL-C lamps.

Installation is easy with just two luminaire parts to handle.

Flexibility is a big benefit with the Coreline Wall Mounted. The range provides all your application requirements, with a variety of light levels, built in controls, and IP65 and IK10 certification. Emergency option available.



Features and Benefits

- Up to 55% energy savings compared to Philips luminaires with PL-C lamps.
- The unobtrusive styling is perfect for a variety of applications.
- Homogenous soft lighting effect.
- Up to 50,000 hours @L70 lifetime makes this a true fit and forget solution.
- Available in white or dark grey housings.

Applications

- Residential
- Offices and stairways
- Hospitality
- Garages

WL120V

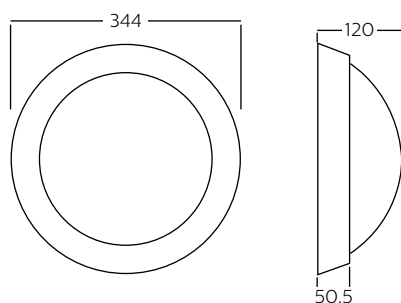

WL121V

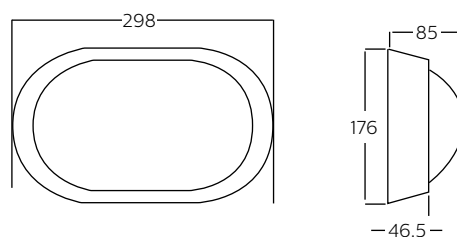



Coreline Wallmount continued

DESCRIPTION	TRADE PRICE
WL120V LED16S/840 PSR WH	\$275.00
WL120V LED16S/840 PSR GR	\$275.00
WL120V LED12S/840 PSR WH	\$253.00
WL120V LED12S/840 PSR GR	\$253.00
WL121V LED5S/840 PSR WH	\$192.50
WL121V LED5S/840 PSR GR	\$192.50
WL120V LED16S/830 PSR WH	\$275.00
WL120V LED16S/830 PSR GR	\$275.00
WL120V LED12S/830 PSR WH	\$275.00
WL120V LED12S/830 PSR GR	\$253.00
WL121V LED5S/830 PSR WH	\$192.50
WL121V LED5S/830 PSR GR	\$192.50
WL120V LED16S/840 PSR EL3 WH	\$577.50
WL120V LED16S/840 PSR EL3 GR	\$577.50



Mini Vandalite LED

The Mini Vandalite LED is a ceiling or wall-mounted security and amenity lighting luminaire. It delivers low-energy lighting all night long. Its translucent bowl provides excellent light distribution for low-level lighting of walls, corridors and surroundings. Mini Vandalite's robust, vandal-resistant construction makes it suitable for both outdoor and indoor applications.



Features and Benefits

- 1 for 1 replacement of CFL and GLS bulkheads.
- 12W (600 lm) and 17W (900 lm).
- 50 lm/W, Energy Savings up to 30%, compared to conventional Philips amenity luminaires.
- Compact and easy to install.
- Lifetime up to 50,000hrs (L70).
- IP65/IK10 robust design and vandal resistant construction with security screws.
- Outdoor Residential / Security Lighting.

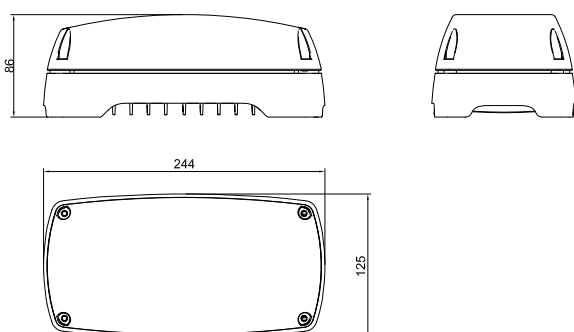

Product ID	L (mm)	W (mm)	H (mm)
BCW098	244	125	86

Dimensions in mm (Nominal)

MINI VANDALITE LED

Family Name	Mini Vandalite	Dimmable	PSU (Fixed output)
Model	BCW098	Installation	Wall Mounted
Lumen/ Watt	900lm/ 17W 600lm/ 12W	IP rating	IP65
Lamp Colour	4000K	IK Rating	IK10
Colour Rendering Index (CRI)	≥85	Colour of housing	Dark grey, RAL 7043
Flex and Plug	Not included	Application	Residential, Security, Public areas, Schools
Lifetime (L70)	50,000hrs		
Optics	120D		
Driver	Integrated driver		

SHORTCODE	DESCRIPTION	TRADE PRICE
BCW098 600 LUMS	BCW098 LED6/NW	\$247.50
BCW098 900 LUMS	BCW098 LED9/NW	\$269.50

Italia Range

A range of bulkhead luminaires combining aesthetics and practicality. Choose from compact fluorescent for high efficiency and long life incandescent sources for perfect colour rendition. Italia bulkheads may be ceiling or wall mounted. Lamps not included.

PL4520



PL4700

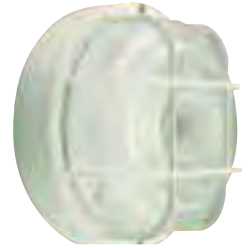

PL4520

PL4700

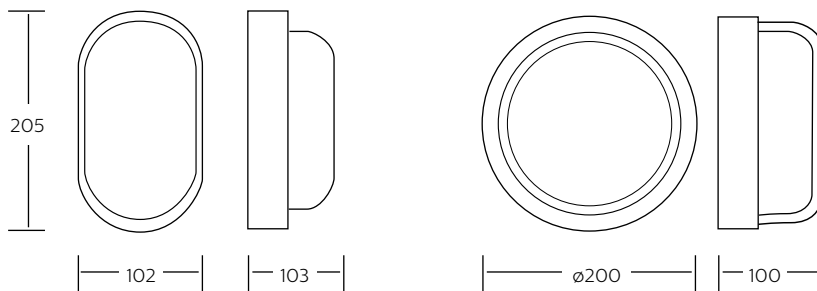

Dimensions in mm

SHORTCODE	DESCRIPTION	IP RATING	TRADE PRICE
PL4500	PL4500 Prego Oval White Clear GLS/CFL	IP44	\$25.11
PL4520	PL4520 Prego Oval Black Clear GLS/CFL	IP44	\$25.11
PL4700	PL4700 Prego Round White Clear GLS/CFL	IP44	\$38.72

* Order lamps separately



Twin Motion LED Sensor

The Philips LED motion sensor incorporates the latest in lighting technology with practical and user friendly features, including adjustable beam angles and sensor timer.

Designed as a total fit and forget solution, the LED motion and daylight sensor is the complete package with low energy usage and extra long life.



Features and Benefits

- Low 2 x 7.5W LED adjustable beam angles.
- Bright 5,000K colour temperature.
- Up to 30,000 hours lifetime.
- IP44 rated for outdoor use.
- Powerful 1,000 lumens light output.

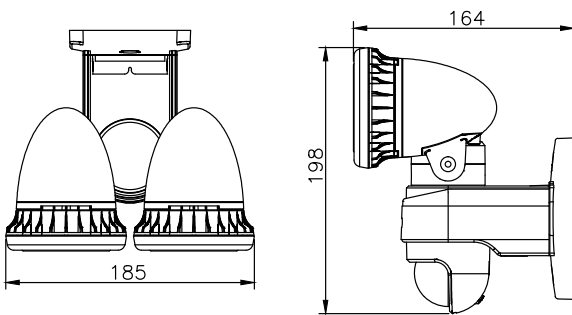

Product ID	L (mm)	W (mm)	H (mm)
EH313L	164	185	198

Dimensions in mm (Nominal)

TWIN MOTION LED SENSOR

Family Name	Twin Motion LED Sensor	Installation	Wall Mounted
Model	EH313L	IP rating	IP44
Lumen/ Watt	EH313L - 1000lm/ 15W	Weight	0.80kg
Lamp Colour	5000K	Colour of housing	Black
Colour Rendering Index (CRI)	80	Application	Residential Security
Flex and Plug	Not included		
Lifetime (L70)	30,000 hrs		
Angle	Directional		
Driver	Integrated driver		

SHORTCODE	DESCRIPTION	TRADE PRICE
EH313L	EH313L LED Twin Motion Sensor	\$152.63

Sensor Lights QHF560

The Philips QHF560 is a compact flexible security light which can be mounted on walls or under eaves. The QHF560 consists of two weatherproof lamp holders and seals. IP42, It has an adjustable PIR movement activated sensor with a 12 metre area of coverage at 110'. Black or white finish. Kombi packs include 2 x PAR38 120W lamps. or 2 x CFL 23W.

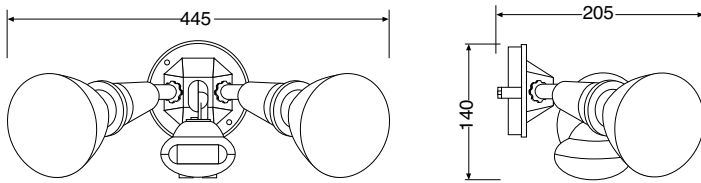

Dimensions in mm

SHORTCODE	DESCRIPTION	IP RATING	TRADE PRICE
QHF560B	QHF560 120W Twin Spot Sensor Light Black	IP42	\$67.01
QHF560W	QHF560 120W Twin Spot Sensor Light White	IP42	\$67.01
QHF560BKPACK *	QHF560B PIR+2xPAR38 120WKombipack-Black	IP42	\$78.72
QHF560WHPACK *	QHF560Wh PIR+2xPAR38 120WKombipack-White	IP42	\$78.72
QHF560BKPACKCFL*	QHF560 2x23W CFL SENSOR KOMBI BLACK	IP42	\$94.57
QHF560WHPACKCFL *	QHF560 2x23W CFL SENSOR KOMBI WHITE	IP42	\$94.57

* Lamps included in fitting



Consumer Luminaires









LED VALUE 'HALO' DOWNLIGHT

Quality lighting for a
cosy home

Bring a glow to your home with Philips LED Value 'Halo' downlights. The range is dimmable so you can create the right ambiance for your mood, while a unique glow ring provides a night light 'Halo' feature. Choose from round or square shapes in cool or warm white for the whole home.

For dimming information, please see our website.



61021/31 and 61025/31 Small Square Downlight



61021/31 AND 61025/31 SMALL SQUARE DOWNLIGHT

Colour/Finish	White
IP Rating	IP20
Light Source	LED Integrated 8W
Light Colour Temp	2700K or 4000K
Dimensions (mm)	132 x 91 x 125
Shortcode	61021/31/66 (27K) or 61025/31/66 (4K)
Barcode/EAN	6947830418855 (27K) or 6947830418879 (4K)
Trade Price	\$52.13

61022/31 and 61026/31 Small Round Downlight



61022/31 AND 61026/31 SMALL ROUND DOWNLIGHT

Colour/Finish	White
IP Rating	IP20
Light Source	LED Integrated 8W
Light Colour Temp	2700K or 4000K
Dimensions (mm)	125 x 91 x 119
Shortcode	61022/31/66 (27K) or 61026/31/66 (4K)
Barcode/EAN	6947830418916 (27K) or 6947830418930 (4K)
Trade Price	\$52.13

61023/27 and 61027/40 Large Square Downlight



61023/27 AND 61027/40 LARGE SQUARE DOWNLIGHT

Colour/Finish	White
IP Rating	IP20
Light Source	LED Integrated 11W
Light Colour Temp	2700K or 4000K
Dimensions (mm)	155 x 97 x 140
Shortcode	61023/27/66 (27K) or 61027/40/66 (4K)
Barcode/EAN	6947830425709 (27K) or 6947830425716 (4K)
Trade Price	\$69.52



61024/27 and 61028/40 Large Round Downlight



61024/27 AND 61028/40 LARGE ROUND DOWNLIGHT

Colour/Finish	White
IP Rating	IP20
Light Source	LED Integrated 11W
Light Colour Temp	2700K or 4000K
Dimensions (mm)	160 x 97 x 155
Shortcode	61024/27/66 (27K) or 61028/40/66 (4K)
Barcode/EAN	6947830425730 (27K) or 6947830425747 (4K)
Trade Price	\$69.52



ESSENTIAL LED

Slimline Ceiling Oyster Range

The new Philips Essential LED Ceiling range delivers the advantages of LED technology in surface mount ceiling luminaires. These are an ideal replacement for older incandescent, ecohalogen or fluorescent based oysters. The LED light sources used are up to 75% more energy efficient versus traditional light sources¹. Using LED allows a stylish slim line design only 50mm thick for a clean, unobtrusive installation.

LED deliver longer life than conventional light sources with up to 15,000 hours² of hassle free light delivered instantly in a soft uniform manner via durable, yellowing & chip resistant acrylic diffusers. The range offers a choice of 3 popular sizes and warm white or cool white colour temperatures.

1. Ultra efficient LED light source saves up to 75% energy vs. Philips EcoClassic halogen lamps with similar light output.
2. Up to 15,000 hours lifetime at 70% lumen maintenances in residential use.



31814 Slimline Ceiling Oyster 12W



31814 CEILING OYSTER 12W

Colour/Finish	White bezel
IP Rating	IP20
Light Source	LED Integrated 12W
Light Colour Temp	2700K or 6500K
Dimensions (mm)	290 x 290 x 50
Shortcode	31814/61/46 (27K) or 31814/31/46 (65K)
Barcode/EAN	8718291534877 (27K) or 8718291534860 (65K)
Trade Price	\$43.43

31815 Slimline Ceiling Oyster 17W



31815 CEILING OYSTER 17W

Colour/Finish	White bezel
IP Rating	IP20
Light Source	LED Integrated 17W
Light Colour Temp	2700K or 6500K
Dimensions (mm)	350 x 350 x 50
Shortcode	31815/61/46 (27K) or 31815/31/46 (65K)
Barcode/EAN	8718291534914 (27K) or 8718291534907 (65K)
Trade Price	\$60.83

31816 Slimline Ceiling Oyster 20W



31816 CEILING OYSTER 20W

Colour/Finish	White bezel
IP Rating	IP20
Light Source	LED Integrated 20W
Light Colour Temp	2700K or 6500K
Dimensions (mm)	380 x 380 x 50
Shortcode	31816/61/46 (27K) or 31816/31/46 (65K)
Barcode/EAN	6947830423804 (27K) or 8718291534945 (65K)
Trade Price	\$78.22



31817 Slimline Ceiling Oyster 12W IP65



31817 CEILING OYSTER 12W

Colour/Finish	White bezel
IP Rating	IP65
Light Source	LED Integrated 12W
Light Colour Temp	2700K or 6500K
Dimensions (mm)	290 x 290 x 50
Shortcode	31817/61/46 (27K) or 31817/31/46 (65K)
Barcode/EAN	6947830423828 (27K) or 6947830423811 (65K)
Trade Price	\$60.83



LED STAR SPOT

Cosy spot lighting for your home

Philips Star Spots are adjustable to instantly add striking accents to your room with bright focussed light. Available in one, two and four lamp combinations. They come in a coordinated range to match your interior style and are suitable for both wall and ceiling mounting.

The LED light source provides energy savings of up to 80% over Philips 35W Halogen spots. They are long lasting with up to 15,000 hours lifetime (L70). The Star Spot range has a specially designed optic lens resulting in soft edges to help create a cosy environment in your home.



56240/31 Single Spotlight



56240/31 SINGLE SPOTLIGHT

Colour/Finish	White
IP Rating	IP20
Light Source	LED Integrated 1x4W
Light Colour Temp	2700K
Dimensions (mm)	82 x 118 x 60
Shortcode	56240/31/86
Barcode/EAN	8718291489962
Trade Price	\$43.43

56242/31 Twin Spotlight



56242/31 TWIN SPOTLIGHT

Colour/Finish	White
IP Rating	IP20
Light Source	LED Integrated 2x4W
Light Colour Temp	2700K
Dimensions (mm)	82 x 198 x 60
Shortcode	56242/31/86
Barcode/EAN	8718291489979
Trade Price	\$60.83

56244/31 Quad Spotlight



56244/31 QUAD SPOTLIGHT

Colour/Finish	White
IP Rating	IP20
Light Source	LED Integrated 4x4W
Light Colour Temp	2700K
Dimensions (mm)	82 x 560 x 60
Shortcode	56244/31/86
Barcode/EAN	8718291489986
Trade Price	\$86.91



LED DYNA RANGE

Decorate your home with light

This playful range will brighten any room to make a better workspace, accent your artwork, help you read at night and just about anything else you can imagine with light. Philips high quality LED's provide clear, even light that is perfect for work or play. The integrated LED light source provides long life of up to 15,000 hours. The head is swivel mounted making finding the perfect position easy.



53235/31 Single Spotlight



53235/31 SINGLE SPOTLIGHT

Colour/Finish	White
IP Rating	IP20
Light Source	LED Integrated 1x3W
Light Colour Temp	2700K
Dimensions (mm)	82 x 198 x 60
Shortcode	53235/31/66
Barcode/EAN	6947830424009
Trade Price	\$34.74

56242/31 Twin Spotlight



56242/31 TWIN SPOTLIGHT

Colour/Finish	White
IP Rating	IP20
Light Source	LED Integrated 2x3W
Light Colour Temp	2700K
Dimensions (mm)	120 x 203 x 80
Shortcode	53232/31/66
Barcode/EAN	8718696129494
Trade Price	\$52.13

53231/31 Clip Spotlight



53231/31 CLIP SPOTLIGHT

Colour/Finish	White
IP Rating	IP20
Light Source	LED Integrated 1x3W
Light Colour Temp	2700K
Dimensions (mm)	82 x 118 x 60
Shortcode	53231/31/46
Barcode/EAN	8718696120224
Trade Price	\$34.74



67413/31 Desk Lamp



67413/31 DESK LAMP

Colour/Finish	White
IP Rating	IP20
Light Source	LED Integrated 1x3W
Light Colour Temp	2700K
Dimensions (mm)	82 x 560 x 60
Shortcode	67413/31/46
Barcode/EAN	8718696120231
Trade Price	\$34.74





LEDINO

Giving light a new experience

Minimalist and elegant. Simple yet versatile. Philips Ledino injects a natural sense of purity and beauty into your home.

With a linear design and an integrated LED light source, it's ideal for the sophisticated living room, dining area or bedroom. And perfect for the savvy urbanite.

You'll enjoy natural white light adjustable to the preferred atmosphere, thanks to its state-of-the-art Power LEDs. Together, they give your interior a beautiful diffused white accent, and an energy-efficient light source that lasts up to 20,000 hours.

Time to feel right at home with the future.



Tunable White

A simple key lets you choose between four different white light colour temperatures (3450, 3100, 2700, 2500 Kelvin) on selected fittings.



69055/48 Pendant Light



69055/48 PENDANT LIGHT

Colour/Finish	Aluminium
IP Rating	IP20
Light Source	LED Integrated 3x7.5W
Light Colour Temp	4000K (Tunable)
Dimensions (mm)	539 x 67 x 53.30
Shortcode	69055/48/86
Barcode/EAN	8717943745142
Trade Price	\$434.74

69053/48 Pendant Light



69053/48 PENDANT LIGHT*

Colour/Finish	Aluminium
IP Rating	IP20
Light Source	LED Integrated 3x7.5W
Light Colour Temp	4000K (Tunable)
Dimensions (mm)	559 x 116 x 553
Shortcode	69053/48/86
Barcode/EAN	8717943742332
Trade Price	\$782.57

*indent only

69049/48 Pendant Light



69049/48 PENDANT LIGHT

Colour/Finish	Aluminium
IP Rating	IP20
Light Source	LED Integrated 3x7.5W
Light Colour Temp	4000K (Tunable)
Dimensions (mm)	959 x 115 x 255
Shortcode	69049/48/86
Barcode/EAN	8717943742660
Trade Price	\$782.57



69064/90 Flexible Wall Light



69064/90 FLEXIBLE WALL LIGHT

Colour/Finish	Black
IP Rating	IP20
Light Source	LED Integrated 1x2.5W
Light Colour Temp	2700K
Dimensions (mm)	244 x 146 x 231
Shortcode	69064/90/86
Barcode/EAN	8718291441984
Trade Price	\$86.91

69064/99 Flexible Wall Light



69064/99 FLEXIBLE WALL LIGHT

Colour/Finish	Grey
IP Rating	IP20
Light Source	LED Integrated 1x2.5W
Light Colour Temp	2700K
Dimensions (mm)	244 x 146 x 231
Shortcode	69064/99/86
Barcode/EAN	8718291441991
Trade Price	\$86.91

69070/31 Wall/Ceiling Light

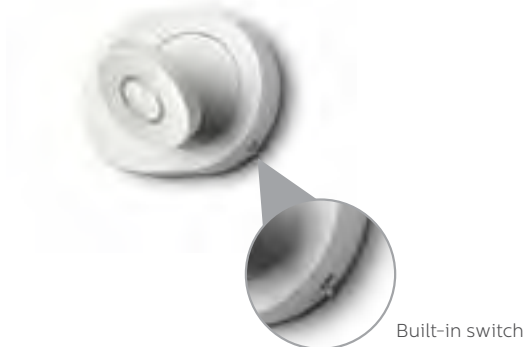

69070/31 WALL/CEILING LIGHT

Colour/Finish	White
IP Rating	IP20
Light Source	LED Integrated 1 x 7.5W
Light Colour Temp	2700K or 4000K
Dimensions (mm)	72 x 168 x 130
Shortcode	69070/29/86 (27K) or 69070/31/86 (4K)
Barcode/EAN	8718291442110 (27K) or 8717943744590 (4K)
Trade Price	\$130.39

*4000K version available as indent only



69072/31 Wall/Ceiling Light



69072/31 WALL/CEILING LIGHT

Colour/Finish	White
IP Rating	IP20
Light Source	LED Integrated 2 x 7.5W
Light Colour Temp	2700K or 4000K
Dimensions (mm)	315 x 133 x 73
Shortcode	69072/29/86 (27K) or 69072/31/86 (4K)
Barcode/EAN	8718291442127 (27K) or 8717943744619 (4K)
Trade Price	\$217.35

*4000K version available as indent only

69074 Wall/Ceiling Light



69074 WALL/CEILING LIGHT

Colour/Finish	White
IP Rating	IP20
Light Source	LED Integrated 4 x 7.5w
Light Colour Temp	2700k or 4000k
Dimensions (mm)	284 x 284 x 73
Shortcode	69074/29/86 (27K) or 69074/31/86 (4K)
Barcode/EAN	8718291442134 (27K) or 8717943744633 (4K)
Trade Price	\$347.78

*4000K version available as indent only

69080/99 Wall/Ceiling Light



Built-in switch

69080/99 WALL/CEILING LIGHT

Colour/Finish	Grey
IP Rating	IP20
Light Source	LED Integrated 1 x 7.5w
Light Colour Temp	2700k or 4000k
Dimensions (mm)	136 x 132 x 102
Shortcode	69080/99/86 (27K) or 69080/31/86 (4K)
Barcode/EAN	8718291442141 (27K) or 871794374465 (4K)
Trade Price	\$130.39

*4000K version available as indent only



69082/99 Wall/Ceiling Light



69082/99 WALL/CEILING LIGHT

Colour/Finish	Grey
IP Rating	IP20
Light Source	LED Integrated 2 x 7.5w
Light Colour Temp	2700k or 4000k
Dimensions (mm)	185 x 503 x 58
Shortcode	69082/99/86 (27K) or 69082/31/86 (4K)
Barcode/EAN	8718291442158 (27K) or 8717943744671 (4K)
Trade Price	\$217.35

*4000K version available as indent only

69084/99 Wall/Ceiling Light



69084/99 WALL/CEILING LIGHT

Colour/Finish	Grey
IP Rating	IP20
Light Source	LED Integrated 4 x 7.5w
Light Colour Temp	2700k or 4000k
Dimensions (mm)	185 x 903 x 58
Shortcode	69084/99/86 (27K) or 69084/31/86 (4K)
Barcode/EAN	8718291442165 (27K) or 8717943744695 (4K)
Trade Price	\$391.26

*4000K version available as indent only

69089/29 Wall Light

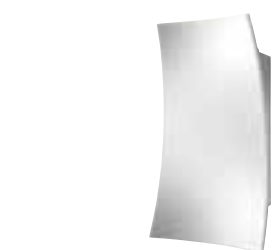

69089/29 WALL LIGHT

Colour/Finish	White
IP Rating	IP20
Light Source	LED Integrated 2 x 2.5w
Light Colour Temp	2700k or 4000k
Dimensions (mm)	95 x 127 x 55
Shortcode	69089/31/86 (4K) or 69089/29/86 (27K)
Barcode/EAN	8718291442189 (27K) or 8717943742264 (4K)
Trade Price	\$147.48

*4000K version available as indent only





myLiving

Saving in style

Beauty and efficiency. The Philips myLiving collection gives you both, with a stylish range specially designed for energy-savers and tube lights. myLiving uses up to 80% less energy than Philips incandescent lights, while bathing your spaces in warm, natural light.

From contemporary ceiling pendant and wall lights, to eye-catching ceiling and task lights, you'll find a light fixture to match your every need. So add a dash of brilliance in every room and save on your energy bills, without compromising on style.



40755 Eclipse Pendant Fitting – Dimmable



40755 ECLIPSE PENDANT FITTING – DIMMABLE*

Colour/Finish	White (available in Black)
IP Rating	IP20
Light Source	LED Integrated 16x2.5W
Light Colour Temp	2700K
Dimensions (mm)	3000 (max height) x 650 x 650
Shortcode	40755/31/86 (White) or 40755/93/86 (Black)
Barcode/EAN	8718291505969 (White) or 8718291505976 (Black)
Trade Price	\$782.57

*indent only

40902 Ayr Pendant Fitting – Dimmable



40902 AYR PENDANT FITTING – DIMMABLE*

Colour/Finish	White (available in Aluminium)
IP Rating	IP20
Light Source	LED Integrated 10x2.5W
Light Colour Temp	2700K
Dimensions (mm)	1500 (max height) x 400 x 400
Shortcode	40902/31/66 (White) or 40902/48/66 (Aluminium)
Barcode/EAN	6947830424443 (White) or 6947830424450 (Aluminium)
Trade Price	\$260.83

*indent only

31126 Wall Fitting



31126 WALL FITTING

Colour/Finish	Nickel
IP Rating	IP20
Light Source	LED Integrated 3W
Light Colour Temp	2700K
Dimensions (mm)	60 x 110 x 110
Shortcode	31126/17/66
Barcode/EAN	6947830424511
Trade Price	\$69.52



31132 Ceiling Surface Mounted Fitting



31132 CEILING SURFACE MOUNTED FITTING

Colour/Finish	White (available in Aluminium)
IP Rating	IP20
Light Source	LED Integrated 28W
Light Colour Temp	2700K
Dimensions (mm)	57 x 404 x 404
Shortcode	31132/11/66
Barcode/EAN	6947830424870
Trade Price	\$217.35

31133 Ceiling Surface Mounted Fitting



31133 CEILING SURFACE MOUNTED FITTING

Colour/Finish	White (available in Aluminium)
IP Rating	IP20
Light Source	LED Integrated 28W
Light Colour Temp	2700K
Dimensions (mm)	50 x 348 x 348
Shortcode	31133/48/66
Barcode/EAN	6947830424887
Trade Price	\$156.48





ROOMSTYLERS

Express your style with light

Understated, yet thoroughly distinct. The Philips Roomstylers contemporary collection blends effortlessly into any modern home décor, thanks to light fixtures that span a wide spectrum of colours and materials.

Available in both stand-alone and coordinated sets, the range includes wall and ceiling lights. All designed to give you the flexibility you need to complement your lifestyle.

QPG300 Suspension Light



QPG300 SUSPENSION LIGHT

Colour/Finish	Aluminium finish. Steel, Adjustable height
IP Rating	IP20
Light Source	Tornado up to 24W E27 lamp, not included
Light Colour Temp	Lamp dependant
Dimensions (mm)	331 x 331 x 1500
Shortcode	36865/48/86
Barcode/EAN	8727900749069
Trade Price	\$130.39

QPG301 Suspension Light



QPG301 SUSPENSION LIGHT

Colour/Finish	Aluminium finish. Steel, Adjustable height
IP Rating	IP20
Light Source	Tornado up to 3x 12W E27 lamp, not included
Light Colour Temp	Lamp dependant
Dimensions (mm)	980 x 191 x 1500
Shortcode	36866/48/86
Barcode/EAN	8727900749083
Trade Price	\$217.35

QCG301 Ceiling Light



QCG301 CEILING LIGHT

Colour/Finish	White, Nickel finish. Steel, sand blasted glass
IP Rating	IP20
Light Source	Tornado up to 20W E27 lamp, not included
Light Colour Temp	Lamp dependant
Dimensions (mm)	317 x 317 x 100
Shortcode	30136/17/86
Barcode/EAN	8727900749953
Trade Price	\$60.83

QCG301 Ceiling Light



QCG301 CEILING LIGHT

Colour/Finish	White, Aluminium. Steel, sand blasted glass
IP Rating	IP20
Light Source	Lamp dependant
Light Colour Temp	Tornado up to 24W E27 lamp, not included
Dimensions (mm)	317 x 317 x 100
Shortcode	30136/48/86
Barcode/EAN	8727900749960
Trade Price	\$60.83

This product is indent only.

FWG301 Wall Light



FWG301 WALL LIGHT

Colour/Finish	Beige, sand blasted glass with fabric
IP Rating	IP20
Light Source	Tornado up to 20W E27 lamp, not included
Light Colour Temp	Lamp dependant
Dimensions (mm)	315 x 111 x 168
Shortcode	33200/38/66
Barcode/EAN	8727900749533
Trade Price	\$69.52

FCG300 Ceiling Light



FCG300 CEILING LIGHT

Colour/Finish	Beige, White colour.. Premium sand blasted glass, Fabric
IP Rating	IP20
Light Source	Tornado up to 24W E27 lamp, not included
Light Colour Temp	Lamp dependant
Dimensions (mm)	316 x 316 x 97
Shortcode	30175/30/86
Barcode/EAN	8727900750010
Trade Price	\$86.91

QCG304 Ceiling Light



QCG304 CEILING LIGHT

Colour/Finish	White colour. Steel, PMMA
IP Rating	IP20
Light Source	Tornado up to 20W E27 lamp, not included
Light Colour Temp	Lamp dependant
Dimensions (mm)	150 x 150 x 175
Shortcode	72894/66/31
Barcode/EAN	8717943001989
Trade Price	\$17.35

FWG300 Wall Light

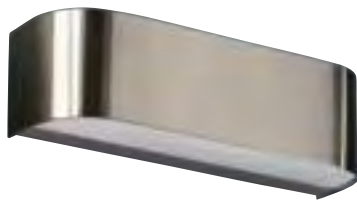

FWG300 WALL LIGHT

Colour/Finish	Nickel finish. Sand blasted glass, steel
IP Rating	IP20
Light Source	Tornado up to 20W E27 lamp, not included
Light Colour Temp	Lamp dependant
Dimensions (mm)	270 x 78 x 78
Shortcode	33067/17/86
Barcode/EAN	8727900749472
Trade Price	\$60.83

FWG300 Wall Light



FWG300 WALL LIGHT

Colour/Finish	Aluminium finish. Sand blasted glass, steel
IP Rating	IP20
Light Source	Tornado up to 20W E27 lamp, not included
Light Colour Temp	Lamp dependant
Dimensions (mm)	270 x 78 x 78
Shortcode	33067/48/86
Barcode/EAN	8727900749489
Trade Price	\$60.83

QPG303 Suspension Light



QPG303 SUSPENSION LIGHT

Colour/Finish	Chrome finish, White inside. Steel, adjustable height
IP Rating	IP20
Light Source	E27 lamp, not included
Light Colour Temp	Lamp dependant
Dimensions (mm)	250 x 250 x 1300 (adjustable)
Shortcode	40227/11/86
Barcode/EAN	8727900748970
Trade Price	\$69.52

QPG303 Suspension Light



QPG303 SUSPENSION LIGHT

Colour/Finish	Grey finish, Blue inside. Steel, adjustable height
IP Rating	IP20
Light Source	E27 lamp, not included
Light Colour Temp	Lamp dependant
Dimensions (mm)	250 x 250 x 1300 (adjustable)
Shortcode	40227/35/66
Barcode/EAN	8727900748994
Trade Price	\$52.13

QPG303 Suspension Light



QPG303 SUSPENSION LIGHT

Colour/Finish	White finish, Orange inside. Steel, adjustable height
IP Rating	IP20
Light Source	E27 lamp, not included
Light Colour Temp	Lamp dependant
Dimensions (mm)	250 x 250 x 1300 (adjustable)
Shortcode	40227/53/76
Barcode/EAN	8727900749007
Trade Price	\$52.13

QPG304 Suspension Light



QPG304 SUSPENSION LIGHT

Colour/Finish	Chrome finish, White inside. Steel, adjustable height
IP Rating	IP20
Light Source	Tornado up to 24W lamp, not included
Light Colour Temp	Lamp dependant
Dimensions (mm)	400 x 400 x 1500 (adjustable)
Shortcode	40228/11/86
Barcode/EAN	8727900749038
Trade Price	\$147.78

QPG304 Suspension Light

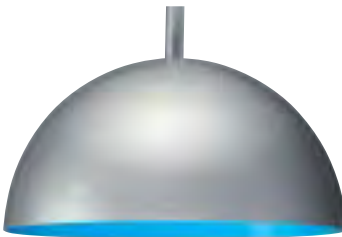

QPG304 SUSPENSION LIGHT

Colour/Finish	Grey finish, Blue inside. Steel, adjustable height
IP Rating	IP20
Light Source	Tornado up to 24W lamp, not included
Light Colour Temp	Lamp dependant
Dimensions (mm)	400 x 400 x 1500 (adjustable)
Shortcode	40228/35/86
Barcode/EAN	8727900749045
Trade Price	\$86.91

QPG304 Suspension Light



QPG304 SUSPENSION LIGHT

Colour/Finish	White finish, Orange inside. Steel, adjustable height
IP Rating	IP20
Light Source	Tornado up to 24W lamp, not included
Light Colour Temp	Lamp dependant
Dimensions (mm)	400 x 400 x 1500 (adjustable)
Shortcode	40228/53/56
Barcode/EAN	8727900749052
Trade Price	\$86.91

FCG310 Single Spot



FCG310 SINGLE SPOT

Colour/Finish	Nickel
IP Rating	IP20
Light Source	Conventional E14 Lamp - Incandescent or equivalent up to 40W
Light Colour Temp	Lamp dependant
Dimensions (mm)	178 x 113 x 148
Shortcode	52160/17/86
Barcode/EAN	8717943004942
Trade Price	\$34.74

FCG311 Twin Spot



FCG311 TWIN SPOT

Colour/Finish	Nickel
IP Rating	IP20
Light Source	Conventional E14 Lamp - Incandescent or equivalent up to 40W
Light Colour Temp	Lamp dependant
Dimensions (mm)	343 x 128 x 138
Shortcode	52162/17/86
Barcode/EAN	8717943004980
Trade Price	\$60.83

FCG312 Triple Spot



FCG312 TRIPLE SPOT

Colour/Finish	Nickel
IP Rating	IP20
Light Source	Conventional E14 Lamp - Incandescent or equivalent up to 40W
Light Colour Temp	Lamp dependant
Dimensions (mm)	588 x 128 x 138
Shortcode	52163/17/86
Barcode/EAN	8717943005000
Trade Price	\$95.61

FCG313 Quad Spot



FCG313 QUAD SPOT

Colour/Finish	Nickel
IP Rating	IP20
Light Source	Conventional E14 Lamp - Incandescent or equivalent up to 40W
Light Colour Temp	Lamp dependant
Dimensions (mm)	133 x 160 x 782
Shortcode	52164/17/86
Barcode/EAN	8717943005024
Trade Price	\$130.39

FCG307 Single Spot



FCG307 SINGLE SPOT

Colour/Finish	Nickel
IP Rating	IP20
Light Source	Conventional E14 Lamp - Incandescent or equivalent up to 40W
Light Colour Temp	Lamp dependant
Dimensions (mm)	178 x 121 x 121
Shortcode	52170/17/86
Barcode/EAN	8717943005031
Trade Price	\$43.43

FCG308 Twin Spot



FCG308 TWIN SPOT

Colour/Finish	Nickel
IP Rating	IP20
Light Source	Conventional E14 Lamp - Incandescent or equivalent up to 40W
Light Colour Temp	Lamp dependant
Dimensions (mm)	423 x 121 x 121
Shortcode	52172/17/86
Barcode/EAN	8717943001033
Trade Price	\$69.52

FCG309 Triple Spot



FCG309 TRIPLE SPOT

Colour/Finish	Nickel
IP Rating	IP20
Light Source	Conventional E14 Lamp - Incandescent or equivalent up to 40W
Light Colour Temp	Lamp dependant
Dimensions (mm)	509 x 138 x 138
Shortcode	52173/17/86
Barcode/EAN	8717943005222
Trade Price	\$104.30

FCG323 Quad Spot - Plate Form



FCG323 QUAD SPOT - PLATE FORM

Colour/Finish	Nickel
IP Rating	IP20
Light Source	Conventional E14 Lamp - Incandescent or equivalent up to 40W
Light Colour Temp	Lamp dependant
Dimensions (mm)	311 x 158 x 305
Shortcode	52174/17/86
Barcode/EAN	8717943005239
Trade Price	\$130.39

FCG324 Quad Spot - Bar Form



FCG324 QUAD SPOT - BAR FORM

Colour/Finish	Nickel
IP Rating	IP20
Light Source	Conventional E14 Lamp - Incandescent or equivalent up to 40W
Light Colour Temp	Lamp dependant
Dimensions (mm)	133 x 160 x 782
Shortcode	52178/17/86
Barcode/EAN	8717943005246
Trade Price	\$173.87





HERITAGE REFINED

Bring home a warm glow

Heritage is what anchors us. It gives us a sense of belonging and keeps us rooted to our values, tradition and family. The Heritage Refined Collection by Philips reflects this. With fine craftsmanship and authentic forms, they evoke the nostalgia of times gone by.

Take a cue from our legacy, and find comfort in tradition.

37712 Wall Fitting



37712 WALL FITTING

Colour/Finish	Bronze
IP Rating	IP20
Light Source	Conventional Lamp - Incandescent or equivalent up to 40W
Light Colour Temp	2700K or 6500K
Dimensions (mm)	218 x 193 x 223
Shortcode	37712/06/86
Barcode/EAN	8717943752003
Trade Price	\$43.43

37710 Pendant Fitting



37710 PENDANT FITTING

Colour/Finish	Bronze
IP Rating	IP20
Light Source	Conventional Lamp - Incandescent or equivalent up to 40W
Light Colour Temp	2700K or 6500K
Dimensions (mm)	220 x 465 x 465
Shortcode	37710/06/86
Barcode/EAN	8717943751983
Trade Price	\$78.22

37934 Wall Fitting



37934 WALL FITTING

Colour/Finish	Bronze
IP Rating	IP20
Light Source	Conventional Lamp - Incandescent or equivalent up to 40W
Light Colour Temp	2700K or 6500K
Dimensions (mm)	218 x 193 x 223
Shortcode	37934/06/86
Barcode/EAN	8717943756186
Trade Price	\$43.43

37932 Pendant Fitting



37932 PENDANT FITTING

Colour/Finish	Bronze
IP Rating	IP20
Light Source	Conventional Lamp - Incandescent or equivalent up to 40W
Light Colour Temp	2700K or 6500K
Dimensions (mm)	420 x 565 x 565
Shortcode	37932/06/86
Barcode/EAN	8717943755981
Trade Price	\$199.96

37933 Ceiling Fitting



37933 CEILING FITTING

Colour/Finish	Bronze
IP Rating	IP20
Light Source	Conventional Lamp - Incandescent or equivalent up to 40W
Light Colour Temp	2700K or 6500K
Dimensions (mm)	420 x 565 x 565
Shortcode	37933/06/86
Barcode/EAN	8717943756209
Trade Price	\$304.30





VIBRANT EXPRESSIONS

Light to imagine and inspire

Vibrant colours, fresh designs and whimsical forms all combine to create a lighting landscape that's as creative as you are. The Vibrant Expressions Collection by Philips allows you to express your individuality while adding a touch of energy and joy to your home.

Lighten up. Make a personal statement of fun and vitality.

41055 Pendant Small Red



41055 PENDANT SMALL RED

Colour/Finish	Red, Aluminium
IP Rating	IP20
Light Source	Tornado 1 x 24W, E27 base cap
Light Colour Temp	Lamp dependant
Dimensions (mm)	350 x 350 x 1750
Shortcode	41055/32/86
Barcode/EAN	8718291476221
Trade Price	\$130.39

41055 Pendant Small Blue



41055 PENDANT SMALL BLUE

Colour/Finish	Blue, Aluminium
IP Rating	IP20
Light Source	Tornado 1 x 24W, E27 base cap
Light Colour Temp	Lamp dependant
Dimensions (mm)	350 x 350 x 1750
Shortcode	41055/35/86
Barcode/EAN	8718291476238
Trade Price	\$130.39

41055 Pendant Small Grey



41055 PENDANT SMALL GREY

Colour/Finish	Grey, Aluminium
IP Rating	IP20
Light Source	Tornado 1 x 24W, E27 base cap
Light Colour Temp	Lamp dependant
Dimensions (mm)	350 x 350 x 1750
Shortcode	41055/87/86
Barcode/EAN	8718291476245
Trade Price	\$130.39

40380 Pendant Large Black



40380 PENDANT LARGE BLACK

Colour/Finish	Black, Aluminium
IP Rating	IP20
Light Source	Tornado 3 x 24W, E27 base cap
Light Colour Temp	Lamp dependant
Dimensions (mm)	700 x 700 x 3000
Shortcode	40380/30/86
Barcode/EAN	8718291475446
Trade Price	\$608.65

40380 Pendant Large White



40380 PENDANT LARGE WHITE

Colour/Finish	White, Aluminium
IP Rating	IP20
Light Source	Tornado 3 x 24W, E27 base cap
Light Colour Temp	Lamp dependant
Dimensions (mm)	700 x 700 x 3000
Shortcode	40380/31/86
Barcode/EAN	8718291475453
Trade Price	\$608.65

60201 Slices Pendant Blue



60201 SLICES PENDANT LIGHT BLUE

Colour/Finish	Blue, Synthetic
IP Rating	IP20
Light Source	Tornado 3 x 24W, E27 base cap
Light Colour Temp	Lamp dependant
Dimensions (mm)	400 x 400 x 1700
Shortcode	60201/35/86
Barcode/EAN	6947830420759
Trade Price	\$434.74

60201 Slices Pendant Yellow



60201 SLICES PENDANT YELLOW

Colour/Finish	Yellow, Synthetic
IP Rating	IP20
Light Source	Tornado 3 x 24W, E27 base cap
Light Colour Temp	Lamp dependant
Dimensions (mm)	400 x 400 x 1700
Shortcode	60201/34/86
Barcode/EAN	6947830420766
Trade Price	\$434.74

60202 Slices Wall Yellow

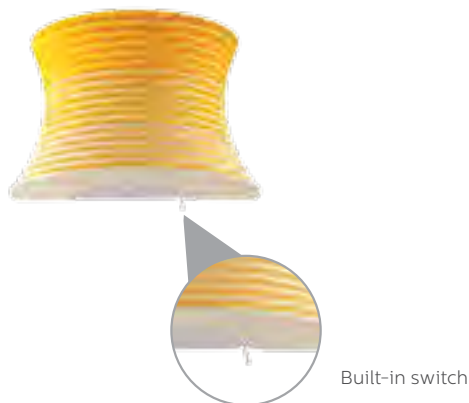

Built-in switch

60202 SLICES WALL YELLOW

Colour/Finish	Yellow, Synthetic
IP Rating	IP20
Light Source	Tornado 1 x 24W, E27 base cap
Light Colour Temp	Lamp dependant
Dimensions (mm)	300 x 183 x 190
Shortcode	60202/34/86
Barcode/EAN	6947830420773
Trade Price	\$173.87

*includes built-in switch

60202 Slices Wall Blue

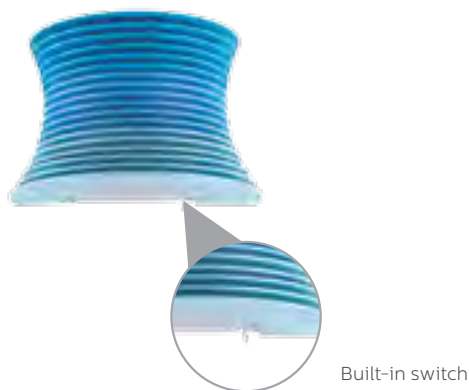

Built-in switch

60202 SLICES WALL BLUE

Colour/Finish	Blue, Synthetic
IP Rating	IP20
Light Source	Tornado 1 x 24W, E27 base cap
Light Colour Temp	Lamp dependant
Dimensions (mm)	380 x 183 x 190
Shortcode	60202/35/86
Barcode/EAN	6947830420780
Trade Price	\$173.87

*includes built-in switch

60200 Slices Ceiling Light Yellow



60200 SLICES CEILING LIGHT YELLOW

Colour/Finish	Yellow, Synthetic
IP Rating	IP20
Light Source	Tornado 7 x 24W, E27 base cap
Light Colour Temp	Lamp dependant
Dimensions (mm)	600 x 600 x 157
Shortcode	60200/34/86
Barcode/EAN	6947830420797
Trade Price	\$434.74

60200 Slices Ceiling Light Blue

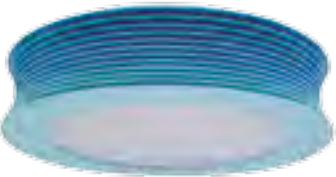

60200 SLICES CEILING LIGHT BLUE

Colour/Finish	Blue, Synthetic
IP Rating	IP20
Light Source	Tornado 7 x 24W, E27 base cap
Light Colour Temp	Lamp dependant
Dimensions (mm)	600 x 600 x 157
Shortcode	60200/35/86
Barcode/EAN	6947830420803
Trade Price	\$434.74





KIDSPLACE

Fun spaces with light & colour

Light up a child's world with Philips Kidsplace – a specially designed collection of child-focussed light fittings. Available in diverse designs with playful colours, they transform a child's bedroom into a magical wonderland.

This collection is the perfect touch for a child to play, learn and create.

QCG314 Ceiling Light



QCG314 CEILING LIGHT

Colour/Finish	Mixed colour, Glass, Wood
IP Rating	IP20
Light Source	Tornado up to 20W lamp, E27, not included
Light Colour Temp	Lamp dependant
Dimensions (mm)	385 x 385 x 450
Shortcode	40096/28/86
Barcode/EAN	8717943003600
Trade Price	\$60.83

QCG316 Ceiling Light



QCG316 CEILING LIGHT

Colour/Finish	Mixed colour, Glass, Wood
IP Rating	IP20
Light Source	Tornado up to 20W lamp, E27, not included
Light Colour Temp	Lamp dependant
Dimensions (mm)	400 x 400 x 430
Shortcode	40153/55/86
Barcode/EAN	8717943003310
Trade Price	\$60.83

FPG301 Suspension Light



FPG301 SUSPENSION LIGHT

Colour/Finish	Mixed colour, Wood, Steel
IP Rating	IP20
Light Source	Ambiance 18W lamp, E27, not included
Light Colour Temp	2700K
Dimensions (mm)	340 x 150 x 1050 (adjustable)
Shortcode	40428/34/86
Barcode/EAN	8717943003365
Trade Price	\$104.30

QPG308 Suspension Light



QPG308 SUSPENSION LIGHT

Colour/Finish	Mixed colour, Steel, Synthetics, Wood
IP Rating	IP20
Light Source	E27, lamp not included
Light Colour Temp	Lamp dependant
Dimensions (mm)	185 x 234 x MAX 1500 (adjustable height)
Shortcode	40279/55/66
Barcode/EAN	8717943003341
Trade Price	\$104.30

QPG315 Suspension Light



QPG315 SUSPENSION LIGHT

Colour/Finish	Mixed colour, Steel, Synthetics, Wood
IP Rating	IP20
Light Source	Ambiance E27, lamp not included
Light Colour Temp	Lamp dependant
Dimensions (mm)	267 x 267 x MAX 1200 (adjustable height)
Shortcode	40204/55/86
Barcode/EAN	8717943003334
Trade Price	\$104.30

FPG302 Suspension Light



FPG302 SUSPENSION LIGHT

Colour/Finish	Mixed colour, Wood, Steel
IP Rating	IP20
Light Source	Ambiance 18W E27, lamp included
Light Colour Temp	2700K
Dimensions (mm)	470 x 130 x MAX 1250 (adjustable height)
Shortcode	40429/55/86
Barcode/EAN	8717943003372
Trade Price	\$86.91





Aquafit LED

Advanced LED Technology

The range is made from premium materials, with high care for aesthetics, details and forms. This collection is designed according to safety standards for water and moisture resistance.

- Designed for humid environments
- Moisture resistant IP44 protection or water proof IP65 protection options
- Uses advanced LED technology which lasts up to 20,000 hours (L70).
- Save up to 80% energy compared to Philips incandescent lamps



The right light for the right area

Take note when choosing bathroom lighting as there are strict regulations concerning the type of light you can use. The following information is a guide to help you understand what light fittings can be placed where.

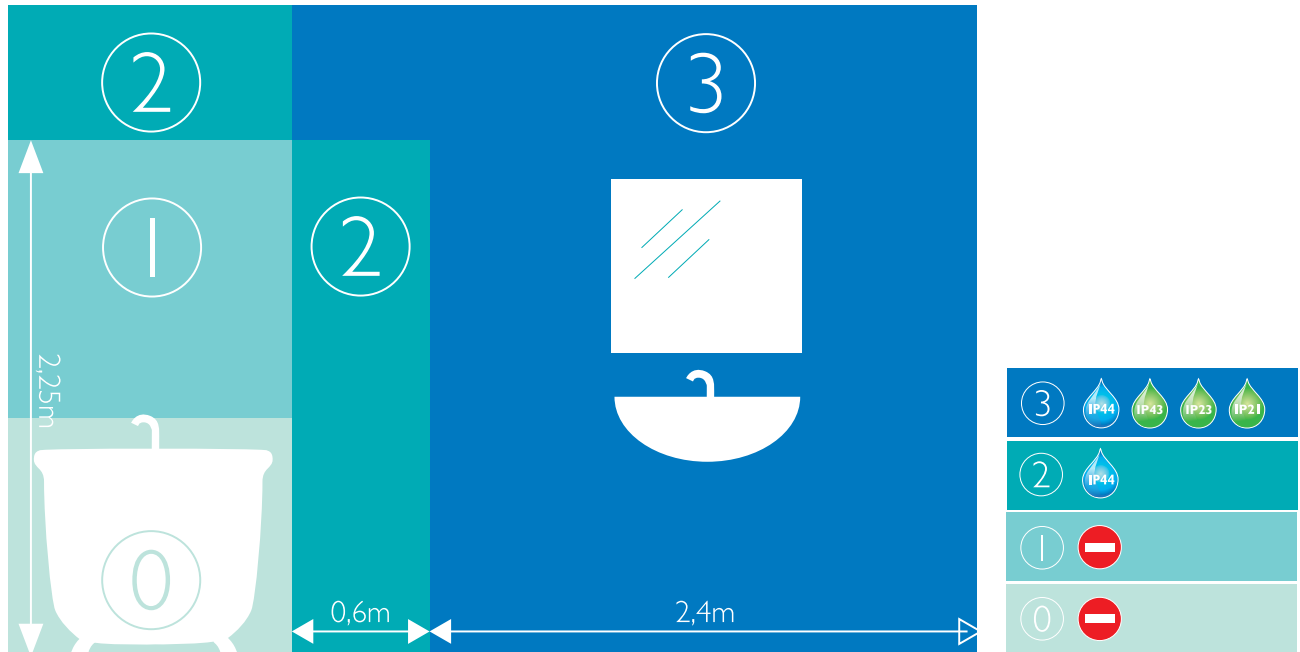

Area 0 - 1 – Bathtub area

Philips does not recommend the use of any lighting fixtures in these areas.

Area 2 – Ceiling and outside shower area

General lighting from luminaires installed on the ceiling can provide the illumination needed here.

Safety requirement:

This area stretches to 0.6m outside the bath/shower and 2.25m above the floor. Since there is a risk of water accidentally splashing on the fitting, an IP rating of at least IP44 is required.

Area 3 – Grooming area near vanity

This area requires bright shadow free light for task orientated activities like shaving or make up application.

Safety requirement:

This area stretches beyond zone 2. As long as there is no chance of the fixture being splashed with water or steam, an IP21 rating is sufficient.

A higher IP rating can always be used to ensure added safety.



32208 LED Ceiling Light



32208 LED CEILING LIGHT

Colour/Finish	Chrome
IP Rating	IP 44
Light Source	LED 2x 7.5W, 700 lumen
Light Colour Temp	2400K - 3500K tunable white included
Dimensions (mm)	46 x 300 x 120
Shortcode	32208/11/86
Barcode/EAN	8717943790180
Trade Price	\$156.48

32209 LED Ceiling Light



32209 LED CEILING LIGHT

Colour/Finish	Chrome
IP Rating	IP 44
Light Source	LED 3x 7.5W, 1050 lumen
Light Colour Temp	2400K - 3500K tunable white included
Dimensions (mm)	46 x 320 x 320
Shortcode	32209/11/86
Barcode/EAN	8717943790166
Trade Price	\$217.35

34208 LED Wall Light



34208 LED WALL LIGHT

Colour/Finish	Chrome
IP Rating	IP 44
Light Source	LED 1x 7.5W, 350 lumen
Light Colour Temp	2400K - 3500K tunable white included
Dimensions (mm)	136 x 101 x 140
Shortcode	34208/11/86
Barcode/EAN	8717943790173
Trade Price	\$130.39



34212 LED Wall Light



34212 LED WALL LIGHT

Colour/Finish	Chrome
IP Rating	IP 44
Light Source	LED 1x 7.5W, 350 lumen
Light Colour Temp	2700K
Dimensions (mm)	130 x 89 x 114
Shortcode	34212/11/86
Barcode/EAN	8717943790227
Trade Price	\$130.39

34213 LED Wall Light



34213 LED WALL LIGHT

Colour/Finish	Chrome
IP Rating	IP 44
Light Source	LED 2x 7.5W
Light Colour Temp	2700K
Dimensions (mm)	109 x 224 x 114
Shortcode	34213/11/86
Barcode/EAN	8717943790234
Trade Price	\$173.87







Aquafit

Turn your bathroom into a spa

Inspired by the beauty of water, Philips Aquafit turns your bathroom into a rejuvenating experience. You'll find bright task and general lighting imbued with style and functionality.

Apply make-up or shave effortlessly with tasteful task lights placed around your mirror. Or create a soothing ambience with basic illumination from our ceiling lights.

All products are specially designed with Ingress Protection (IP) rating, without compromising on brightness or style. Total peace of mind in your oasis of calm.

The right light for the right area

Take note when choosing bathroom lighting as there are strict regulations concerning the type of light you can use. The following information is a guide to help you understand what light fittings can be placed where.

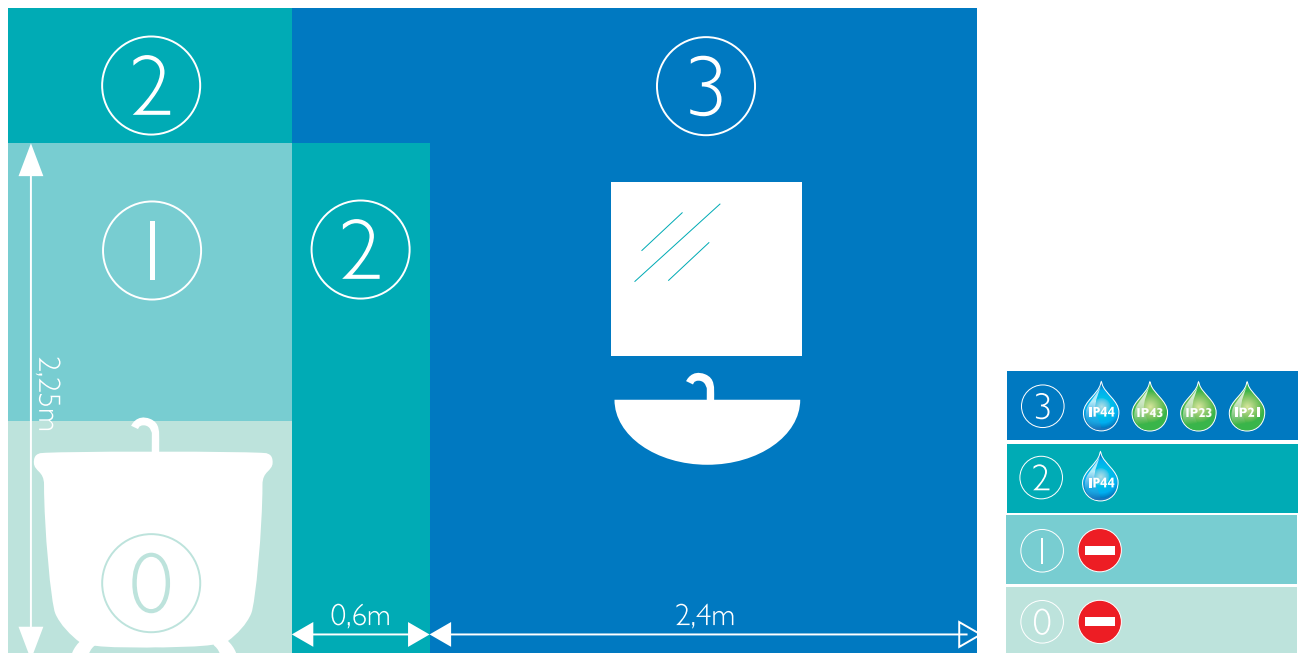

Area 0 - 1 – Bathtub area

Philips does not recommend the use of any lighting fixtures in these areas.

Area 2 – Ceiling and outside shower area

General lighting from luminaires installed on the ceiling can provide the illumination needed here.

Safety requirement:

This area stretches to 0.6m outside the bath/shower and 2.25m above the floor. Since there is a risk of water accidentally splashing on the fitting, an IP rating of at least IP44 is required.

Area 3 – Grooming area near vanity

This area requires bright shadow free light for task orientated activities like shaving or make up application.

Safety requirement:

This area stretches beyond zone 2. As long as there is no chance of the fixture being splashed with water or steam, an IP21 rating is sufficient.

A higher IP rating can always be used to ensure added safety.

QCZ800 Ceiling Light



QCZ800 CEILING LIGHT

Colour/Finish	White colour, glass
IP Rating	IP 44
Light Source	E27, lamp not included, 60W Max
Light Colour Temp	Lamp dependant
Dimensions (mm)	260 x 260 x 120
Shortcode	32005/31/76
Barcode/EAN	8727900750782
Trade Price	\$52.13

QCZ802 Ceiling Light



QCZ802 WALL LIGHT

Colour/Finish	Chrome finish. Handmade 3 layered glass, double wire entry
IP Rating	IP 44
Light Source	Candle 2 x 40W lamp, E14, not included
Light Colour Temp	2700K
Dimensions (mm)	310 x 105 x 80
Shortcode	34006/11/86
Barcode/EAN	8727900693393
Trade Price	\$60.83

QCZ806 Ceiling Light



QCZ806 CEILING LIGHT

Colour/Finish	White colour, glass
IP Rating	IP 44
Light Source	E27, lamp not included, 60W Max
Light Colour Temp	Lamp dependant
Dimensions (mm)	320 x 320 x 110
Shortcode	32066/31/76
Barcode/EAN	8727900750805
Trade Price	\$56.48

FCZ300 Ceiling Light



FCZ300 CEILING LIGHT

Colour/Finish	Nickel finish. Steel with synthetics
IP Rating	IP 44
Light Source	TL5C 40W lamp, 2G x13, included
Light Colour Temp	2700K
Dimensions (mm)	360 x 360 x 55
Shortcode	32070/17/86
Barcode/EAN	8717943005062
Trade Price	\$121.70

FCZ300 Ceiling Light



FCZ300 CEILING LIGHT

Colour/Finish	Chrome finish. Steel with synthetics
IP Rating	IP 44
Light Source	TL5C 40W lamp, 2G x13, included
Light Colour Temp	2700K
Dimensions (mm)	360 x 360 x 55
Shortcode	32070/11/86
Barcode/EAN	8717943005055
Trade Price	\$121.70

32047 Wall Spot



32047 WALL SPOT

Colour/Finish	Chrome colour, metal with glass
IP Rating	IP 44
Light Source	Tornado 1x 12W lamp, E14, not included
Light Colour Temp	Lamp dependant
Dimensions (mm)	202 x 100 x 163
Shortcode	32047/11/66
Barcode/EAN	6947830416325
Trade Price	\$43.43

32048 Wall Spot



32048 WALL SPOT

Colour/Finish	Chrome colour, metal with glass
IP Rating	IP 44
Light Source	Tornado 2x 12W lamp, E14, not included
Light Colour Temp	Lamp dependant
Dimensions (mm)	190 x 320 x 163
Shortcode	32048/11/66
Barcode/EAN	6947830416332
Trade Price	\$69.52

32049 Wall Spot



32049 WALL SPOT

Colour/Finish	Chrome colour, metal with glass
IP Rating	IP 44
Light Source	Tornado 3x 12W lamp, E14, not included
Light Colour Temp	Lamp dependant
Dimensions (mm)	190 x 500 x 163
Shortcode	32049/11/66
Barcode/EAN	6947830416370
Trade Price	\$113.00

32029 Wall Spot



32029 WALL SPOT

Colour/Finish	Chrome colour, metal with glass
IP Rating	IP 21
Light Source	Tornado 1x 12W lamp, E14, not included
Light Colour Temp	Lamp temperature
Dimensions (mm)	190 x 100 x 165
Shortcode	32029/11/66
Barcode/EAN	6947830416295
Trade Price	\$43.43

32030 Wall Spot



32030 WALL SPOT

Colour/Finish	Chrome colour, metal with glass
IP Rating	IP 21
Light Source	Tornado 2x 12W lamp, E14, not included
Light Colour Temp	Lamp dependant
Dimensions (mm)	190 x 320 x 165
Shortcode	32030/11/66
Barcode/EAN	6947830416301
Trade Price	\$86.91

32031 Wall Spot



32031 WALL SPOT

Colour/Finish	Chrome colour, metal with glass
IP Rating	IP 21
Light Source	Tornado 3x 12W lamp, E14, not included
Light Colour Temp	Lamp dependant
Dimensions (mm)	190 x 460 x 165
Shortcode	32031/11/66
Barcode/EAN	6947830416318
Trade Price	\$130.39

FWZ301 Wall Light



FWZ301 WALL LIGHT

Colour/Finish	Chrome finish, Glass, Steel
IP Rating	IP 44
Light Source	TL5, 13W lamp, G5, included
Light Colour Temp	2700K
Dimensions (mm)	616 x 77 x 60
Shortcode	34094/11/86
Barcode/EAN	8717943005093
Trade Price	\$113.00





OUTERSTYLERS

At home with nature

The Philips Outerstylers collection puts you right at home with the great outdoors. Water and weather-resistant, it illuminates your balcony or garden in style.

Designed to leave a lasting impression, you'll find a wide selection of outdoor lighting made from long-lasting materials. So your home – and the space it nestles in – exudes a beauty that's truly enduring.

Yet the collection does more than enhance your outdoor spaces. It ensures your pathways, steps and porches are well and safely lit, without compromising on style or elegance.

For the perfect sanctuary, inside and out.



ECB300 Ceiling Light



ECB300 CEILING LIGHT

Colour/Finish	White colour. Steel, glare-free light with sand blasted glass cover
IP Rating	IP 44
Light Source	Tornado up to 20W lamp, E27 not included
Light Colour Temp	Lamp dependant
Dimensions (mm)	315 x 315 x 100
Shortcode	32010/31/66
Barcode/EAN	8727900751222
Trade Price	\$78.22

ECB300 Ceiling Light



ECB300 CEILING LIGHT

Colour/Finish	Black colour. Steel, glare-free light with sand blasted glass cover
IP Rating	IP 44
Light Source	Tornado up to 20W lamp, E27 not included
Light Colour Temp	Lamp dependant
Dimensions (mm)	315 x 315 x 100
Shortcode	32010/93/66
Barcode/EAN	8727900751256
Trade Price	\$78.22

ECB300 Ceiling Light

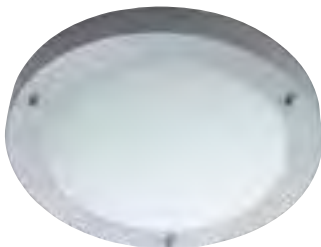

ECB300 CEILING LIGHT

Colour/Finish	Grey colour. Steel, glare-free light with sand blasted glass cover
IP Rating	IP 44
Light Source	Tornado up to 20W lamp, E27 not included
Light Colour Temp	Lamp dependant
Dimensions (mm)	315 x 315 x 100
Shortcode	32010/87/66
Barcode/EAN	8727900751239
Trade Price	\$78.22

EWS300 Wall Light



EWS300 WALL LIGHT

Colour/Finish	White colour. Stainless steel, synthetics, aluminium, 360° Light output
IP Rating	IP 44
Light Source	Tornado up to 20W lamp, E27 not included
Light Colour Temp	Lamp dependant
Dimensions (mm)	235 x 95 x 260
Shortcode	01726/66/31
Barcode/EAN	8727900751437
Trade Price	\$43.43

EWS300 Wall Light



EWS300 WALL LIGHT

Colour/Finish	Dark Grey colour. Stainless steel, 360° light output, synthetics, aluminium,
IP Rating	IP 44
Light Source	Tornado up to 20W lamp, E27 not included
Light Colour Temp	Lamp dependant
Dimensions (mm)	235 x 95 x 260
Shortcode	01726/66/93
Barcode/EAN	8727900751444
Trade Price	\$43.43

EWS300 Wall Light



EWS300 WALL LIGHT

Colour/Finish	Stainless steel finish. Stainless steel, 360° light output, synthetics, aluminium,
IP Rating	IP 44
Light Source	Tornado up to 20W lamp, E27 not included
Light Colour Temp	Lamp dependant
Dimensions (mm)	235 x 95 x 260
Shortcode	17086/47/66
Barcode/EAN	8727900751499
Trade Price	\$43.43

EWP300 Wall Light



EWP300 WALL LIGHT

Colour/Finish	Light Grey colour. Aluminium, synthetics, Indirect down lighting
IP Rating	IP 44
Light Source	Up to E27 lamp, not included
Light Colour Temp	Lamp dependant
Dimensions (mm)	356 x 93 x 75
Shortcode	17130/87/66
Barcode/EAN	8727900751451
Trade Price	\$52.13

EWP300 Wall Light



EWP300 WALL LIGHT

Colour/Finish	Dark Grey colour. Aluminium, synthetics, Indirect down lighting
IP Rating	IP 44
Light Source	Up to E27 lamp, not included
Light Colour Temp	Lamp dependant
Dimensions (mm)	356 x 93 x 75
Shortcode	17130/93/66
Barcode/EAN	8727900751468
Trade Price	\$52.13

17014 Wall Lantern Stainless (Sensor)



Built-in daylight and movement sensor

17014 WALL LANTERN STAINLESS (SENSOR)

Colour/Finish	Stainless Steel finish, synthetics, aluminium, 360° Light Output
IP Rating	IP 44
Light Source	Tornado up to 20W lamp, E27, not included
Light Colour Temp	Lamp dependant
Dimensions (mm)	235 x 95 x 260
Shortcode	17014/47/86
Barcode/EAN	8717943763979
Trade Price	\$69.52

17014 Wall Lantern Anthracite (Sensor)



Built-in daylight and movement sensor

17014 WALL LANTERN ANTHRACITE (SENSOR)

Colour/Finish	Dark Grey Colour. Stainless Steel, synthetics, aluminium, 360° Light Output
IP Rating	IP 44
Light Source	Tornado up to 20W lamp, E27 (not included)
Light Colour Temp	Lamp dependant
Dimensions (mm)	235 x 95 x 260
Shortcode	17014/93/86
Barcode/EAN	8717943763986
Trade Price	\$69.52

17105 Wall Light



17105 WALL LIGHT

Colour/Finish	Light Grey, aluminium, synthetics
IP Rating	IP 44
Light Source	Tornado up to 24W lamp, E27 (not included)
Light Colour Temp	Lamp dependant
Dimensions (mm)	113 x 290 x 130
Shortcode	17105/87/46
Barcode/EAN	8717943006625
Trade Price	\$60.83

17105 Wall Light



17105 WALL LIGHT

Colour/Finish	Anthracite, aluminium, synthetics
IP Rating	IP 44
Light Source	Tornado up to 24W lamp, E27 (not included)
Light Colour Temp	Lamp dependant
Dimensions (mm)	113 x 290 x 130
Shortcode	17105/93/46
Barcode/EAN	8717943006632
Trade Price	\$60.83

01465 Wall Fitting



01465 WALL FITTING

Colour/Finish	Black
IP Rating	IP44
Light Source	Conventional Lamp - Incandescent or equivalent up to 100W
Light Colour Temp	2700K or 6500K
Dimensions (mm)	278 x 133 x 203
Shortcode	01465/30/46
Barcode/EAN	8717943006656
Trade Price	\$26.04

01465 Wall Fitting



01465 WALL FITTING

Colour/Finish	White
IP Rating	IP44
Light Source	Conventional Lamp - Incandescent or equivalent up to 100W
Light Colour Temp	2700K or 6500K
Dimensions (mm)	278 x 133 x 203
Shortcode	01465/31/46
Barcode/EAN	8717943006663
Trade Price	\$26.04

17205 Window Wall Fitting - Plain



17205 WINDOW WALL FITTING - PLAIN

Colour/Finish	Grey
IP Rating	IP54
Light Source	Conventional Lamp - CFLi Lamp up to 2x18W
Light Colour Temp	2700K or 6500K
Dimensions (mm)	300 x 185 x 95
Shortcode	17205/87/86
Barcode/EAN	8718291534785
Trade Price	\$52.13

17204 Window Wall Fitting – Bars



17204 WINDOW WALL FITTING – BARS

Colour/Finish	Grey
IP Rating	IP54
Light Source	Conventional Lamp - CFLi Lamp up to 2x18W
Light Colour Temp	2700K or 6500K
Dimensions (mm)	300 x 185 x 95
Shortcode	17204/87/86
Barcode/EAN	8718291534808
Trade Price	\$52.13





myGarden

Enjoy a beautiful garden with LED light

Philips myGarden fittings with a brushed stainless steel or powder coated aluminum finish light up outdoor areas beautifully. LED lights, synthetic materials and minimalist design give a contemporary feel to outdoor spaces.

Designed for your garden

- IP44 - weather proof
- High quality LED light
- Warm white light



17273 String Wall Fitting



17273 STRING WALL FITTING

Colour/Finish	Inox (Stainless Steel)
IP Rating	IP44
Light Source	LED Integrated 1x4W
Light Colour Temp	2700K
Dimensions (mm)	205 x 162 x 66
Shortcode	17273/47/86
Barcode/EAN	8718291534686
Trade Price	\$78.22

17273 String Wall Fitting



17273 STRING WALL FITTING

Colour/Finish	Anthracite
IP Rating	IP44
Light Source	LED Integrated 1x4W
Light Colour Temp	2700K
Dimensions (mm)	205 x 162 x 66
Shortcode	17273/93/86
Barcode/EAN	8718291534709
Trade Price	\$78.22

17287 Aura Wall Fitting



17287 AURA WALL FITTING

Colour/Finish	Inox (Stainless Steel)
IP Rating	IP44
Light Source	LED Integrated 1x4W
Light Colour Temp	2700K
Dimensions (mm)	122 x 92 x 103
Shortcode	17287/47/86
Barcode/EAN	8718291534723
Trade Price	\$69.52



17287 Aura Wall Fitting



17287 AURA WALL FITTING

Colour/Finish	Anthracite
IP Rating	IP44
Light Source	LED Integrated 1x4W
Light Colour Temp	2700K
Dimensions (mm)	122 x 92 x 103
Shortcode	17287/30/86
Barcode/EAN	8718291534747
Trade Price	\$69.52



LED DESK LAMPS

Give your eyes a break

Breeze through long work sessions with the Philips range of desk lamps to assist with any of your task lighting needs.

The collection of Philips desk lamps are functional with a custom designed reflector which enables apt lighting, while the 2D flexibility lets you direct light along the vertical plane.



Eyecare Black



LED DESK LIGHT EYECARE BLACK

Colour/Finish	Black
IP Rating	IP20
Light Source	LED Integrated 1x15W
Light Colour Temp	4000K, Dimmable
Dimensions (mm)	405 x 200 x 135
Shortcode	69195/30/46
Barcode/EAN	8727900694055
Trade Price	\$104.30

Eyecare White



LED DESK LIGHT EYECARE WHITE

Colour/Finish	White
IP Rating	IP20
Light Source	LED Integrated 1x15W
Light Colour Temp	4000K, Dimmable
Dimensions (mm)	405 x 200 x 135
Shortcode	69195/31/46
Barcode/EAN	8727900694062
Trade Price	\$104.30

CAP White



CAP WHITE

Colour/Finish	White
IP Rating	IP20
Light Source	LED Integrated 1x5.5W
Light Colour Temp	4000K
Dimensions (mm)	370 x 155 x 260
Shortcode	70023/31/56
Barcode/EAN	8718696128305
Trade Price	\$34.74



CAP Black



CAP BLACK

Colour/Finish	Black
IP Rating	IP20
Light Source	LED Integrated 1x5.5W
Light Colour Temp	4000K
Dimensions (mm)	370 x 155 x 260
Shortcode	70023/30/56
Barcode/EAN	8718696128299
Trade Price	\$34.74







LIVING COLORS

Set the mood

Imagine a room with a personality that reflects your own. One that creates the perfect ambience. Dictated not by a mere coat of paint but the entire spectrum of the rainbow.

Want a little 'me' time? Try a soothing blue. Feeling light? Get cheery pink. Romance in the air? Turn passionate red.

All inspired by you.



Living Colors Micro-White



LIVING COLORS MICRO-WHITE

Colour/Finish	White / Synthetics
IP Rating	IP20
Light Source	LED 1 x 5W (creates 64 colours)
Light Colour Temp	Full RGB Spectrum
Dimensions (mm)	110 x 120 x 100
Shortcode	70018/31/46
Barcode/EAN	8718291471424
Trade Price	\$86.91

Living Colors Micro-Black



LIVING COLORS MICRO-BLACK

Colour/Finish	Black / Synthetics
IP Rating	IP20
Light Source	LED 1 x 5W (creates 64 colours)
Light Colour Temp	Full RGB Spectrum
Dimensions (mm)	110 x 120 x 100
Shortcode	70018/30/46
Barcode/EAN	8718291471479
Trade Price	\$86.91

Living Colors Iris-White



LIVING COLORS IRIS-WHITE

Colour/Finish	White / Synthetics
IP Rating	IP20
Light Source	LED 1 x 10W (creates 16 million colours) Dimmable
Light Colour Temp	Full RGB Spectrum
Dimensions (mm)	218 x 218 x 225
Shortcode	70999/30/46
Barcode/EAN	8718291476320
Trade Price	\$260.83



Living Colors Iris-Black



LIVING COLORS IRIS-BLACK

Colour/Finish	Black / Synthetics
IP Rating	IP20
Light Source	LED 1 x 10W (creates 16 million colours) Dimmable
Light Colour Temp	Full RGB Spectrum
Dimensions (mm)	218 x 218 x 225
Shortcode	70999/60/46
Barcode/EAN	8718291476313
Trade Price	\$260.83

Hue Connected Lighting









PHILIPS HUE CONNECTED LIGHTING

What can hue do for you?

Hue can help you relax or concentrate. Change the atmosphere of your room. Help keep your house safe when you're out. Even remind you of that magical moment on holiday. All from your smart device.



Location

When you get close to home, hue can automatically turn on or change settings.



Alarm

When you're away, calendarise your time setting and make hue your guard dog.



Timer

Your hue lights can turn off, flash, or change colour after a set amount of time.



IFTTT

You can also connect your hue lights to many super useful different online products and services with IFTTT recipes.



Hue Bulb E27 3 Piece Starter Kit



BULB E27 3 PIECE STARTER KIT

Colour/Finish	White bridge, silver lamps
IP Rating	IP20
Light Source	LED Integrated 9W
Light Colour Temp	16 million colours
Lifetime	15,000 hours
Shortcode	HUEA609W3PCSET
Barcode/EAN	8718291547792
Trade Price	\$243.43

Hue Bulb E27 Single



BULB E27 SINGLE

Colour/Finish	Silver
IP Rating	IP20
Light Source	LED Integrated 9W
Light Colour Temp	16 million colours
Lifetime	15,000 hours
Shortcode	HUEA609WIPLE27
Barcode/EAN	8718291714200
Trade Price	\$69.52

Hue Lightstrips 2m Extension



LIGHTSTRIPS 2M EXTENSION

Colour/Finish	White
IP Rating	IP20
Light Source	LED Integrated 12W
Light Colour Temp	16 million colours
Lifetime	15,000 hours
Shortcode	HUESTRIP2MIPC
Barcode/EAN	8718291533979
Trade Price	\$121.70

Use of Hue Lightstrips and Hue Bloom products requires a Philips Hue starter kit sold separately. Use of all Hue products requires a smart device with iOS 4.3 or later or Android 2.2 or later, and a wireless internet connection. Third party data download, internet and subscription fees may apply.



Hue Bloom Extension



BLOOM EXTENSION

Colour/Finish	White
IP Rating	IP20
Light Source	LED Integrated 8W
Light Colour Temp	16 million colours
Lifetime	15,000 hours
Shortcode	HUEBLOOMIPCWH
Barcode/EAN	8718291532729
Trade Price	\$104.30

Use of Hue Lightstrips and Hue Bloom products requires a Philips Hue starter kit sold separately. Use of all Hue products requires a smart device with iOS 4.3 or later or Android 2.2 or later, and a wireless internet connection. Third party data download, internet and subscription fees may apply.



Lamps



ONS

Practitone Tubular

Small incandescent lamps for areas with limited space.

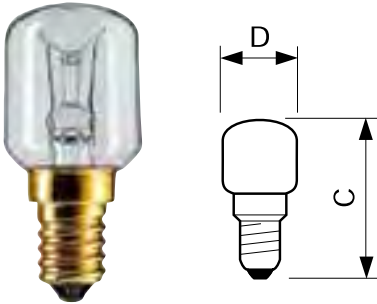

Product ID	Overall Length Diameter	
	C max.	D max.
15W B15 PILOT	52	22
15W B22 PILOT	52	25
15W E14 PILOT	57	25
15W E14 OVEN	49	22
25W E14 OVEN	57	25
25W E27 OVEN	61	29

Dimensions in mm

Pilot Oven Lamps

Shortcode	Wattage (W)	Cap Base	Voltage	Bulb Shape	Luminous Flux Lamp (lm)	Average Lifetime (hrs)	Colour Temperature (K)	Unit	Carton Qty	Trade Price
OVEN15T22	15	E14	230-240V	T22	90	1000	2700	PCE	10	\$ 3.47
OVEN25T25	25	E14	230-240V	T25	172	1000	2700	PCE	10	\$ 3.47
15BCPIL	15	B22	230-240V	T25	115	1000	2700	SET	5	\$ 6.95
15SESPIL	15	E14	230-240V	T25	115	1000	2700	PCE	10	\$ 3.47
15SBCT22CL	15	B15	220-240V	T22	172	1000	2700	PCE	5	\$ 3.47
15SEST25CL	15	E14	220-240V	T25	90	1000	2700	SET	5	\$ 6.95
40SEST25LCL	40	E14	240V	T25	424	1000	2700	PCE	10	\$ 3.47
25ESDECOT29	25	E27	230-240V	T29	162	1000	2700	PCE	5	\$ 3.47

Floodlight PAR38

Made from hard pressed glass, making them suitable for indoor and outdoor applications. Spot versions have a stippled front reflector producing a narrow homogenous beam. Flood versions have a front refractor composed of prismatic elements.

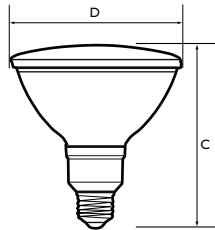

Product ID	Overall Length Diameter	
	C max.	D max.
80W E27	137	122.5
120W E27	137	121
80W E27 Colour	137	122.5
80W E27 Anti Mosquito	137	121

Dimensions in mm

Floodlight PAR38

Shortcode	Wattage (W)	Cap Base	Voltage	Bulb Shape	Luminous Intensity (cd)	Average Lifetime (hrs)	Colour Temperature (K)	Unit	Carton Quantity	Trade Price
120PARFLOOD	120	E27	240V	PAR38	3100	2000	2700	PCE	6	\$14.37
80PARFLOOD	80	E27	240V	PAR38	1800	2000	2700	PCE	6	\$14.37

Reflector Ring Mirror

Reflector lamps based on advanced spotlighting technology. Used for display lighting in shops, hotels, restaurants and homes.

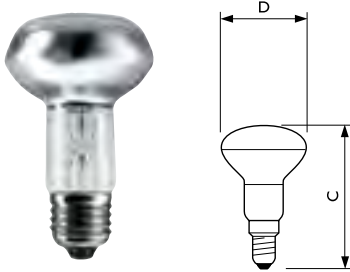

Product ID	Overall Length	
	C max.	Diameter D max.
R39 E14	67	39
NR50 E14	86	50
NR63 E27	104.5	63

Dimensions in mm

Reflector Ring Mirror

Shortcode	Wattage (W)	Cap Base	Voltage	Bulb Shape	Luminous Intensity (cd)	Average Lifetime (hrs)	Colour Temperature (K)	Unit	Carton Quantity	Trade Price
30R39SPOT	30	E14	240V	R39	160	1000	2700	PCE	12	\$3.43
40R50SPOT	40	E14	240V	R50	400	1000	2700	PCE	10	\$3.43
60R63SPOT	60	E27	240V	R63	1050	1000	2700	PCE	8	\$3.43

Reflector Standard Floodline

Reflector lamps based on advanced spotlighting technology. Used for display lighting in shops, hotels, restaurants and homes.

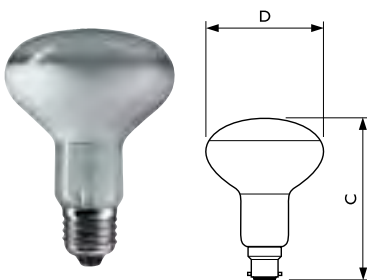

Product ID	Overall Length	
	C max.	Diameter D max.
R80 B22	113	80
R80 E27	114.5	80

Dimensions in mm

Reflector Standard Floodline

Shortcode	Wattage (W)	Cap Base	Voltage	Bulb Shape	Luminous Intensity (cd)	Average Lifetime (hrs)	Colour Temperature (K)	Unit	Carton Quantity	Trade Price
60ESFLOOD	60	E27	240V	R80	270	1000	2700	PCE	6	\$3.77
75ESFLOOD	75	E27	240V	R80	360	1000	2700	PCE	6	\$3.77
100ESFLOOD	100	E27	240V	R80	530	1000	2700	PCE	6	\$3.77





Masterline ES Dichroic

An advanced range of low voltage halogen dichroic lamps featuring the leading infrared reflecting technology for maximum energy savings. Masterline Energy Saving lamps feature a unique Philips patented burner method enabling higher efficiency with reduction of energy usage by up to 30%. The diamond backed dichroic reflector provides a precision beam of bright, white sparkling light. Lifetime 5,000 hours. Improved version featuring a single-ended burner and flat glass to match the look of standard dichroics.

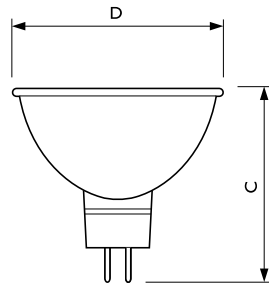

Product ID	Overall Length C max.	Diameter D max.
GU5.3	50.5	51

Dimensions in mm

Masterline ES Dichroic

Shortcode	Beam Angle	Wattage (W)	Cap Base	Voltage	Bulb Shape	Luminous Flux Lamp (lm)	Average Lifetime (hrs)	Colour Temperature (K)	Unit	Carton Quantity	Trade Price
MASES122008	80°	20	GU5.3	12V	MR16	275	5000	3000	PCE	5	\$26.40
MASES122036	36°	20	GU5.3	12V	MR16	300	5000	3000	PCE	5	\$26.40
MASES123524	24°	35	GU5.3	12V	MR16	640	5000	3000	PCE	5	\$26.40
MASES123536	36°	35	GU5.3	12V	MR16	640	5000	3000	PCE	5	\$26.40
MASES123560	60°	35	GU5.3	12V	MR16	640	5000	3000	PCE	5	\$26.40
MASES124536	36°	45	GU5.3	12V	MR16	830	5000	3000	PCE	5	\$26.40
MASES124560	60°	45	GU5.3	12V	MR16	830	5000	3000	PCE	5	\$26.40

Brilliantline Pro Dichroic

A quality low voltage halogen reflector lamp consisting of a high pressure xenon gas filled burner, optically positioned in a Dichroic glass reflector. Designed to transmit heat through the back of the lamp and reflect light to the front, resulting in a “cool” beam. Brilliantline Pro lamps feature a high intensity beam with a clearly defined beam spread and have excellent lumen maintenance over their life. They come complete with front glass and the universal burning position. Lifetime 4,000 hours.

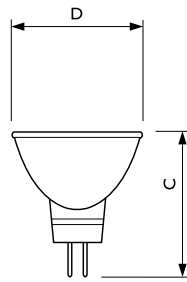

Product ID	Overall Length Diameter	
	C max.	D max.
GU5.3	46	50.8

Dimensions in mm

Brilliantline Pro Dichroic

Shortcode	Beam Angle	Wattage (W)	Cap Base	Voltage	Bulb Shape	Luminous Flux Lamp (lm)	Average Lifetime (hrs)	Colour Temperature (K)	Unit	Carton Quantity	Trade Price
BRIL122024	24°	20	GU5.3	12V	MR16	236	4000	3000	PCE	5	\$20.37
BRIL122036	36°	20	GU5.3	12V	MR16	236	4000	3000	PCE	5	\$20.37
BRIL122060	60°	20	GU5.3	12V	MR16	236	4000	3000	PCE	5	\$20.37
BRIL123536	36°	35	GU5.3	12V	MR16	500	4000	3000	PCE	5	\$20.37
BRIL123560	60°	35	GU5.3	12V	MR16	500	4000	3000	PCE	5	\$20.37
BRIL125036	36°	50	GU5.3	12V	MR16	775	4000	3000	PCE	5	\$20.37
BRIL125060	60°	50	GU5.3	12V	MR16	775	4000	3000	PCE	5	\$20.37

Essential Plus Dichroic

Low voltage halogen reflector lamps, designed to provide crisp white light. Feature a “cool” beam dichroic reflector and UV block on the burner. The closed version offers additional protection from UV via the glass front. Ideally suited for general purpose display and domestic lighting. Lifetime 3,000 hours.

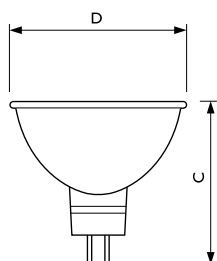

Product ID	Overall Length Diameter	
	C max.	D max.
GU5.3	46	51

Dimensions in mm

Essential Plus Dichroic

Shortcode	Beam Angle	Wattage (W)	Cap Base	Voltage	Bulb Shape	Luminous Flux Lamp (lm)	Average Lifetime (hrs)	Colour Temperature (K)	Unit	Carton Quantity	Trade Price
HAL122036	36°	20	GU5.3	12V	MR16	230	2000	3000	PCE	10	\$13.86
HAL125036	36°	50	GU5.3	12V	MR16	750	2000	3000	PCE	10	\$13.86
HAL125060	60°	50	GU5.3	12V	MR16	750	2000	3000	PCE	10	\$13.86

Masterline 111

Low voltage halogen reflector lamp with double-ended burner and high-purity aluminium reflector. It has a unique infra-red coated burner technology, and revolutionary compact precision burner for maximum performance of the infra-red reflecting coating. The ceramic filament shield reduces glare and improves beam shape. It has a flat profile, very tight beam pattern, and excellent glare control.

Increased lifetime (4,000 hours) ensures low maintenance costs.

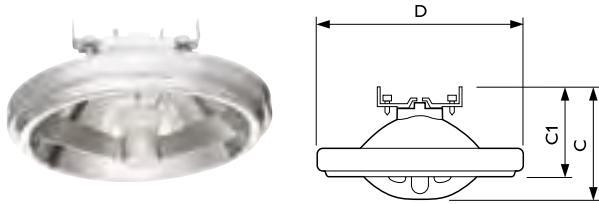

Product ID	Overall Length C max.	Overall Length C1 max.	Diameter D max.
30, 45, 60W	65	49	111
Dimensions in mm			

Masterline 111

Shortcode	Beam Angle	Wattage (W)	Cap Base	Voltage	Bulb Shape	Luminous Intensity (cd)	Average Lifetime (hrs)	Colour Temperature (K)	Unit	Carton Quantity	Trade Price
MASALR123024	24°	30	G53	240V	AR111	4000	4000	2700	PCE	6	\$50.82
MASALR124524	24°	45	G53	240V	AR111	5300	4000	2700	PCE	6	\$50.82
MASALR124545	45°	45	G53	240V	AR111	1900	4000	2700	PCE	6	\$50.82
MASALR126024	24°	60	G53	240V	AR111	8500	4000	2700	PCE	6	\$50.82
MASALR126045	45°	60	G53	240V	AR111	2800	4000	2700	PCE	6	\$50.82

Essential Twistline Dichroic

A range of compact quartz halogen reflector lamps that offer a mains voltage look-alike to low voltage dichroic MR16 lamps. The lamp can be connected directly to 240V mains supply eliminating the need for a transformer. Featuring an aluminium reflector which directs most of the heat to the front to prevent overheating in the luminaire/ceiling space where ventilation is not adequate. Features a GU10 lamp base. Twistline provides a constant quality of light over lamp life and remains bright and shining.

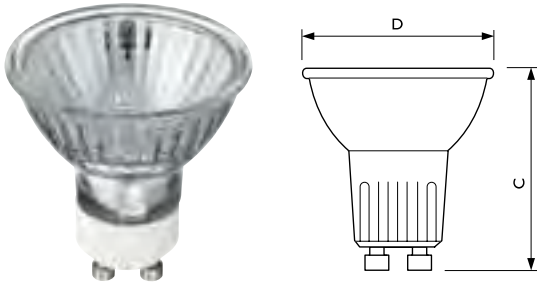

Product ID	Overall Length C max.	Diameter D max.
GU10	51	51

Dimensions in mm

Essential Twistline Dichroic

Shortcode	Beam Angle	Wattage (W)	Cap Base	Voltage	Bulb Shape	Luminous Flux Lamp (lm)	Average Lifetime (hrs)	Colour Temperature (K)	Unit	Carton Quantity	Trade Price
ESS2403536	36°	35	GU10	240V	MR16	235	2000	3000	PCE	5	\$12.08
ESS2405036	36°	50	GU10	240V	MR16	385	2000	3000	PCE	5	\$12.08

Essential Capsule LV

- Sturdy and compact
- Dimmable with a universal burning position
- For use in fixtures with protected front glass in accordance with IEC
- Low voltage – transformer required

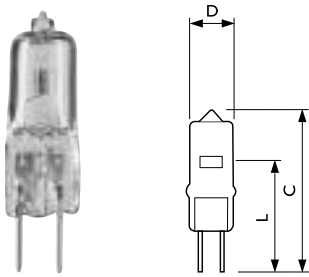

Product ID	Overall Length C max.	Diameter D max.	Overall Length L nom.
G4	32	9	22
GY6.35	44	12	30

Dimensions in mm

Essential Capsule - Low Voltage

Shortcode	Wattage (W)	Cap Base	Voltage	Bulb Shape	Luminous Flux Lamp (lm)	Average Lifetime (hrs)	Colour Temperature (K)	Unit	Carton Quantity	Trade Price
ESSCAP10W	10	G4	12V	CAP	100	2000	3000	PCE	5	\$8.09
ESSCAP20W	20	G4	12V	CAP	250	2000	3000	PCE	5	\$8.09
ESSCAP50W	50	GY6.35	12V	CAP	700	2000	3000	PCE	5	\$8.09
HAL13283	5	G4	12V	CAP	60	2000	3000	PCE	5	\$8.09

Eco Halogen Capsule MV

Mains-voltage halogen capsule with G.9 base.

- UV block quartz glass
- G9 base for easy insertion and replacement
- Mains voltage so no transformer needed
- Easily dimmable
- General lighting in homes, hotels, bars and restaurants
- Ideal for use in small, lightweight, open luminaires
- Used in luminaires without front glass in accordance with IEC 598

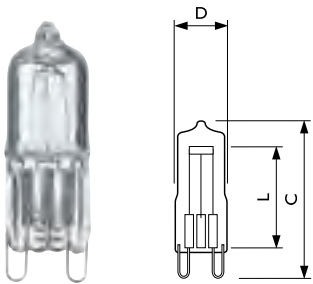

Product ID	Overall Length Diameter	
	C max.	D max.
G9	44.6	12.75

Dimensions in mm

Eco Halogen Capsule - Mains Voltage

Shortcode	Wattage (W)	Cap Base	Voltage	Bulb Shape	Luminous Flux Lamp (lm)	Average Lifetime (hrs)	Colour Temperature (K)	Unit	Carton Quantity	Trade Price
ECOHALG918WCL	18	G9	240V	CAP	204	2000	2800	PCE	15	\$7.60
ECOHALG928WCL	28	G9	240V	CAP	370	2000	2800	PCE	15	\$7.60
ECOHALG942WCL	42	G9	240V	CAP	630	2000	2800	PCE	15	\$7.60

EcoClassic A55

New generation halogen-technology lamp to replace the standard GLS bulb. Offering the same shape, size, and dimming functions.

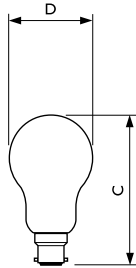

Product ID	C	D
A55	95.5	55

Dimensions in mm

EcoClassic A55 Clear

Shortcode	Wattage (W)	Cap Base	Voltage	Luminous Flux Lamp (lm)	Average Lifetime (hrs)	Colour Temperature (K)	Colour	Carton Quantity	Trade Price
ECO28WE27A55CL	28	E27	240	340	2000	2900	Clear	100	\$3.72
ECO28WB22A55CL	28	B22	240	340	2000	2900	Clear	100	\$3.72
ECO42WE27A55CL	42	E27	240	630	2000	2900	Clear	100	\$3.72
ECO42WB22A55CL	42	B22	240	630	2000	2900	Clear	100	\$3.72
ECO53WE27A55CL	53	E27	240	850	2000	2900	Clear	100	\$3.72
ECO53WB22A55CL	53	B22	240	850	2000	2900	Clear	100	\$3.72
ECO70WB22A55CL	70	B22	240	1200	2000	2900	Clear	100	\$3.72
ECO70WE27A55CL	70	E27	240	1200	2000	2900	Clear	100	\$3.72

EcoClassic A55 Frosted

Shortcode	Wattage (W)	Cap Base	Voltage	Luminous Flux Lamp (lm)	Average Lifetime (hrs)	Colour Temperature (K)	Colour	Carton Quantity	Trade Price
ECO28WE27A55FR	28	E27	240	340	2000	2900	Frosted	100	\$3.72
ECO28WB22A55FR	28	B22	240	340	2000	2900	Frosted	100	\$3.72
ECO42WE27A55FR	42	E27	240	630	2000	2900	Frosted	100	\$3.72
ECO42WB22A55FR	42	B22	240	630	2000	2900	Frosted	100	\$3.72
ECO53WE27A55FR	53	E27	240	850	2000	2900	Frosted	100	\$3.72
ECO53WB22A55FR	53	B22	240	850	2000	2900	Frosted	100	\$3.72
ECO70WB22A55FR	70	B22	240	1200	2000	2900	Frosted	100	\$3.72
ECO70WE27A55FR	70	E27	240	1200	2000	2900	Frosted	100	\$3.72
EC30A55105WBC	105	B22	240V	2100	2000	2900	Frosted	10	\$3.72
EC30A55140WBC	140	E27	240V	2800	2000	2900	Frosted	10	\$3.72

EcoClassic Candle

New generation halogen-technology lamp to replace the standard GLS candle. Offering the same shape, size, and dimming functions. Sold as a twin pack.



Product ID	C	D
Candle	95.5	36

Dimensions in mm

EcoClassic Candle Clear

Shortcode	Wattage (W)	Cap Base	Voltage	Bulb Shape	Luminous Flux Lamp (lm)	Average Lifetime (hrs)	Colour Temperature (K)	Unit	Carton Quantity	Trade Price
EC28WB35FR2BC	28	B22	240V	B35	346	2000	2800	SET	7	\$6.64
EC28WB35FR2SBC	28	B15	240V	B35	346	2000	2800	SET	7	\$6.64
EC28WB35FR2SES	28	E14	240V	B35	346	2000	2800	SET	7	\$6.64

EcoClassic Candle Frosted

Shortcode	Wattage (W)	Cap Base	Voltage	Bulb Shape	Luminous Flux Lamp (lm)	Average Lifetime (hrs)	Colour Temperature (K)	Unit	Carton Quantity	Trade Price
EC28WB35CL2BC	28	B22	240V	B35	346	2000	2800	SET	7	\$6.64
EC28WB35CL2SBC	28	B15	240V	B35	346	2000	2800	SET	7	\$6.64
EC28WB35CL2SES	28	E14	240V	B35	346	2000	2800	SET	7	\$6.64
EC42WB35CL2SES	42	E14	240V	B35	630	2000	2800	SET	7	\$6.64
EC28WB35CL2ES	28	E27	240V	B35	346	2000	2800	SET	7	\$6.64

EcoClassic Lustre

New generation halogen-technology lamp to replace the standard GLS lustre. Offering the same shape, size, and dimming functions. Sold as a twin pack.

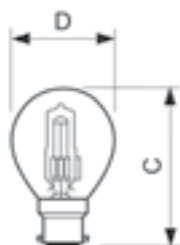

Product ID	C	D
Lustre	72.5	46

Dimensions in mm

EcoClassic Lustre Clear

Shortcode	Wattage (W)	Cap Base	Voltage	Bulb Shape	Luminous Flux Lamp (lm)	Average Lifetime (hrs)	Colour Temperature (K)	Unit	Carton Quantity	Trade Price
EC28WP45FR2BC	28	B22	240V	P45	346	2000	2800	SET	10	\$6.64
EC28WP45FR2SES	28	E14	240V	P45	346	2000	2800	SET	10	\$6.64

EcoClassic Lustre Frosted

Shortcode	Wattage (W)	Cap Base	Voltage	Bulb Shape	Luminous Flux Lamp (lm)	Average Lifetime (hrs)	Colour Temperature (K)	Unit	Carton Quantity	Trade Price
EC28WP45CL2SBC	28	B15	240V	P45	346	2000	2800	SET	10	\$6.64
EC28WP45CL2BC	28	B22	240V	P45	346	2000	2800	SET	10	\$6.64
EC28WP45CL2ES	28	E27	240V	P45	630	2000	2800	SET	10	\$6.64
EC42WP45CL2SES	42	E14	240V	P45	630	2000	2800	SET	10	\$6.64

Plusline Pro – Compact / Small / Large

These high performance, general purpose, linear halogen lamps give perfect colour rendition. These lamps feature two arc prevention fuses built-in for added safety. The burning position is universal on the compact and small types. Used mainly for outdoor floodlighting applications.

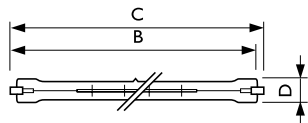
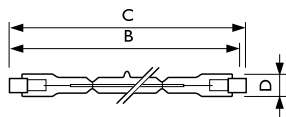
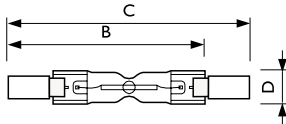

Product ID	Description	Overall Length B nom.	Diameter Length C max.	Overall Length D max.
100W	COMPACT	74.9	78.3	15
150W	COMPACT	74.9	78.3	15

Dimensions in mm

Product ID	Description	Overall Length B nom.	Diameter Length C max.	Overall Length D max.
200W	SMALL	114.2	117.6	12
300W	SMALL	114.2	117.6	12
500W	SMALL	114.2	117.6	12

Dimensions in mm

Product ID	Description	Overall Length B nom.	Diameter Length C max.	Overall Length D max.
1000W	LARGE	185.7	189.1	11
1500W	LARGE	250.7	254.1	11

Dimensions in mm

Plusline - Compact / Small / Large

Shortcode	Wattage (W)	Cap Base	Voltage	Bulb Shape	Luminous Flux Lamp (lm)	Average Lifetime (hrs)	Colour Temperature (K)	Unit	Carton Quantity	Trade Price
100PLUS	100	R7	240V	R7	1550	2000	2900	PCE	10	\$17.35
150PLUS	150	R7	240V	R7	2400	2000	2900	PCE	12	\$17.35
200PLUS	200	R7	240V	R7	3000	2000	2900	PCE	10	\$17.35
300PLUS	300	R7	240V	R7	5000	2000	2900	PCE	10	\$17.35
500PLUS	500	R7	240V	R7	9660	2000	2900	PCE	12	\$17.35
1000PLUS	1000	R7	240V	R7	21500	2000	2900	PCE	10	\$17.35
1500PLUS	1500	R7	240V	R7	33000	2000	2900	PCE	10	\$17.35



MASTER TL5 High Efficiency ECO

This extremely efficient TL5 lamp (tube diameter 16mm) saves considerable energy in quality T5 fittings. The TL5 HE Eco lamp offers excellent lumen maintenance and colour rendering. Application areas vary from offices and industry to schools and retail environments.

Benefits:

- Up to 10% energy saving with compatible current controlled ballasts
- The same quality of light as compared with MASTER TL5 HE lamps
- All benefits of regular TL5 lamps

Warnings and Safety:

- Energy reduction is only achieved with current-controlled gear
- The lamps operate with power-controlled gear, but in that case give more light output instead of using less energy.

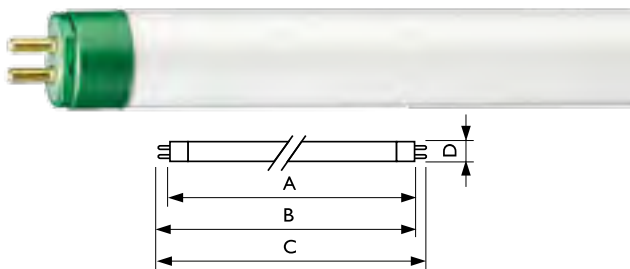

Product ID	A max.	B max.	C max.	D max.
14W → 13W	549.0	556.1	563.2	17
21W → 19W	849.0	856.1	863.2	17
28W → 25W	1149.0	1156.1	1163.2	17
35W → 32W	1449.0	1456.1	1463.2	17

Dimensions in mm

MASTER TL5 High Efficiency Eco

Shortcode	Wattage (W)	Cap Base	Luminous Flux Lamp (35°, lm)	Average Lifetime (hrs)	Colour Rendering Index (Ra)	Colour Temperature (K)	Min Order Quantity	Carton Quantity	Trade Price
TL513W830ECO	13	G5	1350	25000	85	3000	40	40	\$23.64
TL513W840ECO	13	G5	1350	25000	85	4000	40	40	\$23.64
TL513W865ECO	13	G5	1250	25000	85	6500	40	40	\$23.64
TL519W830ECO	19	G5	2100	25000	85	3000	40	40	\$24.55
TL519W840ECO	19	G5	2100	25000	85	4000	40	40	\$24.55
TL525W830ECO	25	G5	2900	25000	85	3000	40	40	\$25.45
TL525W840ECO	25	G5	2900	25000	85	4000	40	40	\$25.45
TL525W865ECO	25	G5	2700	25000	85	6500	40	40	\$25.45
TL532W830ECO	32	G5	3650	25000	85	3000	40	40	\$27.27
TL532W840ECO	32	G5	3650	25000	85	4000	40	40	\$27.27
TL532W865ECO	32	G5	3400	25000	85	6500	40	40	\$27.27

MASTER TL5 High Output ECO

This extremely efficient TL5 lamp (tube diameter 16mm) saves considerable energy by simple lamp-for-lamp replacement. The TL5 HO Eco lamp offers excellent lumen maintenance and colour rendering. Application areas vary from offices and industry to schools and retail environments.

- Benefits:**
- Up to 10% energy saving with compatible current controlled ballasts
 - The same quality of light as compared with MASTER TL5 HO lamps
 - All benefits of regular TL5 lamps

- Warnings and Safety:**
- Energy reduction is only achieved with current-controlled gear
 - The lamps operate with power-controlled gear, but in that case give more light output instead of using less energy.

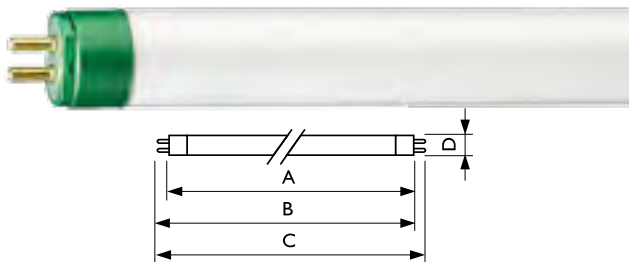

Product ID	A max.	B max.	C max.	D max.
20W - 24W	549.0	556.1	563.2	17
34W - 39W	849.0	856.1	863.2	17
45W - 49W	1449.0	1456.1	1463.2	17
50W - 54W	1149.0	1156.1	1163.2	17
73W - 80W	1449.0	1456.1	1463.2	17

Dimensions in mm

MASTER TL5 High Output Eco

Shortcode	Wattage (W)	Cap Base	Luminous Flux Lamp (35°, lm)	Average Lifetime (hrs)	Colour Rendering Index (Ra)	Colour Temperature (K)	Min Order Quantity	Carton Quantity	Trade Price
TL520W830ECO	20	G5	1950	30000	85	3000	40	40	\$32.73
TL520W840ECO	20	G5	1950	30000	85	4000	40	40	\$32.73
TL534W830ECO	34	G5	3500	30000	85	3000	40	40	\$32.73
TL534W840ECO	34	G5	3500	30000	85	4000	40	40	\$32.73
TL545W830ECO	45	G5	4800	30000	85	3000	40	40	\$32.73
TL545W840ECO	45	G5	4800	30000	85	4000	40	40	\$32.73
TL545W865ECO	45	G5	4550	30000	85	6500	40	40	\$32.73
TL550W830ECO	50	G5	5000	30000	85	3000	40	40	\$32.73
TL550W840ECO	50	G5	5000	30000	85	4000	40	40	\$32.73
TL550W865ECO	50	G5	4650	30000	85	6500	40	40	\$32.73
TL573W830ECO	73	G5	7000	30000	85	3000	40	40	\$35.15
TL573W840ECO	73	G5	7000	30000	85	4000	40	40	\$35.15
TL573W865ECO	73	G5	6650	30000	85	6500	40	40	\$35.15

MASTER TL5 High Efficiency

Low-pressure mercury discharge lamps with a tubular 16mm envelope. Specifically designed for operation with electronic gear, and suited for dimming. Optimal lighting efficiency at 35°C ambient temperature (compared with TL-D at 25°C). Allows use of more compact luminaires for lighting system minimalisation.

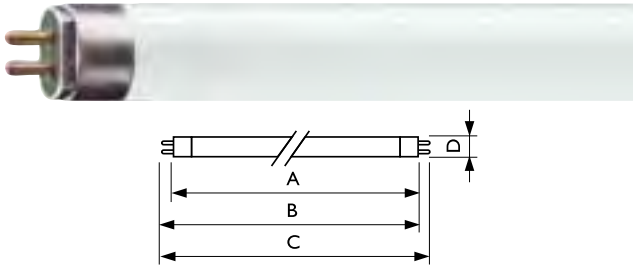

Product ID	A max.	B max.	C max.	D max.
14W	549.0	556.1	563.2	17
21W	849.0	856.1	863.2	17
28W	1149.0	1156.1	1163.2	17
35W	1449.0	1456.1	1463.2	17

Dimensions in mm

MASTER TL5 High Efficiency

Shortcode	Wattage (W)	Cap Base	Luminous Flux Lamp (35°, lm)	Average Lifetime (hrs)	Colour Rendering Index (Ra)	Colour Temperature (K)	Min Order Quantity	Carton Quantity	Trade Price
TL514W830HE	14	G5	1350	24000	85	3000	40	40	\$21.45
TL514W840HE	14	G5	1350	24000	85	4000	40	40	\$21.45
TL514W865HE	14	G5	1250	24000	85	6500	40	40	\$21.45
TL521W830HE	21	G5	2100	24000	85	3000	40	40	\$22.00
TL521W840HE	21	G5	2100	24000	85	4000	40	40	\$22.00
TL521W865HE	21	G5	1950	24000	85	3000	40	40	\$22.00
TL528W830HE	28	G5	2900	24000	85	3000	40	40	\$23.10
TL528W840HE	28	G5	2900	24000	85	4000	40	40	\$23.10
TL528W865HE	28	G5	2700	24000	85	6500	40	40	\$23.10
TL535W830HE	35	G5	3650	24000	85	3000	40	40	\$24.75
TL535W840HE	35	G5	3650	24000	85	4000	40	40	\$24.75
TL535W865HE	35	G5	3400	24000	85	6500	40	40	\$24.75

MASTER TL5 High Output

Low-pressure mercury discharge lamps with a tubular 16mm envelope. Specifically designed for operation with electronic gear, and suited for dimming. Optimal lighting efficiency at 35°C ambient temperature (compared with TL-D at 25°C). Allows use of more compact luminaires for lighting system minimalisation.

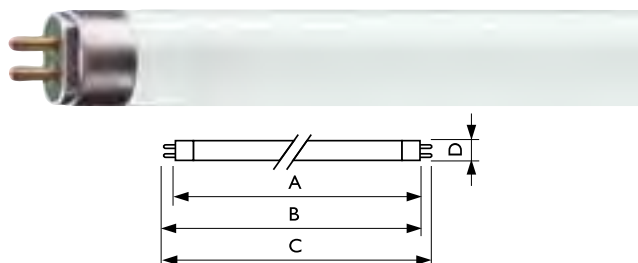

Product ID	A max.	B max.	C max.	D max.
24W	549.0	556.1	563.2	17
39W	849.0	856.1	863.2	17
49W	1449.0	1456.1	1463.2	17
54W	1149.0	1156.1	1163.2	17
80W	1449.0	1456.1	1463.2	17

Dimensions in mm

MASTER TL5 High Output

Shortcode	Wattage (W)	Cap Base	Luminous Flux Lamp (35°, lm)	Average Lifetime (hrs)	Colour Rendering Index (Ra)	Colour Temperature (K)	Min Order Quantity	Carton Quantity	Trade Price
TL524W830HO	24	G5	1950	24000	85	3000	40	40	\$27.50
TL524W840HO	24	G5	1950	24000	85	4000	40	40	\$27.50
TL524W865HO	24	G5	1820	24000	85	6500	40	40	\$27.50
TL539W830HO	39	G5	3500	24000	85	3000	40	40	\$27.50
TL539W840HO	39	G5	3500	24000	85	4000	40	40	\$27.50
TL539W865HO	39	G5	3300	24000	85	6500	40	40	\$27.50
TL549W830HO	49	G5	4900	24000	85	3000	40	40	\$29.70
TL549W840HO	49	G5	4900	24000	85	4000	40	40	\$29.70
TL549W865HO	49	G5	4650	24000	85	6500	40	40	\$29.70
TL554W830HO	54	G5	5000	24000	85	3000	40	40	\$29.70
TL554W840HO	54	G5	5000	24000	85	4000	40	40	\$29.70
TL554W865HO	54	G5	4750	24000	85	6500	40	40	\$29.70
TL580W840HO	80	G5	7000	24000	85	4000	40	40	\$31.90

MASTER TL5 HO Xtra

Long life low-pressure high-output mercury discharge lamps with a tubular 16mm envelope.

- Benefits:**
- Longer lifetime and fewer early failures mean lower maintenance costs and facilitate change from spot to group replacement
 - Allow system miniaturisation with maximum luminaire design freedom
 - Optimised for installations which need high luminous flux
 - Excellent lumen maintenance
 - Good colour rendering
- Features:**
- Significant reduction of early failures through advanced long life technology
 - Extra long lifetime and high reliability
 - Highly efficient 3-band fluorescent coating in combination with precoating
 - Maximum lumen output reached at approx. 35°C in free-burning position
 - Can be ignited from -15° to + 50°C
 - Low mercury dose
- Application:**
- Where maintenance costs are high, e.g. high ceilings or other hard to-reach locations
 - Department stores, supermarkets, warehouses, production halls and public areas like car parks and railway stations
- System:**
- Can be used with TL5 electronic gear

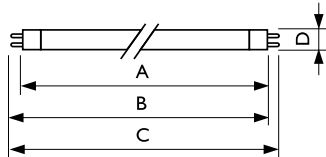

Product ID	A max.	B max.	C max.	D max.
49W	1449.0	1456.1	1463.2	17
54W	1149.0	1156.1	1163.2	17
80W	1449.0	1456.1	1463.2	17

Dimensions in mm

MASTER TL5 HO Xtra

Shortcode	Wattage (W)	Cap Base	Luminous Flux Lamp (35°, lm)	Average Lifetime (hrs)	Colour Rendering Index (Ra)	Colour Temperature (K)	Min Order Quantity	Carton Quantity	Trade Price
TL549W840HOX	49	G5	4900	45000	85	4000	20	20	\$33.33
TL554W840HOX	54	G5	5000	45000	85	4000	20	20	\$33.33
TL580W840HOX	80	G5	7000	45000	85	4000	20	20	\$36.36

MASTER TL5 HO TOP

Low-pressure Mercury discharge lamps with a tubular 16mm envelope. This TL5 HO TOP lamps (Temperature Optimised Performance) offer a constant light level, independent of temperature fluctuations, making it an excellent solution for warm or cool applications. The TL5 HO TOP can be operated on equivalent systems as MASTER TL5 HO. Excellent solution for non air conditioned applications such as warehouses, wall washers, etc.

- Benefits:**
- Allows system miniaturisation with maximum luminaire design freedom
 - Lamp lengths enable easy fitting into ceiling module systems
 - Retrofit to current TL5 HO non-amalgam lamps
 - Optimised for installations which need high luminous flux, especially in hot (above 40°C) conditions
 - Constant lumen level over a wide temperature range (20-75°C) with excellent lumen maintenance
 - Good colour rendering

- Features:**
- Lumen output higher than 90% of maximum value at ambient lamp temperatures from 20 to 75°C due to amalgam-controlled operation
 - Allows dimming-down to 30% light output
 - Hot restrike and good run-up behaviour compared to high intensity discharge lamps due to auxiliary amalgams at both lamp ends
 - Can be ignited at temperatures from -15 to +75°C

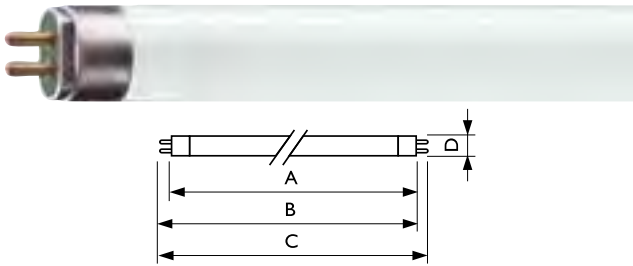

Product ID	A max.	B max.	C max.	D max.
54W	1149.0	1156.1	1163.2	17
80W	1449.0	1456.1	1463.2	17

Dimensions in mm

MASTER TL5 HO TOP

Shortcode	Wattage (W)	Cap Base	Luminous Flux Lamp (35°, lm)	Average Lifetime (hrs)	Colour Rendering Index (Ra)	Colour Temperature (K)	Min Order Quantity	Carton Quantity	Trade Price
TL549W840HOTOP	49	G5	4900	30000	85	4000	20	20	\$40.91
TL554W840HOTOP	54	G5	5000	30000	85	4000	20	20	\$40.91
TL580W840HOTOP	80	G5	7000	30000	85	4000	20	20	\$53.03

MASTER TL5 HO 90 Deluxe

Low-pressure mercury discharge lamps with high colour rendering.

- Benefits:**
- Allows system miniaturisation and maximum luminaire design freedom, with lamp lengths defined for easy fitting into ceiling module systems
 - Virtually constant lumen level with good lumen maintenance
 - Excellent colour rendering
- Features:**
- Highly efficient multi-band fluorescent coating in combination with precoating and high lamp load
 - Specifically designed for operation with electronic gear and well suited for dimming
 - Maximum light output reached at approx. 35°C in free-burning position if an electronic ballast without additional electrode heating is used
 - Can be ignited from -15 to +50°C
- Application:**
- Where a high colour recognition is needed: first aid and treatment rooms in hospitals, printing rooms, jewellery manufacturing, dentists, hairdressing, museums and shops

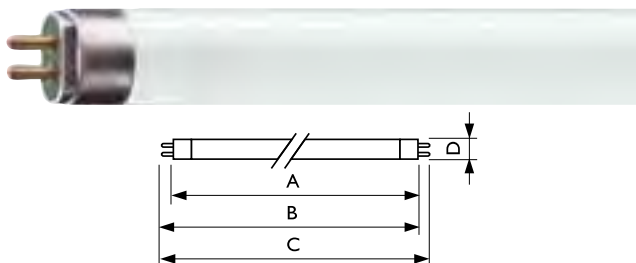

Product ID	A max.	B max.	C max.	D max.
24W	549.0	556.1	563.2	17
49W	1449.0	1456.1	1463.2	17
54W	1149.0	1156.1	1163.2	17

Dimensions in mm

MASTER TL5 HO TOP

Shortcode	Wattage (W)	Cap Base	Luminous Flux Lamp (35°, lm)	Average Lifetime (hrs)	Colour Rendering Index (Ra)	Colour Temperature (K)	Min Order Quantity	Carton Quantity	Trade Price
TL524W940HO	24	G5	1750	30000	91	4000	20	20	\$40.91
TL524W950HO	24	G5	1750	30000	92	5000	20	20	\$40.91
TL524W965HO	24	G5	1750	30000	93	6500	20	20	\$40.91
TL549W940HO	49	G5	4200	30000	91	4000	20	20	\$40.91
TL549W950HO	49	G5	4200	30000	92	5000	20	20	\$40.91
TL549W965HO	49	G5	4200	30000	93	6500	20	20	\$40.91
TL554W940HO	54	G5	4300	30000	91	4000	20	20	\$40.91
TL554W950HO	54	G5	4300	30000	92	5000	20	20	\$40.91
TL554W965HO	54	G5	4300	30000	93	6500	20	20	\$40.91

MASTER TL5 HE Secura

Shatterfree fluorescent lighting. This TL5 High Efficiency Secura lamp (tube diameter 16 mm) has a protective coating that keeps glass and lamp components together in the event of accidental breakage. The lamp is easily identifiable by a blue ring at one end. Application areas are all places where glass shatters can disturb operations and can have an impact on product and people safety, e.g. the food and beverage industry.

- Benefits:**
- Special protective coating around the lamp prevents products from contamination in case of accidental lamp breakage
 - High temperature-resistance (up to 200 °C) and no degradation under influence of temperature or UV
- Features:**
- Protective coating around the lamp
 - Fully compliant with IEC 61549 - Fragment Retention Lamp Standard
 - Superior coating material (Teflon) with high temperature resistance (up to 200 °C) and no degradation under influence of temperature or UV
 - Single blue ring around one end for identification
 - Direct retrofit for all TL5 HE lamps
- Application:**
- For use where contamination resulting from lamp breakage must be prevented, e.g. in food industry, suppliers to the food industry, health care, pharmaceuticals, cleanrooms etc.
 - Suitable for use in environments with increased risk of breakage, e.g. sports halls

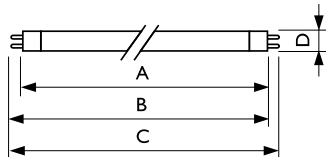

Product ID	A max.	B max.	C max.	D max.
14W	549.0	556.1	563.2	17
28W	1149.0	1156.1	1163.2	17
35W	1449.0	1456.1	1463.2	17

Dimensions in mm

MASTER TL5 High Efficiency Secura

Shortcode	Wattage (W)	Cap Base	Luminous Flux Lamp (35°, lm)	Average Lifetime (hrs)	Colour Rendering Index (Ra)	Colour Temperature (K)	Min Order Quantity	Carton Quantity	Trade Price
TL514W840HESEC	14	G5	1350	24000	85	4000	40	40	\$36.00
TL528W840HESEC	28	G5	2900	24000	85	4000	40	40	\$36.00
TL535W840HESEC	35	G5	3650	24000	85	4000	40	40	\$36.00

MASTER TL5 HO Secura

Shatterfree fluorescent lighting. This TL5 High Output Secura lamp (tube diameter 16 mm) has a protective coating that keeps glass and lamp components together in the event of accidental breakage. The lamp is easily identifiable by a blue ring at one end. Application areas are all places where glass shatters can disturb operations and can have an impact on product and people safety, e.g. the food and beverage industry.

- Benefits:**
- Special protective coating around the lamp prevents products from contamination in case of accidental lamp breakage
 - High temperature-resistance (up to 200 °C) and no degradation under influence of temperature or UV
- Features:**
- Protective coating around the lamp
 - Fully compliant with IEC 61549 – Fragment Retention Lamp Standard
 - Superior coating material (Teflon) with high temperature resistance (up to 200 °C) and no degradation under influence of temperature or UV
 - Single blue ring around one end for identification
 - Direct retrofit for all TL5 HO lamps
- Application:**
- For use where contamination resulting from lamp breakage must be prevented, e.g. in food industry, suppliers to the food industry, health care, pharmaceuticals, cleanrooms etc.
 - Suitable for use in environments with increased risk of breakage, e.g. sports halls

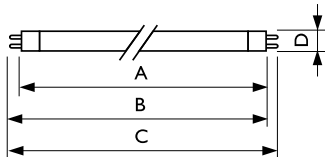

Product ID	A max.	B max.	C max.	D max.
49W	1449.0	1456.1	1463.2	17
54W	1149.0	1156.1	1163.2	17

Dimensions in mm

MASTER TL5 High Output Secura

Shortcode	Wattage (W)	Cap Base	Luminous Flux Lamp (35°, lm)	Average Lifetime (hrs)	Colour Rendering Index (Ra)	Colour Temperature (K)	Min Order Quantity	Carton Quantity	Trade Price
TL549W840SECURA	49	G5	4900	30000	85	4000	40	40	\$40.00
TL554W840SECURA	54	G5	5000	30000	85	4000	40	40	\$40.00

MASTER TL5 Circular

16mm tube diameter circular fluorescent lamps with a choice of various diameters.

- Benefits:**
- Slim 16mm tube allows creation of extremely flat luminaires
 - Allows appealing circular designs
 - High lamp efficacy
 - Good colour rendering
 - Temperature independent light output
 - Higher average system efficiency

- Features:**
- Perfect circular shape
 - Highly efficient 3-band fluorescent coating
 - Specifically designed for operation with electronic gear
 - Can be ignited from -15 to +50°C
 - Amalgam technology

- Application:**
- Brings the benefits of TL5 lighting to an even wider range of attractive applications
 - Suitable for a wide range of professional and semi-professional applications
 - Ideal for use in shops, offices and public areas with non-traditional layouts
 - Amalgam lamps have limited suitability for dimming applications.

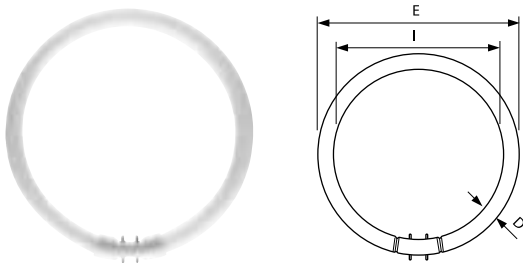

Product ID	D max.	E max.	I max.
22W	18	230	197
40W/55W	18	305	272
60W	18	379	346

Dimensions in mm

MASTER TL5 Circular

Shortcode	Wattage (W)	Cap Base	Luminous Flux Lamp (25°, lm)	Average Lifetime (hrs)	Colour Rendering Index (Ra)	Colour Temperature (K)	Min Order Quantity	Carton Quantity	Trade Price
TL5C22W830	22	2GX13	1800	12000	85	3000	10	10	\$30.00
TL5C22W840	22	2GX13	1800	12000	85	4000	10	10	\$30.00
TL5C40W830	40	2GX13	3300	12000	85	3000	10	10	\$33.00
TL5C40W840	40	2GX13	3300	12000	85	4000	10	10	\$33.00
TL5C55W830	55	2GX13	4200	12000	85	3000	10	10	\$33.00
TL5C55W840	55	2GX13	4200	12000	85	4000	10	10	\$33.00
TL5C60W830	60	2GX13	5000	12000	85	3000	10	10	\$35.00
TL5C60W840	60	2GX13	5000	12000	85	4000	10	10	\$35.00

MASTER TL-D ALTO

The difference is green. The ALTO lamp, a green flagship product, features technology that employs a unique capsule injection dosing system that delivers significantly less mercury into each tube; now only two milligrams. The lamps Next Generation triphosphor technologies ensures high light output, high lumen maintenance, and good colour rendering.

Features a distinct green end cap for easy identification for relamping. So make the switch to green!

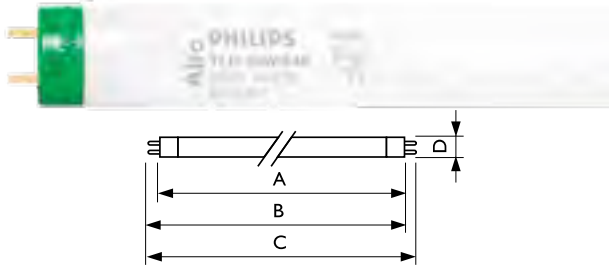

Product ID	A max.	B max.	C max.	D max.
18W	589.8	596.9	604.0	28
36W	1199.4	1206.5	1213.6	28
58W	1500.0	1507.0	1514.2	28

Dimensions in mm

MASTER TL-D ALTO

Shortcode	Wattage (W)	Cap Base	Luminous Flux Lamp (25°, lm)	Average Lifetime EL (hrs)	Colour Rendering Index (Ra)	Colour Temperature (K)	Min Order Quantity	Carton Quantity	Trade Price
TLD18W830ALTO	18	G13	1350	20000	83	3,000	25	25	\$11.85
TLD18W840ALTO	18	G13	1350	20000	82	4,000	25	25	\$11.85
TLD18W850ALTO	18	G13	1310	20000	80	5,000	25	25	\$11.85
TLD18W865ALTO	18	G13	1275	20000	80	6,500	25	25	\$11.85
TLD36W830ALTO	36	G13	3250	20000	83	3,000	25	25	\$14.80
TLD36W840ALTO	36	G13	3250	20000	82	4,000	25	25	\$14.80
TLD36W850ALTO	36	G13	3170	20000	80	5000	25	25	\$14.80
TLD36W865ALTO	36	G13	3070	20000	80	6500	25	25	\$14.80
TLD58W830ALTO	58	G13	5150	20000	83	3000	25	25	\$17.75
TLD58W840ALTO	58	G13	5200	20000	82	4000	25	25	\$17.75
TLD58W850ALTO	58	G13	4950	20000	80	5000	25	25	\$17.75
TLD58W865ALTO	58	G13	4800	20000	80	6500	25	25	\$17.75

MASTER TL-D Eco

The MASTER TL-D Eco lamp offers the same light output as a MASTER TL-D Super 80 lamp, while using less energy, thanks to the use of specific phosphors and a special gas filling. Application areas are schools, offices, governmental buildings and healthcare environments.

- Benefits:
- Simple lamp-for-lamp replacement for more than 10% energy savings
 - Relatively high efficacy, both initially and during lifetime, with high lumen maintenance
- Features:
- The only T8 fluorescent lamp that saves more than 10% of energy in existing luminaires with electromagnetic gear
 - Lower power savings with electronic gear depending on type of gear (current- or power-controlled)
 - Can be directly retrofitted into existing fluorescent fittings operating on electromagnetic or electronic gear in indoor applications
 - Uses the latest highly efficient phosphors and special filling gas
 - High-quality lighting with good colour rendering (CRI>80)
 - Light output comparable to TL-D Alto
 - Lumen maintenance and lifetime the same as TL-D Alto
 - Dimmable

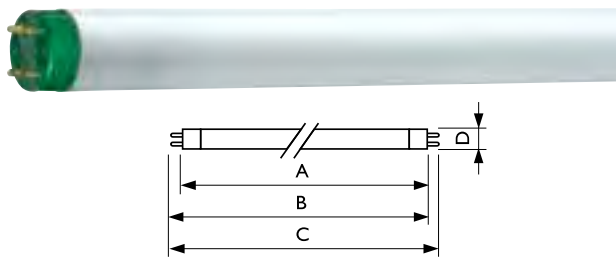

Product ID	A max.	B max.	C max.	D max.
32W	1199.4	1204.1	1213.6	28
51W	1500	1507	1514.2	28

Dimensions in mm

MASTER TL-D ECO

Shortcode	Wattage (W)	Cap Base	Luminous Flux (25°, lm)	Average Lifetime (hrs)	Colour Rendering Index (Ra)	Colour Temperature (K)	Min Order Quantity	Carton Quantity	Trade Price
TLD32W840ECO	32	G13	3000	20000	85	4000	25	25	\$25.00
TLD32W865ECO	32	G13	2850	20000	85	6500	25	25	\$25.00
TLD51W840ECO	51	G13	4800	20000	85	4000	25	25	\$27.50
TLD51W865ECO	51	G13	4470	20000	85	6500	25	25	\$27.50

MASTER TL-D Super 80

Next Generation triphosphor tubes with alternate wattages/lengths.

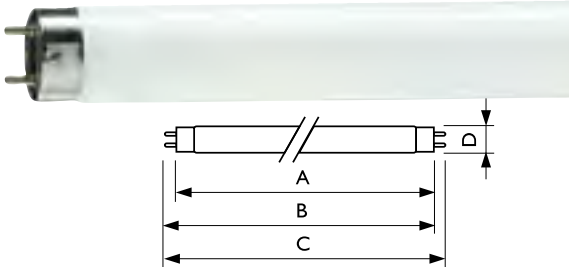

Product ID	A max.	B max.	C max.	D max.
16W	589.8	596.9	604.0	28
23W	970.0	977.1	984.2	28
30W	894.6	901.7	908.8	28
32W	1199.4	1206.5	1213.6	28
38W	1047.0	1054.1	1061.2	28
50W	1500	1507.1	1514.2	28
70W	1763.8	1770.9	1778.0	28

Dimensions in mm

MASTER TL-D Super 80

Shortcode	Wattage (W)	Cap Base	Luminous Flux Lamp (25°, lm)	Average Lifetime EL (hrs)	Colour Rendering Index (Ra)	Colour Temperature (K)	Min Order Quantity	Carton Quantity	Trade Price
TLD16W840	16	G13	1200	20,000	82	4000	25	25	\$14.17
TLD23W840	23	G13	2050	20,000	82	4000	25	25	\$14.17
TLD30W830	30	G13	2400	20,000	85	3000	25	25	\$14.17
TLD30W840	30	G13	2400	20,000	85	4000	25	25	\$17.00
TLD30W865	30	G13	2300	20000	80	6500	25	25	\$17.00
TLD32W840	32	G13	3200	20000	85	4000	25	25	\$17.00
TLD38W840	38	G13	3350	20000	85	4000	25	25	\$12.00
TLD50W840	50	G13	5000	20000	85	4000	25	25	\$12.00
TLD70W840	70	G13	6200	20000	85	4000	25	25	\$22.00

MASTER TL-D Xtreme

Next Generation triphosphor tube with long service life and fewer early failures. Xtreme (extremely long life) are suited for applications where maintenance costs are high; such as areas with high ceilings or difficult to reach areas (department stores, supermarkets, warehouses, halls, airports etc). The Xtreme lamps are also suited to areas that require minimum disruption due to relamping; such as production facilities and transport tunnels. Philips recommends Xtreme lamps in applications where users are looking for longer periods between group replacement of lamps. Features a distinct X-cap to identify as a long-life lamp.

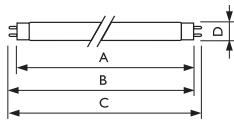

Product ID	A max.	B max.	C max.	D max.
18W	589.8	596.9	604	28
36W	1199.4	1206.5	1213.6	28
58W	1500.0	1507.1	1514.2	28

Dimensions in mm

MASTER TL-D Xtreme

Shortcode	Wattage (W)	Cap Base	Luminous Flux Lamp (25°, lm)	Average Lifetime EL (hrs)	Colour Rendering Index (Ra)	Colour Temperature (K)	Min Order Quantity	Carton Quantity	Trade Price
TLD18W830XTRE	18	G13	1350	47000	85	3000	25	25	\$41.20
TLD18W840XTRE	18	G13	1350	47000	85	4000	25	25	\$41.20
TLD18W865XTRE	18	G13	1250	47000	85	6500	25	25	\$41.20
TLD36W830XTRE	36	G13	3250	47000	85	3000	25	25	\$43.00
TLD36W840XTRE	36	G13	3250	47000	85	4000	25	25	\$43.00
TLD36W865XTRE	36	G13	3150	47000	85	6500	25	25	\$43.00
TLD58W840XTRE	58	G13	5150	47000	85	4000	25	25	\$45.00
TLD58W865XTRE	58	G13	5000	47000	85	6500	25	25	\$45.00

MASTER TL-D 90 De Luxe / Graphica

When natural colour reproduction is important the De Luxe and Graphica range of TL-D lamps offer a simple retro fit solution delivering very good (De Luxe CRI >90) and excellent (Graphica CRI >95) colour reproduction.

De Luxe Applications include first aid and treatment rooms in hospitals, printing rooms, jewellery, dentists, hairdressing, museums and shops etc.

Graphica Applications include the graphical industry, printing industry, photo shops, hospitals, etc.

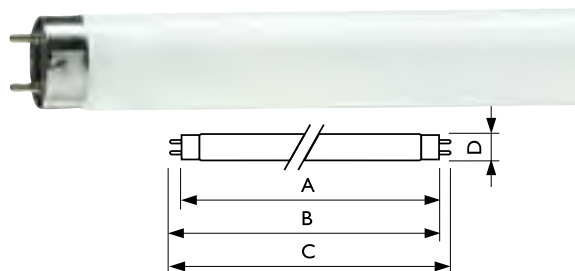

Product ID max.	A max.	B max.	C max.	D max.	E max.
18W	589.8	594.5	96.9	604	28
36W	1199.4	1204.7	1206.5	1213.6	28
58W	1500.0	1504.7	1507.1	1514.2	28

Dimensions in mm

MASTER TL-D 90 De Luxe

Shortcode	Wattage (W)	Cap Base	Voltage	Luminous Flux Lamp (lm)	Average Lifetime (hrs)	Colour Rendering Index (Ra)	Colour Temperature (K)	Min Order Quantity	Carton Quantity	Trade Price
928043593081	TLD18W930	18	G13	1200	20000	91	3000	10	10	\$20.00
928043594081	TLD18W940	18	G13	1200	20000	91	4000	10	10	\$20.00
928043595081	TLD18W950	18	G13	1150	20000	92	5000	10	10	\$20.00
928044593081	TLD36W930	36	G13	2800	20000	91	3000	10	10	\$20.00
928044594081	TLD36W940	36	G13	2800	20000	91	4000	10	10	\$20.00
928044595081	TLD36W950	36	G13	2800	20000	92	5000	10	10	\$20.00
928044596581	TLD36W965	36	G13	2800	20000	93	6500	10	10	\$20.00
928045093081	TLD58W930	58	G13	4350	20000	91	3000	10	10	\$24.00
928045094081	TLD58W940	58	G13	4600	20000	91	4000	10	10	\$24.00
928045095081	TLD58W950	58	G13	4550	20000	92	5000	10	10	\$24.00

MASTER TL-D Graphica

Shortcode	Wattage (W)	Cap Base	Luminous Flux Lamp (25°, lm)	Average Lifetime EL (hrs)	Colour Rendering Index (Ra)	Colour Temperature (K)	Min Order Quantity	Carton Quantity	Trade Price
TLD18W950GRAPH	18	G13	950	20000	97	5300	25	25	\$23.00
TLD18W965GRAPH	18	G13	930	20000	98	6500	25	25	\$23.00
TLD36W950GRAPH	36	G13	2340	20000	97	5300	25	25	\$26.00
TLD36W965GRAPH	36	G13	2100	20000	98	6500	25	25	\$26.00
TLD58W950GRAPH	58	G13	3670	20000	97	5300	25	25	\$28.00
TLD58W965GRAPH	58	G13	3350	20000	98	6500	25	25	\$28.00

MASTER TL-D Secura

Next Generation triphosphor tube with protective coating. Outer sleeve keeps glass and other lamp components together in case of accidental lamp breakage. Suited for use in areas with open food and beverage areas, production facilities, sports facilities, animal enclosures etc.

Features a distinct blue-ring to identify as protected tubes. MASTER TL-D Secura is HACCP Certified.

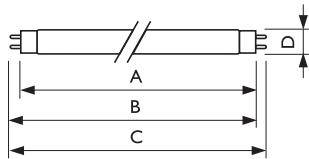

Product ID	A max.	B max.	C max.	D max.
36W	1199.4	1206.5	1213.6	28
58W	500.0	1507.0	1514.2	28

Dimensions in mm

MASTER TL-D Secura

Shortcode	Wattage (W)	Cap Base	Luminous Flux Lamp (lm)	Average Lifetime (hrs)	Colour Rendering Index (Ra)	Colour Temperature (K)	Min Order Quantity	Carton Quantity	Trade Price
TLD36W840SECURA	36	G13	3200	20000	85	4000	25	25	\$36.00
TLD58W840SECURA	58	G13	5000	20000	85	4000	25	25	\$40.00

MASTER TL-D Food Pro (Butcher)

The colour 79 butcher tube. Next Generation triphosphor tube designed specifically for the presentation of fresh meat and poultry. Lamps emphasize the deep red colours such as those of meat, without the lamp having a red appearance.

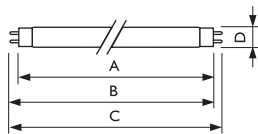

Product ID	A max.	B max.	C max.	D max.
18W	589.8	594.5	604.0	28
30W	894.6	899.3	908.8	28
36W	1199.4	1204.1	1213.6	28
36W	970.0	974.7	984.2	28
58W	1500.0	1504.7	1514.2	28

Dimensions in mm

MASTER TL-D Food Pro (Butcher)

Shortcode	Wattage (W)	Cap Base	Luminous Flux Lamp (lm)	Average Lifetime EL (hrs)	Colour Rendering Index (Ra)	Colour Temperature (K)	Min Order Quantity	Carton Quantity	Trade Price
TLD18W79	18	G13	740	20000	74	3800	25	25	\$29.10
TLD30W79	30	G13	1300	20000	74	3800	25	25	\$31.88
TLD36W79	36	G13	1750	20000	74	3800	25	25	\$31.88
TLD36W791M	36	G13	1600	20000	74	3800	25	25	\$34.64
TLD58W79	58	G13	2800	20000	74	3800	25	25	\$34.64

TL-D Standard Colours

Low-wattage standard colour tubes with shorter length and moderate colour rendering.

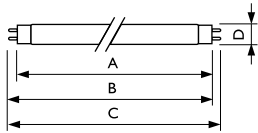

Product ID	A max.	B max.	C max.	D max.
10W	331.5	338.6	345.7	28
15W	437.4	444.5	451.6	28

Dimensions in mm

TL-D STANDARD COLOURS

Shortcode	Wattage (W)	Cap Base	Luminous Flux Lamp (lm)	Average Lifetime (hrs)	Colour Rendering Index (Ra)	Min Order Quantity	Carton Quantity	Trade Price
TLD10W33	10	G13	520	10000	60	25	25	\$10.00
TLD15W33	15	G13	960	10000	63	9	9	\$10.61

Blacklight Blue (BLB)

UV Lamps for fly traps, reprography and other applications requiring UV Lamps.

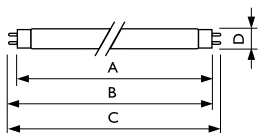

Product ID	A max.	B max.	C max.	D max.
6W	212.1	219.2	226.3	16
18W	589.8	596.9	604.0	28
36W	1199.4	1206.5	1206.5	28

Dimensions in mm

TL-D Black Light Blue (BLB)

Shortcode	Wattage (W)	Cap Base	Luminous Flux Lamp (lm)	Average Lifetime (hrs)	Colour Rendering Index (Ra)	Colour Temperature (K)	Min Order Quantity	Carton Quantity	Trade Price
TL6WBLB	6	G5	N/A	10000	N/A	N/A	25	250	\$7.00
TLD18WBLB	18	G13	N/A	13000	N/A	N/A	25	25	\$11.67
TLD36WBLB	36	G13	N/A	15000	N/A	N/A	25	25	\$8.75

TL-E Circular Super 80

A range of simple, yet decorative shaped circular fluorescent lamps. To provide non-directional light in decorative or functional fittings.

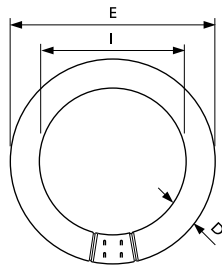

Product ID	D max.	E max.	I max.
22W	30.9	215.9	157.5
32W	30.9	304.8	246.1
40W	30.9	406.4	347.7

Dimensions in mm

TL-E Circular Super 80

Shortcode	Wattage (W)	Cap Base	Luminous Flux Lamp (lm)	Average Lifetime (hrs)	Colour Rendering Index (Ra)	Colour Temperature (K)	Min Order Quantity	Carton Quantity	Trade Price
TLE22W840	22	G10q	1285	9000	85	4000	20	20	\$20.50
TLE22W865	22	G10q	1250	9000	85	6500	20	20	\$20.50
TLE32W840	32	G10q	2130	9000	85	4000	20	20	\$27.00
TLE32W865	32	G10q	2130	9000	85	6500	20	20	\$27.00
TLE40W865	40	G10q	3100	9000	85	6500	20	20	\$28.13

TL Miniature

Miniature tubes with 16mm diameter. Suited to orientation or compact lighting applications, and where space is limited.

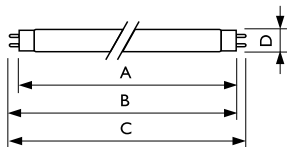

Product ID	A max.	B max.	C max.	D max.
6W TL	212.1	219.2	226.3	16
8W TL	288.3	295.4	302.5	16
13W TL	516.9	524	531.1	16

Dimensions in mm

TL Miniature

Shortcode	Wattage (W)	Cap Base	Luminous Flux Lamp (lm)	Average Lifetime (hrs)	Colour Rendering Index (Ra)	Colour Temperature (K)	Min Order Quantity	Carton Quantity	Trade Price
TL6W33	6	G5	260	10,000	60	4100	10	10	\$7.00
TL8W33	8	G5	410	5,000	60	4100	25	250	\$11.67
TL13W33	13	G5	930	8,000	60	4100	25	250	\$6.67

TL-X XL Instant Start

Instant start safety lamps specifically designed for use in potentially explosive atmospheres. Internal ignition switch and nickel single pin caps. Must be used with explosion-proof ballasts in flameproof or increased safety fittings.

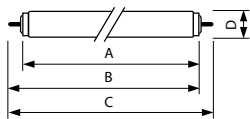

Product ID	A max.	B max.	C max.	D max.
20W	574	592.5	611	40.5
40W	1183.5	1202	1220.5	40.5
65W	1484.1	1502.6	1521.1	40.5

Dimensions in mm

TL-X XL Instant Start

Shortcode	Wattage (W)	Cap Base	Luminous Flux Lamp (lm)	Average Lifetime (hrs)	Colour Temperature (K)	Min Order Quantity	Carton Quantity	Trade Price
TLXXL20W33	20	FA6	1100	26000	4100	25	25	\$66.00
TLXXL40W33	40	FA6	2350	26000	4100	25	25	\$66.00
TLXXL65W33	65	FA6	4400	26000	4100	25	25	\$66.00

Starter Switches

Premium quality 2-pin flame-retardant polycarbonate ignitors for starting of fluorescent lamps on conventional electromagnetic circuits.

Controlled preheating of the lamp filaments and sufficient pulse voltage for longer lamp life.

Features a radio-interference suppression capacitor.

S2 starters for ignition in single-circuit operation 110-130V and series operation 220-240V.

S10 starters for ignition in series operation 220-240V.

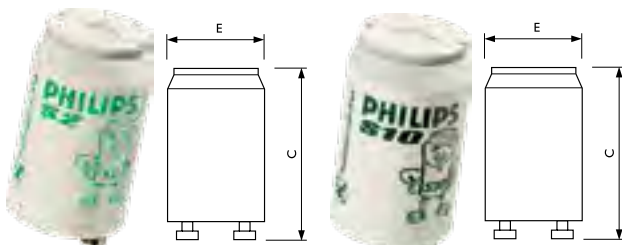

Product ID	Overall Length C max.	Diameter E max.
S2	40.3	21.5
S10	40.3	21.5
S16	40.6	21.5

Dimensions in mm

Starter Switches

Shortcode	Wattage	Min Order Quantity	Carton Quantity	Trade Price
S2	4-22	25	300	\$1.67
S10	4-65	25	300	\$1.67
S16	70-125	10	200	\$6.67

MASTER PL-R Eco

MASTER PL-R-Eco is an extremely efficient compact fluorescent lamp for downlight applications. It consists of six parallel tubes with a new innovative 'Twist and Lock' lamp base, designed for use with electronic gear.

- Benefits:**
- Optimal light and efficiency performance for short or long operation per switch in indoor downlighters
 - Up to 50% less energy consumption in application versus 18 and 26 W PL-C/T on EM gears for comparable lighting levels
 - Up to 25% less energy consumption in application versus 18 and 26 W PL-C/T on HF drivers for comparable lighting levels
 - Long life, sustainable light output and less early failures lead to less hassle and lower maintenance costs and facilitate the change from spot to group replacement
 - Easy lamp (re-)placement and stable fixation due to new twist and lock lampbase/holder

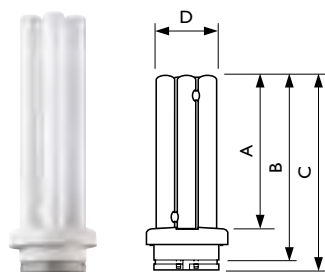

Product ID	A max.	B max.	C max.	D max.
14W	99.7	120.0	126.6	41.0
17W	121.7	142.0	148.6	41.0

Dimensions in mm

MASTER PL-R Eco

Shortcode	Wattage (W)	Cap Base	Luminous Flux Lamp (lm)	Average Lifetime (hrs)	Colour Rendering Index (Ra)	Colour Temperature (K)	Min Order Quantity	Carton Quantity	Trade Price
PLR14W830	14	GR14q-1	1200	24000	82	3000	10	10	\$40.00
PLR14W840	14	GR14q-1	1200	24000	82	4000	10	10	\$40.00
PLR17W830	17	GR14q-1	1500	24000	82	3000	10	10	\$40.00
PLR17W840	17	GR14q-1	1500	24000	82	4000	10	10	\$40.00

PL-C 2-PIN

PL-C lamps are compact, single ended fluorescent lamps. All require external control gear which normally comes complete with the luminaire. 2-pin (non-dimming) option.

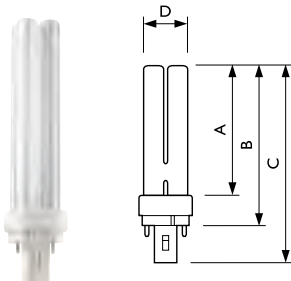

Product ID	Base Face to Base Face A max.	Insertion Length B max.	Overall Length C max.	Diameter D max.
10W	75.7	94	116.4	27.1
13W	97.7	116	138.4	27.1
18W	109.7	128	150.4	27.1
26W	130.7	149	171.4	27.1

Dimensions in mm

PL-C 2-PIN

Shortcode	Wattage (W)	Cap Base	Luminous Flux Lamp (lm)	Average Lifetime (hrs)	Colour Temperature (K)	Min Order Quantity	Carton Quantity	Trade Price
PLC10W8272P	10	G24d-1	600	10000	2700	50	50	\$25.00
PLC10W8402P	10	G24d-1	600	10000	4000	1	50	\$25.00
PLC13W8272P	13	G24d-1	900	10000	2700	1	50	\$28.41
PLC13W8302P	13	G24d-1	900	10000	3000	1	50	\$28.41
PLC13W8402P	13	G24d-1	900	10000	4000	1	50	\$28.41
PLC18W8302P	18	G24d-2	1200	10000	3000	1	50	\$28.41
PLC18W8402P	18	G24d-2	1200	10000	4000	1	50	\$28.41
PLC26W8272P	26	G24d-3	1800	10000	2700	1	50	\$28.41
PLC26W8302P	26	G24d-3	1800	10000	3000	1	50	\$28.41
PLC26W8402P	26	G24d-3	1800	10000	4000	1	50	\$28.41
PLC26W8652P	26	G24d-3	1740	10000	6500	50	50	\$28.41

PL-C 4-PIN

PL-C lamps are compact, single ended fluorescent lamps. All require external control gear which normally comes complete with the luminaire. 4-pin (dimming) option.

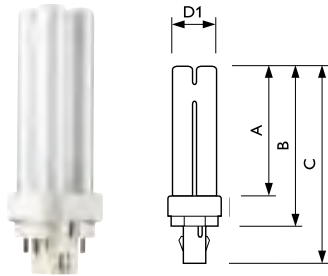

Product ID	A max.	B max.	C max.	D1 max.
13W	97.5	117	131.9	27.1
18W	109.5	129	143.9	27.1
26W	130.7	150	164.9	27.1

Dimensions in mm

PL-C 4-PIN

Shortcode	Wattage (W)	Cap Base	Luminous Flux Lamp (lm)	Average Lifetime (hrs)	Colour Rendering Index (Ra)	Colour Temp (K)	Min Order Quantity	Carton Qty	Trade Price
PLC13W8404P	13	G24q-1	900	13000	82	4000	1	50	\$30.68
PLC18W8304P	18	G24q-2	1200	13000	83	3000	1	50	\$30.68
PLC18W8404P	18	G24q-2	1200	13000	82	4000	1	50	\$30.68
PLC26W8304P	26	G24q-3	1760	13000	83	3000	1	50	\$30.68
PLC26W8404P	26	G24q-3	1760	13000	82	4000	1	50	\$30.68

MASTER PL-L 4-PIN

PL-L lamps have two parallel fluorescent tubes and a 4-pin base. Dimming possible on electronic gear.

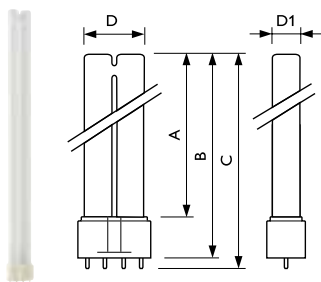

Product ID	A max.	B max.	C max.	D max.	D1 max.
18W	194.2	220.0	226.6	39	18
24W	289.2	315.0	321.6	39	18
36W	384.2	410.0	416.6	39	18
40W	509.2	535.0	541.6	39	18
55W	539.2	565.0	571.6	39	18

Dimensions in mm

MASTER PL-L 4-PIN

Shortcode	Wattage (W)	Cap Base	Luminous Flux Lamp (lm)	Average Lifetime (hrs)	Colour Rendering Index (Ra)	Colour Temp (K)	Min Order Quantity	Carton Qty	Trade Price
PLL18W8404P	18	2G11	1200	20000	82	4000	1	25	\$30.30
PLL24W8404P	24	2G11	1800	20000	82	4000	1	25	\$30.30
PLL36W8404P	36	2G11	2900	20000	82	4000	1	25	\$33.33
PLL40W8404P	40	2G11	3500	20000	82	4000	1	25	\$45.71
PLL55W8404P	55	2G11	4800	20000	82	4000	1	25	\$45.71

PL-S 2-PIN

PL-S lamps are compact, single ended fluorescent lamps, with two parallel tubes. They have either a 2-pin or 4-pin base incorporating a special instant starter and capacitor.

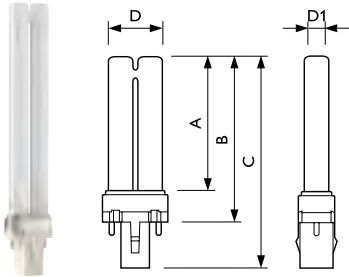

Product ID	A max.	B max.	C max.	D max.	D1 max.
5W 2P	67	83	105	28	13
7W 2P	97	113	135.0	28	13
9W 2P	129	145	167.0	28	13
11W 2P	198	214	235.8	28	13

Dimensions in mm

PL-S 2-PIN

Shortcode	Wattage (W)	Cap Base	Luminous Flux Lamp (lm)	Average Lifetime (hrs)	Colour Temp (K)	Min Order Quantity	Carton Qty	Trade Price
PLS5W8402P	5	G23	250	10000	4000	1	50	\$11.55
PLS7W8272P	7	G23	400	10000	2700	25	25	\$12.86
PLS7W8402P	7	G23	400	10000	4000	1	25	\$12.86
PLS9W8272P	9	G23	600	10000	2700	1	25	\$12.86
PLS9W8402P	9	G23	600	10000	4000	1	25	\$12.86
PLS11W8272P	11	G23	900	10000	2700	25	25	\$12.86
PLS11W8402P	11	G23	900	10000	4000	1	25	\$12.86

MASTER PL-S 4-PIN

PL-S lamps are compact, single ended fluorescent lamps, with two parallel tubes. They have either a 2-pin or 4-pin base incorporating a special instant starter and capacitor.

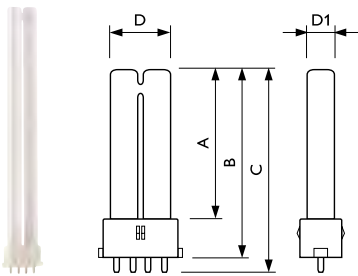

Product ID	A max.	B max.	C max.	D max.	D1 max.
7W	96.0	113.0	119.1	28	13
9W	128.0	145.0	151.1	28	13
11W	196.0	214.0	219.9	28	13

Dimensions in mm

PL-S 4-PIN

Shortcode	Wattage (W)	Cap Base	Luminous Flux Lamp (lm)	Average Lifetime (hrs)	Colour Rendering Index (Ra)	Colour Temp (K)	Min Order Quantity	Carton Qty	Trade Price
PLS7W8404P	7	2G7	400	13000	82	4000	50	50	\$14.00
PLS9W8404P	9	2G7	600	13000	82	4000	1	50	\$14.00
PLS11W8274P	11	2G7	900	13000	82	2700	50	50	\$14.00
PLS11W8404P	11	2G7	900	13000	82	4000	1	50	\$14.00

MASTER PL-T 2-PIN

PL-T lamps are compact, single ended fluorescent lamps. All require external control gear which normally comes complete with the luminaire.

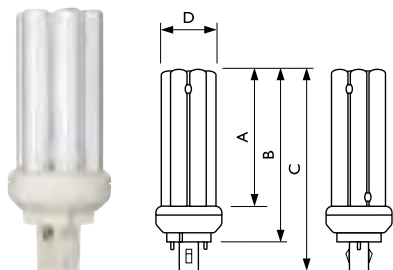

Product ID	A max.	B max.	C max.	D max.
18W	71.8	96	119.2	41.0
26W	86.7	111.0	134.2	41.0

Dimensions in mm

PL-T 2-PIN

Shortcode	Wattage (W)	Cap Base	Luminous Flux Lamp (lm)	Average Lifetime (hrs)	Colour Temp (K)	Min Order Quantity	Carton Qty	Trade Price
PLT18W8302P	18	Gx24d-2	1200	10000	3000	50	50	\$48.00
PLT26W8302P	26	Gx24d-3	1800	10000	3000	50	50	\$48.00
PLT26W8402P	26	Gx24d-3	1800	10000	4000	1	50	\$48.00

MASTER PL-T 4-PIN

MASTER PL-T is an efficient compact fluorescent lamp, typically used in general downlights for retail, hospitality and office applications demanding higher lighting levels. The original Philips-invented bridge technology guarantees optimum performance in the application, enabling more light and higher efficacy than the bended technology. The 4-pin version is designed for operation on electronic gear and is provided with a plug-in/pull-out lamp base.

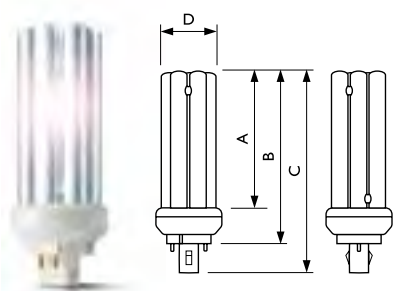

Product ID	A max.	B max.	C max.	D max.
32W	98.7	123.0	138.7	41
42W	120.7	145.0	160.7	41

Dimensions in mm

MASTER PL-T 4-PIN

Shortcode	Wattage (W)	Cap Base	Luminous Flux (250, lm)	Average Lifetime (hrs)	Colour Rendering Index (Ra)	Colour Temp (K)	Min Order Quantity	Carton Qty	Trade Price
PLT32W8304P	32	GX24q-3	2400	13000	82	3000	50	50	\$38.50
PLT32W8404P	32	GX24q-3	2400	13000	82	4000	50	50	\$38.50
PLT42W8304P	42	GX24q-3	3200	13000	82	3000	50	50	\$38.50
PLT42W8404P	42	GX24q-3	3200	13000	82	4000	1	50	\$38.50

MASTER PL-T TOP 4-PIN

PL-T TOP (Temperature Optimised Performance) energy saving compact fluorescent lamp. Compact long-arc low-pressure mercury discharge lamp envelope consists of 6 parallel narrow fluorescent tubes. Amalgam controlled operation.

- Benefits:**
- Optimal lighting performance for long periods of continuous operation
 - High temperature independency at higher application temperatures due to Amalgam technology
 - Long life and sustainable light output

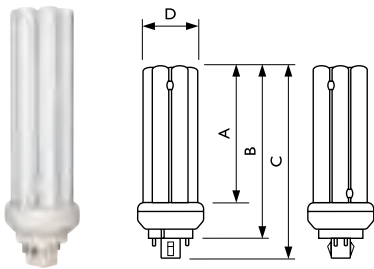

Product ID	A max.	B max.	C max.	D max.
18W	71.7	96.0	111.7	41.0
26W	86.7	111.0	126.7	41.0
32W	98.7	123.0	138.7	41.0
42W	120.7	145.0	160.7	41.0
57W	157.7	182.0	197.7	41.0

Dimensions in mm

PL-T TOP 4-PIN

Shortcode	Wattage (W)	Cap Base	Luminous Flux Lamp (lm)	Average Lifetime (hrs)	Colour Rendering Index (Ra)	Colour Temp (K)	Min Order Quantity	Carton Qty	Trade Price
PLTT18W8404P	18	Gx24q-2	1200	13000	82	4000	1	50	\$53.50
PLTT26W8304P	26	Gx24q-3	1800	13000	82	3000	50	50	\$53.50
PLTT26W8404P	26	Gx24q-3	1800	13000	82	4000	1	50	\$53.50
PLTT32W8304P	32	Gx24q-3	2400	13000	82	3000	1	50	\$53.50
PLTT32W8404P	32	Gx24q-3	2400	13000	82	4000	1	50	\$53.50
PLTT42W8304P	42	Gx24q-4	3200	13000	82	3000	1	50	\$53.50
PLTT42W8404P	42	Gx24q-4	3200	13000	82	4000	1	50	\$53.50
PLTT57W8404P	57	Gx24q-5	4300	13000	82	4000	1	50	\$53.50

PL-Q 2-PIN & 4-PIN Quadrant

PL-Q lamps are compact fluorescent lamps consisting of three double-bent parallel fluorescent tubes.

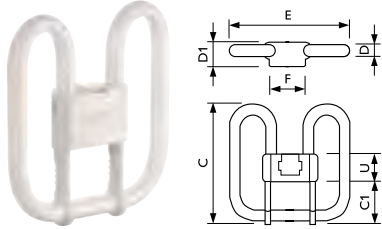

Product ID	C max.	C1 max.	D max.	D1 max.	E max.	F max.	U max.
16W	141	51	15	27.5	138	41	40
28W	207	77	24	33	205	41	49
38W	207	77	24	33	205	41	49

Dimensions in mm

MASTER PL-Q 2 PIN & 4 PIN

Shortcode	Wattage (W)	Cap Base	Luminous Flux Lamp (lm)	Average Lifetime (hrs)	Colour Rendering Index (Ra)	Colour Temp (K)	Min Order Quantity	Carton Qty	Trade Price
PLQ16W8272P	16	GR8	1050	10000	82	2700	1	10	\$25.76
PLQ16W8352P	16	GR8	1050	10000	82	3500	1	10	\$25.76
PLQ28W8274P	28	GR10Q	2050	13000	82	2700	1	10	\$31.82
PLQ28W8354P	28	GR10Q	2050	13000	82	3500	1	10	\$31.82
PLQ38W8354P	38	GR10Q	2850	13000	82	3500	1	10	\$36.36



Tornado

An energy saving twist-shape compact fluorescent lamp with optimal light distribution.

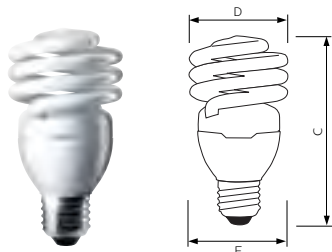

Product ID	Overall Length C max.	Diameter D max.	Width F max.
5W	80	47	40.5
8W	87	47	40.5
12W	94	47	40.5
15W	109	58	52.5
20W	114	62	52.4
24W	126	62	52.5

Dimensions in mm

Tornado Warm White 2700K

Shortcode	Wattage (W)	Cap Base	Voltage	Bulb Shape	Luminous Flux Lamp (lm)	Average Lifetime (hrs)	Colour Temp (K)	Unit	Carton Qty	Trade Price
TND5WWWBCSM	5	B22	220-250V	Spiral	300	8000	2700	PCE	6	\$9.87
TND5WWWSESSM	5	E14	220-250V	Spiral	300	8000	2700	PCE	6	\$9.87
TND5WWWESSM	5	E27	220-250V	Spiral	300	8000	2700	PCE	6	\$9.87
TND8WWWBCSM	8	B22	220-250V	Spiral	500	8000	2700	PCE	6	\$9.87
TND8WWWSESSM	8	E14	220-250V	Spiral	500	8000	2700	PCE	6	\$9.87
TND8WWWESSM	8	E27	220-250V	Spiral	500	8000	2700	PCE	6	\$9.87
TND12WWWBCSM	12	B22	220-250V	Spiral	750	8000	2700	PCE	6	\$9.87
TND12WWWESSM	12	E27	220-250V	Spiral	750	8000	2700	PCE	6	\$9.87
TND12WWWSESSM	12	E14	220-250V	Spiral	725	8000	2700	PCE	6	\$9.87
TND15WWWBCT2	15	B22	220-250V	Spiral	950	8000	2700	PCE	6	\$9.87
TND15WWWEST2	15	E27	220-250V	Spiral	950	8000	2700	PCE	6	\$9.87
TND20WWWBCT2	20	B22	220-250V	Spiral	1250	8000	2700	PCE	6	\$9.87
TND20WWWEST2	20	E27	220-250V	Spiral	1250	8000	2700	PCE	6	\$9.87
TND24WWWBCT2	24	B22	220-250V	Spiral	1550	8000	2700	PCE	6	\$9.87
TND24WWWEST2	24	E27	220-250V	Spiral	1550	8000	2700	PCE	6	\$9.87

Tornado continued

Tornado Cool Daylight 6500K

Shortcode	Wattage (W)	Cap Base	Voltage	Bulb Shape	Luminous Flux Lamp (lm)	Average Lifetime (hrs)	Colour Temp (K)	Unit	Carton Qty	Trade Price
TND5WCDLBSCSM	5	B22	220-250V	Spiral	285	8000	6500	PCE	6	\$9.87
TND5WCDLSESSM	5	E14	220-250V	Spiral	285	8000	6500	PCE	6	\$9.87
TND8WCDLBSCSM	8	B22	220-250V	Spiral	475	8000	6500	PCE	6	\$9.87
TND8WCDLESSM	8	E27	220-250V	Spiral	475	8000	6500	PCE	6	\$9.87
TND12WCDLBSCSM	12	B22	220-250V	Spiral	700	8000	6500	PCE	6	\$9.87
TND12WCDLESSM	12	E27	220-250V	Spiral	700	8000	6500	PCE	6	\$9.87
TND12WCDLSESSM	12	E14	220-250V	Spiral	685	8000	6500	PCE	6	\$9.87
TND15WCDLBCT2	15	B22	220-250V	Spiral	900	8000	6500	PCE	6	\$9.87
TND15WCDLEST2	15	E27	220-250V	Spiral	900	8000	6500	PCE	6	\$9.87
TND20WCDLBCT2	20	B22	220-250V	Spiral	1200	8000	6500	PCE	6	\$9.87
TND20WCDLEST2	20	E27	220-250V	Spiral	1200	8000	6500	PCE	6	\$9.87
TND24WCDLBCT2	24	B22	220-250V	Spiral	1450	8000	6500	PCE	6	\$9.87
TND24WCDLEST2	24	E27	220-250V	Spiral	1450	8000	6500	PCE	6	\$9.87

Genie

An energy saving stick-shape compact fluorescent lamp of a small size. Sold in twinpack.

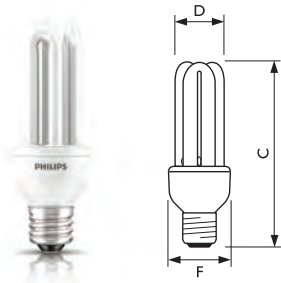

Product ID	Overall Length C max.	Diameter D max.	Width F max.
14W	132	35	44.4
18W	135	41	48.4

Dimensions in mm

Genie Twinpack

Shortcode	Wattage (W)	Cap Base	Voltage	Bulb Shape	Luminous Flux Lamp (lm)	Average Lifetime (hrs)	Colour Temp (K)	Unit	Carton Qty	Trade Price
GENIE14WWWBCPK2	14	B22	230-240V	Stick	840	8000	2700	SET	6	\$13.00
GENIE14WWWESPK2	14	E27	230-240V	Stick	840	8000	2700	SET	6	\$13.00
GENIE18WWWBCPK2	18	B22	230-240V	Stick	1100	8000	2700	SET	6	\$13.00
GENIE18WWWESPK2	18	E27	230-240V	Stick	1100	8000	2700	SET	6	\$13.00
GENIE14WCDLESKP2	14	E27	230-240V	Stick	790	8000	6500	SET	6	\$13.00
GENIE14WCDLBCPK2	14	B22	230-240V	Stick	790	8000	6500	SET	6	\$13.00
GENIE18WCDLESKP2	18	E27	230-240V	Stick	1040	8000	6500	SET	6	\$13.00
GENIE18WCDLBCPK2	18	B22	230-240V	Stick	1040	8000	6500	SET	6	\$13.00

Ambiance PAR38

Due to its shape, PAR38 is ideal to replace current incandescent PAR38 applications. Suited for use in shops, office, homes and outdoors*.

* For outdoor application, we suggest using this product with light fittings greater than IP54.

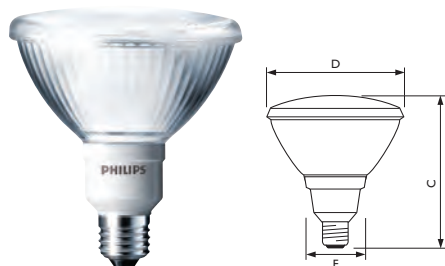

Product ID	Overall Length C max.	Diameter D max.	Width F max.
23W	140.2	122	43.5

Dimensions in mm

Ambiance PAR38

Shortcode	Wattage (W)	Cap Base	Voltage	Bulb Shape	Luminous Flux Lamp (lm)	Average Lifetime (hrs)	Colour Temp (K)	Unit	Carton Qty	Trade Price
PAR23WWWES	23	E27	230-240V	PAR38	1180	6000	2700	PCE	6	\$22.75
PAR23WCDLES	23	E27	230-240V	PAR38	1200	6000	6500	PCE	6	\$22.75

Ecotone High Lumen Twister

The Ecotone High Lumen lamps offer energy saving solutions in high lumen applications. Features an Air Pump system that blocks heat from the burner and provides forced cooling by pushing hot air out of the system. A recommended choice for direct replacement of ML blended mercury lamps.



Product ID	Overall Length C max.	Diameter D max.	Width F max.
45W	207	98	80.3
65W	223	98	80.3

Dimensions in mm

Genie

Shortcode	Wattage (W)	Replaces	Cap Base	Voltage	Luminous Flux Lamp (lm)	Average Lifetime (hrs)	Colour Temp (K)	Carton Qty	Trade Price
EHLT45W840BC	45	100W ML	B22	220-240	3000	10000	4000	6	\$26.04
EHLT45W840ES	45	100W ML	E27	220-240	3000	10000	4000	6	\$26.04
EHLT65W840BC	65	160W ML	B22	220-240	4200	10000	4000	6	\$34.74
EHLT65W840ES	65	160W ML	E27	220-240	4200	10000	4000	6	\$34.74



The Basics of LED Technology





LED

An LED (light emitting diode) is a semi-conductor device or chip that produces light when an electrical current is applied.

What to remember:

LEDs are just one of many components – optics, housing, power sources, to name a few – used to create an LED fixture or lamp. When looking at claims about lifetime, efficiency and design, it is important to compare the specifications of the entire LED system as a whole not just the specifications of the individual system components.

Efficiency and efficacy

The “efficacy” of a lighting fixture is usually expressed as the amount of light (in lumens) produced by a certain amount of electricity (in watts). Lighting fixture “efficiency” is the ratio of the total lumens exiting the fixture to the total lumens produced by the light source. Efficiency is also used to discuss the broader concept of using resources efficiently.

What to remember:

It is important to note that the efficacy of the LEDs themselves is always greater than the efficacy of the LED fixture. This is caused by many factors including losses as light bounces off reflectors and passes through lenses. Make sure when specifying a light fixture that you are looking at the appropriate fixture data versus the LED source data.

Lifetime

For traditional lighting sources lifetime is reported as “mean time to failure,” which means the average time it takes for some percentage of lamps (usually 50%) to fail completely. With an LED source, light output diminishes over time. Therefore for LED sources, lifetime typically refers to the useful life of the light output, which is referred to as lumen maintenance.

What to remember:

The lifetimes of LED sources and traditional light sources are defined differently. For white LEDs, lifetime is referred to as the time after which 70% of the original light output remains, not when the source has completely burnt out.

Low voltage versus line voltage

As opposed to the simplicity of direct line voltage feed, historically all LED fixtures required an external, low voltage power supply or transformer resulting in a more complex installation process than that of traditional fixtures. However, today direct line voltage LED fixtures are available.

What to remember:

Some LED fixtures can accept direct line voltage. Philips has developed Powercore® technology specifically to increase efficiency, lower the overall cost, and ease installation of LED lighting systems by integrating power management directly into the fixture. Fixtures with Powercore technology can be plugged directly into a standard wall outlet or wired directly into a standard junction box, eliminating the need for external low-voltage power supplies that can complicate installation.

Directionality

LEDs are directional sources. Traditional light sources (e.g. the incandescent bulb) emit light in all directions. In order to collect light and direct it onto the surface you are trying to illuminate, you must use lenses and reflectors, which absorb light and reduce the total output of the fixture.

What to remember:

Because an LED source is already emitting the majority of light in a defined direction, it requires significantly less beam shaping optics, leading to a more efficient light fixture. A traditional source may produce more lumens than an LED source, but it may lose much of its light when passing through the required optics. It is important to consider total illuminance, measured in foot candles or lux, when making comparisons between light fixtures.

Colour Rendering Index (CRI)

Colour Rendering Index (CRI), is a measure of the ability of a light source to render colors, compared to a reference source (incandescent or daylight), on a scale of up to 100, with 100 being identical to the reference source.

What to remember:

The higher the CRI, the better the fixture’s ability to show true colours.

Sustainability

LED lighting is often linked to sustainability in the context of energy. But sustainability is a much larger concept, with energy efficiency being just one component. Sustainability takes into account environmental responsibility, including waste reduction, recyclability, materials and resources, and building and design practices themselves.

What to remember:

LED lighting supports sustainable design in several ways: it can reduce energy consumption, it requires infrequent replacement (leading to less waste), and it contains no hazardous mercury. Some LED fixtures are designed to be disassembled more easily for recycling.



LED Lamps

Application Guide

Please read the following installation instructions very carefully when installing your Philips LED lamp.

- Always switch off power supply before commencing work.
- Operating temperature range of the lamp should be between -20°C and 45°C ambient. Over-heating can affect lamp performance.
- Only use in indoor applications and in open fixtures providing 10mm free air space.
- Ensure the fixture has the appropriate lamp-holder.
- Do not use or install the lamp in highly dusty or smoky environments. It is recommended that you install the lamp only after construction is completed.
- Input voltage should be +/-10% the amount stipulated in the specifications.
- Philips Dimmable LED lamps are only dimmable with compatible mix of transformers and dimmers, actual dimming performance depends on dimmer type (refer to the recommended dimmer & transformer list). Please note the different combinations based on the type of lamp and number of lamps.
- For LV MR16 range the wiring length between lamp and transformer should be less than 1.5 metres.
- Not intended to use with emergency light fixtures or exit lights or DC transformers.
- Customer may notice a one second flicker during startup. This is normal and will not affect lamp performance and lifetime.
- Relative humidity in the installation should not exceed 80% Relative Humidity. Do not install in bathrooms and wet areas. These lamps have no tolerance to water.
- Do not install the lamp close to medical equipment.
- Electrical installation in which the product operates must not be subjected to voltage fluctuations. The mains supply should have surge or over voltage protection equipment.
- It is also recommended that all lamps on one transformer share the same Philips brand.
- Approximate lifetimes are based on usage not exceeding 4,000 hrs/year.

For detailed information, please visit www.philips.com/masterledlamps





MASTER LEDspot Mains Voltage GU10

The perfect replacement for mains voltage halogen spots. Delivering a warm, halogen-like accent beam, MASTER LEDspot MV is a perfect fit for spot lighting. MASTER LEDspot MV delivers huge energy savings and minimizes maintenance cost without any compromise on brightness.



Product ID	Overall Length C max.	Diameter D max.
5.5W	55.0	50.0
5.3W	55.0	50.0

Dimensions in mm

LEDspot Mains Voltage GU10

Shortcode	Wattage (W)	Cap Base	Voltage	Luminous Intensity (cd)	Luminous Flux (lm)	Average Lifetime (hrs)	Colour Temp (K)	Beam Angle °	Min Order Quantity	Carton Qty	Trade Price
MAS5.5WGU1082725D	5.5	GU10	220-240	1100	370	40000	2700	25	10	10	\$41.17
MAS5.5WGU1082740D	5.5	GU10	220-240	800	370	40000	2700	40	1	10	\$41.17
MAS5.5WGU1083025D	5.5	GU10	220-240	1200	400	40000	3000	25	1	10	\$41.17
MAS5.5WGU1083040D	5.5	GU10	220-240	850	400	40000	3000	40	1	10	\$41.17
MAS5.5WGU1084025D	5.5	GU10	220-240	1200	415	40000	4000	25	1	10	\$41.17
MAS5.5WGU1084040D	5.5	GU10	220-240	850	415	40000	4000	40	1	10	\$41.17
LEDGU1083036D	5.3	GU10	220-240	950	385	25000	3000	36	1	10	\$19.17

Dimming compatibility for Master LED GU10 5.5W

5.5W GU10

Brand	Model	Type	Load	Lamps
Clipsal	32E450LM	Leading	450W	1-2
Clipsal	KB31RD400	Trailing	400W	1-3
KIWI	K400U	Universal	400W	1-7

5.3W GU10

Brand	Model	Type	Load	Lamps
Clipsal	32E2CFLDM	Leading	300W	1-8
Clipsal	32E450LM	Leading	450W	1-8
Clipsal	32E450TM	Trailing	450W	1-8
Clipsal	32E450UDM	Universal	450W	1-8
HPM	400T	Trailing	400W	1-8
HPM	400L	Leading	400W	1-8
PDL	654MWh	Trailing	450W	1-8
PDL	624TMWH	Trailing	450W	6-8



MASTER LEDspot Low Voltage MR16 – Non-dimmable

Delivering a warm, halogen/incandescent-like accent beam, MASTER LEDspot MR16 non-dimmable lamp is an ideal retrofit solution for spot and general lighting applications where dimming is not required. It is particularly suited to public areas such as receptions, lobbies, corridors, stairwells and washrooms in the hospitality industry. These lamps provide an alternative to traditional GU5.3 halogen reflector lamps.



Product ID	Overall Length	
	C max.	Diameter D max.
4W	47.8	50
5.5W	47.8	50

Dimensions in mm

*image guide only.

LEDspot Low Voltage MR16 – Non-dimmable

Shortcode	Wattage (W)	Cap Base	Voltage (V)	Luminous Intensity (cd)	Luminous Flux (lm)	Average Lifetime (hrs)	Colour Temp (K)	Beam Angle °	Min Order Quantity	Carton Qty	Trade Price
MAS4WMR16WW24D	4	GU5.3	12	1100	210	25000	2700	24	1	10	\$25.00
MAS4WMR16WH24D	4	GU5.3	12	1150	220	25000	3000	24	1	10	\$25.00
5.5WMR16WW36D	5.5	GU5.3	12	800	415	25000	2700	36	1	10	\$35.00
5.5WMR16WH36D	5.5	GU5.3	12	820	425	25000	3000	36	1	10	\$35.00



MASTER LEDspot Low Voltage MR16 – Dimmable

Philips 12V MASTER LED Dimmable MR16 is the latest in Philips' series of low voltage (12VAC) Halogen spot replacements. Not only does it employ Philips patented solution offering compatibility with a variety of standard 12V Halogen electronic transformers and wall dimmers, it also delivers good beam intensity. The Philips MASTER LED 7W 12V Dimmable MR16 fits into most halogen lamp fittings.

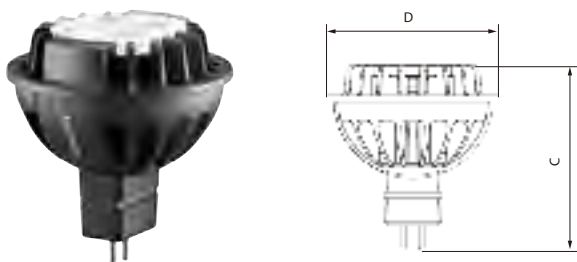

Product ID	Overall Length	Diameter
	C max.	D max.
7W MASTER LED Dimmable MR16	54.5	50.5
7.2W MASTER LED Dimmable MR16	54.5	50.5

Dimensions in mm

LEDspot Low Voltage MR16 – dimmable*

Shortcode	Wattage (W)	Cap Base	Voltage	Luminous Intensity (cd)	Luminous Flux (lm)	Average Lifetime (hrs)	Colour Temp (K)	Beam Angle °	Min Order Quantity	Carton Qty	Trade Price
AF7WMR16WW15D	7	GU5.3	12	2900	380	40000	2700	15	10	10	\$45.00
AF7WMR16WH15D	7	GU5.3	12	3150	420	40000	3000	15	10	10	\$45.00
AF7WMR16CW15D	7	GU5.3	12	3250	440	40000	4000	15	10	10	\$45.00
AF7WMR16WW24D	7	GU5.3	12	2100	420	40000	2700	24	1	10	\$45.00
AF7WMR16WH24D	7	GU5.3	12	2200	440	40000	3000	24	1	10	\$45.00
AF7WMR16CW24D	7	GU5.3	12	2350	470	40000	4000	24	1	10	\$45.00
AF7WMR16WW36D	7	GU5.3	12	1200	420	40000	2700	36	1	10	\$45.00
AF7WMR16WH36D	7	GU5.3	12	1250	440	40000	3000	36	1	10	\$45.00
AF7WMR16CW36D	7	GU5.3	12	1300	470	40000	4000	36	1	10	\$45.00
AF7WMR16WW60D	7	GU5.3	12	460	420	40000	2700	60	1	10	\$45.00
AF7WMR16WH60D	7	GU5.3	12	480	440	40000	3000	60	1	10	\$45.00
AF7WMR16CW60D	7	GU5.3	12	510	470	40000	4000	60	1	10	\$45.00
7.2WMR16WH24D	7.2	GU5.3	12	1300	510	40000	3000	24	10	10	\$50.00
7.2WMR16WH36D	7.2	GU5.3	12	1350	510	40000	3000	36	1	10	\$50.00
7.2WMR16WH60D	7.2	GU5.3	12	1350	510	40000	3000	60	1	10	\$50.00

*Refer to Dimming Compatibility table.



Dimming Compatibility

7 W MR16 7.2 W MR16										
Brand	Model	Type	Load	Lamps	philips et-s60	osram htm70	osram redback 60va	tridonic speedy	tridonic possum	tridonic viper
Clipsal	32E450UDM	Universal	450W	'1-6						
Clipsal	32E450TM	Trailing	450W	'1-9						
Clipsal	32E2CFLDM		300W	'1-6						
HPM	Cat 400L	Leading	300W	'1-8						
HPM	Cat 400T	Trailing	400W	'1-8						
HPM	Cat 400P		400W	'1-8						
PDL	624TMWH	Trailing	450W	'1-9						
KIWI	K004U	Universal	400W	'1-8						
KIWI	K005T	Trailing	500W	'1-10						
Lutron	GXI-3104-T-CE-WH	-								
Dynalite	DDMC802+DDL102	-								
Dynalite	DDMC802+DDTM102	-								
Dynalite	DLE1205	-								



LEDbulb 10-60 W Dimmable

LEDbulb dimmable lamps deliver high quality light and are compatible with existing fixtures with an E27 holder and are designed for retrofit replacement of incandescent bulbs where dimming is required. Delivering energy savings with LED technology and minimising maintenance cost through long life

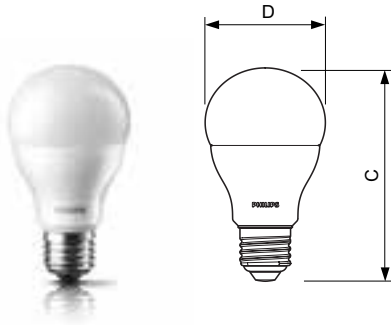

Product ID	Overall Length C max.	Diameter D max.
LEDbulb Dimmable	110	60

Dimensions in mm

LEDbulb 10-60W dimmable*

Shortcode	Wattage (W)	Cap Base	Voltage	Luminous Flux (lm)	Average Lifetime (hrs)	Colour Temp (K)	Min Order Quantity	Carton Qty	Trade Price
LED10WDWWE27	10	E27	220-240	806	15000	2700	1	6	\$26.03

10 W A55

Brand	Model	Type	Load	Lamps
Kiwi	KO05T	Trailing	500W	1-9
Clipsal	32E450UDM	Universal	450W	1-8
Clipsal	32E450TM	Trailing	450W	1-8



LEDbulbs Non Dimmable

LEDbulbs are designed for retrofit replacements of incandescent bulbs, and are compatible with existing fixtures with E27 or B22 holders. Available in warm white or cool daylight.

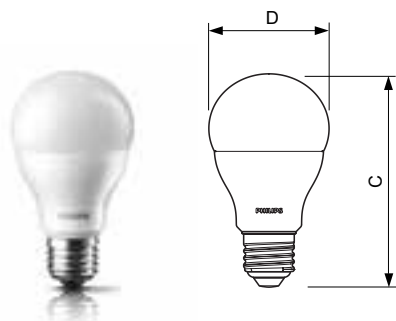

Product ID	Base Cap	C max.	D max.
A55	E27	103.0	56.0
	B22	101.0	56.0
A67	E27	132.0	68.0
	B22	130.0	68.0

Dimensions in mm

LEDbulbs - Non Dimmable

Shortcode	Wattage (W)	Cap Base	Voltage	Luminous Flux (lm)	Average Lifetime (hrs)	Colour Temp (K)	Min Order Quantity	Carton Qty	Trade Price
LED4WWWES	4	E27	220-240	350	15000	3000	1	12	\$8.65
LED4WWWBC	4	B22	220-240	350	15000	3000	1	12	\$8.65
LED4CDLESG3	4	E27	220-240	350	15000	6500	1	12	\$8.65
LED7.5WWWESG3	7.5	E27	220-240	600	15000	3000	1	12	\$10.39
LED7.5WWWBCG3	7.5	B22	220-240	600	15000	3000	1	12	\$10.39
LED7WCDLESG3	7	E27	220-240	600	15000	6500	1	12	\$10.39
LED7WCDLBCG3	7	B22	220-240	600	15000	6500	1	12	\$10.39
LED9.5WWWESG3	9.5	E27	220-240	806	15000	3000	1	12	\$12.13
LED9.5WWWBCG3	9.5	B22	220-240	806	15000	3000	1	12	\$12.13
LED9WCDLESG3	9	E27	220-240	806	15000	6500	1	12	\$12.13
LED9WCDLBCG3	9	B22	220-240	806	15000	6500	1	12	\$12.13
LED10.5WWWES	10.5	E27	220-240	1055	15000	3000	1	12	\$14.74
LED10.5WWWBC	10.5	B22	220-240	1055	15000	3000	1	12	\$14.74
LED10.5WCDLES	10.5	E27	220-240	1055	15000	6500	1	12	\$14.74
LED10.5WCDLBC	10.5	B22	220-240	1055	15000	6500	1	12	\$14.74

LEDbulbs - Non Dimmable A67

LED14WWWESG3	14	E27	220-240	1400	15000	3000	1	6	\$17.35
LED14WWWBCG3	14	B22	220-240	1400	15000	3000	1	6	\$17.35
LED14WCDLESG3	14	E27	220-240	1400	15000	6500	1	6	\$17.35
LED14WCDLBC	14	B22	220-240	1400	15000	6500	1	6	\$17.35



MASTER LEDbulb A60

The new MASTER LED A60 10W bulb delivers a dimmable glow effect similar to a 60W incandescent bulb for a welcoming, warm atmosphere, making it ideal for general lighting applications. Its innovative design radiates warm light in all directions, making it a good alternative to the incandescent lamp.



* Image guide only.

Product ID	C max.	D max.
10W	122.6	66.0

Dimensions in mm

LEDbulb A60

Shortcode	Wattage (W)	Cap Base	Voltage	Lumen Output (lm)	Average Lifetime (hrs)	Colour Temp (K)	Min Order Quantity	Carton Qty	Trade Price
MAS10WDE27A67WW	10	E27	220-240	806	25000	2700	6	6	\$53.33
MAS10WDB22A67WW	10	B22	220-240	806	25000	2700	6	6	\$53.33

Dimming compatibility for Master LED A60 10W

Brand	Type #	Load	Operation Condition	Max no. of lamps
Clipsal	31E800T	Trailing	800W	1-8
Clipsal	32E2CFLDM	Trailing	300W	1-5
Clipsal	32E450LM	Leading	450W	1-8
Clipsal	32E450TM	Trailing	450W	1-8
Clipsal	32E450UDM	Universal	450W	1-8
Clipsal	E3031HD	Universal	40-60W	1
KIWI	K400U	Universal	400W	1-7
KIWI	K005T	Trailing	500W	1-8
PDL	654MWH	Trailing	20-450W	1-8
PDL	624TMWH	Universal	20-450W	1-8



MASTER LEDbulb A67

MASTER LEDbulbs deliver a dimmable glow effect for a welcoming, warm atmosphere, making it ideal for general lighting applications. Its unique design radiates warm light in all directions, making it a true alternative to the incandescent lamp even up to the equivalent of a 100W incandescent lamp. They are particularly suitable for public areas such as lobbies, corridors, stairwells, where the light is always on. Compatible with existing fixtures with an E27 or B22 holder and designed for retrofit replacement of incandescent bulbs, MASTER LEDbulb delivers energy savings and minimizes maintenance cost without any compromise on light quality.

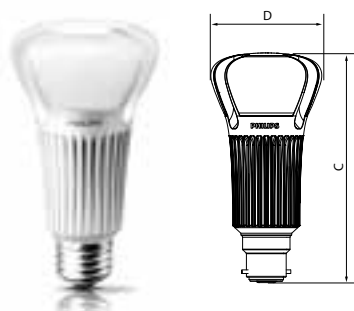

Product ID	Overall Length C max.	Overall Length D max.
18W	127	61

Dimensions in mm

* Image guide only.

LEDbulb A67

Shortcode	Wattage (W)	Cap Base	Voltage	Lumen Output (lm)	Average Lifetime (hrs)	Colour Temp (K)	Min Order Quantity	Carton Qty	Trade Price
MAS18WDB22WW	18	B22	220-240	1521	25000	2700	6	6	\$75.00
MAS18WDE27WW	18	E27	220-240	1521	25000	2700	6	6	\$75.00

18 W A67

Brand	Model	Type	Load	Lamps
KIWI	K005T	Trailing	500W	1-6
KIWI	K005T	Universal	500W	1-6



MASTER LEDlustre Lamp

Delivering incandescent-like sparkling light effects, MASTER LEDlustre bulbs are ideal for general and decorative lighting in the hospitality industry, as well as in home environments. The dimmable MASTER LEDlustres drive further efficiencies, while helping to create the desired atmosphere. Mounted in full view in chandeliers, wall scones or modern luminaires. Drawing upon inputs from chandelier makers and designed to enhance the aesthetic appeal of the chandelier or luminaire, not only when lit but also when not, these lamps come in a classical shape with a unique, eye-catching lens design. They produce a beautiful sparkling warm light that delivers huge energy savings and minimises maintenance cost.

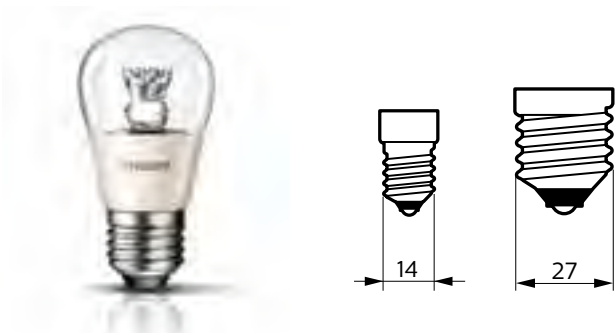

Product ID	C max.	D max.
E14	95	48
E27	91	48

Dimensions in mm

LEDlustre Lamp

Shortcode	Wattage (W)	Cap Base	Voltage	Lumen Output (lm)	Average Lifetime (hrs)	Colour Temp (K)	Min Order Quantity	Carton Qty	Trade Price
LUS6WE14WWCL	6	E14	220-240	470	25000	2700	10	10	\$41.17
LUS6WE27WWCL	6	E27	220-240	470	25000	2700	10	10	\$41.17





MASTER LED Decorative Candle Dimmable

Delivering sparkling light effects, MASTER LED candle bulbs are ideal for general and decorative lighting in the hospitality industry, as well as in home environments. Mounted in full view in chandeliers, wall sconces or modern luminaires, the clear bulb fits existing fixtures with an E14 and B22 sockets and are dimmable.



Product ID	C max.	D max.
6W E14	113.0	39.0
6W B22	107.0	39.0

Dimensions in mm

LED Decorative Candle - Dimmable

Shortcode	Wattage (W)	Cap Base	Voltage	Luminous Flux (lm)	Average Lifetime (hrs)	Colour Temp (K)	Min Order Quantity	Carton Qty	Trade Price
CND6WE14WWCL	6	E14	220-240	250	25000	2700	1	10	\$41.17
CND6WB22WWCL	6	B22	220-240	470	25000	2700	1	10	\$41.17

LED Decorative Candle - Non Dimmable

The LEDcandle is designed for retrofit replacement of incandescent lamps. It is compatible with fixtures with an E14 holder and is an attractive product for chandeliers with lens provide sparkle and realism not usually found in LED Candles. LED lamps deliver energy savings and minimize maintenance cost from the long lamp life.



Product ID	C max.	D max.
3W	113	39

Dimensions in mm

LED Decorative Candle - Non Dimmable

Shortcode	Wattage (W)	Cap Base	Voltage	Luminous Flux (lm)	Average Lifetime (hrs)	Colour Temp (K)	Min Order Quantity	Carton Qty	Trade Price
LED25WB39E14WW	3	E14	220-240	250	15,000	2,700	1	4	\$13.00



MASTER LEDspot PAR

With its robust design and warm-white beam of light, PAR lamps are ideal for general lighting and spot lighting in the hospitality industry. They are especially suitable for public areas such as lobbies, corridors, and stairwells. Compatible with existing fixtures with an E27 holder and designed for retrofit replacement of halogen lamps.



*Image guide only.

Product ID	Overall Length Diameter	
	C max.	D max.
9.5W	94.1	92

Dimensions in mm

LEDspot PAR

Shortcode	Wattage (W)	Cap Base	Voltage	Lumen Output (lm)	Average Lifetime (hrs)	Colour Temp (K)	Beam Angle °	Min Order Qty	Carton Qty	Dimmable	Trade Price
MAS9.5WPAR30DIM	9.5	E27	220-240V	650	40000	2700	25	6	6	Yes	\$63.33

14.5 W PAR38

Brand	Model	Type	Load	Lamps
Clipsal	31E800T	Trailing	800W	1-8
Clipsal	32E2CFLDM	Trailing	300W	1-4
Clipsal	32E450LM	Leading	450W	1-5
Clipsal	32E450TM	Trailing	450W	1-5
Clipsal	32E450UDM	Universal	450W	1-5
KIWI	K400U	Universal	400W	1-4
KIWI	KO05T	Trailing	500W	1-5
PDL	654MWH	Trailing	20-450W	1-5
PDL	624TMWH	Universal	20-450W	1-5



MASTER LEDspot AR111 Dimmable

Delivering a warm, halogen-like accent beam, MASTER LEDspot LV AR111 is an ideal retrofit solution for spot and general lighting applications in the hospitality and retail industry. It is particularly suitable for general lighting and creative accent lighting applications in shops, restaurants, hotels, and museums. Direct retrofit to existing halogen transformers.

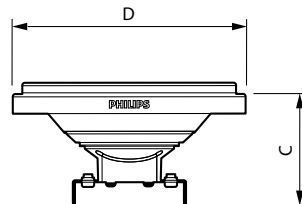

Product ID	Overall Length C max.	Diameter D max.
15W	56	111

Dimensions in mm

MASTER LEDspot AR111 - Non Dimmable

Shortcode	Wattage (W)	Cap Base	Voltage (V)	Luminous Intensity (cd)	Lumen Output (lm)	Average Lifetime (hrs)	Colour Temp (K)	Beam Angle °	Min Order Qty	Carton Qty	Trade Price
15WDAR11183024D	15	G53	12	4950	840	40000	3000	24	6	6	\$96.67
15WDAR11183040D	15	G53	12	1700	800	40000	3000	40	1	6	\$96.67

7 W MR16 7.2 W MR16

Brand	Model	Type	Load	Lamps	philips et-s60	osram htm70	osram redback 60va	tridonic speedy	tridonic possum	tridonic viper
Clipsal	32E450UDM	Universal	450W	'1-6						
Clipsal	32E450TM	Trailing	450W	'1-6						
Clipsal	32E450LM	Leading	450W	'1-6						
HPM	Cat 400L	Leading	400W	'1-5						
HPM	Cat 400T	Trailing	400W	'1-5						
PDL	624TMWH	Trailing	450W	'1-6						
KIWI	K004U	Universal	400W	'1-5						
KIWI	K005T	Trailing	500W	'1-6						



TLED LED Tubes

The CorePro LEDtube integrates an LED light source into a traditional fluorescent form factor for an affordable LED solution suitable for replacing T8 fluorescent lamps. The product provides a natural lighting effect for use in general lighting applications. Its unique design creates a perfectly uniform visual appearance which cannot be distinguished from traditional fluorescent, as well as instant energy savings – an environmentally friendly solution. Perfect for those that are looking for value for money within limited budget and re-lamping efforts for better light effect and lifetime.

- Features:**
- Only 50% energy consumption compared to fluorescent tubes
 - Lasts two times longer than fluorescent tubes
 - Retrofit replacement of existing T8 lamps on electromagnetic (EM) ballast installations

- Application:**
- Parking lots and covered car parks
 - Warehouses and cold stores
 - Signage

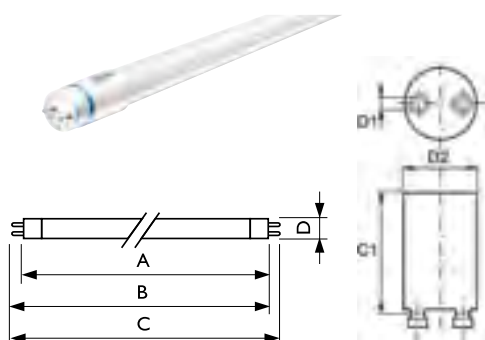

Product ID	A1 max.	A2 max.	A3 max.	D1 max.	D2 max.
600mm	588.5	595.5	602.5	25.7	28
1200mm	1198	1205	1212	25.7	28
1500mm	1500	1507	1514	25.7	28
TLEDSTARTER				40.3	21.5

Dimensions in mm

LEDtube

Shortcode	Wattage (W)	Cap Base	Voltage	Lumen Output (lm)	Average Lifetime (hrs)	Colour Temp (K)	Min Order Quantity	Carton Qty	Trade Price
TLED600840	9	G13	220-240	800	30000	4000	10	10	\$25.00
TLED600865	9	G13	220-240	800	30000	6500	10	10	\$25.00
TLED1200840	18	G13	220-240	1600	30000	4000	10	10	\$33.33
TLED1200865	18	G13	220-240	1600	30000	6500	10	10	\$33.33
TLED1500840	22	G13	220-240	2000	30000	4000	10	10	\$50.00
TLED1500865	22	G13	220-240	2000	30000	6500	10	10	\$50.00
TLEDSTARTER	N/A	N/A	N/A	N/A	N/A	N/A	10	10	\$3.50

MASTER CDM-T Evolution

Single-ended, highest-efficiency, longest-life Ceramic Metal Halide discharge lamp producing crisp white sparkling light with high colour rendering. High-intensity beam of crisp white sparkling light makes merchandise look irresistible. Stable colour and lumen output over life keeps your store attractive season after season. Lowest Total Cost of Ownership as a result of high efficacy (same light, less energy or same energy, more light) and long life. Use only with electronic control gear.

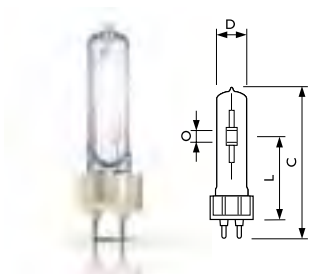

Product ID	C max.	D max.	L max.	O
20W	103.0	20.0	57	3.6
35W	103.0	20.0	57	5.5
50W	103.0	20.0	57	7.2
70W	103.0	20.0	57	9.0

Dimensions in mm

MASTER CDM-T Evolution

Shortcode	Description	Wattage (W)	Cap Base	Voltage	Colour Rendering Index (Ra)	Luminous Flux (lm)	Average Lifetime (hrs)	Colour Temp (K)	Min Order Qty	Carton Qty	Trade Price
CDMTEVO20W930	MASTERC colour CDM-T Evolution 20W/930 G12	20	G12	105	90	2050	20000	3000	12	12	\$176.67
CDMTEVO35W930	MASTERC colour CDM-T Evolution 35W/930 G12	35	G12	102	90	4300	20000	3000	12	12	\$176.67
CDMTEVO50W930	MASTERC CDM-T Evolution 50W/930 OEM G12	50	G12	95	90	5700	20000	3000	12	12	\$176.67
CDMTEVO70W930	MASTERC CDM-T Evolution 70W/930 OEM G12	70	G12	96	90	8800	20000	3000	12	12	\$176.67

MASTER CDM-T

Range of single-ended, compact, high-efficiency, discharge lamps with a stable colour over lifetime and a crisp, sparkling light. Long lamp life compared with incandescent and halogen lamps. Low heat output and UV-block for reduced fading risks. Available in small CDM-T, for use with ballast and ignitor or electronic gear.

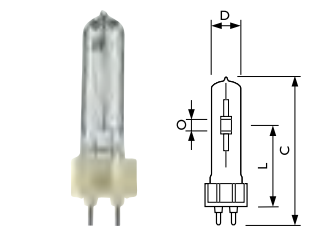

Product ID	C max.	D max.	L max.	O
150W	110	20	57	8
250W	135	25	73	12.3

Dimensions in mm

MASTER CDM-T

Shortcode	Description	Wattage (W)	Cap Base	Voltage	Colour Rendering Index (Ra)	Luminous Flux (lm)	Average Lifetime (hrs)	Colour Temp (K)	Min Order Qty	Carton Qty	Trade Price
CDMT150W942	MASTERC CDM-T 150W/942 G12 ICT/12	150	G12	90	96	12700	12000	4200	12	12	\$154.00
CDMT250W830	MASTERC CDM-T 250W/830 G12 ICT/12	250	G12	95	85	27540	12000	3000	12	12	\$302.50
CDMT250W942	MASTERC CDM-T 250W/942 G12 ICT/12	250	G12	93	91	26000	12000	4200	10	10	\$302.50

MASTER CDM-T Elite

Single-ended, very high-efficiency, long-life Ceramic Metal Halide discharge lamp producing crisp white sparkling light with high colour rendering. High-intensity beam of crisp white sparkling light makes merchandise look irresistible. Stable colour and lumen output over life keeps your store attractive season after season. Lower Total Cost of Ownership as a result of high efficacy (same light, less energy or same energy, more light) and long life.

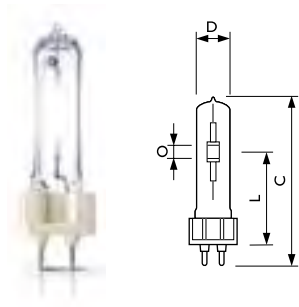

Product ID	C max.	D max.	L max.	O
35W	103	20	57	4.8
50W	103	20	57	7.1
70W	103	20	57	7.15
100W	110	20	57	8.5
150W	135	24	73.5	10

Dimensions in mm

MASTER CDM-T Elite

Shortcode	Description	Wattage (W)	Cap Base	Volatge	Colour Rendering Index (Ra)	Luminous Flux (lm)	Average Lifetime (hrs)	Colour Temp (K)	Min Order Qty	Carton Qty	Trade Price
CDMT35W930	MASTERC CDM-T Elite 35W/930 G12 1CT/12	35	G12	85	90	4000	15000	3000	1	12	\$154.00
CDMT35W942	MASTERC CDM-T Elite 35W/942 G12 1CT	35	G12	84	90	3800	15000	4200	1	12	\$154.00
CDMT50W930	MASTERC CDM-T Elite 50W/930 G12 1CT/12	50	G12	90	90	5400	15000	3000	12	12	\$154.00
CDMT50W942	MASTERC CDM-T Elite 50W/942 G12 1CT	50	G12	91	90	5000	15000	4200	12	12	\$154.00
CDMT70W930	MASTERC CDM-T Elite 70W/930 G12 1CT/12	70	G12	85	90	7800	15000	3000	1	12	\$154.00
CDMT70W942	MASTERC CDM-T Elite 70W/942 G12 1CT/12	70	G12	84	90	7500	15000	4000	1	12	\$154.00
CDMT100W930	MASTERC CDM-T Elite 100W/930 G12 1CT/12	100	G12	88	92	11000	15000	3000	1	12	\$154.00
CDMT100W942	MASTERC CDM-T Elite 100W/942 G12 1CT	100	G12	88	91	10500	15000	4200	1	12	\$154.00
CDMT150W930	MASTERC CDM-T Elite 150W/930 G12 1CT/12	150	G12	92	92	15000	15000	3000	1	12	\$154.00

MASTER CDM-TC Evolution

Single-ended, highest-efficiency, longest-life Ceramic Metal Halide discharge lamp producing crisp white sparkling light with high colour rendering. High-intensity beam of crisp white sparkling light makes merchandise look irresistible. Stable colour and lumen output over life keeps your store attractive season after season. Lowest Total Cost of Ownership as a result of high efficacy (same light, less energy or same energy, more light) and long life. Use only with electronic control gear.

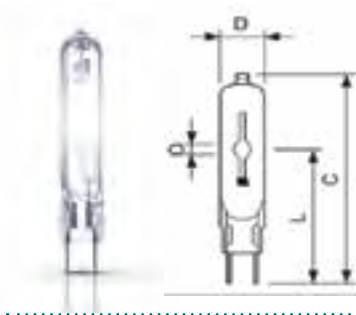

Product ID	C max.	D max.	L max.	O
20W	85.0	15.0	53.0	3.6
35W	85.0	15.0	53.0	5.5
50W	85.0	15.0	53.0	7.2
70W	85.0	15.0	53.0	9.0

Dimensions in mm

MASTER CDM-TC Evolution

Shortcode	Description	Wattage (W)	Cap Base	Voltage	Colour Rendering Index (Ra)	Luminous Flux (lm)	Average Lifetime (hrs)	Colour Temp (K)	Min Order Qty	Carton Qty	Trade Price
CDMTCEVO20W930	MASTERC colour CDM-TC Evolution 20W/930 G8.5	20	G8.5	105	90	2050	20000	3000	12	12	\$176.67
CDMTCEVO35W930	MASTERC colour CDM-TC Evolution 35W/930 G8.5	35	G8.5	102	90	4300	20000	3000	12	12	\$176.67
CDMTCEVO50W930	MASTERC CDM-TC Evolution 50W/930 G8.5	50	G8.5	97	90	5700	20000	3000	12	12	\$176.67
CDMTCEVO70W930	MASTERC CDM-TC Evolution 70W/930 G8.5	70	G8.5	97	90	8800	20000	3000	12	12	\$176.67

MASTER CDM-T/TC Warm

The most efficient and lowest-cost accent lighting is available in highly efficient sparkling warm light. CDM Warm is the only light source that combines very warm light with near-perfect colour rendering and very high efficacy. Warm atmosphere creation with accurate colour reproduction to make your merchandise look very attractive. Ideal for retail display and general lighting (particularly in Supermarkets, bakeries and furniture stores). Use only with electronic control gear.



Product ID	C max.	D max.	L max.	O
CDM-T	103.0	20.0	57	5
CDM-TC	85.0	15.0	53	5

Dimensions in mm

MASTER CDM-T/TC Warm

Shortcode	Description	Wattage (W)	Cap Base	Voltage	Colour Rendering Index (Ra)	Luminous Flux (lm)	Average Lifetime (hrs)	Colour Temp (K)	Min Order Qty	Carton Qty	Trade Price
CDMTWARM70W925	MASTERC colour CDM-T Warm 70W/925 G12	70	G12	95	93	6500	15000	2500	12	12	\$154.00
CDMTCWARM70W925	MASTERC colour CDM-TC Warm 70W/925 G8.5	70	G8.5	95	93	6500	15000	2600	12	12	\$154.00

MASTER CDM-T/TC Fresh

The most efficient and lowest-cost accent lighting is available with special colour enhancement properties. CDM Fresh combines colour enhancement with very high efficacy. Makes fresh food (meat, fish, fruit and vegetables) look incredibly beautiful with full colours. Makes coloured packaging material look vibrant. Saves 30-50% energy compared to normal SDW and can be operated on standard electronic CDM gear.

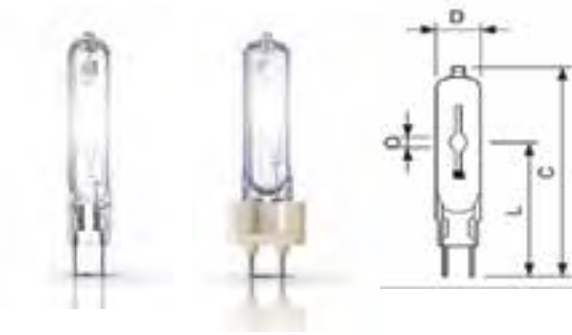

Product ID	C max.	D max.	L max.	O
CDM-T	103.0	20.0	57.0	7.1
CDM-TC	85.0	15.0	53.0	7.1

Dimensions in mm

MASTER CDM-T/TC Fresh

Shortcode	Description	Wattage (W)	Cap Base	Voltage	Colour Rendering Index (Ra)	Luminous Flux (lm)	Average Lifetime (hrs)	Colour Temp (K)	Min Order Qty	Carton Qty	Trade Price
CDMTFRESH70W740	MASTERCcolour CDM-T Fresh 70W/740 G12.1CT	70	G12	83	70	6000	15000	4000	12	12	\$154.00
CDMTCFRESH70W740	MASTERCcolour CDM-TC Fresh 70W/740 G8.5	70	G8.5	83	70	6000	15000	4000	12	12	\$154.00

MASTER CDM-TC Elite

Single-ended, very high-efficiency, long-life Ceramic Metal Halide discharge lamp producing crisp white sparkling light with high colour rendering. High-intensity beam of crisp white sparkling light makes merchandise look irresistible. Stable colour and lumen output over life keeps your store attractive season after season. Lower Total Cost of Ownership as a result of high efficacy (same light, less energy or same energy, more light) and long life.

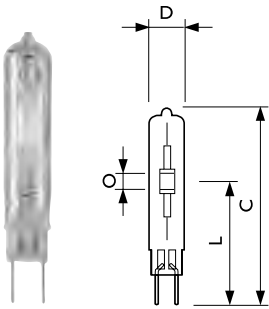

Product ID	C max.	D max.	L max.	O
35W	85	15	53	4.8
50W	85	15	53	7.1
70W	58	15	53	7.1

Dimensions in mm

MASTER CDM-TC Elite

Shortcode	Description	Wattage (W)	Cap Base	Voltage	Colour Rendering Index (Ra)	Luminous Flux (lm)	Average Lifetime (hrs)	Colour Temp (K)	Min Order Qty	Carton Qty	Trade Price
CDMTC35W930	MASTERC CDM-TC Elite 35W/930 G8.5 ICT/12	35	G8.5	85	90	4000	15000	3000	1	12	\$154.00
CDMTC35W942	MASTERC CDM-TC Elite 35W/942 G8.5 ICT	35	G8.5	84	88	3700	15000	4200	1	12	\$154.00
CDMTC50W930	MASTERC CDM-TC Elite 50W/930 G8.5 ICT/12	50	G8.5	93	90	5400	15000	3000	12	12	\$154.00
CDMTC50W942	MASTERC CDM-TC Elite 50W/942 G8.5 ICT	50	G8.5	90	90	5100	15000	4200	12	12	\$154.00
CDMTC70W930	MASTERC CDM-TC Elite 70W/930 G8.5 ICT/12	70	G8.5	85	90	7700	15000	3000	1	12	\$154.00
CDMTC70W942	MASTERC CDM-TC Elite 70W/942 G8.5 ICT	70	G8.5	84	90	7400	15000	4200	1	12	\$154.00

MASTER CDM-TD

CDM-TD range of double-ended, compact, high-efficiency, discharge lamps with a stable colour over lifetime and a crisp, sparkling light. UV-block for reduced health and fading risks. Direct retrofit in place for quartz metal halide lamps providing lower operating costs, reduced heat output, and better light quality.

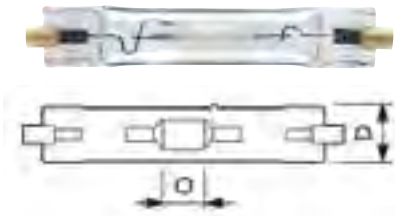

Product ID	C max.	D max.	O
CDMTD70W830	120	22	8
CDMTD70W942	120	22	7
CDMTD150W830	137	25	10
CDMTD150W942	137	25	10

Dimensions in mm

Master CDM-TD

Shortcode	Description	Wattage (W)	Cap Base	Luminous Flux (lm)	Average Lifetime (hrs)	Colour Temp (K)	Min Order Qty	Carton Qty	Trade Price
CDMTD70W830	MASTERC CDM-TD 70W/830 RX7s 1CT/12	70	RX7s	6500	15000	3000	1	12	\$154.00
CDMTD70W942	MASTERC CDM-TD 70W/942 RX7s 1CT/12	70	RX7s	6000	15000	4200	1	12	\$154.00
CDMTD150W830	MASTERC CDM-TD 150W/830 RX7s 1CT/12	150	RX7s	13250	15000	3000	1	12	\$154.00
CDMTD150W942	MASTERC CDM-TD 150W/942 RX7s 1CT/12	150	RX7s	14200	15000	4200	1	12	\$154.00

MASTER CDM-T Elite Medium Wattage

The medium wattage lighting system that gives superior, longer-lasting white light for both indoor and outdoor use. Long reliable lifetime combined with high system efficacy. Outdoor Applications; floodlighting of buildings and other interesting structures. Illumination of roads and pedestrian areas, public spaces, car parks, petrol stations etc. Indoor Applications; larger (high-bay) retail outlets, warehouses, manufacturing facilities etc.

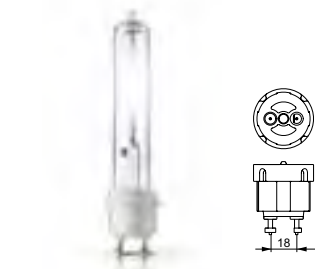

Product ID	C max.	D max.
CDMTMW210W930	188	29
CDMTMW210W942	193	38
CDMTMW315W930	188	29
CDMTMW315W942	193	38

Dimensions in mm

MASTER CDM-T Elite Medium Wattage

Shortcode	Description	Wattage (W)	Cap Base	Voltage	Colour Rendering Index (Ra)	Luminous Flux (lm)	Average Lifetime (hrs)	Colour Temp (K)	Min Order Qty	Carton Qty	Trade Price
CDMTMW210W930	CDM-T Elite 210W/930 PGZ18.1CT/12	210W	PGZ18	100	90	24150	30000	2940	12	12	\$275.00
CDMTMW210W942	CDM T12 ELITE 210W/942/U/O EU	210W	PGZX18.	105	92	22800	30000	3960	12	12	\$275.00
CDMTMW315W930	CDM-T Elite 315W/930 PGZ18.1CT/12	315W	PGZ18	100	90	38700	30000	3090	12	12	\$300.00
CDMTMW315W942	CDM Elite TMW 315/942/U/O EU	315W	PGZX18.	100	90	34300	30000	4140	12	12	\$300.00

MASTER CDM-R Mini

Provides users with a compact, high-efficiency, discharge reflector lamp. Low operating costs, long-lamp life, UV block for reduced fading risk and a stable colour impression all benefit the shop owner. Low heat output and crisp, sparkling light, enhances the experience for shoppers and staff. Requires CDM electronic HID driver.

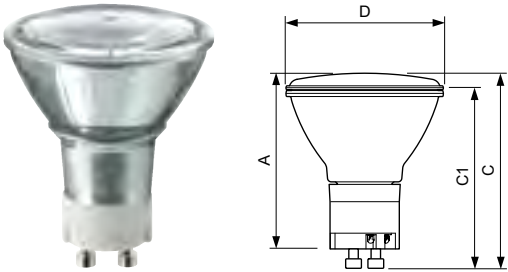

Product ID	A max.	C max.	C1 max.	D max.
20W	59	65.4	60.9	51

Dimensions in mm

MASTER CDM-R Mini

Shortcode	Description	Wattage (W)	Cap Base	Voltage	Colour Rendering Index (Ra)	Luminous Flux (lm)	Average Lifetime (hrs)	Colour Temp (K)	Min Order Qty	Carton Qty	Trade Price
CDMRM20W83025	CDM-Rm Mini 20W/830 GX10 MR16 25D	20	GX10	93	84	4500	15000	3000	12	12	\$164.00
CDMRM20W83040	CDM-Rm Mini 20W/830 GX10 MR16 40D	20	GX10	93	84	2100	15000	3000	12	12	\$164.00

MASTER CDM-R Mini Elite

The easy way to reflect more sparkle. The new Philips MasterColour CDM- R Mini Elite brings trusted quality to 50mm reflector lamps and with the superior output and colour stability to create the right atmosphere to match your customers retail brand and positioning.

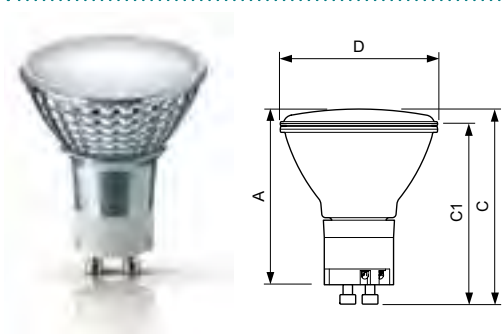

Product ID	A max.	C max.	C1 max.	D max.
35W	59	65.4	60.9	51
50W	59	65.4	60.9	51

Dimensions in mm

MASTER CDM-R Mini Elite

Shortcode	Description	Wattage (W)	Cap Base	Luminous Intensity (cd)	Average Lifetime (hrs)	Colour Temp (K)	Min Order Qty	Carton Qty	Trade Price
CDMRM35W93010	CDM-Rm Elite Mini 35W/930 10D	35	GX10	20000	15000	3000	12	12	\$164.00
CDMRM35W93025	CDM-Rm Elite Mini 35W/930 25D	35	GX10	8500	15000	3000	12	12	\$164.00
CDMRM35W93040	CDM-Rm Elite Mini 35W/930 40D	35	GX10	4400	15000	3000	12	12	\$164.00
CDMRME50W93025	CDM-Rm Elite Mini 50W/930 25D	50	GX10	11500	15000	3000	12	12	\$164.00
CDMRME50W93040	CDM-Rm Elite Mini 50W/930 40D	50	GX10	7000	15000	3000	12	12	\$164.00
CDMRME50W93060	CDM-Rm Elite Mini 50W/930 60D	50	GX10	3000	15000	3000	12	12	\$164.00

MASTER CDM-R PAR 20 Elite

Provides users with a compact, high-efficiency, discharge reflector lamp. Low operating costs, long-lamp life, UV block for reduced fading risk and a stable colour impression all benefit the shop owner. Low heat output and crisp, sparkling light, enhances the experience for shoppers and staff.

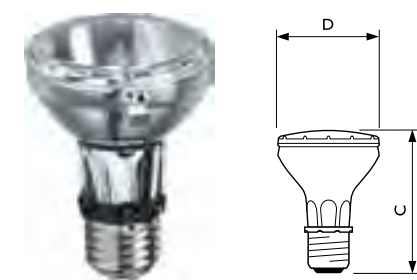

Product ID	Overall Length C max.	Diameter D max.
PAR20	95	65

Dimensions in mm

MASTER CDM-R PAR 20

Shortcode	Description	Wattage (W)	Cap Base	Voltage	Colour Rendering Index (Ra)	Luminous Flux (lm)	Average Lifetime (hrs)	Colour Temp (K)	Min Order Qty	Carton Qty	Trade Price
CDMRE35W9302010	MC CDM-R Elite 35W/930 E27 PAR20 10D	35	E27	88	91	23000	15000	3000	12	12	\$164.00
CDMRE35W9302030	MC CDM-R Elite 35W/930 E27 PAR20 30D	35	E27	88	91	6500	15000	3000	12	12	\$164.00

MASTER CDM-R PAR 30

Compact, high-efficiency, long-life Ceramic Metal Halide discharge reflector lamp producing crisp white sparkling light with good colour rendering that enhances the look of merchandise. Stable colour over lifetime. Easy to install in simple open luminaires, reducing installation and relamping costs.

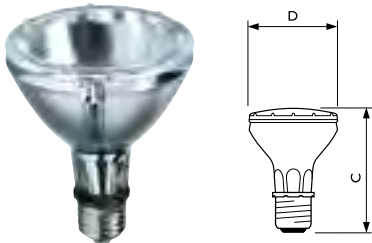

Product ID	Overall Length C max.	Diameter D max.
PAR30L	123	95

Dimensions in mm

MASTER CDM-R PAR 30

Shortcode	Description	Wattage (W)	Cap Base	Luminous Intensity (cd)	Average Lifetime (hrs)	Colour Temp (K)	Min Order Qty	Carton Qty	Trade Price
CDMR70W9423010	CDM-R 70W /942 E27 PAR30L 10D 1CT/6	70	E27	63000	12000	4200	1	12	\$164.00
CDMR70W9423030	CDM-R 70W /942 E27 PAR30L 30D 1CT/6	70	E27	13000	12000	4200	1	12	\$164.00
CDMR70W9423040	CDM-R 70W /942 E27 PAR30L 40D 1CT/6	70	E27	9000	12000	4200	1	12	\$164.00

MASTER CDM-R PAR 30 Elite

Compact, very high-efficiency, long-life Ceramic Metal Halide discharge reflector lamp producing crisp white sparkling light with high colour rendering that makes merchandise look irresistible. Stable colour and lumen output over life keeps your store attractive season after season. Easy to install in simple open luminaires, reducing installation and relamping costs.

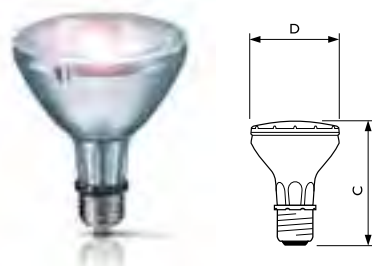

Product ID	Overall Length C max.	Diameter D max.
PAR30L	123	95

Dimensions in mm

MASTER CDM-R PAR 30 Elite

Shortcode	Description	Wattage (W)	Cap Base	Voltage	Colour Rendering Index (Ra)	Luminous Flux (lm)	Average Lifetime (hrs)	Colour Temp (K)	Min Order Qty	Carton Qty	Trade Price
CDMRE35W9303010	MC CDM-R Elite 35W/930 E27 PAR30L 10D	35	E27	92	91	49000	15000	3000	6	6	\$164.00
CDMRE35W9303030	MC CDM-R Elite 35W/930 E27 PAR30L 30D	35	E27	92	91	8000	15000	3000	6	6	\$164.00
CDMRE50W9303010	MC CDM-R Elite 50W/930 E27 PAR30L 10D	50	E27	94	91	56000	15000	3000	6	6	\$164.00
CDMRE50W9303030	MC CDM-R Elite 50W/930 E27 PAR30L 30D	50	E27	94	91	11000	15000	3000	12	12	\$164.00
CDMRE50W9303040	MC CDM-R Elite 50W/930 E27 PAR30L 40D	50	E27	94	91	7200	15000	3000	12	12	\$164.00
CDMRE70W9303010	MC CDM-R Elite 70W/930 E27 PAR30L 10D	70	E27	86	92	61000	15000	3000	6	6	\$164.00
CDMRE70W9303030	MC CDM-R Elite 70W/930 E27 PAR30L 30D	70	E27	86	92	14000	15000	3000	6	6	\$164.00
CDMRE70W9303040	MC CDM-R Elite 70W/930 E27 PAR30L 40D	70	E27	86	92	10300	15000	3000	1	6	\$164.00

CDM-R 111

Offering the benefits of a Mastercolour PAR in the stylish look of a 111mm aluminium reflector lamp.

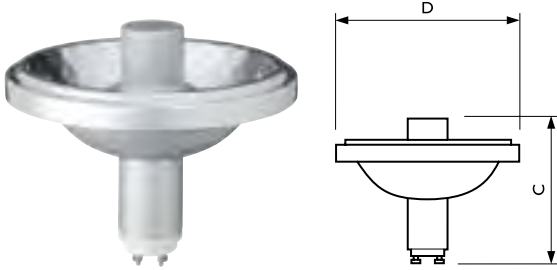

Product ID	Overall Length C max.	Diameter D max.
20W	95	111
35W	95	111
70W	95	111

Dimensions in mm

CDM-R 111

Shortcode	Description	Wattage (W)	Cap Base	Luminous Intensity (cd)	Average Lifetime (hrs)	Colour Temp (K)	Min Order Qty	Carton Qty	Trade Price
CDMR11120W83024	MASTERC CDM-R111 20W/830 24D 1CT/6	20	GX8.5	4500	9000	3000	1	6	\$164.00
CDMR11120W83010	MASTERC CDM-R111 20W/830 10D 1CT/6	20	GX8.5	20000	9000	3000	1	6	\$164.00
CDMR11135W83040	MASTERC CDM-R111 35W/830 40D 1CT/6	35	GX8.5	4000	11000	3000	1	6	\$164.00
CDMR11135W83024	MASTERC CDM-R111 35W/830 24D 1CT/6	35	GX8.5	8500	11000	3000	1	6	\$164.00
CDMR11135W83010	MASTERC CDM-R111 35W/830 10D 1CT/6	35	GX8.5	35000	11000	3000	1	6	\$164.00
CDMR11135W94240	MASTERC CDM-R111 35W /942 GX8.5 40D 1CT/6	35	GX8.5	4000	9000	4200	1	6	\$164.00
CDMR11135W94224	MASTERC CDM-R111 35W /942 GX8.5 24D 1CT/6	35	GX8.5	8500	9000	4200	1	6	\$164.00
CDMR11135W94210	MASTERC CDM-R111 35W /942 GX8.5 10D 1CT/6	35	GX8.5	35000	9000	4200	1	6	\$164.00
CDMR11170W83040	MASTERC CDM-R111 70W/830 40D 1CT/6	70	GX8.5	9000	9000	3000	1	6	\$164.00
CDMR11170W83024	MASTERC CDM-R111 70W/830 24D 1CT/6	70	GX8.5	15000	9000	3000	1	6	\$164.00
CDMR11170W83010	MASTERC CDM-R111 70W/830 10D 1CT/6	70	GX8.5	50000	9000	3000	1	6	\$164.00
CDMR11170W94240	MASTERC CDM-R111 70W /942 GX8.5 40D 1CT/6	70	GX8.5	9000	11000	4200	1	6	\$164.00
CDMR11170W94224	MASTERC CDM-R111 70W /942 GX8.5 24D 1CT/6	70	GX8.5	15000	11000	4200	1	6	\$164.00
CDMR11170W94210	MASTERC CDM-R111 70W /942 GX8.5 10D 1CT/6	70	GX8.5	50000	11000	4200	1	6	\$164.00

CosmoPolis Outdoor

New-generation ceramic metal-halide tubular lamps used in outdoor applications, offering efficient and pleasant white light. Attractive white-light alternative to current standard mercury-vapour, HPS and ceramic solutions. Designed for electronic gear platforms including all control features and dimming options offering flexible light levels and reduced energy consumption. Highly efficient white light; extremely high system efficacy.

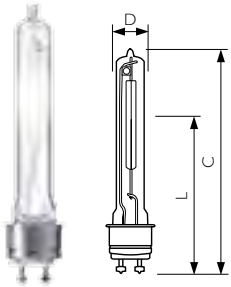

Product ID	Overall Length C max	Diameter D max.	Arc Length O	Light Centre Length L
45W	132	20	15	59
60W	132	20	14	59
90W	143	20	18	66
140W	147	20	20	66

Dimensions in mm

CosmoPolis Outdoor

Shortcode	Description	Wattage (W)	Cap Base	Luminous Intensity (cd)	Average Lifetime (hrs)	Colour Temp (K)	Min Order Qty	Carton Qty	Trade Price
CPOTWHITE45W728	MST CosmoWh CPO-TW Xtra 45W/728 PGZ12	45	PGZ12	4950	32000	2815	12	12	\$180.00
CPOTWHITE60W728	MST CosmoWh CPO-TW Xtra 60W/728 PGZ12	60	PGZ12	7200	32000	2715	1	12	\$180.00
CPOTWHITE90W728	MST CosmoWh CPO-TW Xtra 90W/728 PGZ12	90	PGZ12	10800	32000	2870	1	12	\$180.00
CPOT140W728	MST CosmoWh CPO-TW Xtra 140W/728 PGZ12	140	PGZ12	17600	32000	2900	1	12	\$230.00
CPOTTX60WE27	MST CosmoWhite CPO-TT Xtra 60W/628 E27	60	E27	7090	32000	2800	12	12	\$165.00
CPOTTX90WE40	MST CosmoWhite CPO-TT Xtra 90W/628 E40	90	E40	10000	32000	2800	12	12	\$165.00
CPOTTX140WE40	MST CosmoWhite CPO-TT Xtra 140W/628 E40	140	E40	16800	32000	2800	12	12	\$187.00
CPOTTX210WE40	MST CosmoWhite CPO-TT Xtra 210W/942 E40	210	E40	22000	32000	4200	12	12	\$187.00
CPOTTX315WE40	MST CosmoWhite CPO-TT Xtra 315W/942 E40	315	E40	34750	30000	4200	12	12	\$210.00

CDO-TT & CDO-ET Elliptical

The Mastercolour City range of high intensity discharge lamps feature a CDM Mastercolour discharge tube placed in a high pressure sodium lamp outer bulb. The result is a robust lamp which emits a pleasant light, with stable colour and excellent colour rendering (Ra>80), and which is compatible with a SON ballast and igniters.

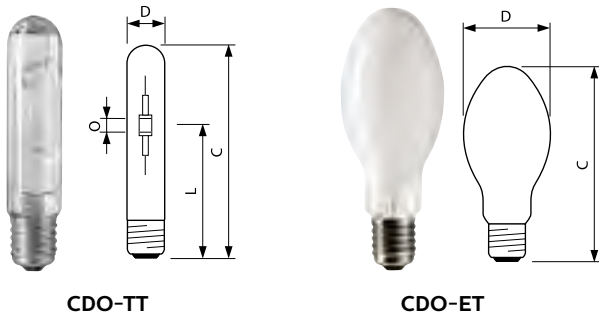

Product ID	C max.	D max.	O max.	L max.
CDM-TT 70W	156	36	102	6
CDM-TT 150W	211	460	133	8
CDO-TT 70W	156	36	102	7.1
CDO-TT 100W	211	47	132	8.5
CDO-TT 150W	211	47	132	10
CDO-TT 250W	255	47	158	12.3
CDO-ET 50W	156	71	N/A	N/A
CDO-ET 70W	156	71	N/A	N/A
CDO-ET 100W	186	76	N/A	N/A
CDO-ET 150W	227	91	N/A	N/A

Dimensions in mm

CDO-TT & CDO-ET Elliptical

Shortcode	Description	Wattage (W)	Cap Base	Luminous Intensity (cd)	Average Lifetime (hrs)	Colour Temp (K)	Min Order Qty	Carton Qty	Trade Price
CDMTT70W942	MASTERC CDM-TT 70W/942 E27 SLV/12	70	E27	6300	18000	4200	12	12	\$145.00
CDMTT150W942	MASTERC CDM-TT 150W/942 E40 1SL/12	150	E40	11200	20000	42000	12	12	\$180.00
CDOTT70W828	MASTER CityWh CDO-TT Plus 70W/828 E27	70	E27	7500	20000	2800	1	12	\$145.00
CDOTT100W828	MASTER CityWhite CDO-TT Plus 100W/828 E40	100	E40	10500	27000	2800	1	12	\$180.00
CDOTT150W828	MASTER CityWh CDO-TT Plus 150W/828 E40	150	E40	16500	27000	2800	1	12	\$145.00
CDOTT250W830	MASTER CityWhite CDO-TT Plus 250W/830 E40	250	E40	28300	23000	3000	12	12	\$160.00
CDOTT250W940	MASTER CityWhite CDO-TT Plus 250W/940 E40 1CT/12	250	E40	26500	18000	4000	1	12	\$160.00
CDOET50W828	MASTER CityWh CDO-ET Plus 50W/828 E27	50	E27	5150	20000	2800	24	24	\$160.00
CDOET70W828	MASTER CityWh CDO-ET Plus 70W/828 E27	70	E27	7230	27000	2900	24	24	\$160.00
CDOET100W828	MASTER CityWh CDO-ET Plus 100W/828 E40	100	E40	9400	27000	2890	12	12	\$160.00
CDOET150W828	MASTER CityWh CDO-ET Plus 150W/828 E40	150	E40	15100	27000	2830	12	12	\$160.00

HPI-T Quartz Metal Halide

Quartz metal halide lamps in tubular shape with clear outer bulb (HPI-T), or ovoid shape with coated outer bulb (HPI). Features unique 3-band technology for high luminous efficacy over a long lifetime. Metal halide gas discharge lamps designed to be suitable in retrofit applications, HPI(T) Plus lamps are compatible with high pressure sodium control gear as well as standard metal halide control gear. This makes it possible to enjoy the benefits of quality colour and exceptional performance without a costly gear upgrade for retrofit sodium systems. HPI(T) Plus offers a high lumen output, good efficacy and excellent colour rendition.

“S”- type for direct retrofit for HPL lamps, due to its internal ignitor

“P”- type is suitable for use in open luminaires

Lamps run on sodium and metal halide control gear

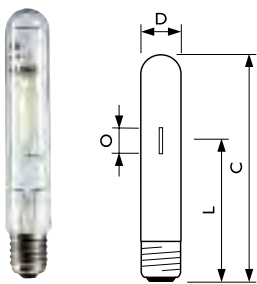

Product ID	Overall Length	Diameter D max.	Light Centre Length L max.	Arc Length
	C max.	D max.	L max.	O max.
250W	257	47	155	29
400W	286	47	168	30
1000W	382	66	240	80
2000W/380V	430	102	267	120
2000W/220V	430	102	290	89

Dimensions in mm

HPI-T Quartz Metal Halide

Shortcode	Wattage (W)	Cap Base	Luminous Flux (lm)	Average Lifetime (hrs)	Colour Temp (K)	Min Order Quantity	Carton Qty	Trade Price
HPIT250WGES	250	E40	20500	20000	4500	1	12	\$140.00
HPIT400WGES	400	E40	32000	20000	4500	1	12	\$140.00
HPIT1000WGES	1000	E40	85000	12000	4300	1	4	\$450.00
HPIT2000220V	2000	E40	189000	12000	4200	1	4	\$660.00
HPIT2000380V	2000	E40	210000	12000	3800	1	4	\$660.00

HPI PLUS Quartz Metal Halide

Energy saving compact fluorescent lamp. Compact long-arc low-pressure mercury discharge lamp envelope consists of 6 parallel narrow fluorescent tubes.

- Features:**
- Ovoid, internally white coated outer bulb.
 - 3-band technology resulting in high luminous efficacy, both initially and over long lifetime.
 - Available in cool white and daylight colour appearance demonstrating good colour stability.
 - “S”- type for direct retrofit for HPL lamps.
 - “P”- type for use without protective front shield.

- Luminaires:**
- HPI Plus BU-P and BUS-P suitable for use in open luminaires.
 - For other HPI Plus lamps a protective front glass is required.

- System:**
- Can be run on HPI-gear as well as on SON-gear (“Plus”-concept). The results in both light output and colour temperature are different.
 - HPI Plus BUS and BUS-P types require an HPL-gear and no ignitor.

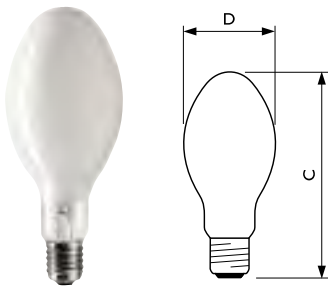

Product ID	Overall Length C max.	Diameter D max.
250W	226	91
400W	290	122

Dimensions in mm

MASTER HPI Plus Quartz Coated Metal Halide Lamp – Ovoid Coated (Base up, Ignitor required)

Shortcode	Description	Wattage (W)	Cap Base	Voltage	Colour Rendering Index (Ra)	Luminous Flux (lm)	Average Lifetime (hrs)	Colour Temp (K)	Min Order Qty	Carton Qty	Trade Price
HPI250WBU	HPI PLUS 250W /745 BU E40 SLV/12	250	E40	128	65	18000	20000	4500	1	12	\$190.00
HPI400WBU	HPI PLUS 400W /745 BU E40 SLV/6	400	E40	125	65	32500	20000	4500	1	6	\$190.00

MASTER HPI Plus Quartz Metal Halide Lamp – Daylight Ovoid Coated (Base up, Ignitor required)

Shortcode	Description	Wattage (W)	Cap Base	Voltage	Colour Rendering Index (Ra)	Luminous Flux (lm)	Average Lifetime (hrs)	Colour Temp (K)	Min Order Qty	Carton Qty	Trade Price
HPI250W667BU	HPI PLUS 250W/667BU E40 1SL/12	250	E40	128	69	18000	20000	6700	12	12	\$190.00
HPI400W667BU	HPI PLUS 400W/667 BU E40 1SL/6	400	E40	125	69	32500	20000	6700	6	6	\$190.00

HPI PLUS Quartz Metal Halide continued

MASTER HPI Plus Ovoid Coated, (Base up, Ignitor required, Protected)

Shortcode	Description	Wattage (W)	Cap Base	Luminous Flux (lm)	Average Lifetime (hrs)	Colour Temp (K)	Min Order Qty	Carton Qty	Trade Price
HP1250WBUP	MASTER HPI Plus 250W/645 BU-P E40 SLV/12	250	E40	18000	20000	4500	12	12	\$230.00
HP1400WBUP	MASTER HPI Plus 400W/645 BU-P E40 SLV/6	400	E40	32500	20000	4500	1	6	\$230.00

MASTER HPI Plus Ovoid Coated (Base up, Self Start, no ignitor required)

Shortcode	Description	Wattage (W)	Cap Base	Luminous Flux (lm)	Average Lifetime (hrs)	Colour Temp (K)	Min Order Qty	Carton Qty	Trade Price
HP1400WBUS	HPI-PLUS 400W BUS645 E40.15LV/6	400	E40	32500	20000	4500	1	6	\$228.00

MASTER HPI Plus Ovoid Coated, (Self Start, no ignitor required, Protected)

Shortcode	Description	Wattage (W)	Cap Base	Luminous Flux (lm)	Average Lifetime (hrs)	Colour Temp (K)	Min Order Qty	Carton Qty	Trade Price
HP1400WBUSP	MASTER HPI Plus 400W/645 BUS-P E40 SLV/6	400	E40	32500	20000	4500	6	6	\$255.00

Metal Halide – Universal Operating Ovoid

Metal halide gas discharge lamps offer good luminous efficacy, good colour rendering and reliable long life. In anovoid style, with coated outer-bulb, and operates at any position.

Low wattage lamps with extra quartz tube around discharge tube prevents risk of outer bulb shattering when abnormally operated or at end of life.

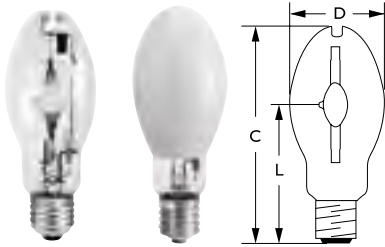

Product ID	C max.	D max.	L max.
70W/100W/150W	141	56	83

Dimensions in mm

Metal Halide – Universal Operating Ovoid

Shortcode	Description	Type	Wattage (W)	Cap Base	Luminous Flux (lm)	Average Lifetime (hrs)	Colour Temp (K)	Min Order Qty	Carton Qty	Trade Price
MH70CO	MH 70W/640 P E27 CO SLV/24	Coated	70	E27	5300	10000	4000	24	24	\$90.00
MH70	MH 70W/640 P E27 CL SLV/24	Clear	70	E27	5600	10000	4000	1	24	\$90.00
MH100	MH 100W/640 P E27 CL SLV/24	Clear	100	E27	9000	10000	4000	1	24	\$90.00
MH150CO	MH 150W/640 P E27 CO SLV/24	Coated	150	E27	13000	10000	4000	24	24	\$90.00

American Metal Halide – Universal Operating – MHNasc

Sodium Scandium Metal Halide Lamps consisting of a gas filled glass bulb and an internal coated quartz discharge tube.

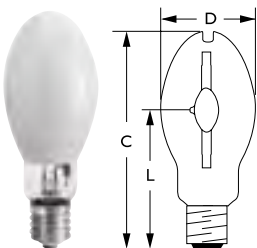

Product ID	C max.	D max.	L max.
250W	226	91	149
400W	290	121	184

Dimensions in mm

American Metal Halide – Universal Operating – MHNasc

Shortcode	Description	Wattage (W)	Cap Base	Voltage	Colour Rendering Index (Ra)	Luminous Flux (lm)	Average Lifetime (hrs)	Colour Temp (K)	Min Order Qty	Carton Qty	Trade Price
MH250	MH 250W /637 U E40 CO SLV/12	250	E40	133	61	19000	10000	3700	1	12	\$113.33
MH400	MH 400W /637 U E40 CO SLV/6	400	E40	135	61	33400	16000	3700	1	6	\$113.33

Metal Halide – ArenaVision/OptiVision Lamps

MHN-SA/MHN-LA lamps with their excellent natural white colour, high luminous efficacy and compact size are designed to meet the demanding requirements of professional sports lighting and flood lighting applications. Double pinch concept results in longer lifetime. Available in short arc (MHN-SA) and long arc (MHN-LA) versions.

MHN-SA X830R



MHN-SA PSFC

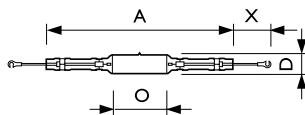

Product ID	A max.	D max.	O max.	X nom.
1800W	364	41	25	N/A
2000W	364	41	25	25
2000W HO	226	34.3	25	34

Dimensions in mm

Metal Halide – Short Arc

Shortcode	Description	Wattage (W)	Cap Base	Voltage	Colour Rendering Index (Ra)	Luminous Flux (lm)	Average Lifetime (hrs)	Colour Temp (K)	Min Order Qty	Carton Qty	Trade Price
MHNSA1800W400V	MHN-SA 1800W /956 (P)SFC 400V UNP	1800	(P)SFC	400	86	160000	6100	5600	1	1	\$1,040.00
MHNSA2000W400V	MHN-SA 2000W /956 X830R 400V UNP	2000	X830R	400	90	200000	3700	5600	1	1	\$981.76
MHNSA2KW400VHO	MASTER MHN-SA 2000W/956 400V XW HO UNP/1	2000	X830R	400	81	226000	5000	5600	1	1	\$1,080.00

MHN-LA 2000W



MHN-LA 1000W

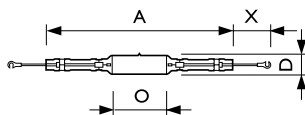

Product ID	C max.	D max.	L max.	O nom.
1800W/X830R	318	41	25	25
2000W/X830R	318	41	25	25
1800W (P) SFC	364	41	25	25

Dimensions in mm

Metal Halide – Long Arc

Shortcode	Description	Wattage (W)	Cap Base	Voltage	Colour Rendering Index (Ra)	Luminous Flux (lm)	Average Lifetime (hrs)	Colour Temp (K)	Min Order Qty	Carton Qty	Trade Price
MHNLA1000W230V	MASTER MHN-LA 1000W/842 230V XWH	1000	X528	230	70	100000	15000	4200	1	1	\$860.00
MHNLA1000W956	MASTER MHN-LA 1000W/956 230V XWH	1000	X528	230	80	90000	15000	5600	1	1	\$860.00
MHNLA2000W400V	MASTER MHN-LA 2000W/842 400V XWH	2000	X528	400	72	220000	13000	4200	1	1	\$890.00
MHNLA2000W956	MASTER MHN-LA 2000W/956 400V XWH	2000	X528	400	82	190000	13000	5600	1	1	\$890.00

Metal Halide – ArenaVision/OptiVision Lamps

Very compact quartz metal halide lamps with single-pinch GX-22 lamp cap for professional sports lighting. The compact lamp size allows compact, highly efficient luminaire systems with high-precision optics for good beam control and minimal light spill. The very good colour rendering creates a pleasant ambience with high visual comfort for players and spectators. Continuous spectral distribution offers a superior solution for professional stadiums with regular TV coverage. Daylight colour temperature eases transition from daylight to artificial lighting.



Product ID	C max.	D max.	O max.
2000W	198	39	25
Dimensions in mm			

Metal Halide – ArenaVision/OptiVision Lamps

Shortcode	Description	Wattage (W)	Cap Base	Voltage	Colour Rendering Index (Ra)	Luminous Flux (lm)	Average Lifetime (hrs)	Colour Temp (K)	Min Order Qty	Carton Qty	Trade Price
MHNSE2000W956	MASTER MHN-SE 2000W/956 GX22 400V HO UNP	2000	GX22	400	84	220000	3000	5600	1	1	\$1,250.00

Sodium Lamps

High pressure sodium vapour lamps have a sintered aluminium oxide discharge tube enclosed in an internally coated outer bulb. They offer a long, reliable lifetime and have excellent lumen maintenance. SON lamps require control gear to operate and have a universal burning position.

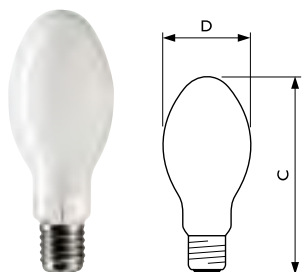

Product ID	C max.	D max.
50W, 70W	156	71
150W, 250W	226	91
400W	290	122

Dimensions in mm

SODIUM LIGHT

Shortcode	Description	Wattage (W)	Cap Base	Voltage	Colour Rendering Index (Ra)	Luminous Flux (lm)	Average Lifetime (hrs)	Colour Temp (K)	Min Order Qty	Carton Qty	Trade Price
SON50	SON 50W E E27 CO CRP/24	50	E27	85	25	3500	28000	2000	1	24	\$60.00
SON50I	SON 50W I E27 CRP/24	50	E27	85	25	3500	28000	2000	1	24	\$66.00
SON70	SON 70W E E27 CO ICT/24	70	E27	90	25	5600	28000	2000	1	24	\$60.00
SON70I	SON 70W/220 I E27 ICT/24	70	E27	90	25	5600	28000	2000	1	24	\$66.00
SON100PLUS	SON PLUS 100W E E40 SLV/12	100	E40	100	25	9700	36000	2000	1	12	\$72.00
SON150	SON 150W E E40 CO SLV/12	150	E40	100	25	13750	28000	2000	1	12	\$80.00
SON250	SON 250W E E40 CO SLV/12	250	E40	100	25	27000	28000	2000	1	12	\$84.00
SON400	SON 400W E E40 CO SLV/12	400	E40	105	25	48000	28000	2000	1	12	\$88.00

SON-T

High Pressure Sodium lamps with clear tubular outer bulb.

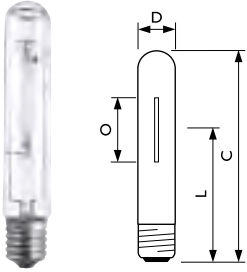

Product ID	C max.	D max.	L nom.	O nom.
150W	209	47	132	58
250W	255	47	158	66
400W	286	47	175	82
1000W	390	66	240	145

Dimensions in mm

SON-T

Shortcode	Description	Wattage (W)	Cap Base	Luminous Flux (lm)	Average Lifetime (hrs)	Colour Rendering Index (Ra)	Colour Temp (K)	Min Order Qty	Carton Qty	Trade Price
SONT150	SON-T 150W E E40 SLV/12	150	E40	15000	28000	25	2000	1	12	\$80.00
SONT250	SON-T 250W E E40 SLV/12	250	E40	28000	28000	25	2000	1	12	\$84.00
SONT400	SON-T 400W E E40 SLV/12	400	E40	48000	28000	25	2000	1	12	\$88.00
SONT1000	SON-T 1000W E E40 SLV/4	1000	E40	130000	20000	25	2000	1	4	\$240.00

SON-T PIA

High Pressure Sodium lamp with clear tubular outer bulb, high lumen output that is maintained over life and Unique Philips Integrated Antenna (PIA) concept enabling long and reliable lifetime. Robust construction with few welding points is highly vibration- and shock-resistant, further reducing early failures and extending lamp life.

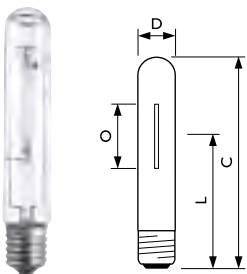

Product ID	C max.	D max.	L nom.	O nom.
150W	209	47	132	58
250W	255	47	158	66
400W	286	47	175	82
1000W	390	66	240	145

Dimensions in mm

SON-T PIA

Shortcode	Description	Wattage (W)	Cap Base	Voltage	Colour Rendering Index (Ra)	Luminous Flux (lm)	Average Lifetime (hrs)	Colour Temp (K)	Min Order Qty	Carton Qty	Trade Price
SONT50PLUS	SON-T PIA PLUS 50W E E27 SLV/12	50	E27	91	25	4400	30000	2000	1	12	\$88.00
SONT70PLUS	MST SON-T PIA Plus 70W E27 1SL/12	70	E27	93	25	6600	28000	2000	1	12	\$92.00
SONT100PLUS	MST SON-T PIA Plus 100W E40 1SL/12	100	E40	100	25	10700	28000	2000	1	12	\$96.00
SONT150PLUS	MST SON-T PIA Plus 150W E40 1SL/12	150	E40	100	25	18000	32000	2000	1	12	\$100.00
SONT250PLUS	MST SON-T PIA Plus 250W E40 1SL/12	250	E40	100	25	33000	36000	2000	1	12	\$104.00
SONT400PLUS	SON-T PIA PLUS 400W E E40 SLV/12	400	E40	100	25	55800	36000	2000	1	12	\$120.00
SONT600PLUS	SON-T PIA PLUS 600W E40 SLV/12	600	E40	115	25	90000	30000	2000	1	12	\$160.00

Sodium - High Pressure Tubular Agro

SON-T Agro lamp was specifically developed for use in the professional plant growing market. The lamp matches the lighting needs of many kinds of plants, both in respect of lighting level and in spectral composition of the light.

Suitable for use on SON control gear.

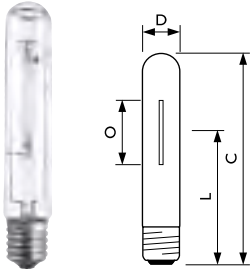

Product ID	C max.	D max.	L nom.	O nom.
400W AGRO	278	47	175	83

Dimensions in mm

SON-T Agro

Shortcode	Description	Wattage (W)	Cap Base	Luminous Flux (lm)	Average Lifetime (hrs)	Colour Temp (K)	Min Order Qty	Carton Qty	Trade Price
SONT400AGRO	SON-T AGRO 400W E E40 SLV/12	400	E40	57000	18000	2000	1	12	\$124.00

SON-H

High Pressure Sodium lamp with opalized outer bulb retrofit for High Pressure Mercury lamps. An instant and cost-effective upgrade of light level and reduction of energy use when replacing HPL lamps.

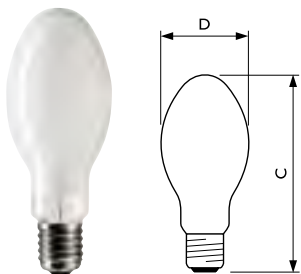

Product ID	C max.	D max.
110W	156	71
220W	227	91

Dimensions in mm

SON-H

Shortcode	Description	Wattage (W)	Cap Base	Voltage	Colour Rendering Index (Ra)	Luminous Flux (lm)	Average Lifetime (hrs)	Colour Temp (K)	Min Order Qty	Carton Qty	Trade Price
SONH110	SON H 110W I E27 ICT/24	110W	E27	107	25	9600	28000	2000	24	24	\$90.00
SONH220	SON H 220W E40 SLV/12	220W	E40	120	25	19000	26000	2000	12	12	\$100.00

Mercury - High Pressure Ovoid

High pressure mercury vapour lamps with a quartz discharge tube enclosed in an internally coated ovoid outer bulb. For indoor or outdoor applications. HPL-N lamps require control gear to operate and have a universal burning position.

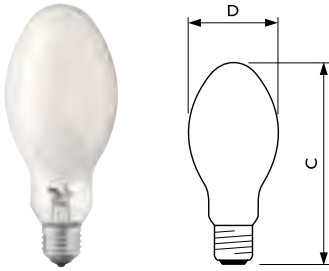

Product ID	C max.	D max.
50W	130	56
80W	155	71
125W	173	76
250W	226	91
400W	290	122

Dimensions in mm

HPL-N

Shortcode	Description	Wattage (W)	Cap Base	Luminous Flux (lm)	Average Lifetime (hrs)	Colour Temp (K)	Min Order Qty	Carton Qty	Trade Price
HPLN50	HPL-N 50W E27 SG 1CT/24	50	E27	1770	16000	4200	1	24	\$24.17
HPLN80	HPL-N 80W E27 SG 1CT/24	80	E27	3600	16000	4200	1	24	\$24.17
HPLN125	HPL-N 125W E27 SG 1CT/24	125	E27	6200	16000	4200	1	24	\$24.17
HPLN250	HPL-N 250W E40 HG 1CT/12	250	E40	12700	16000	4100	1	12	\$62.50
HPLN400	HPL-N 400W E40 HG 1CT/6	400	E40	22000	16000	4200	1	6	\$68.33

Low Pressure Sodium Lamps - SOX

Low Pressure Sodium lamp with high luminous efficacy leading to low energy consumption. The uniform sodium distribution in the discharge tube is achieved by means of dimples for a more stable discharge, higher efficacy and better lumen maintenance and lamp life. Monochromatic yellow colour with non-existent colour rendering.

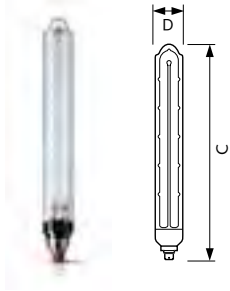

Product ID	C max.	D max.
35W	311	52
55W	425	52
90W	528	66
135W	775	66

Dimensions in mm

SOX

Shortcode	Description	Wattage (W)	Cap Base	Voltage	Luminous Flux (lm)	Average Lifetime (hrs)	Colour Temp (K)	Min Order Qty	Carton Qty	Trade Price
SOXPSG35	MASTER SOX PSG 35W BY22d T50 1SL	35	BY22d	57	1800	18000	1800	12	12	\$140.00
SOX35	SOX 35W BY22d 1SL	35	BY22d	70	4550	18000	1800	12	12	\$120.00
SOX55	SOX 55W BY22d 1SL/12	55	BY22d	109	7800	18000	1800	12	12	\$120.00
SOX90	SOX 90W BY22D SLV/12	90	BY22d	112	13600	18000	1800	12	12	\$120.00
SOX135	SOX 135W BY22D SLV/12	135	BY22d	164	22600	18000	1800	12	12	\$120.00

Low Pressure Sodium Lamps - Master SOX-E

Low Pressure Sodium lamp with improved efficacy. Extremely high luminous efficacy makes these the most efficient sodium light source. Uniform sodium distribution in the discharge tube by means of dimples for a more stable discharge, higher efficacy and better lumen maintenance and lamp life. Special coating of SOX-E outer tube results in higher lamp efficacy than SOX. Monochromatic yellow colour with non-existent colour rendering.

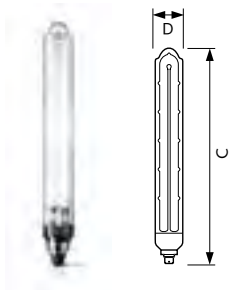

Product ID	C max.	D max.
18W	216	52
26W	311	52
36W	425	52

Dimensions in mm

Master SOX-E

Shortcode	Description	Wattage (W)	Cap Base	Voltage	Luminous Flux (lm)	Average Lifetime (hrs)	Colour Temp (K)	Min Order Qty	Carton Qty	Trade Price
SOXE18	Master SOX-E 18W BY22D SLV/12	18	BY22d	57	1800	18000	1800	1	12	\$104.00
SOXE26	Master SOX-E 26W BY22D SLV/12	26	BY22d	69	3700	18000	1800	12	12	\$104.00
SOXE36	Master SOX-E 36W BY22D SLV/12	36	BY22d	120	6100	18000	1800	12	12	\$104.00

UV - Blacklight Blue

Low-pressure, mercury vapour, fluorescent lamps. These lamps have an inner envelope coated in a fluorescent powder emitting long wave UV radiation to excite luminescence.

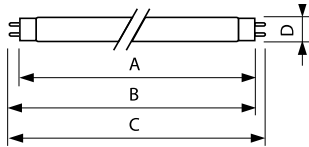

Product ID	A max.	B max.	C max.	D max.
18W	589.8	596.9	604	28
36W	1199.4	1206.5	1213.6	28

Dimensions in mm

UV - Blacklight Blue

Shortcode	Wattage (W)	Cap Base	UV-A Radiation (W)	Min Order Quantity	Carton Qty	Trade Price
TLD18W108	18	G13	3.5	25	25	\$51.00
TLD36W108	36	G13	8.0	25	1	\$65.50



Lighting controls



ToBeTouched

Simplicity Itself.

People working in busy office, school, shop, hospitality and health care environments don't have time to waste working out how to operate the lighting. Building upon the iconic design and user-friendliness of the colour ring used in LivingColours, the ToBeTouched range of intuitive user interfaces brings the same style and ease of interaction to professional lighting applications.

The dynamic "Light Wheel", can change its appearance to visualise different light parameters including brightness, colour, saturation and colour temperature. The user can select which parameter to edit and the "Light Wheel" changes according to the selection. The "what you see is what you get" visualisation of the "Light Wheel" makes it intuitive and easy for the user to predict the result of his or her choice. The soft touch control and the dynamic light ring enriches the experience and adds an element of wonder.

ToBeTouched currently comprises four models. These range from a simple on/off switch, plus a version with dimming, through to a cool/warm white controller and a full-colour model.

Assisting the user with light, sound and colour feedback, these easy-to-install interfaces make operating a lighting system easy – and fun!



ToBeTouched

Shortcode	Description	Min Order Quantity	Carton Quantity	Trade Price
UID8510	UID8510 TOBETOUCHED IR	10	10	\$240.00
UID8520	UID8520 TOBETOUCHED DIM DALI	1	10	\$540.00
UID8530	UID8530 TOBETOUCHED COLOUR TEMPERATURE DMX	10	10	\$650.00
UID8540	UID8540 TOBETOUCHED COLOUR DMX	10	10	\$730.00
UIA8550	UIA8550 TOBETOUCHED POWER SUPPLY UNIT	1	1	\$180.00

OccuSwitch DALI

The OccuSwitch DALI is a combined sensor and controller. It will dim and switch the lights in a room or area on occupancy and available daylight, with an option for local override. A detachable wiring connector enables easy installation and mounting in the ceiling.

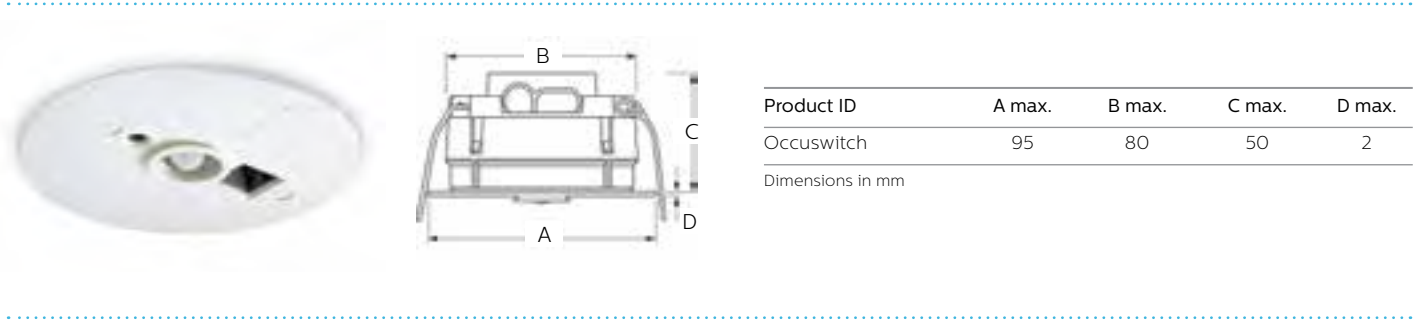

Product ID	A max.	B max.	C max.	D max.
Occuswitch	95	80	50	2

Dimensions in mm

Occuswitch

Shortcode	Description	Min Order Quantity	Carton Quantity	Trade Price
LRM2070	LRM2070/10DALI BASIC	42	42	\$290.00
LRH1070	LRH1070/00 SENSR SURFACE BOX	42	42	\$36.00

OccuSwitch – LRM1070 Movement Detector

LRM1070 is a movement detector with a built in lighting switch. The unit is designed for the automatic switching of light in indoor applications, with a light sensor range between 10 and 1000 lux. It comes with 360D movement detection, with built in photo cell sensor and adjustable switch of delay (1min – 30min). It is capable of switching 1380 VA. The product also comes with an optional surface mount box accessory.

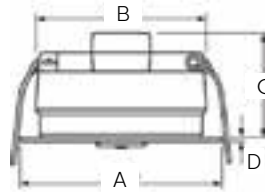

Product ID	A max.	B max.	C max.	D max.
Occuswitch	95	80	50	2

Dimensions in mm

OccuSwitch – LRM1070

Shortcode	Description	Min Order Quantity	Carton Quantity	Trade Price
LRM1070	LRM1070/00 Sensr Mov Det St	1	42	\$210.00
LRH1070	LRH1070/00 Sensr Surface Box	42	42	\$36.00



Electronic Control Gear





HF Regulator Intelligent Touch & DALI for TL5, TL5 Eco, TLD and PLL

Intelligent high-frequency electronic dimming ballast, using DALI (Digital Addressable Lighting Interface according to IEC62386) or Touch and Dim push-button protocol for fluorescent lamps. Pre-empting upcoming legislation meeting A1 BAT (Best Available Technology) requirements. With a special command you can retrieve the mains power consumption of the system, and with another command you can ask which lamp wattages are connected using the Philips multi one tool.

- Benefits:**
- Extremely low stand-by losses, controlled cut-off for dim levels above 80%, hybrid control dimming (current control at 100% and power control at 1%), combined with MASTER TL5 Eco for extra energy savings.
 - HF operation improves light quality, lamp lifetime.
 - Combined with controls, additional energy savings can be achieved.
 - Compliant with European and Asian norms and suitable for emergency lighting systems.
- Features:**
- The HF-R Intelligent recognises which lamp (T5 HE, HO, ECO, TL-D or PLL) is connected and is operated accordingly.
 - Programmed start: flicker-free ignition < 1.0 second and striation free operation, no stroboscopic effects. Preheating the lamp electrodes enables the lamps to be switched on and off without reducing life.
 - Smart power ensures constant light, independent of mains fluctuations and dimming from 10 to 100%.
 - Stop circuit is activated within 5 seconds in the event of lamp failure (safety stop), and ballast resets automatically after lamp replacement.



Product ID	A1 (Norm)	A2 (Norm)	B1 (Norm)	C1 (Norm)	D1 (Norm)
HF-Ri TD 1 35/49/80 TL5 E+	360.0	350.0	30.0	22.0	4.1
HF-Ri TD 1 28/35/49/54 TL5 E+	360.0	350.0	30.0	22.0	4.1
HF-Ri TD 2 28/35/49/54 TL5 E+	360.0	350.0	30.0	22.0	4.1
HF-Ri TD 1 14/21/24/39 TL5 E+	360.0	350.0	30.0	22.0	4.1
HF-Ri TD 2 14/21/24/39 TL5 E+	360.0	350.0	30.0	22.0	4.1
HF-Ri TD 3 14/24 TL5 E+ 195-240V 50/60Hz	360.0	350.0	39.0	22.0	4.2
HF-Ri TD 4 14/24 TL5 E+ 195-240V 50/60Hz	360.0	350.0	39.0	22.0	4.2

Dimensions in mm

HF Regulator Intelligent Touch & DALI for TL5, TL5 Eco, TLD and PLL CONTINUED

HF-RI TD					
Shortcode	Description	Voltage	Min Order Quantity	Carton Quantity	Trade Price
HFRITD114-39	HF-Ri TD 1 14/21/24/39 E+	220-240	10	10	\$104.50
HFRITD128-54	HF-Ri TD 1 28/35/49/54 TL5 E+ 195-240V	195-240	1	10	\$104.50
HFRITD214-39	HF-Ri TD 2 14/21/24/39 E+	220-240	12	12	\$114.50
HFRITD228-54	HF-Ri TD 2 28/35/49/54 TL5 E+ 195-240V	195-240	1	12	\$114.50
HFRITD314-24	HF-Ri TD 3 14/24 TL5 E+ 195-240V	195-240	10	10	\$128.00
HFRITD414-24	HF-Ri TD 4 14/24 TL5 E+ 195-240V	195-240	10	10	\$128.00

Shortcode	No.of lamps	T5 HE/T5 ECO HE				T5 HO/T5 ECO HO				TLD			PLL			
		14/13	21/19	28/25	35/32	24/20	39/34	49/45	54/50	18	36	58	24	36	40	55
HFRITD114-39	1	•	•			•	•				•		•	•	•	
HFRITD128-54	1			•	•			•	•			•				•
HFRITD214-39	2	•	•			•	•				•		•	•	•	
HFRITD228-54	2			•	•			•	•			•				•
HFRITD314-24	3	•				•				•						
HFRITD414-24	4	•				•				•						

HF Regulator 1-10V Dimming

High-frequency electronic dimming ballast, using the analogue protocol (1-10 V) for TL5 HE/HO, TL5 Eco and TLD lamps.

- Benefits:**
- The lamp power can be dimmed from 10 to 100% via the Analogue control input (in accordance with the 1-10 V industry standard).
 - Compliant with European and Asian norms and suitable for emergency lighting systems.
 - HF operation improves light quality, lamp lifetime.
 - Combined with controls, additional energy savings can be achieved.
- Features:**
- Programmed start: flicker-free ignition < 0.5 seconds and striation free operation, no stroboscopic effects. Preheating the lamp electrodes enables the lamps to be switched on and off without reducing life.
 - Smart power ensures constant light, independent of mains fluctuations.
 - Up to 60% reduction in energy consumption by using automatic lighting control systems.
 - Stop circuit is activated within 5 seconds in the event of lamp failure (safety stop), and ballast resets automatically after lamp replacement.



Product ID	Length A1	Fixing Hole Distance Length A2	Width B1	Height C1	Fixing Hole Diameter D1
HF-R 114-35 TL5 EII 220-240V 50/60Hz	360	350	30	22	4.2
HF-R 214-35 TL5 EII 220-240V 50/60Hz	360	350	30	22	4.2
HF-R 314 TL5 EII 220-240V 50/60Hz	359	350	39	22	4.2
HF-R 154 TL5 EII 220-240V 50/60Hz	360	350	30	22	4.2
HF-R 254 TL5 EII 220-240V 50/60Hz	360	350	30	22	4.2
HF-R TL-D EII range	360	350	30	22	4.2

Dimensions in mm

HF Regulator 1-10V Dimming

Shortcode	Description	Voltage	Min Order Quantity	Carton Qty	Trade Price
HFR114-35TL5	HF-R 114-35 TL5 EII 220-240V 50/60Hz	220-240	12	12	\$35.75
HFR214-35TL5	HF-R 214-35 TL5 EII 220-240V 50/60Hz	220-240	1	12	\$41.25
HFR314TL5	HF-R 314 TL5 EII 220-240V 50/60Hz	220-240	10	10	\$55.00
HFR154TL5	HF-R 154 TL5 EII 220-240V 50/60Hz	220-240	12	12	\$35.75
HFR254TL5	HF-R 254 TL5 EII 220-240V 50/60Hz	220-240	12	12	\$41.25
HFR118	HF-R 118 TL-D EII 220-240V 50/60Hz	220-240	12	12	\$35.75
HFR136	HF-R 136 TL-D EII 220-240V 50/60Hz	220-240	1	12	\$41.25
HFR158	HF-R 158 TL-D EII 220-240V 50/60Hz	220-240	1	12	\$35.75
HFR218	HF-R 218 TL-D EII 220-240V 50/60Hz	220-240	12	12	\$41.25
HFR236	HF-R 236 TL-D EII 220-240V 50/60Hz	220-240	1	12	\$35.75
HFR258	HF-R 258 TL-D EII 220-240V 50/60Hz	220-240	1	12	\$41.25

HF Performer III (Fixed Output) for TLD

One of the most energy efficient fixed output (A2 BAT), slim, high frequency electronic ballast for fluorescent lamps. HF-operation reduces eye strain as caused by electromagnetic ballasts. Automatic restart (after voltage dip or lamp exchange) ensures easy operation and hassle free re-lamping.

- Key Features:
- Programmed, flicker-free, preheated start (< 1.0s).
 - 100,000 hour lifetime at Ta 50°C and over 100,000 on/off switches on one lamp.
 - Automatic restart (after voltage dip or lamp exchange) ensures easy operation and hassle free re-lamping.

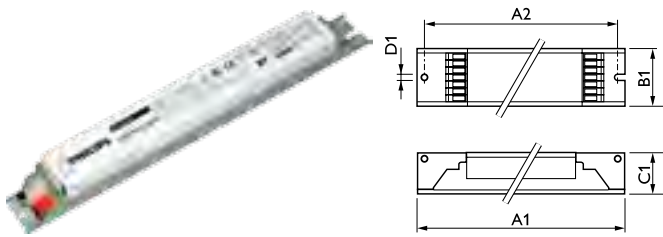

Product ID	Length A1	Fixing Hole Distance Length A2	Width B1	Height C1	Fixing Hole Diameter D1
HFP111	280	265	40	28	4.2
Dimensions in mm					

HF Performer 111 (Fixed Output) for TLD

Shortcode	Description	Voltage	Min Order Quantity	Carton Qty	Trade Price
HFP3418TLD	HF-P 3/418 TL-D III 220-240V 50/60Hz IDC	220-240	1	10	\$40.00
HFP336TLD	HF-P 336 TL-D III 220-240V 50/60Hz IDC	220-240	1	10	\$40.00

HF-Performer Intelligent (Fixed Output) for TL5, TLD, PL and TL5C

HF-Performer Intelligent for Master and ECO TL5 HE/HO, TL5C, TL-D and PL-L lamps. HF-Performer Intelligent features automatic recognition of the connected lamp and is independently able to adjust its operation parameters exactly to the respective lamp. This results in a substantial benefit, especially for T5 lamps, as it means TL5 HE and HO lamps of the same length can be interchanged.

- Benefits:**
- Maximum reliability in system operation, and flexibility for designers, operators and facility managers in terms of stock-keeping management.
 - Multi-power technology for precise operation of multiple lamp types of various wattages.
 - OptimiSed for high maintenance efficiency and reliability.

- Features:**
- Highest CELMA Energy Efficiency Index A2 BAT.
 - Average nominal service lifetime over 100,000 hours (at Ta 50 °C) with a failure rate ≤ 0.1 % per 1,000 hours.
 - OptimiSed lamp preheating for a minimum of 50,000 On/Off switch operations without lamp replacement.

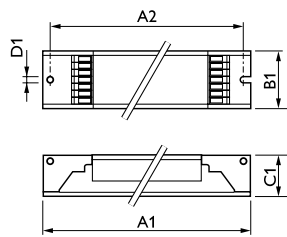

Product ID	A1	A2	B1	C1	D1
HF-Pi	360	350	30	22	4.2

Dimensions in mm

HF-Performer Intelligent (Fixed Output) for TL5, TLD, PL and TL5C

Shortcode	Description	Voltage	Min Order Quantity	Carton Qty	Trade Price
HFPI114-39TL5	HF-Pi 1 14/21/24/39 TL5 EII 220-240V	220-240	1	12	\$46.00
HFPI128-54TL5	HF-Pi 1 28/35/49/54 TL5 EII 220-240V	220-240	1	12	\$46.00
HFPI214-39TL5	HF-Pi 2 14/21/24/39 TL5 EII 220-240V	220-240	1	12	\$46.00
HFPI228-54TL5	HF-Pi 2 28/35/49/54 TL5 EII 220-240V	220-240	1	12	\$60.00
HFPI341424TL5PLL	HF-Pi 3/4 14/24 TL5/PL-L EII 220-240V	220-240	1	12	\$60.00

Shortcode	No. of lamps	T5 HE/T5 ECO HE				T5 HO/T5 ECO HO				TLSC			TLD			PLL				
		14/13	21/19	28/25	35/32	24/20	39/34	49/45	54/50	22	40	60	18	36	58	18	24	36	40	55
HFPI114-39TL5	1	•	•			•	•			•	•		•	•		•	•	•	•	
HFPI128-54TL5	1			•	•			•	•		•			•						•
HFPI214-39TL5	2	•	•			•	•			•	•		•	•		•	•	•	•	
HFPI228-54TL5	2			•	•			•	•		•			•						•
HFPI341424TL5PLL	3/4	•	3			•									•	•				

HID-PrimaVision Mini

Miniature HID electronic gear for CDM lamps – freeing up the boundaries of creativity and innovation in luminaire design.

- Benefits:**
- Miniaturisation enables stylish luminaire design and retrofit halogen replacement.
 - Optimal lamp performance thanks to minimal lamp power tolerance.
 - Easy luminaire design-in.

- Features:**
- Loop Through feature (in independent version).
 - Smallest gear and highest wattage in miniature size.
 - Minimal lamp power spread.
 - Microprocessor-controlled.
 - Lamp end-of-life detection.
 - High Tambient and Tcase temperatures.
 - Long lifetime of 40,000 hours.

"I" TYPE

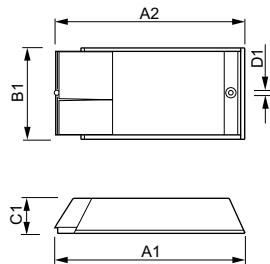

Product ID	Length A1	Fixing Hole Distance Length A2	Width B1	Height C1	Fixing Hole Diameter D1
HIDPVMPGJ520I	190.0	154.0	43.3	30.0	4.2
HIDPVM020ICDM	234.7	225.1	49.4	34	4.8
HIDPVM035ICDM	234.7	225.1	49.4	34	4.8

Dimensions in mm

"S" TYPE

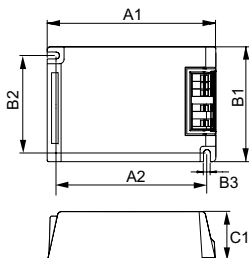

Product ID	Length A1	Fixing Hole Distance Length A2	Width B1	Height C1	Fixing Hole Diameter D1
HID-PV m PGJ5 20/S CDM HPF 220-240V	97.3	88.3	43.3	30.2	4.2
HID-PV m 35 /S CDM HPF 220-230V 50/60Hz	97.3	88.3	43.3	30.2	4.2

Dimensions in mm

HID PrimaVision Mini

Shortcode	Description	Wattage (W)	Voltage	Min Order Quantity	Carton Qty	Trade Price
HIDPVMPGJ520I	HID-PV m PGJ5 20 /I CDM LPF 220-240V	20	220-240	12	12	\$198.00
HIDPVMPGJ520S	HID-PV m PGJ5 20/S CDM HPF 220-240V	20	220-240	12	12	\$198.00
HIDPVM020ICDM	HID-PV m 20 /I CDM HPF 220-240V 50/60Hz	20	220-240	10	10	\$198.00
HIDPVM035ICDM	HID-PV m 1x035/I CDM HPF 220-240V	35	220-240	10	10	\$198.00
HIDPVM035SCDM	HID-PV m 35 /S CDM HPF 220-230V 50/60Hz	35	220-230	12	12	\$198.00

HID-AspiraVision and PrimaVision

AspiraVision is the mark of excellence in HID electronic gear technology – high-end, compact, lightweight and easy to use, with added features for optimal performance of 35, 50 and 70 W CDM lamps. The recently added switching function provides maximum flexibility for users by integrating three different wattage choices into a single driver. PrimaVision Power gear is designed for optimal performance of 100 and 150 W CDM lamps – ideal where high-intensity light is key.

- Benefits:**
- SOFT START allows installation with fewer circuit breakers; Loop Through (I type) allows faster, cost-efficient installation.
 - Longer lifetime.
 - Driver can be set to 35, 50 or 70 W with the integrated switch, which means there is no need to replace the driver if the installation requires lower or higher-wattage lamps in the future.
 - Optimal lamp performance thanks to minimal lamp power tolerance.
 - Eliminates all visible lamp flicker.

- Features:**
- Improved thermal performance.
 - Low electromagnetic interference.
 - Voltage drop detection.
 - Lamp end-of-life detection.
 - High Tambient and Tcase temperatures.
 - Long lifetime of 40,000 hours.

"I" TYPE

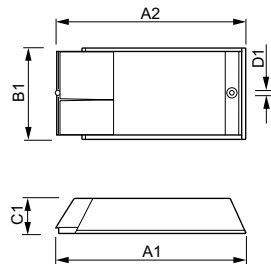

Product ID	Length A1	Fixing Hole Distance Length A2	Width B1	Height C1	Fixing Hole Diameter D1
HID-AV C 35-70 /I CDM	189.2	170.7	83.5	34.7	4.8
HID-PV C 100 & 150 /I CDM	224	206	82.7	34.2	4.8

Dimensions in mm

"S" TYPE

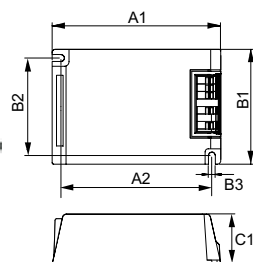

Product ID	Length A1	Fixing Hole Distance Length A2	Width B1	Height C1	Fixing Hole Diameter D1
HID-AV C 35-70 /S CDM	110	98.5	75	32.1	4.5
HID-PV C 100 /S CDM	135	123.5	75	32	4.5
HID-PV C 150 /S CDM	135	123.5	75	32	4.8

Dimensions in mm

HID-Aspiravision and Primavision

Shortcode	Description	Wattage (W)	Voltage	Min Order Quantity	Carton Qty	Trade Price
HIDAVC355070ICDM	HID-AV C 35-70 /I CDM 220-240V 50/60Hz	35/50/70	220-240	1	12	\$150.00
HIDAVC355070SCDM	HID-AV C 35-70 /S CDM 220-240V 50/60Hz	35/50/70	220-240	1	12	\$150.00
HIDPVC100ICDM	HID-PV C 100 /I CDM 220-240V SOFT START	100	220-240	10	10	\$198.00
HIDPVC150ICDM	HID-PV C 150 /I CDM 220-240V 50/60Hz 190	150	220-240	10	10	\$198.00
HIDPVC100SCDM	HID-PV C 100 /S CDM 220-240V 50/60Hz	100	220-240	10	10	\$198.00
HIDPVC150SCDM	HID-PV C 150 /S CDM 220-240V 50/60Hz	150	220-240	10	10	\$198.00

HID PrimaVision Medium Wattage

Highly reliable electronic drivers for medium-wattage lamps: 80,000 hours lifetime for the Xtreme version and 50,000 hours for the non-Xtreme versions. Most efficient white-light system in the industry in its power range. Minimized maintenance costs for outdoor lighting thanks to very long lifetime. Same energy consumption and smooth driving of the lamp regardless of fluctuations in mains voltage.

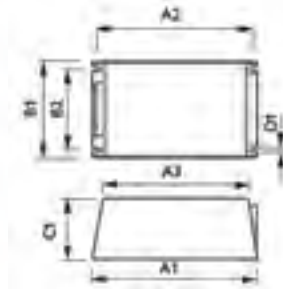

Product ID	A1	A2	B1	B2	C1	D1
HID-DV PROG Xt 210 CDMe/CPO	169	156.0	100	81.5	58	4.8
HID-PV 315/S CDM	215.0	204.5	128.5	111.5	60.0	4.2

Dimensions in mm

HID PV MW Elite Ballasts

Shortcode	Description	Wattage (W)	Voltage	Min Order Quantity	Carton Qty	Price Trade
HIDDVXT210CDMeCPO	HID-DV PROG Xt 210 CDMe/CPO C2 208-277V	210	208-277	6	6	\$440.00
HIDPV315SCDM	HID-PV 315 /S CDM 220-240V 50/60Hz	315	220-240	4	4	\$460.00

HID PrimaVision Xtreme for CPO

Compact, robust, outdoor, one-piece, electronic ballasts for CosmoPolis White (CPO-TW) lamps. Offering an energy-saving street and road light solution with extremely long life, and suitable for withstanding outdoor environments (storms, lightning strikes, etc.).

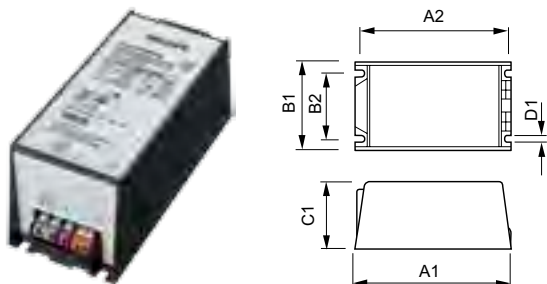

Product ID	A1	A2	B1	B2	C1	D1
HIDPVCI	150	135.9	65	46.8	65	5
HIDPVQ	150	133.6	90	70	40	4.5

Dimensions in mm

HID DynaVision DALI Xtreme for CPO

Shortcode	Description	Wattage (W)	Voltage	Min Order Quantity	Carton Qty	Trade Price
HIDPVXT45CPOC1	HID-PV Xt 45 CPO C1 208-277V	45	208-277	12	12	\$200.00
HIDPVXT60CPOC1	HID-PV Xt 60 CPO C1 208-277V	60	208-277	12	12	\$200.00
HIDPVXT90CPOC1	HID-PV Xt 90 CPO C1 208-277V	90	208-277	12	12	\$220.00
HIDPVXT140CPOC1	HID-PV Xt 140 CPO C1 208-277V	140	208-277	12	12	\$220.00
HIDPVXT45CPOQ	HID-PV Xt 45 CPO Q 208-277V	45	208-277	12	12	\$200.00
HIDPVXT60CPOQ	HID-PV Xt 60 CPO Q 208-277V	60	208-277	12	12	\$200.00
HIDPVXT90CPOQ	HID-PV Xt 90 CPO Q 208-277V	90	208-277	12	12	\$220.00
HIDPVXT140CPOQ	HID-PV Xt 140 CPO Q 208-277V	140	208-277	12	12	\$220.00

ET-S Halogen Transformer

A high frequency electronic transformer for operation with 12 volt halogen lamps. The ET-Standard transformer is uniquely compact and lightweight. It is also dimmable with approved leading and trailing edge dimmers. A range of benefits include short-circuit protection in the event of lamp failure, temperature protection, constant output voltage, and operates at a whisper (30dB).

Wire cross section on mains and lamp sides of terminals is 0.5 to 2.5mm². Distance between lamp and transformer; minimum 20cm, maximum 2m. Distance from other transformers must be more than 25cm.

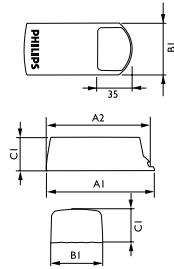

Product ID	A1	A2	B1	C1
ET-S 60	105	110	52	33.5
ET-S 105	110	-	45	33

Dimensions in mm

ET-S Halogen Transformer

Shortcode	Description	Wattage (W)	Voltage	Min Order Quantity	Carton Qty	Trade Price
ETS60	ET-S 60 220-240V 20-60VA	20-150	220-240V	1	50	\$27.72
ETS105	ET-S 105 230-240V 50/60HZ	50-105	230-240V	1	50	\$38.28



Technical Data





The principles of LED technology

The basis for light generation inside a Light Emitting Diode (LED), a solid-state semiconductor, is the conversion of electrical energy directly into light.

On its most basic level this can be seen as an electron that moves from one material into another while losing an amount of energy. Due to the law of conservation of energy, this loss of energy needs to be converted and, inside a LED, this energy is converted into radiation energy composed of light in the visible part of the spectrum, and a bit of infrared radiation dissipated as heat.

The LED is comprised of two semiconductor regions, a positive electrically charged or p-region and a negative electrically charged or n-region, see Diagram 1. In the p-region there is a shortage of electrons and in the n-region a surplus of electrons. When voltage is applied across these two regions, current begins to flow and electrons move across the p-n junction, from the n-region into the p-region. The process of an electron moving through the p-n junction releases energy. The dispersion of this energy produces photons with visible wavelengths. The higher the energy released, the shorter the wavelength becomes. Low-energy photons will emit in the infrared part of the spectrum, and as the energy increases, the colour of the light will change from deep red, via yellow, green, cyan and blue to the ultra-violet part of the spectrum – in fact it follows the colours of the rainbow.

Diagram 1. LED composition with the electrically charged p- and n-regions and the p-n junction emitting light.

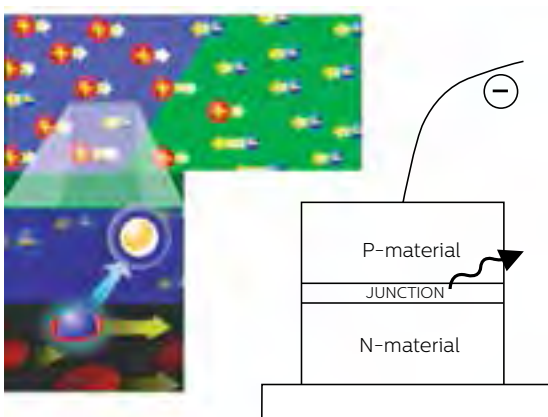
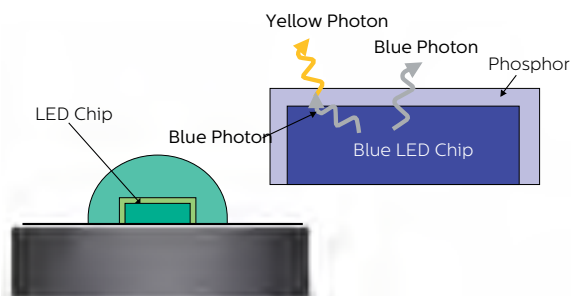

Diagram 2. White LED, the principle of white light generation.



White light and RGB (red, green and blue)

A white LED consists of a blue LED chip and a yellow phosphor coating, see Diagram 2. The blue photons generated in the semiconductor chip can either pass the phosphor layer unaffected, or be converted into yellow photons. These two colours – blue and yellow – combine to produce white light.

It is also possible to generate white light with the aid of a red, green and blue LED. Such LED array systems are called RGB systems. Normally the RGB systems are used to make different colour effects. With a RGB system all colours of light within the colour triangle can be produced.

Graph. Colour triangle for a RGB system; all colours within the triangle can be reproduced.

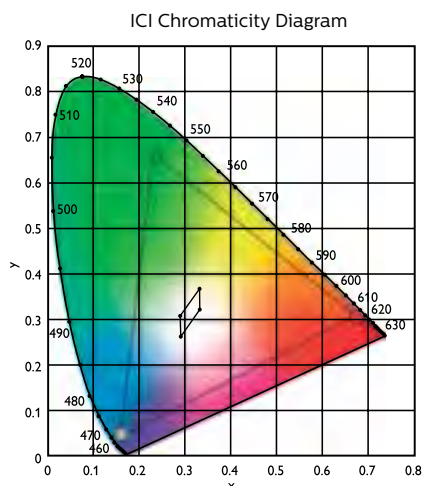



Characteristics and benefits

On this page you will find an overview of the characteristics and benefits of LEDs. In the various indoor and outdoor applications different advantages will be important. Architectural applications will use the vivid colours and dynamic colour control, whereas the traffic signal market is focused on maximising energy savings and reducing maintenance costs to practically zero.

In general:

- More energy-efficient than incandescent and halogen lamps
- Much longer life, up to 50,000 hours at 70 percent of lumen maintenance
- Reduced maintenance cost
- No unwanted IR or UV radiation in the beam of light, less risk of fading of colour pigments and textile
- Highly efficient low-cost plastic optics can be used

Architecture/design:

- Design flexibility, hidden compact light sources
- Vivid saturated colours without the use of additional filters
- Directed light for increased system efficacy
- Robust, vibration-proof, solid-state lighting
- Less light pollution due to precise optical control

Unique LED advantages:

- Dynamic colour control, white point adjustable
- Fully dimmable without colour variation
- Instant switch-on at full colour and full lighting level
- No transmission loss due to colour filters
- Install and forget for a long time

Environment:

- No hazardous metals e.g. mercury in the light source
- Safety and low temperature:
- Low voltage DC operation
- Highly efficient in cold environment
- Cold start capability down to -40°C
- Sealed for life waterproof luminaires

Value chain

The definition of levels of integration describes the road from LED chip to luminaire, with increasing complexity and value. Philips undertakes business activities at all levels of the value chain.

Level 0. LED chip

Semiconductor chips are the basis for every LED and these are grown in complex wafer production equipment. The wavelength of the LED is defined according to the manufacturing process, the parameters and the tolerance.



The principles of LED technology

Level 1. LED component

Packaging is the next step. Here the thermal and optical properties are determined and the chip is connected to its package by means of bond wires for external connections.

Level 2. LED array

A miniature printed circuit board is used to connect one or more LEDs, possibly together with driver electronics, and acts as a thermal interface between LEDs and heat sink.

Level 3. LED module

A LED module combines heat sink, optics and separate driver in one module, ready to be installed in a luminaire.

A mono-colour traffic light source is an example of level 3. Three of these modules will be combined in a level-4 traffic signal head.

Level 4. LED luminaire

A LED luminaire can be connected directly to the outside, mechanically and electrically. It houses, supplies power to and protects the LED array(s) from the environment while maintaining optimal operating conditions.

Philips LEDline is an example of a level-4 product.

				
Level 0	Level 1	Level 2	Level 3	Level 4
LED-Chip	LED or lamp	LED's on PCB	LED module with optics and driver	Luminaire

Table. Survey of levels of integration and LED products.

LED lighting system

A LED lighting system comprises several components like a power supply, controller, control interface and luminaire/LED arrays/optics. In many cases one or more components are combined in one product for ease of installation. In other cases there might be a need for more flexibility in terms of system configuration and control. e.g. a power supply or control interface may be shared by a group of luminaires. Every single component is selected to fit the application demands.

Lighting controls

The revolution of LED technology for lighting creates new possibilities in the application of lighting. In many applications the dynamic character of LED enables a lighting solution to create a unique experience. By using RGB colours or variation in colour temperature, all sorts of effects are made possible and can be specified for a particular lighting design or application, both indoor and outdoor. To enable these dynamic lighting solutions there is a need for lighting control systems that create the right experience for the customer. Philips provides a range of smart scene-setting lighting controllers that offers a reliable solution for any project, from simple colour selection at the push of a button or the turn of a wheel to fully automated, pre-programmed light control and/or multimedia integration.

Colour characteristics of lamps

Lamps do not all emit light of the same colour. There is, for example, a striking difference between the pronounced amber light from standard sodium lamps and the white light from most other lamps. Even then, one white light is not the same as another. To select the right light source for the colour characteristics required, two separate parameters have to be considered, i.e. the colour temperature of the emitted light and its colour rendering.

Colour temperature

Given that the colour of the light has an important influence on the colour impression of the area, the colour temperature of the light source plays an essential role. To enable an objective comparison of the colour impressions from various sources, subjective terms such as the popular words 'cool' and 'warm' are inadequate. A precise scale is required and given by the term 'correlated colour temperature'; the colour gradation of the light is compared with the light emitted by an intensely heated iron bar of which the temperature is known. In this way, the light colour can be specified by a value in kelvin (K). A low colour temperature represents warm, yellow, orange or red light and a high colour temperature cool, blue or violet light.

Four categories, as a practical guideline, are:

2000 – 3000 K warm/cosy

The colour from incandescent lamps, (compact) fluorescent lamps in the colours 827 and 927 and the SDW-T White SON lamp. Generally used for intimate and cosy environments where the emphasis is on a peaceful relaxing ambience.

3000 – 4000 K warm/neutral

The colour from halogen lamps, colour 830 and 930 (compact) fluorescent lamps and MASTERColour 830 lamps. Used in places where people are active, requiring a welcoming comfortable ambience.

4000 – 5000 K neutral/cool

The light colour from 840 and 940 fluorescent lamps as well as MASTERColour 942 and MHN metal halide lamps. Usually applied in commercial areas and offices where a look of cool efficiency is desired.

5000 K and above daylight and cool daylight

The light colour that best matches natural daylight, such as fluorescent colours 850, 865, 950 and 965.

Colour rendering

The perception of surface colours, the colour rendering of the light, depends on the colour content of the incident light. The light emitted by a light source is composed of a mixture of colours, all in different intensities. A change in the colour mixture and intensity yields a different colour rendering.

Daylight incandescent lamps have fully natural colour rendering properties. The same is true for halogen lamps. The reason for this is the continuous spectrum of the sources, which is typical for filament lamps.

Most gas discharge sources, however, have an interrupted or line spectrum. This has an influence on the quality of their colour rendering properties, which vary from very poor, with SOX low-pressure sodium gas discharge lamps, to excellent, with the colour 90 De Luxe series fluorescent and MASTERColour 942 lamps.

When selecting a particular lamp type, a clear understanding of the colour rendering properties is essential. A fair indication is given by the colour rendering index (CRI), which is a standardised scale with 100 as the maximum value. Colours are best shown under a light source with the highest colour rendering index. Incidentally, it is only worthwhile to compare CRI values of lamps of similar colour temperature.

In practice, three colour rendering categories are normally found

CRI between Ra 90 and 100.

- Excellent colour rendering properties.
- Applications are mainly those where correct colour appraisal is a critical task.

CRI between Ra 80 and 90.

- Good colour rendering properties.
- Applications in areas where critical colour appraisal is not the primary consideration but where good rendition of colours is essential.

CRI below Ra 80.

- Moderate to poor colour rendering properties.
- Applications in areas where the quality of colour rendering is of minor importance.

The choice in favour of a particular colour rendering class does, of course, depend on the demands that an application makes on a lamp.

For example, a CRI of Ra 60 is inadequate for shop lighting, but is qualified as good for functional road lighting.

Light colour	Colour temp. in kelvin	Type of lamp or lamp colour
Cool Daylight	17000	452
	8000	451
	6500	865, 965
Daylight	6000	
Cool White	5000	850, 950
	4500	HPI (-T) Plus
	4200	942, HPL-N, MHN
Neutral White	4000	840, 940
	3500	
	3400	HPL Comfort
'Crisp' Warm White	3000	Halogen 12V, 830, 930
	2900	
	2800	Halogen Plusline
	2700	Halogen PAR Incandescent, 827, 927
'Cosy' Warm White	2500	SDW-T
	2150	SON Comfort
Very Warm White	2000	SON PIA Plus

Indoor applications	CRI	Type of lamp or lamp colour
Excellent	100	Incandescent, halogen 12V, 230V 927, 930, 940, 950, 965 CDM 942
	92	
	90	
Good	83	SDW-T 451, 452, 827, 830, 840, 850, 865 CDM 830, SDW-T, MHN, QL
	82	
	80	
Moderate	75	54 25 HPI (-T) Plus SON Comfort 33
	70	
	69	
	65	
	60	
Insufficient	55	35, HPL Comfort 29
	50	
Poor	45	HPL-N SON Plus SON
	40	
	25	

Areas of application

Correct light impressions and correct rendering of colours assists us in recognising our surroundings.

The colour climate of an artificially-lit space is determined by light colour temperature and colour rendering.

Room furnishings of wood and fabrics in warm colours require warm lighting in the colours 827 or 927.

For pleasing light the colours 830 and 930 are most suitable for many applications. The more business-like the interiors are, the cooler the light can be. Furniture using chromium, glass and marble, or in black and white, is emphasised by the neutral light colours 840 and 940. Colours 865 and 965 are best used in environments where there is a high daylight content.

For (compact) fluorescent lamps it is most economical to choose the colours 830 and 840 as they produce the highest light output. Colours 927, 930, 940 and 950, on the other hand, give the best colour rendering.

Proper use of fluorescent lamps

Philips light colours	Special			Neutral white		Cool daylight		
	79	830	930	840	940	950	865	965
Sales areas								
Groceries								
Meat								
Textiles, leather								
Furniture, carpets								
Sports, games, stationery								
Photo, clocks and jewellery								
Cosmetics, hairdressing								
Flowers								
Bookshops								
Industry								
Workshops								
Electro mechanical assembly								
Textile manufacture								
Printing, graphical tasks								
Colour testing								
Paintshops								
Stores								
Plant nurseries								
Offices, schools								
Office areas								
Conference rooms								
Teaching areas								
Lobbies, corridors								
Others								
Dwellings								
Restaurants								
Museums								
Sport, multipurpose areas								
Hospital bedrooms								
Treatment rooms								

	Optimal solution		Also suitable
--	------------------	--	---------------

Protection against ingress of solid objects, dust & moisture

The Ingress Protection system (IP) EN 60529, 1991 defines various degrees of protection against the ingress of foreign bodies, dust and moisture. The term 'foreign bodies' includes things like fingers and tools coming into contact with the electrical live parts of the product.

Both safety aspects (contact with live parts) and harmful effects on the function of the luminaire are defined.

The exact testing method for luminaires for each IP classification is described in the standard EN 60598.

Some testing methods from EN 60529 were found to be inappropriate for luminaires and it must be noted that the specific conditions in an application may differ from the conditions during testing.

The designation to indicate the degree of protection consists of the characteristic letters IP followed by 2 digits indicating conformity with the conditions stated in the two tables. All Philips luminaires fulfil the minimum classification: IP20 (protected against finger contact with live parts), however a selection of luminaires, especially those for industrial and outdoor (road) applications, meet a higher IP classification. It is important to realise that the specification and safety of luminaires are only secured if the necessary maintenance is carried out according to the instructions of the manufacturer within the time schedules indicated.

Protection against ingress of dust, solid objects and moisture

First number: Degree of protection against contact with external elements			Second number: Degree of protection against ingress of moisture		
First number	Description	Explanation	Second number	Description	Explanation
0	Non-protected	Not protected	0	Non-protected	Not protected against moisture
1	Hand-protected	Protected against solid objects exceeding 50mm in diameter	1	Drip-proof against vertical water drops	Water drips falling vertically shall have no harmful effect
2	Finger-protected	Protected against finger contact with live parts; and against solid objects exceeding 12mm in diameter	2	Drip-proof when tilted at angles of up to 15°	Water drips shall have no harmful effect
3	Tool-protected	Protected against contact with live parts by tools, wire or similar objects over 2.5mm thick; and protection against penetration of solid objects exceeding 2.5mm in diameter	3	Rain/spray-proof	Water falling at an angle of up to 60° shall have no harmful effect
4	Wire-protected	Protected against contact with live parts by tools, wire or similar objects over 1mm thick; protection against penetration of solid objects exceeding 1mm in diameter	4	Splash-proof	Splashing water from any direction shall have no harmful effect
5	Dust accumulation-protected	Complete protection against contact with live parts and against harmful accumulation of dust; some dust may penetrate but not to the extent that operation is impaired	5	Jet-proof	Water projected by a nozzle from any direction shall have no harmful effect. (Nozzle diameter 6.3mm, pressure 30kPa)
6	Dust penetration-protected	Complete protection against contact with live parts and against penetration of dust	6	Jet-proof	Water projected by a nozzle from any direction shall have no harmful effect. (Nozzle diameter 12.5mm, pressure 100kPa)
			7	Watertight	Watertight; temporary immersion in water under specified conditions of pressure and time possible without ingress of water in harmful quantities
			8	Pressure watertight	Pressure watertight; continuous submersion in water under specified conditions of pressure and time without ingress of water in harmful quantities

Optics to suit all requirements

The optic in a luminaire is made up of the reflector and louvres, diffuser or refractor system that controls the light direction and beam pattern of the luminaire. It is an essential control device. It is therefore not surprising that Philips offers a wide variety of optics, each designed to perform a specific function.

Which optic is best for the practical situation in question?

The function of the area to be illuminated and the task to be performed usually determine the type of luminaire and optic you need, while the ceiling system often determines the dimensions and the way the luminaire is to be mounted. The luminaire-optic combination must fulfil the lighting requirements defined for each specific area and task. In addition, other requirements, such as image, efficiency and aesthetics, will influence the decision. Light distribution, direct and reflected glare control and efficiency are parameters that influence the performance of the lighting installation. These elements are described in the European standard EN 12464-1 (Light and lighting - Lighting of workplaces).

The following optic guide is comprised of optics for fluorescent luminaires with TL5 and TL-D lamps, grouped in the different optic dimensions (Micro, Mini, Midi and Maxi), for downlights with compact fluorescent lamps and for projectors with compact HID lamps.

The overview offers an indication of the optic description and performance. As the optical performance may vary with lamp type and number of lamps, please consult the photometric database via www.lightingsoftware.philips.com in conjunction with calculation programmes like DIALUX and RELUX.

Micro optics – New generation optics for TL5

Micro optics are the latest state-of-the-art in optical design and available for TL5 lamps only. The very slim-line optics, with an opening of only 55mm, are integrated in high-end luminaires. The aluminium optics with their curved underside enhance the aesthetic appearance and have an improved efficiency.

Micro optics are applied in innovative luminaire families like Arano, Celino and Savio, in slim-line and square luminaires.

C8/D8

Performer micro optic made of high-quality standard aluminium, reflection $\geq 83\%$, available in high gloss (C) and semi-high gloss (D). Delta-shaped light distribution and all-round glare control.

LOR	up to 82%
UGR _R	≤ 19
L	$< 1000\text{cd}/\text{m}^2$

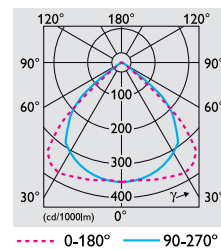

36

Medium beam rotationally symmetric optic for downlighting and accent lighting. Made of anodised aluminium with 99% reflection. Intensity varies greatly with lamp type and power. For accent and general lighting in areas where high-quality light sources are required.

LOR	up to 60%
I_{max}	approx. 1 kcd/klm

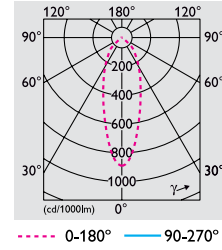

60

Wide-beam rotationally symmetric optic for down lighting. Made of anodised aluminium with 99% reflection. Intensity varies greatly with lamp type and power. For general lighting in retail areas, museums, hotels and lobby areas, in offices and public buildings.

LOR	up to 60%
I_{max}	approx. .75 kcd/klm

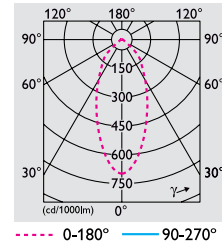

Explanation of type numbers – example only

Luminaires

The method used for type numbers is explained in the following. This explanation covers the major part of the type numbers.

For the precise choice of luminaire for a particular lighting assignment it is advisable to contact a representative of Philips Lighting.

TBS 769 1xTL5-28W/840 HFP M6

1st letter
Lamp category
Indicates the lamp type or non-luminaire product types

- B Luminaires for LEDs
- C Combinations of lamps
- F Compact fluorescent
- G Attachments (optical)
- H Gas discharge luminaires
- K Special lamps (e.g. QL lamps)
- L Low voltage (halogen)
- M Compact discharge
- P Projection lamps
- Q Mains voltage incandescent (incl. halogen)
- R Power tracks (incl. accessories)
- T Linear fluorescent luminaires
- V Terminations for fibre optics
- Z Accessories

2nd letter
Mounting position
Indicates the mounting or version

- B Recessed
- C Surface
- D Desktop
- F Floor
- G Special
- K Electrical components
- M Electrical unit (batten)
- P Suspended/pendant
- R Power track mounted
- T Trunking
- W Wall
- Z Multi-use/functional accessory

3rd letter
Design/application
Indicates the type of usage

- G Decorative
- H Special
- K High and low bay
- L Components
- N Air-handling
- S Stand-alone
- V Fibre optics
- W Waterproof
- X Systems/structures
- Z Increased safety

Family name

Key-words Lamp (example):

Key-words	Description
1xTL5-28W/840	1xTL5 fluorescent lamp 28 Watt lampcolour 840
2xTL-D36W	2xTL-D fluorescent lamp 36 Watt
1xA60-MAX100W	1xincandescent lamp with conventional pear shape E27 lampsocket for maximum 100 Watt
1xHAL-PR50W-GU5.3	1xhalogen dichroic reflector lamp 50 Watt 12 volts with lampbase GU5.3
1xHAL-C50W/12V-GY6.35-SI	1xhalogen capsule lamp 50 Watt 12 volts in silver with lampbase GY6.35
1xSDW-T50W	1xWhite SON lamp (SDW-T) 50 Watt
1xCDM-T70W	1xMASTER Colour lamp T-version (CDM-T) 70 Watt
1xCDM-TD100W	1xMASTER Colour lamp TD-version (CDM-TD) 100 Watt
1xPL-S/2P9W	1xcompact fluorescent PL-S lamp / 2pins / 9 Watt
2xPL-C/4P18W/830	2xcompact fluorescent PL-C lamp / 4 pins / 18 Watt lampcolour 830

Key-words Gear (example):

Key-words	Description
HFP	performer version of HF electronic gear for fluorescent lamps
HFR	regulated version of HF electronic gear for fluorescent lamps
EI	electronic included
IC	electromagnetic gear, parallel compensated

Key-words Optics* (example):

Key-words	Description
M6	OLC matt aluminium optic with 3D lamellae
M2	matt aluminium optic with flat profiled cross lamellae

Naming of HID control gear

example only
BMH 70 L 300 ITS

SN	SON
SD	SON dim
SL	White SON
SX	SOX
MH	Metal Halide
HL	High Pressure Mercury
HA	HPA

Lamp power(s)

Inductive circuit

Number of electrical terminals

TS	thermoswitch
I	Ignitor tap
0	220V 50Hz
1	220V 60Hz
2	230V 50Hz
4	240V 50Hz
7	230/240V 50Hz
8	220/240V 50Hz
10	220...250V 50/60Hz
12	230/240/250V 50Hz
0	standard screw contacts
2	insert contacts

The next three digits in the designation indicate the family of luminaires.

Lamp Characteristics

Efficacy of fluorescent lamp systems – typical examples:

Lamp type		Conventional gear	Electronic gear HFR, HFP, EBS or EBE
TL-D 18 W 4-lamp system	Lamp Ballast Total Lamp flux System efficacy Energy saving potential	4 x 18 W 14 W 86 W 4 x 1350 lumen 63 lumen/Watt	4 x 16 W 10 W 74 W 4 x 1400 lumen 76 lumen/Watt 16%
TL-D 36 W l-lamp system	Lamp Ballast Total Lamp flux System efficacy Energy saving potential	36 W 8 W 44 W 3350 lumen 76 lumen/Watt	32 W 4 W 36 W 3200 lumen 89 lumen/Watt 22%
TL-D 58 W l-lamp system	Lamp Ballast Total Lamp flux System efficacy Energy saving potential	58 W 11 W 69 W 5200 lumen 75 lumen/Watt	50 W 5 W 55 W 5000 lumen 89 lumen/Watt 26%
TL5 HE 14 W 4-lamp system	Lamp Ballast Total Lamp flux System efficacy	Not available	4 x 14 W 6 W 62 W 4 x 1350 lumen 87 lumen/Watt
TL5 HE 28 W l-lamp system	Lamp Ballast Total Lamp flux System efficacy	Not available	28 W 4 W 32 W 2900 lumen 91 lumen/Watt
TL5 HO 49 W l-lamp system	Lamp Ballast Total Lamp flux System efficacy	Not available	49 W 5 W 54 W 4900 lumen 91 lumen/Watt

Colour temperature and colour rendering

Correct light colours and correct reproduction of colours assists us in recognising our surroundings. The colour climate of an artificially-lit space is determined by the light colour and the colour rendering. Room furnishings of wood and fabrics in warm or pastel colours require warm lighting in the colour /827 or /927.

The more business-like the interior is, the cooler the light can be. Furniture using chromium, glass and marble, or in black and white, is emphasised by the cool light colours /840 and /940.

Colour Rendering (Ra)

Colour rendering is the ability of a light source to reproduce colour. The light source is put over an 8-colour slide test, and the light source's ability to reproduce colour is tested. From this, it is rated on the CRI (Colour Rendering Index). E.g. The '8' in 840 indicates a colour rendering between 80-90.



Moderate:
60 < Ra < 80

Good:
80 ≤ Ra < 90

Excellent:
Ra ≥ 90

Colour Temperature (K)

Colour temperature refers to the colour appearance of a light source. It is measured in degrees Kelvin(K). E.g. The '40' in 840 indicates a colour temperature of 4000K.



Warm

Cool





Glossary of Terminology

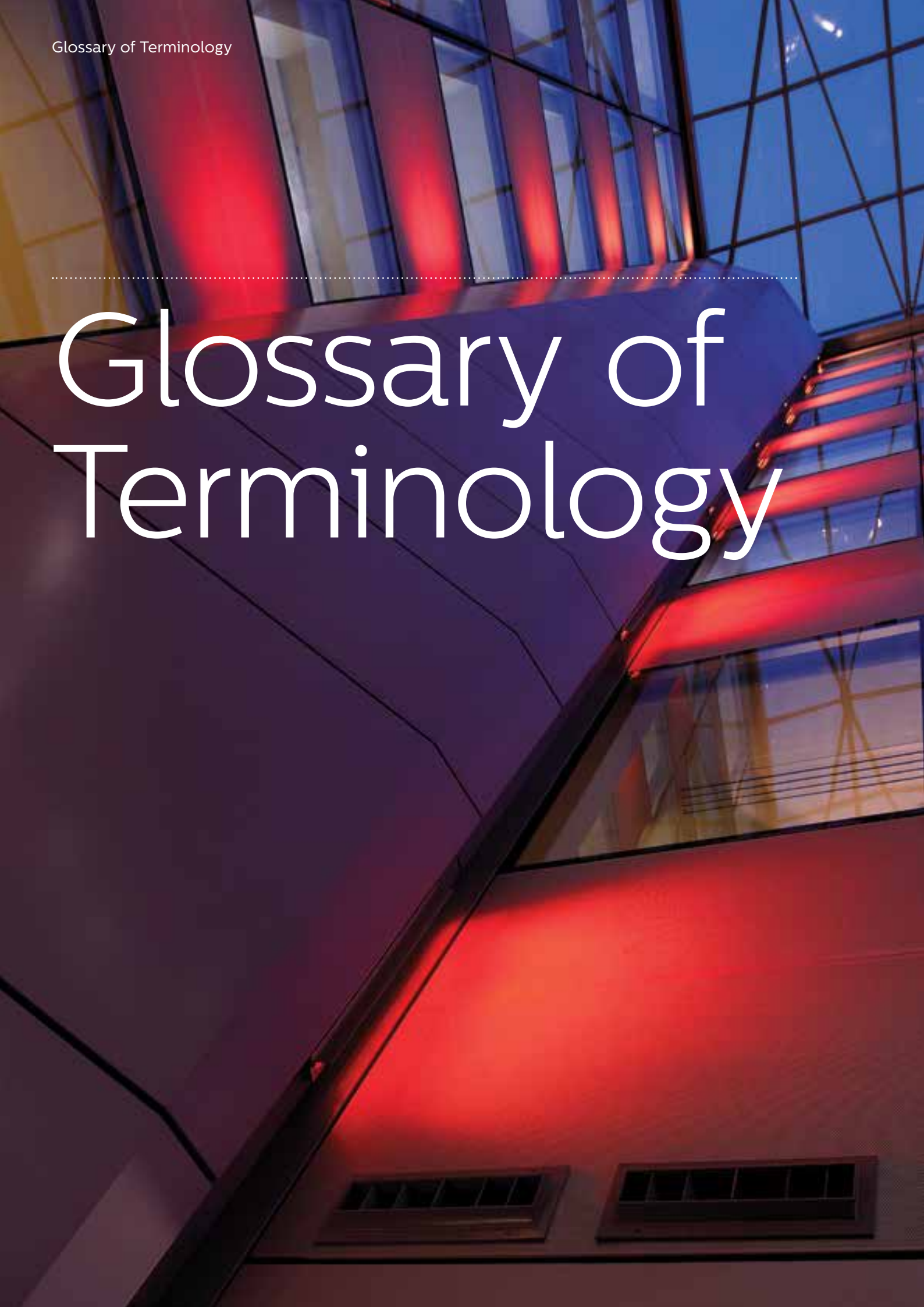

Average illuminance

Illuminance averaged over a specified surface.

Unit: lux (lx) = lm/m²

Symbol: E_{av}

Ballast

Electrical device used with discharge lamps for stabilising the current in the discharge.

Beam spread

Angle in the plane through the beam axis over which the luminous intensity drops to a stated percentage (e.g. 50%) of its peak intensity.

Brightness

Attribute of visual sensation according to which an area appears to emit more or less light. Brightness according to the definition is also an attribute of colour.

Candela

The standard unit of light intensity, abbreviated to “cd”, which is one lumen per steradian.

CDM

See MASTERColour CDM.

Colour appearance

General expression for the colour impression received when looking at a light source.

Colour change

The facility to change the colour temperature of a lighting installation makes it possible to create a more comfortable working environment or to introduce dynamic lighting effects.

Colour rendering

Ability of a light source to render colours naturally, without distorting the hues seen under a full spectrum radiator (like daylight or incandescent lamps). The colour rendering index (CRI) ranges from 0 to 100.

Colour rendering index CRI

See Colour rendering.

Symbol: R_a

Colour temperature

Temperature in kelvin of a full spectrum radiator closest to the colour appearance of a light source at the same brightness.

Unit: kelvin, K

Symbol: Tc

Contrast C (between two parts of a visual field)

The relevant luminance difference between two parts in accordance with the formula:

$$C = \frac{L1 - L2}{L2}$$

Where the size of the two parts differs greatly and where:

L1 = luminance of the smallest part (object)

L2 = luminance of the largest part (background).

DALI

Digital Addressable Lighting Interface, a standardised communication interface to regulate lighting levels and to switch electronic HFD ballasts on and off.

Daylight linking

Using natural light saves energy and is beneficial to individual users. Daylight linking is a technique that regulates the light output of luminaires in accordance with daylight conditions, thus maintaining a constant level of indoor lighting and ensuring comfort at all times.

Diffuser

Optical element used to mix light rays to improve uniformity or reduce glare. An opal cover is an example of a diffuser.

Direct lighting

Lighting by means of luminaires with a light distribution such that 90 – 100% of the emitted luminous flux reaches the working plane directly, assuming that this plane is unbounded.

Disability glare

Glare that impairs vision.

Discharge lamp

Lamp in which the light is produced, directly or indirectly, by an electric discharge through a gas, a metal vapour or a mixture of several gases and vapours.

Discomfort glare

Glare that causes discomfort without necessarily impairing vision.

Dust-proof luminaire

Luminaire constructed so that dust of a specified nature and fineness cannot enter when it is used in a dust-laden atmosphere.

Emergency lighting

Lighting provided for use when the supply to the normal lighting fails.

Escape lighting

That part of emergency lighting provided to ensure that an escape route can be effectively identified and used in the case of failure of the normal lighting system.

Flashed area

The light of a luminaire in a given direction. The area of the orthogonal projection of the luminous surface on a plane perpendicular to the specified direction.

Fresnel lens or reflector

A Fresnel lens or reflector is an optical element of reduced height. By means of discrete steps, the basic shape is flattened yet the optical characteristics are retained.

Glare

Condition of vision in which there is discomfort or a reduction in the ability to see significant objects, or both, due to an unsuitable distribution or range of luminance or to extreme contrast in space or time.

Halogen lamp

Incandescent lamp in which the inclusion of halogens in the gas filling and a high-temperature quartz envelope promote the tungsten halogen cycle, permitting a higher filament temperature. The result is a higher colour temperature and a significantly extended life.

Halogen HV

“High voltage” 230 – 240V halogen lamp, which does not require a ballast or a transformer.

Halogen LV

“Low voltage” 6 V, 12 V or 24 V halogen lamp. An electronic or electromagnetic transformer is required to operate low-voltage halogen lamps and is often integrated into the luminaire.

HFR-DALI

Electronic regulating DALI ballast for various fluorescent lamps. With this new-style electronic ballast standard push-buttons can be used to dim the light output down to 3%. The lamp can also be switched on or off using the push-button control.

Ballast functions according to the DALI protocol.

HFP PERFORMER

Electronic ballast for various fluorescent lamp types with warm-start principle. See also ‘Specification data luminaires’.

HFR 1-10V

Electronic regulating ballast for various fluorescent lamp types by which light dimming is possible. The main ranges of HFR ballasts allow step-less dimming down to 3%. See also ‘Specification data luminaires’.

Horizontal illuminance (E_{hor})

Illuminance incident on the horizontal surface.

Unit: lux (lx) = lm/m²

Symbol: E_{hor}

HPI Plus lamp

Metal-halide high-intensity discharge lamp combining high luminous efficacy with white light of moderate colour rendering. Main indoor applications are big industrial halls and lighting of discount stores, hyper/supermarkets and DIY shops. HPI Plus lamps are usually applied in high-bay luminaires and floodlights.

Illuminance

The luminous flux density at the surface being lit. The illuminance in the full summer sun is approx. 100,000 lux. Recommended illuminances for work places range from 200 lux for rough work to 2000 lux for detailed or critical work.

Unit: lux (lx) = lm/m²

Symbol: E

Incandescent lamp

Lamp in which light is produced by means of an element heated to incandescence by the passage of an electric current.

Indirect lighting

Lighting by means of luminaires with a light distribution such that not more than 10 per cent of the emitted luminous flux reaches the working plane directly, assuming that this plane is unbounded.

Induction lighting refractor

Optical element used to concentrate light rays to focus or improve the direction of light. A prismatic cover is an example of a refractor.

Infrared remote control

In offices and meeting rooms where the lighting requirement changes frequently, wireless infrared control offers the flexibility to set the lighting and change it at any time.

Isocandela curve (diagram)

Curve traced on an imaginary sphere with the source at its centre and joining all adjacent points corresponding to those directions in which the luminous intensity is the same, or a plane projection of this curve.

Isolux curve (diagram)

Locus of points on a surface where the illuminance has the same value.

Jet-proof luminaire

Constructed to withstand a direct jet of water from any direction.

LED

Light Emitting Diode used as a light source. Solid-state semiconductor device that converts electrical energy directly into light of a specific colour or white light.

Light output ratio (LOR)

Ratio of the total light emitted by a luminaire to the total light output of the lamp(s) it contains measured at standard operating conditions.

Low-pressure sodium lamp

Sodium vapour lamp in which the partial pressure of the vapour during operation does not exceed 5 Pa – for example: a SOX lamp.

Lumen depreciation

The decline in the light output of a light source during its lifetime.

Luminaire

Appliance that distributes, filters or transforms the light given by a light source (LED or lamp), and which contains all the necessary elements for fixing and protecting the light source(s) and facilitates their power supply and operating conditions.

Luminance

The light intensity per square metre of apparent area of the light source, luminaire or illuminated surface. Where surfaces are lit, the luminance depends upon both lighting level and reflection characteristics of the luminous surface.

Unit: cd/m²

Symbol: L

Luminous efficacy

The quantity of light that a light source emits per unit of electrical energy consumed. Notice that the luminous efficacy can be specified for a light source or for a lighting system (lamp and ballast).

The luminous efficacy of a system is lower than that of the light source.

Unit: lm/W

Luminous flux

The total light output emitted by a light source. Also the total light falling on a surface. The light output of a light source is measured in lumen.

Unit: lumen

Symbol: ϕ

Luminous intensity

The luminous flux in a given direction, e.g. from a floodlight or projector.

Unit: candela (cd) = one lumen per steradian

Symbol: I

Luminous intensity distribution diagram (table)

Luminous intensity shown in the form of a polar diagram, cartesian diagram or table, in terms of candelas per 1,000 lumens of lamp flux.

The diagram (table) for non-symmetrical light distributions gives the light distribution of a luminaire in at least two planes:

1. In a vertical plane through the longitudinal axis of the luminaire,
2. In a plane at right angles to that axis.

Note: The luminous intensity diagram (table) can be used:

- a. To provide a rough idea of the light distribution of the luminaire.
- b. For the calculation of illuminance values at a point.
- c. For the calculation of the luminance distribution of the luminaire.

Lux

The standard unit of illuminance of a surface being lit. One lux equals one lumen per square metre.

Maintained emergency lighting

Emergency lighting where the lamps are operated from the normal supply during standard conditions. In an emergency situation the emergency lamp (usually one lamp in luminaires of two or more lamps) remains in operation.

Maintained illuminance (luminance)

Value below which the average illuminance on the specified surface is not allowed to fall. The maintained illuminance is specified at the end of the maintenance cycle, taking into consideration the maintenance factor. It is one of the main specification elements for the lighting designer. In the various standards the maintained illuminance is specified for various activities.

Unit: lux

Symbol: E_m, L_m

Maintenance factor

Correction factor used in lighting design to compensate for the rate of lumen depreciation, caused by lamp ageing (lumen depreciation and lamp failure) and dirt accumulation (luminaire and environment).

It determines the maintenance cycle needed to ensure that illuminance does not fall below the maintained value.

MASTERColour CDM lamp

Series of metal-halide discharge lamps with excellent colour rendering and a warm or neutral colour impression. MASTERColour lamps, also available as reflector lamps, are applied in projectors and downlights for shop and office applications.

Mercury lamp

This High-intensity discharge lamp is used in industry and large public spaces. Higher quality light characteristics are obtained by applying metal-halide lamps.

Metal-halide lamp

Single or double-ended discharge lamp for use in industry, public spaces and shops. Metal-halide lamps combine a natural white colour with a pleasant light and a high luminous intensity.

Movement detection

Sensing of occupancy by movement detection ensures lights are activated only when needed and enables the lighting in a specific area to be controlled.

Non-maintained emergency lighting

Emergency lighting where the emergency lighting lamps come into operation only when the power supply to normal lighting fails.

Obtrusive light

Spill light which because of quantitative, directional and spectral attributes in a given context, gives rise to annoyance, discomfort, distraction or a reduction in the ability to see essential information.

OLC

Omnidirectional Lighting Control, a Philips patented series of optics for TL5 and TL-D lamps offering optimal lighting efficiency in combination with excellent glare and luminance control all around the luminaire.

Optic

A device that changes the direction of a beam of light, usually by reflection, diffusion or refraction by a lens. The optic may include louvres for reduction of glare.

PL lamp

Single-ended compact fluorescent lamp in which the discharge tube is folded into two, four or six limbs. PL lamps are characterised by unusually high light output for their length. They are applied in compact luminaires for professional and domestic use. Also available with integrated ballast.

Power factor

Ratio of the circuit power in watts over the product of the root-mean-square values of voltage and current. For sinusoidal waveforms, it is equal to the cosine of the angle of phase difference between voltage and current. For electronic ballasts the power factor is 0.95 so that no additional phase compensation is required.

Refractor

Optical element used to concentrate light rays to focus or improve the direction of light. A prismatic cover is an example of a refractor.

RGB

Red, green and blue, used to specify the colours of a light source.

SDW-T

White SON or SDW-T lamps offer a high luminous efficacy in combination with warm-white light. The colour rendering is excellent. SDW-T lamps are applied in shops and public spaces where the atmosphere should be warm and cosy.

Sky glow

The brightening of the night sky that results from the reflection of radiation (visible and non-visible), scattered from the constituents of the atmosphere (gas molecules, aerosols and particulate matter) in the direction of observation. It comprises two separate components as follows:

- a. Natural sky glow: That part of the sky glow which is attributable to radiation from celestial sources and luminescent processes in the earth's upper atmosphere.
- b. Man-made sky glow: That part of the sky glow which is attributable to man-made sources of radiation (e.g. outdoor electric lighting), including radiation that is emitted directly upwards and radiation that is reflected from the surface of the earth.

Sodium lamp, SON lamp

High-pressure discharge lamp with a yellowish colour appearance and an extremely high efficiency. SON and SON Comfort lamps, with improved colour characteristics, are mainly applied in high-bay industrial applications.

Solid-state lighting (SSL) eg. LED

Description of a lighting device that does not contain moving parts or parts that can break, rupture, shatter, leak or contaminate the environment (such as a lamp), (SSL).

Spill light (stray light)

Light emitted by a lighting installation which falls outside the boundaries of the site for which the lighting installation is designed.

Starter

Device for starting a discharge lamp, in particular a fluorescent lamp, that preheats the electrodes and/or causes a voltage surge in combination with the series ballast.

Switching and dimming control

As more and more light sources can be dimmed economically, lighting controls need to provide both switching and light regulating capabilities.

TL5

Linear double-ended fluorescent lamp with a diameter of 16mm. In combination with OLC optics and high-frequency ballasts the TL5 system offers a superb performance, both in terms of lighting technology and energy consumption.

TL-D

Linear double-ended fluorescent lamp with a diameter of 26mm. Available in a range of colours and colour rendering characteristics.

Threshold increment (TI)

The measure of disability glare expressed as the percentage increase in the contrast required between an object and its background for it to be seen equally well with a source of glare present.

Note: Higher values of TI correspond to greater disability glare.

Uniformity ratio

Ratio of the minimum over the average illuminance for a specified area (E_{min}/E_{ave}).

When defined as such, the uniformity ratio is also the ratio of the minimum over the maximum illuminance for a specified surface area (E_{min}/E_{max}).

Utilisation factor

Utilisation factor (UF) of a lighting installation represents the percentage of the luminous flux of the lamp(s) that reaches the defined working plane. UF can be seen as the efficiency of the lighting installation. UF is used to calculate the number of luminaires required.

Vertical illuminance

Illuminance incident on the vertical surface.

Unit: lux (lx) = lm/m²

Symbol: E_{vert}

Visual guidance

The sum of the measures taken to give the user of a space an unambiguous and immediately recognisable picture of the course of the path ahead. Visual guidance is important in shops and other public buildings. The lighting designer takes the demands for visual guidance into consideration.



© 2015 Koninklijke Philips Electronics N.V.

All rights reserved. Reproduction in whole or in part is prohibited without the prior written consent of the copyright owner. The information presented in this document does not form part of any quotation or contract, is believed to be accurate and reliable and may be changed without notice. No liability will be accepted by the publisher for any consequence of its use. Publication thereof does not convey nor imply any license under patent or other industrial or intellectual property rights.

Release date: April 2015.

