



SAFER DRUG USE HANDBOOK

Adapted by the Indiana Recovery Alliance from content by Joelle Puccio,
PHRA warrior since 2010, BSN, RN

TABLE OF CONTENTS:

Terms.....	2
Alternate Methods.....	3
Smoking.....	3
Eating.....	3
Booty Bumping.....	3
Inhaling.....	4
Injection.....	4
Plan ahead if you can.....	4
Ready to Inject.....	5
Cookers and handles.....	5
Water.....	5
Cottons.....	6
Choosing an injection site.....	7
Finding a vein.....	8
Cleaning the skin.....	8
Needles.....	9
Injecting in veins.....	11
Injecting in a muscle.....	12
Femoral injecting.....	12
Safe disposal.....	13
Cocaine and Methamphetamine	13
Smoking crack cocaine.....	13
Crack smoking Step by Step.....	14
Meth smoking step by step.....	15
DIY equipment Sterilization.....	15
Common Health Problems.....	16
Cellulitis.....	16
Abscess.....	17
Sepsis (blood poisoning).....	18
Endocarditis.....	19
Hepatitis C.....	19
Overdose Prevention and Treatment/Detox.....	20
Pregnancy and Withdrawal.....	21
Opiates, anti-opiates, cocaine and meth.....	22
Treatment drugs.....	22
NALOXONE (NARCAN) STEP BY STEP.....	23
Detox/Treatment referrals.....	25
HIV/Hepatitis C referrals.....	25
References.....	26

TERMS:

Underlined terms found in this zine will be defined

- Bevel – the flat part at the very end of a needle (pic on p. 11)
- Bugs – bacteria, viruses, fungi, generally stuff that can give you an infection
- Clean – not guaranteed to be sterile
- Chlorhexidine – an chemical sometimes added to alcohol swabs
- Embolus (plural emboli) – a solid particle floating around in the bloodstream
- Healthcare provider – doctor, nurse practitioner, physician assistant, etc.
- Lance – to cut open an abscess
- Localized – in one area of your body
- mL vs. cc – cubic centimeters are a measure of solids and milliliters are a measure of liquids. They both mean the same amount for our purposes.
- Solution – a mixture with something dissolved into a liquid
- Sepsis – infection in every part of your body (blood poisoning)
- Sterile – has no germs on it



This symbol will appear next to tips for pregnant women.

ALTERNATE METHODS

Smoking

The most common method of smoking is “chasing the dragon”. This involves placing a line of dope on some tinfoil and heating it from below with a flame. You then use a tube to suck up the resulting smoke. Only Shiva has enough hands to smoke this way alone using a lighter. Using a zippo or a candle can free up your hands to hold the foil and the tube. Using a straw can be very wasteful, so try to get a wider tube, like from a toilet paper roll. You can also put it on top of whatever else you’re smoking, roll it up in a spliff, smoke it out of a glass piece, put some on the end of a small metal object like a safety pin or straightened out paper clip, heat it up with a lighter, and inhale the smoke. Make sure your apparatus is clean. (see DIY sterilization section) It only takes a few seconds to feel the effect when you smoke.

Eating

You don’t need to cook it up before eating, but if it’s already cooked up it will start to work faster. Eating can take longer for effect, around 30 minutes, and your peak will be in roughly an hour. Eating is less efficient than injecting, as you have to use about twice as much for the same effect. You can decrease absorption time and increase the strength if you hold the solution under your tongue until it is absorbed. This can be a nice thing to do if you are out of injection equipment, or if you are getting frustrated trying to find a vein.

Booty bumping

Cook up your drugs as usual, and then put your solution into a syringe with the needle removed. Then insert the syringe into your anus (butthole) and push in the drugs. Lube can make insertion more comfortable, and a friend to help can make this a less difficult process. Afterward, you need to lie down with your butt above your head for a few minutes, until all of the liquid is absorbed, otherwise, when you stand up, your drugs may leak out. You will start to feel the effect within a few minutes.

Inhaling

You can cook up your drugs as usual, and then put the solution in an empty nasal spray bottle, to be squirted up your nose conveniently and discreetly. You may want to use as little water as possible to make the solution more potent, so you don't have to use 50 sprays to get high. This method is effective in just a few minutes. The longer you store cooked drugs, the more likely it will start growing bacteria. Try to use it up within a few days. Store it in the refrigerator, in a paper bag or something to block out light, which can cause it to start breaking down.

Always use caution when trying a new method or a new batch for the first time. Use a small amount first to see how your body will react and avoid overdose!

INJECTION

Plan ahead if you can

- Try to use a secure, warm, dry place. If you are relaxed, your veins will come up easier and you will miss your shot less often.
- Using alone can be dangerous if something goes wrong. People you trust and who care about you can be helpful hitting veins you can't reach, sharing safer use tips, and helping if you accidentally OD.
- If you are in a hurry or frustrated, try taking a small amount in another way like smoking or eating. Then, when you are calm, finish injecting.

Before you use

- Push up your sleeves to the elbow and wash your hands with soap and water for at least 20 seconds, cleaning between fingers and under nails.
- Clean the area you will be using to prepare your drugs. Clear a surface. Wipe with bleach water, alcohol, or hot water. Lay down a clean dry towel, piece of paper, or shirt.
- Remember which parts of your body and your space are clean. If necessary, keep a clean hand and a dirty hand. Hands that touch your face, door handles, etc. should be considered dirty.
- Touch your works as little as possible.

Ready to inject

- **Skin:** needs a couple days to heal before it can resume its job as a barrier to infection. So choose a new place each time!
- **Veins:** also need a couple days to heal before repeated use. Blown veins happen when there is more than one hole in the vein, either from the needle going all the way through, or a tear due to pressure inside the vein. When this happens, remove the tourniquet and apply pressure and ice to the site. Do not use this vein farther down until it heals. Veins carry blood toward your heart. If you blow all the veins in your upper arm, the shot you put in your lower arm vein will leak out on its way back into the bloodstream. If your circulation is still generally good, use the veins farther away from your heart first. That way if they become unusable, you still have the ones closer to your heart.

Cookers and handles

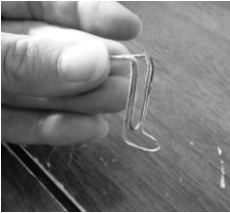

<< bent



unbent >>

We provide bent and unbent paperclips to be used for handles. The bent ones are used by fitting the loops of the shorter end beneath and inside the cooker. The unbent ones are used by bending the paperclip into a triangle and placing the cooker in the middle. You can also use a twist tie, tear off a little strip of metal from the cooker itself, a roach clip, pliers, etc.

- **BEST:** *Our cookers* and paper clips are clean, not sterile. You may sterilize them at home if you want. We have no limit on how many you can take.

Take as many cookers as you have needles

- **BETTER:** A *spoon or bottle cap* should be sterilized before use. If you can't sterilize, clean with soap and water and then wipe with alcohol. Allow to dry.
- **WORST:** *Sharing* any kind of cooker can spread diseases like Hep C.

Water

- Water that has been sitting for a long time can grow germs. Running water from a clean sink is better than water that has been

in a container for a while. Cool water is better than hot because bugs that like to grow in our bodies like warm temperatures.

- Bacteriostatic water has had alcohol or another antibacterial added to it. This keeps any bugs from growing in it. If you cook it with your drugs, it is no longer bacteriostatic, because the alcohol will “cook off” very quickly. So this is not harmful.
- Boiling while cooking your drugs is not long enough to kill germs.
- To boil water for injection use, use a clean pot with a lid. (See DIY sterilization) Start timing when the water is at a full boil, and let it boil for 30 minutes. After you turn off the heat, cover the pot while it cools so that no floating germs fall into it. When it is cool, pour it into sterile or clean small bottles with lids. Use gloves if you have them, or wash hands thoroughly before handling sterile water.

BEST: sterile water, sterile saline, tap water, sealed bottled water, 30 min boiled water.

BETTER: opened bottles of water that you have been in control of since they were opened, water from the back part of the toilet.

WORST: puddle/gutter water, water from the front of the toilet.

Cottons

- Filtering your shot helps to strain out particles, which can become emboli. An embolus is a piece of something solid floating in your bloodstream. It can be dirt, undissolved drugs, filter pieces, fat, or a blood clot. These can cause heart attack, stroke, or deep vein thrombosis (DVT).
- Deep vein thrombosis symptoms: localized heat, pain, swelling, or redness in a limb, usually the lower leg. DVT can become stroke or heart attack if the embolus moves.
- Heart attack symptoms: trouble breathing, arm, neck, or chest pain, extreme fatigue. Heart attack can come with full recovery, permanent disability, or death.
- Stroke symptoms: sudden dizziness or confusion, loss of consciousness (passing out). Drooping on one side of the face. Stroke can come with full recovery, permanent disability, or death.
- DVT, heart attack, and stroke are emergencies that you cannot safely deal with at home. Please call 911 if you or a friend experiences these symptoms.

- **BEST:** We distribute 3 sizes of dental *cotton pellets* with no limit. They are clean when we start, and we bag them with as little contamination as possible. **Please take at least as many cottons as you have needles.**
- **BETTER:** *Q-tips and tampons* are clean but rolled looser than our cottons and you can draw up long strands of cotton in your needle. If injected, these will irritate your veins and can cause embolus. Always wash your hands thoroughly before tightly hand rolling wisps of cotton from these sources.
Cigarette butts are made of cellulose acetate, not fiberglass. They are not good filters. Long fibers, particles, and microorganisms will be drawn up with your shot. If you must use cigarette filters, please use new ones. Used filters will have germs, tar, and broken down fibers.
- **WORST:** *Old cottons* can very quickly start growing bacteria and other organisms. Using old cottons introduces harmful mold and bacteria directly into your bloodstream and can cause sepsis. Please don't do it!

Choosing an injection site

- **BEST:** arms and legs
Arms and legs have the best circulation so they will heal faster than hands and feet.
- **BETTER:** hands and feet
- Hands and feet are farther away from the heart, so the blood is slower moving. They also hurt more and the veins are smaller, making it more difficult to hit them.
- **WORST:** femoral veins, neck veins
Femoral: There are nerves and arteries nearby which can complicate injection. It is a big vein, which can make bleeding a serious problem. An abscess here can cut off blood to your leg, and possibly cause you to lose it.
Neck: Comes with all the problems of the fem. There are also cranial nerves to worry about, and there are 12 of them. You can also hit your windpipe or food pipe. Add to all that that it requires a mirror or another person. Please don't do it!

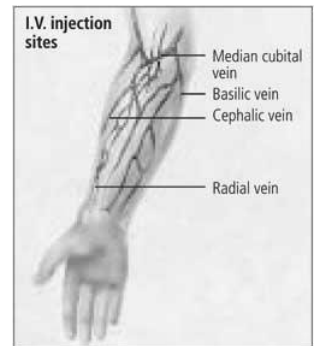

Finding a vein

- Veins are the blood vessels bringing blood back to the heart after circulation. They become smaller when you are cold or not using a limb and larger when you are warm or exercising.
- To bring up veins, take a bath or shower, swing your arms, do some pushups, use a hot pack, and wait to pee until after your shot.
- Veins closer to your heart have better circulation, but if you blow a vein, you cannot use it again farther from the heart or it will not drain properly.
- Always use a tourniquet and clean it with soap or alcohol between uses. Use something stretchy if you can. Belts and shoelaces can cause bruising and vein damage. If you have nothing, a friend's hand can do the trick. Just have them squeeze above your injection site.
- Release the tourniquet after you're in. If you inject too much fluid too fast, you can blow the vein much easier.
- You can probably reuse your own tourniquet a few times. Throw it away if it gets dirty, bloody, or if it is used by someone else. If you can't get another one after a few uses, you can clean it with soap and water or alcohol. This will weaken it, so make sure to get a new one soon.
- **BEST:** tourniquet
- **BETTER:** something stretchy or a friend's clean hand
- **WORST:** nothing

Cleaning the skin

- Soap and water works very well. Use a clean towel, paper towel, or air dry.
- If using a swab, start where you plan to inject, and wipe in an expanding circle. (Like the Yellow Brick Road)
- Alcohol swabs have 70% ethanol or 140 proof.
- Most liquor is only 40% alcohol, or 80 proof. This not an effective cleanser, but it better than nothing.
- Alcohol, chlorhexidine, and



iodine need to be allowed time to dry or they do not work.

- Chlorhexidine wipes available in the United States have the same amount of alcohol plus a small amount of chlorhexidine.
- Chlorhexidine/alcohol probably works better than alcohol alone.

Please take at least as many swabs as you have needles

- **BEST:** wash with soap and water, then wipe with alcohol swab
- **BETTER:** wipe with alcohol swab, wipe with cotton ball and rubbing alcohol, hydrogen peroxide, iodine, or bleach. Rub with hand sanitizer. Wipe away visible dirt and particles with clean water. Wipe with drinking liquor.
- **WORST:** injecting into dirty skin.

Needles

- Needle shaft sizes become smaller as the number goes up just like piercings. An 18 gauge needle is bigger than a 28 gauge needle.
- Needle length can also vary.
- Any size syringe barrel can be attached to any size needle.
- Our most popular needle is **28g ½ in with a 1mL barrel**. This is ideal for medium sized veins, but can also be used for smaller or larger ones or muscling. The needle tips are not removable.
- For large muscles or if there is a lot of fat above the muscle, use a 1 in needle to be sure you are in deep enough, for smaller muscles like women's arms, you can use a ½ in needle.
- For shooting in larger veins like the femoral, we offer **25g 1 in needles with a 3mL barrel**. The needle tips are removable.
- For smaller veins like hands, it is best to use the smallest needle you can, like a 31g 5/16 in.
- For injection of hormones or to drain an abscess, we have **18g, 20g, and 22g 1 ½ in needle tips**.
- We also have:
 - 31g 5/16 in needle with a 1 mL barrel**
 - 28g ½ in needles with a ½ mL barrel**
 - 25g 5/8 in needle with a 1 mL barrel**
- Use a new needle and syringe every time if you can. If you must share, limit the number of people you share with.

- Needles that have been reused tear larger holes in your skin and veins.
- Inject with the bevel facing up.
- Practice injection techniques with both hands so that you can rotate your injection site. To learn this, try to use your other hand on a friend or when you're not in a hurry. Get comfortable with the equipment by playing with empty stuff in your other hand.
- **BEST:** new, sterile needle and syringe.
- **BETTER:** re-used only once, shared with only one person.
- **WORST:** sharing and reusing.

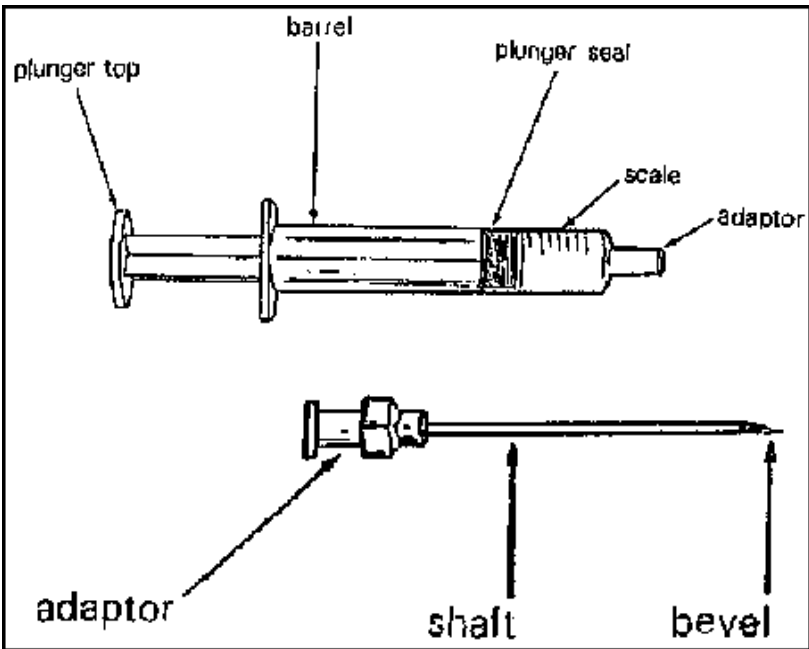

Tips for buying syringes:

- Dress up in your most boring, respectable outfit
- Use correct terms: "I would like 100 28 gauge, half inch, 1mL (or 1cc) syringes"

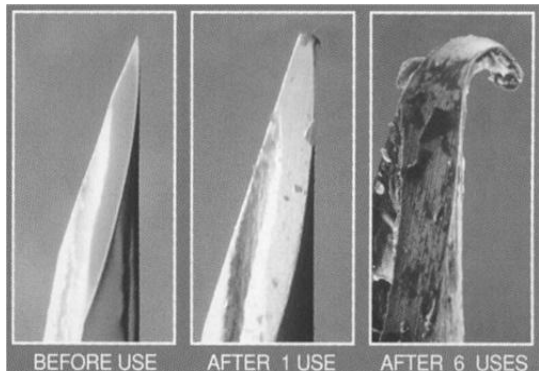

- Remember that it is legal to buy or have syringes. You could be a diabetic or transgendered person for all they know.

Injecting in veins

- Hold the needle with the bevel up. (see picture below)
- Insert into the vein at a 45° angle. You can get the angle by pointing straight up and down and then lowering the syringe halfway. If you miss, you can pull back a little bit, not enough to remove from the skin, and try again. Don't dig around in there too much. If you miss repeatedly or blow the vein, remove the needle and start again somewhere else.
- To check if you are in the vein, you can pull back gently on the plunger to see if you get blood coming back into the syringe. If the blood is slow moving and dark red, you are in the vein. If it is bright red and frothy, you are in an artery.
- If you hit an artery, place a clean tissue or towel over the injection site and pull out slowly. Keep pressure on the site for at least one minute and then check to be sure the bleeding has stopped. If you can't stop the bleeding, call your healthcare provider or 911. Once bleeding stops, you shouldn't have anything to worry about other than infection. Don't use this spot again for a couple days
- Once you are sure you hit the vein, release the tourniquet.
- Push the drugs in slowly to be sure you don't overload and break the vein.
- Place a clean tissue or towel over the site and slowly remove the needle. Keep pressure on the site for a few seconds.
- If bleeding has not stopped after a few seconds, place pressure with the tissue over the site for one full minute and check again. If you can't get bleeding to stop, see a healthcare provider or call 911.
- Cover with a sterile bandage and don't use this site again for a couple days.

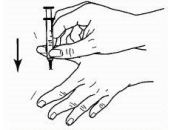
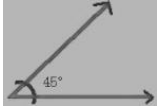

Injecting in a muscle

- Pinch the muscle.
- Insert the needle straight down.
- Inject the fluid slowly. This decreases pain and makes the pool of fluid inside your muscle smaller, possibly decreasing chances of abscess formation.
- Place a clean tissue or gauze over the site

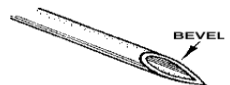

and slowly remove the needle. Keep pressure on the site for a few seconds.

- If bleeding has not stopped after a few seconds, place pressure with the tissue over the site for one full minute and check again. If you can't get bleeding to stop, see a healthcare provider or call 911.
- Cover with a sterile bandage and don't use this site again for a couple days.

Femoral Injecting

- Try to use arms, legs, hands, and feet before shooting in your fem. It is very dangerous and increases your risk of abscesses, blood clots, infection, and loss of a leg.
- **Hitting your femoral vein will not make you higher.**
- Hitting an artery can increase injection risks. You know you've hit an artery when bright red blood rushes into the syringe without pulling back and it hurts worse than usual. Place a clean tissue or towel over the injection site and pull out slowly. Keep pressure on the site for at least one minute and then check to be sure the bleeding has stopped. If you can't stop the bleeding, call 911. Once bleeding stops, you shouldn't have anything to worry about other than infection. Don't use this spot again for a couple days
- If you hit a nerve, it will hurt a LOT. Some people report a sharp pain running down their leg. Pull out slowly and put light pressure on the site until bleeding stops. It should feel better in a few days, but this may cause permanent damage to your nerve, affecting movement and feeling.
- Clean your groin very carefully. You may need to use two or more swabs.

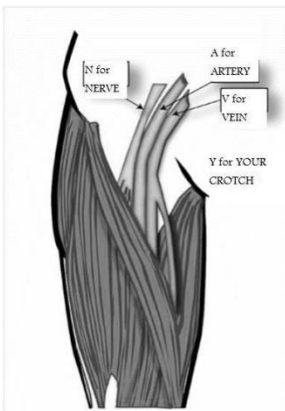

- To find your vein, remember NAVY (nerve, artery, vein, your crotch).
- When you find a pulse, this is your artery. Place your middle finger over the pulse and your pointer finger should be over the vein.
- Insert the needle straight down, not at an angle like for arm veins. Pull back on the syringe, looking for dark



red, slow blood. Inject slowly.

- Place pressure with a clean tissue over the site for 1 minute, or until the bleeding has stopped.
- Cover with a sterile or clean bandage and don't use this site again for a couple days.

Safe Disposal

- **BEST:** We will take your dirty works in any container and safely dispose of them for you.
- **BETTER:** You can keep yourself and the community safe by using wide mouth hard plastic bottles like sports drink bottles or laundry detergent bottles.
- **WORST:** Please never put dirty rigs into regular garbage or on the ground. If you must, please cap them well to keep others safe.

COCAINE & METHAMPHETAMINE

- Eat a small meal before you use these drugs, because they decrease your hunger.
- Get high in a cool room with good ventilation, because these drugs make you hot.
- The longer your session, the less high you will get. Taking a break even for 10 min can help you recharge. Set yourself an alarm every hour or two to remind you to pee, take a walk, drink some water, or another calming activity.
- Pipes and straws can have tiny bits of blood on them which transmit disease. Please don't share!

Smoking crack cocaine

- Smoking anything is bad for your lungs and respiratory system. Crack smoking can cause burns, constriction of the airway, and other problems.
- Oral herpes (HSV, "cold sores") and tuberculosis (TB) can be spread by spit or blood on a pipe.
- Hepatitis C can be spread by invisible specks of blood and can survive on a pipe for a long time.
- **Using lemon juice to break down crack for injection can cause fungal infections. Please don't do it! Use 1 part citric acid and 3 parts crack.**

- Taking good care of your lips and mouth is very important in preventing skin breaks. Lip balm and chewing gum should be used to keep lips and mouth moist and intact.

Crack smoking step by step

- Place the filter into the pipe and push it back and forth with the pusher (chopstick) and when it is compressed enough, leave it near one end. The filter keeps burning chunks of crack from flying into your mouth, throat, or lungs. Change filters often, as they can break down and become flying chunks as well. If you use a metal pusher, it can chip or weaken the pipe, so use something softer like a chopstick.
- Put a crack condom over the other end. This is to protect your lips from burning if the pipe becomes hot, and can help reduce disease transmission if you are not using your own new pipe.
- Dance the lighter flame close to, but not directly on the pipe. This should still be hot enough to create the crack vapor without making the whole pipe burning hot. It will also make your rock last longer
- To break down crack for injection, use 1 part citric acid for 3 parts crack.

Screens

- **BEST:** There is no perfect screen that we know of.
- **BETTER:** Brass pipe screens from a smoke shop can be wadded up and placed inside a stem. They break down slowly, but can become flying chunks of burning metal, so should be replaced often. The brillo filters that we pass out can break down quickly and release lots of tiny bits of burning metal, so they should also be replaced often.
- **WORST:** no filter.

Methamphetamine smoking step by step

- Check your pipe for cracks or weak spots before you use it.
- Put your drugs into the bulb part of the pipe
- Dance the lighter around the bottom of the bulb until a vapor forms

Keep in mind that meth smoke is heavy and will hover near the floor. If you have a baby, small child, or pet at home, never smoke in the same room with them, to avoid exposing them to meth smoke.

Pipes

- **BEST:** Use a new glass, heat resistant pipe with a crack condom and don't share!
- **BETTER:** Clean rose or incense stem.
- **WORST:** Using plastic bottles, cans, car antennas, or light bulbs to smoke out of can involve inhaling toxic fumes.

DIY EQUIPMENT STERILIZATION

- **New and sterile is always best. Come see us!**

Otherwise, the Center for Disease Control (CDC) recommends:

- Boiling glass or metal items for 30 minutes. This will not kill bacterial spores. Plastic may warp or melt.
- Immersion in bleach and water with a ratio of 1:50 for 5 min. **DO NOT MIX BLEACH WITH ANYTHING BUT WATER.** If you do, it may release vapor that can kill you.
- Immersion in Hydrogen Peroxide and water 1:10 for 30 min.
- Immersion in 70% alcohol for 5 min. This will not kill bacterial spores. (Rubbing alcohol is usually at least 70%, while most drinking liquor is only 40% and will not work as well.)

To make a solution with a ratio of 1:10 use one cup of the first thing and ten cups of the second thing. Example: bleach and water 1:50 would be 1 cup of bleach in 50 cups of water

Other recommendations:

- Bake at 350° for 60 min.
- Immersion in vinegar is recommended but there are no parameters as to time, concentration, etc. Kills E. Coli.

Not recommended, but probably better than nothing:

- Microwave **latex** parts for 12 min.
- Lighter flame does not work for sterilization, but if you hold the flame until the item is very hot, it's probably better than nothing. Be sure it's cool before use.

- Rinsing removes large particles and some blood. It will not protect against disease. Running water is better than water that has been sitting for a while. Use the cleanest water possible.

Remember, if any one piece of your works is contaminated, the whole process is contaminated. These tips can help you be safer, but please **use new everything every time** if you can! (with the exception of ties, see p. 8)

COMMON HEALTH PROBLEMS

Cellulitis

- This is a localized area of infection without a capsule.
- Symptoms are pain, heat, swelling, and redness around an injection site.
- Elevate the limb. Cover any open area with a clean bandage.

Please see a healthcare provider:

If it does not get better in a few days

If you have signs of sepsis or blood poisoning (see p. 18)

If there are red lines coming away from it



Abscess

- An abscess forms when there is an infection below the skin that the body can surround and contain in a capsule.
- Abscesses are more common when you muscle.
- An abscess in your fem can cause you to lose your leg.
- **Abscesses are not fatal if treated early.**

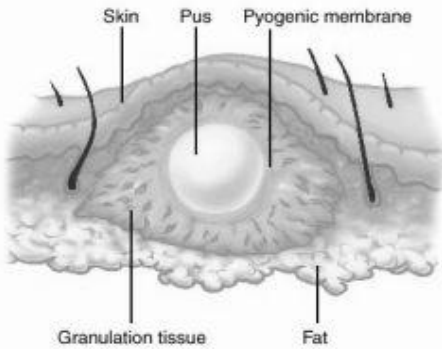

- If left untreated, abscesses can pop outside the body and be ok, or inside the body, possibly leading to sepsis.
- Symptoms include: localized heat, swelling, pain, or redness near an injection site.
- To help an abscess heal on its own, raise the area above the rest of your body. You can also use hot packs for about 15 minutes every few hours.
- A healthcare provider can lance (pop) the abscess for you, prescribe antibiotics and pain killers, and give you bandage material

Abscess care

- We provide wound care kits, which contain gloves, gauze, antibiotic ointment, and tape.
- It is *very dangerous* to lance a femoral abscess yourself.
- If your abscess has red lines coming away from it, please see a healthcare provider immediately.

To lance an abscess at home:

For abscesses in hard to reach places, like the femoral vein, do this in a bathtub or shower. Clean the tub when you are done.

Materials: soap and water, rubbing alcohol or wipes, gloves, a large sterile needle (at least 25g, preferably bigger – ask us for 18g tips) or sterile knife, bowl to catch fluid, gauze, tape, antibiotic ointment

- Wash hands and abscess site thoroughly and soak in rubbing alcohol if you have it. Put on gloves.
- For a small abscess, use sterile needles to poke several holes in the abscess until fluid runs out. You can also pull back on the syringe to pull fluid out of an abscess. For a larger one, make the smallest hole possible with the knife, no more than an inch and a half.
- Milk the area around the abscess to get all the fluid out.

- For a larger abscess, rinse it out with sterile/clean water and then milk that out as well.
- Clean the area with soap and water.
- Cover the area with antibiotic ointment and a sterile/clean bandage.

Continue to use hot packs for a few days. Change the bandage after each hot pack, whenever it gets wet, or daily until healed.

Sepsis (blood poisoning)

- Can happen when germs get into your blood stream and start growing. It can be something on your skin, on the needle, cooker, cotton, something in the drugs, something that gets in an old injection site, or a localized infection spreading.
- Prevent sepsis by using new works every time, never sharing, and rotating your site.
- Symptoms include increased or sometimes decreased temperature, nausea, increased heart rate and breathing rate, and low blood pressure. You can check for this by looking at the color and warmth of hands and feet. Press with one finger on the bottom of a finger or toe and see how long it takes to turn pink again. It should be less than 3 seconds unless your circulation is bad in that arm or leg for other reasons, like blocked veins.
- Please see a healthcare provider. Sepsis can kill you. Treatment should include blood tests, IV antibiotics, and probably IV fluids and a few days in the hospital.
- If you can't go to a healthcare provider, only use as much as you need to avoid withdrawal, drink lots of fluids, pee often, eat, rest, stay warm but not too warm (temp of 104 °F/40 °C or greater can cause permanent brain damage).

Endocarditis

- Endocarditis is infection of the inside of the heart. Its causes are similar to the causes of sepsis, just that instead of being in every part of your body (yet), the infection settles on one or more heart valves.
- The valves can get tiny mushroom-like vegetation growing on them and they may not close properly,

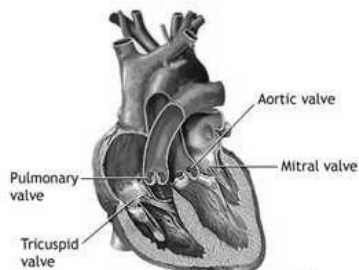

leading to heart failure. If vegetation breaks off and goes somewhere else, sepsis can result.

- Please see a healthcare provider! There is nothing you can do at home for endocarditis other than remaining generally healthy.
- Symptoms: fever, chills, fatigue, aches, night sweats, difficulty breathing, paleness, swelling of feet, cough, weight loss, bloody urine and:

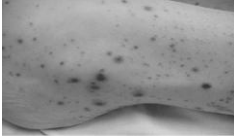

Petechiae (Pe-TEEK-ee-ay)



Osler's Nodes

Hepatitis C

- Caused by a virus in blood
- There is no vaccine for Hep C
- Prevention:
Don't share: needles, pipes, coke straws, ANY other works, toothbrushes, razors. Ok to share food and drinks, kiss and hug as long as there are no open sores on either of you.
There are different kinds of Hep C, so even sharing between 2 Hep C+ people is not safe.
Be aware of skin breaks on hands, mouth, etc.
Get tested

- Signs and symptoms:
Acute infection: right after exposure, usually no symptoms, 20% of people clear infection without treatment.
Chronic infection: Developed by 80% of exposed people. Causes fatigue, less commonly nausea, ↓appetite, joint pain.
- At home treatment
↓ alcohol, marijuana, herbal supplement, other drug use.
Get plenty of sleep at about the same time every night, eat as healthy as you can, lots of fruits and vegetables, and drink water!
Herbal treatments are best discussed with a healthcare provider.
Hep A and B are worse when you also have C, but there are vaccinations for A and B, so get vaccinated.

Medical treatments for Hep C are getting better rapidly! Check with your doctor about which treatment options are available.

Overdose (OD) Prevention and Treatment/Detox

- Drug tolerance
When your body becomes used to a drug and needs increasing amounts to do the same thing.
- Drug dependence (addiction)
When your body becomes used to constantly having a drug so that it becomes sick when the drug is withheld.
- Opiate overdose
Overdose happens when you have so much opiate in your body that breathing stops. It can be opiates alone or combined with other drugs like alcohol or benzodiazepines.
- Methamphetamine or Cocaine Overdose
There is no official overdose point. When you get over apmeed, you can have heart attack, stroke, aneurysm, or seizures, which can cause death. Call 911 immediately for: chest pain, difficulty breathing, passing out, seizures, sudden confusion, or droopy face.
- The only kinds of withdrawal that can kill grown ups are alcohol, benzodiazepines, and barbiturates. Please see a [healthcare provider](#) or at least slow down gradually before stopping if you have severe shakes, irregular heartbeat, confusion, fever, or hallucinations.
- Opiate withdrawal symptoms include: pain, nausea, sweating, runny nose, emotional ups and downs, trouble sleeping, throwing up, and diarrhea. Length of time depends on which opiates were used and how often. Usually the worst is over in a few days.
- Detoxification under anesthesia is not proven to shorten your detox time or eliminate your physical or psychological addiction and can come with fatal complications.
- Detoxification should be accompanied by treatment of underlying reasons for drug use.

Withdrawal and pregnancy:

- Opiate withdrawal can cause severe developmental problems or death to a fetus or newborn. If you are pregnant and want to stop using drugs, please do not do so without medical supervision or at least slow down gradually before stopping.
- Not every newborn whose mother used drugs will have withdrawal symptoms. Going in for checkups, eating healthy, and taking prenatal vitamins can decrease risk of newborn effects.
- Withdrawal in newborns usually starts in first day or two but can start as late as one week of life. Signs of withdrawal in newborns are: jitters (shaking of arms and legs that stops when you place a hand on the limb), constant crying, constantly flexed muscles, poor feeding, diarrhea, seizures (jitters that don't stop when you place a hand on the limb, or sometimes the only sign is repeatedly twitching eyeballs), constant or frantic sucking, skin breakdown especially on elbows and knees from rubbing clothing during jitters.
- If you used drugs during pregnancy and your baby was not observed for at least 48 hours by a healthcare provider, or if you used a long acting opiate like methadone, look for signs of withdrawal and report to a healthcare provider if your baby has seizures, skin breakdown, doesn't get better after 1 week, or isn't able to eat enough. You can tell the baby is getting enough if she pees about 6 times a day, poops at least once a day, and is gaining weight.

Opiates, anti-opiates, cocaine and meth

- *Opiates activate the receptors in your brain (also called an agonist)*
heroin, opium, morphine, methadone, fentanyl, oxycontin, oxycodone (Percocet), hydrocodone (Vicodin, Norco), codeine (Tylenol 3 or Canadian 222s), meperidine (Demerol), hydromorphone (Dilaudid), nalbuphine (Nubain), propoxyphene (Darvon)
Slows down heart rate and breathing → less oxygen and nutrients to your body.
Slows down poop in your colon and urine in your bladder → constipation and urinary tract infections.
Interrupts menstrual periods → decreased fertility.

- *Opiates/opiate blockers sometimes activate and sometimes block receptors (also called an agonist/antagonist)*
buprenorphine (Subutex), buprenorphine/naloxone (Suboxone), butorphanol (Stadol), pentazocine (Talwin)
- *Opiate blockers block receptors Naloxone (Narcan) Naltrexone (Revia) (also called an antagonist)*
Blocks receptors and kicks other opiates out temporarily. Causes immediate withdrawal symptoms. More on that on p. 23
- *Cocaine and Amphetamines*
Put you into “fight or flight” mode → increased heart rate, breathing, increased need for oxygen and nutrients, decreased appetite.
Speeds up poop in your colon → diarrhea.
Interrupts menstrual periods → decreased fertility.

Treatment drugs

Methadone

- Methadone is a long lasting opiate painkiller. It can stay in the body fluids for up to 3 days, and possibly hide out in the liver for even longer, especially if you have liver disease.
- Methadone as a substance comes with similar health risks to heroin. The benefits of methadone treatment are that it is not an illegal activity, and that it can help reduce unhealthy behaviors associated with unprescribed opiate use.
- Because of how long it stays in the body, methadone overdose is a very real risk. Each dose may not be processed completely before more is taken. Combination with other drugs should be discussed with your healthcare provider. Drugs prescribed for pain, anxiety, depression, and unprescribed drugs can also cause respiratory depression, causing a person to stop breathing.
- Methadone use during pregnancy can cause similar fetal development problems and withdrawal symptoms to babies born dependent on heroin. It is important to continue methadone treatment during pregnancy, as cold turkey can be fatal to the fetus (unborn baby).

Buprenorphine (Subutex) and buprenorphine/naloxone (Suboxone)

- Buprenorphine is a mixed agonist/antagonist. If taken too soon after a dose of opiates, it can cause withdrawal. This is especially true for Suboxone, and especially true if injected.
- Treatment is usually started for a few days on Subutex, and then maintenance Suboxone.
- As a mixed agonist/antagonist, buprenorphine can cause respiratory depression and other classic opiate side effects, or it can cause withdrawal symptoms if taken with other opiates.
- Researchers are not sure about whether buprenorphine, methadone, or heroin dependent babies have less symptoms.
- If you are already on Suboxone when you become pregnant, it is fine to continue. If you become pregnant and seek treatment, you will probably be prescribed methadone to avoid fetal withdrawal. Talk to your healthcare provider about drugs and pregnancy.

Naloxone (Narcan)

- Narcan is a short acting opiate blocker, which means that it kicks out other opiates and blocks opiate receptors in the brain for 60 – 90 minutes. **It does not remove the drugs from the body.** It will only work for opiate overdose or opiates and something else. It may not work for Suboxone or Subutex, because buprenorphine holds onto the receptor very tightly.
- **Give 1mL in a large muscle**, like the butt, thigh, or upper arm. Do not inject into a vein, as this can take too long, or possibly cause seizures and complications.
- **Takes about 1-3 minutes** and lasts about 60-90 min.
- **You can repeat** doses every few min **until they wake up.**
- While you wait for them to wake up, **give rescue breathing** (mouth to mouth). Chest compressions are not usually necessary. If they still have a pulse, they do not need chest compressions.
- Recent changes to the CPR guidelines suggest that you use only chest compressions and no mouth to mouth breathing. These guidelines are meant for people whose problem is that their heart stopped beating. In opiate overdose, the breathing stops first and the heart keeps beating for several minutes. So for us, breathing is still the most important thing.
- **Indiana law requires that you call 911.** Say “my friend is not breathing”. If you say, “my friend is overdosing on drugs”, the dispatcher may send an ambulance and a police car.

- Does not “reverse” overdose, just postpones it. If the body cannot get rid of enough drugs before Narcan wears off, they will go back into OD.
- They will wake up sick and upset.
- **DO NOT LET THEM FIX.** First, it will not work anyway until Narcan wears off. Second, they still have drugs circulating in their blood, so fixing can lead to a second overdose.
- During pregnancy, overdose or withdrawal caused by Narcan can cause the baby to die or have severe developmental problems. Please give Narcan, provide rescue breathing and call 911 immediately.

Rescue Breathing (mouth to mouth)

- Tilt the head back a little bit and lift the chin.
- Plug the nose with the hand that is on their forehead.
- Place your mouth completely over the other person’s and give a slow breath until you see the chest rise.
- If you do not see the chest rise, reposition and look to see if there is anything in the mouth blocking the airway.
- Once you get chest rise, give one small breath every 5 seconds.
- They may throw up. Turn the head to the side so they don’t choke if you are sure their neck isn’t hurt.

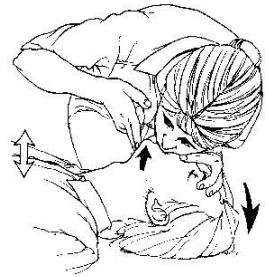

Treatment services

- Alcoholics Anonymous
812.336.0400
<http://dist10.area23aa.org/>
- Narcotics Anonymous
812.331.9767
<http://www.naindiana.org/>
- Centerstone
645 S Rogers Bloomington, IN
812.339.1691 <https://www.centerstone.org>
- Restorative Solutions
1602 W 3rd St Bloomington, IN 47404
(812) 337-0771 <http://restorativerecoveryolutions.com/>
- Amethyst House
645 N Walnut St Bloomington, IN

812.336.3570

<http://www.amethysthouse.org>

HIV/Hepatitis C services

- Positive Link
333 East Miller Drive, Bloomington, IN
812.353.9150 or 800.313.4645
- Volunteers in Medicine
811 W 2nd St
Bloomington, IN
812.333.4001
<http://www.vimmonroecounty.org/>

REFERENCES

- Series of informal interviews with Jeanette Puccio BSN, RN (IV therapy specialist) from Jan 2012-2014 **re: vein care**
- Interview with Dr. Phillip Coffin (overdose prevention specialist) on 1/17/2012 **re: naloxone, overdose, and pregnancy**
- Input from staff 1/24/2012: Shilo, Ria, Cate, Lee, Tony, and Colin.

Websites:

- <http://consensus.nih.gov/2002/2002HepatitisC2002116html.htm> **Hep C overview**
- <http://www.medpagetoday.com/MeetingCoverage/AASLD/29655> **Milk Thistle for Hep C**
- <http://www.scn.org/crisis/medical.html> **Seattle area free/reduced fee clinics**
- <http://www.kingcounty.gov/healthservices/health/communicable/hiv/resources/needle.aspx> **Public Health Needle Exchange hours and locations**
- http://www.cdc.gov/hicpac/pdf/guidelines/Disinfection_Nov_2008.pdf **CDC disinfection guidelines**

Research articles:

- [Urology](#). 1990 Mar;35(3):219-22. Microwave: practical cost-effective method for sterilizing urinary catheters in the home. [Douglas C](#), [Burke B](#), [Kessler DL](#), [Cicmanec JF](#), [Bracken RB](#). Department of Surgery, University of Cincinnati Medical Center, Ohio.
- [PLoS One](#). 2012 ;7(9):e44277. Epub 2012 Sep 5. The forgotten role of alcohol: a systematic review and meta-analysis of the clinical efficacy and perceived role of [chlorhexidine](#) in skin antiseptics. [Maiwald M](#), [Chan ES](#). Department of Pathology and Laboratory Medicine, KK Women's and Children's Hospital, Singapore, Singapore; Department of Microbiology, National University of Singapore, Singapore, Singapore; Duke-National University of Singapore Graduate Medical School, Singapore, Singapore.
- [J Urol](#). 1989 Jan;141(1):88-90. Microwave sterilization: a method for home sterilization of urinary catheters. [Silbar EC](#), [Cicmanec JF](#), [Burke BM](#), [Bracken RB](#). Department of Surgery, University of Cincinnati Medical Center, Ohio.
- [N Engl J Med](#). 2010 Dec 9;363(24):2320-31. Neonatal abstinence syndrome after methadone or buprenorphine exposure
- [J Biomed Sci](#). 2010 Jun 7;17:46. Enhancement of tolerance development to morphine in rats prenatally exposed to morphine, methadone, and buprenorphine.
- [Eur J Clin Pharmacol](#). 2011 Oct;67(10):1053-9. Epub 2011 May 3. Buprenorphine versus methadone in pregnant opioid-dependent women: a prospective multicenter study.
- [Guidelines for injecting in the groin: A femoral injecting resource](#) by the Asia regional HIV/AIDS Project retrieved from: http://www.shootclean.org/Downloads/femoral_injecting_final.pdf

Good websites for harm reduction info:

- www.Harmreduction.org
- www.bluelight.ru (information on message boards may not be accurate)

About the Indiana Recovery Alliance:

The IRA collaborates with and assists people towards making positive change, as the person defines it for themselves, without judgment of their lifestyle. We envision a community with comprehensive harm reduction services within reach of anyone seeking recovery, as they define recovery. Our core values include dignity and respect; engaged and participatory decision-making; harm reduction philosophy and practices.

Contact the IRA: 812-964-9497,
www.facebook.com/indianarecoveryalliance
indianarecoveryalliance.org (coming soon)

About Joelle:

I've been a nurse since May 2009. I have degrees from Bellevue Community College, Lake Washington Technical College, and the University of Washington. My specialties are neonatal intensive care (sick babies), Postpartum (well moms and babies). I have been with PHRA since February 2010. I have researched a lot for this zine, but you certainly have knowledge that I don't have. If you have a safer use tip or story, please share!

Contact Joelle: Joelle@peoplesharmreductionalliance.org