



BIAX

Professional Power

GRINDERS, FILES AND DEBURRING TOOLS

Pneumatic tools for professionals

resistant · consistent · approved



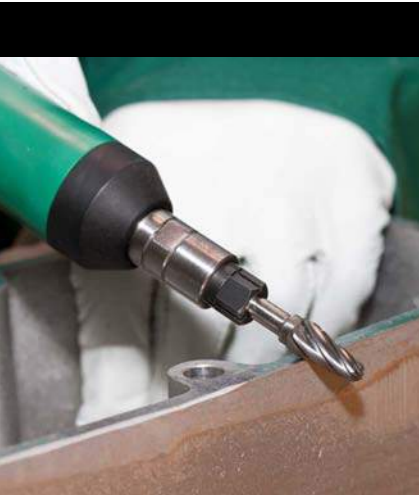

BIAX pneumatic tools –
A class of their own.

Table of contents	Page
Oil-free grinders	4
High speed mini grinders 85.000 rpm	5-6
High-power grinders 20.000 - 55.000 rpm	7-11
Rough grinders 10.000 - 18.000 rpm	12
Angle grinders 20.000 - 85.000 rpm	13-14
Belt sander 20.000 rpm	15-16
Angle drilling deburrers	17-18
Drilling deburrers	19
Brushing tools	20
Chisels & drills	21 ^{SW14}
Filers	22-24 ^{SW17}
Saws	25
Accessories	26-30
Order forms for catalogues	31

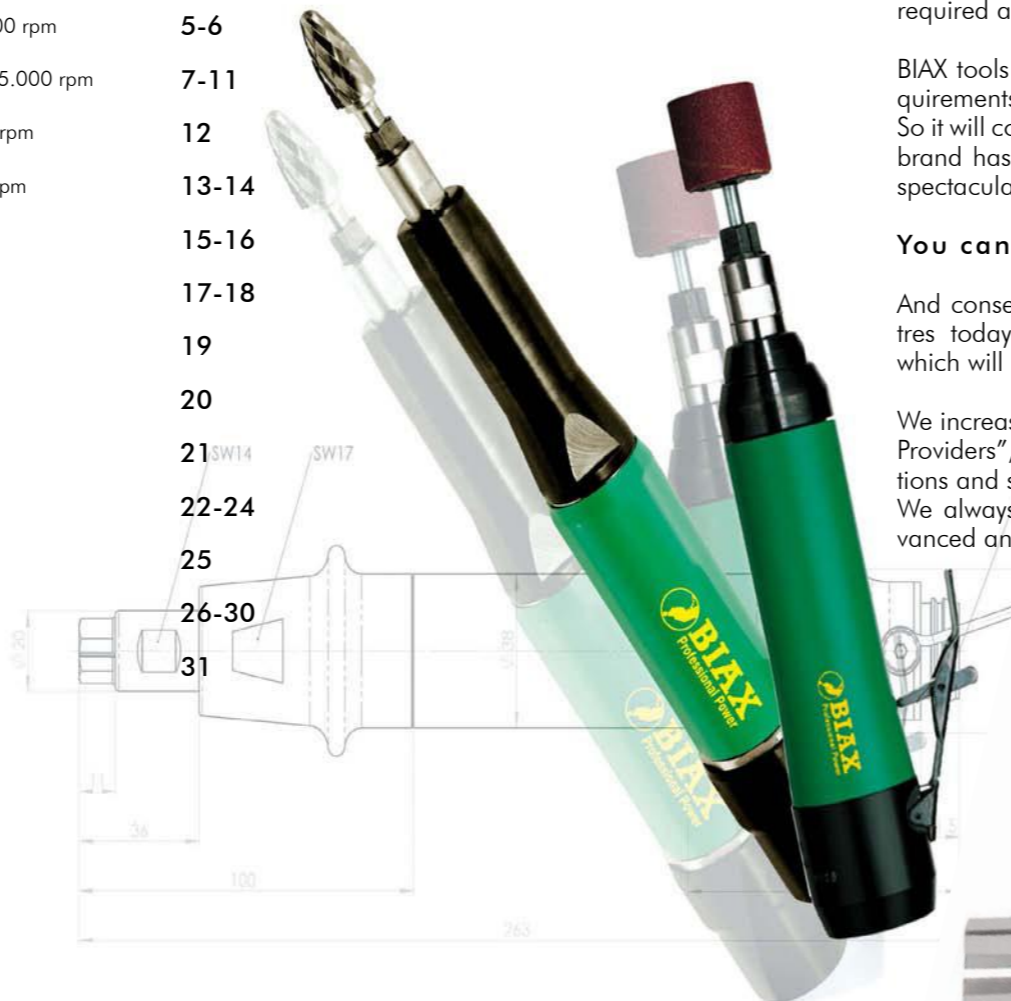

BIAX – Quality since 1919

Schmid & Wezel was one of the first companies to work with pneumatic tools and to carry out real pioneering work in this field.

The company has stood for high precision, quality and collaboration since 1919. If pneumatic tools are the topic of discussion nowadays — wherever in the world it may be — the BIAX brand is often the main point of conversation.

This is because of our superb product quality and pursuit of technical perfection. These virtues have been the basis and guarantor of our success since 1919.

BIAX – A partner for the industry

If you develop and manufacture tools for industrial use, you have to know what is required and be receptive to the market.

BIAX tools meet market demand, the requirements and wishes of our partners. So it will come as no surprise that the BIAX brand has frequently produced the most spectacular innovations in the industry.

You can expect a lot from BIAX

And consequently our development centres today are still producing products which will set future standards.

We increasingly see ourselves as “Service Providers”, who offer you complete solutions and services.

We always strive to be better, more advanced and efficient than anyone else.

BIAX – superior technology and impressive quality.

The superior technology of BIAX products is especially evident in the many careful details. For example, the high-quality materials from which we manufacture all our devices. Or the user-friendly device which is always designed to meet the latest ergonomic requirements specific to a working person.

Not to mention the superb workmanship and long-term operational reliability. For us this is a matter of course - for you it is indispensable!

After all, BIAX devices are amongst the best on the market

The future with BIAX

This catalogue contains many of the pneumatic tools you might need in your company.

If you can't find just what you need, give us a call. If it falls under our expertise, we will find a solution. And that's a promise!



Quality -
Made in Germany

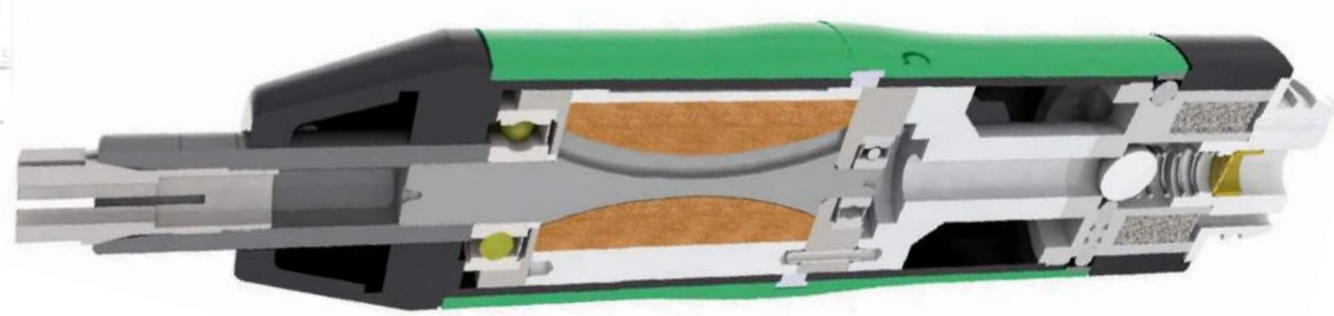

BIAX pneumatic tools - for the manufacture of your high-quality products only the best will do!

Oil-free grinders - for finest deburring operations

TVD 3-100/2



TVD 3-100/2

100.000 rpm and an elastic spindle support mean you achieve an optimal surface quality when working on metallic materials. Noise emissions are also low. Thanks to the turbo drive it can be operated without lubrication (oil-free). No chatter marks also with finest deburring jobs.

T 3-65 S



T 3-65 S

This newly developed, low-maintenance turbine drive is very powerful and runs at 65.000 rpm. The motor requires absolutely no oil. Thanks to the double support, clean surfaces can be achieved quickly and easily. Persuasive due to smooth and gentle mode.

T 365/2



T 365/2

The turbo drive means that this machine needs no lubrication either. A brake run provides a high level of safety. A governor valve ensures that the speed remains constant whatever the load and serves to reduce air consumption. An elastic spindle support considerably improves the surface quality and reduces the wear of the milling tool.

T 6-50 S



T 6-50 S

With the same ergonomic design like the turbo grinder T 3-65 S and also oil-free and silent pneumatic actuator. Developed specifically for use with shaft diameters up to 6 mm. Thus ideal for spotting of molds.

TSD 385



TSD 385 / TSH 385

This grinder, with its multi-disc motor, has a unique and patented oil-free drive. As with turbo drives, the machine needs no lubrication and is nevertheless slim and handy. It has the same durability of lubricated multi-disc motors. A double row of bearings means that this grinder is even suited to extreme applications.

(TSH 385 - but with lever valve)

Name	TVD 3-100/2	T 3-65 S	T 365/2	TSD 385	TSH 385	T 6-50 S
Valve	Rotary valve	Rotary valve	Slide valve	Rotary valve	Lever valve	Rotary valve
Exhaust air direction	forwards	backwards	backwards	backwards	backwards	backwards
Front bearing set	elastic	pair	elastic	pair	pair	pair
Revolutions per minute [min ⁻¹]	100.000	65.000	65.000	85.000	85.000	50.000
Power [watts]	80	80	80	100	100	150
Air consumption [l/min]	180	250	180	170	170	270
Noise level [db (A)]	70	70	70	74	74	70
Weight [g]	250	390	220	190	210	400
Max. tool shank Ø [mm]	3	3	3	3	3	6
Max. tool Ø [mm]						
- HM tools	3	3	6	4	4	6
- Profile grinding body	5	6	8	6	6	10
Synthetic grinding discs	-	-	-	-	-	-
Collet	ZG 5/3 mm	ZG 5/3 mm	ZG 5/3 mm	ZG 5/3 mm	ZG 5/3 mm	ZG 4/6 mm
Hose unit	001 366 537 inclusive	001 367 502 inclusive	001 366 594 inclusive	001 366 576 inclusive	001 366 576 inclusive	001 367 503 inclusive
Order no.	150 149 906	150 149 810	150 149 730	150 001 710	150 001 700	150 149 820

We will send you measurement and exploded drawings on request.

For fine grinding, milling and engraving works. 85.000 rpm

SRD 3-85/2 – SRH 3-85/2

This perfectly constructed machine can be also fitted at the front with a pair of high-performance supports instead of a single one and is, therefore, the ideal tool for extreme and long-term use.

It is nevertheless light and sits snugly in your hand. Due to the high speed of this grinder it creates a very clean pattern, which makes it ideal for fine grinding, milling and engraving jobs.

The following variants of the machine are available:

Support: Single or pair
Valve: Rotary or lever valve
Exhaust air direction: Backwards or forwards

BIAX Compressed air tools

For example, the lubrication-free high speed products. Professionals from all over the world appreciate the excellent product characteristics and exemplary quality.

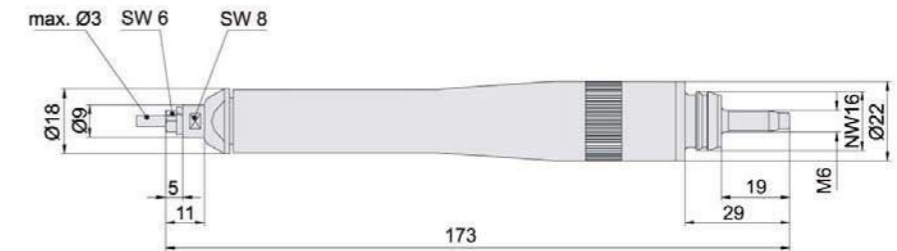

SRD 3-85/2

SRD 3-85/2

SRH 3-85/2

Name	SRD 3-85/2	SRD 3-85/2D	SVD 3-85/2	SVD 3-85/2D	SRH 3-85/2	SRH 3-85/2D	SVH 3-85/2	SVH 3-85/2D
Valve	Rotary valve	Rotary valve	Rotary valve	Rotary valve	Lever valve	Lever valve	Lever valve	Lever valve
Exhaust air direction	backwards	backwards	forwards	forwards	backwards	backwards	forwards	forwards
Front bearing set	single	pair	single	pair	single	pair	single	pair
Revolutions per minute [min ⁻¹]	85.000	85.000	85.000	85.000	85.000	85.000	85.000	85.000
Power [watts]	80	80	80	80	80	80	80	80
Air consumption [l/min]	170	170	170	170	170	170	170	170
Noise level [db (A)]	76	76	78	78	76	76	78	78
Weight [g]	130	140	180	190	170	170	210	220
Max. tool shank Ø [mm]	3	3	3	3	3	3	3	3
Max. tool Ø [mm]								
- HM tools	4	4	4	4	4	4	4	4
- Profile grinding body	6	6	6	6	6	6	6	6
Synthetic grinding discs	-	-	-	-	-	-	-	-
Collet	ZG 5/3 mm	ZG 5/3 mm	ZG 5/3 mm	ZG 5/3 mm	ZG 5/3 mm	ZG 5/3 mm	ZG 5/3 mm	ZG 5/3 mm
Hose unit	001 366 595 inclusive	001 366 595 inclusive	001 366 537 -	001 366 537 -	001 366 595 inclusive	001 366 595 inclusive	001 366 539 -	001 366 539 -
Order no.	150 001 060	150 001 035	150 001 085	150 001 080	150 001 065	150 001 040	150 001 070	150 001 075

We will send you measurement and exploded drawings on request.

High-speed pencil grinders. 55.000 rpm



SRD 3-55/2

Lightweight, with a proven, low-vibration SRD 355 motor; it ensures high precision and a long operating life. Its lightness and ergonomic form means that you don't tire quickly and allows you to carry out delicate deburring. It can be guided like a pencil and is also qualified for fine grinding, milling and engraving operations.

SRD 3-55/2 S

The unique quick-change system works with standard tools such as HM cutters or grinding bodies.

- No opening and shutting the collet with tool keys — you save time and increase productivity
- No collet wear — you save money.

SRD 3-55/2 KE

The basis of the machine is the standard model. This tool also has an adjustable attachment for cutting edges. Different settings create different chamfer values. A very fast and consistent chamfering is the result.

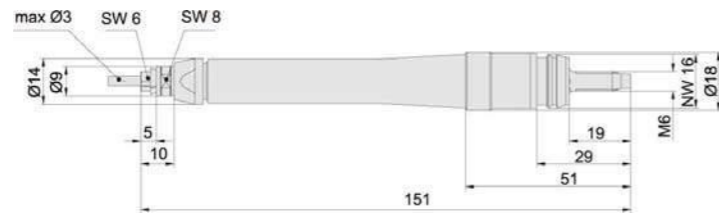

SRD 3-55/2

Name	SRD 3-55/2	SRD 3-55/2 S	SRD 3-55/2 KE
Valve	Rotary valve	Rotary valve	Rotary valve
Exhaust air direction	backwards	backwards	backwards
Front bearing set	single	single	single
Revolutions per minute [min ⁻¹]	55.000	55.000	55.000
Power [watts]	60	60	60
Air consumption [l/min]	170	170	170
Noise level [db (A)]	74	74	74
Weight [g]	93	103	95
Max. tool shank Ø [mm]	3	3	3
Max. tool Ø [mm]			
- HM tools	6	4	TCA 0303-63 incl.
- Profile grinding body	8	8	-
Synthetic grinding discs	-	-	-
Collet	ZG 5/3 mm	-	ZG 5/3 mm
Hose unit	001 366 595 inclusive	001 366 595 inclusive	001 366 595 inclusive
Order no.	150 000 925	150 000 935	150 000 965

We will send you measurement and exploded drawings on request.

High-power grinders. 45.000 rpm

SRD 6-45/2 – SRH 6-45/2

This high-performance grinder is the improved successor of the proven straight grinder SRD 645. Despite the high speed of 45.000 rpm, it consumes just 260 W of power. This design required a further improvement of the ratio of performance to air consumption. The lightweight and ergonomic shape also ensure perfect handling.

SRD 6-45/2 SL

This BIAX grinder has a special floating support which prevents chatter marks, and guarantees an excellent surface quality. Furthermore it operates with reduced noise level.

SRD 3-45/2 – SRH 3-45/2

A finish similar to that achieved with the SRD 6-45/2, but using a long, thin tool spindle to reach more difficult to access areas.

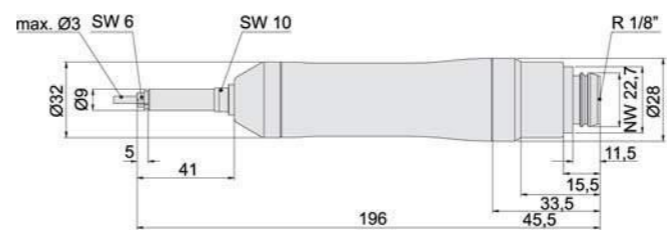

SRD 3-45/2

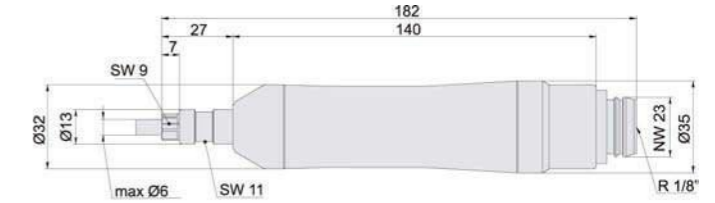

SRD 6-45/2

Name	SRD 6-45/2	SRH 6-45/2	SRD 6-45/2 SL	SRH 6-45/2 SL	SRD 3-45/2	SRH 3-45/2
Valve	Rotary valve	Lever valve	Rotary valve	Lever valve	Rotary valve	Lever valve
Exhaust air direction	backwards	backwards	backwards	backwards	backwards	backwards
Front bearing set	single	single	floating	floating	single	single
Revolutions per minute [min ⁻¹]	45.000	45.000	45.000	45.000	45.000	45.000
Power [watts]	260	260	260	260	260	260
Air consumption [l/min]	380	380	380	380	380	380
Noise level [db (A)]	76	76	76	76	76	76
Weight [g]	310	360	590	610	310	360
Max. tool shank Ø [mm]	6	6	6	6	3	3
Max. tool Ø [mm]						
- HM tools	8	8	8	8	8	8
- Profile grinding body	10	10	10	10	10	10
Synthetic grinding discs	-	-	-	-	-	-
Collet	ZG 4/6 mm	ZG 4/6 mm	ZG 4/6 mm	ZG 4/6 mm	ZG 5/3 mm	ZG 5/3 mm
Hose unit	001 366 577	001 366 577	001 366 577	001 366 577	001 366 577	001 366 577
Order no.	150 010 750	150 010 760	150 010 755	150 010 765	150 010 770	auf Anfrage

We will send you measurement and exploded drawings on request.

High-power grinders. 30.000 rpm

SRD 8-30/2



SRD 8-30/2 SRH 8-30/2
SARD 830 SARH 830

Due to its revolution speed and high performance this quality machine can be used diversely, e.g. with a collet for tools of 3–8 mm diameter.
A very impressive machine that stands for endurance and strength whilst meeting all ergonomic and weight requirements.
A version with a pair of supports for hard applications is also available.

SBRD 830



SBRD 830 SBRH 830

The machine was constructed using the SRD 8-30/2 as a basis, and is designed for extreme loads.
The extended spindle means you can use it with both hands.
The pair of bearing set increases the tool's life. Ideal for slight roughing of cast parts.

SVKH 630



SVKH 630

Easy to handle and strong - these two characteristics come together perfectly in this machine.
Its compact size, high torque and the special forward exhaust air direction are additional features.

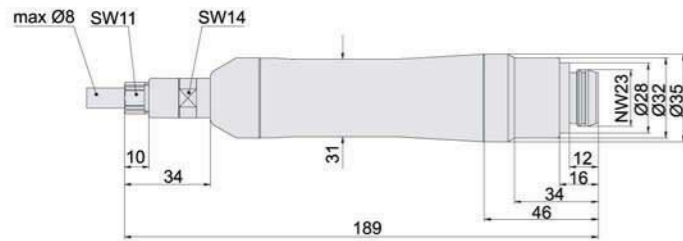

SRD 8-30/2

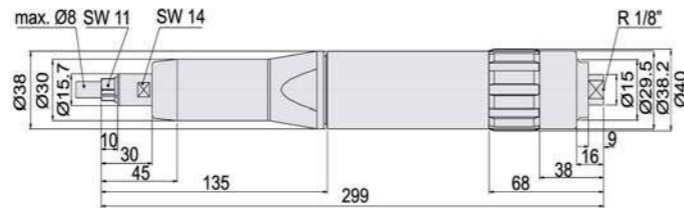

SBRD 830

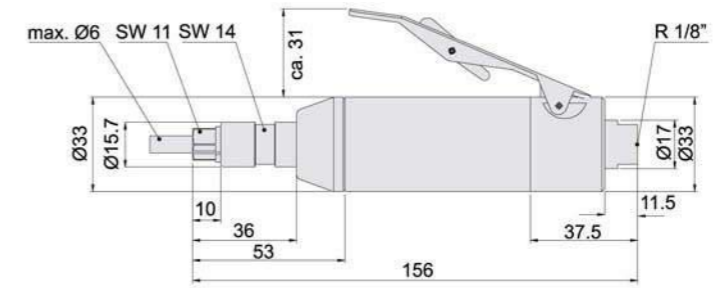

SVKH 630

(please see the table page 8)

Name	SRD 8-30/2	SRH 8-30/2	SARD 830	SARH 830	SBRD 830	SBRH 830	SVKH 630
Valve	Rotary valve	Lever valve	Rotary valve	Lever valve	Rotary valve	Lever valve	Lever valve
Exhaust air direction	backwards	backwards	backwards	backwards	backwards	backwards	forwards
Front bearing set	single	single	pair	pair	pair	pair	single
Revolutions per minute [min ⁻¹]	30.000	30.000	30.000	30.000	30.000	30.000	30.000
Power [watts]	240	240	260	260	260	260	280
Air consumption [l/min]	450	450	400	400	400	400	420
Noise level [db (A)]	76	76	75	75	75	75	78
Weight [g]	370	410	500	520	720	750	360
Max. tool shank Ø [mm]	8	8	8	8	8	8	8
Max. tool Ø [mm]							
- HM tools	10	10	10	10	10	10	10
- Profile grinding body	16	16	16	16	16	16	16
Synthetic grinding discs	32	32	32	32	32	32	32
Collet	ZG 7/6 mm	ZG 7/6 mm	ZG 7/6 mm	ZG 7/6 mm	ZG 7/6 mm	ZG 7/6 mm	ZG 7/6 mm
Hose unit	001 366 577	001 366 577	001 366 505	001 366 505	001 366 505	001 366 505	001 366 502
Order no.	150 010 920	150 010 925	150 012 005	150 012 015	150 012 022	150 012 032	150 011 850

We will send you measurement and exploded drawings on request.

SRD 8-30/2 SL SRH 8-30/2 SL

This BIAX grinder has a special floating support which prevents chatter marks and ensures a super surface quality.

SRD 6-30/2 SRH 6-30/2

This high-performance grinder is the improved successor of the proven straight grinder SRD 630. Despite its high speed of 30.000 rpm, it consumes just 150 W of power.
This design required further improvement of the ratio of performance to air consumption. The lightweight and ergonomic shape also ensure perfect handling.

SRD 3-30/2

Achieves the same finish as the SRD 6-30/2, but with the use of a long, thin tool spindle to reach more difficult to access areas.

SRD 8-30/2 SL
low vibration



SRD 6-30/2



SRD 3-30/2



Name	SRD 8-30/2 SL	SRH 8-30/2 SL	SRD 6-30/2	SRH 6-30/2	SRD 3-30/2
Valve	Rotary valve	Lever valve	Rotary valve	Lever valve	Rotary valve
Exhaust air direction	backwards	backwards	backwards	backwards	backwards
Front bearing set	floating	floating	double	double	double
Revolutions per minute [min ⁻¹]	30.000	30.000	30.000	30.000	30.000
Power [watts]	240	240	150	150	150
Air consumption [l/min]	450	450	370	370	370
Noise level [db (A)]	76	76	74	74	74
Weight [g]	500	540	335	390	345
Max. tool shank Ø [mm]	8	8	6	6	3
Max. tool Ø [mm]					
- HM tools	10	10	8	8	6
- Profile grinding body	16	16	12	12	10
Synthetic grinding discs	32	32	-	-	-
Collet	ZG 7/6 mm	ZG 7/6 mm	ZG 4/6 mm	ZG 4/6 mm	ZG 5/3 mm
Hose unit	001 366 577	001 366 577	001 366 577	001 366 577	001 366 577
Order no.	150 010 922	150 010 926	150 011 520	150 011 510	150 011 522

We will send you measurement and exploded drawings on request.

High-power grinders. 20.000 rpm

SRD 8-20/2



SRD 8-20/2 SRH 8-20/2

The basic version of this ergonomically precise straight grinder is available in three different types. All have a sound damping exhaust air direction and are also available with a safety lever valve.

SRH 8-20/2 SL
low vibration



SRD 8-20/2 SL SRH 8-20/2 SL

This powerful machine has been designed with floating bearing. Long-term use is significantly improved also for rough work.

SRD 8-20/2 L 100



SRD 8-20/2 L 100 bzw. L 200
SRH 8-20/2 L 100 bzw. L 200

The machines are available in short, medium (L100) and long (L200) versions and thus ideal for jobs in hard to reach scopes.

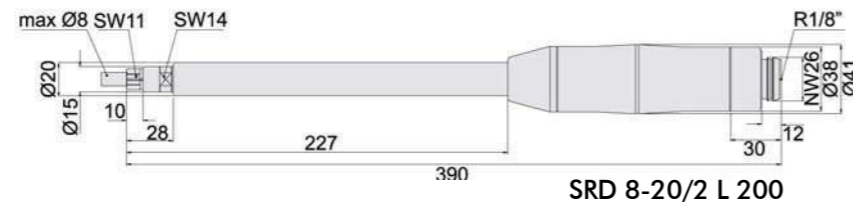

SRD 8-20/2 L 200

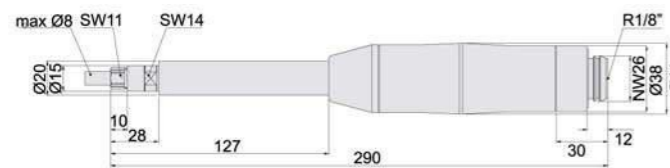

SRD 8-20/2 L 100

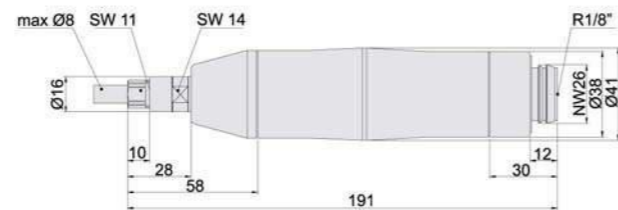

SRD 8-20/2

High-power grinders. 20.000 rpm

SARD 820 SARH 820

This is a powerful 20.000 rpm straight grinder based on the SRD 8-20/2 (see page 10). To overcome the high load it is subjected to, the tool spindle has a double support.



SARD 820

SBRD 820 SBRH 820

It has been designed for extreme loads. The elongated spindle allows use with both hands. The double support ensures a long life, even in the most difficult conditions - such as rough machining.



SBRD 820

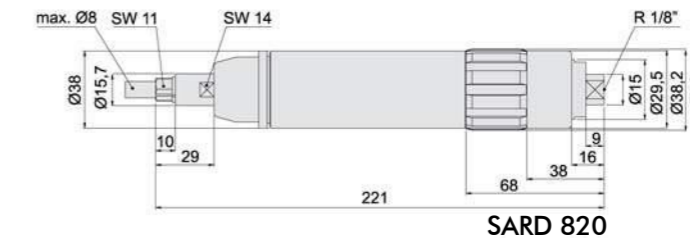

SARD 820

Name	SRD 8-20/2	SRH 8-20/2	SRD 8-20/2 SL	SRH 8-20/2 SL	SRD 8-20/2 L100	SRH 8-20/2 L100	SRD 8-20/2 L200	SRH 8-20/2 L200
Valve	Rotary valve	Lever valve	Rotary valve	Lever valve	Rotary valve	Lever valve	Rotary valve	Lever valve
Exhaust air direction	backwards	backwards	backwards	backwards	backwards	backwards	backwards	backwards
Front bearing set	single	single	floating	floating	elastic	elastic	elastic	elastic
Revolutions per minute [min ⁻¹]	20.000	20.000	20.000	20.000	20.000	20.000	20.000	20.000
Power [watts]	300	300	300	300	300	300	300	300
Air consumption [l/min]	500	500	500	500	500	500	500	500
Noise level [db (A)]	74	74	74	74	74	74	74	74
Weight [g]	570	620	630	680	750	790	940	980
Max. tool shank Ø [mm]	8	8	8	8	8	8	8	8
Max. tool Ø [mm]								
- HM tools	12	12	12	12	12	12	12	12
- Profile grinding body	24	24	24	24	24	24	24	24
Synthetic grinding discs	40	40	40	40	40	40	40	40
Collet	ZG 7/6 mm	ZG 7/6 mm	ZG 7/6 mm	ZG 7/6 mm	ZG 7/6 mm	ZG 7/6 mm	ZG 7/6 mm	ZG 7/6 mm
Hose unit	001 366 578	001 366 578	001 366 578	001 366 578	001 366 578	001 366 578	001 366 578	001 366 578
Order no.	150 020 700	150 020 800	150 020 705	150 020 805	150 020 710	150 020 810	150 020 720	150 020 820

We will send you measurement and exploded drawings on request.

Name	SARD 820	SARH 820	SBRD 820	SBRH 820
Valve	Rotary valve	Lever valve	Rotary valve	Lever valve
Exhaust air direction	backwards	backwards	backwards	backwards
Front bearing set	double	double	double	double
Revolutions per minute [min ⁻¹]	20.000	20.000	20.000	20.000
Power [watts]	300	300	300	300
Air consumption [l/min]	500	500	500	500
Noise level [db (A)]	73	73	73	73
Weight [g]	770	830	1040	1100
Max. tool shank Ø [mm]	8	8	8	8
Max. tool Ø [mm]				
- HM tools	12	12	12	12
- Profile grinding body	24	24	24	24
Synthetic grinding discs	40	40	40	40
Collet	ZG 7/6 mm	ZG 7/6 mm	ZG 7/6 mm	ZG 7/6 mm
Hose unit	001 366 505	001 366 505	001 366 505	001 366 505
Order no.	150 021 105	150 021 125	150 021 135	150 021 115

We will send you measurement and exploded drawings on request.

Roughing and polishing grinders. 10.000 up to 18.000 rpm

SBRH 818



SBRH 818

The ideal machine for the hardest applications. This is guaranteed in particular by the extremely powerful motor. Designed for two-handed operation with two high-performance bearing sets, this grinder is a faithful servant.

SRH 10-12/2 SRH 10-15/2

One construction type, 2 speeds:
12.000 rpm or
15.000 rpm.

You can, therefore, pick the right one for your requirements. SRH 10-15/2 - elastic spindle support to take good care of the cutters.

SRH 10-12/2 - rigid spindle support for brushing.
The machines of the SRH series are equipped with a safety lever.

SRH 8-10

With the reduced speed of 10.000 rpm and the double bearing sets, this machine is perfectly suited to demanding polishing and grinding work.

The low weight and noise also make the user's experience more pleasant.

SRH 10-12/2
SRH 10-15/2



SRH 8-10

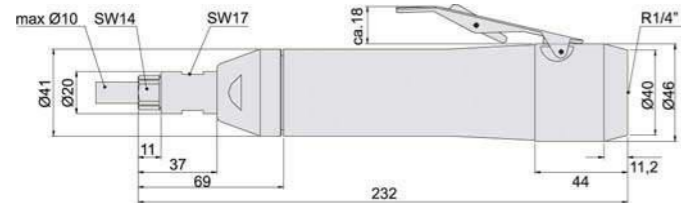

**SRH 10-12/2
SRH 10-15/2**



BIAX - Tungsten carbide tools for an efficient metal working.

Name	SBRH 818	SRH 10-15/2	SRH 10-12/2	SRH 8-10
Valve	Lever valve	Lever valve	Lever valve	Lever valve
Exhaust air direction	backwards	backwards	backwards	backwards
Front bearing set	double	elastic	single	double
Revolutions per minute [min ⁻¹]	18.000	15.000	12.000	10.000
Power [watts]	550	400	400	280
Air consumption [l/min]	750	700	700	300
Noise level [db (A)]	79	80	79	67
Weight [g]	1440	970	960	645
Max. tool shank Ø [mm]	8	10	10	8
Max. tool Ø [mm]				
- HM tools	15	15	15	16
- Profile grinding body	30	24	24	24
Synthetic grinding discs	40	40	40	40
Collet	ZG 7/6 mm	ZG 8/6 mm	ZG 8/6 mm	ZG 7/6 mm
Hose unit	001 366 528	001 366 580	001 366 580	001 366 505
Order no.	150 021 210	150 010 955	150 010 950	150 010 980

We will send you measurement and exploded drawings on request.

Angle grinders. 20.000 up to 85.000 rpm

WRD 3-85/2 WRH 3-85/2

The angle head of this machine is very small. Carrying out good work in very inaccessible places is now much easier. Another advantage: the drive is in the angle head. This means that gears are not required, meaning less weight and no wear.

**WRD 6-20/3 Z WRH 6-20/3 Z
WRD 10-20/3 S WRH 10-20/3 S**

These small-powerful angle grinders have a flat head, robust gears and, with their double bearing sets, are superbly suited to transferring high torque.

You have the choice of two tool-receiving sockets:

- 6 mm collet
- M10 mounting thread



WRH 3-85/2



WRD 6-20/3 Z



WRH 10-20/3 S



Professional tools have to have a long life, be robust and operationally sound. BIAX pneumatic tools meet all of these requirements.

Name	WRD 3-85/2	WRH 3-85/2	WRD 6-20/3 Z	WRH 6-20/3 Z	WRD 10-20/3 S	WRH 10-20/3 S
Valve	Rotary valve	Lever valve	Rotary valve	Lever valve	Rotary valve	Lever valve
Exhaust air direction	backwards	backwards	backwards	backwards	backwards	backwards
Front bearing set	pair	pair	pair	pair	pair	pair
Revolutions per minute [min ⁻¹]	85.000	85.000	20.000	20.000	20.000	20.000
Power [watts]	100	100	300	300	300	300
Air consumption [l/min]	170	170	500	500	500	500
Noise level [db (A)]	74	74	78	78	78	78
Weight [g]	260	230	730	770	880	920
Max. tool shank Ø [mm]	3	3	6	6	M10	M10
Max. tool Ø [mm]						
- HM tools	4	4	12	12	-	-
- Profile grinding body	6	6	24	24	-	-
Synthetic grinding discs	-	-	75	75	80	80
Collet	ZG 5/3 mm	ZG 5/3 mm	ZG 4/6 mm	ZG 4/6 mm	-	-
Hose unit	001 366 595 inclusive	001 366 595 inclusive	001 366 578	001 366 578	001 366 578	001 366 578
Order no.	150 100 315	150 100 305	150 123 475	150 123 485	150 123 455	150 123 465

We will send you measurement and exploded drawings on request.

Angle grinders. up to 20.000 rpm



WRD 6-20/2 ZL 90 WRH 6-20/2 ZL 90
WRD 6-20/2 ZL 45 WRH 6-20/2 ZL 45

The finish of the angle grinder with elongated neck and a small angle head is particularly suited to working in not easy to reach places with a high degree of precision and performance.

Two versions are available:
version with 90° head (ZL 90)
version with 45° head (ZL 45)

WRH 14-13/2

This BIAX pneumatic angle grinder has its drive in the angle head and works without fault-prone gears - and is very powerful.

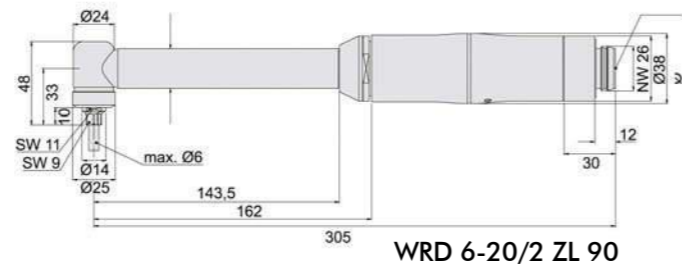
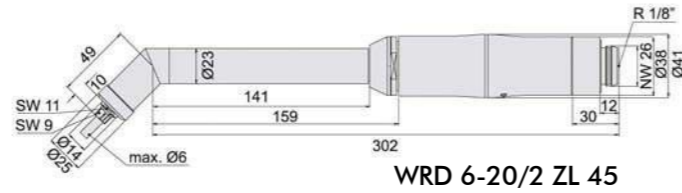

Name	WRD 6-20/2 ZL 90	WRH 6-20/2 ZL 90	WRD 6-20/2 ZL 45	WRH 6-20/2 ZL 45	WRH 14-13/2
Valve	Rotary valve	Lever valve	Rotary valve	Lever valve	Lever valve
Exhaust air direction	backwards	backwards	backwards	backwards	backwards
Front bearing set	single	single	single	single	single
Revolutions per minute [min ⁻¹]	20.000	20.000	20.000	20.000	13.000
Power [watts]	300	300	300	300	600
Air consumption [l/min]	500	500	500	500	700
Noise level [db (A)]	78	78	78	78	80
Weight [g]	930	960	940	980	1760
Max. tool shank Ø [mm]	6	6	6	6	M14
Max. tool Ø [mm]					
- HM tools	10	10	10	10	-
- Profile grinding body	16	16	16	16	-
Grinding plate	50	50	50	50	115
Collet	ZG 4/6 mm	ZG 4/6 mm	ZG 4/6 mm	ZG 4/6 mm	-
Hose unit	001 366 578	001 366 578	001 366 578	001 366 578	001 366 580
Order no.	150 123 430	150 123 440	150 123 490	150 123 500	150 912 010

We will send you measurement and exploded drawings on request.

Belt sanders. 20.000 rpm

HBH 200

It is not only being able to change the belt so quickly that makes this belt grinder so distinctive.

You can grind an area using the telescopic arm and then change to grinding a point on the rubber roller with the fixed grinding arm. This can be done very easily with a clamping screw.

In addition, the machine is available, entirely in accordance with your requirements, with grinding arms for belt widths of 8, 15 or 20 mm.

Changing them is easy and requires little effort.

HB 12 S

The unique belt guide system allows the use of very small belt widths without the belt coming off the roller.

The tensioning system ensures continual tension in the belt thus contributing to the safety of the guide system.

Available in lever or rotary valve variants. Individual work through the rotatable head. Furthermore it has a protective cap for safe handling.

HB 20

The HB 20 has a motor in the angle head. This means there is almost no wear.

With a belt width of 20 mm and a fixed belt support the machine is perfect for working on long edges, such as sheets of metal, or for the production of tools. Grinding belts are available in different grain sizes.

HB 15-1

Light and compact belt sander for belt widths between 8 and 15mm.

Different grinding arms in straight and angled forms are available.



To retain your position as market leader you must always be a step ahead of the competition.



Name	HBH 200	HB 12 S	HB 20	HB 15-1
Valve	Lever valve	Lever valve	Lever valve	Lever valve
Exhaust air direction	backwards	backwards	backwards	backwards
Front bearing set	pair	single	single	single
Revolutions per minute [min ⁻¹]	20.000	20.000	20.000	20.000
Power [watts]	300	300	300	300
Air consumption [l/min]	500	500	500	420
Noise level [db (A)]	78	78	81	78
Weight [g]	870	1470	1520	960
Max. belt width [mm]	20	12	20	15
Hose unit	001 366 578	001 366 505	001 366 505	001 366 505
Order no.	150 123 770	150 123 105	150 122 602	150 123 645

Grinding arms not included incl. grinding arm without grinding arm

We will send you measurement and exploded drawings on request.



Grinding arms for HBH 200					Grinding belts		
Roller Ø	Width	14,0 mm	14,0 mm	14,0 mm	Length x width	Grit	Order no.
Name	S 8 B	S 15 B	S 20 B		330 x 8	60	001 620 509
Rubber roller	150 124 875	150 124 880	150 124 885		for S 8 A	120	001 620 511
					S 8 B	180	001 620 512
						240	001 620 513
Name	S 8 A	S 15 A	S 20 A		330 x 15	60	001 620 508
Steel roller	150 124 850	150 124 855	150 124 860		for S 15 A	80	001 620 515
					S 15 B	120	001 620 516
					S 15 C	180	001 620 517
						240	001 620 518
Name	-	S 15 C	S 20 C		330 x 20	60	001 620 584
Steel roller	-	150 124 865	150 124 870		for S 20 A	120	001 620 586
					S 20 B	180	On request
					S 20 C	240	On request
Grinding arms for HB 12 S					Grinding belts		
Roller	Roller Ø	Belt width	Name	Order no.	Length x width	Grit	Order no.
Rubber	16 x 3	6	HB 6163	150 123 320		60	001 620 559
					610 x 6	120	001 620 561
						180	001 620 562
						240	001 620 570
Rubber	25 x 9	6	HB 6259	150 123 330		60	001 620 559
					610 x 6	120	001 620 561
						180	001 620 562
						240	001 620 570
Steel	8 x 9	12	HB 1289	150 123 310		60	001 620 565
					610 x 12	120	001 620 567
						180	001 620 568
						240	001 620 571
Rubber	16 x 9	12	HB 12169	150 123 300		60	001 620 565
					610 x 12	120	001 620 567
						180	001 620 568
						240	001 620 571
Rubber	18 x 12	12	HB 121812	150 123 340		60	001 620 565
					610 x 12	120	001 620 567
						180	001 620 568
						240	001 620 571
Grinding arms for HB 15-1 (without picture)					Grinding belts		
Roller	Roller Ø	Belt width	Name	Order no.	Length x width	Grit	Order no.
Steel	11 x 5	8	8 A-1	150 122 020		60	001 620 509
					330 x 8	120	001 620 511
						180	001 620 512
						240	001 620 513
Steel	11 x 12	15	15 A-1	150 122 120		60	001 620 508
					330 x 15	120	001 620 516
						180	001 620 517
						240	001 620 518
Steel	11 x 12	15	15 C-1	150 122 320		60	001 620 508
					330 x 15	120	001 620 516
						180	001 620 517
						240	001 620 518
Steel	11 x 12	15	15 AL-1	150 122 520		60	001 620 572
					475 x 15	120	001 620 573
						180	001 620 574
						240	001 620 575

Angle drilling deburrers

BEW 309 E

Our top device when it comes to deburring in difficult-to-reach places, such as holes in cross holes. The height (excluding countersink) of the very low-wear drive head is just 15 mm and can, therefore, also reach very narrow places. The extremely quiet and light drive can be set from 0 to 900 RPM and has very low air consumption: 150 l/min.



Sink area/hole-Ø 2-6 mm
(HSS) 001 950 293 (incl.)
(HM) 001 950 299
Sink area/hole-Ø 2,5-10 mm
(HSS) 001 950 297

BEW 606

This angle-design machine allows you to deburr holes in very difficult-to-reach places, e.g. holes in cross holes, which have to be deburred from the inside. The measurement drawings below show the different head sizes. Adjustable speed from 0 to 600 RPM.

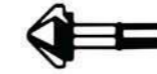

Sink area/hole-Ø 3,5-14 mm
Shaft hexagon 6,3 mm
001 950 294 (incl.)

BEW 606 K

This variant of the proven BIAx hole deburrer has an improved leverage effect due to its shortness so that deburring can take place with little pressure.



Sink area/hole-Ø 3,5-14 mm
Shaft hexagon 6,3 mm
001 950 294 (incl.)

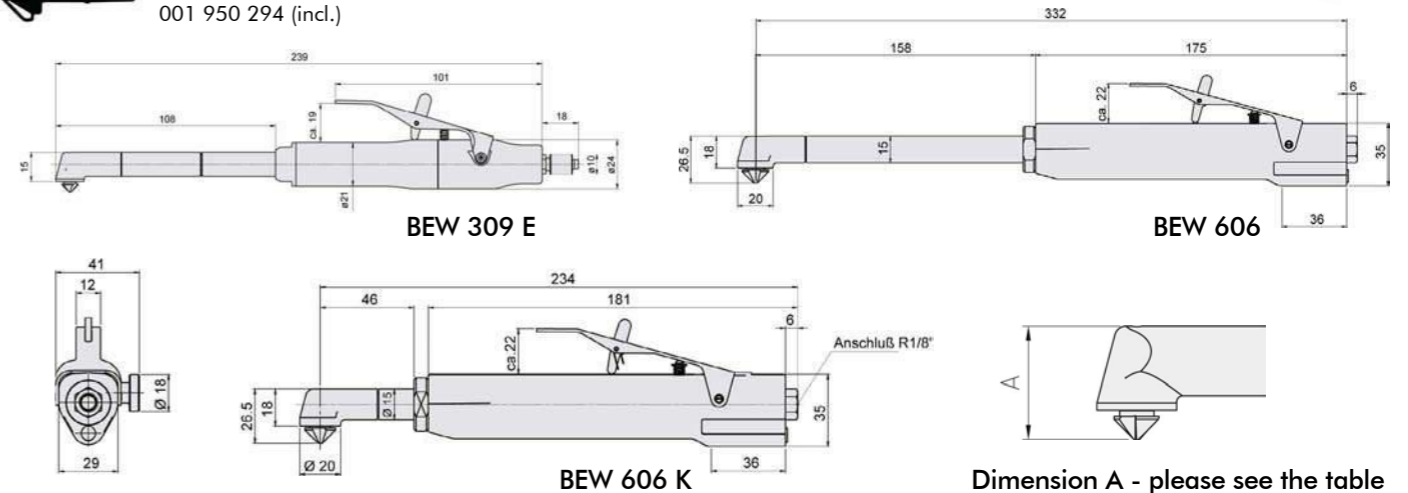

Dimension A - please see the table

Name	BEW 309 E	BEW 606	BEW 606 K	BEW 603
Valve	Lever valve	Lever valve	Lever valve	Lever valve
Exhaust air direction	backwards	backwards	backwards	backwards
Revolutions per minute [min ⁻¹]	0-900	0-600	0-600	0-300
Power [watts]	20	80	80	80
Air consumption [l/min]	150	300	300	300
Noise level [db (A)]	71	71	71	71
Weight [g]	240	810	630	630
Max. tool shank Ø [mm]	3 Skt	6,3 Skt.	6,3 Skt.	6,3 Skt.
Max. hole Ø [mm]	10	14	14	14
Countersink Ø [mm]	8 12	15	15	15
Head A at countersink [mm]	20,0 21,5	26,5	26,5	26,5
Hose unit	001 366 549	001 366 548	001 366 548	001 366 548
	inclusive	inclusive	inclusive	inclusive
Order no.	150 800 726	150 810 925	150 810 927	150 810 926

We will send you measurement and exploded drawings on request.

Angle drilling deburrers

BEW 605



BEW 605

This angle-design machine allows you to deburr holes in hard to reach areas, e.g. holes in cross holes, which have to be deburred from the inside.



Sink area/hole - Ø 3,5-14 mm
(HSS) 001 950 295
Sink area/hole - Ø 5-24 mm
(HSS) 001 950 296

BEW 605 K

This variant of the proven BIAx hole deburrer has an improved leverage effect due to its shortness so that deburring can take place with little pressure.



Sink area/hole - Ø 3,5-14 mm
(HSS) 001 950 295
Sink area/hole - Ø 5-24 mm
(HSS) 001 950 296

BEW 605 K

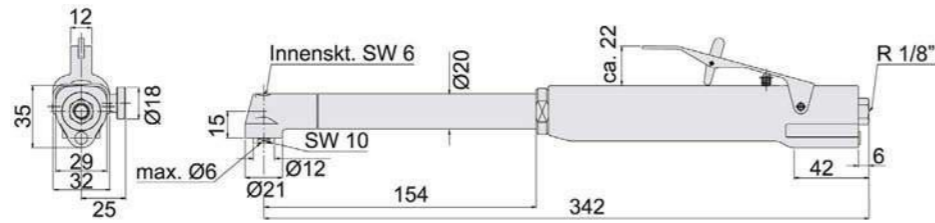

BEW 605

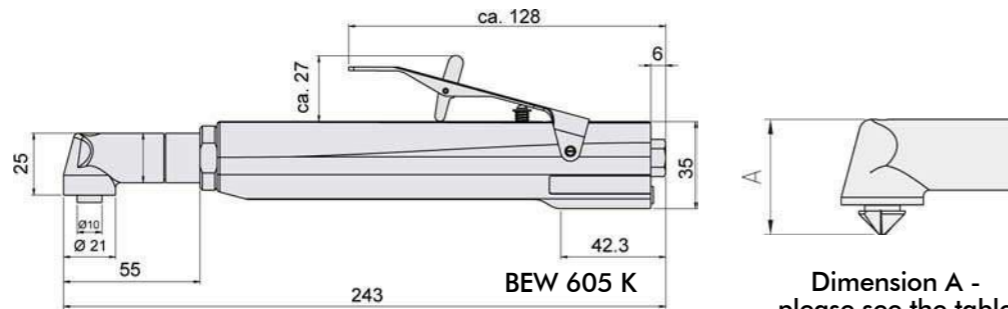

BEW 605 K

Dimension A - please see the table

Name	BEW 605	BEW 605 K
Valve	Lever valve	Lever valve
Exhaust air direction	backwards	backwards
Revolutions per minute [min ⁻¹] adjustable	0-500	0-500
Power [watts]	80	80
Air consumption [l/min]	300	300
Noise level [db (A)]	71	71
Weight [g]	820	620
Max. tool shank Ø [mm]	6	6
Max. hole Ø [mm]	24	24
Countersink Ø [mm]	15 25	15 25
Head A at countersink [mm]	40 48	40 48
Collet	6 mm	6 mm
Hose unit	001 366 548 inclusive	001 366 548 inclusive
Order no.	150 810 930	150 810 931

We will send you measurement and exploded drawings on request.

Drilling deburrers

BE 309 BE 805 BE 1005

The straight drilling deburrers come in three different sizes for different holes. The push start makes handling easier and you can also regulate the speed.

BEG 309

If it is not possible to set the countersink correctly, this lever version is recommended.

for BE 309 BEG 309



Sink area/hole - Ø 2-5,5 mm
(HSS) 001 950 292

for BE 805



Sink area/hole - Ø 3,5-14 mm
(HSS) 001 950 290
Sink area/hole - Ø 5-24 mm
(HSS) 001 950 291

for BE 1005



Sink area/hole - Ø 6-29 mm
(HSS) 001 950 341

Special countersinks available on request.



BE 309

BEG 309

BE 805

BE 1005

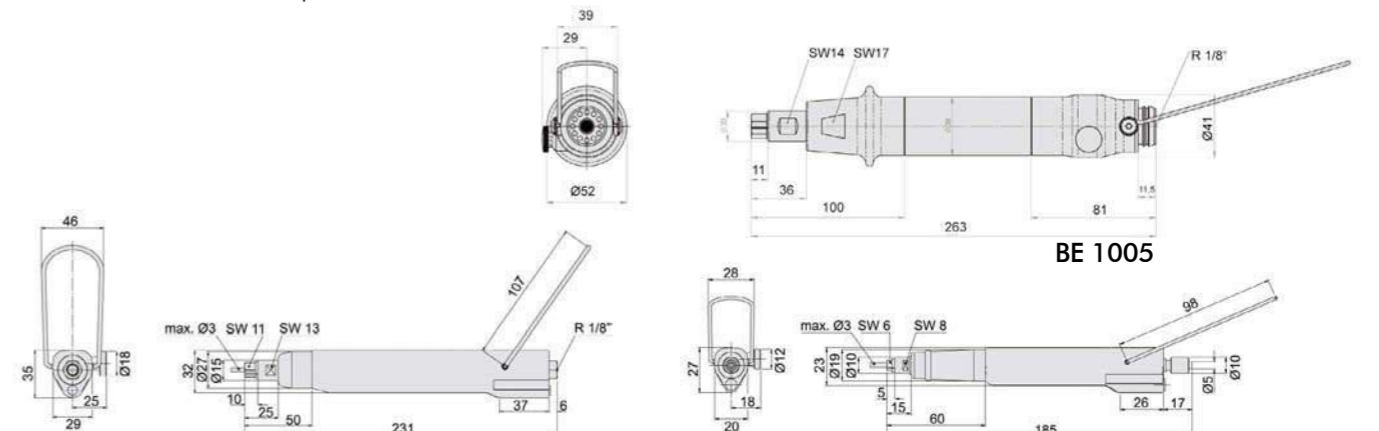

BE 805

BE 1005

BE 309

Name	BE 309	BEG 309	BE 805	BE 1005
Valve	Push start	Lever valve	Push start	Push start
Exhaust air direction	backwards	backwards	backwards	backwards
Revolutions per minute [min ⁻¹] adjustable	0-900	0-900	0-500	0-550
Power [watts]	20	20	80	200
Air consumption [l/min]	150	150	280	450
Noise level [db (A)]	71	71	71	76
Weight [g]	180	250	520	920
Max. tool shank Ø [mm]	3	3	8	10
Max. hole Ø [mm]	5,5	5,5	24	29
Countersink Ø [mm]	6	6	15 25	30
Collet	ZG 5/3 mm	ZG 5/3 mm	ZG 7/8 mm	ZG 8/10 mm
Hose unit	001 366 549 inclusive	001 366 549 inclusive	001 366 548 inclusive	001 366 578 inclusive
Order no.	150 800 710	150 800 745	150 810 901	150 800 800

We will send you measurement and exploded drawings on request.

Brushing tools

B 805 H



BE 805 H

This device is a version of the BE 805, which has a lever valve instead of a push start.

The control button on the side allows you to switch between clockwise and counterclockwise rotation.

The machine is superbly suited to brushing holes. By changing the direction of rotation the life of the brush can be increased many times over.

BWH 6-25/2

Drilling in difficult to access areas is no longer a problem with this angle drill with its long spindle and the small angle head.

You can choose between the 90° or 45° versions.

But the machine is not just perfectly suited to drilling. Brushes can also be attached to the angle head with its optimised gearbox mount.

Therefore, you can also use this machine for deburring, cleaning surfaces and refining metals, plastics and wood. A real multitalent.

BWH 6-25/2 K 90

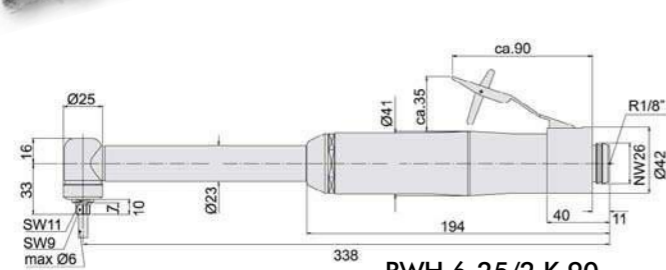

BWH 6-25/2 K 90

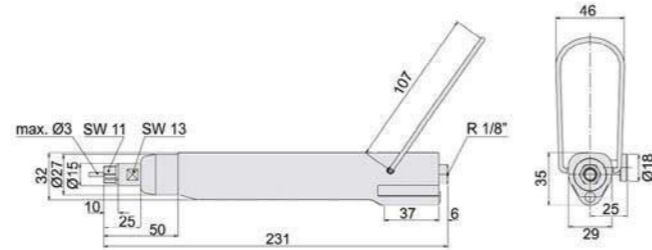

BE 805 H



BIAX offers a wide range of device versions so that have a suitable device for every application.

Name	BE 805 H	BWH 6-25/2 K90	BWH 6-25/2 K45
Valve	Lever valve	Lever valve	Lever valve
Exhaust air direction	backwards	backwards	backwards
Revolutions per minute [min ⁻¹]	500	2500	2500
Power [watts]	80	300	300
Air consumption [l/min]	280	500	500
Noise level [db (A)]	71	75	75
Weight [g]	570	1220	1240
Max. tool shank Ø [mm]	8	6	6
Collet chuck	ZG 7/8 mm	ZG 4/6 mm	ZG 4/6 mm
Hose unit	001 366 548 inclusive	001 366 578	001 366 578
Order no.	150 810 915	150 222 310	150 222 320

We will send you measurement and exploded drawings on request.

Chisels & drills

MD 100

This strong chisel is particularly suited to working with metal. It's construction is also light and powerful.

GMD 3

A device that is used for engraving and chiselling. The following accessories are included:

1 style made of hard metal, different chisels, a chisel blank and an extension pipe.

BP 0,5-10 BP 3-10 BP 6-50

These two variants of the BIAX drills are particularly suited to robust use. Consequently, both tools have very good tractive power too.



MD 100



GMD 3



BP 6-50 (without picture)

BP 3-10



BP 0,5-10

Chisel type MD 100

	Flat chisel narrow 6 mm Order number: 001 963 529
	Flat chisel wide B 12,5 mm Order number: 001 963 531
	Flat chisel angled B 9 mm Order number: 001 963 530

Chisel type GMD 3

	Flat chisel narrow B 3 mm Order number: 003 000 730
	Flat chisel wide B 5 mm Order number: 003 000 463
	Nut chisel B 1 mm Order number: 003 000 895
	Hexagon blank 3 mm Order number: 003 000 979
	Style Order number: 007 001 184

Chisel set, complete Order no: 007 000 979

Name	MD 100	GMD 3	BP 0,5-10	BP 3-10	BP 6-50
Valve	Rotary valve	Rotary valve	Push start	Push start	Push start
Exhaust air direction	backwards	forwards	backwards	backwards	backwards
No. of strokes [min ⁻¹]	3000	3000	-	-	-
Revolutions per minute [min ⁻¹]			500	3000	5000
Power [watts]			220	250	150
Air consumption [l/min]	130	80	450	450	500
Noise level [db (A)]	65	80	77	77	79
Weight [g]	530	100	1700	1250	760
Max. tool shank Ø [mm]	6 Skt.	3 Skt.	10	10	6,5
Hose unit	inclusive	001 366 539	001 366 912	001 366 912	001 366 912
Order no.	150 800 310	150 800 301	150 223 100	150 223 020	150 921 320

We will send you measurement and exploded drawings on request.

Filers

FR 10-5/2



FR 10-5/2

Its 6 mm tool-receiving socket, the stable finish and the almost maintenance-free reciprocating engine make this filer an indispensable tool even when under extreme and continuous strain - for instance rough machining of casted parts.

FR 5-4



FR 5-4

This version has a very powerful motor. The stroke length and the number of strokes can be set. The device comes with a rotary valve.

FR 8-2



FR 8-2

An incredibly robust device that will master even the hardest jobs.

The stroke length is set to 8 mm, the number of strokes is set to 2000 per minute.

Name	FR 10-5/2	FR 5-4	FR 8-2
Valve	Lever valve	Rotary valve	Lever valve
Exhaust air direction	backwards	backwards	backwards
No. of strokes [min ⁻¹]	up to 5500 adjustable	2000-4000	2000
Stroke length [mm]	10	1-5 adjustable	8
Air consumption [l/min]	280	260	310
Noise level [db (A)]	72	74	73
Weight [g]	750	940	1250
Max. tool shank Ø [mm]	6	3	6
HM-tools			
Collet chuck	Straining screw	ZG 5/3 mm	ZG 4/6 mm
Hose unit	001 964 528 incl.	001 366 505	001 366 505
Order no.	150 930 220	150 310 810	150 322 611

We will send you measurement and exploded drawings on request.

Filers

FR 5-8

This pistol file is very easy to handle. It is also quiet and low in vibration. The number of strokes and the stroke length can be adjusted. The file holder can be turned in the optimal working position and is therefore a perfect tool for mold makers.

FR 5-8



FR 3-8
FR 5-8 N



FR 3-8 und FR 5-8 N

These pistol-design files are identical in construction. The stroke length of the FR 3-8 is set to 3 mm. The stroke length of the FR 5-8 N is set to 5 mm. Due to its low weight the machine is ideal for machining aluminum.



Name	FR 5-8	FR 3-8	FR 5-8 N
Valve	Lever valve	Lever valve	Lever valve
Exhaust air direction	backwards	backwards	backwards
No. of strokes [min ⁻¹ adjustable]	0-8000	0-8000	0-8000
Stroke length [mm]	1-5 adjustable	3	5
Air consumption [l/min]	230	230	230
Noise level [db (A)]	72	72	72
Weight [g]	800	720	720
Max. tool shank Ø [mm]	4	4	4
Tool holder	Straining screw	Straining screw	Straining screw
Hose unit	001 366 571 inclusive	001 366 571 inclusive	001 366 571 inclusive
Order no.	150 322 830	150 322 730	150 322 735

We will send you measurement and exploded drawings on request.

Filers

FR 8-12



FR 8-12

This device has been designed for simple filing and deburring work.

FLV 8-12 F
low vibration



FLV 8-12 F

This newly developed device is suitable for the same applications as the PLF 88 file. The special thing about this machine is that it hardly vibrates during operation and the easy to adjust stroke length.

This patented vibration dampening in accordance with the Vibration Directive protects you and the tool.

* Accessories provided for FLV 8-12 F

- 1 Flat file rough 001 620 204
- 1 Semicircular file rough 001 620 207
- 1 Flat file medium 001 620 201
- 1 Rounded file medium 001 620 210
- 1 Pointed rounded file 001 620 211
- 1 Polishing shoe 35 x 25 mm 001 974 436
- 1 x abrasive strip each
- Grit 80, 120, 240, 400
- 4 different saws
- tool holder for 3 and 6mm

PLF 88



PLF 88

This powerful multi-purpose device has been designed for filing, deburring, polishing and cutting. In the lower vertical adjustment area this filing device is particularly powerful.

Name	FR 8-12	FLV 8-12 F	PLF 88
Power [watts]	280	300	300
Valve	Lever valve	Lever valve	Lever valve
Exhaust air direction	backwards	backwards	backwards
No. of strokes [min ⁻¹] adjustable	0-12.000	12.000	0-12.000
Stroke length [mm] adjustable	4-8	4-9	2-8
Air consumption [l/min]	250	250-300	250
Noise level [db (A)]	73	70	71
Weight [g]	640	700	760
Max. tool shank Ø [mm]	4,0	6,0	6,0
Tool holder installed	4 mm	4 mm	4 mm
Hose unit	001 974 552 inclusive	001 974 552 inclusive	001 974 552 inclusive
Order no.	150 322 850	150 322 870	150 322 860
Accessories	Plastic suitcase	Plastic suitcase Tool holder 3,4 und 6,0 Counter holder	Plastic suitcase Tool holder 3,4 und 6,0 Counter holder

We will send you measurement and exploded drawings on request.

Saws

PS 2

High power device in a robust aluminum housing with handy shape.

PS 3

Gentle work due to patented vibration damping. More power produced by new drive. Also suitable for harder steel. Exceptionally robust because of the stable aluminium housing.

PS 25

The solution for very solid steel thanks to better cutting performance given by the new drive. More safety ensured by the redeveloped tool-receiving socket. Work is made easier by the patented vibration damping.

PLF 90

The robust and established alternative in metal housing. Very popular due to the high tractive power of the reciprocating engine.

FR 10-5/2

The powerful universal saw for all applications. Frequently used for aluminium profiling work.



Saws (please see page 27)

Name	PS 2	PS 3	PS 25	PLF 90	FR 10-5/2
Power [watts]	280	300	340	300	-
Valve	Lever valve	Lever valve	Lever valve	Lever valve	Lever valve
Exhaust air direction	backwards	backwards	backwards	backwards	backwards
No. of strokes [min ⁻¹]	12.000	12.000	6.000	12.000	up to 5.500 adjustable
Stroke length [mm]	8	8	25	8	10
Air consumption [l/min]	250	250	280	250	280
Noise level [db (A)]	73	73	74	71	72
Weight [g]	720	980	1250	760	750
Max. tool shank Ø [mm]	4	4	4	6	6
Tool holder installed	4 mm	4 mm	4 mm	4 mm	6 mm
Hose unit	001 974 552 inclusive	001 974 552 inclusive	007 012 349 inclusive	001 982 531 inclusive	001 964 528 inclusive
Order no.	150 322 920	150 322 921	150 322 910	150 322 890	150 930 220
Accessories	Counter holder 2 installation wrenches 4 saw blades (14/18/24/32 tpi)	Plastic case Counter holder 2 installation wrenches 4 saw blades (14/18/24/32 tpi)	Plastic case Counter holder 2 installation wrenches 4 saw blades (14/18/24/32 tpi)	Plastic case Counter holder 2 installation wrenches 4 saw blades (14/18/24/32 tpi)	Plastic case Counter holder 2 installation wrenches 4 saw blades (14/18/24/32 tpi)

We will send you measurement and exploded drawings on request.

BIAX files								Straight design		Pack: 5 units	
Shaft-Ø 3,8 mm, usable length 60 mm Suitable for BIAX pneumatic files: FR 3-8, FR 5-8, FR 5-8 N								File set (1 Unit of every profile)			
Profile	Scale 1:1										
Width x Height	mm	7 x 2	2,8 x 2,8	4 x 4	6 x 2,5	7,5 x 2	ø 4				
Cut 1 (coarse)	Order no.	001 620 837	001 620 838	001 620 839	001 620 840	001 620 841	001 620 842	300 000 500			
Cut 3 (fine)	Order no.	001 620 849	001 620 850	001 620 851	001 620 852	001 620 853	001 620 854	300 002 000			
Shaft-Ø 6 mm, usable length 80 mm		Suitable for BIAX pneumatic files: FR 8-2, FR 10-5, FLV 8-12									
Profile	Scale 1:2							File set (1 Unit of every profile)			
Width x Height	mm	12 x 6	8 x 8	9 x 9	12 x 5	12 x 6	ø 6				
Cut 1 (coarse)	Order no.	001 620 801	001 620 802	001 620 803	001 620 804	001 620 805	001 620 806	300 000 300			
Cut 3 (fine)	Order no.	001 620 813	001 620 814	001 620 815	001 620 816	001 620 817	001 620 818	300 001 700			

BIAX files										Straight design		Pack: 10 units		
Shaft-Ø 4 mm Suitable for BIAX pneumatic files: FR 3-8, FR 5-8, FR 8-12, FLV 8-12, PLF 88, FR 5-8 N										File set (1 Unit of every profile)				
Profile	Scale 1:2													
Length	mm	90	90	65	90	90	90	90	75	90				
Width x Height	mm	6,5 x 2	10 x 3	15 x 3	ø 4	ø 6	6,5 x 2,5	10 x 3	10 x 3	4,3 x 4,3				
Cut 1 (coarse)	Order no.	001 620 202	001 620 203	001 620 204	001 620 213	-	001 620 207	001 620 205	001 620 209	001 620 212				
Cut 2 (medium)	Order no.	001 620 201	-	-	001 620 210	001 620 211	001 620 206	-	001 620 208	-				

BIAX files								Curved design		Pack: 5 units	
Shaft-Ø 3,8 mm, usable length 65 mm Suitable for BIAX pneumatic files: FR 3-8, FR 5-8, FR 5-8 N								File set (1 Unit of every profile)			
Profile	Scale 1:1										
Width x Height	mm	7 x 2	3,5 x 3,5	4 x 4	6 x 2,5	7,5 x 2	ø 4				
Cut 2 (medium)	Order no.	001 620 879	001 620 880	001 620 881	001 620 882	001 620 883	001 620 884	300 000 700			
Cut 1 (coarse)	Order no.	001 620 885	-	-	-	-	-				

BIAX-diamond coated files								Straight design		Pack: 5 units	
Shaft-Ø 3 mm, usable length 25 mm Suitable for BIAX pneumatic files: FR 3-8, FR 5-8, FR 5-8 N, FR 5-4, FR 8-12, FLV 8-12, PLF 88								File set (1 Unit of every profile)			
Profile	Scale 1:1										
Width x Height	mm	5 x 2	4 x 4	3 x 3	6 x 3	ø 2	ø 4				
Grit D 100	Order no.	001 620 861	001 620 862	001 620 863	001 620 864	001 620 865	001 620 866	300 000 600			



Tool holder for FR 8-12, PS 1, PLF 88/PLF 90, FLV 8-12F/PS 8				
Tool shank Ø [mm]	3,2	4	6	6,4
Order no.	001 974 430	001 974 411	001 974 443	001 974 431
Tool holder for PS2, PS3				
Tool shank Ø [mm]	-	4	-	-
Order no.	-	008 012 314	-	-
Tool holder for PS 25				
Tool shank Ø [mm]	-	4	-	-
Order no.	-	008 012 186	-	-
Counter holder for FR 8-12/PS 1, PLF 88/PLF 90, FLV 8-12 F/PS 8, FR 10-5/2, PS 2/PS 3/PS 25				
Order no.	001 974 418	001 974 542	001 974 623	001 964 532 003 012 066

The counter holder is required if the files are used as a saw to support the machine against the workpiece. The holder can be adjusted continuously, e.g. for limiting the depth of the saw blade.

Saw blades (pack: 10 units)	
	<ul style="list-style-type: none"> - set high standards for tool life and economic viability - provide maximum cut performance - are extremely flexible and stress resistant
The teeth are made of high-quality HSS steel. The carrier material is spring steel – selected and point heat treated – for high flexibility, toughness and lack of metal fatigue.	

for PS 25, PS 2, PS 3				
Saw blade length [mm] L	Teeth interval [mm] Z	No. of teeth	Order no.	Range of application
60	0,8	32 tpi*	007 012 393	Thin sheets of metal and high-strength steel up to 1.5 mm
60	1,0	24 tpi*	007 012 392	Double and triple sheet up to 1.5 mm
60	1,4	18 tpi*	007 012 391	Aluminium, plastic
60	1,8	14 tpi*	007 012 390	Wood, composites, plastic

for PS 1, PS 8, PLF 90				
Saw blade length [mm] L	Teeth interval [mm] Z	No. of teeth	Order no.	Areas of application
96	0,8	32 tpi*	001 974 432	All thin metal sheets, steel sheet up to 1.0 mm
96	1,0	24 tpi*	001 974 433	Steel sheet up to 3,0 mm Aluminium up to 1,5 mm Chrome steel sheet up to 1,5 mm
96	1,8	14 tpi*	001 974 434	Nonferrous heavy metal, aluminium, Nonferrous metal up to 4 mm wood, fixing plate
72	1,4	18 tpi*	001 974 435	Specially designed to saw tight curves

for FR 10-5/2				
Saw blade length [mm] L	Teeth interval [mm] Z	No. of teeth	Order no.	Areas of application
90	0,8	32 tpi*	001 974 445	All thin sheets, Steel sheet up to 1.0 mm
90	1,0	24 tpi*	001 974 446	Steel sheet up to 3.0 Aluminium up to 1.5 mm Chrome steel sheet up to 1.5 mm
90	1,4	18 tpi*	001 974 447	Nonferrous heavy metal, aluminium, wood, fixing plate



* tpi = tooth per inch

Accessories

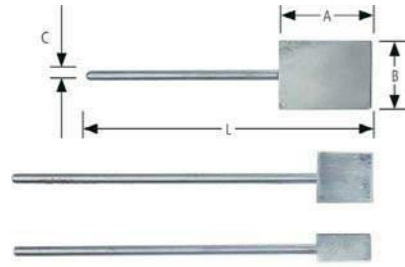

Polishing shoes				
Shoe length A [mm]	Shoe width B [mm]	Total length L [mm]	Shaft C Ø [mm]	Order-number
35	25	110	4	001 974 436
20	20	140	4	001 974 437
20	11	140	4	001 974 438

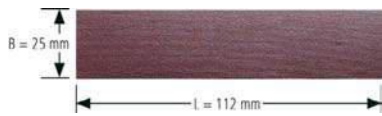

Emery strips for polishing shoes, self-adhesive (pack: 10 units)				
Grit	80	120	240	400
Order no.	001 974 439	001 974 440	001 974 441	001 974 442

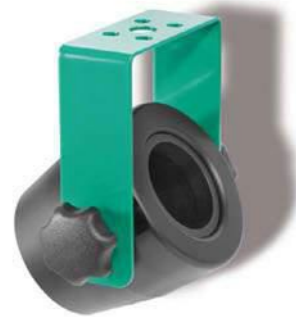

hanging



standing

Vario-holder V3

Brings organisation and safety to your workplace. Your high-value tools are parked drop certain on your work bench. Suitable for almost all BIAx grinders thanks to the individually adjustable internal sleeves. Suitable for:

TVD 3-100/2, T 365/2,
 TSD 385, T 3-65 S,
 SRD 3-85/2, SRD 3-85/2D,
 SVD 3-85/2, SVD 3-85/2D,
 SRH 3-85/2, SRH 3-85/2D,
 SVH 3-85/2, SVH 3-85/2D,
 SRD 3-55/2, SRD 3-55/2 S, SRD 3-55/2 KE,
 SRD 6-45/2, SRD 6-45/2 SL, SRD 3-45/2,
 SRH 6-45/2, SRH 6-45/2 SL, SRH 3-45/2,
 SRD 8-30/2, SARD 830, SBRD 830,
 SRH 8-30/2, SARH 830, SBRH 830, SVKH 630,
 SRD 8-30/2 SL, SRD 6-30/2, SRD 3-30/2,
 SRH 8-30/2 SL, SRH 6-30/2,
 SRD 8-20/2, SRD 8-20/2 SL,
 SRH 8-20/2, SRH 8-20/2 SL,
 SARD 820, SARH 820,
 SRH 10-15/2, SRH 10-12/2, SRH 8-10

Order no. 007 012 848

Installation possible acc. to requirements.

Hose unit

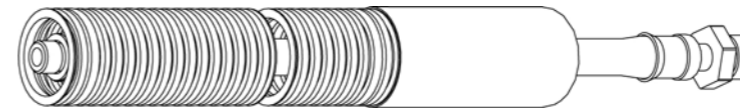

Hose unit, complete	001 366 505	001 366 528	001 366 594	001 366 595	001 366 548	001 366 549	001 366 577	001 366 578	001 366 580	001 366 576
Plug-in nipple attached (8)	001 367 711	001 367 712	001 367 711	001 367 711	001 367 711	001 367 711	001 367 711	001 367 711	001 367 712	-
Washer attached (9)	001 367 616	001 313 102	001 367 616	001 367 616	001 367 616	001 367 616	001 367 616	001 367 616	001 313 102	-
Hose plug-in sleeve (1)	001 366 207	001 366 202	001 366 207	001 366 216	001 366 207	001 366 216	001 366 207	001 366 207	001 366 202	001 366 610
Hose clamp (2)	001 372 606	001 372 610	001 369 406	001 369 408	001 372 606	001 369 408	001 372 606	001 372 606	001 372 610	001 369 408
Pressure hose (3)	001 366 357	001 366 320	001 366 357	001 366 308	001 366 357	001 366 308	001 366 357	001 366 357	001 366 320	001 366 308
Silencer (4)	003 008 026	001 365 014	-	003 008 000	-	-	003 008 023	003 008 026	001 365 014	003 008 000
Exhaust air hose (5)	001 331 142	001 331 142	-	001 331 189	001 331 161	001 331 158	001 331 177	001 331 163	001 331 142	001 331 189
External thread sleeve (6)	003 003 528	003 003 702	-	003 003 447	001 366 204	-	001 366 204	001 366 204	001 366 211	003 006 356
Washer (7)	001 312 005	001 313 103	-	-	001 312 205	-	001 312 205	001 312 205	001 313 303	001 312 202

Metre material:										
Pressure hose	001 366 356	001 366 318	001 366 356	001 366 309	001 366 356	001 366 309	001 366 356	001 366 356	001 366 318	001 366 309
Exhaust air hose	001 331 143	001 331 143	-	001 331 184	001 331 160	001 331 157	001 331 160	001 331 162	001 331 143	-
Technical data										
Length [m]	3	3	3	1,5	1,5	1,5	3	3	3	1,5
Inside diameter [mm]	7	10	7	4,5	7	4,5	7	7	10	4,5
Weight [kg]	0,5	0,7	0,24	0,11	0,21	0,1	0,4	0,4	0,7	0,11

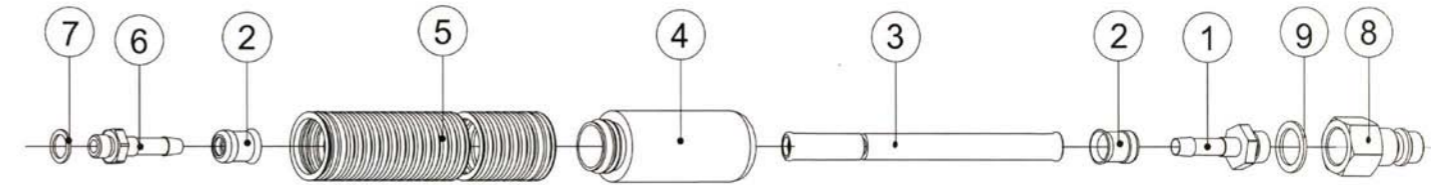

Collets and installation wrenches



Type	ZG 1	ZG 1 A	ZG 4	ZG 5	ZG 7	ZG 8
	Order no.	Order no.	Order no.	Order no.	Order no.	Order no.
Inner diameter 0,5 mm	-	-	-	001 999 871	-	-
Inner diameter 1,0 mm	-	-	001 999 957	001 999 989	001 999 868	-
Inner diameter 1,5 mm	-	-	001 999 960	001 999 988	-	-
Inner diameter 2,0 mm	001 999 932	-	001 999 959	001 999 987	001 999 867	-
Inner diameter 2,5 mm	-	-	001 999 952	001 999 986	-	-
Inner diameter 3,0 mm	001 999 999	001 999 995	001 999 991	001 999 985	001 999 982	-
Inner diameter 3,5 mm	-	-	001 999 951	-	001 999 924	-
Inner diameter 4,0 mm	001 999 998	001 999 949	001 999 961	-	001 999 973	-
Inner diameter 5,0 mm	001 999 997	-	001 999 958	-	001 999 972	-
Inner diameter 6,0 mm	001 999 996	001 999 994	001 999 990	-	001 999 981	001 999 977
Inner diameter 7,0 mm	-	-	-	-	001 999 971	-
Inner diameter 8,0 mm	-	001 999 993	-	-	001 999 980	001 999 976
Inner diameter 10,0 mm	-	001 999 992	-	-	-	001 999 975
Inner diameter 1/8"	-	-	001 999 964	001 999 983	001 999 979	-
Inner diameter 1/4"	-	-	001 999 965	-	001 999 978	-
Inner diameter 3/32"	-	-	001 999 970	001 999 984	-	-
Installation wrenches	001 365 806 + Retaining pin 002 000 069	001 365 811 + Retaining pin 002 000 070	007 899 874 (Size 9+11 in the set)	007 899 751 (Size 6+8 in the set)	007 899 746 (Size 11+14 in the set)	007 899 721 (Size 14+17 in the set)

Maintenance units



Special oil



Order no.	001 367 022	001 367 024	001 367 023	001 367 045	Order no. (1,0l) 001 365 665
Connection thread	R 1/4"	R 1/4"	R 1/4"	R 1/2"/R 3/8"	
Max. operating pressure [bar]	10	10	10	10	Order no. (5,0l) 001 365 605
Throughput at 6 bar [l/min]	550	800	500	1900	
Control range [bar]	0,5-8	0,5-10	0,5-10	0,5-8	
Weight [kg]	0,83	0,81	0,5	1,9	

For oil-free pneumatic tools

One-hand couplings



Connection thread	R 1/4"	R 3/8"	R 1/4" i	-	-	R 1/8"	R 1/4"	-	-
For hose width	-	-	-	7	10	4,5	4,5	4,5	7
Order no.	001 366 706	001 366 709	001 366 717	001 366 707	001 366 711	001 366 215	001 366 216	001 369 408	001 369 401

Hose plug-in sleeve



Outer thread sleeve



Connection thread	-	-	-	R 1/8"	R 1/4"	R 1/4"	R 3/8"
For hose width	4,5	7	10	7	7	10	10
Order no.	001 366 610	001 366 603	001 366 607	001 366 204	001 366 207	001 366 211	001 366 202

Nipple with male thread



Nipple with female thread



Manifold block with couplings



Connection thread	R 1/8"	R 1/4"	R 3/8"	R 1/4" i	R 3/8" i	R 3/8" i	R 1/4" i
Order no.	001 367 703	001 367 710	001 367 706	001 367 711	001 367 712	001 367 211	001 367 212

Double nipple



Reducing adapter



Sealing ring



Connection thread	R 1/4" x R 1/4"	R 3/8" x R 3/8"	R 1/4" x R 1/8"	R 3/8" x R 1/4"	R 1/2" x R 3/8"	R 1/8"	R 1/4"	R 3/8"
Order no.	001 367 101	001 367 102	001 370 901	001 370 902	001 370 903	001 312 205	001 367 616	001 313 102

More BIAX quality products

For further information, please order our catalogues:

Units	Pneumatic power screwdrivers		Units	Machines with flexible shafts
Units	Robot tools		Units	Tungsten carbide tools
Units	Professional grinding and polishing accessories		Units	Electronic scrapers

Please ask for further catalogues !
Please copy this page, fill it out and send it by fax to: **+49 7043 102-78**

Company

Contact person

Street, no.

Post code-Country

Phone / Fax No.

E-Mail



**Druckluftwerkzeuge
Pneumatic Tools
Outils pneumatiques**



Hartmetallwerkzeuge

**Hartmetall-Werkzeuge
Carbide Tools
Outils en carbure
de tungstène**



**Biegsame Welle
Flexible Shafts
Machines á arbre flexible**



**Fleischereimaschinen
Meat Processing Machines
Machines pour l'industrie
de la viande**



**Vertriebsgesellschaft Italien
Distribution company Italy
Société de distribution
en Italy**

**Schmid & Wezel GmbH & Co.
Maschinenfabrik**

Maybachstr. 2
D - 75433 Maulbronn
Tel. +49 7043 102-0
Fax +49 7043 102-78
biax-verkauf@biax.de
www.biax.de

BIAX Maschinen GmbH

Industrieplatz 1
CH-8212 Neuhausen/Rheinfall
Tel +41 52 6746961
Fax +41 52 6746564
info@biax.ch
www.biax-schweiz.ch

**Schmid & Wezel
Hilsbach GmbH & Co.**

Breite Str. 38
D-74889 Sinsheim-Hilsbach
Tel +49 7260 9133-0
Fax +49 7260 9133-25
flexwellen@biax.de
www.biax-flexwellen.de

**Schmid & Wezel GmbH & Co.
Maschinenfabrik**

Maybachstr. 2
D-75433 Maulbronn
Tel +49 7043 102-0
Fax +49 7043 102-78
efa-verkauf@efa-germany.de
www.efa-germany.de

BIAX Italia S.r.l.

Zona Industriale
Via del Garda 46/N
I-38068 Rovereto (TN)
Tel +39 (0) 464 433124
Fax +39 (0) 464 489952
biaxitalia@biaxitalia.com
www.biaxitalia.com