

AS 200 IT



Safety Notes

- Installation and Maintenance of the System only by trained personnel.
- Important! To prevent personal injury and damage to equipment please ensure that the system is properly earthed and that the appropriate cable is connected in the mains plug.
- The System must be installed horizontal so that the connection panel is on the right hand side.
- Do not connect or disconnect any PSTN lines during a thunderstorm.
- Install lines and extensions in such a way that no one walks or trips over them.
- Disconnect the System from the mains supply before opening the connection panel.
Before connection of lines and extensions please ensure that the system is unplugged from the mains supply. DANGER!
- Preventive measure! Before carrying out any installation work, please touch briefly the PC/Printer socket of the telephone system. This will discharge any possible electrostatic charges, thus protecting the telephone system's electrostatically sensitive components.
- Do not allow liquids to enter the system as short-circuits may occur.
- No liability will be accepted for consequential damages such as an unintentional continued connection of a line.
- The telephone system will not operate in case of power failure and you will not be able to make any type of call.

The PBX System can be connected to Basic Rate ISDN lines (DSS1, Point to Point, System Access, or Point to Multi Point, Standard Access) and may also be connected to analogue exchange lines.

Should you operate your PBX-System on an analogue exchange line, then please ensure that your telephone service provider has meter pulse sending disabled as this may otherwise interfere with speech quality of a call.

You may connect any equipment which has been approved for the connection to the Public Switched Telephone Network (PSTN) to the extension port of the system.

Any DSS1 ISDN device which has been approved for the connection to the ISDN telephone exchange may be connected to the internal SO Bus. In addition you may connect up to two digital AGFEO System Phones to each SO Bus.

Any other use of the telephone system which is not listed or described is prohibited.

The telephone system has been issued with a universal connection licence.

The system fulfils the specified conformity and safety regulations.

About this manual

The instruction is valid for the default setting of the system. If the system should be modified due to software made available through the manufacturer then it may be possible that sections of the instruction manual become invalid. All listed ISDN features will be supported by the system. However, some features may not be available through the Network Operator.

Table of Contents

About this manual	2
Safety Notes	2
The AS 200 IT Telephone System	4
Technical Data	5
Installation of the System on telescopic tracks	5
Opening the Cover on the AS 200 IT	6
Removing the Patch Panel	6
Installation Note	6
Inserting the Modules	6
Inserting the Modules' Patch Panels	7
Connecting Patch Panel to Modules	7
Patch Panel of Modules	8
Patch Plug Assignment	8
Patch Panel of the K-Module 524	8
Patch Panel of the AL-Module 4504	9
Patch Panel of the S0-Module 540	9
Patch Panel of the T-Module 508	10
Patch Panel of the UP0-Module 508	10
Patch Panel of the LAN-Module 510	10
Patch Panel of the LAN-Module 508	11
Patch Panel of the S2M-Module 500	11
T-Shaped S0 Bus	11
LEDs of the AS 200 IT	12
Display of the AS 200 IT	13
Declaration of Conformity	14

The AS 200 IT Telephone System

The AGFEO AS 200 IT is a modular ISDN telephone system in a 19 inch rack housing with a temperature controlled cooling fan. The current operating temperature will be displayed when the system status is idle. This system with its various expansion facilities can be tailor made with the numerous AGFEO modules and is ideal for an IT environment in a 19 inch rack housing. The system will be delivered with 5 free module slots and 5 blanking plates. Due to this the system can be individual designed to a powerful ISDN telephone system to the highest specification.

AGFEO AS 200 IT initial configuration:

- 1 PC connection (RS 232)
- 1 USB connection for programming
- 1 AIS Module (on Motherboard)
- 1 Interconnection sockets to link 2 AS 200 IT (on Motherboard)

Optional Expansion Modules

AGFEO K-Module 524

The K-Module 524 offers two switchable ISDN BRI Lines (Trunk Access/Internal for System Phones and/or ISDN Devices) and 4 Analogue Extensions (SLT's).

AGFEO S0-Module 540

The S0-Module 540 has four switchable ISDN BRI Lines (Trunk Access/Internal for System Phones and/or ISDN Devices). Up to 8 Digital System Phones can be operated with this module.

AGFEO S2M-Modul 500

The S2M-Module 500 will allow the connection of your AGFEO Telephone System to a Primary Rate Interface ISDN line (ISDN 30). This type of connection will offer the simultaneous use of 20 channels.

AGFEO T-Module 508

The T-Module 508 offers up to eight Analogue Extensions (SLT's) and includes CLIP.

AGFEO AL-Module 4504

The AL-Module 4504 offers up to four Analogue Trunk Lines.

AGFEO DECT S0-Base plus

Up to eight AGFEO DECT 35, DECT 45 or DECT 50 System DECT's or GAP compliant DECT Handsets can be connected to this Base Station.

K-Module 544

The K-Module 544 offers 4 alarm input contacts, 3 Analogue Extensions or one FTZ 123D12 Door Phone, one two-wire Door Phone and one analogue two-wire doorphone (e.g. AGFEO TFE 2/4), two switching Relays, one audio output symmetrical for loudspeakers, switchable as preamp output (asymmetrical) for an external amplifier and one Audio Input for external MoH.

UP0-Module 508

The UP0-Module 508 offers up to eight UP0 ports.

AGFEO LAN-Module 508

The LAN Module 508 offers an ASIP server with the utilisation of 8 internal channels. This will enable you to utilise the existing network structure and register up to 8 ST 40 IP's to your LAN Module 508. The ST 40 IP will offer the same features as any other internal phone for use with AGFEO Telephone Systems.

AGFEO LAN-Module 510

The AGFEO LAN-Module 510 will enable you to integrate the AGFEO AS 200 IT into the LAN.

With the integrated ADSL2+ modem and router the LAN-Module 510 enables various PC's within the local network access to the Internet. The local network will be protected via an integrated firewall. In addition the LAN Module 510 offers up to 8 channels for Internet-Telephony (SIP) or ISDN over IP. Depending on the configuration the LAN-Module 510 will support of up to 8 ST 40 IP's.

AS 200 IT

Tecnicl Data

Specification	ModularISDN Telephone System with 5 Expansion Slots and On board Interconnection in a 19" rack
Measurements	3 HE x 19" x 31 cm (High x Width x Depth)
Weight	6,4 kg
Ambient temperature	
- Operation/Storage	5 °C to 40 °C / -25 °C to +70 °C
Humidity	max. 70 % (none condensing)
Mains Connection	230 VAC, +6%/-10%, 50 Hz
- Power Consumption	$P_{\max} = 60 \text{ W}$
PC/ Printer Connection	RS 232C
- Range/Level	3 m / +/- 5 V
- Connector	9 pin D-Socket
USB Connection	Universal Serial Bus
- Cable Length	3 m

Installation of the System on telescopic tracks

The AGFEO AS 200 IT from Serial Number 001301 can be fixed to Telescopic Tracks from Accuride. These tracks enable the system to be drawn from the IT cabinet and giving easy access to all modules.

The following Telescopic Tracks can be fixed to the AS 200 IT:

DZ0201-0014
Overall length 356mm

DZ0201-0020
Overall length 508mm

Please enquire via your dealer or manufacturer of the IT cabinet if these tracks can be used/fixed in your IT cabinet.

AS 200 IT

Installation Note

After disassembling the mounting brackets from the AS 200 IT, please be aware to reassemble the screws before switching on the AS 200 IT.

Opening the Cover on the AS 200 IT

Remove the screws on the side of the housing cover. Slide the cover backwards and remove it.
Please read the safety instructions first, each time you remove the cover!

Removing the Patch Panel

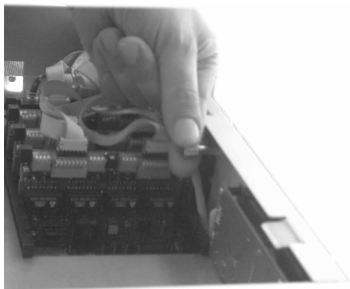

You can remove the patch panel after you have taken off the cover. To do so, loosen the knurled screws on each front panel. Then tilt the front panel forwards and pull it out.

Inserting the Modules



Slide the modules into the guide and press down until they fit securely into the slot.

At first, please read the module installation instructions (Item No. 1101332) before performing the installation.

Inserting the Modules' Patch Panels



To insert the patch panel, hook the notch on the bottom edge into the appropriate groove. Push the cable through the opening in the front plate as shown in the photograph. Then shut the front plate and screw it tight using the knurled screws.

Connecting Patch Panel to Modules

The plug strips on the patch panels are numbered, pin 1 is marked with a red wire. Please make a note of the pinning for each patch panel. (See pages 8-10)

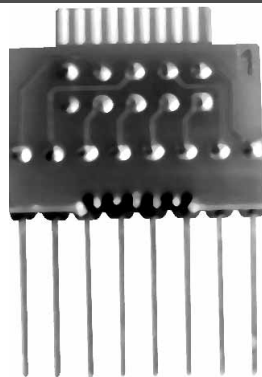

After you have connected the patch panels to the modules, shorten the cables by tying them together using cable ties.

Patch Panel of Modules

The correct patch panel is required for each AGFEO standard module so that the module's terminals rest flush against the patch panel. Please refer to the reverse side of each patch panel to identify which module it has been designed for. A soldering point is located next to the name of the module for which the patch panel has been designed. The wires marked red on the patch panel connectors signify pin 1.

If a switchable S0 bus is switched to a module, the patch panel has to be set appropriately by porting a jumper. The patch panels' default settings are switched to 'internal' and pins 1 and 2 are connected. Pins 2 and 3 have to be connected to switch to 'external'. The jumpers are assigned to the appropriate S0s spatially.

External

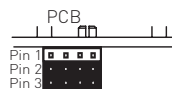

Internal

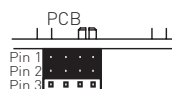

Patch Plug Assignment

Plug Assignment on Analogue Ports

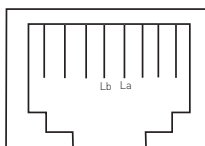

Plug Assignment on external S0s

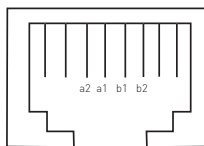

Plug Assignment on internal S0s

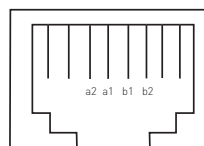

Patch Panel of the K-Module 524

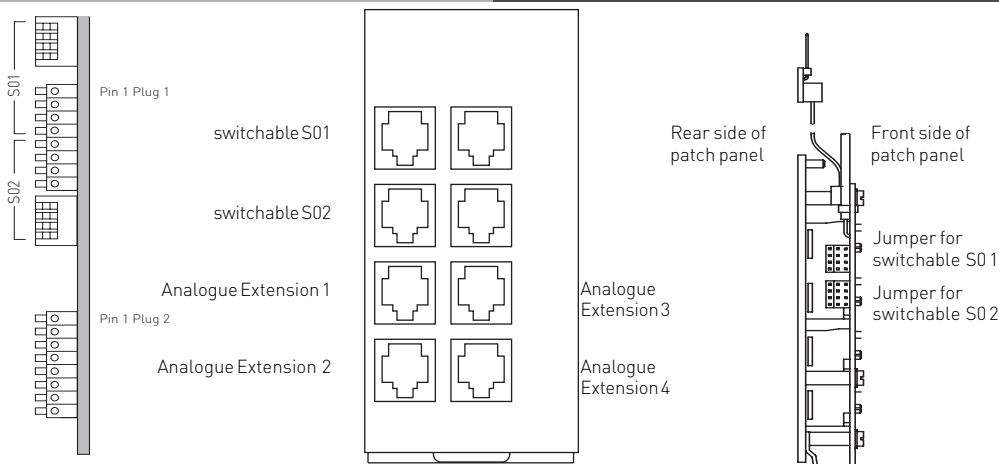

For notes referring to the plugs, please read "Connecting Patch Panel to Modules" on Page 7. For notes referring to the jumper setting of the Patch Panel, please read "Patch Panel of Modules" on Page 8.

AS 200 IT

Patch Panel of the AL-Module 4504

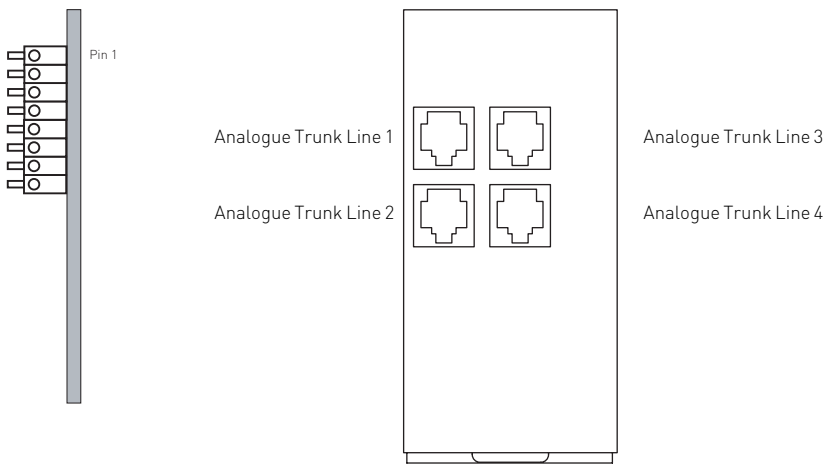

Patch Panel of the S0-Module 540

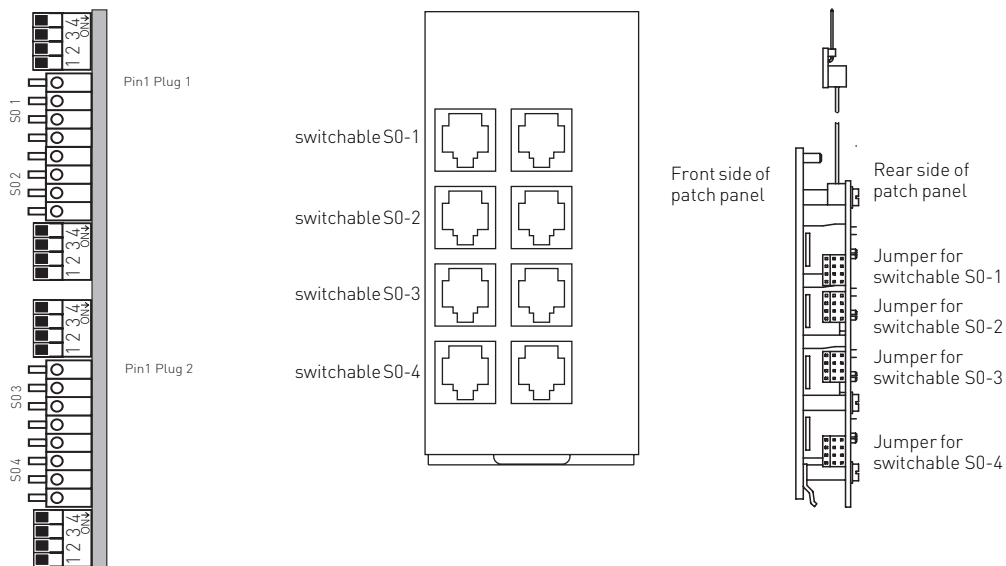

For notes referring to the plugs, please read "Connecting Patch Panel to Modules" on Page 7. For notes referring to the jumper setting of the Patch Panel, please read "Patch Panel of Modules" on Page 8.

Patch Panel of the T-Module 508 Patch Panel of the UP0-Module 508

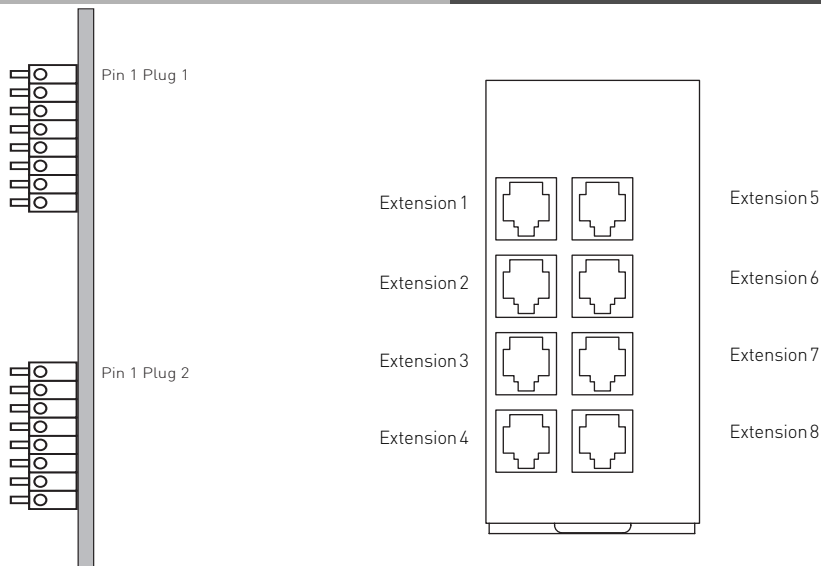

For notes referring to the plugs, please read "Connecting Patch Panel to Modules" on Page 7.

Patch Panel of the LAN-Module 510

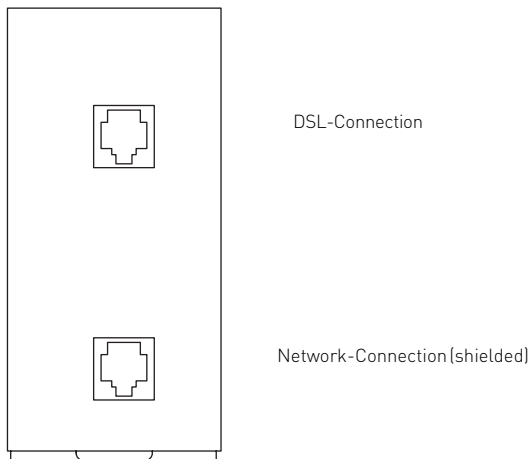

- Connect the 2 wire cable of the patch panel to the DSL connection of your LAN Module.
- Connect the enclosed network cable to the LAN socket at the rear of the patch panel and the LAN socket of your LAN Module 510.
- Connect the network connection on the front of the patch panel to your network.
- Connect the DSL connection on the front of the patch panel to your splitter.
- Should you use your own cable then ensure that the middle contacts of your plug (PIN 4 and 5) are connected.

AS 200 IT

Patch Panel of the LAN-Module 508 Patch Panel of the S2M-Module 500

- Connect the socket to the rear of the patch panel to the socket of the module by using the enclosed network cable
- Connect the socket at the front of the patch panel to your network (LAN Module 508) or your PRI connection (S2M-Module 500).

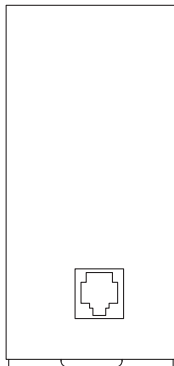

Shielded connection

T-Shaped S0 Bus

Until now, AGFEO systems were not designed for split internal (t-shaped) S0 buses. The AS 100 IT now provides for this. However, the termination resistance assignment required has changed in this respect. While the PABX and the outlet furthest away have to be terminated with 100 Ohms, with t-shaped wiring, the PABX has no terminating resistance. The outlets to the left and the right of the system which are furthest away have to be terminated with 100 Ohms. The S0 bus cannot exceed the previous maximum length of 150 meters.

Old Wiring:

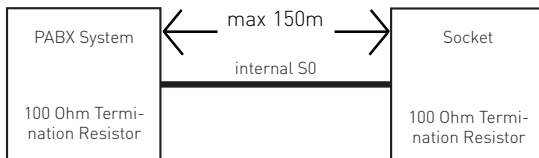

New Wiring:

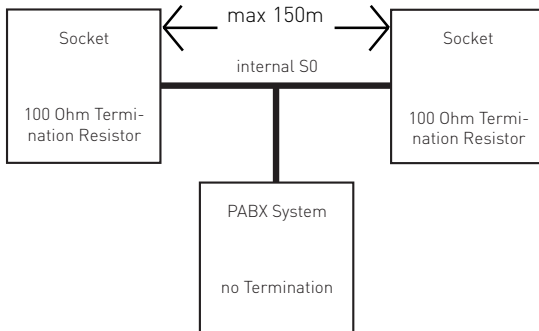

AS 200 IT

LEDs of the AS 200 IT

- LED 1
- LED 2
- LED 3
- LED 4

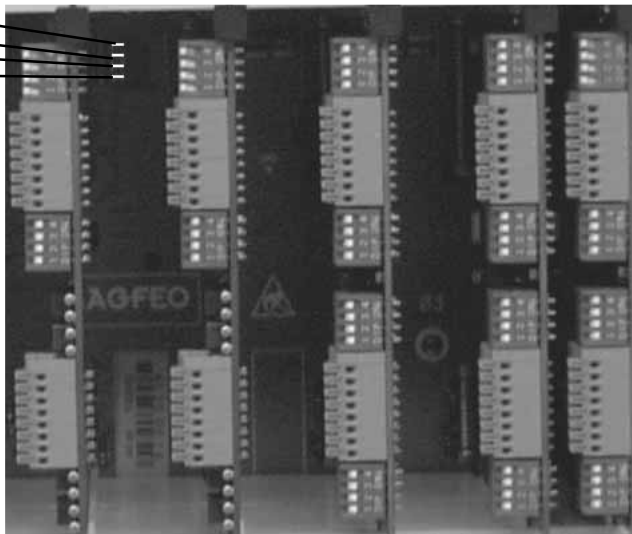

Permanently Lit

Flashes

LED 1 (red)

System is operational

System being initialised

LED 2 (green)

Data being transferred

LED 3 (green)

System is connected to the computer via USB

USB Activity

LED 4 (green)

Interconnection Active

Interconnection not synchronised

AS 200 IT

Display of the AS 200 IT

You can read the system status, slot configuration and module configuration from the display on the AS 200 IT. Simply use the two arrow buttons on the housing to do so.

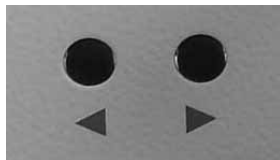

AS 200 IT standby display

```
AS 200 IT
Fr 02.01.2009 00:00
Operating Temperature 24.8°
System on Standby
```

If you press a button for longer than a second in standby display mode, the system's status is shown in the display.

```
Version      8.2k
Checksum     168a
Operating Time
00000 Days 00 hrs 00 min
```

If the display remains in status mode, the display reading changes to operating mode after about 10 seconds. In this mode, the configuration for each individual slot (1 - 5) is seen in sequence for about five seconds and then returns to standby mode. Press any button to quit the operating mode.

If you press any button briefly in standby mode, you can page through the slot configuration manually. If you press the right-hand button, you can page through slots 1 - 5, ending in standby mode. You can do this in the opposite direction by pressing the left-hand button.

```
Modulslot   1 _ _ _ _
K-Module 524
( ext int )
```

The exact configuration of the module is displayed if you press any button for longer than a second. For instance, for the K-Module 524.

```
External1 External1
Mr. Miller ST30(15)
ab(11)      ab(13)
ab(12)      ab(14)
```

Press any button to quit the display mode.

EU-Konformitätserklärung

EC-Declaration of Conformity
CE-Déclaration de Conformité

Der Hersteller: AGFEO GmbH & Co. KG

The Manufacturer:
Le Constructeur:

Adresse: Gaswerkstr. 8
D - 33647 Bielefeld

Address:
Adresse:

Erklärt, dass das Produkt: AS 200 IT

Declares that the Product:
Déclare que le Produit:

Type: Telefonanlage

Model: AS 200 IT

Components:

die grundlegenden Anforderungen gemäß Artikel 3 der nachstehenden EU-Richtlinien erfüllt:

meets the essential requirements according to article 3 of the following EC-Directive:
est conforme aux exigences essentielles d' article 3 de la Directive CE:

**Richtlinie 1999/5/EG des Europäischen Parlaments und des Rates vom 09. März 1999
über Funkanlagen und Telekommunikationsendeinrichtungen und die gegenseitige
Anerkennung ihrer Konformität**

Directive 1999/5/EC of the European Parliament and of the Council of 09 March 1999 relating to radio and telecommunications terminal equipment, including the mutual recognition of their conformity
Directive 1999/5/CE du Parlement européen et du Conseil du 09 mars 1999 concernant les radio et équipement terminaux de télécommunications, incluant la reconnaissance mutuelle de leur conformité

und dass die folgenden harmonisierten Normen angewandt wurden:

and that the following harmonised standards has been applied:
et que les standards harmonisés suivants ont été appliqués:

EN 55022/2003
EN 55024/2003

Bielefeld, 3. November 2005

Ort und Datum der Konformitätserklärung
Place and date of the declaration Lieu et date de la déclaration

Phone : +49(0)5 21 44 70 9-0
FAX : +49(0)5 21 44 70 9-50

Name und Unterschrift
Name and Signature Nom et Signature

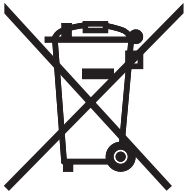

The crossed out wheeled bin on the product means that this belongs to the group of Electro- and electronic apparatus.

In this context you are directed by the European regulation to dispose of used apparatus

- at the point of buying an item of equal proportion / value
- at the local available collection point for disposal

With this you will participate in the reuse of material and valorisation of disused electric- and electronic apparatus, which otherwise could be a health hazard and be negative to the environment.



Ident no. 1101331
Subject to change without
notice. No liability can be
accepted for errors contained in
this document.
Printed in Germany
0092

AGFEO GmbH & Co. KG
Gaswerkstr. 8
D-33647 Bielefeld
Internet: <http://www.agfeo.com>