

Rittal – The System.

Faster – better – everywhere.

► Rittal North America Data Center Solutions Catalog

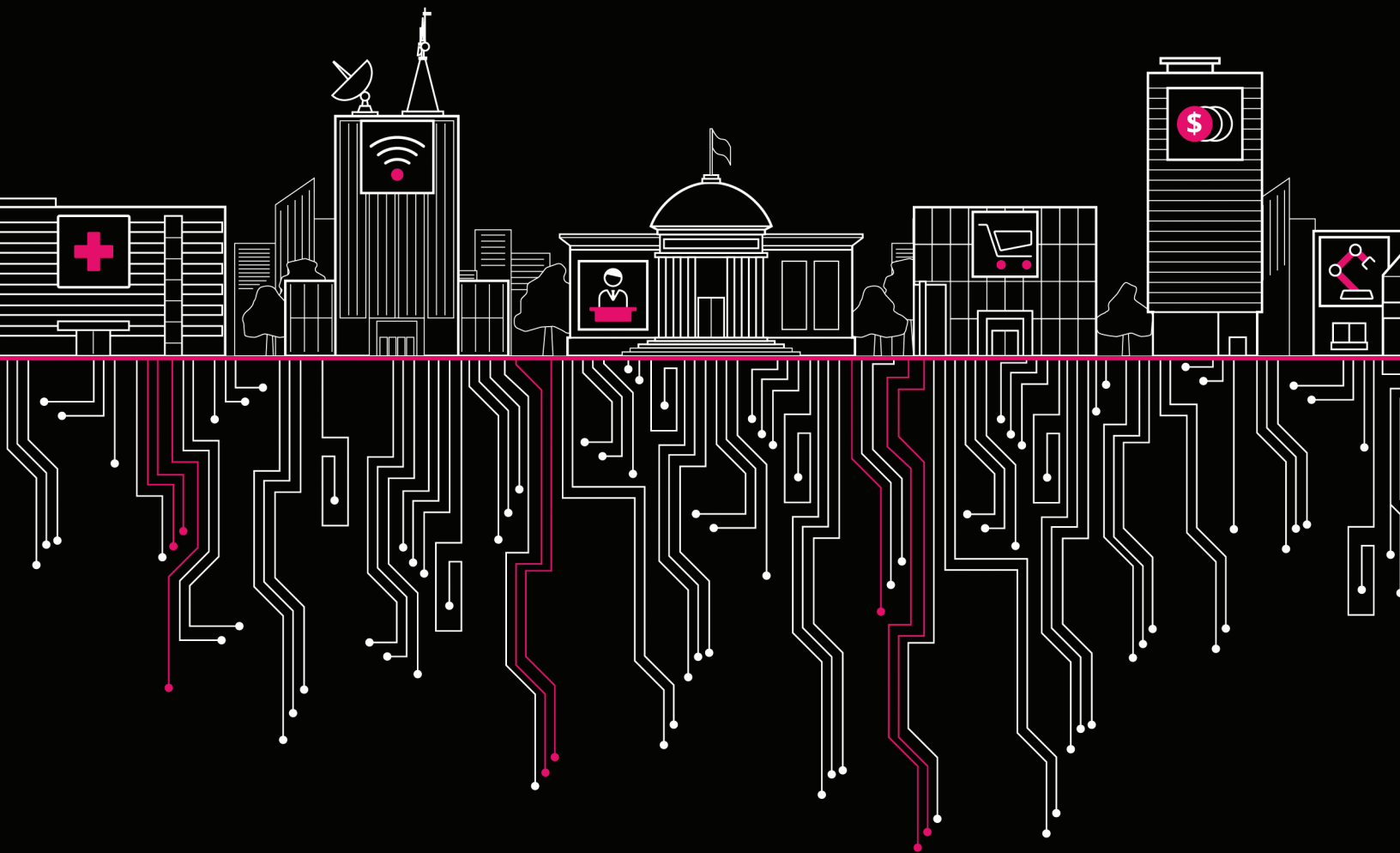

ENCLOSURES

POWER DISTRIBUTION

CLIMATE CONTROL

IT INFRASTRUCTURE

SOFTWARE & SERVICES



FRIEDHELM LOH GROUP

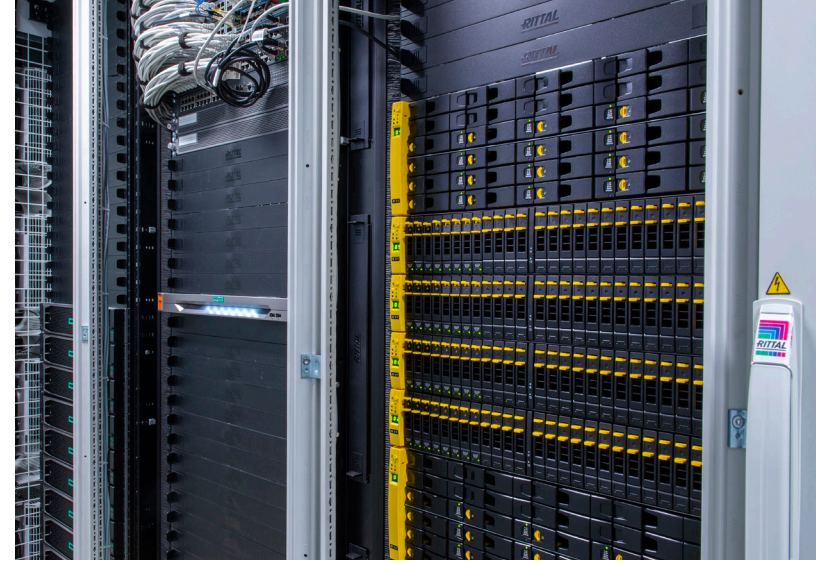

Discover it – a world of solutions for any IT environment.

The digital transformation in business, trade and industry offers a whole host of opportunities, but also throws up new challenges for IT infrastructures. Dealing with complex tasks and huge volumes of data calls for increasingly fast, flexible and efficient IT solutions.

Our response to this is a comprehensive product portfolio for all challenging IT scenarios. This provides a wide range of efficient and reliable options that can be purchased both quickly and cost-effectively.

In conjunction with our consulting expertise, Rittal offers a multitude of options for all requirements. That way, you can focus on what really matters – your core business.

Enclosures

- Xpress enclosure6
- TS IT network/server enclosure with glass viewing door8
- TS IT network/server enclosure with perforated viewing door 10
- Colocation enclosure..... 12
- NEMA 12/UL Type 12 network enclosure.....13
- FlatBox..... 15
- EL 3-part enclosure 16
- EL 3-part NEMA 12 enclosure.....17
- LCP–Liquid Cooling Package Rack CW20
- LCP–Liquid Cooling Package Inline CW21
- LCP–Liquid Cooling Package DX.....22
- Liquid Cooling Package Accessories 23
- Edge Platform Designs.....25

Security

- Fire alarm and extinguisher system DET–AC/EFD Plus37
- CMC III Processing Unit Compact System Overview38
- CMC III Processing Unit System Overview39
- CMC III Processing Unit Compact40
- CMC III Accessories.....41
- Door Control System48
- Door Control System Accessories.....49

Base/plinth System for TS IT

- Modular Base/Plinth System for TS IT51
- Base/plinth Technical Details58

Accessories

- Baying 65
- Door Locks 66

Interior Installation

- Interior Installation67
- Rail Systems67
- Assembly Components68
- Component Shelves72
- Slide Rails.....74
- LED System Lights76
- LED System Lights Accessories77
- Grounding78
- Cable Management.....80
- Ventilation Fans 88

Technical Details

- TS IT92



**Creating your ideal solution
from numerous modules.**
Discover the possibilities.

ENCLOSURES

POWER DISTRIBUTION

CLIMATE CONTROL

Digitization is leading to ever more profound changes in virtually all areas of life. Industry 4.0, the Internet of Things, big data, analytics and edge computing are the driving forces behind this process. The business world as you know it is also affected. It must use innovative IT infrastructures to meet the associated requirements – and this will apply even more in the future. To meet these challenges, you need an efficient, solution-oriented IT partner such as Rittal.

Maximum modularity and efficiency

You can totally rely on our portfolio of solutions for meeting these complex, holistic requirements – from individual IT racks to a complete data center solution that offers maximum modularity and efficiency. Combined with all our expertise, this creates the right solution for each and every requirement.

Three dimensions – one perfect solution

All solutions are integrated into a cyclical process that offers you the full support of our experience and consulting expertise. The IT solutions can be scaled flexibly to suit your precise needs. The range of services offered by Rittal and its partners also includes comprehensive application solutions that are perfectly tailored to your specific requirements.

The end result is a wide range of data center modules that can be up and running in no time at all. They are cost-efficient, reliable and of the quality you have come to expect from Rittal.

IT INFRASTRUCTURE

SOFTWARE & SERVICES



Xpress enclosure



Ships complete with perforated single front door and split rear doors keyed alike, leveling feet, casters, roof with brush baffle cable access channels, cable management wall, and dual PDU vertical mounting wall.

Material:

- Carbon steel
- Aluminum

Surface finish:

- Enclosure frame: Dipcoat-primed
- Interior installation: Dipcoat-primed
- Doors and roof: Dipcoat-primed, powder-coated

Color:

Enclosure frame and panels: Black RAL 9005,
Interior installation: Black RAL 9005

Protection rating:

UL/cUL

Supply includes:

- Enclosure frame TS8 with door and roof plate
- M6 cage nuts (Package of 100)
- M6 mounting screws (Package of 100)

Load capacity of 19" levels:

- 3372 lbs (15000 N)

Distance between rails

as delivered:

- 29" (745 mm)

Detailed drawings:

Available at www.rittal.com

Height: 80" (2000 mm), Depth: 42" – 48" (1050 - 1200 mm)

Height units U	42 U	42 U	42 U	42 U	42 U	42 U	42 U	42 U
Height inches (mm)	80 (2000)	80 (2000)	80 (2000)	80 (2000)	80 (2000)	80 (2000)	80 (2000)	80 (2000)
Width inches (mm)	24 (600)	24 (600)	32 (800)	32 (800)	24 (600)	24 (600)	32 (800)	32 (800)
Depth inches (mm)	42 (1050)	48 (1200)	42 (1050)	48 (1200)	42 (1050)	48 (1200)	42 (1050)	48 (1200)
Aluminum sheet steel front door, vented Carbon steel rear door, vented	■	■	■	■	■	■	■	■
Front and rear comfort handles with push button keyed door lock	■	■	■	■	■	■	■	■
Installed caster kits	■	■	■	■	■	■	■	■
Installed leveling feet	■	■	■	■	■	■	■	■
Solid sidewalls pre-installed	■	■	■	■	–	–	–	–
PDU buckets (shipped loose)	■	■	■	■	–	–	–	–
Cable management wall pre-installed	■	■	■	■	–	–	–	–
Dual cable management walls pre-installed with integrated PDU mounting points	–	–	–	–	■	■	■	■
Part No.	Black RAL 9005 9982100	9982101	9982104	9982105	9982112	9982113	9982116	9982117

Height: 88" (2200 mm), Depth: 42" – 48" (1050 - 1200 mm)

Height units U	47U	47U	47 U	47 U	47 U	47 U
Height inches (mm)	88 (2200)	88 (2200)	88 (2200)	88 (2200)	88 (2200)	88 (2200)
Width inches (mm)	24 (600)	24 (600)	28 (700)	28 (700)	32 (800)	32 (800)
Depth inches (mm)	42 (1050)	48 (1200)	42 (1050)	48 (1200)	42 (1050)	48 (1200)
Aluminum sheet steel front door, vented Carbon steel rear door, vented			■	■	■	■
Front and rear comfort handles with push button keyed door lock			■	■	■	■
Installed caster kits			■	■	■	■
Installed leveling feet			■	■	■	■
Solid sidewalls pre-installed	■	■	■	■	■	■
PDU buckets (shipped loose)			-	-	-	-
Cable management wall pre-installed			-	-	-	-
Dual cable management walls pre-installed with integrated PDU mounting points			■	■	■	■
Part No. Black RAL 9005	9982124	9982125	9982126	9982127	9982128	9982129

Height: 87" (2200 mm), Depth: 42" – 48" (1050 - 1200 mm)

Height units U	47U	47U	47 U	47 U	47 U	47 U
Height inches (mm)	88 (2200)	88 (2200)	88 (2200)	88 (2200)	88 (2200)	88 (2200)
Width inches (mm)	24 (600)	24 (600)	28 (700)	28 (700)	32 (800)	32 (800)
Depth inches (mm)	42 (1050)	48 (1200)	42 (1050)	48 (1200)	42 (1050)	48 (1200)
Aluminum sheet steel front door, vented Carbon steel rear door, vented			■	■	■	■
Front and rear comfort handles with push button keyed door lock			■	■	■	■
Installed caster kits			■	■	■	■
Installed leveling feet			■	■	■	■
Solid sidewalls pre-installed	-	-	-	-	-	-
PDU buckets (shipped loose)			-	-	-	-
Cable management wall pre-installed			-	-	-	-
Dual cable management walls pre-installed with integrated PDU mounting points			■	■	■	■
Part No. Black RAL 9005	9982136	9982137	9982138	9982139	9982140	9982141

TS IT network/server enclosure with glass viewing door



Material:

- Enclosure: Carbon steel
- Viewing window: Single-pane safety glass, 0.12" (3.0 mm)

Surface finish:

- Enclosure frame, interior installation: Dipcoat-primed

- Doors and roof: Dipcoat-primed, powder-coated

Color:

- Black RAL 9005
- Light Gray RAL 7035

Protection rating:

UL/cUL

Included (not preinstalled):

- Spacers for passive cooling (4)
- Grounding provisions (1 set)
- M5 multi-tooth screws and cage nuts, conductive (50)

Load capacity of rails:

- 3372 lbs (15000 N)

Distance between rails as delivered:

- Depth ≤ 32" (800 mm): 21.5" (545 mm)
- Depth ≥ 39" (1000 mm): 29.3" (745 mm)

Detailed drawings:

Available at www.rittal.us

Height: 48 - 79" (1200 - 2000 mm), Depth: 24 - 40" (600 - 1000 mm)

		24 U	24 U	38 U	42 U	42 U
Height inches (mm)		48 (1200)	48 (1200)	71 (1800)	79 (2000)	79 (2000)
Width inches (mm)		32 (800)	32 (800)	32 (800)	32 (800)	32 (800)
Depth inches (mm)		32 (800)	40 (1000)	32 (800)	24 (600)	32 (800)
Aluminum front viewing door, 180° hinges, with comfort handle for semi-cylinder and security lock 3524 E		■	■	■	■	■
Carbon steel rear door, 180° hinges, with comfort handle for semi-cylinder and security lock 3524 E		■	■	–	–	–
Carbon steel rear door, 180° hinges, vertically divided, with comfort handle for semi-cylinder and security lock 3524 E		–	–	■	■	■
Depth-variable 19" (482.6 mm) rails front and rear, on depth stays with quick-release fasteners		■	■	■	■	■
Multi-piece roof plate with side cable entry in the depth and covered cut-out for fan mounting plate		■	■	■	■ ¹⁾	■
Part No.	Light Gray RAL 7035	5503.120	5504.120	5505.120	5506.120	5507.120
	Black RAL 9005	5503.220	5504.220	5505.220	5506.220	5507.220
Accessories		Packs of				
Sidewalls, lockable	Split sidewall (top/bottom), Light Gray RAL 7035 ²⁾	1	–	–	–	5501.010 5501.020
	Split sidewall (top/bottom), Black RAL 9005 ²⁾	1	–	–	–	5501.015 5501.025
Sidewalls, screw attachment	Solid sidewall, Light Gray RAL 7035 ³⁾	2	8175.235	8176.235	–	–
	Solid sidewall, Black RAL 9005 ³⁾	2	9969.949	9969.952	–	–
Base mount	Light Gray RAL 7035	2	5501.310	5501.320	5501.310	– 5501.310
	Black RAL 9005	2	5501.315	5501.325	5501.315	– 5501.315
Gland plates, modular			See Accessory Options			
Base/plinth			See Accessory Options			
Fan mounting plate for TS IT incl. thermostat	Light Gray RAL 7035	1	5502.020	5502.020	5502.020	5502.010 5502.020
	Black RAL 9005	1	5502.025	5502.025	5502.025	5502.015 5502.025
Air baffle plate		1 set	–	–	–	5501.815 5501.815
Cable route		1	–	–	–	5502.120 5502.120
Cable duct		1	–	–	–	5502.100 5502.105

■ Included ¹⁾ Cable entry, rear ²⁾ Packaged as top/bottom set for one side only; order two sets to cover both sides of cabinet

³⁾ Packaged as pair; set will cover both sides of cabinet

TS IT network/server enclosure with glass viewing door

Height: 79 - 81" (2000 - 2200 mm), Depth: 32 - 48" (800 - 1200 mm)

		42 U	42 U	42 U	42 U	47 U	
Height inches (mm)		79 (2000)	79 (2000)	79 (2000)	79 (2000)	87 (2200)	
Width inches (mm)		24 (600)	32 (800)	24 (600)	32 (800)	32 (800)	
Depth inches (mm)		40 (1000)	40 (1000)	48 (1200)	48 (1200)	32 (800)	
Aluminum front viewing door, 180° hinges, with comfort handle for semi-cylinder and security lock 3524 E		■	■	■	■	■	
Carbon steel rear door, 180° hinges, vertically divided, with comfort handle for semi-cylinder and security lock 3524 E		■	■	■	■	■	
Depth-variable 19" (482.6 mm) rails front and rear, on depth stays with quick-release fasteners		■	■	■	■	■	
Multi-piece roof plate with side cable entry in the depth and covered cut-out for fan mounting plate		■	■	■	■	■	
Part No.	Light Gray RAL 7035	5508.120	5509.120	5510.120	5511.120	5512.120	
	Black RAL 9005	5508.220	5509.220	5510.220	5511.220	5512.220	
Accessories	Packs of						
Sidewalls, lockable	Split sidewall (top/bottom), Light Gray RAL 7035 ¹⁾	1	5501.030	5501.030	5501.040	5501.040	5501.050
	Split sidewall (top/bottom), Black RAL 9005 ¹⁾	1	5501.035	5501.035	5501.045	5501.045	5501.055
Base mount	Light Gray RAL 7035	2	5501.320	5501.320	5501.350	5501.350	5501.310
	Black RAL 9005	2	5501.325	5501.325	5501.355	5501.355	5501.315
Gland plates, modular		See Accessory Options					
Base/plinth		See Accessory Options					
Fan mounting plate for TS IT incl. thermostat	Light Gray RAL 7035	1	5502.010	5502.020	5502.010	5502.020	5502.020
	Black RAL 9005	1	5502.015	5502.025	5502.015	5502.025	5502.025
Air baffle plate		1 set	5501.805	5501.815	5501.805	5501.815	5501.835
Cable route		1	5502.120	5502.120	5502.120	5502.120	5502.120
Cable duct		1	–	5502.100	–	5502.105	5502.101

■ Included ¹⁾ Packaged as top/bottom set for one side only; order two sets to cover both sides of cabinet

TS IT network/server enclosure with perforated door



Material:
Carbon steel

Surface finish:
– Enclosure frame, interior installation: Dipcoat-primed
– Doors and roof: Dipcoat-primed, powder-coated

Color:
– Frame and enclosure panels: Black RAL 9005, Light Gray RAL 7035
– Interior installation: Black RAL 9005

Protection rating:
UL/cUL

Included (not preinstalled):
– Spacers for passive cooling (4)
– Grounding provisions (1 set)
– M5 multi-tooth screws and cage nuts, conductive (50)

Load capacity of rails:
– 3372 lbs (15000 N)

Distance between rails as delivered:
29" (745 mm)

Detailed drawings:
Available at www.rittal.us

Height: 48 - 79" (1200 - 2000 mm), Depth: 40 - 48" (1000 - 1200 mm)

U		24 U	42 U	42 U	42 U	42 U	42 U	42 U	42 U	42 U	
Height inches (mm)		48 (1200)	79 (2000)	79 (2000)	79 (2000)	79 (2000)	79 (2000)	79 (2000)	79 (2000)	79 (2000)	
Width inches (mm)		32 (800)	24 (600)	32 (800)	24 (600)	28 (700)	32 (800)	24 (600)	28 (700)	32 (800)	
Depth inches (mm)		40 (1000)	40 (1000)	40 (1000)	41 (1050)	41 (1050)	41 (1050)	48 (1200)	48 (1200)	48 (1200)	
Perforated ¹⁾ carbon steel front door, 180° hinges, with comfort handle for semi-cylinder and security lock 3524 E		■	■	■	■	■	■	■	■	■	
Perforated ¹⁾ carbon steel rear door, 180° hinges, with comfort handle for semi-cylinder and security lock 3524 E		■	–	–	–	–	–	–	–	–	
Perforated ¹⁾ carbon steel rear door, 180° hinges, vertically divided, with comfort handle for semi-cylinder and security lock 3524 E		–	■	■	■	■	■	■	■	■	
Depth-variable 19" (482.6 mm) rails front and rear, on depth stays with quick-release fasteners		■	■	■	■	■	■	■	■	■	
Multi-piece roof plate with side cable entry in the depth and covered cut-out for fan mounting plate		■	■	■	■	■	■	■	■	■	
Part No.	Light Gray RAL 7035	5504.110	5508.110	5509.110	–	9972.001	–	5510.110	9972.003	5511.110	
	Black RAL 9005	5504.210	5508.210	5509.210	5521.210	9972.000	5522.210	5510.210	9972.002	5511.210	
Accessories	Pack of										
Sidewalls, lockable	Split sidewall (top/bottom), Light Gray RAL 7035 ²⁾	1	–	5501.030	5501.030	–	–	–	5501.040	5501.040	5501.040
	Split sidewall (top/bottom), Black RAL 9005 ²⁾	1	–	5501.035	5501.035	5501.095	5501.095	5501.095	5501.045	5501.045	5501.045
Sidewalls, screw attachment	Solid sidewall, Light Gray RAL 7035 ³⁾	2	7824.120	–	–	–	–	–	–	–	–
	Solid sidewall, Black RAL 9005 ³⁾	2	9969.952	–	–	–	–	–	–	–	–
Base mount	Light Gray RAL 7035	2	5501.320	5501.320	5501.320	–	–	–	5501.350	5501.350	5501.350
	Black RAL 9005	2	5501.325	5501.325	5501.325	–	–	–	5501.355	5501.355	5501.355
Gland plates, modular	Light Gray RAL 7035 or Black RAL 9005								See Accessory Options		
Base/plinth									See Accessory Options		
Fan mounting plate for TS IT incl. thermostat	Light Gray RAL 7035	1	5502.020	5502.010	5502.020	–	–	–	5502.010	–	5502.020
	Black RAL 9005	1	5502.025	5502.015	5502.025	5502.015	–	5502.025	5502.015	–	5502.025
Air baffle plate		1 set	–	5501.805	5501.815	5501.805	9972.925	5501.815	5501.805	9972.925	5501.815
Cable route		1	–	5502.120	5502.120	5502.120	–	5502.120	5502.120	–	5502.120
Cable duct		1	–	5502.100	–	–	–	–	5502.105	–	5502.105

■ Included ¹⁾Vented surface area approx. 85% perforated ²⁾Packaged as top/bottom set for one side only; order two sets to cover both sides of cabinet
³⁾Packaged as pair; set will cover both sides of cabinet

TS IT network/server enclosure with perforated viewing door

Height: 87" (2200 mm), Depth: 40 - 48" (1000 - 1200 mm)

U		47 U	47 U	47 U	47 U	47 U	47 U	47 U	47 U	
Height inches (mm)		87 (2200)	87 (2200)	87 (2200)	87 (2200)	87 (2200)	87 (2200)	87 (2200)	87 (2200)	
Width inches (mm)		24 (600)	32 (800)	24 (600)	28 (700)	32 (800)	24 (600)	28 (700)	32 (800)	
Depth inches (mm)		40 (1000)	40 (1000)	42 (1050)	41 (1050)	42 (1050)	48 (1200)	48 (1200)	48 (1200)	
Perforated ¹⁾ carbon steel front door, 180° hinges, with comfort handle for semi-cylinder and security lock 3524 E		■	■	■	■	■	■	■	■	
Perforated ¹⁾ carbon steel rear door, 180° hinges, with comfort handle for semi-cylinder and security lock 3524 E		■	■	■	■	■	■	■	■	
Depth-variable 19" (482.6 mm) rails front and rear, on depth stays with quick-release fasteners		■	■	■	■	■	■	■	■	
Multi-piece roof plate with side cable entry in the depth and covered cut-out for fan mounting plate		■	■	■	■	■	■	■	■	
Part No.	Light Gray RAL 7035	5513.110	5514.110	–	9972.005	–	5515.110	9972.007	5516.110	
	Black RAL 9005	5513.210	5514.210	5523.210	9972.004	5524.210	5515.210	9972.006	5516.210	
Accessories		Pack of								
Sidewalls, 2-part	Split sidewall (top/bottom), Light Gray RAL 7035 ²⁾	1	5501.060	5501.060	–	–	–	5501.070	5501.070	5501.070
	Split sidewall (top/bottom), Black RAL 9005 ²⁾	1	5501.065	5501.065	5501.105	5501.105	5501.105	5501.075	5501.075	5501.075
Base mount	Light Gray RAL 7035	2	5501.320	5501.320	–	–	–	5501.350	5501.350	5501.350
	Black RAL 9005	2	5501.325	5501.325	–	–	–	5501.355	5501.355	5501.355
Gland plates, modular	See Accessory Options									
Base/plinth	See Accessory Options									
Fan mounting plate for TS IT incl. thermostat	Light Gray RAL 7035	1	5502.010	5502.020	–	–	–	5502.010	–	5502.020
	Black RAL 9005	1	5502.015	5502.025	5502.015	–	5502.025	5502.015	–	5502.025
Air baffle plate		1 set	5501.825	5501.835	5501.805	9972.926	5501.815	5501.825	9972.926	5501.835
Cable route		1	5502.120	5502.120	5502.120		5502.120	5502.120		5502.120
Cable duct		1	–	5502.101	–		–	–		5502.145

■ Included ¹⁾Vented surface area approx. 85% perforated ²⁾Packaged as top/bottom set for one side only; order two sets to cover both sides of cabinet

Colocation enclosure



Intensive physical security requirements are met with durable construction, doors with 2-point latching, internal hinges, locking handles and secure cable management.

Doors:

- Vented surface area approximately 64% perforated
- Two point latch on each compartment for optimum security

- Can convert a multi-door cabinet into a single door version when requirements change
- TS 8 comfort handle with lock insert
- Optional individually keyed compartments available

- Can be either right hand or left hand hinged
- Internal hinges for optimum security

Color:

Black RAL 9005

Height: 87" (2200 mm), Depth: 42" (1050 mm)

		2 – 22 U each
Height inches (mm)		87 (2200)
Width inches (mm)		24 (600)
Depth inches (mm)		42 (1050)
Part No.		9963.770
Accessories	Packs of	
Cable security kit	1	9962.840
Quick-adjust EIA rail kit	1	9962.843
Combination lock handle ¹⁾	1	7200.801
Security lock insert ¹⁾	1	2467.000
Pushbutton lock insert ¹⁾	1	2469.000

¹⁾Handles and lock inserts sold separately

NEMA 12/UL Type 12 network enclosure



Our NEMA/UL Type 12 enclosures provide a high degree of protection from dirt, dust, dripping water and external condensation of non-corrosive liquids.

Doors and walls:

- Secure to external surfaces of frame
- Doors can be easily removed or reversed
- Internal door hinge and lock points for maximum security

Vertical mounting rails:

- Fully depth adjustable, maintain load capacity regardless of where the rails are positioned
- Floating installation system, vertical rails are not secured to frame members or lateral support channels; can be adjusted independently
- “Z” shaped, multi-fold profile, high load bearing capacity and multiple mounting surfaces

- U markings on front and rear surfaces of each rail
- Unique rail design allows for up to 32 U in the zero “U” space
- Each cabinet includes M6 Cage Nuts with insertion tool (bag of 50) and M6 Mounting screws with plastic washers (bag of 100)

Note:

23" mounting capability on 32" (800 mm) wide cabinets

Supply includes:

- One set of 19" (482.6 mm) EIA rails, front & rear
- Leveling feet

Height: 48" (1200 mm), Depth: 24 - 32" (600 - 800 mm)

		24 U	24 U	24 U	24 U	24 U	24 U
Height inches (mm)		48 (1200)	48 (1200)	48 (1200)	48 (1200)	48 (1200)	48 (1200)
Width inches (mm)		24 (600)	24 (600)	24 (600)	24 (600)	32 (800)	32 (800)
Depth inches (mm)		24 (600)	24 (600)	32 (800)	32 (800)	32 (800)	32 (800)
Color	Light Gray RAL 7035	■	–	■	–	■	–
	Black RAL 9005	–	■	–	■	–	■
Part No.	NEMA 12 viewing door, solid rear door	9969.876	9969.877	9969.884	9969.885	9969.886	9969.887
	UL Type 12 solid front & rear door	9963.487	–	9963.488	–	–	–
Accessories	Packs of						
Sidewalls - full	2	8170.235	9969.948	8175.235	9969.949	8175.235	9969.949
Base/plinths 8" (200 mm) front and rear	2	8602.605	9967.491	8602.605	9967.491	8602.805	9967.492
Base/plinths 8" (200 mm) side trim	2	8602.065	–	8602.085	–	8602.085	–
Caster kit	4	7825.900	7825.900	7825.900	7825.900	7825.900	7825.900

NEMA 12/UL Type 12 network enclosure

Height: 79 - 87" (2000 - 2200 mm), Depth: 24 - 32" (600 - 800 mm)

		42 U	42 U	47 U	47 U	42 U	42 U	42 U	42 U
Height inches (mm)		79 (2000)	79 (2000)	87 (2200)	87 (2200)	79 (2000)	79 (2000)	79 (2000)	79 (2000)
Width inches (mm)		24 (600)	24 (600)	24 (600)	24 (600)	24 (600)	24 (600)	32 (800)	32 (800)
Depth inches (mm)		24 (600)	24 (600)	24 (600)	24 (600)	32 (800)	32 (800)	32 (800)	32 (800)
Color	Light Gray RAL 7035	■	–	■	–	■	–	■	–
	Black RAL 9005	–	■	–	■	–	■	–	■
Part No.	NEMA 12 viewing door, solid rear door	9969.880	9969.881	9969.882	9969.883	9969.892	9969.893	9969.894	9969.895
	UL Type 12 solid front & rear door	9960.301	–	9963.492	–	9960.302	–	9960.303	–
Accessories	Packs of								
Sidewalls - full	2	8106.235	9969.920	8126.235	9969.917	8108.235	9969.916	8108.235	9969.916
Base/plinths 8" (200 mm) front and rear	2	8602.605	9967.491	8602.605	9967.491	8602.605	9967.491	8602.805	9967.492
Base/plinths 8" (200 mm) side trim	2	8602.065	–	8602.065	–	–	–	8602.085	–
Cable management panel	1	–	9978.360	–	9978.361	–	9978.360	–	9978.360
Caster kit	4	7825.900	7825.900	7825.900	7825.900	7825.900	7825.900	7825.900	7825.900

Height: 79 - 87" (2000 - 2200 mm), Depth: 32 - 40" (800 - 1000 mm)

		47 U	47 U	47 U	47 U	42 U	42 U
Height inches (mm)		87 (2200)	87 (2200)	87 (2200)	87 (2200)	79 (2000)	79 (2000)
Width inches (mm)		24 (600)	24 (600)	32 (800)	32 (800)	24 (600)	32 (800)
Depth inches (mm)		32 (800)	32 (800)	32 (800)	32 (800)	40 (1000)	40 (1000)
Color	Light Gray RAL 7035	■	–	■	–	■	■
	Black RAL 9005	–	■	–	■	–	–
Part No.	NEMA 12 viewing door, solid rear door	9969.896	9969.897	9969.898	9969.899	–	–
	UL Type 12 solid front & rear door	–	–	–	–	9963.490	9963.608
Accessories	Packs of						
Sidewalls - full	2	8128.235	9969.352	8128.235	9969.352	8100.235	8100.235
Base/plinths 8" (200 mm) front and rear	2	8602.605	9967.491	8602.805	9967.492	8602.605	8602.805
Base/plinths 8" (200 mm) side trim	2	8602.085	–	8602.085	–	8602.015	8602.015
Cable management panel	1	–	9978.361	–	9978.361	–	–
Caster kit	4	7825.900	7825.900	7825.900	7825.900	7825.900	7825.900

Height: 79 - 87" (2000 - 2200 mm), Depth: 48" (1200 mm)

		47 U	47 U	47 U	47 U
Height inches (mm)		79 (2000)	79 (2000)	87 (2200)	87 (2200)
Width inches (mm)		24 (600)	32 (800)	24 (600)	32 (800)
Depth inches (mm)		48 (1200)	48 (1200)	48 (1200)	48 (1200)
Color	Light Gray RAL 7035	■	■	■	■
	Black RAL 9005	–	–	–	–
Part No.	NEMA 12 viewing door, solid rear door	–	–	–	–
	UL Type 12 solid front & rear door	9963.491	9963.609	9963.495	9963.498
Accessories	Packs of				
Sidewalls - full	2	9969.955	9969.955	9969.957	9969.957
Base/plinths 8" (200 mm) front and rear	2	8602.605	8602.805	8602.605	8602.805
Base/plinths 8" (200 mm) side trim	2	8602.025	8602.025	8602.085	8602.025
Cable management panel	1	–	–	–	–
Caster kit	4	9968.751	9968.751	7825.900	7825.900



For flexible use as a wall-mounted or floor-standing enclosure.

Advantages:

- Tool-free quick mounting
- System configuration on an open 19" frame

Material:

- Carbon steel
- Viewing window: Single-pane safety glass, 3 mm

Surface finish:

- Powder-coated Color:
- Light Gray RAL 7035

Supply includes:

- Flat-packed enclosure
- 1 wall section
- 2 basic supports
- 2 roof/base plates, with cut-outs for cable entry via brush strips
- 2 sidewalls, lockable

- 1 glazed door, lockable, security lock 3524 E, door catch freely selectable
 - Connection components for tool-free, fast assembly
 - Grounding kit for system -compatible grounding of all enclosure parts
- Please note the product-specific scope of supply.

Note:

- Max. installation depth: 112 mm
- Max. distance between two 19" levels: Depth -126 mm

Technical details:

Available on the Internet

Photo shows a configuration example with equipment not included in the scope of supply

Version with 19" Profile Rails

Height Units U		6	6	9	9
Height inches (mm)		14 (358)	14 (358)	19 (492)	19 (492)
Width inches (mm)		24 (600)	24 (600)	24 (600)	24 (600)
Depth inches (mm)		16 (400)	24 (600)	16 (400)	24 (600)
Model No.		7507.000	7507.100	7507.010	7507.110
Product-specific scope of supply					
19" profile rails, front only		■	■	■	■
Accessories	Packs of				
Profile rails 19"	2 pc(s).	7507.706	7507.706	7507.709	7507.709
Ground rail, horizontal	1 pc(s).	7113.000	7113.000	7113.000	7113.000
Fan expansion kit		See Accessory Options			
Internal enclosure thermostat	1 pc(s).	3110.000	3110.000	3110.000	3110.000
Cable management panel	1 pc(s).	5502.205	5502.205	5502.205	5502.205

Version with 19" Mounting Frame

Height Units U		12	12	15	15	18	21
Height inches (mm)		25 (625)	25 (625)	30 (758)	30 (758)	35 (892)	40 (1025)
Width inches (mm)		24 (600)	24 (600)	24 (600)	28 (700)	28 (700)	28 (700)
Depth inches (mm)		16 (400)	24 (600)	16 (400)	28 (700)	28 (700)	28 (700)
Model No.		7507.020	7507.120	7507.030	7507.200	7507.210	7507.220
Product-specific scope of supply							
19" mounting frame, front only		■	■	■	■	■	■
Leveling feet		■	■	■	■	■	■
Accessories	Packs of						
Profile rails 19"	2 pc(s).	7507.712	7507.712	7507.715	7507.715	7507.718	7507.721
Ground rail, horizontal	1 pc(s).	7113.000	7113.000	7113.000	7113.000	7113.000	7113.000
Fan expansion kit		See Accessory Options					
Internal enclosure thermostat	1 pc(s).	3110.000	3110.000	3110.000	3110.000	3110.000	3110.000
Cable management panel	1 pc(s).	5502.205	5502.205	5502.205	5502.205	5502.205	5502.205

EL 3-part enclosure

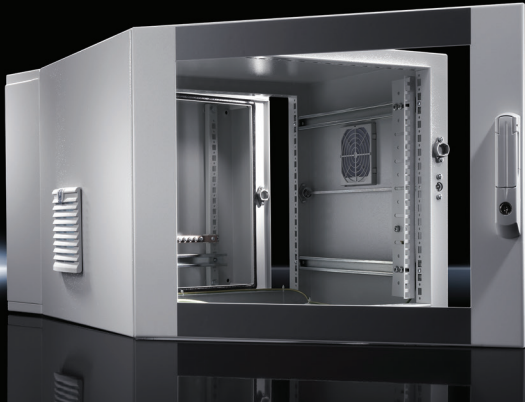

Material:

- Wall and hinged part: Carbon steel, 16 ga (1.5 mm)
- Viewing window: Single-pane safety glass, 3.0 mm

Surface finish:

Powder-coated

Color:

- Wall, hinged part: Light Gray RAL 7035
- Viewing door: Light Gray RAL 7035/7015

Protection rating:

UL listed

Supply includes:

- Wall section

- Hinged middle with 25 mm hole pattern in the front and rear frame
- Designer viewing door
- Mini comfort handle for 3 – 15 U
- Comfort handle and 2-point lock for 18 – 21 U
- Includes security lock 3524 E

Detailed drawings:

Available at www.rittal.us

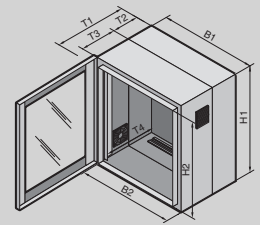

Depth: 23 - 27" (573 - 673 mm), preconfigured

Height units U	9 U	9 U	15 U	15 U	21 U	21 U
Height (H1) inches (mm)	19 (478)	19 (478)	29 (746)	29 (746)	40 (1012)	40 (1012)
Width (B1) inches (mm)	24 (600)	24 (600)	24 (600)	24 (600)	24 (600)	24 (600)
Depth (T1) inches (mm)	23 (573)	27 (673)	23 (573)	27 (673)	23 (573)	27 (673)
Clearance width (B2) inches (mm)	20 (502)	20 (502)	20 (502)	20 (502)	20 (502)	20 (502)
Clearance height (H2) inches (mm)	16 (415)	16 (415)	27 (683)	27 (683)	37 (949)	37 (949)
Depth of wall section (T2) inches (mm)	5 (135)	5 (135)	5 (135)	5 (135)	5 (135)	5 (135)
Depth of hinged part (T3) inches (mm)	16 (416)	20 (516)	16 (416)	20 (516)	16 (416)	20 (516)
Max. installation depth (T4) inches (mm)	20 (520)	24 (620)	20 (520)	24 (620)	20 (520)	24 (620)
Load capacity of hinged part lbs (kg, static)	99 (45)	99 (45)	165 (75)	165 (75)	165 (75)	165 (75)
Part No.	7709.735	7709.535	7715.735	7715.535	7721.735	7721.535
Product-specific configuration						
Wall section:	Gland plate, solid, top	■	■	■	■	■
	Gland plate with brush strip, bottom	■	■	■	■	■
	2 Vertical punched rails	■	■	■	■	■
	C rail mounted horizontally for cable clamping	■	■	■	■	■
Hinged part:	19" (482.6 mm) mounting rails, fully depth adjustable	■	■	■	■	■
	Side outlet filters left and right	■	■	■	■	■
Ground rail with star grounding	■	■	■	■	■	■
4 x 0.0.4" (10 mm) trim panels	■	■	■	■	■	■
Mini-comfort handle	■	■	■	■	–	–
Security lock 3524E	■	■	■	■	■	■
Comfort handle and 2-point latching	–	–	–	–	■	■
Accessories	Packs of					
Gland plate for metric cable glands	1	7705.235	7705.235	7705.235	7705.235	7705.235
Fan expansion kit	1	7980.100	7980.100	7980.100	7980.100	7980.100
Spare filter mats	5	3322.700	3322.700	3322.700	3322.700	3322.700
Wall mounting bracket, 1.57" (40 mm)	4	2503.010	–	2503.010	–	2503.010
Component shelf, 2 U, static installation	1	5501.615	5501.615	5501.615	5501.615	5501.615

EL 3-part NEMA 12 enclosure



Material:

- Wall, hinged part: Carbon steel, 16 ga (1.5 mm)
- Viewing window: Single-pane safety glass, 3.0 mm

Surface finish:

Powder-coated

Color:

- Wall, hinged part: Light Gray RAL 7035
- Viewing door: Light Gray RAL 7035/7015

Protection rating:

NEMA 12 (IP 55 to IEC 60 529);
UL listed

Supply includes:

- Wall section
- Hinged part with 25 mm hole pattern in front and rear frame
- Designer viewing door
- Mini comfort handle for 3 – 15 U
- Comfort handle and 2-point lock for 18 – 21 U
- Includes security lock 3524 E

Detailed drawings:

Available at www.rittal.us

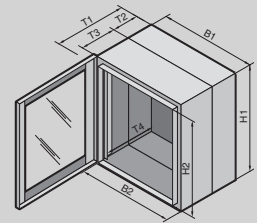

Depth: 19" (473 mm), with punched rails

	6 U	9 U	12 U	15 U	21 U
Height (H1) inches (mm)	14 (345)	19 (478)	24 (612)	29 (746)	40 (1012)
Width (B1) inches (mm)	24 (600)	24 (600)	24 (600)	24 (600)	24 (600)
Depth (T1) inches (mm)	19 (473)	19 (473)	19 (473)	19 (473)	19 (473)
Clearance width (B2) inches (mm)	20 (502)	20 (502)	20 (502)	20 (502)	20 (502)
Clearance height (H2) inches (mm)	11 (282)	16 (415)	22 (549)	27 (683)	37 (949)
Depth of wall section (T2) inches (mm)	5 (135)	5 (135)	5 (135)	5 (135)	5 (135)
Depth of hinged part (T3) inches (mm)	12 (316)	12 (316)	12 (316)	12 (316)	12 (316)
Max. installation depth (T4) inches (mm)	17 (420)	17 (420)	17 (420)	17 (420)	17 (420)
Load capacity of hinged part lbs (kg, static)	66 (30)	99 (45)	132 (60)	165 (75)	165 (75)
Part No.	7706.135	7709.135	7712.135	7715.135	7721.135

Product-specific configuration

	6 U	9 U	12 U	15 U	21 U
Wall section: Gland plate, solid, top and bottom	■	■	■	■	■
Wall section: Vertical punched rails	■	■	■	■	■
Wall section: Horizontal C rail for cable clamping	■	■	■	■	■
Hinged part: 19" (482.6 mm) mounting rails, fully depth adjustable	■	■	■	■	■
Wall mounting bracket, 0.39" (10 mm)	■	■	■	■	■

Accessories	Packs of	6 U	9 U	12 U	15 U	21 U
Gland plate with brush insert	1	7705.035	7705.035	7705.035	7705.035	7705.035
Gland plate for metric cable glands	1	7705.235	7705.235	7705.235	7705.235	7705.235
Wall mounting bracket, 1.57" (40 mm)	4	2503.010	2503.010	2503.010	2503.010	2503.010
Ground rail, horizontal	1	7113.000	7113.000	7113.000	7113.000	7113.000

EL 3-part NEMA 12 enclosure

Depth: 24" (600 mm), with punched rails

		12 U	15 U	21 U
Height (H1) inches (mm)		24 (612)	29 (746)	40 (1012)
Width (B1) inches (mm)		24 (600)	24 (600)	24 (600)
Depth (T1) inches (mm)		24 (600)	24 (600)	24 (600)
Clearance width (B2) inches (mm)		20 (502)	20 (502)	20 (502)
Clearance height (H2) inches (mm)		22 (549)	27 (683)	37 (949)
Depth of wall section (T2) inches (mm)		5 (135)	5 (135)	5 (135)
Depth of hinged part (T3) inches (mm)		18 (445)	18 (445)	18 (445)
Max. installation depth (T4) inches (mm)		21 (530)	21 (530)	21 (530)
Load capacity of hinged part lbs (kg, static)		132 (60)	165 (75)	165 (75)
Part No.		9969.580¹⁾	9969.581¹⁾	9969.582¹⁾
Product-specific configuration	Packs of			
Wall section: Gland plate, solid, top and bottom	2	■	■	■
Vertical punched rails	2	■	■	■
Horizontal C rail for cable clamping	1	■	■	■
Hinged part: 19" (482.6 mm) mounting rails, fully depth adjustable	2	■	■	■
Wall mounting bracket, 0.39" (10 mm)	4	■	■	■
Accessories	Packs of			
Gland plate with brush insert	1	7705.035	7705.035	7705.035
Gland plate for metric cable glands	1	7705.235	7705.235	7705.235
Wall mounting bracket, 1.57" (40 mm)	4	2503.010	2503.010	2503.010
Ground rail, horizontal	1	7113.000	7113.000	7113.000

¹⁾ Not UL listed

Depth: 15" (373 mm), with mounting panel

		3 U	6 U	9 U	12 U	15 U	21 U
Height (H1) inches (mm)		8 (212)	14 (345)	19 (478)	24 (612)	29 (746)	40 (1012)
Width (B1) inches (mm)		24 (600)	24 (600)	24 (600)	24 (600)	24 (600)	24 (600)
Depth (T1) inches (mm)		15 (373)	15 (373)	15 (373)	15 (373)	15 (373)	15 (373)
Clearance width (B2) inches (mm)		20 (502)	20 (502)	20 (502)	20 (502)	20 (502)	20 (502)
Clearance height (H2) inches (mm)		6 (149)	11 (282)	16 (415)	22 (549)	27 (683)	37 (949)
Depth of wall section (T2) inches (mm)		5 (135)	5 (135)	5 (135)	5 (135)	5 (135)	5 (135)
Depth of hinged part (T3) inches (mm)		9 (216)	9 (216)	9 (216)	9 (216)	9 (216)	9 (216)
Max. installation depth (T4) inches (mm)		13 (320)	13 (320)	13 (320)	13 (320)	13 (320)	13 (320)
Width of mounting panel (B3) inches (mm)		19 (485)	19 (485)	19 (485)	19 (485)	19 (485)	19 (485)
Height of mounting panel (H3) inches (mm)		7 (165)	12 (299)	17 (432)	22 (565)	28 (699)	38 (965)
Load capacity of hinged part lbs (kg, static)		33 (15)	66 (30)	99 (45)	132 (60)	165 (75)	165 (75)
Part No.		2243.605	2246.605	2249.605	2252.605	2255.605	2261.605
Product-specific configuration	Packs of						
Wall section: Gland plate, solid, top and bottom	2	■	■	■	■	■	■
Mounting panel supplied loose	1	■	■	■	■	■	■
Hinged part: 19" (482.6 mm) mounting rails	2	■	■	■	■	■	■
Accessories	Packs of						
Wall mounting bracket, 0.39" (10 mm)	4				2508.010		
Wall mounting bracket, 1.57" (40 mm)	4				2503.010		
Gland plate with brush insert	1				7705.035		
Gland plate for metric cable glands	1				7705.235		
Blanking panels, 19" (482.6 mm)	3						see Accessory Options

EL 3-part NEMA 12 enclosure

Depth: 19" (473 mm), with mounting panel

	3 U	6 U	9 U	12 U	15 U	21 U
Height (H1) inches (mm)	8 (212)	14 (345)	19 (478)	24 (612)	29 (746)	40 (1012)
Width (B1) inches (mm)	24 (600)	24 (600)	24 (600)	24 (600)	24 (600)	24 (600)
Depth (T1) inches (mm)	19 (473)	19 (473)	19 (473)	19 (473)	19 (473)	19 (473)
Clearance width (B2) inches (mm)	20 (502)	20 (502)	20 (502)	20 (502)	20 (502)	20 (502)
Clearance height (H2) inches (mm)	6 (149)	11 (282)	16 (415)	22 (549)	27 (683)	37 (949)
Depth of wall section (T2) inches (mm)	5 (135)	5 (135)	5 (135)	5 (135)	5 (135)	5 (135)
Depth of hinged part (T3) inches (mm)	13 (316)	13 (316)	13 (316)	13 (316)	13 (316)	13 (316)
Max. installation depth (T4) inches (mm)	17 (420)	17 (420)	17 (420)	17 (420)	17 (420)	17 (420)
Width of mounting panel (B3) inches (mm)	19 (485)	19 (485)	19 (485)	19 (485)	19 (485)	19 (485)
Height of mounting panel (H3) inches (mm)	7 (165)	12 (299)	17 (432)	22 (565)	28 (699)	38 (965)
Load capacity of hinged part lbs (kg, static)	33 (15)	66 (30)	99 (45)	132 (60)	165 (75)	165 (75)
Part No.	2253.605	2256.605	2259.605	2262.605	2265.605	2271.605
Product-specific configuration	Packs of					
Wall Gland plate, solid, top and bottom	2	■	■	■	■	■
section: Mounting panel supplied loose	1	■	■	■	■	■
Hinged part: 19" (482.6 mm) mounting rails	2	■	■	■	■	■
Accessories	Packs of					
Wall mounting bracket, 0.39" (10 mm)	4	2508.010				
Wall mounting bracket, 1.57" (40 mm)	4	2503.010				
Gland plate with brush insert	1	7705.035				
Gland plate for metric cable glands	1	7705.235				
Blanking panels, 19" (482.6 mm)	3	See Accessory Options				

LCP–Liquid Cooling Package Rack CW



Benefits:

- Maximum energy efficiency due to EC fan technology and IT-based control
- Minimal pressure loss at the air end, which in turn minimizes the power consumption of the fans
- Control of the server intake air temperature
- Redundant temperature sensor integrated at the air end
- Optimum adaptability due to dynamic, continuous control of the cold water volume flow
- By using high water inlet temperatures the proportion of indirect free cooling is increased, which in turn reduces operating costs

- Targeted cooling output due to modular fan units
- Fan modules configurable as n+1 redundancy
- The separation of cooling and enclosure prevents water from entering the server enclosure
- Up to 60 kW cooling output on a footprint of just 3.87 ft²
- Minimal area load thanks to low weight

Approvals:

- UL
- cUL

Functions:

The LCP draws in the air at the sides at the rear of the server enclosures, cools it using a

high performance multi-row heat exchanger, and blows the cooled air back into the front part of the server enclosure at the sides.

Monitoring:

- Monitoring of all system-relevant parameters such as server air intake temperature, server waste air temperature, water inlet/return temperature, water flow, cooling output, fan speed, and leakage
- Direct connection of the unit via SNMP over Ethernet

Temperature control:

- Infinitely variable fan control
- 2-way control valve

Color:

- Black RAL 9005

Protection category IP to IEC 60 529:

- IP 20

Cooling medium:

- Water

Optional:

- Automatic server enclosure door opening
- Various sensors
- Racks 2200 mm high

Technical details:

Available on the Internet. Photo shows a configuration example with equipment not included in the scope of supply.

LCP Rack CW (North American Version) Model Number	3311.238	3311.268
Total cooling output/number of fan modules required BTU (kW)	34121 (10)/1 68243 (20)/2 102364 (30)/3	136486 (40)/4 153546 (45)/5 187668 (60)/6
Number of fan modules in supplied state	1	4
Height inches (mm)	79 (2000)	79 (2000)
Width inches (mm)	12 (300)	12 (300)
Depth inches (mm)	47 (1200)	47 (1200)
Installation in bayed enclosure suite	Flush	Flush
Rated operating voltage V, ~, Hz	208, 2~, 60 230, 1~, 50/60	208, 2~, 60 230, 1~, 50/60
Type of connection (electrical)	Hard-wired	Hard-wired
Air throughput at max. cooling output cfm (m ³ /h)	2825 (4800)	4709 (8000)
Fans may be exchanged with the system operational	■	■
EC fan	■	■
Water inlet temperature °F	59	59
Permissible operating pressure (p. max.) psi (bar)	87 (6)	87 (6)
Duty cycle %	100	100
Water connection	1½" BSP Male Thread	1½" BSP Male Thread
Weight in supplied state lb (kg)	485 (220.0)	529 (240.0)
Accessories	Packs of	
Fan module	1 pc(s).	3311.016
Touchscreen display, color	1 pc(s).	3311.030

LCP–Liquid Cooling Package Inline CW



Benefits:

- Maximum energy efficiency due to EC fan technology and IT-based control
- Minimal pressure loss at the air end, which in turn minimizes the power consumption of the fans
- Optimum adaptability due to dynamic, continuous control of the cold water volume flow
- By using high water inlet temperatures the proportion of indirect free cooling is increased, which in turn reduces operating costs
- Targeted cooling output due to modular fan units
- Fan modules configurable as n+1 redundancy
- Redundant temperature sensor integrated at air end

- The separation of cooling and enclosure prevents water from entering the server enclosure
- Water supply can be set to either top or bottom
- Up to 60 kW cooling output on a footprint of just 3.87 ft²
- Minimal area load thanks to low weight

Functions:

The hot air is drawn in from the room or hot aisle at the rear of the device and passing through a high efficiency multi-row heat exchanger expelled at the front into the cold aisle after cooling. The LCP achieves maximum performance and efficiency

in conjunction with cold aisle containment. With this product, a raised floor is not necessary.

Approvals:

- UL
- cUL

Monitoring:

- Monitoring of all system-relevant parameters such as a server air intake temperature, server waste air temperature, water inlet/return temperature, water flow, cooling output, fan speed, and leakage
- Direct connection of the unit via SNMP over Ethernet
- Integration into RiZone

Temperature control:

- Infinitely variable fan control
- 2-way control valve

Color:

- Black RAL 9005

Protection category IP to IEC 60 529:

- IP 20

Cooling medium:

- Water
- Water/Glycol

Optional:

- Various sensors
- Racks 2200 mm high

Technical details:

Available on the Internet. Photo shows a configuration example with equipment not included in the scope of supply.

LCP Inline CW North American Version Model No.	3311.148	3311.538	3311.548	3311.568
Total cooling output/number of fan modules required BTU (kW)	61419 (18)/2 92128 (27)/3 102364 (30)/4	34121 (10)/1 68243 (20)/2 102364 (30)/3	61419 (18)/2 92128 (27)/3 102364 (30)/4	136486 (40)/4 153546 (50)/5 187668 (60)/6
Number of fan modules in supplied state	2	1	2	4
Height inches (mm)	79 (2000)	79 (2000)	79 (2000)	79 (2000)
Width inches (mm)	12 (300)	12 (300)	12 (300)	12 (300)
Depth inches (mm)	41 (1050)	47 (1200)	47 (1200)	47 (1200)
Installation in bayed enclosure suite	Flush	Protruding	Flush	Protruding
Rated operating voltage V, ~, Hz	208, 2~, 60 230, 1~, 50/60	208, 2~, 60 230, 1~, 50/60	208, 2~, 60 230, 1~, 50/60	208, 2~, 60 230, 1~, 50/60
Type of connection (electrical)	Hard-wired	Hard-wired	Hard-wired	Hard-wired
Air throughput at max. cooling output cfm (m ³ /h)	2825 (4800)	2825 (4800)	2825 (4800)	4709 (8000)
Fans may be exchanged with the system operational	■	■	■	■
EC fan	■	■	■	■
Permissible operating pressure (p. max.) psi (bar)	87 (6)	87 (6)	87 (6)	87 (6)
Duty cycle %	100	100	100	100
Water connection	1½" BSP Male Thread	1½" BSP Male Thread	1½" BSP Male Thread	1½" BSP Male Thread
Water inlet temperature °F	59	59	59	59
Weight in supplied state lb (kg) 485	485 (220.0)	485 (220.0)	485 (220.0)	529 (240.0)
Accessories	Packs of			
Fan module	1 pc(s)	3311.016	3311.016	3311.016
Touchscreen display, color	1 pc(s)	3311.030	3311.030	3311.030

LCP—Liquid Cooling Package DX



Benefits:

- Cooling output up to 20kW
- Standard and high ambient condensers for all North American locations
- Small footprint due to innovative large surface area cooling design
- Easy maintenance with tool less EC fan replacement and easy access electrical connections
- High partial load efficiencies from the inverter controlled compressor which maintains set point temperature as heat loads vary
- Electronic expansion valve to quickly react to changing thermal loads and optimize system operation

- Redundancy achieved by inter-connecting up to 8 units
- Low environmental impact with R410a refrigerant
- Protects sensitive equipment by rapidly responding to changing heat loads

Functions:

Introducing the NEW LCP DX 20kW: The NEW LCP DX provides 20 kW of cooling capacity and is available in closed loop Rack and open loop Inline. The LCP Rack DX is coupled with one or two enclosed racks allowing placement in non-controlled environments. The LCP Inline DX is the optimal choice for maintaining

temperatures in re-purposed data rooms and server closets.

LCP Rack and Inline DX 12kW:

The LCP DX 12 kW is also available in Rack and Inline versions and provide flexible and scalable cooling for small data centers. The Rack version is paired with NEMA 12 rated server racks for a completely stand-alone system in uncontrolled environments. The Inline version provides whole room cooling of racks and other equipment while maintaining optimal inlet temperatures. Redundancy is achieved through N+1 EC fans and a designated primary and backup LCP DX control scheme.

Temperature control:

- Infinitely variable fan control
- Inverter-controlled compressor

Color:

- Black RAL 9005

Protection category IP to IEC 60 529:

- IP 20

Cooling medium:

- R410a

Photo shows a configuration example with equipment not included in the scope of supply.

Model No.	LCP Rack DX			LCP Inline DX		
	3311.415	3311.425	3311.392	3311.435	3311.445	3311.391
Total cooling output/number of fan modules required BTU (kW)	40,946 (12)/4	40,946 (12)/4	40,946 (20)/4	40,946 (12)/4	40,946 (12)/4	40,946 (20)/4
Height inches (mm)	79 (2000)	79 (2000)	79 (2000)	79 (2000)	79 (2000)	79 (2000)
Width inches (mm)	12 (300)	12 (300)	12 (300)	12 (300)	12 (300)	12 (300)
Depth inches (mm)	39 (1000)	47 (1200)	48 (1200)	39 (1000)	47 (1200)	48 (1200)
Rated operating voltage V, ~, Hz	208, 1~, 60	208, 1~, 60	208, 1~, 60	208, 1~, 60	208, 1~, 60	208, 1~, 60
Type of connection (electrical)	Terminal	Terminal	Terminal	Terminal	Terminal	Terminal
Air throughput at max. cooling output cfm (m³/h)	2825 (4800)	2825 (4800)	2825 (4800)	2825 (4800)	2825 (4800)	2825 (4800)
Fans may be exchanged with the system operational	Yes, toolless	Yes, toolless	Yes, toolless	Yes, toolless	Yes, toolless	Yes, toolless
Fan type (Number of fan modules)	EC (4)	EC (4)	EC (4)	EC (4)	EC (4)	EC (4)
Duty cycle %	100	100	100	100	100	100
Weight in supplied state lb (kg)	399 (181.0)	399 (181.0)	443 (201)	399 (181.0)	399 (181.0)	443 (201)
Compressor type	Twin Rotary	Twin Rotary	Scroll	Twin Rotary	Twin Rotary	Scroll
Piping (max) distance feet (m)	98 (30)	98 (30)	150 (45)	98 (30)	98 (30)	150 (45)
Accessories						
SNMP card	3311.320	3311.320	Included	3311.320	3311.320	Included
Condenser unit	9951.077	9951.077	9951.077	9951.077	9951.077	9951.077

Liquid Cooling Package

Accessories

Touchscreen display, color for LCP CW rack and inline

The display offers the opportunity of directly monitoring key LCP functions and implementing settings.

Packs of	Part No.
1	3311.030



Condenser unit

The condenser unit is needed to operate the refrigerant-based LCP DX's, and comprises the external condenser, and fan.

Refrigerant:
R410a

For LCP DX	Packs of	Model No.
3311.415 3311.425 3311.435 3311.445 3311.391 3311.392	1 pc(s).	Single Circuit 9951.077
For 2 LCP DX units	1 pc(s).	Dual Circuit 9982.148



Note:

– The pipework between the LCP DX and the condenser is not included with the supply

Vertical shielding

To block the airflow on the left and right of the 19" (482.6 mm) rails, for enclosure height 79" (2000 mm).

Material:

- Cellular PU foam
- Flame-inhibiting to UL 94 (HF1)
- Length: 75" (1900 mm)
- Self-adhesive on one side

For sealing between	For enclosure width inches (mm)	Packs of	Part No.
Side panel and 19" (482.6 mm) rails	24 (600)	1	3301.380
	32 (800)	1	3301.390
LCP and 19" (482.6 mm) rails	24 (600)	1	3301.370
	32 (800)	1	3301.320

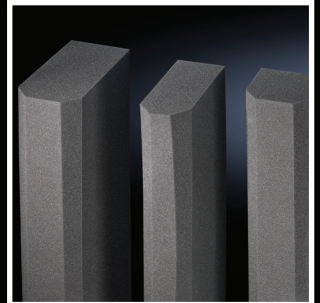

Connection hose, bottom and top

Flexible rubber hose, may be shortened. Requires Hose Conversion Kit 9977.379 for connection to LCP CW.

Part Number	Description	Packs of
9977.379	Hose Connection Kit	1
9971.173	10' Hose	1
9971.174	15' Hose	1
9971.175	25' Hose	1

For use with LCP CW 3311.148, 3311.238, 3311.268, 3311.538, 3311.548, 3311.568



Liquid Cooling Package

Accessories



Fan Module for LCP CW

To increase the cooling output, individual fan modules can be retro-fitted into the LCPs. This helps to generate redundancy or reduce the electrical power consumption of the LCP.

For LCP	Color	Packs of	Model No.
3311.148, 3311.238, 3311.268, 3311.538, 3311.548, 3311.568	Black RAL 9005	1 pc(s).	3311.016

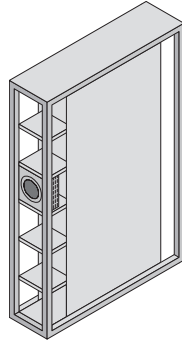

The LCP 3311.238/538 (max. 30 kW) is supplied with one fan module as standard

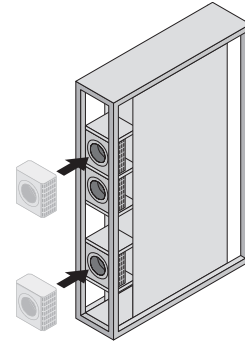

To achieve the max. cooling output of 30kW, the customer/service should install two additional fan modules.

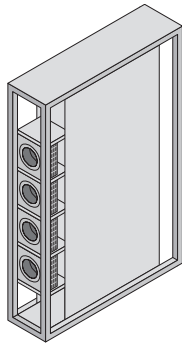

The LCP 3311.268/568 (max. 60 kW) is supplied with four fan modules as standard

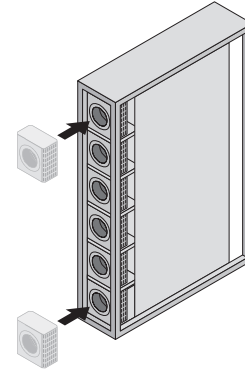

To achieve the max. cooling output of 60 kW, the customer/service should install two additional fan modules

Rittal edge solutions

Edge computing is speeding up IT by bringing the network closer to the data to reduce latency and increase real-time analysis. From the plant floor to the subway tunnel and remote desert solar installations, the Internet of Things (IoT) is integrating sensors, data and systems to help decentralize and localize control over the systems that run the world today.

The lifecycle IT

Scalable solutions and flexible services for your data center at clearly calculable costs

Optimization

Optimization: The efficiency, cost, sustainability and scalability is carefully analyzed to so that we can identify ways to optimize your IT infrastructure.

Operation

Your data center operations need to be protected to ensure 24x7 uptime. Our individualized service agreements with guaranteed response times can provide the peace of mind and keep your data center solution running.

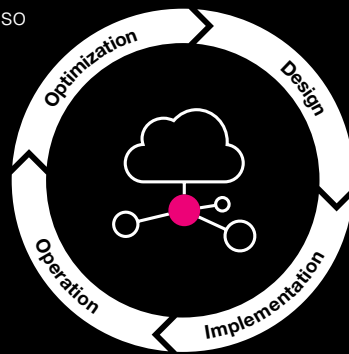

Design

We will design the data center infrastructure to give you the optimal balance of CAPEX and OPEX. Our solutions are developed based on pre-engineered platform designs that can be customized to your needs and can be deployed globally.

Implementation

Our installation team will build and install the supporting infrastructure (power, cooling, fire suppression, monitoring & security data) needed to operate your critical IT. Once built, it will be tested, commissioned and handed over to you.

Maximum efficiency in a minimal space

Edge data centers with innovative cooling technology

Edge Data centers are often located in unconditioned environments and exposed to harsh conditions, making protection of the IT equipment from such contaminants crucial. Rittal offers a full spectrum of cooling solutions designed to operate in these harsh environments maintaining the proper conditioned space for your IT equipment.

Application example:

Single enclosure solution designed to install in space constrained locations. The stand-alone roof top air conditioner and solid front and rear enclosure doors ensures operation in the harshest of environments.

Your benefits at a glance:

- Pre-engineered solutions - unpack, install, and deploy
- Industrial strength - protect the mission critical IT deployment
- Safety, security, stability - designed to maximize uptime
- IP 54 with pleated filter rating keeps equipment safe from dust and water droplets
- Remote monitoring and control – sustain locations with limited IT support infrastructure

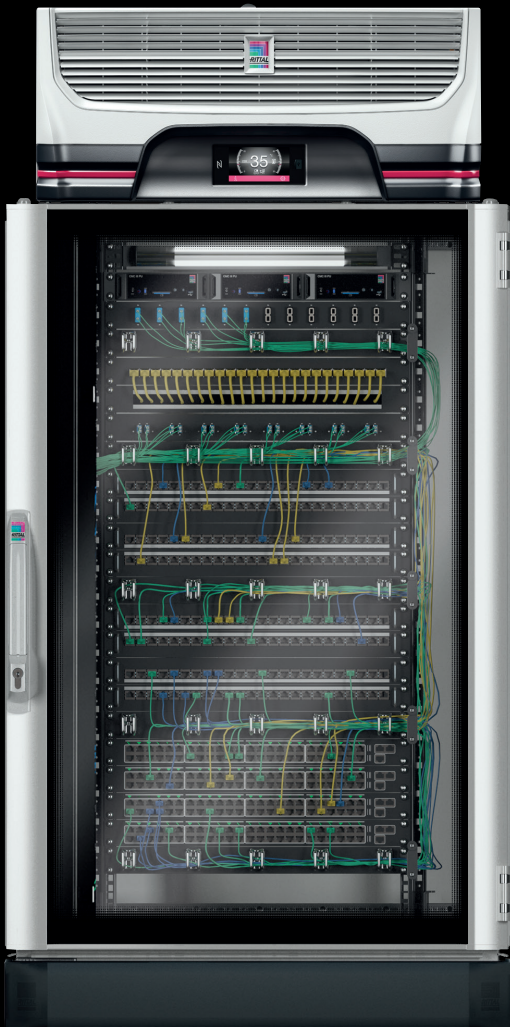

EAC – 13

IT infrastructure	Product description
IT rack	(1) TS IT Network/server enclosure, with solid roof
IT cooling	Roof mounted cooling unit, Blue e+, up to 1.3kW, with IoT Interface
IT power	PDU, Metered, 120V, 1PH, 60Hz
IT power	UPS, 3000VA/2700W, 120V
IT monitoring	Additional temperature, humidity and vandalism sensors
IT security	Electronic locking with keypad and network access
IT fire suppression	In-rack Novec 1230 fire suppression system
IT accessories	IT LED system light. Raised platform base.

All the variants shown are sample configurations. Individually adaptable.



EAC-26

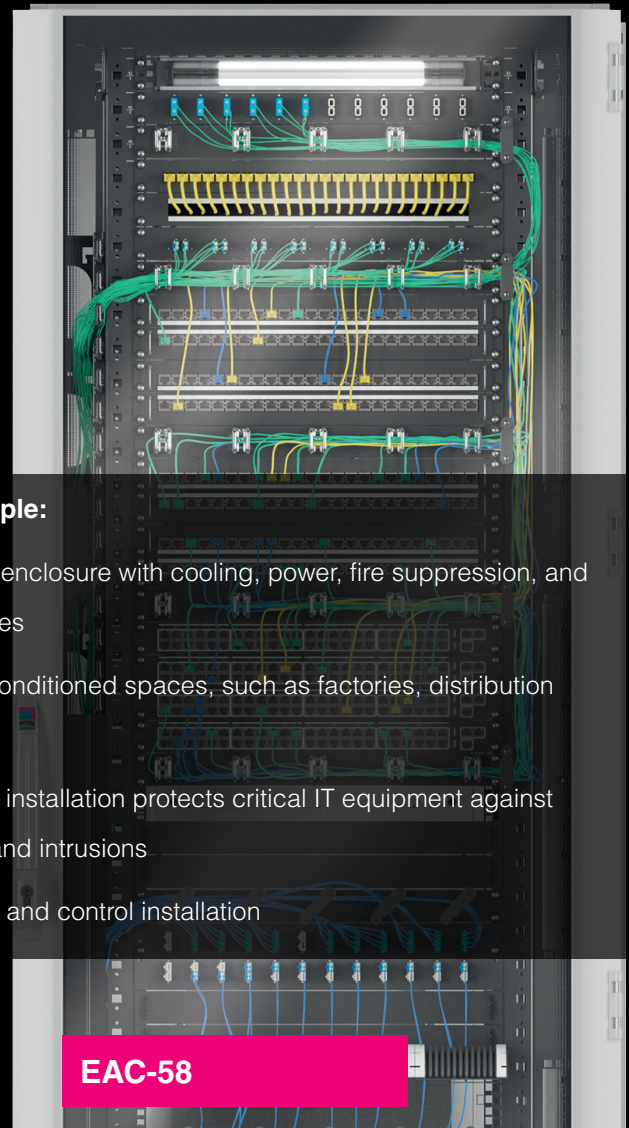

EAC-58

Application example:

- Integrated single enclosure with cooling, power, fire suppression, and related accessories
- Designed for unconditioned spaces, such as factories, distribution centers, closets
- Physically secure installation protects critical IT equipment against dust, water, fire, and intrusions
- Remotely monitor and control installation

IT infrastructure	Product description	Product description
IT rack	(1) TS IT Network/server enclosure, with solid or cable management roof	(1) TS IT Network/server enclosure, with solid or cable management roof
IT cooling	Blue e+ cooling unit, up to 2.6kW, rear door mounted with duct or sidewall mounted, with IoT Interface	Blue e+ cooling unit, up to 5.8kW, sidewall mounted, with IoT Interface
IT power	PDU, Metered, 120V, 1PH, 60Hz	PDU, Metered, 208V, 1PH, 60Hz
IT power	UPS, 3000VA/2700W, 120V	UPS, 8000VA/6900W, 208V
IT monitoring	Additional temperature, humidity and vandalism sensors	Additional temperature, humidity and vandalism sensors
IT security	Electronic locking with keypad and network access	Electronic locking with keypad and network access
IT fire suppression	In-rack Novec 1230 fire suppression system	In-rack Novec 1230 fire suppression system
IT accessories	IT LED system light. Raised platform base.	IT LED system light. Raised platform base

All the variants shown are sample configurations. Individually adaptable.

Reliable, redundant and fail-safe

Edge data centers in the small output category

Edge data centers can handle a wide variety of tasks, not just data capture and condition monitoring. With critical processes, such as controlling traffic flows or monitoring production processes, it is particularly vital for an edge data center to reflect the availability of the application. Scalable redundancy is the key here.

Application example:

IT infrastructures comprising just one or two IT racks must still offer the same features as a large data center. This begins with a reliable power supply and cooling, and extends through to monitoring.

Smaller edge data centers are ideally suited for distributed installation across various locations for processing data in real time (for example, traffic monitoring and control).



EDX-XCL or EDX-XOP

IT infrastructure	Product description
IT rack	(1) or (2) TS IT Network/server enclosure, viewing and solid doors (closed loop) or perforated doors (open loop)
IT cooling	Close-coupled LCP DX unit, up to 20kW, closed or open loop
IT power	PDU, Metered, 208V, 1PH, 60Hz
IT power	UPS, 8000VA/6900W, 208V
IT monitoring	Additional temperature, humidity and vandalism sensors
IT security	Electronic locking with keypad and network access
IT fire suppression	In-rack Novec 1230 fire suppression system
IT accessories	IT LED system light. Raised platform base.

All the variants shown are sample configurations. Individually adaptable.

Scalable in multiple dimensions

Edge data centers in the medium output range

Edge data centers are always defined by the application. CPU-intensive applications may require multiple enclosures with a higher cooling output. The modular system from Rittal safeguards your growth plan, as it is scalable in terms of size, redundancy and maximum load.



Pre-Engineered, Ready to Deploy

Edge data centers available for rapid installation

The continued increase of edge data center to support an unparalleled demand for data presents new challenges. When it comes to installation, having the capacity for rapid deployment allows businesses to get their IT equipment operational quicker.



RDX-55 or RCW-55

IT infrastructure	Product description
IT rack	(6) TS IT Network/server enclosures, perforated doors
IT cooling	Close-coupled LCP DX or CW units, open loop
IT containment	Aisle containment
IT power	PDU, Switched, 208V, 3PH, 60Hz
IT power	UPS, 60kW, 208V
IT monitoring	Additional temperature, humidity and vandalism sensors
IT security	Electronic locking with keypad and network access
IT fire suppression	Room Novec 1230 fire suppression system. early smoke detection system
IT accessories	IT LED system light. Raised platform base.

All the variants shown are sample configurations. Individually adaptable.

Application example:

Your business may involve running numerous critical IT applications simultaneously and the data center needed to support may necessitate multiple IT cabinets. These data centers even though not as large as the hyperscale ones, need to be designed and built to the same standards and quality as the hyperscale ones. Rittal's pre-engineered platform designs allows you to have a superior, code compliant data center customized to your needs at a tier level you want.



RDX-90 or RCW-90

IT infrastructure	Product description
IT rack	(9) TS IT Network/server enclosures, perforated doors
IT cooling	Close-coupled LCP DX or CW units, open loop
IT containment	Aisle containment
IT power	PDU, Switched, 208V, 3PH
IT power	UPS, 100+20kW, 208V, 3PH
IT monitoring	Additional temperature, humidity and vandalism sensors
IT security	Electronic locking with keypad and network access
IT fire suppression	Room Novec 1230 fire suppression system. early smoke detection system
IT accessories	IT LED system light. Raised platform base.

All the variants shown are sample configurations. Individually adaptable.

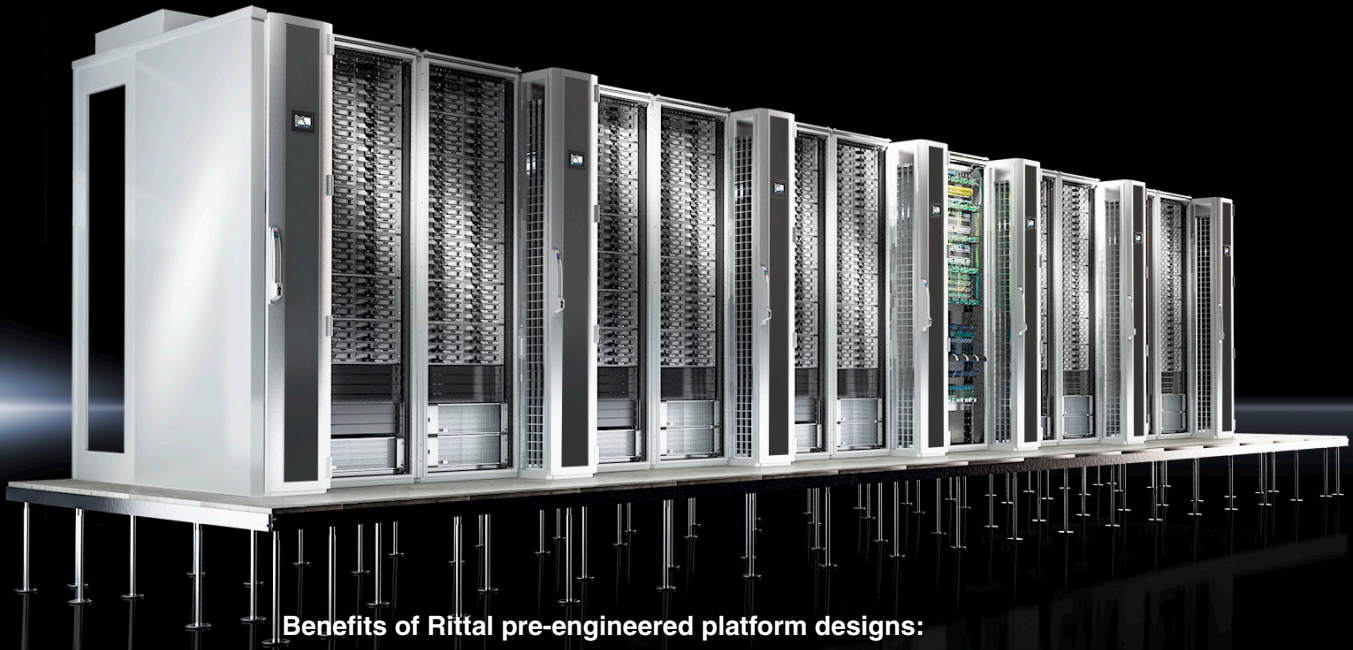

Benefits of Rittal pre-engineered platform designs:

- Pre-engineered designs complete with electrical, mechanical, fire suppression, etc. for various IT loads
- Easy customization of design to suit your individual requirement on redundancy, power, rack density, etc
- Project planning and management
- Complete turnkey delivery with commissioning of installed data center

RCW-180

IT infrastructure	Product description
IT rack	(18) TS IT Network/server enclosures, perforated doors
IT cooling	Close-coupled LCP CW units, open loop
IT containment	Aisle containment
IT power	PDU, Switched, 208V, 3PH
IT power	UPS, 200kW, 480V, 3PH / 208V, 3PH
IT monitoring	Additional temperature, humidity and vandalism sensors
IT security	Electronic locking with keypad and network access
IT fire suppression	Room Novec 1230 fire suppression system. early smoke detection system
IT accessories	IT LED system light. Raised platform base.

All the variants shown are sample configurations. Individually adaptable.

High availability to suit every application

Edge data center in a security room*

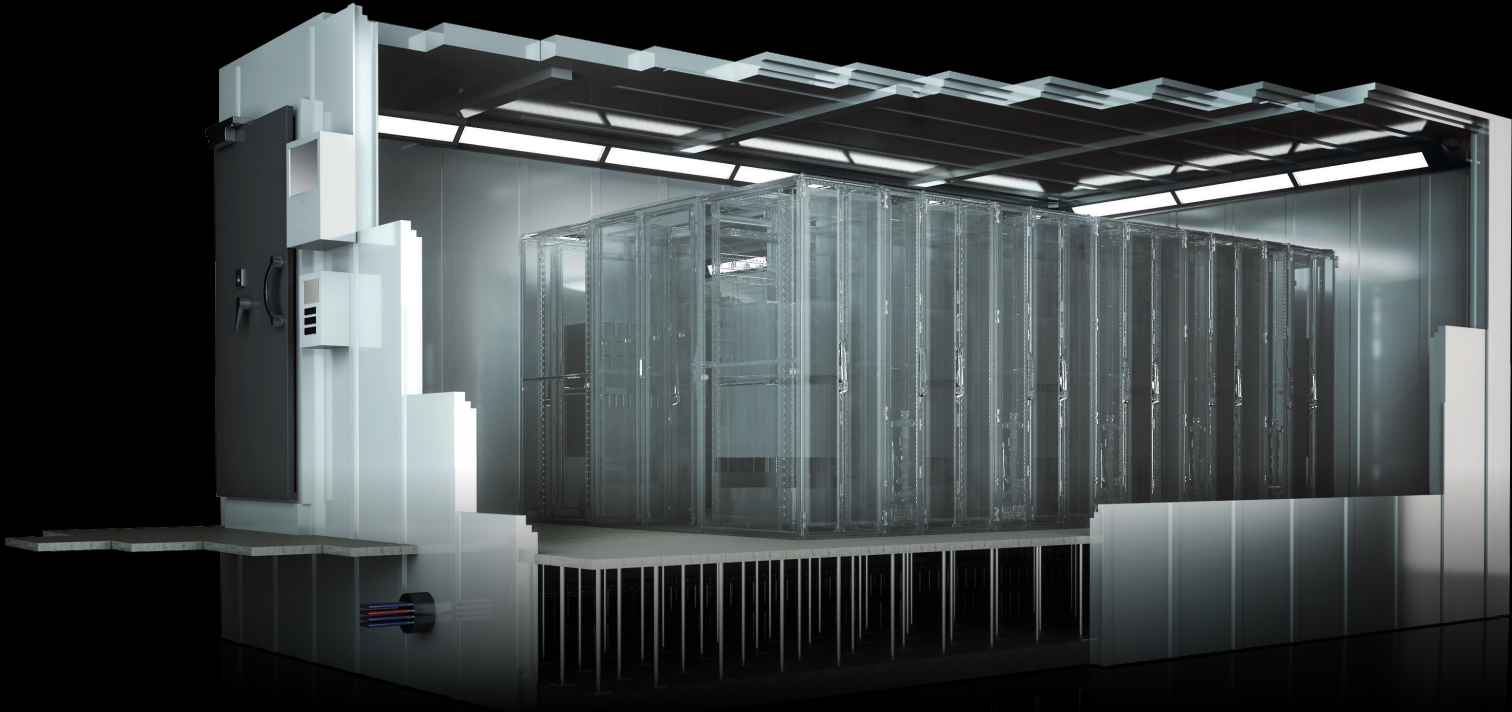

Application example:

Innovative services provided by regional and local government demand the highest standards of security for storing sensitive citizen data and protecting it from manipulation, as well as real-time and long-term data processing. Additionally, data centers must often adapt flexibly to local situations and offer the option of dismantling and reassembly at another location.

The modular, scalable edge data centers in the Rittal security room meet all these requirements – the optimum solution for efficient e-government applications.

**TIER IV
High-Availability room**

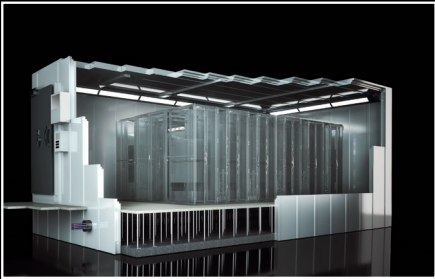

**TIER III
Basic Protection Plus room**

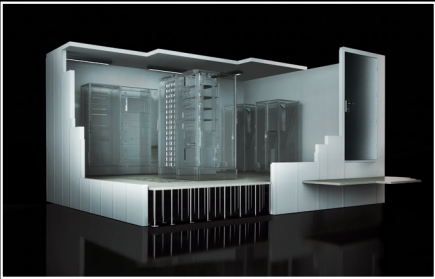

**TIER II
Basic Protection room**

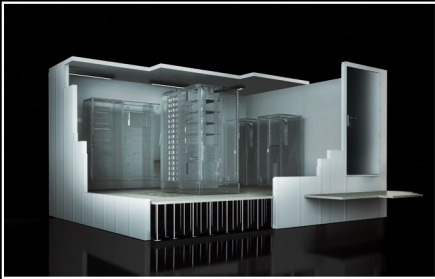

**To be available soon*

The flexible modules concept

Edge data center in a container*

The IT infrastructure is significantly impacted by ever-growing data volumes. Demand for CPU and storage capacity is growing at a similar pace, leading to a need for more server and storage systems, yet space to increase the footprint of the IT infrastructure is limited. Rittal's data centers in containers offer the perfect solution, because the standardized systems are installed in a short time and the concept is individually tailored to your requirements.

Application examples for Rittal container solutions:

- Lack of space, because more IT hardware is needed as data volumes grow
- Influence of IoT and Industry 4.0: Data exchange between the machines and data center must be guaranteed
- With edge data centers, the computing performance is provided locally, data volumes are reduced, and pressure on the main company data center is relieved

Benefits of Rittal container solutions:

- Customized container solutions on a platform basis
- Predefined modules are individually compiled to create a container data center
- Pre-configured container solutions can be up and running in next to no time
- Project planning by Rittal
- Turnkey delivery of a field-tested solution complete with comprehensive documentation

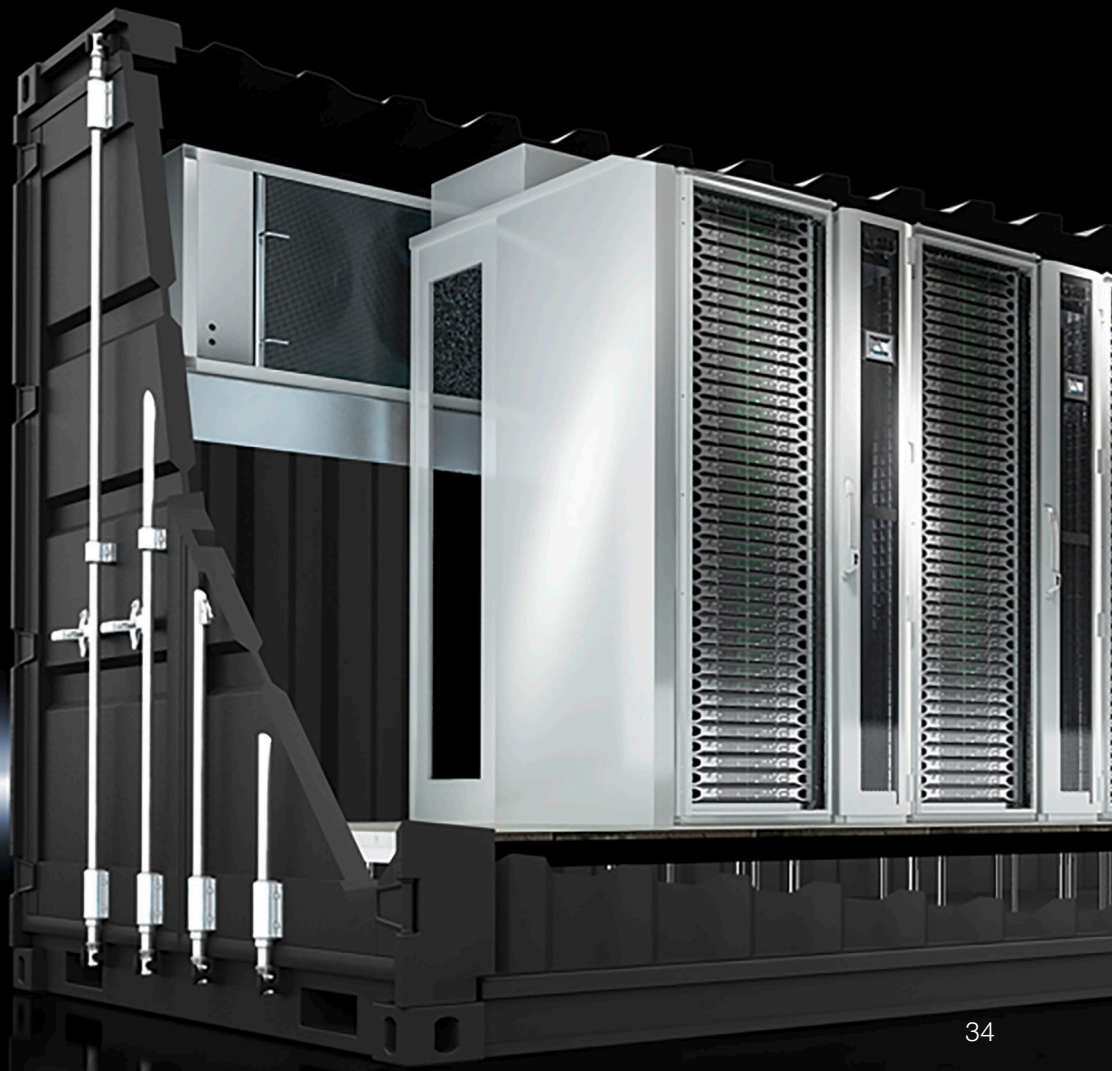

**To be available soon*

A smarter world with edge

The future is digital – for life and work

The extent to which the IoT transforms our future will depend on faster, scalable and more secure networks: Consumers and companies alike need reliable connections to large numbers of systems that coordinate our lives and work. Edge computing plays a pivotal role in this new, smarter world.

Edge computing quite literally moves computer applications, data and services away from centralized nodes to the very edge of the Internet, facilitating rapid on-site analyses and data processing in real time. This doesn't just benefit sectors such as healthcare and transport, but any area of life which interacts with IoT devices.



Smart Healthcare

- Maximum data security
- Compliance with data protection
- Implementation of private clouds



Smart Telco

- 5G networks
- Mobile streaming
- Urban security
- Real-time risk detection



Smart Industry

- Smart factories
- Digital twin
- Anticipatory maintenance



Smart Finance

- Blockchain technologies
- Real-time transactions
- Smart contracts



Data Center Implementation and Operation

Turnkey Installation and After Sales Services

Mechanical and Electrical Design

- Calculation of cooling requirements for data center
- Designing piping layouts
- Selecting type and number of cooling units needed – Rittal and/ or third party
- Calculation electrical load for IT and cooling
- Gaseous Fire Suppression System Design – if room fire protection is required

Installation Services

- Install condensers and associated piping
- Install electrical power to racks, cooling units and UPS systems
- Install lighting and convenient outlets as required
- Install Hot/Cold aisle containment solutions
- Buildout room to install solution
- Install room security access solution

Commissioning

- Review startup reports
- Develop tests scripts
- Perform testing of the solution as a total system
- Develop final report and review with client

Project Management

- Single point of contact for customer
- Manage the day to day activity
- Coordinate with sub-contractors
- Provide Schedule, Status Reports and Closeout Documentation
- Coordinate customer training

After Sales Services

- Maintenance contracts
- Extended warranties
- Defined onsite response time
- 24x7x365 Customer support



Fire alarm and extinguisher system DET-AC/EFD Plus



Advantages:

- Early fire detection
- Automatic extinguishing
 - Innovative extinguisher gas NOVEC™ 1230
 - Eco-friendly
 - Uncritical for IT components, non-conductive
- 19" slide-in equipment with just 1 U
- Testing by VdS (VdS Schadenverhütung GmbH tests and certifies accident prevention equipment components or entire systems in its own laboratories)
- CAN bus interface for direct connection with the CMC III monitoring system

Material:

- Housing: Carbon Steel

Protection category IP to IEC 60 529:

- IP 30

Color:

- Housing: Light Gray RAL 7035
- Front trim panel: Black RAL 9005

Note:

- All three systems are designed exclusively for use in closed non-accessible enclosure systems
- Product based on European standards

DET-AC III Master

The active extinguisher system for use in sealed 19" server enclosures includes the smoke extraction system and the extinguisher unit in a 19" subrack, built into just 1 height unit. The smoke extraction system is identical to that used in the EFD III. When a main alarm is triggered, the extinguishing process starts automatically. The extinguisher medium used, NOVEC™ 1230, is stored in liquid form in the extinguisher tank. For the extinguishing process, pressure is applied to the tank and the extinguisher medium vaporizes at the extinguisher nozzle and is distributed within the server enclosure. Alarms and malfunctions can be forwarded to the CMC III monitoring system directly via the CAN bus interface. Floating contacts make it possible for the alarms (pre-alarm and main alarm) and the collective fault signal from the device to be forwarded to a superordinate location (monitoring or control system).

EFD III

The EFD III early fire detection system includes the smoke extraction system in a 19" subrack built into just 1 height unit. An integrated fan continuously extracts air from the area to be protected, via a pipeline system. The extracted air is passed over two fire detectors. If smoke aerosols are detected, the highly-sensitive detector emits a pre-alarm, with the second fire detector emitting the main alarm. The correct functioning of the fire detectors is monitored at all times by the evaluation and control electronics on the control board. Alarms and malfunctions can be forwarded to a superordinate location (monitoring or control system) via floating contacts. The integrated CAN bus interface enables direct connection to the CMC III.

DET-AC III Slave

The add-on unit for the DET-AC III Master contains another extinguisher unit. Up to five bayed enclosures may be extinguished in combination. In addition to the DET-AC III Master unit, a DET-AC III Slave unit is used for each additional bayed enclosure and contains the extinguisher gas for the enclosure in question. Detection takes place via the DET-AC III Master unit, even if there are multiple bayed enclosures. When a main alarm goes off, the DET-AC III Master triggers extinguishing at all units simultaneously. The DET-AC III Slave unit can also be used in conjunction with the EFD III unit.

Technical details:

Available on the Internet

	Fire alarm and extinguisher system DET-AC III Master	Early fire detection system EFD III	Additional unit DET-AC III Slave
Height U (mm)	2 (44) (1 U)	2 (44) (1 U)	2 (44) (1 U)
Width inches (mm)	19" (482.6 mm) rack mount	19" (482.6 mm) rack mount	19" (482.6 mm) rack mount
Depth inches (mm)	26 (660)	19 (490)	26 (660)
Weight lbs (kg)	47 (21.5)	33 (15.0)	42 (19.1)
Rated voltage V, ~, Hz	100–240 (AC), 1~, 50/60	100–240 (AC), 1~, 50/60	24 (DC)
Emergency power supply h	approx. 4	approx. 4	approx. 4
Part No.	7338.121	7338.221	7338.321
Also required			
Pipe kit	7338.130	7338.130	7338.130
Access sensors	7320.530	–	7320.530
CAN bus connection cable RJ 45, 1m	7030.091	7030.091	7030.091
Slide rails, depth-variable	5501.480	5501.480	5501.480

CMC III Processing Unit Compact

System overview



Up to 4 CAN-Bus components are supported.¹⁾

CMC III sensors
for direct connection

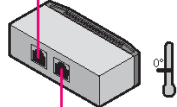

CMC III CAN-Bus sensor
as adapter
for CMC II sensors

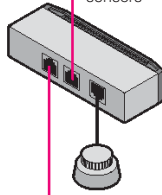

CMC III CAN-Bus access
with integral
IR access sensor

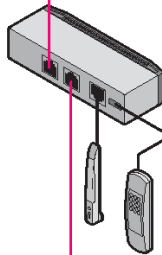

Mini USB:
Programming cable 7030.080 is required
for programming

Internal infrared access sensor

CMC III Processing Unit Compact

**24 V (DC) and voltage supply and 24 V DC
redundant voltage supply**
Power packs

Alarm relay output:
Changeover contact for protective low voltage

Ethernet 10/100 BaseT RJ 45 with PoE:
Ethernet interface to IEEE 802.3
Over 10/100 BaseT full-duplex 10/100 Mbit/s.

RJ 12/RS232 accessory modules:
Display Unit, ISDN Unit, GSM Unit

External temperature sensor:
(Supplied with the PUC)

Two integral digital inputs

¹⁾ Depending on the power supply/connection combinations

Note:
Server shutdown software for CMC III is required to shut down the server.

CMC III Processing Unit

System overview

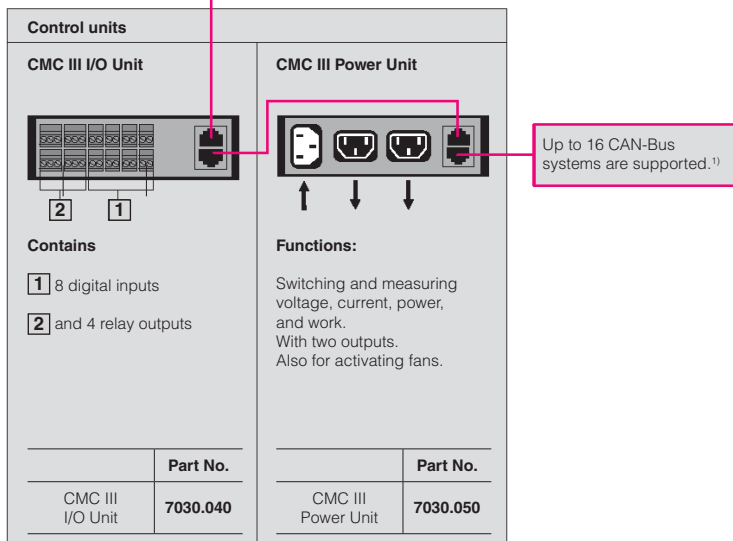
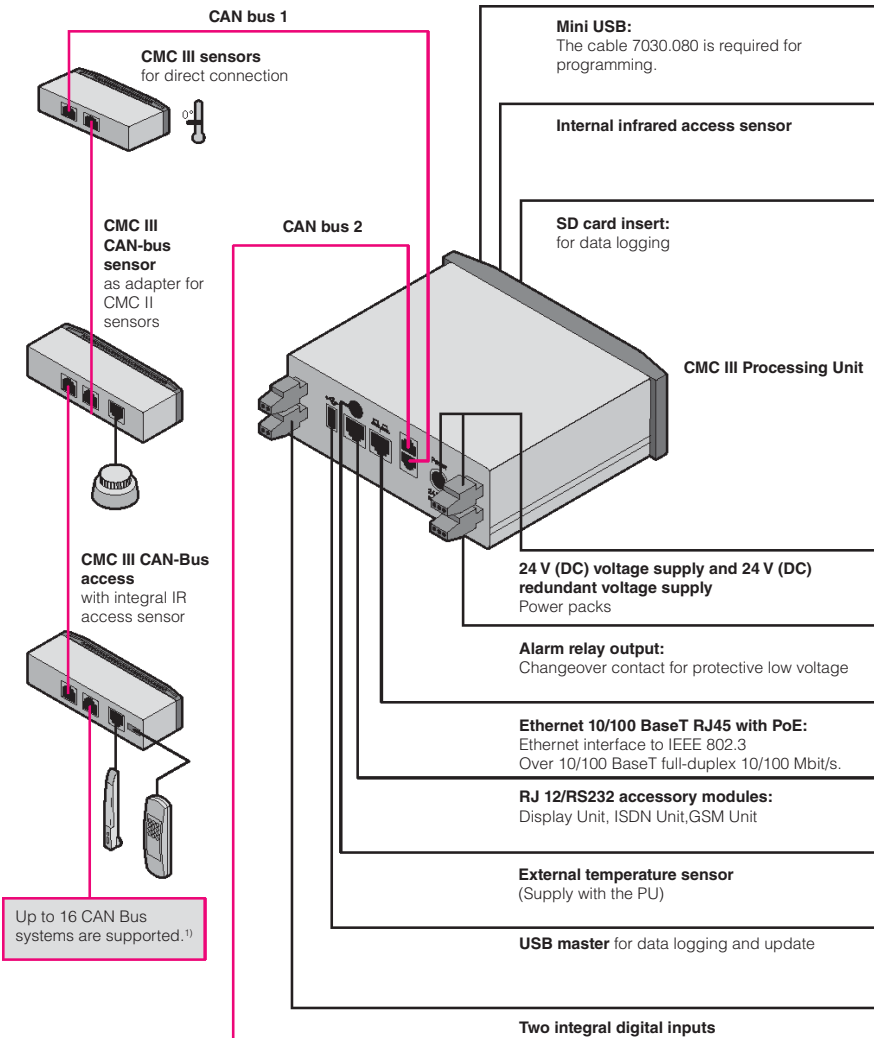

¹⁾ Depending on the power supply/connection combinations.

CMC III Processing Unit Compact



- Power supply designed for redundancy, plus Power over Ethernet (PoE)
- Simple cabling with the CAN bus connection system (RJ 45)
- Connection to control room systems via OPC UA

Material:

– Plastic

Surface finish:

– Front: smooth
– Housing: textured

Color:

– Front: RAL Black 9005
– Enclosure: Light Gray RAL 7035

Protection category IP to IEC 60 529:

– IP 30

Supply includes:

- Basic system
- Quick-start instructions
- 4 mounting feet

Approvals:

– cULus

Photo shows a configuration example with equipment not included in the scope of supply

	CMC III Processing Unit	CMC III Processing Unit Compact	
W x H x D U inches (mm)	5.4 x 1.6 x 4.7 + 0.47 (138 x 40 x 120 +12 front assembly)	5.4 x 1.6 x 4.7 + 0.47 (138 x 40 x 120 +12 front assembly)	
Operation temperature range	32°F...+113° F	32°F...+113° F	
Operating humidity range	5% to 95% relative humidity, non-condensing	5% to 95% relative humidity, non-condensing	
Sensors/CAN-Bus connection units	Max. 32	Max. 4	
Max. overall cable length for CAN-bus	2 x 1969" (2 x 50 m)	1x 1969" (1 x 50 m)	
Part No.	7030.000	7030.010	
Interfaces	Network interface (RJ 45)	Ethernet to IEEE 802.3 via 10/100BaseT with PoE	Ethernet to IEEE 802.3 via 10/100BaseT with PoE
	Front USB port	Mini USB for system setup	Mini USB for system setup
	Rear USB port	For USB stick for recording up to 32 GB of data	–
	Front SD-HC slot	1x up to 32 GB for recording data	–
	Rear serial RS232 (RJ 12)	1 x for connecting Display Unit, GSM Unit or ISDN Unit	1 x for connecting Display Unit, GSM Unit or ISDN Unit
Inputs and outputs	CAN bus (RJ 45)	2 x for max. 16 sensors each = 32 sensors in total (number is restricted)	1 x for max. 4 sensors (number is restricted)
	Digital inputs (terminal)	2	2
Operation/ signals	Relay output (terminal)	Change-over contact max. 24 V (DC), 1 A	Change-over contact max. 24 V (DC), 1 A
	Buttons	1 x acknowledgement button	1 x acknowledgement button
	Hidden reset button	1 x service button	1 x service button
	Piezoelectric signal transmitter	1	1
	LED display	1 x multi-color OK/warning/alarm	1 x multi-color OK/warning/alarm
Protocols	Rear LED	1 x for network status	1 x for network status
	Ethernet	TCP/IPv4, TCP/IPv6, SNMPv1, SNMPv2c, SNMPv3, Telnet, SSH, FTP, SFTP, HTTP, HTTPS, NTP, DHCP, DNS, SMTP, Syslog, LDAP	TCP/IPv4, TCP/IPv6, SNMPv1, SNMPv2c, SNMPv3, Telnet, SSH, FTP, SFTP, HTTP, HTTPS, NTP, DHCP, DNS, SMTP, Syslog, LDAP
Redundant power supply	Input 24 V DC (jack)	1 x for connecting CMC III power pack	1 x for connecting CMC III power pack
	Input 24 V DC (terminals)	1 x for direct connection or for connecting CMC III power pack	1 x for direct connection or for connecting CMC III power pack
	Power over Ethernet PoE	1 x 53 BTU (15.4 W)	1 x 53 BTU (15.4 W)
Functions	Time function	Real-time clock, energy-buffered (24h) without battery/rechargeable battery, with NTP	Real-time clock, energy-buffered (24h) without battery/rechargeable battery, with NTP
	User administration	LDAP	LDAP
	User interface	Integrated WEB server, with flexible dashboard	Integrated WEB server, with flexible dashboard
	Control room connection	Integrated OPC US server, Modbus TCP	Integrated OPC US server, Modbus TCP
Integral sensors	Temperature sensor	NTC sensor with cable, supplied loose	NTC sensor with cable, supplied loose
	Access sensor	Infrared technology in front of housing	Infrared technology in front of housing



Control Units for CMC III Processing Unit

Dimensions:

- H x W x D
40 x 130 x 120 + 12 mm front frame

Material:

- Plastic

Surface finish:

- Front: Smooth
- Housing Textured

Color:

- Front: Black RAL 9005
- Housing: Light Gray RAL 7035

Protection category IP to IEC 60 529:

- IP 30



Also required:

- CAN bus connection cable 7030.090/.095,
- Mounting unit 1 U, 7030.070

		① Connection RJ 45 2 x Can bus	② Inputs	③ Outputs	Model No.	PU Compact	PU
						Maximum number	
<p>CMC III IO Unit</p>	<p>I/O Unit Control Unit</p> <p>The relays can be linked with measurements in the software so that they switch under certain conditions. Devices can be monitored or messages forwarded in this way.</p> <p>Cannot be operated with the Processing Unit Compact</p> <ul style="list-style-type: none"> - Inputs for floating signals - Relay output (changeover contact) can handle loads of up to max. 24 V (DC)/1 A 	■	8 x digital	4 x relay	7030.040	-	16
<p>CMC III Power Unit</p>	<p>Power Unit Control Unit</p> <p>The input is switched to the outputs by two relays. In this way the outputs can be linked with measurements and therefore switched automatically. Fan control is one application example. Manual switching via the CMC III user interface is also possible. Each output is individually monitored and different values are measured.</p> <p>Cannot be operated with the Processing Unit Compact</p> <ul style="list-style-type: none"> - Switches 2 outputs - Measures voltage, current, power, work - Application: Controlling and switching fans, heaters, equipment 	■	1 x voltage C14 110 – 230 V 50/60 Hz	2 x current C13 Aggregate current max. 10 A	7030.050	-	16



CMC III Sensors for Direct Connection

Connection III sensors are used to monitor the physical environment and can be directly connected to the PU by an RJ 45 CAN bus connection cable. The sensors can also be interconnected as a bus.

Dimensions:

- 7030.110, .111, .120, .130
H x W x D: 28 x 80 x 40mm
- 7030.140, .150, .190, .430, .440
H x W x D: 30 x 110 x 40 mm
- 7030.400
Ø x H: 100 x 60 mm

Material:

- Plastic

Surface finish:

- Front: Smooth
- Housing: Textured

Color:

- Front: Black RAL 90005
- Housing: Light Gray RAL 7035
- Smoke detector: White











Supply includes:

- Sensor
- Mounting bracket
- Assembly components
- Instructions bookletr



Also required:

- CAN bus connection cable 7030.090/.095

	RJ 45 connection 2 x CAN bus	Inputs	Model No.	PU Compact	PU
				Maximum Number	
 Temperature sensor - External NTC sensor, 2 m cable - Measurement range for external sensors: -40°F...+176°F	■	-	7030.110	4	32
 Temperature/humidity sensor - Measurement range 32°F...+131°F/ 55 r.h. ... 95% r.h.	■	-	7030.111	4	32
 Infrared access sensor Monitoring with reflector on the door, distance adjustable	■	-	7030.120	4	32
 Vandalism sensor - Axis: x, y, z - Acceleration limits: -7 ... 7g, adjustable	■	-	7030.130	4	32
 Analog airflow sensor - External airflow sensor: 4 -20 mA - Measurement range: 0.5 - 15 m/s - Application: Fan, filter, climate control devices	■	-	7030.140	4	10 ¹⁾
 Analog differential pressure sensor - 2 pressure measuring points (infeed via hose) - Measurement range: -500 m PA - +500 m PA - Application: Cold aisle containment, raised floor	■	-	7030.150	4	32
 Universal sensor Choice of digital inputs for an application - Floating signals - S ₀ input for energy measurement systems - 1 Wiegand interface (external access systems)	■	2 x digital, may be switched to pulse input S ₀ or a Wiegand interface 1 x analog 4-20 mA	7030.190	4	32
 Smoke detector - With an optical element for monitoring the ambient air for smoke particles	■	-	7030.400	4	32
 Leakage sensor - For monitoring a point on the floor in the data center or in the enclosure for liquids. The external sensor can be used to choose any location for monitoring.	■	-	7030.430	4	32
 Leakage sensor, 15m - For monitoring a larger area on the floor for liquids, using the 15 meter detection cable. The sensor also reports the section of the cable in which leakage has been detected.	■	-	7030.440	4	32



Interface for CMC-TC Sensors

With the CMC III CAN bus sensor, it is possible to connect certain CMC-TC system sensors to the new CMC III. Old applications can be upgraded in this way with the CMC III Processing Unit/Compact. The unit not only has two CAN bus connections, but also one extra connection for one of the CMC-TC Sensors. The unit therefore acts as the interface between the CMC-TC sensor and the new processing unit, and adapts the sensor data to the CAN bus protocol.

Dimensions:

- H x W x D:
30 x 110 x 40mm

Material:

- Plastic

Surface finish:

- Front: Smooth
- Housing Textured

Color:

- Front: Black RAL 90005
- Housing: Light Gray RAL 7035

Protection category IP to IEC 60 529:

- IP 30

Supply includes:

- Sensor
- Assembly parts
- Assembly component
- Instructions booklet

The following CMC-TC sensors can be connected to the CMC III CAN bus sensor:

- 1 x temperature sensor
- 1 x analog input 4 – 20 mA
- 5 x access sensors in series
- 1 x airflow sensor
- 1 x smoke detector
- 1 x motion detector
- 1 x digital input
- 1 x digital relay output
- 1 x voltage monitoring system
- 1 x 48 V voltage sensor
- 1 x leakage sensor
- 1 x leakage sensor, 15 m sensor length
- 1 x door control unit (two connections)
- 1 x DET-AC extinguisher system (three connections)
- 1 x DET-AC early fire detection system (three connections)



Also required:

- CAN bus connection cable 7030.090/.095

	①	②	③	Model No.	PU Compact	PU
	Connection RJ 45 2 x CAN bus	Input RJ 12	Output RJ 12		Maximum Number	
<p>① CAN bus sensor To connect a CMC-TC sensor</p>	■	1 x	–	7030.100	4	32
Sensors that may be connected (max. 1 sensor per CAN bus sensor)						
<p>② CMC-TC access sensor – Sensor: Reed Contact/Magnet – Max. 5 reed contacts in series – 2 m cable included with the supply</p>	–	–	1 x	7320.530	–	–
<p>③ CMC-TC motion detector – Sensor: Infrared – 2 m cable included with the supply</p>	–	–	1 x	7320.570	–	–



Access system

CMC III unit for controlling and monitoring access to the enclosures. One handle and one reader unit can be connected to each CMC III CAN bus access. The handles can be linked with different number codes or RFID card numbers via the CMC III Processing Unit/Compact website, so that all the handles connected to a CMC III Processing Unit/Compact can be controlled with just one reading system. Thanks to the integrated infrared sensor, the status of the controlled door (open/closed) is still monitored

Dimensions:

- H x W X D:
30 x 110 x 40mm

Material:

- Plastic

Surface finish:

- Front: Smooth
- Housing: Textured

Color:

- Front: Black RAL 90005
- Housing: Light Gray RAL 7035

Protection category IP to IEC 60 529:

- IP 30

Supply includes:

- CAN bus access
- Assembly parts
- Assembly components
- Instructions booklet



Also required:

- CAN bus connection cable 7030.090/.095

	Connection	Inputs		Outputs		Model No.	PU Compact	PU	
		①	②	③	④		⑤	Maximum number	
		RJ 45 2 x CAN bus	RJ 12	Flat Connector	RJ 12		Flat Connector		
<p>1 CAN bus access</p> <ul style="list-style-type: none"> - To connect a handle and reader unit for monitoring a door - Integrated IR access sensor 	■	1 x	1 x	-	-	7030.200	2	16 ¹⁾	
Handles and reader units that may be connected (max. 1 handle and max. 1 reader unit per CAN bus access)									
<p>2 Handles</p> <ul style="list-style-type: none"> - TS 8 handle with master key function - Handle monitoring - Rated voltage: 24 V (DC) - 3 m and 2 m cable included with the supply 	-	-	-	1 x	-	7320.721 (Light Gray RAL 7035) 9970.139 (Black RAL 9005)	-	-	
<p>3 CMC III Reader Units</p> <ul style="list-style-type: none"> - Coded Lock - Any number code with up to 8 digits - 3 m and 2 m cable included with the supply - Transponder reader - The contact-free provision of a transponder card allows the authorization (card UID) in the CMC III Processing Unit/Compact to be verified, and the relevant door/s released - Technology: 13.56 MHz transponder - Tags: ISO 14443A, ISO 14443B, ISO 15693, ISO 18000-3 - 3 m cable included with the supply 	-	-	-	-	1 x	7030.220	-	-	
	-	-	-	-	1 x	7030.230	-	-	

¹⁾ Max. 5 pc(s) for power supply with PoE

Power Pack Power Supply

for PU, PU Compact, CAN bus unit, CAN bus DRC, door control system.

The power pack is specifically adapted to the CMC III design and can be placed in a CMC III mounting unit. As well as a special connector for the CMC III Processing Unit/Compact, there are also two terminals available as 24 V outputs.

Technical specifications:

- Input voltage: 100 – 240 V / 50/60 Hz
- Output voltage: 24 V (DC)/2.5 A
- Length of 24 V DC connection cable: 0.6 m

Dimensions:

- H x W x D:
40 x 138 x 120 + 12 mm front frame

Material:

- Plastic

Surface finish:

- Front: Smooth
- Housing: Textured

Pack of	Part No.
1 pc(s).	7030.060

Color:

- Front: Black RAL 9005
- Housing: Light Gray RAL 7035

Supply includes:

- Assembly components
- Instructions booklet



Also required:

- Connection cable (see page 34)



Accessories:

- Mounting unit (see page 34)



Interference Suppressor for Fans for CMC III

For connection of fans via the CMC III Power Unit 7030.050. Prevents malfunctions when switching off the fan motor. One interference suppressor is required per fan.

Material:

- Plastic

Packs of	Part No.
1 pc(s).	7030.051

Color:

- Black RAL 9005

Supply includes:

Assembly components

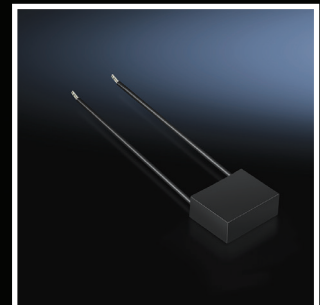

Programming Cable

For initial commissioning of the Processing Unit (PU) or PU Compact. The CMC III Processing Unit/ Compact is connected to a PC USB port via the programming cable to do this. A driver for Windows systems is also supplied, which must be installed on the PC.

Supply includes:

- CD with driver and system description

Packs of	Part No.
1 pc(s).	7030.080



CAN Bus Connection Cable

With this cable, the PU can be hard-wired with the CAN bus III sensors, III units and III control units as a bus. Also for cabling with one another. The different lengths allow the CMC III system to be adapted to different applications and specifically configured.

CMC III CAN bus connection cable	length inch (mm)	Packs of	Model No.
RJ 45	20 (0.5)	1 pc(s).	7030.090
RJ 45	39 (1)	1 pc(s).	7030.091
RJ 45	59 (1.5)	1 pc(s).	7030.092
RJ 45	79 (2)	1 pc(s).	7030.093
RJ 45	118 (3)	1 pc(s).	7030.480
RJ 45	157 (4)	1 pc(s).	7030.490
RJ 45	197 (5)	1 pc(s).	7030.094
RJ 45	304 (10)	1 pc(s).	7030.095





Connection Cable/Extension

For connecting to:

- CMC III Power Pack C13
- CMC III Power Unit C 13.

Technical specifications:

- PVC cable, 3-pole, with IEC connector (non-heating appliances) with CEE22 contact protection
- Length: Min. 1.8 m

Country version	Voltage Volt	Packs of	Model No.
Non-heating appliance extension C13/C14	230/115	1 pc(s).	7200.215



RJ 12 Extension Cable with RJ 12 connector/jack

To extend the cable connections to the CMC-TC sensors.

Length inches (m)	Packs of	Model No.
30 (1)	2 pc(s).	7320.814



Mounting Unit, 1 U

To make it easier to install the CMC III units in network and server enclosures. Mounting in the 19" (482.6 mm) profile (for three CMC III units).

To hold

- PU
- PU Compact
- Control units
- CMC III CAN bus DRC
- CMC III power pack
- CMC III GSM unit
- CMC III door control module

Can hold up to 3 CMC III housings and is mounted in the 19" frame.

Packs of	Part No.
1	7030.088

Material:

- Carbon steel

Surface finish:

- Zinc plated

Supply includes:

- 2 blanking covers



Accessories:

- Cable clamp bracket 7030.087 (see page 34)

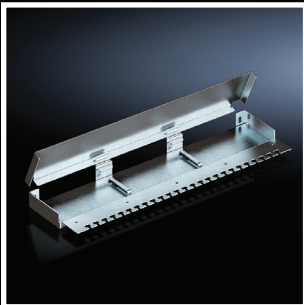

Cable Clamp Bracket for CMC III

For attachment to the rear of the CMC III 19" mounting unit 7030.070. Enables neat cable routing at the rear of the installed CMC III devices, as well as fixing of the cables for strain relief. The cables can easily be laid as a loop, so that the installed CMC III devices can be removed from the mounting unit without the need for any tools.

Supply includes:

- Assembly components

Packs of	Part No.
1 pc(s).	7030.087

Mounting Unit

For mounting on the enclosure section (for a CMC III unit).

To hold

- PU
- PU Compact
- Control units
- CMC III CAN bus DRC
- CMC III power pack
- CMC III GSM unit
- CMC III door control module

Can hold one CMC III housing and is mounted on the enclosure frame

Packs of	Part No.
1 pc(s).	7030.071

Material:

– Carbon steel

Surface finish:

– Zinc plated

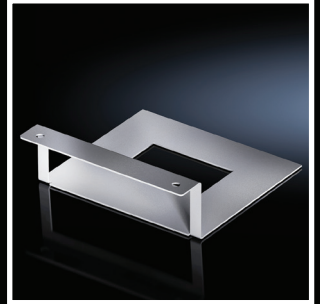

CMC III GSM Unit

For establishing a redundant transmission path or, if no network infrastructure is available, for alarm forwarding. The alarm message is sent as an SMS. To cover 4 GSM frequencies (quad band): 850 MHz, 900 MHz, 1800 MHz and 1900 MHz. A standard, commercially available SIM card must be provided by the customer.

Packs of	Part No.
1	7030.570

Material:

– Plastic

Color:

– Front: Light Gray RAL 7035
 – Housing: Light Gray RAL 7035

Supply includes:

- RJ 12 cable
- GSM aerial
- Assembly components
- Instructions booklet



Door Control System



Door Control System DCS

Comprising:

- Door Control Module
- Door Control Kit

For automatic opening of TS IT rack doors

Application examples:

- Overtemperature in the sealed TS IT rack
- Extinguisher gas should get from the room to the rack

Control takes place through the Door Control Module DCM control unit. One DCM must control one rack with 2 doors (front/rear door). The use of CMC III and access sensors is recommended.

Note:

The following door kits can be connected:

- Two door kits (magnet systems with damper) 7030.240/.241/.250 (Required for all applications, Model No. depends on the door version)
- Two door kits (spindle motor) 7030.261 (For applications with negative pressure in the rack, e.g. LCP, powerful server fan motors, etc.)
- All the power packs used must be connected to the same power supply as the server, e.g. extinguisher systems

Activation in event of alarm:

- CMC III Task
- DCM, integrated temperature sensor
- DCM digital input

Activation for user access:

- One door switch/comfort handle 7320.793/.794 per door, see page
- Coded lock/transponder reader 7030.220/.230, see page



Also required:

- Door Control Module DCM (see page 37)
- Door kits (see page 37)
- Power packs (see page 33)
- Connection cable (see page 34)
- Mounting unit 1 U (see page 34)



Accessories:

- CMC III Processing Unit/Compact with connection, supply and mounting accessories (see page 28)
- Door switch/comfort handle (see page 38)
- Coded lock/transponder reader (see page 32)
- Access sensor (see from page 32)

System Diagram Door Control System:

- Max. 16 Door Control Modules can be connected per Processing Unit
- Max. 4 Door Control Modules can be connected per Processing Unit Compact

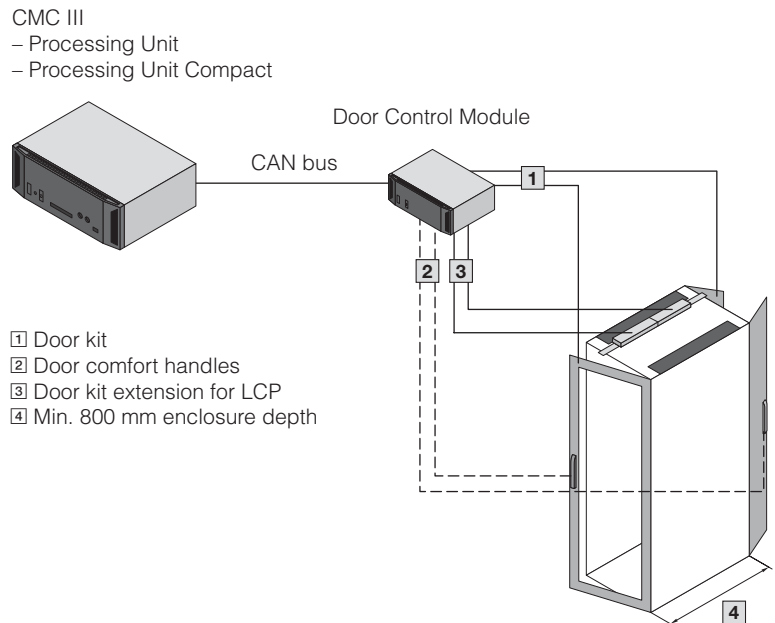

Door Control Systems Accessories

Door Control Module

Control unit for automatic opening of TS IT rack doors. Designed for a rack with a front and rear door. Suitable for the CMC III system with CAN bus.

Material:

- Plastic

Color:

- Front: Black RAL 9005
- Housing: Light Gray RAL 7035

Supply includes:

- Basic system
- 4 mounting feet
- Quick reference guide



Also required:

- Door kits (see page 37)
- Power packs (see page 33)
- Connection cable (see page 33)
- Mounting unit 1 U (see page 34)



Accessories:

- CMC bus connection cable (see page 33)
- Door switch/comfort handle (see page 38)
- Coded lock/transponder reader (see page 32)



Model No.	7030.500
Packs of	1 pc(s).
1st rated voltage	24 V (DC) Door Control Module via CMC III CAN bus, redundant at 2nd rated voltage
2nd rated voltage	24 V (DC) 7030.060 for Door Control Module and magnet systems
3rd rated voltage	24 V (DC) 7030.060 for spindle motors only (protect via UPS)
1 x temperature sensor input	NTC sensor (included with the supply)
3 x digital inputs	Alarm/front door/rear door
1 x input for readers	Coded lock/transponder reader
2 x outputs for door kits	Magnet system with damper
2 x outputs for door kits extension	Spindle motors
2 x CAN bus CMC III	RJ 45 for CAN bus cables

Door Kit

for TS IT (magnet system with damper)

To open the door in emergency situations. Connection and activation via the Door Control Module, for standard TS IT doors. The doors are kept closed by a magnet system. If the voltage of the magnets is interrupted, the gas pressure damper system opens the door

Technical specifications:

- Rated voltage: 24 V DC
- Rated current 7030.240/241: 390 mA
- Rated current 7030.250: 520 mA

Material:

- Carbon Steel

Surface finish:

- Zinc-plated

TS IT version	Packs of	Model No.
1-piece glazed aluminum door	1 pc(s).	7030.240
1-piece carbon steel door	1 pc(s).	7030.241
2-piece door	1 pc(s).	7030.250

Supply includes:

- Gas pressure damper
- Cable harness
- Magnet system with damper
- Instruction booklet
- Assembly components



Also required:

- Door Control Module DCM (see page 37)
- For 7030.250: Tubular door frame (see page 37)

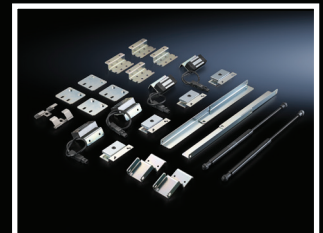

Door Kit Extension

for TS IT, LCP (spindle motor)

To open the door in emergency situations. For applications with negative pressure in the rack, e.g. LCP, powerful server fan motors, etc., this kit is required in addition to the magnetic lock. The motor pushes the door open until the negative pressure is resolved. Mounting takes place on the roof.

Technical specifications:

- Rated current: 900 mA
- Compressive force: 1000 N
- Length of travel: Max. 200 mm

Material:

- Carbon Steel
- Aluminum
- Plastic

Packs of	Model No.
2 pc(s).	7030.261

Supply includes:

- 2 spindle motors
- 2 push frames
- Instruction booklest
- Assembly components



Also required:

- Door Control Module DCM (see page 37)
- Door kits (see page 37)
- Power pack (with UPS protection) (see page 33)

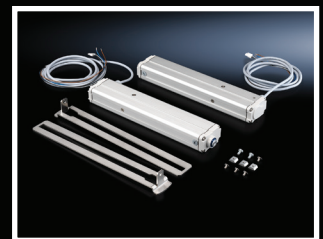



Door Comfort Handle with door opener function

When the lock mechanism is actuated, the door is released by the automatic door opening system. Designed for the installation of commercially available 40 mm semi-cylinders and SZ lock and push-button inserts.
Length: 302 mm.

Technical specifications:

- Rated voltage: 24 V (DC)
- Rated current: Max. 3 A
- Connection cable: Length 3 m
- Temperature application range: +41°F...+104°F

Color:

- Light Gray RAL 7035

Packs of	Model No.
1 pc(s).	7320.794



Also required:

- Handle adapter for mounting on glazed door 8611.080



Accessories:

- Lock and push-button inserts, see page 56



Door Switch

Switch with normally closed contact for Door Control Module 7320.790 for manual door opening. Mounting takes place in the 25 mm hole pattern of the TS IT frame profile.

Technical specifications:

- Installation: Ø 16.2 mm
- 250 V/2 A

Supply includes:

- 3 m connection cable
- Mounting bracket
- Assembly components

Packs of	Part No.
1 pc(s).	7320.793

Base/plinth for TS IT

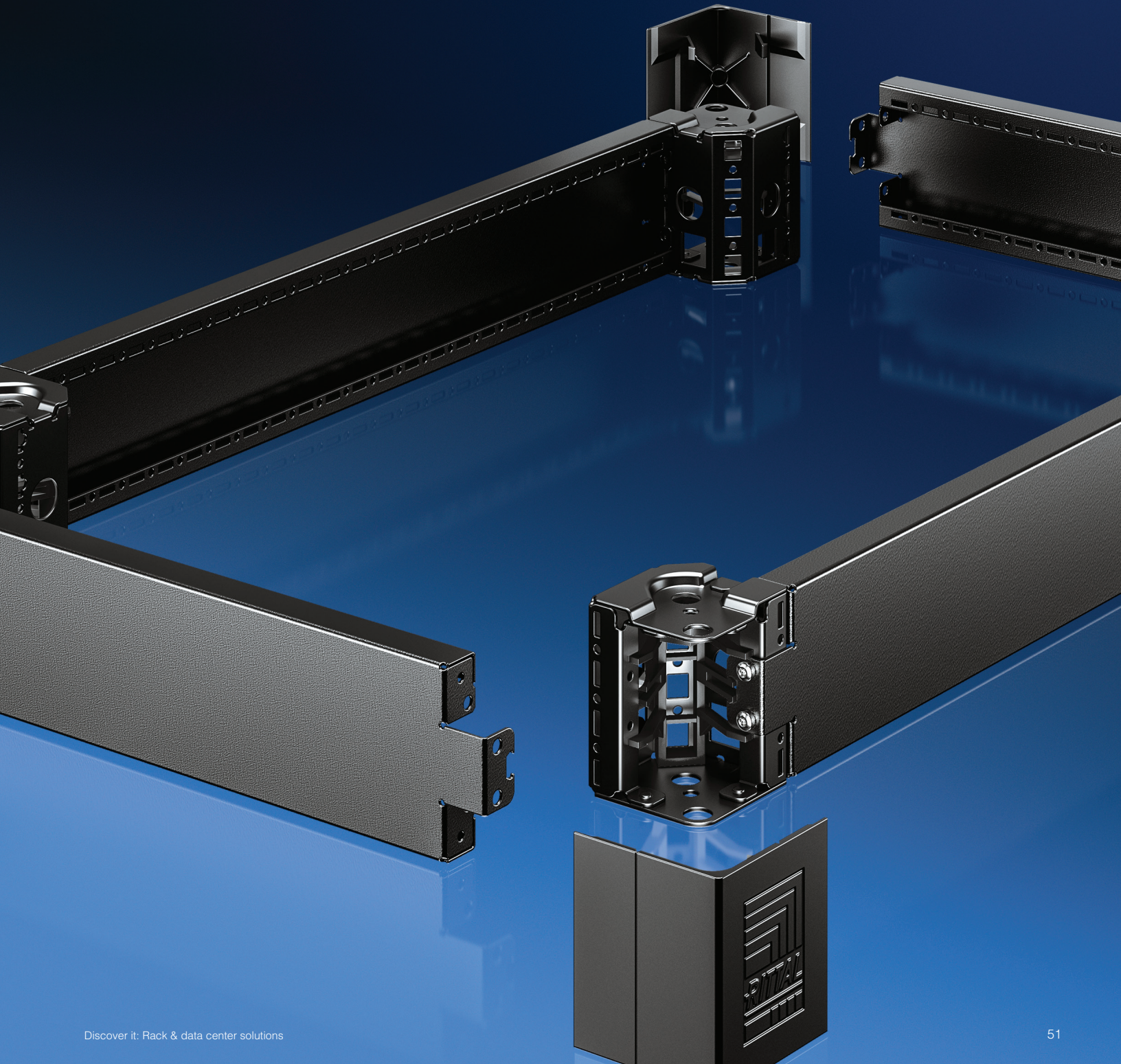

Accessories

Base/plinth system for TS IT	41
Modular Base/plinth diversity	41
Base/plinth corner pieces with base/plinth trim panels, front and rear	42
Base/plinth trim panels, sides	43
Base/plinth trim panels with brush strip	43
Baying bracket, internal	44
Base mounting plate	44
Complete caster	44
Leveling component	45
Base/plinth adaptor	45
Leveling feet	45
Technical details	46
Base	47
Base plate	47
Base plate accessories	51
Clips	51
Base mount	51
Walls	52
Sidewall, divided	52
Sidewall, solid.....	52
Cable pass through partition wall.....	53
Solid partition wall	53
Baying	54
Baying connectors, external	54
Baying Bracket.....	54
Handles/locks	55
Comfort handle for lock insert	55
Comfort handle for semi-cylinder	55
Security handle with code	55
Lock and push-button inserts	55
Lock and push-button inserts, semi-cylinder inserts ..	55
Rail systems	56
Interior installation	56
TS system chassis 17 x73 mm	56
System bars, 23 x 23 mm	57
Mounting bracket	57
Support bracket	57
U nuts	58
Mounting plate.....	58
Mounting bracket	58
Mounting plate locatable.....	58
Mounting plate Screw-fastening large	59
Fastener, 1 U with contact 19".....	59
Captive nut M5/M6	59
Multi-tooth screw	60
Metal multi-tooth screw	60
Self-tapping screw	60
Assembly screws M6 x 0.63".....	60
Component shelf, fixed depth.....	61
Component shelf, pull out, 2U.....	61
Component shelf, depth variable, static installation ..	61
Component shelf, depth variable, pull-out.....	61
Handle for pull-out component shelves.....	62

Pull-out drawer	62
Telescopic support rail, heavy duty.....	63
Slide rails, static installation	63
Slide rails, depth-variable.....	63
Button mount bracket.....	63
Slide rails, static installation	64
Mounting kit for 19" equipment.....	64
LED system light.....	65
Connection accessories for LED system light.....	66
Door-operated switch for LED system light.....	66
Mounting kit magnet for LED system light.....	66
Grounding	67
Central grounding point	67
Complete grounding kit.....	67
ESD connection point.....	67
Ground rail, horizontal.....	67
Grounding kit, preassembled.....	68
Ground rail, vertical	68
Extension kit for ground rail, vertical	68
Cable management	69
Cable management panel.....	69
Horizontal cable management with hingeable/removable cover.....	69
Cable clamp strap.....	69
Cable tie	69
Nylon tape	70
Nylon loop	70
Quarter-turn cable fastener	70
Quarter-turn nylon tape supports	70
Cable manager.....	71
Cable guide ring.....	71
Quarter-turn cable collection.....	71
Quarter-turn D-ring	72
Cable management panel, 19".....	72
Cable routing bars.....	72
Cable finger, 6 u	73
Cable finger, for TS IT North American version.....	73
Cable duct.....	73
Cable slack spool.....	73
Cable management panel with cable routing bars	73
Cable routing channel	74
Cable entry panel.....	74
Roof system supports for cable routes	74
Cable route.....	74
Cable management panels.....	75
Roof-mounted Cable management.....	75
Roof-mounted Cable Routing with Ladder Rack.....	75
TS IT End Corner Brackets.....	75
Roof-mounted Cable Management End Covers	76
Roof End Ladder Rack Installation Brackets.....	76
ROof Ladder Rack.....	76
Ventilation	77
Fan mounting plate for TS IT	77
Fan expansion kit	77
Air baffle plate	78
Cover, magnetic	78
Split rear door fan.....	78
Blanking Panels.....	78

Base/plinth

Base/plinth system for TS IT

Modular base/plinth diversity

The new, innovative base/plinth system VX offers an unprecedented diversity of functions and applications. It combines all existing base/plinth functions in a single solution, as well as opening up many new applications. As if that weren't enough, it is also backward-compatible with existing enclosure solutions TS, TS IT, SE, CM, TP, PC, IW and TE. In short, it is a base/plinth system.

The base/plinth system VX comprises the following components:

- Base/plinth corner pieces with base/plinth trim panels, front and rear
- Base/plinth trim panels, sides

Due to fully symmetrical corner pieces, and by using the same base/plinth trim panels in the width and depth, the system opens up many new applications. For example, the vented trim panels and trim panels with brush strips available as accessories may now optionally be attached at the sides, or exchanged for the front/rear trim panels.

All trim panels may optionally be clipped into the corner piece, or screw-fastened. Depending on the application, for example, users can dispense with the trim panels between bayed enclosure suites, or a 100 mm high trim panel may be used to stabilize the base/plinth corner pieces. In combination with its extensive range of accessories, and due to its compatibility with enclosure accessories, the base/plinth system VX offers almost infinite possibilities in terms of siting, transportation, cable routing, cable attachment and base/plinth configuration.

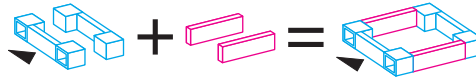

One Model No. for the **base/plinth corner pieces with base/plinth trim panels, front and rear**

One Model No. for the **base/plinth trim panels, sides**

One complete **base/plinth VX**

Base/plinth	Basic form	Cable entry options				Stabilization of bayed base/plinths
100 mm (4 in.)						
200 mm (8 in.)						

Configuration examples

Order includes	Functional benefits
3 packs Base/plinth corner pieces with base/plinth trim panels 1 pack Base/plinth trim panels, sides 200mm (8") high	Continuous cable chamber
3 packs Base/plinth corner pieces with base/plinth trim panels 1 pack Base/plinth trim panels, sides, 200 mm (8") high 1 pack Base/plinth trim panels, sides, 100 mm (4") high 1 pack Baying brackets, internal (8617.500, packs of 6) 4 pc(s). are required for this solution	Additional stability during transportation with base/plinth trim panels rotated through 90°
3 packs Base/plinth corner pieces with base/plinth trim panels 2 packs Base/plinth trim panels, sides, 200 mm (8") high	Shielding of the base/plinths from one another
Other option: ■ Cable entry at the side by fitting a 100 mm (4") base/plinth trim panel with brush strip ■ Cable entry from the rear by dismantling one or more trim panels from the base/plinth corner pieces and replacing them with trim panels with brush strips ■ Cable routing in the base/plinth by using punched sections with mounting flanges on the base/plinth trim panels	

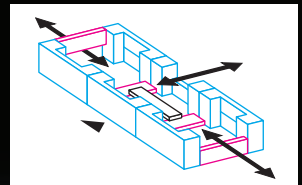
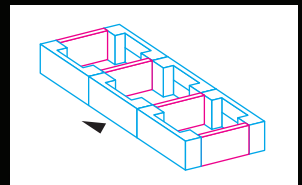
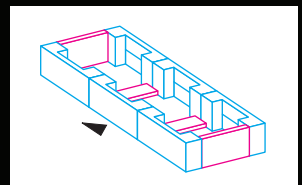
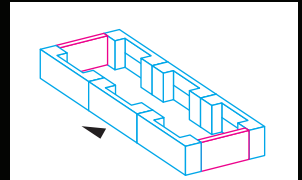

Base/plinth

Base/plinth system for TS IT

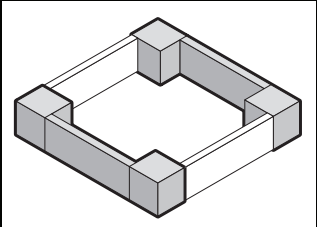
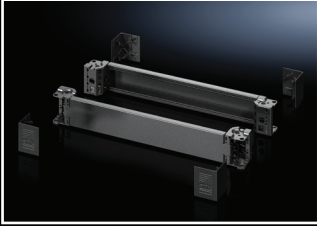

Base/plinth corner pieces with base/plinth trim panels, front and rear

Carbon steel for TS IT

High-load capacity base/plinth corner pieces with molded self-positioning to the baying enclosure system VX25, may be used with or without base/plinth trim panels depending on the application. Large openings in the corner piece for optimum access to the screw-fastening point, may be concealed with a plastic corner and baying cover.

Material:

- Base/plinth corner piece: Carbon steel
- Base/plinth trim panel front/rear: Carbon steel
- Corner and baying cover: Plastic

Color:

- Black RAL 9005

100 mm (4 in.) high supply includes:

- 4 base/plinth corner pieces, 100 mm (4 in.) high
- 4 corner covers
- 1 baying cover
- 2 base/plinth trim panels, front/rear, 100 mm (4 in.) high
- Assembly parts

200 mm (8 in.) high supply includes:

- 4 base/plinth corner pieces, 200 mm (8 in.) high
- 4 corner covers
- 1 baying cover
- 1 base/plinth trim panel, front/rear, 200 mm (8 in.) high
- 2 base/plinth trim panels, front/rear, 100 mm (4 in.) high
- Assembly parts

100 mm (4 in.) high

For enclosure width mm (in.)	Model No.
300 (12)	8640.000
600 (24)	8640.002
800 (32)	8640.003
1000 (40)	8640.005
1200 (48)	8640.007

200 mm (8 in.) high

For enclosure width mm (in.)	Model No.
300 (12)	8640.020
600 (24)	8640.022
800 (32)	8640.023
1000 (40)	8640.024
1200 (48)	8640.025



Also required:

- Base/plinth trim panels, sides, to finish off a unit, for additional stabilization between base/plinths, or for interior configuration, see page 41



Accessories:

- Base/plinth trim panels with brush strip, see page 43
- Base/plinth installation bracket, see page 44
- Leveling component for base/plinth, see page 45
- Base mounting plate, see page 44
- Base plinth adapter for twin casters and leveling feet, see page 45
- Baying bracket, internal, see page 44
- Transport casters for base/plinth VX, see page 44

Base/plinth

Base/plinth for TS IT

Base/plinth trim panels, sides

Carbon steel

To finish off a base/plinth unit at the sides and for additional stabilization or for the interior configuration of bayed base/plinths. One 200 mm (8 in.) or two 100 mm (4 in.) high trim panels may optionally be fitted on 200 mm (8 in.) high base/plinths.

Material:

– Carbon steel

Color:

– Black RAL 9005

Supply includes:

– 2 base/plinth trim panels
– Assembly parts

100 mm (4 in.)	
For enclosure depth mm (in.)	Model No.
300 (12)	8640.030
600 (24)	8640.033
800 (32)	8640.034
1000 (40)	8640.035
1200 (48)	8640.036

200 mm (8 in.) high	
For enclosure depth mm (in.)	Model No.
300 (12)	8640.040
600 (24)	8640.043
800 (32)	8640.044
1000 (40)	8640.045
1200 (48)	8640.046

+ Accessories:

– Base/plinth installation bracket, see page 44

➔ Possible alternative:

– Base/plinth trim panels with brush strip, see page 43
– Base/plinth trim panels, vented, see page

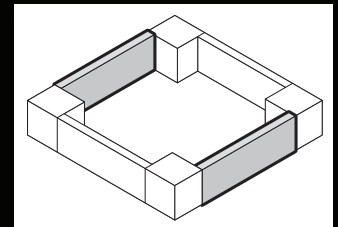
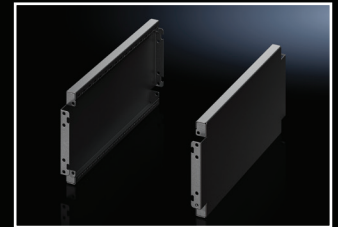
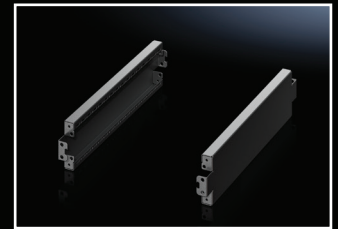

Base/plinth trim panels with brush strip

Carbon steel

For cable entry in the base/plinth. With a base/plinth height of 200 mm (8 in.), one or two trim panels with brush strips may optionally be used. Due to the complete symmetry of the base/plinth system VX, the trim panels with brush strip may either be fitted at the front, rear or side on the base/plinth corner piece.

Material:

– Base/plinth trims: Carbon steel
– Brush strip: Plastic, self-extinguishing

Color:

– Black RAL 9005

Supply includes:

– 2 base/plinth trim panels with brush strip
– Assembly parts

For enclosure width/depth mm (in.)	Model No.
600 (24)	8620.092
800 (32)	8620.093
1000 (40)	8620.094
1200 (48)	8620.095

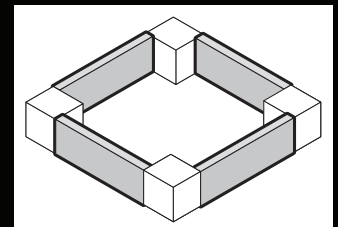
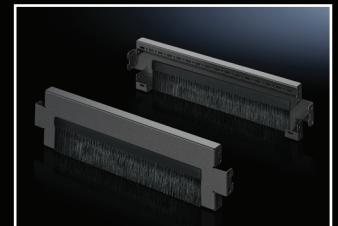

Base

Base/plinth for TS IT

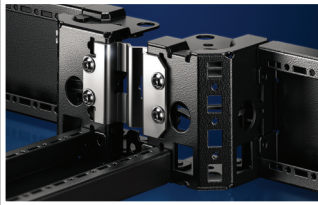
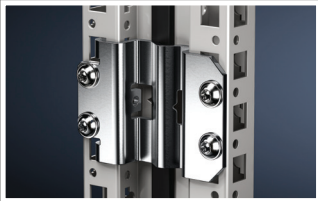

Baying bracket, internal

- Fast, secure installation either from the front or from the side
- For all-round installation on the baying joint
- May be flexibly positioned to avoid collisions with installed equipment
- Also suitable for baying the VX base/plinth system

Material:

- Carbon steel

Surface finish:

- Zinc-plated

Supply includes:

- Baying bracket, internal
- Baying seal
- Assembly parts

P. of	Model No.
6 pc(s).	8617.500

Base mounting plate

For attaching the base/plinth to the floor.
For assembly screws up to 12 mm (.5 in.) Ø

Material:

- Carbon steel

Surface finish:

- Zinc-plated

P. of	Model No.
10 pc(s).	2817.000

Base/plinth for TS IT

Leveling component

For retrospective leveling on uneven floors at the installation site up to maximum of 15 mm (.6 in.) Installed through the base/plinth corner piece. Adjusted using a hex spanner, width across flats 19 mm (.8 in.)

Benefits:

- A door offset caused by uneven flooring can be corrected
- Installed on the assembled enclosure, i.e. no need to plan leveling in advance

Load capacity:

- Max. admissible load: 2500 N per leveling component (check the load capacity of the floor).

Supply includes:

- Assembly parts

For base/plinth height mm (in.)	P. of	Model No.
100 (4)	4 pc(s).	8100.710
200 (8)	4 pc(s).	8100.711

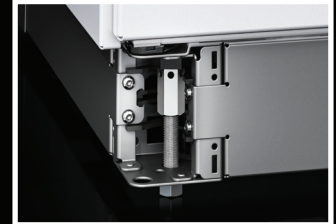
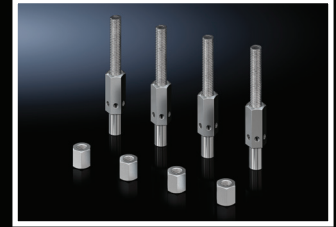

Base/plinth adaptor

For twin casters and leveling feet

For mounting twin casters and leveling feet to the VX base/plinth system.

Material	P. of	Model No.
Carbon steel	4 pc(s).	8100.770
Stainless steel	4 pc(s).	8100.771

Note:

- When fitting twin casters, side trim panels, see page 43, are required.

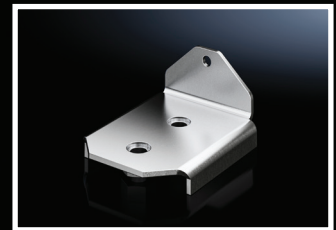

Leveling feet

18 – 43 mm (1 – 2 in.) high

To compensate for height differences with floor irregularities. Mounting thread M12.

Load capacity:

- Max. admissible load: approx. 3000 N per leveling foot

Description	Capacity	P. of	Model No.
For TS IT	675 lb (306 kg) per leveling foot	4 pc(s).	4612.000
For Plinth Installation	675 lb (306 kg) per leveling foot	4 pc(s).	8100.780
High Load	800 lb (363 kg) per leveling foot	4 pc(s).	9961.504



Technical Details

Base/plinth for TS IT

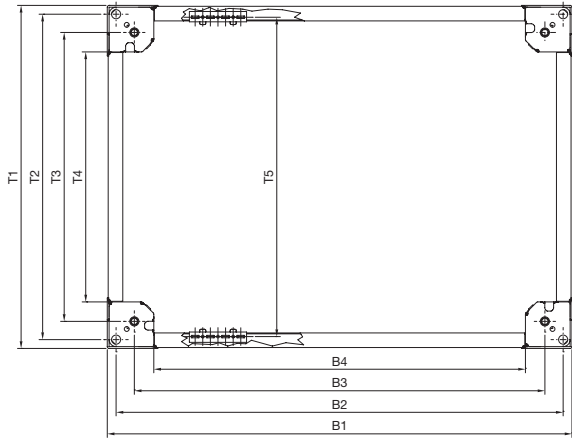

Base/plinth, 100 mm (4 in.) high

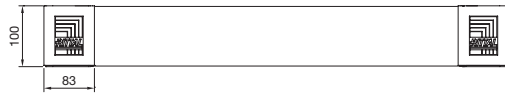

Base/plinth, trim panels, solid, 100 mm (4 in.) high, front view

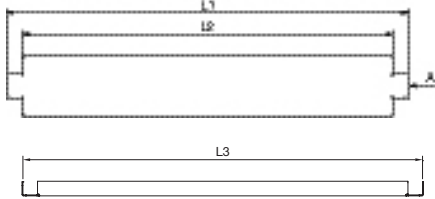

Rear view



Base/plinth trim panels with brush strip, 100 mm (4 in.) high, front view

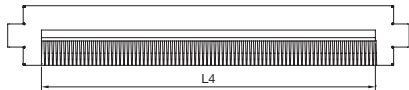

View A

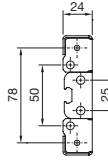

View B

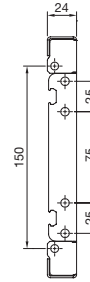

Base/plinth, 200 mm (3 in.) high

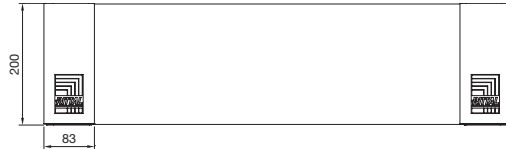

Base/plinth, trim panels, solid, 200 mm (8 in.) high, front view

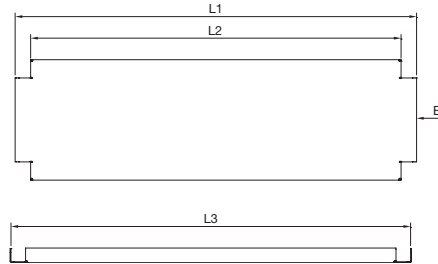

Rear view



For enclosure width or depth mm	Width dimensions mm				Length dimensions mm				Depth dimensions mm				
	B1	B2	B3	B4	L1	L2	L3	L4	T1	T2	T3	T4	T5 ¹⁾
300	264	235	175	111	160	109	157	–	264	235	175	111	225
600	564	535	475	411	460	409	457	349	564	535	475	411	525
800	764	735	675	611	660	609	657	549	764	735	675	611	725
1000	964	935	875	811	860	809	857	–	964	935	875	811	925
1200	1164	1135	1075	1011	1060	1009	1057	–	1164	1135	1075	1011	1125

¹⁾T5 = Distance between system punchings including base/plinth installation bracket

For enclosure depth 39" (1000 mm)

A Base plate set	Packs of	Packs required	For enclosure width inches (mm)	
			24 (600)	32 (800)
			Model No.	
Base plate, solid, with sliding panel, multi-piece	1 set(s)	1	5502.540	5502.550

Base plate modules	Packs of	Packs required	For enclosure width inches (mm)	
			24 (600)	32 (800)
			Model No.	

B 1 module plate as selected				Model No.	
Base plate, depth 10" (250 mm)		1 pc(s).	2	5001.222	5001.223
Base plate, depth 2" (50 mm)		1 pc(s).	1	5001.210	5001.211
Sliding plate, depth 6" (150 mm)		1 pc(s).	1	5001.239	5001.240
Module plate, depth 9.4" (237.5 mm)	Cable entry with brush strip	1 pc(s).	1	–	7825.381
	Vented			7825.360	7825.380
	Cable entry with brush strip, super-airtight			–	7825.387

C 2 module plates as selected				Model No.	
Base plate, depth 10" (250 mm)		1 pc(s).	1	5001.222	5001.223
Base plate, depth 4" (100 mm)		1 pc(s).	1	5001.214	5001.215
Sliding plate, depth 6" (150 mm)		1 pc(s).	1	5001.239	5001.240
Module plate, depth 9.4" (237.5 mm)	Cable entry with brush strip	1 pc(s).	2	–	7825.381
	Cable entry with brush strip, super-airtight			–	7825.387

D Cable entry, rear or front				Model No.	
Base plate, depth 10" (250 mm)		1 pc(s).	2	5001.222	5001.223
Base plate, depth 4" (100 mm)		1 pc(s).	1	5001.214	5001.215
Sliding plate, depth 6" (150 mm)		1 pc(s).	2	5001.239	5001.240
Self-adhesive foam cable clamp strip		1118 (3 m)	1	2573.000	2573.000

E Cable entry, center				Model No.	
Base plate, depth 10" (250 mm)		1 pc(s).	2	5001.222	5001.223
Base plate, depth 4" (100 mm)		1 pc(s).	1	5001.214	5001.215
Sliding plate, depth 6" (150 mm)		1 pc(s).	2	5001.239	5001.240
Profile for cable entry, center		1 set(s).	1	8802.060	8802.080

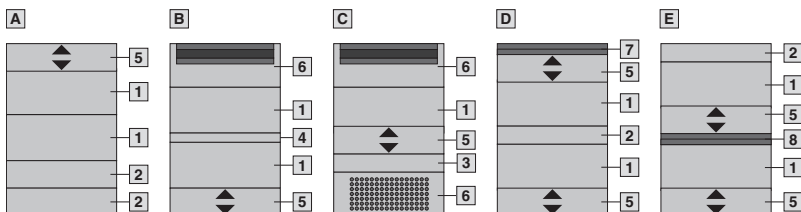

- 1 Base plate, depth 10" (250 mm)
- 2 Base plate, depth 6" (150 mm)
- 3 Base plate, depth 4" (100 mm)
- 4 Base plate, depth 2" (50 mm)
- 5 Sliding plate, depth 6" (150 mm)
- 6 Module plate, depth 9.4" (237.5 mm)
- 7 Self-adhesive foam cable clamp strip
- 8 Profile for cable entry, center

! Also required:

– Base mount, see page 51

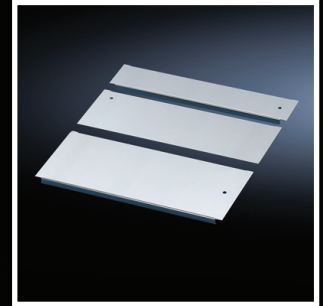

Base

Base plate, TS IT

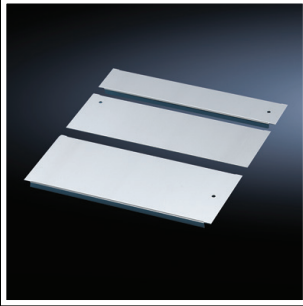

For enclosure depth 47" (1200 mm)

A Base plate set	Packs of	Packs Required	For enclosure width inches (mm)	
			24 (600)	32 (800)
Model No.				
Base plate, solid, with sliding panel, multi-piece	1 set(s)	1	5502.560	5502.570

Base plate modules	Packs of	Packs required	For enclosure width inches (mm)	
			24 (600)	32 (800)

B 1 module plate as required				Model No.	
Base plate, depth 10" (250 mm)		1 pc(s)	3	5001.222	5001.223
Sliding plate, depth 6" (150 mm)		1 pc(s)	1	5001.239	5001.240
Module plate, depth 9.4" (237.5 mm)	Cable entry with brush strip	1 pc(s)	1	–	7825.381
	Cable entry with brush strip, super-airtight			–	7825.387

C 2 module plates as required				Model No.	
Base plate, depth 10" (250 mm)		1 pc(s)	2	5001.222	5001.223
Base plate, depth 2" (50 mm)		1 pc(s)	1	5001.210	5001.211
Sliding plate, depth 6" (150 mm)		1 pc(s)	1	5001.239	5001.240
Module plate, depth 9.4" (237.5 mm)	Cable entry with brush strip	1 pc(s)	2	–	7825.381
	Cable entry with brush strip, super-airtight			–	7825.387

D Cable entry, rear or front				Model No.	
Base plate, depth 10" (250 mm)		1 pc(s)	2	5001.222	5001.223
Base plate, depth 6" (150 mm)		1 pc(s)	3	5001.218	5001.219
Sliding plate, depth 6" (150 mm)		1 pc(s)	1	5001.239	5001.240
Self-adhesive foam cable clamp strip		118" (3 m)	1	2573.000	2573.000

E Cable entry, center				Model No.	
Base plate, depth 10" (250 mm)		1 pc(s)	2	5001.222	5001.223
Base plate, depth 6" (150 mm)		1 pc(s)	3	5001.218	5001.219
Sliding plate, depth 6" (150 mm)		1 pc(s)	1	5001.239	5001.240
Profile for cable entry, center		1 set	1	8802.060	8802.080

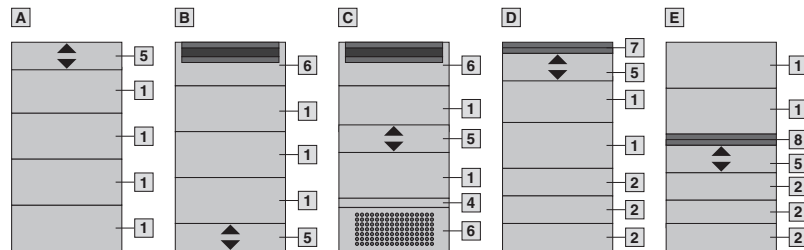

- 1 Base plate, depth 10" (250 mm)
- 2 Base plate, depth 6" (150 mm)
- 3 Base plate, depth 4" (100 mm)
- 4 Base plate, depth 2" (50 mm)
- 5 Sliding plate, depth 6" (150 mm)
- 6 Module plate, depth 9.4" (237.5 mm)
- 7 Self-adhesive foam cable clamp strip
- 8 Profile for cable entry, center

! Also required:

– Base mount, see page 51

Base plate accessories

Clips for base plates

As replacement and for additional gland plate attachments in TS.

Packs of	Model No.
50 pc(s).	8800.075

Material:
Carbon steel

Surface finish:
Zinc-plated

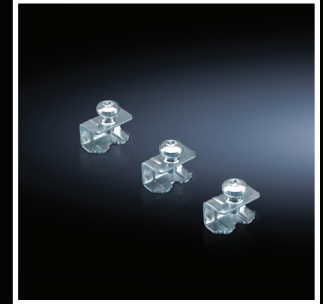

Base mount for TS IT

To accommodate base plate modules.
– Tool-free mounting or screw-fastening
– Easily retrofitted and can be combined with the stabilizer

For enclosure depth inches (mm)	Packs of	Model No.
32 (800)	2 pc(s).	5501.310
39 (1000)	2 pc(s).	5501.320
47 (1200)	2 pc(s).	5501.350

Material:
– Carbon steel

Surface finish:
– Spray-finished

Color:
– Light Gray RAL 7035

Supply includes:
– 2 mounting rails including assembly parts.

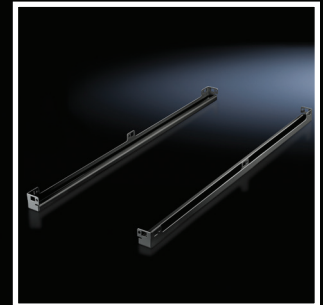

Bolt down anchoring kit

For anchoring the enclosure even if it is on casters at any position of the base frame. Has a vertical slot to account for different vertical positions. Additional holes in the base are required for mounting.

Packs of	Model No.
4 pc(s).	9970.989

Material:
Carbon steel

Surface finish:
Primed



Base

Casters



Complete caster

Complete casters have 2 casters per piece. Cable entry holes included.

Configuration:

1 set = 2 caster plates with 2 casters per plate
1 caster plate with swivel casters

Load Capacity:

Supports dynamic load rating of 2250 lb
(1020 kg) per cabinet

Width inches (mm)	Color	Part No.
24 (600)	Black RAL 9005	9967.480
24 (600)	Light Gray RAL 7035	9967.483
28 (700)	Black RAL 9005	9967.481
28 (700)	Light Gray RAL 7035	9967.484
32 (800)	Black RAL 9005	9967.482
32 (800)	Light Gray RAL 7035	9967.485

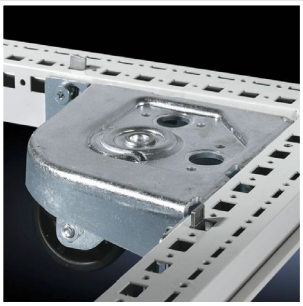

Corner Caster Kit

Only for enclosures without base plates and base tray/base mount.

Configuration:

4 castors (2 steerable) including assembly components

Load Capacity:

Supports dynamic load rating of 551.2 lb
(250 kg) per cabinet

Packs of	Model No.
4 pc(s).	7825.900

Sidewall, divided

for TS IT

- Easy handling and tool-free assembly
- Quick-release fastener including security lock 3524 E
- Internal latch included (cannot be opened with a key)
- Lock with chassis, cable clamp rail may be top-mounted on the outer mounting rail
- Suitable for IT climate control and rack extinguishing

Material:

Carbon steel

Color:

Light Gray RAL 7035, Black RAL 9005

Supply includes:

- 1 console
- 1 pedestal
- Ground conductor
- Assembly parts

For enclosures		Packs of	RAL 7035 Part No.	RAL 9005 Part No.
Height inches (mm)	Depth inches (mm)			
80 (2000)	24 (600)	1	5501.010	5501.015
80 (2000)	32 (800)	1	5501.020	5501.025
80 (2000)	41 (1000)	1	5501.030	5501.035
80 (2000)	41 (1050)	1	–	5501.095
80 (2000)	48 (1200)	1	5501.040	5501.045
88 (2200)	32 (800)	1	5501.050	5501.055
87 (2200)	39 (1000)	1	5501.060	5501.065
88 (2200)	41 (1050)	1	–	5501.105
88 (2200)	48 (1200)	1	5501.070	5501.075



Sidewall, solid

Material:

Carbon steel, electrophoretic dipcoat-primed, powder-coated

Color:

Light Gray RAL 7035, Black RAL 9005

Supply includes:

2 side panels

Protection category:

IP 55

For Enclosures:		Color		Part No.
Height inches x (mm)	Depth inches x (mm)	RAL 7035	RAL 9005	
48 (1200)	32 (800)	■	–	8175.235
48 (1200)	32 (800)	–	■	9966.010
79 (2000)	32 (800)	■	–	8108.235
79 (2000)	32 (800)	–	■	9966.011
79 (2000)	40 (1000)	■	–	8100.235
79 (2000)	40 (1000)	–	■	9966.012
79 (2000)	42 (1050)	■	–	9969.309
79 (2000)	42 (1050)	–	■	9966.013
79 (2000)	48 (1200)	■	–	9969.955
79 (2000)	48 (1200)	–	■	9966.014
87 (2200)	32 (800)	■	–	8128.235
87 (2200)	32 (800)	–	■	9966.015
87 (2200)	40 (1000)	■	–	9968.593
87 (2200)	40 (1000)	–	■	9966.016
87 (2200)	42 (1050)	■	–	9969.312
87 (2200)	42 (1050)	–	■	9966.017
87 (2200)	48 (1200)	■	–	9969.957
87 (2200)	48 (1200)	–	■	9966.018



Walls

Partition wall



Cable pass through partition wall

For side partitioning of bayed TS server enclosures. Installs without the need for additional hardware or tools. Has four 4.41" (112 mm) cable pass through holes, grommet covers included.

Color:

Black RAL 9005

Note:

Use baying connector 8800.490 (see page 54).
Not for use in conjunction with a baying seal.
Can be installed and removed without moving the cabinet. Left side mounting for cable pass through in the rear of the rack.

Height inches (mm)	Depth inches (mm)	Part No.
79 (2000)	39 (1000)	9971.042
79 (2000)	42 (1050)	9971.043
79 (2000)	47 (1200)	9971.044
87 (2200)	39 (1000)	9971.046
87 (2200)	42 (1050)	9971.047
87 (2200)	47 (1200)	9971.048



Solid partition wall

For side partitioning of bayed TS server enclosures. Installs without the need for additional hardware or tools.

Color:

Black RAL 9005

Note:

Use baying connector 8800.490 (see page 54).
Not for use in conjunction with a baying seal.
Can be installed and removed without moving the cabinet.

Height inches (mm)	Depth inches (mm)	Part No.
79 (2000)	40 (1000)	9978.378
79 (2000)	42 (1050)	9978.379
79 (2000)	48 (1200)	9978.380
87 (2200)	40 (1000)	9978.382
87 (2200)	42 (1050)	9978.383
87 (2200)	48 (1200)	9978.384

Connection hardware

Baying connectors, external

For mounting on the vertical enclosure sections. Simply position on the outside and screw-fasten either from the inside or outside.

Supply includes:

Assembly parts

Material/surface finish	Packs of	Part No.
Carbon steel, zinc-plated	6	8800.490

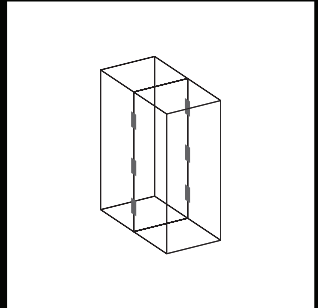

Baying bracket

For additional stabilization, or in cases where mounting panel brackets, swing frame or busbar supports prevent the installation of angular baying brackets.

Material:

Carbon steel, zinc-plated, passivated

Supply includes:

Assembly parts

Accessories:

For mounting on vertical TS enclosure:
Snap-on nut M8, 8800.808

Packs of	Part No.
4	4582.500

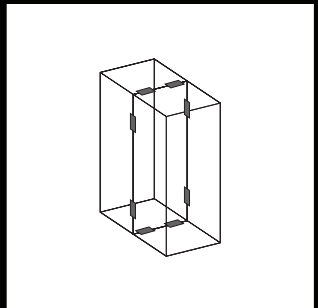
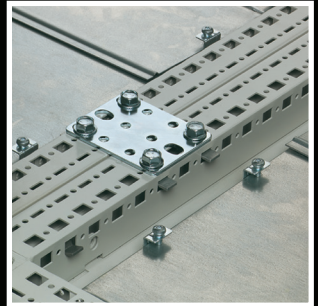

Doors/locks

Handle



Comfort handle for lock insert

Prepared for the installation of lock inserts, safety and push-button inserts.

Material:
Die-cast zinc

Color	Part No.
RAL 7035	8611.020
RAL 9005	8611.350



Comfort handle for semi-cylinder

Prepared for the installation of commercially available semi-cylinder, 1.6 or 1.8" total length.

Length:
11.9" (302 mm)

Material:
Die-cast zinc

Design	Part No.
RAL 7035	8611.070
RAL 9005	8611.360



Security handle with code

Flexible access opportunities with
– individual 3-digit code without key or
– with the master key function via an additional semi-cylinder of 40 or 45 mm to DIN 18 252, irrespective of the code.

Note:
Security handle combination lock reset tool available upon request.

Design with	Part No.
RAL 7035 comfort handle for TS	7200.800
RAL 9005 comfort handle for TS	7200.801

Material:
Die-cast zinc

Accessories:
– Lock and push-button inserts, see below.



Lock and push-button inserts

For installation in comfort handles that use lock inserts.

Design	Part No.
Security lock insert no. 3524 E	8611.180¹⁾
Push-button inserts	8611.190
Push-button and lock inserts, lock no 1231; no other lock is possible	611.200

¹⁾ 2 keys included



Lock and push-button inserts

For installation in comfort handles that use semi-cylinder inserts

Design	Part No.
Security lock inserts no. 3524 E	2467.000¹⁾
Push-button inserts	2468.000
Push-button and lock inserts, lock no. 2123 E; no other lock is possible	2469.000

¹⁾ 2 keys included

Interior installation

Rail systems

TS System chassis 17 x 73 mm

For designing a flexible interior installation, or for accommodating additional components. The system chassis with mounting flanges may be attached directly onto a 19" (482.6 mm) mounting frame horizontally at the rear or in the enclosure depth between two mounting frames. An additional screw fastening secures the unit. Variable, with 5 rows of holes for universal skeleton structure or partial assembly.

Material:

– Carbon steel

Surface finish:

– Zinc-plated

Supply includes:

Assembly screws



Also required:

- For installation in CM, TP:
Rail for interior fitting, see page 56



Accessories:

- Screws, see page
- Cable ties for quick mounting 2597.000, see page 69

For the outer mounting level

For Enclosure width/ depth inches (mm)	Packs of	Model No.
12 (300)	4 pc(s).	8612.130
16 (400)	4 pc(s).	8612.140
20 (500)	4 pc(s).	8612.150
24 (600)	4 pc(s).	8612.160
32 (800)	4 pc(s).	8612.180
39 (1000)	4 pc(s).	8612.100
47 (1200)	4 pc(s).	8612.120

For inner mounting level or for tubular door frames

For door width (for tubular door frames) inches (mm)	For Enclosure width/ depth (for inner mounting level) inches (mm)	Length inches (mm)	Packs of	Model No.
20 (500)	16 (400)	15 (390)	4 pc(s).	8612.040
24 (600)	20 (500)	19 (490)	4 pc(s).	8612.050
–	24 (600)	23 (590)	4 pc(s).	8612.060
32 (800)	–	27 (690)	4 pc(s).	8612.070
35 (900)	32 (800)	31 (790)	4 pc(s).	8612.080
39 (1000)	–	35 (890)	4 pc(s).	8612.090
–	39 (1000)	39 (990)	4 pc(s).	8612.000
–	47 (1200)	47 (1190)	4 pc(s).	8612.020

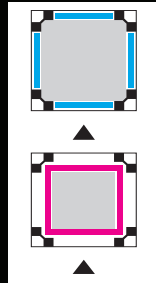
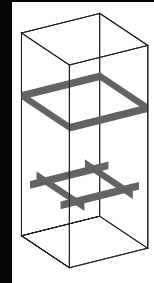
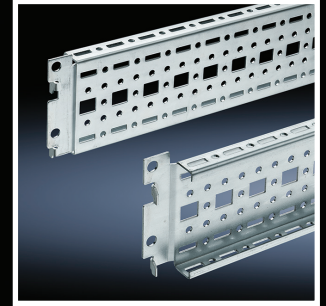

Interior installation

Rail systems/assembly components

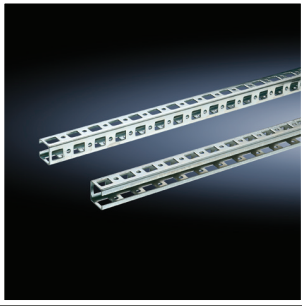

System bars, 23 x 23 mm

For TS

Installation options:

- On the vertical enclosure section directly via support brackets TS
- On the horizontal enclosure section directly via angle brackets, mounting brackets

Length inches (mm)	For WHD inches (mm)	Packs of	Part No.
18 (445)	24 (600)	12	4171.500
25 (645)	24 (600)	12	4172.500
75 (1895)	79 (2000)	6	4177.000
82 (2095)	87 (2200)	6	4178.000

Material:

Carbon steel, zinc-plated, passivated

Note:

Requires mounting bracket 4182.000, see below



Mounting bracket

For TS

For variable attachment of system bar 23 x 23 mm.

Installation options:

- Optionally flush with:
 - Outer enclosure edge or
 - Enclosure clearance width
- On the horizontal TS enclosure section
- On enclosures and rails with rectangular system hole patterns 12.5 x 10.5 mm

Packs of	Part No.
24	4182.000

Material:

Die-cast zinc

Supply includes:

1 set = 1 mounting bracket, 1 screw M6 x 12 mm, 1 cage nut M6

Also required:

- U nuts for system bars (recommended: M6, 4179.000), see page 58
- Multi-tooth screws M6 x 12 mm (2504.500), see page 60



Support bracket

For TS

For the attachment of system chassis without mounting flange, 23 x 73 mm or system bars, 23 x 23 mm.

Installation options:

- On the horizontal TS enclosure section
- On enclosures and rails with rectangular hole patterns, 12.5 x 10.5 mm.

Material:

Die-cast zinc

Packs of	Part No.
24 set	4183.000

Supply includes:

1 set =
1 support bracket,
2 countersunk screws,
2 serrated lock washers.

Also required:

- U nuts for system bars (recommended: M6, 4179.000), see page 58
- Multi-tooth screws M6 x 12 mm (2504.500), see page 60

Interior installation

Assembly components

U nuts

For

- System bars 23 x 23 mm
- System chassis without mounting flange, 23 x 73 mm
- System chassis without mounting flange, 45 x 88 mm
- System chassis with mounting flange, 23 x 73 mm

For mounting system bars and system chassis without mounting flanges on angle brackets, mounting brackets and support brackets, we recommend U nuts with M6 thread (4179.000).

Thread	Packs of	Part No.
M4	20	4119.000
M5	20	4157.000
M6	20	4179.000
M8	20	4180.000

Accessories:

Multi-tooth screws M6 x 12 mm, (for 4179.000), see page 60

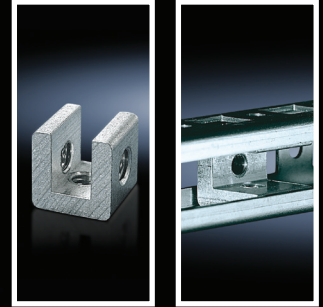

Mounting plate

Screw-fastened, small

Packs of	Part No.
4	4532.000

Material:

Carbon steel

Surface finish:

Zinc-plated

Supply includes:

Assembly screws

Detailed drawings:

Available at www.rittal.com

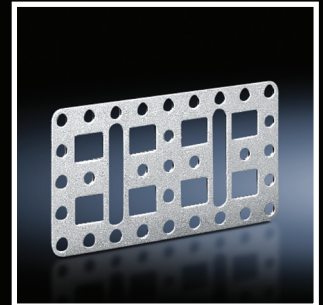

Mounting bracket

May be screw-fastened onto all enclosures and mounting parts with 25 mm hole patterns.

Packs of	Part No.
4	4597.000

Material:

Carbon steel

Surface finish:

Zinc-plated

Supply includes:

Assembly screws

Accessories:

- Screws, see page 66
- Cable tie for fast assembly 2597.000, see page 69.

Detailed drawings:

Available at www.rittal.com

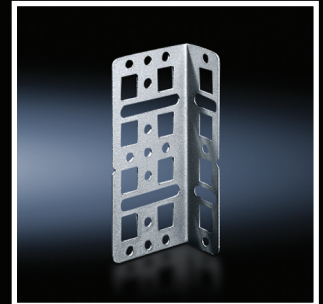

Mounting plate

Locatable

on

- the vertical TS enclosure section
- TS system chassis with mounting flange, 17 x 73 mm

Packs of	Part No.
4	8612.400

Material:

Carbon steel

Surface finish:

Zinc-plated

Supply includes:

Assembly screws

Detailed drawings:

Available at www.rittal.com

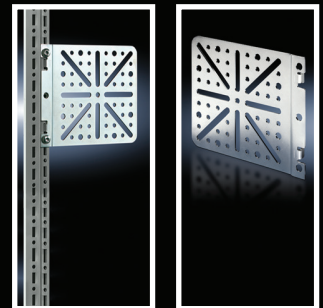

Interior installation

Assembly components

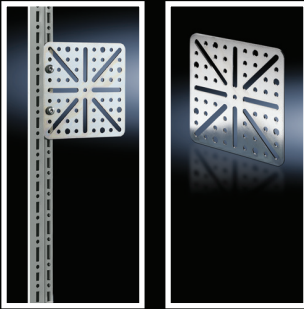

Mounting plate

Screw-fastened, large

On all enclosures and mounting parts with 25 mm hole patterns.

Material:

Carbon steel

Surface finish:

Zinc-plated

Supply includes:

Assembly screws

Packs of	Part No.
4	8612.410

Detailed drawings:

Available at www.rittal.com



Fastener, 1 U with Contact 19" (482.6 mm)

For the simple screw-fastening of expansion components within the 482.6 mm (19") mounting level. Simply slide onto the profile rail from the inside and clip into position.

- Integrated contact for equipotential bonding
- Preconfigured 1 U support with 3 cage nuts including center attachment in accordance with EIA 310 standard
- Rapid positioning and assembly instead of using individual captive nuts
- Repeated removal and re-use possible

Material:

Carbon steel

Dimensions mm	Size of mounting hole inches (mm)	Packs of	Part No.
M5			2090.000

Material:

Carbon steel

Surface finish:

Zinc-plated



Captive nut M5/M6

For the attachment of rack-mounted electronic equipment, 19" (482.6 mm) installed equipment and blanking plates to mounting rails, 19" (482.6 mm). For use with metal thickness from 20 – 14 ga (0.8 – 2.0 mm). In areas of narrow tolerance, captive nuts for metal thicknesses of 18 – 16 ga (1.2 – 1.5 mm) should be used. Optionally with or without contact of the installed equipment to the 19" (482.6 mm) section/ enclosure.

Captive nut M5

Design	For metal thicknesses ga (mm)	Packs of	Part No.
With contact	20 – 14 (0.8 – 2.0)	50	2094.500
Without contact	20 – 14 (0.8 – 2.0)	50	2092.500

Captive nut M6

Design	For metal thicknesses ga (mm)	Packs of	Part No.
With contact	20 – 14 (0.8 – 2.0)	50	2094.200
Without contact	20 – 14 (0.8 – 2.0)	50	2092.200
With contact	18 – 16 (1.2 – 1.5)	50	2094.300
Without contact	18 – 16 (1.2 – 1.5)	50	2092.300

Captive nut 10/32

Design	For metal thicknesses ga (mm)	Packs of	Part No.
Without contact	20 – 14 (0.8 – 2.0)	50	9957.324

Interior installation

Assembly components

1 Multi-tooth screw

- M6 x 12 to fit:
 – Snap-on nuts (8800.806)
 – U nuts for system bars (4179.000)
 – Captive nuts (4164.000)
 – Threaded blocks (4162.000)

- M8 x 12 to fit:
 – Snap-on nuts (8800.808)

2 Metal multi-tooth screw

For the round holes 4.5 mm diameter in the enclosure section, system bars and system chassis without mounting flanges

3 Self-tapping screw

For the round holes 4.5 mm diameter in the enclosure section, system bars and system chassis without mounting flanges

4 Self-tapping screw

Mark, drill and tighten in a single operation using electric or pneumatic tools
 For metal thickness: 20 – 11 ga (0.8 – 3 mm)
 Length: 0.6" (16 mm)
 Usable length: 0.4" (9.5 mm)
 Width across flats: 0.3" (8 mm)

Multi-tooth drive for optimum transmission of torque, an extended tool life and increased safety and reliability when tightening and loosening screw connections.

Dimensions mm	Packs of	Part No.
Multi-tooth screws		
M6 x 12	300	2504.500
M8 x 12	300	2504.800
Metal multi-tooth screws		
5.5 x 13	300	2486.500
Metal multi-tooth screws for stainless steel		
5 x 13	300	2486.300
Self-tapping hex screws		
M5 x 10	500	2504.000
Self-tapping posidrive raised countersunk screws		
M5 x 12	500	2488.000
Self-tapping pan-head screws, posidrive		
M5 x 12	500	2489.000
Self-tapping multi-tooth pan-head screws		
M5 x 12	500	2489.500
Self-tapping screws		
ST 4.8 x 16	300	2487.000

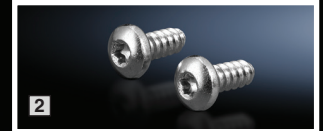

Assembly screws M6 x 0.63" (16 mm), M5 x 0.63" (16 mm)

For captive nuts, 19" (482.6 mm) enclosure mount components and blanking panels. Plastic washers included.

Type	Packs of	Part No.
Slotted screw M6	50	7094.110
Phillips screw M6	50	7094.100¹⁾
Phillips screw M5	50	7094.120
Multi-tooth 25 M5	50	7094.130
Multi-tooth 30 M6	50	7094.140

¹⁾Included standard with TS8 network and server enclosures in this publication.



Interior installation

Component shelves

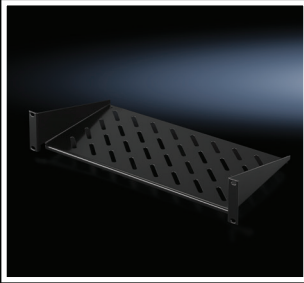

Component shelf, fixed depth static installation

For static installation between 19" (482.6 mm) mounting rails.

Load capacity:
55 lbs (25 kg) surface load, static

Material:
Carbon steel

Surface finish:
Spray-finished

Color:
Black RAL 9005

Supply includes:
Assembly parts.

Component shelf depth inches (mm)	Packs of	Part No.
10 (250)	1 set	5501.615
16 (400)	1 set	5501.625

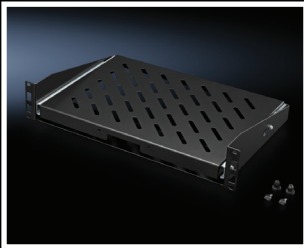

Component shelf, pull-out, 2 U for one 19" mounting level

For simple, front installation of wall-mounted or floor-standing enclosures with at least one 482.6 mm (19") mounting level. This complete set includes the pre-configured variant including telescopic slides, moulded handle, flange and locking pins.

Load capacity:
Max. 250 N, static

Material:
Carbon steel

Surface finish:
Spray-finished

Color:
Black RAL 9005

Supply includes:
Component shelf, pre-configured
Assembly parts.

Contact surface inches (mm)	Packs of	Part No.
11.8 (300)	1 pc(s).	5501.635

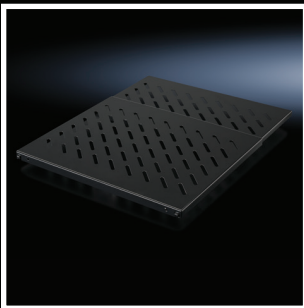

Component shelf, depth variable, static installation

For static installation between two 19" (482.6 mm) mounting rails.
– Depth-variable to adapt to individual distances between rails
– Tool-free, time-saving one-man assembly

Material:
Carbon steel

Surface finish:
Spray-finished

Color:
Black RAL 9005

Supply includes:
Assembly parts

Distance between rails inches (mm)	Load capacity, static lbs (kg)	Height U	Packs of	Part No.
16–24 (400–600)	110 (50)	½	1 set	5501.655
24–35 (600–900)	110 (50)	½	1 set	5501.665
16–24 (400–600)	220 (100)	1	1 set	5501.695
24–35 (600–900)	220 (100)	1	1 set	5501.705



Interior installation

Component shelves/handle/drawer

Component shelf, depth variable, pull-out

- For mounting between two 19" (482.6 mm) mounting rails.
- Depth-variable to adapt to individual distances between rails
 - Tool-free, time-saving one-man assembly from the enclosure front
 - Self-locking
 - Fully extendible

Material:
Carbon steel

Surface finish:
Spray-finished

Color:
Black RAL 9005

Supply includes:

- Installation kit
- Telescopic slide with mounting kit
- Assembly parts

Accessory:
Handle, 5501.730, see below.

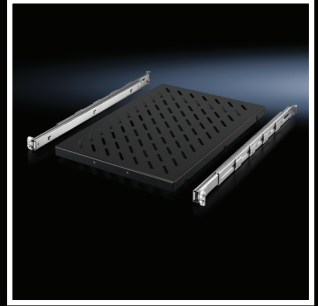

Distance between rails inches (mm)	Load capacity, static lbs (kg)	Height U	Depth inches (mm)	Packs of	Part No.
16–24 (400–600)	110 (50)	1	20 (500)	1 set	5501.675
24–35 (600–900)	110 (50)	1	28 (700)	1 set	5501.685
16–24 (400–600)	220 (100)	1½	20 (500)	1 set	5501.715
24–35 (600–900)	220 (100)	1½	28 (700)	1 set	5501.725

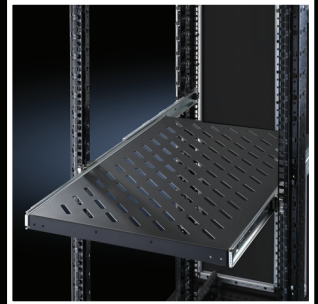

Handle for pull-out component shelves

All component shelves have mounting holes for handles.

Material:
Die-cast zinc

Surface finish:
Spray-finished, silver-grey

Supply includes:
Assembly parts

Packs of	Part No.
2	5501.730

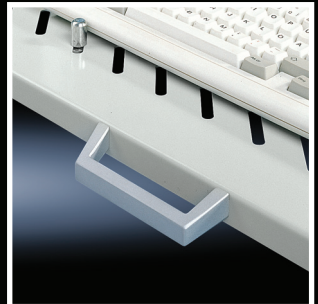

Pull-out drawer

For front attachment to mounting rails. With cover and telescopic slides to accommodate assignment lists, operating manuals and small parts. The 2 U version is also suitable for mounting inside a swing frame. Fully assembled, including assembly parts.

Material:
Carbon steel

Color:
Black RAL 9005

U	Clearance openings		Install depth inches (mm)	Packs of	Part No.
	Width inches (mm)	Depth inches (mm)			
2	16 (411)	16 (419)	17 (427)	1	5502.305
3	16 (411)	16 (419)	17 (427)	1	5502.325

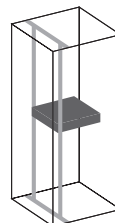

Interior installation

Slide rails

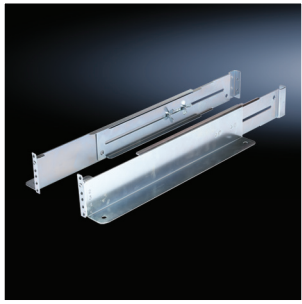

Telescopic support rail, heavy duty

These telescopic support rails are designed to support components from underneath, and can support up to 200 lbs (91 kg). Rails extend from 22" (560.5 mm), totally retracted, to 30" (762 mm), totally extended.

Supply includes:

2 support rails

Packs of	Part No.
2	9963.499

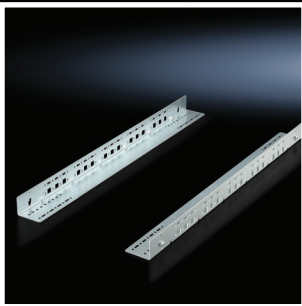

Slide rails, static installation

For mounting between a front and a rear pair of mounting rails.

- To support heavy installed equipment
- Side system hole pattern for mounting accessories and cooling components that expel to the side
- Fit into the system hole pattern of the TS IT

Technical specifications:

Load capacity: 176 lbs (80 kg), static

Material:

Carbon steel

U	19" (482.6 mm) distance between rails inches (mm)	Packs of	Part No.
1	14 (345)	2	5501.410
1	18 (445)	2	5501.420
1	21 (545)	2	5501.430
1	25 (645)	2	5501.440
1	29 (745)	2	5501.450

Surface finish:

Zinc-plated

Supply includes:

Assembly parts

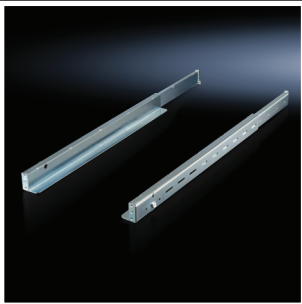

Slide rails, depth-variable

For mounting between a front and a rear pair of mounting rails.

- To support heavy installed equipment
- To adapt to individual distances between rails
- Tool-free, time-saving one-man assembly from the enclosure front
- All three mounting holes are available for screw-fastening the equipment

Material:

Carbon steel

Surface finish:

Zinc-plated

Supply includes:

Assembly parts

19" (482.6 mm) distance between rails inches (mm)	Load capacity lbs (kg)	Packs of	Part No.
16-24 (400-600)	176 (80)	2	5501.460
24-35 (600-900)	331 (150)	2	5501.480

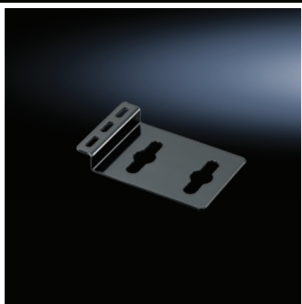

Button mount bracket

- Enables tool-less installation of PDUs
- Black, E-coated

Description	Packs of	Part No.
Dual PDU, Recessed	2	9963.800
0U PDU button mount	2	9971.066
Dual PDU button	2	9971.067
45 degree double PDU	2	9977.399
TS IT 0U button	2	9978.522

Interior installation

Slide rails/mounting kit

Slide rails, static installation

For mounting between two 19" (482.6 mm) mounting rails.

– System hole pattern for mounting accessories and cooling active components

Technical specifications:

Load capacity: 66 lbs (30 kg), static

Material:

Carbon steel

U	Length inches (mm)	Packs of	Part No.
2	6 (150)	2	5501.400

Surface finish:

Zinc-plated

Supply includes:

Assembly parts



Mounting kit

for 19" (482.6 mm) equipment

Facilitates fast, simple integration of additional mounting space within an enclosure by attaching to the enclosure frame or to the existing mounting rails at the sides. The flexible slot fastening of the brackets means that the distance between the two installation brackets may be freely selected, so that other 19" (482.6 mm) attachment dimensions may be implemented. The second row of holes is used for the optional configuration of additional mounting surfaces.

U	Color	Packs	Part No.
1	Black	2	9970.986
2	Carbon steel	2	7246.420

Material:

Carbon steel, zinc-plated, passivated

Supply includes:

Assembly parts

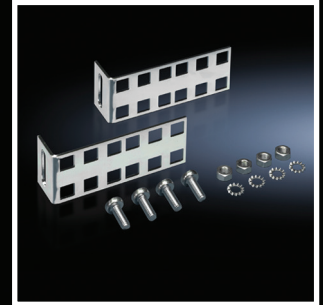

Interior installation

LED system light

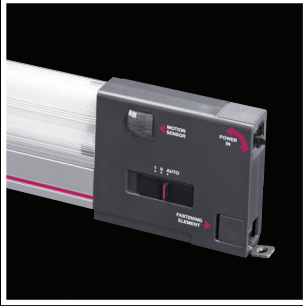

LED system light

- Optimum illumination of the entire enclosure
- Optionally with clip, screw and magnetic attachment
- A configuration to suit every application

Material:

- Plastic
- Aluminum

Color:

- Enclosure: RAL 7016

Light Color:

- 4000 K (neutral white)

Supply includes:

- Assembly screws

Note:

- Connection accessories should be ordered separately
- Information on other country-specific versions with socket can be found on the internet.

Model No.		2500.314	2500.300	2500.320	2500.214	2500.200	2500.220	2500.114	2500.104
Output (lumen)		1200	1200	1200	900	900	900	600	400
Length (inches/mm)		17/437	17/437	17/437	17/437	17/437	17/437	13/337	10/262
Motion sensor		■	■	■	–	–	–	–	–
Rated operating voltage	100 – 240 V AC	■	■	–	■	■	–	■	■
	24 V DC	–	–	■	–	–	■	–	–
Equipment	Socket – NEMA	■	–	–	■	–	–	–	–
	90° rotating connector	■	■	■	■	■	■	–	–
	Adjustable light direction	■	■	■	–	–	–	–	–
	Adjustable light distribution	■	■	■	■	■	■	–	–
Protection class II		II (all-insulated)		III (SELV)	II (all-insulated)		III (SELV)	II (all-insulated)	
Approvals	UL	■	■	■	■	■	■	■	■
	cUL	■	■	■	■	■	■	■	■
	CCC	–	■	■	–	■	–	■	■
	ENEC	■	■	■	■	■	■	■	■
Installation type	Screw-fastening	■	■	■	■	■	■	■	■
	Clip attachment	■	■	■	■	■	■	■	■
	Magnetic attachment	–	■	■	–	■	■	■	■
Connection options	Infeed	3-pole	3-pole	2-pole	3-pole	3-pole	2-pole	2-pole	2-pole
	Through-wiring	3-pole	3-pole	2-pole	3-pole	3-pole	2-pole	2-pole	2-pole
	Door-operated switch	–	–	–	■	■	■	■	■
Accessories									
Universal bracket 2373.000		2373.000	2373.000	2373.000	2373.000	2373.000	2373.000	2373.000	2373.000
Mounting kit magnet		–	2500.490	2500.490	–	2500.490	2500.490	2500.490	2500.490
Door-operated switch		–	–	–	2500.460	2500.460	2500.460	2500.460	2500.460
Door-operated switch, UL		–	–	–	2500.470	2500.470	2500.470	2500.470	2500.470
Connection accessories									
Infeed, 2-pole		–	–	2500.410	–	–	2500.410	2500.420	2500.420
Infeed, 2-pole, ENEC, UL		–	–	–	–	–	–	2500.520	2500.520
Infeed, 3-pole		2500.400	2500.400	–	2500.400	2500.400	–	–	–
Infeed, 3-pole, ENEC, UL		2500.500	2500.500	–	2500.500	2500.500	–	–	–
Through-wiring, 2-pole		–	–	2500.440	–	–	2500.440	2500.450	2500.450
Through-wiring, 2-pole, ENEC, UL		–	–	–	–	–	–	2500.550	2500.550
Through-wiring, 3-pole		2500.430	2500.430	–	2500.430	2500.430	–	–	–
Through-wiring, 3-pole, ENEC, UL		2500.530	2500.530	–	2500.530	2500.530	–	–	–

Interior installation

LED System light accessories

Connection accessories for LED system light

The following components can be used for time-saving and simple installation of the lights.

+ Accessories:

– Cable ties for quick assembly, see page 69

Connection cable for	ENEC	UL	Length inches (mm)	Packs of	Model No.	
					Orange	Black
① Infeed, 3-pole, 100–240 V/AC	■	■	118 (3000)	1 pc(s).	2500.500	–
	■	–	118 (3000)	5 pc(s).	2500.400	–
② Infeed, 2-pole, 100–240 V/AC	■	■	118 (3000)	1 pc(s).	2500.520	–
	■	–	118 (3000)	5 pc(s).	2500.420	–
③ Infeed, 2-pole, 24 V DC	■	–	118 (3000)	5 pc(s).	–	2500.410
④ Through-wiring, 3-pole, 100–240 V AC	■	■	39 (1000)	1 pc(s).	2500.530	–
	■	–	39 (1000)	5 pc(s).	2500.430	–
⑤ Through-wiring, 2-pole, 100–240 V AC	■	■	39 (1000)	1 pc(s).	2500.550	–
	■	–	39 (1000)	5 pc(s).	2500.450	–
⑥ Through-wiring, 2-pole, 24 V DC	■	–	39 (1000)	5 pc(s).	–	2500.440

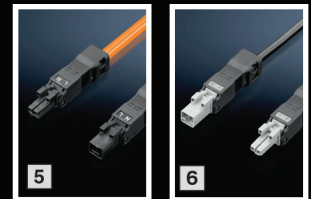
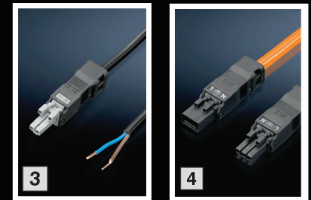
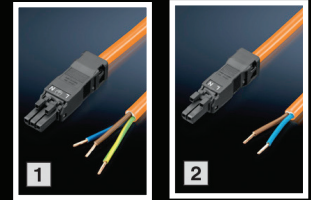

Connection accessories for self-assembly for LED system light

Sockets for power supply/through-wiring

	P. of	Model No.
Socket, 3-pole, 100-240 V AC	5 pc(s).	2500.600
Socket, 2-pole, 24 V DC	5 pc(s).	2500.610
Socket, 2-pole, 100-240 V AC	5 pc(s).	2500.620

Connectors for through-wiring

	P. of	Model No.
Connector, 3-pole, 100-240 V AC	5 pc(s).	2500.630
Connector, 2-pole, 24 V DC	5 pc(s).	2500.640
Connector, 2-pole, 100-240 V AC	5 pc(s).	2500.650

Connection cable

	UL	Length mm.	P. of	Model No.
For door-operated switch	–	3000	1 pc(s).	2500.660
	■	3000	1 pc(s).	2500.670



Door-operated switch for LED system light

Supply includes:
– Assembly parts

Connection cable	ENEC	UL	Length inches (mm)	to fit	Packs of	Model No.
						Black
Connection cable	■	–	30 (800)	230 V AC/24 V DC, 1 A	1 pc(s).	2500.460
	–	■	30 (800)		1 pc(s).	2500.470



Mounting kit magnet for LED system light

For sticking onto the rear of lights without a socket

Packs of	Model No.
2 pc(s).	2500.490

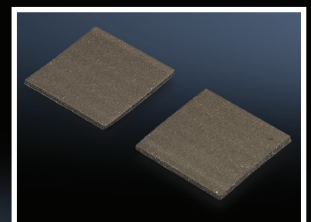

Interior installation

Grounding



Central grounding point

For connecting
 – Ground straps
 – Grounding braids
 to the vertical and horizontal enclosure profile.
 The connection bracket is connected to the enclosure frame with 2 screws and is securely contacted. Ground connection is carried out via the threaded bolt M8 x 0.8" (20 mm).

Material:
 Carbon steel, zinc-plated

Packs of	Part No.
10	7829.200

Supply includes:
 – 1 connection bracket
 – 2 screws 5.5 x 0.5" (13 mm)
 – 2 serrated washers
 – 1 nut M8
 – 1 contact washer M8
 – 1 washer

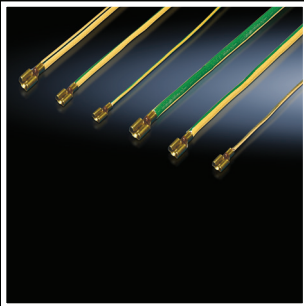

Complete grounding kit

To DIN EN 60 950/VDE 0805, Ø 4 mm², I_{max}. 40 A
 For system-compatible grounding of all enclosure parts on the enclosure frame according to VDE.
 The ground conductors are preassembled ready for connection with connectors and cut to the correct length.

Supply includes:
 – 8 grounding straps
 – Central grounding point and assembly parts

Packs of	Part No.
1 set	7829.150



ESD connection point

Dangerously high potential differences can occur during maintenance or conversion work on the enclosure. To protect sensitive electronic components, this standardized connection point (push button) provides potential equalization. The connection point is directly conductivity connected to the enclosure frame via two screws.

Material:
 Carbon steel, zinc-plated

Supply includes:
 Assembly parts

Packs of	Part No.
1	7752.950

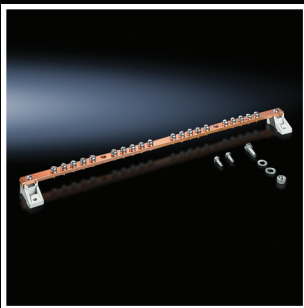

Ground rail, horizontal

Potential equalization rail, Current carrying capacity approx. 200 A.

Supply includes:
 – Rail made from E-Cu 57 to DIN 12 163, DIN EN 13 601, 15 x 5 mm
 – 20 connection points with M5 screws
 – 2 ground connections, 25 mm²
 – 2 isolators, including assembly parts

Length inches (mm)	Packs of	Part No.
18 (450)	1	7113.000

Grounding kit, preassembled

For star grounding. With the preassembled ground conductors on a potential equalization rail, star potential equalization is easily integrated into network enclosures.

Supply includes:

- Ground rail made from E-Cu 57 to DIN EN 12 163, DIN EN 13 601
- 16 grounding leads, 6 mm²
- 2 insulators
- Assembly parts

For TS enclosures up to H x W x D inches (mm)	Packs of	Part No.
79 x 32 x 32 (2000 x 800 x 800)	1 set	7829.100
87 x 32 x 39 (2200 x 800 x 1000)	1 set	7829.110

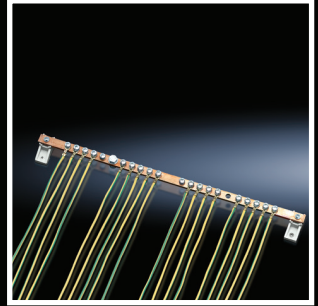

Ground rail, vertical

Easily fitted to the 25 mm DIN pitch pattern of distributors or to the 19" (482.6 mm) mounting rails. The supplied ground conductors facilitate star grounding of the cable clamp straps in the patch panels. The ground terminals are fully adjustable. Current carrying capacity of rail approx. 200 A.

Supply includes:

- Ground rail made from E-Cu 57 to DIN 12 163, DIN EN 13 601, 15 x 5 mm
- 16 conductor connection clamps, (2.5 – 16 mm²)
- 15 grounding leads, 6 mm², L = 20" (500 mm)
- Assembly parts

For enc. height inches (mm)	Length inches (mm)	Packs of	Part No.
32 (800)	24 (600)	1 set	7541.000
39 (1000)	32 (800)	1 set	7542.000
47 (1200)	39 (1000)	1 set	7543.000
55 (1400)	47 (1200)	1 set	7544.000
63 (1600)	55 (1400)	1 set	7545.000
71 (1800)	63 (1600)	1 set	7546.000
79 (2000)	71 (1800)	1 set	7547.000
87 (2200)	79 (2000)	1 set	7548.000



Extension kit for ground rail, vertical

For system-compatible expansion of the star grounding on the vertical potential equalization rail.

Supply includes:

- 15 grounding leads 6 mm², L = 20" (500 mm)
- Preassembled, with ring terminal and wire end ferrule
- Ground terminals, (2.5 – 16 mm²)
- Assembly parts

Packs of	Part No.
10	7549.000

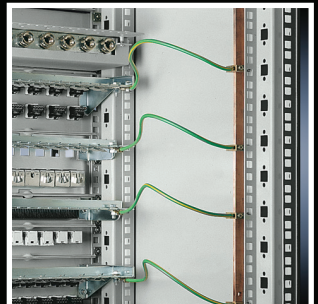

Cable management

Routing

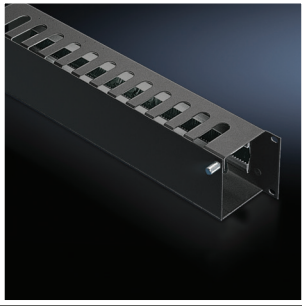

Cable management panel

The cable routing chamber has cut-outs from above, into which the patch cables can be inserted. The cable management panel is equipped with a flap and quick-release fasteners at the front, for optimum access to the cables. From the rear, the cables can be inserted via a cut-out with brush strips. With accommodation facility for cable clamp straps 7610.000 or 7611.000.

Material:
Carbon steel

U	Depth inches (mm)	Packs of	Part No.
2	3 (85)	1	5502.235

Color:
Black RAL 9005

Accessories:
Cable clamp straps, see below.

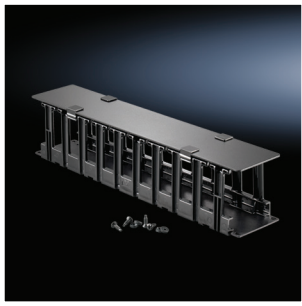

Horizontal cable management with hingeable/removable cover

Attaches to the 19" rack mount and provides cable management side to side. Available in 1 U or 2 U.

Description	Packs of	Cable Diameter (sq. in.)							Part No.
		0.15	0.17	0.19	0.21	0.23	0.25	0.27	
1 U	2	260	202	162	132	110	93	80	9969.736
2 U	2	127	98	79	64	54	45	39	9969.597

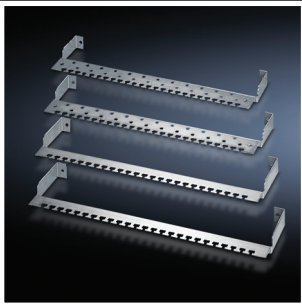

Cable clamp strap for patch panels

To provide strain relief of incoming or outgoing data cables. Optionally available with spring brackets for accommodating and contacting the cable screen. Connection to the patch panel is by means of bolts on the panel itself.

Material:
Carbon steel, 14 ga (2.0 mm), zinc-plated

Supply includes:
Assembly parts

Design	Packs of	Part No.
Without cable screen contact	1	7610.000
With spring clips for contacting the cable screen	1	7611.000



Cable tie

The super-fast solution for fastening cables to the enclosure profile or mounting system parts. Simply clip into the round hole patterns.

Length inches (mm)	Packs of	Part No.
6 (150)	100	2597.000

Nylon tape

For tidy cable routing. Supplied on a reel for

cutting to the required length.

Unlike cable ties, nylon tape

– protects the cable sheathing

– is easily reopened and

– is reusable

Length ft (mm)	Width inches (mm)	Packs of	Part No.
16 (5000)	0.6 (16)	1	2203.400



Nylon loop

With the nylon loop, secured cables are easily released, allowing individual cables to be added or removed. Ideal for sensitive data cables (fiber-optic/Cu), as it avoids indentations on the cable sheathing. In addition, the nylon loop may be screw-fastened to the round system holes or attached using a quick-release fastener.

Width inches (mm)	Length inches (mm)	Max. cable diam. inches (mm)	PU	Part No.
0.8 (20)	5 (130)	1.2 (30)	10	7072.220
0.8 (20)	0.8 (20)	2.0 (50)	10	7072.230
0.8 (20)	12 (300)	3.5 (90)	10	7072.240

Also required:

Screw 2486.500 for screw-fastening to the round hole pattern, see page 60

Color:

Black

Supply includes:

Quick-release fastener

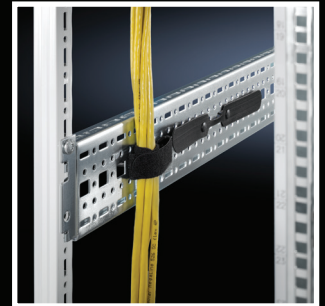

Quarter-turn cable fastener

Adjustable hook and loop fastening strap provides flexibility for bundling cables. Strap attaches to cabinet with a quarter turn base.

Strap length inches (mm)	Packs of	Part No.
17 (420)	10	9969.599



Quarter-turn nylon tape supports

- For simple, fast cable attachment
- Tool-free mounting in the system hole pattern with a quarter rotation
- Direct use on the horizontal TS section, on the support strips and mounting rails of the 19" (482.6 mm) interior installation on the cable route or on system chassis with mounting flanges
- Length of nylon tape: 16" (400 mm)

Packs of	Part No.
10	5502.155

Material:

Plastic

Supply includes:

10 supports including nylon tape



Cable management

Routing



Cable manager

Packs of	Part No.
10	5502.405

- For system-compatible cable deflection while complying with minimal bending radii and to accommodate surplus cables and excess length. The elements may optionally be used individually or in combination for cable routing. They may be combined into semi-circular or circular elements.
- Suitable for use on corners and edges to allow protected cable routing around them.
- Mounting clips for use above the arc hold the routed cables back within the elements. The elements are also bayable in an axial direction to allow U-based cable routing to the mounting rail, or channelling of the cable sections.

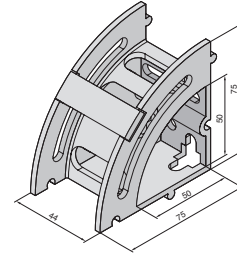

Material:

Plastic, UL 94-V0

Color:

Black RAL 9005

Supply includes:

Mounting clips and assembly parts



Cable guide ring

For flexible, system-compatible cable routing at the side of the 19" (482.6 mm) mounting frame or on 19" (482.6 mm) mounting rails.

Material:

Carbon steel, zinc-plated

Supply includes:

Mounting accessories

Dimensions inches (mm)	Packs of	Part No.
5 x 3 (125 x 85)	10	7111.900
5 x 3 (125 x 65)	10	7111.000
3 x 2 (85 x 43)	10	7112.000

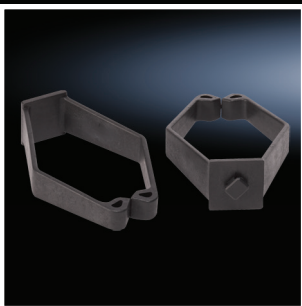

Quarter-turn cable collection

Collection claw organizes cables and can attach to the enclosure frame and EIA rails.

Width x depth inches (mm)	Packs of	Part No.
3.00 x 4.45 (76.2 x 113)	10	9969.600

Quarter-turn D-ring

D-ring organizes cables and can be used on enclosure frame and side of EIA rails.

Description	Packs of	Part No.
5.00 x 3.50" (127 x 88.9 mm)	10	9961.780
3.50 x 1.75" (88.9 x 44.5 mm)	10	9961.779
3.50 x 1.75" (88.9 x 44.5 mm)	10	9972.922



Cable management panel, 19" (482.6 mm)

For horizontal management of the patch cables, with 5 cable cable guide rings.

Material:

- Panel: Carbon steel
- Ring: Steel

Surface finish:

Ring: Zinc-plated

Color:

Black RAL 9005

U	Ring size inches (mm)	Packs of	Part No.
1	2 x 3 (43 x 55)	1	5502.205
1	4 x 2 (105 x 43)	1	7257.005
2	5 x 3 (125 x 85)	1	7257.105¹⁾

¹⁾ Extended delivery times.

Note:

The sizes given are external dimensions.



Cable routing bars

For structured routing of entire cable bundles, the cable routing bars may be secured to a variety of different positions inside the enclosure.

Material:

- Support: Carbon steel
- Cable routing bars, connection combs: Plastic

Color:

Black RAL 9005

Supply includes:

- Cable routing bars
- Connection combs

19" (482.6 mm) attachment

For horizontal cable routing within the distributor level. Thanks to their open mounting holes, they can also be retrospectively slotted onto the 19" (482.6 mm) rails at any time and secured with the existing mounting screws of the installed components.

U	No. of connection combs	Packs of	Part No.
4	2	4	7111.224
1	5	10	7111.214

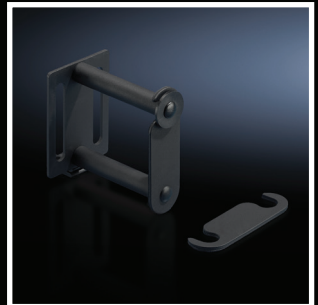

All-round attachment for universal use

For vertical and horizontal cable routing inside the enclosure or within the distributor level.

U	No. of connection combs	Packs of	Part No.
4	2	4	7111.222
1	5	10	7111.212



Cable management

Routing



Cable finger, 6 U

- For U-based cable routing
- Simple, tool-free assembly
- Cable routing possible in conjunction with air baffle plates

Material:

Plastic, UL 94-V0

Color:

Black RAL 9005

Packs of	Part No.
14	5502.115



Cable finger, for TS IT North American version

- Cable management fingers for TS IT
- Installs on rear vertical TS IT rails

Color:

Black RAL 9005

Packs of	Part No.
2 pc(s).	9972.912
2 pc(s).	9972.913



Cable duct

High packing density due to U-based cable routing

- Removable duct cover hinged on both sides
- Optional cable slack spool may be used (7827.330, see below)
- Suitable for back-to-back baying
- Simple assembly with tool-free quick-release fastening
- Alternatively suitable for screw-fastening

Material:

Carbon steel, plastic UL 94 V0

For enclosure height inches (mm)	U	Packs of	Part No.
79 (2000)	36	1	5502.100
87 (2200)	42	1	5502.101
80 (2000)	36	1	9972.927

Color:

Black RAL 9005

Supply includes:

Cover and assembly parts

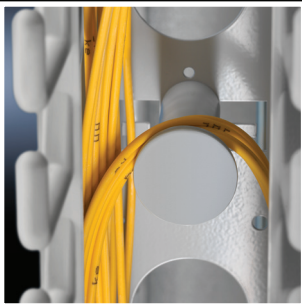

Cable slack spool

For use with cable duct (see above).

Packs of	Part No.
4	7827.330

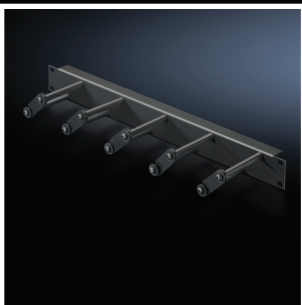

Cable management panel with cable routing bars 19" (482.6 mm)

For horizontal management of the patch cables with cable routing bars. Opening the individual cable routing bars allows user-friendly modification and extension of the cabling.

Material:

- Panel: Carbon steel, spray finished
- Cable routing bars: Plastic

Color:

- Panel: Black RAL 9005
- Cable routing bars: Black

U	Aprox. bar depth mm (inches)	No. of bars/U	Packs of	Part No.
1	3 (80)	5	1	5502.225

Cable routing channel

19" (482.6 mm)

To hold the patching cables.

Material:

Carbon steel

Color:

Black RAL 9005

U	Depth inches (mm)	Packs of	Part No.
1	3 (85)	1	5502.245

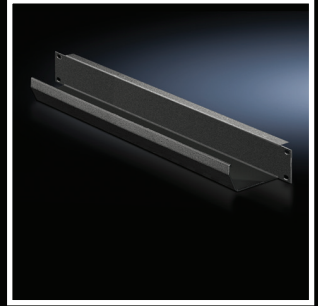

Cable entry panel

19" (482.6 mm)

Cut-out 15" x 1 U (390 x 44 mm) or 15" x 2 U (390 x 89 mm) with brush insert. With accommodation facility for cable clamp straps 7610.000 or 7611.000.

Material:

Carbon steel

Color:

Black RAL 9005

Accessories:

Cable clamp straps, see page 69.

U	Packs of	Part No.
1	1	5502.255
2	1	5502.265

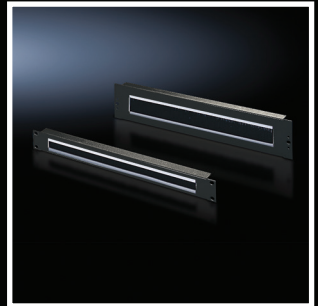

Roof system supports for cable routes

The depth-variable support system may be attached to all 32 – 47" (800 – 1200 mm) deep TS enclosures with external screw-fastening of the roof plate. The integral hole pattern, for screws or cage nuts, support the attachment of most common cable route systems. May be combined with TS IT fan mounting plate. In combination with system bar, suitable for accommodating additional cable guide rails or pipelines. For front of rack mounting.

Packs of	Color	Part No.
2	RAL 7035	7831.472
2	RAL 9005	5502.135

Material:

Carbon steel

Surface finish:

Powder-coated

Accessories:

- Metal multi-tooth screws 5.5 x 13 mm, 2486.500, see page 60.
- Cage nuts M6, 8800.340.



Cable route

For cable clamping and routing with network and server applications

- Mounting across the entire depth with 32" (800 mm) width, mounting only behind the second 19" (482.6 mm) pair of mounting rails with 24" (600 mm) width
- Tool-free, fast assembly
- Alternatively suitable for screw-fastening
- Multi-functional openings for cable management accessories

Material:

Carbon steel

Color:

Black RAL 9005

Height inches (mm)	Packs of	Part No.
79 - 87 (2000 - 2200)	1	5502.120

Accessories:

- Cable ties, nylon loops, see page 69, 70.
- Cable guide rings, see page 71.
- Cable routing bars, see page 72.



Cable management

Routing



Cable management panel

Organizes and stores cables in the 0 U space. Includes attachment points for tool-less quarter turn cable management accessories and PDU mounting locations. Attaches securely to the frame.

Color:

Black RAL 9005

Note:

Only for use in 28" - 32" (700 - 800 mm) wide cabinets.

Dimensions		Packs of	Model No.
Height inches (mm)	Width inches (mm)		
79 (2000)	8 (215)	1	9978.360
87 (2200)	8 (215)	1	9978.361

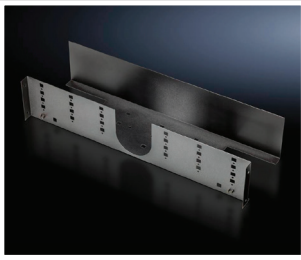

Roof-mounted Cable Management

Allows for easy cable routing outside the enclosure. Tool-free fixing to roof using 2 snap-on rings and existing cable entries on the enclosure roof. The square system punchings enables the use of cable management retaining claws and rings.

Color:

Black RAL 9005

Width inches (mm)	Packs of	Model No.
24 (600)	1 pc(s).	9970.292
28 (700)	1 pc(s).	9970.293
31 (800)	1 pc(s).	9970.294



Roof-mounted Cable Routing with Ladder Rack

Roof mount cable manager with ladder rack provision for TS IT.

Color:

Black RAL 9005

Width inches (mm)	Packs of	Model No.
24 (600)	1 pc(s).	9970.295
28 (700)	1 pc(s).	9970.296
31 (800)	1 pc(s).	9970.297



TS IT End Corner Brackets

End covers and installation brackets for roof mount cable managers.

Color:

Black RAL 9005

Packs of	Model No.
1 pair	9970.298

Roof-mounted Cable Management End Covers

End covers and installation brackets for roof mount cable managers.

Color:
Black RAL 9005

Packs of	Model No.
1	9970.260

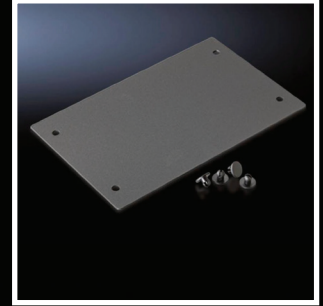

Roof End Ladder Rack Installation Brackets

Required when ladder rack is attached at the end of the roof mount cable managers.

Color:
Black RAL 9005

Packs of	Model No.
4 pack.	9970.270



Roof Ladder Rack

Facilitates cable management across the roof from on cabinet to the next.

Color:
Black RAL 9005

Width inches (mm)	Length ft. (m)	Packs of	Model No.
10 (254)	10 (3.04)	1 pc(s).	9970.271

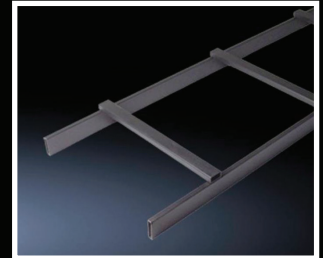

Air Flow Management

Fans

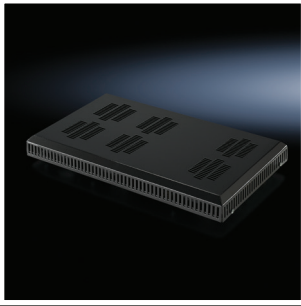

Fan mounting plate for TS IT

For active ventilation. For use in the cut-out integrated into the roof plate. The unit may optionally be extended with additional fans.

Technical specifications for one fan:

Uses 7980.000 fans, see below for further details.

Technical specifications of thermostat:

- Rated operating voltage: 250 V
- Temperature range: +41° to +131° F (+5° to +55° C)

Supply includes:

- Fan unit
- 2 fans
- 1 thermostat
- Open connection cable
- Assembly parts.

Note:

Connection via distributor box or country-specific connector.

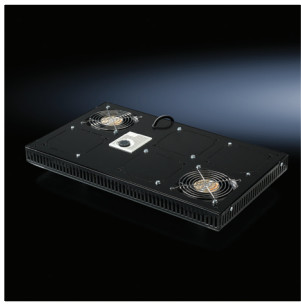

W x D inches (mm)	Number of prewired fans	Possible number of fans	Color		Part No.
			Black RAL 9005	Light Gray RAL 7035	
32x24, 24x39, 24x47 (800x600, 600x1000, 600x1050, 700x1050, 600x1200)	2	3	-	■	5502.010
			■	-	5502.015
32x32, 32x39, 32x47 (800x800, 800x1000, 800x1050, 800x1200)	2	6	-	■	5502.020
			■	-	5502.025



Roof mounted fan

Roof-mounted fan with a high protection category and flexible installation options.

Dimensions:

- HxWxD
5.24"x15.75"x15.75" (133x400x400 mm)

Required mounting cutout:

- WxD
10.2"x10.2" (258x258 mm)

Color:

- Light Gray RAL 7035

Protection category:

- NEMA 12 with filter mat

Voltage	Air Throughput w/o Filter	Air Throughput With Filter	Power Consumption	Noise Level	Part No.
220V - 240V 1~	309 cfm (525 m3/h)	263 cfm (446 m3/h)	62 W	54 dB(A)	3139.100
220V - 240V 1~	568 cfm (965 m3/h)	447 cfm (759 m3/h)	130 W	60 dB(A)	3140.100
115 V 1~	309 cfm (525 m3/h)	263 cfm (446 m3/h)	65 W	54 dB(A)	3139.110
115 V 1~	568 cfm (965 m3/h)	447 cfm (759 m3/h)	138 W	60 dB(A)	3140.110

Fan expansion kit

For retrofitting various fan units or to supplement the fan mounting panel and modular fan roof.

Technical specifications 7980.000:

- Rated operating voltage: 230 V
- Power consumption: 15/14 W at 50/60 Hz
- Air throughput (unimpeded air flow): 94/106 cfm (160/180 m³/h), 50/60 Hz
- Noise level (unimpeded air flow): 37 dB (A)
- Operating temperature range: +14° to +131° F (–10° to +55° C)

Technical specifications 7980.100, 110:

- Rated operating voltage: 230 V
- Power consumption: 14/12 W at 50/60 Hz
- Air throughput (unimpeded air flow): 64/71 cfm (108/120 m³/h), 50/60 Hz
- Noise level (unimpeded air flow): 34 dB (A)
- Operating temperature range: –4° to +158° F (–20° to +70° C)
- 7980.110 includes 6' cable with NEMA 1-15 plug

Technical specifications 7980.148:

- Rated operating voltage: 48 V (DC)
- Power consumption: 7.7 W
- Air throughput (unimpeded air flow): 108 cfm (184 m³/h)
- Noise level (unimpeded air flow): 43 dB (A)
- Operating temperature range: –4° to +158° F (–20° to +70° C)

Dimensions W x H x D inches (mm)	Packs of	Part No.
5 x 5 x 1 (119 x 119 x 25)	1	7980.110
5 x 5 x 2 (119 x 119 x 38)	1	7980.000
5 x 5 x 1 (119 x 119 x 25)	1	7980.100
5 x 5 x 2 (119 x 119 x 38)	1	7980.148

Supply includes:

- Fans
- Assembly parts
- Connection cable 24" (0.61 m)



Split rear door fan

Split rear door fans take advantage of the front to rear airflow of most servers. The design allows for positioning the fan assembly in the most critical location within the cabinet. Two high pressure fans provide the ability to exhaust hot air out the rear of the enclosure at a dramatically higher rate than traditional roof mount fan trays. The result is cooler operating equipment, even with very high enclosure heat loads.

Supply includes:

- 2 fans per assembly (210 cfm total)
- Includes 10 ft (3048 mm) cord/plug, mounting hardware
- Can be used for venting through roof by installing system bars/dual brackets (not included)

Volts	Total cfm (m ³ /hr)	Enclosure width inches (mm)	Color	Part No.
110	210 (356)	24 - 39 (600 - 1000)	Light Gray RAL 7035	9969.936
			Black RAL 9005	9969.937
208	210 (356)	24 - 39 (600 - 1000)	Light Gray RAL 7035	9969.938
			Black RAL 9005	9969.939



Air Flow Management



Air baffle plate for TS IT

- To separate the hot/cold zones within an enclosure with aisle containment or when using an LCP system
- With all-round brush strip for collision-free shielding with installed bar systems on the outer mounting rail
- For width 32" (800 mm), 6 U blanking panel additionally included

Material:

Carbon steel, plastic UL 94 V0

Surface finish:

Spray-finished

Width x height inches (mm)	Packs of	Part No.
24 x 79 (600 x 2000)	1 set	5501.805
32 x 79 (800 x 2000)	1 set	5501.815
24 x 87 (600 x 2200)	1 set	5501.825
28 x 79 (700 x 2000)	1 set	9972.925
28 x 87 (700 x 2200)	1 set	9972.926
32 x 87 (800 x 2200)	1 set	5501.835

Supply includes:

Assembly parts

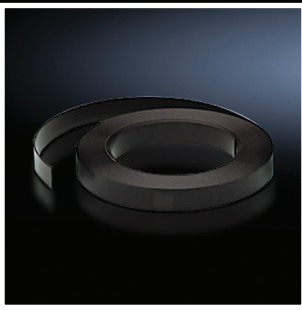

Cover, magnetic

For optionally covering the front mounting rail holes in the event of complete air blocking of the front, or in the absence of installed cable fingers.

Length ft. (mm)	Packs of	Part No.
16.4 (5000)	1	5501.895

Blanking panels

To place in unused or vacant space, to block off airflow. Installs without the need for additional hardware or tools.

U	Packs of	Item	Part No.
1	12	Black RAL 9005 tool-less (plastic)	9960.676¹⁾
1	10	Black RAL 9005 tool-less (metal)	9970.016
3	5	Black RAL 9005 tool-less (metal)	9970.017
1	2	Black RAL 9005 (metal)	7151.005
2	2	Black RAL 9005 (metal)	7152.005
3	2	Black RAL 9005 (metal)	7153.005²⁾
6	2	Black RAL 9005 (metal)	7156.005²⁾
1	3	Aluminium, natural-anodized	1931.200
2	3	Aluminium, natural-anodized	1932.200
3	3	Aluminium, natural-anodized	1933.200
4	3	Aluminium, natural-anodized	1934.200
6	3	Aluminium, natural-anodized	1936.200
9	3	Aluminium, natural-anodized	1939.200

¹⁾ UL 94-VO

²⁾ Extended delivery times

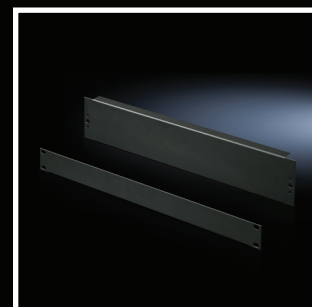

With viewing door for rack climate control

Width 600 mm

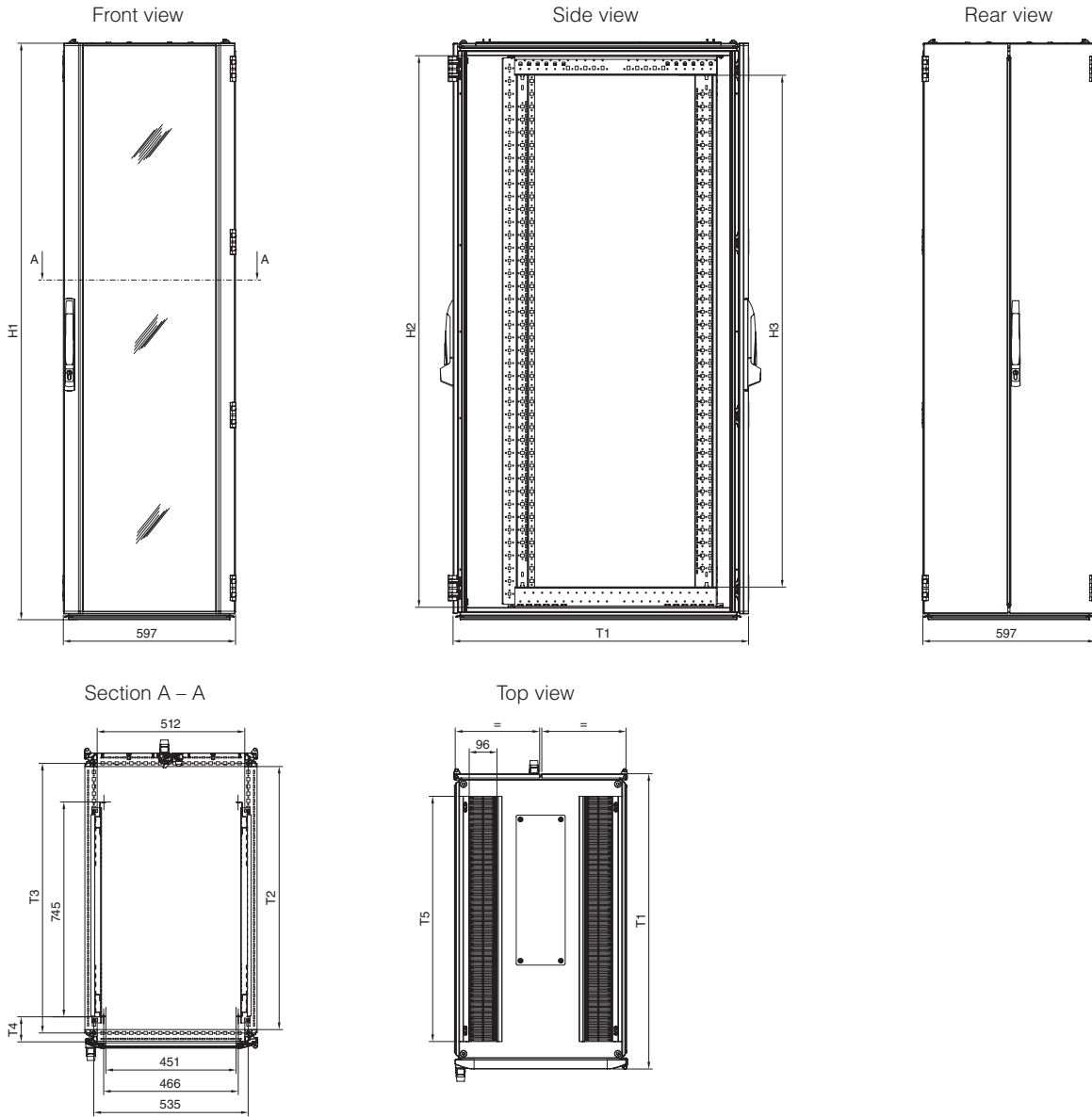

Part No.	U	Color		Height inches (mm)			Depth dimensions inches (mm)				
		Light Gray RAL7035	Black RAL9005	H1	H2	H3	T1	T2	T3	T4	T5
5508.120	42	■	–	78.68 (1998.5)	75.28 (1912)	69.84 (1774)	40.32 (1024)	35.91 (912)	36.81 (935)	3.43 (87)	33.47 (850)
5508.220	42	–	■	78.68 (1998.5)	75.28 (1912)	69.84 (1774)	40.32 (1024)	35.91 (912)	36.81 (935)	3.43 (87)	33.47 (850)
5510.120	42	■	–	78.68 (1998.5)	75.28 (1912)	69.84 (1774)	40.32 (1024)	43.78 (1112)	44.69 (1135)	5.79 (147)	41.34 (1050)
5510.220	42	–	■	78.68 (1998.5)	75.28 (1912)	69.84 (1774)	40.32 (1024)	43.78 (1112)	44.69 (1135)	5.79 (147)	41.34 (1050)

With viewing door for rack climate control

Width 800 mm

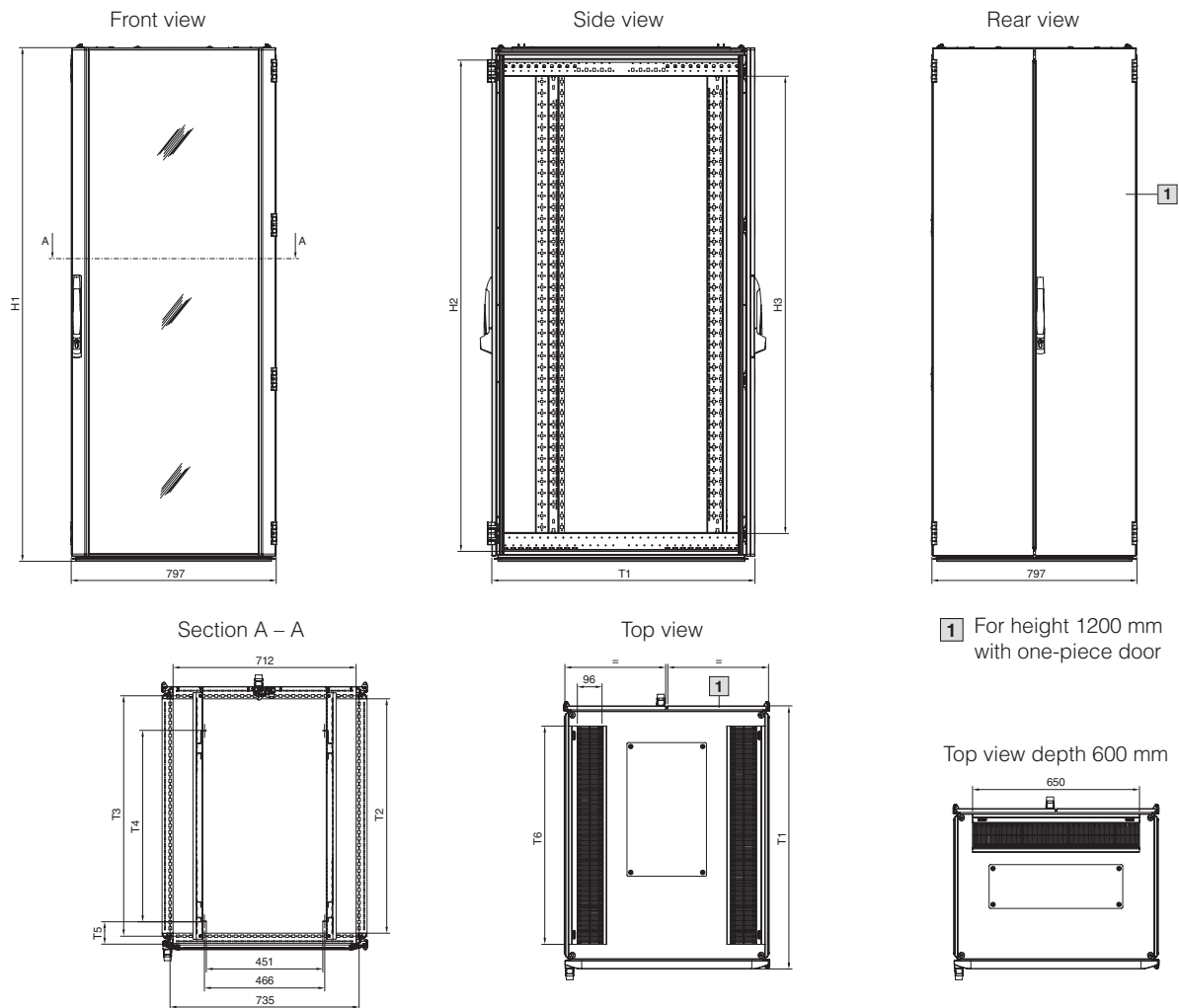

Part No.	U	Color		Height dimensions inches (mm)			Depth dimensions inches (mm)					
		Light Gray RAL7035	Black RAL9005	H1	H2	H3	T1	T2	T3	T4	T5	T6
5503.120	24	■	-	47.19 (1198.5)	43.78 (1112)	38.35 (974)	32.44 (824)	28.03 (712)	28.94 (735)	21.46 (545)	5.79 (147)	25.59 (650)
5503.220	24	-	■	47.19 (1198.5)	43.78 (1112)	38.35 (974)	32.44 (824)	28.03 (712)	28.94 (735)	21.46 (545)	5.79 (147)	25.59 (650)
5504.120	24	■	-	47.19 (1198.5)	43.78 (1112)	38.35 (974)	40.32 (1024)	35.91 (912)	36.81 (935)	29.33 (745)	3.43 (87)	33.47 (850)
5504.220	24	-	■	47.19 (1198.5)	43.78 (1112)	38.35 (974)	40.32 (1024)	35.91 (912)	36.81 (935)	29.33 (745)	3.43 (87)	33.47 (850)
5505.120	38	■	-	70.81 (1798.5)	67.40 (1712)	61.97 (1574)	32.44 (824)	28.03 (712)	28.94 (735)	21.46 (545)	5.79 (147)	25.59 (650)
5505.220	38	-	■	70.81 (1798.5)	67.40 (1712)	61.97 (1574)	32.44 (824)	28.03 (712)	28.94 (735)	21.46 (545)	5.79 (147)	25.59 (650)
5506.120	42	■	-	78.68 (1998.5)	75.28 (1912)	69.84 (1774)	24.57 (624)	20.16 (512)	21.06 (535)	17.52 (445)	3.43 (87)	25.59 (650)
5506.220	42	-	■	78.68 (1998.5)	75.28 (1912)	69.84 (1774)	24.57 (624)	20.16 (512)	21.06 (535)	17.52 (445)	3.43 (87)	25.59 (650)
5507.120	42	■	-	78.68 (1998.5)	75.28 (1912)	69.84 (1774)	32.44 (824)	28.03 (712)	28.94 (735)	21.46 (545)	5.79 (147)	25.59 (650)
5507.220	42	-	■	78.68 (1998.5)	75.28 (1912)	69.84 (1774)	32.44 (824)	28.03 (712)	28.94 (735)	21.46 (545)	5.79 (147)	25.59 (650)
5509.120	42	■	-	78.68 (1998.5)	75.28 (1912)	69.84 (1774)	40.32 (1024)	35.91 (912)	36.81 (935)	29.33 (745)	3.43 (87)	33.47 (850)
5509.220	42	-	■	78.68 (1998.5)	75.28 (1912)	69.84 (1774)	40.32 (1024)	35.91 (912)	36.81 (935)	29.33 (745)	3.43 (87)	33.47 (850)
5511.120	42	■	-	78.68 (1998.5)	75.28 (1912)	69.84 (1774)	48.19 (1224)	43.78 (1112)	44.69 (1135)	29.33 (745)	3.43 (87)	41.34 (1050)
5511.220	42	-	■	78.68 (1998.5)	75.28 (1912)	69.84 (1774)	48.19 (1224)	43.78 (1112)	44.69 (1135)	29.33 (745)	3.43 (87)	41.34 (1050)
5512.120	47	■	-	86.56 (2198.5)	83.15 (2112)	77.72 (1974)	32.44 (824)	28.03 (712)	28.94 (735)	21.46 (545)	5.79 (147)	25.59 (650)
5512.220	47	-	■	86.56 (2198.5)	83.15 (2112)	77.72 (1974)	32.44 (824)	28.03 (712)	28.94 (735)	21.46 (545)	5.79 (147)	25.59 (650)

With perforated door for rack climate control

Width 600 mm

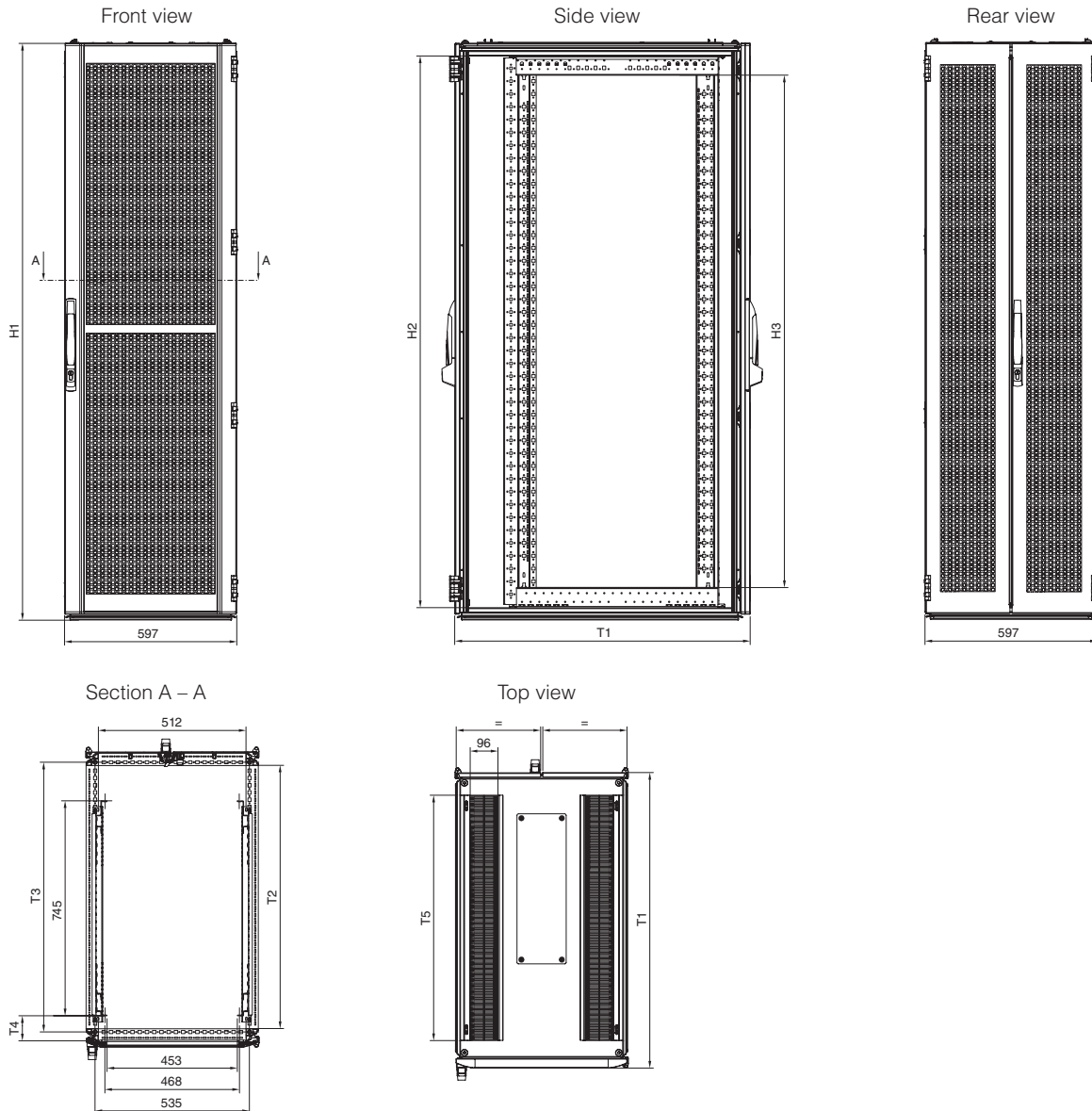

Part No.	U	Color		Height dimensions inches (mm)			Depth dimensions inches (mm)				
		Light Gray RAL7035	Black RAL9005	H1	H2	H3	T1	T2	T3	T4	T5
5508.110	42	■	–	78.68 (1998.5)	75.28 (1912)	69.84 (1774)	40.32 (1024)	35.91 (912)	36.81 (935)	3.43 (87)	33.47 (850)
5508.210	42	–	■	78.68 (1998.5)	75.28 (1912)	69.84 (1774)	40.32 (1024)	35.91 (912)	36.81 (935)	3.43 (87)	33.47 (850)
5510.110	42	■	–	78.68 (1998.5)	75.28 (1912)	69.84 (1774)	48.19 (1224)	43.78 (1112)	44.69 (1135)	5.79 (147)	41.34 (1050)
5510.210	42	–	■	78.68 (1998.5)	75.28 (1912)	69.84 (1774)	48.19 (1224)	43.78 (1112)	44.69 (1135)	5.79 (147)	41.34 (1050)
5521.210	42	–	■	78.68 (1998.5)	75.28 (1912)	69.84 (1774)	42.28 (1074)	37.87 (962)	38.77 (985)	3.58 (91)	35.43 (900)
5513.110	47	■	–	86.56 (2198.5)	83.15 (2112)	77.72 (1974)	40.32 (1024)	35.91 (912)	36.81 (935)	3.43 (87)	33.47 (850)
5513.210	47	–	■	86.56 (2198.5)	83.15 (2112)	77.72 (1974)	40.32 (1024)	35.91 (912)	36.81 (935)	3.43 (87)	33.47 (850)
5515.110	47	■	–	86.56 (2198.5)	83.15 (2112)	77.72 (1974)	48.19 (1224)	43.78 (1112)	44.69 (1135)	5.79 (147)	41.34 (1050)
5515.210	47	–	■	86.56 (2198.5)	83.15 (2112)	77.72 (1974)	48.19 (1224)	43.78 (1112)	44.69 (1135)	5.79 (147)	41.34 (1050)
5523.210	47	–	■	86.56 (2198.5)	83.15 (2112)	77.72 (1974)	42.28 (1074)	37.87 (962)	38.77 (985)	3.58 (91)	35.43 (900)

Technical details

With perforated door for rack climate control

Width 800 mm

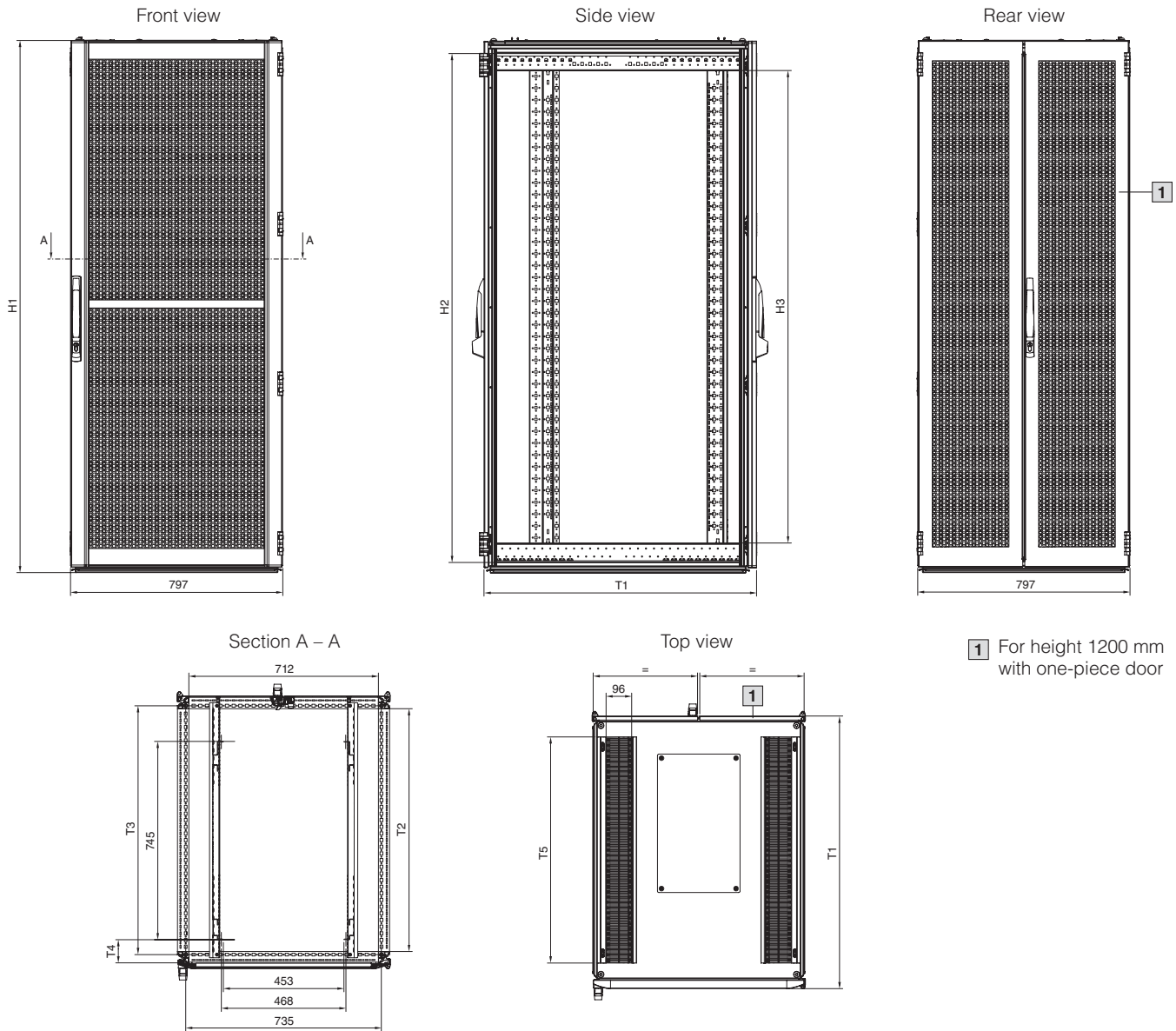

Part No.	U	Color		Height dimensions inches (mm)			Depth dimensions inches (mm)				
		Light Gray RAL 7035	Black RAL9005	H1	H2	H3	T1	T2	T3	T4	T5
5504.110	24	■	-	47.19 (1198.5)	43.78 (1112)	38.35 (974)	40.32 (1024)	35.91 (912)	36.81 (935)	3.43 (87)	33.47 (850)
5504.210	24	-	■	47.19 (1198.5)	43.78 (1112)	38.35 (974)	40.32 (1024)	35.91 (912)	36.81 (935)	3.43 (87)	33.47 (850)
5509.110	42	■	-	78.68 (1998.5)	75.28 (1912)	69.84 (1774)	40.32 (1024)	35.91 (912)	36.81 (935)	3.43 (87)	33.47 (850)
5509.210	42	-	■	78.68 (1998.5)	75.28 (1912)	69.84 (1774)	40.32 (1024)	35.91 (912)	36.81 (935)	3.43 (87)	33.47 (850)
5511.110	42	■	-	78.68 (1998.5)	75.28 (1912)	69.84 (1774)	40.32 (1024)	43.78 (1112)	44.69 (1135)	5.79 (147)	41.34 (1050)
5511.210	42	-	■	78.68 (1998.5)	75.28 (1912)	69.84 (1774)	48.19 (1224)	43.78 (1112)	44.69 (1135)	5.79 (147)	41.34 (1050)
5522.210	42	-	■	78.68 (1998.5)	75.28 (1912)	69.84 (1774)	42.28 (1074)	37.87 (962)	38.77 (985)	3.58 (91)	35.43 (900)
5514.110	47	■	-	86.56 (2198.5)	83.15 (2112)	77.72 (1974)	40.32 (1024)	35.91 (912)	36.81 (935)	3.43 (87)	33.47 (850)
5514.210	47	-	■	86.56 (2198.5)	83.15 (2112)	77.72 (1974)	40.32 (1024)	35.91 (912)	36.81 (935)	3.43 (87)	33.47 (850)
5516.110	47	■	-	86.56 (2198.5)	83.15 (2112)	77.72 (1974)	48.19 (1224)	43.78 (1112)	44.69 (1135)	5.79 (147)	41.34 (1050)
5516.210	47	-	■	86.56 (2198.5)	83.15 (2112)	77.72 (1974)	48.19 (1224)	43.78 (1112)	44.69 (1135)	5.79 (147)	41.34 (1050)
5524.210	47	-	■	86.56 (2198.5)	83.15 (2112)	77.72 (1974)	42.28 (1074)	37.87 (962)	38.77 (985)	3.58 (91)	35.43 (900)

Rittal – The System.

Faster – better – everywhere.

- Enclosures
- Power Distribution
- Climate Control
- IT Infrastructure
- Software & Services

Rittal North America LLC

Woodfield Corporate Center

425 North Martingale Road, Suite 400 • Schaumburg, Illinois 60173 • USA

Toll-free: 800-477-4000 #2 • Phone: 847-240-4630

Email: datacentersales@rittal.us • Online: www.rittal.us

Rittal Systems Ltd.

6485 Ordan Drive • Mississauga, Ontario L5T 1X2 • Canada

Toll-free: 800-399-0748 • Phone: 905-795-0777

E-Mail: marketing@rittal.ca • Online: www.rittal.ca

Rittal Mexico

Dr. Roberto Gayol 1219-1B • Col. Del Valle Sur, 03100 • Mexico, D.F.

Toll-free: 01 800 8 Rittal (748.825) • Phone: (+52) (55) 5559-5369

E-Mail: info@rittal.com.mx • Website: www.rittal.com.mx

www.rittal.us

US255 ■ 6/20

ENCLOSURES

POWER DISTRIBUTION

CLIMATE CONTROL

IT INFRASTRUCTURE

SOFTWARE & SERVICES



FRIEDHELM LOH GROUP