



# CHAIN & RIGGING ATTACHMENTS

SHACKLES

CHAIN & SYNTHETIC  
SLING COMPONENTS

RIGGING HARDWARE

CLAMPS

TRANSPORTATION  
CHAIN & ATTACHMENTS

SPECIALTY PRODUCTS



Since 1875, Columbus McKinnon Corporation has provided quality material handling products and services to meet the needs of users in a variety of industries around the globe. Professional riggers, maintenance workers, plant engineers and safety specialists rely on the CM line of chain and attachments to lift, pull and secure loads in a variety of applications. We continue to innovate and expand our rigging portfolio to meet industry needs and give customers the products they need for their unique and challenging applications.

# TABLE OF CONTENTS

<b>PRODUCT OVERVIEW</b> .....	9
<b>SLING INSPECTION, USE &amp; CARE</b> .....	23
<b>SHACKLES</b> .....	45
<b>CHAIN SLING COMPONENTS</b> .....	59
Herc-Alloy® 1000 Products, Grade 100 .....	62-73
Herc-Alloy 800® Products, Grade 80 .....	74-86
<b>SYNTHETIC SLING COMPONENTS</b> .....	87
<b>RIGGING HARDWARE</b> .....	95
Specialty Overhead Lifting Hooks & Lugs .....	97
Master Links & Sub-Assemblies .....	103
Wire Rope Compression Hardware .....	107
<b>BELOW-THE-HOOK ATTACHMENTS</b> .....	113
<b>TRANSPORT CHAIN &amp; ATTACHMENTS</b> .....	131
<b>ENTERTAINMENT RIGGING PRODUCTS</b> .....	155
<b>HOISTS, TROLLEYS &amp; BEAM CLAMPS</b> .....	159
<b>GLOSSARY</b> .....	182
<b>INDEX</b> .....	184

Look for these important icons throughout this catalog.



**In-Stock Guarantee Product**  
Contact your representative for details.



**Made in the USA**  
Products proudly made in America.



**Did You Know?**  
Industry, application and additional product details.



**Inspection, Care & Use**  
Information every rigger should know.



**Safety Warnings**  
Important information for safe and proper use.



**Videos & Safety Webinars**  
Useful Educational and Sales Presentations

Contact Columbus McKinnon Corporation

800.888.0985 716.689.5400

## FORWARD THINKING

Since 1875, when L.E. McKinnon opened a small shop to produce hardware for horse-drawn carriages, CM has pioneered many significant advances in our industry.

Our long history of innovation includes the development of the first alloy chain in 1935, which would eventually replace the industry-standard wrought iron chain used for overhead lifting. That first alloy chain was the predecessor to today's **Herc-Alloy 800®** and **Herc-Alloy® 1000** chains, hooks, and overhead rigging attachments and is now one of the most recognized brands in the rigging industry.

CM also invented the **Hammerlok®** coupling link in 1955, which enabled users of chain slings to build slings at the job site, rather than relying on a factory or service station for assembly. Today, the Hammerlok is used side-by-side with Herc-Alloy chain in all parts of the world.

Keeping innovation at the forefront of how we do business, an important recent CM milestone is our enhanced shackle identification markings. Our new forged identification markings are some of the largest and most user-friendly on the market and help to improve operator safety, reduce replacement costs, and allow for easier identification of CM products in the field. We've also developed dual-rated rigging attachments that can be used for both Grade 80 and 100 applications, helping customers reduce and better manage their rigging inventory.

Today, we continue our forward-thinking approach to our rigging business with our **In-Stock Guarantee**. The In-Stock Guarantee ensures availability of the American-made rigging products our customers rely on most. It's a new way of doing business that our competitors cannot offer and part of our commitment to providing best-in-class service to our end-users.



L.E. McKinnon





**MCKINNON COLUMBUS CHAIN, LIMITED**

**Instructions and Definitions Governing the Purchase and Use of Chains**

**FACTORS:** The above named "good steel" "standard" chain is made of "best quality" steel and is manufactured in accordance with the specifications of the American Society of Mechanical Engineers. It is not to be used for any purpose other than that for which it is designed. It is not to be used for any purpose other than that for which it is designed. It is not to be used for any purpose other than that for which it is designed.

**DEFINITIONS:** The following definitions apply to the above named chain: "Good steel" means steel of the highest quality, as specified in the specifications of the American Society of Mechanical Engineers. "Standard" means the standard of the American Society of Mechanical Engineers. "Best quality" means the best quality of steel available.

**VERIFIED LIFTING USE:** This chain is suitable for use in lifting and lowering loads. It is not to be used for any other purpose.

**VERIFIED LIFTING USE:** This chain is suitable for use in lifting and lowering loads. It is not to be used for any other purpose.

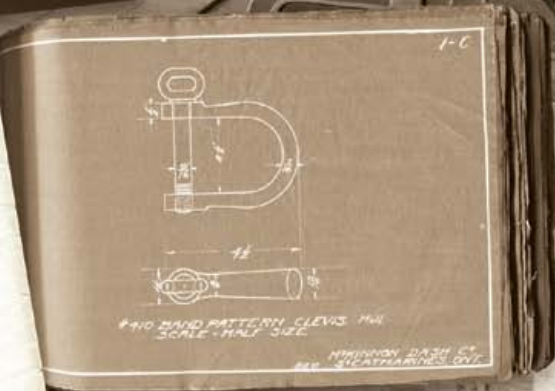

2196686

69980

**UNITED STATES OF AMERICA**

**IN TESTIMONY WHEREOF, I have hereunto set my hand and caused the seal of the Patent Office to be affixed at the City of Washington this ninth day of April, in the year of our Lord one thousand nine hundred and forty, and of the Independence of the United States of America the one hundred and sixty-fourth.**

*W. S. Miller*  
Law Examiner.

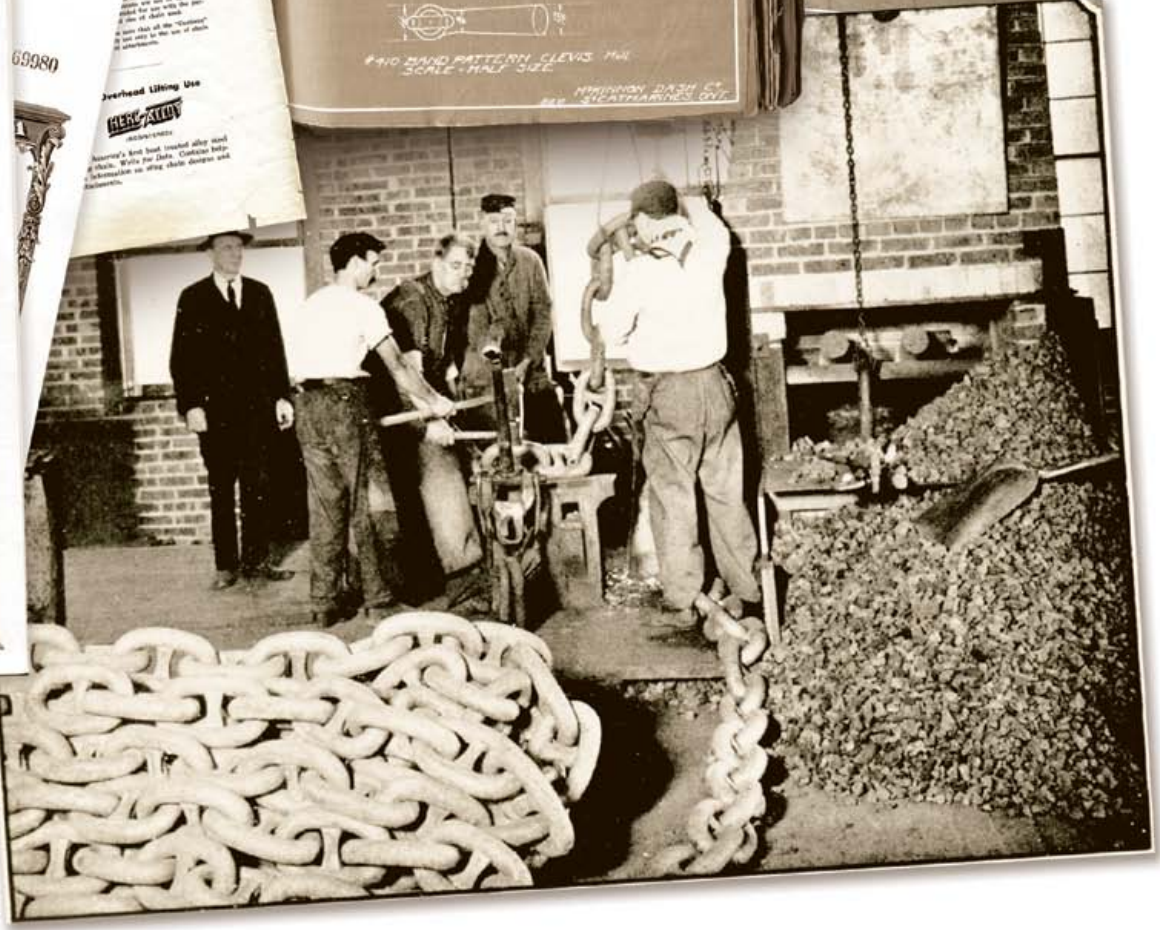

## BUY WITH CONFIDENCE

### CM is Proud to be Compliant with the “Buy American Act”

We know that American-made products are important to our customers. That’s why CM manufactures the majority of its chain and rigging attachments at our two Tennessee facilities. We also manufacture many of our hoists here in America as well.

Dating back to 1933, the Buy American Act requires end products for supplies or construction material to be manufactured domestically. For a product to comply with this Act, it is required that more than half the cost of its components is derived from U.S.-made components.

CM is proud to comply with the Buy American Act and is happy to supply a Certificate of Compliance upon request.



## SERVICING CUSTOMERS AROUND THE GLOBE

In today’s global economy, Columbus McKinnon is ready to meet the needs of customers anywhere in the world.

We rely on our world-class global manufacturing facilities to produce best-in-class material handling products as well as perform product testing that exceeds standards outlined by industry regulations. To quickly and efficiently meet customer demands, we have also strategically positioned our warehouses to ensure our products are available to the customer when they need them.

Our material handling knowledge and expertise surpasses the competition. Our dedicated team of engineers, trainers and sales representatives continually work with customers to solve tough application problems and better understand their needs to fuel future product development.

## IN-STOCK GUARANTEE

Columbus McKinnon’s In-Stock Guarantee is a company-wide commitment to ship its most popular hoists, chain and forged attachment products in days, not weeks – so customers can get the products they need, when they need them.

The In-Stock Guarantee is designed to provide our Channel Partners and Distributors with best-in-class service and delivery of the material handling products they use every day. It also ensures product availability and reduces their on-hand product inventory.

Our In-Stock Guarantee includes hundreds of products guaranteed to ship in three days or less. We’ll continue to expand the offering to include more and more of the products our customers use most.



**WATCH OUR ISG VIDEO**  
SCAN THE QR CODE  
WITH YOUR SMARTPHONE



# QUALITY MATTERS.

Rely on our Authorized Rigging Centers to build, service and repair your CM® rigging products.

Our CM® Authorized Rigging Centers are held to the highest levels of quality and safety and are part of an exclusive network of rigging product and service experts certified by Columbus McKinnon to:

- build and repair welded and mechanical chain slings
- service rigging products and manual hoists from CM, Coffing and all other Columbus McKinnon brands
- perform authorized Columbus McKinnon warranty work

These centers are classified two different ways:

**WELD & SERVICE CENTERS** have the capability to build and service welded and mechanical slings.

**SERVICE CENTERS** have the capability to build and service mechanical slings.

**FOR A LIST OF THE LOCATIONS, VISIT:**

<https://www.cmworks.com/riggingsc/RiggSvcCtrResults.aspx>

AUTHORIZED  
**RIGGING**  
WELD & SERVICE CENTER

AUTHORIZED  
**RIGGING**  
SERVICE CENTER









# PRODUCT OVERVIEW

Our broad product offering is complemented by an unmatched wealth of knowledge and expertise that far surpasses our competition. This includes:





- A thoroughly trained and knowledgeable technical sales force that provides expertise on applications, regulations, training requirements and product features and benefits.
- A global network of authorized distributors that provide inventory, technical support, service after the sale, and consultation regarding specific needs.
- Knowledgeable customer service representatives to help customers with shipment information, product selection, specifications and auxiliary items.
- An engineering team constantly working to improve existing products, while developing unique and innovative new products.
- Training programs dedicated specifically to rigging products, as well as broad-based programs to cover all aspects of lifting and positioning.
- The unique ability to not only manufacture high-quality rigging products, but also lead the industry in the design and manufacture of hoists, overhead cranes, and related motion control products.

# CHAIN OVERVIEW

Our chain manufacturing roots date back to the late 1800s and the Columbus Chain Company. We hold patents in chain and chain link design as well as patents in chain manufacturing processes, which help ensure our chain is the strongest and most reliable on the market today. We also invented the first alloy chain in 1933 – the forerunner to our industry-changing Herc-Alloy 800® and 1000 chains.

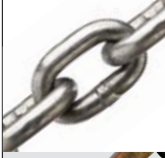
Today, Columbus McKinnon is an industry-leading chain manufacturer. Relying on more than a century of chain-making expertise and innovation, we manufacture a wide selection of graded chain in Tennessee, for use in a variety of industries. We have always been an innovator in chain and rigging products, and we continually work to improve our processes and materials to ensure we manufacture the best chain in the industry year after year.

## GRADED CHAIN AT A GLANCE

	ASTM & NACM Grade	CM Chain Embossment	ASTM Specification	Name	Typical Uses
	<b>GRADE 30</b>	G30	A413	Proof Coil	General-purpose, low-carbon chain for industrial and agricultural applications including guard rails, logging and load securement. <b>Not to be used for overhead lifting.</b>
	<b>GRADE 43</b>	G43	A413	High Test	Grade 43 chain is manufactured to meet ASTM & NACM specifications. Typical uses include container securement, logging, towing and marine industry applications. Grade 43 is available in many finishes. <b>Not to be used for overhead lifting.</b>
	<b>GRADE 70</b>	G70	A413	Transport	A higher-strength, heat-treated carbon steel chain typically used by truckers, loggers and highway crews for load securement, towing, lashing and as trawler chain. Load ratings of Grade 70 chain are approximately 20% higher than Grade 43. <b>Not to be used for overhead lifting.</b>
	<b>GRADE 80</b>	HA800	A391	Alloy	A higher-strength, heat-treated alloy steel chain primarily used as a sling component for overhead lifting, but can also be used in rigging and tie-down applications where a lighter weight, higher strength chain is desirable. <b>Meets NACM, ASME, and OSHA standards for overhead lifting.</b>
	<b>GRADE 100</b>	HA1000	A973	Alloy	With approximately 25% higher strength than Grade 80, Grade 100 chain is used primarily as a sling component for overhead lifting. Grade 100 chain can be used for all of the same applications as Grades 30 through 80. <b>Meets NACM, ASME, and OSHA standards for overhead lifting.</b>

**DIMENSIONS, WEIGHTS & WLL**

Chain Size (in.)	Wire Diameter Nominal (in.)	Inside Length Nominal (in.)	Inside Width Nominal (in.)	Weight Per 100 ft (lbs.)	Working Load Limit (lbs.)
<b>GRADE 30 (PROOF COIL)</b>					
3/16	0.22	0.97	0.45	39.8	800
1/4	0.28	1.22	0.51	64.6	1,300
5/16	0.33	1.27	0.60	97.6	1,900
3/8	0.39	1.35	0.58	140.2	2,650
1/2	0.50	1.73	0.81	227.0	4,500
5/8	0.63	1.92	0.86	363.0	6,900
3/4	0.78	2.40	1.07	568.0	10,600
<b>GRADE 43 (HIGH TEST)</b>					
1/4	0.28	1.22	0.51	64.6	2,600
5/16	0.34	1.25	0.54	104.0	3,900
3/8	0.39	1.35	0.58	140.3	5,400
1/2	0.50	1.73	0.81	227.0	9,200
5/8	0.63	1.92	0.86	363.0	13,000
3/4	0.78	2.40	1.07	568.0	20,200
<b>GRADE 70 (TRANSPORT)</b>					
1/4	0.39	0.84	0.47	76.4	3,150
5/16	0.33	0.98	0.46	100.5	4,700
5/16*	0.33	1.10	0.50	96.9	4,700
3/8	0.39	1.14	0.54	145.5	6,600
3/8*	0.39	1.38	0.60	136.5	6,600
1/2	0.53	1.56	0.73	267.0	11,300
<b>HERC-ALLOY 800® (GRADE 80)</b>					
7/32	0.22	0.68	0.31	44.3	2,100
9/32	0.28	0.88	0.40	72.9	3,500
5/16	0.33	1.02	0.46	90.9	4,500
3/8	0.39	1.25	0.57	144.0	7,100
1/2	0.51	1.44	0.73	255.0	12,000
5/8	0.63	1.78	0.86	382.3	18,100
3/4	0.79	2.23	1.07	595.0	28,300
7/8	0.88	2.25	1.14	776.0	34,200
1	1.00	3.07	1.49	941.0	47,700
1-1/4	1.25	3.92	1.74	1,420.0	72,300
<b>HERC-ALLOY® 1000 (GRADE 100)</b>					
7/32	0.22	0.68	0.31	44.3	2,700
9/32	0.28	0.88	0.40	72.9	4,300
3/8	0.39	1.25	0.57	144.0	8,800
1/2	0.52	1.56	0.73	251.0	15,000
5/8	0.63	1.92	0.86	370.0	22,600
3/4	0.79	2.40	1.07	577.0	35,300

\* Standard Link Grade 70 Chain

**GRADE 30**

**GRADE 43**

**GRADE 70**

**GRADE 80**

**GRADE 100**

# CHAIN SLINGS OVERVIEW

Chain slings are a combination of chain, hooks, rings or other attachments used primarily for overhead lifting applications. Slings are generally used in conjunction with a crane or some type of lifting device and allow riggers to create a custom configuration to lift a load depending on the needs of the unique application.

## CHAIN SLING CONFIGURATIONS

Standard sling configurations consist of chain branches that are affixed on one end to a master link or ring with some type of attachment, typically a hook, attached to the opposite end. CM manufactures the chain and attachments needed to build a sling. The following symbols are used to describe a sling.

### FIRST SYMBOL (BASIC TYPE):

- S** : Single chain sling
- C** : Single choker chain sling with a standard end link on each end, no hooks.
- D** : Double branch chain sling (2 legs)
- T** : Triple branch chain sling (3 legs)
- Q** : Quadruple branch chain sling (4 legs)

### SECOND SYMBOL (TYPE OF MASTER OR END LINK):

- O** : Oblong master link of standard dimensions
- P** : Pear shaped master link (available on request)
- R** : Ring

### THIRD SYMBOL (TYPE OF HOOK):

- S** : Sling Hook
- G** : Grab Hook
- F** : Foundry Hook
- L** : Latchlok

A hook safety latch is not required by OSHA. However, if a latch is present it must be in working condition.

If attachments are other than standard, give detailed specifications.

Sling tags are stamped 1 to 4 to reflect number of branches. Additional coding is defined as follows:

- |                                     |                                     |
|-------------------------------------|-------------------------------------|
| <b>AS</b> : Adjustable Single       | <b>SB</b> : Single Basket           |
| <b>ES</b> : Endless Single          | <b>ED</b> : Endless Double          |
| <b>SAL</b> : Single Adjustable Loop | <b>DAL</b> : Double Adjustable Loop |
| <b>AD</b> : Adjustable Double       | <b>DB</b> : Double Basket           |

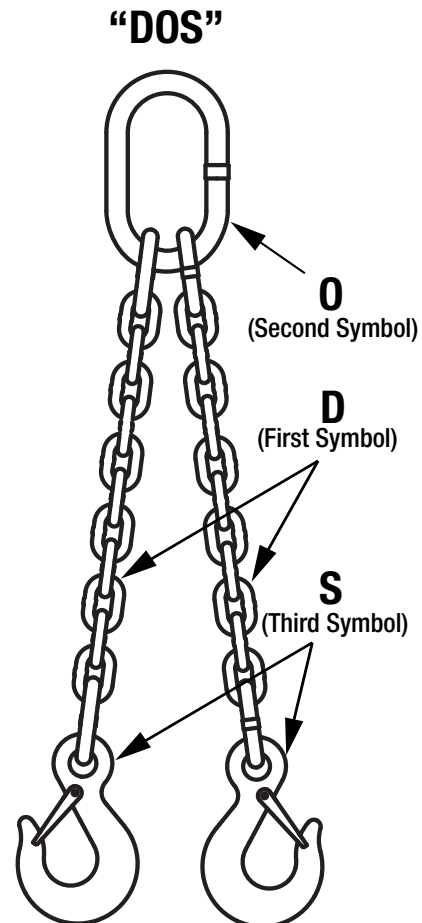

# STANDARD TYPES OF CHAIN SLINGS

## SINGLE CHAIN SLINGS : TYPE S & C

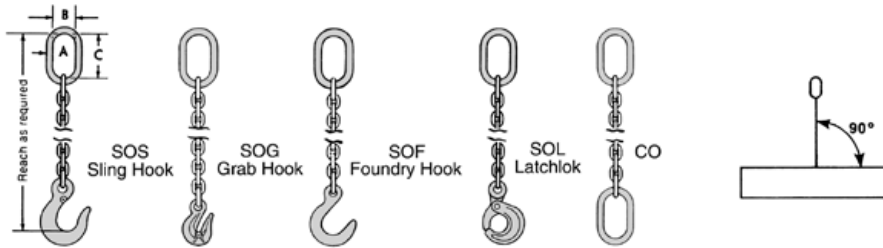

## DOUBLE CHAIN SLINGS : TYPE D

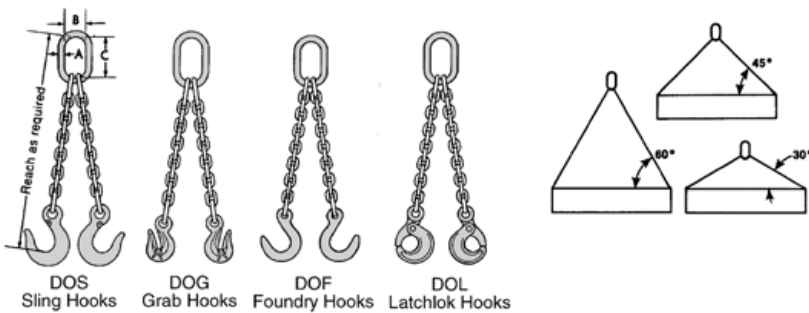

## TRIPLE CHAIN SLINGS : TYPE T

## QUADRUPLE CHAIN SLINGS : TYPE Q

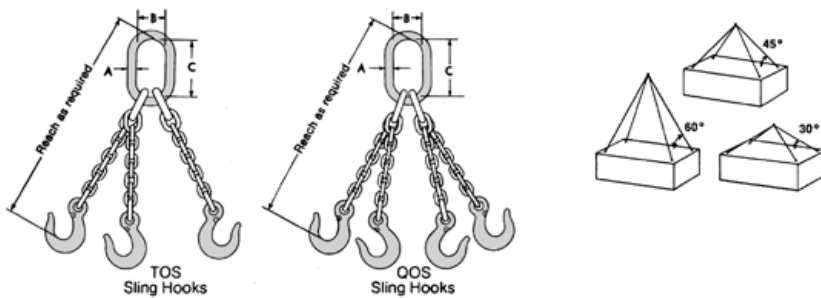

### SAFETY NOTE

A quad branch chain sling, especially when used on a load of rigid structure, is usually not sustaining the load evenly on each of its four branches. The maximum working load limits are therefore set at the same values as triple branch chain slings of equal quality and size with branches used at same angle of inclination.

# HOOKS OVERVIEW

Whether you're lifting, pulling, towing or securing loads, the Columbus McKinnon line of hooks has you covered. Our history in rigging-type products dates back more than 100 years, and we rely on this long-standing knowledge and expertise to develop durable and reliable hooks that can stand up to even the toughest overhead lifting and binding applications.

Available in numerous grades and materials, we have a variety of hook styles for both overhead and non-overhead lifting applications. Learn more about all of our available hook styles below.

## OVERHEAD LIFTING HOOKS

Not all hooks are appropriate for overhead lifting. When choosing an overhead lifting hook, it's important to consider the application you will be using it for. If you are lifting a plate, you may need one type of hook, while lifting a vehicle engine may require another. **Only Grade 80 and Grade 100 alloy hooks should be used in overhead lifting applications.** CM dual rates many Grade 80 and Grade 100 hooks to minimize inventory requirements for our distributors and create more versatility for riggers. Below are various types of hooks CM recommends for overhead lifting applications.

### CLEVLOK® HOOKS

CM trademarked Clevlok® Herc-Alloy® Hooks are typically used for overhead lifting applications. This line of hooks offers easy installation in the shop or in the field. These hooks are 100% proof tested at the factory, thus requiring no additional testing once installed.



Grab Hooks with and without Cradle

Sling Hooks

Foundry Hooks

Latchlok Hooks

### EYE HOOKS

CM Herc-Alloy® Eye Hooks are an excellent choice for welded assemblies. For some applications, they also may be used with mechanical couplers such as the CM Hammerlok®. These hooks are designed for overhead lifting and can be used in place of Clevlok® hooks if preferred. Overhead lifting eye hooks are 100% proof tested at the factory, thus requiring no additional testing once installed using the CM Hammerlok.



Grab Hooks with Cradle

Sling Hooks

Foundry Hooks

Latchlok Hooks

Rigging Hooks

### "S" HOOKS

CM Herc-Alloy® "S" Hooks are built and designed for special lifting applications. CM "S" hooks are 100% proof tested at the factory and can be used for various applications where a wide throat opening is desired.



### PLATE HOOKS

CM Herc-Alloy® Plate Hooks are designed for lifting plate material, like steel, in vertical and horizontal orientations. Plate hooks should be used in pairs and careful attention should be paid to sling angles when determining the working load limit.



### SORTING HOOKS

CM Sorting Hooks are designed to lift and move material with long narrow throat openings. Sorting hooks are 100% proof tested and are available with and without handles.



### HOOKS FOR USE WITH SYNTHETICS

CM manufactures a line of hooks designed specifically for use with synthetic slings.



Quick Connect™ Hooks

Flat Eye Rigging Hooks

## NON-OVERHEAD LIFTING HOOKS

Non-overhead lifting hooks are designed for pulling or load securement application. These hooks do not have the same requirements as those used for overhead lifting. Non-overhead lifting hooks are available in Grades 30, 43, and 70. Grade 80 hooks that are not suitable for overhead lifting are marked T-80 and should only be used for load securement.

### CLEVIS HOOKS (NON-CRADLE GRAB & SLIP HOOKS)

Clevis Hooks are not designed for overhead lifting, but instead are most often used for load securement with tie-down chains. Clevis hooks are easy to install in the field and can be used in combination with various grades of chain including Grade 30, 43, 70 and 80. These feature a U-shaped attachment point with a pin to secure chain or other rigging attachments. Different grades of clevis hooks have different working load limits, therefore you must ensure you use the correct hook grade and size for your application.



Grab Hooks    Slip Hooks

### EYE HOOKS (NON-CRADLE GRAB & SLIP HOOKS)

Standard Eye Hooks are not designed for overhead lifting, but instead are most often used for load securement with tie-down chains. Eye hooks are used in combination with various grades of chain including Grade 30, 43, 70 and 80. Eye hooks feature a simple circular attachment point for rigging chain or other attachments. Different grades of eye hooks have different working load limits, therefore you must ensure you use the correct hook grade and size for your application.



Grab Hooks    Slip Hooks

## ▶ HOOK INSPECTION & USE

### INSPECTION:

- ▲ Discard hooks that are worn more than 10% of the original dimension or are worn beyond a specific dimension or tolerance as provided in a wear allowance table, chart or diagram.
- ▲ Discard hooks that have an increase in throat or slot opening more than 5% of the original opening (not to exceed 1/4 inch).
- ▲ Discard hooks with any visibly apparent bend or twist from the plane of the unbent hook.
- ▲ Replace load pins that are permanently distorted.
- ▲ Hooks should not be subjected to bending, exposed to sharp objects or tip loaded.
- ▲ Replacement load pins shall be obtained from the manufacturer of the hook.

### USE:

- ▲ Care should be exercised during use, so the hook is not abused or damaged.
- ▲ Hooks attached to chain should be selected to match the size and working load limit of the chain.
- ▲ Do not exceed the working load limit or shock load the chain or attachments. Loads applied rapidly or dropped freely can result in serious overloading of the hook.
- ▲ Use proper size chain in the throat of the grab hook.
- ▲ Hooks should not be subjected to bending, exposed to sharp objects, tip loaded (unless specified by the manufacturer) or loaded in a manner inconsistent with its design.
- ▲ Avoid exposure to corrosive mediums or high temperatures that could affect the thermal treatment and strength of the hook.
- ▲ Hooks can be used from -40 degrees F to 400 degrees F without reduction of working load limit. Call the manufacturer if you exceed these temperatures.

Refer to American Society of Mechanical Engineers ASME B30.10 for a discussion of hooks, inspection procedures and operating practices.

### HOOK LATCHES



CORRECT    INCORRECT

Hook latches (when required) must be in good working condition. If not, the hook should be removed from service.

### NEVER TIP LOAD A HOOK!

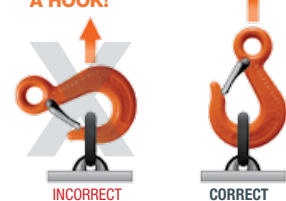

INCORRECT

CORRECT

### 90° MAX INCLUDED ANGLE FOR HOOKS

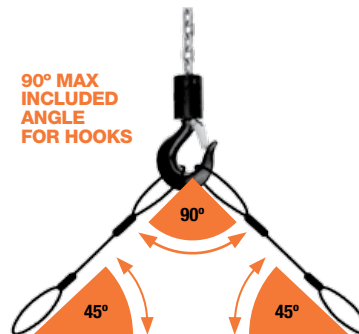

### SELECTING THE RIGHT SIZE HOOK/SLING

Be sure the component is of adequate size and shape so that it can be properly seated in the saddle of hook or lifting device.

### LOW HORIZONTAL ANGLES

Use a shackle or oblong master link when working with low horizontal angles. Both can be used with included angles up to 120°.

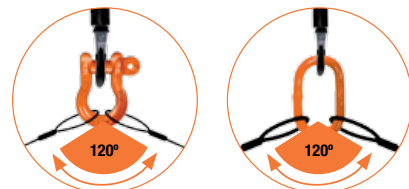

Always verify manufacturer's information prior to use.



# RINGS & LINKS OVERVIEW

While alloy steel rings and links may be used individually for lifting and rigging applications, they are used most frequently as components of a sling. Rings and links are sized for use with Grade 80 or Grade 100 chain and enable the user to construct a balanced sling system for lifting and rigging. We offer a variety of rings and links suitable for overhead and non-overhead lifting applications, explained in detail below.

## FOR OVERHEAD LIFTING

### MASTER RINGS

Master Rings are an important part of most rigging applications and can be used universally because of their round configuration.



### OBLONG MASTER LINKS

Featuring an optimum design for sling construction, Oblong Master Links have a greater capacity when compared with master rings of the same size because of their smaller width. Oblong master links' oval shape is also ideal for use with crane hooks, since the depth of a crane hook is normally greater than the width.



### PEAR-SHAPED MASTER LINKS

These links may be used for the same applications as oblong master links, but their design is not optimum for multiple branch slings and, in some cases, may interfere with the crane hook.



### OBLONG MASTER LINK SUB-ASSEMBLIES

Designed primarily for constructing slings with multiple branches, Oblong Master Link Sub-Assemblies allow you to construct a sling using mechanical couplers between the welded master couplers and the chain branches.



### GRAB LINKS

Grab Links can be used to create a variable length loop-type sling. The grab link design captures a link of the chain in the link slot – similar to that of a grab hook. Grab links have a narrow neck, which restricts their use.



### HAMMERLOK® COUPLING LINKS

Constructed of drop forged alloy steel and used primarily in the construction of overhead lifting slings. Specifically used for connecting the chain branches to the master link and to the hook attachments. Dual-rated Hammerloks® meet the strength levels of Grade 80 and 100. Must be matched to the chain size. Not to be used for repair or splicing of the chain.



### OMEGALOKS

CM Omegaloks offer an alternative to the CM Hammerlok® as a mechanical coupler. The load and retain pin design is similar to the trademarked Clevlok® connectors. Dual-rated Omegaloks are designed to be used in conjunction with ML Series Master Links and are 100% proof tested. They can also be field installed.



### WEBLOK™ ASSEMBLIES

When working with synthetic slings, CM Weblok assemblies allow for quick, easy and safe sling attachment. CM Webloks are available in two designs. Synthetic-to-attachment Webloks combine our industry-leading CM Hammerlok® coupling link with a CM synthetic sling attachment. Synthetic-to-synthetic Webloks feature two synthetic sling attachments. CM Webloks are available with either single or double load pin retention, depending on your application.



Synthetic to attachment with double retention



Synthetic to synthetic with single retention

## FOR NON-OVERHEAD LIFTING

### MID-LINKS

Mid-Links are typically used for quick repair, both temporary and permanent, of chain or for attaching chain hooks, rings and swivels to chain. They should not be used for overhead lifting. Can be used for cargo securement.







**A Columbus McKinnon Original.** ▶  
 First introduced by Columbus McKinnon in 1955, the CM Hammerlok® coupling link made it possible for riggers to build chain slings at the job site.



## ▶ LINK INSPECTION & USE

### INSPECTION:

Care should be exercised so that the ring and link(s) are not abused in any way during use.

- ▲ Links should not be subjected to bending or exposed to sharp corners or objects.
- ▲ Avoid exposure to corrosive mediums or high temperatures.

Visually inspect all rings and links before each use for the following conditions:

- ▲ Twists or bends
- ▲ Nicks or gouges
- ▲ Excessive wear at bearing points (innerlink area)
- ▲ Elongation (link elongation)
- ▲ Corrosion or other obvious damage

Since any of these conditions can affect the strength of the attachments shown above, a qualified person should conduct the inspection and determine whether replacement is necessary.

## ⚠ WARNING

Improper use or care of rings and links can result in bodily injury or property damage. To avoid injury:

- ▲ Always inspect before use for wear, damage, and elongation.
- ▲ Do not use if excessively worn or damaged.
- ▲ Never exceed the working load limit.
- ▲ Ensure the proper size link is used, and the working load limit of the ring or link is equal to or greater than the working load limit of the chain.
- ▲ Do not impact or shock load. Apply load slowly.
- ▲ Do not use on oversize crane hooks where link does not fit in saddle of the hook.
- ▲ Protect from corrosion.
- ▲ Use only alloy chain and attachments for overhead lifting.
- ▲ Do not use Hammerlok® coupling links or any of the couplers shown above to repair alloy chain for overhead lifting.

# SHACKLES OVERVIEW

When it comes to shackles, Columbus McKinnon prides itself on providing the strongest and most reliable products on the market. We carry a full line of anchor and chain shackles, manufactured in the U.S.A. through our state-of-the-art forging process.

CM shackles are available in three materials, including carbon, super strong and alloy. Our innovative Super Strong Shackles are unique in the industry, featuring strength ratings up to 50 percent stronger than comparable sized carbon shackles and a 6:1 design factor for ultimate safety.

CM shackles are available in a three styles: **Screw Pin; Bolt, Nut & Cotter; and Round Pin.** Learn more about the uses and benefits of each shackle style below.

## BOLT, NUT & COTTER SHACKLES

Of all shackle types, Bolt, Nut and Cotter Shackles provide the most secure pin arrangement, resisting axial and torsional loading. This type of shackle should be used in semi-permanent applications where the pin is removed infrequently or where cyclical loading occurs. This is the preferred type of shackle in areas that are difficult to reach or inspect. Recommended for overhead lifting, bolt, nut and cotter shackles are available in capacities up to 120 tons.



## SCREW PIN SHACKLES

Screw Pin Shackles allow for quick and easy removal of the screw pin, which makes this style ideal for applications where the shackle is removed frequently. While the threaded pin can resist axial forces, it should not be cyclically loaded and is unreliable and vulnerable to backing out in applications where the pin is subjected to a torque or twisting action. Recommended for overhead lifting, screw pin shackles are available in capacities up to 43 tons. Screw pins should be moused in some applications.



## ROUND PIN SHACKLES

Round Pin Shackles allow for easy removal by simply removing the cotter that holds the pin in place. These shackles perform well where the pin is subjected to a torque or twisting action, but they should not be subjected to an axial load. Round pin shackles are available in capacities up to 43 tons and are **not recommended for overhead lifting.**



## 3 TYPES OF SHACKLE MATERIAL

MATERIAL	STYLE	WLL (TONS)	SIZES (IN.)	STYLES	DESIGN FACTOR	FINISHES
CARBON	Anchor	1/3 to 85 ton	3/16" to 3"	Bolt, Nut & Cotter; Screw Pin; Round Pin	6:1*	Orange Powder Coated, Galvanized
	Chain	1/2 to 35 ton	1/4" to 2"			
SUPER STRONG 17 to 50% stronger than comparable-sized Carbon	Anchor	1/2 to 55 ton	3/16" to 2-1/2"	Bolt, Nut & Cotter; Screw Pin; Round Pin	6:1**	Orange Powder Coated, Self Colored, Galvanized
	Chain	3/4 to 35 ton	1/4" to 2"			
ALLOY (U.S.) ~50% stronger than comparable-sized Carbon and ~25% stronger than Super Strong	Anchor	2 to 120 ton	3/8" to 3"	Bolt, Nut & Cotter; Screw Pin; Round Pin	5:1	Orange Powder Coated, Self Colored, Galvanized

\* 2-1/2" and 3" carbon shackles have a 5:1 design factor.

\*\* Round pin and all 2-1/2" Super Strong shackles have a 5:1 design factor.

# WIRE ROPE ATTACHMENTS OVERVIEW

Wire rope is frequently used to make slings for rigging applications. The CM portfolio of wire rope attachments, including wire rope and bundling clips, are used to secure loops or turn back in wire rope. Learn more about our specific wire rope attachment products and their uses below.

## WIRE ROPE CLIPS

Wire Rope Clips are used to secure the end of wire rope when forming a loop; i.e., for wire rope turn-back. Clips are available in two configurations: mid-grip (double saddle) and single saddle. Each configuration is equally strong and effective, but care must be exercised for proper installation of single saddle clips; i.e., saddle must rest against live end of wire rope. All clips should be used in conjunction with a wire rope thimble and may require re-torquing after the initial install.



NOTE: Wire rope clips are not recommended for fabricating slings for overhead lifting. Reference ASME B30.9 for special applications.

## MID-GRIP WIRE ROPE CLIPS

The CM Mid-Grip is designed for applications in the scaffolding industry. The redesigned mid-grip features a hexagon bolt head that fits securely into a forged, hex-shaped socket that prevents spinning even after repeated use and re-torquing. It has precise threading on the nut and bolt to ensure tight alignment. This design also allows for full arc wrench swing, making installation and retightening quick and easy. The mid-grip meets FF-C-450 performance requirements and comes with a smooth, mechanical galvanized finish for protection in harsh environments.



## BUNDLING CLIPS

The CM Bundling Clip is built for harsh environments and demanding applications of the oil and gas industry. They are user-friendly with an easy-to-assemble, U-shaped design, allowing for fewer dropped or lost parts. The CM bundling clip design eliminates shear points and damage to wire rope, and prevents the choker from going slack and the load spreading after tension is released from the sling.



## PIGGYBACK® WEDGE SOCKET CLIPS

The CM PiggyBack® Wedge Socket Clip is the only clip on the market specifically designed for securing the dead end of a wire rope on a wedge socket. Its revolutionary dual saddle design attaches quickly and easily to prevent crimping and damage to the live end of wire rope and eliminates the need for a short rope piece or loop on dead end. Properly secured dead end will not snag/foul and shear off at wedge socket. Available in 3/8 inch to 1-1/2 inch sizes. Hot dip galvanized with orange painted U-bolts and drop forged saddles.



# LOAD SECUREMENT OVERVIEW

Load securement, also known as tie-down or load binding, can be a complex rigging application that often has strict specifications and regulations. CM offers a number of load securement products, including load binders, binder chain assemblies and tie-down hooks, that help you safely secure loads for transport as well as meet federal, state and Commercial Vehicle Safety Alliance (CVSA) regulations. Our load securement products comply with the National Association of Chain Manufacturers (NACM) Welded Steel Chain specifications and the American Society of Testing and Materials (ASTM) specifications. They are also designed to meet applicable Federal Motor Carrier Safety Administration (FMCSA) rules for cargo securement.

## LOAD BINDERS

Load Binders are typically used to take up slack and apply tension to a tie-down system. Designed primarily for use with graded chains, they can also be used with cable, steel strap or fiber webbing to secure loads in a variety of applications. Load binders are available in two general configurations: **Lever-type** (over the center) and **Ratchet-type**. CM load binders are rated by working load limit and are provided with the appropriate hooks to accept the chain size and grade consistent with the binder's load rating.

### LEVER-TYPE LOAD BINDERS

Lever-Type, or over-the-center, Binders utilize mechanical advantage to reduce the manpower required to secure a load. When using a lever-type load binder, tension can be applied and released quickly. Operators should use caution, as the handle may whip suddenly. When securement is complete, the lever stores in line with load.



Lever-Type Load Binder

### RATCHET-TYPE LOAD BINDERS

Ratchet Binders utilize a screw or rotating motion to tighten and secure loads. Ratchet binders tighten slower but are easier to operate than lever-type load binders. They also do not require a handle to lock in place to ensure the binder stays tightened. Available with a variety of end fittings.



Ratchet-Type Load Binder

### RIVER RATCHETS

River Ratchets operate similar to ratchet-type load binders, but have a substantially larger capacity. Typically, these ratchets are used to gang barges utilizing a gravity-operated, loose pawl design. River ratchets are available with a variety of attachments.



River Ratchet

## BINDER CHAIN ASSEMBLIES

Binder Chain Assemblies are most often used to secure loads to trucks, rail cars or truck trailers. They typically consist of a length of chain ranging from 6 to 26 feet in length with a grab hook at each end. The grab hook can be clevis style or eye style depending on your application. Standard binder chain assemblies are available in Grades 30, 43, 70, 80 and 100.

### CLEVIS HOOK ASSEMBLIES

Clevis Hook Assemblies are available in various lengths and grades, depending on your application. CM offers different dimensional binder chains as part of these assemblies, including short link chain, which provides you with easier take up and better cornering, or traditional pitch chain that gives you less pounds per foot in weight.

### EYE HOOK ASSEMBLIES

Similar to CM clevis hook assemblies, Eye Hook Assemblies prevent the loss or theft of hooks from the binder chain. Eye hook assemblies are offered with short or traditional pitch chain.



## TIE-DOWN HOOKS

Tie-down Hooks come in various grades, designs and installation types. Both clevis and eye style tie-down hooks are high-quality forgings made here in the U.S. The clevis style hook is most popular because of the ability to self-install with limited need for tools. The eye style hook is typically factory installed during a welding process, but is beneficial in that it protects against loss or theft of the hook.

### GRADE 30 & 43 HIGH TEST HOOKS

Grade 30 and 43 Hooks are dual rated, allowing the operator to use with both grades of chain. Grade 30 and 43 hooks are available in both clevis and eye types in either slip or grab styles and should be selected based on the type and grade of chain being used in the application. Available in self-colored or zinc-plated finishes.



### GRADE 70 TRANSPORT HOOKS

Transport Hooks are available in both clevis and eye types in either slip or grab styles. These hooks are rated for use with Grade 70 chain and are available in self-colored or yellow chromate finishes.



### GRADE 80 HEAVY-DUTY HOOKS

Grade 80 Hooks available in both clevis and eye types in either slip or grab styles and are rated for use with Grade 80 chain. Grade 80 hooks that are marked "T80" should not be used for overhead lifting. These hooks are available in self-colored or orange powder-coated finishes.



## WARNING

Improper use or care of load binders can result in bodily injury or property damage.

To avoid injury:

- ▲ Never exceed working load limit.
- ▲ Always inspect binder before use for wear, damage, and elongation.
- ▲ Do not use cheater bar or handle extension.
- ▲ Do not operate load binder while anyone is on the load.
- ▲ Release load on lever type binders with extreme care. Make sure everyone is clear of the load. Handle may whip suddenly.

# PLATE CLAMPS OVERVIEW

Plate clamps are most often used to lift and move steel plates from both horizontal and vertical positions. CM Plate Clamps operate through a self-actuating spring that engages when the clamp is attached to a plate. When using plate clamps, it is important that the load weighs no less than 20 percent of the clamp's working load limit. When lifting stainless steel, materials over 300 HRB in hardness or when leaving marks on the material is undesirable, special clamps are available.

Plate Clamps are available in universal, hinged, and horizontal styles. A few examples of plate clamps include:



Universal Plate Clamps



Hinged Plate Clamps



Gentle Grip Clamps



Girder Clamps



Horizontal Clamps



Container Lugs



# SLING INSPECTION, USE & CARE

Warnings .....	25
<b>CHAIN &amp; CHAIN SLINGS</b>	
General Inspection .....	26
In-Depth Inspection .....	26-27
General Care & Use .....	28
<b>CHAIN</b>	
Selection & Working Load Limits .....	29
<b>CHAIN SLINGS</b>	
Selection & Working Load Limits .....	30-32
<b>SYNTHETIC SLINGS</b>	
Selection & Inspection .....	34-35
Web Sling Working Load Limits .....	38
Round Sling Working Load Limits .....	39
<b>WIRE ROPE SLINGS</b>	
Working Load Limits .....	40-41
<b>TRAINING</b>	
Rigging Training .....	42
CMCO University™ .....	43

Columbus McKinnon Corporation assumes no responsibility for the misuse or misapplication of any of its products. Products are provided with the express understanding that the purchaser and/or user are thoroughly familiar with the correct application and proper use of such rigging products. Warnings and definitions are provided as an aid to the user in understanding the correct application and proper use of the product. Chain and rigging products should not be used by personnel unless they are properly trained and/or certified for that application

For instant access to valuable rigging and hoisting application information, check out our portable Rigging Guide. Small enough to fit in your pocket or toolbox, the CM Rigging Guide is full of the tools and specifications that every rigger should have, such as:

- Working Load Limits for Shackles, Hooks and Slings
- Easy to Understand Visual References for Proper Rigging
- Load Angle Charts
- Leverage, Tension & Pull Force Calculators
- And Much More

For more information or to order your copies of the CM Rigging Guides, contact your Columbus McKinnon representative.



Literature code: CMRG



## **⚠ WARNING**

The use of all mechanical equipment presents the possibility of personal injury or property damage if the equipment is not properly installed, operated or maintained. Before using CM chain, accessories, load binders, lifting clamps, or other hardware, users should become thoroughly familiar with application, installation, operation and maintenance requirements.

### **IMPROPER USE OR CARE OF CHAIN & RIGGING ATTACHMENTS CAN RESULT IN BODILY INJURY OR PROPERTY DAMAGE. TO AVOID INJURY:**

#### **CHAIN**

- ▲ Do not exceed the working load limit. Refer to the catalog for product-specific load limit data.
- ▲ Always inspect chain before use. Do not use chains with links that are bent, elongated, nicked, or excessively worn or damaged.
- ▲ Do not impact load or jerk chain. Apply load slowly. Rapid load application can cause overloading.
- ▲ Use only alloy chain and attachments for overhead lifting (Grade 80 or 100).
- ▲ Do not use twisted, knotted or kinked chain. Load should be applied in a straight line fashion.
- ▲ Select the proper grade and size chain for the application.
- ▲ Select attachments such as hooks to match the grade, size, and working load limit of the chain.
- ▲ Be aware of the environment where chain and hardware are being used. Extreme temperatures and corrosive media can affect the working load limit and life of the chain and hardware.
- ▲ Full chain inspection and use information can be found on pages 26 through 28. Refer to product manuals for complete warning and use information if applicable.

#### **RIGGING ATTACHMENTS**

- ▲ Do not exceed the working load limit. Refer to the catalog for product-specific load limit data.
- ▲ Always inspect rigging attachments before use. Do not use equipment with components that are bent, elongated, nicked, or excessively worn or damaged.
- ▲ Center the load in hooks, shackles, rings and other such equipment. Use spacers on bolts and pins as necessary to maintain center loading.
- ▲ Do not move unbalanced loads.
- ▲ Do not tip load or use attachments in any manner for which they were not intended.
- ▲ Do not shock or dynamic load. Rapid load application can cause overloading.
- ▲ Do not apply load to latches. Latches are to retain slack slings.
- ▲ Select attachments to match the grade, size, and working load limit of the chain.
- ▲ Ensure that nuts, bolts pins and other fasteners are tightened and secured.
- ▲ Do not use mechanical coupling links to repair alloy chains used for overhead lifting.
- ▲ Size the master link or ring to fit properly over the crane hook.
- ▲ Do not replace pins or bolts with other than original equipment parts.
- ▲ Wire rope clips are not recommended for fabricating slings for overhead lifting. Reference ASME B30.9 for special applications.
- ▲ Use wire rope clips in conjunction with wire rope thimbles.
- ▲ When using shoulder eyebolts, always apply load in the plane of the eye.
- ▲ When using shoulder eyebolts, make sure shoulder is fully seated.
- ▲ When using hoist rings, verify full 360 degree rotation and 180 degree pivot and re-torque periodically.
- ▲ Make sure plate clamps are functional and capable of lifting the load before use.
- ▲ Product-specific warning and hazard information can be found throughout this catalog. Refer to product manuals for complete warning and use information.

#### **DISCLAIMER**

The manufacturer does not accept any liability for damages which result from the product being used in excess of the working load limit or from abuse or misuse.

Always refer to applicable industry standards, specifications and regulations such as OSHA and ASME. Always adhere to any manufacturers recommendations.

# CHAIN & CHAIN SLING INSPECTION GUIDE

To ensure long life and continued strength of CM chain, it is important that the product is properly used, inspected and maintained. This section provides details on chain and chain sling inspection methods as well as the proper use and care of chain or slings. Following these guidelines will ensure safe and long use of CM products.

In addition to what is provided in this section, ASME and OSHA have specific regulations related to chain and chain sling use. For detailed information, refer to ASME B30.9 and OSHA 1910.184

## GENERAL CHAIN & CHAIN SLING INSPECTION

It is important to inspect chain and chain slings regularly and to keep a record of all chain inspections. Follow the steps below when developing your inspection requirements and tracking system. CM will supply chain and sling record cards or sheets as requested.

Before inspection, clean the chain so that marks, nicks, wear and other defects can be seen. Use a non-acid/non-caustic solvent. Each chain link and sling component should be individually inspected for the conditions noted below.

1. Excessive wear and corrosion at chain and attachment bearing points. Refer to page 27, "Wear Allowance chart for Herc-Alloy 800® and 1000 chain". The table should also be used as a guide when inspecting coupling links.
2. Nicks or gouges
3. Stretch or link elongation
4. Twists or bends
5. Distorted or damaged links, master links, coupling links or attachments, especially spread in throat opening of hooks. (Refer to other sections in this catalog for inspection guidelines regarding distortion and wear of hooks, master links and Hammerloks®.)

When inspecting chain slings specifically, it's important to note that damage is most likely to occur in the lower portion of a sling. Therefore, particular attention should be given to those sections.

Each link or component having any condition listed above is to be marked to clearly indicate rejection. Since any of the above noted conditions can affect chain performance and/or reduce the chain strength, chains and chain slings containing any of the conditions should be removed from service. A qualified person should examine the chain, assess the damage, and make a decision on whether or not repair is necessary before returning it to service. Extensively damaged chain should be scrapped.

Because of its use in critical lifting applications, repair of alloy chain should only be done by an authorized CM chain sling repair station. Nicks and gouges can be removed from the chain by a qualified person as instructed in the "Nicks and Gouges" section on this page.

## IN-DEPTH CHAIN & CHAIN SLING INSPECTION

Since Grade 80 and 100 chains are used for overhead lifting, and used frequently as part of a sling component, a more detailed and in-depth inspection is necessary.

### TWISTING & BENDING

Twisted and bent links are relatively easy to recognize and affect chain performance significantly. Twisting and bending of links results from use of slings around sharp corners without padding, use of links with grab hooks under certain adverse conditions, and from loading of chain that is twisted, knotted, or kinked. (Refer to Hook Section for a more information on grab hooks.)

Consider that chain is evaluated by applying loads in a pure tensile link end-to-link-end fashion and rated accordingly. Bent or twisted links alter this normal loading pattern significantly and thus alter inner link stresses accordingly. For this reason all chain containing twisted or bent links must be removed from service.

### NICKS & GOUGES

The outsides of links are exposed to contact with foreign objects that can cause damage. Nicks and gouges frequently occur on the sides. Therefore, they usually are located on surfaces under compressive stress and their potentially harmful effects are reduced.

The unique geometry of a chain link tends to protect tensile stress areas against damage from external causes. Figure 1 shows that these tensile stress areas are on the outside of the link body at the link ends where they are shielded against most damage by the presence of interconnected links. Tensile stress areas are located also on the insides of the straight barrels, but these surfaces are similarly sheltered by their location. However, gouges cause localized increases in the link stress. They can be harmful if they are located in areas of tensile stress and particularly so if they are perpendicular to the direction of stress. Refer to Figure 1.

Figure 2 shows nicks of varying degrees of severity. Reading clockwise, at three o'clock there is a longitudinal mark in a compressive stress area. Since it is longitudinal and located in a compressive stress area, its effect is mitigated, but good workmanship calls for it to be ground out. At about five o'clock there is a deep



Figure 1: Pattern of tensile and compression stress shown by a link under load.

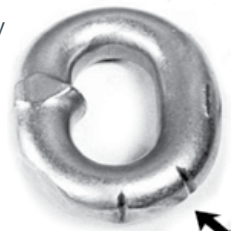

Figure 2: Location of nicks, gouges, and notches will dictate their severity.

transverse nick in an area of high shear stress. A similar nick is located at six o'clock in the zone of maximum tensile stress. Both of these can create a potentially dangerous escalation of the local stress and must be filed out. A nick that was located at eight o'clock has been filed out properly. Although the final cross section is smaller, the link is stronger because the stress riser effect of the notch has been removed. The remaining cross section can now be evaluated for acceptability by measuring it and applying the criterion for worn chain. See "Wear Allowances Table" below.

### WEAR & CORROSION

Corrosion results in a reduction of link cross-section and can be detected using the same criteria as that for wear. Wear can occur in any portion of a link that is subject to rubbing contact with another surface.

The natural shape of chain confines wear, for practical considerations, to only 2 areas. These are, in order of importance, (a) at the bearing points of interlink contact, and (b) on the outside surfaces of the straight side barrels which may be abraded from dragging chains along hard surfaces or from under loads. Figure 3 illustrates the condition of interlink wear and shows how to inspect for it. Notice how easily such wear can be detected by collapsing the chain to separate each link from its neighbors.



Figure 3 : Inspection for interlink wear can be detected easily by collapsing the chain.

When wear is observed, the next step is to determine how severe the damage is and if the chain can still be safely used. To determine this, make a caliper measurement across the worn section of chain and compare it to the minimum allowable dimension for that chain. See the chart below for minimum section dimensions or wear allowances for Columbus McKinnon Grade 80 and 100 Chain.

#### WEAR ALLOWANCES OF HERC-ALLOY 800® & 1000 CHAIN\*

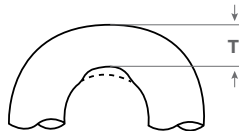

Measure cross section at link ends to determine wear. If chain is worn to less than the minimum allowable thickness, remove from service.

Note: For sizes not listed, the Minimum Allowable Thickness can be calculated as 87% of the original material diameter.

\* May also be used as a guide for CM Grade 63 Alloy Chain

Chain Size		Minimum Allowable Thickness (T)	
(in.)	(mm.)	(in.)	(mm.)
7/32	5.5	0.189	4.8
9/32	7.0	0.239	6.1
3/8	10.0	0.342	8.7
1/2	13.0	0.443	11.3
5/8	16.0	0.546	13.9
3/4	20.0	0.687	17.5
7/8	22.0	0.750	19.1
1	26.0	0.887	22.5
1-1/4	32.0	1.091	27.7

### CHAIN INSPECTION

The strength of welded link chain is relatively unaffected by a moderate degree of wear. The reason for this will be understood better if we take a brief look at the pattern of stress distribution in a chain link supporting an axial tension load.

Figure 4 shows in exaggerated manner the change in shape that takes place under such loading conditions. Note that the ends move farther apart while the side barrels move closer together. If the link were in a neutral stress condition to start with, the loaded link shown in broken outline would contain stresses of compression and tension. This is clearly illustrated in Figure 5 showing an inflated inner tube which is sustaining a load in the manner of a chain link. The wrinkled sections clearly indicate the areas of compression.

Figure 1 on the previous page shows the location of these stresses in a chain link. Tensile stresses are represented by arrows pointing away from each other, and compression stresses are depicted by arrows pointing toward each other. Notice that the bending, which occurs when link elongation takes place, induces compressive stresses at the interlink bearing surfaces and on the outside surfaces of the side barrels. Therefore, we see that these surfaces, which are the potential wear areas, play a lesser role in supporting the tensile load on the chain. For that reason, some amount of interlink or side barrel wear can occur before chain tensile strength decreases significantly.

Corrosion will generally be exhibited in the form of rusting and pitting. Rusted chain with a smooth unpitted surface finish can remain in service provided that the minimal section dimensions or wear allowances published by the chain manufacturer are complied with. However, visually discernible pitting should be carefully inspected using the technique outlined for "Nicks and Gouges", paying particular attention to areas of tensile stress.

Alloy steel sling chain typically exhibits well over 20% elongation before rupture. The combination of elongation and high strength provides energy absorption capacity. However, high elongation or stretch, by itself, is not an adequate indicator of shock resistance or general chain quality and should not be relied upon by riggers to provide advance warning of serious overloading and impending failure. Overloading must be prevented before it happens by selection of the proper type and size of slings.

### STRETCH & CHAIN ELONGATION

A visual link-by-link inspection is the best way to detect dangerously stretched links. The smallest sign of binding or loss of clearance at the juncture points of a link indicates a collapse in the links' sides due to stretch. Any amount of stretch indicates overloading, and the chain should be removed from service.

Note that a significant degree of stretch in a few individual links may be hidden by the apparent acceptable length gage of the overall chain. This highlights the importance of link-by-link inspection.

**There is no short-cut method that will disclose all types of chain damage. Safety can only be achieved through proper inspection procedures. There is no adequate substitute for careful link-by-link scrutiny.**

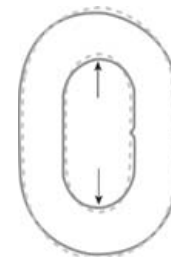

Figure 4 : Changes in link shape that take place under axial tension loading.

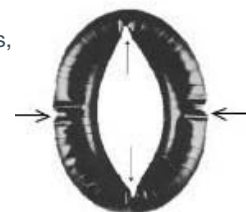

Figure 5 : The tube "under load" shows wrinkles in the areas of compression.

## OSHA CHAIN SLING INSPECTION

Since first published in final form on July 27, 1975, few changes have been made to the OSHA Chain Sling Inspection section. Specifically, the applicable sections of Code of Federal Regulations (29 CFR 1910.184) are quoted as follows:

- (d) **INSPECTIONS** – Each day before being used, the sling and all fastenings and attachments shall be inspected for damage or defects by a competent person designated by the employer. Additional inspections shall be performed during sling use where service conditions warrant. Damaged or defective slings shall be immediately removed from service.
- (e) **ALLOY STEEL CHAIN SLINGS**
- (3) Inspections (i) in addition to the inspection required by paragraph (d) of this section, a thorough periodic inspection of alloy steel chain steel slings in use shall be made on a regular basis, to be determined on the basis of (A) frequency of slings in use; (B) severity of service conditions; (C) nature of lifts being made; and (D) experience gained on the service life of slings used in similar circumstances. Such inspections shall in no event be at intervals greater than once every 12 months.
- (ii) The employer shall make and maintain a record of the most recent month in which each alloy steel chain sling was thoroughly inspected, and shall make such record available for examination.
- (iii) The thorough inspection of alloy steel chain slings shall be performed by a competent person designated by the employer, and shall include a thorough inspection for wear, defective welds, deformation and increase in length. Where such defects or deterioration are present, the sling shall be immediately removed from service.”

Note that while the requirements under (d) for daily inspections are not explicit as to scope or maintenance of records, it is possible that individual OSHA inspectors may have different views on conformity. However, the minimum 12-month interval inspections required under (e) call for thorough inspection and written records. It is this thorough type inspection which the procedures recommended in this catalog and in CMCO Training Classes are designed to satisfy. Of course, the fundamentals are equally applicable to the more cursory daily inspections made by the riggers, users, or inspectors (a competent person) and will enable them to fulfill their responsibility efficiently.

## CHAIN & SLING GENERAL CARE & USE

### PROPER CARE

Chain and chain slings require careful storage and regular maintenance.

1. Store chain and chain slings in a clean, dry place.
2. Avoid exposure to corrosive mediums. Oil chain before prolonged storage.
3. Never alter the thermal treatment of chain or chain sling components by heating.
4. Do not plate or change surface finish of chain or components. Contact Columbus McKinnon for special requirements.

### PROPER USE

To protect both operators and materials, observe these precautions when using chain slings.

1. Before use, inspect chain and attachments following the inspection instructions on pages 26 through 28.
2. Do not exceed working load limit as indicated on the chain or chain sling identification tag. Any of the following factors can reduce the strength of the chain or sling and cause failure:
  - Rapid load application can produce dangerous overloading.
  - Variation in the angle of the load to the sling. As the angle decreases, the working load of the sling will increase. (For more information, see page 30 )
  - Twisting, knotting or kinking subjects links to unusual loading, decreasing the working load of the sling.
  - Using slings for purposes other than those for which slings are intended can reduce the working load of the sling.
3. Free chain of all twists, knots and kinks.
4. Center load in hook(s). Hook latches must not support load.
5. Avoid sudden jerks when lifting and lowering.
6. Balance all loads to avoid tipping.
7. Use pads around sharp corners.
8. Do not drop load on chains.
9. Match the size and working load limit of attachments such as hooks and rings to the size and working load limit of the chain.
10. Use only alloy chain and attachments for overhead lifting.

# CHAIN SELECTION & WORKING LOAD LIMITS

Understanding the working load limit of chain and chain slings is critical when choosing the best option for your application. This section details the working load limits of chain and chain slings, as well as explains how the working load limit is affected by temperature and lifting angles.

## GENERAL CHAIN WORKING LOAD LIMITS

Below is a chart of the working load limits of Grade 30 through Grade 100 chain.

Trade Diameter (in)	NACM Working Load Limits (lbs.)				
	Grade 30	Grade 43	Grade 70	Grade 80	Grade 100
1/8	400	—	—	—	—
3/16	800	—	—	2,100	2,700
7/32	—	—	—	2,100	2,700
1/4	1,300	2,600	3,150	—	—
9/32	—	—	—	3,500	4,300
5/16	1,900	3,900	4,700	4,500	5,700
3/8	2,650	5,400	6,600	7,100	8,800
7/16	3,700	7,200	8,750	—	—
1/2	4,500	9,200	11,300	12,000	15,000
5/8	6,900	13,000	15,800	18,100	22,600
3/4	10,600	20,200	24,700	28,300	35,300
7/8	12,800	24,500	—	34,200	42,700
1	17,900	—	—	47,700	59,700
1-1/4	—	—	—	72,300	90,400

Only Grade 80 or Grade 100 should be used for overhead lifting.

## CHAIN WORKING LOAD LIMITS UNDER EXTREME TEMPERATURE CONDITIONS

When chain is subject to extreme temperatures, working load limits should be reduced as indicated in the chart below.

Temperature		Grade 80	
(°F)	(°C)	Reduction of Working Load Limit WHILE AT Temperature	Reduction of Working Load Limit AFTER EXPOSURE to Temperature
Below 400	Below 204	NONE	NONE
400	204	10%	NONE
500	260	15%	NONE
600	316	20%	5%
700	371	30%	10%
800	427	40%	15%
900	482	50%	20%
1,000	538	60%	25%
Over 1,000	Over 538	OSHA 1910.184 requires all slings heated to temperatures over 1,000° F to be removed from service	
Temperature		Grade 100	
Below 400	Below 204	NONE	NONE
400	204	15%	NONE
500	260	25%	5%
600	316	30%	15%
700	371	40%	20%
800	427	50%	25%
900	482	60%	30%
1,000	538	70%	35%
Over 1,000	Over 538	OSHA 1910.184 requires all slings heated to temperatures over 1,000° F to be removed from service	

# CHAIN SLING SELECTION & WORKING LOAD LIMITS

## HOW TO SELECT THE PROPER CHAIN SLING

1. Determine the weight and configuration of the load(s) to be lifted.
2. Determine the type of chain sling required, according to weight and configuration.
3. Determine the size of the body chain according to the working load limits.  
Be sure to take into consideration the effect of the required angle (see diagram below).
4. Determine the reach required to give the desired angle. This is measured from the upper bearing surface of the master link to the bearing surface of the lower attachment.
5. Know share of load on pick points and location of center of gravity.

## WHAT DETERMINES A SLING'S WORKING LOAD LIMIT

The working load limit of slings is based on the following factors:

- Type of hitch
- Material strength
- Design factor
- Diameter of curvature (D/d)
- Angle of loading

For specific information on the working load limit of various slings, see page 31.

When using a sling, loads are frequently lifted at an angle. This can affect their working load limits. In the diagram to the right, the percentages shown represent the maximum working load limit of the sling when used at the designated angle.

### For example:

One 3/8" Grade 80 double sling used at 90° would have a working load limit of 2 times the working load of a 3/8" Grade 80 single or 2 x 7, 100 lbs. = 14,200 lbs.

The same double sling used at 35° would have a maximum working load limit of 57% of 14,200 lbs. or .57 x 14,200 lbs. = 8,094 lbs.

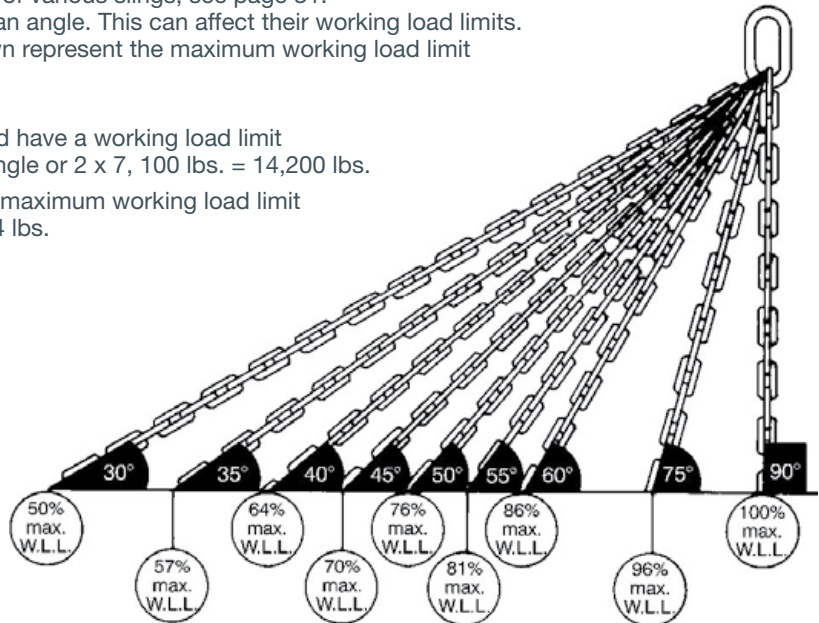

## WARNING

Improper use, application or care of slings can result in injury or property damage. To avoid injury or damage:

- ▲ Never exceed the working load limit. Confirm the working load limit of all sling components are of equal or greater strength.
- ▲ Always inspect slings before use for wear, damage, and elongation. Refer to ANSI B30.9 and OSHA regulations.
- ▲ Do not impact or shock load. Apply load slowly.
- ▲ Protect from corrosion and high temperatures.
- ▲ Use with alloy chain for overhead lifting.
- ▲ Do not use twisted, knotted or kinked chain.

American National Standard ANSI B30.9, the National Association of Chain Manufacturers, and the Occupational Safety & Health Administration recommend only the use of alloy steel chain for overhead lifting i.e. for sling chain. Slings may be constructed by the user using CM Grades 80 or 100 Chain, CM alloy attachments and CM mechanical coupling links (Hammerloks®). Columbus McKinnon uses Grade 80 or 100 chain and alloy steel welded coupling links instead of Hammerloks for construction of welded slings. Refer to this catalog's product overview sections for "Chain," "Hooks" and "Rings and Links" for detailed information on components which may be used in the construction of slings.



**SINGLE LEG  
(VERTICAL)**

**SINGLE LEG  
(CHOKER)**

**DOUBLE  
(2 LEGS)**

**TRIPLE  
(3 LEGS)**

**QUADRUPLE  
(4 LEGS)**

**BASKET  
TYPE**

**DOUBLE  
BASKET TYPE**

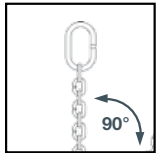

**SINGLE OR  
SINGLE ENDLESS**

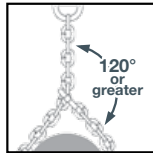

**SINGLE  
CHOKER**

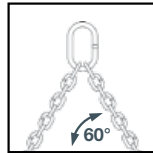

**DOUBLE, DOUBLE ENDLESS\*  
OR SINGLE BASKET**

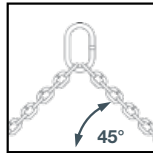

**45°**

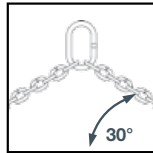

**30°**

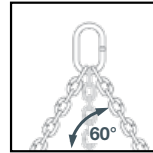

**60°**

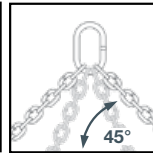

**45°**

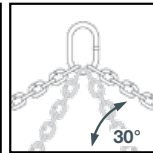

**30°**

**TRIPLE, QUADRUPLE  
OR DOUBLE BASKET**

Chain Size (in.)	Working Load Limits for Sling Types Show Above														
	Single (1 leg)	Single Choker	Double (2 legs)			Triple (3 legs)			Quad (4 legs)			Single Basket	Double Basket	Single Endless	Double Endless*
	90° (lbs.)	90° (lbs.)	60° (lbs.)	45° (lbs.)	30° (lbs.)	60° (lbs.)	45° (lbs.)	30° (lbs.)	60° (lbs.)	45° (lbs.)	30° (lbs.)	60° (lbs.)	60° (lbs.)	90° (lbs.)	60° (lbs.)
<b>GRADE 80 CHAIN SLINGS</b>															
7/32	2,100	1,700	3,600	3,000	2,100	5,500	4,400	3,200	5,500	4,400	3,200	3,600	5,500	2,100	3,600
9/32	3,500	2,800	6,100	4,900	3,500	9,100	7,400	5,200	9,100	7,400	5,200	6,100	9,100	3,500	6,100
5/16	4,500	3,600	7,800	6,400	4,500	11,700	9,500	6,800	11,700	9,500	6,800	7,800	11,700	4,500	7,800
3/8	7,100	5,700	12,300	10,000	7,100	18,400	15,100	10,600	18,400	15,100	10,600	12,300	18,400	7,100	12,300
1/2	12,000	9,600	20,800	17,000	12,000	31,200	25,500	18,000	31,200	25,500	18,000	20,800	31,200	12,000	20,800
5/8	18,100	14,500	31,300	25,600	18,100	47,000	38,400	27,100	47,000	38,400	27,100	31,300	47,000	18,100	31,300
3/4	28,300	22,600	49,000	40,000	28,300	73,500	60,000	42,400	73,500	60,000	42,400	49,000	73,500	28,300	49,000
7/8	34,200	27,400	59,200	48,400	34,200	88,900	72,500	51,300	88,900	72,500	51,300	59,200	88,900	34,200	59,200
1	47,700	38,200	82,600	67,400	47,700	123,900	101,200	71,500	123,900	101,200	71,500	82,600	123,900	47,700	82,600
1-1/4	72,300	57,800	125,200	102,200	72,300	187,800	153,400	108,400	187,800	153,400	108,400	125,200	187,800	72,300	125,200
<b>GRADE 100 CHAIN SLINGS</b>															
7/32	2,700	2,100	4,700	3,800	2,700	7,000	5,700	4,000	7,000	5,700	4,000	4,700	7,000	2,700	4,700
9/32	4,300	3,500	7,400	6,100	4,300	11,200	9,100	6,400	11,200	9,100	6,400	7,400	11,200	4,300	7,400
5/16	5,700	4,500	9,900	8,100	5,700	14,800	12,100	8,500	14,800	12,100	8,500	9,900	14,800	5,700	9,900
3/8	8,800	7,100	15,200	12,400	8,800	22,900	18,700	13,200	22,900	18,700	13,200	15,200	22,900	8,800	15,200
1/2	15,000	12,000	26,000	21,200	15,000	39,000	31,800	22,500	39,000	31,800	22,500	26,000	39,000	15,000	26,000
5/8	22,600	18,100	39,100	32,000	22,600	58,700	47,900	33,900	58,700	47,900	33,900	39,100	58,700	22,600	39,100
3/4	35,300	28,300	61,100	49,900	35,300	91,700	74,900	53,000	91,700	74,900	53,000	61,100	91,700	35,300	61,100
7/8	42,700	34,200	74,000	60,400	42,700	110,900	90,600	64,000	110,900	90,600	64,000	74,000	110,900	42,700	74,000
1	59,700	47,800	103,400	84,400	59,700	155,100	126,600	89,600	155,100	126,600	89,600	103,400	155,100	59,700	103,400
1-1/4	90,400	72,300	156,600	127,800	90,400	234,900	191,700	135,600	234,900	191,700	135,600	156,600	234,900	90,400	156,600

Do not use double endless slings at angles less than 60°. Based on OSHA and ASME B30.9 standards – Always use the sling tag for the working load limits. Factory assembled HERC-ALLOY 800® or HERC-ALLOY® 1000 chain slings have the “HERC-ALLOY 800®” or “HERC-ALLOY® 1000” trademark on serial number tags and on the sling hooks. On chain sizes 7/32” through 1-1/4” (7/32” through 3/4” for HA1000), links are embossed with grade symbol “HA-800” or “HA-1000”. This data applies to Herc-Alloy 800® & Herc-Alloy® 1000 chain only. Ratings apply to both factory assembled slings and slings assembled with Hammerlok® coupling links, Clevlok® hooks, or Lodelok® hooks.

# CHAIN SLING SELECTION & WORKING LOAD LIMITS

## SLING SAFETY: LOADING, ANGLES & CHOKING

When choosing a sling for your rigging application, specifically a sling, you need to be aware of the load that will be imposed on the sling and select the proper size chain for the job.

All chain manufacturers publish working load ratings for single chain slings in straight tension and for double, triple and quad-branch slings when used at various angles. Figure 1 illustrates how such tables would rate the capacity of a commercial Grade 80 sling made from 5/8 inch alloy chain. (See a full working load limit chart on page 31)

However, it is often overlooked that a single strand sling may be rigged to be a double branch sling and as such would create sharp loading angles. This is the reason that chain damage and overloading are usually localized in the lower portion of the sling near the load. Figure 2 illustrates this issue.

### OVERLOAD EXAMPLE:

On the left side of Figure 2, we see a double branch sling used in the conventional manner. Unfortunately, such idealized rigging, where sling hooks are neatly seated in eyebolts or clevises and all portions of the chain are in straight tension, is not always possible. A more typical and frequent rigging arrangement is shown in the illustration on the right of Figure 2.

In the right-side image of the diagram, a single sling equipped with a hook is being used in a choke hitch format. Above the crotch, the chain tension is 9 tons – the same tension as shown in the illustration on the left. Let us assume that 9 tons is an acceptable load for this size chain in straight tension. In many cases, one would assume that the load is rigged correctly and the load can be safely moved, but that is not the case. If you look below the hook, you see a double branched sling. Also, typical of the flat branch angles in tight choke hitches, the legs are at angles of only 15 degrees from the horizontal. At those angles the tension load in each leg of our 9 ton capacity is 17.4 tons — an overload of nearly 100%. This is why it is important to fully understand the tension and loads that your rigging will be under. This greatly depends on the rigging configuration and the materials used to create the sling. (See the chart on the effect angles have on the working load limit of slings on pg. 30)

## SHOCK LOADING

Shock loading can also damage a sling. If a load is raised with a jerk or permitted to fall and be snubbed by slack chain, the dynamic load applied to the chain can vastly exceed the static weight being lifted.

### SHOCK LOADING EXAMPLE:

For example, 1/2" Herc-Alloy 800® has a working load rating of 12,000 lbs. It will sustain this amount of total load for a long period time if used correctly. However, a payload weighing considerably less than 12,000 lbs. can break the chain in a one-time situation if permitted to drop and produce high dynamic stresses.

This Herc-Alloy 800 1/2" chain has a rupture work capacity (impact strength) capacity of about 9,000 ft.lbs./ft. This means that if a 9-foot-long sling were being used to raise a 12,000 lb. payload and the load snagged and dropped onto the slack chain hook, a drop of about 7 feet would break the chain. Ex. 9,000 ft. lbs./ft x 9 ft. approximately equals 12,000 lbs. x 7 ft.

The amount of dynamic load imposed on a chain in such a situation cannot be planned for. Although the cited example is rather extreme, it can happen.

Therefore, it is important to ensure you do not overload your chain, whether it be from an improper rigging configuration that decreases the working load limit of the materials used or a shock loading situation.

**FIGURE 1**  
WORKING LOAD LIMITS FOR 5/8"  
CM Herc-Alloy 800® ALLOY STEEL CHAIN SLINGS

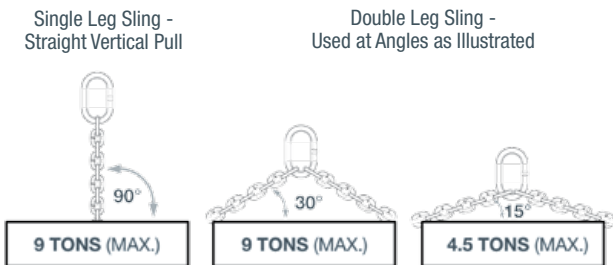

Working load limits for 5/8 inch alloy steel chain slings, (single and double leg configurations.)

**FIGURE 2**  
5/8" CM Herc-Alloy 800® ALLOY STEEL CHAIN SLINGS

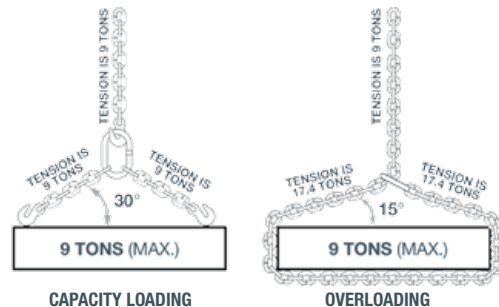





**VISIT OUR BLOG AT [BLOG.CMWORKS.COM](http://BLOG.CMWORKS.COM) FOR GREAT ARTICLES ON RIGGING PRODUCTS & SAFETY TOPICS LIKE THIS:**

## Who is responsible for putting tags on chain slings? Can I retag my chain slings with missing tags, and do I have to load test a sling after I retag it?

It is the sling manufacturer's responsibility to put ID tags on chain slings. The sling manufacturer is a person or company assembling or fabricating sling components into their final form. The sling manufacturer and the manufacturer of the sling materials may or may not be identical. An end user who buys components and assembles them mechanically is the sling manufacturer. If the user does not know who the sling manufacturer is because the old tag fell off and went missing, then a decision needs to be made. It's the user's or rigger's responsibility to maintain the tag and be sure it remains legible. A rigger cannot use a sling without a tag or when a tag is illegible or missing information.

For retagging, the user would need to start their own serial number for documentation purposes. In doing so, this user would become the "sling manufacturer." This can only be done if the user is properly trained and deemed competent. Per OSHA, a person who tags a sling must be a competent person designated by the employer. ASME B30.9 states: replacement of the sling identification shall be considered a repair. Slings shall be repaired only by the sling manufacturer or a qualified person. A repair shall be marked to identify the repairing agency. To be considered competent and or qualified, the user should have some inspection experience and complete a rigging gear inspection course from a reputable training organization.

If the user feels they are not competent to properly inspect and retag the sling, they would need to send the sling out to a rigging house with a competent person for inspection and retagging. That rigging house now becomes the "sling manufacturer." Tags must have information per OSHA 1910.184(e) Alloy steel chain slings. Key OSHA and ASME standards regarding this include:

### **OSHA 1910.184(E)(1) SLING IDENTIFICATION**

Alloy steel chain slings shall have permanently affixed durable identification stating size, grade, rated capacity, and reach.

### **ASME B30.9: SECTION 9-1.7: Sling Identification 9-1.7.1 Identification Requirements**

Each sling shall be marked to show:

- (a) name or trademark of manufacturer
- (b) grade
- (c) nominal chain size
- (d) number of legs
- (e) rated loads for the type(s) of hitch(es) used and the angle upon which it is based
- (f) serial number
- (g) reach

A load test is not required if a sling is made up of individual load-tested components from the component manufacturer. If the sling is always found in acceptable condition per ASME B30.9, OSHA 1910.184 and manufacturers' recommendations, then the sling can remain in service without ever needing another load test performed.

# SYNTHETIC SLING SELECTION

Synthetic slings are a combination of synthetic straps, hooks, rings or other attachments used primarily for overhead lifting applications. Slings are generally used in conjunction with a crane or some type of lifting device and allow riggers to create a custom configuration to lift a load depending on the needs of the unique application.

## STANDARD TYPES OF SYNTHETIC SLINGS

Standard sling configurations consist of synthetic straps that are affixed on one end to a master link or ring with some type of attachment, typically a hook, attached to the opposite end. When choosing a synthetic sling, there are six different types to choose from:

### TYPE I: TC SLING

Triangle fitted on one end and a slotted triangle choker fitting on the other end.

*Hitches: vertical, basket or choker hitch.*



### TYPE II: TT SLING

Triangle fitted on both ends.

*Hitches: vertical, basket only.*



### TYPE III: EE SLING

Flat loop eye on each end, loop eye opening on the same plane as sling body. Also called flat eye, eye and eye, or double eye sling.



### TYPE IV: EE SLING

Both loop eyes formed as Type III, except the loop eyes are turned to form a loop eye that is at a right angle to the plane of the sling body. Also called twisted eye sling.



### TYPE V: EN SLING

Endless web sling, referred to as a grommet. Sling is a continuous loop formed by joining ends of the webbing together with a load-bearing splice.



### TYPE VI: RE SLING

Reverse eye web sling is formed by using multiple widths of webbing held edge to edge. A wear pad is attached on one or both sides of the web sling body and on one or both sides of the loop eyes to form a loop eye at each end at a right angle to the plane of the web sling body.



Source: WSTDA

# SYNTHETIC SLING INSPECTION

Per ASME B30.9 and OSHA 1910.184 you are required to perform sling inspections, including frequent and periodic inspections. In addition to these required inspections, upon receipt, all new, altered, modified or repaired slings shall be inspected to ensure compliance with the applicable ASME / OSHA standards and regulations.

## FREQUENT VS. PERIODIC INSPECTIONS

### FREQUENT INSPECTION:

Visual inspection for damage shall be performed each day or shift the sling is used. Slings found with damage per ASME B30.9 or OSHA 1910.184 shall immediately be removed from service. Slings shall not be returned to service until approved by a qualified person. Records do not need to be kept for frequent inspections.

### PERIODIC INSPECTION:

Complete inspection of the sling shall be performed during periodic inspections. Inspection shall be conducted on the entire length of the sling, including splices and fittings. Slings found with damage per ASME B30.9 and OSHA 1910.184 shall be removed from service immediately. Slings shall not be returned to service until approved by a qualified person.

**A thorough (periodic) inspection of slings, including rigging hardware, shall be performed by a competent person designated by the employer and shall include a thorough inspection for:**

- Wear
- Deformation (twist)
- Increase in length (stretch)
- Sharp transverse nicks and gouges
- Abrasion (dragging or pulling out from under loads)
- Corrosion (pitting)
- Heat damage (burn, weld spatter)

Note: These are general guidelines for inspection. Depending on the environment the sling is used in, additional inspection may be required. Some criteria may only apply to rigging hardware.

**The frequency of periodic inspections shall not exceed one year. Frequency of inspection should be based on:**

- Frequency of sling use
- Severity of service conditions
- Nature of load handling activities
- Experience gained on the service life of slings used in similar circumstances

Slings used for normal service should be inspected once per year. Slings used for severe service should be inspected monthly to quarterly. Slings used for special service should be inspected as recommended by a qualified person.

Source: American Society of Mechanical Engineers ASME B30.9 and Occupational Safety and Health Administration OSHA 1910.184

## REMOVAL FROM SERVICE CRITERIA

Per ASME standards, there are certain criteria under which synthetic slings and rigging hardware should be removed from service. It is important to follow these service criteria to prevent serious harm, bodily injury or death.

### SYNTHETIC WEBBING SLINGS REMOVAL FROM SERVICE CRITERIA

Per ASME B30.9-5.9.5, synthetic webbing slings shall be removed from service if any of these conditions exist.

1. Missing or illegible sling identification (Shall be marked with: name or trademark of manufacture, manufacturer's code or stock number, rated load for at least one hitch type and the angle upon which it is based, type of synthetic web material and number of legs, if more than one)
2. Acid or caustic burns
3. Melting or charring of any part of the sling
4. Holes, tears, cuts or snags
5. Broken or worn stitching in load-bearing splice
6. Excessive abrasive wear
7. Knots in any part of the sling
8. Discoloration and brittle or stiff areas on any part of the sling, which may mean chemical or UV sunlight damage
9. Fittings that are pitted, corroded, cracked, bent, twisted, gouged or broken. (Refer to the proper standard for full removal from service criteria: ASME B30.10 for hooks or ASME B30.26 for rigging hardware)
10. Any other conditions, including visible damage that cause doubt to the continued use of the sling

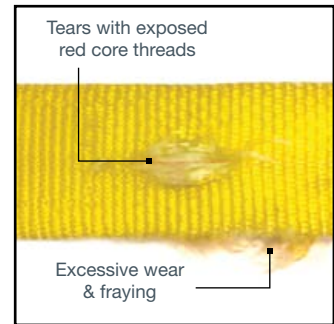
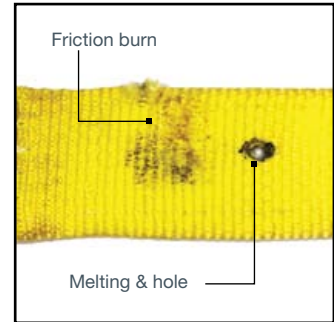

### POLYESTER & HIGH-PERFORMANCE ROUND SLINGS REMOVAL FROM SERVICE CRITERIA

A round sling is any sling fabricated in an endless or continuous configuration. Polyester round slings have a double wall exterior cover and load-bearing polyester core yarns internally. High-performance round slings have a double wall exterior and a synthetic blend of load-bearing core yarns internally.

Whether categorized as polyester or high-performance, round slings must be inspected and follow specific removal from service criteria as set forth by ASME B30.9-6.9.5. These criteria include:

1. Missing or illegible sling identification (Shall be marked with: name or trademark of manufacture, manufacturers code or stock number, rated load for at least one hitch type and the angle upon which it is based, core material, cover material if different from core material and number of legs, if more than one)
2. Acid or caustic burns
3. Evidence of heat damage
4. Holes, tears, cuts, abrasive wear or snags that expose core yarns
5. Broken or damaged core yarns
6. Weld spatter that exposes core yarns
7. Knots in the round sling except for core yarns inside the cover
8. Fittings that are pitted, corroded, cracked, bent, twisted, gouged, or broken (Refer to the proper standard for full removal from service criteria: ASME B30.10 for hooks or ASME B30.26 for rigging hardware)
9. Any other conditions, including visible damage that cause doubt to the continued use of the sling

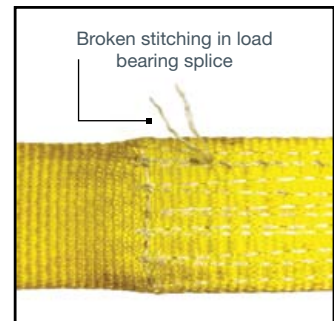
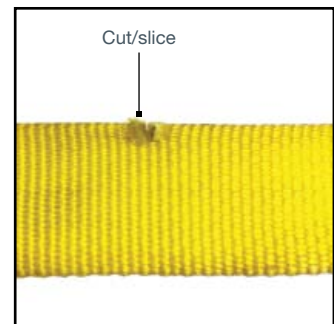

Source: American Society of Mechanical Engineers

## UNDERSTANDING & CALCULATING BEARING STRESS

Bearing stress is an important, but commonly overlooked, calculation to ensure safe sling use. This calculation will determine how much stress a sling is seeing in the working area of the shackle.

Per WSTDA, the recommended bearing stress value is 7,000 lbs./sq. in. or less. This calculation should be done any time a lift is being conducted with a synthetic strap and connecting hardware.

To calculate bearing stress, follow the calculations below:

### DETERMINE EFFECTIVE WIDTH:

This is the width the sling can use inside of a shackle.

**Effective Width = Shackle Width (catalog width from the manufacturer) x .75**

### DETERMINE LOAD BEARING AREA:

This is the area the sling is in contact with.

**Load Bearing Area = Hardware Diameter x Effective Width**

### DETERMINE BEARING STRESS AT HARDWARE CONNECTION:

Should be 7,000 lbs./sq. in. or less to prevent damage to the sling.

**Bearing Stress = Sling Load (IN POUNDS) ÷ Load Bearing Area**

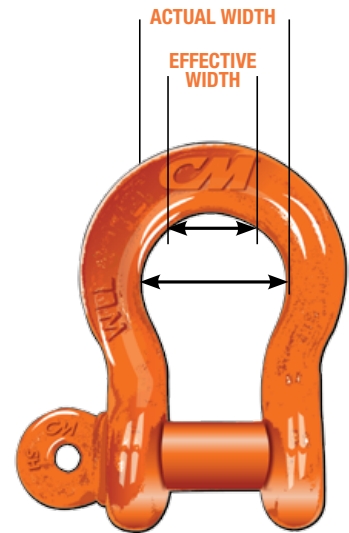

Source: WSTDA 4.7.1.1 – 4.7.1.3

# SYNTHETIC WEB SLING WORKING LOAD LIMITS

## SYNTHETIC WEB SLING (EYE & EYE) WORKING LOAD LIMITS

EE LIGHT DUTY (CLASS 5) (1-PLY & 2-PLY)

Synthetic Sling Size (in.)	Working Load Limit (lbs.)			Working Load Limit (lbs.)		
	Vertical	Choker	Vertical Basket 90°	Two Leg or Single Basket		
				60°	45°	30°
<b>1-PLY, CLASS 5, EE LIGHT DUTY</b>						
1	1,100	880	2,200	1,905	1,555	1,100
1-1/2	1,600	1,280	3,200	2,771	2,262	1,600
1-3/4	1,900	1,520	3,800	3,291	2,687	1,900
2	2,200	1,760	4,400	3,810	3,111	2,200
3	3,300	2,640	6,600	5,716	4,666	3,300
4	4,400	3,520	8,800	7,621	6,222	4,400
5	5,500	4,400	11,000	9,526	7,777	5,500
6	6,600	5,280	13,200	11,431	9,332	6,600
<b>2-PLY, CLASS 5, EE LIGHT DUTY</b>						
1	2,200	1,760	4,400	3,810	3,111	2,200
1-1/2	3,300	2,640	6,600	5,716	4,666	3,300
1-3/4	3,800	3,040	7,600	6,582	5,373	3,800
2	4,400	3,520	8,800	7,621	6,222	4,400
3	6,600	5,280	13,200	11,431	9,332	6,600
4	8,200	6,560	16,400	14,202	11,595	8,200
5	10,200	8,160	20,400	17,666	14,423	10,200
6	12,300	9,840	24,600	21,304	17,392	12,300

## SYNTHETIC WEB SLING (ENDLESS) WORKING LOAD LIMITS

EN LIGHT DUTY (CLASS 5) (1-PLY & 2-PLY) (TYPE V)

Synthetic Sling Size (in.)	Working Load Limit (lbs.)			Working Load Limit (lbs.)		
	Endless Vertical	Choker	Vertical Basket 90°	Two Leg or Single Basket		
				60°	45°	30°
<b>1-PLY, CLASS 5, EN LIGHT DUTY</b>						
1	2,200	1,760	4,400	3,810	3,111	2,200
1-1/2	3,200	2,560	6,400	5,542	4,525	3,200
1-3/4	3,800	3,040	7,600	6,582	5,373	3,800
2	4,400	3,520	8,800	7,621	6,222	4,400
3	6,600	5,280	13,200	11,431	9,332	6,600
4	8,800	7,040	17,600	15,242	12,443	8,800
5	11,000	8,800	22,000	19,052	15,554	11,000
6	13,200	10,560	26,400	22,862	18,665	13,200
<b>2-PLY, CLASS 5, EN LIGHT DUTY</b>						
1	4,400	3,520	8,800	7,621	6,222	4,400
1-1/2	6,600	5,280	13,200	11,431	9,332	6,600
1-3/4	7,600	6,080	15,200	13,163	10,746	7,600
2	8,800	7,040	17,600	15,242	12,443	8,800
3	13,200	10,560	26,400	22,862	18,665	13,200
4	16,400	13,120	32,800	28,405	23,190	16,400
5	20,400	16,320	40,800	35,333	28,846	20,400
6	24,600	19,680	49,200	42,607	34,784	24,600

## SYNTHETIC WEB SLING (EYE & EYE) WORKING LOAD LIMITS

EE HEAVY DUTY (CLASS 7) (1-PLY & 2-PLY)

Synthetic Sling Size (in.)	Working Load Limit (lbs.)			Working Load Limit (lbs.)		
	Vertical	Choker	Vertical Basket 90°	Two Leg or Single Basket		
				60°	45°	30°
<b>1-PLY, CLASS 7, EE HEAVY DUTY</b>						
1	1,600	1,280	3,200	2,771	2,262	1,600
1-1/2	2,300	1,840	4,600	3,984	3,252	2,300
1-3/4	2,700	2,160	5,400	4,676	3,818	2,700
2	3,100	2,480	6,200	5,369	4,383	3,100
3	4,700	3,760	9,400	8,140	6,646	4,700
4	6,200	4,960	12,400	10,738	8,767	6,200
5	7,800	6,240	15,600	13,510	11,029	7,800
6	9,300	7,440	18,600	16,108	13,150	9,300
8	11,800	9,440	23,600	20,438	16,685	11,800
10	14,700	11,760	29,400	25,460	20,786	14,700
12	17,600	14,080	35,200	30,483	24,886	17,600
<b>2-PLY, CLASS 7, EE HEAVY DUTY</b>						
1	3,100	2,480	6,200	5,369	4,383	3,100
1-1/2	4,700	3,760	9,400	8,140	6,646	4,700
1-3/4	5,400	4,320	10,800	9,353	7,636	5,400
2	6,200	4,960	12,400	10,738	8,767	6,200
3	8,800	7,040	17,600	15,242	12,443	8,800
4	11,000	8,800	22,000	19,052	15,554	11,000
5	13,700	10,960	27,400	23,728	19,372	13,700
6	16,500	13,200	33,000	28,578	23,331	16,500
8	22,700	18,160	45,400	39,316	32,098	22,700
10	28,400	22,720	56,800	49,189	40,158	28,400
12	34,100	27,280	68,200	59,061	48,217	34,100

## SYNTHETIC WEB SLING (ENDLESS) WORKING LOAD LIMITS

EN HEAVY DUTY (CLASS 7) (2-PLY) (TYPE V)

Synthetic Sling Size (in.)	Working Load Limit (lbs.)			Working Load Limit (lbs.)		
	Endless Vertical	Single Choker	Vertical Basket 90°	Two Leg or Single Basket		
				60°	45°	30°
1	6,200	4,960	12,400	10,738	8,767	6,200
1-1/2	9,400	7,520	18,800	16,281	13,262	9,400
1-3/4	10,800	8,640	21,600	18,706	15,271	10,800
2	12,400	9,920	24,800	21,477	17,534	12,400
3	17,600	14,080	35,200	30,483	24,886	17,600
4	22,000	17,600	44,000	38,104	31,108	22,000
5	27,400	21,920	54,800	47,457	38,744	27,400
6	33,000	26,400	66,000	57,156	46,662	33,000
8	42,350	33,880	84,600	74,801	59,812	42,300
10	52,900	42,320	105,800	91,623	74,801	52,900
12	63,500	50,800	127,000	109,982	89,789	63,500

SLING INSPECTION, USE & CARE

# SYNTHETIC ROUNDSLING WORKING LOAD LIMITS

## SYNTHETIC ROUNDSLING WORKING LOAD LIMITS

FOR VERTICAL & CHOKER HITCHES

Size	Working Load Limit (lbs.)		Minimum Diameter	
	Vertical	Choker	Decimals (in.)	Fractions (in.)
1	2,600	2,100	.5	1/2
2	5,300	4,200	.625	5/8
3	8,400	6,700	.75	3/4
4	10,600	8,500	.875	7/8
5	13,200	10,600	1	1
6	16,800	13,400	1.125	1-1/8
7	21,200	17,000	1.375	1-3/16
8	25,000	20,000	1.25	1-1/4
9	31,000	24,800	1.5	1-1/2
10	40,000	32,000	1.625	1-5/8
11	53,000	42,400	2	2
12	66,000	52,800	2.125	2-1/8
13	90,000	72,000	2.5	2-1/2



Chart is for reference only. Product not sold by Columbus McKinnon Corporation.

Always verify information on sling tag. © Copyright 1994 by Web Sling & Tie Down Association. Never choke into the eye of hooks, bows of shackles and shackle pins and/or other rigging hardware.

SLING INSPECTION, USE & CARE

## SYNTHETIC ROUNDSLING WORKING LOAD LIMITS

FOR BASKET HITCHES

Size	Working Load Limit (lbs.)				Minimum Diameter	
	Basket				Decimals (in.)	Fractions (in.)
	90°	60°	45°	30°		
1	5,200	4,500	3,700	2,600	.625	5/8
2	10,600	9,200	7,500	5,300	.875	7/8
3	16,800	14,500	11,900	8,400	1.0625	1-1/16
4	21,200	18,400	15,000	10,600	1.25	1-1/4
5	26,400	22,900	18,700	13,200	1.375	1-3/8
6	33,600	29,100	23,800	16,800	1.625	1-5/8
7	42,400	36,700	30,000	21,200	1.625	1-5/8
8	50,000	43,300	35,400	25,000	1.875	1-7/8
9	62,000	53,700	43,800	31,000	2	2
10	80,000	69,300	56,600	40,000	2.375	2-3/8
11	106,000	91,800	74,900	53,000	2.75	2-3/4
12	132,000	114,300	93,300	66,000	3	3
13	180,000	155,900	127,300	90,000	3.5	3-1/2

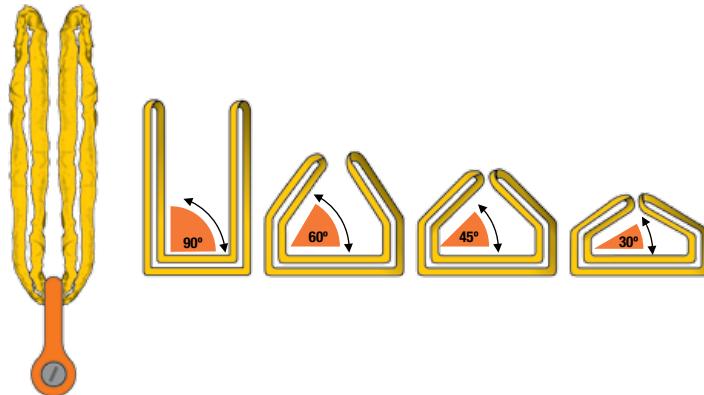

Chart is for reference only. Product not sold by Columbus McKinnon Corporation.

Always verify information on sling tag. © Copyright 1994 by Web Sling & Tie Down Association. Never choke into the eye of hooks, bows of shackles and shackle pins and/or other rigging hardware.

## SYNTHETIC ROUNDSLING COLOR CHART

IDENTIFYING SLINGS BY COLOR

Industry norms only. Be sure to consult the sling tag and confirm manufacturer's sling working load limits prior to use.

Size	Color	Working Load Limit (lbs.)		
		Vertical	Choker	Basket 90°
1	Purple	2,600	2,100	5,200
2	Green	5,300	4,200	10,600
3	Yellow	8,400	6,700	16,800
4	Tan	10,600	8,500	21,200
5	Red	13,200	10,600	26,400
6	White	16,800	13,400	33,600
7	Blue	21,200	17,000	42,400

# WIRE ROPE SLING WORKING LOAD LIMITS

6X19 AND 6X36 CLASS

SLING INSPECTION,  
USE & CARE

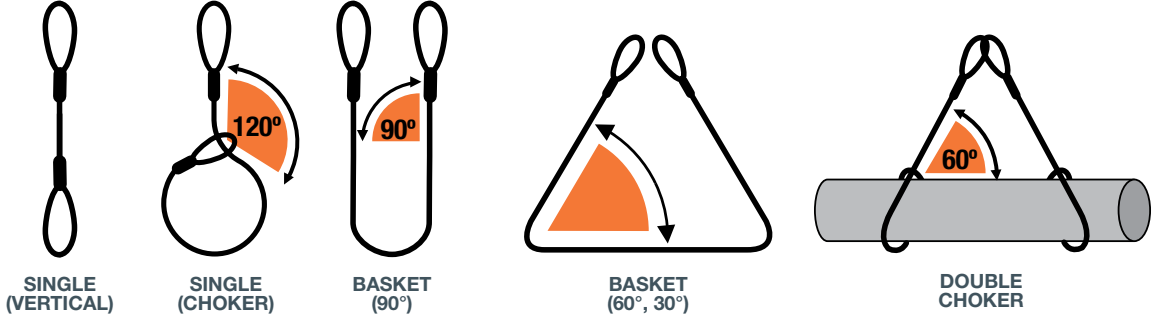

Wire Rope Size	WORKING LOAD LIMIT (TONS)						
	Single (1 Leg) Vertical	Single Choker	Basket 90°	Basket 60°	Basket 30°	Double Choker (2 Chokers)	
						60°	30°
<b>EIPS-MS-IWRC (EXTRA IMPROVED PLOW STEEL, MECHANICAL SPLICE, INDEPENDENT WIRE ROPE CORE)</b>							
1/4"	0.65	0.48	1.30	1.10	0.65	0.82	0.48
5/16"	1.00	0.74	2.00	1.70	1.00	1.30	0.74
3/8"	1.40	1.10	2.90	2.50	1.40	1.80	1.10
7/16"	1.90	1.40	3.90	3.40	1.90	2.50	1.40
1/2"	2.50	1.90	5.10	4.40	2.50	3.20	1.90
9/16"	3.20	2.40	6.40	5.50	3.20	4.10	2.40
5/8"	3.90	2.90	7.80	6.80	3.90	5.00	2.90
3/4"	5.60	4.10	11.00	9.70	5.60	7.10	4.10
7/8"	7.60	5.60	15.00	13.00	7.60	9.70	5.60
1"	9.80	7.20	20.00	17.00	9.80	13.00	7.20
1-1/8"	12.00	9.10	24.00	21.00	12.00	16.00	9.10
1-1/4"	15.00	11.00	30.00	26.00	15.00	19.00	11.00
1-3/8"	18.00	13.00	36.00	31.00	18.00	23.00	13.00
1-1/2"	21.00	16.00	42.00	37.00	21.00	28.00	16.00
1-5/8"	24.00	18.00	49.00	42.00	24.00	32.00	18.00
1-3/4"	28.00	21.00	57.00	49.00	28.00	37.00	21.00
1-7/8"	32.00	24.00	64.00	56.00	32.00	42.00	24.00
2"	37.00	28.00	73.00	63.00	37.00	48.00	28.00

Wire Rope Size	WORKING LOAD LIMIT (TONS)						
	Single (1 Leg) Vertical	Single Choker	Basket 90°	Basket 60°	Basket 30°	Double Choker (2 Chokers)	
						60°	30°
<b>EEIPS-MS (EXTRA-EXTRA IMPROVED PLOW STEEL, MECHANICAL SPLICE)</b>							
1/4"	0.71	0.52	1.40	1.20	0.71	0.90	0.52
5/16"	1.10	0.81	2.20	1.90	1.10	1.40	0.81
3/8"	1.60	1.20	3.20	2.70	1.60	2.00	1.20
7/16"	2.10	1.60	4.30	3.70	2.10	2.70	1.60
1/2"	2.80	2.00	5.50	4.80	2.80	3.50	2.00
9/16"	3.50	2.60	7.00	6.10	3.50	4.50	2.60
5/8"	4.30	3.20	8.60	7.50	4.30	5.50	3.20
3/4"	6.20	4.50	12.00	11.00	6.20	7.90	4.50
7/8"	8.30	6.10	17.00	14.00	8.30	11.00	6.10
1"	11.00	8.00	22.00	19.00	11.00	14.00	8.00

Chart is for reference only. Product not sold by Columbus McKinnon Corporation.  
 Based on OSHA standards - Always use the sling tag for the working load limits or consult sling manufacturer.  
 Note: Rated loads based on a minimum D/d of 25:1  
 Values listed in US tons.



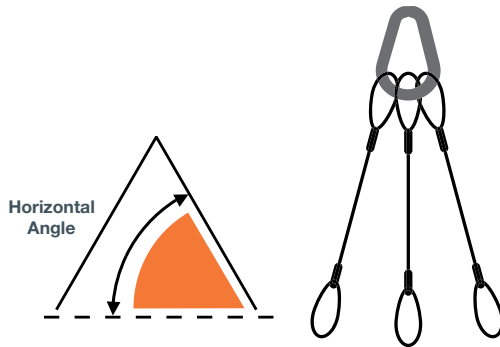

### 3-LEG BRIDLE

6X19 AND 6X36 CLASS

Wire Rope Size (in.)	WORKING LOAD LIMIT (TONS)			
	Vertical	60°	45°	30°
<b>EIPS-MS-IWRC (EXTRA IMPROVED PLOW STEEL, MECHANICAL SPLICE, INDEPENDENT WIRE ROPE CORE)</b>				
1/4	1.90	1.70	1.40	0.97
5/16	3.00	2.60	2.10	1.50
3/8	4.30	3.70	3.00	2.20
7/16	5.80	5.00	4.10	2.90
1/2	7.60	6.60	5.40	3.80
9/16	9.60	8.30	6.80	4.80
5/8	12.00	10.00	8.30	5.90
3/4	17.00	15.00	12.00	8.40
7/8	23.00	20.00	16.00	11.00
1	29.00	26.00	21.00	15.00
1-1/8	36.00	31.00	26.00	18.00
1-1/4	44.00	38.00	31.00	22.00
1-3/8	53.00	46.00	38.00	27.00
1-1/2	63.00	55.00	45.00	32.00
1-5/8	73.00	63.00	52.00	37.00
1-3/4	85.00	74.00	60.00	42.00
1-7/8	97.00	84.00	68.00	48.00
2	110.00	95.00	78.00	55.00

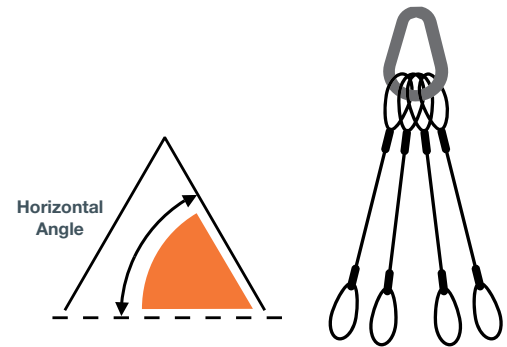

### 4-LEG BRIDLE

6X19 AND 6X36 CLASS

Wire Rope Size (in.)	WORKING LOAD LIMIT (TONS)			
	Vertical	60°	45°	30°
<b>EIPS-MS-IWRC (EXTRA IMPROVED PLOW STEEL, MECHANICAL SPLICE, INDEPENDENT WIRE ROPE CORE)</b>				
1/4	2.6	2.2	1.8	1.3
5/16	4.0	3.5	2.8	2.0
3/8	5.7	5.0	4.1	2.9
7/16	7.8	6.7	5.5	3.9
1/2	10.0	8.8	7.1	5.1
9/16	13.0	11.0	9.0	6.4
5/8	16.0	14.0	11.0	7.8
3/4	22.0	19.0	16.0	11.0
7/8	30.0	26.0	21.0	15.0
1	39.0	34.0	28.0	20.0
1-1/8	48.0	42.0	34.0	24.0
1-1/4	59.0	51.0	42.0	30.0
1-3/8	71.0	62.0	50.0	36.0
1-1/2	84.0	73.0	60.0	42.0
1-5/8	98.0	85.0	69.0	49.0
1-3/4	113.0	98.0	80.0	57.0
1-7/8	129.0	112.0	91.0	64.0
2	147.0	127.0	104.0	73.0

SLING INSPECTION,  
USE & CARE

Chart is for reference only. Product not sold by Columbus McKinnon Corporation.

Based on OSHA standards - Always use the sling tag for the working load limits or consult sling manufacturer.

Note: Rated loads based on a minimum D/d of 25:1

Values listed in US tons.



# RIGGING TRAINING

Columbus McKinnon is a global leader in providing expertise and training in the proper use and inspection of rigging and overhead lifting equipment. With a range of comprehensive programs conducted at venues throughout North America, as well as on site at private companies, we have a large course offering perfect for virtually any industry or application. Our rigging courses include:

## **QUALIFIED RIGGER HANDS-ON WORKSHOP**

INCLUDES LEVEL 1 BASIC RIGGING, LEVEL 2 ADVANCED RIGGING & RIGGING GEAR & SLING INSPECTION (THOSE COURSES MAY ALSO BE TAKEN INDIVIDUALLY)

This 3-day workshop will prepare students to take the nationally accredited CIC Rigger/Signalperson Certification Exam and Level 2 Advanced Qualified Rigger Certification Exam. Businesses may wish to seek certification as a way to verify and promote their employees' knowledge of rigging.

## **LEVEL 1: BASIC RIGGING & SIGNAL PERSON TRAINING**

Learn how to properly select, inspect and use slings and rigging hardware. Students will learn the requirements of OSHA regulations and ASME guidelines. Course also covers basic hitches, effects on working load limits, limitations of rigging equipment, load chart interpretation, proper knot tying and hand signals.

## **LEVEL 2: ADVANCED RIGGING**

This course covers all aspects of Level 1 Basic Rigging as well as rigging math, calculating load weights, center of gravities, share of loads, sling tensions, load drifts and rigging block loads. Calculations are then applied in the hands-on rigging center.

## **RIGGING GEAR & SLING INSPECTION**

Participants learn how to properly inspect chain, wire rope and synthetic slings, below-the-hook lifting devices, manual hoists and rigging hardware. Inspections are performed per OSHA, ASME and manufacturers' guidelines. This course is designed for riggers, sales people, and technicians who only inspect rigging gear.

## **RIGGING: TRAIN THE TRAINER**

This workshop incorporates topics covered in Level 1: Basic Rigging & Signalperson, Rigging Gear Inspection and Level 2 Advanced Rigging coupled with hands-on rigging training.

## **LOAD SECUREMENT**

Course is designed to educate those responsible for securing loads on over-the-road transportation vehicles and those responsible for enforcement. Course information is based on the North American Cargo Securement Standard incorporated in the regulations for the United States and Canada.

## **LOAD SECUREMENT: TRAIN THE TRAINER**

This workshop is designed for companies needing to develop an in-house training program to educate those responsible for securing loads on over-the-road transportation vehicles and those responsible for enforcement. Participants then learn how to develop proper training/communications techniques, exercises, workshops and equipment required to deliver professional presentations. Course information is based on the North American Cargo Securement Standard incorporated in the regulations for the United States and Canada.

For a list of all rigging training available from Columbus McKinnon visit [www.cmworks.com](http://www.cmworks.com)



# CMCO UNIVERSITY™

CMCO University™ is an intense two-day program designed to elevate your sales revenue by giving you an intimate knowledge of our products, the information you'll need to select and sell the right product for the application, and the know-how to win in the marketplace.

If you are a CMCO Channel Partner and are interested in learning about our portfolio, product features and benefits, applications, proper product selection, and how to sell against competitive products, this is a must attend course.

## KNOWLEDGE TO SALES

It's a fact — the more comfortable a sales force is with the product they're selling, the higher the conversion rate. With a deeper and wider breadth of understanding for an entire product line, a sales force will establish themselves as product and application knowledge leaders. That translates into stronger customer relationships, which in turn will lead to more sales.

## OUR VISION, YOUR SUCCESS

CMCO University was conceived and designed by our staff of full-time professional instructors along with an advisory committee of product managers, sales leaders and industry specialists to do one thing — arm our Channel Partners with the knowledge they need to convert sales and generate revenue.

During the two-day program at CMCO University, attendees will have an opportunity to get hands-on experience using most of our products. For example, rather than simply speaking to the benefits of alloy chain and hooks, students will be able to see and participate in live rigging demonstrations.

Some of the topics covered in the classroom training and hands-on product demonstrations include:

- Overview of the CMCO product portfolio – manual hoists, powered hoists, crane components, chain and rigging
- Meet Our Associates – Customer Service, Management & Application Teams
- Features & Benefits of Our Products
- Applications & Industries
- CMCO Difference Against Competition
- Advantages of Pricing & Sales Programs
- Benefits to Selling & Promoting Training

## NIAGARA TRAINING CENTER

Columbus McKinnon's corporate headquarters in Getzville, New York, is home to our state-of-the-art Niagara Training Center. The 3,000-square-foot facility is dedicated to training Channel Partners and end users on the safe and proper use of hoist and rigging products. The Center offers a one-of-a-kind training experience on chain and rigging equipment with more than 75 manual and powered hoists, enclosed track systems and our 50-foot-wide crane system with 3-ton Yale Global King wire rope hoist.



## UNIVERSITY BENEFITS

Graduates of CMCO University will possess an intimate knowledge of all Columbus McKinnon brand overhead cranes, hoists and rigging products; as well as real world insight and instruction on how to best position, promote, and sell them. In addition to having a command of our product portfolio, graduates will be prepared to leverage our company's 141 years of product and application expertise to increase sales. New to the industry or veterans, outside sales or inside; we are confident that graduates of CMCO University will be better equipped to sell more product and to sell it better.

## REGISTRATION

There is no registration fee to attend CMCO University. Students are responsible for their travel and hotel expenses. Daily after-class activities, including dinner events, will be announced as the class session approaches. Prior to attending the training, we ask that all registered students review a pre-course presentation to familiarize themselves with our company and products. This information is a great foundation for the on-site training.





# SHACKLES

## GENERAL INFORMATION

Design and Development .....	46
Forging Versus Casting .....	46
Standard and Specialty Shackles .....	47
Material and Finishes .....	48
Use, Care & Inspection .....	49
Specifications & Comparison Testing .....	50

## PRODUCT OFFERING

Super Strong Anchor Shackles .....	51
Super Strong Chain Shackles .....	52
Alloy Anchor Shackles .....	53
Carbon Anchor Shackles (Industrial/Government Rated) .....	54
Carbon Chain Shackles (Industrial/Government Rated) .....	55
Web Sling Shackles (Carbon & Alloy) .....	56
Trawling Shackles .....	57
Long Reach Shackles .....	57

Columbus McKinnon is proud to offer some of the strongest and most reliable shackles on the market. Manufactured in the U.S.A. through our state-of-the-art forging process, CM shackles are available in a variety of different styles and materials for virtually any rigging application.

**DESIGN & DEVELOPMENT**

**SPECIFICATIONS**

When manufacturing our shackles, Columbus McKinnon utilizes state-of-the-art forging equipment. The forging process is closely monitored to ensure consistent quality and the heat treatment process is computer-controlled and monitored to ensure that maximum performance parameters are met.

**Each lot of product is checked to verify that the desired hardness range has been obtained.**

All CM shackles are made from special bar quality material and comply with ASTM A322, ASTM A576 or ASTM A921. Galvanized shackles meet ASTM A153 or ASTM B695. Pins and bolts meet SAE J429 and ASTM A354.

CM shackles meet or exceed the performance requirements of the specs listed below:

- ASME B30.26    ■ ANSI B18
- EN 13889      ■ ISO 2415

CM also offers shackles that meet U.S. Government Specification RR-C-271.

Every CM shackle is marked with an alpha-numeric trace code. For full information on CM shackle identification markings, see the Shackle Identification box to the right.

**ENGINEERING & TESTING REQUIREMENTS**

Columbus McKinnon has the capability to apply fracture mechanics, predict product life expectancy and conduct a multi-axial fatigue analysis to solve engineering problems related to safety-critical applications.

CM products having strength requirements are sample tested to ensure hardness, ductility and requisite loading parameters. All testing and measuring equipment is calibrated on a periodic basis. CM testing equipment is calibrated to National Institute for Standards and Testing (NIST) requirements. Columbus McKinnon is also ISO 9001:2008 certified.

Certifications for all shackles are available online. RR-C-271 certification is available if requested at time of order.

Columbus McKinnon can also provide the following information if requested at time of order:

- Material certification
- Magnetic particle inspection
- Proof, ultimate, charpy, deformation and fatigue testing

**FORGING VERSUS CASTING**

Forging and casting are two very different manufacturing methods. When something is cast the material is heated above its melting temperature and poured into a mold where it solidifies. When something is forged it is physically forced into shape while remaining in a solid state – although it is frequently heated.

Forged shackles are generally better than cast. Forgings normally have less porosity, finer grain structure, higher tensile strength, better fatigue life and strength, and greater ductility than cast shackles. Why is this the case? When you melt metal to cast it, the grain size is free to expand. When it cools back to a solid, the grain structure is coarser and more random, decreasing its strength. Interior voids are also possible. The diagrams on the right illustrate the difference in grain flow between a forging and a casting.

For these reasons, CM utilizes a best-in-class forging process to ensure our shackles are strong, durable and reliable. All of our forged shackles are made right here in America at our Chattanooga, Tennessee facility.

**CUSTOMIZATION**

CM shackles are always designed to meet internal, customer, contractual and regulatory requirements. Columbus McKinnon has the capability to develop original product designs based on unique customer applications. The CM Engineering department has CAD stations to facilitate design and development activities. New product design and tooling is subject to computerized Finite Element Analysis (FEA) and all drawings are filed electronically.

Custom products, or specials, designed to meet customer requirements require customer approval before the design is finalized.

In addition to product design, Columbus McKinnon also performs tooling and machine design to manufacture and process these products. Tooling that is required is purchased by the customer and remains their proprietary property throughout the life of the product.

**▶ SHACKLE IDENTIFICATION**

**CM shackles and other rigging products can be identified by their unique markings.**

We have taken extra efforts to enhance our shackle identification markings and our products now feature some of the largest and most user-friendly forged identification markings on the market. This innovation improves operator safety, reduces replacement costs and allows for easier identification of CM products in the field.

Every shackle is forged with the CM logo, its body or diameter size in imperial and/or metric units, trace code, USA, "Forged" and its specified strength requirements/working load limit (WLL). Most CM products also carry an alpha-numeric traceability code. Implemented in July 1980, this trace code system enables us to identify and track products once they ship from our plant, as well as determine:

- ▲ Date the product was forged
- ▲ Type and chemistry of steel
- ▲ Heat treating parameters
- ▲ In-process hardness testing results
- ▲ Strength data testing

Design and markings meet or exceed ASME B30.26

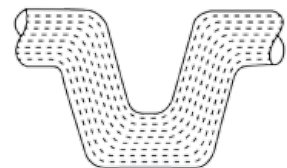

**FORGING**  
 Uniform grain flow gives material higher strength



**CASTING**  
 Random grain flow with larger grain structure makes material weaker than forged products

SHACKLES

## STANDARD & SPECIALTY SHACKLES

CM offers a full line of forged chain and anchor shackles for standard and specialty applications that are made right here in America. Chain shackles are best used for straight-line pulls, while anchor shackles have a more generous loop that allows them to be side loaded or used for multiple connections.

### STANDARD:

#### SCREW PIN SHACKLES

Screw Pin Shackles allow for quick and easy removal of the screw pin, which makes this style ideal for applications where the shackle is removed frequently. While the threaded pin can resist axial forces, it should not be cyclically loaded and is unreliable and vulnerable to backing out in applications where the pin is subjected to a torque or twisting action. In some applications, it is recommended to mouse the screw pin to prevent the pin from unscrewing. **Recommended for overhead lifting**, screw pin shackles are available in Super Strong, carbon and alloy steel with capacities up to 43 tons.

Shackles meet ASME B30.26. They also meet the performance and dimensional requirements of RR-C-271.



#### BOLT, NUT & COTTER SHACKLES

Of all shackle types, Bolt, Nut and Cotter Shackles provide the most secure pin arrangement, resisting axial and torsional loading. This type of shackle should be used in semi-permanent applications where the pin is removed infrequently.

**Recommended for overhead lifting**, bolt, nut and cotter shackles are available in Super Strong, carbon and alloy steel with capacities up to 120 tons.

Shackles meet ASME B30.26. They also meet the performance and dimensional requirements of RR-C-271.



#### ROUND PIN SHACKLES

Round Pin Shackles allow for easy removal by simply removing the cotter that holds the pin in place. These shackles perform well where the pin is subjected to a torque or twisting action, but are not best for use where the pin is subject to an axial load.

Round pin shackles are **not recommended for overhead lifting or side loaded**. They feature a forged, heat-treated steel body with forged, heat-treated alloy steel pin and are available in Super Strong, carbon and alloy steel with capacities up to 43 tons.

Shackles meet the performance and dimensional requirements of RR-C-271.



### SPECIALTY:

#### WEB SLING SHACKLES

Designed primarily for use with a synthetic web and round slings up to 6" in width. Available in capacities up to 12 tons. Body is made of carbon steel or heat-treated alloy steel.

NOTE: Shackles cannot be point loaded. The load should be evenly distributed over the entire pin to achieve full working load limit.

#### LONG REACH SHACKLES

Made of alloy steel, CM is one of the only manufacturers of long reach shackles. These shackles are ideal for use in construction applications where a longer reach is needed to attach to pick points, and can also be used as a bail for lifting thicker products.

NOTE: Shackles cannot be side loaded. The load should be evenly distributed over the entire pin to achieve full working load limit.



# SHACKLE MATERIAL & FINISHES

## MATERIALS

CM forged shackles are made exclusively from domestically produced (U.S.A.) Special Bar Quality (SBQ) steel having fine grain, with reduced sulfur and phosphorus. Silicon inclusions and oxide inclusions are minimized to enhance forging performance characteristics. Steel used in our products may include, but is not restricted to the following:

- Carbon Steel 1037, 1020, 1040, 1080, 1141
- Microalloy Steel
- Alloy 4130, 4140, 8630, 8640

Using this Special Bar Quality steel, CM manufactures shackles in three distinct materials: carbon, super strong and alloy. Each material has different properties and specifications. See our complete material comparison below.

## 3 TYPES OF SHACKLE MATERIAL

MATERIAL	STYLE	WLL (TONS)	SIZES (IN.)	STYLES	DESIGN FACTOR	FINISHES
<b>CARBON</b>	<b>Anchor</b>	1/3 to 85 tons	3/16" to 3"	Bolt, Nut & Cotter; Screw Pin; Round Pin	6:1*	Orange Powder Coated, Galvanized
	<b>Chain</b>	1/2 to 35 tons	1/4" to 2"			
<b>CARBON SPECIFICATIONS:</b> Meet dimensional, performance and marking requirements of Federal Specification RR-C-271 (Regular Strength).						
<b>SUPER STRONG</b> 17 to 50% stronger than comparable-sized Carbon	<b>Anchor</b>	1/2 to 55 tons	3/16" to 2-1/2"	Bolt, Nut & Cotter; Screw Pin; Round Pin	6:1**	Orange Powder Coated, Self Colored, Galvanized
	<b>Chain</b>	3/4 to 35 tons	1/4" to 2"			
<b>SUPER STRONG SPECIFICATIONS:</b> Meet dimensional and exceed performance requirements of Federal Specification RR-C-271 (Regular Strength). Because they exceed requirements and are marked with higher strengths, they cannot be marked as meeting RR-C-271.						
<b>ALLOY (U.S.)</b> ~50% stronger than comparable-sized Carbon and ~25% stronger than Super Strong	<b>Anchor</b>	2 to 120 tons	3/8" to 3"	Bolt, Nut & Cotter; Screw Pin; Round Pin	5:1	Orange Powder Coated, Self Colored, Galvanized
<b>ALLOY SPECIFICATIONS:</b> Meet dimensional, performance and marking requirements of Federal Specification RR-C-271 (High Strength).						

\* 2-1/2" and 3" carbon shackles have a 5:1 design factor.

\*\* Round pin and all 2-1/2" Super Strong shackles have a 5:1 design factor.

## FINISHES

CM shackles are available in three finishes: galvanized, self-colored and the recognizable CM orange powder coating.

### GALVANIZED

Provides the best corrosive protection of all finishes which prevents it from wearing over time. Meets ASTM standards.

### SELF-COLORED

Natural steel color easily blends with other steel finishes. Provides no protection from corrosion, but enables full exposure of identification markings.

### CM ORANGE POWDER COATED

Easily recognizable as a CM product. Provides protection from corrosion and harsh environments and allows for visual identification of the manufacturer.



## SHACKLE USE, CARE & INSPECTION

Improper use or care of shackles can result in bodily injury or property damage. Always observe the following guidelines when using shackles.

- Do not exceed the working load limit.
- Do not shock load.
- If the shackle is side loaded, the WLL must be reduced in accordance with the manufacturer's recommendation or a qualified person. Shackles are designed and rated for in-line applied tension. You can attach multiple slings in the body of a shackle without reducing the capacity provided that the shackle is symmetrically loaded and the included angle does not exceed 120 degrees. (See Side Loading and Symmetrical Loading sections).
- Do not replace pin or bolt with other than original equipment.
- Inspect before use for wear, deformation and pin engagement as outlined in ASME B30.26. (See full inspection guidelines below).

Care should be exercised so that the shackle is not abused during use. When using shackles, it is important to:

- If necessary, use spacers on the shackle pin to assure that the shackle is not loaded at an angle. Load line of action should be through the center line of the shackle body and the middle of the shackle pin.
- The shackle should be protected with zinc plating or a galvanized finish if used in harsh environments.
- The shackle should not be subjected to high or low temperatures that could affect thermal treatment and the strength of the shackle. (Note: Per ASME B30.26 shackles are rated for temperatures between -40°F to 400°F.

### SCREW PIN TIGHTENING

When tightening screw pins, it is important that shackle screw pin threads and the tapped threads in the shackle head are clean and free of burrs and damage. These conditions can cause an under-tightening of the shackle screw pin. The shackle screw pin should be tightly fitted into the shackle's leg opening until the threads engage and the shoulder of the screw pin makes contact with shackle body.

### SIDE LOADING

When side loading a shackle with a single sling, the rated WLL will be reduced in accordance with the manufacturer's recommendation or a qualified person. ASME B30.26 also recommends reducing the capacity of a shackle when it is side loaded. (See figure below.) Note that only anchor shackles 3/16" to 3" may be side loaded. Chain or long-reach shackles should not be side loaded.

#### ANCHOR SHACKLES SIZES 3/16" TO 3"

Angles in Degrees	Working Load Limit Reduction
0° to 10°	0%
11° to 20°	15%
21° to 30°	25%
31° to 45°	30%
46° to 55°	40%
56° to 70°	45%
71° to 90°	50%

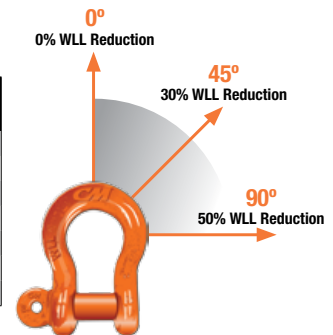

### SYMMETRICAL LOADING

Shackles symmetrically loaded with two legs at a maximum included angle of 120° can be used to full working load limit. Side and symmetrical loading data applies to screw pin and bolt nut cotter anchor shackles as shown to the right.

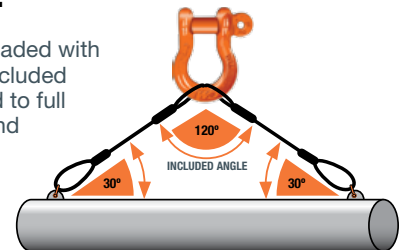

### SHACKLE INSPECTION

Shackles should be visually inspected before each use in line with ASME B30.26 regulations. Shackles should be discarded if any of the following conditions are apparent:

- ▲ Any parts are worn more than 10% of the original dimensions
- ▲ Load bearing components are bent, twisted, distorted, stretched, elongated, cracked or broken
- ▲ Excessive pitting, corrosion, nicks or gouges
- ▲ Indication of heat damage
- ▲ Missing or illegible manufacturer's name or trademark, working load limit or size
- ▲ Load pins have bent or visibly damaged threads
- ▲ Cotter pins or hairpin retainers are damaged

**CHARPY IMPACT TEST**

The Charpy V-Notch Test was developed during World War 2 to test the penetration resistance of steel armor. It has since evolved into a method to test for toughness of steel in critical structures such as buildings or bridges.

In this test, a bar is mounted horizontally with the notch facing away from an impact weight suspended on a pendulum. When the weight is released, it swings down and breaks through the bar. An indicator measures how far the pendulum continues to swing after breaking the bar. The momentum of the pendulum is then the measure of the resistance of the material to breaking or penetration.

CM Super Strong shackles, with the lower hardness values, will consistently pull more than a competitor's carbon shackles of the same diameter. CM Super Strong shackles were designed to improve overall load strength and ductility without an increase in shackle diameter.

CM alloy shackles will meet the Charpy Impact Test requirements. Results of this testing show that CM Super Strong shackles greatly exceed the minimum strength requirements.

**RESULTS OF COMPARISON TESTING**  
**CM SUPER STRONG SHACKLES VERSUS STANDARD CARBON SHACKLES**

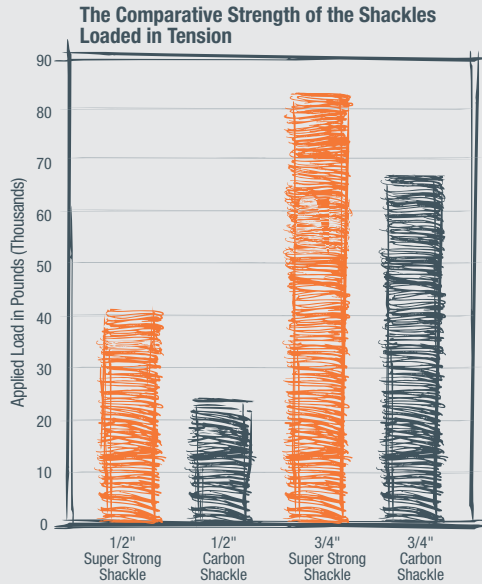

"Clearly the CM Big Orange<sup>®</sup> shackles exhibited superior strength and more ductility than the carbon steel shackles of the same nominal section size. While all of the shackles performed above their ratings, the CM Big Orange shackle performance was superior.

The CM Big Orange<sup>®</sup> shock test results indicated severe deformation occurred but no fracture was present. The carbon steel parts fractured in two tests and were severely cracked in a third test. These results indicate that the CM Big Orange shackle assembly is stronger and more ductile than the carbon steel shackle of the same size. For these reasons, the CM Big Orange shackle provides more extensive deformation prior to fracture. In conclusion, this test demonstrates the superiority of the CM Big Orange shackles when compared to the carbon steel shackles under the shock loaded conditions."

Verified by John Bloodworth, P.E.  
 Q.C. Metallurgical Laboratory, Inc.

\* CM Big Orange<sup>®</sup> shackles are now referred to as CM Super Strong shackles.

**SHACKLE SPECIFICATIONS**

**DIMENSIONS & WORKING LOAD LIMITS**

CM shackles are available in different dimensions with varying working load limits depending on the material they are made of. See the charts below for sizes and working load limits of our alloy, carbon and super strong shackles.

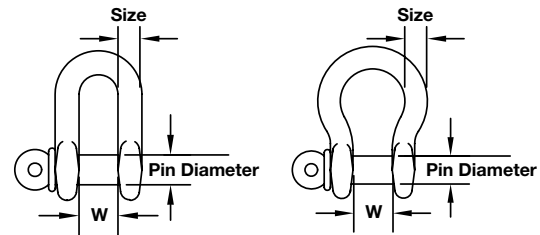

**CARBON**

Size (in.)	WLL (tons)	WLL (lbs.)	Pin Dia. (in.)	W dim. (in.)
3/16	1/3	667	0.25	0.38
1/4	1/2	1,000	0.31	0.47
5/16	3/4	1,500	0.38	0.53
3/8	1	2,000	0.44	0.66
7/16	1-1/2	3,000	0.50	0.72
1/2	2	4,000	0.63	0.84
5/8	3-1/4	6,500	0.75	1.06
3/4	4-3/4	9,500	0.88	1.28
7/8	6-1/2	13,000	1.00	1.44
1	8-1/2	17,000	1.13	1.72
1-1/8	9-1/2	19,000	1.25	1.84
1-1/4	12	24,000	1.38	2.03
1-3/8	13-1/2	27,000	1.50	2.25
1-1/2	17	34,000	1.63	2.41
1-5/8	20	40,000	1.75	2.66
1-3/4	25	50,000	2.00	2.94
2	35	70,000	2.25	3.28
2-1/2	55	110,000	2.75	4.13
3	85	170,000	3.25	5.00

**SUPER STRONG**

Size (in.)	WLL (tons)	WLL (lbs.)	Pin Dia. (in.)	W dim. (in.)
3/16	1/2	1,000	0.25	0.38
1/4	3/4	1,500	0.31	0.47
5/16	1	2,000	0.38	0.53
3/8	1-1/2	3,000	0.44	0.66
7/16	2	4,000	0.50	0.72
1/2	3	6,000	0.63	0.84
5/8	4-1/2	9,000	0.75	1.06
3/4	6-1/2	13,000	0.88	1.28
7/8	8-1/2	17,000	1.00	1.44
1	10	20,000	1.13	1.72
1-1/8	12	24,000	1.25	1.84
1-1/4	14	28,000	1.38	2.03
1-3/8	17	34,000	1.50	2.25
1-1/2	20	40,000	1.63	2.41
1-5/8	24	48,000	1.75	2.66
1-3/4	30	60,000	2.00	2.94
2	35	70,000	2.25	3.28
2-1/2	55	110,000	2.75	4.13

**ALLOY**

Size (in.)	WLL (tons)	WLL (lbs.)	Pin Dia. (in.)	W dim. (in.)
3/8	2	4,000	0.44	0.66
7/16	2.6	5,200	0.50	0.72
1/2	3.3	6,600	0.63	0.84
5/8	5	10,000	0.75	1.06
3/4	7	14,000	0.88	1.28
7/8	9.5	19,000	1.00	1.44
1	12.5	25,000	1.13	1.72
1-1/8	15	30,000	1.25	1.84
1-1/4	18	36,000	1.38	2.03
1-3/8	21	42,000	1.50	2.25
1-1/2*	25	50,000	1.63	2.41
1-1/2**	30	60,000	1.63	2.41
1-5/8*	29	58,000	1.75	2.66
1-5/8**	35	70,000	1.75	2.66
1-3/4*	34	68,000	2.00	2.94
1-3/4**	40	80,000	2.00	2.94
2*	43	86,000	2.25	3.28
2**	50	100,000	2.25	3.28
2-1/2**	85	170,000	2.75	4.13
3**	120	240,000	3.25	5.00
3-1/2**	150	300,000	3.75	5.25

\* Screw Pin & Round Pin style only  
 \*\* Bolt, Nut & Cotter style only



# SUPER STRONG ANCHOR SHACKLES

WORKING LOAD LIMIT: 1/2 TO 55 TONS

CM Super Strong Shackles are carbon-type shackles with strength ratings that are 17 to 50% stronger than comparable-sized carbon shackles. As a result, these shackles are designed with a 6:1 design factor. Anchor shackles can be side loaded or used for multiple connections.

## BENEFITS & FEATURES

- Manufactured from technically advanced domestic (U.S.A.) micro alloy steel with optimal hardness for strength and ductility
- Shackles show major deformation before failure
- Working load limit and traceability codes shown as permanent markings on body
- All shackles have alloy quenched and tempered pins
- Available in sizes 3/16" to 2-1/2"
- Available finishes include powder coated, galvanized or self-colored
- Shackles meet dimensional requirements and exceed performance requirements of RR-C-271
- Special testing and certification is available if requested at the time of the order
- Note: Screw pin and bolt/nut/cotter shackles have a 6:1 design factor. 2-1/2" and all round pin shackles have a 5:1 design factor.



Screw Pin

SHACKLES



Round Pin



Bolt, Nut & Cotter

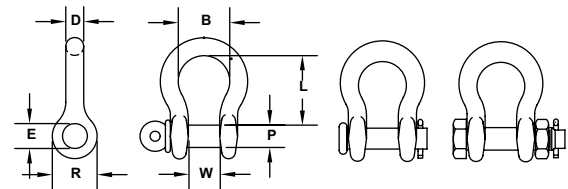

**STYLES:** Screw Pin, Round Pin, Bolt/Nut/Cotter  
**FINISHES:** Self Colored, Galvanized, Orange Powder Coated

Size D (in.)	Working Load Limit (Ton)	Std. Pkg.	Weight (lbs.)	Product Code									Dimensions (in.)					
				Screw Pin			Round Pin			Bolt, Nut & Cotter			P	E	W	R	L	B (min.)
				Self Colored	Galvanized	Orange Powder Coated	Self Colored	Galvanized	Orange Powder Coated	Self Colored	Galvanized	Orange Powder Coated						
3/16	1/2	50	0.06	M645	M645G	-	M345	M345G	-	-	-	-	0.25	0.29	0.38	0.57	0.88	0.58
1/4	3/4	50	0.12	M646	M646G	M646P	M346	M346G	M346P	M846	M846G	M846P	0.31	0.36	0.47	0.75	1.13	0.75
5/16	1	50	0.20	M647	M647G	M647P	M347	M347G	M347P	M847	M847G	M847P	0.38	0.45	0.53	0.84	1.25	0.81
3/8	1-1/2	50	0.30	M648	M648G	M648P	M348	M348G	M348P	M848	M848G	M848P	0.44	0.52	0.66	1.00	1.40	1.00
7/16	2	50	0.50	M649	M649G	M649P	M349	M349G	M349P	M849	M849G	M849P	0.50	0.58	0.72	1.15	1.69	1.19
1/2	3	50	0.75	M650	M650G	M650P	M350	M350G	M350P	M850	M850G	M850P	0.63	0.70	0.84	1.34	1.94	1.38
5/8	4-1/2	25	1.30	M651	M651G	M651P	M351	M351G	M351P	M851	M851G	M851P	0.75	0.83	1.06	1.66	2.41	1.63
3/4	6-1/2	10	2.30	M652	M652G	M652P	M352	M352G	M352P	M852	M852G	M852P	0.88	0.95	1.28	1.94	2.84	1.89
7/8	8-1/2	10	3.50	M653	M653G	M653P	M353	M353G	M353P	M853	M853G	M853P	1.00	1.09	1.44	2.14	3.31	2.06
1	10	5	5.00	M654	M654G	M654P	M354	M354G	M354P	M854	M854G	M854P	1.13	1.22	1.72	2.44	3.75	2.52
1-1/8	12	Bulk	7.00	M655	M655G	M655P	M355	M355G	M355P	M855	M855G	M855P	1.25	1.36	1.84	2.66	4.02	2.69
1-1/4	14	Bulk	9.50	M656	M656G	M656P	M356	M356G	M356P	M856	M856G	M856P	1.38	1.52	2.03	3.15	4.63	2.88
1-3/8	17	Bulk	12.50	M666	M666G	M666P	M366	M366G	M366P	M866	M866G	M866P	1.50	1.65	2.25	3.25	5.19	3.25
1-1/2	20	Bulk	17.20	M657	M657G	M657P	M357	M357G	M357P	M857	M857G	M857P	1.63	1.77	2.41	3.50	5.63	3.50
1-5/8	24	Bulk	23.50	M685	M685G	M685P	M385	M385G	M385P	M885	M885G	M885P	1.75	1.88	2.66	3.91	6.13	4.13
1-3/4	30	Bulk	27.70	M677	M677G	M677P	M377	M377G	M377P	M877	M877G	M877P	2.00	2.13	2.94	4.06	6.97	4.75
2	35	Bulk	39.00	M658	M658G	M658P	M358	M358G	M358P	M858	M858G	M858P	2.25	2.38	3.28	4.51	7.44	5.50
2-1/2	55	Bulk	90.50	-	-	-	-	-	-	MC860	MC860G	-	2.75	2.91	4.13	6.25	10.48	6.75

Check with your sales rep for a list of models eligible for our In-Stock Guarantee.



# SUPER STRONG CHAIN SHACKLES

**WORKING LOAD LIMIT: 3/4 TO 35 TONS**

CM Super Strong Shackles are carbon-type shackles with strength ratings that are 17 to 50% stronger than comparable-sized carbon shackles. As a result, these shackles are designed with a 6:1 design factor. Chain shackles are best suited for straight-line pulls.

## BENEFITS & FEATURES

- Manufactured from technically advanced domestic (U.S.A.) micro alloy steel with optimal hardness for strength and ductility.
- Shackles show major deformation before failure
- Working load limit and traceability codes shown as permanent markings on body
- All shackles have alloy quenched and tempered pins
- Available in sizes 1/4" to 2"
- Available finishes include powder coated, galvanized or self-colored
- Shackles meet dimensional requirements and exceed performance requirements of RR-C-271
- Special testing and certification is available if requested at the time of the order
- Note: Screw pin and bolt/nut/cotter shackles have a 6:1 design factor. Round pin shackles have a 5:1 design factor.



Screw Pin

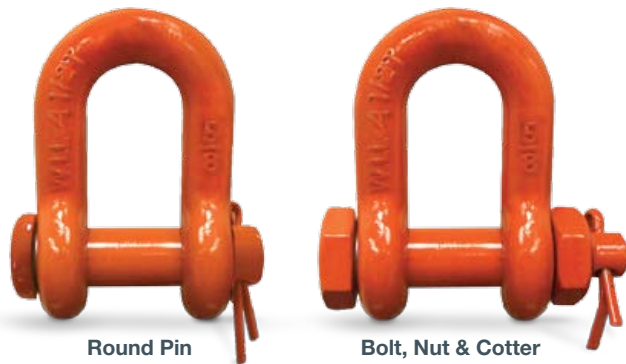

Round Pin

Bolt, Nut & Cotter

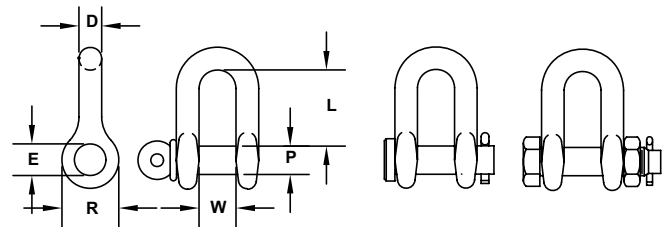

**STYLES:** Screw Pin, Round Pin, Bolt/Nut/Cotter  
**FINISHES:** Self Colored, Galvanized, Orange Powder Coated

Size D (in.)	Working Load Limit (Ton)	Std. Pkg.	Weight (lbs.)	Product Code									Dimensions (in.)				
				Screw Pin			Round Pin			Bolt, Nut & Cotter			P	E	W	R	L
				Self Colored	Galvanized	Orange Powder Coated	Self Colored	Galvanized	Orange Powder Coated	Self Colored	Galvanized	Orange Powder Coated					
1/4	3/4	50	0.12	M746	M746G	M746P	M546	M546G	M546P	M946	M946G	M946P	0.31	0.36	0.47	0.75	0.88
5/16	1	50	0.20	M747	M747G	M747P	M547	M547G	M547P	M947	M947G	M947P	0.38	0.46	0.56	0.84	1.03
3/8	1-1/2	50	0.30	M748	M748G	M748P	M548	M548G	M548P	M948	M948G	M948P	0.44	0.52	0.66	0.99	1.25
1/2	3	50	0.75	M750	M750G	M750P	M550	M550G	M550P	M950	M950G	M950P	0.63	0.70	0.84	1.25	1.69
5/8	4-1/2	25	1.30	M751	M751G	M751P	M551	M551G	M551P	M951	M951G	M951P	0.75	0.83	1.09	1.58	2.00
3/4	6-1/2	10	2.30	M752	M752G	M752P	M552	M552G	M552P	M952	M952G	M952P	0.88	0.95	1.25	1.89	2.38
7/8	8-1/2	10	3.50	M753	M753G	M753P	M553	M553G	M553P	M953	M953G	M953P	1.00	1.09	1.44	2.14	2.88
1	10	5	5.00	M754	M754G	M754P	M554	M554G	M554P	M954	M954G	M954P	1.13	1.22	1.72	2.41	3.19
1-1/8	12	Bulk	7.00	M755	M755G	M755P	M555	M555G	M555P	M955	M955G	M955P	1.25	1.34	1.81	2.69	3.56
1-1/4	14	Bulk	9.50	M756	M756G	M756P	M556	M556G	M556P	M956	M956G	M956P	1.38	1.50	2.03	3.13	3.94
1-3/8	17	Bulk	12.50	M766	M766G	M766P	M566	M566G	M566P	M966	M966G	M966P	1.50	1.63	2.25	3.32	4.44
1-1/2	20	Bulk	17.20	M757	M757G	M757P	M557	M557G	M557P	M957	M957G	M957P	1.63	1.78	2.38	3.57	4.88
1-5/8	24	Bulk	23.50	M785	M785G	M785P	M585	M585G	M585P	M985	M985G	M985P	1.75	1.88	2.63	3.94	5.25
1-3/4	30	Bulk	27.70	M777	M777G	M777P	M577	M577G	M577P	M977	M977G	M977P	2.00	2.13	2.88	4.06	5.75
2	35	Bulk	39.00	M758	M758G	M758P	M558	M558G	M558P	M958	M958G	M958P	2.25	2.38	3.28	4.53	6.75



# ALLOY ANCHOR SHACKLES

**WORKING LOAD LIMIT: 2 TO 120 TONS**

CM Alloy Shackles are designed with a 5:1 design factor and have a strength rating approximately 50% higher than a comparable-sized carbon shackle and about 25% stronger than super strong shackles. Anchor shackles can be side loaded or used for multiple connections.

## BENEFITS & FEATURES

- 3/8" to 2" sizes made in the U.S.A. from domestic (U.S.A.) Special Bar Quality (SBQ) steel having fine grain, reduced sulfur and phosphorus.
- Shackles show major deformation before failure
- Working load limit and traceability codes shown as permanent markings on body
- All shackles have alloy quenched and tempered pins
- Available in sizes 3/8" to 3"
- Available finishes include powder coated, galvanized or self-colored
- Shackles meet dimensional, marking and performance requirements of RR-C-271
- Special testing and certification is available if requested at the time of the order
- Design factor 5:1

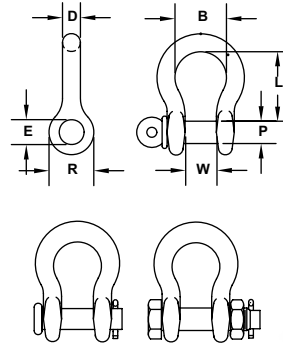

Screw Pin



Round Pin

Bolt, Nut & Cotter

SHACKLES

**STYLES:** Screw Pin, Round Pin, Bolt/Nut/Cotter  
**FINISHES:** Self Colored, Galvanized, Orange Powder Coated

Size D (in.)	Working Load Limit (Ton)	Std. Pkg.	Weight (lbs.)	Product Code									Dimensions (in.)					
				Screw Pin			Round Pin			Bolt, Nut & Cotter			P	E	W	R	L	B min
				Self Colored	Galvanized	Orange Powder Coated	Self Colored	Galvanized	Orange Powder Coated	Self Colored	Galvanized	Orange Powder Coated						
3/8	2	50	0.30	M648A	M648AG	M648AP	-	-	-	M848A	M848AG	M848AP	0.44	0.52	0.66	1.00	1.40	1.00
7/16	2.6	50	0.50	M649A	M649AG	M649AP	-	-	-	M849A	M849AG	M849AP	0.50	0.58	0.72	1.15	1.69	1.19
1/2	3.3	50	0.75	M650A	M650AG	M650AP	M350A	M350AG	M350AP	M850A	M850AG	M850AP	0.63	0.70	0.84	1.34	1.94	1.38
5/8	5	25	1.30	M651A	M651AG	M651AP	M351A	M351AG	M351AP	M851A	M851AG	M851AP	0.75	0.83	1.06	1.66	2.41	1.63
3/4	7	10	2.30	M652A	M652AG	M652AP	M352A	M352AG	M352AP	M852A	M852AG	M852AP	0.88	0.95	1.28	1.94	2.84	1.89
7/8	9.5	10	3.50	M653A	M653AG	M653AP	M353A	M353AG	M353AP	M853A	M853AG	M853AP	1.00	1.09	1.44	2.14	3.31	2.06
1	12.5	5	5.00	M654A	M654AG	M654AP	M354A	M354AG	M354AP	M854A	M854AG	M854AP	1.13	1.22	1.72	2.44	3.75	2.52
1-1/8	15	Bulk	7.00	M655A	M655AG	M655AP	M355A	M355AG	M355AP	M855A	M855AG	M855AP	1.25	1.36	1.84	2.66	4.02	2.69
1-1/4	18	Bulk	9.50	M656A	M656AG	M656AP	M356A	M356AG	M356AP	M856A	M856AG	M856AP	1.38	1.52	2.03	3.15	4.63	2.88
1-3/8	21	Bulk	12.50	M666A	M666AG	M666AP	M366A	M366AG	M366AP	M866A	M866AG	M866AP	1.50	1.65	2.25	3.25	5.19	3.25
1-1/2	25	Bulk	17.20	M657A	M657AG	M657AP	M357A	M357AG	M357AP	-	-	-	1.63	1.77	2.41	3.50	5.63	3.50
1-1/2	30	Bulk	17.20	-	-	-	-	-	-	M857A	M857AG	M857AP	1.63	1.77	2.41	3.50	5.63	3.50
1-5/8	29	Bulk	23.50	M685A	M685AG	M685AP	M385A	M385AG	M385AP	-	-	-	1.75	1.88	2.66	3.91	6.13	4.13
1-5/8	35	Bulk	23.50	-	-	-	-	-	-	M885A	M885AG	M885AP	1.75	1.88	2.66	3.91	6.13	4.13
1-3/4	34	Bulk	27.70	M677A	M677AG	M677AP	M377A	M377AG	M377AP	-	-	-	2.00	2.13	2.94	4.06	6.97	4.75
1-3/4	40	Bulk	27.70	-	-	-	-	-	-	M877A	M877AG	M877AP	2.00	2.13	2.94	4.06	6.97	4.75
2	43	Bulk	39.00	M658A	M658AG	M658AP	M358A	M358AG	M358AP	-	-	-	2.25	2.38	3.28	4.51	7.44	5.50
2	50	Bulk	39.00	-	-	-	-	-	-	M858A	M858AG	M858AP	2.25	2.38	3.28	4.51	7.44	5.50
2-1/2	85	Bulk	109.00	-	-	-	-	-	-	MC860A	MC860AG	-	2.75	2.99	4.13	6.13	10.48	6.75
3	120	Bulk	148.00	-	-	-	-	-	-	MC862A	MC862AG	-	3.25	3.53	5.00	6.56	13.00	7.38

Check with your sales rep for a list of models eligible for our In-Stock Guarantee.



# CARBON ANCHOR SHACKLES (INDUSTRIAL/GOVERNMENT-RATED)

**WORKING LOAD LIMIT: 1/3 TO 85 TONS**

CM Industrial/Government-Rated Carbon Shackles are designed with a 6:1 design factor. Anchor shackles can be side loaded or used for multiple connections.

### BENEFITS & FEATURES

- Manufactured from technically advanced domestic (U.S.A.) micro alloy steel with optimal hardness for strength and ductility.
- All shackles have alloy quenched and tempered pins
- Working load limit and traceability codes shown as permanent markings on body
- Available in sizes 3/16" to 3"
- Available finishes include powder coated, self-colored or galvanized per ASTM A153
- All bolt, nut & cotter shackles have thread-protected ends
- Shackles meet dimensional, marking and performance requirements of RR-C-271
- Standard industry tolerances apply
- Design factor 6:1 (2-1/2" and 3" carbon shackles have a 5:1 design factor)



Screw Pin



Round Pin



Bolt, Nut & Cotter

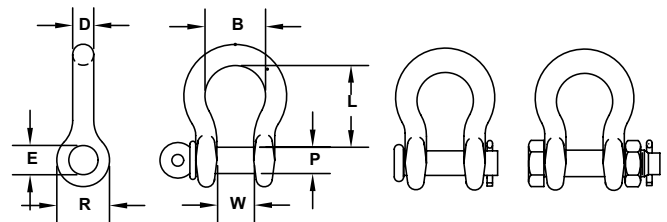

### ▶ DID YOU KNOW?

#### CM INDUSTRIAL/GOVERNMENT VS. CM SUPER STRONG SHACKLES

An Industrial/Government shackle is a Super Strong shackle de-rated to meet, not exceed, the Federal Specification RR-C-271.

That means it has the same dimensions and performance characteristics as a Super Strong shackle but is marked with specifications to meet government requirements.

#### Example:

- 1" Super Strong shackle will be marked 10 Ton WLL
- 1" Industrial/Government shackle will be marked 8-1/2 Ton WLL

For more information, visit us at [www.cmworks.com](http://www.cmworks.com)

**STYLES:** Screw Pin, Round Pin, Bolt/Nut/Cotter  
**FINISHES:** Galvanized, Orange Powder Coated

Size D (in.)	Working Load Limit (Ton)	Std. Pkg.	Weight (lbs.)	Product Code			Dimensions (in.)						
				Screw Pin		Round Pin	Bolt, Nut & Cotter	P	E	W	R	L	B (min.)
				Galvanized	Orange Powder Coated	Galvanized	Galvanized						
3/16	1/3	50	0.06	MC645G	-	MC345G	-	0.25	0.29	0.38	0.57	0.88	0.58
1/4	1/2	50	0.12	MC646G	MC646P	MC346G	MC846G	0.31	0.36	0.47	0.75	1.13	0.75
5/16	3/4	50	0.20	MC647G	MC647P	MC347G	MC847G	0.38	0.45	0.53	0.84	1.25	0.81
3/8	1	50	0.30	MC648G	MC648P	MC348G	MC848G	0.44	0.52	0.66	1.00	1.40	1.00
7/16	1-1/2	50	0.50	MC649G	MC649P	MC349G	MC849G	0.50	0.58	0.72	1.15	1.69	1.19
1/2	2	50	0.75	MC650G	MC650P	MC350G	MC850G	0.63	0.70	0.84	1.34	1.94	1.38
5/8	3-1/4	25	1.30	MC651G	MC651P	MC351G	MC851G	0.75	0.83	1.06	1.66	2.41	1.63
3/4	4-3/4	10	2.25	MC652G	MC652P	MC352G	MC852G	0.88	0.95	1.28	1.94	2.84	1.89
7/8	6-1/2	10	3.50	MC653G	MC653P	MC353G	MC853G	1.00	1.09	1.44	2.14	3.31	2.06
1	8-1/2	5	5.00	MC654G	MC654P	MC354G	MC854G	1.13	1.22	1.72	2.44	3.75	2.52
1-1/8	9-1/2	Bulk	7.00	MC655G	-	MC355G	MC855G	1.25	1.36	1.84	2.66	4.02	2.69
1-1/4	12	Bulk	9.00	MC656G	-	MC356G	MC856G	1.38	1.52	2.03	3.15	4.63	2.88
1-3/8	13-1/2	Bulk	12.50	MC666G	-	MC366G	MC866G	1.50	1.65	2.25	3.25	5.19	3.25
1-1/2	17	Bulk	17.20	MC657G	-	MC357G	MC857G	1.63	1.77	2.41	3.50	5.63	3.50
1-5/8	20	Bulk	23.50	MC685G	-	MC385G	MC885G	1.75	1.88	2.66	3.91	6.13	4.13
1-3/4	25	Bulk	27.70	MC677G	-	MC377G	MC877G	2.00	2.13	2.94	4.06	6.97	4.75
2	35	Bulk	39.00	M658G	M658P	M358G	-	2.25	2.38	3.28	4.51	7.44	5.50
2-1/2	55	Bulk	90.00	-	-	-	MC860G	2.75	2.91	4.13	6.25	10.48	6.75
3	85	Bulk	138.00	-	-	-	MC862G	3.25	3.41	5.00	6.75	13.00	7.38

SHACKLES



# CARBON CHAIN SHACKLES (INDUSTRIAL/GOVERNMENT-RATED)

**WORKING LOAD LIMIT: 1/2 TO 35 TONS**

CM Industrial/Government-Rated Carbon Shackles are designed with a 6:1 design factor. Chain shackles are best suited for straight-line pulls.

### BENEFITS & FEATURES

- Manufactured from technically advanced domestic (U.S.A.) micro alloy steel with optimal hardness for strength and ductility.
- Working load limit and traceability codes shown as permanent markings on body
- All shackles have alloy quenched and tempered pins
- Available in sizes 1/4" to 2"
- Available finishes include powder coated, self-colored or galvanized per ASTM A153
- All bolt, nut & cotter shackles have thread-protected ends
- Shackles meet dimensional, marking and performance requirements of RR-C-271
- Standard industry tolerances apply
- Design factor 6:1



Screw Pin



Round Pin



Bolt, Nut & Cotter

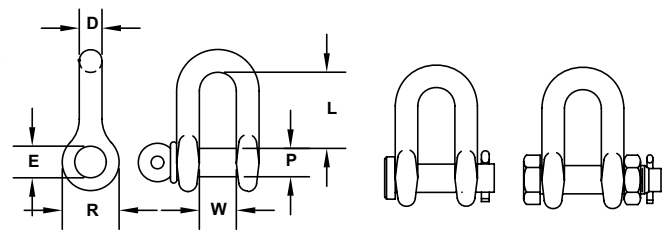

**STYLES:** Screw Pin, Round Pin, Bolt/Nut/Cotter  
**FINISHES:** Self Colored, Galvanized, Orange Powder Coated

Size D (in.)	Working Load Limit (Ton)	Std. Pkg.	Weight (lbs.)	Product Code			Dimensions (in.)				
				Screw Pin	Round Pin	Bolt, Nut & Cotter	P	E	W	R	L
				Galvanized	Galvanized	Galvanized					
1/4	1/2	50	0.11	MC746G	MC546G	MC946G	0.31	0.36	0.47	0.75	0.88
5/16	3/4	50	0.17	MC747G	MC547G	MC947G	0.38	0.46	0.56	0.84	1.03
3/8	1	50	0.25	MC748G	MC548G	MC948G	0.44	0.52	0.66	0.99	1.25
1/2	2	50	0.75	MC750G	MC550G	MC950G	0.63	0.70	0.84	1.25	1.69
5/8	3-1/4	25	1.30	MC751G	MC551G	MC951G	0.75	0.83	1.09	1.58	2.00
3/4	4-3/4	10	2.30	MC752G	MC552G	MC952G	0.88	0.95	1.25	1.89	2.38
7/8	6-1/2	10	3.50	MC753G	MC553G	MC953G	1.00	1.09	1.44	2.14	2.88
1	8-1/2	5	5.00	MC754G	MC554G	MC954G	1.13	1.22	1.72	2.41	3.19
1-1/8	9-1/2	Bulk	7.00	MC755G	MC555G	MC955G	1.25	1.34	1.81	2.69	3.56
1-1/4	12	Bulk	9.50	MC756G	MC556G	MC956G	1.38	1.50	2.03	3.13	3.94
1-3/8	13-1/2	Bulk	12.50	MC766G	MC566G	MC966G	1.50	1.63	2.25	3.32	4.44
1-1/2	17	Bulk	17.20	MC757G	MC557G	MC957G	1.63	1.78	2.38	3.57	4.88
1-5/8	20	Bulk	23.50	MC785G	MC585G	MC985G	1.75	1.88	2.63	3.94	5.25
1-3/4	25	Bulk	27.70	MC777G	MC577G	MC977G	2.00	2.13	2.88	4.06	5.75
2	35	Bulk	39.00	M758G	M558G	M958G	2.25	2.38	3.28	4.53	6.75

SHACKLES



## CARBON WEB SLING SHACKLE

**WORKING LOAD LIMIT: 8,000 TO 23,500 LBS.**

Web sling shackles are designed to connect synthetic web and round slings to eye bolts and other lifting hardware.

### BENEFITS & FEATURES

- Design factor 4:1
- Web Sling Shackles can be used on web slings from 2 to 6 inches in width
- Shackle body: carbon steel, heat treated
- Shackle pin: alloy steel, heat treated
- Finish: hot dip galvanized
- Zinc-plated linch pin comes standard. Cotter or hairpin available on special order.
- Do not point load. The load should be evenly distributed over the entire pin to achieve full working load limit.

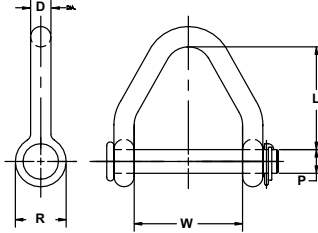

Product Code	Pin Number	Linch Pin Number	Working Load Limit (lbs.)	Dimensions (in.)					Weight (lbs.)
				P	D	L	W	R	
M702	2X702	65930	8,000	0.75	0.63	2.25	2.00	1.63	1.70
M703	2X703	65930	13,000	0.88	0.75	3.25	3.00	1.88	2.86
M704	2X704	65930	11,000	0.88	0.75	3.75	4.00	1.88	3.15
M705	2X705	65934	18,000	1.00	0.88	4.25	5.00	2.13	4.75
M706	2X706	65934	18,000	1.13	1.00	4.75	6.00	2.38	6.75
M706H	2X706H	65934	23,500	1.25	1.13	4.75	6.00	2.63	9.80

SHACKLES

## ALLOY WEB SLING SHACKLE

**WORKING LOAD LIMIT: 13,500 TO 22,500 LBS.**

Web sling shackles are designed to connect synthetic web and round slings to eye bolts and other lifting hardware.

### BENEFITS & FEATURES

- Design factor 6:1
- Web Sling Shackles can be used on web slings from 3 to 6 inches in width
- Utilize a bolt and nut with linchpin to secure the assembly in place
- All shackles are galvanized for longer life
- Marked with working load limit (WLL) and size
- Do not point load. The load should be evenly distributed over the entire pin to achieve full working load limit.

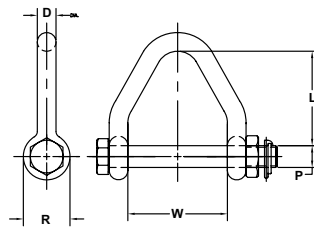

Product Code	Pin Number	Linch Pin Number	Working Load Limit (lbs.)	Dimensions (in.)					Weight (lbs.)
				P	D	L	W	R	
M703A	2X8703A	65930	13,500	0.88	0.75	3.25	3.00	1.88	3.01
M704A	2X8704A	65930	14,500	0.88	0.75	3.75	4.00	1.88	3.16
M705A	2X8705A	65934	19,000	1.00	1.00	4.25	5.00	2.38	6.04
M706A	2X8706A	65934	22,500	1.13	1.13	4.75	6.00	2.63	9.02







# TRAWLING SHACKLE

**WORKING LOAD LIMIT: 4,000 TO 20,000 LBS.**

Load-rated trawling chain shackles are used for various applications, such as on trawl doors, the rigging of nets, and areas where critical loads are applied.

### BENEFITS & FEATURES

- Design factor 6:1
- Micro-alloy steel bodies
- Heat-treated alloy pins
- Square head pins for convenience in wrench tightening and loosening
- Durable orange powder coated finish

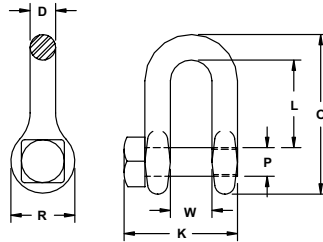

Product Code	Working Load Limit (lbs.)	Dimensions (in.)							Weight (lbs.)
		D	P	W	L	O	R	K	
M449G*	4,000	0.44	0.50	0.72	1.50	2.75	1.13	1.91	0.43
M450	6,000	0.50	0.63	0.84	1.69	3.13	1.25	2.06	0.60
M451	9,000	0.63	0.75	1.09	2.00	3.78	1.58	2.63	1.30
M452	13,000	0.75	0.88	1.25	2.38	4.53	1.89	3.13	2.20
M453	17,000	0.88	1.00	1.44	2.88	5.31	2.14	3.63	3.00
M454	20,000	1.00	1.13	1.72	3.19	5.81	2.41	4.44	4.70

\* Product has a hex-head bolt and galvanized finish

SHACKLES

# LONG-REACH SHACKLE

**WORKING LOAD LIMIT: 7,000 TO 50,000 LBS.**

As one of the only manufacturers of long-reach shackles, we designed these shackles for use in construction applications where a longer reach is needed to attach to pick points.

### BENEFITS & FEATURES

- Design factor of 5:1
- Meets the requirements of ASME B30.26, but must not be side loaded
- Alloy steel
- WLL forged on body
- Offered in self-colored or durable orange powder coated finish
- Do not point load. The load should be evenly distributed over the entire pin to achieve full working load limit.
- Do not side load long-reach shackles
- 80% of bolt/pin must be covered to obtain full working load limit



Screw Pin



Bolt, Nut & Cotter

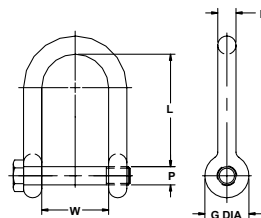

**STYLES:** Screw Pin, Bolt/Nut/Cotter  
**FINISHES:** Self Colored, Orange Powder Coated



Size (in.)	Working Load Limit (lbs.)	Screw Pin		Weight (lbs.)	Bolt, Nut & Cotter		Weight (lbs.)	Dimensions (in.)				
		Product Code			Product Code			P	D	L	W	G
		Self Colored	Painted		Self Colored	Painted						
5/8	7,000	M7151	M7151P	1.80	M9151	M9151P	1.95	0.75	0.63	4.00	2.25	1.57
3/4	10,000	M7152	M7152P	2.72	M9152	M9152P	3.21	0.88	0.75	5.00	2.75	1.81
1	19,000	M7154	M7154P	5.86	M9154	M9154P	6.31	1.00	1.00	5.50	3.25	2.38
1-1/4	28,000	M7156	M7156P	11.90	M9156	M9156P	12.90	1.38	1.25	6.19	3.88	3.06
1-1/2	34,000	M7157	M7157P	19.60	M9157	M9157P	20.70	1.50	1.50	7.00	4.50	3.50
1-3/4	50,000	M7177	M7177P	30.70	M9177	M9177P	33.30	2.00	1.75	8.00	5.25	4.00

Check with your sales rep for a list of models eligible for our In-Stock Guarantee.



HERPOLD & PILLIODY 1000  
S/N 10M 65222  
S/N FB3/8X 5 FT 1





# CHAIN SLING COMPONENTS

**RATED FOR OVERHEAD LIFTING**

## **SECTION OVERVIEW** ..... 60

### **HERC-ALLOY® 1000 PRODUCTS (Grade 100)**

Product Overview .....	62-63
Chain .....	64
Master Link (Dual Rated) .....	66
Sub-Assembly (Dual Rated) .....	66
Pear Shaped Master Link .....	67
EZ-Connect Master Link & Chain Shortener.....	67
Hammerlok® (Dual Rated) .....	66
Chain Shortener .....	68
Omegalok Connector (Dual Rated) .....	68
Rigging Hook (Dual Rated) .....	69
Clevlok® Sling Hook (Dual Rated) .....	69
Eye Sling Hook (Dual Rated) .....	69
Clevlok® Cradle Grab Hook (Dual Rated) .....	70
Eye Cradle Grab Hook (Dual Rated) .....	70
Clevlok® Foundry Hook .....	71
Eye Foundry Hook (Dual Rated) .....	71
Clevlok® Style Latchlok® Hook .....	72
Eye Style Latchlok® Hook .....	72
Swivel Style Latchlok® Hooks .....	73

### **HERC-ALLOY 800® PRODUCTS (Grade 80)**

Product Overview .....	74-75
Chain .....	76
Master Link (Dual Rated) .....	78
Forged Master Link .....	78
Master Link With and Without Flats .....	79
Flat Bottom Master Link .....	79
Sub-Assembly (Dual Rated) .....	80
Wide Body Sub-Assembly with Flats .....	80
Master Ring .....	81
Grab Link .....	81
Hammerlok® (Herc-Alloy 800®) .....	82
Weblok™ Assembly .....	82
Clevlok® Sling Hook (Dual Rated) .....	83
Eye Sling Hook (Dual Rated) .....	83
Clevlok® Grab Hook without Cradle .....	84
Clevlok® Cradle Grab Hook (Dual Rated) .....	84
Eye Cradle Grab Hook (Dual Rated) .....	85
Eye Foundry Hook (Dual Rated) .....	85

# CHAIN SLING COMPONENTS OVERVIEW

Chain slings are a combination of chain, hooks, rings and other attachments used primarily for overhead lifting. CM's selection of Grade 80 and Grade 100 chain and attachments can be combined in a variety of configurations to fit virtually any application.

## THE STRENGTH OF CM HERC-ALLOY®

Made in America, CM Herc-Alloy® 800 and 1000 products are made of superior triple alloy steel that provides the best strength-to-weight performance in the industry. These products also meet and exceed ASTM A973 standards. Herc-Alloy® is now one of the most recognized and trusted brands in the rigging industry and is only offered by Columbus McKinnon.

## DUAL-RATED RIGGING ATTACHMENTS

To help customers reduce and better manage their rigging inventory, Columbus McKinnon has developed several dual-rated rigging attachments that can be used for both Grade 80 and Grade 100 applications. Forged in the U.S.A, CM dual-rated rigging products are the best choice for even the toughest overhead lifting applications.















# HERC-ALLOY® 1000

Columbus McKinnon has a long history of developing innovative products that have changed the material handling industry – including the development of the first alloy chain in 1933. This alloy chain eventually replaced the industry-standard wrought iron chain used for overhead lifting and is the predecessor to today’s Herc-Alloy® 1000 chain, hooks and overhead lifting attachments. Made in America, CM Herc-Alloy® products are made of superior triple alloy steel that provides the best strength-to-weight performance in the industry. Herc-Alloy® 1000 chain meets ASTM A973 standards while components, such as hooks and Hammerloks®, meet ASTM A952 standards.

Herc-Alloy® is now one of the most recognized and trusted brands in the rigging industry and is only offered by Columbus McKinnon.

## HERC-ALLOY® 1000 PRODUCT OVERVIEW

The chart below is an overview of our most popular Herc-Alloy® 1000 products. Our full product offering, including detailed specifications and available sizes, can be found on the product pages within this section.

	Chain Size		Working Load Limit (lbs.)	COMPONENTS											
				Chain (Per Ft.)	Chain (Drum)	Master Link	Sub-Assembly	Pear Shaped Master Link	EZ-Connect Master Link & Chain Shortener	Hammerlok®	Chain Shortener	Omegalok Connector	Rigging Hook	Clevlok® Sling Hook w/Latch	Clevlok® Sling Hook w/o Latch
	(in.)	(mm.)		Page 64	Page 64	Page 66	Page 66	Page 67	Page 67	Page 68	Page 68	Page 68	Page 69	Page 69	Page 69
															
Single at 60°	7/32	5.5	2,700	607321	677310	555231	-	554702	-	667021-2	-	-	M7502A	657716	557716
	9/32	7	4,300	607328	677311	555232	-	554702	555232S1	667028-2	M71805A-2	644128	M7503A	657718	557718
	3/8	10	8,800	607339	677313	555235	-	554702	555325S1	667038-2	M71806A-2	644138	M7504A	657719	557719
	1/2	13	15,000	607351	677315	555238	-	554706	555328S1	667050-2	M71808A-2	644150	M7505A	657720	557720
	5/8	16	22,600	607363	677316	555238	-	554710	555239S1	667062-2	M71810A-2	644162	M7507A	657721	557721
	3/4	20	35,300	607378	677317	555240	-	554714	-	667075-2	-	-	M7509A	657722	557722
Double at 60°	7/32	5.5	4,700	607321	677310	555231	-	554702	-	667021-2	-	-	M7502A	657716	557716
	9/32	7	7,400	607328	677311	555232	-	554702	555232S2	667028-2	M71805A-2	644128	M7503A	657718	557718
	3/8	10	15,200	607339	677313	555235	-	554706	555325S2	667038-2	M71806A-2	644138	M7504A	657719	557719
	1/2	13	26,000	607351	677315	555238	-	554710	555328S2	667050-2	M71808A-2	644150	M7505A	657720	557720
	5/8	16	39,100	607363	677316	555240	-	554714	555240S2	667062-2	M71810A-2	644162	M7507A	657721	557721
	3/4	20	61,100	607378	677317	555243	-	554719	-	667075-2	-	-	M7509A	657722	557722
Triple & Quad at 60°	7/32	5.5	7,000	607321	677310	-	555274	554702	-	667021-2	-	-	M7502A	657716	557716
	9/32	7	11,200	607328	677311	-	555275	554706	-	667028-2	M71805A-2	644128	M7503A	657718	557718
	3/8	10	22,900	607339	677313	-	555276	554710	-	667038-2	M71806A-2	644138	M7504A	657719	557719
	1/2	13	39,000	607351	677315	-	555277	554714	-	667050-2	M71808A-2	644150	M7505A	657720	557720
	5/8	16	58,700	607363	677316	-	555278	554719	-	667062-2	M71810A-2	644162	M7507A	657721	557721
	3/4	20	91,700	607378	677317	-	555279	554726	-	667075-2	-	-	M7509A	657722	557722



To help customers reduce and better manage their rigging inventory, Columbus McKinnon has developed several **DUAL-RATED RIGGING ATTACHMENTS** that can be used for both Grade 80 and 100 applications.



HERC-ALLOY® 1000  
CHAIN SLING  
COMPONENTS

	Chain Size		Working Load Limit (lbs.)	COMPONENTS									
				Eye Sling Hook w/Latch	Eye Sling Hook w/o Latch	Clevlok® Cradle Grab Hook	Eye Cradle Grab Hook	Clevlok® Foundry Hook	Eye Foundry Hook	Clevlok® Style Latchlok® Hook	Eye Style Latchlok® Hook	Bearing Swivel Style Latchlok® Hook	Bushing Swivel Style Latchlok® Hook
	(in.)	(mm.)		Page 69	Page 69	Page 70	Page 70	Page 71	Page 71	Page 72	Page 72	Page 73	Page 73
Single at 90°	7/32	5.5	2,700	558618	458618	659718	559724	-	-	-	-	-	-
	9/32	7	4,300	558622	458622	659722	559725	475798	474798	M616005	M626005	M696005	M676005
	3/8	10	8,800	558625	458625	659725	559737	475799	474799	M616010	M626010	M696010	M676010
	1/2	13	15,000	558628	458628	659728	559750	475800	474800	M616015	M626015	M696015	M676015
	5/8	16	22,600	558629	458629	659729	559762	475801	474801	M616020	M626020	M696020	M676020
	3/4	20	35,300	558630	458630	659730	559775	475802	474802	-	-	-	-
Double at 60°	7/32	5.5	4,700	558618	458618	659718	559724	-	-	-	-	-	-
	9/32	7	7,400	558622	458622	659722	559725	475798	474798	M616005	M626005	M696005	M676005
	3/8	10	15,200	558625	458625	659725	559737	475799	474799	M616010	M626010	M696010	M676010
	1/2	13	26,000	558628	458628	659728	559750	475800	474800	M616015	M626015	M696015	M676015
	5/8	16	39,100	558629	458629	659729	559762	475801	474801	M616020	M626020	M696020	M676020
	3/4	20	61,100	558630	458630	659730	559775	475802	474802	-	-	-	-
Triple & Quad at 60°	7/32	5.5	7,000	558618	458618	659718	559724	-	-	-	-	-	-
	9/32	7	11,200	558622	458622	659722	559725	475798	474798	M616005	M626005	M696005	M676005
	3/8	10	22,900	558625	458625	659725	559737	475799	474799	M616010	M626010	M696010	M676010
	1/2	13	39,000	558628	458628	659728	559750	475800	474800	M616015	M626015	M696015	M676015
	5/8	16	58,700	558629	458629	659729	559762	475801	474801	M616020	M626020	M696020	M676020
	3/4	20	91,700	558630	458630	659730	559775	475802	474802	-	-	-	-

Sling ID Tags available. See page 64 for details.



# HERC-ALLOY® 1000 CHAIN

**WORKING LOAD LIMIT: 2,700 TO 35,300 LBS.**

## BENEFITS & FEATURES

- Meets ASTM A973 & NACM standards
- 25% higher working load limit when compared to Grade 80
- Environmentally friendly black coating for distinct appearance and ease of identification
- Certification included with every drum
- 100% proof tested
- 4:1 design factor

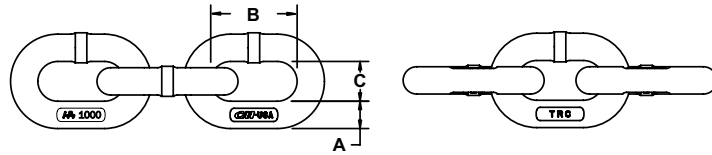

Chain Size (in.)	Working Load Limit (lbs.)	Nominal Chain Dimensions (in.)			Per Foot			Per Drum		
		Material Diameter A	Inside Length B	Inside Width C	Product Code	Weight (lbs./ft.)	Approximate Number of Links (per ft.)	Product Code	Length (ft.)	Weight (lbs.)
7/32	2,700	0.22	0.68	0.31	607321	0.44	17.8	677310	800	354
9/32	4,300	0.28	0.88	0.40	607328	0.73	13.6	677311	500	365
3/8	8,800	0.40	1.25	0.57	607339	1.48	9.6	677313	500	740
1/2	15,000	0.52	1.56	0.73	607351	2.51	7.7	677315	300	754
5/8	22,600	0.64	1.92	0.86	607363	3.81	6.3	677316	200	762
3/4	35,300	0.79	2.40	1.07	607378	5.77	5.0	677317	100	577

HERC-ALLOY® 1000  
CHAIN SLING COMPONENTS

## ▶ INSPECTION, CARE & USE

### HOW TO SELECT AND ORDER THE PROPER CHAIN SLING

1. Determine the weight and configuration of the load(s) to be lifted.
2. Determine the type of chain sling required, according to weight and configuration.
3. Determine the size of the body chain according to the working load limits. Be sure to take into consideration the effect of the required angle. The working load limit is the maximum load in pounds which should be applied in direct tension to a straight length of chain.

Note: Working load limit can be affected by angles of loading, type of hitch used, environmental conditions such as hot and cold temperatures, and D/d ratio.

4. Determine the reach required to give the desired angle. The reach is measured from the upper bearing surface of the master link to the bearing surface of the lower attachment. If chain slings are to be used in pairs and are to be matched for reach, indicate when ordering.
5. Know share of load on pick points and location of center of gravity.



For more information, visit us at [www.cmworks.com](http://www.cmworks.com)

## SLING ID TAGS

Description	Product Code
Alloy Sling ID Tag	557038
Carbon Sling ID Tag	457106
Attachment Ring	557193

Information on tag includes sling size, reach, WLL, serial number, name of manufacturer, grade of sling & number of branches





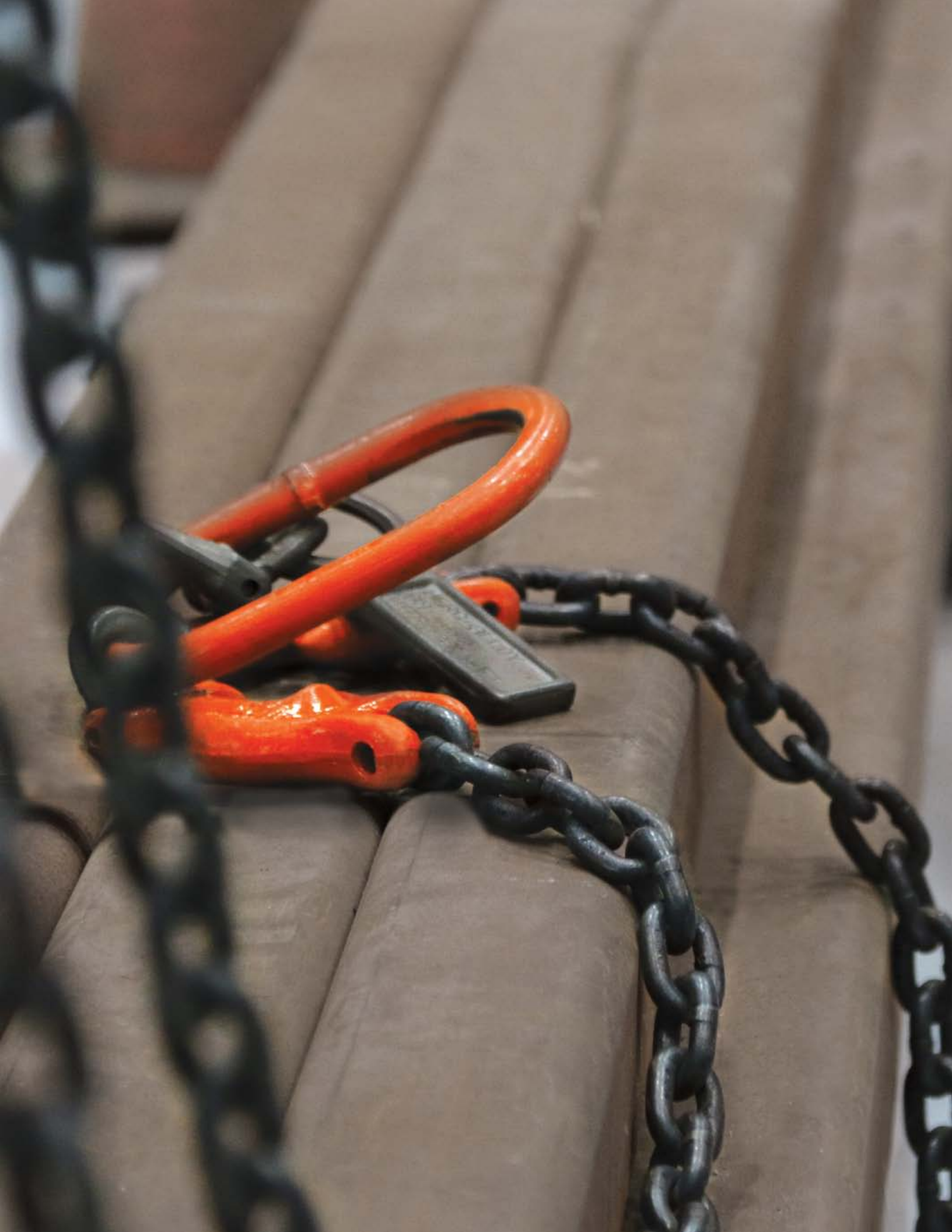



# MASTER LINK DUAL RATED FOR USE WITH HA800 OR HA1000

**WORKING LOAD LIMIT: 5,400 TO 105,900 LBS.**

### BENEFITS & FEATURES

- Accepts both Herc-Alloy® 1000 & 800 chain and components
- Durable orange powder coated finish
- May be used for mechanical and welded sling assemblies
- 100% proof tested
- 4:1 design factor

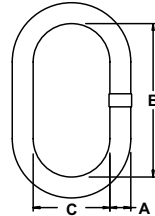
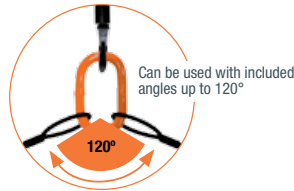

Trade Size (in.)	Working Load Limit (lbs.)	Catalog Number	Product Code	Nominal Dimensions (in.)			Weight (lbs.)	Type and Size of Chain Sling on Which Used (in.)			
				Material Diameter A	Inside Length B	Inside Width C		Single	Double	Triple	Quad
13/32	5,400	HA40	555231	0.41	3.00	1.50	0.33	7/32	7/32	–	–
1/2	8,600	HA50	555232	0.56	5.00	2.50	1.02	9/32	9/32	7/32	7/32
3/4	17,600	HA75	555235	0.75	5.50	2.75	2.08	3/8	3/8	9/32	9/32
1	30,000	HA100	555238	1.00	7.00	3.50	4.59	1/2 & 5/8	1/2	3/8	3/8
1-1/4	45,200	HA125	555240	1.25	8.75	4.38	9.31	3/4	5/8	1/2	1/2
1-1/2	70,600	HA150	555243	1.50	10.50	5.25	15.60	–	3/4	5/8	5/8
1-3/4	105,900	HA175	555246	1.75	12.00	6.00	24.40	–	–	3/4	3/4

# SUB-ASSEMBLY DUAL RATED FOR USE WITH HA800 OR HA1000

**WORKING LOAD LIMIT: 7,000 TO 91,700 LBS.**



### BENEFITS & FEATURES

- Designed for triple and quad branch Herc-Alloy® chain slings
- Consists of an oblong master link and two welded master coupling links
- Accepts both Herc-Alloy 1000 & 800 chain and components
- Durable orange powder coated finish
- May be used for mechanical or welded sling assemblies
- 100% proof tested
- 4:1 design factor

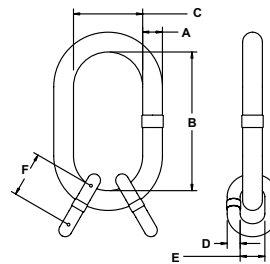
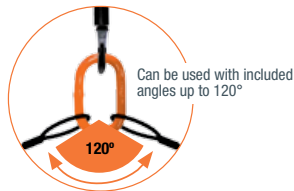

Trade Size (in.)	Working Load Limit at 60° (lbs.)	Catalog Number	Product Code	Master Link Nominal Dimensions (in.)			Intermediate Link Nominal Dimensions (in.)			Weight (lbs.)	Type and Size of Chain Sling on Which Used (in.)	
				Material Diameter A	Inside Length B	Inside Width C	Material Diameter D	Inside Width E	Inside Length F		Triple	Quad
1/2	7,000	SA050	555274	0.56	5.00	2.50	0.44	1.06	1.75	1.35	7/32	7/32
3/4	11,200	SA075	555275	0.75	5.50	2.75	0.47	0.88	1.56	2.64	9/32	9/32
1	22,900	SA100	555276	1.00	7.00	3.50	0.78	1.50	2.63	7.25	3/8	3/8
1-1/4	39,000	SA125	555277	1.25	8.75	4.38	0.91	1.75	3.13	13.51	1/2	1/2
1-1/2	58,700	SA150	555278	1.50	10.50	5.25	1.13	2.25	4.00	24.28	5/8	5/8
1-3/4	91,700	SA175	555279	1.75	12.00	6.00	1.50	2.75	5.25	44.58	3/4	3/4

**HERC-ALLOY® 1000**  
**CHAIN SLING COMPONENTS**



# PEAR SHAPED MASTER LINK HERC-ALLOY® 1000

WORKING LOAD LIMIT: 9,000 TO 125,200 LBS.

### BENEFITS & FEATURES

- Made from alloy material
- Proof tested at two times WLL
- Durable orange powder coated finish
- Custom sizes available upon request
- 4:1 design factor

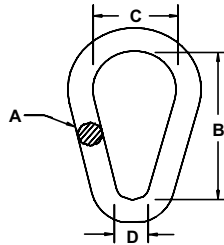

Trade Size (in.)	Working Load Limit (lbs.)	Product Code	Nominal Dimensions (in.)				Weight (lbs.)	Type and Size of Chain Sling		
			Diameter A	Inside Length B	Inside Width C	Inside Width D		Single (in.)	Double (in.)	Triple (in.)
1/2	9,000	554702	0.56	5.31	2.50	1.25	0.81	7/32, 9/32 & 3/8	7/32 & 9/32	7/32
3/4	18,000	554706	0.75	5.63	2.75	2.00	2.08	1/2	3/8	9/32
1	30,300	554710	1.00	7.25	3.50	2.63	4.59	5/8	1/2	3/8
1-1/4	45,500	554714	1.25	8.75	4.63	3.25	9.17	3/4	5/8	1/2
1-1/2	71,200	554719	1.50	10.50	5.25	3.88	15.28	-	3/4	5/8
1-3/4	86,000	554723	1.75	12.00	6.00	4.50	23.93	-	-	-
2	120,000	554726	2.00	14.00	7.00	3.50	35.93	-	-	3/4
2-1/4	125,200	554731	2.25	16.00	8.00	6.00	52.83	-	-	-

# EZ·CONNECT™ MASTER LINK & CHAIN SHORTENER DUAL RATED FOR USE WITH HA800 OR HA1000

WORKING LOAD LIMIT: 9,000 TO 125,200 LBS.

### BENEFITS & FEATURES

- Fits Grade 80 and Grade 100 chain
- Durable orange powder coated finish
- Allows you to adjust sling legs quickly and easily, utilizing the same sling for various reaches
- Chain shortener features cradle hook to ensure full load seating for safe operation.
- Does not require the sling to be de-rated.
- Ability to use 30° to 60° angles, preventing dangerous side loading
- 4:1 design factor

### FOR SINGLE LEG SLING

Product Code	Chain Size (in.)	Working Load Limit @ 90° (lbs.)	Weight (lbs.)	Nominal Dimensions (in.)							
				Master Link			Shortener		Overall Reach		
				Material Dia. A	Width B	Pitch C	Pitch D	Pitch E	F	G	
555232S1	9/32	4,300	1.9	0.56	2.50	5.00	4.76	3.38	8.38	9.76	
555235S1	3/8	8,800	4.6	0.75	2.75	5.50	6.25	4.74	10.24	11.75	
555238S1	1/2	15,000	9.6	1.00	3.50	7.00	7.57	5.82	12.82	14.57	
555239S1	5/8	22,600	12.8	1.00	3.50	7.00	9.32	7.04	14.04	16.32	

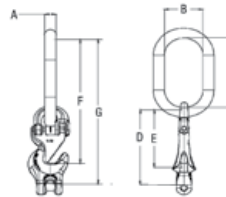

### FOR DOUBLE LEG SLING

Product Code	Chain Size (in.)	Working Load Limit			Weight (lbs.)	Nominal Dimensions (in.)						
		60°	45°	30°		Master Link			Shortener		Overall Reach	
		Material Dia. A	Width B	Pitch C		Pitch D	Pitch E	F	G			
555232S2	9/32	7,400	6,100	4,300	3.0	0.562	2.50	5.00	4.76	3.38	8.38	9.76
555235S2	3/8	15,200	12,400	8,800	7.1	0.75	2.75	5.50	6.25	4.74	10.24	11.75
555238S2	1/2	26,000	21,200	15,000	14.5	1.00	3.50	7.00	7.57	5.82	12.82	14.57
555240S2	5/8	39,100	32,000	22,600	26.6	1.25	4.38	8.75	9.32	7.04	15.79	18.07

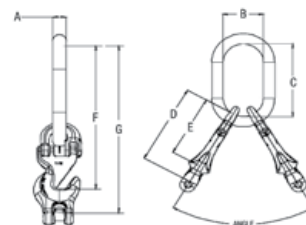



# HAMMERLOK®

**WORKING LOAD LIMIT: 2,700 TO 35,300 LBS.**
**BENEFITS & FEATURES**

- Used for overhead lifting slings to connect chain branches to the master link and the hook to attachments
- Constructed of drop forged alloy steel
- Must be matched to chain size
- Do not use for chain repair or splicing
- Meets ASTM A952 standards
- 4:1 design factor

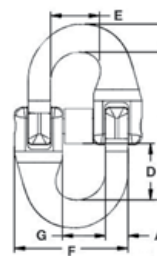

Size (in.)	Working Load Limit (lbs.)	Product Code	Load Pin Kit Product Code	Dimensions (in.)								Weight (lbs.)
				A (Max)	B (Max)	C	D	E	F	G		
7/32	2,700	667021-2	R667021-2	0.29	0.28	1.85	0.69	0.61	1.44	0.52	0.27	
9/32	4,300	667028-2	R667028-2	0.37	0.44	1.94	0.69	0.68	1.58	0.61	0.28	
3/8	8,800	667038-2	R667038-2	0.52	0.50	3.02	1.15	1.05	2.33	0.81	0.84	
1/2	15,000	667050-2	R667050-2	0.64	0.68	3.79	1.43	1.29	2.98	1.10	1.87	
5/8	22,600	667062-2	R667062-2	0.81	0.91	4.50	1.70	1.54	3.57	1.32	3.13	
3/4	35,300	667075-2	R667075-2	0.97	1.07	5.36	2.06	1.78	4.69	1.52	5.75	

# CHAIN SHORTENER HERC-ALLOY® 1000

**WORKING LOAD LIMIT: 4,300 TO 22,600 LBS.**
**BENEFITS & FEATURES**

- Quickly and easily adjust chain length of sling when the load has uneven pick points
- Durable orange powder coated finish
- Marked with both fraction and metric sizes
- Forged alloy steel – quenched & tempered
- Mechanically attaches directly to master ring
- 4:1 design factor

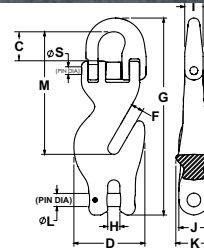

Size (in.)	Working Load Limit (lbs.)	Product Code	Standard Package	Dimensions (in.)											Weight (lbs.)
				C	D	G	H	J	K	L	F	M	S	T	
9/32	4,300	M71805A-2	10	0.69	2.16	5.86	0.38	0.80	1.00	0.36	0.38	3.38	0.21	0.54	1.20
3/8	8,800	M71806A-2	10	1.15	2.74	7.61	0.47	1.17	1.41	0.51	0.47	4.74	0.31	0.71	2.50
1/2	15,000	M71808A-2	10	1.43	3.34	9.36	0.65	1.38	2.07	0.63	0.65	5.82	0.41	0.93	4.80
5/8	22,600	M71810A-2	5	1.74	4.19	11.56	0.79	1.53	2.46	0.75	0.79	7.04	0.48	1.06	8.20

Note: If used as a choker, working load limit should be reduced by 20%.

# OMEGALOK CONNECTOR

**WORKING LOAD LIMIT: 3,500 TO 22,600 LBS.**
**BENEFITS & FEATURES**

- Fraction and metric markings
- Durable orange powder coated finish
- 100% proof tested
- For use with master link with flats (see page 77)
- 4:1 design factor

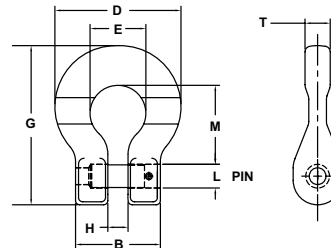

Size (in.)	Working Load Limit (lbs.)	Standard Package	Product Code			Dimensions (in.)									Weight (lbs.)
			Completed Unit	Load Pin	Retainer Pin	B	D	E	G	H	L	M	T		
9/32	4,300	12	644128	595780SP	602306	1.36	2.30	0.98	2.81	0.33	0.36	1.45	0.43	0.55	
3/8	8,800	12	644138	595781	495828	1.90	2.82	1.25	3.57	0.45	0.51	1.77	0.57	1.18	
1/2*	15,000	12	644150	SP595782P	495829	2.31	3.52	1.56	4.44	0.59	0.63	2.26	0.70	2.00	
5/8*	22,600	5	644162	SP595783P	495823	2.87	4.46	2.00	5.45	0.75	0.75	2.72	0.88	3.76	

\* Grade 80 only



## RIGGING HOOK DUAL RATED FOR USE WITH HA800 OR HA1000

WORKING LOAD LIMIT: 2,700 TO 22,600 LBS.

### BENEFITS & FEATURES

- For use with both Grade 80 & 100 chain
- Large eye to easily accommodate other fittings
- Quenched & tempered alloy steel
- Durable orange powder coated finish
- 5:1 design factor
- Meets ASTM A952 standards

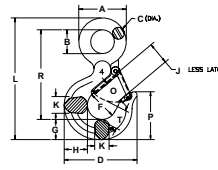

Size (in.)	Working Load Limit (lbs.)	Product Code			Standard Package	Dimensions (in.)														Weight (lbs.)
		With Latch	Without Latch	Latch Kit		A	B	C	D	F	G	H	J	K	L	O	P	R	T	
7/32	2,700	M7502A	M7402A	4X1302	10	1.50	0.74	0.38	3.12	1.25	0.87	1.01	0.93	0.63	4.37	0.93	2.13	3.12	0.87	0.66
9/32	4,300	M7503A	M7403A	4X1303	10	1.75	0.86	0.45	3.37	1.38	0.94	1.11	0.97	0.71	5.04	0.97	2.27	3.66	0.97	1.12
5/16	5,700	M7504A	M7404A	4X1304	10	2.13	1.10	0.52	3.79	1.50	1.07	1.23	1.02	0.88	5.65	1.02	2.56	4.08	1.03	1.46
3/8	8,800	M7505A	M7405A	4X1305	10	2.50	1.23	0.64	4.24	1.63	1.26	1.43	1.19	0.94	6.54	1.16	2.85	4.67	1.21	2.42
1/2	15,000	M7507A	M7407A	4X1307	5	3.08	1.55	0.77	5.10	2.00	1.44	1.63	1.50	1.38	7.98	1.41	3.47	5.77	1.47	4.10
5/8	22,600	M7509A	M7409A	4X1309	5	3.88	1.98	0.95	6.24	2.50	1.82	2.01	1.78	1.68	10.07	1.69	4.59	7.31	1.71	8.16

## CLEVLOK® SLING HOOK DUAL RATED FOR USE WITH HA800 OR HA1000

WORKING LOAD LIMIT: 2,700 TO 35,300 LBS.

### BENEFITS & FEATURES

- For use with both Grade 80 & 100 chain
- Fatigue rated to Grade 100 specifications
- 100% proof tested
- Durable orange powder coated finish
- Improved cast latch
- New CE compliant hooks and latches
- Meets EN 1677 and ASTM A952 standards
- Fraction and metric markings
- 4:1 design factor

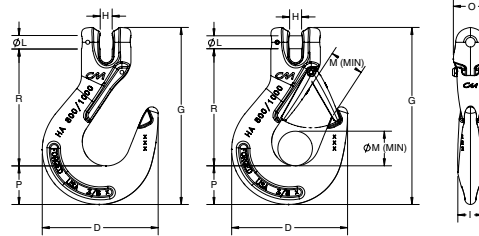

HERC-ALLOY® 1000  
CHAIN SLING COMPONENTS

Size (in.)	Working Load Limit (lbs.)	Standard Package	Product Code					Dimensions (in.)										Weight (lbs.)
			With Latch	Without Latch	Latch Kit	Alloy Load Pin	Retaining Pin	D	G	H	I	L	M	O	P	R		
7/32	2,700	10	657716	557716	4X455321	SP595778P	495827	3.05	5.00	0.31	0.66	0.28	0.96	1.13	0.94	3.45	1.10	
9/32	4,300	10	657718	557718	4X455322	595780SP	495827	3.53	5.55	0.38	0.75	0.36	0.83	1.32	1.11	3.75	1.20	
3/8	8,800	10	657719	557719	4X455325	595781	495828	4.54	6.93	0.47	1.00	0.51	1.06	1.34	1.51	4.58	2.21	
1/2	15,000	5	657720	557720	4X455328	SP595782P	495823	5.48	8.28	0.58	1.33	0.63	1.38	1.87	1.55	5.59	4.22	
5/8	22,600	5	657721	557721	4X455329	SP595783P	495849	6.20	9.61	0.71	1.47	0.75	1.69	2.11	1.83	6.44	6.64	
3/4	35,300	Bulk	657722	557722	4X455330	595786	495824	7.63	11.79	0.88	1.88	0.94	2.09	2.55	2.51	7.74	11.22	

## EYE SLING HOOK DUAL RATED FOR USE WITH HA800 OR HA1000

WORKING LOAD LIMIT: 2,700 TO 35,300 LBS.

### BENEFITS & FEATURES

- For use with both Grade 80 & 100 chain
- Fatigue rated to Grade 100 specifications
- Available with or without latch
- Durable orange powder coated finish
- 100% proof tested
- Fraction and metric markings
- 4:1 design factor
- Meets ASTM A952 standards

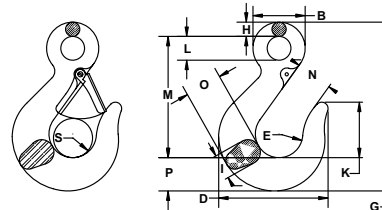

Size (in.)	Working Load Limit (lbs.)	Product Code			Standard Package	Dimensions (in.)										Weight (lbs.)			
		With Latch	Without Latch	Latch Kit		B	D	E	G	H	I	K	L	M	N		O	P	S
7/32	2,700	558618	458618	4X455321	10	1.50	3.04	1.30	5.06	0.38	0.66	1.47	0.75	3.75	0.97	0.99	0.94	0.99	0.8
9/32	4,300	558622	458622	595523	10	1.65	3.48	1.50	5.25	0.45	0.75	1.75	0.72	3.75	1.19	1.21	1.05	1.10	1.1
3/8	8,800	558625	458625	595525	10	2.06	4.33	1.88	6.66	0.58	0.97	2.19	0.91	4.77	1.44	1.46	1.31	1.29	1.9
1/2	15,000	558628	458628	595528	5	2.63	5.50	2.25	8.16	0.77	1.10	2.56	1.09	5.67	1.78	1.91	1.68	1.63	4.5
5/8	22,600	558629	458629	595529	5	3.06	6.23	2.63	9.63	0.89	1.46	2.62	1.31	6.50	2.03	2.20	2.23	1.69	7.3
3/4	35,300	558630	458630	595530	Bulk	3.50	7.82	3.00	11.38	1.00	1.69	3.47	1.50	7.81	2.50	2.82	2.58	2.31	11.4



# CLEVLOK® CRADLE GRAB HOOK

## DUAL RATED FOR USE WITH HA800 OR HA1000

**WORKING LOAD LIMIT: 2,700 TO 35,300 LBS.**

### BENEFITS & FEATURES

- For use with both Grade 80 & 100 chain
- Meets ASTM A952 standards
- 100% proof tested
- Durable orange powder coated finish
- Fraction and metric markings
- 4:1 design factor

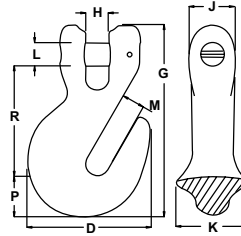

Size (in.)	Working Load Limit (lbs.)	Product Code	Standard Package Quantity	Dimensions (in.)									Weight (lbs.)
				D	G	H	J	K	L	M	P	R	
7/32	2,700	659718	10	1.62	3.21	0.31	0.75	0.94	0.28	0.31	0.62	1.98	0.50
9/32	4,300	659722	10	2.18	3.39	0.38	0.82	0.97	0.36	0.38	0.82	1.86	0.63
3/8	8,800	659725	10	2.72	4.33	0.47	1.18	1.29	0.51	0.74	1.03	2.47	1.30
1/2	15,000	659728	5	3.65	5.27	0.65	1.39	2.01	0.63	0.60	1.19	3.04	2.10
5/8	22,600	659729	5	4.50	6.54	0.77	1.55	2.42	0.75	0.77	1.41	3.76	4.20
3/4	35,300	659730	Bulk	5.40	8.80	0.88	2.05	2.69	0.88	0.91	1.89	5.30	10.50

Note: If used as a choker, working load limit should be reduced by 20%. Reference CM Rigging Guide for more details.

HERC-ALLOY® 1000  
CHAIN SLING COMPONENTS



# EYE CRADLE GRAB HOOK

## DUAL RATED FOR USE WITH HA800 OR HA1000

**WORKING LOAD LIMIT: 2,700 TO 35,300 LBS.**

### BENEFITS & FEATURES

- For use with both Grade 80 & 100 chain
- Meets ASTM A952 standards
- 100% proof tested
- Durable orange powder coated finish
- Fraction and metric markings
- 4:1 design factor

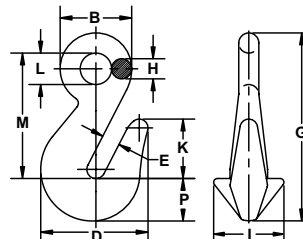

Size (in.)	Working Load Limit (lbs.)	Product Code	Standard Package Quantity	Dimensions (in.)									Weight (lbs.)	
				B	D	E	G	H	I	K	L	M		P
7/32	2,700	559724	10	1.20	1.68	0.31	3.22	0.33	0.92	0.99	0.55	2.20	0.69	0.35
9/32	4,300	559725	10	1.40	1.93	0.37	3.72	0.39	1.07	1.15	0.63	2.58	0.76	0.55
3/8	8,800	559737	10	1.78	2.86	0.47	4.81	0.52	1.38	1.66	0.75	3.27	1.02	1.39
1/2	15,000	559750	5	2.28	3.69	0.59	6.36	0.63	1.81	2.15	1.06	4.23	1.53	3.05
5/8	22,600	559762	5	2.75	4.53	0.75	7.62	0.75	2.13	2.65	1.25	5.06	1.80	4.36
3/4	35,300	559775	Bulk	3.50	5.23	0.91	9.54	1.00	2.88	3.55	1.52	6.70	1.85	9.00

Note: If used as a choker, working load limit should be reduced by 20%.



# CLEVLOK® FOUNDRY HOOK HERC-ALLOY® 1000

WORKING LOAD LIMIT: 4,300 TO 35,300 LBS.

## BENEFITS & FEATURES

- Clevlok® head designed for easy assembly
- "I" beam body design increases grip when removing from load
- Meets ASTM A952 standards
- Quenched & tempered alloy steel
- Individually proof tested
- Durable orange powder coated finish
- 4:1 design factor

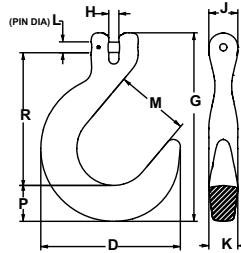

Size (in.)	Working Load Limit (lbs.)	Clevlok Foundry Hook			Alloy Load Pin Product Code	Retaining Pin Product Code	Dimensions (in.)									
		Product Code	Standard Package Quantity	Weight (lbs.)			D	G	H	J	K	L	M	P	R	
9/32	4,300	475798	5	2.43	595780SP	602306	4.82	6.52	0.35	1.00	1.00	0.36	2.55	1.24	4.59	
3/8	8,800	475799	5	4.14	595781	495828	5.73	7.87	0.47	1.16	1.27	0.51	3.05	1.43	5.59	
1/2	15,000	475800	5	7.10	SP595782P	495829	6.83	9.40	0.59	1.50	1.50	0.63	3.55	1.75	6.58	
5/8	22,600	475801	5	12.03	595785	495824	7.94	10.98	0.70	1.74	1.81	0.75	4.07	2.03	7.69	
3/4	35,300	475802	5	21.00	595786	495824	9.17	13.20	0.88	2.05	2.00	0.91	4.50	2.63	8.87	

# EYE FOUNDRY HOOK

DUAL RATED FOR USE WITH HA800 OR HA1000

WORKING LOAD LIMIT: 4,300 TO 35,300 LBS.

## BENEFITS & FEATURES

- For use with both Grade 80 & 100 chain
- Throat opening to 4.5" (114 mm)
- Meets ASTM A952 standards
- Durable orange powder coated finish
- 100% proof tested
- For welded 7/32" chain sling use 9/32" eye foundry hook
- 4:1 design factor

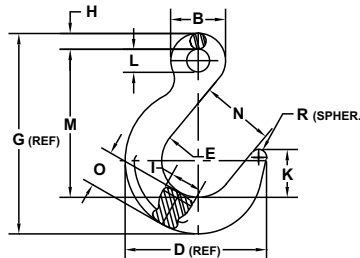

Size (in.)	Working Load Limit (lbs.)	Product Code	Standard Package Quantity	Dimensions (in.)												Weight (lbs.)
				B	D	E	G	H	I	K	L	M	N	O	R	
9/32	4,300	474798	5	1.56	4.73	2.50	6.45	0.47	1.00	1.56	0.63	4.75	2.50	1.23	0.25	2.4
3/8	8,800	474799	5	2.00	5.72	3.00	7.88	0.63	1.27	1.88	0.80	5.77	3.00	1.50	0.31	4.5
1/2	15,000	474800	5	2.50	6.74	3.50	9.38	0.75	1.50	2.22	1.00	6.88	3.50	1.75	0.38	7.1
5/8	22,600	474801	5	3.00	7.79	4.00	10.97	0.88	1.81	2.63	1.13	8.06	4.00	2.03	0.44	11.6
3/4	35,300	474802	Bulk	3.50	9.07	4.50	12.81	1.00	2.20	3.00	1.50	9.25	4.50	2.56	0.50	20.0



## LATCHLOK® HOOK USE

Working load limits are based on chain size. Hooks are embossed with the chain size they attach to and are not embossed with the working load limit (WLL).

Example: A 9/32" hook embossed (HA1000 9/32") means it's a Grade 100 hook for 9/32" Grade 100 chain with a working load limit of 4,300 lbs. If you are putting it on Grade 80 chain you de-rate the assembly to the 9/32" Grade 80 rating of 3,500 lbs.

The chart below shows the working load limit of Latchlok® hooks when used with Grade 100 and Grade 80 chain slings. It also provides working load limit information for these hooks when used with synthetic web, round or wire rope slings. CM Webloks can be used to avoid bunching when attaching synthetic slings to eye hooks.

Attachment Type	Hook Size: 9/32" Maximum WLL: 4,300 lbs.		Hook Size: 3/8" Maximum WLL: 8,800 lbs.		Hook Size: 1/2" Maximum WLL: 15,000 lbs.		Hook Size: 5/8" Maximum WLL: 22,600 lbs.	
	Size (in.)	WLL 4:1 (lbs.)	Size (in.)	WLL 4:1 (lbs.)	Size (in.)	WLL 4:1 (lbs.)	Size (in.)	WLL 4:1 (lbs.)
When used with Herc-Alloy® chain use the working load limits stated below. Chain WLL are based on 4:1 design.								
Herc-Alloy® 800 Chain	9/32	3,500	3/8	7,100	1/2	12,000	5/8	18,000
Herc-Alloy® 1000 Chain	9/32	4,300	3/8	8,800	1/2	15,000	5/8	22,600
Synthetic web, round and wire rope slings have a 5:1 design factor. If you wish to use these hooks with these slings and maintain the 5:1 sling design factor, use the WLL below.								
Synthetic Web, Round and Wire Rope Slings	9/32	3,500	3/8	7,100	1/2	12,000	5/8	18,000

Always use proper connecting hardware with web, round and wire rope slings. Never choke slings in the eye of the hook.

## CLEVLOK® STYLE LATCHLOK® HOOK HERC-ALLOY® 1000



WORKING LOAD LIMIT: 4,300 TO 22,600 LBS.

### BENEFITS & FEATURES

- High-cycling, long-life spring
- 100% proof tested
- Meets ASTM A952 standards
- Durable orange powder coated finish
- Positive locking hook
- 4:1 design factor

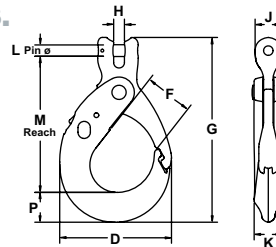

Size (in.)	Working Load Limit (lbs.)	Product Code	Replace Latch Kit Part #	Dimensions (in.)										Weight (lbs.)
				H	M	P	D	F	J	K	G	L		
9/32	4,300	M616005	656005	0.35	5.05	0.88	3.77	1.64	1.00	0.91	6.61	0.36	2.40	
3/8	8,800	M616010	656010	0.45	6.08	1.07	4.76	2.26	1.17	1.15	7.98	0.51	4.20	
1/2	15,000	M616015	656015	0.59	7.88	1.58	6.26	2.91	1.50	1.47	10.54	0.63	9.00	
5/8	22,600	M616020	656020	0.71	8.96	1.97	7.37	3.22	1.74	1.85	12.19	0.75	14.00	

## EYE STYLE LATCHLOK® HOOK HERC-ALLOY® 1000



WORKING LOAD LIMIT: 4,300 TO 22,600 LBS.

### BENEFITS & FEATURES

- Large eye design for use with chain, wire rope and synthetic material
- 100% proof tested
- Meets ASTM A952 standards
- Durable orange powder coated finish
- For welded 7/32" chain sling use 9/32" eye Lodelok hook
- Positive locking hook
- 4:1 design factor

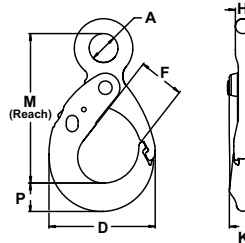

Size (in.)	Working Load Limit (lbs.)	Product Code	Replace Latch Kit Part #	Dimensions (in.)							Weight (lbs.)
				A	M	P	D	F	H	K	
9/32	4,300	M626005	656005	1.09	5.37	0.88	3.77	1.64	0.47	0.91	2.50
3/8	8,800	M626010	656010	1.36	6.65	1.07	4.74	2.27	0.59	1.15	4.74
1/2	15,000	M626015	656015	1.57	8.79	1.58	6.26	2.91	0.80	1.47	10.00
5/8	22,600	M626020	656020	2.00	10.37	1.97	7.37	3.22	1.03	1.85	16.00





# SWIVEL STYLE LATCHLOK® HOOKS

## HERC-ALLOY® 1000

WORKING LOAD LIMIT: 4,300 TO 22,600 LBS.

### BENEFITS & FEATURES OF BOTH STYLES

- The eye easily positions to attach to the load
- 100% proof tested
- Meets ASTM A952 standards
- Certification of test available
- Durable orange powder coated finish
- For welded 7/32" chain sling use 9/32" swivel Lodelok hook
- Positive locking hook
- 4:1 design factor

### ▶ DID YOU KNOW?

#### BEARING VS. BUSHING STYLE SWIVEL HOOKS

##### BEARING SWIVEL HOOKS

The load may be swiveled and turned into position WITH or WITHOUT the load attached.

##### BUSHING SWIVEL HOOKS

The load must be swiveled and turned into position BEFORE attaching, lifting or moving a load.

For more information, visit us at  
[www.cmworks.com](http://www.cmworks.com)



BEARING STYLE SWIVEL HOOK



BUSHING STYLE SWIVEL HOOK

### BEARING SWIVEL STYLE

Size (in.)	Working Load Limit (lbs.)	Product Code	Replace Latch Kit Part #	Dimensions (in.)								Weight (lbs.)
				H	M	P	D	F	A	B	K	
9/32	4,300	M696005	656005	0.62	7.43	0.88	3.77	1.64	1.50	1.31	0.91	3.5
3/8	8,800	M696010	656010	0.77	9.11	1.07	4.76	2.26	1.75	1.62	1.15	4.8
1/2	15,000	M696015	656015	0.93	11.49	1.58	6.26	2.91	2.25	1.82	1.47	10.7
5/8	22,600	M696020	656020	1.00	13.73	1.97	7.37	3.22	2.50	2.16	1.85	17.4

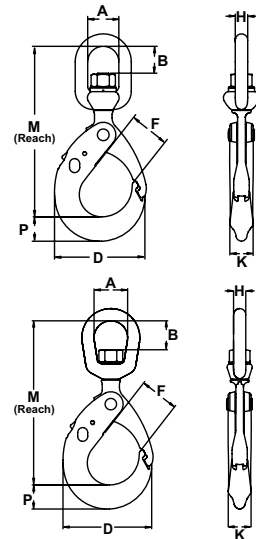

### BUSHING SWIVEL STYLE

Size (in.)	Working Load Limit (lbs.)	Product Code	Replace Latch Kit Part #	Dimensions (in.)								Weight (lbs.)
				H	M	P	D	F	A	B	K	
9/32	4,300	M676005	656005	0.62	7.17	0.88	3.77	1.64	1.50	1.33	0.91	3.5
3/8	8,800	M676010	656010	0.77	8.73	1.07	4.76	2.26	1.75	1.63	1.15	4.8
1/2	15,000	M676015	656015	0.93	11.18	1.58	6.26	2.91	2.00	1.76	1.47	10.6
5/8	22,600	M676020	656020	1.00	13.35	1.97	7.37	3.22	2.75	2.38	1.85	17.0

HERC-ALLOY® 1000  
CHAIN SLING COMPONENTS

### ▶ INSPECTION, CARE & USE

#### USING LATCHLOK® HOOKS SAFELY

- ▲ Do not apply load unless latch and hook are completely closed and locked
- ▲ Make certain that the latch does not support any part of the load
- ▲ When lifting, make certain that the load is firmly seated in the base (bowl) of the hook
- ▲ Inspect hook and latch periodically. If the hook or latch is damaged or if the latch fails to interlock with the tip, the hook should be removed from service
- ▲ Do not exceed the working load limit
- ▲ Do not use if the hook is visibly distorted, damaged or worn
- ▲ Keep body and other objects clear of the latch when closing to avoid the pinch point
- ▲ Do not side load or tip load hook
- ▲ User should be properly trained and understand safe rigging practices

For more information, visit us at  
[www.cmworks.com](http://www.cmworks.com)









# HERC-ALLOY 800®

Columbus McKinnon has a long history of developing innovative products that have changed the material handling industry – including the development of the first alloy chain in 1933. This alloy chain eventually replaced the industry-standard wrought iron chain used for overhead lifting and is the predecessor to today’s Herc-Alloy 800® chain, hooks and overhead lifting attachments. Made in America, CM Herc-Alloy® products are made of superior triple alloy steel that provides the best strength-to-weight performance in the industry. These products also meet and exceed ASTM A391 standards.

Herc-Alloy® is now one of the most recognized and trusted brands in the rigging industry and is only offered by Columbus McKinnon.

## HERC-ALLOY 800® PRODUCT OVERVIEW

The chart below is an overview of our most popular Herc-Alloy 800® products. Our full product offering, including detailed specifications and available sizes, can be found on the product pages within this section.

	Chain Size (in.)		Working Load Limit (lbs.)	COMPONENTS							
				Chain (Per Ft.)	Chain (Drum)	Master Link	Master Link w/Flats	Sub- Assembly	Sub- Assembly w/Flats	Hammerlok®	Weblok™ Assembly
	(in.)	(mm.)		Page 76	Page 76	Page 78	Page 79	Page 80	Page 80	Page 82	Page 82
											
Single at 90°	7/32	5.5	2,100	607020	677010	555231	ML040	–	–	664021-2	–
	9/32	7	3,500	607028	677011	555232	ML040	–	–	664028-2	–
	3/8	10	7,100	607037	677013	555235	ML063	–	–	664038-2	867010-4
	1/2	13	12,000	607050	677015	555238	ML075	–	–	664050-2	–
	5/8	16	18,100	607062	677016	555238	ML100	–	–	664062-2	867020-4
	3/4	20	28,300	607075	677017	555240	ML125	–	–	664075-2	867025-4
	7/8	23	34,200	607087	677018	554943	ML125	–	–	664089-2	867030-4
	1	26	47,700	607101	677019	554946	ML150	–	–	664100-2	867035-4
1-1/4	32	72,300	607128	677070	554949	ML200	–	–	664125-2	867040-4	
Double at 60°	7/32	5.5	3,600	607020	677010	555231	ML050	–	–	664021-2	–
	9/32	7	6,100	607028	677011	555232	ML063	–	–	664028-2	–
	3/8	10	12,300	607037	677013	555235	ML075	–	–	664038-2	–
	1/2	13	20,800	607050	677015	555238	ML100	–	–	664050-2	–
	5/8	16	31,300	607062	677016	555240	ML125	–	–	664062-2	–
	3/4	20	49,000	607075	677017	555243	ML150	–	–	664075-2	–
	7/8	23	59,200	607087	677018	554946	ML175	–	–	664089-2	–
	1	26	82,600	607101	677019	554949	ML200	–	–	664100-2	–
1-1/4	32	125,200	607128	677070	554951	ML250	–	–	664125-2	–	
Triple & Quad at 60°	7/32	5.5	5,500	607020	677010	–	–	555274	SA063	664021-2	–
	9/32	7	9,100	607028	677011	–	–	555275	SA075	664028-2	–
	3/8	10	18,400	607037	677013	–	–	555276	SA100	664038-2	–
	1/2	13	31,200	607050	677015	–	–	555277	SA125	664050-2	–
	5/8	16	47,000	607062	677016	–	–	555278	SA175	664062-2	–
	3/4	20	73,500	607075	677017	–	–	555279	SA200	664075-2	–
	7/8	23	88,900	607087	677018	–	–	554980	SA225	664089-2	–
	1	26	123,900	607101	677019	–	–	554981	SA250	664100-2	–
1-1/4	32	187,800	607128	677070	–	–	554983	SA300	664125-2	–	



To help customers reduce and better manage their rigging inventory, Columbus McKinnon has developed several **DUAL-RATED RIGGING ATTACHMENTS** that can be used for both Grade 80 and 100 applications.



	Chain Size (in.)		Clevlok® Sling Hook w/Latch	Clevlok® Sling Hook w/o Latch	Eye Sling Hook w/Latch	Eye Sling Hook w/o Latch	Clevlok® Grab Hook	Clevlok® Cradle Grab Hook	Eye Cradle Grab Hook	Eye Foundry Hook
	(in.)	(mm.)	Page 83	Page 83	Page 83	Page 83	Page 84	Page 84	Page 85	Page 85
Single at 90°	7/32	5.5	657716	557716	558618	458618	–	659718	559724	–
	9/32	7	657718	557718	558622	458622	659222	659722	559725	474798
	3/8	10	657719	557719	558625	458625	659225	659725	559737	474799
	1/2	13	657720	557720	558628	458628	659228	659728	559750	474800
	5/8	16	657721	557721	558629	458629	659229	659729	559762	474801
	3/4	20	657722	557722	558630	458630	–	659730	559775	474802
	7/8	23	–	–	558332	458732	–	–	559387	474503
	1	26	–	–	558333	458733	–	–	559100	474504
1-1/4	32	–	–	558335	458735	–	–	559124*	474505	
Double at 60°	7/32	5.5	657716	557716	558618	458618	–	659718	559724	–
	9/32	7	657718	557718	558622	458622	659222	659722	559725	474798
	3/8	10	657719	557719	558625	458625	659225	659725	559737	474799
	1/2	13	657720	557720	558628	458628	659228	659728	559750	474800
	5/8	16	657721	557721	558629	458629	659229	659729	559762	474801
	3/4	20	657722	557722	558630	458630	–	659730	559775	474802
	7/8	23	–	–	558332	458732	–	–	559387	474503
	1	26	–	–	558333	458733	–	–	559100	474504
1-1/4	32	–	–	558335	458735	–	–	559124*	474505	
Triple & Quad at 60°	7/32	5.5	657716	557716	558618	458618	–	659718	559724	–
	9/32	7	657718	557718	558622	458622	659222	659722	559725	474798
	3/8	10	657719	557719	558625	458625	659225	659725	559737	474799
	1/2	13	657720	557720	558628	458628	659228	659728	559750	474800
	5/8	16	657721	557721	558629	458629	659229	659729	559762	474801
	3/4	20	657722	557722	558630	458630	–	659730	559775	474802
	7/8	23	–	–	558332	458732	–	–	559387	474503
	1	26	–	–	558333	458733	–	–	559100	474504
1-1/4	32	–	–	558335	458735	–	–	559124*	474505	

\* Not cradle type

Sling ID Tags available. See page 75 for details.



# HERC-ALLOY 800® CHAIN

**WORKING LOAD LIMIT: 2,100 TO 72,300 LBS.**

## BENEFITS & FEATURES

- A higher strength heat treated alloy steel chain primarily used as a sling component for overhead lifting
- Can be used in rigging and tie down applications where a lighter weight, higher strength chain is desirable
- Meets NACM, ASME, and OSHA standards for overhead lifting
- 4:1 design factor

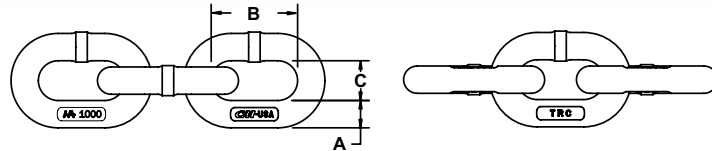

Chain Size (in.)	Working Load Limit (lbs.)	Nominal Chain Dimensions (in.)			Per Foot			Per Drum		
		Material Diameter A	Inside Length B	Inside Width C	Product Code	Weight (lbs./ft.)	Approximate Number of Links (per ft.)	Product Code	Length (ft.)	Weight (lbs.)
7/32	2,100	0.22	0.68	0.31	607020	0.44	17.8	677010	800	354
9/32	3,500	0.28	0.88	0.40	607028	0.73	13.6	677011	500	365
5/16	4,500	0.33	1.02	0.46	607031	0.91	11.8	-	-	-
3/8	7,100	0.39	1.25	0.57	607037	1.44	9.6	677013	500	719
1/2	12,000	0.51	1.44	0.73	607050	2.55	8.3	677015	300	765
5/8	18,100	0.63	1.78	0.86	607062	3.82	6.8	677016	200	765
3/4	28,300	0.79	2.23	1.07	607075	5.95	5.4	677017	100	595
7/8	34,200	0.88	2.25	1.14	607087	7.76	5.3	677018	100	776
1	47,700	1.00	3.07	1.49	607101	9.41	3.9	677019	100	941
1-1/4	72,300	1.25	3.92	1.74	607128	14.20	3.1	677070	90	1,278

HERC-ALLOY 800®  
CHAIN SLING COMPONENTS

## ▶ INSPECTION, CARE & USE

### HOW TO SELECT AND ORDER THE PROPER CHAIN SLING

1. Determine the weight and configuration of the load(s) to be lifted.
2. Determine the type of chain sling required, according to weight and configuration.
3. Determine the size of the body chain according to the working load limits. Be sure to take into consideration the effect of the required angle. The working load limit is the maximum load in pounds which should be applied in direct tension to a straight length of chain.  
 Note: Working load limit can be affected by angles of loading, type of hitch used, environmental conditions such as hot and cold temperatures, and D/d ratio.
4. Determine the reach required to give the desired angle. The reach is measured from the upper bearing surface of the master link to the bearing surface of the lower attachment. If chain slings are to be used in pairs and are to be matched for reach, indicate when ordering.
5. Know share of load on pick points and location of center of gravity.



For more information, visit us at [www.cmworks.com](http://www.cmworks.com)

## SLING ID TAGS

Description	Product Code
Alloy Sling ID Tag	557038
Carbon Sling ID Tag	457106
Attachment Ring	557193

Information on tag includes sling size, reach, WLL, serial number, name of manufacturer, grade of sling & number of branches







# MASTER LINK DUAL RATED FOR USE WITH HA800 OR HA1000

WORKING LOAD LIMIT: 5,400 TO 187,800 LBS.

### BENEFITS & FEATURES

- Accepts both Herc-Alloy® 800 & 1000 chain and components
- Durable orange powder coated finish
- May be used for mechanical and welded sling assemblies
- 100% proof tested
- 4:1 design factor

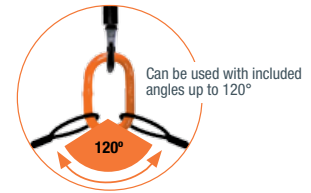
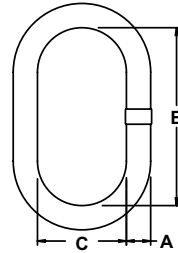

Trade Size (in.)	Working Load Limit (lbs.)	Catalog Number	Product Code	Nominal Dimensions (in.)			Weight (lbs.)	Type and Size of Grade 80 Chain Sling (in.)	
				Material Diameter A	Inside Length B	Inside Width C		Single	Double
<b>Standard Sizes (DUAL RATED THROUGH 1-3/4" SIZE ONLY)</b>									
13/32	5,400	HA40	555231	0.41	3.00	1.50	0.33	7/32 & 9/32	7/32
1/2	8,600	HA50	555232	0.56	5.00	2.50	1.02	3/8	9/32
3/4	17,600	HA75	555235	0.75	5.50	2.75	2.08	1/2	3/8
1	30,000	HA100	555238	1.00	7.00	3.50	4.59	5/8 & 3/4	1/2
1-1/4	45,200	HA125	555240	1.25	8.75	4.38	9.31	7/8	5/8
1-1/2	70,600	HA150	555243	1.50	10.50	5.25	15.60	1	3/4 & 7/8
1-3/4	105,900	HA175	555246	1.75	12.00	6.00	24.40	1-1/4	1
2*	88,900	HA200	554949	2.00	14.00	7.00	38.00	1-1/4	1
2-1/4*	125,200	HA225	554951	2.25	16.00	8.00	55.00	-	1-1/4
2-3/4*	187,800	HA275	554957	2.75	16.00	9.00	84.84	-	-
<b>Special Sizes (NOT DUAL RATED)</b>									
1	18,200	N/A	554969	1.00	8.00	4.00	5.25	N/A	N/A
1-1/4	22,800	N/A	554942	1.25	12.00	6.00	12.08	N/A	N/A
1-1/2	36,700	N/A	554944	1.50	14.00	7.00	20.16	N/A	N/A
1-1/2	42,900	N/A	554970	1.50	12.00	6.00	17.60	N/A	N/A
1-3/4	57,100	N/A	554945	1.75	14.00	7.00	27.92	N/A	N/A
2	77,800	N/A	554952	2.00	16.00	8.00	43.00	N/A	N/A

NOTE: Standard sizes dual rated through 1-3/4" only. Special sizes not dual rated.

# FORGED MASTER LINK GRADE 80

WORKING LOAD LIMIT: 5,100 TO 20,400 LBS.



### BENEFITS & FEATURES

- Quenched and tempered alloy steel
- Fatigue rated to Grade 80 specifications
- 100% proof tested
- Raised markings for better identification
- Durable orange powder coated finish
- 6:1 design factor

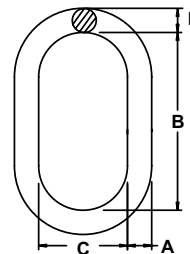
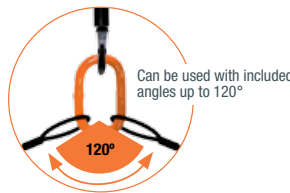

Trade Size (in.)	Working Load Limit (lbs.)	Product Code	Nominal Dimensions (in.)			Weight (lbs.)
			Material Diameter A	Inside Length B	Inside Width C	
1/2	5,100	M50P	0.50	5.00	2.50	0.90
5/8	7,700	M62P	0.63	6.00	3.00	1.75
3/4	10,600	M75P	0.75	6.00	3.00	2.35
1	20,400	M100P	1.00	8.00	4.00	6.00

HERC-ALLOY 800®  
CHAIN SLING COMPONENTS



# MASTER LINK WITH & WITHOUT FLATS

## HERC-ALLOY 800®

WORKING LOAD LIMIT: 4,200 TO 327,800 LBS.

### BENEFITS & FEATURES

- Designed to accept HA800 chain, wire rope and synthetic attachments
- Use with mechanical and welded assemblies
- Sizes up to 1-1/4" available with flats to accommodate Omega link
- 100% proof tested
- 6:1 design factor
- Extra wide body makes these links ideal for wire rope applications and use with Omegaloks. Master link with flat allows for easy installation of these attachments.

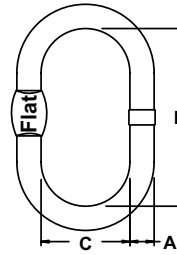
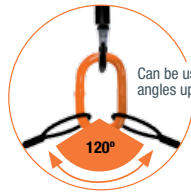

Trade Size (in.)	Working Load Limit (lbs.)		Product Code	Nominal Dimensions (in.)			Flat Dimensions (in.)		Weight (lbs.)	Type and Size of Chain Sling (in.)	
	With Chain	With Wire Rope & Synthetics		Material Diameter A	Inside Length B	Inside Width C	Width	Thickness		Single	Double
7/16	4,200	3,360	ML040 ML040NF	0.44	4.13	2.29	0.94 -	0.28 -	0.50	7/32 & 9/32	7/32
1/2	5,750	4,600	ML050 ML050NF	0.56	4.84	2.69	0.94 -	0.28 -	1.02	-	7/32
5/8	9,000	7,200	ML063 ML063NF	0.63	5.29	2.98	1.22 -	2.81 -	1.34	3/8	9/32
3/4	14,200	11,360	ML075 ML075NF	0.75	6.61	3.72	1.41 -	0.40 -	2.36	1/2	3/8
7/8	17,300	13,840	ML087 ML087NF	0.88	7.35	4.14	1.56 -	0.44 -	3.60	-	-
1	26,500	21,200	ML100 ML100NF	1.00	7.53	4.30	1.56 -	0.53 -	5.20	5/8	1/2
1-1/4	37,400	29,920	ML125 ML125NF	1.25	9.26	5.29	1.56 -	0.68 -	9.60	3/4 & 7/8	5/8
1-1/2	53,000	42,400	ML150	1.50	11.03	6.30	-	-	16.20	1	3/4
1-3/4	72,150	57,720	ML175	1.75	12.86	7.35	-	-	25.10	-	7/8
2	94,200	75,360	ML200	2.00	14.70	8.40	-	-	41.00	1-1/4	1
2-1/4	119,200	95,360	ML225	2.25	16.54	9.45	-	-	58.00	-	-
2-1/2	147,150	117,720	ML250	2.50	18.38	10.50	-	-	74.90	-	1-1/4
2-3/4	178,050	142,440	ML275	2.75	20.21	11.55	-	-	99.80	-	-

NOTE: \*Master link with flats are available through 1-1/4" only  
Part numbers with "NF" are for master links WITHOUT flats

# FLAT BOTTOM MASTER LINK GRADE 80

WORKING LOAD LIMIT: 73,500 TO 187,800 LBS.

### BENEFITS & FEATURES

- Designed to accept HA800 chain and components
- Made from alloy steel
- Extra wide width allows for larger hook usage
- 100% proof tested
- 4:1 design factor

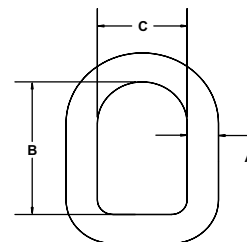

Chain Size (in.)	Trade Size (in.)	Working Load Limit (lbs.)	Product Code	Nominal Dimensions (in.)			Weight (lbs.)
				Material Diameter A	Inside Length B	Inside Width C	
5/8 & 3/4	1-3/4	73,500	554966	1.75	8.00	5.000	18.96
7/8 & 1	2	123,900	554950	2.00	8.98	5.000	28.04
1 & 1/4	2-1/2	187,800	554965	2.50	11.92	6.500	54.73



# SUB-ASSEMBLY DUAL RATED FOR USE WITH HA800 & HA1000

**WORKING LOAD LIMIT: 7,000 TO 187,800 LBS.**

### BENEFITS & FEATURES

- Designed for triple and quad branch Herc-Alloy® chain slings
- Consists of an oblong master link and two welded master coupling links
- Accepts both Herc-Alloy 800 & 1000 chain and components
- Durable orange powder coated finish
- May be used for mechanical or welded sling assemblies
- 100% proof tested
- 4:1 design factor

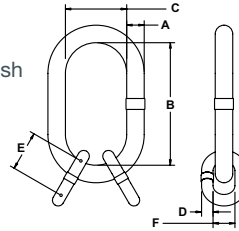

Can be used with included angles up to 120°

Trade Size (in.)	Catalog Number	Working Load Limit at 60° (lbs.)	Product Code	Master Link Nominal Dimensions (in.)			Intermediate Link Nominal Dimensions (in.)			Weight (lbs.)	Type & Size of Chain Sling (in.)	
				Material Diameter A	Inside Length B	Inside Width C	Material Diameter D	Inside Length E	Inside Width F		Triple	Quad
1/2	SA50	7,000	555274	0.56	5.00	2.50	0.44	1.75	1.06	1.35	7/32	7/32
3/4	SA75	11,200	555275	0.75	5.50	2.75	0.47	1.56	0.88	2.64	9/32	9/32
1	SA100	22,900	555276	1.00	7.00	3.50	0.78	2.63	1.50	7.25	3/8	3/8
1-1/4	SA125	39,000	555277	1.25	8.75	4.38	0.91	3.13	1.75	13.51	1/2	1/2
1-1/2	SA150	58,700	555278	1.50	10.50	5.25	1.13	4.00	2.25	24.28	5/8	5/8
1-3/4	SA175	91,700	555279	1.75	12.00	6.00	1.50	5.25	2.75	44.58	3/4 & 7/8	3/4 & 7/8
2*	HA200-SA	88,900	554980	2.00	14.00	7.00	1.53	5.25	2.75	57.34	7/8	7/8
2-1/4*	HA225-SA	123,900	554981	2.25	16.00	8.00	1.78	6.00	3.00	81.48	1	1
2-3/4*	HA275-SA	187,800	554983	2.75	16.00	9.00	2.00	7.00	3.50	126.66	1-1/4	1-1/4

\* Grade 80 only

# WIDE BODY SUB-ASSEMBLY WITH FLATS HERC-ALLOY 800®

**WORKING LOAD LIMIT: 4,600 TO 178,050 LBS.**



### BENEFITS & FEATURES

- Designed to accept Herc-Alloy 800® chain, wire rope and synthetic attachments
- Durable orange powder coated finish
- 100% proof tested
- May be used for mechanical and welded sling assemblies
- Extra wide body is ideal for wire rope applications
- Sizes up to 1-1/4" intermediate links available with flats to accommodate Omega links
- 6:1 design factor

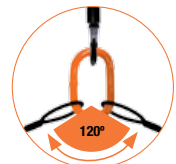
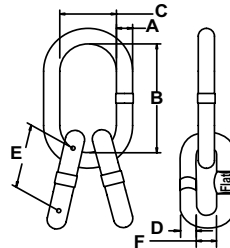

Can be used with included angles up to 120°

Trade Size (in.)	Working Load Limit (lbs.)		Complete Assembly Product Code	Master Link Nominal Dimensions (in.)			Intermediate Link Nominal Dimensions (in.)			Weight (lbs.)	Type and Size of Chain Sling (in.)			
	With Chain	With Wire Rope & Synthetic		Product Code	Material Diameter A	Inside Length B	Inside Width C	Product Code	Material Diameter D		Inside Length E	Inside Width F	Triple	Quad
1/2	5,750	4,600	SA050	ML050	0.56	4.84	2.69	ML040	0.44	4.13	2.29	1.8	-	-
5/8	9,000	7,200	SA063	ML063	0.63	5.29	2.98	ML050	0.56	4.84	2.69	2.9	7/32	7/32
3/4	14,000	11,200	SA075	ML075	0.75	6.61	3.72	ML063	0.63	5.29	2.98	5.5	9/32	9/32
7/8	17,300	13,840	SA087	ML087	0.88	7.35	4.14	ML063	0.63	5.29	2.98	6.3	-	-
1	26,500	21,200	SA100	ML100	1.00	7.53	4.30	ML075	0.75	6.61	3.72	10.2	3/8	3/8
1-1/4	37,400	29,920	SA125	ML125	1.25	9.26	5.29	ML100	1.00	7.53	4.30	20.0	1/2	1/2
1-1/2	53,000	42,400	SA150	ML150	1.50	11.03	6.30	ML100	1.00	7.53	4.30	26.6	-	-
1-3/4	72,150	57,720	SA175	ML175	1.75	12.86	7.35	ML125	1.25	9.26	5.29	44.3	5/8	5/8
2	94,200	75,360	SA200	ML200	2.00	14.70	8.40	ML150	1.50	11.03	6.30	73.4	3/4	3/4
2-1/4	119,200	95,360	SA225	ML225	2.25	16.54	9.45	ML175	1.75	12.86	7.35	108.2	7/8	7/8
2-1/2	147,150	117,720	SA250	ML250	2.50	18.38	10.50	ML200	2.00	14.70	8.40	156.9	1	1
2-3/4	178,050	142,400	SA275	ML275	2.75	20.21	11.55	ML200	2.00	14.70	8.40	181.0	-	-

NOTE: Master link with flats are available through 1-1/4" only

HERC-ALLOY 800®  
CHAIN SLING COMPONENTS





## MASTER RING HERC-ALLOY 800®

WORKING LOAD LIMIT: 3,500 TO 141,000 LBS.

### BENEFITS & FEATURES

- Made from alloy material
- Proof tested at two times WLL
- Durable orange powder coated finish
- 4:1 design factor

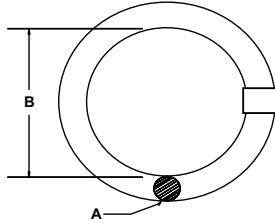

Trade Size (in.)	Working Load Limit (lbs.)	Product Code	Dimensions (in.)		Weight (lbs.)	Type and Size of Chain Sling (in.)			
			Material Diameter A	Inside Length B		Single	Double	Triple	Quadruple
1/2	3,500	554611	0.51	2.50	0.52	7/32 & 9/32	–	–	–
5/8	6,100	554613	0.63	3.00	0.99	–	7/32	7/32	7/32
3/4	10,500	554615	0.75	4.00	1.86	3/8	9/32	9/32	9/32
7/8	12,300	554617	0.88	4.00	2.60	1/2	–	–	–
1	18,400	554619	1.00	4.00	3.45	5/8	3/8	–	–
1-1/4	28,300	554623	1.25	5.00	6.98	3/4	1/2	3/8	3/8
1-1/2	31,300	554627	1.50	6.00	11.80	–	–	–	–
2	73,500	554635	2.00	8.00	27.90	1-1/4	7/8	5/8	5/8
2-1/4	88,900	554636	2.25	9.00	39.90	–	–	3/4	3/4
2-1/2	141,000	554640	2.50	10.00	54.60	–	1	7/8 & 1	7/8 & 1

HERC-ALLOY 800®  
CHAIN SLING COMPONENTS

## GRAB LINK HERC-ALLOY 800®

WORKING LOAD LIMIT: 3,500 TO 18,100 LBS.



### BENEFITS & FEATURES

- Made from alloy material
- Proof tested at two times the WLL
- Economical chain adjuster for single slings
- Durable orange powder coated finish
- 4:1 design factor

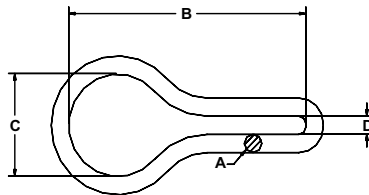

Chain Size (in.)	Trade Size (in.)	Working Load Limit (lbs.)	Product Code	Dimensions (in.)				Weight (lbs.)
				Diameter A	Inside Length B	Inside Width C	Inside Width D	
9/32	1/2	3,500	554320	0.56	5.50	2.50	0.54	1.01
3/8	3/4	7,100	554326	0.75	6.06	2.75	0.63	2.08
1/2	1	12,000	554332	1.00	7.63	3.50	0.75	4.59
5/8	1-1/4	18,100	554337	1.25	9.25	4.38	1.00	9.16



# HAMMERLOK® HERC-ALLOY 800®

WORKING LOAD LIMIT: 2,100 TO 72,300 LBS.

## BENEFITS & FEATURES

- Used for overhead lifting slings to connect chain branches to the master link and the hook to attachments.
- Constructed of drop forged alloy steel
- Can be used with Grade 80 chain
- Must be matched to chain size
- Do not use for chain repair or splicing
- Meets ASTM A952 standards.
- 4:1 design factor

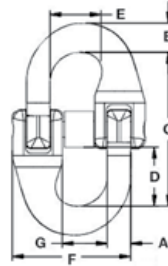

Size (in.)	Working Load Limit (lbs.)	Completed Unit			Load Pin Kit		Dimensions (in.)						
		Product Code	Weight (lbs.)	Standard Package	Product Code	Weight (lbs.)	A	B	C	D	E	F	G
7/32	2,100	664021-2	0.12	36	R664021-2	0.01	0.25	0.25	1.40	0.50	0.58	1.21	0.44
9/32	3,500	664028-2	0.26	36	R664028-2	0.02	0.34	0.31	1.94	0.75	0.70	1.51	0.56
3/8	7,100	664038-2	0.59	36	R664038-2	0.05	0.48	0.50	2.41	0.88	0.91	2.09	0.80
1/2	12,000	664050-2	1.42	24	R664050-2	0.12	0.66	0.70	3.51	1.29	1.41	2.96	1.15
5/8	18,100	664062-2	2.35	12	R664062-2	0.20	0.78	0.81	4.06	1.50	1.70	3.52	1.40
3/4	28,300	664075-2	3.67	12	R664075-2	0.30	0.96	0.94	4.78	1.80	1.97	4.11	1.71
7/8	34,200	664089-2	5.98	6	R664089-2	0.40	1.16	1.05	5.25	1.97	2.09	4.95	1.88
1	47,700	664100-2	9.47	-	R664100-2	0.70	1.32	1.25	6.00	2.31	2.37	5.87	2.33
1-1/4	72,300	664125-2	16.61	-	R664125-2	1.20	1.57	1.53	6.81	2.17	2.98	7.04	2.67

HERC-ALLOY 800®  
CHAIN SLING COMPONENTS

# WEBLOK™ ASSEMBLY HERC-ALLOY 800®

WORKING LOAD LIMIT: 5,000 TO 75,000 LBS.

**SEE PAGE 88**  
For the full Weblok product offering!



## BENEFITS & FEATURES

- Combines our industry-leading Hammerlok coupling link with a CM web sling attachment, making it ideal for use with synthetic slings.
- Features a unique double load pin retention system to prevent the load pin from backing out during extreme use. Uses both traditional and bolt/lock nut retention.
- Durable orange powder coated finish on web sling arrangement.
- Made of durable forged alloy steel.
- 100% proof tested.
- Meets ASTM A952 & WSTDA-RS1 standards.
- 5:1 design factor



**Retention Component 1:**  
Traditional stud tube and spring assembly engages the center of the load pin.

**Retention Component 2:**  
Load pin is designed to act like a bolt, featuring a capped end and lock nut.

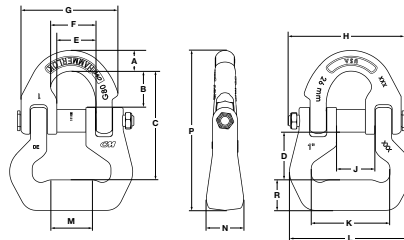

Size (in.)	Working Load Limit (lbs.)		Product Code	Load Pin Kit	Dimensions (in.)															Weight (lbs.)	
	Design Factor				A	B	C	D	E	F	G	H	J	K	L	M	N	P	R		Locknut
	5:1	4:1																			
3/8	5,000	6,250	867010-4	R867010-4	0.530	1.157	3.151	1.306	0.931	1.048	2.327	2.883	0.931	2.000	3.175	0.750	1.000	4.482	0.800	1/4-20 UNC	1.49
5/8	10,000	12,500	867020-4	R867020-4	0.875	1.737	4.320	1.520	1.347	1.551	3.574	4.372	1.347	2.750	4.130	1.250	1.250	6.185	0.990	3/8-16 UNC	3.96
3/4	15,000	18,750	867025-4	R867025-4	1.039	2.022	5.467	2.132	1.547	1.781	4.313	5.341	1.547	2.750	4.479	1.200	1.380	7.607	1.100	1/2-13UNC	6.62
7/8	25,000	31,250	867030-4	R867030-4	1.046	1.829	5.145	2.004	1.919	2.247	5.003	6.103	1.919	3.750	6.000	2.410	1.750	7.601	1.410	5/8-11UNC	8.96
1	40,000	50,000	867035-4	R867035-4	1.250	2.313	6.573	2.885	2.365	2.735	5.856	7.030	2.365	4.744	7.446	2.500	2.250	9.670	1.848	5/8-11UNC	15.83
1-1/4	60,000	75,000	867040-4	R867040-4	1.531	2.625	7.406	3.219	2.701	3.000	7.035	8.536	2.701	5.753	8.882	3.375	2.310	10.918	1.980	3/4-16UNC	25.35



# CLEVLOK® SLING HOOK

## DUAL RATED FOR USE WITH HA800 OR HA1000

WORKING LOAD LIMIT: 2,700 TO 35,300 LBS.

### BENEFITS & FEATURES

- For use with both Grade 80 & 100 chain
- Available with and without a latch (improved cast latch)
- Quenched and tempered alloy steel
- Clevlok head design
- 100% proof tested and fatigue rated
- Durable orange powder coated finish
- Replacement pin and latch kit available
- New CE compliant hooks and latches
- Meets EN 1677, ASTM A953 and ASME B30.10 standards
- 4:1 design factor

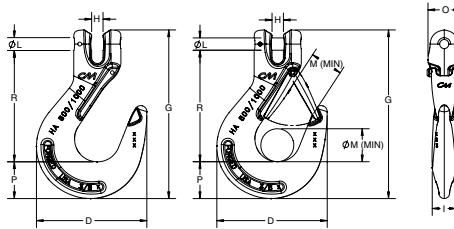

Size (in.)	Working Load Limit (lbs.)	Standard Package	Product Code					Dimensions (in.)										Weight (lbs.)
			With Latch	Without Latch	Latch Kit	Alloy Load Pin	Retaining Pin	D	G	H	I	L	M	O	P	R		
7/32	2,700	10	657716	557716	4X455321	SP595778P	495827	3.05	5.00	0.31	0.66	0.28	0.96	1.13	0.94	3.45	1.10	
9/32	4,300	10	657718	557718	4X455322	595780SP	495827	3.53	5.55	0.38	0.75	0.36	0.83	1.32	1.11	3.75	1.20	
3/8	8,800	10	657719	557719	4X455325	595781	495828	4.54	6.93	0.47	1.00	0.51	1.06	1.34	1.51	4.58	2.21	
1/2	15,000	5	657720	557720	4X455328	SP595782P	495823	5.48	8.28	0.58	1.33	0.63	1.38	1.87	1.55	5.59	4.22	
5/8	22,600	5	657721	557721	4X455329	SP595783P	495849	6.20	9.61	0.71	1.47	0.75	1.69	2.11	1.83	6.44	6.64	
3/4	35,300	Bulk	657722	557722	4X455330	595786	495824	7.63	11.79	0.88	1.88	0.94	2.09	2.55	2.51	7.74	11.22	

# EYE SLING HOOK

## DUAL RATED FOR USE WITH HA800 OR HA1000

WORKING LOAD LIMIT: 2,700 TO 72,300 LBS.

### BENEFITS & FEATURES

- For use with both Grade 80 & 100 chain
- Available with and without a latch
- Quenched and tempered alloy steel
- 100% proof tested
- Fatigue rated
- Durable orange powder coated finish
- 4:1 design factor

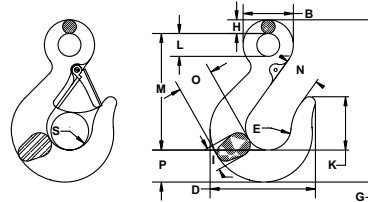

Size (in.)	Working Load Limit (lbs.)	Standard Package	Product Code					Dimensions (in.)										Weight (lbs.)	
			With Latch	Without Latch	Latch Kit	B	D	E	G	H	I	K	L	M	N	O	P		S
7/32	2,700	10	558618	458618	4X455321	1.50	3.04	1.03	5.06	0.38	0.66	1.48	0.75	3.75	1.17	0.98	0.94	0.96	0.8
9/32	4,300	10	558622	458622	595523	1.63	3.50	1.50	5.25	0.44	0.73	1.59	0.75	3.75	1.19	1.20	1.05	1.06	1.10
3/8	8,800	10	558625	458625	595525	2.06	4.33	1.88	6.64	0.56	0.95	2.19	0.94	4.78	1.44	1.45	1.28	1.31	1.90
1/2	15,000	5	558628	458628	595528	2.63	5.50	2.25	8.16	0.75	1.17	2.56	1.13	5.69	1.78	1.94	1.66	1.63	4.30
5/8	22,600	5	558629	458629	595529	3.06	6.34	2.63	9.66	0.88	1.44	2.63	1.31	6.50	2.03	2.38	2.19	1.75	7.30
3/4	35,300	Bulk	558630	458630	595530	3.50	7.83	3.00	11.38	1.00	1.69	3.44	1.50	7.81	2.50	2.83	2.51	2.19	12.50
7/8*	34,200	Bulk	558332	458732	595532	3.88	8.59	3.38	12.72	1.09	1.94	3.88	1.69	8.75	2.78	3.22	2.84	2.38	18.10
1*	47,700	Bulk	558333	458733	595533	4.31	9.59	4.00	14.23	1.22	2.14	4.25	1.88	9.88	3.13	3.55	3.09	2.88	22.60
1-1/4*	72,300	Bulk	558335	458735	595535	5.31	11.56	4.66	17.00	1.50	2.62	4.64	2.31	11.50	3.88	4.25	3.89	3.41	47.00

\* Herc-Alloy 800® only

HERC-ALLOY 800®  
 CHAIN SLING  
 COMPONENTS





# CLEVLOK® GRAB HOOK WITHOUT CRADLE HERC-ALLOY 800®

**WORKING LOAD LIMIT: 3,500 TO 18,100 LBS.**

### BENEFITS & FEATURES

- Quenched and tempered alloy steel
- Fatigue rated
- Built without lugs to avoid catching when slipping into tight clearance
- Durable orange powder coated finish
- Replacement pin available
- 4:1 design factor

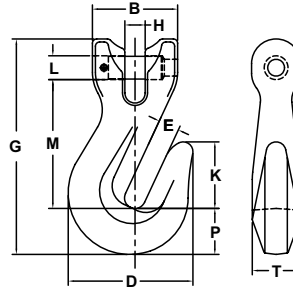

Size (in.)	Working Load Limit (lbs.)	Standard Package	Product Code			Dimensions (in.)										Weight (lbs.)
			Completed Unit	Load Pin	Retainer Pin	B	D	E	G	H	K	L	M	P	T	
9/32	3,500	10	659232	595780SP	602306	1.36	1.91	0.36	3.70	0.33	1.04	0.36	2.29	0.76	0.81	0.6
3/8	7,100	10	659235	595781	495828	1.90	2.78	0.47	4.81	0.45	1.49	0.51	2.87	1.03	1.06	1.3
1/2	12,000	5	659238	SP595782P	495829	2.31	3.62	0.59	6.35	0.59	1.98	0.63	3.78	1.51	1.38	2.5
5/8	18,100	5	659239	SP595783P	495823	2.87	4.41	0.75	7.74	0.75	2.39	0.75	4.82	1.80	1.69	4.4

Note: If used as a choker, working load limit should be reduced by 20%.

HERC-ALLOY 800®  
CHAIN SLING COMPONENTS

# CLEVLOK® CRADLE GRAB HOOK DUAL RATED FOR USE WITH HA800 OR HA1000



**WORKING LOAD LIMIT: 2,700 TO 28,300 LBS.**

### BENEFITS & FEATURES

- For use with both Grade 80 & 100 chain
- Unique cradle grab design
- Quenched and tempered alloy steel
- Fatigue rated
- Durable orange powder coated finish
- Replacement pin available
- 4:1 design factor

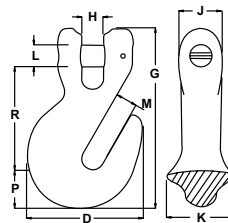

Size (in.)	Working Load Limit (lbs.)	Product Code	Standard Package Quantity	Dimensions (in.)									Weight (lbs.)
				D	G	H	J	K	L	M	P	R	
7/32	2,700	659718	10	1.62	3.21	0.31	0.75	0.94	0.28	0.31	0.62	1.98	0.50
9/32	4,300	659722	10	2.18	3.39	0.38	0.82	0.97	0.36	0.38	0.82	1.86	0.63
3/8	8,800	659725	10	2.72	4.33	0.47	1.18	1.29	0.51	0.74	1.03	2.47	1.30
1/2	15,000	659728	5	3.65	5.27	0.65	1.39	2.01	0.63	0.60	1.19	3.04	2.10
5/8	22,600	659729	5	4.50	6.54	0.77	1.55	2.42	0.75	0.77	1.41	3.76	4.20
3/4*	28,300	659430	Bulk	5.23	9.08	0.88	2.05	2.88	0.91	0.88	1.87	5.50	10.24

\* 3/4" is Herc-Alloy 800® only. Hook shape/style differs from photo and dimension drawing shown.

Note: If used as a choker, working load limit should be reduced by 20%.



## EYE CRADLE GRAB HOOK

DUAL RATED FOR USE WITH HA800 OR HA1000

WORKING LOAD LIMIT: 3,200 TO 72,300 LBS.

### BENEFITS & FEATURES

- For use with both Grade 80 & 100 chain
- Unique cradle grab design
- Quenched and tempered alloy steel
- 100% proof tested
- Fatigue rated
- Durable orange powder coated finish
- 4:1 design factor

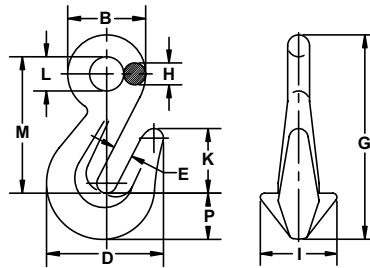

Size (in.)	Working Load Limit (lbs.)	Standard Package	Product Code	Dimensions (in.)										Weight (lbs.)
				B	D	E	G	H	I	K	L	M	P	
7/32	3,200	10	559724	1.20	1.68	0.31	3.22	0.33	0.92	0.99	0.55	2.20	0.69	0.35
9/32	4,300	10	559725	1.40	1.93	0.36	3.72	0.39	1.07	1.13	0.63	2.57	0.76	0.55
3/8	8,800	10	559737	1.78	2.86	0.47	4.81	0.52	1.65	1.49	0.78	3.27	1.02	1.06
1/2	15,000	5	559750	2.28	3.63	0.59	6.36	0.63	1.81	2.15	1.06	4.23	1.53	2.00
5/8	22,600	5	559762	2.75	4.53	0.75	7.62	0.75	2.13	2.65	1.22	5.06	1.80	5.40
3/4	35,300	Bulk	559775	3.50	5.23	0.91	9.54	1.00	2.88	3.52	1.52	6.70	1.85	9.00
7/8*	34,200	Bulk	559387	3.75	5.69	1.00	9.63	1.00	3.00	3.75	1.75	6.50	2.12	10.40
1*	47,700	Bulk	559100	4.31	7.00	1.19	12.44	1.22	3.88	4.31	1.88	8.09	3.12	20.90
1-1/4*	72,300	Bulk	559124**	5.38	8.50	1.53	15.56	1.56	2.50	5.50	2.25	10.50	3.50	40.00

\* Herc-Alloy 800® only \*\* Not cradle style

Note: If used as a choker, working load limit should be reduced by 20%.

HERC-ALLOY 800®  
CHAIN SLING  
COMPONENTS

## EYE FOUNDRY HOOK

DUAL RATED FOR USE WITH HA800 OR HA1000

WORKING LOAD LIMIT: 4,300 TO 72,300 LBS.

### BENEFITS & FEATURES

- For use with both Grade 80 & 100 chain
- Throat opening up to 6 inches
- Quenched and tempered alloy steel
- Fatigue rated
- Durable orange powder coated finish
- 4:1 design factor

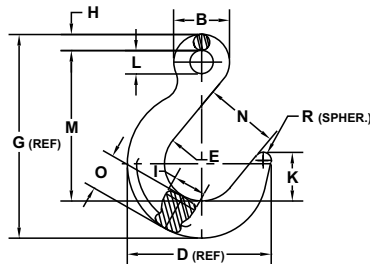

Size (in.)	Working Load Limit (lbs.)	Standard Package	Product Code	Dimensions (in.)												Weight (lbs.)
				B	D	E	G	H	I	K	L	M	N	O	R	
9/32	4,300	5	474798	1.56	4.73	2.50	6.45	0.47	1.00	1.56	0.63	4.75	2.50	1.23	0.25	2.4
3/8	8,800	5	474799	2.00	5.72	3.00	7.88	0.63	1.27	1.88	0.80	5.77	3.00	1.50	0.31	4.5
1/2	15,000	5	474800	2.50	6.75	3.50	9.38	0.75	1.50	2.22	1.00	6.88	3.50	1.75	0.38	7.1
5/8	22,600	5	474801	3.00	7.81	4.00	10.97	0.88	1.81	2.63	1.25	8.06	4.00	2.03	0.44	11.6
3/4	35,300	Bulk	474802	3.50	9.10	4.50	12.81	1.00	2.20	3.00	1.50	9.25	4.50	2.56	0.50	20.0
7/8*	34,200	Bulk	474503	4.00	10.09	5.00	14.23	1.13	2.25	3.38	1.70	10.38	5.00	2.78	0.56	26.0
1*	47,700	Bulk	474504	4.50	11.55	5.50	16.17	1.29	2.63	3.75	2.13	11.56	5.50	3.45	0.62	36.8
1-1/4*	72,300	Bulk	474505	5.13	12.87	6.00	18.03	1.38	3.17	4.25	2.33	12.88	6.00	3.81	0.75	58.4

\* Herc-Alloy 800® only



# SYNTHETIC SLING COMPONENTS

Weblok™ Assemblies .....	88
Flat-Eye Rigging Hooks .....	90
Quick Connect™ Hooks .....	91
Web Sling Shackles .....	92
Master Links With And Without Flats .....	93
Wide Body Sub-Assemblies With Flats .....	93



## WEBLOK ASSEMBLY

**WORKING LOAD LIMIT: UP TO 75,000 LBS.**  
**AVAILABLE IN 6 SIZES FROM 3/8" TO 1-1/4"**

When working with synthetic slings, CM Weblok assemblies allow for quick, easy and safe sling attachment. CM Webloks are available in two designs. Synthetic-to-attachment Webloks combine our industry-leading CM Hammerlok® coupling link with a CM synthetic sling attachment. Synthetic-to-synthetic Webloks feature two synthetic sling attachments. CM Webloks are available with either single or double load pin retention, depending on your application.

### BENEFITS & FEATURES

- Versatile & easy to use
- made of durable forge alloy steel
- 5:1 design factor
- 100% proof tested
- Durable orange powder coated finish
- Meets ASTM A952 & WSTDA-RS1 standards
- industry-leading safety



SYNTHETIC TO ATTACHMENT  
WITH DOUBLE RETENTION

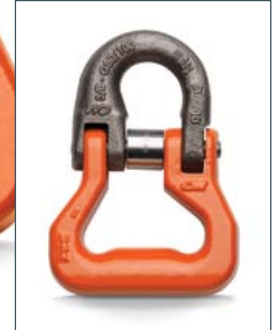

SYNTHETIC TO ATTACHMENT  
WITH SINGLE RETENTION



SYNTHETIC TO SYNTHETIC  
WITH SINGLE RETENTION



SYNTHETIC TO SYNTHETIC  
WITH DOUBLE RETENTION

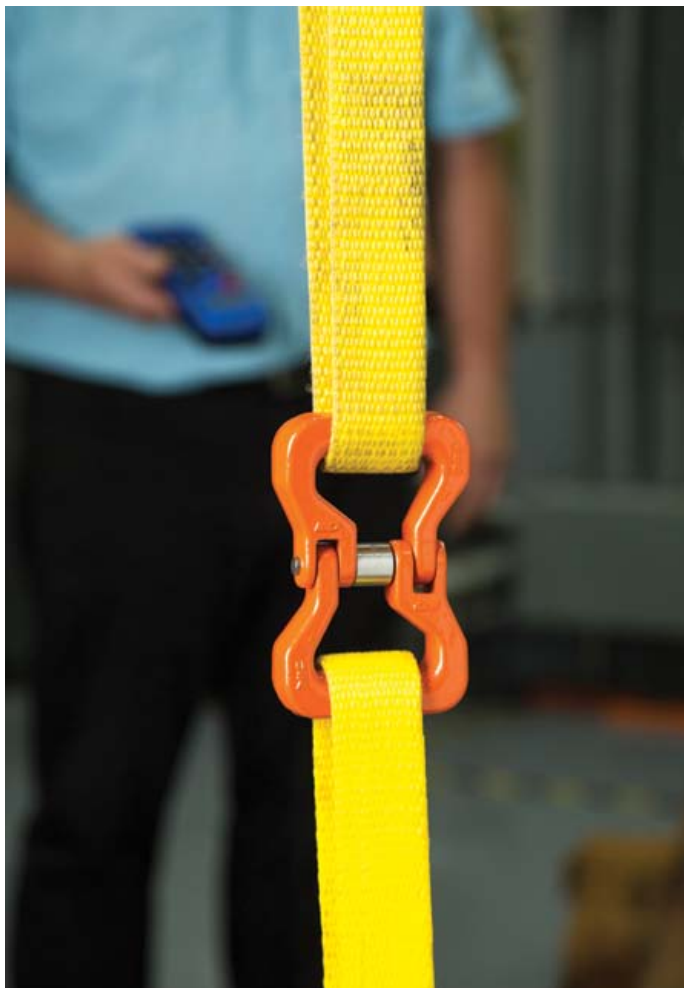

SYNTHETIC SLING COMPONENTS



**OPTIONAL  
UNIQUE DOUBLE LOAD PIN RETENTION**

**SAFETY IS A TOP PRIORITY**

When working with synthetic slings, CM Weblok assemblies allow for quick, easy and safe sling attachment. CM Webloks are available with either single or double load pin retention, depending on your application.



SINGLE RETENTION



DOUBLE RETENTION

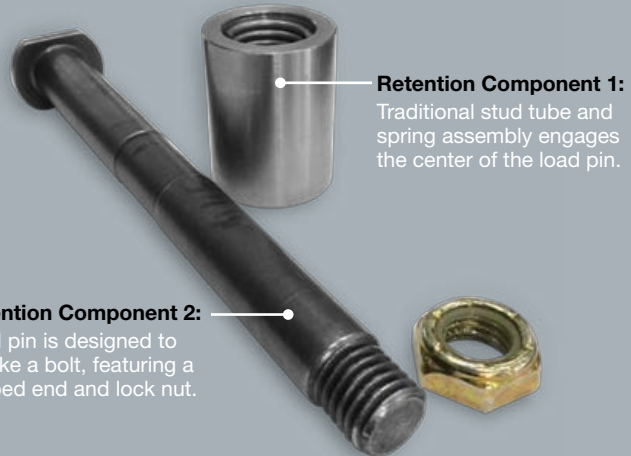

**Retention Component 1:**  
Traditional stud tube and spring assembly engages the center of the load pin.

**Retention Component 2:**  
Load pin is designed to act like a bolt, featuring a capped end and lock nut.

SYNTHETIC TO ATTACHMENT

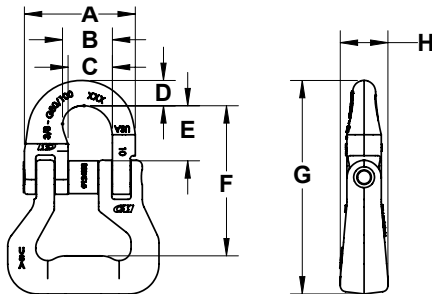

SYNTHETIC TO SYNTHETIC

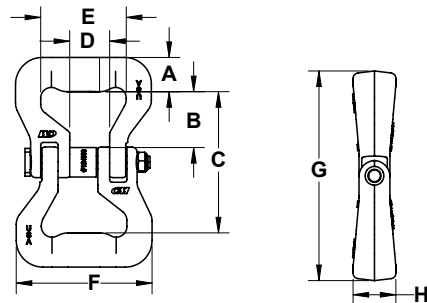

Size (in.)	Working Load Limit (lbs.)		Product Code		Double Retention Load Pin Kit	Dimensions (in.)								Weight (lbs.)
	Design Factor		Single Retention	Double Retention		A	B	C	D	E	F	G	H	
	5:1	4:1												
<b>Synthetic to Attachment</b>														
3/8	6,250	7,850	867010-2	867010-4	R867010-4	2.33	1.05	0.93	0.53	1.16	3.15	4.48	1.00	1.49
5/8	12,500	15,650	867020-2	867020-4	R867020-4	3.57	1.55	1.35	0.88	1.74	4.32	6.19	1.25	3.96
3/4	18,750	23,450	867025-2	867025-4	R867025-4	4.31	1.78	1.55	1.04	2.02	5.47	7.61	1.38	6.62
7/8	30,000	37,500	867030-2	867030-4	R867030-4	5.00	2.25	1.92	1.05	1.83	5.15	7.60	1.75	8.96
1	40,000	50,000	N/A	867035-4	R867035-4	5.86	2.74	2.37	1.25	2.31	6.57	9.67	2.25	16.18
1-1/4	60,000	75,000	N/A	867040-4	R867040-4	7.04	3.00	2.70	1.53	2.63	7.41	10.92	2.31	25.35
<b>Synthetic to Synthetic</b>														
3/8	5,000	N/A	877010-2	877010-4	R867010-4	0.80	1.31	3.30	0.93	2.00	3.18	4.90	1.00	2.03
5/8	10,000	N/A	877020-2	877020-4	R867020-4	0.99	1.52	4.10	1.38	2.75	4.13	6.08	1.25	4.56
3/4	15,000	N/A	877025-2	877025-4	R867025-4	1.10	2.13	5.58	1.55	2.75	4.48	7.78	1.38	6.96
7/8	25,000	N/A	877030-2	877030-4	R867030-4	1.41	2.00	5.32	1.92	3.75	6.00	8.14	1.75	11.00
1	40,000	N/A	N/A	877035-4	R867035-4	1.85	2.89	7.15	2.37	4.74	7.45	10.84	2.25	22.79
1-1/4	60,000	N/A	N/A	877040-4	R867040-4	1.98	3.22	8.00	2.70	5.75	8.88	11.96	2.31	33.30

SYNTHETIC SLING COMPONENTS



# FLAT EYE RIGGING HOOK

**WORKING LOAD LIMIT: UP TO 5 TONS • WEB SLING EYE WIDTHS UP TO 3"**

Designed specifically for use with synthetic slings, CM Flat Eye Rigging Hooks provide a wide, smooth, load-bearing surface that won't damage synthetic material, promoting longer sling life. The flat eye opening eliminates bunching and pinching of the synthetic sling, ensuring the sling can be used at full capacity.

### BENEFITS & FEATURES

- High sling strength
- Longer sling life
- Strong and durable.
- Versatile use
- Available with and without latches
- CE compliant
- 5:1 design factor
- Meets or exceeds ASME B30.10 standards

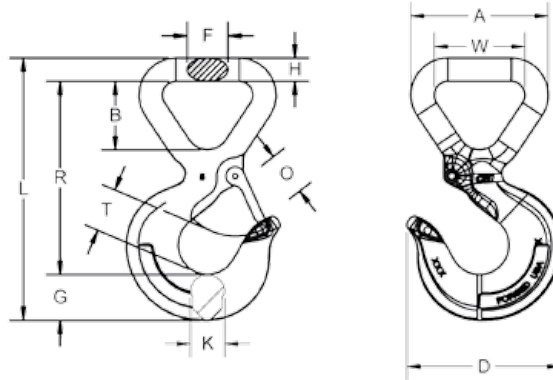

Working Load Limit (tons)	Product Code			Dimensions (in.)											Weight (lbs.)	
	With Latch	Without Latch	Latch Kit	A	B	D	F	G	K	L	O	R	T	W	without Latch	with Latch
1-1/2	M8503	M8403	4X1303	2.38	1.20	3.37	0.75	0.94	0.71	5.36	0.97	3.98	0.97	1.50	1.16	1.25
3	M8505	M8405	4X1305	3.79	1.88	4.25	1.13	1.26	0.94	7.21	1.21	5.31	1.21	2.50	2.82	3.00
5	M8507	M8407	4X1307	5.53	2.84	5.11	1.63	1.44	1.38	9.27	1.47	7.06	1.47	4.00	5.50	5.90

SYNTHETIC SLING COMPONENTS





# QUICK CONNECT HOOK

WORKING LOAD LIMIT: UP TO 13,200 LBS • WEB SLING EYE WIDTHS UP TO 3"

Ideal for use with synthetic slings, CM Quick Connect Hooks are the quickest and easiest way to add hooks to any synthetic sling by eliminating the need for additional hardware or assembly tools. Designed with a large bearing surface, these hooks prevent the sling from bunching, allowing the sling to be used at full capacity. And, for easy selection, Quick Connect Hooks are color coded to match common industry synthetic sling capacities.

## BENEFITS & FEATURES

- Quick and efficient attachment
- Longer sling life
- Low sling weight and cost
- Easy selection
- Secure sling attachment
- Strong and durable
- Standard hook latches
- I-Beam design reduces overall sling weight
- Embossed for worldwide use

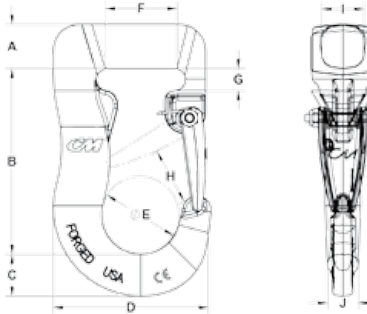

WLL: 2,600 LBS.

Color	Working Load Limit (lbs.)	Product Code	Latch Kit	Dimensions (in.)										Weight (lbs.)
				A	B	C	D	E	F	G	H	I	J	
Purple	2,600	M85030	4X85030	0.770	3.530	0.794	2.884	1.500	1.500	0.418	0.938	0.813	0.580	1.450
Green	5,300	M85060	4X85060	1.034	4.589	1.040	3.751	1.625	1.875	0.553	1.200	1.188	0.865	3.735
Yellow	8,400	M85090	4X435329	1.208	5.410	1.172	4.325	1.875	2.375	0.640	1.500	1.250	1.043	5.835
Red	13,200	M85120	4X455329	1.384	6.141	1.392	5.026	2.125	2.625	0.744	1.750	1.438	1.200	8.282



COLOR CODED TO MATCH COMMON SYNTHETIC SLING CAPACITIES



SYNTHETIC SLING COMPONENTS



# CARBON WEB SLING SHACKLE

**WORKING LOAD LIMIT: 8,000 TO 23,500 LBS.**

### BENEFITS & FEATURES

- Designed to connect synthetic web and round slings to eye bolts and other lifting hardware
- Design factor 4:1
- Web sling shackles can be used on web slings from 2 to 6 inches in width
- Shackle body: carbon steel, heat treated
- Shackle pin: alloy steel, heat treated
- Finish: hot dip galvanized
- Zinc-plated linchpin comes standard. Cotter or hairpin available on special order.
- Do not point load. The load should be evenly distributed over the entire pin to achieve full working load limit.



Product Code	Pin Number	Linch Pin Number	Working Load Limit (lbs.)	Dimensions (in.)					Weight (lbs.)
				P	D	L	W	R	
M702	2X702	65930	8,000	0.75	0.63	2.25	2.00	1.63	1.70
M703	2X703	65930	13,000	0.88	0.75	3.25	3.00	1.88	2.86
M704	2X704	65930	11,000	0.88	0.75	3.75	4.00	1.88	3.15
M705	2X705	65934	18,000	1.00	0.88	4.25	5.00	2.13	4.75
M706	2X706	65934	18,000	1.13	1.00	4.75	6.00	2.38	6.75
M706H	2X706H	65934	23,500	1.25	1.13	4.75	6.00	2.63	9.80

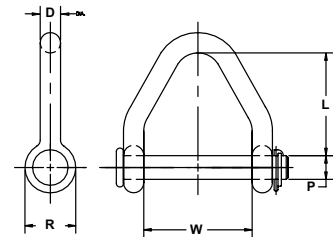

# ALLOY WEB SLING SHACKLE

**WORKING LOAD LIMIT: 13,500 TO 22,500 LBS.**



### BENEFITS & FEATURES

- Designed to connect synthetic web and round slings to eye bolts and other lifting hardware
- Design factor 6:1
- Web sling shackles can be used on web slings from 3 to 6 inches in width
- Utilize a bolt and nut with linchpin to secure the assembly in place
- All shackles are galvanized for longer life
- Marked with working load limit (WLL) and size
- Do not point load. The load should be evenly distributed over the entire pin to achieve full working load limit.



Product Code	Pin Number	Linch Pin Number	Working Load Limit (lbs.)	Dimensions (in.)					Weight (lbs.)
				P	D	L	W	R	
M703A	2X8703A	65930	13,500	0.88	0.75	3.25	3.00	1.88	3.01
M704A	2X8704A	65930	14,500	0.88	0.75	3.75	4.00	1.88	3.16
M705A	2X8705A	65934	19,000	1.00	1.00	4.25	5.00	2.38	6.04
M706A	2X8706A	65934	22,500	1.13	1.13	4.75	6.00	2.63	9.02

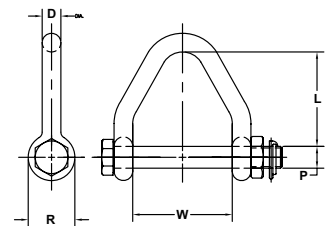

SYNTHETIC SLING COMPONENTS



# MASTER LINK WITH & WITHOUT FLATS

WORKING LOAD LIMIT: 3,360 TO 142,440 LBS.

## BENEFITS & FEATURES

- Designed to accept HA800 chain, wire rope and synthetic attachments
- Use with mechanical and welded assemblies
- Sizes up to 1-1/4" available with flats to accommodate Omega link
- 100% proof tested
- 6:1 design factor
- Extra wide body makes these links ideal for wire rope applications and use with Omegaloks. Master link with flat allows for easy installation of these attachments.

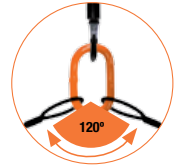
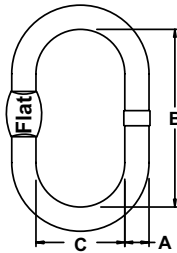

Can be used with included angles up to 120°

Trade Size (in.)	Working Load Limit with Wire Rope & Synthetics (lbs.)	Product Code	Nominal Dimensions (in.)			Flat Dimensions (in.)		Weight (lbs.)	Sling Type and Size (in.)	
			Material Diameter A	Inside Length B	Inside Width C	Width	Thickness		Single	Double
7/16	3,360	ML040 ML040NF	0.44	4.13	2.29	0.94	0.28	0.50	7/32 & 9/32	7/32
1/2	4,600	ML050 ML050NF	0.56	4.84	2.69	0.94	0.28	1.02	-	7/32
5/8	7,200	ML063 ML063NF	0.63	5.29	2.98	1.22	2.81	1.34	3/8	9/32
3/4	11,360	ML075 ML075NF	0.75	6.61	3.72	1.41	0.40	2.36	1/2	3/8
7/8	13,840	ML087 ML087NF	0.88	7.35	4.14	1.56	0.44	3.60	-	-
1	21,200	ML100 ML100NF	1.00	7.53	4.30	1.56	0.53	5.20	5/8	1/2
1-1/4	29,920	ML125 ML125NF	1.25	9.26	5.29	1.56	0.68	9.60	3/4 & 7/8	5/8
1-1/2	42,400	ML150	1.50	11.03	6.30	-	-	16.20	1	3/4
1-3/4	57,720	ML175	1.75	12.86	7.35	-	-	25.10	-	7/8
2	75,360	ML200	2.00	14.70	8.40	-	-	41.00	1-1/4	1
2-1/4	95,360	ML225	2.25	16.54	9.45	-	-	58.00	-	-
2-1/2	117,720	ML250	2.50	18.38	10.50	-	-	74.90	-	1-1/4
2-3/4	142,440	ML275	2.75	20.21	11.55	-	-	99.80	-	-

NOTE: Master link with flats are available through 1-1/4" only. Part numbers with "NF" are for master links WITHOUT flats.

# WIDE BODY SUB-ASSEMBLY WITH FLATS

WORKING LOAD LIMIT: 4,600 TO 142,400 LBS.

## BENEFITS & FEATURES

- Designed to accept Herc-Alloy 800® chain, wire rope and synthetic attachments
- Durable orange powder coated finish
- 100% proof tested
- May be used for mechanical and welded sling assemblies
- Extra wide body is ideal for wire rope applications
- Sizes up to 1-1/4" intermediate links available with flats to accommodate Omega links
- 6:1 design factor

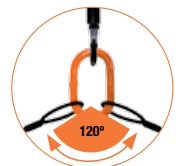
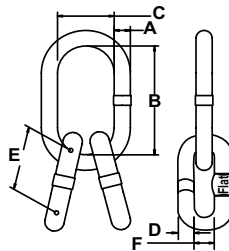

Can be used with included angles up to 120°

Trade Size (in.)	Working Load Limit with Wire Rope & Synthetics (lbs.)	Complete Assembly Product Code	Master Link Nominal Dimensions (in.)			Intermediate Link Nominal Dimensions (in.)			Weight (lbs.)	Sling Type and Size (in.)			
			Product Code	Material Diameter A	Inside Length B	Inside Width C	Product Code	Material Diameter D		Inside Length E	Inside Width F	Triple	Quad
1/2	4,600	SA050	ML050	0.56	4.84	2.69	ML040	0.44	4.13	2.29	1.8	-	-
5/8	7,200	SA063	ML063	0.63	5.29	2.98	ML050	0.56	4.84	2.69	2.9	7/32	7/32
3/4	11,200	SA075	ML075	0.75	6.61	3.72	ML063	0.63	5.29	2.98	5.5	9/32	9/32
7/8	13,840	SA087	ML087	0.88	7.35	4.14	ML063	0.63	5.29	2.98	6.3	-	-
1	21,200	SA100	ML100	1.00	7.53	4.30	ML075	0.75	6.61	3.72	10.2	3/8	3/8
1-1/4	29,920	SA125	ML125	1.25	9.26	5.29	ML100	1.00	7.53	4.30	20.0	1/2	1/2
1-1/2	42,400	SA150	ML150	1.50	11.03	6.30	ML100	1.00	7.53	4.30	26.6	-	-
1-3/4	57,720	SA175	ML175	1.75	12.86	7.35	ML125	1.25	9.26	5.29	44.3	5/8	5/8
2	75,360	SA200	ML200	2.00	14.70	8.40	ML150	1.50	11.03	6.30	73.4	3/4	3/4
2-1/4	95,360	SA225	ML225	2.25	16.54	9.45	ML175	1.75	12.86	7.35	108.2	7/8	7/8
2-1/2	117,720	SA250	ML250	2.50	18.38	10.50	ML200	2.00	14.70	8.40	156.9	1	1
2-3/4	142,400	SA275	ML275	2.75	20.21	11.55	ML200	2.00	14.70	8.40	181.0	-	-

NOTE: Master link with flats are available through 1-1/4" only



100  
CM

USA

570

CM

150



# RIGGING HARDWARE

**SECTION OVERVIEW** ..... 96

**SHACKLES** ..... 97

**SPECIALTY OVERHEAD LIFTING  
HOOKS & LUGS**

Sorting Hook ..... 98

Shank Hook ..... 98

Plate Hook ..... 99

Alloy "S" Hook ..... 99

Rigging Hook ..... 100

Swivel Rigging Hook ..... 100

Replacement Latches ..... 101

Yale® Import Weld-On Lifting Hook ..... 101

Replacement Hook with Latch ..... 102

CLB Container Lifting Lugs ..... 102

CLT Container Lifting Lugs ..... 102

**MASTER LINKS & SUB-ASSEMBLIES**

Master Link (Dual Rated) ..... 103

Forged Master Link ..... 103

Master Link With and Without Flats ..... 104

Wide Body Sub-Assembly with Flats ..... 105

**WIRE ROPE COMPRESSION HARDWARE**

Turnbuckles ..... 106

Wire Rope Clips ..... 107

Mid-Grip Wire Rope Clips ..... 108

Piggyback® Wedge Socket Clips ..... 109

Bundling Clip ..... 110

# RIGGING HARDWARE OVERVIEW

Whether you need specialty overhead lifting hooks or wire rope compression devices, CM has a large selection of detachable rigging hardware that's strong, durable and reliable. We carry a variety of links, hooks and wire rope clips to meet all of your rigging and load handling needs.

## SPECIALTY OVERHEAD LIFTING HOOKS & LUGS

Designed for a variety of overhead lifting applications, our assortment of specialty lifting hooks and lugs help position and move everything from plates to large cylinders and coils. Choose from sorting hooks, plate hooks, swivel hooks and more.

## RINGS & LINKS

Oftentimes it is necessary to use collector rings, such as shackles, rings, links and master links, in conjunction with crane hooks to lift a load. Rings and links ensure proper alignment and loading of a hook. Rather than improperly loading the hook, operators should use rings and links to ensure safe handling and also prevent overcrowding the hook with multiple attachments.

## TURNBUCKLES

Turnbuckles provide easy means for tensioning, loosening and removing chain and rope load lines.

## WIRE ROPE COMPRESSION HARDWARE

Wire rope compression hardware, including wire rope clips and bundling clips, are used to secure and manipulate wire rope for lifting applications. Wire rope clips are typically used to secure wire rope when forming a loop. Bundling clips eliminate shear points and damage to wire rope.



RIGGING HARDWARE



# SHACKLES

**WORKING LOAD LIMIT: 1/3 TO 120 TON**

When it comes to shackles, Columbus McKinnon prides itself on providing the strongest and most reliable products on the market. We carry a full line of anchor and chain shackles, manufactured through our state-of-the-art forging process in Chattanooga, Tennessee.

CM shackles are available in three materials, including carbon, super strong and alloy. Our innovative Super Strong Shackles are unique in the industry, featuring strength ratings up to 50 percent stronger than comparable sized carbon shackles and a 6:1 design factor for ultimate safety.

CM shackles are available in a three styles: **Screw Pin; Bolt, Nut & Cotter; and Round Pin.** Learn more about the uses and benefits of each shackle style below.

## BOLT, NUT & COTTER SHACKLES

Of all shackle types, Bolt, Nut and Cotter Shackles provide the most secure pin arrangement, resisting axial and torsional loading. This type of shackle should be used in semi-permanent applications where the pin is removed infrequently or where cyclical loading occurs. This is the preferred type of shackle in areas that are difficult to reach or inspect. Recommended for overhead lifting, bolt, nut and cotter shackles are available in capacities up to 120 tons.



## SCREW PIN SHACKLES

Screw Pin Shackles allow for quick and easy removal of the screw pin, which makes this style ideal for applications where the shackle is removed frequently. While the threaded pin can resist axial forces, it should not be cyclically loaded and is unreliable and vulnerable to backing out in applications where the pin is subjected to a torque or twisting action. Recommended for overhead lifting, screw pin shackles are available in capacities up to 43 tons. Screw pins should be moused in some applications.



## ROUND PIN SHACKLES

Round Pin Shackles allow for easy removal by simply removing the cotter that holds the pin in place. These shackles perform well where the pin is subjected to a torque or twisting action, but they should not be subjected to an axial load. Round pin shackles are available in capacities up to 43 tons and are **not recommended for overhead lifting.**



## 3 TYPES OF SHACKLE MATERIAL

MATERIAL	STYLE	WLL (TONS)	SIZES (IN.)	STYLES	DESIGN FACTOR	FINISHES
CARBON	Anchor	1/3 to 120 ton	3/16" to 3"	Bolt, Nut & Cotter; Screw Pin; Round Pin	6:1*	Orange Powder Coated, Galvanized
	Chain	1/2 to 35 ton	1/4" to 2"			
SUPER STRONG 17 to 50% stronger than comparable-sized Carbon	Anchor	1/2 to 55 tons	3/16" to 2-1/2"	Bolt, Nut & Cotter; Screw Pin; Round Pin	6:1**	Orange Powder Coated, Self Colored, Galvanized
	Chain	3/4 to 35 tons	1/4" to 2"			
ALLOY (U.S.) ~50% stronger than comparable-sized Carbon and ~25% stronger than Super Strong	Anchor	2 to 120 ton	3/8" to 3"	Bolt, Nut & Cotter; Screw Pin; Round Pin	5:1	Orange Powder Coated, Self Colored, Galvanized

\* 2-1/2" and 3" carbon shackles have a 5:1 design factor.

\*\* Round pin and all 2-1/2" Super Strong shackles have a 5:1 design factor.



# SORTING HOOK HERC-ALLOY 800®

**WORKING LOAD LIMIT: 7-1/2 TONS**

### BENEFITS & FEATURES

- Quenched and tempered alloy steel
- Long tapered point designed for easy grab in rings, pear links, eye bolts or lifting holes
- Most useful for efficient handling of cylindrical shapes
- Durable orange powder coated finish
- Design factor 5:1
- May be loaded within 1 in. of the tip. The working load limit with the load sitting in the bowl (or saddle) of the hook is 7-1/2 tons, whereas the working load limit is 2 tons if the hook is being loaded 1 in. from the tip. **DO NOT LOAD THE LAST ONE INCH OF THE TIP.**

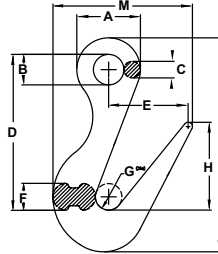

Working Load Limit (lbs.)		With Handle		Without Handle		Dimensions (in.)									
At Tip (ton)	At bottom of Hook (ton)	Product Code	Weight (lbs.)	Product Code	Weight (lbs.)	A	B	C	D	E	F	G	H	I	M
2	7-1/2	M129H	7.0	M129	6.8	3	1.44	0.78	7.34	3.75	1.28	1.25	3.93	10.09	6.58

# SHANK HOOK HERC-ALLOY 800®

**WORKING LOAD LIMIT: 1 TO 7 TONS**



### BENEFITS & FEATURES

- Heat treated alloy steel provides strength without bulk or weight
- Pre-drilled boss allows for latch
- Shank hooks are supplied unthreaded, but can be supplied threaded as a special order item
- Shank hooks made from other material (bronze, stainless steel, etc.) available upon request
- Design factor 5:1

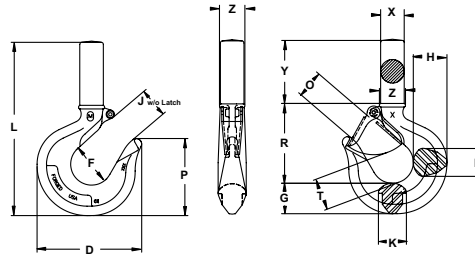

Alloy Shank Hook		Weight (lbs.)	Latch Kit Product Code	Max Shank Diameter (in.)	Latch Hole (in.)	Dimensions (in.)												
Working Load Limit* (ton)	Product Code					D	F	G	H	J	K	L	O	P	R	X	Y	Z
1	M1302AV	0.65	4X1302	0.72	0.14	3.09	1.25	0.87	1.01	0.94	0.63	5.44	0.88	2.13	2.35	0.68	2.22	0.69
1-1/2	M1303AV	0.80	4X1303	0.79	0.19	3.37	1.38	0.94	1.11	0.97	0.71	5.94	0.91	2.27	2.59	0.76	2.41	0.80
2	M1304AV	1.47	4X1304	0.86	0.18	3.75	1.50	1.04	1.21	1.06	0.88	6.45	1.00	2.58	2.75	0.82	2.66	1.00
3	M1305AV	1.85	4X1305	1.11	0.18	4.23	1.63	1.25	1.43	1.21	0.94	7.42	1.16	2.84	3.16	0.99	3.01	1.03
5	M1307AV	4.04	4X1307	1.30	0.20	5.16	2.00	1.44	1.63	1.51	1.38	8.80	1.41	3.52	3.85	1.27	3.52	1.30
7	M1309AV	7.25	4X1309	1.56	0.20	6.28	2.50	1.82	2.01	1.76	1.68	10.72	1.69	4.63	4.70	1.53	4.01	1.56

\* Working Load Limits in Metric Tons.

## WARNING

The following should be observed:

- ▲ Shanks are not intended for internal threading or swaging.
- ▲ To obtain maximum strength threads should be class 1 or 2.
- ▲ Thread engagement in nut or object must be a minimum of 1-1/2 times the thread diameter. Insufficient thread engagement can result in loss of load.



# PLATE HOOK HERC-ALLOY 800®

WORKING LOAD LIMIT: 3,600 TO 34,900 LBS.

## BENEFITS & FEATURES

- Made from alloy material
- Designed to handle plate steel
- Designed to be used in pairs at 60°
- Durable orange powder coated finish
- Available as components or attached to certified slings
- Design factor 5:1
- Meets ASME B30.10 standards

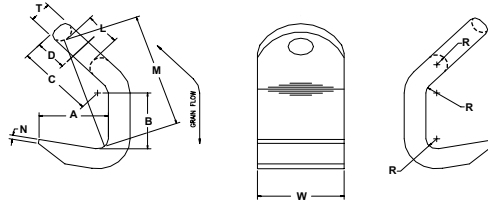

Size (in.)	Product Code	Working Load Limit (lbs.)	Dimensions (in.)										Weight (lbs.)
			A	B	C	D	L	M	N	T	W	R	
9/32	462528	3,600	2.00	1.75	2.50	0.94	1.00	3.48	0.13	0.63	2.50	0.31	2.80
3/8	462537	7,050	2.63	2.97	4.31	1.24	1.13	6.53	0.19	0.75	2.75	0.50	5.70
1/2	462550	11,400	3.50	4.00	4.38	1.50	1.50	6.98	0.28	1.00	3.50	0.50	13.00
5/8	462562	17,800	4.38	5.00	5.44	1.88	1.88	9.25	0.31	1.25	5.00	0.63	26.50
3/4	462575	25,600	5.19	6.00	6.50	2.38	2.25	10.88	0.38	1.50	5.75	0.75	42.00
7/8	462587	34,900	6.00	7.00	7.63	2.50	2.63	13.06	0.44	1.75	6.00	1.00	65.00

Other sizes available

## WARNING

**NEVER USE PLATE HOOKS ON A QUAD SLINGS.**  
Instead, use a spreader or beam and two double chain slings. Hooks would go on the end of double chain slings and would be attached to each end of the beam.



# ALLOY "S" HOOK HERC-ALLOY 800®

WORKING LOAD LIMIT: 210 TO 6,250 LBS.

## BENEFITS & FEATURES

- Made from alloy material
- Proof tested at two times WLL
- Durable orange powder coated finish
- WLL embossed on hooks
- Custom sizes available upon request
- Serialized upon request
- Design factor 4:1

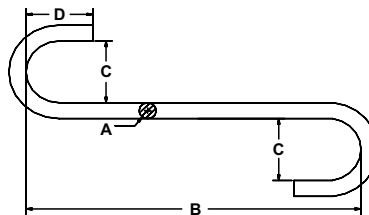

Size (in.)	Working Load Limit (lbs.)	Product Code	Dimensions (in.)				Weight (lbs.)
			A	B	C	D	
9/32	210	562228	0.28	4.50	1.13	1.13	0.15
3/8	410	562237	0.38	6.00	1.50	1.50	0.35
1/2	870	562250	0.56	7.50	2.00	2.00	1.04
5/8	1,120	562262	0.63	9.00	2.50	2.50	1.56
3/4	1,730	562275	0.75	10.50	3.00	3.00	2.60
7/8	2,370	562287	0.88	12.00	3.50	3.50	4.20
1	2,920	562300	1.00	13.00	4.00	4.00	6.00
1-5/32	3,150	562310	1.13	15.00	4.50	4.50	9.30
1-1/4	4,450	562325	1.25	16.00	5.00	5.00	11.70
1-3/8	6,100	562337	1.38	17.00	5.50	5.50	15.40
1-1/2	6,250	562350	1.50	18.00	6.00	6.00	19.50

RIGGING HARDWARE



# RIGGING HOOK

**WORKING LOAD LIMIT: 3/4 TO 22 TONS**

**BENEFITS & FEATURES**

- Load rating marked on each hook body
- Design factor 5:1
- Hook tips are pre-drilled to allow securement of the latch
- Powder coated orange

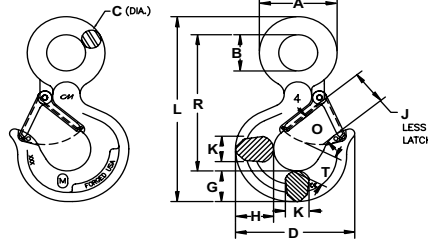

Standard Package	Carbon				Alloy			Zinc Plated Latch Kit (optional)	Dimensions (in.)											Weight (lbs.)		
	Painted Orange		Painted Orange		Painted Orange				Product Code	A	B	C	D	G	H	J	K	L	O		R	T
	WLL* (tons)	Product Code	WLL* (tons)	Product Code	without Latch	with Latch	Product Code															
10	3/4	M6402C	M6502C	1	M6402A	M6502A	4X1302	1.50	0.75	0.38	3.12	0.87	1.01	0.93	0.63	4.37	0.93	3.13	0.87	0.66		
10	1	M6403C	M6503C	1-1/2	M6403A	M6503A	4X1303	1.75	0.88	0.44	3.37	0.94	1.11	0.97	0.71	5.04	0.97	3.66	0.97	1.12		
5	1-1/2	M6404C	M6504C	2	M6404A	M6504A	4X1304	2.13	1.10	0.50	3.80	1.06	1.21	1.02	0.74	5.65	1.02	4.09	1.03	1.46		
5	2	M6405CB	M6505CB	3	M6405A	M6505A	4X1305	2.50	1.25	0.64	4.20	1.26	1.43	1.19	0.94	6.55	1.16	4.67	1.16	2.42		
5	3	M6407C	M6507C	5	M6407A	M6507A	4X1307	3.08	1.56	0.77	5.11	1.44	1.63	1.50	1.38	7.97	1.41	5.78	1.53	4.10		
5	5	M6409C	M6509C	7	M6409A	M6509A	4X1309	3.88	1.98	0.94	6.24	1.82	2.01	1.78	1.68	10.07	1.69	7.31	1.94	8.16		
-	7-1/2	M6411C	M6511C	11	M6411A	M6511A	4X1311	4.69	2.44	1.13	7.89	2.25	2.63	2.38	1.88	12.41	2.19	9.03	2.52	15.60		
-	10	M6415C	M6515C	15	M6415A	M6515A	4X1315	5.34	2.84	1.25	8.53	2.75	3.10	2.50	2.03	14.05	2.30	10.21	2.54	21.58		

Other finishes are available as special orders.

\* Working Load Limits in Metric Tons.

# SWIVEL RIGGING HOOK

**WORKING LOAD LIMIT: 1 TO 22 TONS**

**BENEFITS & FEATURES**

- Design factor 5:1
- Pre-drilled for latches
- Hooks furnished with or without latches
- Powder coated orange
- Hooks are heat treated, quenched and tempered

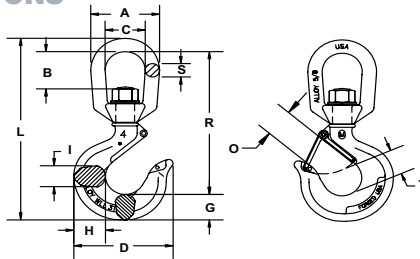

Standard Package	Alloy				Zinc Plated Latch Kit (optional)	Dimensions (in.)											Latch Kit	Weight (lbs.)	
	WLL* (tons)	Product Code		Product Code		A	B	C	D	G	H	I	L	R	S	T			O
		without Latch	with Latch																
10	1	M3402A	M3502A	4X1302	2.00	1.11	1.31	3.06	0.87	1.05	0.63	5.83	4.63	0.38	0.87	0.93	4X1302	1.05	
10	1-1/2	M3403A	M3503A	4X1303	2.50	1.38	1.50	3.33	0.94	1.11	0.71	6.83	5.44	0.50	0.97	0.97	4X1303	1.56	
10	2	M3404A	M3504A	4X1304	3.00	1.65	1.75	3.67	1.06	1.21	0.88	7.76	6.25	0.63	1.03	1.06	4X1304	2.50	
10	3	M3405A	M3505A	4X1305	3.00	1.65	1.75	4.20	1.27	1.43	0.94	8.40	6.49	0.63	1.16	1.16	4X1305	3.20	
10	5	M3407A	M3507A	4X1307	3.50	1.77	2.00	5.11	1.44	1.63	1.31	9.76	7.53	0.75	1.53	1.41	4X1307	5.36	
Bulk	7	M3409A	M3509A	4X1309	4.75	2.39	2.75	6.24	1.82	2.01	1.68	12.42	9.67	1.00	1.94	1.69	4X1309	10.56	
Bulk	11	M3411A	M3511A	4X1311	5.50	2.55	3.25	7.69	2.25	2.63	1.88	14.89	12.06	1.13	2.46	2.22	4X1311	19.00	
Bulk	15	M3415A	M3515A	4X1315	6.00	2.47	3.50	8.37	2.59	2.94	2.19	15.79	11.95	1.25	2.62	2.23	4X1315	26.75	
Bulk	22	M3422A	M3522A	4X1322	7.75	3.82	4.75	10.19	3.00	3.50	2.69	21.18	16.68	1.50	2.74	3.05	4X1322	51.80	

\* Working Load Limits in Metric Tons

RIGGING HARDWARE

## REPLACEMENT LATCHES FOR SWIVEL, RIGGING & SHANK HOOKS

Working Load Limit (tons)		Product Code			
Alloy	Carbon	Old Style	New Style		
		Stainless	Zinc	Stainless	Locking
1	3/4	4X405	4X1302	4X1302S	4X1302M
1-1/2	1	4X405	4X1303	4X1303S	4X1303M
2	1-1/2	4X406	4X1304	4X1304S	4X1304M
3	2	4X406	4X1305	4X1305S	4X1305M
5	3	4X410	4X1307	4X1307S	4X1307M
7	5	4X412	4X1309	4X1309S	4X1309M
11	7-1/2	4X414	4X1311	4X1311S	4X1311M
15	10	595530	4X1315	-	4X1315M
22	15	595533	4X1322	-	4X1322M



Old Style

New Style

## YALE® IMPORT WELD-ON LIFTING HOOK

WORKING LOAD LIMIT: 2,205 TO 17,500 LBS.

### BENEFITS & FEATURES

- Heavy steel construction with a durable finish
- Designed for use with excavating equipment – can be welded directly onto the bucket
- Latch prevents chain from accidentally unhooking
- Design factor 4:1

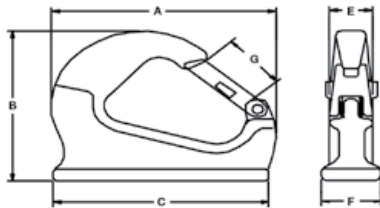

Product Code	Working Load Limit (lbs.)	Dimensions (in.)						Weight (lbs.)	Replacement Latch Product Code
		A	B	C	E	F	G		
48211	2,205	4.63	4.13	2.78	1.00	1.25	0.84	0.88	4X48211
48212	6,615	5.81	4.72	3.74	1.25	1.30	0.98	2.88	4X48212
48213	11,025	7.97	6.45	5.12	1.16	1.72	1.79	5.31	4X48213
48214	17,500	7.61	5.43	6.69	1.58	1.97	1.85	8.50	4X48214

Design Factor 4:1

Imported

## REPLACEMENT HOOK WITH LATCH

**WORKING LOAD LIMIT: 1 TON**

### BENEFITS & FEATURES

- Easy installation
- Bolt, nut, and cotter pin provides safe and secure attaching points
- Self colored finish
- Easy installation
- Design factor 4:1

Working Load Limit (ton)	Product Code	Dimensions (in.)					Weight (lbs.)
		A	B	C	D	E	
1	M134	7.56	5.63	1.13	0.50	0.44	2.56

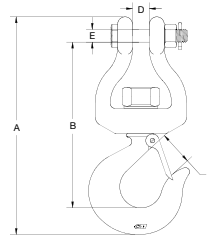

## CLB CONTAINER LIFTING LUGS

**WORKING LOAD LIMIT: 88,100 LBS. (PER SET OF 4)**

Supplied in sets of 4, CLB Lifting Lugs serve as flexible lashing points for transporting containers from the sides.

### BENEFITS & FEATURES

- Spring-loaded bolt to prevent accidental release
- Mounted horizontally at the side of the container in either upper or lower holes
- Easy installation and removal – simply insert and turn to install
- Designed to eliminate the dangerous use of standard hooks
- Lugs cannot drop out when slings become slack
- The set of (4) lugs has (2) right hand and (2) left hand units.
- For maximum capacity, use a lifting beam in conjunction with CLB lifting lugs
- Design factor 4:1

Product Code	Working Load Limit (lbs. per set of 4)	Dimensions							Weight (lbs.)
		A	B	C	D	E	F	G	
CLB40	88,100	5.98	7.13	1.77	1.46	2.87	2.95	1.58	39.7

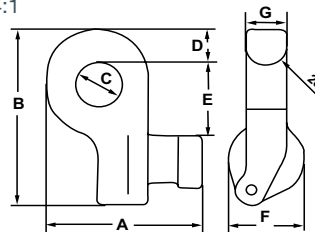

## CLT CONTAINER LIFTING LUGS

**WORKING LOAD LIMIT: 123,480 LBS. (PER SET OF 4)**

Supplied in sets of 4, CLT Lifting Lugs serve as flexible lashing points for transporting containers from the top.

### BENEFITS & FEATURES

- Mounted vertically at the top of the container
- Easy installation and removal – simply insert and turn to install
- Designed to eliminate the dangerous use of standard hooks
- Lugs lock into place by simply turning the lug 90°. This configuration allows for transportation via the use of a lifting frame in conjunction with cables, chains or slings.
- Design factor 4:1

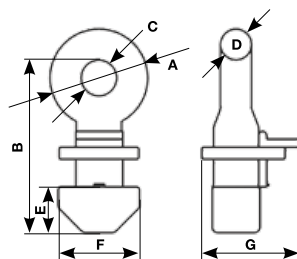

Product Code	Working Load Limit at 90° (lbs. per set of 4)	Dimensions (in.)							Weight (lbs.)
		A	B	C	D	E	F	G	
CLT56	123,480	4.84	8.54	1.77	1.54	2.24	3.98	4.76	61.7





# MASTER LINK DUAL RATED FOR USE WITH HA800 OR HA1000

WORKING LOAD LIMIT: 5,400 TO 187,800 LBS.

## BENEFITS & FEATURES

- Accepts both Herc-Alloy® 800 & 1000 chain and components
- Durable orange powder coated finish
- May be used for mechanical and welded sling assemblies
- 100% proof tested
- Design factor 4:1

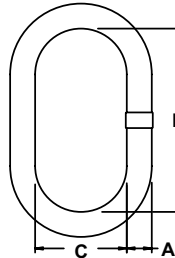

Trade Size (in.)	Working Load Limit (lbs.)	Catalog Number	Product Code	Nominal Dimensions (in.)			Weight (lbs.)	Type and Size of Grade 80 Chain Sling (in.)	
				Material Diameter A	Inside Length B	Inside Width C		Single	Double
<b>Standard Sizes (DUAL RATED THROUGH 1-3/4" SIZE ONLY)</b>									
3/8	5,400	HA40	555231	0.41	3.00	1.50	0.33	7/32 & 9/32	7/32
1/2	8,600	HA50	555232	0.56	5.00	2.50	1.02	3/8	9/32
3/4	17,600	HA75	555235	0.75	5.50	2.75	2.08	1/2	3/8
1	30,000	HA100	555238	1.00	7.00	3.50	4.59	5/8 & 3/4	1/2
1-1/4	45,200	HA125	555240	1.25	8.75	4.38	9.31	7/8	5/8
1-1/2	70,600	HA150	555243	1.50	10.50	5.25	15.60	1	3/4 & 7/8
1-3/4	105,900	HA175	555246	1.75	12.00	6.00	24.40	1-1/4	1
2*	88,900	HA200	554949	2.00	14.00	7.00	38.00	1-1/4	1
2-1/4*	125,200	HA225	554951	2.25	16.00	8.00	55.00	-	1-1/4
2-3/4*	187,800	HA275	554957	2.75	16.00	9.00	84.84	-	-
<b>Special Sizes (NOT DUAL RATED)</b>									
1	18,200	N/A	554969	1.00	8.00	4.00	5.25	N/A	N/A
1-1/4	22,800	N/A	554942	1.25	12.00	6.00	12.08	N/A	N/A
1-1/2	36,700	N/A	554944	1.50	14.00	7.00	20.16	N/A	N/A
1-1/2	42,900	N/A	554970	1.50	12.00	6.00	17.60	N/A	N/A
1-3/4	57,100	N/A	554945	1.75	14.00	7.00	27.92	N/A	N/A
2	77,800	N/A	554952	2.00	16.00	8.00	43.00	N/A	N/A

NOTE: Standard sizes dual rated through 1-3/4" only. Special sizes not dual rated.

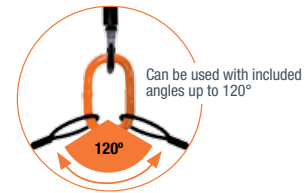

# FORGED MASTER LINK

WORKING LOAD LIMIT: 5,100 TO 20,400 LBS.

## BENEFITS & FEATURES

- Quenched and tempered alloy steel
- Fatigue rated to Grade 80 specifications
- 100% proof tested
- Raised markings for better identification
- Durable orange powder coated finish
- Design factor 6:1

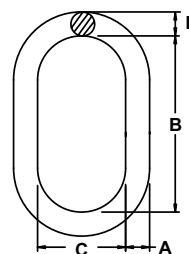
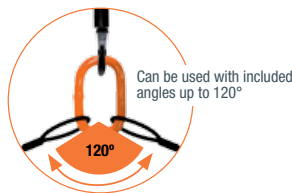

Trade Size (in.)	Working Load Limit (lbs.)	Product Code	Nominal Dimensions (in.)			Weight (lbs.)
			Material Diameter A	Inside Length B	Inside Width C	
1/2	5,100	M50P	0.50	5.00	2.50	0.90
5/8	7,700	M62P	0.63	6.00	3.00	1.75
3/4	10,600	M75P	0.75	6.00	3.00	2.35
1	20,400	M100P	1.00	8.00	4.00	6.00



# MASTER LINK WITH & WITHOUT FLATS

## HERC-ALLOY 800®

**WORKING LOAD LIMIT: 3,360 TO 178,050 LBS.**

### BENEFITS & FEATURES

- Designed to accept HA800 chain, wire rope and synthetic attachments
- Use with mechanical and welded assemblies
- Sizes up to 1-1/4" available with flats to accommodate Omega link
- 100% proof tested
- Extra wide body makes these links ideal for wire rope applications and use with Omegaloks. Master link with flat allows for easy installation of these attachments.
- Design factor 6:1

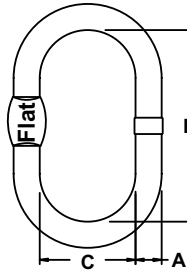
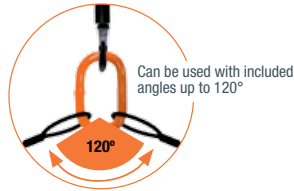

Trade Size (in.)	Working Load Limit (lbs.)		Product Code	Nominal Dimensions (in.)			Flat Dimensions (in.)		Weight (lbs.)	Type and Size of Chain Sling (in.)	
	With Chain	With Wire Rope & Synthetics		Material Diameter A	Inside Length B	Inside Width C	Width	Thickness		Single	Double
7/16	4,200	3,360	ML040 ML040NF	0.44	4.13	2.29	0.94 -	0.28 -	0.50	7/32 & 9/32	7/32
1/2	5,750	4,600	ML050 ML050NF	0.56	4.84	2.69	0.94 -	0.28 -	1.02	-	7/32
5/8	9,000	7,200	ML063 ML063NF	0.63	5.29	2.98	1.22 -	2.81 -	1.34	3/8	9/32
3/4	14,200	11,360	ML075 ML075NF	0.75	6.61	3.72	1.41 -	0.40 -	2.36	1/2	3/8
7/8	17,300	13,840	ML087 ML087NF	0.88	7.35	4.14	1.56 -	0.44 -	3.60	-	-
1	26,500	21,200	ML100 ML100NF	1.00	7.53	4.30	1.56 -	0.53 -	5.20	5/8	1/2
1-1/4	37,400	29,920	ML125 ML125NF	1.25	9.26	5.29	1.56 -	0.68 -	9.60	3/4 & 7/8	5/8
1-1/2	53,000	42,400	ML150	1.50	11.03	6.30	-	-	16.20	1	3/4
1-3/4	72,150	57,720	ML175	1.75	12.86	7.35	-	-	25.10	-	7/8
2	94,200	75,360	ML200	2.00	14.70	8.40	-	-	41.00	1-1/4	1
2-1/4	119,200	95,360	ML225	2.25	16.54	9.45	-	-	58.00	-	-
2-1/2	147,150	117,720	ML250	2.50	18.38	10.50	-	-	74.90	-	1-1/4
2-3/4	178,050	142,440	ML275	2.75	20.21	11.55	-	-	99.80	-	-

NOTE: \*Master link with flats are available through 1-1/4" only  
 Part numbers with "NF" are for master links WITHOUT flats



# WIDE BODY SUB-ASSEMBLY WITH FLATS HERC-ALLOY 800®

WORKING LOAD LIMIT: 4,600 TO 178,050 LBS.

## BENEFITS & FEATURES

- Designed to accept Herc-Alloy 800® chain, wire rope and synthetic attachments
- Durable orange powder coated finish
- 100% proof tested
- May be used for mechanical and welded sling assemblies
- Extra wide body is ideal for wire rope applications
- Sizes up to 1-1/4" intermediate links available with flats to accommodate Omega links
- Design factor 6:1

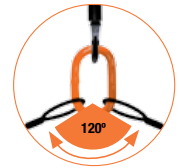
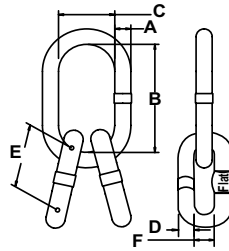

Can be used with included angles up to 120°

Trade Size (in.)	Working Load Limit (lbs.)		Complete Assembly Product Code	Master Link Nominal Dimensions (in.)			Intermediate Link Nominal Dimensions (in.)				Weight (lbs.)	Type and Size of Chain Sling (in.)		
	With Chain	With Wire Rope & Synthetic		Product Code	Material Diameter A	Inside Length B	Inside Width C	Product Code	Material Diameter D	Inside Length E		Inside Width F	Triple	Quad
1/2	5,750	4,600	SA050	ML050	0.56	4.84	2.69	ML040	0.44	4.13	2.29	1.8	-	-
5/8	9,000	7,200	SA063	ML063	0.63	5.29	2.98	ML050	0.56	4.84	2.69	2.9	7/32	7/32
3/4	14,000	11,200	SA075	ML075	0.75	6.61	3.72	ML063	0.63	5.29	2.98	5.5	9/32	9/32
7/8	17,300	13,840	SA087	ML087	0.88	7.35	4.14	ML063	0.63	5.29	2.98	6.3	-	-
1	26,500	21,200	SA100	ML100	1.00	7.53	4.30	ML075	0.75	6.61	3.72	10.2	3/8	3/8
1-1/4	37,400	29,920	SA125	ML125	1.25	9.26	5.29	ML100	1.00	7.53	4.30	20.0	1/2	1/2
1-1/2	53,000	42,400	SA150	ML150	1.50	11.03	6.30	ML100	1.00	7.53	4.30	26.6	-	-
1-3/4	72,150	57,720	SA175	ML175	1.75	12.86	7.35	ML125	1.25	9.26	5.29	44.3	5/8	5/8
2	94,200	75,360	SA200	ML200	2.00	14.70	8.40	ML150	1.50	11.03	6.30	73.4	3/4	3/4
2-1/4	119,200	95,360	SA225	ML225	2.25	16.54	9.45	ML175	1.75	12.86	7.35	108.2	7/8	7/8
2-1/2	147,150	117,720	SA250	ML250	2.50	18.38	10.50	ML200	2.00	14.70	8.40	156.9	1	1
2-3/4	178,050	142,400	SA275	ML275	2.75	20.21	11.55	ML200	2.00	14.70	8.40	181.0	-	-

NOTE: Master link with flats are available through 1-1/4" only

# TURNBUCKLES

**WORKING LOAD LIMIT: 400 TO 21,400 LBS.**

## BENEFITS & FEATURES

- Turnbuckles can be used to apply tension to wire rope or cable.
- Composed of a forged body and two end fittings. End fittings can be eyes, jaws, or hooks.
- Must only be applied to loads within their working load limit as specified for the particular end fitting being applied.
- Apply turnbuckles in a straight in-line manner only. Do not allow anything to contact the turnbuckle body or end attachment threaded shanks.
- Apply load to the center of end attachment eyes and bowl of hooks. Do not tip load hooks or side load eyes.
- Design factor 5:1

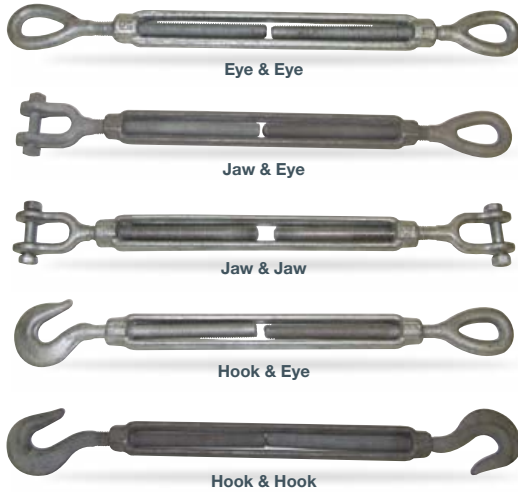

Eye & Eye		Jaw & Eye		Jaw & Jaw		Thread Diameter (in.)	Take Up (in.)	WLL (lbs.)	Weight (lbs.)
Product Code	Weight (lbs.)	Product Code	Weight (lbs.)	Product Code	Weight (lbs.)				
0404EE	0.3	0404JE	0.3	0404JJ	0.4	1/4	4	500	0.4
0504EE	0.5	0504JE	0.5	0504JJ	0.6	5/16	4.5	800	0.6
0606EE	0.8	0606JE	0.9	0606JJ	0.9	3/8	6	1,200	0.9
0806EE	1.5	0806JE	1.7	0806JJ	1.8	1/2	6	2,200	1.8
0809EE	1.9	0809JE	2.0	0809JJ	2.1	1/2	9	2,200	2.1
0812EE	2.3	0812JE	2.4	0812JJ	2.4	1/2	12	2,200	2.4
1006EE	2.5	1006JE	3.0	1006JJ	3.0	5/8	6	3,500	3.0
1009EE	3.3	1009JE	3.5	1009JJ	3.7	5/8	9	3,500	3.7
1012EE	3.8	1012JE	4.0	1012JJ	4.2	5/8	12	3,500	4.2
1206EE	3.9	1206JE	4.3	1206JJ	4.6	3/4	6	5,200	4.6
1209EE	4.8	1209JE	5.1	1209JJ	5.4	3/4	9	5,200	5.4
1212EE	5.4	1212JE	5.7	1212JJ	6.0	3/4	12	5,200	6.0
1218EE	7.0	1218JE	7.3	1218JJ	7.7	3/4	18	5,200	7.7
1412EE	7.4	1412JE	7.9	1412JJ	8.4	7/8	12	7,200	8.4
1418EE	9.6	1418JE	10.2	1418JJ	10.7	7/8	18	7,200	10.7
1606EE	9.0	1606JE	9.4	1606JJ	9.7	1	6	10,000	9.7
1612EE	11.2	1612JE	11.6	1612JJ	11.9	1	12	10,000	11.9
1618EE	13.8	1618JE	14.3	1618JJ	14.8	1	18	10,000	14.8
1624EE	17.1	1624JE	17.6	1624JJ	18.2	1	24	10,000	18.2
2012EE	20.9	-	-	2012JJ	23.8	1-1/4	12	15,200	23.8
2018EE	25.7	-	-	2018JJ	27.5	1-1/4	18	15,200	27.5
2024EE	29.7	-	-	2024JJ	33.7	1-1/4	24	15,200	33.7
2412EE	29	-	-	2412JJ	38.1	1-1/2	12	21,400	38.1
2418EE	35.2	-	-	2418JJ	44.2	1-1/2	18	21,400	44.2
2424EE	40.7	-	-	2424JJ	48.4	1-1/2	24	21,400	48.4

## CARE & INSPECTION

Inspect turnbuckles before use for bent components and worn threads. Do not use if body or end fitting is bent more than 10° from the axial center line. Do not use if threads are visibly worn or feel loose. If in doubt, consult a rigging handbook or discuss with a qualified person.

## WARNING

Improper use or care of turnbuckles can result in bodily injury or property damage. To avoid injury:

- ▲ Inspect turnbuckles for distortion and wear.
- ▲ Do not use if anything is in contact with the turnbuckle body or an end fitting.
- ▲ Only apply load to center of eyes and bowl of hooks.
- ▲ Do not exceed working load limit.



## TURNBUCKLE LOCK NUTS

Size (in.)	Product Code		Weight (lbs.)
	Right Hang Nut	Left Hang Nut	
1/4	3X845	3X845L	0.005
5/16	-	-	0.008
3/8	3X847	-	0.010
1/2	3X849R	3X849L	0.030
5/8	-	3X850L	0.050
3/4	-	3X851L	0.090
7/8	-	3X852L	0.130
1	-	3X853L	0.200
1-1/4	-	3X855L	0.410
1-1/2	-	3X866L	0.700

Imported. Hot Dip Galvanized.

Imported.

Product Code		Thread Diameter (in.)	Take Up (in.)	WLL (lbs.)	Weight (lbs.)
Hook & Eye	Hook & Hook				
0404HE	0404HH	1/4	4	400	-
0504HE	0504HH	5/16	4-1/2	700	-
0606HE	0606HH	3/8	6	1,000	0.8
0806HE	0806HH	1/2	6	1,500	1.5
0809HE	0809HH	1/2	9	1,500	1.9
0812HE	0812HH	1/2	12	1,500	2.3
1006HE	1006HH	5/8	6	2,250	2.5
1009HE	1009HH	5/8	9	2,250	3.3
1012HE	1012HH	5/8	12	2,250	3.8
1206HE	-	3/4	6	3,000	3.9
1209HE	1209HH	3/4	9	3,000	4.8
1212HE	1212HH	3/4	12	3,000	5.4
1218HE	-	3/4	18	3,000	7.0
-	-	7/8	12	4,000	7.4
-	1418HH	7/8	18	4,000	9.6
-	-	1	6	5,000	9.0
1612HE	1612HH	1	12	5,000	11.2
1618HE	1618HH	1	18	5,000	13.8
-	-	1	24	5,000	17.1
2418HE	2418HH	1-1/2	18	7,500	31.2
2424HE	2424HH	1-1/2	24	7,500	38.2

Imported.



# WIRE ROPE CLIPS

SIZES: 1/8 TO 1-1/2 IN.

## BENEFITS & FEATURES

- Precision manufactured and galvanized to meet federal specifications (FF-C-450 Type 1 Class 1) on 1/4" and larger.
- Drop forged base

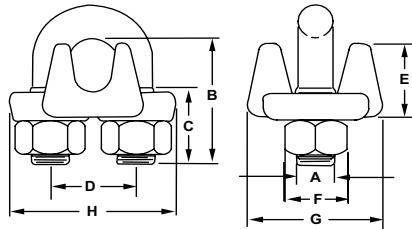

Size (in.)	Standard Package	Product Code	Dimensions (in.)								Minimum Number of Clips	Torque (ft./lbs.)	Rope Turnback	Weight (lbs.)
			A	B	C	D	E	F	G	H				
1/8	50	M244	1/8-24UNC	0.72	0.44	0.47	0.42	0.38	0.81	1.09	2	4-1/2	3-1/4	0.08
3/16	50	M245	1/4-20UNC	0.94	0.56	0.59	0.50	0.50	0.94	1.19	2	7-1/2	3-3/4	0.12
1/4	50	M246	5/16-18UNC	1.03	0.50	0.75	0.66	0.56	1.19	1.44	2	15	4-3/4	0.18
5/16	50	M247	3/8-16UNC	1.38	0.75	0.88	0.72	0.69	1.31	1.69	2	30	5-1/4	0.30
3/8	50	M248	7/16-14UNC	1.50	0.75	1.00	0.91	0.75	1.63	1.94	2	45	6-1/2	0.42
7/16	50	M249	1/2-13UNC	1.88	1.00	1.19	1.06	0.88	1.78	2.31	2	65	7	0.70
1/2	20	M250	1/2-13UNC	1.88	1.00	1.19	1.16	0.88	1.91	2.31	3	65	11-1/2	0.85
9/16	20	M296	9/16-12UNC	2.38	1.25	1.31	1.24	0.94	1.94	2.50	3	95	12	1.00
5/8	20	M251	9/16-12UNC	2.38	1.25	1.31	1.34	0.94	2.00	2.49	3	95	12	1.00
3/4	10	M252	5/8-11UNC	2.75	1.44	1.50	1.44	1.06	2.34	2.81	4	130	18	1.53
7/8	10	M253	3/4-10UNC	3.13	1.63	1.75	1.63	1.25	2.44	3.16	4	225	20	2.40
1	10	M254	3/4-10UNC	3.50	1.81	1.88	1.78	1.25	2.63	3.47	5	225	26	2.50
1-1/8	5	M255	3/4-10UNC	3.88	2.00	2.00	1.88	1.25	2.81	3.59	6	225	34	3.10
1-1/4	5	M256	7/8-9UNC	4.25	2.13	2.31	2.19	1.44	3.15	4.22	7	360	37	4.10
1-3/8	5	M257	7/8-9UNC	4.63	2.31	2.38	2.25	1.44	3.08	4.25	7	360	44	4.50
1-1/2	5	M258	7/8-9UNC	4.94	2.38	2.59	2.50	1.44	3.41	4.47	8	360	48	5.40

NOTE: 1/8" through 5/8" packed 1 piece per poly bag. 3/4" & larger shipped assembled in factory packs and tagged.

## PROPER USE OF WIRE ROPE CLIPS

1. Refer to the chart above when following these instructions. Turn back specified amount of rope from thimble or loop. Apply first clip one base width from dead end of rope. Apply U-bolt over dead end of wire rope, ensuring live end rests in saddle. Tighten nuts evenly, alternate from one nut to the other until reaching the recommended torque.
2. When two clips are required, apply the second clip as near the thimble or loop as possible. Tighten nuts evenly, alternating until reaching the recommended torque. When more than two clips are required, apply the second clip as near the loop or thimble as possible and turn nuts on second clip firmly, but do not tighten. Proceed to Step 3.
3. When three or more clips are required, space additional clips equally between the first two and take up rope slack. Then tighten nuts on each U-bolt evenly, alternating from one nut to the other until reaching the recommended torque.
4. Apply an initial load equal to loads expected in use. Inspect for proper orientation and spacing of clips and retighten the nuts to recommended torque.

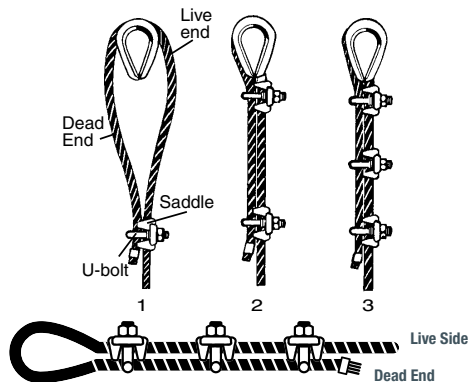

NOTE: Mechanical spliced or finished eyes slings are the preferred method of wire rope sling construction. OSHA does not allow the use of clips to form the eyes of wire rope slings.

## CARE

- Care should be exercised in the installation and use of wire rope clips so that the clip, wire rope, or thimble is not damaged.
- Do not over torque or under torque the nuts. Too much torque can result in damage to the clip and/or the wire rope. Too little torque can result in the wire rope slipping. Torque nuts to the value specified in the accompanying instructions.
- Clips should not be subjected to bending or come in contact with sharp object.
- Avoid exposure to corrosive mediums.

## INSPECTION

- Visually inspect wire rope clips before each use.
- Be certain threads are not stripped and that nuts are tight.
- Check torque of nuts periodically.
- Replace distorted thimbles.
- Shorten wire rope and form new loop if damaged.
- Replace distorted thimbles.

### WARNING

**NEVER INSTALL THE U-BOLT ON THE LIVE SIDE!**

**IMPROPER USE OF WIRE ROPE CLIPS**

RIGGING HARDWARE



# MID-GRIP WIRE ROPE CLIPS

**SIZES: 3/16 TO 3/4 IN.**

## BENEFITS & FEATURES

- Allows for full arc wrench swing for quicker installation, retightening and disassembly.
- Saddles are made of forged steel for strength and wearability. Full assembly is mechanical galvanized per ASTM B695-04 Class 25 Type 1.
- Size, manufacturer and trace code are clearly marked on the saddle for easy identification.
- Meets or exceeds performance requirements of FF-C-450 specifications, Type III, Class 1 and will provide maximum holding strength.

## NEW & IMPROVED HEX BOLT & NUT DESIGN

### TIGHT, SECURE FIT

Hexagon bolt head fits securely into hex-shaped socket for exceptional rotation resistance. This prevents spinning even after repeated use and re-torquing.

### PRECISE THREADING

Precise threading on bolt and nut ensures tight alignment and exceptional strength.

### FEWER LOOSE PARTS TO DROP

Hex bolt is knurled & machine pressed into socket to securely couple with the saddle.

### EASY TO INSPECT

Sight window/notch on top of mid-grip allows for easy inspection of the bolts.

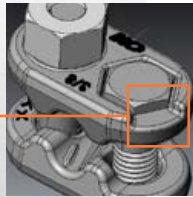

**NEW STYLE**  
Available in 3/16" through 5/8"

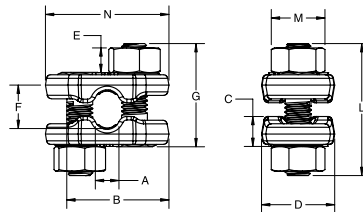

**OLD STYLE**  
Available in 3/4" only

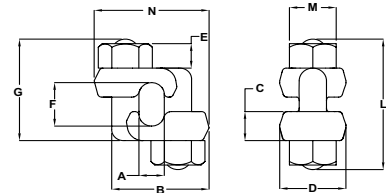

Size (in.)	Standard Package	Product Code	Dimensions (in.)										Minimum Number of Clips	Rope Turn-Back (in.)	Torque (ft./lbs.)	Weight (lbs.)	
			A	B	C	D	E Thread	F	G	L Approx.	M	N					
<b>New Style</b>																	
3/16	20	M2546	0.37	1.53	0.44	1.06	3/8 - 16	0.50	1.50	1.93	0.69	1.74	2	4	30	0.38	
1/4	20	M2546	0.37	1.53	0.44	1.06	3/8 - 16	0.50	1.50	1.93	0.69	1.74	2	4	30	0.38	
5/16	20	M2547	0.34	1.48	0.44	1.06	3/8 - 16	0.63	1.50	1.90	0.69	1.80	2	5	30	0.38	
3/8	20	M2548	0.46	1.67	0.54	1.13	7/16 - 14	0.75	1.84	2.26	0.75	2.00	2	5.5	45	0.49	
7/16	20	M2550	0.65	2.03	0.59	1.31	1/2 - 13	1.05	2.23	2.74	0.88	2.40	2	6.5	65	0.84	
1/2	20	M2550	0.65	2.03	0.59	1.31	1/2 - 13	1.05	2.23	2.74	0.88	2.40	3	11	65	0.84	
9/16	20	M2551	0.78	2.46	0.73	1.63	5/8 - 11	1.38	2.81	3.44	1.06	2.90	3	12.75	130	1.55	
5/8	20	M2551	0.78	2.46	0.73	1.63	5/8 - 11	1.38	2.81	3.44	1.06	2.90	3	13.5	130	1.55	
<b>Old Style</b>																	
3/4	20	M2252	0.81	2.69	0.88	1.81	3/4 - 10	1.50	3.38	5.00	1.25	3.02	3	16	225	1.79	

## ▶ INSPECTION, CARE & USE

### PROPER USE OF MID-GRIP CLIPS

1. Refer to chart above when following these instructions. Turn back specified amounts of rope from thimble or loop. Apply first clip one base width from dead end of rope. Tighten nuts evenly, alternating from one nut to the other until reaching the recommended torque.
2. When two clips are required, apply the second clip as near the loop or thimble as possible. Tighten nuts evenly, alternating until reaching the recommended torque. When more than two clips are required, apply the second clip as near the loop or thimble as possible and turn nuts on second clip firmly, but do not tighten. Proceed to step 3.
3. When three or more clips are required, space additional clips between first two and take up rope slack. Then tighten nuts on all clips, alternating from one nut to the other until reaching the recommended torque.
4. Apply an initial load equal to loads expected in use. Inspect for proper spacing and retighten the nuts to the recommended torque.

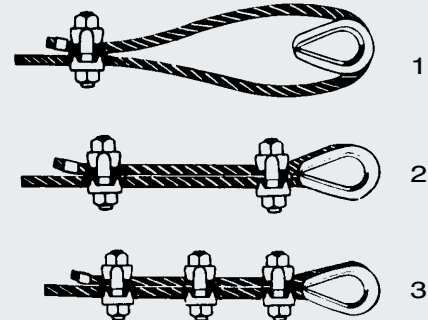

For more information, visit us at [www.cmworks.com](http://www.cmworks.com)



# PIGGYBACK® WEDGE SOCKET CLIPS

SIZES: 3/8 TO 1-1/2 IN.

## BENEFITS & FEATURES

- Forged saddles include size, USA and CM logo
- Drop-forged base for superior function and wearability
- Galvanized finish

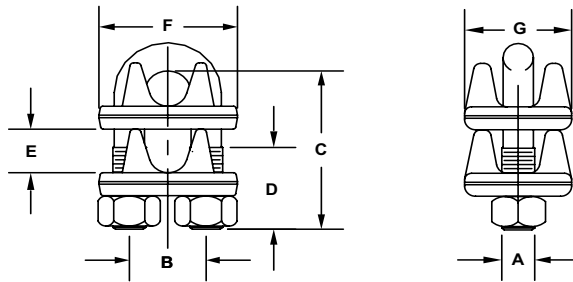

Size (in.)	Standard Package	Product Code	Dimensions (in.)							Torque (ft./lbs.)	Min. Tail (in.)	Weight (lbs.)
			A	B	C	D	E	F	G			
3/8	10	M248D	7/16-14UNC	1.00	2.38	0.75	0.69	1.94	1.62	45	6	0.8
7/16	10	M249D	1/2-13UNC	1.19	2.62	1.00	0.66	2.31	1.78	65	6	1.3
1/2	10	M250D	1/2-13UNC	1.19	2.62	1.00	0.72	2.31	1.91	65	6	1.4
9/16	10	M296D	9/16-12UNC	1.31	3.19	1.25	0.77	2.50	1.97	95	6	1.7
5/8	10	M251D	9/16-12UNC	1.31	3.19	1.25	0.87	2.50	2.00	95	6	1.7
3/4	10	M252D	5/8-11UNC	1.50	3.50	1.50	0.91	2.81	2.34	130	6	2.5
7/8	5	M253D	3/4-10UNC	1.75	3.88	2.00	1.07	3.16	2.44	225	6	3.6
1	5	M254D	3/4-10UNC	1.88	4.25	2.00	1.22	3.47	2.62	225	6	3.9
1-1/8	5	M255D	3/4-10UNC	2.00	4.50	2.00	1.31	3.59	2.81	225	6-3/4	4.9
1-1/4	5	M256D	7/8-9UNC	2.31	5.25	2.38	1.50	4.22	3.15	360	7-1/2	6.5
1-3/8	5	M257D	7/8-9UNC	2.38	5.62	2.38	1.56	4.25	3.08	360	8-1/4	7.1
1-1/2	5	M258D	7/8-9UNC	2.59	6.00	2.38	1.75	4.47	3.41	360	9	8.2

## PROPER USE OF PIGGYBACK WEDGE SOCKET CLIPS

- Dead end wire rope tail length should be at least 6 rope diameters, but not less than 6 inches beyond the wedge socket. See Figure 1.
- Apply U-bolt and first saddle on dead end rope and the second saddle on live end rope. Install nuts. See Figures 1 & 2.
- Position the dual saddle clip so that 3 to 4 inches of dead end rope remain beyond the clip. See Figures 1 & 2.
- Tighten nuts evenly. Alternate tightening each nut until reaching the required torque specified. See Figure 2.
- Check that clip does not pinch or clamp the live wire rope. Apply an initial test load equal to the loads expected in regular use. Be certain rope is secured properly in the wedge socket prior to any use.
- Inspect for proper rope alignment with wedge socket and retighten the nuts to the specified torque.

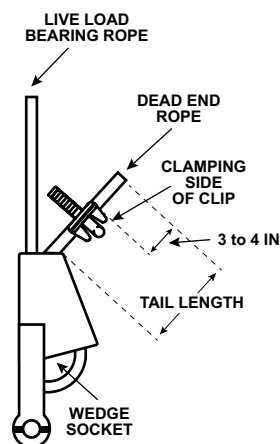

FIGURE 1

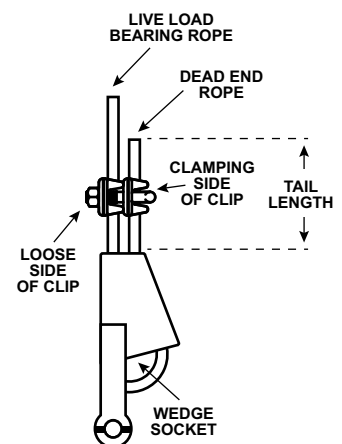

FIGURE 2



# BUNDLING CLIP

**SIZES: 3/4 TO 1-1/8 IN.**

**BENEFITS & FEATURES**

- Galvanized and painted U-bolt with rolled threads. Interchangeable and replaceable with our standard wire rope clip U-bolts.
- Forged and galvanized saddles come with FORGED USA, size, CM logo and trace code forged in.
- Performs to rated capacities.
- After inspection, the CM Bundling Clip is reusable.
- Available for use with 3/4", 7/8", 1" and 1-1/8" wire rope chokers.

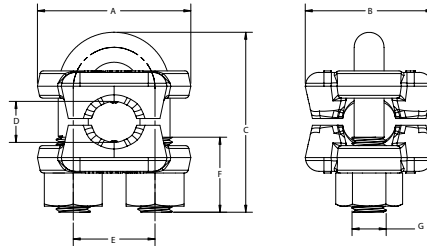

Size (in.)	Standard Package	Product Code	Dimensions (in.)							Torque (ft./lbs.)	Weight (lbs.)
			A	B	C	D	E	F	G		
3/4	10	M252B	2.81	2.34	3.30	0.75	1.50	1.38	5/8"-11 UNC	130	2.5
7/8	5	M253B	3.16	2.44	3.88	0.88	1.75	1.63	3/4"-10 UNC	225	3.6
1	5	M254B	3.47	2.63	4.16	1.00	1.88	1.81	3/4"-10 UNC	225	3.9
1-1/8	5	M255B	3.60	2.81	4.54	1.13	2.00	2.00	3/4"-10 UNC	225	4.9

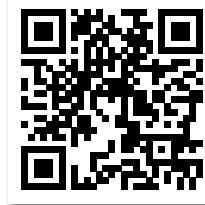

**SEE BUNDLING CLIPS IN ACTION**  
<http://www.youtube.com/user/ColumbusMcKinnon>





105432





# BELOW-THE-HOOK ATTACHMENTS

## CAMLOK™ CLAMPS

General Information & Use .....	114
CZ Universal Plate Clamp .....	116
CY Hinged Universal Plate Clamp .....	117
CX Heavy Duty Hinged Universal Plate Clamp .....	118
LJ Gentle Grip Clamp .....	119
TTR Girder Clamp .....	120
CH Heavy Duty Horizontal Plate Clamp .....	121
CP Pile Pitching Clamp .....	122
TTG Horizontal Girder Clamp .....	122
CG Girder Turning Clamps .....	123
THK Horizontal Plate Clamp .....	124
HG High Grip Plate Clamp .....	125
THS Plate Clamp .....	126
TSH Screw Clamp .....	127
CLB Container Lifting Lugs .....	128
CLT Container Lifting Lugs .....	128
BTG Groundworks .....	129
HGC Hand Grip Clamp .....	129

# Camlok™ PLATE AND BEAM CLAMPS

Camlok™ lifting clamps are part of an extensive portfolio of rigging and below-the-hook attachments from Columbus McKinnon. Available as stand-alone components or complete lifting systems, the Camlok line of clamps address a multitude of application needs and provide secure lifts for a variety of loads. These include:

- Structural Steel Plates
- Stainless Steel
- Iron
- Aluminum
- Girders/Beams
- Sheet Plates
- Steel Piles
- Rolled Steel Joists
- Manhole Pipes
- Shipping Containers

Camlok Clamps are manufactured in accordance with ISO9002, and the company is accredited by BSI (British Standards Institute) and a member of the Lifting Equipment Engineers Association (LEEA).



## HOW TO SELECT THE RIGHT CLAMP FOR YOUR APPLICATION

For efficient, reliable, and secure operation of a lifting clamp, the selection of the correct clamp for the job is extremely important. Clamps can be used on most types and grades of steel up to a surface hardness of 300 Brinell (32HRc), and are suitable for certain grades of aluminum sheet and brass. Clamps are not suitable for steel over 300 Brinell (32HRc), stainless steel, lead, certain grades of copper and materials over 120°C or 250°F surface temperature. Some clamps are available for steel over 300 Brinell and stainless steel upon request.

### DETERMINING PROPER SIZE

The working load limit (WLL) of the clamp should be as close as possible to the actual load to be lifted. This ensures the clamp works at maximum efficiency, reduces wear, and increases the clamp's service life. The maximum jaw capacity of the clamp should also be as close as possible to the plate thickness being lifted. The spring will be stretched to its maximum and will be providing the maximum amount of initial grip to the lift.

Excessive wear and a reduction in working life can be caused if a clamp is continuously used to lift material of the same thickness. With this type of application, the teeth of the clamp's moving jaw where the wear is concentrated must be inspected regularly. Scheduled or periodic rotation of duties will increase the operational life of your clamp inventory. Speciality clamps can be manufactured for specific needs as well.

### DETERMINING PROPER TYPE

**For lifting thin, light sheets,** operators should choose a narrow throat clamp. The pad side of a narrow throat clamp is closer to the moving jaw, thus increasing the initial grip of the clamp by causing the spring to be stretched.

**For lifting thick, but small, plates,** the best solution is a larger clamp where the pad side is further away from the moving jaw.

**For lifting loads of made of hardened steel,** the operator should avoid using clamps with teeth that may damage the load. Non-marking clamps should be used instead.

### CHOOSE AN ACCREDITED & EXPERIENCED SOURCE

Camlok is accredited by BSI (British Standards Institute) and is a member of the Lifting Equipment Engineers Association (LEEA). Our clamps are manufactured in accordance with ISO9002. Whether you need a single clamp or a complete lifting system that includes forged rigging attachments, hoists and overhead cranes, count on the decades of engineering and application-driven experience provided by Columbus McKinnon and Camlok.

## ⚠ WARNING

If not properly installed, operated and maintained, the use of all mechanical equipment presents the possibility of personal injury or property damage. Before using lifting clamps, become familiar with applicable installation, operation and maintenance requirements. Clamps should be used only by authorized, properly trained operators.

#### TO AVOID INJURY:

- ▲ Inspect clamps and equipment before use. Do not use if components are bent, elongated, gouged, nicked excessively, worn, or damaged. Make sure that nuts, bolts, pins and other fasteners are tightened and secure. Make sure clamps are functional and will grip the load.
- ▲ Do not exceed the clamp's rated load or working load limit of other lifting equipment components.
- ▲ Lift only one plate at a time when using lifting clamps.
- ▲ Do not lift unbalanced loads. Avoid sudden jerks when applying the load. Rapid load application can produce overloading.
- ▲ Use clamps and lifting equipment only if authorized and properly trained.
- ▲ Always stand clear when lifting and lowering.
- ▲ Use more than one clamp suspended from a lifting beam when lifting long loads.
- ▲ Always gently lift and lower.

## MECHANICS OF A CLAMP

The maximum load imposed on a device determines the structure and size of a plate clamp. The manufacturer will design the internal components of the clamp to cope with these forces in consideration of the expected mechanical losses of the system.

Most Camlok™ clamps use sharp teeth to bite into the plate being lifted. Once a clamp has bitten into the plate, it effectively becomes one with the plate and allows the plate to be safely lifted. The design of the clamp is such that the load applied to the hook ring is magnified through a system of links to create a high gripping force that pushes the jaw teeth into the lifted plate. This gripping force is directly proportional to the load applied and self actuating (i.e. the higher the load applied, the higher the gripping force). This is known as the primary action.

A secondary force generated by movement in the lifted plate supplements the primary gripping force. If the plate starts to slip from the clamp, the moving jaw is turned with the plate and the cam shape of the jaw increases the gripping force.

**Plate lifting clamps are simple machines. Like all machines with mechanisms they are subject to naturally occurring phenomenon that reduce efficiency. These include:**

- Friction between moving parts. This will reduce the forces transmitted through the mechanism.
- Inertia of the components. This will assert a degree of drag into the system slowing the reaction to changing inputs.

The system of links and pivots in a plate clamp are simple, lightweight, and move over a small distance when in operation. The bearings in a plate clamp are generally simple “metal on metal” type, have large forces acting through them, and have poor lubrication. Therefore, the friction loss can be significant if the clamp is poorly maintained and suffering from wear.

The mechanism of the plate clamp is not static during operation, but the movements are small. The inertia and friction of the mechanism can have a significant effect on the performance of the clamp when lifting material from the horizontal to the vertical position. The imposed load on the clamp fluctuates from 50% of the load being lifted to zero and then to 100% at the “top dead center” position. (The point when the center of gravity of the plate passes over the pivot point contact on the floor and is then lifted clear.)

**The amount a tooth penetrates into the lifted plate is dependent on a number of factors:**

- The gripping force
- The hardness of the plate being lifted
- The shape of the clamp tooth

**In simple terms, a tooth will penetrate into the material until the gripping force, divided by the projected area of the tooth contact, equals the indent stress of the material.**

## LIFTING PAD & JAW DESIGN

### SQUARE PADS

Unlike round pads on the market, Camlok uses a wide spacing or square pad layout. The wide spacing and layout of the teeth on the Camlok square pad help prevent pivoting of the plate and clamp during lifting. This protects the straight teeth on the moving jaw. All the teeth on the square pad can be used to lift the load therefore maximizing efficiency. The pads are marked with the maximum material hardness.

### ROUND PADS

On round pads the gripping force must push all teeth into the material. However, only the top and bottom quarter of the pad can be used to effectively lift the load, thus reducing the efficiency of the pad. There is no resistance to pivoting and straight teeth on the jaw suffer rotational stress and wear.

#### SQUARE VS. ROUND PADS

	SQUARE	ROUND
Pivoting Resistance	Excellent	Poor
Teeth Wear	Excellent	Average
Full Surface Contact	Excellent	Poor
Load Distribution	Excellent	Poor
Pad Bolt Stress	Low	High

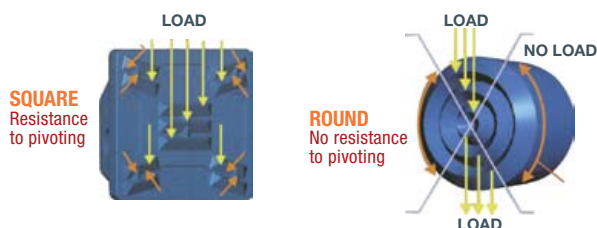

### CAMLOK™ JAW

The wide pad and teeth layout on the Camlok clamp prevents the load from twisting or pivoting in the jaws. This helps prevent any unnecessary wear or damage on the teeth.

The force of the load on the Camlok clamp is distributed through the pad directly to the clamp housing. This means there is no load stress on the pad bolts and reduces the possibility of pad bolt failure during lifting.

**Figure 1.** When the load on round pads twists, the narrow jaw resists it. This places very high loads on the edge of the jaw, which is not designed to sustain this pivoting load.

FIGURE 1

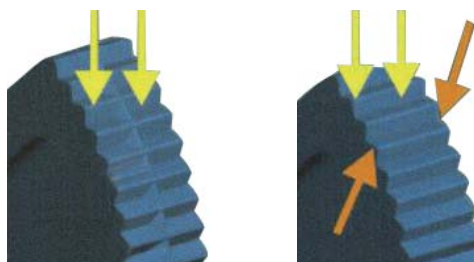

## CZ UNIVERSAL PLATE CLAMP

**WORKING LOAD LIMIT: 120 TO 66,000 LBS.**

CZ Plate Clamps can be used on all hot rolled structural steel plates and sections up to a surface hardness of 300 Brinell (32HRc).

### BENEFITS & FEATURES

- Body of clamp is welded construction
- Can be used to lift a plate from the horizontal to vertical position and vice versa through 180°
- Clamp jaws and pads are manufactured from high-tensile steel
- Fitted with a hold open and lock closed lever. To initiate the self actuating force, a spring is incorporated into the clamp to give an initial bite on the material. If the plate should start to slip during lifting, the cam shape of the jaw turns with the material and increases the gripping force.
- The cam handle is ergonomically designed with a flat surface to allow for ease of operation while wearing protective gloves
- The cam handle connects to the cam via a robust square drive
- Unlike others, these plate clamps are designed with a sloping slot, which increases the grip on the load when the clamp is in the horizontal position
- Design factor 4:1

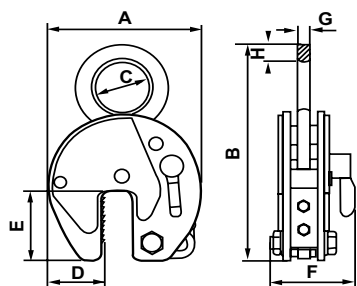
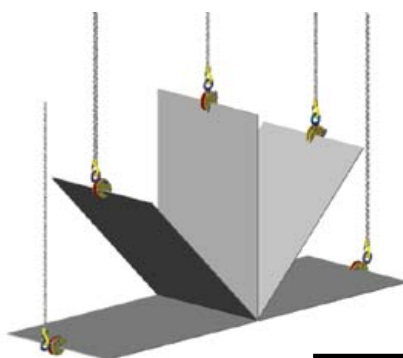

### ▶ INSPECTION, CARE & USE

**DO NOT** side load clamp more than 15° – use type CY or CX clamp for side loading

**DO NOT** lift plates with a temperature greater than 120°C or 250°F

**DO NOT** use to lift stainless steel, lead or copper.

For stainless steel plates, use LJ or HG Clamp.

**DO NOT** use on a double, triple, or quad sling. When using two clamps to lift a steel plate, a lifting beam must be used between the two clamps, so the clamps operate in a vertical position. Use a CY or CX clamp for slings with more than one leg.

For more information, visit us at [www.cmworks.com](http://www.cmworks.com)

Product Code	Working Load Limit		Jaw Capacity (in.)	Dimensions (in.)								Weight (lbs.)
	Minimum (lbs.)	Maximum (lbs.)		A	B	C	D	E	F	G	H	
92 500	120	1,100	0 to 5/8	3.898	7.677	1.142	1.299	1.850	1.969	0.393	0.433	3.3
92 1500	350	3,300	0 to 3/4	4.961	8.858	1.969	1.929	2.756	3.228	0.472	0.472	6.6
92 2000	450	4,400	0 to 1-1/4	7.559	12.283	3.150	2.953	3.780	3.937	0.787	0.787	17.6
92 3000	675	6,600	0 to 1-1/4	7.559	12.283	3.150	2.953	3.780	3.937	0.787	1.181	22.0
CZ4	1,100	8,800	0 to 1-1/4	7.756	14.606	3.150	2.677	3.661	5.079	0.787	1.181	26.5
CZ4L	1,100	8,800	1-1/8 to 2-3/8	8.976	15.354	3.150	2.677	3.661	5.079	0.787	1.181	39.7
CZ6	1,600	13,200	0 to 2	11.535	19.055	3.504	3.740	5.630	5.079	0.984	1.378	46.3
CZ8	2,150	17,600	0 to 2	11.535	19.370	3.504	3.740	5.630	5.079	0.984	1.654	57.3
CZ8L	2,150	17,600	2 to 4	14.252	20.630	3.504	4.488	5.630	5.079	0.984	1.654	70.5
CZ10	3,350	22,000	0 to 2	11.535	21.457	4.331	3.740	5.630	5.472	0.984	1.772	66.1
CZ10L*	3,350	22,000	2 to 4	14.252	21.457	4.331	4.488	5.630	5.472	0.984	1.772	81.6
CZ15	6,650	33,000	0 to 2	14.173	24.134	5.118	4.921	6.378	8.031	1.772	2.165	165.3
CZ15L*	6,650	33,000	2 to 4	18.110	26.693	5.118	6.890	6.378	8.031	1.772	2.165	194.0
CZ20*	8,850	44,000	0 to 2-1/2	18.189	29.724	5.118	6.496	8.268	9.252	1.772	2.559	271.2
CZ20L*	8,850	44,000	2-1/2 to 5	22.047	31.693	5.118	7.677	8.268	9.252	1.772	2.559	299.8
CZ30*	13,250	66,000	0 to 2-1/2	18.189	28.819	2.362	6.496	8.268	11.614	2.559	-	429.9

\*Not Stocked

# CY HINGED UNIVERSAL PLATE CLAMP

**WORKING LOAD LIMIT: 450 TO 6,600 LBS.**

CY Plate Clamps can be used on all structural steel plates up to a surface hardness of 300 Brinell (32HRc). These clamps are designed to be used with a two leg chain sling for lifting longer plates.

## BENEFITS & FEATURES

- Can be used to lift a plate from the horizontal to vertical position and vice versa
- Can turn a plate from the horizontal to vertical position
- Sufficient clamping of the load is achieved by the special shape of the hook ring
- Fitted with a cam-operated closing mechanism that can be replaced with a chain pull open/close mechanism
- Because of the swiveling hook ring, clamps can be fitted to a steel plate in any position
- Design factor 4:1



## INSPECTION, CARE & USE

- DO NOT** lift loads less than 20% of working load limit of clamp
- DO NOT** lift plates with a temperature greater than 120°C or 250°F
- DO NOT** use to lift stainless steel, lead or copper.  
For stainless steel plates, use LJ or HG Clamp.

For more information, visit us at [www.cmworks.com](http://www.cmworks.com)

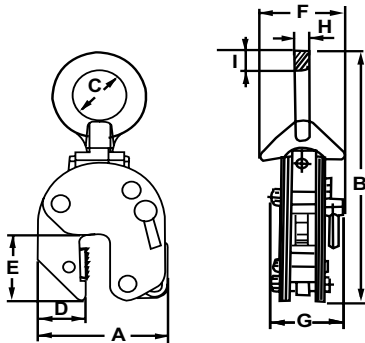

Product Code	Working Load Limit		Jaw Capacity (in.)	Dimensions (in.)								
	Minimum (lbs.)	Maximum (lbs.)		A	B	C	D	E	F	G	H	I
CY1	450	2,200	0 to 3/4	4.961	10.630	1.969	1.929	2.756	3.740	2.480	0.472	0.906
CY2	900	4,400	0 to 1-1/4	7.559	15.039	3.150	2.953	3.780	5.197	3.622	0.787	1.181
CY3	1,350	6,600	0 to 1-1/4	7.559	15.039	3.150	2.953	3.780	5.197	3.622	0.787	1.181

## SAFE LOADS FOR TWO CLAMPS

Angle (degrees)	Product Code		
	CY1 (lbs.)	CY2 (lbs.)	CY3 (lbs.)
0 to 30	4,400	8,800	13,200
30 to 90	2,200	4,400	6,600
90 to 120	1,100	2,200	3,300

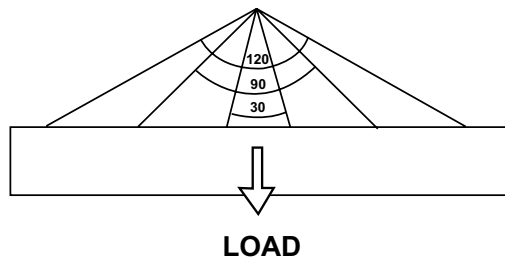

# CX HEAVY-DUTY HINGED UNIVERSAL PLATE CLAMP

**WORKING LOAD LIMIT: 1,000 TO 22,000 LBS.**

CX Plate Clamps are a more robust, heavy-duty model of the CY clamp. The CX clamp has a reinforced plate at the top of the mouth and a heavy-duty hook ring. The CX clamp is more suitable for turning vertically racked plates.

## BENEFITS & FEATURES

- Used on all hot rolled structural steel plates and sections up to a surface hardness of 300 Brinell (32HRc)
- Lifts plates from horizontal to vertical position and vice versa through 180°
- Vertically racked plates can be turned over due to the built-in lifting eye and link
- Clamps can be used with 2 leg slings
- Design factor 4:1



*Hammerlok® and link not included*

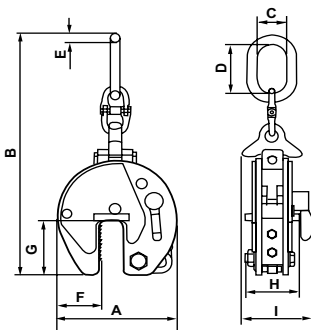

## ▶ INSPECTION, CARE & USE

- DO NOT** lift loads less than 20% of working load limit of clamp
- DO NOT** lift plates with a temperature greater than 120°C or 250°F
- DO NOT** use to lift stainless steel, lead or copper.  
For stainless steel plates, use LJ or HG Clamp.

For more information, visit us at  
[www.cmworks.com](http://www.cmworks.com)

Product Code	Working Load Limit		Jaw Capacity (in.)	Dimensions (in.)									Weight (lbs.)
	Minimum (lbs.)	Maximum (lbs.)		A	B	C	D	E	F	G	H	I	
CX3000	1,000	6,600	0 to 1-1/4	7.756	20.276	2.638	5.433	0.748	2.677	3.661	3.189	4.331	26.5
CX6000	2,650	13,200	0 to 2	11.496	29.016	3.740	6.929	1.102	3.740	5.630	5.394	7.402	83.8
CX6000L	2,650	13,200	2 to 4	14.449	30.906	3.858	7.087	1.102	4.528	5.630	5.315	7.402	105.8
CX8000	3,550	17,600	0 to 2	11.496	29.016	3.858	6.929	1.102	3.740	5.630	5.354	8.268	86.0
CX8000L*	3,550	17,600	2 to 4	14.449	30.906	3.858	7.087	1.102	4.528	5.630	5.354	8.268	112.4
CX10000	4,400	22,000	0 to 2	14.173	35.551	4.331	7.677	1.299	4.921	6.378	6.693	8.780	134.5
CX10000L*	4,400	22,000	2 to 4	17.559	36.260	4.409	7.677	1.299	6.614	6.378	6.693	8.780	167.5

\*Not Stocked

## LJ GENTLE GRIP CLAMP

WORKING LOAD LIMIT: 60 TO 3,300 LBS.

LJ Plate Clamps can be used to lift and turn all structural steel plates, including stainless steel, iron and aluminum, without marking or damaging the surface.

### BENEFITS & FEATURES

- Designed to lift thin-gauge steel plates, stainless steel, iron, timber, and aluminum without marring or damaging the surface
- Lifts plates from the horizontal to vertical position and vice versa through 180°
- The performance on the leather jaws is not affected by standing water so the clamp can be used with submerged plasma cutting machines
- The LJ clamp is suitable for surface hardness greater than 300 Brinell (32HRc)
- Minimum load will not affect the LJ clamps as they do not have teeth for bite. However some load is required to combat friction in the clamp. Extra care must be taken when lifting plates in the lower 20% of their rated capacity. Thin plates are best lifted with the fixed jaw on top when performing a horizontal to vertical lift.
- The clamp may not be suitable for lifting highly polished plates where the polish process may leave lubricating compounds
- Design factor 4:1

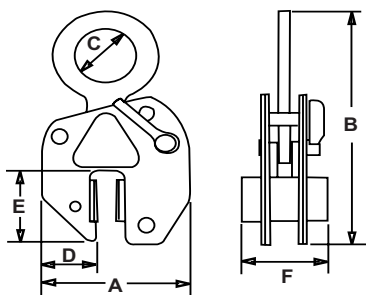

### ► INSPECTION, CARE & USE

**DO NOT** use the clamp on plates with surface contamination (dirt, grease, scale, etc...). Minimize dirt and dust on the surface to be lifted. Pads can tolerate surface water on the plate but shall not be submerged under water.

**DO NOT** use on smooth polished surfaces. Polished surfaces leave behind lubricating compounds. The leather pads need to surround the irregularities in the surface to grip the load effectively.

**DO** clean the leather pads regularly. Clean in water only and use a brass suede brush to rough up the surface.

**DO NOT** use solvents to clean the jaw lining as this may affect the bond between the surface material and the metal of the jaw.

**DO** inspect the clamp before each use. Make sure the pads are clean. If pads are cut or worn, or can not be cleaned, take clamp out of service and replace pads. When in doubt, remove clamp from service.

For more information, visit us at [www.cmworks.com](http://www.cmworks.com)

Product Code	Working Load Limit		Jaw Capacity (in.)	Dimensions (in.)						Weight (lbs.)
	Minimum (lbs.)	Maximum (lbs.)		A	B	C	D	E	F	
LJ500	60	1,100	0 to 3/8	5.000	7.874	2.165	2.047	2.717	2.992	7.7
LJ1500	400	3,300	0 to 3/4	8.465	13.583	3.346	2.953	5.315	4.646	26.5

## TTR GIRDER CLAMP

**WORKING LOAD LIMIT: 90 TO 6,600 LBS.**

TTR Clamps can be used on girders and rolled steel joists up to a surface hardness of 300 Brinell (32HRc). These clamps are designed for handling structural beams with the flange in a vertical position, or “H” position.

### BENEFITS & FEATURES

- Used to lift and transport structural beams up to a surface hardness of 300 Brinell (32HRc) with the flanges in the upright position
- Versatile tool for transporting girders and joists. Can be used to lift and stack girders horizontally.
- The hook rings are designed to be as near to the center of gravity as possible, resulting in a near horizontal lift
- Clamp is fitted with a cam-operated locking mechanism
- Short beams may be lifted with a single clamp, longer beams should use 2 clamps in combination with a spreader beam
- Design factor 4:1

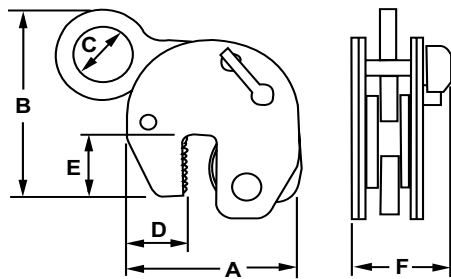

### ▶ INSPECTION, CARE & USE

**DO NOT** lift plates with a temperature greater than 120°C or 250°F  
**DO NOT** use to lift stainless steel, lead or copper.

For more information, visit us at [www.cmworks.com](http://www.cmworks.com)

Product Code	Working Load Limit		Flange (in.)	Dimensions (in.)						Weight (lbs.)
	Minimum (lbs.)	Maximum (lbs.)		A	B	C	D	E	F	
TTR750*	90	1,600	1/4 to 5/8	5.375	7.500	2.000	1.750	2.375	3.500	7.7
TTR1500	350	3,300	1/4 to 1	7.500	10.625	2.625	2.625	3.000	4.875	22.0
TTR3000*	700	6,600	1/4 to 1	8.250	9.875	3.500	2.625	3.375	5.000	26.5

\*Not Stocked

BELOW-THE-HOOK ATTACHMENTS



## CH HEAVY-DUTY HORIZONTAL PLATE CLAMP

WORKING LOAD LIMIT: 2,200 TO 17,600 LBS.

CH Clamps must be used in pairs and can be used on all types of materials in plate form, providing the plate can withstand the forces imposed. Standard CH clamps are supplied with smooth jaws.

### BENEFITS & FEATURES

- CH clamps are designed for loading process machines and to lift and transport sheet steel plates in the horizontal position
- Can be designed to suit any load or plate thickness
- Clamps are suitable for lifting one plate at a time, or bundles of plates provided the plates are the same width, have straight square sides, and are thicker than 10% of the maximum jaw capacity of the clamp
- Clamps have smooth teeth so they can be used on all types of material
- The smooth jaws can be replaced with serrated, hardened steel teeth and used on material up to 300 Brinell (32HRc)
- Designed to be used with 2 legged slings
- CH clamps should never be side loaded
- Sold in pairs
- Design factor 4:1

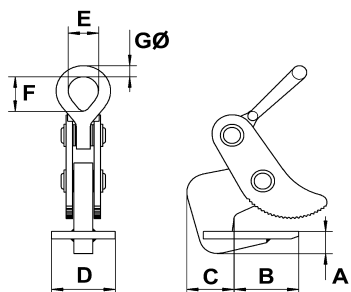

### ▶ INSPECTION, CARE & USE

**DO NOT** side load CH clamps.

**DO NOT** use on a quad sling. When lifting long plates, use a beam or spreader bar that has a double leg sling at each end and connect clamps to the slings.



For more information, visit us at  
[www.cmworks.com](http://www.cmworks.com)

Product Code	Working Load Limit (lbs. per pair)	Jaw Capacity (in.)	Dimensions (in.)							Weight (lbs. per pair)
			A	B	C	D	E	F	G	
CH1	2,200	1/4 to 1-1/4	1.181	3.228	2.362	3.937	1.260	1.732	0.512	13.2
CH2	4,400	1/4 to 1-1/4	1.181	3.228	2.362	3.937	1.969	2.874	0.709	24.3
CH2/L	4,400	3/4 to 2	1.181	3.228	2.362	3.937	1.969	2.874	0.709	26.5
CH4	8,800	1/4 to 1-1/4	1.575	4.409	3.150	3.937	2.520	3.622	0.984	37.5
CH4/L	8,800	2 to 4	1.575	4.409	3.150	3.937	2.520	3.622	0.984	50.7
CH6	13,200	1/4 to 3	2.165	6.772	3.937	5.118	3.543	5.118	1.378	101.4
CH6/L	13,200	2 to 5	2.165	6.772	3.937	5.118	3.543	5.118	1.378	123.5
CH8	17,600	1/4 to 3	2.165	6.772	4.134	5.118	3.543	5.118	1.378	116.8
CH8/L	17,600	2 to 5	2.165	6.772	4.134	5.118	3.543	5.118	1.378	132.3
CH10	22,000	1/4 to 4	2.559	8.465	4.724	5.906	4.488	5.118	1.378	209.4
CH10/L	22,000	2 to 6	2.559	8.465	4.724	5.906	4.488	5.118	1.378	238.1
HH8	17,600	1/4 to 2	2.165	6.614	4.134	5.118	4.134	5.118	3.543	46.3
HH8/L	17,600	2 to 4	2.165	6.614	4.134	5.118	3.543	4.488	1.378	61.7

## CP PILE PITCHING CLAMP

**WORKING LOAD LIMIT: 4,400 TO 11,000 LBS.**

CP Clamps are designed specifically for pitching sheet steel and have the advantage of an attached rope for easy release from the ground.

### BENEFITS & FEATURES

- Designed specifically for pitching sheet steel piling
- Ideal clamp for heavy construction
- Rope is fitted for easy release from the ground
- These are not designed to extract driven piles, use the PP series clamps for this
- Design factor 4:1

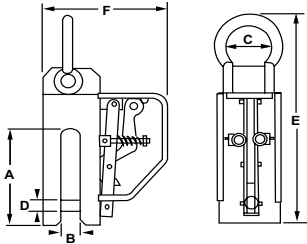

### ▶ INSPECTION, CARE & USE

**DO NOT** use CP Clamps to extract a driven pile. Use the PP series clamps for this application.

For more information, visit us at [www.cmworks.com](http://www.cmworks.com)



Product Code	Working Load Limit (lbs.)	Dimensions (in.)						Weight (lbs.)
		A	B	C	D	E	F	
CP2	4,400	8.976	0.787	2.000	0.787	16.750	8.500	41.9
CP3	6,600	8.976	1.024	2.500	1.181	17.875	8.875	50.7
CP5	11,000	8.976	1.378	3.250	1.181	19.875	9.500	72.8

## TTG HORIZONTAL GIRDER CLAMP

**WORKING LOAD LIMIT: 200 TO 16,500 LBS.**

TTG Clamps are designed to lift and transport structural steel beams in the horizontal position.

### BENEFITS & FEATURES

- Designed to lift and transport structural steel beams in the horizontal position
- Fitted with a Camlok spring-operated safety lock and is operated by pulling the lock upwards
- For short beams, a single clamp can be used. Long beams should be lifted using 2 clamps attached to opposite beam flanges
- Maximum hardness of material to lift should not exceed 300 Brinell (32HRc)
- Design factor 4:1

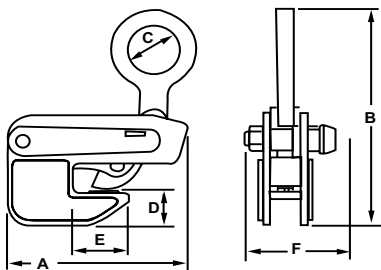

### ▶ INSPECTION, CARE & USE

**DO NOT** lift plates with a temperature greater than 120°C or 250°F

For more information, visit us at [www.cmworks.com](http://www.cmworks.com)



Product Code	Working Load Limit		Plate (in.)	Dimensions (in.)						Weight (lbs.)
	Minimum (lbs.)	Maximum (lbs.)		A	B	C	D	E	F	
TTG1500	200	3,300	0 to 1-1/8	9.000	10.875	3.750	1.750	2.750	4.000	12.1
TTG3000	350	6,600	0 to 1-3/8	11.125	11.625	3.125	2.125	2.875	4.500	24.3
TTG4500	1,000	9,900	0 to 1-1/2	12.375	13.250	3.500	2.375	3.000	4.625	32.0
TTG7500	1,650	16,500	0 to 1-3/4	14.500	15.000	4.375	2.500	3.625	6.625	61.7

## CG GIRDER TURNING CLAMPS

WORKING LOAD LIMIT: 250 TO 13,200 LBS.

CG Clamps can lift and turn girders through 90° and are designed to meet the requirements of the heavy steel industry. They are general purpose clamps and can be used on rolled steel joists, beams, and fabrications up to a surface hardness of 300 Brinell (32HRc).

### BENEFITS & FEATURES

- Can be used on beams, fabrications, channels and rolled steel joists
- Can lift and turn beams up to 90° and are designed to land the beam in either the vertical or horizontal position.
- Fitted with a cam/spring-operated safety lock
- Incorporates a positive lock onto one of the uppermost edges, which will allow the beam to be set down with the flange vertical
- For long girders, fabrications and welded structures, two clamps and a lifting beam may be required
- Design factor 4:1

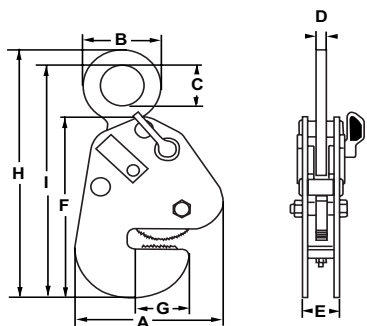

### ▶ INSPECTION, CARE & USE

**DO NOT** lift plates with a temperature greater than 120°C or 250°F

For more information, visit us at  
[www.cmworks.com](http://www.cmworks.com)

Product Code	Working Load Limit		Jaw Capacity (in.)	Dimensions (in.)									Weight (lbs.)
	Minimum (lbs.)	Maximum (lbs.)		A	B	C	D	E	F	G	H	I	
CG1	250	2,200	0 to 5/8	8.307	3.543	1.969	0.512	1.693	10.354	2.520	13.780	13.268	13.2
CG2	450	4,400	0 to 1-1/4	11.417	5.512	3.150	0.787	2.362	12.480	3.937	18.307	17.126	30.9
CG4	900	8,800	0 to 1-1/4	11.417	6.339	3.504	0.787	3.031	12.835	4.252	20.591	18.976	41.9
CG6	1,350	13,200	7/16 to 2	13.268	6.732	3.504	0.984	4.055	14.764	5.709	21.693	20.630	81.6

# THK HORIZONTAL PLATE CLAMP

**WORKING LOAD LIMIT: 90 TO 19,800 LBS.**

THK Clamps have a jaw that pivots in the reverse direction to our normal horizontal clamps and are designed to lift and handle thin sheet plates that tend to sag when being lifted.

### BENEFITS & FEATURES

- Designed to lift and transport thin steel plates in the horizontal position
- The reverse jaw feature ensures that the grip of the clamp increases the more the plate deflects under its own self weight
- Clamps are used in pairs with a two legged chain sling. Two pairs of clamps supported from a lifting beam must be used when handling long plates
- Only lift one plate at a time
- Design factor 4:1

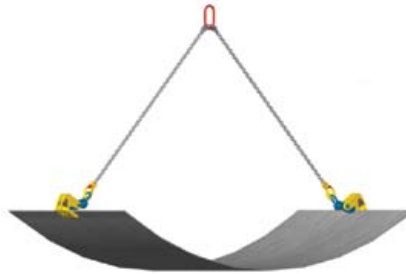
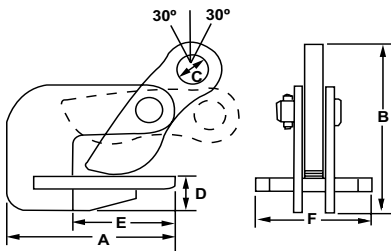

Product Code	Working Load Limit		Plate (in.)	Dimensions (in.)						Weight (lbs. per pair)
	Minimum (lbs.)	Maximum (lbs.)		A	B	C	D	E	F	
THK750	90	1,600	0 to 1	4.625	5.375	0.750	1.000	2.875	3.125	6.6
THK1500	200	3,300	0 to 1-3/8	5.375	6.625	1.000	1.250	3.125	3.500	13.2
THK4500*	500	9,900	0 to 1-3/4	8.625	8.625	1.750	4.000	4.375	4.375	35.3
THK6000	700	13,200	0 to 2-3/8	8.375	10.500	1.375	1.875	4.875	4.375	50.7
THK9000	1,000	19,800	0 to 2-3/8	8.750	11.375	1.625	2.250	4.500	5.500	77.2

\*Not Stocked

### ▶ INSPECTION, CARE & USE

**DO NOT** use THK clamps with 3 or 4 leg slings. Use a spreader beam.



For more information, visit us at  
[www.cmworks.com](http://www.cmworks.com)

## HG HIGH GRIP PLATE CLAMP

**WORKING LOAD LIMIT: 100 TO 8,800 LBS.**

HG High Grip Clamps are designed to give additional grip forces to products during lifting. The High Grip has an additional lever in the clamping mechanism thus asserting a higher gripping force on the plate being lifted.

### BENEFITS & FEATURES

- Can be used on hot rolled structural steel plates
- Can be used to lift stainless steel plates or plates with hardened surfaces due to cold rolling
- Smaller jaw range makes these clamps more efficient for lifting thinner steel
- Suitable for hardness up to 371 Brinell (40 HRc)
- Can be used for lifting and turning plates from the horizontal to vertical position or vice versa, through 180°
- Clamp has serrated teeth and will mark plate
- Standard clamp is fitted with a hook ring but can be alternatively supplied with a short length of chain
- Design factor 4:1

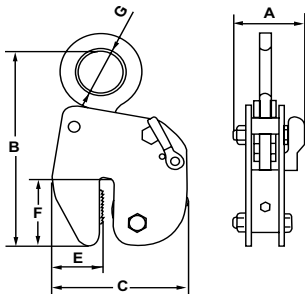
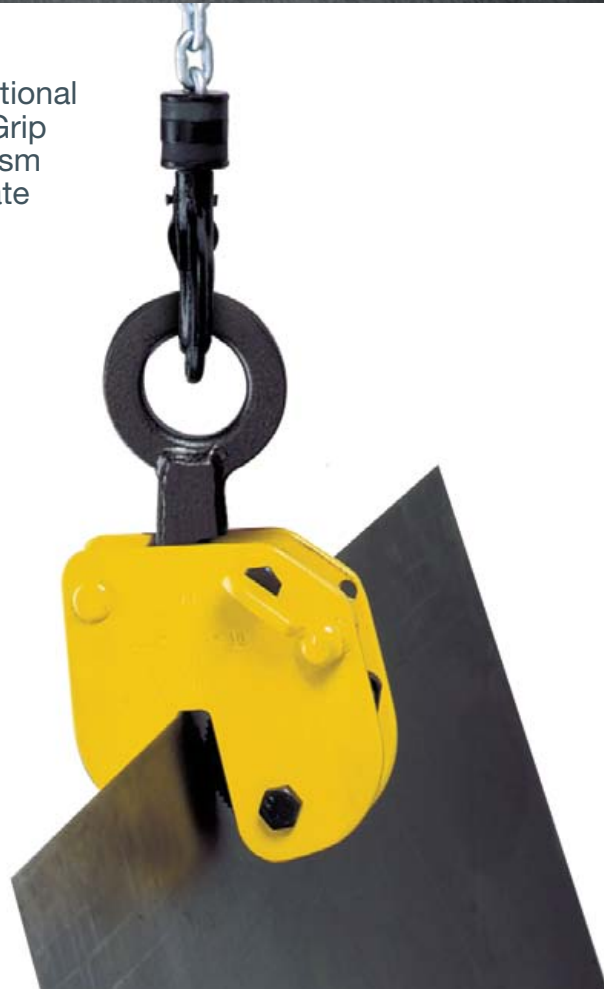

### ► INSPECTION, CARE & USE

**DO NOT** side load clamp more than 15°

**DO NOT** lift plates with a temperature greater than 120°C or 250°F

**DO NOT** use clamps on a double chain sling, when using two clamps to lift a steel plate, a lifting beam must be used between the two clamps to allow clamps to hang vertically



For more information, visit us at  
[www.cmworks.com](http://www.cmworks.com)

Product Code	Working Load Limit		Jaw Capacity (in.)	Dimensions (in.)						Weight (lbs.)
	Minimum (lbs.)	Maximum (lbs.)		A	B	C	E	F	G	
HG500	100	1,100	0 to 3/8	1.654	9.055	5.827	2.165	3.110	1.969	11.0
HG1000	150	2,000	0 to 5/8	3.661	11.698	8.268	2.638	4.488	2.638	26.5
HG2000	450	4,400	0 to 3/4	4.331	16.378	12.008	4.016	6.260	3.150	48.5
HG3000	700	6,600	0 to 3/4	4.331	16.378	12.008	4.016	6.260	3.150	59.5
HG4000	900	8,800	0 to 3/4	4.724	13.189	12.008	4.016	6.220	3.150	70.5

## THS PLATE CLAMP

**WORKING LOAD LIMIT: 90 TO 9,900 LBS.**

THS Plate Clamps can be used with single or two leg slings with a maximum angle of 60°. The clamps are designed to be used on structural steel plates up to a surface hardness of 300 Brinell (32HRc), providing the plate can withstand the forces imposed.

### BENEFITS & FEATURES

- Spring/lever-operated mechanism securely locks the clamp onto the horizontally positioned plate
- Do not use to lift stainless steel, lead or copper
- Can be used in single or 2 leg slings
- Use lifting beams for longer plates
- Clamp locks quickly onto the plate, enabling a single operator to set up the plate for lifting
- Lifts and handles single sheet steel plates in the horizontal position
- Useful for loading plates into guillotines, presses, punching machines and folding presses
- Caution should be used so that maximum sling angle of 60° is not exceeded
- Design factor 4:1

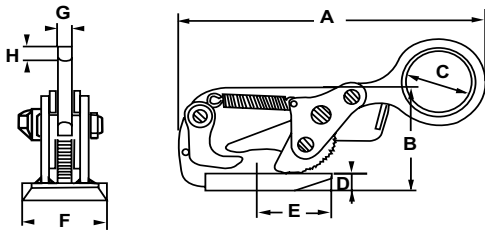
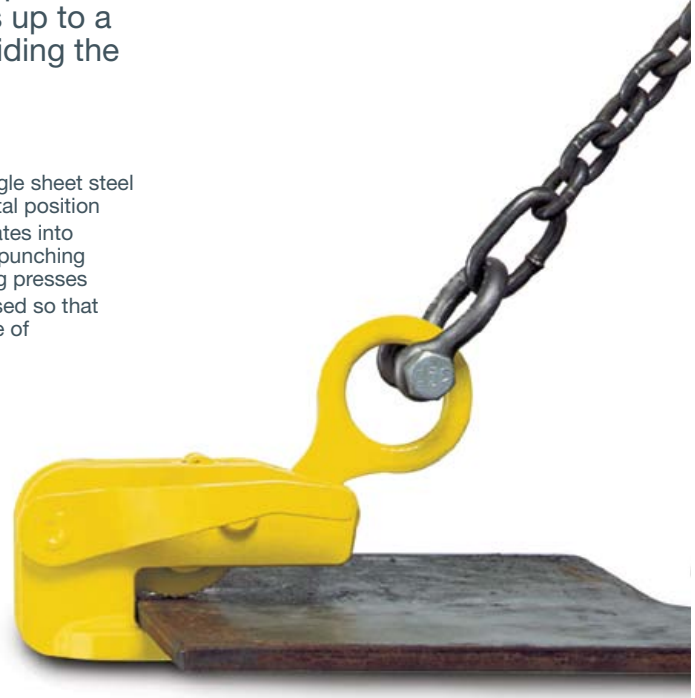

### ▶ INSPECTION, CARE & USE

- DO NOT** use with endless, 3 or 4 leg slings
- DO NOT** exceed 60° angle when lifting
- DO NOT** lift plates with a temperature greater than 120°C or 250°F
- DO NOT** use to lift stainless steel, lead or copper

For more information, visit us at [www.cmworks.com](http://www.cmworks.com)

Product Code	Working Load Limit		Jaw Capacity (in.)	Dimensions (in.)								Weight (lbs.)
	Minimum (lbs.)	Maximum (lbs.)		A	B	C	D	E	F	G	H	
THS750	90	1,600	0 to 3/4	10.039	3.819	1.969	0.591	2.756	3.150	0.472	0.591	6.6
THS1500	175	3,300	0 to 1-3/8	13.189	4.724	2.756	0.787	3.150	3.543	0.591	0.669	13.2
THS4500*	500	9,900	0 to 1-3/4	17.717	7.717	3.543	2.323	4.331	4.331	0.787	1.181	37.5

\*Not Stocked

## TSH SCREW CLAMP

WORKING LOAD LIMIT: 3,300 TO 11,000 LBS.

TSH clamps are designed for pulling and holding sheet metal, girders, and related steel objects.

### BENEFITS & FEATURES

- Recommended for use with lever tools
- Offer the best means of holding and securing loads - great for positioning
- Primarily used as anchor points to allow fabrications to be pulled together and positioned during assembly or prior to welding
- Supplied complete with an alloy shackle that allows for pulling 180°
- High force screw threads
- Hardened steel jaws
- The clamps are attached by turning the screwed threaded axle
- When load is applied to the clamp, the circular toothed pad pivots in a cam action, gripping the load
- Swivel jaws increase grip if plate moves
- Maximum hardness of material to lift should not exceed 300 Brinell (32HRc)
- Not recommended for lifting applications
- Design factor 4:1



### INSPECTION, CARE & USE

**DO NOT** lift plates with a temperature greater than 120°C or 250°F

**DO NOT** use with stainless steel, lead or copper

**DO NOT** over torque the threaded axle. This could cause damage to the pad.

For more information, visit us at [www.cmworks.com](http://www.cmworks.com)

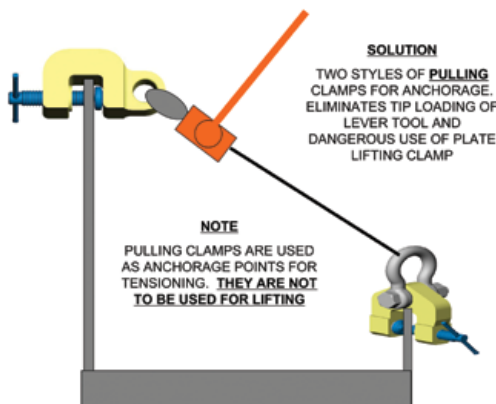
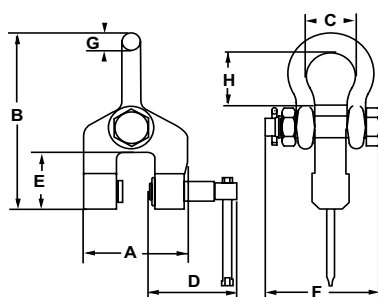

Product Code	Working Load Limit (lbs.)	Jaw Capacity (in.)	Dimensions (in.)								Weight (lbs.)
			A	B	C	D	E	F	G	H	
TSH1500	3,300	0 to 1-1/4	5.118	10.039	2.559	4.528	2.953	5.000	1.024	3.701	15.4
TSH3000	6,600	0 to 2	6.693	11.417	2.913	4.921	3.346	5.669	1.181	4.646	24.3
TSH5000	11,000	0 to 3-1/8	10.039	18.504	5.118	6.890	5.315	9.449	1.969	6.890	59.5

## CLB CONTAINER LIFTING LUGS

**WORKING LOAD LIMIT: 88,100 LBS. (PER SET OF 4)**

Supplied in sets of 4, CLB Lifting Lugs serve as flexible lashing points for transporting containers from the sides.

### BENEFITS & FEATURES

- Spring-loaded bolt to prevent accidental release
- Mounted horizontally at the side of the container in either upper or lower holes
- Easy installation and removal – simply insert and turn to install
- Designed to eliminate the dangerous use of standard hooks
- Lugs cannot drop out when slings become slack
- The set of (4) lugs has (2) right hand and (2) left hand units.
- For maximum capacity, use a lifting beam in conjunction with CLB lifting lugs
- Design factor 4:1



Product Code	Working Load Limit (lbs. per set of 4)	Dimensions							Weight (lbs.)
		A	B	C	D	E	F	G	
CLB40	88,100	5.98	7.13	1.77	1.46	2.87	2.95	1.58	39.7

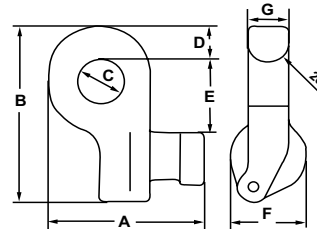

## CLT CONTAINER LIFTING LUGS

**WORKING LOAD LIMIT: 123,480 LBS. (PER SET OF 4)**

Supplied in sets of 4, CLT Lifting Lugs serve as flexible lashing points for transporting containers from the top.

### BENEFITS & FEATURES

- Mounted vertically at the top of the container
- Easy installation and removal – simply insert and turn to install
- Designed to eliminate the dangerous use of standard hooks
- Lugs lock into place by simply turning the lug 90°. This configuration allows for transportation via the use of a lifting frame in conjunction with cables, chains or slings.
- Design factor 4:1

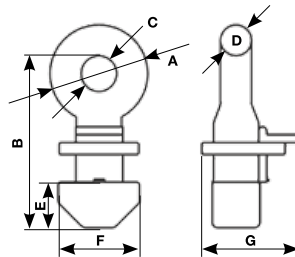

Product Code	Working Load Limit at 90° (lbs. per set of 4)	Dimensions (in.)							Weight (lbs.)
		A	B	C	D	E	F	G	
CLT56	123,480	4.84	8.54	1.77	1.54	2.24	3.98	4.76	61.7





## HGC HAND GRIP CLAMP

WORKING LOAD LIMIT: 500 LBS.

The HGC Hand Grip Clamp is designed to manually lift, carry or pull any object that will fit into the jaws and is primarily used in workshop environments.

### BENEFITS & FEATURES

- Additional lever in clamping mechanism provides a very high gripping force
- Can be used to lift plate from horizontal to vertical position and vice versa
- Can be used on all structural steel plates and sections up to a surface hardness of 300 Brinell (32HRc)
- Not suitable for steel over 300 Brinell, stainless steel, lead, copper and materials over 120°C/ 250°F surface temperature
- Enables the operator to open and attach the clamp to sheet material by depressing the lifting handle
- Two pre-tensioned, hardened, serrated toothed jaws grip the sheet securely when the handle is released, preventing plate slippage
- Design factor 4:1

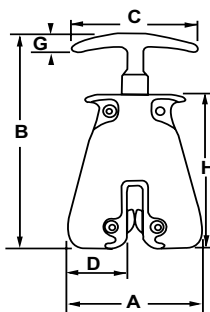

### INSPECTION, CARE & USE

- DO NOT lift plates with a temperature greater than 120°C or 250°F
- DO NOT use to lift stainless steel, lead or copper.
- NOTE: Clamp in photo above is shown with handle. For loads heavier than 75 lbs., use a clamp with a lifting ring.
- DO NOT use a sling in conjunction with the handle-style clamp.

For more information, visit us at [www.cmworks.com](http://www.cmworks.com)

Product Code	Working Load Limit (lbs.)	Plate Size (in.)	Dimensions (in.)							Weight (lbs.)	
			A	B	C	D	E	F (Thickness)	G		H
HGC	500	0 to 3/8	4.25	7.25	3.875	1.875	2.125	0.875	0.375	5.125	2.0

## BTG GROUNDWORKS

WORKING LOAD LIMIT: 3,300 TO 6,600 LBS. (PER SET OF 3)

BTG Clamps are designed to lift and handle concrete manhole pipes in the vertical position. These clamps enable the manhole trench size to be minimized and facilitate accurate positioning of pipes on top of each other.

### BENEFITS & FEATURES

- Solid construction and lightweight design
- Sold in sets of 3
- Simple handling - Attachment and removal of the clamps from the pipes is extremely easy due to the simple and straight-forward design
- Large jaw capacity
- Service friendly
- Design factor 4:1

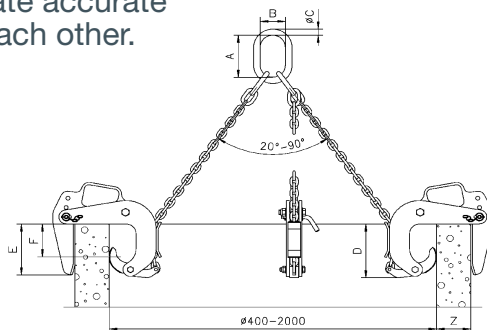

Product Code	Working Load Limit (lbs. per set of 3)	Jaw Capacity (Z, in.)	Dimensions (in.)						Weight (lbs.)
			A	B	C	D	E (Mouth)	F (Pressure Line)	
BTG1500/3	3,300	1-1/2 to 4-3/4	5.315	5.315	0.709	7.087	6.496	3.937	75.0
BTG3000/3	6,600	2 to 7	6.890	3.937	1.024	12.205	9.646	6.890	132.3
BTG3000L/3	6,600	3-1/2 to 8-5/8	6.890	3.937	1.024	12.205	9.646	6.890	172.0





# TRANSPORT CHAIN & ATTACHMENTS

Inspection, Use & Care .....	132
Transport (Binding) Chain .....	134
Welded Assembly .....	135
Clevis Assembly .....	136
Clevis Assembly with Import Hooks .....	136
Rivet Assembly .....	137
Aircraft Assembly .....	137
Double Clevis (Mid Link) .....	138
Clevis Grab Hook (Grade 70 & Grade 80) .....	139
Eye Grab Hook (Grade 70 & Grade 80) .....	140
Clevis Slip Hook .....	141
Eye Slip Hook .....	141
Clevis Style Heavy Duty Tie Downs .....	142
Clevlok® Style Heavy Duty Tie Downs .....	142
Ratchet Binders Heavy Duty Tie Downs .....	142
Forged Ratchet Load Binder .....	143
Forged Lever Load Binder .....	144
Specialty Forged Lever Load Binder .....	144
E-Z Pro® Cam Release Lever Binder .....	145
CMG Ratchet/ Lever Binders .....	145
D-Rings .....	146
Sixth Wheel Ratchet .....	146
High Test Chain .....	147
Welded Assembly .....	148
Clevis Assembly .....	148
Proof Coil Chain .....	149
Hanger Chain .....	149
Clevis Slip Hook .....	150
Eye Slip Hook .....	150
Clevis Grab Hook .....	151
Eye Grab Hook .....	151

# TRANSPORTATION

Columbus McKinnon and our Tennessee-based Dixie Industries are leaders in innovation for the transportation and heavy-duty trucking industry, featuring a full line of chain and forged attachments.

## LOAD BINDER USE, INSPECTION & CARE

### USE

1. Always follow safe work practices and take precautions in use of binders. Particular attention is called to the following sections of D.O.T. Federal Motor Carrier Safety Regulations: S392.9 (relating to safe loading); S393.100 (relating to protection against shifting or falling cargo); and S393.102 (relating to securement systems).
2. Never exceed working load limit shown on the binder. Hand effort will tighten binder to working load limit.
3. Always inspect the load binder before use. See the load binder inspection section below.
4. Always position the load binder so the handle goes downward when securing or tightening the load.
5. Operate only by hand from a firm standing position.
6. Do not operate load binder while anyone is on the load.
7. Do not use a cheater bar or handle extension. Extensions can dangerously overload the binder system and may result in serious injury. Use a ratchet-type binder if sufficient leverage is difficult to develop.
8. Make certain that the lever of the lever-type binder is over center and locked. Always secure the handle in the locked position with a positive retaining method. The handle must be secured since there is a possibility of relaxation of the load, which may result in the lever moving from the locked-over-center position to relaxed mode, resulting in loss of tension in the system.
9. Release handle/load with extreme care. Make sure everyone is clear. Lever binder handle can snap back over center. Use open palm under handle and push up.
10. Tighten binders before moving and frequently recheck and retighten.

### CARE

Care should be exercised during use so that the binder is not abused or damaged.

1. The binder or hooks should not be subjected to bending or sharp objects. Loading should be in a straight line.
2. Avoid exposure to corrosive mediums. Lubricate periodically.

### INSPECTION

Inspect binder prior to each use for damage, distortion, cracks, nicks, or wear.

1. Bending of any feature in any plane of more than 10 degrees is cause for removal of the unit from service. Any distortion indicates overloading or misuse.
2. Distorted or elongated connecting links indicate overloading or misuse and is also cause for removal of the unit from service.
3. If wear of connecting link ends is more than 10% of the original stock, remove unit from service.
4. On lever-type binders inspect yoke periodically for distortion and make certain it is seated on the pins.
5. Deep nicks and gouges should be smoothed out to relief stress concentrations providing that the material removed does not exceed 10% of the total material.
6. If distortion, cracks, nicks, or wear affect more than 10% of the stock, discard the unit.

## TIE-DOWN BINDER CHAIN USE

Depending on the type of cargo you are securing, there are a variety of different factors that can affect the way you secure the load.

### WHEN SECURING CARGO, IT IS IMPORTANT TO CONSIDER THE FOLLOWING:

- What is the gross weight of the load?
- What is the physical size of the load?
- Is the weight uniformly distributed?
- Is the cargo size uniform?

### THE EFFECT OF ANGLE ON INDIRECT TIEDOWNS

You also need to consider the effect that angles will have on indirect tie downs. The chart below demonstrates how the effectiveness of the tie down is impacted by the angle at which it is used.

#### TIEDOWN TIGHTENED TO 1,000 LBS. OF TENSION

Angle	Effectiveness	Downward or Clamping Force	
90	100%	1,000 lbs	
60	85%	850 lbs.	
45	70%	700 lbs.	
30	50%	500 lbs.	
15	25%	250 lbs.	



### DETERMINING THE AGGREGATE WORKING LOAD LIMIT

When using multiple tie downs, you also need to determine the aggregate working load limit. **The aggregate working load limit of any securement system must be at least 50% of the weight of the cargo being secured with a length of less than 10 ft. (3 meters) & blocked from forward motion.** The diagram below illustrates how you would determine the aggregate working load limit when using multiple tie downs.

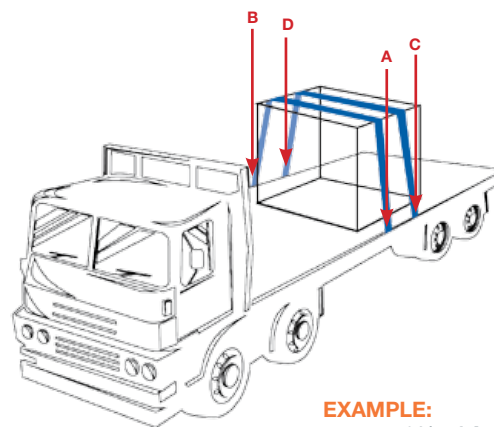

#### EXAMPLE:

- 50% of A
- + 50% of B
- + 50% of C
- + 50% of D

= Aggregate Working Load Limit

For full details on regulations and requirements for securing cargo, refer to FMCSA – Federal Motor Carrier Safety Administration Section(s) 393.100 through 393.136 of the FMCSA regulation handbook. Information is also available online at: <http://www.fmcsa.dot.gov>.



# TRANSPORT (BINDING) CHAIN GRADE 70 STANDARD & SHORT LINK

**WORKING LOAD LIMIT: 3,150 TO 11,300 LBS.**

**BENEFITS & FEATURES**

- Do not use for overhead lifting
- High-carbon steel, heat treated
- Zinc plated with gold chromate finish
- Meets ASTM & NACM standards
- Meets FMCSA & CVSA requirements
- Thermal heat treated using advanced technology
- Heat treated for superior wear and toughness
- 100% proof tested
- Permanent identification on chain (embossed with G70, plus 3 letter trace code)
- Full weld trim
- Design factor 4:1

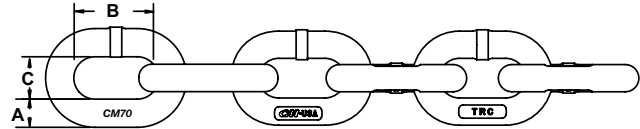

Chain Size (in.)	Working Load Limit (lbs.)	Nominal Chain Dimensions (in.)			Per Foot			Per Drum				Per Pail	
		Material Diameter A	Inside Length B	Inside Width C	Product Code	Weight (lbs./ft.)	Approximate Number of Links (per ft.)	Full Drum		Half Drum		Product Code	Length (ft.)
								Product Code	Length (ft.)	Product Code	Length (ft.)		
1/4	3,150	0.28	0.84	0.47	608927	0.76	14.30	678531	800	678521	400	678517	130
5/16	4,700	0.33	0.98	0.46	608935	1.01	12.20	678532	550	678522	275	678518	90
5/16**	4,700	0.33	1.10	0.50	609035	0.97	10.90	679032	550	679022	275	679018	90
3/8	6,600	0.39	1.14	0.54	608941	1.46	10.50	678533	400	678523	200	678519	60
3/8**	6,600	0.39	1.38	0.60	609041	1.37	8.73	679033	400	679023	200	679019	60
1/2	11,300	0.52	1.56	0.73	608954	2.42	7.70	678535	200	678525	100	-	-

\*\* Standard Link Grade 70 Chain



TRANSPORT CHAIN & ATTACHMENTS



## WELDED ASSEMBLY GRADE 70

WORKING LOAD LIMIT: 4,700 TO 6,600 LBS.

### BENEFITS & FEATURES

- Meets FMCSA, CVSA, DOT requirements
- Available in custom-built lengths
- Assemblies are available with your choice of mechanical or welded end attachments
- Welded assemblies are proof tested after welding.
- Full line of lever and ratchet binders to accommodate binder chain offering
- Gold Chromate per ASTM B633 Fe/ZN 13 Type II
- Design factor 4:1



### ► DID YOU KNOW?

#### INDUSTRY FOCUS: FARMING, TOWING & TRANSPORTATION

Grade 70 welded assemblies have a load rating around 20% higher than Grade 43 assemblies, so a smaller size assembly can be used for many jobs. Advantages include less weight, easier handling and more convenient storage, which is ideal for truckers, loggers and highway crews; for secure load binding and tie-downs; and for towing, hauling and lashing.

For more information, visit us at [www.cmworks.com](http://www.cmworks.com)

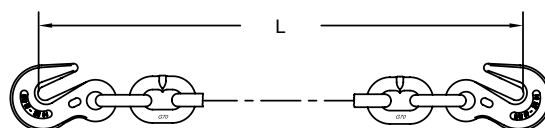

Chain Size (in.)	Working Load Limit (lbs.)	Length (L) (ft.)	Product Code	Product Code in Bag	Weight (lbs.)
<b>Short Link</b>					
5/16	4,700	14	–	638259	15.19
5/16	4,700	16	–	638264	17.20
5/16	4,700	20	638224	–	21.22
5/16	4,700	20	–	638302	21.22
5/16	4,700	25	638260	–	26.24
5/16	4,700	25	–	638306	26.24
3/8	6,600	20	638558	–	31.06
<b>Standard Link</b>					
5/16	4,700	16	639064	–	16.64
5/16	4,700	16	–	639064BG	16.64
5/16	4,700	20	639024	–	20.52
5/16	4,700	20	–	639024BG	20.52
5/16	4,700	25	639060	–	25.36
3/8	6,600	16	639089	–	23.75
3/8	6,600	20	639058	–	29.31



## CLEVIS ASSEMBLY GRADE 70

**WORKING LOAD LIMIT: 3,150 TO 11,300 LBS.**

### BENEFITS & FEATURES

- Hook on each end
- Meets all Department of Transportation (D.O.T.) requirements and is required in most states by the D.O.T.
- Chain won't degrade in ultra-violet light, as compared to nylon straps.
- Custom lengths available
- Gold Chromate per ASTM B633 Fe/ZN 13 Type II
- Design factor 4:1



Chain Size (in.)	Working Load Limit (lbs.)	Product Code	Product Code in Bag	L (ft.)	Weight (lbs.)
<b>Short Link</b>					
1/4	3,150	638265	–	20	16.41
5/16	4,700	638274	–	12	13.10
5/16	4,700	638282	638277	16	17.10
5/16	4,700	638283	–	18	19.12
5/16	4,700	638284	638266	20	21.13
5/16	4,700	638313	–	24	25.15
5/16	4,700	638279	638279BG	25	26.16
3/8	6,600	638291	–	14	22.23
3/8	6,600	638292	638268	16	25.19
3/8	6,600	638293	–	18	28.15
3/8	6,600	638294	638267	20	31.11
1/2	11,300	638350	–	20	56.93
<b>Standard Link</b>					
5/16	4,700	639082	–	16	15.60
5/16	4,700	639084	639084BG	20	20.40
5/16	4,700	639079	–	25	25.30
3/8	6,600	639091	–	14	21.00
3/8	6,600	639092	–	16	23.80
3/8	6,600	639093	–	18	26.60
3/8	6,600	639094	639094BG	20	31.16
3/8	6,600	639097	–	25	36.30

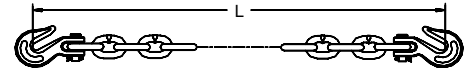

## CLEVIS ASSEMBLY WITH IMPORT HOOKS GRADE 70

**WORKING LOAD LIMIT: 4,700 TO 11,300 LBS.**

### BENEFITS & FEATURES

- Hook on each end
- Meets all Department of Transportation (D.O.T.) requirements and is required in most states by the D.O.T.
- Chain won't degrade in ultra-violet light, as compared to nylon straps.
- Custom lengths available
- Gold Chromate per ASTM B633 Fe/ZN 13 Type II
- Chain is made in the U.S.A.
- Design factor 4:1



Chain Size (in.)	Working Load Limit (lbs.)	Product Code	L (ft.)	Weight (lbs.)
<b>Standard Link</b>				
5/16	4,700	639032GGC20	20	20.30
5/16	4,700	639032GGC25	25	25.20
3/8	6,600	639038GGC20	20	29.20
3/8	6,600	639038GGC25	25	31.16
1/2	11,300	638350GGC20	20	55.50







## RIVET ASSEMBLY GRADE 70

WORKING LOAD LIMIT: 4,700 TO 6,600 LBS.

### BENEFITS & FEATURES

- Riveted hooks prevent loss or theft of hooks
- Gold Chromate per ASTM B633 Fe/ZN 13 Type II
- Design factor 4:1

Chain Size (in.)	Working Load Limit (lbs.)	Product Code	L (ft.)	Weight (lbs.)
<b>Short Link</b>				
5/16	4,700	638281CRV	14	15.10
5/16	4,700	638282CRV	16	17.10
5/16	4,700	638283CRV	18	19.10
5/16	4,700	638284CRV	20	21.10
3/8	6,600	638291CRV	14	22.22
3/8	6,600	638292CRV	16	25.18
3/8	6,600	638293CRV	18	28.14
3/8	6,600	638294CRV	20	31.10
<b>Standard Link</b>				
5/16	4,700	639084CRV	20	20.43
5/16	4,700	639079CRV	25	25.27
3/8	6,600	639094CRV	20	29.33

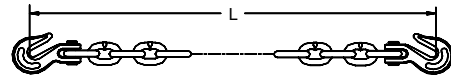

## AIRCRAFT ASSEMBLY

MINIMUM BREAK STRENGTH: 14,100 LBS.

### BENEFITS & FEATURES

- Meets MIL-DTL-6458 Type I specifications
- 100% proof tested in accordance to MIL spec standards
- Gold chromate finish per ASTM B633 Fe/ZN 13 Type II
- Individually packaged assemblies available upon request
- Design factor 4:1

Chain Size (in.)	Minimum Break Strength (lbs.)	Product Code	L (ft.)	Weight (lbs.)
9/32	14,100	627728	9	7.17

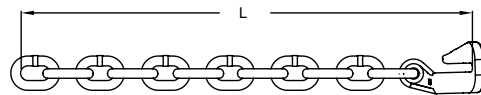



## DOUBLE CLEVIS (MID-LINK)

**WORKING LOAD LIMIT: 4,700 TO 13,000 LBS.**

Designed for use with Grade 70 chain as a quick and easy temporary repair.

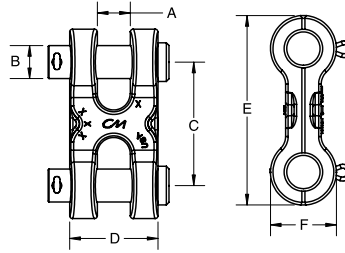

### BENEFITS & FEATURES

- Zinc-plated finish
- Size forged into link
- Quick easy installations
- Design factor 4:1

For Chain Size (in.)	Working Load Limit (lbs.)	Standard Package	Product Code	Dimensions (in.)						Weight (lbs.)
				A	B	C	D	E	F	
1/4 and 5/16	4,700	10	M605	0.43	0.38	1.70	1.12	2.61	0.91	0.35
3/8	6,600	10	M606	0.50	0.38	2.00	1.31	3.06	1.09	0.46
7/16 and 1/2	11,300	5	M608	0.66	0.59	2.59	1.74	3.90	1.31	1.10
5/8	13,000	5	M610	0.75	0.75	2.81	2.01	4.31	1.50	1.70

NOTE: 1/4" through 1/2" sizes are individually bagged

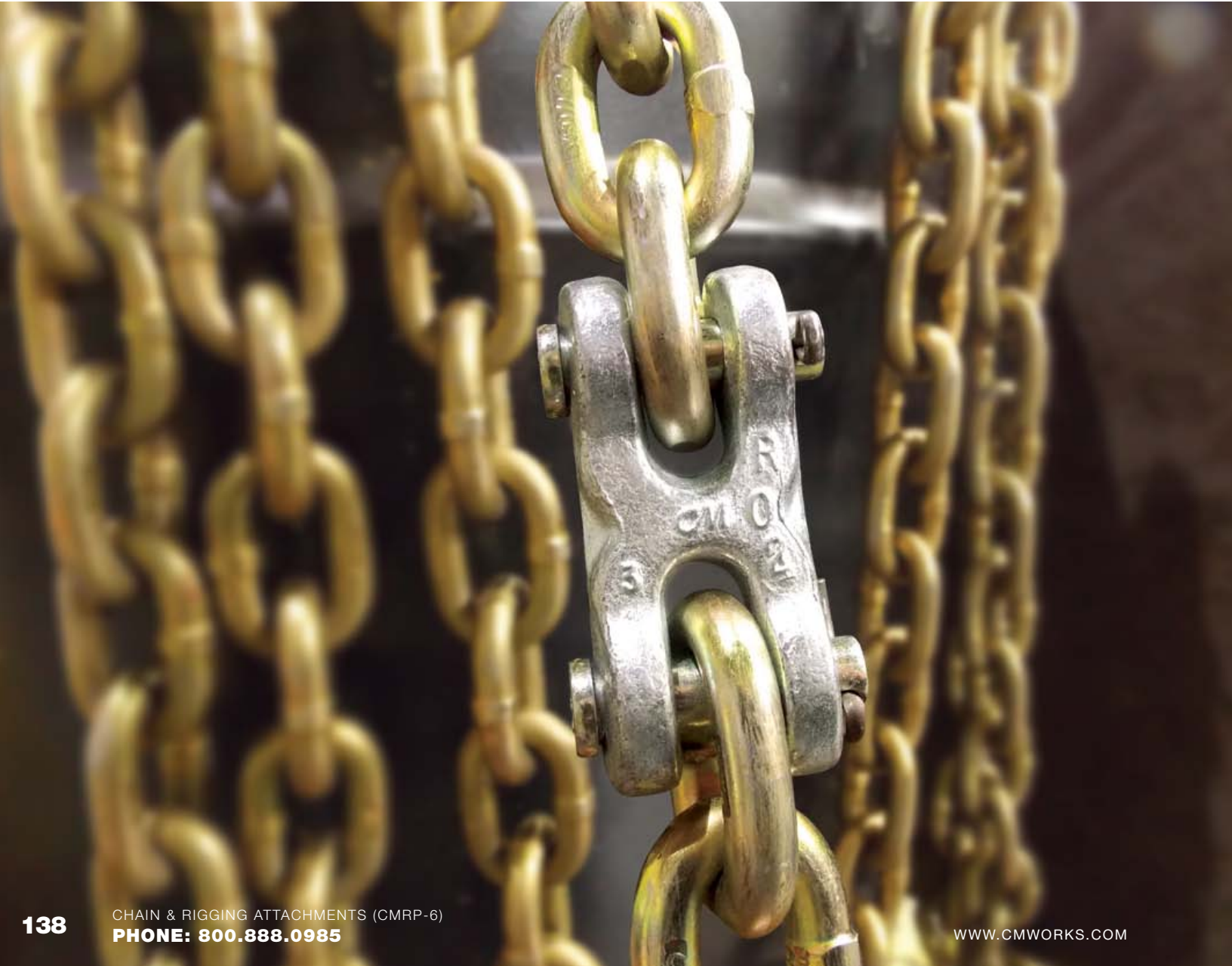



## CLEVIS GRAB HOOK GRADE T80

WORKING LOAD LIMIT: 3,500 TO 18,100 LBS.

### BENEFITS & FEATURES

- Not recommended for overhead lifting
- For use when high-capacity hooks are needed for tiedown/transportation applications
- Quenched and tempered alloy steel
- Durable orange powder coated finish
- Design factor 4:1

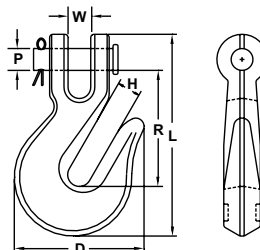

Size (in.)	Working Load Limit (lbs.)	Standard Package	Product Code	Dimensions (in.)						Weight (lbs.)
				W	D	H	L	R	P	
1/4	3,500	30	M804A	0.31	2.06	0.38	3.32	1.88	0.33	0.56
5/16	4,500	30	M805A	0.38	2.57	0.44	4.08	2.34	0.39	0.88
3/8	7,100	30	M806A	0.46	2.66	0.50	4.50	2.64	0.50	1.10
7/16	6,900	20	M807A†	0.51	2.94	0.57	5.02	3.00	0.50	1.50
1/2	12,000	10	M808A	0.59	3.38	0.68	5.64	3.31	0.59	2.36
5/8	18,100	10	M810A	0.75	4.31	0.81	6.86	3.95	0.75	4.00

† Hook is marked Grade 63

## CLEVIS GRAB HOOK GRADE 70

WORKING LOAD LIMIT: 4,700 TO 6,600 LBS.



### BENEFITS & FEATURES

- Designed specifically for transport Grade 70 chain
- Design factor 4:1
- Gold chromate finish
- Not recommended for overhead lifting

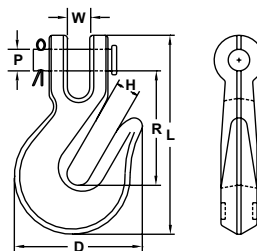

Size (in.)	Working Load Limit (lbs.)	Standard Package	Product Code (Yellow Chromate)	Dimensions (in.)						Weight (lbs.)
				W	D	H	L	R	P	
5/16	4,700	10	62273	0.42	2.40	0.44	3.52	2.18	0.38	0.75
3/8	6,600	10	62373	0.52	2.94	0.54	4.17	2.53	0.44	1.10



## EYE GRAB HOOK GRADE T80

WORKING LOAD LIMIT: 3,600 TO 18,100 LBS.

### BENEFITS & FEATURES

- Quenched and tempered alloy steel
- For use when high-capacity hooks are needed for tiedown/transportation applications
- Durable orange powder coated finish
- Design factor 4:1
- **Not recommended for overhead lifting**

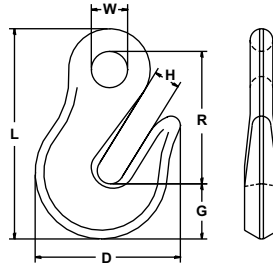

Size (in.)	Working Load Limit (lbs.)	Standard Package	Product Code	Dimensions (in.)							Weight (lbs.)
				W	D	H	L	R	G	Thickness	
1/4	3,600	30	M204A	0.55	2.00	0.38	3.22	2.05	0.80	0.59	0.44
5/16	4,500	30	M205A	0.63	2.41	0.44	3.78	2.41	1.00	0.69	0.69
3/8	7,200	30	M206A	0.80	2.65	0.50	4.34	2.80	1.06	0.83	1.00
7/16	6,900	20	M207A†	0.81	3.05	0.58	4.86	3.17	1.21	0.81	1.20
1/2	12,000	10	M208A	0.95	3.31	0.66	5.56	3.55	1.39	1.00	2.31
5/8	18,100	10	M210A	1.06	4.34	0.78	7.05	4.56	1.77	1.11	4.00

† Hook is marked Grade 63

## EYE GRAB HOOK GRADE 70

WORKING LOAD LIMIT: 4,700 TO 6,600 LBS.



### BENEFITS & FEATURES

- Designed specifically for transport Grade 70 chain
- Design factor 4:1
- Self-colored finish
- **Not recommended for overhead lifting**

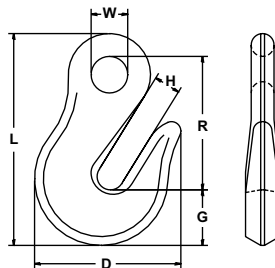

Size (in.)	Working Load Limit (lbs.)	Standard Package	Product Code (Self-Colored)	Dimensions (in.)							Weight (lbs.)
				W	D	H	L	R	P		
5/16	4,700	50	71297	0.70	2.39	0.49	3.69	2.42	1.15	0.75	
3/8	6,600	25	71397	0.67	2.65	0.51	3.73	2.45	1.16	1.10	



## CLEVIS SLIP HOOK GRADE 63/70

WORKING LOAD LIMIT: 2,750 TO 14,200 LBS.

### BENEFITS & FEATURES

- Designed specifically for transport Grade 70 chain
- Design factor 4:1
- Hook embossed with trace code providing traceability throughout the manufacturing and testing process to heat of steel
- Durable orange powder coated finish

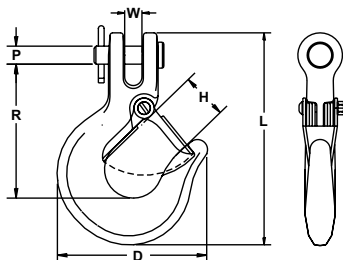

Size (in.)	Working Load Limit (lbs.)		Finish	Standard Package	With Latch		Without Latch		Latch Kit	Dimensions (in.)					
	Grade 63	Grade 70			Product Code	Weight (lbs.)	Product Code	Weight (lbs.)		Product Code	W	D	H	L	R
1/4	2,750	—	Orange Paint	20	—	—	M904A	.50	—	0.32	2.63	0.94	3.67	2.31	0.33
5/16	3,600	4,700	Orange Paint	20	6905AWL	.96	M6905A	.91	4X1304	0.36	3.27	1.06	4.62	2.89	0.38
5/16	3,600	4,700	Yellow Chromate	20	6905AZL	.96	M6905AZ	.91	4X1304	0.36	3.27	1.06	4.62	2.89	0.38
3/8	5,500	6,600	Orange Paint	20	6906AWL	1.66	M6906A	1.61	4X1305	0.45	3.87	1.00	5.42	3.39	0.49
3/8	5,500	6,600	Yellow Chromate	20	6906AZL	1.66	M6906AZ	1.61	4X1305	0.45	3.87	1.00	5.42	3.39	0.49
5/16	3,600	—	Orange Paint	20	—	—	M905A	.75	—	0.38	3.18	1.06	4.27	2.54	0.38
3/8	5,500	—	Orange Paint	20	—	—	M906A	1.25	—	0.45	3.66	1.25	4.88	3.02	0.49
7/16	6,900	—	Orange Paint	10	—	—	M907A	2.00	—	0.50	4.31	1.56	5.69	3.48	0.50
1/2	9,400	—	Orange Paint	10	—	—	M908A	2.80	—	0.59	4.88	1.75	6.41	4.00	0.59
5/8	14,200	—	Orange Paint	5	—	—	M910A	5.00	—	0.81	5.69	2.00	7.56	4.75	0.75

## EYE SLIP HOOK GRADE 63/70

WORKING LOAD LIMIT: 2,750 TO 14,200 LBS.



### BENEFITS & FEATURES

- Designed specifically for transport Grade 70 chain
- Design factor 4:1
- Hook embossed with trace code providing traceability throughout the manufacturing and testing process to heat of steel
- Durable orange powder coated finish

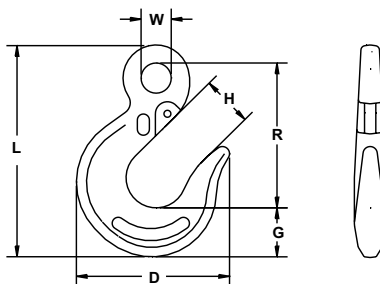

Size (in.)	Working Load Limit (lbs.)		Standard Package	Product Code			Dimensions (in.)						Weight (lbs.)
	Grade 63	Grade 70		With Latch	Without Latch	Latch Kit	W	D	H	L	R	G	
1/4	2,750	3,150	20	M6304WL	M6304	4X1302	0.55	2.69	0.87	3.80	2.62	0.87	0.45
5/16	3,600	4,700	20	M6305WL	M6305	4X405	0.63	3.18	1.01	4.41	3.01	1.03	0.58
3/8	5,500	6,600	20	M6306WL	M6306	4X406	0.80	3.74	1.17	5.38	3.73	1.25	1.40
7/16	7,100	8,750	10	M6307WL	M6307	4X410	0.83	4.34	1.42	5.79	3.93	1.38	1.50
1/2	9,400	—	10	—	M308A	—	0.95	4.94	1.76	6.33	4.31	1.50	2.30
5/8	14,200	—	5	—	M310A	—	1.19	5.63	2.00	7.67	5.29	1.69	3.77

**GENERAL BENEFITS & FEATURES OF CM HEAVY-DUTY TIE-DOWNS**

- Meets FMCSA, CVSA tie-down requirements
- Made from high quality alloy steel
- Made in USA
- Cannot be used for overhead lifting
- Lighter weight than most transport binder chains
- Does not degrade in ultra-violet light
- Permanent identification on chain and attachments
- Design factor 4:1

**CLEVIS STYLE HEAVY-DUTY TIE-DOWNS**  
**GRADE 80**



**WORKING LOAD LIMIT: 4,500 TO 12,000 LBS.**

Chain Size (in.)	Chain Grade	Working Load Limit (lbs.)	Product Code	Length (L) (ft.)	Chain Finish	Weight (lbs.)
5/16	80	4,500	607031CV20	20	Black	19.60
5/16	80	4,500	607031CV25	25	Black	24.10
3/8	80	7,100	607037CV20	20	Black	30.30
3/8	80	7,100	607037CV25	25	Black	37.50
1/2	80	12,000	607050CV20	20	Black	54.60
1/2	80	12,000	607050CV25	25	Black	67.30

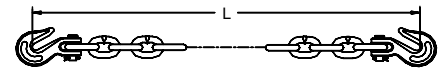

Design factor 4:1

**CLEVLOK® STYLE HEAVY-DUTY TIE-DOWNS** GRADE 80 & 100



**WORKING LOAD LIMIT: 7,100 TO 12,000 LBS.**

Chain Size (in.)	Chain Grade	Working Load Limit (lbs.)	Product Code	Length (L) (ft.)	Chain Finish	Weight (lbs.)
3/8	80	7,100	607037CL20	20	Black	31.00
3/8	80	7,100	607037CL25	25	Black	38.00
1/2	80	12,000	607050CL15	15	Black	42.00
1/2	80	12,000	607050CL20	20	Black	55.00
3/8	100	8,800	607337CL20	20	Black	31.00
3/8	100	8,800	607337CL25	25	Black	38.50

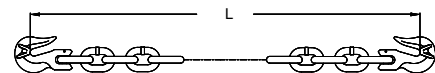

Design factor 4:1

**HEAVY DUTY RATCHET BINDERS**  
**FOR USE WITH GRADE 80 AND/OR GRADE 100 CHAIN**



**WORKING LOAD LIMIT: 5,400 TO 16,000 LBS.**

With Chain Size (in.)	Use With Chain Grade	Working Load Limit (lbs.)	Product Code	End Fittings	Take Up (in.)	Weight (lbs.)
5/16	80	5,400	48365	Hook & Hook	8	12
3/8	80	7,100	48360	Hook & Hook	8	13
3/8	80 or 100	9,200	48366	Hook & Hook	8	13
1/2	80	13,000	48367	Hook & Hook	8	16
1/2	80 or 100	15,000	48358	Hook & Hook	8	16
1/2	80 or 100	16,000	48387	Hook & Hook	8	16

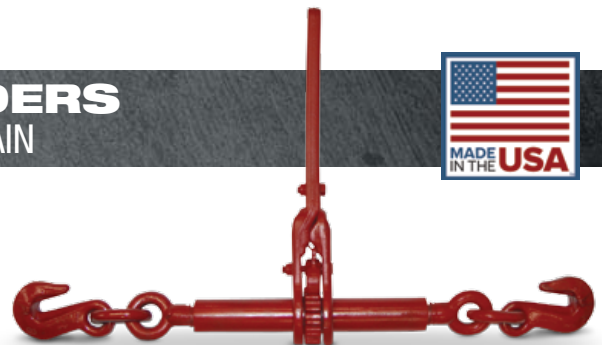

Design factor 4:1



# FORGED RATCHET LOAD BINDER

## GRADES 30, 43, 70, 80, 100

WORKING LOAD LIMIT: 2,600 TO 16,000 LBS.

### BENEFITS & FEATURES

- Handle is designed using a self-locking, open pawl allowing for easy removal of unwanted debris such as mud, snow or ice
- Proof tested to 50% of the minimum breaking strength
- Gears are permanently welded to the barrel
- Durable powder coated finish
- Design factor 4:1 (Except 48358 & 48387, which are 3:1)



Chain Grade & Size (in.)					Product Code	End Fittings	Standard Package	Working Load Limit (lbs.)	Take Up (in.)	Handle Length (in.)	Barrel Size O.D. (Diam. x Length) (in.)	Screw Diameter (in.)	Weight (lbs.)
G30	G43	G70	G80	G100									
3/16 & 1/4	1/4	-	-	-	48364	Hook / Hook	4	2,600	4	12	1-5/16 x 6	5/8	5.4
-	-	-	-	-	48811	Eye / Eye (no hook)	4	5,400	8.5	12	1-5/16 x 10	3/4	8.6
-	-	-	-	-	48363	Eye / Eye (no hook)	4	13,000	8	14	1-1/2 x 10	1	9.8
5/16 & 3/8	5/16 & 3/8	5/16	-	-	48810	Hook / Hook	4	5,400	8.5	12	1-5/16 x 10	3/4	8.6
5/16 & 3/8	5/16 & 3/8	5/16 & 3/8	5/16 & 3/8	-	48360	Hook / Hook	4	7,100	8	14	1-1/2 x 10	1	13.0
5/16 & 3/8	5/16 & 3/8	5/16	5/16	-	48365	Hook / Hook	4	5,400	8	14	1-1/2 x 10	1	12.0
3/8 & 1/2	3/8 & 1/2	3/8	3/8	3/8*	48366	Hook / Hook	4	9,200	8	14	1-1/2 x 10	1	13.0
1/2 & 5/8	1/2 & 5/8	1/2	1/2	-	48367	Hook / Hook	4	13,000	8	14	1-1/2 x 10	1	16.0
-	3/8 & 1/2	3/8 & 1/2	3/8 & 1/2	3/8	48458	Hook / Hook	4	12,000	8	14	1-1/2 x 10	1	13.0
-	5/16 & 3/8	5/16 & 3/8	5/16 & 3/8	5/16 & 3/8	48455	Hook / Hook	4	8,800	8	14	1-1/2 x 10	1	16.0
3/8 & 1/2	3/8 & 1/2	3/8 & 1/2	3/8 & 1/2	3/8 & 1/2	48358	Hook / Hook	4	15,000	8	14	1-1/2 X 10	1	16.0
3/8 & 1/2	3/8 & 1/2	3/8 & 1/2	3/8 & 1/2	3/8 & 1/2	48387	Hook / Hook	4	16,000	8	14	1-1/2 X 10	1	16.0

\* When used with 3/8 inch G100 chain, this assembly will have a 3:1 design factor



## FORGED LEVER LOAD BINDER GRADES 30, 43, 70, 80

**WORKING LOAD LIMIT: 2,600 TO 9,200 LBS.**

### BENEFITS & FEATURES

- All components are forged, not cast
- Forged binders are lighter and stronger than cast binders
- Under equal force a forged handle will yield and bend while a cast handle may break
- Design factor 4:1



Chain Grade & Size (in.)				Product Code	Working Load Limit (lbs.)	Handle Take Up (in.)	Handle Length (in.)	Weight (lbs.)
G30	G43	G70	G80					
1/4	1/4	–	–	48304	2,600	3.75	11.25	3.0
3/8	3/8	5/16	–	48305	5,400	4.50	16.12	8.1
1/2	1/2	3/8	–	48306	9,200	4.75	16.62	10.6
3/8	3/8	3/8	3/8	48769	7,100	4.50	16.62	8.1



## SPECIALTY FORGED LEVER LOAD BINDER GRADES 30, 43, 70

**WORKING LOAD LIMIT: 5,400 LBS.**

### BENEFITS & FEATURES

- Durable powder coated finish, design factor 4:1
- **DIXI-LOC BINDERS** provide extra security by allowing the binder to be locked in closed position using a pad lock, linchpin or bolt.
- **COMPRESSION BINDERS** are designed for securing bar and rod steel, lumber, poles and machinery with rubber tires.



Compression Binders

Binder Type	Description	Chain Grade & Size (in.)			Product Code	Standard Package	Working Load Limit (lbs.)	Take Up (in.)	Handle Length (in.)	Weight (lbs.)
		G30	G43	G70						
Dixi-Loc Binder	Lockable	3/8	3/8	5/16	48385	4	5,400	4.50	16.62	8.50
Compression Binder	Metal Spring	3/8	3/8	5/16	48395	4	5,400	4.50	16.62	14.60

## ▶ INSPECTION, CARE & USE

### LOAD BINDER OPERATING INSTRUCTIONS

1. Follow D.O.T. Federal Motor Carrier Safety Regulations S 392.9, S 393.100, and S 393.102
2. Inspect before use. Replace worn and deformed binders. Lubricate pivot and swivel points for optimum performance.
3. Do not operate with anyone on load.
4. Always apply lever binder in straight line hook-to-hook manner without bending and such that handle goes down when securing load.
5. Tighten binders before moving and recheck frequently.
6. Do not exceed working load limit shown on binder – hand effort will tighten binder to working load limit.
7. Do not use cheater bar or handle extension as their use can overload binder system and result in injury.
8. Secure handle down with a positive retaining method.
9. Release handle/load with extreme care. Make sure everyone is clear. Lever binder handle can snap back over center. Use open palm under handle and push up.

For more information, visit us at [www.cmworks.com](http://www.cmworks.com)

## ⚠ WARNING

Load binder systems store energy which can release suddenly. To avoid injury:

- ▲ Operate only by hand from a firm standing position.
- ▲ Operate handle cautiously.
- ▲ Stay clear of handle path; handle may release suddenly.
- ▲ Follow manufacturer's instructions.





## E-Z PRO® CAM RELEASE LEVER BINDER GRADES 30, 43, 70

WORKING LOAD LIMIT: 5,400 TO 9,200 LBS.

Effortlessly release this load binder without using any tools or prying – all it takes is one finger. Due to its unique design, the binder’s handle releases the load at the same point every time – when the handle is perpendicular to the body of the binder. Low-energy release prevents the binder from snapping back over center.

### BENEFITS & FEATURES

- Binder releases effortlessly without the use of any tools or prying
- Free turning, 360° continuous swivel action in both tongue and clevis for enhanced straight line pull.
- Highly visible, durable yellow powder coated finish
- Design factor 4:1



48405: 5,400 lb. Working Load Limit



48406: 9,200 lb. Working Load Limit



Chain Grade & Size (in.)			Product Code	Standard Package	Working Load Limit (lbs.)	Take Up (in.)	Handle Length (in.)	Weight (lbs.)
G30	G43	G70						
3/8	3/8	5/16	48405	4	5,400	4.75	16.62	9.0
1/2	1/2	3/8	48406	4	9,200	4.75	16.62	9.8

## CMG RATCHET / LEVER BINDERS

WORKING LOAD LIMIT: 2,600 TO 8,800 LBS.

### BENEFITS & FEATURES

- Forged components
- Durable powder coated finish
- Designed to meet CM requirements
- Design factor 3:1
- Imported



Maximum Chain Size (Grade 70) (in.)	Description	Product Code	Working Load Limit (lbs.)	Handle Take Up (in.)	Handle Length (in.)	Weight (lbs.)
5/16 & 3/8	5/16" & 3/8" Ratchet Binder	48362CMG	8,800	8	14	13
1/4	5/16" Lever Binder	48304CMG	2,600	3	11.5	3.4
5/16	3/8" Lever Binder	48305CMG	6,600	4	16	8.8
5/16	3/8" Indirect Binder	48405CMG	5,400	8	15	9.0



# D-RINGS & KEEPER LINKS

**WORKING LOAD LIMIT: 1,200 TO 14,000 LBS.**

D-Rings with weldable clips are designed for quick, easy attachment when securing loads.

**BENEFITS & FEATURES**

- Clips are designed for welding
- Self colored finish
- Links and rings are forged from superior steel
- Proper welding procedures should be followed for d-ring clips
- Design factor 5:1

Size (in.)	Description	Working Load Limit (lbs.)	Standard Package	Product Code	Dimensions (in.)			Weight (lbs)
					A	B	C	
<b>D-Rings</b>								
1 x 3 x 4	D-Ring	12,000	10	93200	3.00	4.00	1.00	3.40
1 x 3 x 3	D-Ring	12,000	10	92501	3.00	4.00	1.00	2.87
1	D-Ring Clip	—	10	93210	—	—	—	0.71
11/16 x 2-3/4 x 2-1/4	D-Ring	7,000	10	92505	2.75	2.25	0.69	1.21
1/2 x 1-1/2	D-Ring Clip	—	10	92504	—	—	—	0.77
3/8 x 1-3/4 x 1-3/4	D-Ring	1,200	10	95610	1.75	1.75	0.38	0.24
<b>Keeper Links</b>								
3/4 x 1.5 x 3.5	Keeper Link	14,000	10	37111	1.52	3.50	0.76	1.42

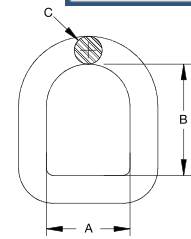

D-Ring with Clip (D-Ring and D-Ring Clip sold separately)

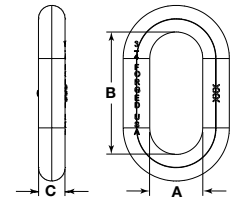

Keeper Link

# SIXTH WHEEL RATCHET



**BENEFITS & FEATURES**

- Ergonomically reduces risk of injury when operating trailer landing gear
- Permits the operator to use an ergonomically-correct posture, utilizing body weight while reducing muscle exertion
- Preferred by 80% of drivers in actual use tests
- US Patent 7,021,659 stamped on all authentic Sixth Wheel units
- Designed to fit all standard gear
- Secured by a self-locking security pin and cap made of hardened steel that can only be removed by using heavy-duty shop equipment

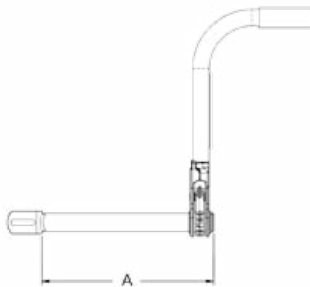

Product Code	Diameter (in.)	Length (A) (in.)
34902R082P	1	8
34902R132P	1	13
34902R202P	1	20



## THE SIXTH WHEEL VS. STANDARD CRANK

**THE SIXTH WHEEL**  
 Utilizes a ratcheting mechanism that allows the operator to exert more force while avoiding awkward and unsafe postures.



**STANDARD CRANK**  
 Requires a full-circle motion. This puts the operator in unsafe postures while exerting extremely high forces.

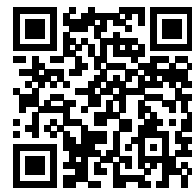

**SEE THE SIXTH WHEEL RATCHET IN ACTION**  
 SCAN THE QR CODE OR VISIT  
<http://www.youtube.com/user/ColumbusMcKinnon>

## HIGH TEST CHAIN GRADE 43

WORKING LOAD LIMIT: 2,600 TO 20,200 LBS.

Grade 43 chain, commonly called High Test, is manufactured to meet ASTM and NACM specifications. Typical uses include container securement, logging, towing, and marine industry. Grade 43 chain is available in many finishes and package configurations. It should not be used for overhead lifting.

### BENEFITS & FEATURES

- Meets ASTM & NACM standards
- Available in a wide assortment of finishes including: self-colored and galvanized
- 50% stronger than Grade 30 chain
- Permanent identification on chain
- 100% proof tested
- Available in drums and multiple styles of assemblies
- Design factor 3:1

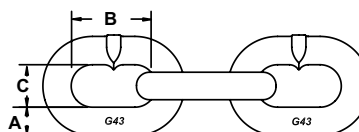

Chain Size (in.)	Working Load Limit (lbs.)	Nominal Chain Dimensions (in.)			Weight (lbs./ft.)	Approximate Number of Links (per ft.)	Self Colored Finish				Hot Dipped Galvanized Finish				
		Material Diameter A	Inside Length B	Inside Width C			Full Drum		Half Drum		Full Drum		Half Drum		
							Product Code	Length (ft.)	Product Code	Length (ft.)	Product Code	Length (ft.)	Product Code	Length (ft.)	
<b>Import</b>															
1/4	2,600	0.28	1.22	0.51	0.65	9.87	678141	800	678131	400	678341	800	-	-	
5/16	3,900	0.34	1.25	0.54	1.04	9.60	678142	550	678132	275	678342	550	-	-	
3/8	5,400	0.39	1.35	0.58	1.40	8.89	678143	400	678133	200	678343	400	678333	200	
<b>North American</b>															
1/2	9,200	0.52	1.73	0.81	2.42	6.93	678145	200	-	-	678345	200	-	-	
5/8	13,000	0.63	1.92	0.86	3.63	6.26	678146	150	678136	75	678346	150	-	-	
3/4	20,200	0.78	2.40	1.07	5.68	5.06	678147	100	678137	50	678347	100	-	-	

**FINISHES:** Self Colored, Galvanized

## WELDED ASSEMBLY GRADE 43

**WORKING LOAD LIMIT: 5,400 LBS.**

### BENEFITS & FEATURES

- Hook on each end (welded)
- Meets FMCSA, CVSA, NACM, & ASTM standards
- Available with welded style hooks
- Chain won't degrade in ultra-violet light, as compared to nylon straps.
- Various end attachments available
- Self-colored finish is standard (galvanized and zinc-plated also available)
- Custom lengths upon request
- Design factor 3:1

Chain Size (in.)	Working Load Limit (lbs.)	Product Code	L (ft.)	Finish	Weight (lbs.)
3/8	5,400	638241	20	Self Colored	28.10

**FINISHES:** Self Colored, Zinc Plated, Galvanized

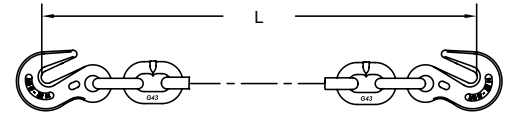

## CLEVIS ASSEMBLY GRADE 43

**WORKING LOAD LIMIT: 2,600 TO 9,200 LBS.**

### BENEFITS & FEATURES

- Hook on each end (clevis style)
- Meets FMCSA, CVSA, NACM, & ASTM standards
- Available in clevis style hooks
- Chain won't degrade in ultra-violet light, as compared to nylon straps.
- Various end attachments available
- Self-colored finish is standard (galvanized and zinc-plated also available)
- Custom lengths upon request
- Design factor 3:1

Chain Size (in.)	Working Load Limit (lbs.)	Product Code	L (ft.)	Finish	Weight (lbs.)
1/4	2,600	638010	10	Self Colored	6.50
5/16	3,900	608401	20	Self Colored	21.85
5/16	3,900	638025	25	Self Colored	27.05
3/8	5,400	638208	10	Self Colored	15.38
3/8	5,400	638215	12	Self Colored	18.20
3/8	5,400	638216	14	Self Colored	20.99
3/8	5,400	638217	16	Self Colored	23.80
3/8	5,400	638219	20	Self Colored	28.10
3/8	5,400	638220	25	Self Colored	36.43
1/2	9,200	638226	20	Self Colored	48.38

**FINISHES:** Self Colored, Zinc Plated, Galvanized

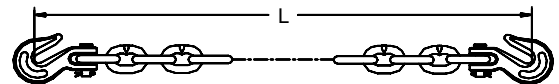

## PROOF COIL CHAIN GRADE 30

**WORKING LOAD LIMIT: 800 TO 10,600 LBS.**

Grade 30 chain, commonly called Proof Coil, is manufactured to meet ASTM & NACM specifications. Typical uses include barrier chains, trailer safety chains, light construction, marine industry, etc. Grade 30 chain is available in a wide assortment of finishes and packaged configurations. It should not be used for overhead lifting.

### BENEFITS & FEATURES

- Meets ASTM & NACM standards
- Available in a wide assortment of finishes including, Self-Colored, Zinc Plated, Galvanized, Powder Coated
- Permanent identification on chain (embossed with CM30)
- 100% proof tested
- Available in drums, pails and multiple styles of assemblies
- Design factor 4:1

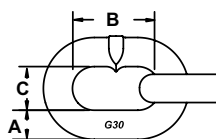

Chain Size (in.)	Working Load Limit (lbs.)	Nominal Chain Dimensions (in.)			Weight (lbs./ft.)*	Approximate Number of Links (per ft.)
		Material Diameter A	Inside Length B	Inside Width C		
3/16	800	0.22	0.97	0.45	0.40	12.4
1/4	1,300	0.28	1.22	0.51	0.65	9.9
5/16	1,900	0.33	1.27	0.60	0.98	9.5
3/8	2,650	0.39	1.35	0.58	1.40	8.9
1/2	4,500	0.52	1.73	0.81	2.42	6.9
5/8	6,900	0.63	1.92	0.86	3.63	6.3
3/4	10,600	0.78	2.40	1.07	5.68	5.0

Chain Size (in.)	Self-Colored Finish				Zinc Plated Finish						Hot Dipped Galvanized Finish					
	Full Drum		Half Drum		Full Drum		Half Drum		Pail		Full Drum		Half Drum		Pail	
	Product Code	Length (ft.)	Product Code	Length (ft.)	Product Code	Length (ft.)	Product Code	Length (ft.)	Product Code	Length (ft.)	Product Code	Length (ft.)	Product Code	Length (ft.)	Product Code	Length (ft.)
<b>Import</b>																
3/16	671040	850	-	-	671440	850	-	-	671410	250	671340	850	671394	500	-	-
1/4	671041	800	671091	400	671441	800	671491	400	671411	140	671341	800	671391	400	-	-
5/16	671042	550	671092	275	671442	550	671492	275	671412	90	671342	550	-	-	-	-
3/8	671043	400	671093	200	671443	400	-	-	671413	60	671343	400	671393	200	-	-
<b>North American</b>																
1/2	-	-	671045	200	671445	200	-	-	671415	40	671345	200	-	-	-	-
5/8	671046	150	-	-	-	-	-	-	-	-	671346	150	-	-	-	-
3/4	671047	100	-	-	-	-	-	-	-	-	671347	100	-	-	-	-

\*Weight for Hot Dipped Galvanized Finish: Add 5% for sizes under 1/2", Add 2% for sizes over 1/2"

## HANGER CHAIN GRADE 30

**WORKING LOAD LIMIT: 1,300 LBS.**

Hanger Chain is used for securement and attachment purposes in mines where a temporary connection is required.

### BENEFITS & FEATURES

- Hooks are heat treated and tempered
- Design factor of 4:1 matching NACM specifications
- Hook embossed with trace code providing traceability through manufacturing and testing process to heat of steel
- Design factor 4:1
- Not to be used for overhead lifting**

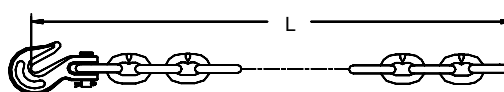

Chain Size (in.)	Working Load Limit (lbs.)	Product Code	L (ft.)	Finish	Weight (lbs.)
1/4	1,300	601710CMG	3	Self Colored	2.23
1/4	1,300	601711CMG	4	Self Colored	2.88
1/4	1,300	601714CMG	7	Self Colored	4.82



# CLEVIS SLIP HOOK GRADE 30/43

**WORKING LOAD LIMIT: 2,600 TO 13,000 LBS.**

### BENEFITS & FEATURES

- Heat-treated pins
- Hooks are heat treated and tempered
- Design factor 4:1 when used with Grade 30
- Design factor 3:1 when used with Grade 43
- When using these hooks with Grade 30 chain, the assembly must be rated to the working load limit of the chain.
- Hook embossed with trace code providing traceability through manufacturing and testing process to heat of steel
- Zinc plated finish
- **Not to be used for overhead lifting**

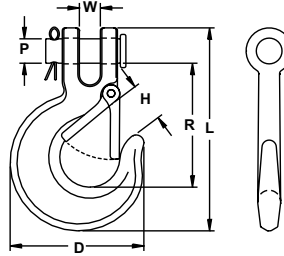

Size (in.)	Working Load Limit (lbs.)	Standard Package	Product Code				Dimensions (in.)						Weight (lbs.)
			Zinc Plated (without Latch)*	Zinc Plated (with Latch)	Latch Kit	W	D	H	L	R	P		
1/4	2,600	25	66193	66173	75199	0.35	2.33	0.72	2.27	2.32	0.31	0.35	
5/16	3,900	25	66293	66273	75199	0.42	2.65	0.86	4.13	2.59	0.38	0.63	
3/8	5,400	25	66393	66373	75299	0.50	3.20	1.01	4.81	3.04	0.44	1.02	
7/16	7,200	10	66493	66473	75299	0.58	3.91	1.02	5.56	3.50	0.50	1.56	
1/2	9,200	10	66593	66573	4X410	0.63	4.16	1.12	6.31	4.15	0.55	2.27	
5/8	13,000	5	M910Z	-	-	0.81	5.69	2.00	7.56	4.75	0.75	4.00	

\* Hooks without latches are not designed for latches to be added.

# EYE SLIP HOOK GRADE 30/43

**WORKING LOAD LIMIT: 2,600 TO 20,200 LBS.**



### BENEFITS & FEATURES

- Hooks are heat treated and tempered
- Design factor 4:1 when used with Grade 30
- Design factor 3:1 when used with Grade 43
- When using these hooks with Grade 30 chain, the assembly must be rated to the working load limit of the chain.
- Hook embossed with trace code providing traceability through manufacturing and testing process to heat of steel
- **Not to be used for overhead lifting**

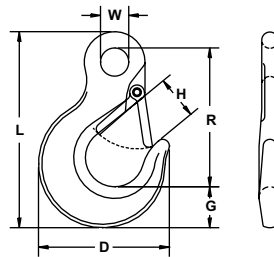

Size (in.)	Working Load Limit (lbs.)	Standard Package	Product Code				Dimensions (in.)						Weight (lbs.)	
			Self Colored (without Latch)*	Zinc Plated (without Latch)*	Zinc Plated (with Latch)	Latch Kit	W	D	H without latch	H with latch	L	R		G
1/4	2,600	50	-	75193	75143	75199	0.53	2.47	0.81	0.73	3.69	2.61	0.81	0.38
5/16	3,900	50	74294	75293	75243	75199	0.69	2.88	0.83	0.82	3.98	2.70	0.91	0.57
3/8	5,400	50	-	75393	75343	75299	0.78	3.25	0.92	0.93	4.11	3.17	1.13	0.83
7/16	7,200	10	-	75493	-	-	0.91	3.73	1.23	-	5.28	3.64	1.31	1.38
1/2	9,200	10	-	75593	75543	4X410	1.03	4.25	1.30	1.21	6.13	4.20	1.50	1.95
5/8	13,000	5	74694	75693	-	-	1.28	5.23	1.69	-	7.41	5.11	1.81	3.72
3/4	20,200	5	-	75793	-	-	1.53	6.28	2.45	-	8.88	6.00	2.34	3.72

\* Hooks without latches are not designed for latches to be added.

**FINISHES:** Self Colored, Zinc Plated



## CLEVIS GRAB HOOK GRADE 30/43

WORKING LOAD LIMIT: 2,600 TO 20,200 LBS.

### BENEFITS & FEATURES

- Heat-treated pins
- Hooks are heat treated and tempered
- Design factor 4:1 when used with Grade 30
- Design factor 3:1 when used with Grade 43
- When using these hooks with Grade 30 chain, the assembly must be rated to the working load limit of the chain.
- Hook embossed with trace code providing traceability through manufacturing and testing process to heat of steel
- Not to be used for overhead lifting**

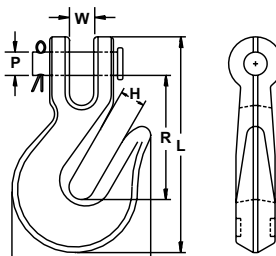

TRANSPORT CHAIN  
& ATTACHMENTS

Size (in.)	Working Load Limit (lbs.)	Standard Package	Product Code		Dimensions (in.)						Weight (lbs.)
			Self Colored	Zinc Plated	W	D	H	L	R	P	
1/4	2,600	50	—	61193	0.36	2.05	0.37	2.88	1.57	0.31	0.37
5/16	3,900	50	—	61293	0.42	2.41	0.44	3.52	1.98	0.38	0.63
3/8	5,400	50	60392	61393	0.50	2.94	0.54	4.20	2.23	0.44	1.10
7/16	7,200	10	60492	61493	0.58	3.25	0.59	4.93	2.94	0.50	1.60
1/2	9,200	10	60592	61593	0.66	3.70	0.67	5.43	2.93	0.55	2.42
5/8	13,000	10	60692	61693	0.75	4.25	0.781	6.88	4.00	0.69	3.61
3/4	20,200	5	M812	M812Z	0.88	5.19	0.94	8.00	4.56	0.75	7.00

**FINISHES:** Self Colored, Zinc Plated

## EYE GRAB HOOK GRADE 30/43

WORKING LOAD LIMIT: 2,600 TO 20,200 LBS.



### BENEFITS & FEATURES

- Hooks are heat treated and tempered
- Design factor 4:1 when used with Grade 30
- Design factor 3:1 when used with Grade 43
- When using these hooks with Grade 30 chain, the assembly must be rated to the working load limit of the chain.
- Hook embossed with trace code providing traceability through manufacturing and testing process to heat of steel
- Zinc plated finish
- Not to be used for overhead lifting**

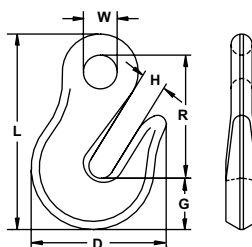

Size (in.)	Working Load Limit (lbs.)	Standard Package	Product Code	Dimensions (in.)						Weight (lbs.)
				W	D	H	L	R	G	
1/4	2,600	50	71193	0.47	1.78	0.35	2.85	1.78	0.81	0.30
5/16	3,900	50	71293	0.61	2.19	0.44	3.47	2.19	0.98	0.56
3/8	5,400	50	71393	0.82	2.86	0.49	4.13	2.69	1.14	0.87
7/16	7,200	10	71493	0.83	2.99	0.59	4.97	3.21	1.34	1.45
1/2	9,200	10	71593	0.93	3.34	0.67	5.38	3.40	1.50	2.17
5/8	13,000	5	71693	1.16	4.63	0.76	6.95	4.49	1.88	3.89
3/4	20,200	5	71793	1.38	5.50	0.98	8.28	5.35	2.28	6.12



# BUOY CHAIN

**WORKING LOAD LIMIT: 15,000 TO 91,000 LBS.**

For use on navigation markers for the U.S. Coast Guard, Public Works Canada and other navigation jurisdictions.

**BENEFITS & FEATURES**

- Not for overhead lifting
- Design factor 4:1

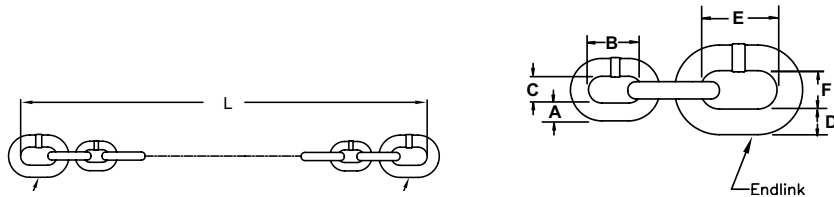

Chain Size (in.)	Minimum Breaking Strength (lbs.)	Product Code	L (ft.)	Chain Dimensions (in.)			Endlink Dimensions (in.)			Finish	Weight (lbs./shot)
				A	B	C	D	E	F		
1/2	15,000	6510049	90	0.50	3.00	1.88	0.75	4.50	2.69	Self Colored	196.00
1/2	15,000	6510048	45	0.50	3.00	1.88	0.75	4.50	2.69	Self Colored	99.26
3/4	32,000	6510050	90	0.75	4.50	2.69	0.88	5.25	3.13	Self Colored	431.66
3/4	32,000	6510051	45	0.75	4.50	2.69	0.88	5.25	3.13	Self Colored	215.66
1	58,000	4340890	90	1.00	6.00	3.56	1.00	6.00	3.56	Self Colored	760.50
1	58,000	4340890G	90	1.00	6.00	3.56	1.00	6.00	3.56	Hot Dipped Galvanized	760.50
1-1/8	77,000	4340990	90	1.13	6.75	4.00	1.13	6.75	4.00	Self Colored	961.20
1-1/4	91,000	4341090	90	1.25	7.50	4.44	1.25	7.50	4.44	Self Colored	1,186.20







WILL 61/25

HS CM

# ENTERTAINMENT RIGGING PRODUCTS

S.T.A.C. Chain .....	158
S.T.A.C. Chain Sets .....	158
Theatrical Shackles .....	159





# S.T.A.C. CHAIN

## SPECIAL THEATRICAL ALLOY CHAIN

**WORKING LOAD LIMIT: 6 TONS**

Ideal for theatrical rigging applications where bridle adjustability is required

### BENEFITS & FEATURES

#### SUPER STRENGTH

Grade 80 alloy material with 1/2" diameter and 6 ton working load limit

#### HEAT TREATED

Alloy steel provides long life

#### MEETS EUROPEAN STANDARDS FOR LONG LINK CHAIN

#### PROOF TESTED

Each link proof tested to assure weld and material integrity

#### FIRE & ABRASION RESISTANT

#### 4:1 DESIGN FACTOR

#### POSITIVE AND EASY ID

Chain embossed with "STAC 8" and "CM USA" for easy identification as CM alloy. Also tagged with size, grade, reach and working load limit.

#### VERSATILITY

Link accepts up to 3/4" shackle for adjustability

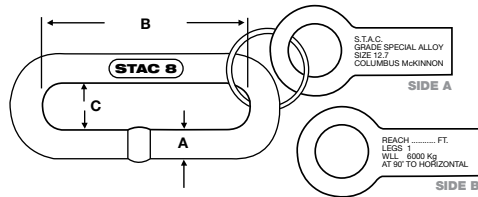

Chain Size (in.)	Working Load Limit (lbs.)	Nominal Chain Dimensions (in.)			Per Foot		Per Drum		
		Material Diameter A	Inside Length B	Inside Width C	Product Code	Weight (lbs./ft.)	Length (ft.)	Product Code	Weight (lbs.)
1/2	12,000	0.53	3.74	0.91	695550	2.03	250	695550D250	506.75
							500	695550D500	1,013.50

# S.T.A.C. CHAIN SETS

## SPECIAL THEATRICAL ALLOY CHAIN



### BENEFITS & FEATURES

- Cut to desired length to meet your needs
- Each assembly tagged with reach and length
- Black finish
- Fits and functions with the CM line of black shackles
- Wide links allow for easy hook up



Chain Size (in.)	Length (ft.)	Cut Length Product Code	Weight (lbs.)
1/2	3	695575	6.70
	4	695576	9.94
	5	695577	11.96
	6	695578	13.99
	7	695579	16.01
	8	695580	18.03
	9	695581	20.05
	10	695582	22.07
	11	695583	24.10
	12	695584	26.12
	13	695585	28.14
	14	695586	30.16
	15	695587	32.18

ENTERTAINMENT RIGGING PRODUCTS



# THEATRICAL SHACKLES PAINTED BLACK

WORKING LOAD LIMIT: 1/2 TO 10 TONS

## BENEFITS & FEATURES

- Manufactured from technically advanced micro alloy material
- Design factor 6:1
- Working Load Limit and traceability codes shown as permanent marking on body
- All shackles have alloy quenched and tempered pins
- Available in sizes 3/16" to 1"
- Available in black powder coated finish only
- Special testing and certification is available upon request at the time of the order



ENTERTAINMENT RIGGING PRODUCTS

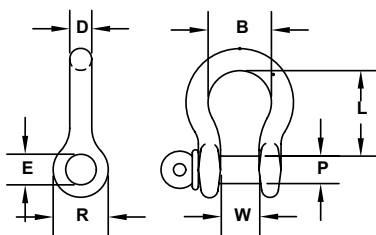

Size D (in.)	Working Load Limit (Ton)	Standard Package	Weight (lbs.)	Product Code	Dimensions (in.)					
					P	E	W	R	L	B min
3/16	1/2	50	0.06	M645B	0.25	0.29	0.38	0.57	0.88	0.58
1/4	3/4	50	0.12	M646B	0.31	0.36	0.47	0.75	1.13	0.75
5/16	1	50	0.20	M647B	0.38	0.45	0.53	0.84	1.25	0.81
3/8	1-1/2	50	0.30	M648B	0.44	0.52	0.66	1.00	1.40	1.00
7/16	2	50	0.50	M649B	0.50	0.58	0.72	1.15	1.69	1.19
1/2	3	50	0.75	M650B	0.63	0.70	0.84	1.34	1.94	1.38
5/8	4-1/2	25	1.30	M651B	0.75	0.83	1.06	1.66	2.41	1.63
3/4	6-1/2	10	2.30	M652B	0.88	0.95	1.28	1.94	2.84	1.89
7/8	8-1/2	10	3.50	M653B	1.00	1.09	1.44	2.14	3.31	2.06
1	10	5	5.00	M654B	1.13	1.22	1.72	2.44	3.75	2.52

**POWER to PERFORM**

For a complete listing of rigging products for the entertainment industry, visit us at [www.cm-et.com](http://www.cm-et.com)



## PRODUCT SHOWCASE

# HOISTS, TROLLEYS & BEAM CLAMPS

**ELECTRIC HOIST  
MODEL COMPARISON** ..... 162-163

**AIR HOIST  
MODEL COMPARISON** ..... 165

**LEVER HOIST  
MODEL COMPARISON** ..... 166-167

**HAND CHAIN HOIST  
MODEL COMPARISON** ..... 168-169

### RATCHET LEVER HOISTS

CM Tornado 360° ..... 170-173

CM Bandit ..... 174-177

### HAND CHAIN HOISTS

CM Hurricane 360° ..... 178-179

### CLAMPS

CTP Adjustable Trolley Clamp ..... 180

CM Beam Clamp ..... 181

Screwlok Beam Clamp with Shackle ..... 182

SC Series Twin Beam Clamp ..... 183

► To see our full line of hoists, trolleys & beam clamps,  
visit us online at [www.cmworks.com](http://www.cmworks.com)



# ELECTRIC HOISTS

## MODEL COMPARISON



**CM**  
**SHOPSTAR**  
Electric Chain Hoist



**CM**  
**SHOPSTAR VS**  
Electric Chain Hoist



**CM**  
**VALUSTAR**  
Electric Chain Hoist



**COFFING**  
**HOISTS**  
**JLC**  
Electric Chain Hoist



**COFFING**  
**HOISTS**  
**EC**  
Electric Chain Hoist



**CM**  
**LODESTAR**  
Electric Chain Hoist

CAPACITY	Speed (fpm)	Reeving	Speed (fpm)	Reeving	Speed (fpm)	Reeving	Speed (fpm)	Reeving	Speed (fpm)	Reeving	Speed (fpm)	Reeving
250 lb.	16, 24, 40	1										
300 lb.	16, 24, 40	1										
500 lb.	8, 12, 16, 20, 24	1 & 2										
3/8 ton												
600 lb.	8, 12, 20	2										
3/4 ton												
1,000 lb.	6, 8, 12	2										
1/8 ton							32	1			32, 60	1
1/4 ton					16	1	16, 32	1	16, 32, 64	1	16, 32	1
1/2 ton					16	1	16, 32	1	9, 16, 32	1	8, 16, 32, 64	1 & 2
1 ton					8, 16	1 & 2	16	1	4, 8, 12, 16, 32, 48	1 & 2	8, 16, 32	1 & 2
2 ton					8	2	8	2	6, 8, 16, 24	1 & 2	8, 16	1 & 2
3 ton									5, 10, 16	2 & 3	5-1/2, 11	3
4 ton									8, 12	2		
5 ton									5, 8	3		
6 ton												
7-1/2 ton												
9 ton												
10 ton												
12 ton												
15 ton												

### STANDARD FEATURES

Total Enclosed Non-Vented Motor	Standard			Standard	Standard	Standard	Standard
Total Enclosed Fan Cooled Motor	N/A			N/A	N/A	ED Model Only	N/A
Vane Motor							N/A
Adjustable Up/Down Limits	N/A			N/A	Standard	Standard	Standard
Paddle Limits	N/A			N/A	N/A	N/A	N/A
Weather Proofing	N/A			N/A	Weather-Resistant Cover	Weather-Resistant Cover	Standard
Load Chain	Std. Unplated/Optional Plated			Unplated	Std. Unplated/Optional Plated	Std. Unplated/Optional Plated	Standard Zinc Plated
Chain Container	Optional			Optional	Standard up to 20' Single Chain	Optional	Standard Fabric Bag
Powder Coat Finish	Standard			Standard	N/A	N/A	Standard
Variable Frequency Drive Versions	N/A			N/A	Standard Offering	Standard Offering	Standard Offering
Two-Speed Version	N/A			N/A	Standard Offering	Standard Offering	Standard Offering
Certification	CUL			N/A	CSA	CSA	CSA/US, TUV, CE, RoHS
Motor Brake	DC			AC Caliper Style	AC Friction Disc	AC Friction Disc	DC Electric, Double Option
Mechanical Load Brake	N/A			N/A	N/A	Standard	N/A
Spark-Resistant Features	N/A			N/A	N/A	N/A	N/A
Upper Suspension	Included			Included	Included	Included	Rigid Hook Standard
Overload Clutch	Standard			Standard	Standard	Standard	Standard Out of Load Path
Metric Rated	Standard			Standard	Optional	Optional	Standard
Suspension Option	Hook and Lug			Hook and Lug	Hook and Lug	Hook and Lug	Hook and Lug
Warranty	Lifetime			1 Year	Lifetime	Lifetime	Lifetime



# ELECTRIC HOISTS

## MODEL COMPARISON



**CM**  
**CLASSIC LODESTAR**  
Electric Chain Hoist



**CM**  
**LODESTAR VS**  
Electric Chain Hoist



**CM**  
**MAN GUARD**  
Electric Chain Hoist



**BUDGIT<sup>®</sup>**  
*Hoists*  
**MANGUARD**  
Electric Chain Hoist



**CM**  
**LODESTAR XL**  
Electric Chain Hoist



**CM**  
**POWERSTAR**  
Electric Chain Hoist



**COFFING<sup>®</sup>**  
**HOISTS**  
**WR**  
Electric Wire Rope Hoist

Speed (fpm)	Reeving	Speed (fpm)	Reeving	Speed (fpm)	Reeving	Speed (fpm)	Reeving	Speed (fpm)	Reeving	Speed (fpm)	Reeving	Speed (fpm)	Reeving
												10, 16, 21, 32	1, 2
32, 60	1	60	1										
16, 32	1	32	1	16, 32	1	16, 32, 64	1						
8, 16, 32, 64	1 & 2	16 & 8	1 & 2	16, 32	1	16, 32	1						
8, 16, 32	1 & 2	8	2	16, 32	1	8, 16, 32	1			20, 24, 32, 40, 48	1	10, 16, 28	1, 2
8, 16	2			8, 16	2	4, 8, 16	2	6, 8, 18, 24, 30	1	20, 24, 32, 40	1	14, 21	1, 2
5-1/2, 11	3			5, 10	3	5, 10	3	3, 4, 9, 12, 15	2	10, 12, 16, 20, 24	2	10, 14, 26	1, 2
								3, 4, 9, 12, 15	2	10, 12, 16, 20, 24	2		
								2, 2.7, 3, 6, 8, 9, 12, 15	2, 3	10, 12, 16, 20	2	16	2
								2.7, 2, 6, 8, 10	3	10, 12, 16, 20	2		
								2, 6, 10	3	7, 8, 11, 14, 16	3		
										7, 8, 11, 13	3		
										7, 8, 11, 13	4		
										5, 6, 8, 10	4		
										4, 5, 6, 8	5		

### STANDARD FEATURES

Standard	Standard	Standard	Standard	Standard	Standard	Standard
N/A	N/A	N/A	N/A	N/A	N/A	N/A
N/A	N/A	N/A	N/A	N/A	N/A	N/A
Standard	EPLS (Electronically Programmable Limit Switches)	N/A	N/A	Standard	Standard	Standard
N/A	N/A	Standard	Standard	Optional	N/A	N/A
Standard	Standard	N/A	N/A	Weather-Resistant Cover	Weather-Resistant Cover	Weather-Resistant Cover
Standard Zinc Plated	Standard Zinc Plated	Std. Plated, 10, 15, 20' Lifts	Std. Unplated/Optional Plated	Unplated/Optional Plated	Unplated/Optional Plated	N/A
Optional	Standard Fabric Bag	Standard up to 20' Lifts	Standard up to 28' Single Chain	Optional	Optional	N/A
Standard	Standard	Standard	Standard	Standard	Standard	N/A
Standard Offering	Standard Offering	Standard 3-Step Infinite Var.	Standard Offering 2-Step	N/A	N/A	Standard Offering
Standard Offering	In Process	For 575V Only	Standard Offering	Optional	Optional	Optional
CSA, TUV, CE	CSA, TUV, CE	CSA	CSA	N/A	N/A	N/A
AC Friction Disc	DC Electric	AC Friction Disc	AC Friction Disc	AC Friction Disc	AC Friction Disc	AC Friction Disc
N/A	N/A	N/A	Optional	N/A	N/A	N/A
N/A	N/A	N/A	N/A	N/A	N/A	N/A
Ordered Separately	Ordered Separately	Included	Included	Included	Included	Included
Standard in Gear Case	Standard in Gear Case	Standard	Standard	Standard	Standard	Standard
Standard	Standard	Standard	Optional	Standard	Most Models	N/A
Hook and Lug	Hook and Lug	Hook Only	Hook and Lug	Hook and Lug	Lug	Lug
Lifetime	Lifetime	Lifetime	Lifetime	Lifetime	Lifetime	Lifetime



**CM**  
**LODESTAR**

WARNING  
DO NOT OPERATE  
THIS HOIST  
UNLESS YOU  
ARE TRAINED  
AND CERTIFIED  
TO DO SO.  
SEE THE  
OPERATOR'S  
MANUAL FOR  
FULL  
OPERATING  
INSTRUCTIONS.  
CM HOISTS  
ARE DESIGNED  
FOR USE WITH  
STEEL AND  
ALUMINUM  
LOADS ONLY.  
DO NOT  
EXCEED THE  
RATED  
CAPACITY.  
DO NOT  
LIFT  
UNBALANCED  
LOADS.  
DO NOT  
LIFT  
LOADS  
NEAR  
ELECTRICAL  
EQUIPMENT.  
DO NOT  
LIFT  
LOADS  
NEAR  
OBSTACLES.  
DO NOT  
LIFT  
LOADS  
NEAR  
PEOPLE.  
DO NOT  
LIFT  
LOADS  
NEAR  
MACHINERY.  
DO NOT  
LIFT  
LOADS  
NEAR  
HANGING  
CABLES.  
DO NOT  
LIFT  
LOADS  
NEAR  
HANGING  
PIPELINES.  
DO NOT  
LIFT  
LOADS  
NEAR  
HANGING  
CABLES.  
DO NOT  
LIFT  
LOADS  
NEAR  
HANGING  
PIPELINES.

# AIR HOISTS

## MODEL COMPARISON



**SHOPAIR**  
Air Chain Hoist

Also available as:  
**BUDGIT 600**  
**COFFING SLA**



**AIRSTAR**  
Air Chain Hoist

Also available as:  
**BUDGIT SERIES 2200**  
**COFFING CAH (SMALL FRAME)**  
**YALE YAL**



**AIRSTAR 6**  
Air Chain Hoist

Also available as:  
**BUDGIT SERIES 6000**  
**COFFING CAH (LARGE FRAME)**  
**YALE KALC**



**LODESTAR AIR XL**  
Air Chain Hoist

Also available as:  
**COFFING CXLA**  
**YALE XL AIR**

CAPACITY	Speed (fpm)	Reeving	Speed (fpm)	Reeving	Speed (fpm)	Reeving	Speed (fpm)	Reeving
250 lb.	31	1						
300 lb.	31	1						
500 lb.	21	1	65	1				
3/8 ton			60	1				
600 lb.	16	2						
3/4 ton			29	2				
1,000 lb.	11	2	45	1	16	1		
1/8 ton								
1/4 ton								
1/2 ton								
1 ton			23	2	8, 13, 30	1		
2 ton					5, 6, 15	2	31	1
3 ton					4, 10	3	21	2
4 ton								
5 ton							13	2
6 ton							10	3
7-1/2 ton							9	3
9 ton								
10 ton								
12 ton								
15 ton								

### STANDARD FEATURES

Total Enclosed Non-Vented Motor	N/A		N/A		N/A		N/A	
Total Enclosed Fan Cooled Motor	N/A		N/A		N/A		N/A	
Vane Motor	Standard		Standard		Standard		Standard	
Adjustable Up/Down Limits	N/A		N/A		N/A		N/A	
Paddle Limits	N/A		Standard		N/A		N/A	
Weather Proofing	Standard		Standard		Standard		Standard	
Load Chain	Unplated/Optional Plated		Unplated/Optional Plated		Unplated/Optional Plated		Unplated/Optional Plated	
Chain Container	Optional		Optional		Optional		Optional	
Powder Coat Finish	Standard		Standard		Standard		Standard	
Variable Frequency Drive Versions	N/A		N/A		N/A		N/A	
Two-Speed Version	N/A		N/A		N/A		N/A	
Certification	N/A		N/A		N/A		N/A	
Motor Brake	Disc		Drum		Mechanical Load Brake		Disc	
Mechanical Load Brake	N/A		N/A		Standard		Standard	
Spark-Resistant Features	N/A		Optional		Optional		N/A	
Upper Suspension	Included		Included		Included		Included	
Overload Clutch	Standard		N/A		Standard		Standard	
Metric Rated	Standard		Standard		Standard		Standard	
Suspension Option	Lug and Hook		Lug and Hook		Lug and Hook		Lug and Hook	
Warranty	Lifetime		Lifetime		Lifetime		Lifetime	

# LEVER HOISTS

## MODEL COMPARISON



**CM**  
**SERIES 602 & 603**  
Mini Ratchet Lever Hoist

**CM**  
**BANDIT**  
Ratchet Lever Hoist

**CM**  
**TORNADO 360°**  
Ratchet Lever Hoist

**CM**  
**SERIES 653**  
Ratchet Lever Hoist

**CM**  
**SHORT HANDLE**  
Puller

**CM**  
**SERIES 640**  
Puller

CAPACITY (Ton)	Capacity	Reeving	Capacity	Reeving	Capacity	Reeving	Capacity	Reeving	Capacity	Reeving	Capacity	Reeving
1/4	✓	1										
1/2	✓	1										
3/4			✓	1	✓	1	✓	1	✓	1	✓	1
1							✓	1				
1-1/2			✓	1	✓	1	✓	1	✓	1	✓	1
2							✓	1				
3			✓	1	✓	1	✓	2	✓	2	✓	2
4-1/2												
6			✓	2	✓	2	✓	2			✓	4
9							✓	3				
11												
13												
15												
FEATURES												
Load Limiter			Optional		Optional				Optional		Optional	
Metal Housing	✓		✓				✓					
Aluminum Housing					✓				✓		✓	
Free Chaining	✓		✓		✓		✓		✓		✓	
Weston Brake	✓		✓		✓		✓		✓		✓	
Ratchet & Pawl												
Standard Lifts (ft.)	5 & 10		5, 10, 15, 20		5, 10, 15, 20		5, 10, 15, 20		5, 10, 20		5, 10, 15, 20	
Zinc-Plated Chain	✓		✓		✓		✓					
Self-Colored Chain									✓		✓	
Metric Rated	✓								✓		✓	
Warranty	Lifetime		Lifetime		Lifetime		5 Years		Lifetime		Lifetime	
OPTIONS												
Bullard Hooks									✓		✓	
Latchlok Hooks									✓		✓	
Bronze Hooks									✓		✓	
Shipyards Hooks			✓		✓		✓					
Extended Lifts			✓		✓		✓		✓		✓	
Chainless Heads			✓		✓		✓		✓		✓	
Zinc-Plated Chain			✓		✓				✓		✓	
Anchor Slings									✓		✓	
Load Sentry											✓	
Non-Free Chaining									✓		✓	
Spark Resistant									✓		✓	

# LEVER HOISTS

## MODEL COMPARISON



**COFFING**  
HOISTS  
**PA**  
Ratchet Lever Hoist



**COFFING**  
HOISTS  
**LSB**  
Ratchet Lever Hoist



**COFFING**  
HOISTS  
**RA**  
Ratchet Lever Hoist



**COFFING**  
HOISTS  
**G SERIES**  
Ratchet Lever Hoist



**LITTLE MULE**  
**WIRE ROPE  
PULLER**



**LITTLE MULE**  
**LINEMAN'S  
STRAP HOIST**

Capacity	Reeving	Capacity	Reeving	Capacity	Reeving	Capacity	Reeving	Capacity	Reeving	Capacity	Reeving
✓	1	✓	1	✓	1	✓	1	✓	1 & 2	✓	1 & 2
✓	1	✓	1	✓	1	✓	1	✓	1 & 2	✓	1 & 2
✓	1	✓	1	✓	2	✓	2	✓	2	✓	1 & 2
				✓	1					✓	2
✓	2	✓	1	✓	2	✓	2			✓	2
		✓	2	✓	3	✓	3				
				✓	4	✓	4				
						✓	5				
						✓	6				
						✓	7				
						✓	8				
		Optional								Handle with overload protection	
		✓				✓				✓	
✓				✓		✓		✓			
✓		✓		✓		✓		✓			
5, 10, 15, 20		5, 10, 15, 20		5		5 (+/-)		6.5 & 10.3		4.5, 5, 5.5, 7, 9, 11, 14	
✓		✓		✓		✓					
Lifetime		Lifetime		Lifetime		Lifetime		Lifetime		Lifetime	
				✓		✓				✓	
				✓		✓					
		✓		✓		✓					
		✓		✓		✓					
		✓		✓		✓					

# HAND CHAIN HOISTS

## MODEL COMPARISON



**CM**  
**SERIES 622**  
Hand Chain Hoist



**COFFING**  
**HOISTS**  
**LHH**  
Hand Chain Hoist



**CHESTER**  
**HOIST**  
**MODEL AM**  
Hand Chain Hoist

CAPACITY (Ton)	Capacity	Reeving	Capacity	Reeving	Capacity	Reeving
1/4						
1/2	✓	1	✓	1	✓	1
1	✓	1	✓	1	✓	1
1-1/2			✓	1	✓	1
2	✓	1	✓	1		
3	✓	2	✓	1	✓	2
4					✓	3
5	✓	2	✓	3		
6					✓	5
8			✓	3		
10			✓	3		
12			✓	5		
15			✓	5		
16						
20			✓	6		
25			✓	8		
30			✓	10		
40			✓	14		
50			✓	20		
<b>FEATURES</b>						
Load Limiter			Optional		Optional	
Metal Housing	✓		✓		✓	
Aluminum Housing						
Weston Brake	✓		✓		✓	
Standard Lifts (ft.)	10, 15, 20		10, 15, 20		15, 20, 25	
Low Headroom Option						
Zinc Plate Hand Chain						
Zinc Plate Load Chain						
Self-Colored Hand Chain	✓		✓		✓	
Self-Colored Load Chain	✓		✓		✓	
Configurator Quoted						
Domestic Hoist						
Warranty	1 Year		Lifetime		1 Year	
Metric Ton Rated	✓		✓		✓	
<b>OPTIONS</b>						
Fabric Chain Bag						
Rigid Chain Container					✓	
Extended Lifts			✓		✓	
Zinc Plate Hand Chain			✓		✓	
Zinc Plate Load Chain			✓		✓	
Stainless Load Chain						
Stainless Load Chain						
Aluminum Hand Chain						
Chainless Heads	✓		✓			
Spark Resistant						
Low Headroom						
Lug Mount					✓	
Trolley Mount					✓	
Special Exterior Finish						
Bronze Hook						
Latchlok Hooks						
Bullard Hook						

# HAND CHAIN HOISTS

## MODEL COMPARISON



**CM**  
**HURRICANE 360°**  
Hand Chain Hoist



**BUDGIT**  
*Hoists*  
**USA**  
Hand Chain Hoist



**CM**  
**CYCLONE®**  
Hand Chain Hoist



**CHESTER**  
**HOIST**  
**ZEPHYR**  
Hand Chain Hoist

Capacity	Reeving	Capacity	Reeving	Capacity	Reeving	Capacity	Reeving
✓	1	✓	1	✓	1	✓	1
✓	1	✓	1	✓	1	✓	1
✓	1	✓	1	✓	1	✓	1
✓	1	✓	1	✓	1	✓	1
✓	1	✓	2	✓	2	✓	2
✓	2	✓	2	✓	2	✓	2
✓	2	✓	3	✓	3	✓	3
✓	2	✓	3	✓	3	✓	3
✓	3	✓	3	✓	4	✓	4
✓	6	✓	5	✓	5	✓	5
✓	6	✓	6*	✓	6*	✓	6
✓	6					✓	8
						✓	10
						✓	12
<b>Additional Features Comparison</b>							
✓		✓		✓			Optional
✓		✓		✓			✓
✓		✓		✓			✓
10, 15, 20		8		10			8
✓		✓		✓			✓
✓		✓		✓			✓
✓		✓		✓			✓
✓		✓		✓			✓
Lifetime		1 Year		Lifetime			1 Year
✓		✓		✓			✓
<b>Optional Features Comparison</b>							
Optional		✓		✓			✓
Optional		✓		✓			✓
✓		✓		✓			✓
✓		✓		✓			✓
✓		✓		✓			✓
✓		✓		✓			✓
✓		✓		✓			✓
✓		✓		✓			✓
✓		✓		✓			✓
✓		✓		✓			✓
✓		✓		✓			✓
✓		✓		✓			✓

# CM<sup>®</sup> TORNADO 360<sup>™</sup>

## RATCHET LEVER HOIST

Redefining lever-operated hoists, the CM<sup>®</sup> Tornado 360<sup>™</sup> features the revolutionary Sidewinder<sup>™</sup> lever handle that allows for efficient operation in both lifting and pulling applications. Ergonomically designed for increased safety, the patent-pending CM Tornado 360<sup>°</sup> lets the operator work up to 12 times faster and with as much as 30% less pull force than with conventional ratchet lever tools.

### SPECIFICATIONS

- **3/4, 1-1/2, 3, & 9 TON CAPACITIES**
- **METRIC RATED**
- **STANDARD LIFTS UP TO 20 FEET**  
Longer lifts are available.

### OPTIONS

#### SHIPYARD HOOKS

Available on 1-1/2 & 3 ton units.

#### INTERNAL LOAD LIMITER

Allows the handle to rotate freely, preventing the lifting of an overload sufficient to damage the hoist. Units equipped with a load limiter feature a black hand wheel for quick and easy on-site identification.

### FEATURES & BENEFITS

#### SIDEWINDER LEVER HANDLE

This first-of-its-kind lever handle design will revolutionize the ratchet lever hoist industry. Its unique foldable handle and 360<sup>°</sup> rotating lever increases productivity while reducing the risk of operator injury.

#### CONVENIENT DIRECTIONAL INDICATOR

Easy-to-use, highly visible directional indicator located on the handle clearly shows the operating direction as lifting, lowering or neutral.

#### EASY & SMOOTH FREE CHAINING

For quick take up and positioning of slack chain – even with one hand. Designed not to accidentally free chain while under load. Cast chain end stop allows the user to easily position the chain in free-chaining mode and prevents it from entering the liftwheel and jamming the hoist.

#### POSITIVE LOAD CONTROL

Enclosed Weston-type brake stays clean and dry for precise load positioning.

#### BUILT TO LAST

Lightweight aluminum housing withstands rigorous use and features high-quality, long-lasting bearings. Powder-coat finish provides extra protection in harsh environments.

#### MEETS ASME B30.21

#### EXCELLENT CORROSION PROTECTION

Robust chain guide and chain stripper made from cast steel and zinc plated for corrosion protection.

#### 100% LOAD TESTED

#### ZINC PLATED CHAIN

Protects against corrosion.

#### EASY-TO-INSPECT SWIVEL HOOKS

Bolt-on hooks with nylon locks help users comply with ASME B30.21 and B30.10 inspection requirements. Hooks are forged, allowing them to yield under overload without breaking. Cast safety latches provide positive and secure load engagement.

#### INDUSTRY-LEADING WARRANTY

Our lifetime warranty on all mechanical components, including the Sidewinder lever handle, is the industry's best warranty against manufacturing and material defects.

With our 3-year brake warranty, if the brake discs wear out within 3 years from the date of purchase, CMCO will replace the ratchet disc assembly free of charge.

#### EASY IDENTIFICATION

Each unit has a unique serial number for easy and accurate identification.





# TORNADO 360™ RATCHET LEVER HOIST

THE PATENT-PENDING CM TORNADO 360° RATCHET LEVER HOIST FEATURES THE REVOLUTIONARY SIDEWINDER™ LEVER HANDLE.

What makes the Sidewinder unique are two innovative components:

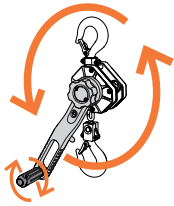

## 1. 360° ROTATING LEVER

The unique offset, or curved, design of the lever keeps the operator's hand and body aligned with the load chain. This reduces the risk of the twist effect (when a hoist twists around the chain) and the need to stabilize the hoist with another hand.

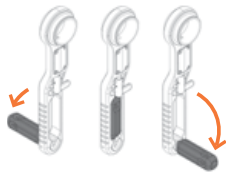

## 2. FOLD-OUT REVOLVING HANDLE

Recessed in the lever, the heavy-duty steel core handle folds down into position on either side of the lever, allowing for easy operation from any angle. The handle is grooved to provide a secure grip – even with gloves.

The handle revolves, allowing the operator to ergonomically and easily maintain control of the lever through its full 360° range of motion.



Together, the Sidewinder's lever and handle allow the operator to realize the full potential of 360° rotation, making the CM Tornado 360° unlike any other ratchet lever hoist on the market.

**DISTINCTIVE  
CLICKING SOUND**  
ENSURES THE HANDLE  
IS LOCKED INTO POSITION

To return handle to upright position, simply pull the handle outward and snap into place inside the lever.



## EASILY CHANGE YOUR GRIP TO SUIT THE APPLICATION

When an application requires a customary ratcheting hand grip, the Tornado 360° can be operated like a traditional lever tool when the lever handle is in the upright position.



## EASILY CARRY & TRANSPORT WITH JUST ONE HAND

When folded out, the lever handle can serve as a carrying grip for easy transport. Simply attach the end stop to the hook and slip the hook onto the Sidewinder lever handle to lift and carry the unit with one hand.



## ERGONOMIC DESIGN DELIVERS OPTIMAL OPERATOR SAFETY

Hoist design allows the operator to work in a safe and ergonomic position.

Sidewinder lever handle enables smooth 360° operation, reducing repetitive wrist action experienced with traditional ratchet lever hoists.

Double reduction gearing and high-quality bearings decrease required pull force by up to 30%, reducing operator fatigue.



## DIMENSIONS & SPECIFICATIONS

Capacity Tons (kg)	Product Code		Standard Lift ft. (m)	Pull Force to Lift Rated Load lbf. (kgf.)		Reeving	Weight lbs. (kg)	Dimensions in. (mm)														
	without load limiter	with load limiter		Sidewinder Lever Handle Operation	Traditional Lever Operation			A (Min.) B C D E F G H J K L M N O P														
0.75 (750)	TOR07505	TOR07505LL	5 (1.5)	38.2 (17.3)	47.2 (21.4)	1	14.7 (6.7)	12.60 (320)	0.79 (20)	1.06 (27)	0.71 (18)	12.87 (327)	11.81 (300)	1.57 (40)	3.19 (81)	4.76 (121)	2.20 (56)	4.13 (105)	6.33 (161)	1.18 (30)	4.72 (120)	10.1 (257)
	TOR07510	TOR07510LL	10 (3.0)				16.8 (7.6)															
	TOR07515	TOR07515LL	15 (4.5)				18.9 (8.6)															
	TOR07520	TOR07520LL	20 (6.0)				21 (9.5)															
	TOR075LCX	TOR075LCXLL	Less Chain				12.3 (5.6)															
1.5 (1,500)	TOR15005	TOR15005LL	5 (1.5)	58.5 (26.5)	60.7 (27.5)	1	21.1 (9.6)	14.76 (375)	1.02 (26)	1.22 (31)	0.83 (21)	12.87 (327)	11.81 (300)	2.01 (51)	3.78 (96)	5.79 (147)	2.71 (69)	4.33 (110)	7.05 (179)	1.18 (30)	4.72 (120)	10.7 (273)
	TOR15010	TOR15010LL	10 (3.0)				24.6 (11.2)															
	TOR15015	TOR15015LL	15 (4.5)				28.2 (12.8)															
	TOR15020	TOR15020LL	20 (6.0)				31.7 (14.4)															
	TOR150LCX	TOR150LCXLL	Less Chain				17 (7.7)															
	00002145	Optional Upper Shipyard Hook					4.4 (2.0)															
	3315WLP	Optional Lower Shipyard Hook					2.87 (1.3)															
3 (3,000)	TOR30005	TOR30005LL	5 (1.5)	79.4 (36)	90.4 (41)	1	38 (17.2)	17.52 (445)	1.46 (37)	1.57 (40)	1.10 (28)	14.84 (377)	13.78 (350)	2.24 (57)	4.84 (123)	7.09 (180)	3.39 (86)	4.76 (121)	8.15 (207)	1.18 (30)	4.72 (120)	11.77 (299)
	TOR30010	TOR30010LL	10 (3.0)				45.4 (20.6)															
	TOR30015	TOR30015LL	15 (4.5)				52.7 (23.9)															
	TOR30020	TOR30020LL	20 (6.0)				60.1 (27.3)															
	TOR300LCX	TOR300LCXLL	Less Chain				29.2 (13.2)															
	00002383	Optional Upper Shipyard Hook					4.23 (1.92)															
	3403WLP	Optional Lower Shipyard Hook					4.81 (2.18)															
6 (6,000)	TOR60005	TOR60005LL	5 (1.5)	83.8 (38)	92.6 (42)	2	63.7 (28.9)	22.17 (563)	1.77 (45)	1.73 (44)	1.38 (35)	14.84 (377)	13.78 (350)	2.80 (71)	6.38 (162)	9.17 (233)	3.39 (86)	4.76 (121)	8.15 (207)	1.18 (30)	4.72 (120)	11.77 (299)
	TOR60010	TOR60010LL	10 (3.0)				78.4 (35.6)															
	TOR60015	TOR60015LL	15 (4.5)				93.1 (42.2)															
	TOR60020	TOR60020LL	20 (6.0)				107.8 (48.9)															
	TOR600LCX	TOR600LCXLL	Less Chain				45 (20.4)															
9 (9,000)	TOR90005	TOR90005LL	5 (1.5)	94 (42.6)	112.9 (51.2)	3	109.1 (49.5)	27.36 (695)	2.67 (68)	2.67 (68)	1.96 (50)	14.84 (377)	13.78 (350)	4.56 (116)	7.83 (199)	12.40 (315)	3.39 (86)	4.76 (121)	8.15 (207)	1.18 (30)	4.72 (120)	11.77 (299)
	TOR90010	TOR90010LL	10 (3.0)				131.1 (59.5)															
	TOR90015	TOR90015LL	15 (4.5)				153.2 (69.5)															
	TOR90020	TOR90020LL	20 (6.0)				175.2 (79.5)															
	TOR900LCX	TOR900LCXLL	Less Chain				82.6 (37.5)															

### 3/4, 1-1/2 AND 3 TON UNITS

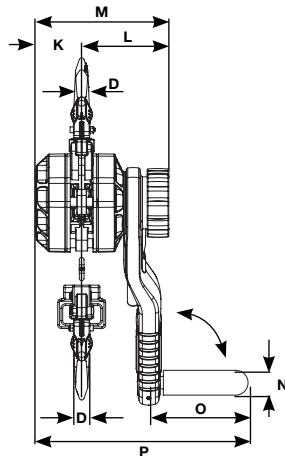
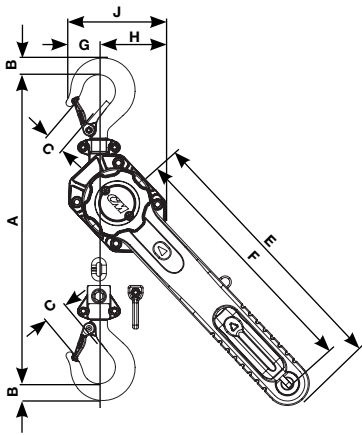

### 6 TON UNITS

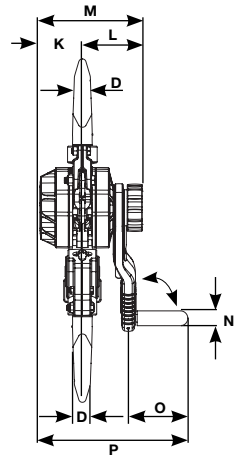
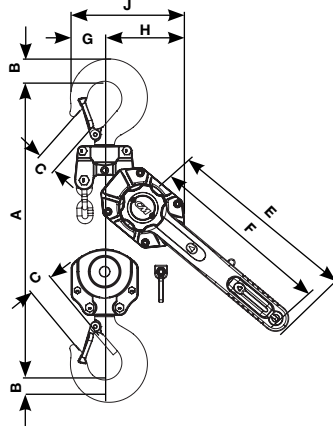

### 9 TON UNITS

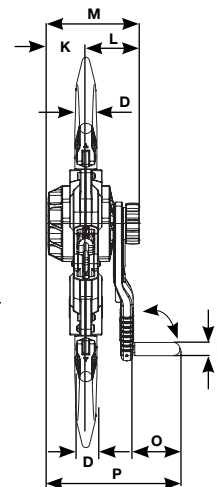
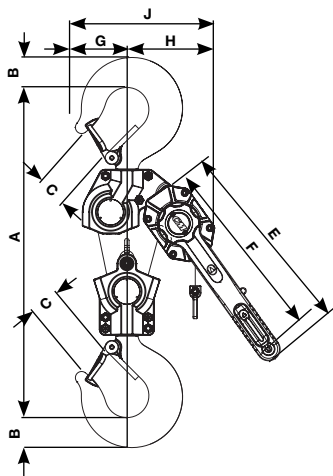

## RATCHET LEVER HOIST

The CM Bandit™ is one of the most compact and durable ratchet lever hoists in the industry. Its lightweight and portable design, easy free-chaining feature and 360° rotating handle make it one of the most versatile hoists on the market today. Now available in 3/4, 1-1/2, 3 and 6 ton capacities for all of your pulling and lifting needs.

- **3/4, 1-1/2, 3 & 6 TON CAPACITIES**
- **METRIC RATED.**
- **STANDARD LIFTS UP TO 20 FEET.**  
Longer lifts are available.

### FEATURES & BENEFITS

#### COMPACT & PORTABLE DESIGN

Rugged, yet lightweight, design and construction allow the Bandit to be easily transported and used in even the most confining spaces.

#### FREE-CHAINING

Easy free-chaining feature allows for quick take up and positioning of slack chain. Designed not to accidentally free chain while under load.

#### 360° ROTATING HANDLE

Full rotation of handle allows for versatile rigging options when working in tight spaces.

#### LOW HANDLE EFFORT

Double reduction gearing provides easy operation with minimal handle effort.

#### COMFORT-FIT HANDLE

Screwed-on comfortable rubber grip makes for a secure hold in all environments.

#### LOAD SECURITY & EASY INSPECTION

Upper and lower hooks feature standard cast safety latches that provide positive and secure load engagement. Hooks are bolted on for easy removal and inspection.

#### MEETS ASME B30.21

#### POSITIVE LOAD CONTROL

Enclosed Weston-type load brake stays clean and dry for positive load positioning.

#### EASY TO POSITION & ATTACH

Upper and lower hooks feature extra-wide throat openings to allow for easier attachment to pick points. Hooks swivel 360° for faster positioning.

#### BUILT TO LAST

Impact-resistant stamped steel housing withstands repeated rigorous use.

#### CORROSION RESISTANT

Standard powder coat finish on housing and zinc plating on major components for extra protection against corrosion when working in harsh environments.

#### 100% LOAD TESTED

#### ZINC PLATED CHAIN

Protects against corrosion.

#### EASY IDENTIFICATION

Each unit has a unique serial number for easy and accurate identification.

#### OPTIONAL SHIPYARD HOOKS

Shipyards hooks are available as an option on 1-1/2 & 3 ton units.

#### OPTIONAL INTERNAL LOAD LIMITER

Allows the handle to rotate but will not lift if load exceeds 125% of the working load limit.

#### SHIPS IN 3 DAYS - GUARANTEED

3/4 & 1-1/2 ton units are eligible for our In-Stock Guarantee.



# BANDIT™ RATCHET LEVER HOIST

## SUGGESTED INDUSTRY APPLICATIONS:



**SHIP BUILDING**  
Position of metal sheets for bolting and welding



**UTILITY LINES & POWER PLANTS**  
Lightweight hoist makes it easier to pull, tighten and secure above ground cables. Compact design makes boiler repairs a much easier task in confined spaces.



**STEEL BEAM & BRIDGE CONSTRUCTION**  
Precise movement for bolt alignment and an excellent tool for deck tensioning



**CONVEYOR MAINTENANCE**  
Great for belt tensioning and repairs

**WASTE TREATMENT PLANTS**  
Excellent for cartridge removal & replacement

**PUMP INSTALLS**  
Small size makes this hoist ideal for lifting condensing units and pumps in confined spaces



## THE WORLD'S FIRST HMI-CERTIFIED RATCHET LEVER HOIST

Columbus McKinnon designed the CM Bandit to be the best lever hoist on the market. As a result, the CM Bandit has become the world's first HMI-Certified ratchet lever hoist, meeting strict, nationally recognized industry standards. This certification supports our commitment to safety, service and aftermarket support. It instills customer confidence in the quality and value of the CM Bandit, which is also backed by our industry-leading lifetime warranty.

### WHAT IS THE HOIST MANUFACTURERS INSTITUTE (HMI)?

HMI members are industry-leading suppliers of material handling equipment, including manual and powered hoist and trolley manufacturing and distribution.

HMI is recognized as the authority and principal resource in the hoist industry. It is the leading advocate for the safe and proper operation of hoisting equipment and related products.

### WHAT DOES HMI-CERTIFIED MEAN?

The purpose of HMI certification is to instill consumer confidence that the product and its manufacturer have met strict HMI requirements, which include that the manufacturer:

- Be a manufacturer of industrial hoisting equipment
- Have its product meet one or more requirements as stated by HMI
- Have a qualified, US-registered professional engineer verify, sign and seal that the product meets the requirements
- Must provide a Declaration of Conformity for Technical, Service and Support

HMI is not a trademark of Columbus McKinnon Corporation.

HOISTS, TROLLEYS & BEAM CLAMPS

## PRODUCT LINE AT A GLANCE (U.S.A MODELS)

Capacities (Ton)	In-Stock Guarantee	Initial Assembly	Final Assembly	Hook Origin	Tri-Point Hook Inspection	Optional Shipyard Hooks
3/4	✓	CMCO China Facility	CMCO USA Facility	CMCO USA Facility		
1-1/2	✓			CMCO USA Facility		✓
3				CMCO China Facility	✓	✓
6				CMCO China Facility	✓	

Check for availability on 3 and 6 ton units.

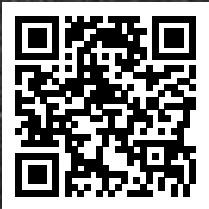

**WATCH OUR  
BANDIT VIDEOS**  
SCAN THE QR CODE  
WITH YOUR SMARTPHONE

# BANDIT™ RATCHET LEVER HOIST

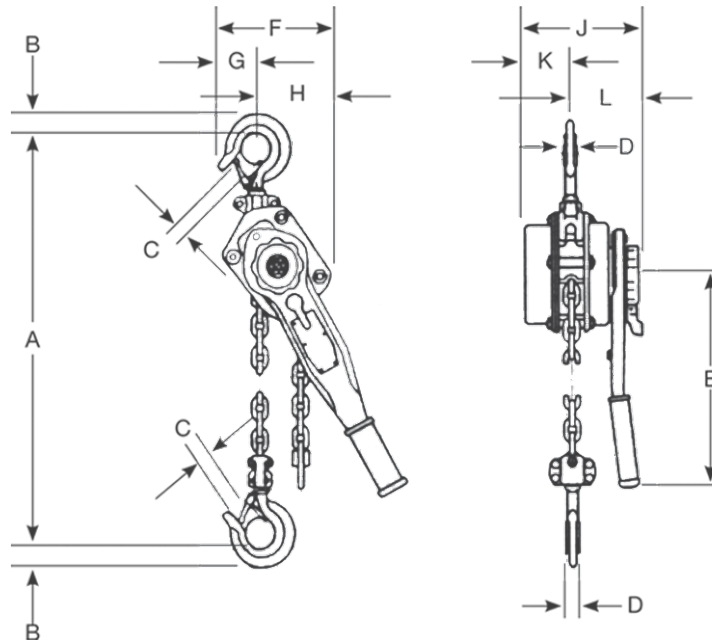

HOISTS, TROLLEYS & BEAM CLAMPS

## DIMENSIONS & SPECIFICATIONS

Model Number	Capacity Metric Rated Ton (kg)	Standard Lift ft. (m)	Lever Pull to Lift Rated Load lbs./ft. (kg)	Weight lbs. (kg)	Dimensions Inches (mm)										
					A	B	C	D	E	F	G	H	J	K	L
BAN07505	3/4 (750)	5 (1.52)	45 (20.41)	13.6 (6.17)	12.80 (325.12)	0.94 (23.88)	1.13 (28.70)	0.69 (17.53)	9.63 (244.60)	4.88 (123.95)	2.19 (55.63)	3.31 (84.07)	6.06 (153.92)	2.11 (53.59)	3.95 (100.33)
BAN07510		10 (3.05)		15.7 (7.12)											
BAN07515		15 (4.57)		18 (8.16)											
BAN07520		20 (6.1)		20.1 (9.12)											
BAN15005	1-1/2 (1500)	5 (1.52)	64 (29.03)	20.7 (9.39)	14.20 (360.68)	1.13 (28.70)	1.25 (31.75)	0.81 (20.57)	10.25 (260.35)	5.63 (143.00)	2.38 (60.45)	3.56 (90.42)	6.75 (171.45)	2.69 (68.33)	4.13 (104.90)
BAN15010		10 (3.05)		24.3 (11.02)											
BAN15015		15 (4.57)		27.9 (12.65)											
BAN15020		20 (6.1)		31.5 (14.29)											
BAN30005	3 (3000)	5 (1.52)	73 (33.11)	38.3 (17.37)	17.50 (444.5)	1.69 (42.93)	1.56 (39.62)	1.25 (31.75)	16.37 (415.8)	7.52 (191.01)	3.38 (85.85)	4.65 (118.11)	7.84 (199.14)	3.29 (83.57)	4.56 (115.82)
BAN30010		10 (3.05)		45.7 (20.73)											
BAN30015		15 (4.57)		53 (24.04)											
BAN30020		20 (6.1)		60.4 (27.4)											
BAN60005	6 (6000)	5 (1.52)	93 (42.18)	63.2 (28.67)	22.00 (558.8)	1.81 (45.97)	2.19 (55.63)	1.50 (38.1)	16.37 (415.8)	9.47 (240.54)	3.38 (85.85)	6.05 (153.67)	7.84 (199.14)	3.29 (83.57)	4.56 (115.82)
BAN60010		10 (3.05)		77.9 (35.33)											
BAN60015		15 (4.57)		92.6 (42.00)											
BAN60020		20 (6.1)		107.3 (48.7)											

Check for availability on 3 and 6 ton units.

# CM HURRICANE 360<sup>°</sup>

## HAND CHAIN HOIST

The CM Hurricane 360<sup>°</sup>™ provides ultimate flexibility for a wide range of applications. The patented hand chain cover rotates a full 360 degrees, allowing operators to lift, pull or position loads from virtually any angle without standing under them.

- 1/2 TO 20 TON CAPACITIES
- STANDARD LIFTS UP TO 30 FT.
- 5-YEAR WARRANTY



## THE CM HURRICANE 360<sup>°</sup>™ IS IDEAL WHEN WORKING:

- **IN TIGHT SPACES** where the rigid handle of a lever hoist would be difficult to maneuver and operate.
- **ABOVE THE LOAD** being lifted.
- **ON A DRIFTING APPLICATION** where the hand chain angle adjusts throughout the operation.
- With large loads to allow the operator to be **A SAFE DISTANCE** away.

### FEATURES & BENEFITS

#### OPERATE FROM ANY ANGLE

360 degree rotating hand chain cover allows the hoist to be operated at any angle from any location, even inverted.

#### STANDARD LOAD LIMITER

For simple, automatic overload protection.

#### BRAKING POWER

Double pawl Weston-Style braking system provides reliable positive load control.

#### POWDER COATED FINISH

For corrosion protection.

#### HEAT TREATED STEEL GEARING

All internal gears and pinions are heat treated steel for high strength and long life.

#### CHAIN GUIDE AND STRIPPER

Assures load chain alignment.

#### PRECISION 4-POCKET LIFTWHEEL

Fully machined for better chain fit and reduced wear allowing for accurate movement of the load chain.

#### HARDENED STEEL CHAIN

Alloy steel load chain assures high strength and long wear life.

#### MINIMAL MAINTENANCE

Easily disassembled, requiring no special tools.

#### MEETS ASME B30.16

And European CE Standard

### OPTIONS

#### ARMY-TYPE, INTEGRATED TROLLEY HOIST

Available in plain or geared trolley configurations.



# HURRICANE 360°™ HAND CHAIN HOIST

## SUGGESTED INDUSTRY APPLICATIONS:



### REFINERIES

Drifting through wall openings



### POWER PLANT MAINTENANCE

Boiler Repair



### CONSTRUCTION

Used in confined spaces when handles could present problems



### THEATRICAL INSTALLATIONS

Truss installations while inverted



### SWITCHGEAR INSTALLS

Used to stand beside the gears instead on over the top pull

### BOILER ROOM MAINTENANCE

Keeps you after from the heater parts if boiler is in use

### MOTOR/PUMP REPLACEMENTS

Pull pumps by standing to the side inside of or under or over the load

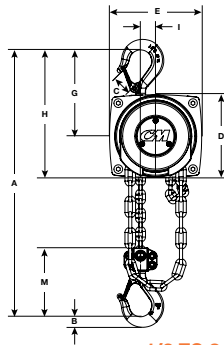

1/2 TO 3 TON

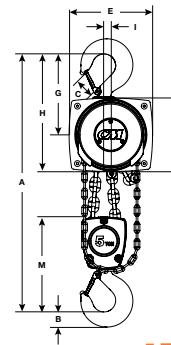
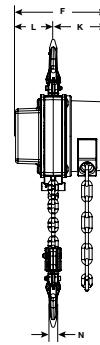

5 TON

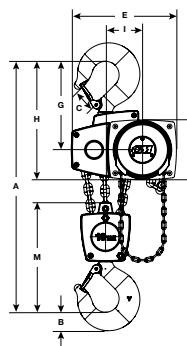
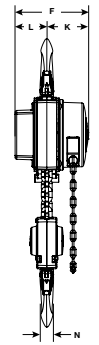

10 TON

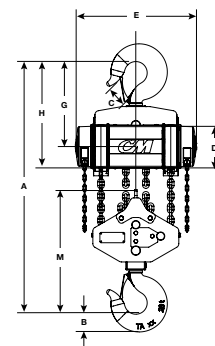
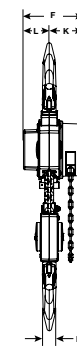

15 & 20 TON

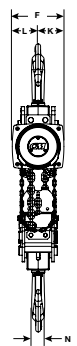

## DIMENSIONS & SPECIFICATIONS

Product Code	Capacity Ton (kg)	Lift		Weight lbs. (kg)	Reeving	Hand Chain Pull to Lift Rated Load lbs. (kg)	Hand Chain Overhauled to Lift Load One Foot ft. (m)	Dimensions in inches (mm)												
		ft.	m					A	B	C	D	E	F	G	H	I	K	L	M	N
5623A	1/2 (500)	10	3	21 (9)	1	44 (20)	30 (9.1)	11.811 (300)	0.669 (17)	0.945 (24)	5.236 (133)	5.827 (148)	5.827 (148)	5.472 (139)	8.110 (206)	0.945 (24)	2.402 (61)	3.425 (87)	4.331 (110)	0.551 (14)
5624A		15	4.5	23 (10)																
5625A		20	6	25 (11)																
5651A		30	9	29 (13)																
5632A		Less Chain		17 (8)																
5626A	1 (1,000)	10	3	28 (13)	1	54 (24)	49 (14.9)	13.189 (335)	0.866 (22)	1.142 (29)	6.142 (156)	6.890 (175)	6.575 (167)	6.457 (164)	9.528 (242)	0.945 (24)	2.756 (70)	3.819 (97)	4.921 (125)	0.748 (19)
5627A		15	4.5	31 (14)																
5628A		20	6	34 (15)																
5653A		30	9	40 (18)																
5633A		Less Chain		23 (10)																
5629A	2 (2000)	10	3	47 (21)	1	74 (34)	71 (21.6)	15.551 (395)	1.181 (30)	1.378 (35)	7.165 (182)	7.992 (203)	7.638 (194)	7.559 (192)	11.142 (283)	1.220 (31)	3.268 (83)	4.370 (111)	6.142 (156)	0.866 (22)
5630A		15	4.5	52 (24)																
5631A		20	6	57 (26)																
5634A		Less Chain		36 (16)																
5635A		3 (3,000)	10	3																
5636A	15		4.5	82 (37)																
5637A	20		6	89 (40)																
5638A	Less Chain		52 (24)																	
5639A	5 (5,000)		10	3	106 (48)	2	76 (34)	174 (53)	25.748 (654)	1.772 (45)	1.850 (47)	8.661 (220)	9.843 (250)	8.622 (219)	9.528 (242)	13.858 (352)	0.827 (21)	3.740 (95)	4.882 (124)	11.220 (285)
5640A		15	4.5	121 (55)																
5641A		20	6	136 (62)																
5642A		Less Chain		74 (34)																
5643A		10 (10,000)	10	3	217 (98)															
5644A	15		4.5	240 (109)																
5645A	20		6	261 (118)																
5646A	Less Chain		168 (76)																	
HU15000H10	15 (15,000)		10	3	455 (206)	6	2 x 76 (2 x 34)	522 (2 x 261) (159.1 (2 x 79.3))	43.543 (1106)	3.386 (86)	3.150 (80)	8.661 (220)	23.071 (586)	9.843 (250)	16.181 (411)	20.512 (521)	-	4.921 (125)	4.921 (125)	23.740 (603)
HU15000H15		15	4.5	508 (230)																
HU15000H20		20	6	554 (251)																
HU15000H30		30	9	653 (296)																
HU20000H10	20 (20,000)	10	3	455 (206)	6	2 x 102 (2 x 46)	522 (2 x 261) (159.1 (2 x 79.3))	43.543 (1106)	3.386 (86)	3.150 (80)	8.661 (220)	23.071 (586)	9.843 (250)	16.181 (411)	20.512 (521)	-	4.921 (125)	4.921 (125)	23.740 (603)	2.480 (63)
HU20000H15		15	4.5	508 (230)																
HU20000H20		20	6	554 (251)																
HU20000H30		30	9	653 (296)																

Other lifts available. Contact factory.  
Standard Hand Chain drop 2 ft. less than Lift.



# CTP ADJUSTABLE TROLLEY CLAMP

## ADJUSTABLE TROLLEY CLAMP

A heavy duty adjustable trolley designed for easy installation while offering superior strength and stability throughout its long service life.

### SPECIFICATIONS

- 2,200 TO 6,600 LB. CAPACITIES
- I-BEAM WIDTHS FROM 2-1/4 TO 12-1/2 IN.
- MINIMUM RADIUS CURVES OF 24, 35 AND 45 IN.

### FEATURES & BENEFITS

**ADJUSTS TO FIT A RANGE BEAM WIDTHS**  
Easily hand-adjusted with its central threaded spindle to fit a wide range of beam widths.

**QUICK & EASY INSTALLATION**  
The CTP requires no tools to install.

**CORROSION RESISTANT**  
Zinc plated spindles for added protection against the elements.

**SAFE & SECURE**  
Unique Locking Nut Handle prevents spindle from loosening.

**THE SMART & ECONOMICAL CHOICE**  
With its competitive price and universal Hanging Clevis able to accept most hoists, the CTP is a tremendous value.

### METRIC RATED

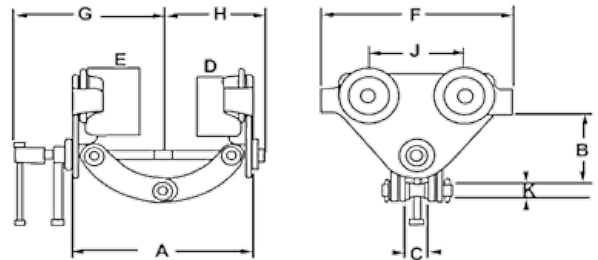

Capacity		Product Code	Model	I-Beam Width (in.)	Minimum Radius Curve (in.)	Wheel Diameter (in.)	Dimensions (in.)													Weight (lbs.)
(lbs.)	(ton)						A		B		C	D	E	F	G	H	J	K		
							Min.	Max.	Min.	Max.										
2,200	1	05500024	CTP/A 1T	2-1/4 to 6	24	2.36	3.74	7.283	3.228	4.291	1.026	2.598	2.874	6.299	6.020	4.134	2.952	0.787	5.5	
4,400	2	05500025	CTP/A 2T	3 to 7-7/8	35	3.27	4.921	9.843	4.173	6.102	1.653	3.543	3.937	10.236	8.070	5.471	5.118	0.787	21.8	
4,400	2	05500026	CTP/B 2T	7-7/8 to 11-7/8	35	3.27	4.921	9.843	5.365	7.519	1.653	3.543	3.937	10.236	10.039	7.441	5.118	0.787	22.7	
6,600	3	05500027	CTP/A 3T	3 to 7-7/8	45	4.37	5.315	10.236	5.039	6.732	1.969	4.331	4.921	12.207	8.661	6.102	5.906	0.866	38.6	
6,600	3	05500028	CTP/B 3T	7-7/8 to 12-1/2	45	4.37	5.315	10.236	5.905	8.346	1.969	4.331	4.921	12.207	11.02	8.464	5.906	0.866	43.0	

► To see our full line of hoists, trolleys & beam clamps, visit us online at [www.cmworks.com](http://www.cmworks.com)

PHONE: 800.888.0985



# CM BEAM CLAMP

## BEAM CLAMP

Ideal as a semi-permanent lifting point for rigging operations (vertical or horizontal), as a hoisting anchor, or as a tool for positioning and holding beams for welding. The Beam Clamp is recommended for commercial, construction and industrial applications.

### SPECIFICATIONS

- 2,000 TO 20,000 LB. CAPACITIES
- I-BEAM WIDTHS FROM 3 TO 12.2 IN.

### FEATURES & BENEFITS

#### REDUCED FLANGE STRESS

Special clamp jaw design distributes load away from flange edge.

#### ADJUSTABLE

Threaded mechanism fits securely on a wide range of flange widths and beam sizes.

#### LOW HEADROOM

Provided by built-in suspension bar.

#### LIFETIME WARRANTY



HOISTS, TROLLEYS  
& BEAM CLAMPS

Capacity		Product Code	Model Number	I-Beam Width (in.)	Weight (lbs.)
(lbs.)	(ton)				
2,000	1	09001W	BC-1	3 to 9	9
4,000	2	09002W	BC-2	3 to 9	13
6,000	3	09003W	BC-3	3.2 to 12.6	18
10,000	5	09004W	BC-5	3.6 to 12.2	22
20,000	10	09005W	BC-10	3.6 to 12.6	34

► To see our full line of hoists, trolleys & beam clamps, visit us online at [www.cmworks.com](http://www.cmworks.com)



# Camlok™ SCREWLOK BEAM CLAMP WITH SHACKLE

## BEAM CLAMP

Screwlok Beam Clamps are designed for attachment to the lower flanges of structural steel beams to provide a semi-permanent lifting point. The clamps can be quickly and easily attached via the screw-type mechanism.

### BENEFITS & FEATURES

- Designed to fit flanges of most structural beams
- Act as a semi-permanent lifting point for use with manual or electric hoists
- Shackle incorporated for quick and easy component attachment

Product Code	Working Load Limit (lbs.)	Jaw Capacity (in.)	Dimensions (in.)						Weight (lbs.)
			A	B	C	D	E	F	
SC921	2,200	3 to 8-1/4	12.625	12.125	1.750	8.250	5.375	2.625	11.0
SC922	4,400	3 to 8-1/4	12.625	12.875	1.750	8.250	5.375	2.875	13.5
SC923	6,600	4 to 10-5/8	16.125	14.750	1.750	10.625	6.500	4.000	17.5
SC923/L	6,600	3 to 12	17.375	16.500	1.750	12.000	8.625	4.000	20.0
SC925	11,000	4 to 10-5/8	16.125	15.375	2.125	10.625	8.500	4.375	22.0
SC925/L	11,000	3 to 12	17.125	17.125	2.125	12.000	8.625	4.375	26.5
SC9210	22,000	3 to 12	18.125	20.000	3.250	12.000	8.625	4.375	35.5

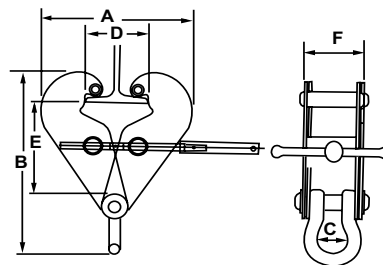

### ► INSPECTION, CARE & USE

**DO NOT** side load more than 15 degrees.

**DO NOT** use as a lifting device. Clamp should only be used for suspension or to anchor a hoist



For more information, visit us at  
[www.cmworks.com](http://www.cmworks.com)

# Camlok™ SC SERIES TWIN BEAM CLAMP

## BEAM CLAMP

Twin Beam Clamps enable one beam to be suspended beneath another beam. These clamps are designed for easy attachment and can only be used with a minimum of two suspension points.

### BENEFITS & FEATURES

- Enables one beam to be suspended beneath another
- Quickly and easily attaches to both beams
- Supplied fixed at parallel, at 90 degrees to each other or with swivel that allows for 360 degree rotation
- Used for supporting vertical loads only

Product Code	Working Load Limit (lbs.)	Flange Width		Weight (lbs.)
		Minimum (in.)	Maximum (in.)	
SC922T	4,400	2.995	8.387	28.7
SC923T	6,600	3.994	10.783	35.3
SC923/LT	6,600	2.995	12.181	44.1
SC925/LT*	11,000	2.995	12.181	59.5
SC925/T	11,000	3.000	12.000	35.5

\*Not Stocked



HOISTS, TROLLEYS  
& BEAM CLAMPS

## ORGANIZATIONS

### ACRP

Association of Crane & Rigging Professionals  
28175 Haggerty Road, Novi, MI 48377  
(800) 690-3921

### ANSI

Refers to American National Standards Institute  
Specifications published by ANSI  
1899 L Street, NW, 11th Floor Washington, DC, 20036  
(202) 293-8020.

### ASME

The American Society of Mechanical Engineers  
Two Park Avenue, New York, NY 10016-5990  
(800) 843-2763.

### ASTM

Refers to American Society of Testing and Materials  
Specifications published by ASTM  
100 Barr Harbor Dr., West Conshohocken, PA 19428  
(610) 832-9500

### AWEA

American Wind Energy Association  
1501 M St. NW, Suite 1000, Washington, DC 20005  
(202) 383-2500

### AWRF

Associated Wire Rope Fabricators  
P.O. Box 748, Walled Lake, MI 48390  
(800) 444-2973

### CVSA

Commercial Vehicle Safety Alliance  
6303 Ivy Lane, Suite 310, Greenbelt, MD 20770-6319  
(301) 830-6143

### DOT

Department of Transportation  
1200 New Jersey Ave, SE, Washington, DC 20590  
(202) 366-4000

### ISO

International Organization for Standardization  
ISO Central Secretariat: Geneva Switzerland

### NACM

Refers to National Association of Chain Manufacturers  
Specifications published by NACM  
Post Office Box 89014, Tucson, AZ 85752-9014  
(520) 886-0695

### OSHA

Occupational Safety & Health Administration  
U.S. Department of Labor  
200 Constitution Avenue, Washington, D.C. 20210  
(800) 321-6742.

### SC&RA

Specialized Carriers & Rigging Association  
5870 Trinity Parkway, Suite 200, Centreville, VA 20120  
(703) 698-0291

### WSTDA

Web Sling & Tie Down Association  
(443) 640-1070.

## INDUSTRY TERMS

### ANGLE OF LOADING

The acute angle between the horizontal and the leg of the rigging referred to as the horizontal angle.

### BASKET HITCH

Rigging a sling in which the sling is passed around the load and both loop eyes or end fittings are attached to the hoist, crane or lifting device.

### BRIDLE SLING

Sling composed of multiple legs with a fitting that attaches to the lifting hook.

### CHOKER HITCH

A type of rigging hitch in which the sling is passed around the load then through one loop eye or other end fitting, with the other loop eye or end fitting attached to the hoist, crane, or lifting device. This method will reduce the lifting capacity of a sling.

### CLEVIS

A U-shaped fitting with holes in each end through which a pin or bolt is run.

### COMPETENT PERSON

As defined by OSHA, this is someone who is capable of identifying existing and predictable hazards in the surroundings or working conditions which are unsanitary, hazardous, or dangerous to employees, and who has authorization to take prompt corrective measures to eliminate them.

### COUPLING LINK

An alloy steel welded connector used as an intermediate link to join alloy steel chain to master links.

### DATE CODE (ALSO KNOW AS TRACE CODE)

A series of letters, numbers or both embossed on products that identifies its manufacturing history.

### DESIGN FACTOR (SAFETY FACTOR)

An industry term usually computed by dividing breaking strength by the catalog working load limit and generally expressed as a ratio – for example 4:1.

### ELONGATION

A test performed on products to determine the amount of stretch prior to fracture. This is typically stated as a percentage.

### LOAD

The total force to be overcome by the hoisting and rigging equipment.

### MASTER LINK

Forged or welded steel link used to support all legs of an alloy-steel chain or wire rope sling.

### MECHANICAL COUPLING LINK

A non-welded, mechanically closed steel link used to attach master links, hooks, and other attachments to alloy steel chain.

### MESSENGER SLING

A short, standard eye-eye wire rope sling often used to connect between a crane hook and another wire rope sling or bridle.

### MINIMUM BREAK FORCE OR MBS

The minimum load/force a product is designed to hold before failure. This test is a manufacturer's attribute acceptance test and SHALL NOT be used as criteria for service and design purposes.

### **OVERHEAD LIFTING**

The process of lifting that would elevate a freely suspended load to such a position that dropping the load would present a possibility of bodily injury or property damage.

### **OVERLOAD**

A static or dynamic load in excess of the "Working load Limit."

### **PROOF LOAD**

The load applied during a manufacturing proof test.

### **PROOF TEST OR PROOF FORCE**

The minimum tensile force applied to a product under a constantly increasing force in direct tension during manufacturing. These tests are manufacturing integrity tests and SHALL NOT be used as criteria for service and design purposes.

### **QUALIFIED PERSON**

As defined by OSHA, this is someone who by possession of a recognized degree, certificate, or professional standing, or who by extensive knowledge, training, and experience, has successfully demonstrated his/her ability to solve or resolve problems relating to the subject matter, the work, or the project.

### **RATED LOAD (CAPACITY)**

The maximum load designated by the manufacturer for which a crane, hoist, rigging, or other lifting device is designed and built. Can also be expressed as WLL, SWLL or Capacity.

### **REACH**

The effective length of an alloy steel chain sling measured from the top bearing surface of the upper terminal component to the bottom bearing surface of the lower terminal component.

### **SAFE WORKING LOAD LIMIT OR SWLL**

The maximum rated capacity that shall be applied in direct tension to an undamaged straight-line product.

### **SHOCK LOADING**

Any condition of rapid lift, sudden shifting of load or arrest of a falling load.

### **SLINGS**

An assembly made of chain, wire rope or synthetic material with or without end fittings that connects to a lifting mechanism at the top and lower portion supports the load.

### **TRACE CODE**

A series of letters, numbers or both embossed on products that identifies its manufacturing history.

### **TEST LOAD**

A load that is periodically applied to hoisting equipment to ensure that it has the ability to safely handle the rated capacity of the equipment. The test load ranges from 100 to 125 percent of the rated load capacity.

### **VERTICAL HITCH**

A method of supporting a load by a single, vertical part or leg of the sling.

### **WORKING LOAD LIMIT (WLL)**

The working load limit of a chain is the maximum load in pounds that should ever be applied to a chain, even when the chain is new and the load is applied in direct tension to a straight length of chain.

PRODUCT NAME	PAGE
<b>A</b>	
Aircraft Assembly .....	137
Alloy “S” Hook (Grade 80) .....	99
<b>B</b>	
Bandit™ Ratchet Lever Hoist .....	172-175
Beam Clamp .....	179
BTG Groundworks .....	129
Bundling Clip .....	110
Buoy Chain .....	152
<b>C</b>	
CG Girder Turning Clamps .....	123
CH Heavy-Duty Horizontal Plate Clamp .....	121
Chain (Herc-Alloy® 1000) .....	64
Chain (Herc-Alloy 800®) .....	76
Chain Sling ID Tags .....	64, 76
Chain Shortener (Herc-Alloy 1000) .....	68
CLB Container Lifting Lugs .....	102, 128
Clevis Assembly (Grade 43) .....	148
Clevis Assembly (Grade 70) .....	136
Clevis Assembly with Import Hooks (Grade 70) .....	136
Clevis Grab Hook (Grade 30/43) .....	151
Clevis Grab Hook (Grade 70) .....	139
Clevis Grab Hook (Grade 80) .....	139
Clevis Slip Hook (Grade 30/43) .....	150
Clevis Slip Hook (Grade 70) .....	141
Clevis Style Heavy-Duty Tie-Downs .....	142
Clevlok® Cradle Grab Hook (Dual Rated) .....	70, 84
Clevlok® Foundry Hook (Dual Rated) .....	70
Clevlok® Grab Hook without Cradle (Grade 80) .....	84
Clevlok® Sling Hook (Dual Rated) .....	69, 83
Clevlok® Style Heavy-Duty Tie-Downs .....	142
CLT Container Lifting Lugs .....	102, 128
CMG Ratchet & Lever Binders .....	145
CP Pile Pitching Clamp .....	122
CTP Adjustable Trolley Clamp .....	178
CX Heavy Duty Hinged Universal Plate Clamp .....	118
CY Hinged Universal Plate Clamp .....	117
CZ Universal Plate Clamp .....	116
<b>D</b>	
D-Rings .....	146
Double Clevis (Mid-Link) .....	138

PRODUCT NAME	PAGE
<b>E</b>	
E-Z Pro® Cam Release Lever Binder .....	145
EZ•Connect Master Link & Chain Shortener (Dual Rated) .....	67
Eye Cradle Grab Hook (Dual Rated) .....	70, 85
Eye Foundry Hook (Dual Rated) .....	71, 85
Eye Grab Hook (Grade 30/43) .....	151
Eye Grab Hook (Grade 70) .....	139
Eye Grab Hook (Grade 80) .....	139
Eye Sling Hook (Dual Rated) .....	69, 83
Eye Slip Hook (Grade 30/43) .....	150
Eye Slip Hook (Grade 70) .....	141
<b>F</b>	
Flat Bottom Master Link (Grade 80) .....	79
Flat-Eye Rigging Hook .....	90
Forged Lever Load Binder .....	144
Forged Master Link (Grade 80) .....	78, 103
Forged Ratchet Load Binder .....	143
<b>G</b>	
Grab Link (Grade 80) .....	81
<b>H</b>	
Hammerlok® (Dual Rated) .....	68
Hammerlok® (Grade 80) .....	82
Hanger Chain (Grade 30) .....	149
HG High Grip Plate Clamp .....	125
HGC Hand Grip Clamp .....	129
High Test Chain (Grade 43) .....	147
Hurricane 360™ Hand Chain Hoist .....	176-177
<b>L</b>	
Latchlok Hook® - Clevlok® Style (Herc-Alloy® 1000) .....	72
Latchlok Hook® - Eye Style (Herc-Alloy® 1000) .....	72
Latchlok Hook® - Swivel Style (Herc-Alloy® 1000) .....	73
LJ Gentle Grip Clamp .....	119
<b>M</b>	
Master Link (Dual Rated) .....	66, 78, 102
Master Link with & without Flats (Grade 80) .....	79, 102
Master Ring (Grade 80) .....	81
Mid-Grip Wire Rope Clips .....	108
<b>O</b>	
Omegalok Connector (Dual Rated) .....	68



PRODUCT NAME	PAGE
<b>P</b>	
Pear Shaped Master Link (Herc-Alloy® 1000).....	67
Piggyback® Wedge Socket Clips .....	109
Plate Hook (Grade 80).....	99
Proof Coil Chain (Grade 30).....	149
<b>Q</b>	
Quick Connect™ Hook .....	91
<b>R</b>	
Ratchet Binders Heavy-Duty Tie Downs.....	142
Removable Handle Load Binder .....	143
Replacement Hook with Latch.....	102
Replacement Latches (for swivel, rigging & shank hooks).....	101
Rigging Hook (Dual Rated, for use with chain).....	69
Rigging Hook .....	100
Rivet Assembly (Grade 70).....	137
<b>S</b>	
S.T.A.C. Chain .....	156
S.T.A.C. Chain Sets .....	156
SC Series Twin Beam Clamp.....	181
Screwlok Beam Clamp with Shackle .....	180
Shackles - Alloy Anchor .....	53
Shackles - Alloy Web Sling.....	56
Shackles - Carbon Anchor (Industrial/Government) .....	54
Shackles - Carbon Chain (Industrial/Government).....	55
Shackles - Carbon Web Sling .....	56
Shackles - Long Reach .....	57
Shackles - Super Strong Anchor.....	51
Shackles - Super Strong Chain .....	52
Shackles - Theatrical.....	157
Shackles - Trawling .....	57
Shank Hook (Grade 80).....	98
Sixth Wheel Ratchet.....	146
Sling ID Tags.....	64, 76
Sorting Hook (Grade 80).....	98
Specialty Forged Lever Load Binder .....	144
Sub-Assembly (Dual Rated) .....	66, 80
Swivel Rigging Hook .....	100

PRODUCT NAME	PAGE
<b>T</b>	
THK Horizontal Plate Clamp.....	124
THS Plate Clamp.....	126
Tornado 360° Ratchet Lever Hoist .....	168-171
Transport (Binding) Chain (Grade 70) .....	134
TSH Screw Clamp .....	127
TTG Horizontal Girder Clamp.....	122
TTR Girder Clamp .....	120
Turnbuckles .....	106
<b>W</b>	
Weblok Assembly .....	82
Welded Assembly (Grade 43).....	47
Welded Assembly (Grade 70).....	135
Wide Body Sub-Assembly with Flats.....	80, 105
Wire Rope Clips.....	107
<b>Y</b>	
Yale® Import Weld-On Lifting Hook .....	101

PRODUCT NAME PAGE

## SHACKLES

Shackles - Super Strong Anchor.....	51
Shackles - Super Strong Chain.....	52
Shackles - Alloy Anchor.....	53
Shackles - Carbon Anchor (Industrial/Government).....	54
Shackles - Carbon Chain (Industrial/Government).....	55
Shackles - Alloy Web Sling.....	56
Shackles - Carbon Web Sling.....	56
Shackles - Long Reach.....	57
Shackles - Trawling.....	57

## CHAIN SLING COMPONENTS (Rated for Overhead Lifting)

### HERC-ALLOY® 1000 (AND DUAL RATED) PRODUCTS

Chain (Herc-Alloy® 1000).....	64
Sling ID Tags.....	64
Master Link (Dual Rated).....	66
Sub-Assembly (Dual Rated).....	66
Pear Shaped Master Link (Herc-Alloy® 1000).....	67
EZ•Connect Master Link & Chain Shortener (Dual Rated).....	67
Hammerlok® (Dual Rated).....	68
Chain Shortener (Herc-Alloy 1000).....	68
Omegalok Connector (Dual Rated).....	68
Rigging Hook (Dual Rated).....	69
Clevlok® Sling Hook (Dual Rated).....	69
Eye Sling Hook (Dual Rated).....	69
Clevlok® Cradle Grab Hook (Dual Rated).....	70
Eye Cradle Grab Hook (Dual Rated).....	70
Clevlok® Foundry Hook (Dual Rated).....	71
Eye Foundry Hook (Dual Rated).....	71
Latchlok® Hook - Clevlok® Style (Herc-Alloy® 1000).....	72
Latchlok® Hook - Eye Style (Herc-Alloy® 1000).....	72
Latchlok® Hook - Swivel Style (Herc-Alloy® 1000).....	73

### HERC-ALLOY 800® (AND DUAL RATED) PRODUCTS

Chain (Herc-Alloy 800®).....	76
Sling ID Tags.....	76
Master Link (Dual Rated).....	78
Forged Master Link (Grade 80).....	78
Flat Bottom Master Link (Grade 80).....	79
Master Link with & without Flats (Grade 80).....	79
Sub-Assembly (Dual Rated).....	80
Wide Body Sub-Assembly with Flats.....	80
Grab Link (Grade 80).....	81
Master Ring (Grade 80).....	81
Hammerlok® (Grade 80).....	82
Weblok Assembly (Grade 80).....	82
Clevlok® Sling Hook (Dual Rated).....	83
Eye Sling Hook (Dual Rated).....	83
Clevlok® Grab Hook without Cradle (Grade 80).....	84
Clevlok® Cradle Grab Hook (Dual Rated).....	84
Eye Cradle Grab Hook (Dual Rated).....	85
Eye Foundry Hook (Dual Rated).....	85

PRODUCT NAME PAGE

## SYNTHETIC SLING COMPONENTS (Rated for Overhead Lifting)

Weblok™ Assemblies.....	88
Flat-Eye Rigging Hooks.....	90
Quick Connect™ Hooks.....	91
Web Sling Shackles.....	92
Master Links With And Without Flats.....	93
Wide Body Sub-Assemblis With Flats.....	93

## RIGGING HARDWARE

Shank Hook (Grade 80).....	98
Sorting Hook (Grade 80).....	98
Alloy "S" Hook (Grade 80).....	99
Plate Hook (Grade 80).....	99
Swivel Rigging Hook.....	100
Rigging Hook.....	100
Replacement Latches (for swivel, rigging & shank hooks)....	101
Yale® Import Weld-On Lifting Hook.....	101
Replacement Hook with Latch.....	102
CLB Container Lifting Lugs.....	102
CLT Container Lifting Lugs.....	102
Master Link (Dual Rated).....	103
Forged Master Link (Grade 80).....	103
Master Link with & without Flats (Grade 80).....	104
Wide Body Sub-Assembly with Flats.....	105
Turnbuckles.....	106
Wire Rope Clips.....	107
Mid-Grip Wire Rope Clips.....	108
Piggyback® Wedge Socket Clips.....	109
Bundling Clip.....	110

## BELOW THE HOOK ATTACHMENTS

CZ Universal Plate Clamp.....	116
CY Hinged Universal Plate Clamp.....	117
CX Heavy Duty Hinged Universal Plate Clamp.....	118
LJ Gentle Grip Clamp.....	119
TTR Girder Clamp.....	120
CH Heavy-Duty Horizontal Plate Clamp.....	121
CP Pile Pitching Clamp.....	122
TTG Horizontal Girder Clamp.....	122
CG Girder Turning Clamps.....	123
THK Horizontal Plate Clamp.....	124
HG High Grip Plate Clamp.....	125
THS Plate Clamp.....	126
TSH Screw Clamp.....	127
CLB Container Lifting Lugs.....	128
CLT Container Lifting Lugs.....	128
HGC Hand Grip Clamp.....	129
BTG Groundworks.....	129

PRODUCT NAME PAGE

**TRANSPORT CHAIN & ATTACHMENTS**

Transport (Binding) Chain (Grade 70) ..... 134  
 Welded Assembly (Grade 70) ..... 135  
 Clevis Assembly (Grade 70) ..... 136  
 Clevis Assembly with Import Hooks (Grade 70)..... 136  
 Aircraft Assembly ..... 137  
 Rivet Assembly (Grade 70) ..... 137  
 Double Clevis (Mid-Link) ..... 138  
 Clevis Grab Hook (Grade 70) ..... 139  
 Clevis Grab Hook (Grade 80) ..... 139  
 Eye Grab Hook (Grade 70) ..... 140  
 Eye Grab Hook (Grade 80) ..... 140  
 Clevis Slip Hook (Grade 70) ..... 141  
 Eye Slip Hook (Grade 70) ..... 141  
 Clevis Style Heavy-Duty Tie-Downs..... 142  
 Clevlok® Style Heavy-Duty Tie-Downs..... 142  
 Ratchet Binders Heavy-Duty Tie Downs..... 142  
 Forged Ratchet Load Binder ..... 143  
 Forged Lever Load Binder..... 144  
 Specialty Forged Lever Load Binder ..... 144  
 CMG Ratchet & Lever Binders ..... 145  
 E-Z Pro® Cam Release Lever Binder ..... 145  
 D-Rings ..... 146  
 Sixth Wheel Ratchet..... 146  
 High Test Chain (Grade 43) ..... 147  
 Clevis Assembly (Grade 43) ..... 148  
 Welded Assembly (Grade 43) ..... 148  
 Hanger Chain (Grade 30)..... 149  
 Proof Coil Chain (Grade 30)..... 149  
 Clevis Slip Hook (Grade 30/43) ..... 150  
 Eye Slip Hook (Grade 30/43)..... 150  
 Clevis Grab Hook (Grade 30/43) ..... 151  
 Eye Grab Hook (Grade 30/43)..... 151  
 Buoy Chain..... 152

PRODUCT NAME PAGE

**ENTERTAINMENT RIGGING PRODUCTS**

S.T.A.C. Chain ..... 156  
 S.T.A.C. Chain Sets ..... 156  
 Shackles - Theatrical..... 157

**HOISTS, TROLLEYS & BEAM CLAMPS**

CM Tornado 360°™ Ratchet Lever Hoist ..... 168-171  
 CM Bandit™ Ratchet Lever Hoist..... 172-175  
 CM Hurricane 360°™ Hand Chain Hoist ..... 176-177  
 CTP Adjustable Trolley Clamp..... 178  
 Beam Clamp..... 179  
 Screwlok Beam Clamp with Shackle ..... 180  
 SC Series Twin Beam Clamp..... 181

# (BY PRODUCT CODE)

PRODUCT  
CODE PAGE

0002145.....171	1209JJ .....106	3X847.....106	48305CMG .....145	4X1311M .....101
0404EE.....106	1212EE.....106	3X849L.....106	48306.....144	4X1311S .....101
0404HE.....106	1212HE.....106	3X849R.....106	48358.....142, 143	4X1315.....100, 101
0404HH.....106	1212HH.....106	3X850L.....106	48360.....142, 143	4X1315M .....101
0404JJ .....106	1212JJ .....106	3X851L.....106	48362CMG .....145	4X1322.....100, 101
0504EE.....106	1218EE.....106	3X852L.....106	48363.....143	4X1322M .....101
0504HE.....106	1218HE.....106	3X853L.....106	48364.....143	4X1330.....100
0504HH.....106	1218JJ .....106	3X855L.....106	48365.....142, 143	4X1337.....100
0504JJ .....106	1412EE.....106	3X866L.....106	48366.....142, 143	4X1345.....100
0606EE.....106	1412JJ .....106	4340890.....153	48367.....142, 143	4X1360.....100
0606HE.....106	1418EE.....106	4340890G.....153	48385.....144	4X405.....101, 141
0606HH.....106	1418HH.....106	4340990.....153	48387.....142, 143	4X406.....101, 141
0606JJ .....106	1418JJ .....106	4341090.....153	48395.....144	4X410.....101, 141, 150
0806EE.....106	1606EE.....106	457106.....64, 76	48405.....145	4X412.....101
0806HE.....106	1606JJ .....106	458618.....63, 69, 83	48405CMG .....145	4X414.....101
0806HH.....106	1612EE.....106	458622.....63, 69, 83	48406.....145	4X455321.....69, 83
0806JJ .....106	1612HE.....106	458625.....63, 69, 83	48455.....143	4X455322 .....69, 83
0809EE.....106	1612HH.....106	458628.....63, 69, 83	48458.....143	4X455325 .....69, 83
0809HE.....106	1612JJ .....106	458629.....63, 69, 83	48769.....144	4X455328 .....69, 83
0809HH.....106	1618EE.....106	458630.....63, 69, 83	48810.....143	4X455329 .....69, 83
0809JJ .....106	1618HE.....106	458732.....83	48811.....143	4X455330 .....69, 83
0812EE.....106	1618HH.....106	458733.....83	495822 .....68	5500024.....178
0812HE.....106	1618JJ .....106	458735.....83	495823 .....68, 69, 83, 84	5500025.....178
0812HH.....106	1624EE.....106	462528 .....99	495824.....69, 71, 83	5500026.....178
0812JJ .....106	1624JJ .....106	462537 .....99	495826.....83	5500027.....178
09001W .....179	2012EE.....106	462550 .....99	495827.....69	5500028.....178
09002W .....179	2012JJ .....106	462562.....99	495828.....68, 69, 71, 84	554320.....81
09003W .....179	2018EE.....106	462575.....99	495829.....69, 71, 84	554326.....81
09004W .....179	2018JJ .....106	462587.....99	495849.....69, 83	554327.....81
09005W .....179	2024EE.....106	474503.....85	4X1302.....69, 100, 101, 141	554611.....81
1006EE.....106	2024JJ .....106	474504.....85	4X1302M .....101	554613.....81
1006HE.....106	2412EE.....106	474505.....85	4X1302S .....101	554615.....81
1006HH.....106	2412JJ .....106	474798.....63, 71, 85	4X1303.....69, 100, 101	554617.....81
1006JJ .....106	2418EE.....106	474799.....63, 71, 85	4X1303M .....101	554619.....81
1009EE.....106	2418HE.....106	474800.....63, 71, 85	4X1303S .....101	554623.....81
1009HE.....106	2418HH.....106	474801.....63, 71, 85	4X1304.....69, 100, 101, 141	554627.....81
1009HH.....106	2418JJ .....106	474802.....63, 71, 85	4X1304M .....101	554635.....81
1009JJ .....106	2424EE.....106	475798.....63, 71	4X1304S .....101	554636.....81
1012EE.....106	2424HE.....106	475799.....63, 71	4X1305.....69, 100, 101, 141	554640.....81
1012HE.....106	2424HH.....106	475800.....63, 71	4X1305M .....101	554702.....62, 67
1012HH.....106	2424JJ .....106	475801.....63, 71	4X1305S .....101	554706.....62, 67
1012JJ .....106	3315WLP .....173	475802.....63, 71	4X1307.....69, 100, 101	554710.....62, 67
1206EE.....106	34902R082P .....146	48211.....101	4X1307M .....101	554714.....62, 67
1206HE.....106	34902R132P .....146	48213.....101	4X1307S .....101	554719.....62, 67
1206JJ .....106	34902R202P .....146	48214.....101	4X1309.....69, 100, 101	554723.....67
1209EE.....106	37111.....146	48304.....144	4X1309M .....101	554726.....62, 67
1209HE.....106	3X845.....106	48304CMG .....145	4X1309S .....101	554731.....67
1209HH.....106	3X845L.....106	48305.....144	4X1311.....100, 101	554942.....78, 103

**PRODUCT  
CODE**

**PAGE**

554944.....	78, 103	557722.....	62, 69, 83	5641A.....	177	607128.....	76	638291CRV.....	137
554945.....	78, 103	558332.....	83	5642A.....	177	607321.....	62	638292.....	136
554952.....	78, 103	558333.....	83	5643A.....	177	607328.....	62	638292CRV.....	137
554969.....	78, 103	558335.....	83	5644A.....	177	607337CL20.....	142	638293.....	136
554970.....	78, 103	558618.....	63, 69, 83	5645A.....	177	607337CL25.....	142	638293CRV.....	137
554980.....	80	558622.....	63, 69, 83	5646A.....	177	607339.....	62	638294.....	136
554981.....	80	558625.....	63, 69, 83	5651A.....	177	607351.....	62	638294CRV.....	137
554983.....	80	558628.....	63, 69, 83	5653A.....	177	607363.....	62	638313.....	136
554332.....	81	558629.....	63, 69, 83	595523.....	69, 83	607378.....	62	638350.....	136
554949.....	78, 103	558630.....	63, 69, 83	595525.....	69, 83	608401.....	148	638350GGC20.....	136
554950.....	79	559100.....	85	595528.....	69, 83	608927.....	134	638558.....	135
554951.....	78, 103	559124.....	85	595529.....	69, 83	608935.....	134	639024.....	135
554957.....	78, 103	559387.....	85	595530.....	69, 83	608941.....	134	639032GGC20.....	136
554965.....	79	559724.....	63, 70, 85	595530.....	101	608954.....	134	639032GGC25.....	136
554966.....	79	559725.....	63, 70, 85	595532.....	83	609035.....	134	639038GGC20.....	136
555231.....	62, 66, 78, 103	559737.....	63, 70, 85	595533.....	83, 101	609041.....	134	639038GGC25.....	136
555232.....	62, 66, 78, 103	559750.....	63, 70, 85	595535.....	83	61193.....	151	639058.....	135
555232S1.....	62, 67	559762.....	63, 70, 85	595781.....	68, 69, 83, 84	61293.....	151	639060.....	135
555232S2.....	62, 67	559775.....	63, 70, 85	595785.....	71	61393.....	151	639064.....	135
555235.....	62, 66, 78, 103	562228.....	99	595786.....	69, 71, 83	61493.....	151	639079.....	136
555235S1.....	67	562237.....	99	595780SP.....	68, 69, 83, 84	61593.....	151	639079CRV.....	137
555235S2.....	67	562250.....	99	601710CMG.....	149	61693.....	151	639082.....	136
555238.....	62, 66, 78, 103	562262.....	99	601711CMG.....	149	62273.....	139	639084.....	136
555238S1.....	67	562275.....	99	601714CMG.....	149	62373.....	139	639084CRV.....	137
555238S2.....	67	562287.....	99	602306.....	68, 71, 84	627728.....	137	639089.....	135
555239S1.....	62, 67	562300.....	99	60392.....	151	638010.....	148	639091.....	136
555240.....	62, 66, 78, 103	562310.....	99	60492.....	151	638025.....	148	639092.....	136
555240S2.....	62, 67	562325.....	99	60592.....	151	638208.....	148	639093.....	136
555243.....	62, 66, 78, 103	562337.....	99	60692.....	151	638215.....	148	639094.....	136
555243.....	66, 78, 103	562350.....	99	607020.....	76	638216.....	148	639094CRV.....	137
555246.....	66, 78, 103	5623A.....	177	607028.....	76	638217.....	148	639097.....	136
555274.....	62, 66, 80	5624A.....	177	607031.....	76	638219.....	148	644128.....	62, 68
555275.....	62, 66, 80	5625A.....	177	607031CV20.....	142	638220.....	148	644138.....	62, 68
555276.....	62, 66, 80	5626A.....	177	607031CV25.....	142	638224.....	135	644150.....	62, 68
555277.....	62, 66, 80	5627A.....	177	607037.....	76	638226.....	148	644162.....	62, 68
555278.....	62, 66, 80	5628A.....	177	607037CL20.....	142	638241.....	148	6510048.....	155
555279.....	62, 66, 80	5629A.....	177	607037CL25.....	142	638260.....	135	6510049.....	155
555325S1.....	62	5630A.....	177	607037CV20.....	142	638265.....	136	6510050.....	155
555325S2.....	62	5631A.....	177	607037CV25.....	142	638274.....	136	6510051.....	155
555328S1.....	62	5632A.....	177	607050.....	76	638279.....	136	657716.....	62
555328S2.....	62	5633A.....	177	607050CL15.....	142	638281CRV.....	137	657716.....	69
557038.....	64, 76	5634A.....	177	607050CL20.....	142	638282.....	136	657716.....	83
557193.....	64, 76	5635A.....	177	607050CV20.....	142	638282CRV.....	137	657718.....	62
557716.....	62, 69, 83	5636A.....	177	607050CV25.....	142	638283.....	136	657718.....	69
557718.....	62, 69, 83	5637A.....	177	607062.....	76	638283CRV.....	137	657718.....	83
557719.....	62, 69, 83	5638A.....	177	607075.....	76	638284.....	136	657719.....	62
557720.....	62, 69, 83	5639A.....	177	607087.....	76	638284CRV.....	137	657719.....	69
557721.....	62, 69, 83	5640A.....	177	607101.....	76	638291.....	136	657719.....	83

# INDEX (BY PRODUCT CODE)

PRODUCT  
CODE PAGE

657720.....62	66493.....150	677011.....76	695575.....156	867030-4.....89
657720.....69	66573.....150	677013.....76	695576.....156	867035-4.....82
657720.....83	66593.....150	677015.....76	695577.....156	867035-4.....89
657721.....62	667021-2.....62	677016.....76	695578.....156	867040-4.....82
657721.....69	667021-2.....68	677017.....76	695579.....156	867040-4.....89
657721.....83	667028-2.....62	677018.....76	695580.....156	877010-2.....89
657722.....62	667028-2.....68	677019.....76	695581.....156	877010-4.....89
657722.....69	667038-2.....62	677070.....76	695582.....156	877020-2.....89
657722.....83	667038-2.....68	677310.....64	695583.....156	877020-4.....89
657726.....62	667050-2.....62	677311.....64	695584.....156	877025-2.....89
659232.....84	667050-2.....68	677313.....64	695585.....156	877025-4.....89
659235.....84	667062-2.....62	677315.....64	695586.....156	877030-2.....89
659238.....84	667062-2.....68	677316.....64	695587.....156	877030-4.....89
659239.....84	667075-2.....62	677317.....64	71193.....151	877035-4.....89
659430.....84	667075-2.....68	678141.....147	71293.....151	877040-4.....89
659718.....63	671040.....149	678142.....147	71297.....140	92501.....146
659718.....70	671041.....149	678143.....147	71393.....151	92504.....146
659718.....84	671042.....149	678145.....147	71397.....140	92505.....146
659722.....63	671043.....149	678146.....147	71493.....151	93200.....146
659722.....70	671045.....149	678147.....147	71593.....151	93210.....146
659722.....84	671046.....149	678341.....147	71693.....151	95610.....146
659725.....63	671047.....149	678342.....147	71793.....151	92 1500.....116
659725.....70	671091.....149	678343.....147	74294.....150	92 2000.....116
659725.....84	671092.....149	678345.....147	74694.....150	92 3000.....116
659728.....63	671093.....149	678346.....147	75143.....150	92 500.....116
659728.....70	671340.....149	678347.....147	75193.....150	BTG1500/3.....129
659728.....84	671341.....149	678517.....134	75199.....150	BTG3000/3.....129
659729.....63	671342.....149	678518.....134	75243.....150	BTG3000L/3.....129
659729.....70	671343.....149	678519.....134	75293.....150	CG1.....123
659729.....84	671345.....149	678521.....134	75299.....150	CG2.....123
659730.....63	671346.....149	678522.....134	75343.....150	CG4.....123
659730.....70	671347.....149	678523.....134	75393.....150	CG6.....123
66173.....150	671391.....149	678525.....134	75493.....150	CH1.....121
66193.....150	671393.....149	678531.....134	75543.....150	CH10.....121
66273.....150	671394.....149	678532.....134	75593.....150	CH10/L.....121
66293.....150	671410.....149	678533.....134	75693.....150	CH2.....121
66373.....150	671411.....149	678535.....134	75793.....150	CH2/L.....121
66393.....150	671412.....149	679018.....134	867010-2.....89	CH4.....121
664021-2.....82	671413.....149	679019.....134	867010-4.....82	CH4/L.....121
664028-2.....82	671415.....149	679022.....134	867010-4.....89	CH6.....121
664038-2.....82	671440.....149	679023.....134	867020-2.....89	CH6/L.....121
664050-2.....82	671441.....149	679032.....134	867020-4.....82	CH8.....121
664062-2.....82	671442.....149	679033.....134	867020-4.....89	CH8/L.....121
664075-2.....82	671443.....149	6905AWL.....141	867025-2.....89	CLB40.....102, 128
664089-2.....82	671445.....149	6905AZL.....141	867025-4.....82	CLT56.....102, 128
664100-2.....82	671491.....149	6906AWL.....141	867025-4.....89	CX10000.....118
664125-2.....82	671492.....149	6906AZL.....141	867030-2.....89	CX10000L.....118
66473.....150	677010.....76	695550.....156	867030-4.....82	CX3000.....118

**PRODUCT  
CODE** **PAGE**

CX6000.....118	M204A.....140	M3404A.....100	M353.....51	M385.....51
CX6000L.....118	M205A.....140	M3405A.....100	M353A.....53	M385A.....53
CX8000.....118	M206A.....140	M3407A.....100	M353AG.....53	M385AG.....53
CX8000L.....118	M207A†.....140	M3409A.....100	M353AP.....53	M385AP.....53
CY1.....117	M208A.....140	M3411A.....100	M353G.....51	M385G.....51
CY2.....117	M210A.....140	M3415A.....100	M353P.....51	M385P.....51
CY3.....117	M2252.....108	M3422A.....100	M354.....51	M449G.....56
CZ10.....116	M244.....107	M345.....51	M354A.....53	M450.....56
CZ10L.....116	M245.....107	M345G.....51	M354AG.....53	M451.....56
CZ15.....116	M246.....107	M346.....51	M354AP.....53	M452.....56
CZ15L.....116	M247.....107	M346G.....51	M354G.....51	M453.....56
CZ20.....116	M248.....107	M346P.....51	M354P.....51	M454.....56
CZ20L.....116	M248D.....109	M347.....51	M355.....51	M546.....52
CZ30.....116	M249.....107	M347G.....51	M355A.....53	M546G.....52
CZ4.....116	M249D.....109	M347P.....51	M355AG.....53	M546P.....52
CZ4L.....116	M250.....107	M348.....51	M355AP.....53	M547.....52
CZ6.....116	M250D.....109	M348G.....51	M355G.....51	M547G.....52
CZ8.....116	M251.....107	M348P.....51	M355P.....51	M547P.....52
CZ8L.....116	M251D.....109	M349.....51	M356.....51	M548.....52
HG1000.....125	M252.....107	M349G.....51	M356A.....53	M548G.....52
HG2000.....125	M252B.....110	M349P.....51	M356AG.....53	M548P.....52
HG3000.....125	M252D.....109	M350.....51	M356AP.....53	M550.....52
HG4000.....125	M253.....107	M3502A.....100	M356G.....51	M550G.....52
HG500.....125	M253B.....110	M3503A.....100	M356P.....51	M550P.....52
HGC.....129	M253D.....109	M3504A.....100	M357.....51	M551.....52
HH8.....121	M254.....107	M3505A.....100	M357A.....53	M551G.....52
HH8/L.....121	M2546.....108	M3507A.....100	M357AG.....53	M551P.....52
HU15000H10.....177	M2547.....108	M3509A.....100	M357AP.....53	M552.....52
HU15000H15.....177	M2548.....108	M350A.....53	M357G.....51	M552G.....52
HU15000H20.....177	M254B.....110	M350AG.....53	M357P.....51	M552P.....52
HU15000H30.....177	M254D.....109	M350AP.....53	M358.....51	M553.....52
HU20000H10.....177	M255.....107	M350G.....51	M358A.....53	M553G.....52
HU20000H15.....177	M2550.....108	M350P.....51	M358AG.....53	M553P.....52
HU20000H20.....177	M2551.....108	M351.....51	M358AP.....53	M554.....52
HU20000H30.....177	M255B.....110	M3511A.....100	M358G.....51, 54	M554G.....52
LJ1500.....119	M255D.....109	M3515A.....100	M358P.....51	M554P.....52
LJ500.....119	M256.....107	M351A.....53	M366.....51	M555.....52
M50P.....78, 103	M256D.....109	M351AG.....53	M366A.....53	M555G.....52
M62P.....78	M257.....107	M351AP.....53	M366AG.....53	M555P.....52
M75P.....78, 103	M257D.....109	M351G.....51	M366AP.....53	M556.....52
M100P.....78, 103	M258.....107	M351P.....51	M366G.....51	M556G.....52
M1302AV.....98	M258D.....109	M352.....51	M366P.....51	M556P.....52
M1303AV.....98	M296.....107	M3522A.....100	M377.....51	M557.....52
M1304AV.....98	M296D.....109	M352A.....53	M377A.....53	M557G.....52
M1305AV.....98	M308A.....141	M352AG.....53	M377AG.....53	M557P.....52
M1307AV.....98	M310A.....141	M352AP.....53	M377AP.....53	M558.....52
M1309AV.....98	M3402A.....100	M352G.....51	M377G.....51	M558G.....52, 55
M134.....102	M3403A.....100	M352P.....51	M377P.....51	M558P.....52

# INDEX (BY PRODUCT CODE)

**PRODUCT  
CODE**

**PAGE**

M566.....52	M6409C.....100	M650AG.....53	M656A.....53	M696005.....73
M566G.....52	M6411A.....100	M650AP.....53	M656AG.....53	M696010.....63
M566P.....52	M6411C.....100	M650B.....159	M656AP.....53	M696010.....73
M577.....52	M6415A.....100	M650G.....51	M656G.....51	M696015.....63
M577G.....52	M6415C.....100	M650P.....51	M656P.....51	M696015.....73
M577P.....52	M6430A.....100	M651.....51	M657.....51	M696020.....63
M585.....52	M6437A.....100	M6511A.....100	M657A.....53	M696020.....73
M585G.....52	M6445A.....100	M6511C.....100	M657AG.....53	M702.....56
M585P.....52	M645.....51	M6515A.....100	M657AP.....53	M702.....92
M605.....138	M645B.....159	M6515C.....100	M657G.....51	M703.....56
M606.....138	M645G.....51	M651A.....53	M657P.....51	M703.....92
M608.....138	M646.....51	M651AG.....53	M658.....51	M703A.....56
M610.....138	M6460A.....100	M651AP.....53	M658A.....53	M703A.....92
M616005.....63	M646B.....159	M651B.....159	M658AG.....53	M704.....56
M616005.....72	M646G.....51	M651G.....51	M658AP.....53	M704.....92
M616010.....63	M646P.....51	M651P.....51	M658G.....51, 54	M704A.....56
M616010.....72	M647.....51	M652.....51	M658P.....51, 54	M704A.....92
M616015.....63	M647B.....159	M652A.....53	M666.....51	M705.....56
M616015.....72	M647G.....51	M652AG.....53	M666A.....53	M705.....92
M616020.....63	M647P.....51	M652AP.....53	M666AG.....53	M705A.....56
M616020.....72	M648.....51	M652B.....159	M666AP.....53	M705A.....92
M626005.....63	M648A.....53	M652G.....51	M666G.....51	M706.....56
M626005.....72	M648AG.....53	M652P.....51	M666P.....51	M706.....92
M626010.....63	M648AP.....53	M653.....51	M676005.....63	M706A.....56
M626010.....72	M648B.....159	M6530A.....100	M676005.....73	M706A.....92
M626015.....63	M648G.....51	M6537A.....100	M676010.....63	M706H.....56
M626015.....72	M648P.....51	M653A.....53	M676010.....73	M706H.....92
M626020.....63	M649.....51	M653AG.....53	M676015.....63	M7151.....57
M626020.....72	M649A.....53	M653AP.....53	M676015.....73	M7151P.....57
M6304.....141	M649AG.....53	M653B.....159	M676020.....63	M7152.....57
M6304WL.....141	M649AP.....53	M653G.....51	M676020.....73	M7152P.....57
M6305.....141	M649B.....159	M653P.....51	M677.....51	M7154.....57
M6305WL.....141	M649G.....51	M654.....51	M677A.....53	M7154P.....57
M6306.....141	M649P.....51	M6545A.....100	M677AG.....53	M7156.....57
M6306WL.....141	M650.....51	M654A.....53	M677AP.....53	M7156P.....57
M6307.....141	M6502A.....100	M654AG.....53	M677G.....51	M7157.....57
M6307WL.....141	M6502C.....100	M654AP.....53	M677P.....51	M7157P.....57
M6402A.....100	M6503A.....100	M654B.....159	M685.....51	M7177.....57
M6402C.....100	M6503C.....100	M654G.....51	M685A.....53	M7177P.....57
M6403A.....100	M6504A.....100	M654P.....51	M685AG.....53	M71805A-2.....62
M6403C.....100	M6504C.....100	M655.....51	M685AP.....53	M71806A-2.....62
M6404A.....100	M6505A.....100	M655A.....53	M685G.....51	M71808A-2.....62
M6404C.....100	M6505CB.....100	M655AG.....53	M685P.....51	M71810A-2.....62
M6405A.....100	M6507A.....100	M655AP.....53	M6905A.....141	M7402A.....69
M6405CB.....100	M6507C.....100	M655G.....51	M6905AZ.....141	M7403A.....69
M6407A.....100	M6509A.....100	M655P.....51	M6906A.....141	M7404A.....69
M6407C.....100	M6509C.....100	M656.....51	M6906AZ.....141	M7405A.....69
M6409A.....100	M650A.....53	M6560A.....100	M696005.....63	M7407A.....69



**PRODUCT  
CODE**

**PAGE**

M7409A .....69	M758P .....52	M850AP .....53	M858AG.....53	M953G .....52
M746 .....52	M766 .....52	M850G .....51	M858AP .....53	M953P .....52
M746G .....52	M766G .....52	M850P .....51	M858G .....51	M954 .....52
M746P .....52	M766P .....52	M851 .....51	M858P .....51	M954G .....52
M747 .....52	M777 .....52	M85120.....91	M866 .....51	M954P .....52
M747G .....52	M777G .....52	M851A .....53	M866A .....53	M955 .....52
M747P .....52	M777P .....52	M851AG .....53	M866AG.....53	M955G .....52
M748 .....52	M785 .....52	M851AP .....53	M866AP .....53	M955P .....52
M748G .....52	M785G .....52	M851G .....51	M866G .....51	M956 .....52
M748P .....52	M785P .....52	M851P .....51	M866P .....51	M956G .....52
M750 .....52	M804A .....139	M852 .....51	M877 .....51	M956P .....52
M7502A .....62	M805A .....139	M852A .....53	M877A .....53	M957 .....52
M7502A .....69	M806A .....139	M852AG .....53	M877AG.....53	M957G .....52
M7503A .....62	M807A† .....139	M852AP .....53	M877AP .....53	M957P .....52
M7503A .....69	M808A .....139	M852G .....51	M877G .....51	M958 .....52
M7504A .....62	M810A .....139	M852P .....51	M877P .....51	M958G .....52
M7504A .....69	M812 .....151	M853 .....51	M885 .....51	M958G .....55
M7505A .....62	M812Z .....151	M853A .....53	M885A .....53	M958P .....52
M7505A .....69	M8403 .....90	M853AG .....53	M885AG .....53	M966 .....52
M7507A .....62	M8405 .....90	M853AP .....53	M885AP .....53	M966G .....52
M7507A .....69	M8407 .....90	M853G .....51	M885G .....51	M966P .....52
M7509A .....62	M846 .....51	M853P .....51	M885P .....51	M977 .....52
M7509A .....69	M846G .....51	M854 .....51	M904A .....141	M977G .....52
M750G .....52	M846P .....51	M854A .....53	M905A .....141	M977P .....52
M750P .....52	M847 .....51	M854AG.....53	M906A .....141	M985 .....52
M751 .....52	M847G .....51	M854AP .....53	M907A .....141	M985G .....52
M751G .....52	M847P .....51	M854G .....51	M908A .....141	M985P .....52
M751P .....52	M848 .....51	M854P .....51	M910A .....141	MC345G .....54
M752 .....52	M848A .....53	M855 .....51	M910Z .....150	MC346G .....54
M752G .....52	M848AG.....53	M855A .....53	M946 .....52	MC347G .....54
M752P .....52	M848AP .....53	M855AG.....53	M946G .....52	MC348G .....54
M753 .....52	M848G .....51	M855AP .....53	M946P .....52	MC349G .....54
M753G .....52	M848P .....51	M855G .....51	M947 .....52	MC350G .....54
M753P .....52	M849 .....51	M855P .....51	M947G .....52	MC351G .....54
M754 .....52	M849A .....53	M856 .....51	M947P .....52	MC352G .....54
M754G .....52	M849AG.....53	M856A .....53	M948 .....52	MC353G .....54
M754P .....52	M849AP .....53	M856AG.....53	M948G .....52	MC354G .....54
M755 .....52	M849G .....51	M856AP .....53	M948P .....52	MC355G .....54
M755G .....52	M849P .....51	M856G .....51	M950 .....52	MC356G .....54
M755P .....52	M850 .....51	M856P .....51	M950G .....52	MC357G .....54
M756 .....52	M8503 .....90	M857 .....51	M950P .....52	MC366G .....54
M756G .....52	M85030.....91	M857A .....53	M951 .....52	MC377G .....54
M756P .....52	M8505 .....90	M857AG.....53	M951G .....52	MC385G .....54
M757 .....52	M85060.....91	M857AP .....53	M951P .....52	MC546G .....55
M757G .....52	M8507 .....90	M857G .....51	M952 .....52	MC547G .....55
M757P .....52	M85090.....91	M857P .....51	M952G .....52	MC548G .....55
M758 .....52	M850A .....53	M858 .....51	M952P .....52	MC550G .....55
M758G .....52, 55	M850AG.....53	M858A .....53	M953 .....52	MC551G .....55

# INDEX (BY PRODUCT CODE)

**PRODUCT  
CODE**

**PAGE**

MC552G .....55	MC846G .....54	ML100..79, 80, 93, 104, 105	TOR07520 .....171
MC553G .....55	MC847G .....54	ML100NF ..... 79, 93, 104	TOR07520LL .....171
MC554G .....55	MC848G .....54	ML125..79, 80, 93, 104, 105	TOR075LCX .....171
MC555G .....55	MC849G .....54	ML125NF ..... 79, 93, 104	TOR075LCXLL .....171
MC556G .....55	MC850G .....54	ML150..79, 80, 93, 104, 105	TOR15005 .....171
MC557G .....55	MC851G .....54	ML175..79, 80, 93, 104, 105	TOR15005LL .....171
MC566G .....55	MC852G .....54	ML200..79, 80, 93, 104, 105	TOR15010 .....171
MC577G .....55	MC853G .....54	ML225..79, 80, 93, 104, 105	TOR15010LL .....171
MC585G .....55	MC854G .....54	ML250..79, 80, 93, 104, 105	TOR15015 .....171
MC645G .....54	MC855G .....54	ML275..79, 80, 93, 104, 105	TOR15015LL .....171
MC646G .....54	MC856G .....54	R664021-2 .....82	TOR15020 .....171
MC646P .....54	MC857G .....54	R664028-2 .....82	TOR15020LL .....171
MC647G .....54	MC860 .....51	R664038-2 .....82	TOR150LCX .....171
MC647P .....54	MC860A .....53	R664050-2 .....82	TOR150LCXLL .....171
MC648G .....54	MC860AG .....53	R664062-2 .....82	TSH1500 .....127
MC648P .....54	MC860G ..... 51, 54	R664075-2 .....82	TSH3000 .....127
MC649G .....54	MC862A .....53	R664089-2 .....82	TSH5000 .....127
MC649P .....54	MC862AG .....53	R664100-2 .....82	TTG1500 .....122
MC650G .....54	MC862G .....54	R664125-2 .....82	TTG3000 .....122
MC650P .....54	MC864A .....53	SC921 .....180	TTG4500 .....122
MC651G .....54	MC864AG .....53	SC9210 .....180	TTG7500 .....122
MC651P .....54	MC866G .....54	SC922 .....180	TTR1500 .....120
MC652G .....54	MC877G .....54	SC922T .....181	TTR3000 .....120
MC652P .....54	MC885G .....54	SC923 .....180	TTR750 .....120
MC653G .....54	MC946G .....55	SC923/L .....180	
MC653P .....54	MC947G .....55	SC923/LT .....181	
MC654G .....54	MC948G .....55	SC923T .....181	
MC654P .....54	MC950G .....55	SC925 .....180	
MC655G .....54	MC951G .....55	SC925/LT .....181	
MC656G .....54	MC952G .....55	SC925L .....181	
MC657G .....54	MC953G .....55	SC925/T .....180	
MC666G .....54	MC954G .....55	SP595778P ..... 69, 83	
MC677G .....54	MC955G .....55	SP595782P ..... 68, 69, 83, 84	
MC685G .....54	MC956G .....55	SP595783P ..... 68, 69, 83, 84	
MC746G .....55	MC957G .....55	THK1500 .....124	
MC747G .....55	MC966G .....55	THK4500 .....124	
MC748G .....55	MC977G .....55	THK6000 .....124	
MC750G .....55	MC985G .....55	THK750 .....124	
MC751G .....55	ML040..79, 80, 93, 104, 105	THK9000 .....124	
MC752G .....55	ML040NF ..... 79, 93, 104	THS1500 .....126	
MC753G .....55	ML050..79, 80, 93, 104, 105	THS4500 .....126	
MC754G .....55	ML050NF ..... 79, 93, 104	THS750 .....126	
MC755G .....55	ML063..79, 80, 93, 104, 105	TOR07505 .....171	
MC756G .....55	ML063NF ..... 79, 93, 104	TOR07505LL .....171	
MC757G .....55	ML075..79, 80, 93, 104, 105	TOR07510 .....171	
MC766G .....55	ML075NF ..... 79, 93, 104	TOR07510LL .....171	
MC777G .....55	ML087..79, 80, 93, 104, 105	TOR07515 .....171	
MC785G .....55	ML087NF ..... 79, 93, 104	TOR07515LL .....171	



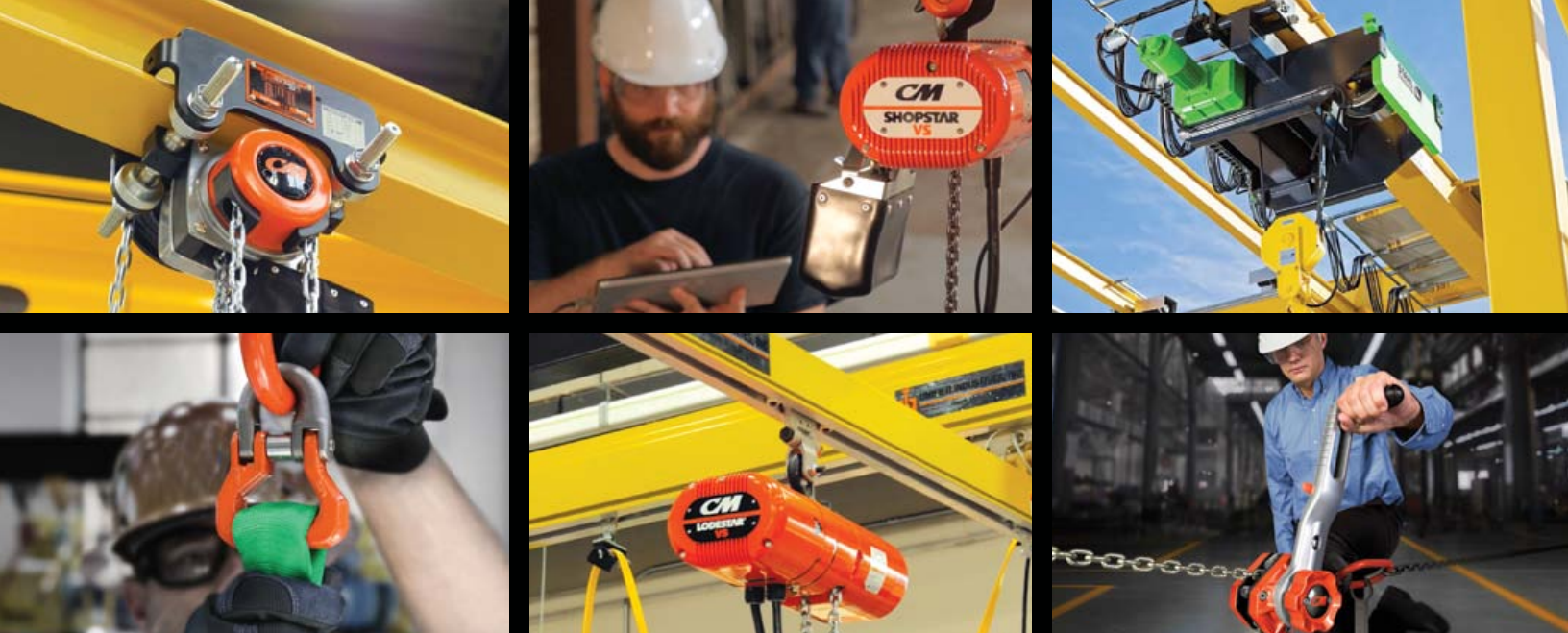

## PARTNERS IN MOTION CONTROL.

Columbus McKinnon is focused on becoming the leading industrial technology company in safe and productive motion control. Together, with our network of value-add Channel Partners, we are uniquely positioned to offer solutions to solve our customer's high-value problems. From variable speed electric chain hoists featuring CM HI-Tech™, our exclusive performance interface platform, to the CM Tornado 360™ and its revolutionary Sidewinder™ lever handle, Columbus McKinnon is engineering motion control solutions for tomorrow's workforce.

## BE SAFE. GET TRAINED.

Columbus McKinnon is committed to providing expert safety training on the proper use and inspection of rigging and overhead lifting equipment. Our company offers comprehensive programs at our national training centers as well as on-site at your facility. Courses include hoist and rigging safety and inspection; crane operation and safety; and load securement.

Columbus McKinnon's corporate headquarters in Getzville, New York, is home to our state-of-the-art **Niagara Training Center**. The 3,000-square-foot facility is dedicated to training Channel Partners and end users on the safe and proper use of hoist and rigging products. The Center offers a one-of-a-kind training experience on chain and rigging equipment with more than 75 manual and powered hoists, enclosed track systems and our 50-foot-wide crane system with 3-ton Yale Global King wire rope hoist.

## CMCO UNIVERSITY™

Win in the marketplace with CMCO University. This intense program is designed to give Channel Partners intimate product and application knowledge that they can use to advise their end-user customers during the product selection and sales processes.



USA 800.888.0985 • 716.689.5400 • fax: 716.689.5644

CANADA 877.264.6478 • fax: 877.264.6477

[www.cmworks.com](http://www.cmworks.com)



Stock # CMRP-6  
5000 EP 1118