





ON COVER  
DOCUMENT



# Contents

125 years of AEG	2	Cooking	23	Cleaning	103
Cooling	9	Ovens	24	Integrated Dishwashers	110
Undercounter Fridges and Freezers	16	MaxiKlasse™	30	Laundry	113
Cabinet Fridges and Freezers	16	Pyroluxe®	33	Built-in Washing Machine	115
Tall Fridges and Freezers	17	ProCombi Steam	38	Built-in Washer Dryer	115
Fridge Freezers	18	Sous Vide	42	Specification Tables	116
PerfektFit™	19	Built-In Double Ovens	48		
American	19	Built-Under Double Ovens	51		
Wine Cooling	20	Compact Range	53		
Compact Wine Cellar	20	Ovens	57		
		Combination Microwaves	59		
		Microwaves	59		
		Coffee Machine	60		
		Compact wine cellar	60		
		Warming Drawers	61		
		Accessories	62		
		Hobs	64		
		MaxiSight Induction	70		
		MaxiSense Induction	73		
		Hob2Hood	79		
		Mixed fuel	81		
		CrystalLine	83		
		Ceramic	87		
		Gas	88		
		Hoods	93		
		Designer Hoods	98		
		Designer Chimney Hoods	99		
		Standard	100		
		Ceiling	101		
		Semi-integrated	101		



## AEG Premier Partner Passion, Experience & Reassurance

**Passion**  
The appliances featured in this brochure have been specially selected for our Premier Partners – kitchen specialists who share our passion for inspired design and turning your dreams into reality.

**Experience**  
The choice of kitchen appliances can sometimes be overwhelming. Our Premier Partners' experience and in-depth understanding of our latest technology will help you make the best choice for your needs.

**Reassurance**  
When you purchase an appliance from a Premier Partner you'll have complete peace of mind. Not only are you buying from an expert who really cares about your kitchen, but you'll also benefit from an exclusive extended warranty.



All the appliances featured in this brochure benefit from a 5 year warranty\*

\*Terms & conditions apply. Extended warranties only apply to appliances bought as part of an overall kitchen project; your retailer must register your appliances on your behalf at time of purchase

\*Full instructions for installation are found in the product user manuals, or at [www.aeg.co.uk](http://www.aeg.co.uk)

# Why AEG?

With our award winning Germanic design and build quality, AEG understand that the kitchen is increasingly becoming the heart of the home. Your kitchen appliances are essential tools that will be used for many years every day and so it is worth choosing a brand that will deliver you exceptional results in performance as well as looking stunning with its seamless design: hence perfect alignment in stainless steel and black glass is offered across the whole range.



## OVENS

Our beautiful ovens feature an impressive XXL capacity. This means that we can offer you 5 shelves of completely even cooking and thanks to our ThermiC° hot air system, you can cook savoury and sweet at the same time with no transfer of flavour. For that all important Christmas feast, we tried and tested our ovens and you can comfortably cook a meal for 12 with all the trimmings!

Our impressive oven range offers you the latest options in innovation including our new Sous Vide oven, multifunction steam, pyrolytic and CuliSense (the clever oven that thinks for itself!)



## HOB'S

AEG offer you stunning designs across all our hobs, with designer gas hobs, sleek ceramic and stunning induction hobs. Have you ever considered induction, the fastest growing hob technology, offering the ultimate in controllability and energy efficiency?

Induction is so easy to keep clean, plus we also offer you exciting cooking solutions with bridging functions, which facilitate sophisticated cooking with grill plates or fish kettles.



## FRIDGES AND FREEZERS

With our fridge freezers food is kept in optimum conditions, so stays fresher for longer, due to ProFresh technology. Our extra tall built in fridge freezers offer you maximum storage space meaning fewer trips to the shops and our stunning designer PerfektFit™ fridge freezer with wine cooler makes a real statement, perfect for entertaining and will align seamlessly within your kitchen units.



## LAUNDRY

Whether in your kitchen or your utility room, our AEG laundry range offers you robust, well-built machines designed to treat your garments with the utmost care, with special programmes that offer the gentlest cleaning for your softest cashmeres and silk scarves.



## HOODS

Our hoods complement our ovens and hobs beautifully. Our stunning designer hoods make a real statement as well as offering you the most efficient extraction solutions to keep your open plan living as fresh as possible.



## DISHWASHERS

The unsung heroes of many kitchens, our AEG dishwashers offer you a greater internal capacity (10 litres more than the average) with outstanding cleaning performance thanks to our extra satellite spray arm, giving you sparkling results.

# COOLING



Built-In	9	Freestanding	19
Undercounter Fridges and Freezers	16	Perfekfit™	19
Cabinet Fridges and Freezers	16	American	19
Tall Fridges and Freezers	17		
Fridge Freezers	18		
Wine Cooling	20		
Compact Wine Cellar	20		

# AEG Fridges and Freezers?

Whether you're buying a fridge for the first time or upgrading your existing fridge-freezer, AEG has the perfect appliance for your home.

## Keep food as fresh and as nutritious as the day you bought it

Great tasting meals start with fresh, nutritious ingredients. Our range of fridge freezers are designed with the latest LongFresh cooling temperature zones to keep food fresher for longer. This not only ensures that your food is full of flavour for that mid week meal, but also means that you waste less food as it can be kept for longer.

## All about space

Cooking with fresh ingredients requires optimal storage space. We design cooling appliances that maximise on the internal storage capacity thus enabling for more food to be stored. Our salad drawers can hold up to 128 apples, and our fridges can hold enough food for 2 weeks worth of evening meals. This means that with busy lifestyles you can store more fresh ingredients and spend less time shopping.



# COOLING



## PROFRESH

Food stays fresher for longer with our ProFresh technology, ensuring that the fridge temperature is cold, stable and with the correct level of humidity.



## LOW FROST

Our advanced freezing technology in selected models means that you only need to defrost the freezer every 2 years, saving yourself a yearly chore.



## LONGFRESH STORAGE

Special drawers in selected models can be set individually to create conditions ideal for different food types. Food will stay fresh, preserving the vitamins and nutritional value of the food for up to three times longer than in a conventional fridge.



## COOLMATIC

Quickly chill large amounts of fresh food, such as the weekly shop, at the optimum storage temperature.



## FROSTMATIC

Frostmatic - ideal for freezing fresh food quickly, preserving flavour, nutritional value and colour.



## ENERGY EFFICIENCY

Our high performance models keep food fresher for longer with the smallest possible amount of energy, with models available in A+, A++ or A+++ energy rating.



## DYNAMIC AIR

Incorporates a powerful fan which automatically activates to ensure that fridge temperatures are maintained at the desired level.



## MULTI AIRFLOW

Ensures food stays fresher for longer as temperatures and humidity levels are extremely stable.



## CLEANAIR CONTROL

Uses charcoal filter to purify the air and reduce odours. So flavours can't be transferred between wrapped and unwrapped foods.



## FRESH BOX

Selected models within the range include a dedicated pull-out drawer providing the perfect storage environment for fresh meat and fish.



## SOFT RISE LED LIGHTING

LED lighting inside the fridge with 'rise on' effect for crisp contemporary illumination.



## LCD

Advanced LCD display with touch controls allows you to set features and temperatures precisely.



## TEMPERATURE ALARM

If the temperature rises too high a visible and audible alarm alerts you.



## 4 STAR FREEZING

You can safely freeze fresh food and store frozen food safely for up to one year.



## FROST FREE

Never defrost your freezer again. Frost free freezers also offer efficient and effective freezing with quicker, more even freezing for better food preservation.



## MINUTE MINDER

This function can be used to set an acoustic alarm after a desired time period i.e. as a reminder to remove bottles left to chill.



# Cooling Range

## Built-in Fridges and Freezers

SKS58200F0



Fully integrated under-counter larder fridge with A+ energy rating.

AGN58210F0



Fully Integrated Frost Free under-counter freezer with A+ energy rating.

SKS71200F0



In-column larder fridge with an A+ energy rating and electronic touch controls precise temperature regulation.

AGN71200F0



In-column Frost Free freezer with an A+ energy rating and electronic touch controls for precise temperature regulation.

SKD71800F0



Large capacity in-column larder fridge with A+ energy, electronic touch controls and Dynamic Air cooling.

AGN71800F0



Large capacity in-column Frost Free freezer with A+ energy and electronic touch controls for precise temperature regulation.

SKZ71800F0



Large capacity in-column fridge with A+ energy and LongFresh storage.

## Built-in Fridge Freezers

SCT71800S1



In-column 70:30 split ProFresh Frost Free fridge freezer with A+ energy and touch control electronics.

SCN71800S1



In-column 50:50 split ProFresh Frost Free fridge freezer with A+ energy efficiency and electronic touch controls for precise temperature regulation.

SCS71801F1



In-column 70:30 split Low Frost fridge freezer with A+ energy efficiency and touch control electronics.

## Built-in Fridge Freezers

SCS51810S0



In-column 50:50 split fridge freezer with A+ energy efficiency.

SCT71900S0



In-column extra tall ProFresh Frost Free fridge freezer with A+ energy efficiency and electronic temperature control.

SCT81900S0



In-column Highly energy efficient extra tall ProFresh Frost Free fridge freezer with A++ energy efficiency.

## PerfektFit™ and Side by Side

S95400XNM0



PerfektFit™ fridge freezer with A+ energy efficiency - this freestanding fridge freezer fits perfectly in line with your kitchen furniture.

S95900XTM0



PerfektFit™ fridge freezer with wine cellar and A+ energy - this freestanding fridge freezer fits perfectly in line with your kitchen furniture.

S96090XVM1



American-style stainless steel food centre with A+ energy efficiency.

## Built-in Wine Coolers

SWD81800G1



In-column large capacity stainless steel wine cooler with dual temperature regulation for red and white wines.

SWS74500G0



45cm compact wine cooler.



SKS58200F0

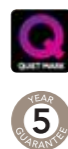

Fully integrated under-counter larder fridge with A+ energy rating.

Full width salad drawer with 2 glass lids makes the best use of the space available.

- Adjustable temperature control
- Full width dairy compartment
- Half width sliding door shelf
- Door on door hinge fixing

Dimensions (HxWxD) in mm 820 x 600 x 550

SKS71200F0

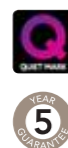

In-column larder fridge with an A+ energy rating and electronic touch controls precise temperature regulation.

LCD touch controls ensure precise temperature and function setting.

- Soft rise LED lighting
- Coolmatic function
- Full width dairy compartment
- Door on door hinge fixing

Dimensions (HxWxD) in mm 1225 x 560 x 550

AGN58210F0 - Never defrost again!



Fully integrated Frost Free under-counter freezer with A+ energy rating.

The Frostmatic function is ideal for freezing fresh food quickly, preserving flavour, nutritional values and colour.

- Store food for up to a year in this 4star freezer
- High temperature and door open alarm
- Door on door hinge fixing

Dimensions (HxWxD) in mm 820 x 600 x 550

AGN71200F0 - Never defrost again!



In-column Frost Free freezer with an A+ energy rating and electronic touch controls for precise temperature regulation.

LCD touch controls ensure precise temperature and function setting, including useful features such as frostmatic, holiday function, child lock and minute minder.

- Frostmatic function is ideal for freezing fresh food quickly
- High temperature and door open alarm
- Includes 4 drawers and one compartment
- Door on door hinge fixing

Dimensions (HxWxD) in mm 1225 x 560 x 550

SKD71800F0



Large capacity in-column larder fridge with A+ energy, electronic touch controls and Dynamic Air cooling.

Dynamic Air cooling means that a powerful fan automatically activates to ensure that fridge temperature is maintained at the desired level and food is cooled quickly, preserving food quality.

- LCD touch control electronics
- Extra large telescopic salad drawer
- Soft rise LED lighting
- Door on door hinge fixing

Dimensions (HxWxD) in mm 780 x 560 x 550

SKZ71800F0 - LongFresh compartment



Large capacity in-column fridge with A+ energy and LongFresh storage.

2 full width LongFresh drawers give you the perfect storage space for fresh vegetables, fish and meat

- Dynamic Air fan cooling
- CleanAir filter
- LCD touch control electronics
- Soft rise LED lighting
- Door on door hinge fixing

Dimensions (HxWxD) in mm 1780 x 560 x 550

AGN71800F0 - Never defrost again!



Large capacity in-column Frost Free freezer with A+ energy and electronic touch controls for precise temperature regulation.

With 5 drawers and 2 compartments this freezer provides a large amount of freezer space.

Includes 5 drawers and two compartments.

- LCD touch control electronics.
- Frostmatic function is ideal for freezing fresh food quickly
- High temperature and door open alarm
- Door on door hinge fixing

Dimensions (HxWxD) in mm 1780 x 560 x 550

SCT71800S1 - Never defrost again!

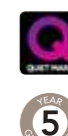

In-column 70:30 split ProFresh Frost Free fridge freezer with A+ energy and touch control electronics.

Our ProFresh technology means that our Frost Free fridge freezers have two cooling systems, one for the fridge and one for the freezer. This means that the temperature is more accurately controlled in either section preventing your food from deteriorating through over cooling of air from the freezer.

- FreshBox chiller drawer
- LCD touch control electronics
- Dynamic Air fan cooling
- Soft rise LED lighting
- Sliding hinge door fixing

Dimensions (HxWxD) in mm 1780 x 560 x 550

SCN71800S1 - Never defrost again!



**In-column 50:50 split ProFresh Frost Free fridge freezer with A+ energy efficiency and electronic touch controls for precise temperature regulation.**

LCD touch controls ensure precise temperature and function setting, including useful features such as Frostmatic, Coolmatic, Child Lock, Door Open Alarm and High Temperature Alarm.

- Soft rise LED lighting
- Frostmatic function is ideal for freezing fresh food quickly
- High temperature and door open alarm
- Full width dairy compartment
- Sliding hinge door fixing

Dimensions (HxWxD) in mm 1780 x 560 x 550

SCS51810S0



**In-column 50:50 split fridge freezer with A+ energy efficiency.**

Adjustable temperature control for your food storage.

- Full width glass shelves with metal trim
- Full width dairy compartment
- 4 star freezer
- Maximum freezer storage with 4 transparent drawers
- A+ energy
- Door on door hinge

Dimensions (HxWxD) in mm 1780 x 560 x 550

SCS71801F1



**In-column 70:30 split LowFrost Fridge Freezer with A+ energy efficiency and touch control electronics.**

LCD touch controls ensure precise temperature and function setting, including useful features such as Frostmatic, Coolmatic, Child Lock, Door Open Alarm and High Temperature Alarm.

- Low Frost technology means that you only need to defrost the freezer every two years
- LED lighting
- Frostmatic
- Coolmatic
- LCD touch control electronics
- A+ energy
- Door on door hinge

Dimensions (HxWxD) in mm 1780 x 560 x 550

SCT71900S0 - Never defrost again!



**In-column extra tall ProFresh Frost Free fridge freezer with A+ energy efficiency and electronic temperature control.**

This model maximises the spare space at the top of the furniture housing, providing you with more useful storage space.

- DynamicAir cooling technology
- Electronic controls including Coolmatic and Frostmatic functions
- Soft rise LED lighting
- Sliding hinge door fixing

Dimensions (HxWxD) in mm 1850 x 560 x 550

SCT81900S0 - Never defrost again!



**In-column highly energy efficient extra tall ProFresh Frost Free fridge freezer with A++ energy efficiency.**

This model maximises the spare space at the top of the furniture housing, providing you with more useful storage space.

- A++ energy appliances are 25% more efficient than standard A+ rated models
- DynamicAir cooling technology
- Electronic controls including Coolmatic and Frostmatic functions
- Soft rise LED lighting
- Sliding hinge door fixing

Dimensions (HxWxD) in mm 1850 x 560 x 550

S95900XTM0



**PerfektFit fridge freezer with wine cellar and A+ energy. This freestanding fridge freezer fits perfectly in line with your kitchen furniture.**

The air circulation fan system within the wine cellar ensures that a constant temperature is maintained, allowing for up to 39 bottles (75cl) to be stored correctly on the 4 wooden shelves.

- DynamicAir cooling technology
- LCD touch control electronics
- Soft rise LED lighting
- Frost Free freezer
- Stainless steel

Dimensions (HxWxD) in mm 1855 x 1110 x 575

S95400XNM0



**PerfektFit fridge freezer with A+ energy - this freestanding fridge freezer fits perfectly in line with your kitchen furniture due to its slim depth.**

Dynamic Air cooling means that a powerful fan automatically activates to ensure that fridge temperature is maintained at the desired level and food is cooled, preserving food quality.

- DynamicAir cooling technology
- LCD touch control electronics
- Soft rise LED lighting
- Frost Free freezer
- Stainless steel

Dimensions (HxWxD) in mm 1855 x 1110 x 575

S96090XVM1



**American-style stainless steel food centre with A+ energy efficiency.**

Multi-Airflow cooling gives extremely stable and even temperature and humidity levels, combined with fast temperature recovery and chilling of fresh food to ensure food stays fresher for longer, meaning you waste less.

- In-door LCD touch control electronics
- In-door (plumbed) water and ice dispenser
- LongFresh zero degree drawer - extends food life by up to 3 times longer
- Soft rise LED lighting
- Frost Free freezer

Dimensions (HxWxD) in mm 1770 x 912 x 783

SWD81800G1



In-column large capacity stainless steel wine cooler with dual temperature regulation for red and white wines. LCD touch controls, combined with an Air Circulation fan system, ensures optimal wine storage for different types of wine with the possibility to personalise the split between each temperature zone.

- Stores up to 91 bottles (75cl) on 6 wooden shelves
- Door open alarm
- Soft rise LED lighting
- Right hinged only

Dimensions (HxWxD) in mm 1780 x 560 x 550

SWS74500G0



45cm compact wine cellar. The single temperature zone, with a range of 5°C - 20°C, provides the perfect environment for your wine. Stores up to 24 bottles (75cl).

- Internal LED lighting illuminates the wine cooler
- Easy access to bottles via the telescopic runners
- UV protected glass door
- Internal fan
- Left hinged only

Dimensions (HxWxD) in mm 450 x 560 x 550



# COOKING



Ovens	24
MaxiKlasse™	30
Pyroluxe®	33
ProCombi Steam	38
Sous Vide	42
Built-In Double Ovens	48
Built-Under Double Ovens	51

Compact Range	53
Ovens	57
Combination Microwaves	59
Microwaves	59
Coffee Machine	60
Compact Wine Cellar	60
Warming Drawers	61
Accessories	62

Hobs	64
MaxiSight Induction	70
MaxiSense Induction	73
Hob2Hood	79
Mixed fuel	81
CrystalLine	83
Ceramic	87
Gas	88

Hoods	93
Designer Hoods	98
Designer Chimney Hoods	99
Standard	100
Ceiling	101
Semi-integrated	101

# Ovens

The heart of every kitchen is the oven, where heat works its magic, turning raw ingredients into wonderful food and aromas.

As you challenge yourself and hone your cooking skills, your oven must be infinitely adaptable, capable of exceedingly delicate adjustment, yet also be amazingly durable.

The starting point for our design brief is the use of very high grade materials. You won't always see them, but you'll know they're there in the feeling of strength and balance, and the quiet, unruffled way an AEG oven does its work, year after year. It's that high quality frame that enables our ovens to introduce outstanding technical features.

Visually, our built-in range of ovens from our Neue Kollektion has a sophisticated control panel within vertical lines, held by flowing horizontal lines: like an 'H' on its side. Whilst the interface is information-rich and extremely powerful in what it enables the user to do, its design is pure and simple: so using it never feels complicated. For example, the number of different materials is kept to a minimal two: glass and steel. The displays are red when lit, as on all appliances in the Neue Kollektion – so that there is just one key 'accent' colour throughout the kitchen.

## Design Awards

Gold Award Winner,  
Design Awards 2011



The Gold Award is the highest classification for products in the Product Innovation Award categories at the Design Awards 2011, organised by Designer magazine.

Products achieving the Gold standard have been judged to be real innovators within their particular product category, delivering something genuinely new to the market.

13 of our products have been awarded Gold in the kitchen category.



# Oven Range

## Multifunction - The very best in traditional cooking

BE531400KM



MaxiKlasse™ oven with our SoftMotion™ Soft Close door.

## PyroLuxe® Plus - Because nobody likes cleaning their oven

BY9314001M



CuliSense oven with PyroLuxe® Plus cleaning.

BP8314001M



PyroLuxe® Plus oven, the ultimate in oven cleaning with ProSight touch controls.

BP5014301M



PyroLuxe® Plus oven with Steam Cooking.

BP531400KM



PyroLuxe® Plus oven, the ultimate in oven cleaning with built-in cleaning reminder.

BP320300KM



PyroLuxe® Plus oven, the ultimate in oven cleaning with built-in cleaning reminder.

## Multifunction with Steam - For the ultimate taste and texture food experience

BS9314001M



ProCombi Steam oven with Navisight™ controls.

BS8314001M



ProCombi multifunction steam oven with ProSight touch controls.

BS8366001M



ProCombi SousVide Multifunctional Steam Oven with ExSight Touch Screen.

VS92903M



Fully integrated Sous Vide VacSealer.

## Built-in Double Ovens - Large capacity with no compromises

DC7013001M



High performance built-in double oven with interactive digital cooking display.

DC4013001M

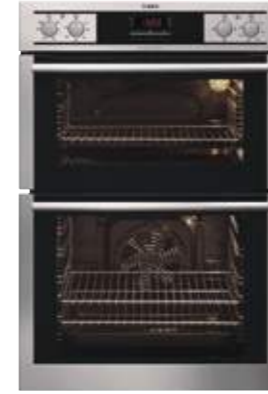

High performance built-in double oven with retractable controls.

## Built-under Double Oven

NC7013001M



High performance built-under double oven with interactive digital cooking and touch controls.

# COOKING

AEG ovens have extra large capacity - our largest standard single oven, with up to 5 shelf positions. With greater room and our ThermiC° hot air cooking system more hot air is circulated to every corner of the oven at a precise temperature for perfectly even cooking, wherever the food is placed.



## TRUE FAN

Our true fan cooking system gently circulates hot air through the oven cavity, allowing you to cook sweet and savoury at the same time with no transfer of flavour and taste. As the oven heats up faster, lower temperatures and shorter cooking times are used to achieve those delicious results.



## THERMIC° HOT AIR

Our exclusive ThermiC° hot air cooking technology ensures precise heat circulation and exact temperature control. The result is perfect cooking in every corner. On any shelf. In any position.



## DEFROST

Defrost your frozen food gently in half the usual time. Air is gently circulated around the oven cavity quickly, defrosting your food hygienically.



## CONVENTIONAL

Top and bottom elements heat the oven providing traditional cooking on one shelf position, which is ideal for baking breads or fruitcakes.



## TURBO GRILLING

This clever function gives an authentic spit roast effect without the mess. Heat from the top elements is circulated by the fan, sealing and crisping the food.



## PIZZA SETTING

Ensures bases are properly cooked. Designed to ensure pastry bases, quiches and pizzas are cooked to your taste.



## BOTTOM HEAT

Oven is heated by the bottom element only. Foods are gently reheated, ideal for pies and pastries as it keeps the pastry crisp. This function is also ideal for plate warming.



## TOP HEAT

Oven is heated by top element only. Ideal for the shepherd's pie, or lasagne that just require gentle browning.



## GRILL

Fully controllable powerful grill, ideal for family sized portions of food.



## ECONOMY GRILLING

Fully controllable economy grill, suitable for smaller quantities.



## SLOW COOK

Come home to a slow cooked roast or casserole. Two slow cook options, dependent on quantity of food being cooked. Food is initially sealed and then cooked at the low temperature to tenderise the ingredients.



## KEEP WARM

This option maintains a temperature of 80°C, perfect for keeping food warm until ready to serve, without drying the food.



## FROZEN FOODS

Cook straight from frozen. All-round intense heat ensures your frozen food is correctly defrosted and cooked at the same time.



## ROASTING

Economical setting for roasting large joints or poultry. Simply select the appropriate cooking time depending on the weight of the food and the oven automatically switches off once the cooking is complete.



## FAST HEAT UP

No waiting for your oven to reach full heat, eliminating the need for preheating, great for those quick convenience meals.



## MOIST FAN BAKING

Allows you to create your light and fluffy fatless sponges and baked soufflés to perfection. Moisture is retained within the oven thus achieving light fluffy results whilst using the oven in a more economical way.



## MAXI TRAY

The largest fitted oven tray available. In real terms, that means 20% more cookies from a single bake. Naturally each one will be perfectly golden and crunchy.



## EXTRA LARGE CAPACITY

Our large XXL MaxiKlasse™ oven has more usable space which allows you to cook on all 5 levels simultaneously, which means you can bake 150 cookies at the same time.



## MAXISIGHT® FLOOD LIGHT

A larger viewing window and inclined floodlight, for a clearer view of your cooking progress.



## CORE TEMPERATURE SENSOR

Measures the precise cooking temperature inside the food, for perfect results every time.



## PYROLUXE® PLUS - SELF CLEANING

A total self-cleaning function, that heats up to 500°C and turns food residue to ash.



## ANTI FINGERPRINT STAINLESS STEEL

Eliminates unsightly fingerprints from the appliance, for an effortless clean look.

## REGENERATE

Steam is used to gently heat food up and keep it warm.

## DOUGH PROVING

Creates the perfect environment to assist bread baking by proving your yeast mixture correctly.

## BREAD BAKING

Optimum temperature and environment for baking yeast mixtures. Using radiant heat and steam to bake a variety of loaves to your taste.

## PRESERVING AND DRYING

Suitable for drying foods like herbs, mushrooms and chillies.

## DIAMOND ENAMEL LINERS

Enamel interior, durable and easy to clean.

## PROSIGHT TOUCH CONTROL

Provides instant feedback, easy to use and looks sleek in the kitchen.

## AUTOSENSE

Advises you of the perfect temperature and duration to cook your food. All food types may be found in the 5 food categories.

## ISO FRONT DOOR

The door has a special heat reflective coating so the outside of the door is cooler to the touch.

## PERFEKTENTRY

PerfektEntry for total flexibility. OptiFlex™ shelf runners which are shaped to make it easier to select and adjust the cooking level you require.

## NAVISIGHT™

LCD and touch-dial navigation controls provide quick access to pre-programmed recipes and oven functions.

BE531400KM



PREMIER PARTNER\*  
**EXCLUSIVE**  
from September 2014

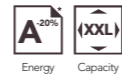

Oven functions



MaxiKlasse™ oven with our SoftMotion™ Soft Close door.

Multifunctional cooking combines all the benefits of hot air cooking with other functions, like conventional cooking, enabling you to achieve your desired result.

- Multifunctional cooking functions
- ThermiC° hot air cooking system
- XXL capacity
- OptiSight illuminated retractable controls
- SoftMotion™ soft close door
- Anti-stick oven shelves

Also available in BE5304001B Black

Dimensions (HxWxD) in mm 594 x 594 x 567







# Pyroluxe® Ovens

Nobody likes cleaning their oven, our energy efficient Pyroluxe® Plus ovens are not only extremely efficient when cooking but also when self-cleaning. Energy consumption is up to 20%\* lower than the requirements for efficiency Class A.

The Pyroluxe® Plus cycle cleans thoroughly at less than the cost of a first class stamp\*\*. The self-cleaning function heats the oven up to 500°C.

At this temperature, all food residue is turned to ash, with no unpleasant odours or chemical cleaning agents. Simply wipe out the ash with a damp cloth. Variable cycles depending on the cleaning need. Some models have more than one cleaning cycle which varies in time depending on how dirty the oven is. Whether it is lightly or heavily soiled these clever ovens will clean themselves to look as good as new – fully automatic self-cleaning at the touch of a button. There is even a cleaning reminder on some models.

\*20% more economical (only 0.79 kWh) than the threshold limit (<1000 kWh) for energy class A (DIN EN 50304/DIN EN 60350)

\*\*Correct at time of print



Point your smartphone camera at the QR code to view extra content.

BY9314001M



**A<sup>20%</sup>** Energy  
**(XXL)** Capacity

**Oven functions**

Pyroluxe	ThermiC <sup>®</sup> air	Defrost	Conventional	Turbo Grilling	Pizza	Bottom Heat	Grill	Fast grill
Slow cook	Keep warm	Fast heat up	Drying	Moist baking	Frozen food	Eco roasting	Core temp sensor	Anti fingerprint

Multifunctional single oven with digital auto-cooking. The advanced sensor system detects the volume of food in the oven and automatically selects the optimum cooking function.

- Digital auto-cooking
- NaviSight™ navigational controls
- Total self-cleaning oven with Pyroluxe® programmes
- CleanAir control
- IsoFront top oven door
- Anti-stick oven shelves
- 100 saved recipes/programmes

Dimensions (HxWxD) in mm 594 x 594 x 567

BP8314001M



**A<sup>20%</sup>** Energy  
**(XXL)** Capacity

**Oven functions**

Pyroluxe	ThermiC <sup>®</sup> air	Defrost	Conventional	Turbo Grilling	Pizza	Bottom Heat	Top Heat	Grill
Slow cook	Keep warm	Frozen food	Eco roasting	Fast heat up	True fan	Core temp sensor	Anti fingerprint	

Pyroluxe® plus oven, the ultimate in oven cleaning with ProSight touch controls.

- Multifunctional cooking functions
- ThermiC<sup>®</sup> hot air cooking system
- XXL capacity
- ProSight touch controls
- SoftMotion™ soft close door
- Anti-stick oven shelves

Dimensions (HxWxD) in mm 594 x 594 x 567

BP5014301M



**A<sup>20%</sup>** Energy  
**(XXL)** Capacity

**Oven functions**

Pyroluxe	ThermiC <sup>®</sup> air	Defrost	25% steam	Turbo Grilling	Conventional	Pizza	Bottom Heat	Top Heat
Grill	Frozen food	Fast heat up	Core temp sensor					

Pyroluxe® Plus oven with Steam Cooking, the best of both worlds.

- Quarter Steam + Heat cooking function
- Multifunctional cooking functions
- ThermiC<sup>®</sup> hot air cooking system
- XXL capacity
- SoftMotion™ soft close door
- Anti-stick oven shelves

Dimensions (HxWxD) in mm 594 x 594 x 567

BP531400KM



**A<sup>20%</sup>** Energy  
**(XXL)** Capacity

**Oven functions**

Pyroluxe	ThermiC <sup>®</sup> air	Defrost	Conventional	Turbo Grilling	Pizza	Bottom Heat	Top Heat	
Grill	Anti fingerprint	Core temp sensor						

**PREMIER PARTNER**  
**EXCLUSIVE**  
 from September 2014

Pyroluxe® Plus oven, the ultimate in oven cleaning with built-in cleaning reminder.

- Multifunctional cooking functions
- ThermiC<sup>®</sup> hot air cooking system
- XXL capacity
- SoftMotion™ soft close door
- Anti-stick oven shelves

Dimensions (HxWxD) in mm 594 x 594 x 567

BP320300KM



PREMIER PARTNER\*  
EXCLUSIVE  
from September 2014



Oven functions



Pyroluxe® Plus oven, the ultimate in oven cleaning with built-in cleaning reminder.

- Multifunctional cooking functions
- ThermiC® hot air cooking system
- XXL capacity
- UniSight™ retractable rotary controls
- SoftMotion™ soft close door
- Anti-stick oven shelves

Dimensions (HxWxD) in mm 594 x 594 x 567



# Multifunction Ovens with Steam

## A world of culinary possibilities

The fusion of steam and heat creates a recipe for success. It's a combination that delivers superior results all round, with soft, tender food on the inside, and a crisp, golden finish on the outside. This versatile cooking technique is now available with the ProCombi Steam Oven - in a full size or compact model - so you can achieve perfect results at home.

## The complete professional cooking tool

As well as combining steam and heat you will also have the additional cooking functions found on our multifunction ovens. This ProCombi oven not only steams and bakes but allows you to slow cook, bake and grill in the usual way. Elevate conventionally baked and roasted dishes to new culinary heights with our unique air flow technology, ThermiC° hot air system. Evenly cooked perfection in every corner.



### QUARTER STEAM + HEAT

25% steam and 75% hot air are combined to create irresistible flavours. Food is golden brown on the outside and succulent on the inside.

**Perfect for:** Homemade bread, meat, poultry, lasagne and your favorite recipes.



### HALF STEAM + HEAT

50% steam and 50% heat is the best way to cook while conserving the texture and moisture of the food.

**Perfect for:** Soufflés, casseroles and fresh or frozen convenience meals and reheating.



### FULL STEAM

Using 100% steam the gentle heat evenly penetrates food making for tasty, healthy dishes. The food retains a higher level of nutrients, vitamins and minerals, while natural colours, flavours and textures are enhanced.

**Perfect for:** Fish, rice, vegetables and fruit.

## Steam cleaning programme

A special preset programme helps you to loosen food residue inside the oven for easier cleaning.

Upon purchase and registration AEG will send you a complimentary Steam Cook Book.



## Not just a steam oven, you can roast, bake, grill and slow cook with our steam oven too.

Your steam oven can roast, bake, grill and slow cook as well as cook with steam. By combining steam and heat at the same time, you can achieve that holy grail of cooking – moist on the inside, crispy and golden on the outside.

The art is knowing how to combine the kinds of cooking for the dish you're creating.

Day	Dish	Time	Oven setting
Monday	Moussaka	60 minutes	25% steam
Tuesday	Pasta Gratin	45 minutes	25% steam
Wednesday	Convenience Meal	25 minutes	50% steam
Thursday	Pizza	10 minutes	Pizza setting
Friday	Poached Salmon	30 minutes	100% steam
Saturday	Paella	60 minutes	100% steam
Sunday	Roast Chicken	20 minutes	25% steam
	Roast Potatoes	45 minutes	25% steam
	Fruit Tart		25% steam



BS9314001M

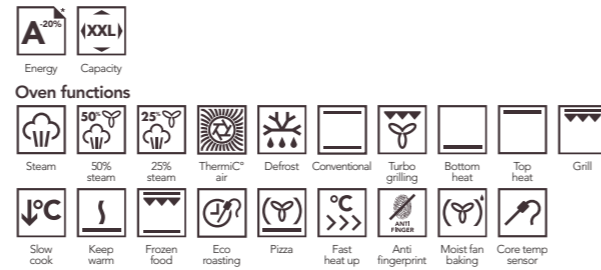

ProCombi™ multifunctional steam oven with NaviSight™ controls.

- Automatic food cooking programmes
- Multifunction cooking function
- XXL capacity
- ThermiC° hot air cooking system
- NaviSight™ navigational controls
- SoftMotion™ soft close door
- Anti-stick oven shelves

Dimensions (HxWxD) in mm 594 x 594 x 567

BS8314001M

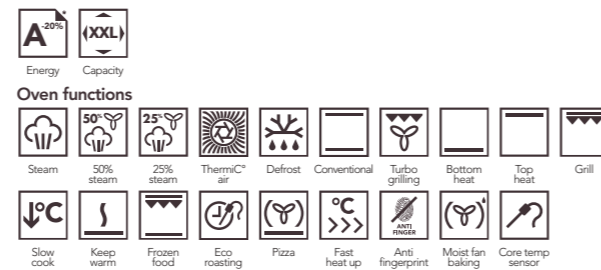

ProCombi™ multifunctional steam oven with ProSight touch controls.

- Three steam settings: 100%, 50% and 25%
- Multifunctional cooking functions
- XXL capacity
- ThermiC° hot air cooking functions
- ProSight touch controls
- SoftMotion™ soft close door
- Anti-stick oven shelves

Dimensions (HxWxD) in mm 594 x 594 x 567



# Taking our steam oven technology to the next level.

AEG are proud to introduce its new ProCombi™ SousVide oven, bringing the professional cooking expertise to your home. The AEG sous vide method brings the precisely controlled and gentle steam bathing technique to your food with our highly intuitive multifunction steam oven; the result for you is unrivalled melt-in-the-mouth taste sensations. The marriage of our ProCombi™ SousVide oven with our specially designed built in vacuum sealer drawer delivers the ultimate steam cooking system to revolutionise the way you cook.



# Introducing our SousVide oven, the ultimate in steam cooking with AEG.

The AEG ProCombi™ SousVide oven offers various programmes to cook vacuum-sealed food at low temperatures through a steam atmosphere.

Cooking Sous Vide keeps meals tasty, juicy and enhances the infusions of herbs, spices and other flavouring agents.



## Simple Sous Vide Beef Fillet

### You will need...

- 700-800g of beef sirloin/fillet with a thickness of 3cm
- 1 Garlic clove, thinly sliced
- 1 Rosemary sprig
- 2 Sage leaves
- 3 table spoons of extra virgin olive oil
- Sea salt flakes and freshly ground black pepper

### To serve

Grilled tomatoes, fried mushrooms and mustard.

### To cook

Sous Vide Beef Fillet Program

60mins

Shelf level 3

40cm



### SousVide VacSealer.

Built-in VacSealer drawer below the oven completes the cooking system. Simply place the bag inside with the ingredients. The air is removed and the bag sealed tightly.



## Step 1

### Prepare.

Place the steak, sliced garlic, rosemary and sage leaves in a vacuum bag. Drizzle in a little olive oil and season with pepper.



## Step 2

### Vacuum seal.

Place the bag in the vacuum sealer drawer.



## Step 3

### Cook.

Select SousVide Beef Fillet program. Add 400ml of water via water drawer and cook for 60 minutes. After cooking remove the meat from the bag and dry with a paper towel.



## Step 4

### Plate & Present.

Grill or sear the steak in a hot pan to lightly brown the meat. Serve the meat cut into 1 cm slices, sprinkled with a little sea salt and olive oil, with grilled tomatoes and fried mushrooms on the side.

BS8366001M

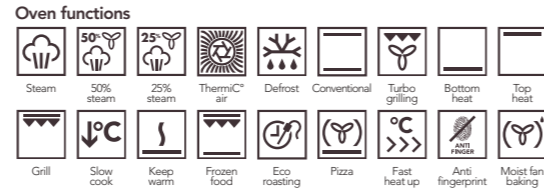

ProCombi™ SousVide multifunction steam oven with ExSight touch screen.

- SousVide setting cooks food under vacuum to temperatures as low as 50°C
- Multifunctional cooking functions
- XXL capacity
- ThermiC° hot air cooking system
- ExSight touch screen controls
- 100 assisted cooking recipes
- SoftMotion™, soft close door

Dimensions (HxWxD) in mm 594 x 594 x 567



VS92903M



Fully integrated Sous Vide VacSealer.

- Vacuum sealer drawer
- 100% vacuum packed food
- Easily pre-prepare professional standard meals in advance
- Flavours, spices and marinades are transferred instantly with vacuum packed food

Dimensions (HxWxD) in mm 594 x 594 x 567



COOLING  
OVENS  
COMPACT RANGE  
HOBS  
HOODS  
DISHCARE  
LAUNDRY  
SPEC TABLES



# Double Ovens

Our AEG double ovens offer you an additional cooking compartment, giving you total flexibility in your kitchen. Our range of built-in double ovens are installed in column at eye-level, alternatively, our range of built-under double ovens will fit neatly under the work surface. For even more flexibility you can combine our built-under ovens in column with our compact products.

## AA Energy efficiency

All our double ovens are extremely efficient and have an AA energy rating in both compartments, meaning whichever oven you decide to use, you are guaranteed excellent energy efficiency.



DC7013001M



Energy Capacity Anti fingerprint



Oven functions top oven



Oven functions bottom oven

High performance built-in double oven with interactive digital cooking display.

Interactive digital cooking recommends the ideal cooking temperature for the function selected and keeps you informed on the cooking process.

- Multifunctional cooking functions
- True fan for even cooking
- CataLuxe® Liners for easy clean
- Large capacity top and bottom ovens
- ProSight LCD display and touch controls
- Interactive digital cooking recommends cooking temperature

Dimensions (HxWxD) in mm 888 x 594 x 548

DC4013001M



Energy Capacity Anti fingerprint

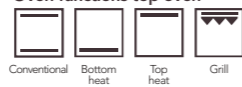

Oven functions top oven



Oven functions bottom oven

High performance built-in double oven with retractable controls.

Multifunction main oven with all the benefits of true fan and conventional cooking. Use different functions to get the best results for what you are cooking.

- Multifunctional cooking functions
- True fan for even cooking
- CataLuxe® Liners for easy clean
- Large capacity top and bottom ovens
- UniSight™ retractable rotary controls
- MaxiView allows you to check the progress of your meal

Dimensions (HxWxD) in mm 888 x 594 x 548

NC7013001M



Energy Capacity Anti fingerprint

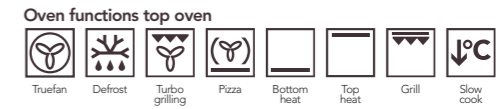

Oven functions top oven



Oven functions bottom oven

High performance built-under double oven with interactive digital cooking and touch controls..

Our sleek and stylish ProSight™ panel enables you to operate both ovens with just one set of controls for fast, simple access and cooking function selection. The Interactive LCD display provides instant feedback.

- Multifunctional cooking functions
- True fan for even cooking
- CataLuxe® Liners for easy clean
- Large capacity top and bottom ovens
- ProSight LCD display and touch controls
- Interactive digital cooking recommends cooking temperature

Dimensions (HxWxD) in mm 715 x 594 x 548





# Compact Range

Our compact ovens provide perfect performance, in concentrated form and offer alignment with all the features of their full-sized counterparts.

A comprehensive range includes steam and multifunction ovens, as well as combi microwaves, coffee machines and warming drawers.



**Concentrated Performance**  
Our compact ovens have all the features of their full-sized counterparts. Choose from steam or multifunction ovens to combi microwaves and coffee machines.



**Bespoke Customisation**  
Create your perfect layout, arranging items however you would like: a horizontal run, a vertical stack, or perhaps a group of four? The choice is yours.



**Design Harmony**  
The compact range matches all our standard-size kitchen appliances in design and perfectly aligns with all single ovens in our range, for a premium touch to your kitchen.



red dot design award  
best of the best 2011

# Performance, concentrated

The new AEG compact range offers powerful performance in a small design. Simply select the combination of appliances to best suit your needs and space, from steam only or multifunction ovens to combi and grill microwaves. Or how about a coffee machine or warming drawer to complete your kitchen?

With AEG Compact, an extended range of options means you should never have to compromise on fitting in everything you need. Our compact ovens have all the features of their full-sized counterparts, but concentrated into a smaller space.

## Bespoke customisation

So you can achieve your ideal combination and your perfect layout, ranging items however you like... a horizontal run, a vertical stack, or perhaps a group of four? With AEG Compact, you can create your own style - perfection.

## Compact Range / Combination Ideas

Group of four



Horizontal run



Vertical stack



Compact vertical stack



# COMPACT OVENS

The new AEG Compact range offers powerful performance in a small design. Simply select the combination of appliances to best suit your needs and space.



### STEAM

Uses 100% steam, retains moisture and nutritional values in the food you cook. Ideal for cooking rice fish vegetables and fruit.



### 50% STEAM

50% steam and 50% heat helps conserve the texture and humidity of the food. Ideal for casseroles, souffles and re-heating dishes.



### 25% STEAM

25% steam and 75% heat locks in moisture and browns the outside for irresistible flavours.



### TRUE FAN

Gently circulates hot air through the oven cavity, allowing you to cook sweet and savoury dishes at the same time without transfer of flavours.



### DEFROST

Air is gently circulated around the oven cavity quickly, defrosting your food hygienically.



### MOIST FAN BAKING

Moisture is retained within the oven thus achieving light and fluffy results, perfect for light sponges and souffles.



### TURBO GRILLING

Gives you an authentic spit roast effect without the mess. Heat from the top is circulated by the fan, sealing and crisping foods.



### CORE TEMPERATURE SENSOR

Measures the precise cooking temperature deep inside the food, taking the guesswork out of the cooking and ensures consistent results every time.



### GRILL

Fully controllable powerful grill, ideal for family sized portions of food.



### ANTI FINGERPRINT STAINLESS STEEL

A coating on all AEG stainless steel products, eliminates unsightly fingerprint marks ensuring your product looks effortlessly clean.



### KEEP WARM

Maintains a temperature of 80°C, ideal temperature for keeping food warm, without drying it out.



### FAST HEAT UP

No waiting for your oven to reach full heat, eliminating the need for preheating, great for those quick convenience meals.



### SOFTMOTION

The door will close itself softly and quietly, when it reaches a certain angle.



### COMBI MICROWAVE

Combines traditional microwave and a fan oven functions.



### MICROWAVE AND GRILL

Combines traditional microwave and grill functions.



### MICROWAVE

Powerful solo microwave with 5 power levels.

KS8404001M

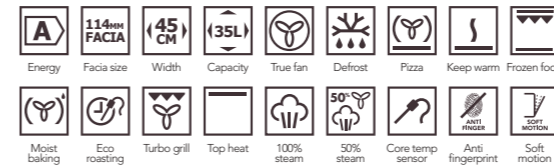

#### Compact ProCombi™ steam oven with ProSight™ touch control.

- Full steam to retain nutrients
- Half steam to conserve moisture
- Quarter steam for a crisp finish and a moist inside
- Touch controls
- Multifunctional cooking functions
- 20 pre set recipes

Dimensions (HxWxD) in mm 455 x 594 x 540

KE8404001M

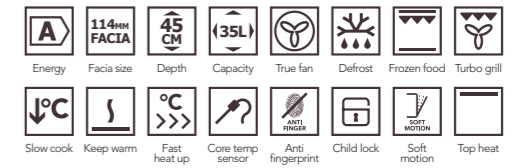

#### Compact multifunction oven.

- Multifunctional oven and grill
- Touch controls
- Core temperature sensor
- Child lock
- 20 pre set recipes
- Keep warm function

Dimensions (HxWxD) in mm 455 x 594 x 540

# Microwave Ovens

Our high-end Neue Kollektion microwave ovens provide a versatile range of cooking solutions in your kitchen. Flexibility is the key. You can microwave, grill, defrost, re-heat or select the convection function. And all this functionality can be used in any combination you desire.

## The perfect partner for your oven

Combine a microwave with your traditional oven for the definitive answer to your cooking needs. In addition to conventional cooking methods, you can gently heat liquids without using precious hob space, as well as speed up the cooking process by par-cooking dishes or defrosting meat and fish.

## Perfect results with automatic programming

Whether you're defrosting, cooking or grilling your food, our new microwave ovens can be depended upon time after time. They're automatically programmed to deal with a range of different dishes and foods at the touch of a button. Simply select the food type, weight and the microwave does the rest.

## Optimal access and ideal cooking capacity

With an expansive XXL cavity size inside our top-of-the-range models, you can prepare large dishes. And it's easy to load and unload heavy plates and trays with the drop-down door.

## Stainless-steel interior finish

Our microwaves feature our SOLO range - microwave only; DUO range - microwave and grill flexibility; and our COMBI range - microwave or grilling combined with fan cooking for fantastic results.

## Quick start control

Enables you to cook for 30 seconds at full power at the touch of a single button, ideal for common tasks such as warming up drinks. Can be pressed up to 5 times continuously for convenience. All our microwaves are fully built in so no additional building in kits are required. Selected models can be built under counter and all models can be built in column, offering flexibility to fit into your kitchen.

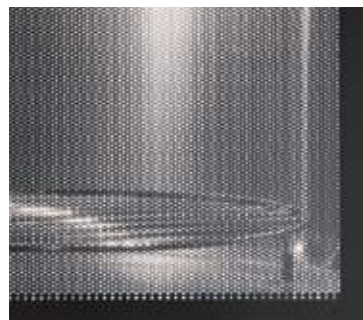

KM8403001M



5 YEAR GUARANTEE

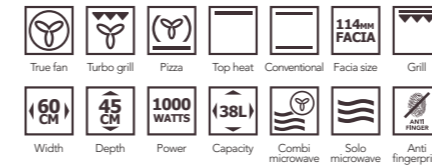

Multifunctional oven with microwave function. Aligns with ovens.

- ProSight touch controls with LCD display
- True fan for even cooking
- Auto weight cooking and defrost programme
- 5 microwave power settings
- Quick Start

Dimensions (HxWxD) in mm 455 x 594 x 542

KR8403001M



5 YEAR GUARANTEE

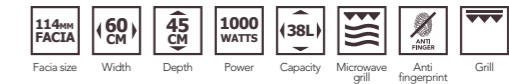

Microwave with grill. Aligns with ovens.

- ProSight touch controls with LCD display
- Auto weight cooking and defrost programme
- 5 microwave power settings
- Quick Start

Dimensions (HxWxD) in mm 455 x 594 x 542

MC2664E-M



5 YEAR GUARANTEE



Large 26L anti-fingerprint stainless steel microwave.

- Large 26litre capacity
- 5 power levels
- Auto weight cooking and defrost programme
- Quick Start
- Glass turntable
- Anti-fingerprint stainless steel

Dimensions (HxWxD) in mm 459 x 594 x 437

MC1763E-M



Best Buy Which?

5 YEAR GUARANTEE



Our active display allows you to change settings whilst the microwave is operating for added versatility.

- 17litre capacity
- 5 power levels
- Auto weight cooking and defrost programme
- Quick Start
- Glass turntable
- Anti-fingerprint stainless steel

Dimensions (HxWxD) in mm 371 x 594 x 306

PE4541M



5 YEAR GUARANTEE



Compact bean to cup coffee machine.

Have authentic Italian coffee at home at the touch of a button.

- ProSight touch controls
- Uses fresh beans for an authentic taste
- Fully automatic programme
- Steam/water spout for frothing milk
- Telescopic runners for easy access
- Multi cup/jug option

Dimensions (HxWxD) in mm 455 x 594 x 361

SWS74500G0



Coming Soon

5 YEAR GUARANTEE



45cm compact wine cellar.

Mix and match with the full range of compact appliances to achieve a stylish feature within your kitchen.

- Single temperature zone ranges 5°C - 20°C
- Stores up to 24 bottles
- Internal LED for illumination
- Telescopic shelving
- Left hinged only

Dimensions (HxWxD) in mm 455 x 594 x 558

Available from September

KD91403M



5 YEAR GUARANTEE



Warming drawer for 6 place settings.

Plate warming at 60°C food will stay warmer for longer on pre-warmed plates.

- 14cm height
- Anti-fingerprint stainless steel
- Keeps food warm until ready to serve
- Plate warming at 60°C
- Cup warming at 40°C

Dimensions (HxWxD) in mm 140 x 594 x 535

KD91404M



5 YEAR GUARANTEE



Warming drawer with push/pull mechanism.

Stylish steel warming drawer with push/pull mechanism for a flush finish in your kitchen.

- 14cm height
- Anti-fingerprint stainless steel
- Keeps food warm until ready to serve
- Plate warming at 60°C
- Cup warming at 40°C

Dimensions (HxWxD) in mm 140 x 594 x 535

KD92903E



5 YEAR GUARANTEE



Warming drawer for 12 place settings.

Ideal for keeping hot food warm until you are ready to serve without drying food out.

- 29cm height
- Anti-fingerprint stainless steel
- Keeps food warm until ready to serve
- Plate warming at 60°C
- Cup warming at 40°C

Dimensions (HxWxD) in mm 295 x 594 x 535

MaxiSense® Plancha Grill



To enable you to enjoy the precision and control of the MaxiSense® hob when griddling food, we have developed the MaxiSense® Plancha Grill.

This professional griddle distributes and retains heat evenly for perfect results.

Simply combine the Plancha Grill with any MaxiSense® hob that has the 'bridge' function - enabling you to griddle to perfection over two cooking zones.

Maxi-grill 944 189 319

Fusion Induction Wok



A tool to extend the abilities of MaxiSense® is the fusion induction wok, a unique wok support giving fast, focused heat for optimum wok cooking performance.

Our Fusion Induction Wok can be used with any Induction hob with a minimum zone width of 20cm and our CrystalLine module ceramic hob.

Fusion wok 944 189 320

CrystalLine Griddle Plate



A specially designed griddle plate that can be used together with our ceramic CrystalLine modular hobs.

This griddle evenly distributes and retains heat for perfect grilling. With an anti-stick coating and special feet, it's very practical and easy to clean.

C-grill 944 189 325

Compact Drawer

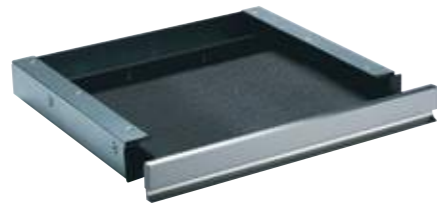

This special drawer is designed to be used in conjunction with our compact oven KS8100001M.

In stylish anti fingerprint stainless steel, with recessed handle and anti-slip mat, it's perfect for storing oven accessories.

BI Compact Drawer KD6070M

Telescopic Shelf Runners



One set of fully extendable telescopic shelf runners suitable for use with our new MaxiKlasse™ oven range.

TR1LFV

One set of fully extendable telescopic shelf runners suitable for use with our new MaxiKlasse™ steam ovens.

TR1LFSTV





# Hobs

Choosing a hob is very much a matter of personal preference, so our Neue Kollektion offers a wide range. Gas is instant with fully automatic ignition, while electric ceramic and induction hobs take control to a whole new level of sophistication.

## Cooking without limits

With the MaxiSense® induction hob, you no longer have to limit your choice of cooking pan to the circle on the hob. Just place the pan so that it covers a cross, and MaxiSense® adjusts to heat precisely that size and shape.

## Gas on glass

The Neue Kollektion's gas on glass hobs offer a beautifully balanced composition of glass and stainless steel, ideal for integrating into a high-end worktop. Alternatively, our professional-looking pure stainless steel range is both durable and elegant, with a low profile ideal for flush mounting.

## Your perfect combination

The CrystallLine range lets you build a professional-standard cooking area precisely to your needs, with options including induction wok, gas and even induction Teppanyaki. With their unique glass-bar design and DirekTouch instant control interfaces, the modules combine to stunning effect, whichever you choose.



# Hobs

## Induction - the most energy efficient and responsive technology



### DIREKTOUCH

Touch controls for quick and precise heat level selection.



### ROTARY CONTROLS

DirekTouch Rotary controls for quick, precise heat level selection.



### BRIDGING ZONES

Bridge function links two zones creating a larger zone for versatile cooking.



### OPTIHEAT

Shows 3 levels of residual heat on each cooking zone.



### MAXISENSE®

Gives you greater flexibility as pans can be positioned at any position as long as the cross is covered. Perfect for oversized pans.



### MAXISIGHT®

TFT colour display that ensures you can see every important detail at a glance.



### STOP+GO

Reduces all zones to a keep warm setting if cooking is interrupted. Press again and the zones return to previous heat levels.



### WOK

Induction wok hob, designed for a large wok that accompanies the hob.



### CHILD LOCK

Controls can be locked for additional safety and prevent alteration to cooking selection.



### COUNT-UP TIMER

Set a reminder or use the count-up timer to keep in control of your cooking.



### ÖKO TIMER

Energy saving timer that switches off the zone and uses residual heat to complete the last few minutes of cooking.

## Gas



### NO. OF BURNERS

Number of burners on the hob.



### WOK

Wok rest and large burner provides maximum heat for wok cooking on gas.



### AUTOMATIC IGNITION

Steel capped control knob with an integral ignition.

## Ceramic



### DUAL ZONE

Automatic hob recognition for two pan sizes.



### TRIPLE ZONE

Automatic hob recognition for up to three pan sizes.



### MULTI-PURPOSE ZONE

Multi-purpose zone for hob cooking flexibility. Ideal for larger pots.



### RESIDUAL HEAT INDICATOR

Shows you the level of residual heat on each zone after cooking.



### TOUCH CONTROL

Precise and immediate temperature control at your fingertips.

# Induction and Ceramic Hobs Range

## MaxiSight® Induction

HK884400XG



80cm MaxiSight® Induction hob with 4 MaxiSense® zones.

HK683320XG



MaxiSight® Induction hob with bridging function.

## MaxiSense® Induction

HK956600FB



Extra wide 90cm MaxiSense® induction with Procook Zone.

HK856600FB



Extra wide 80cm MaxiSense® induction with Procook Zone.

HK874400FB



80cm MaxiSense® induction Purehob with bridging function.

HK855200FB



80cm MaxiSense® induction hob with 5 Zones.

HK953400FB



90cm MaxiSense® induction hob with AutoMax feature.

HK854400FB



80cm MaxiSense® induction hob with Stop+Go feature.

HK854401FB



80cm MaxiSense® induction with Hob2Hood Link.

## Induction Hobs

HK764403XB



71cm MaxiSense® induction hob with DirekTouch controls.

Also available HK764403FB

HK654400XB



60cm MaxiSense® induction hob with bridging function.

Also available HK654400FB

HK854320FB



Extra wide 80cm induction hob with DirekTouch controls.

HK654200FB



Standard 60cm induction hob with DirekTouch controls.

## Mixed Fuel Hobs

HD955100NB



90cm mixed fuel hob with 4 induction zones and 1 gas wok burner.

HD634170NB



60cm mixed fuel hob with 2 induction zones and 2 gas burners.

## Ceramic

HK634060XB



60cm wide Optifit® ceramic hob with Stop+Go.

# Induction Hobs

Induction technology is the fastest, safest and most energy-efficient way to cook on a hob, heating the pan directly with no pre-heating required.

MaxiSense® induction hobs look stunning too, with their sleek, smooth designs – perfect for the most beautiful kitchens.



### Nothing is faster

MaxiSense® induction is simply the quickest way to cook, capable of bringing a pan to the boil faster than a comparable gas or conventional electric hob.



### Precision power

Heat can be adjusted and controlled precisely with extreme sensitivity. It can be very powerful indeed, or just gentle enough to melt chocolate directly in the pan.



### Extra safe

All AEG induction hobs feature automatic pan recognition. By sensing a pan's shape and size, it ensures only the base is heated, leaving the surrounding area always safe to touch.



### Simple to clean.

Spills and splashes can be easily wiped away with a damp cloth, no need for scrubbing or soaking as food will never get burnt on with induction.



## Induction technology

Coils create a magnetic field that adapts to the size and shape of the cookware, heating just its bottom – while surrounding areas remain cool. Up to 90% of the energy used goes into heating your pan.

## Traditional heating technologies

A high share of energy is wasted by heating up the entire cooking circle and surrounding air. On a gas hob, only up to 55% of the energy used goes into heating your pan.



# MaxiSight® Induction

AEG has a range of MaxiSight® induction hobs, with all the benefits of induction and the flexibility of MaxiZones.



### MaxiSight® Range

Featuring a colour hob display, MaxiSight® gives clear, at-a-glance feedback for each zone, with count-down and count-up timers, temperature and progress indicators.

### Bridging Function

On some models two individual zones can be bridged and function as one with just one temperature selection and timer. Perfect for larger pans such as fish kettles.

### Complete Control

Induction technology keeps you in complete control of your cooking. Temperatures are controlled instantly with a simple touch.

HK884400XG



### 80cm MaxiSight® induction hob with 4 MaxiSense® zones.

- MaxiSight® TFT colour display
- 4 MaxiSense® zones giving more cooking flexibility
- DirekTouch controls
- AutoMax quickly brings the hob to the boil
- Power Booster
- Stop+Go function
- OptiHeat control with 3 levels of residual heat
- Child lock

HK683320XG



### 60cm MaxiSight® induction hob with bridging function.

- MaxiSight® TFT colour display
- 2 MaxiSense® zones and 1 large circular zone giving more cooking flexibility
- DirekTouch controls
- AutoMax quickly brings the hob to the boil
- Bridging function
- Stop+Go function
- OptiHeat control with 3 levels of residual heat
- Child lock



reddot design award  
winner 2011

# MaxiSense® Induction – Total Flexibility

MaxiSense® Induction isn't limited by standard circle zones. So now you can use long shaped and bigger pans when entertaining. All you have to do is ensure the pan covers the cross mark.



**Design that always looks good**  
All AEG induction hobs are made of resilient, high quality black glass, so whichever style you choose, it will be a beautiful complement to any modern kitchen.



**No limits cooking**  
The MaxiSense® hob gives you more freedom to create. Just place each pot so that it touches a cross and MaxiSense® adjusts to heat precisely that size and shape.



**DirekTouch control**  
MaxiSense® is controlled by DirekTouch, instantly-responsive fingertip controls, letting you set and adjust temperature to an exceptionally high degree of accuracy, with just one touch.

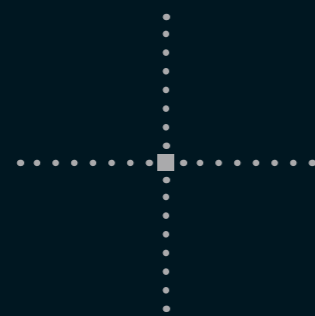

**Borderless cooking with MaxiSense®** means that you can use the cookware required for precision work. It's perfect for specialist cooking styles that require large, unusual shaped items such as a fish kettle, griddle pan or wok.

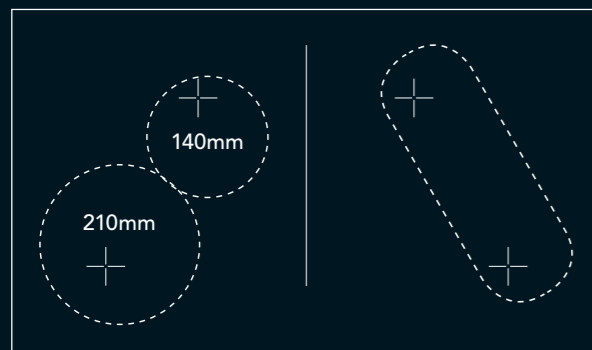

HK956600FB



- Extra wide 90cm MaxiSense® induction with Procook Zones.**
- 2 MaxiSense® zones
  - 1 Procook Zone that can bridge for maximum flexibility
  - DirekTouch controls
  - AutoMax quickly brings the hob to the boil
  - Öko Timer
  - Stop+Go function
  - OptiHeat control with 3 levels of residual heat

HK856600FB



- Extra wide 80cm MaxiSense® induction with Procook Zones.**
- 2 MaxiSense® zones
  - 1 Procook Zone that can bridge for maximum flexibility
  - DirekTouch controls
  - AutoMax quickly brings the hob to the boil
  - Öko Timer
  - Stop+Go function
  - OptiHeat control with 3 levels of residual heat

HK874400FB

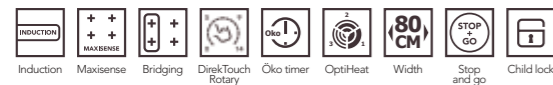

- 80cm MaxiSense® induction Purehob with bridging function.**
- Beautiful unique purehob with a pure black glass design. Available with frame.
- Illuminated controls and zones
  - 4 MaxiSense® zones giving cooking flexibility
  - DirekTouch controls
  - AutoMax quickly brings the hob to the boil
  - Bridge function
  - Stop+Go function
  - OptiHeat control with 3 levels of residual heat

HK855200FB

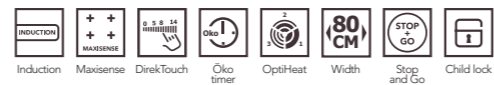

- 80cm MaxiSense® induction hob with 5 zones.**
- 80cm wide cooking space
  - 5 MaxiSense® zones giving cooking flexibility
  - DirekTouch controls
  - AutoMax quickly brings the hob to the boil
  - Power Booster
  - Stop+Go function
  - OptiHeat control with 3 levels of residual heat

HK953400FB



- 90cm MaxiSense® induction hob with AutoMax feature.**
- 3 MaxiSense® zones giving cooking flexibility
  - DirekTouch controls
  - AutoMax quickly brings the hob to the boil
  - Power Booster
  - Stop+Go function
  - OptiHeat control with 3 levels of residual heat

HK854400FB



- 80cm MaxiSense® induction hob with Stop+Go feature.**
- 4 MaxiSense® zones giving cooking flexibility
  - DirekTouch controls
  - AutoMax quickly brings the hob to the boil
  - Stop+Go function
  - OptiHeat control with 3 levels of residual heat



COOLING  
OVENS  
COMPACT RANGE  
HOBS  
HOODS  
DISHCARE  
LAUNDRY  
SPECTABLES

HK764403XB

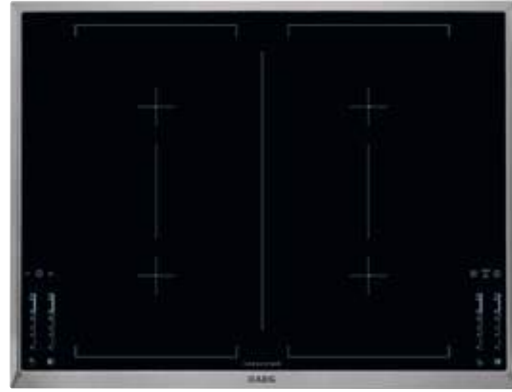

71cm MaxiSense® induction hob with DirekTouch controls.

- 4 MaxiSense® zones giving cooking flexibility
- DirekTouch controls
- Bridging function
- AutoMax quickly brings the hob to the boil
- Stop+Go function

Also available without frame  
HK764403FB

HK654400XB



60cm MaxiSense® induction hob with bridging function.

- 4 MaxiSense® zones giving cooking flexibility
- DirekTouch controls
- Bridging function
- AutoMax quickly brings the hob to the boil
- Stop+Go function

Also available without frame  
HK654400FB

HK854320FB



Extra wide 80cm MaxiSense® induction hob with Procook Zones

- 2 MaxiSense® zones giving cooking flexibility
- DirekTouch controls
- Bridging function
- AutoMax quickly brings the hob to the boil
- Stop+Go function
- OptiHeat control with 3 levels of residual heat

HK654200FB

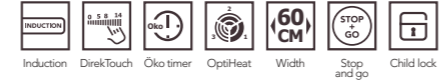

Standard 60cm induction hob with DirekTouch controls.

- 4 MaxiSense® zones giving cooking flexibility
- DirekTouch controls
- AutoMax quickly brings the hob to the boil
- Stop+Go function
- OptiHeat control with 3 levels of residual heat



# Seamless interaction Hob2Hood



Your hood is controlled automatically according to your hob settings, keeping the kitchen fresh while you are concentrating on the food.

## One touch control

When your hob starts heating up, the temperature sensors send a signal to your hood for the fan to start in up to two steps, first before boiling temperature and then before frying temperature has been reached.

It is always the hottest zone that will decide the signal that is sent to the hood. There is a dedicated touch pad on the hob for the user to change or cancel the fan speed manually.



HK854401FB



PREMIER PARTNER\*  
EXCLUSIVE  
from September 2014



80cm MaxiSense® induction with Hob2Hood Link.

- 80cm wide cooking space
- 4 MaxiSense® zones giving cooking flexibility
- DirekTouch controls
- Power Booster
- AutoMax quickly brings the hob to the boil
- Öko Timer
- Stop+Go function
- OptiHeat control with 3 levels of residual heat
- Child lock



# Mixed Fuel Hobs

By mixing induction hobs with gas burners you create the ideal hob for all needs. The benefit of Induction are it's energy efficiency, power and responsiveness. But with gas you are able to still wok cook.



HD955100NB



**Stylish 90cm mixed hob with 4 induction zones and 1 side wok burner**

- Induction with Touch Controls
- Stop+Go function (Induction)
- Designer cast iron pan supports
- Steel capped rotary gas controls
- Automatic integrated gas ignition
- Wok burner

HD634170NB



**Stylish 60cm mixed hob, with 2 induction zones and 2 gas burners**

- Induction with Touch Controls
- Stop+Go function (Induction)
- Designer cast iron pan supports
- Steel capped rotary gas controls
- Automatic integrated gas ignition



# Customise Your Cooking

The Crystalline range lets you build a bespoke cooking area that allows you to mix up fuel types to tailor precisely to your cooking styles, with options including induction wok, gas and even Teppanyaki. With their unique glass-bar design, the modules combine to stunning effect, whichever you choose.

Crystalline modules:



1 Induction hob



2 Teppanyaki



3 Induction wok



4 Gas wok on glass



5 Gas on glass

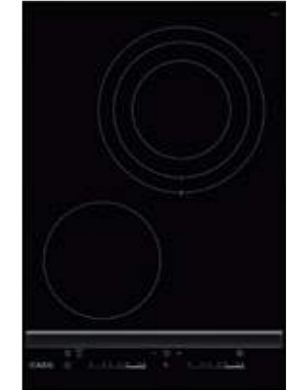

6 Glass ceramic



reddot design award  
winner 2011

HC452400EB



CrystalLine MaxiSense® 2 zone induction hob with bridging function.

- Stylish glass bar magnifies controls
- Bridging function
- DirekTouch controls
- Öko Timer, energy saver
- Stop+Go function
- OptiHeat control with 3 levels of residual heat
- Reminder timer control

HC451500EB



CrystalLine Induction Wok with DirekTouch controls and compatible wok.

- Stylish glass bar magnifies controls
- Induction wok accessory included
- DirekTouch controls
- Öko Timer, energy saver
- Stop+Go function
- Residual heat indicator

HC452600EB



CrystalLine Teppanyaki with DirekTouch controls.

- Stylish glass bar magnifies controls
- Reverse induction technology
- Easy clean
- DirekTouch controls
- Öko Timer, energy saver
- Stop+Go function
- Residual heat indicator
- 2 temperature zones for cooking different foods

HC411520GB



CrystalLine gas Wok burner with steel capped rotary control.

- Stylish glass bar
- Wok burner provides high heat
- Steel capped rotary controls
- Designer cast iron pan supports
- Front controls

HC412000GB



CrystalLine 2 burner gas hob with cast iron pan support.

- Stylish glass bar
- 2 different size burners
- Steel capped rotary controls
- Designer cast iron pan supports
- Front controls

HC452020EB



CrystalLine 2 zone ceramic hob with DirekTouch controls.

- Stylish glass bar magnifies controls
- DirekTouch controls
- Flexible triple zone
- Öko Timer, energy saver
- Stop+Go function
- Residual heat indicator
- Child lock



# Ceramic Hob

Ceramic hobs have a heat element under toughened glass. When switched on, the element heats up and the zone glows red. Our ceramic hob has flexible zones for a variety of cooking needs.



**Beautifully sleek in your kitchen.**

Our ceramic hobs are made from a single sheet of black glass, and give you a stream-lined look in your kitchen.



**Simple to clean.**

Spills and splashes can be easily wiped away with a damp cloth, no need for scrubbing or soaking.



**Touch control.**

The touch controls are simple to operate and are highly responsive, putting you in total control of you cooking.

## HK634060XB

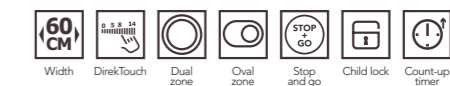

60cm wide OptiFit® ceramic hob with Stop+Go function.

- 4 HiLight zones
- DirekTouch controls
- Residual heat indicator
- AutoMax quickly brings the hob to the boil
- Count up timer
- Stop+Go function



# Gas Hobs

To create a design statement with your hob, our Neue Kollektion features a range of elegant, gas on glass, Semi-flush gas on glass hobs and a premium quality range of ultraflat stainless steel gas hobs.



**Gas on Glass Design**  
The ultimate design statement. Stylish cast iron pan supports combined with the sleek black glass and the versatility and precision of gas cooking.



**Semi-flush Perfect Integration**  
Our Semi-flush gas on glass hobs appear to be integrated into the worktop, giving your kitchen a perfect harmony.



**OptiFit® Premium Frame**  
The new OptiFit® frame provides a premium stainless steel frame that allows easy installation as well as protecting the glass surface.



# Gas Hobs Range

## Gas on Glass

HG795540XB



Designer 75cm semi-flush gas on glass hob with side wok burner.

HG795440XB



Designer 70cm semi-flush gas on glass hob with central wok burner.

## UltraFlat

HG755421UM



Designer UltraFlat 75cm stainless steel hob with 5 burners.

HG654421UM



Designer UltraFlat 60cm stainless steel hob with 4 burners.

## Gas

HG956440SM



Extra wide 90cm stainless steel gas hob with 6 burners.

HG755440SM



75cm wide stainless steel gas hob with 5 burners.

HG654440SM



Stainless steel 60cm gas hob with wok burner.

HG795540XB

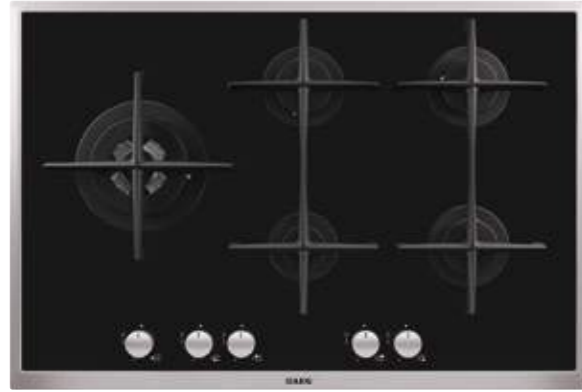

5 YEAR GUARANTEE



Designer 75cm semi-flush gas on glass hob with side wok burner.

- 5 burner gas hob
- Specially designed wok burner
- OptiFit® stainless steel frame
- Designer cast iron pan supports
- LED heat intensity indicators
- Steel capped rotary controls
- Automatic integrated ignition

HG795440XB



5 YEAR GUARANTEE



Designer 70cm semi-flush gas on glass hob with central wok burner.

- 5 burner gas hob
- Central Wok burner
- OptiFit® stainless steel frame
- Designer cast iron pan supports
- LED heat intensity indicators
- Steel capped rotary controls
- Automatic integrated ignition

HG755421UM



5 YEAR GUARANTEE



Stunning UltraFlat designer gas hob with side wok burner.

- 5 burner gas hob
- Stunning flat sheet of stainless steel
- Designer cast iron pan supports
- Specially designed Wok burner
- Steel capped rotary controls
- Automatic integrated ignition

HG654421UM

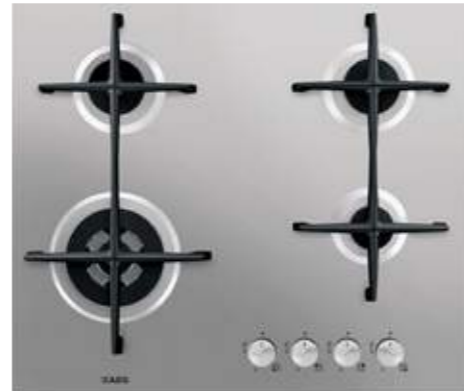

5 YEAR GUARANTEE



Designer UltraFlat 60cm stainless steel hob with 4 burners.

- 4 burner gas hob
- Stunning flat sheet of stainless steel
- Designer cast iron pan supports
- Steel capped rotary controls
- Automatic integrated ignition

HG956440SM



5 YEAR GUARANTEE



Extra wide 90cm stainless steel gas hob with 6 burners.

- Extra wide hob
- 6 burner gas hob
- LED heat intensity indicators
- Stunning flat stainless steel design
- Designer cast iron pan
- Steel capped rotary controls

HG755440SM



5 YEAR GUARANTEE



75cm wide stainless steel gas hob with 5 burners.

- 5 burner gas hob
- Centre wok burner
- Designer cast iron pan supports
- LED heat intensity indicators
- Steel capped rotary controls
- Automatic integrated ignition

HG654440SM



5 YEAR GUARANTEE



Stainless steel 60cm gas hob with wok burner.

- 4 burner gas hob
- Specially designed Wok burner
- Designer cast iron pan supports
- LED heat intensity indicators
- Steel capped rotary controls
- Automatic integrated ignition

# Hoods

AEG hoods can add a real design statement or focal point to any kitchen. Our hoods seamlessly balance glass and stainless steel, to align perfectly with the rest of the kitchen.



**Top Efficiency**  
Our ActiveHeat Sensor monitors kitchen conditions so that the right extraction rate is used, no matter how intense the cooking process.



**LED Lighting**  
Crisp bright illumination, or a gentle glow? Dimmer-controlled LED lighting means you can adjust the effect at the touch of a fingertip.



**DirekTouch Display**  
With our glass touch display, instant control is always at your fingertips.



reddot design award  
winner 2011

# Hoods Range

## Designer Hoods

X94484MV10



Coming Soon

Vertical elegant screen hood with LED lighting.

X66453BV1 / X69453BV03



Sophisticated and premium design in beautiful black glass.

X66453MV1 / X69453MV01



Sophisticated and premium design in stunning stainless steel.

X68163BV1 / X65163WV1



Black glass designer screen hood.

## Designer Chimney Hoods

X99464MK2



Coming Soon

Switch designer wall hood in stainless steel with LED lighting.

X99484MD10



Coming Soon

Stainless steel designer hood with touch controls and LED lighting.

X66453MD1 / X67453MD0 / X69453MD02



Designer hood in stainless steel with glass panel aligning to our kitchen appliances.

DK4460-M / DK4490-M



Stylish stainless steel chimney hood with LED display.

## Island Hoods

X99464MI2



Coming Soon

Switch designer island hood in stainless steel with LED lighting.

X91484MI1



Coming Soon

Stainless steel designer island hood with touch controls and LED lighting.

X91384Mi01



Elegant stainless steel island hood with designer glass panel.

## Ceiling Mounted Hoods

X81284WG1



Coming Soon

Premium ceiling mounted hood with LED lighting.

## Downdraft Hoods

DH1690-M



Beautiful stainless steel downdraught extractor hood.

## Standard Hoods

DL7275-M9



Stainless steel canopy hood.

DE6261-ML



Semi-integrated telescopic hood with stainless steel trim.

DF6164-M



Integrated hood.



# HOODS

## A masterpiece of precision

A cooker hood has a job to do, but there is no reason why it should not look visually stunning at the same time. Our Neue Kollektion hoods balance glass to align perfectly with the rest of the kitchen.

### COOKER HOODS, THE BASICS

The new cooker hoods from AEG aerate your kitchen, deal with humidity, heat, odours and food particles in the most efficient way. Whether you prefer to be discreet or to make a bold statement in the kitchen, we can help you choose a cooker hood that suits your style.

### HANDLING HUMIDITY

When using your hob, water evaporates into the air so that it becomes humid.

If the water particles are not dealt with, they transport grease and odour around your kitchen and home. The new AEG range has been designed to remove water particles from the air as they rise from the hob, keeping your kitchen fresh and clean.

### MANAGING ODOURS

Aromas from the kitchen can get everybody excited about what is due to arrive on the table, lingering odour from past meals on the other hand are not so enticing. When you invest in an AEG hood, you invest in a fresh and pleasant kitchen environment. If not used in venting mode AEG's odour filters (activated carbon filters) ensure that lingering odours are a memory of the past. They are available in single-use versions (disposable) or as reusable versions (suitable for rinsing/regeneration) for selected extractor hoods.

### DEALING WITH GREASE

Whenever you fry something, grease particles dissipate in the air and settle on surfaces throughout your kitchen. These are the perfect breeding grounds for bacteria and are very difficult to get rid of. AEG grease filters are designed to trap the grease particles contained in the vapour when air passes through the filter. Depending on the filter type, grease filters must be replaced (disposable filters) or cleaned (long life filters).



### INCREASED ILLUMINATION

Hobs are often positioned against the wall in kitchens, and in many cases they are located in the corner of the room. This is not the lightest part of the kitchen.

Furthermore, if you have an extractable hood even less light reaches the hob area. AEG top models use the latest in long-life, energy efficient LED lighting, to ensure high visibility of your cooking area. The advanced dimmer controls enable you to choose the light that suits the particular time of the day.

### DIFFERENT OPTIONS FOR DIFFERENT KITCHENS

Depending on the design and size of your kitchen, you can choose from a wide range of attractive designs and widths. AEG's Neue Kollektion offers you Island, chimney, wall, ceiling, retractable table-top and built-in hoods to answer all your specific needs.



## Choosing the right hood for your needs

When it comes to choosing your cooker hood there are some things you will have to consider such as the size of your kitchen, the existing ventilation system and the position of the hob. Once you know this, you can then choose the best design for your kitchen from the AEG Neue Kollektion. Make sure your house is equipped to suit your desired hood.

### HOW BIG IS YOUR KITCHEN?

Air needs to continuously circulate to help prevent grease and odour particles from settling on surfaces. And in smaller kitchens the air becomes saturated with particles more quickly than in larger kitchens. Therefore, the first thing you need to consider when you are looking for a hood is the size of your kitchen.

### CALCULATE THE RIGHT SIZED HOOD

To calculate hood size you need to measure the size of your room (L x W) and the height (H) of the ceiling. When you multiply these two figures together you get the volume of your kitchen (L x W x H). Once you know the volume of your kitchen you need to multiply it by the minimum (6 m<sup>3</sup>/h) and the maximum (12 m<sup>3</sup>/h) air circulation factors. In a 16 m<sup>3</sup> kitchen with a 2.5 m high ceiling this is expressed as:

$$16 \times 2.5 \times 6 = 240$$

$$16 \times 2.5 \times 12 = 480$$

This means you need a hood that can filter at a rate of 240 m<sup>3</sup>/h at low speed and 480 m<sup>3</sup>/h at high speed.

### WHERE IS THE HOOD LOCATED IN THE ROOM?

Your choice of fan will also be affected by its position in the room and the ventilation system you have.

For example, a wall mounted or a built-under hood, will not work on a kitchen island. If you are fitting a hood over an island it is also more likely that air will be recirculated into your kitchen rather than expelled outdoors, due to the location of the ventilation system.

### 60 dB WHISPER QUIET

AEG's powerful hoods make a real difference to your kitchen environment, ensuring that it is a fresher, more peaceful place to cook or relax.



### 530 M<sup>3</sup>/HR EXTRACTION RATES

This is the level at which the cooker hood clears cooking vapours from the kitchen environment. Operation is measured in cubic metres per hour and are in accordance with IEC standards.

### 16 M<sup>3</sup> OPTIMUM EFFICIENCY

To optimise efficiency and performance of the cooker hood it is important to select the correct hood with an appropriate extraction rate for your kitchen environment. To help ensure you select the correct cooker hood we have added an icon to each hood showing the maximum size of the room each one is suitable for.



X94484MV10



Coming Soon

5 YEAR GUARANTEE

LED Lighting DirekTouch Extraction rate Decibels

Vertical elegant screen hood with LED lighting. LED lighting ensures optimal visibility of your cooking area whilst providing pleasant ambient light.

- LED lighting
- DirekTouch controls
- 4 speed control
- ActiveHeat sensors adjust fan speed
- Charcoal filter included for recirculation mode

X66453MV1 / X69453MV01



HOB 2 HOOD ↑  
5 YEAR GUARANTEE

DirekTouch Extraction rate Decibels Efficiency

Sophisticated and premium design in stunning stainless steel. Electronic 4 speed control including Intensive setting with perimeter extraction drawing air from every angle.

- Twin halogen lighting
- DirekTouch controls
- 4 speed control
- ActiveHeat sensors adjust fan speed
- Charcoal filter included for recirculation mode

Available in  
X69453MV01 90cm stainless steel  
X66453MV1 60cm stainless steel

X66453BV1 / X69453BV03



HOB 2 HOOD ↑

5 YEAR GUARANTEE

DirekTouch Extraction rate Decibels Efficiency

Sophisticated and premium design in beautiful black glass. Our electronic glass touch controls with LED display ensures quick, direct access is always at your fingertips.

- Twin halogen lighting
- DirekTouch controls
- 4 speed control
- ActiveHeat sensors adjust fan speed
- Charcoal filter included for recirculation mode

Available in  
X66453BV1 60cm black glass  
X69453BV03 90cm black glass

X65163WV1 / X68163BV1



5 YEAR GUARANTEE

Extraction rate Decibels

Push button controls with 3 speeds. Perimeter extraction and a powerful motor ensure vapours and odours are extracted in the most efficient way. Twin halogen lights for improved illumination.

- Twin halogen lighting
- Push button controls
- 3 speed controls
- ActiveHeat sensors adjust fan speed

Available in  
X65163WV1 60cm black glass  
X68163BV1 80cm black glass

X99464MK2



Coming Soon

5 YEAR GUARANTEE

LED lighting Extraction or recirculation DirekTouch Extraction rate Decibels Efficiency

Switch designer wall hood in stainless steel with LED lighting. With just a touch this hood switches between external extracting to recirculating clean air to ensure that you are using in the most economical way.

- LED lighting
- DirekTouch controls
- ActiveHeat sensors adjust fan speed
- Extraction or recirculation
- Charcoal filter for recirculation mode

Safety distance 500mm Electric; 650mm Gas

X66453MD1 / X67453MD02 / X69453MD02



HOB 2 HOOD ↑  
5 YEAR GUARANTEE

DirekTouch Extraction rate Decibels Efficiency

Designer hood in stainless steel with glass panel. ActiveHeat sensor automatically adjusts the fan speed so its always at the optimum level.

- LED lighting
- DirekTouch controls
- ActiveHeat sensors adjust fan speed
- Extraction or recirculation
- Charcoal filter for recirculation mode

Available in  
X69453MD02 90cm\*  
X67453MD1 70cm  
X66453MD1 60cm

\*Compatible with HK854401FB

X99484MD10



Coming Soon

5 YEAR GUARANTEE

Extraction rate Decibels

Stainless steel designer hood with touch controls and LED lighting. Perimeter extraction and a powerful motor ensure vapours and odours are extracted in the most efficient way.

- LED lighting
- Glass touch controls
- 4 speed controls
- ActiveHeat sensors adjust fan speed

DK4460-M / DK4490-M



5 YEAR GUARANTEE

Extraction rate Decibels Efficiency

Stylish stainless steel chimney hood with LED display. Our special electronic saturation indicators remind you when its time to clean the filters.

- Twin halogen lighting
- 4 speed control
- Filter change indicators
- ActiveHeat sensors adjust fan speed
- Charcoal filter for recirculation mode

X99464MI2



- LED lighting
- Extraction or recirculation
- DirekTouch
- 650 M³/HR
- 69 dB
- 20 M²

Switch designer island hood in stainless steel with LED lighting. With just a touch this hood switches between external extracting to recirculating clean air to ensure that you are using in the most economical way.

- LED lighting
- Extraction or recirculation
- DirekTouch controls
- 4 speed control
- ActiveHeat sensors adjust fan speed
- Charcoal filter for recirculation mode

Safety distance 500mm Electric; 650mm Gas

X91384Mi01



- DirekTouch
- 640 M³/HR
- 68 dB
- 20 M²

Elegant stainless steel island hood with designer glass panel.

Electronic 4 speed control including Intensive setting with perimeter extraction drawing air from every angle.

- DirekTouch controls
- 4 speed
- ActiveHeat sensors adjust fan speed
- Twin halogen lighting
- Charcoal filter for recirculation mode

X91484MI10



- LED lighting
- DirekTouch
- 715 M³/HR
- 60 dB

Stainless steel designer island hood with touch controls and LED lighting.

Perimeter extraction and a powerful motor ensure vapours and odours are extracted in the most efficient way.

- LED lighting
- DirekTouch controls
- 4 speed control
- ActiveHeat sensors adjust fan speed
- Charcoal filter for recirculation mode

X81284WG1



- LED lighting
- DirekTouch
- Remote included
- 780 M³/HR
- 68 dB

Premium ceiling mounted hood with LED lighting.

Advanced dimmable LED lighting strips give you the best of both worlds; high visibility of the cooking area and atmospheric ambient light in the rest of the kitchen.

- LED lighting
- Remote included
- 4 speed
- Powerful perimeter extraction

DH1690-M



- 900 M³/HR
- 58 dB

Beautiful stainless steel downdraught extractor hood.

Our special downdraught extractor retracts neatly back into the worksurface when not in use. Great for island installation or with our slim depth 90cm MaxiSense hob.

- Highly efficient extraction
- 4 speed control
- Aluminium filters and dishwasher safe
- Charcoal filter for recirculation mode

DF6164-M



- 324 M³/HR
- 63 dB
- 12 M²

Semi-integrated telescopic hood with stainless steel trim.

Twin halogen lights for improved hob illumination.

- 3 speed slider control
- Twin halogen lighting
- Aluminium filters and dishwasher safe
- Charcoal filter for recirculation mode

DL7275-M9



- 440 M³/HR
- 64 dB
- 16 M²

Stainless steel canopy hood.

Stainless steel 80cm canopy hood perfectly concealed within furniture designed to match your kitchen.

- 4 speed remote controlled
- Twin halogen lighting
- Aluminium filters and dishwasher safe
- Charcoal filter for recirculation mode

DE6261-ML



- 300 M³/HR
- 56 dB
- 12 M²

Integrated hood.

Integrated hood designed to sit behind a furniture panel creating a seamless look in your kitchen.

- Electronic slider control
- Twin halogen lighting
- Aluminium filters and dishwasher safe
- Charcoal filter for recirculation mode

# CLEANING

---

Cleaning 103

Integrated Dishwashers 110

# Entering a new era of glass care

Our latest dishwashers are designed with busy households in mind. With XXL capacity and spacious enough to cope with 15 place settings- you can expect sparkling results all round for pots and pans as well as your most delicate glassware. For an average household, our ProClean™ dishwasher takes care of breakfast, lunch and dinner in it's stride!

## Entering a new era of glass care SoftGrip®

Even delicate glasses can now be cleaned safely, thanks to a dedicated glass programme, combined with our highly appreciated SoftSpikes® and SoftGrip® that hold your glasses gently yet securely, preventing them from sliding or toppling.

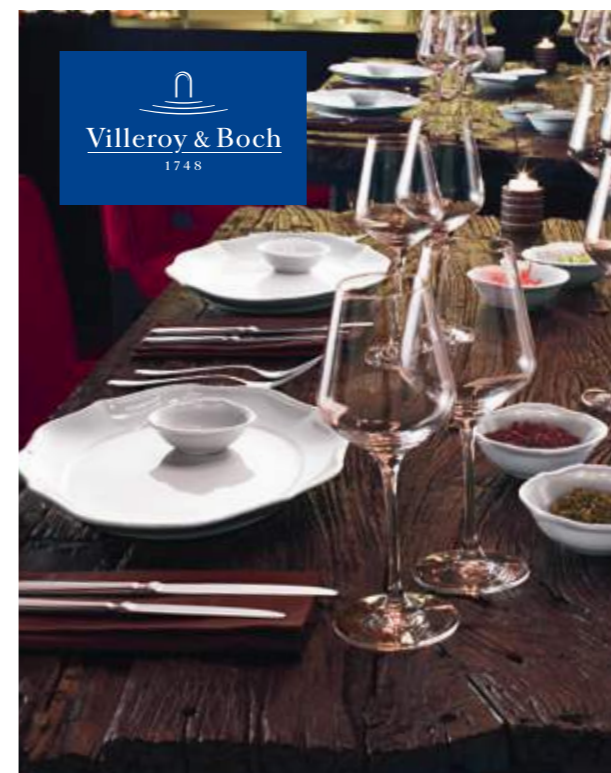
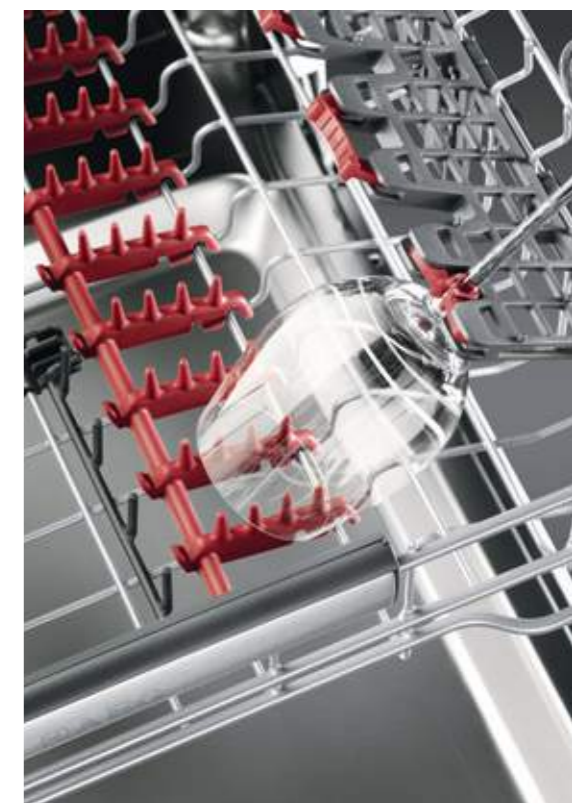

## Villeroy and Boch

To keep your beautiful glassware looking like new, Villeroy and Boch recommend using the new AEG Dishwasher with patented SoftGrip® for perfect care of your fine crystal and glass.



Removable cutlery tray for easy loading and unloading.

## More space and flexibility

Our ProClean™ range has dedicated space to fit all your cookware and is designed to handle any load regardless of size. The XXL tub, which is available with up to 15 place settings, gives you more loadable volume than any other dishwasher currently available on the market, without taking up more space in your kitchen.



Satellite Spray Arm with double rotation to enhance the cleaning performance.

## Superior cleaning

With the new generation of ProClean™ dishwashers you can stop worrying about your dishes getting clean. Its five spray levels, Satellite Spray Arm and adaptable programs ensure that your dishes will always be perfectly clean.



## Ease of installation

PefektFit™ Technology allows the door to be opened completely without coming into contact with the plinth, easy and flexible installation.

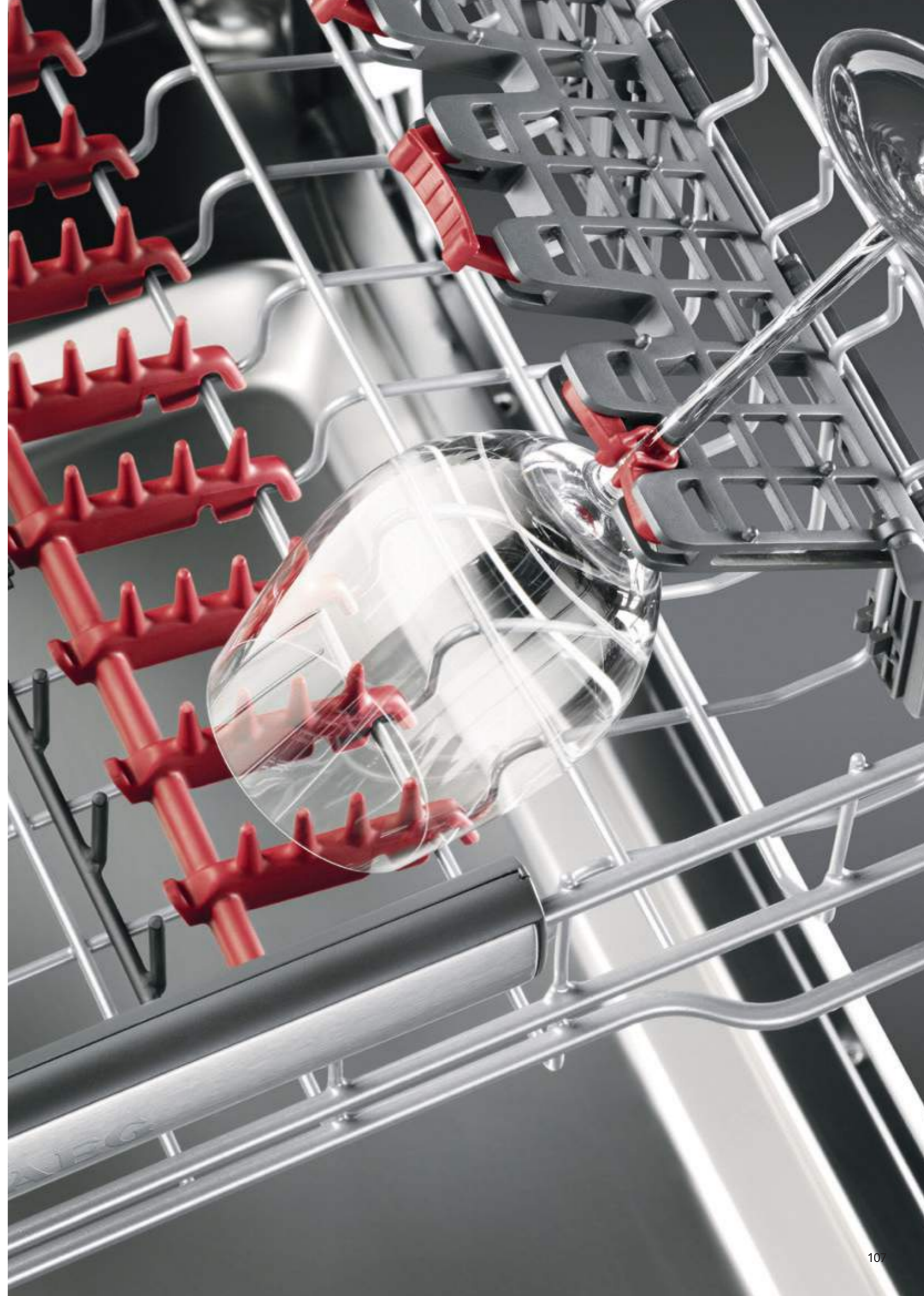

# Dishcare Range

## Integrated Dishwashers

F99705Vi1P



XXL 15 place setting, fully integrated ProClean™ dishwasher with Timebeam.

F66603Vi0P



XXL 13 place setting, fully integrated ProClean™ dishwasher with Timebeam.

F65610iM0P



Stunning Semi integrated ProClean™ dishwasher with Sensorlogic.

F55502Vi0



Fully integrated dishwasher with Sensorlogic.

F78400Vi0P



Fully integrated slimline dishwasher featuring ProClean™.

# DISHWASHERS

ProClean™ dishwashers are designed to take everything from fine crystal to fish kettles.



### 9.9L WATER CONSUMPTION

Our dishwashers use the minimum amount of water needed to wash the load, saving energy.



### 15 CAPACITY

Capacity is based on 'IEC' standard place settings. This standard allows you to compare the capacity of dishwashers using a common measure.



### XXL TUB

Our ProClean dishwasher has a larger tub with an extra 10 litres of space, more capacity for those strangely shaped items.



### TIMEBEAM

Our dishwashers are really quiet. So our fully integrated dishwashers project a beam of light onto the floor to tell you when its running. It changes to green once the cycle has finished.



### GLASS CARE

Glass programme suitable for all dishwasher-safe glassware.



### SOFTSPIKES

Gives your glasses and cups extra stability when moving the basket and during cleaning.



### SOFTGRIP

Special SoftGrip clamps will hold stem glasses safely with an extra gentle grip



### FLEXISPRAY

Satellite spray arm with third ceiling arm for impeccable cleaning whatever the load.



### SENSORLOGIC

Uses two sensors to measure the size of load and soiling of dishes, electronically fine tuning the selected programme to the specific needs of the wash loads.



### AUTO OFF

This function completely eliminates energy use in standby mode, representing a breakthrough in energy efficiency.



### FLEXILIFT

Allows you to adjust the upper basket position whether its empty or full, depending on your load and the space needed.



### PRO ZONE

Ideal for the most challenging cleaning, with water pressure up to 3 times higher and temperature up to 25% higher in the lower basket.



### PROBOOST

Increases jet water pressure for extra cleaning effectiveness when you need it.



### MULTI TAB

Adjusts the time and temperature of the wash phases for sparkling results.

### DRYTECH

Gives an improved drying result by removing the steam from the dishwasher leaving your dishes dryer.

F99705Vi1P

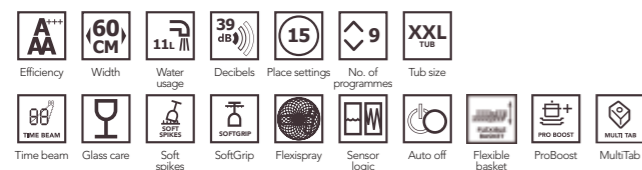

XXL 15 place setting, fully integrated ProClean™ dishwasher with superior glass care.

- 15 place settings
- Timebeam
- SoftGrips® & SoftSpikes®
- XXL tub with FlexiSpray satellite spray arm
- 9 programmes
- FlexiLift basket and removable cutlery tray
- DryTech

Dimensions (HxWxD) in mm 818 x 596 x 550

F65610iMOP

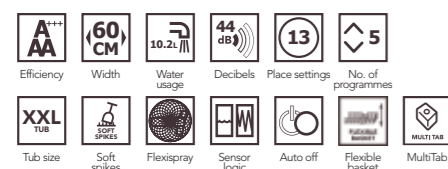

Stunning Semi-integrated ProClean™ dishwasher with Sensorlogic.

5 Programmes including our AutoSense 45°C - 70°C programme. Ideal for washing anything from glasses to roasting dishes.

- 13 place settings
- SoftSpikes®
- XXL tub with FlexiSpray satellite spray arm
- FlexiLift basket
- DryTech

Dimensions (HxWxD) in mm 818 x 596 x 550

F66603Vi0P



XXL 13 place setting, fully integrated ProClean™ dishwasher with Timebeam.

Our unique Timebeam projects the programme time remaining on to the floor.

- 13 place settings
- Timebeam
- SoftGrips® & SoftSpikes®
- XXL tub with FlexiSpray satellite spray arm
- 6 programmes
- FlexiLift basket
- DryTech

Dimensions (HxWxD) in mm 818 x 596 x 550

F55502Vi0

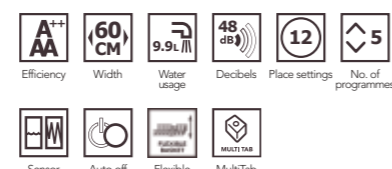

Fully integrated dishwasher with Sensorlogic.

The Auto off function completely eliminates energy use in the standby mode.

- 12 place settings
- 5 programmes including quick wash
- Auto Off
- SensorLogic
- DryTech

Dimensions (HxWxD) in mm 818 x 596 x 555

F78400Vi0P



Fully integrated slimline dishwasher featuring ProClean™.

The Auto Off function completely eliminates energy use in the standby mode.

- 9 place settings
- Beam on floor
- SoftSpikes®
- FlexiSpray satellite spray arm
- 8 programmes
- FlexiLift basket
- DryTech

Dimensions (HxWxD) in mm 818 x 446 x 550





# LAUNDRY

---

Built-In 113

Washing Machine 115

Washer Dryer 115

# LAUNDRY

## STANDARD FEATURES

**7 KG** WASH CAPACITY

Generous drum capacities offer more space for the movement of delicates, and allow you to wash larger loads at once, saving both time and energy.

**7/4 KG** WASH & DRY CAPACITY

Automatically wash and dry up to 7kg in a single, fully automatic operation.

**1400** SPIN SPEED

Choose a spin speed to suit you. We estimate that increasing your washing machine cycle by 200rpm will reduce tumble-drying time by up to 10 minutes.

**A** ENERGY EFFICIENCY CLASS

By incorporating advanced technologies, AEG appliances minimise energy usage and reduce running costs.

## STANDARD FEATURES

**A** WASH PERFORMANCE

With a standard wash performance rating of 'A', whichever freestanding appliance you choose, you're going to get great results.

**B** SPIN PERFORMANCE

Higher spin performance ensures better water removal at the end of the cycle, cutting down drying times.

## LAUNDRY PROGRAMMES

**EASY IRON PLUS PROGRAMME**

Easy Iron Plus adjusts the water level and spin speed to reduce creasing by up to 50%.

**WOOL PLUS PROGRAMME**

Our Wool Plus programme features gentle drum movement and a special cool down phase to reduce the risk of shrinkage.

## SUPERIOR TECHNOLOGY BENEFITS

**OPTISENSE**

OptiSense wash technology automatically adjusts the cycle time, water usage and energy consumption to adapt to each load meaning your clothes will stay looking newer for longer.

**TIME SAVER**

With Time Saver, you can reduce wash cycle times by up to 60%. Perfect for lightly soiled clothes that you need in a hurry.

## L61470BI



Fully integrated washing machine with OptiSense technology. Wool plus programme helps reduce wool shrinkage by gradually reducing the temperature before the rinse phase.

- OptiSense wash technology
- Innovative ProTex drum
- Time Saver, you can reduce wash cycle times by up to 60%
- Wool Plus programme
- Delay start of up to 20 hours
- Digital LCD display

Dimensions (HxWxD) in mm 820 x 596 x 544

## L61470WDBI

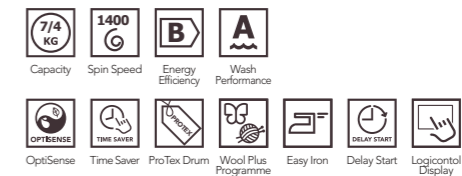
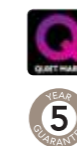

Fully integrated condenser washer dryer with OptiSense technology. Advanced controls with LCD display for programme confirmation and audible signal for programme end.

- OptiSense wash technology
- Innovative ProTex drum
- Time Saver, you can reduce wash cycle times by up to 60%
- Wool Plus programme
- Easy Iron Plus
- Delay start of up to 20 hours
- Digital LCD display

Dimensions (HxWxD) in mm 820 x 596 x 544