



# UNMANNED AIRCRAFT SYSTEMS ROADMAP

2005 - 2030



Office of the  
Secretary of Defense

4 AUG 2005

MEMORANDUM FOR SECRETARIES OF THE MILITARY DEPARTMENTS  
CHIEF OF STAFF OF THE AIR FORCE  
CHIEF OF STAFF OF THE ARMY  
COMMANDANT OF THE MARINE CORPS  
CHIEF OF NAVAL OPERATIONS  
DIRECTOR, DEFENSE ADVANCED RESEARCH  
PROJECTS AGENCY  
DIRECTOR, NATIONAL GEOSPATIAL-INTELLIGENCE  
AGENCY

SUBJECT: Unmanned Aircraft Systems (UAS) Roadmap, 2005-2030

We are pleased to endorse the release of this edition of the UAS Roadmap. The use of UAS in military operations has expanded rapidly since entering the war on terrorism in the fall of 2001. Supporting military operations in both Iraq and Afghanistan, unmanned aircraft have transformed the current battlespace with innovative tactics, techniques, and procedures. UAS not only provide persistent intelligence, surveillance, and reconnaissance, but also very accurate and timely direct and indirect fires. Combatant Commanders are requesting UAS in even greater numbers. Our challenge is the rapid and coordinated integration of this technology to support the joint fight.

The overarching goal of this Roadmap is to guide the Department toward a logical, systematic migration of UAS mission capabilities focused on the most urgent warfighter needs.

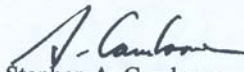
  
Stephen A. Cambone  
USD(I) JUL 20 2005

  
Kenneth S. Krieg  
USD(AT&L)

  
Peter Pace  
General, USMC  
Vice Chairman, JCS

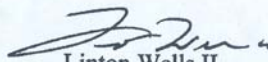
  
Linton Wells II  
Acting, ASD(NII)



## **EXECUTIVE SUMMARY**

As the Global War on Terrorism (GWOT) enters its fourth year, the contributions of unmanned aircraft (UA)\* in sorties, hours, and expanded roles continue to increase. As of September 2004, some twenty types of coalition UA, large and small, have flown over 100,000 total flight hours in support of Operation ENDURING FREEDOM (OEF) and Operation IRAQI FREEDOM (OIF). Their once reconnaissance-only role is now shared with strike, force protection, and signals collection, and, in doing so, have helped reduce the complexity and time lag in the sensor-to-shooter chain for acting on “actionable intelligence.” UA systems (UAS) continue to expand, encompassing a broad range of mission capabilities. These diverse systems range in cost from a few thousand dollars to tens of millions of dollars, and range in capability from Micro Air Vehicles (MAV) weighing less than one pound to aircraft weighing over 40,000 pounds. UA, and unmanned systems in general, are changing the conduct of military operations in the GWOT by providing unrelenting pursuit without offering the terrorist a high value target or a potential captive.

As the Department of Defense (DoD) develops and employs an increasingly sophisticated force of unmanned systems, including UA over the next 25 years (2005 to 2030), technologists, acquisition officials, and operational planners require a clear, coordinated plan for the evolution and transition of this capability. The overarching goal of this Roadmap, in following the Strategic Planning Guidance (SPG), is to guide the Military Departments and defense agencies toward a logical, systematic migration of mission capabilities to this new class of military tools. The goal is to address the most urgent mission needs that are supported both technologically and operationally by various UAS. Some DoD missions can be supported by the current state of the art in unmanned technology where the capabilities of current or near-term assets are sufficient and the risk to DoD members is relatively low. Other mission areas, however, are in urgent need of additional capability and present high risk to aircraft crews. These mission areas, highlighted in this Roadmap, will receive significant near-term effort by the Department.

Each Service is developing a wide range of UAS capabilities, and the Office of the Secretary of Defense (OSD) is responsible for ensuring these capabilities support the Department’s larger goals of fielding transformational capabilities, establishing joint standards, and controlling costs. OSD is establishing the following broad goals to achieve key UAS capabilities. The organizations in parenthesis are those which must cooperatively engage to attain the stated goal.

1. Develop and operationally assess for potential fielding, a joint unmanned combat aircraft system capable of performing Suppression of Enemy Air Defenses (SEAD)/Strike/Electronic Attack/Intelligence Surveillance, and Reconnaissance (ISR) in high threat environments. (OSD, USAF, USN)
2. Field secure Common Data Link (CDL) communications systems for aircraft control and sensor product data distribution for all tactical and larger UA, with improved capability to prevent interception, interference, jamming, and hijacking. Migrate to Joint Tactical Radio System (JTRS)/Software Communications Architecture (SCA) compliant capability when available. (OSD, USA, USAF, USN, USMC)
3. Ensure compliance with the existing DoD/Intelligence Community Motion Imagery Standards Board metadata standard and profiles for all full motion video capable UA. Operationally demonstrate and

---

\* This roadmap adopts the terminology unmanned aircraft (UA), rather than unmanned aerial vehicle (UAV), when referring to the flying component of an unmanned aircraft system. Unmanned Aircraft Systems (UAS) are the focus of this roadmap. This change in terminology more clearly emphasizes that the aircraft is only one component of the system, and is in line with the Federal Aviation Administration’s decision to treat “UAVs” as aircraft for regulatory purposes.

field near real time (<3 minutes) UAS meta data derived targeting capability for coordinate seeking weapons. (OSD, USAF, USA, USN, USMC)

4. Foster the development of policies, standards, and procedures that enable safe, timely, routine access by UA to controlled and uncontrolled airspace, to include:
  - promoting the development, adoption, and enforcement of industry-wide airworthiness standards for the design, manufacturing, testing, and employment of UAS (OSD)
  - coordinating with FAA procedures for operating DoD UA in unrestricted airspace comparable to those of manned counterparts (i.e., aircraft, light-sport aircraft, and radio-controlled model aircraft) (OSD)
  - developing and fielding the capability for UA to “see” and autonomously avoid other aircraft, providing an equivalent level of safety to comparable manned systems (USAF, USA, USN, USMC)
5. Improve Combatant Commander UAS effectiveness through improved joint service collaboration. (OSD, JFCOM, USAF, USA, USN, USMC)
6. Develop and field reliable propulsion alternatives to gasoline-powered internal combustion engines on UA, specifically their replacement with heavy fuel engines. (OSD, USAF, USA, USN, USMC)
7. Improve adverse-weather UA capabilities to provide higher mission availability and mission effectiveness rates. (OSD, USAF, USA, USN, USMC)
8. Ensure standardized and protected positive control of weapons carried on UA. Develop a standard UAS architecture including weapons interface for all appropriate UA. (OSD, USAF, USA, USN, USMC)
9. Support rapid integration of validated combat capability in fielded/deployed systems through a more flexible test and logistical support process. (OSD, JFCOM, USAF, USA, USN, USMC)



**TABLE OF CONTENTS**

<b>1.0</b>	<b>Introduction.....</b>	<b>1</b>
1.1	PURPOSE .....	1
1.2	SCOPE .....	1
1.3	DEFINITIONS .....	1
1.4	WHY UNMANNED AIRCRAFT? .....	1
<b>2.0</b>	<b>Current UAS.....</b>	<b>3</b>
2.1	MAJOR UAS .....	4
2.2	CONCEPT EXPLORATION UAS .....	15
2.3	SPECIAL OPERATIONS UAS .....	20
2.4	SMALL UAS.....	26
2.5	UNMANNED AIRSHIPS .....	32
2.6	UAS PROGRAMMATIC DATA .....	37
2.7	UAS WORLDWIDE GROWTH.....	38
<b>3.0</b>	<b>Requirements.....</b>	<b>41</b>
3.1	HISTORICALLY VALIDATED UAS ROLES .....	41
3.2	COMBATANT COMMANDER REQUIREMENTS FOR UAS .....	41
3.3	MISSION REQUIREMENTS RANKED FOR UAS.....	42
3.4	MISSION AREAS OPEN TO UAS .....	43
3.5	INTEROPERABILITY .....	45
<b>4.0</b>	<b>Technologies .....</b>	<b>47</b>
4.1	PROCESSOR TECHNOLOGIES.....	48
4.2	COMMUNICATION TECHNOLOGIES .....	49
4.3	PLATFORM TECHNOLOGIES.....	51
4.4	PAYLOAD TECHNOLOGIES.....	56
<b>5.0</b>	<b>Operations .....</b>	<b>63</b>
5.1	TRAINING.....	63
5.2	OPERATIONAL CONCEPTS DEVELOPMENT—PARTICIPATING AGENCIES .....	64
5.3	OPERATIONS .....	67
5.4	WEAPON DELIVERY .....	69
5.5	OPERATING AND SUPPORT COSTS .....	69
<b>6.0</b>	<b>Roadmap.....</b>	<b>71</b>
6.1	UAS CAPABILITIES ROADMAP.....	71
6.2	UAS MISSIONS ROADMAP .....	72
6.3	GOALS FOR UNMANNED AVIATION.....	74
6.4	FUTURE DIRECTIONS.....	75
<b>Appendix A: Missions.....</b>		<b>A-1</b>
<b>Appendix B: Sensors.....</b>		<b>B-1</b>
<b>Appendix C: Communications .....</b>		<b>C-1</b>
<b>Appendix D: Technologies .....</b>		<b>D-1</b>
<b>Appendix E: Interoperability Standards.....</b>		<b>E-1</b>
<b>Appendix F: Airspace .....</b>		<b>F-1</b>
<b>Appendix G: Task, Post, Process, and Use Considerations .....</b>		<b>G-1</b>
<b>Appendix H: Reliability.....</b>		<b>H-1</b>
<b>Appendix I: Homeland Security .....</b>		<b>I-1</b>

**Appendix J: Unmanned Ground Vehicles.....J-1**  
**Appendix K: Survivability .....K-1**

**LIST OF FIGURES AND TABLES**

FIGURE 2.0-1. TIMELINE OF CURRENT AND PLANNED DoD UAS SYSTEMS..... 3  
 FIGURE 2.6-1. DoD ANNUAL FUNDING PROFILE FOR UAS..... 37  
 FIGURE 2.7-1. UAS MANUFACTURING COUNTRIES. .... 40  
 FIGURE 4.0-1. DoD INVESTMENT IN UAS RESEARCH AND DEVELOPMENT. .... 47  
 FIGURE 4.0-2. TREND IN UA AUTONOMY. .... 48  
 FIGURE 4.1-1. TREND IN PROCESSOR SPEED. .... 49  
 FIGURE 4.1-2. RELATIONSHIPS OF PROCESSOR SPEED AND MEMORY. .... 49  
 FIGURE 4.3-1. MASS SPECIFIC POWER TRENDS..... 54  
 FIGURE 4.3-2. MISHAP RATE COMPARISON..... 55  
 FIGURE 4.3-3. UA CAPABILITY METRIC: WEIGHT V. COST..... 57  
 FIGURE 4.3-4. UA PERFORMANCE METRIC: ENDURANCE V. COST..... 57  
 FIGURE 4.4-1. UA PAYLOAD CAPACITY VS. ENDURANCE..... 58  
 FIGURE 4.4-2. STILL IMAGERY SENSOR TECHNOLOGY FORECAST. .... 59  
 FIGURE 4.4-3. MOTION/VIDEO IMAGERY SENSOR TECHNOLOGY FORECAST. .... 59  
 FIGURE 4.4-4. RADAR IMAGERY SENSOR TECHNOLOGY FORECAST..... 59  
 FIGURE 4.4-5. SIGINT SENSOR TECHNOLOGY FORECAST. .... 60  
 FIGURE 4.4-6. MASINT SENSOR TECHNOLOGY FORECAST..... 60  
 FIGURE 4.4-7. FORECAST SENSOR CAPABILITIES. .... 60  
 FIGURE 5.3-1. LOCATIONS OF U.S.-BASED DoD UAS. .... 68  
 FIGURE 6.1-1. UAS CAPABILITIES ROADMAP. .... 72  
 FIGURE 6.2-1. UAS MISSIONS ROADMAP. .... 74

FIGURE C-1. GLOBAL HAWK COMMUNICATIONS ARCHITECTURE. .... C-3  
 FIGURE C-2. PREDATOR OPERATING IN DEPLOYED MODE..... C-4  
 FIGURE C-3. PREDATOR REMOTE SPLIT OPERATIONS. .... C-5  
 FIGURE C-4. UA PROGRESSION FROM CIRCUIT BASED TO NET-CENTRIC COMMUNICATIONS. ... C-6  
 FIGURE C-5. JTRS GROUND AND AIRBORNE NETWORKS. .... C-11  
 FIGURE C-6. THE TRANSFORMATIONAL COMMUNICATIONS ARCHITECTURE..... C-12  
 FIGURE C-7. BLACK TRANSPORT EDGE-TO-EDGE..... C-13  
 FIGURE C-8. AIRCRAFT SYSTEMS ENGINEERING MODEL – IP FRIENDLY NETWORK INTERFACES. ...  
 ..... C-14  
 FIGURE C-9. SPIRALED STAGES TO A UA COMMUNICATIONS NETWORK..... C-20  
 FIGURE C-10. POTENTIAL CDL MIGRATION PATHS..... C-21  
 FIGURE C-11. CONSOLIDATED HIGH LEVEL PROGRAM SCHEDULE..... C-22  
 FIGURE D-1. PERFORMANCE PAYOFF OF A NOTIONAL COMBAT UA UTILIZING TECHNOLOGIES  
 FROM THE JETEC PHASE III GOALS. .... D-1  
 FIGURE D-2. JETEC COST GOAL IN COMPARISON TO EXISTING SYSTEMS. .... D-2  
 FIGURE D-3. ENGINE EFFECTS ON TAKE-OFF GROSS WEIGHT FOR A DESIRED MISSION  
 ENDURANCE. .... D-5  
 FIGURE D-4. SPECIFIC ENERGY CALCULATION..... D-6  
 FIGURE D-5. AUTONOMOUS CAPABILITY LEVELS (ACLs). .... D-10  
 FIGURE F-1. JOINT FAA/OSD APPROACH TO REGULATING UA..... F-2

FIGURE F-2: U.S. MILITARY AIRCRAFT AND UA CLASS A MISHAP RATES (LIFETIME), 1986-2003. .... F-3

FIGURE F-3. UA AND AIRSPACE CLASSES OF THE NATIONAL AIRSPACE SYSTEM..... F-4

FIGURE H-1. U.S. MILITARY AIRCRAFT AND UA CLASS A MISHAP RATES (LIFETIME), 1986 – 2004..... H-3

FIGURE H-2. AVERAGE SOURCES OF SYSTEM FAILURES FOR U.S. MILITARY UA FLEET ..... (BASED ON 194,000 HRS)..... H-5

FIGURE H-3. AVERAGE SOURCES OF SYSTEM FAILURES FOR IAI UA FLEET (BASED ON 100,000 HRS). .... H-5

FIGURE I-1. UA ACTIVITIES AND PROGRAMS IN SUPPORT OF HOMELAND SECURITY. .... I-2

FIGURE J-1. JRP FUNDING HISTORY. .... J-1

FIGURE J-2. JRP MANAGEMENT STRUCTURE..... J-2

FIGURE J-3: JRP STRATEGY AND EVOLVING ROBOTICS REQUIREMENTS..... J-7

FIGURE J-4: ROBOTIC EVOLUTION. .... J-7

TABLE 2.6-1. SUMMARY STATUS OF RECENT UAS..... 37

TABLE 2.6-2. FY06 PRESIDENT’S BUDGET REQUEST FOR UAS RDT&E AND PROCUREMENT (\$M)\*. .... 38

TABLE 2.6-3. FY06 PRESIDENT’S BUDGET FOR UAS OPERATIONS AND MAINTENANCE (\$M)\*... 38

TABLE 2.7-1. CLASSES OF WORLDWIDE MILITARY RECONNAISSANCE UAS. .... 39

TABLE 2.7-2. MTCR MEMBER INTEREST IN UAS..... 40

TABLE 3.1-1. HISTORICALLY VALIDATED UAS ROLES..... 41

TABLE 3.2-1. IPL PRIORITIES FOR UAS-RELATED APPLICATIONS BY COCOM. .... 42

TABLE 3.2-2. UAS-RELATED IPL ITEMS BY JOINT FUNCTIONAL CATEGORY. .... 42

TABLE 3.3-1. COMBATANT COMMANDER/SERVICE UAS MISSION PRIORITIZATION MATRIX— 2004..... 43

TABLE 3.4-1. UAS MISSION AREAS..... 44

TABLE 4.3-1. PROPULSION AND POWER TECHNOLOGY FORECAST..... 54

TABLE 4.3-2. UAS AND UA COSTS AND WEIGHTS. .... 56

TABLE 5.3-1. CURRENT UAS INVENTORY. .... 67

TABLE 6.1-1. EXAMPLE CAPABILITY METRICS. .... 71

TABLE C-1. WNW FEATURES..... C-11

TABLE C-2. KEY SOURCES FOR COMMUNICATIONS STANDARDS..... C-19

TABLE D-1. FUTURE FUNDING OF DoD. .... D-11

TABLE F-1. ALIGNMENT OF UA CATEGORIES WITH FAA REGULATIONS..... F-5

TABLE H-1. SUMMARY OF UA RELIABILITY FINDINGS. .... H-3

TABLE H-2: SUMMARY OF UA FAILURE MODE FINDINGS ..... H-4

TABLE H-3. TECHNOLOGY TO ENHANCE UA RELIABILITY..... H-8

TABLE I-1. DHS/BTS CAPABILITY REQUIREMENTS APPLICABLE TO UA. .... I-1

TABLE I-2. PAST AND PLANNED DHS-SPONSORED UA DEMONSTRATIONS..... I-2

TABLE K-1. SURVIVABILITY CLASSIFICATION LETHAL THREAT MATRIX..... K-5

TABLE K-2. SURVIVABILITY CLASSIFICATION NON-LETHAL THREAT MATRIX. .... K-5

TABLE K-3. SURVIVABILITY DESIGN FEATURES BY SURVIVABILITY CLASSIFICATION. .... K-5



**ACRONYM LIST**

AATD	Advanced Aviation Technology Directorate	J-UCAS	Joint Unmanned Combat Air Systems
ABCI	Arizona Border Control Initiative	JUSC2	Joint Unmanned Systems Common Control
ACAS	Auto-Aircraft Collision Avoidance System	KI	Kinetic Intercept
ACC	Air Combat Command	LADAR	Laser Detection and Ranging
ACL	Autonomous Control Levels	LAN	Local Area Network
ACN	Airborne Communication Node	LANDSAT	Land Remote-Sensing Satellite
ACP	Allied Communications Publication	LAW	Light Anti-Armor Weapon
ACTD	Advanced Concept Technology Demonstration	LCC	Life Cycle Cost
ACTM	Aircraft Collection Tasking Message	LCS	Littoral Combat Ship
ADatP-16	Allied Data Publication-16	LDRF	Laser Designator Rangefinder
ADS-B	Automatic Dependent Surveillance-Broadcast	LIDAR	Light, Detection, and Ranging
ADT	Air Data Terminal	LNO	Liaison officers
AEHF	Advanced Extremely High Frequency	LO	Low Observable
AESA	Active Electronically Steered Antenna	LOE	Limited Objective Experiments
AFMSS	Air Force Mission Support System	LOS	Line-of-Sight
AFRL	Air Force Research Laboratory	LRE	Launch and Recovery Element
AFSOC	Air Force Special Operations Command	LRIP	Low-Rate Initial Production
AIA	Advanced Information Architecture	LVOSS	Light Vehicle Obscurant Smoke System
AIAA	American Institute of Aeronautics and Astronautics	MAR	Mission Available Rate
AJCN	Adaptive Joint C4ISR Node	MASINT	Measurements and Signatures Intelligence
ALERT	Air Launched Extended Range Transporter	MAV	Micro Air Vehicle
AMAD	Airframe Mounted Accessory Drive	MBC	Maritime Battle Center
AMF	Airborne, Maritime, and Fixed Station	MC2C	Multi-Sensor Command and Control Constellation
AMO	Air and Marine Operations	MCE	Mission Control Element
AMRDEC	Aviation and Missile, Research, Development, and Engineering Center	MCM	Mine Counter Measures
AMTI	Airborne Moving Target Indicator	MCWL	Marine Corps Warfighting Lab
AO	Autonomous Operations; Area of Operations	MDARS	Mobile Detection Assessment Response System
AOC	Air Operations Center	MDARS-E	Mobile Detection Assessment Response System-Expeditionary
AOR	Area of Responsibility	MEF	Marine Expeditionary Force
API	Application Program Interface	METOC	Meteorology and Oceanography
APOBS	Anti-Personnel/Obstacle Breaching System	MHS	Message Handling Systems
APU	Auxiliary Power Unit	MIAG	Modular Integrated Avionics Group
ARL	Army Research Laboratory	MILSATCOM	Military Satellite Communications
ARTS	All-Purpose Remote Transport System	MISB	Motion Imagery Standards Board
ASARS 2A	Advanced Synthetic Aperture Radar System	MISP	Motion Imagery Standards Profile
ASD	Assistant Secretary of Defense; Advanced Signals Intelligence Program	MMR	Multi Mode Radar
ASIP	Advanced Signals Intelligence Payload	MOCU	Multi-Robot Operator Control Unit
ASOC	Air Support Operations Center	MOGAS	Motor Gasoline
ASTM	American Society of Testing & Materials	MOUT	Military Operations In Urban Terrain
ASW	Anti Submarine Warfare	MP-CDL	Multi-Platform CDL
ATC	Automatic Target Cueing; Air Traffic Control	MPEG	Moving Picture Experts Group
ATM	Asynchronous Transfer Mode	MP-RTIP	Multi-Platform Radar Technology Insertion Program
ATR	Air Traffic Regulation; Automatic Target Recognition	MR-TCDL	Multi-Role – TC DL
AUMS	Autonomous UAV Mission System	MSA	Mechanically-Steered Antenna
AVGAS	Aviation Gasoline	MSI	Multispectral Imagery
AWACS	Airborne Warning and Control System	MSL	Mean Sea Level
AWE	Advanced Warfighting Experiments	MTBF	Mean Time Between Failure
BA	Battlespace Awareness	MTCR	Missile Technology Control Regime
BAMS	Broad Area Maritime Surveillance	MTI	Moving Target Indicator
BDA	Bomb Damage Assessment	MTRS	Man-Transportable Robotic System
BIIF	Basic Image Interchange Format	MTS	Multispectrum Targeting System
BLOS	Beyond Line of Sight	MTTF	Mean Time To Failure
BSFC	Brake Specific Fuel Consumption	MUA	Military Utility Assessment
BTS	Border and Transportation Security	MUDO	Maritime Unmanned Development and Operations
C2	Command and Control	MUOS	Mobile User Objective System
C3	Command, Control, and Communications	MUSE	Multiple Unified Simulation Environment
C3I	Command, Control, Communications, and Intelligence	NAMRL	Navy Aerospace Medical Research Laboratory
CAI	Composites Affordability Initiative	NAS	National Airspace System
CALA	Community Airborne Library Architecture	NAVAIR	Naval Air Systems Command
CAOC	Combined Air Operations Center	NAWC-AD	Naval Air Warfare Center–Aircraft Division

## UAS ROADMAP 2005

CBP	Customs and Border Protection	NBC	Nuclear, Biological and Chemical
CBRNE	Chemical Biological Radiological Nuclear Explosive	NCES	Net-Centric Enterprise Services
CCD	Charge-Coupled Device; Camouflage, Concealment, and Denial; Coherent Change Detection	NGA	National Geospatial-Intelligence Agency
CDL	Common Data Link	NIB	Not To Interfere Basis
CEE	Collaborative Engagement Experiment	NII	Networks and Information Integration
CENTCOM	U.S. Central Command	NIMA	National Imagery and Mapping Agency
CFACC	Combined Forces Air Component Commander	NITF	National Imagery Transmission Format
CFR	Code of Federal Regulations	NNMSB	Non-Nuclear Munition Safety Board
CIO	Chief Information officer	NORTHCOM	Northern Command
CIP	Common Imagery Processor; Continuous Improvement Program	NR-KPP	Net-Ready Key Performance Parameters
CIRPAS	Center For Interdisciplinary Remotely Piloted Aircraft Studies	NRL	Naval Research Laboratory
CJTFFEX	Combined Joint Task Force Exercise	NRT	Near Real Time
CLS	Contractor Logistics Support	NRTD	Near Real Time Dissemination
CN	Counter Narcotics	NSA	National Security Agency
COA	Certificate of Authorization	NSAWC	Naval Strike and Air Warfare Center
COCOM	Combatant Command	NSIF	NATO Secondary Imagery Format
COMINT	Communications Intelligence	NSMV	Near Space Maneuvering Vehicle
COMPASS	Compact Army Spectral Sensor	NSWC	Naval Surface Weapons Center
CONOPS	Concept of Operations	NUSE2	National Unmanned Systems Experimentation Environment
CONUS	Continental United States	NVESD	Night Vision Electronic Sensors Directorate
COS	Class of Service	O&S	Operating and Support
CoT	Cursor on Target	OASD	Office of the ASD
COTS	Commercial off-the-Shelf	OAV	Organic Air Vehicle
COUGAR	Cooperative Unmanned Ground Attack Robot	OCU	Operator Control Unit
CRW	Canard Rotor/Wing	ODIS	Omni-Directional Inspection System
CSAR	Combat Search and Rescue	OEF	Operation ENDURING FREEDOM
CSP	Common Security Protocol	OIF	Operation IRAQI FREEDOM
CUCS	Common Unmanned Systems Control Station	OMC	Outer Mold Casing
DAISRP	Defense Airborne Intelligence, Surveillance, and Reconnaissance Plan	OMFTS	Operational Maneuver From The Sea
DAMA	Demand Assigned Multiple Access	OMG	Object Management Group
DARO	Defense Airborne Reconnaissance Office	ONR	Office of Naval Research
DARPA	Defense Advanced Research Projects Agency	ONS	Operational Needs Statement
DASC	Direct Air Support Center	OPOC	Opposed Cylinder
DATMS	DISN Asynchronous Transfer Mode Services	OPR	Office of Primary Responsibility
DCGS	Distributed Common Ground System	ORD	Operational Requirements Document
DCMA	Defense Contract Management Agency	OSD	Office of the Secretary of Defense
DDMS	DoD Discovery Metadata Specification	OSI	Systems Interconnect
DE	Directed Energy	P&P	Power/Propulsion
DEAD	Destruction of Enemy Air Defense	PAT	Pointing, Acquisition, and Tracking
DEM	Digital Elevation Models	PBFA	Policy Board On Federal Aviation
DepSO	Departmental Standardization Office	PFPS	Portable Flight Planning Software
DEW	Directed Energy Weapons	PKI	Public-Key Infrastructure
DGS	Deployable Ground Station	PPS	Predator Primary Satellite
DHS	Department of Homeland Security	PSYOPS	Psychological Operations
DISA	Defense Information Systems Agency	PTIR	Precision Track Illumination Radar
DISN	Defense Information Services Network	QDR	Quadrennial Defense Review
DISR	DoD Information Technology Registry	QIS	Quantum Interference Switch
DLI	Data Link Interface	QoS	Quality of Service
DMS	Defense Message System	QRC	Quick Reaction Capability
DoD	Department of Defense	R&D	Research and Development
DOTMLPF	Doctrine, Organization, Training, Materiel, Leadership, Personnel and Facilities	RAID	Rapid Aerostat Initial Deployment
DPPDB	Digital Point Positioning Data Base	RATO	Rocket Assisted Take-off
DSA	Digital Signature Algorithm	RC	Radio-Controlled
DSCS	Defense Satellite Communications System	RDC	Coast Guard Research and Development Center
DSPO	Defense Standardization Program Office	REAP	Rapidly Elevated Aerostat Platform
DSS	Digital Signature Standard	RF	Radio Frequency
DTED	Digital Terrain Elevation Data	RFP	Request For Proposal
EA	Electronic Attack	ROE	Rules of Engagement
EASA	European Aviation Safety Agency	RPV	Remotely Piloted Vehicles

## UAS ROADMAP 2005

ELINT	Electronic Intelligence	RSO	Remote Split Operations
EMD	Engineering and Manufacturing Development	RSTA	Reconnaissance, Surveillance, and Target Acquisition
EMI	Electromagnetic Interference	RT	Real-Time
EMP	Electro-Magnetic Pulse	S&A	See and Avoid
EO/IR	Electro-Optical/Infra Red	S&T	Science and Technology
EOD	Explosive Ordnance Disposal; Explosive Ordnance Device	SADL	Situational Awareness Data Link
EPLRS	Enhanced Position Location Reporting System	SAE	Society of Automotive Engineers
ER/MP	Extended Range/Multi-Purpose	SAR	Synthetic Aperture Radar
ESA	Electronically Steered Antenna; Electronically Scanned Array	SARP	Standard and Recommended Procedures
ESM	Electronic Support Measures	SATCOM	Satellite Communications
F2T2EA	Find, Fix, Track, Target, Engage, and Assess	SBIR	Small Business Innovative Research
FA	Force Application	SCA	Software Communications Architecture
FAA	Federal Aviation Administration	SCAR	Strike Control and Reconnaissance
FAB-T	Family of Advanced Beyond Line-of-Sight Terminals	SDB	Small Diameter Bomb
FBE	Fleet Battle Experiment	SDD	System Design and Development
FCS	Future Combat System	SEAD	Suppression of Enemy Air Defenses
FIRRE	Family of Integrated Rapid Response Equipment	SFC	Specific Fuel Consumption
FL	Focused Logistics; Flight Level	SHP	Shaft Horsepower
FLIR	Forward Looking Infrared	SIAP	Single Integrated Air Picture
FMECA	Failure Mode Effect and Criticality Analysis	SIF	Selective Identification Feature
FNC	Future Naval Capability	SIGINT	Signals Intelligence
FOPEN	Foliage Penetration	SIL	System Integration Laboratory
FOR	Field of Regard	SINCGARS	Single Channel Ground and Airborne Radio System
FP	Force Protection	SIP	Sensor Interface Protocol
FPASS	Force Protection Aerial Surveillance System	SIPRNET	Secret Internet Protocol Router Network
FRP	Full-Rate Production	SLS	Sea Level Standard
FUE	First Unit Equipped	SMUD	Standoff Munitions Disruption
FWV	Fixed Wing Vehicle	SNMP	Simple Network Management Protocol
GBS	Global Broadcast Service	SOF	Special Operations Forces
GCCS	Global Command and Control System	SP	Specific Power
GCS	Ground Control Station	SPG	Strategic Planning Guidance
GDT	Ground Data Terminal	SPIRITT	Spectral Infrared Remote Imaging Transition Testbed
GES	GIG Enterprise Services	SPOT	Systeme Pour L'observation De La Terre
GFP	Generic Framing Procedure	SSGN	Submersible, Ship, Guided, Nuclear
GHMD	Global Hawk Maritime Demonstration	SSL	Secure Socket Layer
GIG	Global Information Grid	SuR	Surveillance Radar
GIG CRD	GIG Capstone Requirements Document	SWAP	Size, Weight, and Power
GIG-BE	GIG Bandwidth Expansion	SYERS 2	Senior-Year Electro-Optical Reconnaissance System
GMTI	Ground Moving Target Indicator	T/W	Thrust-to-Weight
GOTS	Government off-the-Shelf	TACP	Tactical Control Party
GUI	Graphics User Interface	TAMD	Theater Air Missile Defense
GWOT	Global War On Terror	TARS	Tethered Aerostat Radar System
HAA	High Altitude Airship	TBD	To Be Determined
HAIZE	High Assurance Internet Protocol Encryption	TCA	Transformation Communications Architecture
HAIPIS	Haize Interoperability Specification	TCAS	Traffic Collision/Avoidance System
HDTV	High Definition Television	TCDL	Tactical Common Data Link
HFE	Heavy Fuel Engines	TCS	Transformational Communications System; Tactical Control System
HMI	Human-Machine Interaction	TDDS	Trap Data Distribution System
HMMWV	High-Mobility Multipurpose Wheeled Vehicle	TDMA	Time Division Multiple Access
HPM	High Power Microwave	TESAR	Tactical Endurance Synthetic Aperture Radar
HSI	Hyperspectral Imagery	TIBS	Tactical Information Broadcast System
HSUAV	Homeland Security UAV	TLS	Transport Layer Security
HyLITE	Hyperspectral Longwave Imager For the Tactical Environment	TNMC	Total Not Mission Capable
IA	Information Assurance	TOS	Time On Station
IADS	Integrated Air Defense Systems	TPPU	Task, Post, Process, Use
IAI	Israeli Aircraft Industries	TRADOC	Training and Doctrine Command
IBS	Integrated Broadcast System	TRAP	Tactical Related Applications
ICAO	International Civil Aviation Organization	TRIXS	Tactical Intelligence Exchange System
ICE	Internal Combustion Engines; Immigration and Customs Enforcement	TRL	Technology Readiness Level

## UAS ROADMAP 2005

ID	Identification	TSA	Transportation Security Administration
IETF	Internet Engineering Task Force	TSAS	Tactile Situation Awareness System
IFF	Identification Friend or Foe	TSAT	Transformational Satellite
IFR	Instrument Flight Rules	TSC	Tactical Support Centers
IFSAR	Interferometric Synthetic Aperture Radars	TSM	TRADOC System Manager
I-Gnat	Improved Gnat	TSP	Tactical SIGINT Payload
IHPTET	Integrated High Performance Turbine Engine Technology	TTP	Tactics, Techniques, and Procedures
IMINT	Imagery Intelligence	TUAV	Tactical Unmanned Aerial Vehicle
INEEL	Idaho National Engineering and Environmental Laboratory	TUGV	Tactical Unmanned Ground Vehicle
INMARSAT	International Marine/Maritime Satellite	TUT	Targets Under Trees
IOC	Initial Operational Capability	UA	Unmanned Aircraft; Unit of Action
IP	Internet Protocol	UAB	UAV Battlelab
IPL	Integrated Priorities List; Image Product Library	UAS	Unmanned Aircraft System
IPT	Integrated Product Team	UAV	Unmanned Aerial Vehicle
ISAR	Inverse SAR	UCAD	Unmanned Combat Airborne Demonstrator
ISR	Intelligence, Surveillance, and Reconnaissance	UCAR	Unmanned Combat Armed Rotorcraft
ISR&T	Intelligence, Surveillance, Reconnaissance and Targeting	UCAV	Unmanned Combat Air Vehicle
ISS	Integrated Sensor Suite	UCS	Unmanned Control System
ITU	International Telecommunications Union	UFO	UHF Follow-On
JASA	Joint Airborne SIGINT Architecture	UGV	Unmanned Ground Vehicle
JAUGS	Joint Architecture For Unmanned Ground Systems	UHF	Ultra High Frequency
JAUS	Joint Architecture Unmanned Systems	UMV	Unmanned Marine Vehicle
JCAD	Joint Chemical Agent Detector	US&P	United States and Its Possessions
JCS	Joint Chiefs of Staff	USJFCOM	U.S. Joint Forces Command
JDAM	Joint Direct Attack Munition	USSOCOM	United States Special Operations Command
JEFX	Joint Expeditionary Forces Experiment	USV	Unmanned Surface Vehicle
JETEC	Joint Expendable Turbine Engine Concept	UUV	Unmanned Undersea Vehicle
JFC	Joint Forces Commander	UVGG	Unmanned Vehicles Common Control
JFCOM	Joint Forces Command	UXO	Unexploded Ordnance
JLENS	Joint Land Attack Elevated Netted Sensor	VAATE	Versatile Affordable Advanced Turbine Engine
JMTOF	Joint Multi-TADIL Operating Procedures	VFR	Visual Flight Rules
JOTBS	Joint Operational Test Bed System	VTOL	Vertical Take-Off and Landing
JP	Jet Petroleum	VTUAV	Vertical Take-Off and Landing Tactical UAV
JPO	Joint Program Office	WAN	Wide Area Network
JROC	Joint Requirements Oversight Council	WATCH-IT	Wide-Area All-Terrain Change Indication and Tomography
JRP	Joint Robotics Program	WGS	Wideband Gap filler System
JSF	Joint Strike Fighter	WMD	Weapons of Mass Destruction
JSTARS	Joint Surveillance, Targeting, and Attack Radar System	WNW	Wide Band Networking Waveform
JTA	Joint Technology Architecture	WSADS	Wind Supported Air Delivery System
JTC	Joint Technology Center	WSUA	Wing Store UA
JTIDS	Joint Tactical Information Distribution System	WWW	World Wide Web
JTRS	Joint Tactical Radio System	XML	Extensible Markup Language
JUAV-JTE	Joint UAV Joint Test and Evaluation	XUV	Experimental Unmanned Vehicle





### 1.0 INTRODUCTION

#### 1.1 PURPOSE

The purpose of this Roadmap is to stimulate the planning process for U.S. military UA development over the period from 2005-2030. It is intended to assist DoD decision makers in developing a long-range strategy for UA development and acquisition in future Quadrennial Defense Reviews (QDRs) and other planning efforts, as well as to guide industry in developing UA-related technology. Additionally, this document may help other U.S. Government organizations leverage DoD investments in UA technology to fulfill their needs and capabilities. The Roadmap addresses the following key questions:

- What requirements for military capabilities could potentially be filled by UA systems?
- What processor, communication, platform, and sensor technologies are necessary to provide these capabilities?
- When could these technologies become available to enable the above capabilities?

This Roadmap is meant to complement ongoing Service efforts to redefine their roles and missions for handling 21st century contingencies. The Services see UAS as integral components of their future tactical formations. As an example, the Army's current transformation initiative envisions each Brigade Combat Team having a reconnaissance, surveillance, and target acquisition (RSTA) squadron equipped with an UAS, reflecting the initiative's emphasis on reducing weight, increasing agility, and integrating robotics in their future forces.

#### 1.2 SCOPE

OSD, as part of its oversight responsibilities for Defense-wide acquisition and technology, intends this Roadmap to be strong guidance in such cross-program areas as standards development and other interoperability solutions. It neither authorizes specific UAS nor prioritizes the requirements, as this is the responsibility of the Services and the Joint Requirements Oversight Council (JROC). It does, however, identify future windows when technology should become available to enable new capabilities, linked to warfighters' needs, to be incorporated into current or planned UAS. Many of the technologies discussed in this document are currently maturing in defense research laboratories and contractor facilities. The Roadmap span of 25 years was chosen to accommodate what typically constitutes a generation of aircraft and payload technology, from laboratory project to fielded system. The information presented in this study is current as of March 30, 2005. Programmatic information is current as of February 7, 2005 when the FY06 President's Budget went to Congress.

#### 1.3 DEFINITIONS

Cruise missile *weapons* are occasionally confused with UA *weapon systems* because they are both unmanned. The key discriminators are (1) UA are equipped and intended for recovery at the end of their flight, and cruise missiles are not, and (2) munitions carried by UA are not tailored and integrated into their airframe whereas the cruise missile's warhead is. This distinction is clearly made in the Joint Publication 1-02 DoD Dictionary's definition for "UAV" (or UA).

*A powered, aerial vehicle that does not carry a human operator, uses aerodynamic forces to provide vehicle lift, can fly autonomously or be piloted remotely, can be expendable or recoverable, and can carry a lethal or non-lethal payload. Ballistic or semi ballistic vehicles, cruise missiles, and artillery projectiles are not considered unmanned aerial vehicles.*

#### 1.4 WHY UNMANNED AIRCRAFT?

The familiar saying that UA are better suited for "dull, dirty, or dangerous" missions than manned aircraft presupposes that man is (or should be) the limiting factor in performing certain airborne roles. Although any flight can be dull or dangerous at times, man continues to fly such missions, whether because of

tradition or as a substitute for technology inadequacies. The following examples validate this saying.

### *The Dull*

B-2 crews flew 30-hour roundtrip missions from Missouri to Serbia during 34 days of the Kosovo conflict in 1999. The normal two-man crews were augmented with a third pilot, but even so, fatigue management was the dominant concern of unit commanders, who estimated 40-hour missions would have been their crews' maximum. The post-Kosovo RAND assessment states "...the crew ratio of two two-man crews per aircraft might need to be increased to four crews or else provisions made [for foreign basing.] A serious limiting factor...is that doubling the B-2's crew ratio would require either doubling the number of training sorties and hours flown by the Air Force's limited B-2 inventory or reducing the number of sorties and flying hours made available to each B-2 crew member—to a point where their operational proficiency and expertise would be unacceptably compromised." Contrast this short term imposition on crew endurance with the nearly continuous string of day-long MQ-1 missions over Afghanistan and Iraq that have been flown by stateside crews operating on a four-hour duty cycle for nearly two years.

### *The Dirty*

The Air Force and the Navy used unmanned B-17s and F6Fs, respectively, from 1946 to 1948 to fly into nuclear clouds within minutes after bomb detonation to collect radioactive samples, clearly a dirty mission. Returning UA were washed down by hoses and their samples removed by cherrypicker-type mechanical arms to minimize the exposure of ground crew to radioactivity. In 1948, the Air Force decided the risk to aircrews was "manageable," and replaced the UA with manned F-84s whose pilots wore 60-pound lead suits. Some of these pilots subsequently died due to being trapped by their lead suits after crashing or to long term radiation effects. Manned nuclear fallout sampling missions continued into the 1990s (U-2 Senior Year Olympic Race).

### *The Dangerous*

Reconnaissance has historically been a dangerous mission; 25 percent of the 3rd Reconnaissance Group's pilots were lost in North Africa during World War II compared to 5 percent of bomber crews flying over Germany. When the Soviet Union shot down a U.S. U-2 and captured its pilot on 1 May 1960, manned reconnaissance overflights of the USSR ceased. What had been an acceptable risk on 1 May became unacceptable, politically and militarily on 2 May. Although this U-2 and its pilot (Francis Gary Powers) were neither the first nor the last of 23 manned aircraft and 179 airmen lost on Cold War reconnaissance missions, their loss spurred the Air Force to develop UA for this mission, specifically the AQM-34 Firebee and Lockheed D-21. The loss of seven of these UA over China between 1965 and 1971 went virtually unnoticed. Thirty years later, the loss of a Navy EP-3 and capture of its crew of 24 showed that manned peacetime reconnaissance missions remain dangerous and politically sensitive. Other historically dangerous missions that appear supportable with UAS are SEAD, strike and portions of electronic attack. The highest loss rates to aircrew and aircraft in Vietnam and the Israeli-Arab conflicts were during these types of missions. One of the primary purposes for the employment of UA is risk reduction to loss of human life in high threat environments. Assignment of these missions to Unmanned Combat Air Vehicles (UCAV) directly addresses the dangerous mission of attacking or degrading integrated air defense systems.

The attributes that make the use of unmanned preferable to manned aircraft in the above three roles are, in the case of the dull, the better sustained alertness of machines over that of humans and, for the dirty and the dangerous, the lower political and human cost if the mission is lost, and greater probability that the mission will be successful. Lower downside risk and higher confidence in mission success are two strong motivators for continued expansion of unmanned aircraft systems.

## 2.0 CURRENT UAS

This Section provides condensed descriptions of current and planned DoD UAS efforts for the users of this Roadmap. It categorizes DoD's UAS as *Major UAS*, *Concept Exploration* (those being used to develop new technologies or operating concepts), *Special Operations* (those UAS unique to SOCOM), *Small* (those mini and micro UAS that can be operated by 1-2 people), and *Unmanned Airships* (aerostats and blimps). Detailed descriptions are available at the websites listed with specific systems below.

Figure 2.0-1 presents a consolidated timeline of the Services' ongoing and planned programs of record for tactical, endurance, and combat UAS. The vertical line on each program's bar represents actual or projected initial operational capability (IOC). This Figure is a key component of the overall UAS Roadmap for the next 25 years, shown in Figure 6.2-1.

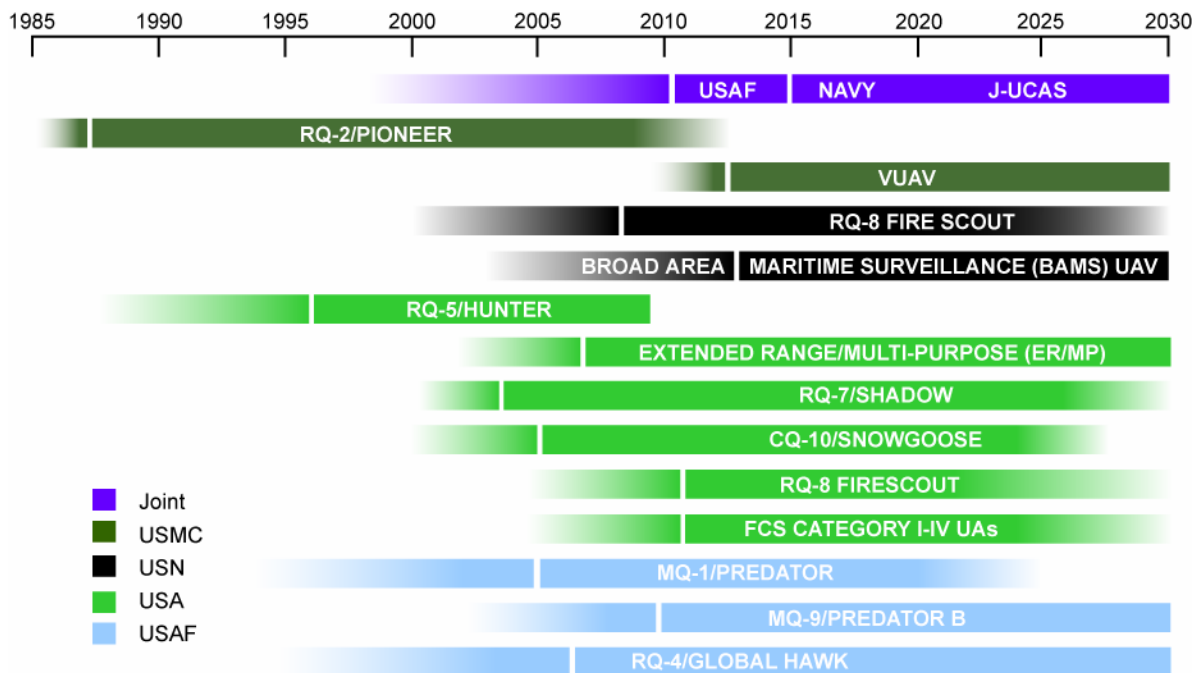

FIGURE 2.0-1. TIMELINE OF CURRENT AND PLANNED DoD UAS SYSTEMS.



**2.1 MAJOR UAS**

**2.1.1 MQ-1 Predator**

**User Service:** Air Force

**Manufacturer:** General Atomics Aeronautical Systems Inc.

**Inventory:** 120+ (All types) Delivered/77 Planned

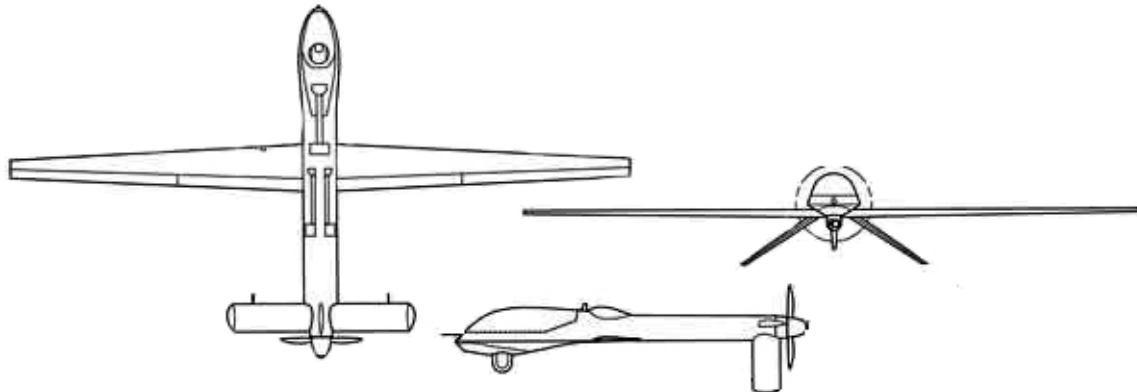

**Background:** The Air Force MQ-1 Predator was one of the initial Advanced Concept Technology Demonstrations (ACTDs) in 1994 and transitioned to an Air Force program in 1997. Since 1995, Predator has flown surveillance missions over Iraq, Bosnia, Kosovo, and Afghanistan. In 2001, the Air Force demonstrated the ability to employ Hellfire missiles from the Predator, leading to its designation being changed from RQ-1 to MQ-1 to reflect its multi-mission capability. The Air Force operates 12 systems in three Predator squadrons. The MQ-1 fleet reached the 100,000 flight hour mark in October 2004, and was declared operationally capable (IOC) in March 2005.

[http://www.af.mil/factsheets/factsheet\\_print.asp?fsID=122&page=1](http://www.af.mil/factsheets/factsheet_print.asp?fsID=122&page=1).

**Characteristics:**

	MQ-1 B		MQ-1 B
Length	26.7 ft	Wing Span	48.7 ft
Gross Weight	2,250 lb	Payload Capacity	450 lb
Fuel Capacity	665 lb	Fuel Type	AVGAS
Engine Make	Rotax 914F	Power	115 hp
Data Link(s)	BLOS	Frequency	Ku-band
	LOS		C-band

**Performance:**

Endurance	24+ hr/clean 14 hr/external stores	Max/Loiter Speeds	118/70 kt
Ceiling	25,000 ft	Radius	500 nm
Takeoff Means	Runway	Landing Means	Runway
Sensor	EO/IR	Sensor Make	Raytheon AN/AAS-52
	SAR		Northrop Grumman AN/ZPQ-1

### 2.1.2 RQ-2B Pioneer

**User Service:** Marine Corps

**Manufacturer:** Pioneer UAV, Inc.

**Inventory:** 175 Delivered/35 In-Service

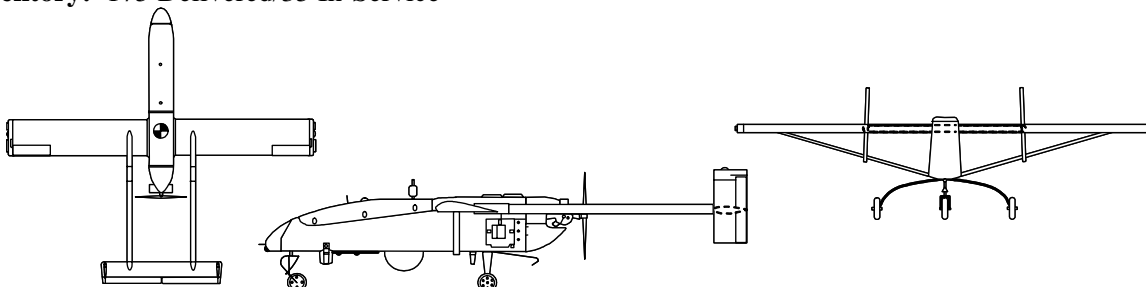

**Background:** The Navy/Marine RQ-2B Pioneer has served with Navy, Marine, and Army units, deploying aboard ship and ashore since 1986. Initially deployed aboard battleships to provide gunnery spotting, its mission evolved into reconnaissance and surveillance, primarily for amphibious forces. Launched by rocket assist, pneumatic launcher, or from a runway, it recovers on a runway with arresting gear after flying up to 5 hours with a 75 pound payload. It currently flies with a gimballed electro-optical/infra red (EO/IR) sensor, relaying analog video in real time via a C-band line-of-sight (LOS) data link. Since 1991, Pioneer has flown reconnaissance missions during the Persian Gulf, Bosnia, and Kosovo conflicts. It is currently flying in support of Marine Forces in OIF. The Navy ceased Pioneer operations at the end of FY02 and transferred assets to the Marine Corps. The Marine Corps is sustaining the Pioneer to extend their operations with it until replaced by a follow-on vertical UA.  
<http://uav.navair.navy.mil/>.

**Characteristics:**

	RQ-2B		RQ-2B
Length	14 ft	Wing Span	17 ft
Gross Weight	452 lb	Payload Capacity	75 lb
Fuel Capacity	76 lb	Fuel Type	AVGAS
Engine Make	Sachs SF 350	Power	26 hp
Data Link(s)	LOS C2	Frequency	C-band UHF

**Performance:**

Endurance	5 hr	Max/Loiter Speeds	110/65 kt
Ceiling	15,000 ft	Radius	100 nm
Takeoff Means	RATO/Runway/ Pneumatic Launch	Landing Means	Net/Runway with Arresting Gear
Sensor	EO/IR	Sensor Make	Tamam POP 200

### 2.1.3 RQ-4 Global Hawk

**User Service:** Air Force

**Manufacturer:** Northrop Grumman

**Inventory:** 12 Delivered/58 Planned (7 ACTD + 51 Production aircraft)

**Background:** The Air Force RQ-4 Global Hawk is a high altitude, long endurance UA designed to provide wide area coverage of up to 40,000 nm<sup>2</sup> per day. The size differences between the RQ-4A (Block 10) and RQ-4B (Blocks 20, 30, 40) models are shown above.

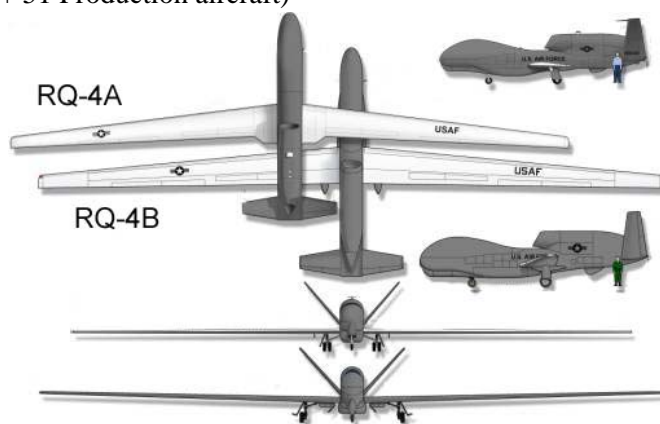

Global Hawk completed its first flight in February 1998 and transitioned from an ACTD into engineering and manufacturing development (EMD) in March 2001. Global Hawk carries both an EO/IR sensor and a Synthetic Aperture Radar (SAR) with moving target indicator (MTI) capability, allowing

day/night, all-weather reconnaissance. Sensor data is relayed over CDL LOS (X-band) and/or beyond-line-of-site (BLOS) (Ku-band SATCOM) data links to its mission control element (MCE), which distributes imagery to up to seven theater exploitation systems. The Air Force has budgeted for 34 production aircraft in FY05-10, and plans a total fleet of 51. The first of 44 'B' models is to be available for flight test in November 2006. The first Multi-Int payload which includes Advanced Signals Intelligence Program (ASIP) will be available for flight test in May 2007 followed by the Multi-Platform Radar Technology Insertion Program (MP-RTIP) payload in July 2007. The Air Force plans to add other sensor and communications capabilities in a spiral development process as this fleet is procured. Ground stations in theaters equipped with the common imagery processor (CIP) will eventually be able to receive Global Hawk imagery directly. IOC for imagery intelligence (IMINT)-equipped aircraft is expected to occur in FY06. <http://www.af.mil/factsheets/factsheet.asp?fsID=175>.

**Characteristics:**

	RQ-4A (Block 10)	RQ-4B (Block 20, 30, 40)		RQ-4A (Block 10)	RQ-4B (Block 20, 30, 40)
Length	44.4 ft	47.6 ft	Wing Span	116.2 ft	130.9 ft
Gross Weight	26,750 lb	32,250 lb	Payload Capacity	1,950 lb	3,000 lb
Fuel Capacity	14,700 lb	16,320 lb	Fuel Type	JP-8	JP-8
Engine Make	Rolls Royce AE-3007H	Rolls Royce AE-3007H	Power	7,600 lb (SLS)	7,600 lb (SLS)
Data Link(s)	LOS	LOS	Frequency	UHF	UHF
	LOS	LOS		X-band	X-band
	BLOS (SATCOM)	BLOS (SATCOM)		Ku-band INMARSAT	Ku-band INMARSAT

**Performance:**

Endurance	32 hr	28 hr	Max/Loiter Speeds	350/340 kt	340/310 kt
Ceiling	65,000 ft	60,000 ft	Radius	5,400 nm	5,400 nm
Takeoff Means	Runway	Runway	Landing Means	Runway	Runway
Sensor	EO/IR	EO/IR and SIGINT	Sensor Make	Raytheon	Raytheon
	SAR/MTI	SAR/MTI		Raytheon	Raytheon

**2.1.4 RQ-5A/MQ-5B Hunter**

**User Service:** Army

**Manufacturer:** Northrop Grumman

**Inventory:** 62 Delivered/35 In-Service

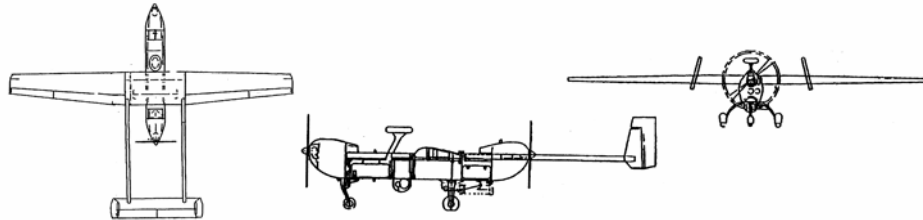

**Background:** The RQ-5 Hunter was originally a joint Army/Navy/Marine Corps Short Range UAS that the Army intended to meet division and corps level requirements. A gimbaled EO/IR sensor is used to relay video in real time via a second airborne Hunter over a C-band LOS data link. Hunter deployed to Macedonia to support NATO Balkan operations in 1999 and to Iraq in 2002. Although full-rate production (FRP) was canceled in 1996, seven low-rate initial production (LRIP) systems of eight aircraft each were acquired; an additional 18 aircraft were purchased in FY04 for delivery in FY05. All 18 aircraft will deliver as MQ-5s which have been modified to carry the Viper Strike and BLU 108 munitions. A competitively selected Extended Range/Multi-Purpose (ER/MP) UAS will begin to replace Hunter as early as FY07. Hunter is expected to remain in service through 2009.

**Characteristics:**

	RQ-5A	MQ-5B		RQ-5A	MQ-5B
Length	22.6 ft	23 ft	Wing Span	29.2 ft	34.25 ft
Gross Weight	1,620 lb	1,800 lb	Payload Capacity	200 lb	200 lb
Fuel Capacity	Moto Guzzi 421 lb HFE 280 lb	Moto Guzzi 421 lb HFE 280 lb	Fuel Type	MOGAS	JP-8
Engine Make	Moto Guzzi (x2)	Moto Guzzi (x2) Mercedez HFE (x2)	Power	57 hp (x2)	57 hp (x2) 56 hp (x2)
Data Link	LOS	LOS	Frequency	C-band	C-band

**Performance:**

Endurance	11.6 hr	18 hr	Max/Loiter Speeds	106/89 kt	106/89 kt
Ceiling	15,000 ft	18,000 ft	Radius	144 nm	144 nm
Takeoff Means	Runway	Runway	Landing Means	Runway/Wire	Runway/Wire
Sensor	EO/IR	EO/IR	Sensor Make	Tamam MOSP	Tamam MOSP

**2.1.5 RQ-7A/B Shadow 200**

**User Service:** Army

**Manufacturer:** AAI

**Inventory:** 100 + Delivered/332 Planned

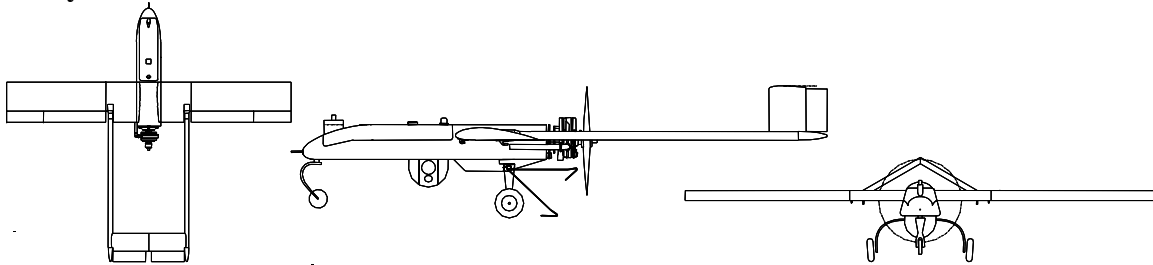

**Background:** The Army selected the RQ-7 Shadow 200 (formerly tactical UA (TUA)) in December 1999 to meet the Brigade-level UA requirement for support to ground maneuver commanders. Catapulted from a rail, it is recovered with the aid of arresting gear. Its gimballed EO/IR sensor relays video in real time via a C-band LOS data link. The first upgraded 'B' model was delivered in August 2004. The RQ-7B can now accommodate the high bandwidth tactical common data link (TCDL) and features a 16 inch longer wingspan, 7 hours endurance (greater fuel capacity), and an improved flight computer. Approval for FRP and IOC occurred in September 2002. Current funding allows the Army to procure 63 systems of four aircraft each for the active duty forces and reserve forces. The Army's acquisition objective, with the inclusion of the Army Reserve component, is 88 total systems. Shadow systems have been deployed to Iraq in support of GWOT and to South Korea.

**Characteristics:**

	RQ-7A	RQ-7B		RQ-7A	RQ-7B
Length	11.2 ft	11.2 ft	Wing Span	12.8 ft	14 ft
Gross Weight	327 lb	375 lb	Payload Capacity	60 lb	60 lb
Fuel Capacity	51 lb	73 lb	Fuel Type	MOGAS	MOGAS
Engine Make	UEL AR-741	UEL AR-741	Power	38 hp	38 hp
Data Link(s)	LOS C2	LOS C2	Frequency	S-band UHF	S-band UHF
	LOS Video	LOS Video		C-band	C-band

**Performance:**

Endurance	5 hr	7 hr	Max/Loiter Speeds	110/70 kt	105/60 kt
Ceiling	14,000 ft	15,000 ft	Radius	68 nm	68 nm
Takeoff Means	Catapult	Catapult	Landing Means	Arresting Wire	Arresting Wire
Sensor	EO/IR	EO/IR	Sensor Make	Tamam POP 200	Tamam POP 300

### 2.1.6 RQ-8A/B Fire Scout

**User Service:** Army and Navy

**Manufacturer:** Northrop Grumman

**Inventory:** 5 Delivered/192 Planned

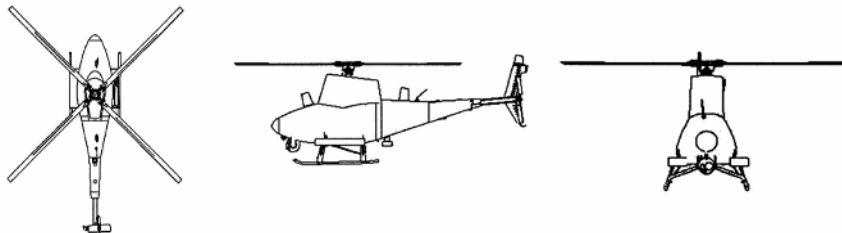

**Background:** The Fire Scout Vertical Take-Off and Landing (VTOL) Tactical UAV (VTUAV) program is currently in EMD. Five RQ-8A air vehicles and four ground control stations are now in developmental testing. Over 100 successful test flights have been accomplished demonstrating autonomous flight, TCDL operations, Multi-Mission Payload performance, and ground control station operations. The Army selected the four-bladed RQ-8B model as its category IV UA for its future combat system (FCS) in 2003. Planned delivery for the first two prototypes is in 2006. The Navy has selected the RQ-8B to support the Littoral Combat Ship (LCS) class of surface vessels. <http://uav.navair.navy.mil/>.

**Characteristics:**

	RQ-8A		RQ-8B
Length	22.9 ft	Wing Span	27.5 ft
Gross Weight	3,150 lb	Payload Capacity	600 lb
Fuel Capacity	1,288 lb	Fuel Type	JP-5/JP-8
Engine Make	Rolls Royce 250-C20W	Power	420 shp
Data Link(s)	LOS C2	Frequency	Ku-band/UHF
	LOS Video		Ku-band

**Performance:**

Endurance	6+ hr	Max/Loiter Speeds	125/0 kt
Ceiling	20,000 ft	Radius	150 nm
Takeoff Means	Vertical	Landing Means	Hover
Sensor	EO/IR/LDRF	Sensor Make	FSI Brite Star II

### 2.1.7 MQ-9 Predator B

**User Service:** Air Force

**Manufacturer:** General Atomics Aeronautical Systems Inc.

**Inventory:** 6 Delivered/60 Planned



**Background:** The MQ-9 is a medium-to-high altitude, long-endurance unmanned aircraft system. Its primary mission is as a persistent hunter-killer for critical time sensitive targets and secondarily to act as an intelligence collection asset. The MQ-9 system consists of four aircraft, a ground control station (GCS), and a Predator Primary Satellite Link. The integrated sensor suite includes a moving target-capable synthetic aperture radar (SAR) and a turret that houses electro-optical and mid wave infrared sensors, a laser range finder, and a laser target designator. The crew for the MQ-9 is one pilot and one sensor operator. The USAF proposed the MQ-9 system in response to the Department of Defense request for Global War On Terrorism (GWOT) initiatives, in October 2001. In June 2003, Air Combat Command (ACC) approved the MQ-9 Concept of Operations. The objective force structure includes nine combat-coded systems and 36 aircraft. ACC approved the final basing decision to put the MQ-9 squadron at Indian Springs Air Force Auxiliary Field in February 2004.

[http://www.af.mil/factsheets/factsheet\\_print.asp?fsID=122&page=1](http://www.af.mil/factsheets/factsheet_print.asp?fsID=122&page=1).

**Characteristics:**

	MQ-9 A		MQ-9 A
Length	36 ft	Wing Span	66 ft
Gross Weight	10,500 lb	Payload Capacity	*750 lb
Fuel Capacity	4,000 lb	Fuel Type	JP
Engine Make	Honeywell TPE 331-10	Power	900 shp
Data Link(s)	BLOS	Frequency	Ku-band
	LOS		C-band

\* Up to 3,000 lb total externally on wing hardpoints.

**Performance:**

Endurance	30 hr/clean 16-20 hr/external stores	Max/Loiter Speeds	225/TBD kt
Ceiling	50,000 ft	Radius	2,000 nm
Takeoff Means	Runway	Landing Means	Runway
Sensor	EO/IR	Sensor Make	MTS-B
	SAR/MTI	Weapons	Four, 500 lb class or 8-10, 250 lb class

### 2.1.8 Joint Unmanned Combat Air Systems (J-UCAS)

**User Service:** Air Force and Navy

**Manufacturers:** Boeing, Northrop Grumman

**Inventory:** 2 X-45A Delivered, 1 X-47A Demonstrated/3 X-45C Planned, 3 X-47B Planned

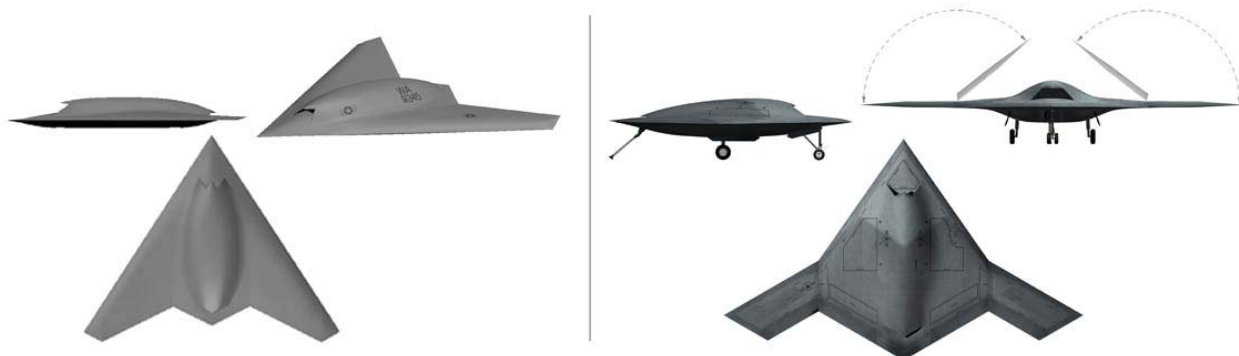

**Boeing X-45C (L) and Northrop Grumman X-47B (R) J-UCAS Demonstrators**

**Background:** The Air Force UCAV and Navy UCAV-N demonstrator programs were combined into a joint program under Defense Advanced Research Projects Agency (DARPA) management in FY04. First flights of the original prototypes, the Boeing X-45A and the Northrop Grumman X-47A, occurred in May 2002 and February 2003, respectively. Testing of the two X-45As continues through September 2005. First flights of the larger X-45C and X-47B models and introduction of a *Common Operating System* are to occur in 2007. J-UCAS is focused on demonstrating a versatile combat network in which air and ground components are nodes that can be changed over time to support a wide range of potential missions. The program demonstrated weapon delivery and coordinated flight in 2004. Program management responsibility is planned to transfer from DARPA to the Air Force in FY06. <http://www.darpa.mil/j-ucas/>.

**Characteristics:**

	X-45C	X-47B		X-45C	X-47B
Length	39 ft	38 ft	Wing Span	49 ft	62 ft
Gross Weight	36,500 lb	46,000 lb	Payload Capacity	4,500 lb	4,500 lb
Fuel Capacity	14,000 lb	17,000 lb	Weapon	GBU-31	GBU-31
Engine Make	GE F404-GE-102D	F100-PW-220U	Fuel Type	JP-8	JP-8
Data Link(s)	Link 16	Link 16	Frequency	Ku, Ka	Ku, Ka

**Performance:**

Endurance	7 hr	9 hr	Max/Loiter Speeds	460/TBD kt	460/TBD kt
Ceiling	40,000 ft	40,000 ft	Radius	1,200 nm	1,600 nm
Takeoff Means	Runway Carrier Option	Runway/Carrier	Landing Means	Runway Carrier Option	Runway/Carrier
Sensor	ESM	ESM	Sensor Make	ALR-69	ALR-69
	SAR/GMTI	SAR/GMTI EO/IR		TBD	TBD



### 2.1.9 Future Combat System (FCS)

**User Service:** Army

**Manufacturer:** The Boeing Company

**Inventory:** 0 Delivered/TBD Planned

**Background:** The Army's FCS consists of 18 systems, 4 of them unmanned aircraft, that are expected to appear in an experimental brigade in 2008 and reach IOC in 2014. TRADOC designated Raven as the interim Class I UAV, an improved Shadow as the interim Class III UAV and Fire Scout as the Class IV UAV in April 2004. A fifth UA category, Class IV B, has been created, requiring 24-hour endurance by a single aircraft, perhaps the eventual ER/MP UA.

**Characteristics:**

	Class I UAV	Class II UAV	Class III UAV	Class IV UAV
Type	Platoon UA	Company UA	Battalion UA	Brigade UA
Weight	5-10 lb	100-150 lb	300-500 lb	> 3,000 lb

**Performance:**

	Class I UAV	Class II UAV	Class III UAV	Class IV UAV
Endurance	50 min	2 hr	6 hr	24 hr continuous ops
Radius	8 km	16 km	40 km	75 km
Transport	Manpackable (35 lb system)	2 Soldier Remount	2 Man Lift	100m x 50m Recovery Area
Aircraft	Raven (interim)	TBD	Shadow (interim)	Fire Scout

### 2.1.10 I-Gnat-ER

**User Service:** Army

**Manufacturer:** General Atomics Aeronautical Systems, Inc.

**Inventory:** 3 Delivered/5 Planned

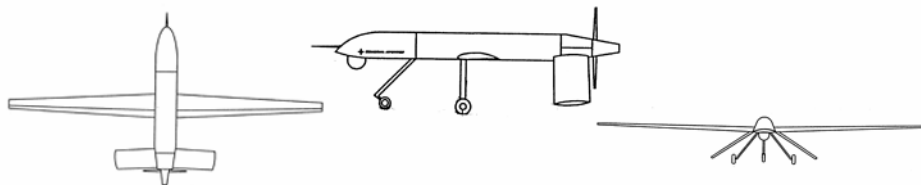

**Background:** The Army acquired three I-Gnat-ER UA in FY04 as a result of a Congressional budget increase for CONOPS development for the ER/MP program. The Army subsequently deployed these assets to Iraq as a gap filler during the Hunter reconstitution. Two more UA are on order and are to deliver in FY05. These two will have SATCOM data links and be equipped with the Raytheon 17 inch MTS sensor/designator system. I-Gnat-ER is a variant of the Predator. The I-Gnat-ER is slightly larger than the Gnat 750, has external hardpoints, an air-to-air data link ability, and more capable avionics. In 2002, Canada employed an I-Gnat to augment security surveillance during the G-8 Heads of State Meeting in Alberta and in a Canadian Army exercise. The Army has had I-Gnat-ERs deployed to Iraq since March 2004.

**Characteristics:**

	I-Gnat – ER		I-Gnat – ER
Length	27 ft	Wing Span	49 ft
Gross Weight	2,300 lb	Payload Capacity	450 lb
Fuel Capacity	625 lb	Fuel Type	AVGAS
Engine Make	Rotax 914F	Power	115 hp
Data Link(s)	LOS	Frequency	C-band

**Performance:**

Endurance	30 hr	Max/Loiter Speeds	120/70 kt
Ceiling	25,000 ft	Radius	150 nm
Takeoff Means	Runway	Landing Means	Runway
Sensor	EO/IR	Sensor Make	Wescam MX-15

### 2.1.11 Global Hawk Maritime Demonstration (GHMD)

**User Service:** Navy

**Manufacture:** Northrop Grumman

**Inventory:** 0 Delivered/2 Planned



**Background:** The GHMD program is a non-acquisition demonstration program. Its purpose is to provide the Navy a multi-INT, high altitude, persistent, ISR demonstration capability for doctrine; CONOPS; Tactics, Techniques, and Procedures development; and participation as a Sea Trial 21 initiative (a part of Trident Warrior 05). In FY03, the Navy contracted with Northrop Grumman through the Air Force Global Hawk program office for the purchase of:

- Two RQ-4 (Block10) Global Hawks (2,000 pound payload) with EO/IR and SAR sensors
- Ground control/support equipment
- Engineering to include Navy changes for:
  - Maritime sensor modes software (maritime surveillance, target acquisition, inverse SAR)
  - 360 degree field-of-regard electronic support measures capability
  - Satellite and direct data link upgrades

When delivered, these two UA with sensors and ground control/support equipment will be delivered to the Navy's GHMD main operating base at Patuxent River, MD. <http://uav.navair.navy.mil>.

### 2.1.12 Broad Area Maritime Surveillance (BAMS) UA

**User Service:** Navy

**Manufacturer:** TBD

**Inventory:** 0 Delivered/TBD Planned

**Background:** The Navy is developing the BAMS UA to provide a persistent, maritime, worldwide access, ISR capability. Operating as an adjunct to the Multi-mission Maritime Aircraft, the BAMS UA will conduct continuous open-ocean and littoral surveillance of targets as small as 30-foot vessels. The BAMS UA will be unarmed, possess high endurance, and will operate from land-based sites worldwide. BAMS UAS of up to 5-6 air vehicles at each operating location will provide persistence by being airborne 24 hours a day, 7 days a week out to on-station ranges of 2,000 nautical miles. Worldwide access will be achieved by providing coverage over nearly all the world's high-density sea-lanes, littorals, and areas of national interest from its operating locations. BAMS UA will also contribute to providing the Fleet Commander a common operational picture of the battlespace day and night. Additionally, a communication relay capability will provide the Fleet Commander a 'low hanging satellite' capability, linking him to widely dispersed forces in the theater of operation and serving as a communication node in the Navy's FORCENet strategy. [http://uav.navair.navy.mil/bams/BAMS\\_AUVSI\\_Brief.pdf](http://uav.navair.navy.mil/bams/BAMS_AUVSI_Brief.pdf)

### 2.1.13 Extended Range/Multipurpose (ER/MP) UA

**User Service:** Army

**Manufacturer:** TBD

**Inventory:** 0 Delivered/90 Planned (Increment 2)

**Background:** The Army began defining requirements for a successor to its RQ-5 Hunter systems in late 2001. Called the ER/MP UAS, it is envisioned as a medium altitude, endurance UA, its preliminary requirements closely resemble Hunter's capabilities. Funding started in FY04 and an IOC is planned for 2007, the ER/MP acquisition approach is to procure an in-production system. The ER/MP request for proposal (RFP) was released in September 2004. Two contractor teams successfully completed the System Concept Demonstration in March 2005. A Milestone B decision was made on April 20, 2005, with a single contractor award expected in May 2005. A key requirement is that the ER/MP UA must be controllable from the RQ-7 Shadow ground station. Five systems (12 aircraft each) are planned for Increment 1, with each system increasing to 18 aircraft in Increment 2.

## 2.2 CONCEPT EXPLORATION UAS

### 2.2.1 X-50 Dragonfly Canard Rotor/Wing (CRW)

**User Service:** DARPA

**Manufacturer:** Boeing

**Inventory:** 2 Delivered/2 Planned



**Background:** The CRW concept combines the VTOL capability of a helicopter with the high-subsonic cruise speed (as high as 400 kt) of a fixed-wing aircraft. CRW intends to achieve this by stopping and locking the rotor and using it as a wing to achieve high speed forward flight; the canard and tail provide additional lifting and control surfaces. For both rotary and fixed-wing flight modes, the CRW is powered by a conventional turbofan engine. The X-50 is a technology demonstrator designed to assess and validate the CRW concept. Hover tests were conducted in December 2003 and March 2004, but a hard landing resulted in significant damage to the first air vehicle. The second X-50 is now being readied to continue the flight testing, planned for summer 2005. <http://www.darpa.mil/tto/programs/crw.html>.

**Characteristics:**

	X-50		X-50
Length	17.7 ft	Rotorspan	12 ft
Gross Weight	1,485 lb	Payload Capacity	none
Fuel Capacity	160 gal	Fuel Type	Jet-A, JP-8
Engine Make	Williams F115	Power	700 lbf

**Performance:**

Endurance	1/2 hr	Max/Loiter Speeds	220/0 kt
Ceiling	20,000 ft	Radius	30 nm
Takeoff Means	Hover	Landing Means	Hover

### 2.2.2 A-160 Hummingbird

**User Service:** DARPA/Army/Navy

**Manufacturer:** Boeing/Frontier

**Inventory:** 4 Delivered/10 Planned



**Background:** The A160 Hummingbird is designed to demonstrate the capability for marked improvements in performance (range, endurance, and controllability), as compared to conventional helicopters, through the use of a rigid rotor with variable RPM, lightweight rotor and fuselage structures, a high efficiency internal combustion engine, large fuel fraction, and an advanced semi-autonomous flight control/flight management system. The patented Optimum Speed Rotor (OSR) system allows the rotor to operate over a wide band of RPM and enables the A160 rotor blades to operate at the best lift/drag ratio over the full spectrum of flight conditions. First flight occurred in January 2002. In flight testing, using a 4-cylinder racing car engine, the A160 has achieved 135 kt speed, 7.3 hour endurance on an 18% fuel load, 7,000 ft altitude, and wide variation in rotor RPM. Autonomous flight achieved for take-off, waypoint flight, landing, and lost-link return to base. Current plans are to test with a 6-cylinder engine, then migrate to a turboshaft engine, and ultimately to a diesel engine, to achieve high endurance (24+ hours) and high altitude (30,000 feet). The DARPA contract ends in 2007. <http://www.darpa.mil/tto/programs/a160.html>.

**Characteristics:**

	A-160		A-160
Length	35 ft	Rotorspan	36 ft
Gross Weight	4,300 lb	Payload Capacity	300+ lb
Fuel Capacity	2,500 lb	Fuel Type	Gasoline
Engine Make	6-cylinder car	Power	390 hp

**Performance:**

Endurance	18 hr at 15kft	Max/Loiter Speeds	140+/-0 kt
Ceiling	28,000 ft	Radius	1,700 nm
Takeoff Means	Hover	Landing Means	Hover

### 2.2.3 Cormorant

**User Service:** DARPA

**Manufacturer:** Lockheed Martin

**Inventory:** 0 Delivered/TBD Planned

**Background:** The Cormorant project is currently conducting a series of risk reduction demonstrations for a multi-purpose UA that is “immersible” and capable of launch, recovery, and re-launch from a submerged SSGN submarine or a surface ship. Such an UA could provide all- weather ISR&T, BDA, armed reconnaissance, or SOF and specialized mission support. In particular, the combination of a stealthy SSGN submarine and a survivable air vehicle could introduce a disruptive capability to support future joint operations. If the current demonstrations are successful, follow-on efforts could involve building an immersible and flyable demonstrator UA.



**Characteristics:**

	Cormorant			Cormorant	
Length	19 ft		Wing Span	16 ft	
Gross Weight	9,000 lb		Payload Capacity	1,000 lb	
Fuel Capacity	2,500 lb		Fuel Type	JP-5	
Engine Make	TBD		Power	3,000 lb thrust	

**Performance:**

Endurance	3 hr	Max/Loiter Speeds	0.8M/0.5M
Ceiling	35,000 ft	Radius	400-500 nm
Takeoff Means	Rocket-Boosted	Landing Means	Splashdown

### 2.2.4 DP-5X

**User Service:** DARPA

**Manufacturer:** Dragonfly Pictures

**Inventory:** 0 Delivered/TBD Planned

**Background:** The DP-5X is planned to be an FCS Class III-compliant VTOL UA. The program has successfully completed development and test milestones and is planning to enter initial flight demonstrations. The vehicle is modular and will facilitate reconfigurations to include or remove subsystem components. The modular design allows the aircraft to be separated into distinct modules that are man-transportable. The DP-5X has an ample payload capacity and is designed to fit into a common HMMWV system. The unique construction allows it to be rapidly launched by two operators. The vehicle can serve as a tactical Reconnaissance, Surveillance, and Target Acquisition (RSTA) and Communication Relay platform to the Army small unit commanders at the Battalion and below level.

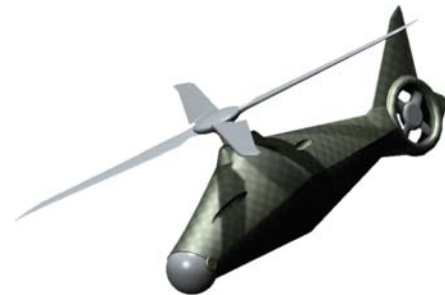

**Characteristics:**

	DP-5X			DP-5X	
Length	11 ft		Rotor Span	10.5 ft	
Gross Weight	475 lb		Payload Capacity	75 lb	
Fuel Capacity	165 lb		Fuel Type	Heavy Fuel	
Engine Make	TPR 80-1		Power	97 HP @ SL	

**Performance:**

Endurance	5.5 hr	Max/Loiter Speeds	100 kt
Ceiling	10,000 ft	Range	410 nm
Takeoff Means	Hover	Landing Means	Hover

### 2.2.5 Long Gun

**User Service:** DARPA

**Manufacturer:** Titan Corporation

**Inventory:** 0 Delivered/TBD Planned

**Background:** The DARPA Long Gun program will evaluate and develop a re-useable, long endurance, low cost, joint, unmanned/armed missile system combined with a tri-mode long wave infrared/near infrared/visible (LWIR/NIR/VIS) sensor with laser spot targeting. Ducted fan propulsion will provide efficient thrust for long endurance. The missile will be launched from a canister carried on a sea or ground vehicle, will fly to a specified target area, and use a tri-mode sensor operating at visible, long, and near-infrared wavelengths to search for targets. If a qualified target is found, the missile will attack the target with a self-contained munition. If no targets are found, the missile could be commanded to return to base. The missile will include a data link back to a human controller/operator to confirm target characteristics, approve engagement, and perform battle damage assessment.



**Characteristics:**

	Long Gun		Long Gun
Length	12 ft	Wing Span	13 ft
Gross Weight	720 lb	Payload Capacity	160 lb
Fuel Capacity	300 lb	Fuel Type	JP-8, JP-5, Diesel
Engine Make	UEV Engines	Power	28 hp, 1KW generator

**Performance:**

Endurance	30+ hrs	Max/Loiter Speeds	125 kt
Ceiling	15,000 ft	Radius	1800 km
Takeoff Means	HIMARS or rail	Landing Means	Remote field

### 2.2.6 Unmanned Combat Armed Rotorcraft (UCAR)

**User Service:** Army

**Manufacturer:** Lockheed Martin and Northrop Grumman

**Inventory:** 0 Delivered/0 Planned



**Background:** The goal of the joint DARPA/Army Unmanned Combat Armed Rotorcraft (UCAR) program was to demonstrate the technical feasibility, military utility, and operational value of an intelligent vertical takeoff and landing UAV to effectively and affordably perform armed reconnaissance and attack missions as an element of the Future Force. The UCAR program had begun to design, develop, integrate, and demonstrate critical and enabling technologies, such as: autonomous and collaborative operations, autonomous low altitude flight, survivability, and targeting/weapons delivery. Teams led by Lockheed Martin and Northrop Grumman completed preliminary design of their UCAR Demonstration Systems in July 2004. One team was selected in 2004 to build representative demonstrators. These “A-model” demonstrators were to fly in 2006, followed by a “B-model” fieldable prototype in 2008, followed by transition to an Army acquisition program by 2010. **The UCAR program was terminated in December 2004 as a result of Army funding priorities.**

## 2.2.7 Eagle Eye

**User Service:** Coast Guard

**Manufacturer:** Bell Textron

**Inventory:** 0 Delivered/69 Planned

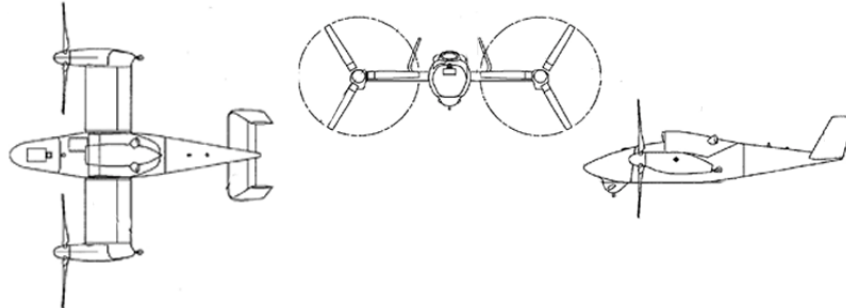

**Background:** The Coast Guard selected the Bell model TR911D Eagle Eye tiltrotor in February 2003 to serve as the cutter-based UA in its Deepwater program. The Deepwater program will begin evaluation of a prototype aircraft in 2007.

### Characteristics:

	Eagle Eye		Eagle Eye
Length	17 ft	Rotor Span	15.2 ft
Gross Weight	2,850 lb	Payload Capacity	200-300 lb
Fuel Capacity	832 lb	Fuel Type	JP/Diesel
Engine Make	P&W 200-55	Power	641 hp
Data Link(s)	LOS C2/Video LOS C2	Frequency	Ku-Band/S-Band

### Performance:

Endurance	5.5 hr	Max/Loiter Speeds	210/97 kt
Ceiling	20,000 ft	Radius	110 nm w/3 hr TOS
Takeoff Means	Hover	Landing Means	Hover
Sensor	MMR	Sensor Make	Telephonics 1700-CG
	EO/IR		FSI Star Safire III



## 2.3 SPECIAL OPERATIONS UAS

### 2.3.1 Neptune

**User Service:** Navy

**Manufacturer:** DRS Unmanned Technologies

**Inventory:** 15 Delivered/27 Planned

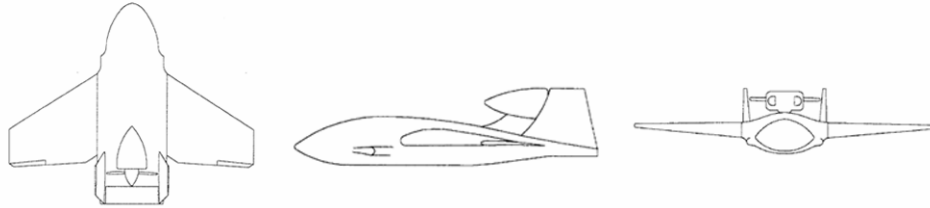

**Background:** Neptune is a new tactical UA design optimized for at-sea launch and recovery. Carried in a 72x30x20 inch case that transforms into a pneumatic launcher, it can be launched from small vessels and recovered in open water. It can carry IR or color video sensors, or can be used to drop small payloads. Its digital data link is designed to minimize multipath effects over water. First flight occurred in January 2002, and an initial production contract was awarded to DRS Unmanned Technologies in March 2002.

**Characteristics:**

	Neptune		Neptune
Length	6 ft	Wing Span	7 ft
Gross Weight	80 lb	Payload Capacity	20 lb
Fuel Capacity	18 lb	Fuel Type	MOGAS
Engine Make	2 Stroke	Power	15 hp
Data Link(s)	LOS C2	Frequency	UHF
	LOS Video		UHF

**Performance:**

Endurance	4 hr	Max/Loiter Speeds	84/60 kt
Ceiling	8,000 ft	Radius	40 nm
Takeoff Means	Pneumatic	Landing Means	Water/Skid/Parachute
Sensor	EO or IR	Sensor Make	DRS

**2.3.2 Maverick**

**User Service:** DARPA/Army/Navy

**Manufacturer:** Boeing/Frontier/Robinson

**Inventory:** 4 Delivered/5 Planned

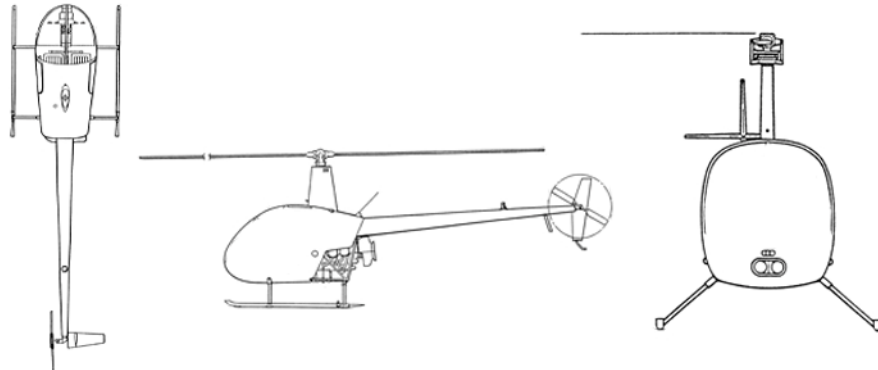

**Background:** Maverick is an unmanned version of the Robinson R22 helicopter. Frontier modified it in 1999 to serve as a testbed for developing the control logic for their DARPA A-160 UA effort. Subsequently, the Navy decided to acquire four Mavericks in 2003.

**Characteristics:**

	Maverick		Maverick
Length	28.8 ft	Rotorspan	25.2 ft
Gross Weight	1,370 lb	Payload Capacity	400 lb
Fuel Capacity	100 lb	Fuel Type	AVGAS
Engine Make	Lycoming 0-360-J2A	Power	145 hp
Data Link(s)	TBD	Frequency	TBD

**Performance:**

Endurance	7 hr	Max/Loiter Speeds	118/0 kt
Ceiling	10,800 ft	Radius	175 nm
Takeoff Means	Hover	Landing Means	Hover
Sensor	EO/IR	Sensor Make	Wescam

### 2.3.3 XPV-1 Tern

**User Service:** SOCOM

**Manufacturer:** BAI Aerosystems

**Inventory:** 65 Delivered/65 Planned

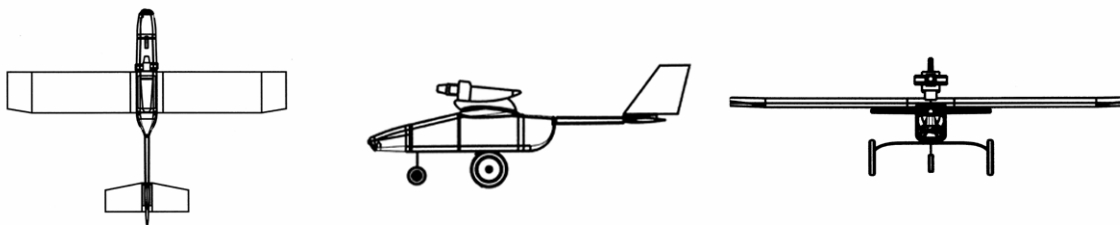

**Background:** Originally an Army testbed for a fiber-optic guided UA, Tern was completely retooled in late 2001 to give it a larger, steerable nose gear and main gear fitted with tires suitable for rough terrain with electronically-actuated disc brakes to aid short-field recovery that enabled the aircraft to carry a belly-mounted dispensing mechanism. Tern was operated in support of Special Operations Forces by Navy personnel from Fleet Composite Squadron Six (VC-6, previously the USN's Pioneer UA Squadron) in Afghanistan to perform force protection missions and to dispense an unattended ground sensor weighing over 20 pound. Over 225 combat hours were flown during two 3-month long deployments. In early 2004, a Tern variant was developed that eliminated the landing gear and incorporated skids and a tail-hook. A maritized control station was developed, and the system was successfully demonstrated onboard a Navy LPD (USS Denver). The reduced drag of the skid/tailhook recovery system improved the vehicle's mission endurance from 4 to over 6 hours.

**Characteristics:**

	XPV-1		XPV-1
Length	9.0 ft	Wing Span	11.4 ft
Gross Weight	130 lb	Payload Capacity	25 lb
Fuel Capacity	28 lb	Fuel Type	MOGAS/oil
Engine Make	3W 100 cc	Power	12 hp
Data Link(s)	LOS C2	Frequency	L/S-band
	LOS Video		UHF

**Performance:**

Endurance	2 hr	Max/Loiter Speeds	87/50 kt
Ceiling	10,000 ft	Radius	40 nm
Takeoff Means	Runway	Landing Means	Runway
Sensor	EO or IR	Sensor Make	BAI PTZ

### 2.3.4 XPV-2 Mako

**User Service:** SOCOM

**Manufacturer:** NAVMAR Applied Sciences Corporation/BAI Aerosystems

**Inventory:** 30 Delivered/30 Planned

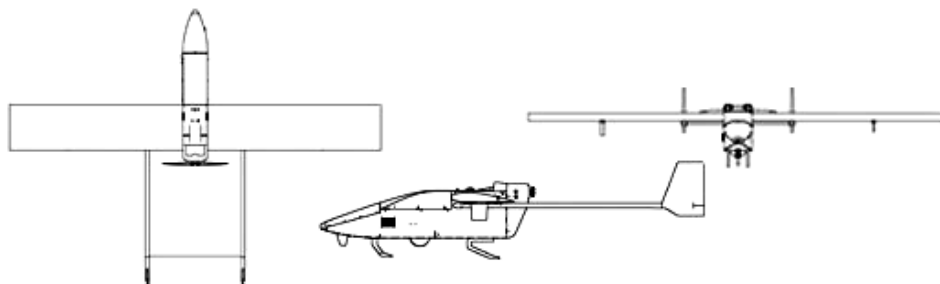

**Background:** Mako is a lightweight long endurance versatile unmanned aircraft capable of a variety of missions, yet of sufficiently low cost to be discarded after actual battle, if necessary. It is a single engine, high wing, Radio Controlled or computer assisted autopilot UA capable of daylight or infrared reconnaissance and other related missions. Although it is a relatively new aircraft, the recent modifications that included the addition of navigation/strobe lights, a Mode C transponder, dual GCS operational capability, and a new high resolution digital camera, made it a success during support to OIF.

**Characteristics:**

	XPV-2		XPV-2
Length	9.11 ft	Wing Span	12.8 ft
Gross Weight	130 lb	Payload Capacity	30 lb
Fuel Capacity	5 gal	Fuel Type	MOGAS/oil
Engine Make	3W 100cc	Power	9.5 hp
Data Link(s)	C2	Frequency	VHF/UHF
	Video		L-band Video Downlink

**Performance:**

Endurance	8.5 hr	Max/Loiter Speeds	75/50 kt
Ceiling	10,000' MSL	Radius	40 NM
Takeoff Means	Runway	Landing Means	Runway
Sensor	EO/IR	Sensor Make	BAI

### 2.3.5 CQ-10 SnowGoose

**User Service:** USSOCOM, Army

**Manufacturer:** MMIST Inc.

**Inventory:** 15 Delivered/TBD Planned

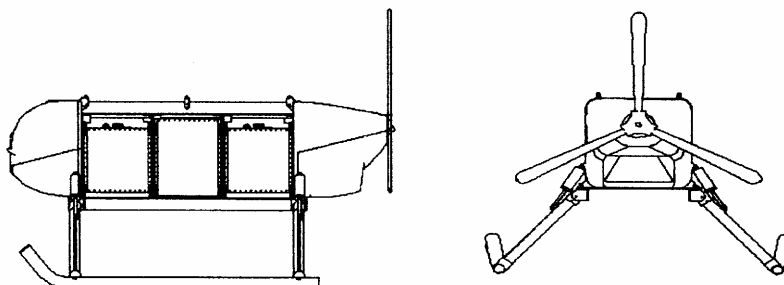

**Background:** USSOCOM selected the CQ-10A SnowGoose to dispense leaflets for Psychological Operations (PSYOP), deliver small supply bundles to Special Operations Forces, provide aerial surveillance and communications relay capabilities. The SnowGoose is a powered, programmable, GPS-guided parafoil with modular payload bays that can carry up to six individual payload or fuel bins. The SnowGoose can be ground launched from a HMMWV or air-deployed from a C-130, C-141, or C-17 at altitudes up to 25,000 feet. From the ground, it can climb to 18,000 feet. It can carry up to 575 pounds of leaflets, supplies, or other fixed cargo payloads with an endurance of 1-3 hours or it can stay aloft with a 75 pound payload for 14-16 hours. (Note: Endurance is a function of the selection of ground launch or air launch parachute kit, with greater endurance achieved in its ground launch configuration). The SnowGoose is designed to operate with only four operators with a turn-around time of less than four hours between uses. The SnowGoose was originally developed as the Wind Supported Aerial Delivery System (WSADS) and refined in the Air-Launched Extended Range Transporter (ALERT) ACTD. The first flight occurred in April 2001, and IOC was achieved in Jan 2005.

**Characteristics:**

	CQ-10A		CQ-10A
Length	9.5 ft	Wing Span	6.8 ft
Gross Weight	1,400 lb fully loaded	Payload Capacity	575 lb
Fuel Capacity	Up to 91 U.S. gal	Fuel Type	MOGAS/AVGAS
Engine Make	Rotax 914 UL	Power	110 hp
Data Link(s)	LOS/BLOS C2	Frequency	L-band
	LOS Video		

**Performance:**

Endurance	Up to 19 hr (Maximum), 9-11 hr with 200 lb cargo	Max/Loiter Speeds	33/33 kt
Ceiling	> 18,000 ft	Radius	160 nm
Takeoff Means	Airdrop/Truck Launch	Landing Means	Parafoil
Sensor	Configurable	Sensor Make	n/a

### 2.3.6 Onyx Autonomously Guided Parafoil System

**User Service:** Army (USSOCOM)

**Manufacturer:** Atair Aerospace, Inc.

**Inventory:** 5 Delivered/5 Planned

**Background:** Onyx is an autonomously guided parafoil system developed by the U.S. Army Natick Soldier Center (NSC). Onyx systems are air-deployed from a C-130, C-141, or C-17 at up to 35,000 ft., autonomously glide over 30 miles, and land cargo within 150 ft. of a target. Cargo for ground and special operations forces includes food and water, medical supplies, fuel, munitions and other critical battlefield payloads. Onyx includes advanced capabilities such as flocking (formation flying), active collision avoidance, and adaptive control (self-learning functions). With this technology, multiple systems (50+) can be deployed in the same airspace, guiding payloads to one, or multiple targets without possibility of midair collisions. Smaller versions have been developed to precisely deliver sensors or submunitions.



**Characteristics:**

	Onyx		Onyx
Length	45 ft	Wing Span	38 ft
Gross Weight	2,300 lb	Payload Capacity	2,200 lb
Fuel Capacity	N/A	Fuel Type	N/A
Engine Make	N/A	Power	N/A

**Performance:**

Endurance	Varies	Max/Loiter Speeds	0/70 kt
Ceiling	35,000 ft	Radius	30 nm
Takeoff Means	Airdrop	Landing Means	Parafoil

2.4 SMALL UAS

2.4.1 Mini UA

	Dragon Eye	FPASS	Pointer	Raven	BUSTER
Manufacturer	AeroVironment	Lockheed Martin	AeroVironment	AeroVironment	Mission Technologies, Inc.
User Service	Marine Corps	Air Force	SOCOM, AF	Army, SOCOM, AF	Night Vision Labs, US Army
Weight	4.5 lb	7 lb	8.3 lb	4 lb	10 lb
Length	2.4 ft	2.7 ft	6 ft	3.4 ft	41 inches
Wingspan	3.8 ft	4.3 ft	9 ft	4.3 ft	49.5 inches
Payload Capacity	1 lb	1 lb	1 lb	2 lb	3.0 lb
Engine Type	Battery	Battery	Battery	Battery	Gasoline/JP-5& JP-8
Ceiling	1,000 ft	1,000 ft	1,000 ft	1,000 ft	10,000 ft
Radius	2.5 nm	6 nm	6 nm	6 nm	10 km
Endurance	45-60 min	1 hr	2 hr	1.5 hr	4 + hr
Number Planned	467 systems*	21 systems	50 systems	300+ systems	9 systems
Number of UA/System	3	6	2	3	4

\* Does not include 4 Dragon Eye, 6 Swift, and 15 Evolution systems (58 UA total) for SOCOM.

**Dragon Eye**

**Background:** Dragon Eye fulfills the first tier of the Marine Corps UA Roadmap by providing the company/platoon/squad level with an organic RSTA capability out to 10 km (5 nm). The first prototype flew in May 2000, with low rate production contracts (40 aircraft) awarded to AeroVironment and BAI Aerosystems in July 2001. In March 2003 the Marine Corps awarded a production contract to AeroVironment following a user operational assessment. IOC has been completed. A total of 467 systems, each with three aircraft and one ground station, are planned. The Dragon Eye program has resulted in several other UA development activities. Swift is a system derived from a Dragon Eye UA and a Raven GCS, Evolution an export version by BAI, and Sea-All an ONR initiative.



<http://www.mcwl.quantico.usmc.mil/factsheets/Dragon%20Eye%20Improvements.pdf>.

**Force Protection Aerial Surveillance System (FPASS)**



**Background:** FPASS is designed for ease of use by Air Force security personnel to improve situational awareness of the force protection battlespace by conducting area surveillance, patrolling base perimeters and runway approach/departure paths, and performing convoy over watch. The Air Force Electronic Systems Center developed FPASS to address a 1999 U.S. Central Command (CENTCOM) request for enhancing security at overseas bases. CENTAF refers to the FPASS vehicle as Desert Hawk. Each system consists of six aircraft and a laptop control station. Delivery of initial systems began in July 2002.

***FQM-151 Pointer***

**Background:** Approximately 100 hand-launched, battery powered FQM-151/Pointers have been acquired by the Marines, Army, and Air Force since 1989 and were employed in the Gulf War and are currently used in OEF and OIF. USSOCOM acquired 60 systems (2 aircraft each) and is using them in both Afghanistan and Iraq. Pointers have served as testbeds for numerous miniaturized sensors (e.g., uncooled IR cameras and chemical agent detectors) and have operated with the Drug Enforcement Agency and National Guard. Some 50 systems remain.



***Raven***

**Background:** AeroVironment reengineered the Pointer to take advantage of advances in battery and electric motor technologies. The result, Raven, is two-thirds the size and weight of the backpackable Pointer. Introduced into Iraq for “over the hill” and route reconnaissance, Raven requires minimal operator skills and maintenance. The Army is buying 185 three-aircraft systems, specifically for OEF/OIF, the Air Force 41 two-aircraft systems, and SOCOM 70 three-aircraft systems.

***BUSTER***

**Background:** BUSTER is a UAS on contract with the U.S. Army Night Vision Laboratories, Fort Belvoir, VA. The Night Vision Lab is using BUSTER as a testbed for sensors. Nine systems are being delivered through the remainder of this year. Other contracts in being are with the United Kingdoms Ministry of Defense JUEP/JUET program with BUSTER training being conducted for the Royal Artillery, the Royal Air Force and the Special Operating Forces.





	Silver Fox	ScanEagle	Aerosonde	BATCAM
Manufacturer	Advanced Ceramics	Insitu Group/Boeing	Aerosonde/Lockheed Martin	ARA
User Service	Navy	Marine Corps	Navy	SOCOM
Weight	20 lb	39.6 lb	33 lb	0.84 lb
Length	4.8 ft	3.9 ft	5.7 ft	24 in
Wingspan	7.8 ft	10 ft	9.4 ft	21 in
Payload Capacity	5 lb	5-7 lb	12 lb	0.09 lb
Engine Type	Diesel/Gasoline	Gasoline	Gasoline	Battery
Ceiling	16,000 ft	19,000 ft	20,000 ft	1,000 ft
Radius	20 nm	60 nm	1,000 nm	1.6 nm
Endurance	10 hr	20 hr	30 hr	18 min
Number Planned	20-30 systems	2 systems (lease)	1 system	23 systems
Number UA/System	3	8	5-8	2



**Silver Fox**

**Background:** Silver Fox is a modular UA capable of running on either MOGAS or JP fuel. The Office of Naval Research is testing its utility for ship security and harbor patrol. It has demonstrated an endurance of 8 hours and is attempting to control four airborne aircraft simultaneously. Canada’s armed forces are acquiring a system for joint evaluation.

**ScanEagle**

**Background:** ScanEagle is a long endurance, low cost UA. It recently supported JFCOM’s Forward Look exercises, and two systems of eight aircraft each deployed to Iraq to provide force protection for the 1<sup>st</sup> Marine Expeditionary Force (I MEF). ScanEagle carries an inertially stabilized camera turret for both EO/IR imagery. Its sensor data links have integrated Cursor on Target (CoT) capability, allowing it to be interoperable with other legacy systems and enabling the operator to integrate operations with larger, high-value UA such as Predator through the ground control station. Its Skyhook (near-vertical recovery system) and pneumatic catapult launcher allow operations from ships or from remote, unimproved areas. ScanEagle’s longest endurance flight aloft is 20.1 hours. A planned version will feature improved endurance of over 30 hours.



**Aerosonde**

**Background:** Aerosonde is a very long endurance, low cost UAS. Aerosonde can carry a family of compact payloads including TV cameras, IR cameras, ESM, and jammer electronics. Aerosonde is currently operating at NASA’s Wallops Island Flight Facility, at an arctic facility in Barrow, Alaska, and at two locations in Australia. The Office of Naval Research has purchased several aircraft along with services for instrument/payload development. Aerosonde has also been selected for the USAF Weather Scout Foreign Cooperative Test.



**BATCAM**

**Background:** The Battlefield Air Targeting Camera Micro Air Vehicle (BATCAM) is the result of a Secretary of the Air Force (SECAF) acquisition initiative. The program used very rapid prototyping and field testing, in multiple spirals, with heavy warfighter involvement. First flown in 2003, the BATCAM will be a recoverable/atritable asset for the AFSOC Special Operators and Air Force Battlefield Airmen. The BATCAM will provide the ability to covertly navigate, reconnoiter, and target objectives, ultimately enhancing situational awareness, reducing fratricide, increasing survivability, and mission success rates.

**2.4.2 Micro Air Vehicles (MAV)**

*MAV/Wasp/Hornet*

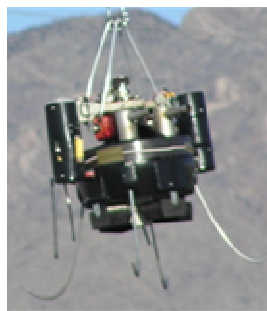

**MAV**

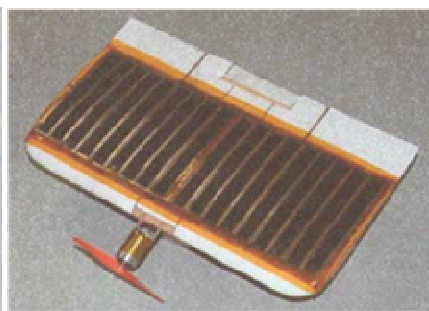

**Hornet**



**Wasp**

**Performance**

	MAV	Hornet	Wasp
Manufacturer	Honeywell	AeroVironment	AeroVironment
Sponsor	DARPA/Army	DARPA	DARPA
Weight	15 lb	0.4 lb	0.4 lb
Length	15 in	7 in	8 in
Wingspan	13 in duct diameter	15 in	13 in
Payload	2 lb	0.1 lb	0.1 lb
Engine Type	Heavy Fuel Piston	Fuel Cell	Battery
Ceiling	10,500 ft		1,200 ft
Radius	~6 nm		5 nm
Endurance	~40 min		60 min

**Background** DARPA and the Army are exploring designs for MAV. The MAV is focused on a small system suitable for backpack deployment and single-man operation. Honeywell was awarded an agreement to develop and demonstrate the MAV as part of the MAV ACTD, which pushes the envelope in small, lightweight propulsion, sensing, and communication technologies. Following its military utility assessment (MUA) in FY05-06, 25 MAV systems are to transfer to the Army in FY07.

[www.darpa.mil/tto/programs/mavact.html](http://www.darpa.mil/tto/programs/mavact.html)

DARPA’s Synthetic Multifunctional Materials program, has developed a 6-ounce MAV, the AeroVironment Wasp, having an integrated wing-and-battery which has flown for 1.8 hours. The current

Wasp variant has flown at sea level and at 5,000 feet and 105° F, and is capable of several hands-free, autonomous flight modes, including GPS waypoint navigation, loiter, altitude and heading hold. It carries fixed, forward- and side-looking color daylight cameras with real time video downlink, and uses the same ground control unit as Raven. The Wasp MAV has been selected for Disruptive Technology Opportunity Fund (DTOF) by the Navy to a) establish a preproduction capability for hardened, autonomous, hands-free operation vehicles at a cost goal of \$5,000 per vehicle; b) assess operational utility; and c) engage in user-driven demonstrations and utility assessments. Prototype Wasp vehicles have flown off the USS PHILLIPINE SEA in theatre in early FY04. Spiral 1 Wasp vehicles are currently (FY05) in user evaluations with the US Navy's STRIKE GROUP 11 and a number of Wasp systems are planned for field evaluation by the Marine Corps in late FY05 and early FY06.

Key new technology development objectives for future Wasp variants include the development of 1) conformal, un-cooled IR detector arrays that can be incorporated into the wing of the aircraft to provide a low aerodynamic drag at minimum weight and power requirements; 2) an optic flow collision avoidance and navigation system for use in GPS-denied environments and urban canyons; and 3) transition to digital protocols for up- and downlink communications.

AeroVironment's Hornet became the first UA totally powered by hydrogen fuel when it flew in March 2003. Its fuel cell is shaped to also serve as the wing.

**2.4.3 Organic Air Vehicle – II**



**Aurora Concept**

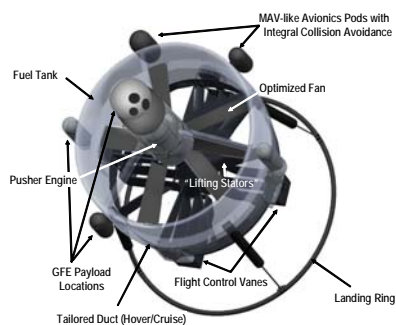

**Honeywell Concept**



**BAE Concept**

Manufacturer	Aurora Flight Sciences, BAE Systems, Honeywell
Sponsor	DARPA/ Army
Weight	112 lb dry
Length	TBD inches
Duct Dia	20-36 inches
Payload	22 lb
Engine Type	Heavy Fuel - Cycle type TBD
Ceiling	11,000 ft *
Radius	~10* nm
Endurance	120* min
* Design requirement; not yet demonstrated.	

**Background:** DARPA and the Army have been exploring scalable designs for an organic air vehicle (OAV) since FY02. DARPA recently began a follow-on to the original OAV program. The new program is called OAV-II. The OAV-II is aimed at a larger system transported aboard one of the FCS ground vehicles. Aurora Flight Sciences, BAE Systems and Honeywell were awarded contracts for Phase I of a competitive program to develop and demonstrate a prototype FCS Class II UA using only ducted fan technology for achieving hover and stare capability. The OAV is envisioned as an UA that can be

## UAS ROADMAP 2005

---

launched and controlled from a high-mobility multipurpose wheeled vehicle (HMMWV) or robotic vehicle to provide over-the-hill RSTA. The OAV-II program is closely coupled to the Army Science and Technology Objective (STO) that is being conducted by the U.S. Army CECOM, Night Vision and Electronic Systems Directorate (NVESD) for development of a RSTA mission equipment package (MEP) for the Class II UA. In Phase III of the OAV-II program the Class II MEP will be integrated with the DARPA-developed UA. The combined system will be used to demonstrate Class II RTSA and target designation capabilities in early FY09. [http://www.darpa.mil/tto/programs/fcs\\_oav.html](http://www.darpa.mil/tto/programs/fcs_oav.html).



**2.5 UNMANNED AIRSHIPS**

A number of unmanned airship projects, both free-flying and tethered (aerostats), have been initiated to provide synergistic capabilities to those provided by unmanned aircraft, most notably extended persistence. Such airships are capable of endurance ranging from 5 days (RAID) to a month (JLENS) and primarily provide local area surveillance for defensive roles, such as force protection and cruise missile detection. A number of aerostats are now employed in the force protection role in Iraq and Afghanistan. Psychological operations (TARS) and border monitoring (TARS) are other niche roles in which they can complement aircraft. There appears to be potential for synergy between airships and UAS that enhance capability or reduce cost in several mission applications including force protection, signals intelligence collection, communications relay and navigation enhancement. Airships most significant challenge appears to be limited mobility.

**2.5.1 Advanced Airship Flying Laboratory**

**User Service:** Navy

**Manufacturer:** American Blimp Corporation

**Inventory:** 0 Delivered/1 Planned



**Background:** The Advanced Airship Flying Laboratory (AAFL) will serve as a prototype test bed for improving the state-of-the-art of airship systems technologies, ISR sensors, related processors, and communications networks. The initial airship systems to be developed and tested will be bow thrusters for slow speed control authority to reduce ground crew requirements; heavy fuel engines to increase efficiency, safety, and military operations interoperability; and automated flight controls to increase payload, altitude, and reduce flight operations costs. AAFL will be equipped with dedicated hard points, equipment racks, high bandwidth network interfaces, and 5 kW of power for rapid integration to test a great variety of Network Centric Warfare payload options from a persistent ISR platform.

**Characteristics:**

	AAFL		AAFL
Length	200 ft	Tail Span	55 ft
Volume	275,000 ft <sup>3</sup>	Payload Capacity	1,000 lb

**Performance:**

Endurance	48 hr	Altitude	20,000 ft
Sensor	Various	Sensor Make	TBD

### 2.5.2 Tethered Aerostat Radar System (TARS)

**User Service:** Air Force

**Manufacturer:** ILC Dover

**Inventory:** 10 Delivered/10 Planned

**Background:** TARS primary mission is to provide low level radar surveillance data in support of federal agencies involved in the nation’s drug interdiction program. Its secondary mission is to provide North America Aerospace Defense Command with low level surveillance coverage for air sovereignty in the Florida Straights. One aerostat, located at Cudjoe Key, FL, transmits TV Marti, which sends American television signals to Cuba for the Office of Cuba broadcasting. All radar data is transmitted to a ground station, then digitized and fed to the various users. Airborne time is generally limited by the weather to 60 percent operational availability; notwithstanding weather, aerostat and equipment availability averages more than 98 percent system wide. For security and safety reasons, the air space around USAF aerostat sites is restricted for a radius of at least two to three statute miles and an altitude up to 15,000 feet. <http://www2.acc.af.mil/library/factsheets/tars.html>.



**Characteristics:**

	TARS		TARS
Length	208 ft	Tail Span	100 ft
Volume	275,000/420,000 ft <sup>3</sup>	Payload Capacity	1,200 lb

**Performance:**

Endurance	10/30 days	Altitude	12,000-15,000 ft
Sensor	Radar	Sensor Make	AN/TPS-63

### 2.5.3 Joint Land Attack Elevated Netted Sensor (JLENS)

**User Service:** Joint (Army Lead)

**Manufacturer:** Raytheon/TCOM

**Inventory:** 12 Planned

**Background:** JLENS is primarily intended to tackle the growing threat of cruise missiles to U.S. forces deployed abroad with radars to provide over-the-horizon surveillance. A JLENS system consists of two aerostats, one containing a surveillance radar (SuR) and one containing a precision track illumination radar (PTIR). Each aerostat is tethered to a mobile mooring station and attached to a processing station via a fiber optic/power tether. The SuR provides the initial target detection and then cueing to the PTIR, which generates a fire control quality track. The JLENS system is integrated into the joint tactical architecture via Link 16, cooperative engagement capability, single-channel ground and air radio system, and enhanced position location reporting system. Both radar systems will include identification, friend or foe interrogators.



**Characteristics:**

	JLENS		JLENS
Length	233 ft	Tail Span	75 ft
Volume	590,000 ft <sup>3</sup>	Payload Capacity	5,000 lb

**Performance:**

Endurance	30 days	Altitude	10-15,000 ft
Sensor	Radar	Sensor Make	Jaspor

### 2.5.4 Rapid Aerostat Initial Deployment (RAID)

**User Service:** Army

**Manufacturer:** Raytheon/TCOM

**Inventory:** 3 Delivered/3 Planned

**Background:** The Army initiated RAID to support Operation ENDURING FREEDOM (OEF). The tethered RAID aerostat was a smaller version of the JLENS platform, operating at an altitude of 1,000 feet and with a coverage footprint extending for several kilometers. In Afghanistan, the RAID aerostat is performing the missions of area surveillance and force protection against small arms, mortar and rocket attacks. Although considerably smaller than the JLENS platform, and performing missions secondary to those of missile detection and early warning, the RAID experience in Afghanistan represents a valuable learning opportunity that should be useful to future tactical users of the JLENS.



**Characteristics:**

	RAID		RAID
Length	49 ft	Tail Span	21 ft
Volume	10,200 ft <sup>3</sup>	Payload Capacity	200 lb

**Performance:**

Endurance	5 days	Altitude	900+ ft
Sensor	EO/IR	Sensor Make	FSI Safire III

### 2.5.5 Rapidly Elevated Aerostat Platform (REAP)

**User Service:** Army

**Manufacturer:** Lockheed Martin/ISL-Bosch Aerospace

**Inventory:** 2 Delivered/2 Planned

**Background:** REAP was jointly developed by the Navy's Office of Naval Research and the Army's Material Command for use in Iraq. This 31-foot long aerostat is much smaller than the TARS, and operates at only 300 feet above the battlefield. It is designed for rapid deployment (approximately 5 minutes) from the back of a HMMWV and carries daytime and night vision cameras. Its sensors can see out to 18 nm from 300 feet. REAP deployed to Iraq in December 2003.



**Characteristics:**

	REAP		REAP
Length	31 ft	Tail Span	17 ft
Volume	2,600 ft <sup>3</sup>	Payload Capacity	35 lb

**Performance:**

Endurance	10 days	Altitude	300 ft
Sensor	EO	Sensor Make	ISL Mark 1
	IR		Raytheon IR 250

### 2.5.6 High Altitude Airship (HAA)

**User Service:** Army

**Manufacturer:** Lockheed Martin

**Inventory:** 0 Delivered/10-12 Planned

**Background:** HAA is sponsored by the North American Aerospace Defense Command with the U.S. Army as the lead service and the Missile Defense Agency as the executing agent/technical manager. The objective of this ACTD is to demonstrate the engineering feasibility and potential military utility of an unmanned, untethered, solar powered airship that can fly at 65,000 feet. The prototype airship developed under this effort will be capable of continuous flight for up to a month while carrying a multi-mission payload. This ACTD is intended as a developmental step toward an objective HAA that can self-deploy from CONUS to worldwide locations and remain on station in a geo-stationary position for a year or more before returning to a fixed launch and recovery area in CONUS for servicing. This ACTD is currently under review due to technical challenges with the airship fabric. Disposition should be resolved during FY05. <http://www.smdc.army.mil/FactSheets/HAA.pdf>.



The prototype airship developed under this effort will be capable of continuous flight for up to a month while carrying a multi-mission payload. This ACTD is intended as a developmental step toward an objective HAA that can self-deploy from CONUS to worldwide locations and remain on station in a geo-stationary position for a year or more before returning to a fixed launch and recovery area in CONUS for servicing. This ACTD is currently under review due to technical challenges with the airship fabric. Disposition should be resolved during FY05. <http://www.smdc.army.mil/FactSheets/HAA.pdf>.

**Characteristics:**

	HAA		HAA
Length	500 ft	Tail Span	150 ft
Volume	5,000,000 ft <sup>3</sup>	Payload Capacity	4,000 lb

**Performance:**

Endurance	30 days	Altitude	65,000 ft
Sensor	TBD	Sensor Make	TBD

### 2.5.7 Near Space Maneuvering Vehicle (NSMV)/Ascender/V-Airship

**User Service:** Air Force

**Manufacturer:** JP Aerospace

**Inventory:** 1 Delivered/1 Planned

**Background:** The Air Force plans to test the V-shaped Ascender, manufactured by JP Aerospace (Sacramento, CA), under contract to Scitor Corporation (Sunnyvale, CA) in 2005. A smaller, 93-ft model has been successfully tested inside its hangar. The Air Force Space Battlelab plans to fly it to 120,000 feet with a 100-lb payload and loiter for 5 days at a distance of 200 nm. Although Ascender uses lightweight carbon-fiber propellers to generate thrust, it also has a unique system that transfers helium between its two chambers to provide additional maneuverability by shifting its center of gravity and adjusting trim. The NMSV is intended to carry ISR, communications relay, and other mission loads for extended periods of time. Canceled in November 2004



Although Ascender uses lightweight carbon-fiber propellers to generate thrust, it also has a unique system that transfers helium between its two chambers to provide additional maneuverability by shifting its center of gravity and adjusting trim. The NMSV is intended to carry ISR, communications relay, and other mission loads for extended periods of time. Canceled in November 2004

**Characteristics:**

	NSMV		NSMV
Length	175 ft	Tail Span	126.5 ft
Volume	290,000 ft <sup>3</sup>	Payload Capacity	100 lb

**Performance:**

Endurance	5 days	Altitude	120,000 ft
Sensor	IRS; Communication Relay	Sensor Make	TBD



### 2.5.8 Marine Airborne Re-Transmission System (MARTS)

**User Service:** Marine Corps  
**Manufacturer:** SAIC/TCOM LP  
**Inventory:** 1 Delivered/6 Planned



**Background:** The DARPA/Marine Airborne Re-Transmitter System (MARTS) program developed a tethered aerostat communications relay in response to an USMC Urgent Need Statement for a secure, reliable, over-the-horizon relay of USMC VHF/UHF PRC 117 (SINCGARS/HAVE QUICK), 119 and 113 radio links, as well as EPLRS. MARTS will provide 24/7 connectivity within a radius of 68 nm. It is designed to continue operations despite punctures created by small arms fire, as well as in windy conditions up to 50+kts and be able to survive lightning strikes. MARTS is easily maintained because all complex radios and power supplies are located on the ground; the aerostat payload contains only simple, highly reliable transponders with a fiber optic cable to the ground equipment. The aerostat only needs a gas boost every fifteen days (15), minimizing its exposure to hostile forces.

**Characteristics:**

	MARTS		MARTS
Length	105 ft	Trail Span	75 ft
Volume	63,000 ft <sup>3</sup>	Payload Capacity	500 lb

**Performance:**

Endurance	15 Days	Altitude	3,000 ft
Sensors	VHF/UHF Radios	Sensor Make	PRC 113, 117, 119, EPLRS

## 2.6 UAS PROGRAMMATIC DATA

Between 1990 and 1999, DoD invested over \$3 billion in UAS development, procurement, and operations (see Table 2.6-1). In the wake of September 11, 2001, FY03 was the first billion-dollar year in UAS history and FY05 will be the first two billion-dollar year (see Figure 2.6-1 and Tables 2.6-2 and 2.6-3). The U.S. UAS inventory is expected to grow from 250 today to 675 by 2010 and 1400 by 2015 (not including micro and mini UA) and to support a wider range of missions—e.g. signals intelligence (SIGINT), cargo, communication relay, and Suppression of Enemy Air Defenses (SEAD)—compared to today’s imagery reconnaissance and strike roles.

**TABLE 2.6-1. SUMMARY STATUS OF RECENT UAS PROGRAMS.**

System	Manufacturer	Lead Service	First Flight	IOC	Aircraft Built	Aircraft Fielded	Status
MQ-1/Predator	General Atomics	Air Force	1994	2005	100+	60	100+ ordered
RQ-2/Pioneer	Pioneer UAV, Inc.	Marine Corps	1985	1986	175	35	Sustainment through FY13
RQ-3/DarkStar	Lockheed Martin	Air Force	1996	n/a	3	0	Cancelled '99
RQ-4/G'Hawk	Northrop Grumman	Air Force	1998	2006	10	7	51 planned
RQ-4/G'Hawk	Northrop Grumman	Navy	2004	n/a	2	2	2 planned
RQ-5/Hunter	Northrop Grumman	Army	1991	n/a	72	35	18 on order
RQ-6/Outrider	Alliant Techsystems	Army	1997	n/a	19	0	Cancelled '99
RQ-7/Shadow200	AAI	Army	1991	2003	100+	90	164 planned
RQ-8/Fire Scout	Northrop Grumman	Navy	1999	2007	5	0	168 planned
MQ-9/Predator B	General Atomics	Air Force	2001	TBD	5	0	63 planned
CQ-10/Snow Goose	MMIST	Army	2002	2005	10	0	49 planned

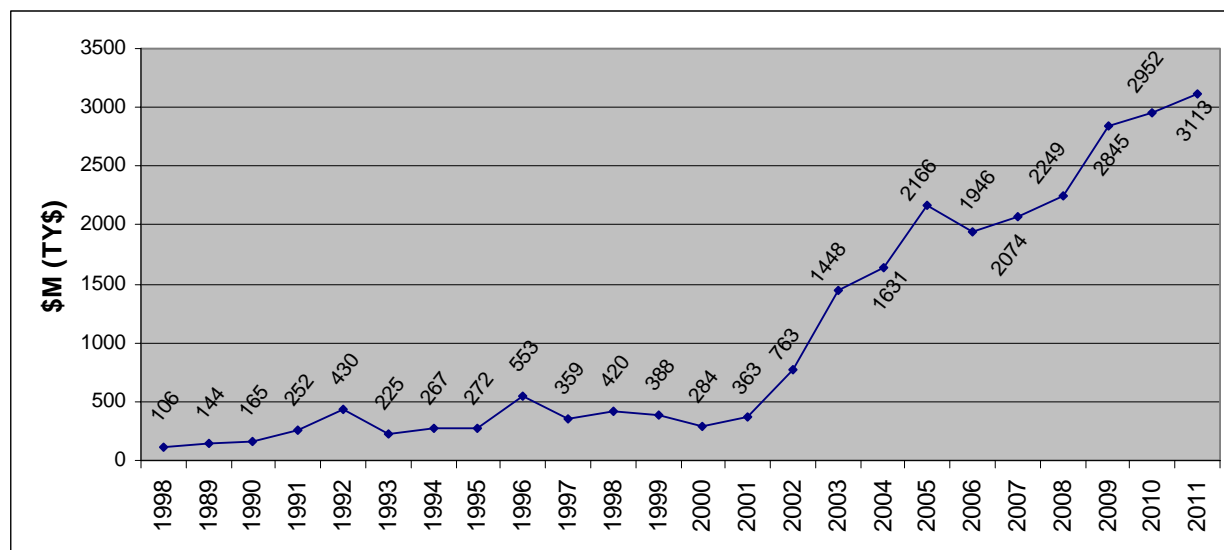

**FIGURE 2.6-1. DoD ANNUAL FUNDING PROFILE FOR UAS.**

## UAS ROADMAP 2005

**TABLE 2.6-2. FY06 PRESIDENT'S BUDGET REQUEST FOR UAS RDT&E AND PROCUREMENT (\$M)\*.**

UAS Program FY06PB (\$M)	FY05	FY06	FY07	FY08	FY09	FY10	FY11	Total
Dragon Eye	8.9	20.3	17.7	13.7	17.4	7.2	6.8	92.0
Predator (Air Force)	288.5	216.9	131.4	143.2	218.7	224.1	226.9	1,449.7
Global Hawk (Air Force)	687.6	706.2	719.1	746.1	762.8	682.0	674.5	4,978.3
Shadow (Army)	114.5	49.3	48.9	50.4	107.6	134.4	35.4	540.5
ER/MP (Army)	0.0	113.7	134.0	151.3	222.2	233.5	183.0	1,037.7
FCS (All UA Classes) (Army)	147.3	105.3	114.0	88.0	75.8	50.4	33.6	614.4
Pioneer (USMC)	8.7	2.0	2.0	2.0	2.1	0.0	0.0	16.7
Fire Scout/VTUA (Navy)	59.1	77.6	96.7	69.0	70.8	104.1	102.7	580.0
(VUAV)(USMC)	0.0	9.2	21.2	24.1	19.1	0.0	0.0	73.6
BAMS UA (Navy)	85.8	0.0	29.3	121.4	253.4	242.2	444.7	1,176.8
J-UCAS (Air Force)	586.5	350.1	400.1	554.1	780.5	955.2	1,064.1	4,690.6
Small UA (Army)	12.4	20.0	20.4	20.5	20.5	10.7	0.0	104.5
<b>Total</b>	<b>1,998.5</b>	<b>1,670.3</b>	<b>1,734.8</b>	<b>1,983.8</b>	<b>2,550.0</b>	<b>2,643.4</b>	<b>2,771.1</b>	<b>15,354.8</b>

Note: DARPA Unmanned Combat Armed Rotorcraft (UCAR) cancelled in CY2004  
 \*Does not include 2005 supplemental request for OIF, OEF, and Operation UNIFIED ASSISTANCE

**TABLE 2.6-3. FY06 PRESIDENT'S BUDGET FOR UAS OPERATIONS AND MAINTENANCE (\$M)\*.**

UAS Program FY06PB (\$M)	FY05	FY06	FY07	FY08	FY09	FY10	FY11	Total
Predator (Air Force)	71.9	160.4	175.1	103.0	115.1	116.6	119.2	861.3
Pioneer (USMC)	8.7	10.4	7.7	6.7	3.9	9.5	11.2	58.0
Hunter (Army)	27.9	30.0	30.1	29.8	28.1	9.7	1.1	156.7
Global Hawk (Air Force)	20.0	19.5	68.7	71.3	94.3	108.5	113.5	495.7
Shadow (Army)	29.2	36.2	38.0	34.8	34.0	44.3	45.7	262.3
Fire Scout/VTUA (Navy)	0.0	0.0	0.0	TBD	TBD	TBD	TBD	0.0
BAMS UA (Navy)	0.0	0.0	0.0	0.0	0.0	0.0	31.3	31.3
GH Maritime Demo (Navy)	9.6	18.9	19.1	20.0	20.0	20.0	20.0	127.6
<b>Total</b>	<b>167.3</b>	<b>275.4</b>	<b>338.7</b>	<b>265.6</b>	<b>295.4</b>	<b>308.6</b>	<b>342.0</b>	<b>1992.9</b>

\*Does not include 2005 supplemental request for OIF, OEF, and Operation UNIFIED ASSISTANCE

## 2.7 UAS WORLDWIDE GROWTH

### 2.7.1 Foreign UAS Development

Currently, some 32 nations are developing or manufacturing more than 250 models of UA (see Figure 2.7-1); 41 countries operate some 80 types of UA, primarily for reconnaissance. Table 2.7-1 categorizes selected foreign UA and can be used to identify mission capabilities either complementing or not being performed by current U.S. UA. Knowledge of such niches allows U.S. planners to rely on and better integrate the unique capabilities of coalition UA assets in certain contingencies. The one niche common to a number of other countries but missing in the U.S. is a survivable penetrator, for use in high threat environments. France and Germany have employed CL-289s with success in Bosnia and Kosovo, Russia's VR-3 Reys may be succeeded soon by the Tu-300, and Italy's new Mirach 150 supports its corps-level intelligence system. All are essentially jet engines with cameras attached which fly at low altitude at high subsonic speed to increase their survivability.

**TABLE 2.7-1. CLASSES OF WORLDWIDE MILITARY RECONNAISSANCE UAS.**

Country	Tactical		Specialized		Endurance	
	Over-the-Hill	Close Range	Maritime	Penetrating	Medium Rng	Long Rng
United States	Dragon Eye FPASS, Raven	Hunter Shadow	Pioneer <i>Fire Scout</i>	<i>J-UCAS</i>	Predator	Global Hawk
France	Tracker	Crecerelle <i>MCM</i>		CL-289 <i>Neuron</i>	<i>Eagle 1</i> <i>MALE</i>	
Germany	Luna	Brevel	<i>Seamos</i>	CL-289		<i>Eurohawk</i>
United Kingdom		Phoenix <i>Hermes 180</i>		<i>J-UCAS</i>	<i>Hermes 450</i>	
Italy		<i>Mirach 26</i> <i>Falco</i>		Mirach 150 <i>Neuron</i>	Predator	
Israel		Scout/Searcher			Hermes 450 <i>Heron</i>	
Russia		Shmel/Yak-61		VR-3 Reys VR-2 Strizh		

Systems not yet fielded are italicized.

### 2.7.2 Export Policy

The sale of U.S.-manufactured UAS to foreign militaries offers the triple advantages of 1) supporting the U.S. industrial base for UAS, 2) potentially lowering the unit costs of UAS to the Services, and 3) ensuring interoperability by equipping allied forces with mutually compatible systems. Balanced against these advantages, however, are two areas of concern. The first concern is the potential for transfer of critical technology. This is mitigated by export license reviews and establishment of UAS disclosure/reliability policy guidance. The second concern is that an UA capable of carrying a given weight of reconnaissance sensors and data links on a round trip could be modified to carry an equal weight of advanced weapons twice that distance on a one-way mission. As the range, accuracy, and payload capacity of UA have overtaken those of cruise missiles and some ballistic missiles, controlling their proliferation has become a concern. UA fall under the terms of the Missile Technology Control Regime (MTCR), an informal and voluntary political agreement among 33 countries to control the proliferation of unmanned rocket and aerodynamic systems capable of delivering weapons of mass destruction (see Table 2.7-2). MTCR makes no distinction in terms of payload (weaponized vs. non-weaponized). Predator, Predator B, and Global Hawk fall under Category I definitions (vehicles capable of carrying 500 kg of payload to a range of 300 km) of the MTCR and therefore are subject to a strong presumption of denial for export under the existing agreement. The U.S. Defense and State Departments drafted an updated interim policy to the MTCR in late 2001 to allow UA (including J-UCAS) exports to selected countries on a case-by-case basis. The policy was used effectively to facilitate the sale of a non-weaponized Predator system to Italy in 2001.

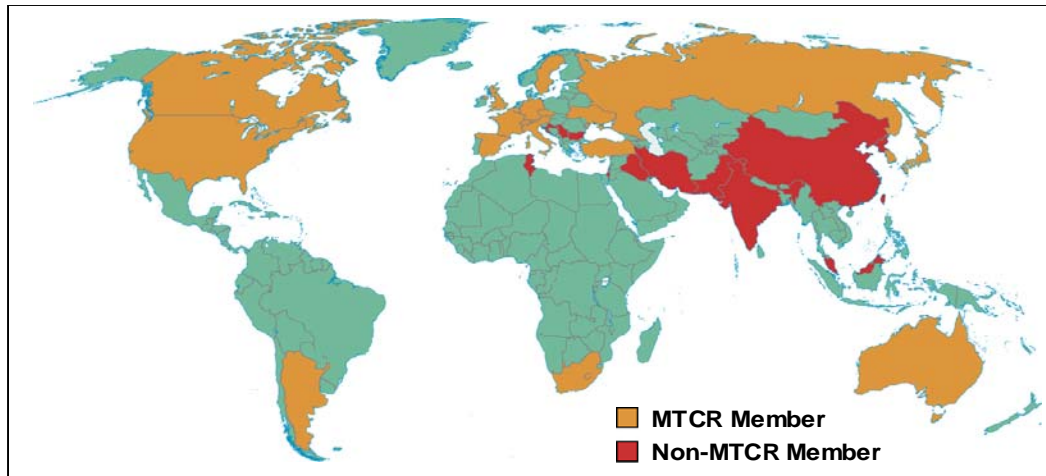

**FIGURE 2.7-1. UAS MANUFACTURING COUNTRIES.**

**TABLE 2.7-2. MTCR MEMBER INTEREST IN UAS.**

MTCR Member*	UA Exporter	UA Operator	UA Manufacturer	UA Developer
Argentina	no	yes	yes	yes
Australia	yes	yes	yes	yes
Austria	yes	no	yes	yes
Belgium	no	yes	yes	yes
Brazil	no	no	no	no
Canada	yes	no	yes	yes
Czech Republic	no	yes	yes	yes
Denmark	no	yes	no	no
Finland	no	yes	no	no
France	yes	yes	yes	yes
Germany	yes	yes	yes	yes
Greece	no	no	no	yes
Hungary	no	no	no	yes
Iceland	no	no	no	no
Ireland	no	no	no	no
Italy	yes	yes	yes	yes
Japan	yes	yes	yes	yes
Luxembourg	no	no	no	no
The Netherlands	no	yes	no	no
New Zealand	no	no	no	no
Norway	no	no	no	yes
Poland	no	no	no	no
Portugal	no	no	no	yes
Russia	yes	yes	yes	yes
South Africa	yes	yes	yes	yes
South Korea	no	yes	yes	yes
Spain	no	no	yes	yes
Sweden	no	yes	yes	yes
Switzerland	yes	yes	yes	yes
Turkey	yes	yes	yes	yes
Ukraine	yes	yes	yes	yes
United Kingdom	yes	yes	yes	yes
United States	yes	yes	yes	yes

\*Although not a member of the MTCR, Israel has pledged to abide by its guidelines.

**3.0 REQUIREMENTS**

Requirements, along with the available systems (Section 2) and the emerging technologies to enable them (Section 4), are the three foundation stones of this Roadmap. The purpose of this Section is to identify current and emerging requirements for military capabilities that could likely be addressed by UA, without presupposing that a needs statement will be written against them. Three sources of these requirements are examined here: 40 years of historical UA use by the Services, the annual Combatant Commanders’ (COCOMs) Integrated Priority Lists (IPLs), and the most recent (August 2004) poll by the Joint Chief of Staff (JCS) of the theaters and the Services of their UA needs.

**3.1 HISTORICALLY VALIDATED UAS ROLES**

How the Services have employed UAS over the past 40 years is not a sure indicator of how UA will be used in the next 25 years, but most of the current UAS programs show a strong correlation with a line of past UAS programs built to fulfill similar requirements. The Services have repeatedly sought to fill five variations of the reconnaissance role with UAS, implying the underlying requirements are of a long-term, enduring validity and therefore can be expected to continue throughout the period of this Roadmap. These five roles, and the succession of UAS, procured or attempted, to fill them, see Table 3.1-1.

**TABLE 3.1-1. HISTORICALLY VALIDATED UAS ROLES.**

<b>UAS Role:</b>	Brigade/division asset for RSTA
Proponent:	Army, Marine Corps
Heritage:	Falconer (1950-60s) – Aquila (1970-80s) – Pioneer (1980-2000s)-Dragon Drone (1990s) – Outrider (1990s) – Shadow 200 (2000s)
<b>UAS Role:</b>	Shipborne asset for reconnaissance and weapon support
Proponent:	Navy
Heritage:	DASH (1960s) – Project Blackfly (1970s) – Pioneer (1980-2000s) – Fire Scout (2000s)
<b>UAS Role:</b>	Small unit asset for over-the-hill reconnaissance
Proponent:	Marine Corps
Heritage:	Bikini (1960s) – Pointer (1980-90s) – Dragon Eye (2000s)
<b>UAS Role:</b>	Survivable asset for strategic penetrating reconnaissance
Proponent:	Army/Air Force/Navy
Heritage:	Osprey (1960s) – D-21 (1960s) – Classified Program (1980s) – DarkStar (1990s) – JUCAS (2000s)
<b>UAS Role:</b>	High altitude endurance asset for standoff reconnaissance
Proponent:	Air Force
Heritage:	Compass Arrow (1960s) – Compass Dwell (1970s) – Compass Cope (1970s) – Condor (1980s) – Global Hawk (1990-2000s)

**3.2 COMBATANT COMMANDER REQUIREMENTS FOR UAS**

Each COCOM annually submits a prioritized IPL of shortfalls in that theater’s warfighting capabilities. IPLs are the seminal source of joint requirements from our nation’s warfighters and possess three essential attributes as requirements sources. They are (1) “direct from the field” in pedigree, (2) joint in perspective, and (3) reexamined annually, so their requirements remain both current and auditable over the years. At SECDEF direction, the latest IPLs (for FY06-11) changed their focus from identifying programmatic challenges to capability gaps and tied these gaps to the five QDR-defined “operational risk” categories (battlespace awareness (BA), command and control (C2), focused logistics (FL), force application (FA), and force protection (FP)).

Of the 50 capability gaps specified in the FY06-11 IPLs, 27 (54 percent) are capabilities that are currently, or could potentially be, addressed by UAS. Four of the 27 shortfalls specifically identified unmanned platforms as a desired solution. Table 3.2-1 depicts where the COCOMs place their priorities (1-8) on these 27 capability gaps that UA, current and potential, could fill. Red are functions UA do

today (e.g., surveillance, force protection) and yellow those that are under development (e.g., communications relay, electronic attack). The figure visually shows that UA have a role to play in the top half of all COCOMs' priorities, including supporting the #1 priority for five of the nine COCOM, plus NORAD. All of the red ones fall in the top three for every COCOM, showing the COCOM's 'appreciation' for what UA are doing for them today. Additional detail can be found at [www.acqs.osd.pentagon.smil.mil/uas/](http://www.acqs.osd.pentagon.smil.mil/uas/).

**TABLE 3.2-1. IPL PRIORITIES FOR UAS-RELATED APPLICATIONS BY COCOM.**

Priority	CENTCOM	EUCOM	JFCOM	NORTHCOM	NORAD	PACOM	SOUTHCOM	SOCOM	STRATCOM	TRANSCOM
1	Red				Red		Red	Yellow	Yellow	
2	Red			Yellow				Red		Red
3		Red	Yellow	Yellow	Yellow	Red		Yellow	Red	Yellow
4	Yellow	Yellow		Yellow		Yellow			Yellow	
5				Yellow		Yellow				
6	Yellow									
7						Yellow				
8						Yellow				

Of the five joint functional categories (JFC) examined in the IPL process, Table 3.2-2 counts the total number of UAS-related IPLs in each. Battlespace awareness shortfalls call for additional surveillance platforms with persistence and multi-capable sensors, such as provided by increased numbers of Global Hawks, Predators, and other endurance UAS. Command and control shortfalls call for increases in tactical communications, such as could be provided by communication relay payloads on endurance UA (e.g., DARPA/Army AJCN). Force application shortfalls call for survivable, quick response, precision strike combined with actionable intelligence, such as the Predator/Hellfire and Predator B/GBU-12 provide and future J-UCAS will provide. Protection shortfalls call for increased base security and CBRNE reconnaissance, for which roles a number of small UAS types are now deployed (Dragon Eye, FPASS, ScanEagle) are being developed.

**TABLE 3.2-2. UAS-RELATED IPL ITEMS BY JOINT FUNCTIONAL CATEGORY.**

Joint Functional Category	Battlespace Awareness	Command & Control	Focused Logistics	Force Application	Force Protection
Number of UA-related IPL items	8	9	0	4	6

**3.3 MISSION REQUIREMENTS RANKED FOR UAS**

In response to a 2004 JCS request, each COCOM and Service was given the opportunity to rank the importance of 18 missions relative to four general classes of UAS, small, tactical, theater, and combat. Their responses were consolidated into a single matrix of rankings, as provided in Table 3.3-1. Reconnaissance is ranked as a higher priority (#1) for combat UA than is the strike mission itself (#3). SOCOM rankings showed little/no divergence from those of the other COCOMs, reversing the trend found in past surveys.

**TABLE 3.3-1. COMBATANT COMMANDER/SERVICE UAS MISSION PRIORITIZATION MATRIX—2004.**

Mission	Small	Tactical	Theater	Combat	JFC
Reconnaissance	1	1	1	1	BA
Signals Intel	10	3	2	5	BA
Mine Detection/CM	7	11	13	14	FP
Precision Target Location and Designation	2	2	3	2	FA
Battle Management	4	10	4	7	C2
Chem/Bio Reconnaissance	3	7	6	9	BA
Counter Cam/Con/Deception	8	5	7	11	BA
Electronic Warfare	14	9	10	4	FP
Combat SAR	6	8	8	10	FA
Communications/Data Relay	5	6	5	8	C2
Information Warfare	15	12	11	6	FA
Digital Mapping	11	13	9	12	BA
Littoral Undersea Warfare	17	15	14	13	FA
SOF Team Resupply	9	16	17	16	FL
Weaponization/Strike	16	4	12	3	FA
GPS Psuedolite	18	18	15	18	C2
Covert Sensor Insertion	12	14	16	15	BA
Decoy/Pathfinder	13	17	18	17	FA

**3.4 MISSION AREAS OPEN TO UAS**

Although EO/IR/SAR sensors have been the predominant payload fielded on DoD UA to date, Table 3.4-1 identifies a number of other payloads that have been previously flown on UA in proof-of-concept demonstrations. These demonstrations show that UA can perform the tasks inherent in most of these 17 mission areas, and therefore be a candidate solution for certain requirements. UA should be the preferred solution over manned counterparts when the requirements involve the familiar three jobs best left to UA: the dull (long dwell), the dirty (sampling for hazardous materials), and the dangerous (extreme exposure to hostile action). Table 3.4-1 is a representative cross section of other payloads that have been demonstrated on UA. It is not meant to be an all inclusive list.



**TABLE 3.4-1. UAS MISSION AREAS.**

Requirements (Mission Areas)	Justification for UA Use			UA Experience
	“Dull”	“Dirty”	“Dangerous”	(UA/Payload, Place Demonstrated, Year)
ISR	x		x	Pioneer, Exdrone, Pointer/Gulf War, 1990-91 Predator, Pioneer/Bosnia, 1995-2000 Hunter, Predator, Pioneer/Kosovo, 1999 Global Hawk, Predator, /Afghanistan, Iraq 2003 – Present Hunter, Pioneer, Shadow/Iraq-2003-Present
C2/Communications	x			Hunter/CRP, 1996; Exdrone/TRSS, 1998 Predator/ACN, 2000
Force Protection	x	x	x	Camcopter, Dragon Drone/Ft Sumner, 1999 FPASS, Dragon Eye, Pointer, Raven, Scan Eagle/Iraq -Present
SIGINT	x		x	Pioneer/SMART, 1995 Hunter/LR-100/COMINT, 1996 Hunter/ORION, 1997 Global Hawk/German Demo, 2003; Iraq, 2004 - Present
Weapons of Mass Destruction (WMD)		x	x	Pioneer/RADIAC/LSCAD/SAWCAD, 1995 Telemaster/Analyte 2000, 1996 Pointer/CADDIE 1998 Hunter/SAFEGUARD, 1999
Theater Air Missile Defense (TAMD)	x		x	Israeli HA-10 development, (canceled) Global Hawk study, 1997
SEAD			x	Hunter/SMART-V, 1996 Hunter/LR-100/IDM, 1998 J-UCAS/TBD
Combat Search and Rescue (CSAR)			x	Exdrone/Woodland Cougar Exercise, 1997 Exdrone/SPUDS, 2000
Mine Counter Measures (MCM)			x	Pioneer/COBRA, 1996 Camcopter/AAMIS, 1999 (Germany)
Meteorology and Oceanography (METOC)	x	x	x	Aerosonde/Visala, 1995 Predator/T-Drop, 1997 Predator/BENVINT ACTD, 2002
Counter Narcotics (CN)	x		x	Predator/Ft Huachuca, 1995 Pioneer/So. California, 1999 Hunter, Shadow/Ft Huachuca, 2003-2004
Psychological Ops			x	Tern/Leaflet Dispensing, 2004
All Weather/Night Strike			x	DASH/Vietnam, 1960s Predator/Afghanistan/Iraq, 2001 Global Hawk/Iraq, 2003
Exercise Support	x			Predator/Joint Operational Test Bed System (JOTBS), 2002
Anti Submarine Warfare	x			DASH, 1960s
Navigation	x			Hunter/GPS Pseudolite, 2000
Table is not all inclusive				

### **3.5 INTEROPERABILITY**

With the growing use of UA systems by the warfighter, the limitations of interoperability between UA systems (and manned systems) and the wider user community at large is becoming apparent. Many UA systems have been developed with limited attention to Joint interoperability requirements. As UA become the predominant collection systems across virtually every echelon of command, the need to coordinate, share, and integrate into the larger warfighting community is becoming painfully apparent. Due in large part to persistence, range, and improving communications capability, UA systems no longer serve a single user or even a single Service. Current combat operations are highlighting deficiencies in several areas including lack of standard communications frequencies and waveforms, lack of standardized sensor products, lack of standardized meta-data for both sensors and platform information, and lack of a common tasking system that crosses the traditional command seams. Additionally there are related issues concerning training, logistics support, airspace integration, and CONOPS that could benefit from greater cross-Service interoperability. Today the highest priorities for improving UA capability in combat operations are:

- Improving tasking and collection efficiencies through a common, Joint use, ISR tasking and collection management capability that integrates tactical and theater level requirements and capabilities.
- Improving UA data dissemination and platform access through the use of common, secure, tactical data-links utilizing less congested spectrum.
- Improving product access and better situational awareness of the current operational picture through improved distribution and networking capabilities
- Improved delivery of critical, time sensitive, actionable data to tactical units through improved mobile, 2-way communications capability and associations CONOPS.
- Improved cross Service, integrated UA and manned CONOPS that provide improved overall collection capability.





## 4.0 TECHNOLOGIES

Unmanned aviation has been the driving or contributing motivation behind many of the key technical innovations in aviation: the autopilot, the inertial navigation system, and data links, to name a few. Although UAS development was hobbled by technology insufficiencies through most of the 20th century, focused efforts in various military projects overcame the basic problems of automatic stabilization, remote control, and autonomous navigation by the 1950s. The last several decades have been spent improving the technologies supporting these capabilities largely through the integration of increasingly capable microprocessors in the flight control and mission management computers flown on UA. By 1989, technology had enabled an UA (DARPA's Condor) to perform fully autonomous flight, from take-off to landing without human intervention. The early part of the 21st century will likely see even more enhancements in UAS as they continue their growth. The ongoing revolution in the biological sciences, together with ever-evolving microprocessor capabilities, are two general technology trends that will impact aviation and enable more capable UAS to appear in the timeframe of this Roadmap. UA technology enablers are discussed in more detail in Appendix D.

Although, DoD continues to strongly invest in researching and developing technologies with the potential to advance the capabilities of UAS, commercial applications now drive many unmanned technologies. Figure 4.0-1 shows the Air Force, Army, and Navy research laboratories investments, along with DARPA's, in UAS-related research and development (R&D) in the FY05-09 President's Budget. Together, the Services fund \$1.662 billion in 79 UAS-related R&D projects, a significant increase over the \$1.241 billion and 60 projects funded in 2000. Appendix D, Table D-1 contains a detailed listing of the projects being funded.

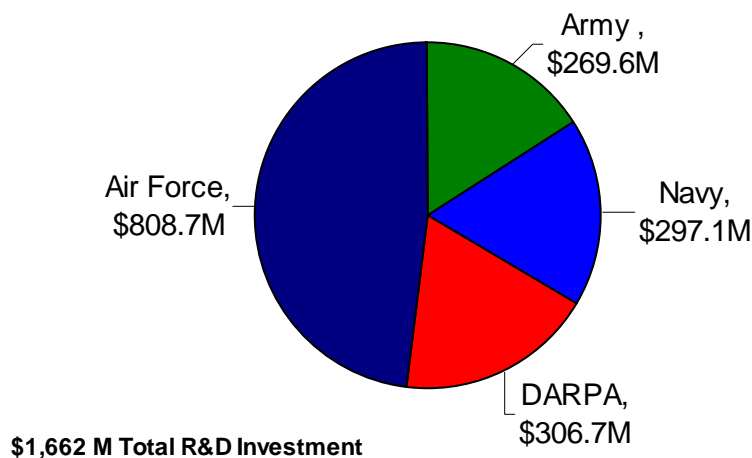
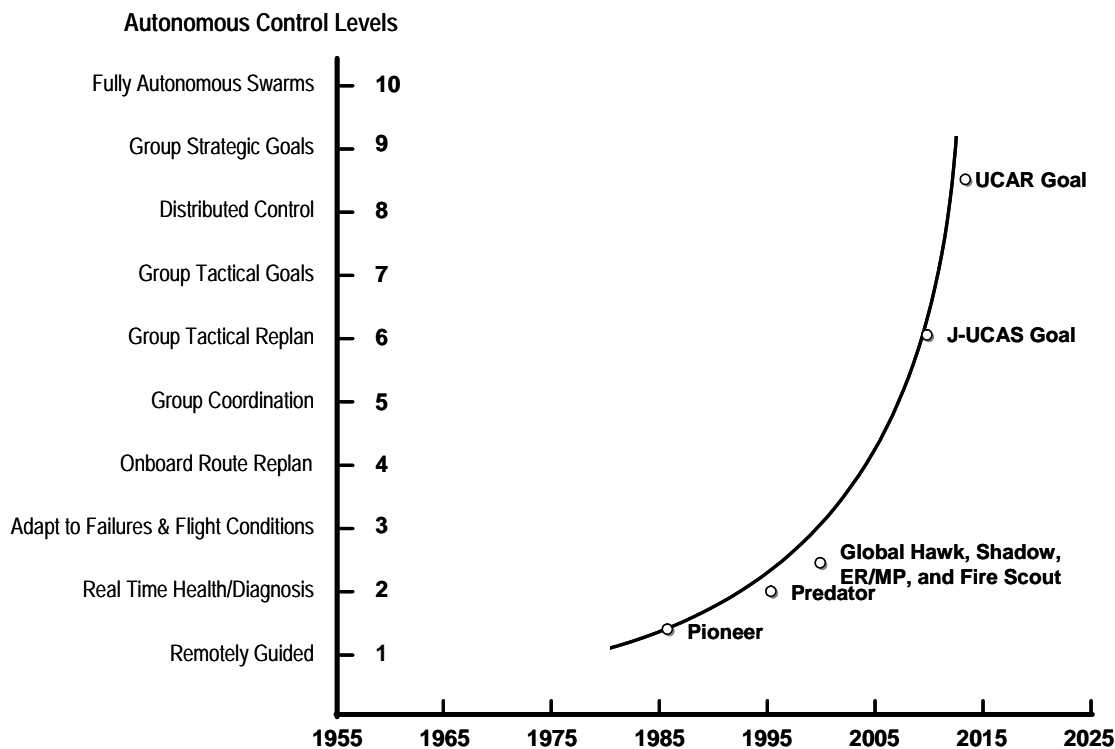

**FIGURE 4.0-1. DOD INVESTMENT IN UAS RESEARCH AND DEVELOPMENT, FY05 - FY09.**

The two basic approaches to implementing unmanned flight, autonomy (illustrated by the RQ-4) and pilot-in-the-loop (illustrated by the MQ-1), rely predominantly on microprocessor and communication (data link) technology, respectively. While both technologies are used to differing levels in all current UA, it is these two technologies that compensate for the absence of an onboard pilot and thus enable unmanned flight. Advances in both are driven today by their commercial markets, the personal computer industry for microprocessors and the banking and wireless communication industries for data protection and compression. This chapter focuses on forecasting trends in these two technologies over the coming 25 years; sections on aircraft and payload advances are included and apply equally to manned aircraft.

As for what constitutes "autonomy" in UA, the directors of the Service research laboratories have adopted an onion-like layered series of capabilities to define this measure of UA sophistication. These definitions run the span from teleoperated and preprogrammed flight by single aircraft to self-actualizing group

flight. Figure 4.0-2 depicts where example UA stand in comparison to their ten levels of autonomy.



**FIGURE 4.0-2. TREND IN UA AUTONOMY.**

#### **4.1 PROCESSOR TECHNOLOGIES**

Although today's processors allow UA to fly entire missions with little or no human intervention, if the ultimate goal is to replace a pilot with a mechanical facsimile of equal or superior thinking speed, memory capacity, and responses (algorithms) gained from training and experience, then processors of human-like speed, memory, and situational adaptability are necessary. Human capabilities are generally agreed to equate to 100 million million-instructions-per-second (MIPS) in speed and 100 million megabytes (MB) in memory. In the 1980s, AFRL attempted to develop a robotic adjunct to a fighter pilot under the Pilot's Associate program, but the available processor technology proved insufficient.

Figures 4.1-1 and 4.1-2 illustrate the progress in processor technology toward human levels of performance that has occurred and that are likely to be seen in the coming 25 years. Both show that today's supercomputers' are within a factor of 10 of achieving human equivalence in speed and capacity and could achieve human parity by the 2015 timeframe. The cost of a supercomputer is however uncompetitive with that of a trained human, but by 2030 the cost of a 100 million MIP processor should approach \$10,000. As for inculcating a fighter pilot's training and experience into a robot brain, the equivalent of Top Gun school for tomorrow's J-UCAS will consist of a post-flight download in seconds.

Today's silicon-based semiconductor processors will be limited to features about 0.1 micron in size, the so-called "point one limit," by current manufacturing techniques based on ultraviolet lithography. Once the limits of silicon semiconductors are reached, presumably in the 2015-2020 period, what are the alternatives for developing more advanced processors? Just as computers have evolved from using vacuum tubes to transistors to integrated circuits of semiconductors over the past 60 years, future ones may progressively use optical, biochemical, quantum interference switching (QIS), and molecular ("moletronics") processors, or some combination of them, to achieve ever faster speeds and larger memories. QIS offers a thousandfold increase in speed and moletronics a potential billionfold increase

over present computers. Ultimately, quantum computing may replace traditional computing based on ones and zeros with using nuclear magnetic resonance to encode the spin of atoms.

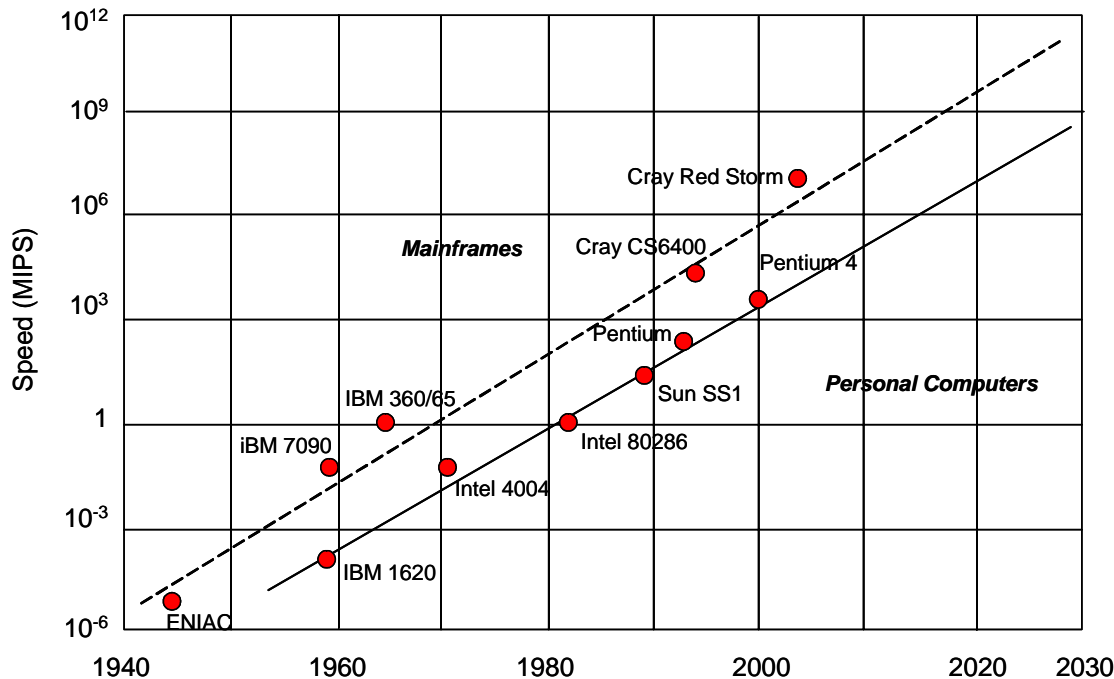

FIGURE 4.1-1. TREND IN PROCESSOR SPEED.

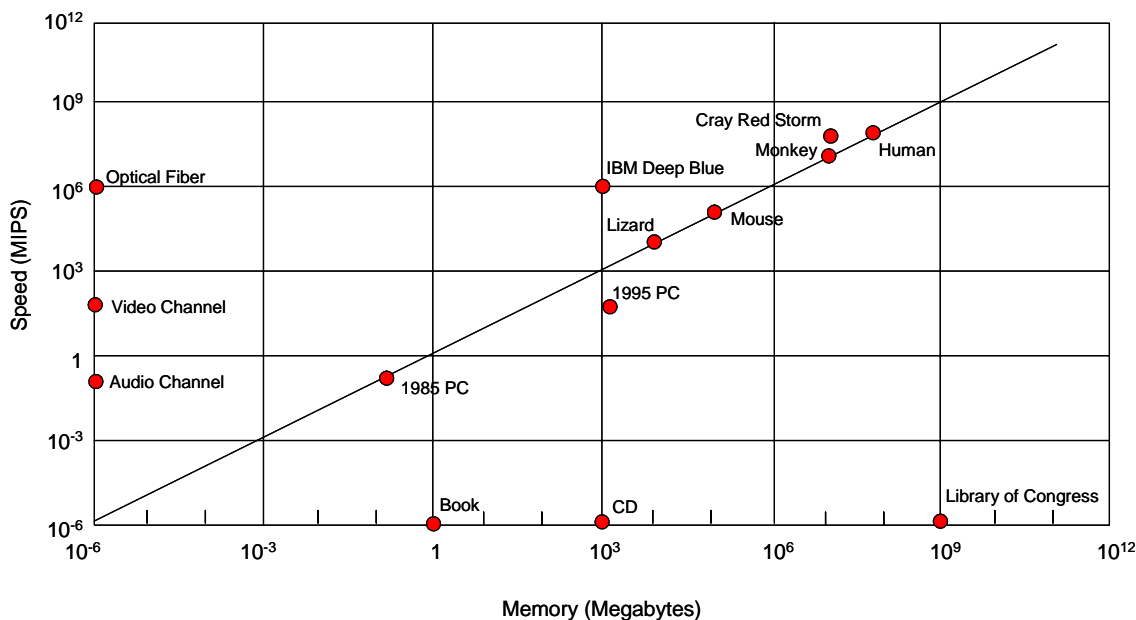

FIGURE 4.1-2. RELATIONSHIP OF PROCESSOR SPEED AND MEMORY.

**Recommended Investment Strategy:** Rely on commercial markets (personal and commercial computers) to drive processor technology. Focus DoD research on radiation-tolerant integrated circuit components and algorithms.

## 4.2 COMMUNICATION TECHNOLOGIES

The principal issue of communications technologies is flexibility, adaptability, and cognitive

controllability of the bandwidth, frequency, and information/data (e.g. differentiated services, separate routing of data based on priority, latency, etc) flows. This means that the systems will be net-centric and that network services like C2, data management and flow control, etc., will have to be integrated into the systems and concepts of operations. In-flight entertainment and finance-based systems will not handle these issues well for military applications. The personal information services providers might provide technology paths forward, but major portions of the government will need to invest in the net-centric solutions required by the U.S. Government. One way of addressing bandwidth and spectrum constraints is by re-using certain communications paths in new ways (e.g. tactical radios used as orderwires for directional links, tightly coupled RF backup links for free space optics (lasercomm), etc.). Communications technologies might be repartitioned to address apertures, RF Front ends, software defined modems/bandwidth efficient waveforms, multiple signals in space, crossbanding, digital interfaces, new communications approaches (e.g. free space optics), and hybrid approaches.

### 4.2.1 Data Links

Airborne data link rates and processor speeds are in a race to enable future UA capabilities. Today, and for the near-term, the paradigm is to relay virtually all airborne data to the ground and process it there for interpretation and decision-making. Eventually, onboard processing power will outstrip data link capabilities and allow UA to relay the *results* of their data to the ground for decision making. At that point, the requirement for data link rates in certain applications, particularly imagery collection, should drop significantly. Meanwhile, data compression will remain relevant as long as band-limited communications exist, but it is unlikely compression algorithms alone will solve the near term throughput requirements of advanced sensors. A technology that intentionally discards information is not the preferred technique. For now, compression is a concession to inadequate bandwidth.

In the case of radio frequency (RF) data links, limited spectrum and the requirement to minimize airborne system size, weight, and power (SWAP) have been strong contributors for limiting data rates. Rates up to 10 Gbps (40 times currently fielded capabilities) are considered possible at current bandwidths by using more bandwidth-efficient modulation methods. At gigahertz frequencies however, RF use becomes increasingly constrained by frequency congestion. This is especially true for the 1-8 GHz range which covers L, S, and C bands. Currently fielded digital data links provide an efficiency varying between 0.92 and 1.5 bps/Hz, where the theoretical maximum is 1.92.

Airborne optical data links, or lasercom, will potentially offer data rates two to five orders of magnitude greater than those of the best future RF systems. However, lasercom data rates have held steady for two decades because their key technical challenge was adequate pointing, acquisition, and tracking (PAT) technology to ensure the laser link was both acquired and maintained. Although mature RF systems are viewed as lower risk, and therefore attract investment dollars more easily, Missile Defense Agency funding in the 1990s allowed a series of increasingly complex demonstrations at Gbps rates. The small apertures (3 to 5 inches) and widespread availability of low power semiconductor lasers explains why lasercom systems typically weigh 30 to 50 percent that of comparable RF systems and consume less power. The smaller apertures also provide for lower signatures, greater security, and provide more jam resistance.

Although lasercom could surpass RF in terms of airborne data transfer rate, RF will continue to dominate at the lower altitudes for some time into the future because of its better all-weather capability. Thus, both RF and optical technology development should continue to progress out to 2025.

### 4.2.2 Network-Centric Communications

There are several areas of networking technology development that should be identified as critical to the migration path of UAS and their ability to provide network services, whether they be transit networking or stub networking platforms. Highflying UAS, such as the Global Hawk or Predator, have the ability to

provide coverage that lends itself well to network backbone and transit networking applications. In order to provide these services, the networked communications capabilities need to migrate to provide capacity, stability, reliability and rich connectivity/interoperability options. The following technologies are essential to this development:

- High Capacity Directional Data links
- High capacity routers with large processing capacity - Ruggedized IP enabled Wideband Routers
- Modular and Programmable Router Architecture
- Well-known and Standardized Protocols and Interfaces
- Mobile Ad-hoc quasi-stable mesh - requirement to manage topology
- Interdependent relationships between the following:
  - Switching/Routing
  - Topology Management
  - QoS – packet level
  - Hierarchical management
- Multiple link interfaces and types per platform
- Gateway functionality on platforms (legacy, disparate networks)
- Embedded INFOSEC/network security
- Performance Enhancing Proxies

While these large stable UAS platforms are ideal for providing theater backbone services, smaller UAS may provide similar networking capability and services on a smaller scale. Additionally, the same networking functions that enable UAS platforms to provide network-centric services to the warfighter also allow the UAS to take advantage of networking to augment their capabilities.

In the future for UAS and networks, the role of autonomy; the definition of team coordination, cooperation, and collaboration concepts; the role of cognitive decision aids; and the importance of air space layer and control are all concepts that need to be developed.

**Recommended Investment Strategy:** Rely on commercial markets (wireless communications, airliner links, finance) to drive link modulation methods technology. Focus DoD research on increasing the power of higher frequency (Ka) SCA waveform components and decrease size, weight, for UAS applications.

### 4.3 PLATFORM TECHNOLOGIES

#### 4.3.1 Airframe

Bioengineers and aerospace engineers may soon be working on common aircraft projects. The need for lighter, stronger aerostructures has led from wood and canvas to aluminum to titanium to composites. The next step may well be transgenic biopolymers. One biopolymer nearing commercialization has twice the tensile strength of steel yet is 25 percent lighter than carbon composites, and it is flexible. In a future aircraft skin made of such a biopolymer, the servo actuators, hydraulics, electric motors, and control rods of today's aircraft control surfaces could be replaced by the ability to warp wings and stabilizers by flexing their skin, much as the Wright brothers first conceived. Signature control would also be enhanced by both the nature of the material and its ability to responsively shape itself to minimize reflection.

Composites have enabled lighter airframes, but the repair of damaged composites is far weaker than the original due to the loss of the material's originally plyed construction, called aeroelastic tailoring. Researchers have recently devised a way to manufacture composite material with embedded microcapsules of "glue," so that any damage will open these capsules and seal the crack before it can propagate. This is known as an autonomic, or self-repairing, material. Further ahead but currently being



researched are materials (isomers) that are self-healing, in which the damaged structure regenerates itself to original condition. Such materials would be of most value in long endurance and strike UA.

**Recommended Investment Strategy:** Explore productionizing autonomic composites in the near term and the feasibility of using transgenetic biopolymers for airframe skins in the far term.

### 4.3.2 Control

The antennas necessary for UA to communicate with their handlers have evolved from dishes or blades to being conformal, and are even today being made of film or sprayed on. Imagine an entire aircraft fuselage and/or wing that functions as an antenna, providing higher gain while eliminating the weight and power draw of present antenna drives. In-flight entertainment systems for airliners are pushing this technology.

Future UA will evolve from being robots operated at a distance to independent robots, able to self-actualize to perform a given task. This autonomy, has many levels emerging by which it is defined, but ultimate autonomy will require capabilities analogous to those of the human brain by future UA mission management computers. To achieve that level, machine processing will have to match that of the human brain in speed, memory, and quality of algorithms, or thinking patterns. Moore's Law predicts the speed of microprocessors will reach parity with the human brain around 2015. Others estimate the memory capacity of a PC will equal that of the human memory closer to 2030. As to when or how many lines of software code equate to "thinking" is still an open question, but it is noteworthy that pattern recognition by software today is generally inferior to that of a human.

Standards based interoperability is another critical area of evolution within the control environment. DoD is adopting this approach to achieving interoperability (through efforts such as NATO Standardization Agreement (STANAG) 4586) that will foster an environment supporting C4ISR support to the warfighter from UAS regardless of manufacturer, UA, or GCS.

As for those UA remaining under human control, the controller will eventually be linked to his remote charge through his own neuromuscular system. Today's ground station vans are already being superseded by wearable harnesses with joysticks and face visors allowing the wearer to "see" through the UA sensor, regardless of where he faces. Vests will soon provide him the tactile sensations "felt" by the UA when it turns or dives or encounters turbulence. Eventually, UA pilots will be wired so that the electrical signals they send to their muscles will translate into instantaneous control inputs to the UA. To paraphrase a popular saying, the future UA pilot will transition from seeing the plane to being the plane.

**Recommended Investment Strategy:** Focus DoD research and development on improved standards, improved man/machine interfaces for UAS, conformal low observable antennae, and advanced UA management systems.

### 4.3.3 Propulsion

Unmanned aircraft already exploit more forms of propulsion than do manned aircraft, from traditional gas turbines and reciprocating engines to batteries and solar power, and are exploring scramjets (X-43), fuel cells (Helios and Hornet), reciprocating chemical muscles, beamed power, and even nuclear isotopes. Technological advances in propulsion that were previously driven by military-sponsored research are now largely driven by commercial interests—fuel cells by the automotive industry, batteries by the computer and cellular industries, and solar cells by the commercial satellite industry. UAS are therefore more likely to rely on COTS or COTS-derivative powerplants than their manned predecessors were; Global Hawk and Dark Star both selected business jet engines in their design. Because endurance ("persistence") is

recognized today as the prime attribute of an UA when compared to manned aircraft, and endurance is determined largely by the efficiency of the powerplant, propulsion is, with processors, one of the two key UA technologies.

Two key propulsion metrics are specific fuel consumption (SFC) for efficiency and specific power (SP) for performance. AFRL's Versatile Affordable Advanced Turbine Engines (VAATE) program aims to achieve a 10 percent decrease in SFC by 2015, while improving thrust-to-weight (T/W) by 50 percent and lowering engine production and maintenance costs. Reciprocating engines for aircraft generally produce 1 hp per pound of engine weight (746 watts/lb), and today's fuel cells are approaching this same level, while lithium-ion batteries have about half this SP (See Figure 4.3-1). Fuel cells in particular are expected to show rapid advancement over the coming decade due their increasing use in hybrid automobiles. Heavy fuel engine (HFE) technology has advanced over the last few decades to the point where replacement with internal combustion engines on tactical UA is now practicable. However, further HFE development investment needs to be made to make their use on small UA practicable. Additional investment also needs to be made in turbine technology for a J-UCAS class engine with a high thrust to weight ratio and low SFC. Specific power trends in propulsion and power technology are forecast in Figure 4.3-1 and Table 4.3-1.

**Recommended Investment Strategy:** Focus DoD research on developing diesel reformers for fuel cell use, enhanced engine durability and time between overhaul, improved specific fuel consumption for enhanced endurance, and alternative propulsive power sources like fuel cells, photovoltaic, and nuclear propulsion systems.

### 4.3.4 Reliability

Aircraft reliability and cost are closely coupled, and unmanned aircraft are widely expected to cost less than their manned counterparts, creating a potential conflict in customer expectations. The expected benefit of lower unit prices may be negated by higher attrition rates due to poorer system reliability. The impact of reliability on UA affordability, availability, and acceptance is described in detail in Appendix H. Figure 4.3-2 illustrates how the mishap rates of larger UA compare to that of representative manned aircraft (F-16 and U-2) after similar numbers of flying hours have been accumulated. Since UA fleets are generally smaller than manned fleets, they have accumulated flying hours at lower rates resulting in slower progress down this curve. As an example, the MQ-1 Predator fleet just reached the 100,000-hour mark in October, 2004, 10 years and 3 months after its first flight, whereas the F-16 reached this same mark in one quarter of that time and the 800,000-hour mark in that same time. However, the Figure shows that the mishap rates of the recent, larger UA track closely with that of the F-16 fleet at a comparable point in its career.

**Recommended Investment Strategy:** See "Recommendations" in Appendix H

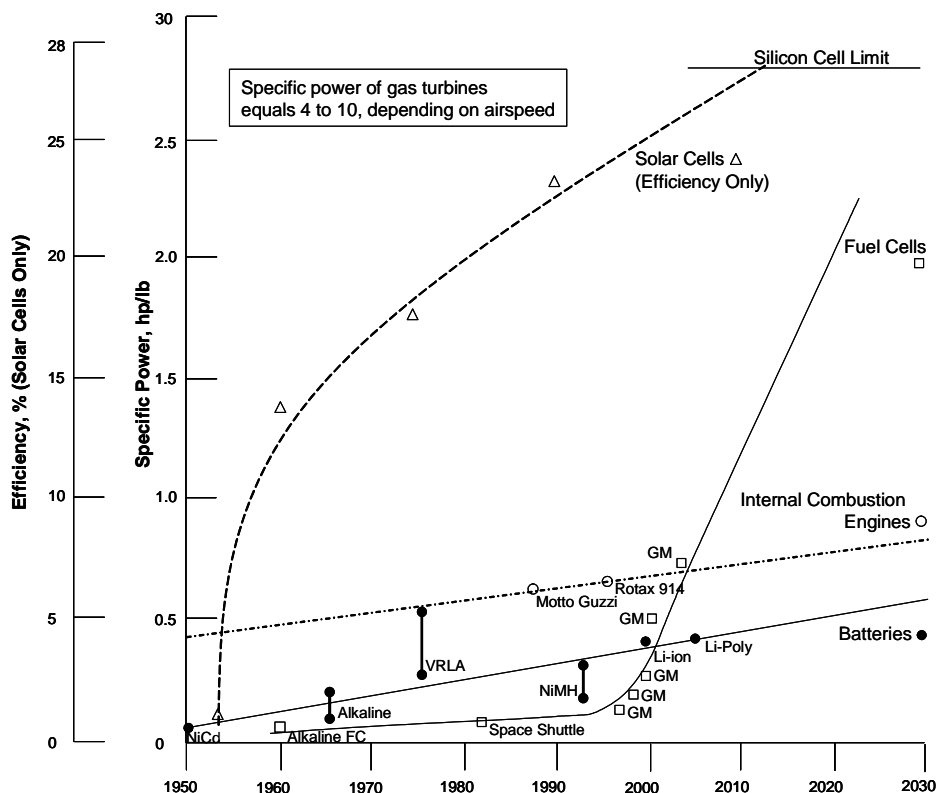

FIGURE 4.3-1. MASS SPECIFIC POWER TRENDS.

TABLE 4.3-1. PROPULSION AND POWER TECHNOLOGY FORECAST.

	Now	2010	2015
Turbine Engine	Turbofan, turboprop, Integrated High Performance Turbine Engine Technology (IHPTET)	Versatile Affordable Advanced Turbine Engines (VAATE-1)	VAATE-II Note: VAATE ends in 2017
Hypersonics Scramjets	AF Single Engine Scramjet Demo, Mach 4-7, X-43C Multi-engine, Mach 5-7	Robust Scramjet: broader operating envelope and reusable applications (e.g. turbine-based combined cycles)	Hypersonic cruise missiles could be in use w/in operational commands. Prototype high Mach (8-10) air vehicles possible
Turboelectric Machinery	Integrated Drive Generator on Accessory Drive, Integrated Power Unit – F-22	No AMAD, Electric Propulsive Engine Controls, Vehicle Drag Reduction/Range Extension	Enabling electrical power for airborne directed energy weaponry
Rechargeable Batteries	Lead Acid, NiCd, in wide use, Lithium Ion under development –(B-2 battery – 1st example)	Lithium Ion batteries in wide use (100-150 WH/kg)	Solid State Lithium batteries initial use (300-400 WH/kg)
Photovoltaics	Silicon based single crystal cells in rigid arrays	Flexible thin films Multi-junction devices – Germanium, Gallium based	Concentrator cells and modules technologies (lens, reflectors)
Fuel Cells	Prototypes demonstrated in ground-based assets.	Production PEM/SO fuel cells available for UA Begin UA integration	Fuel cells size/weight reductions Fuel flexible reformers

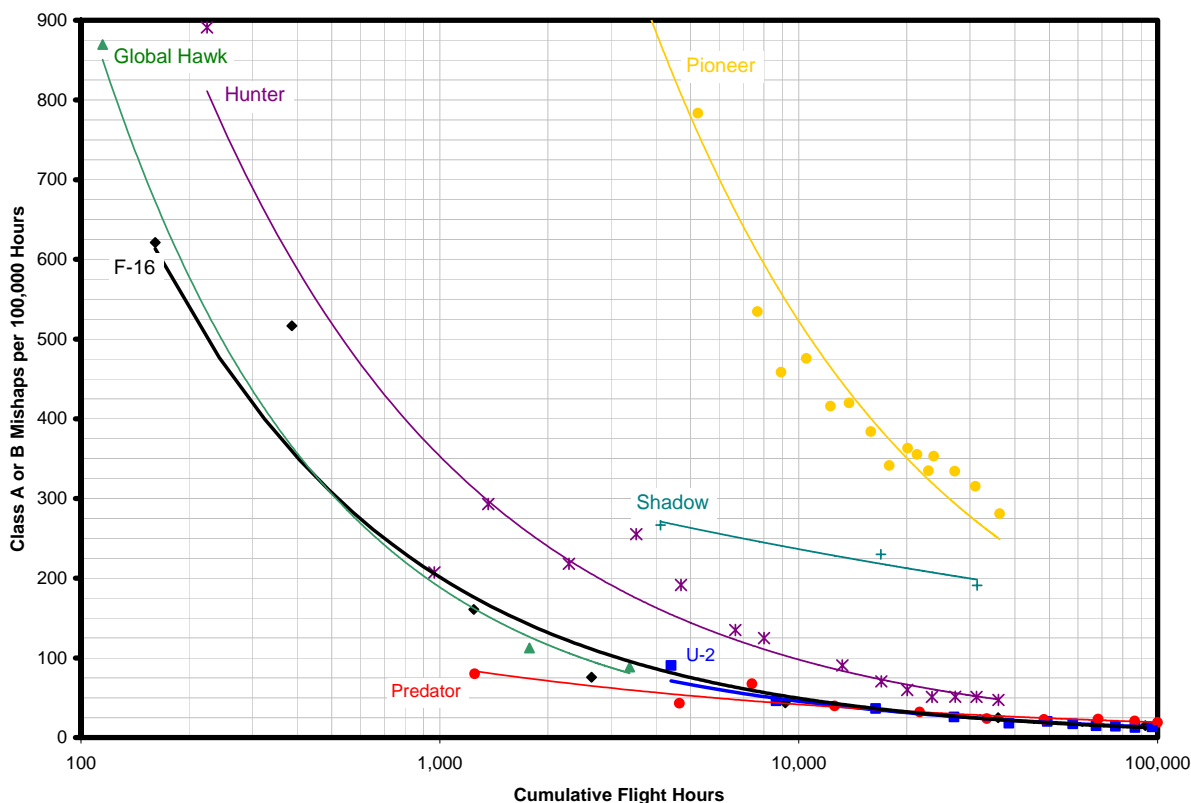

FIGURE 4.3-2. MISHAP RATE COMPARISON.

### 4.3.5 Survivability

Aircraft survivability is a balance of CONOPS, tactics, technology (for both active and passive measures), and cost for a given threat environment. For manned aircraft, aircraft survivability equates to crew survivability, on which a high premium is placed. For UA, this equation shifts, and the merits of making them highly survivable, vice somewhat survivable, for the same mission come into question. Insight into this tradeoff is provided by examining the Global Hawk and DarkStar programs. Both were built to the same mission (high altitude endurance reconnaissance) and cost objective (\$10 million flyaway price was not achieved by either program); one (DarkStar) was to be more highly survivable by stealth, the other only moderately survivable. Performance could be traded to meet the cost objective. The resulting designs therefore traded only performance for survivability. The low observable DarkStar emerged as one-third the size (8,600 versus 25,600 pound) and had one-third the performance (9 hours at 500 nm versus 24 hours at 1200 nm) of its conventional stable mate, Global Hawk. It was canceled for reasons that included its performance shortfall outweighing the perceived value of its enhanced survivability. Further, the active countermeasures planned for Global Hawk’s survivability suite were severely reduced as an early cost savings measure during its design phase.

The value of survivability in the UA design equation will vary with the mission, but the DarkStar lesson will need to be reexamined for relevance to future designs. To the extent UA inherently possess low or reduced observable attributes, such as having seamless composite skins, fewer windows and hatches, and/or smaller sizes, they will be optimized for some level of survivability. Trading performance and/or cost for survivability beyond that level, however, runs counter to the prevailing perception that UA must be cheaper, more attritable versions of manned aircraft to justify their acquisition. As an illustration, both the Air Force and Navy UCAVs (now part of the J-UCAS program) were originally targeted at one third

the acquisition cost of their closest manned counterpart with the same tactical range, the Joint Strike Fighter (JSF); although the range and payload requirements more than doubled in addition to the signature goals being lowered, they are still expected to cost less than that of their manned counterparts.

Aircraft acoustic signature is often overlooked as a key low/reduced observable requirement for UA use in the force protection, homeland defense, and special operations roles. These roles can be better supported by using quieter vehicles that are less susceptible to detection. Electric power systems, such as fuel cells, offer lower noise signatures for smaller UA while providing comparable mass specific power (equals endurance) to that of internal combustion engines (ICE).

Survivability enhancements also need to be considered in a systems context. While keeping the UA from being shot down in a hostile environment is the most obvious challenge, an adversary can employ other techniques to make an UA ineffective such as communications and navigation jamming. Appendix K further discusses UA survivability.

**4.3.6 System Cost Control**

Empty weight cost is a commonly used metric in the aviation industry because it tends to remain constant across a variety of aircraft types. That number today is roughly \$1500 per pound. Table 4.3-2 provides the empty weight and cost data for DoD UA depicted in Figure 4.3-3. It shows current DoD UA platforms cost approximately \$1500 per pound of empty weight and \$8,000 per pound of payload capacity as one “cost per capability” metric. Figure 4.3-4 takes this metric further by factoring in UA endurance to also provide a link between performance and cost in terms of dollars per pound-hour.

**4.4 PAYLOAD TECHNOLOGIES**

Payloads currently in use or envisioned for use on UA fall into the four general categories of sensors (electro-optical, radar, signals, meteorological, chem-bio), relay (communications, navigation signals), weapons, and cargo (leaflets, supplies), or combinations of these. The desire for endurance in many UA demands a high fuel fraction, resulting in a corresponding low payload fraction, typically 10 to 20 percent of gross weight. Figure 4.4-1 illustrates this trade-off between endurance and payload weight. Appendix B presents a detailed evaluation of future sensor technologies for UA.

**TABLE 4.3-2. UAS AND UA COSTS AND WEIGHTS.**

System	Aircraft Cost, FY04\$*	Aircraft Weight, lb*	Payload Capacity, lb	System Cost, FY04\$	Number Acft/System
Dragon Eye	\$28.5K	3.5	1	\$130.3K	3
RQ-7A Shadow	\$0.39M	216	60	\$12.7M	4
RQ-2B Pioneer	\$0.65M	307	75	\$17.2M	5
RQ-8B Fire Scout	\$4.1M	1,765	600	\$21.9M	4
RQ-5A Hunter	\$1.2M	1,170	200	\$26.5M	8
MQ-1B Predator	\$2.7M	1,680	450**	\$24.7M	4
MQ-9A Predator	\$5.2M	3,050	750**	\$45.1M	4
RQ-4 (Block 10) Global Hawk	\$19.0M	9,200	1,950	\$57.7M	1
RQ-4 (Block 20) Global Hawk	\$26.5M	15,400	3,000	\$62.2M	1
*Aircraft costs are minus sensor costs, and aircraft weights are minus fuel and payload capacities					
** Internal payload weight capacity only					

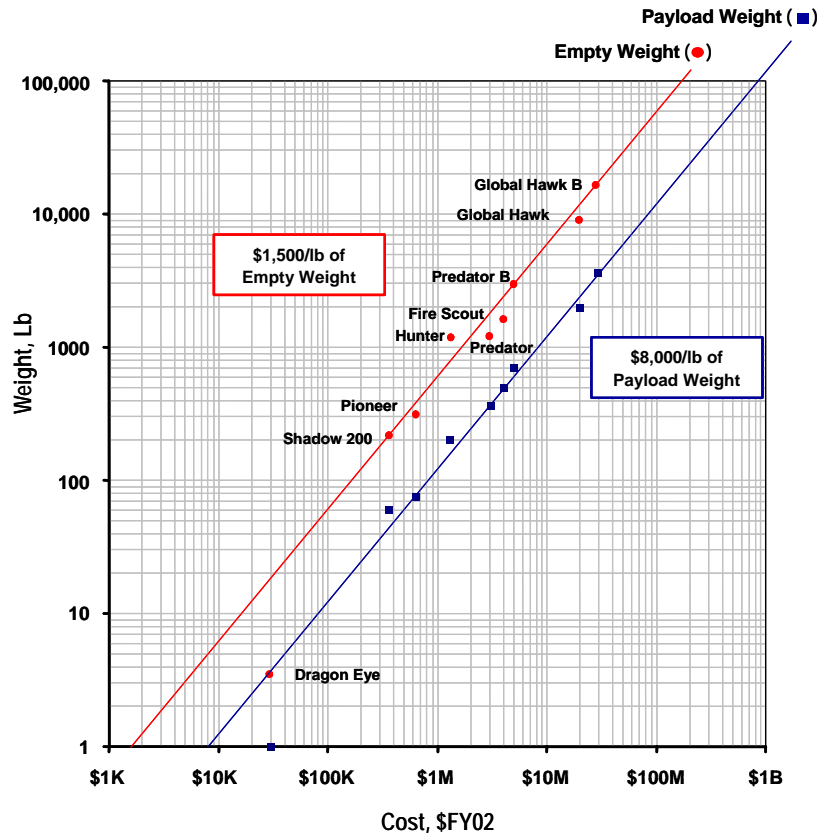

FIGURE 4.3-3. UA CAPABILITY METRIC: WEIGHT V. COST.

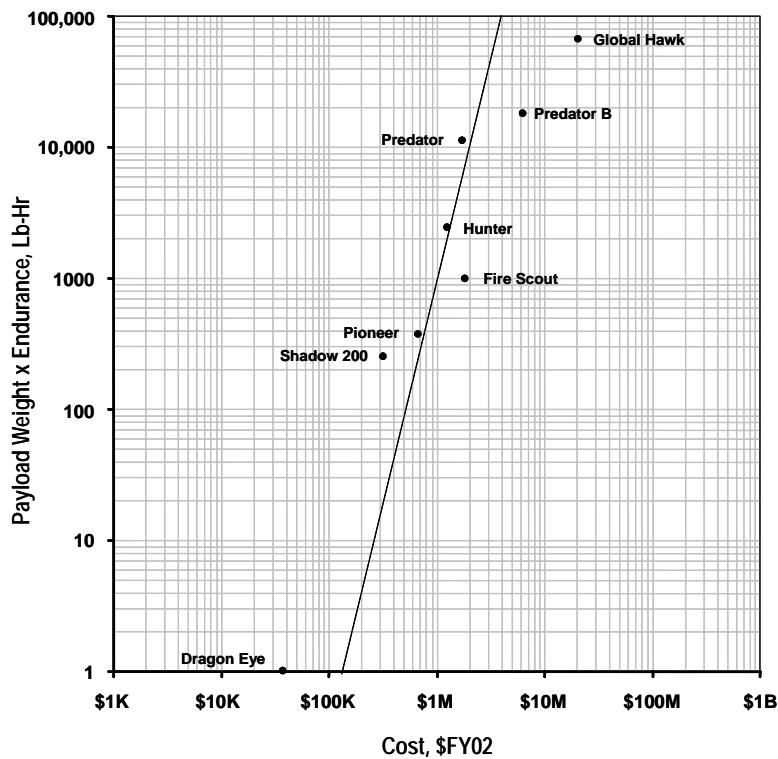

FIGURE 4.3-4. UA PERFORMANCE METRIC: ENDURANCE V. COST.

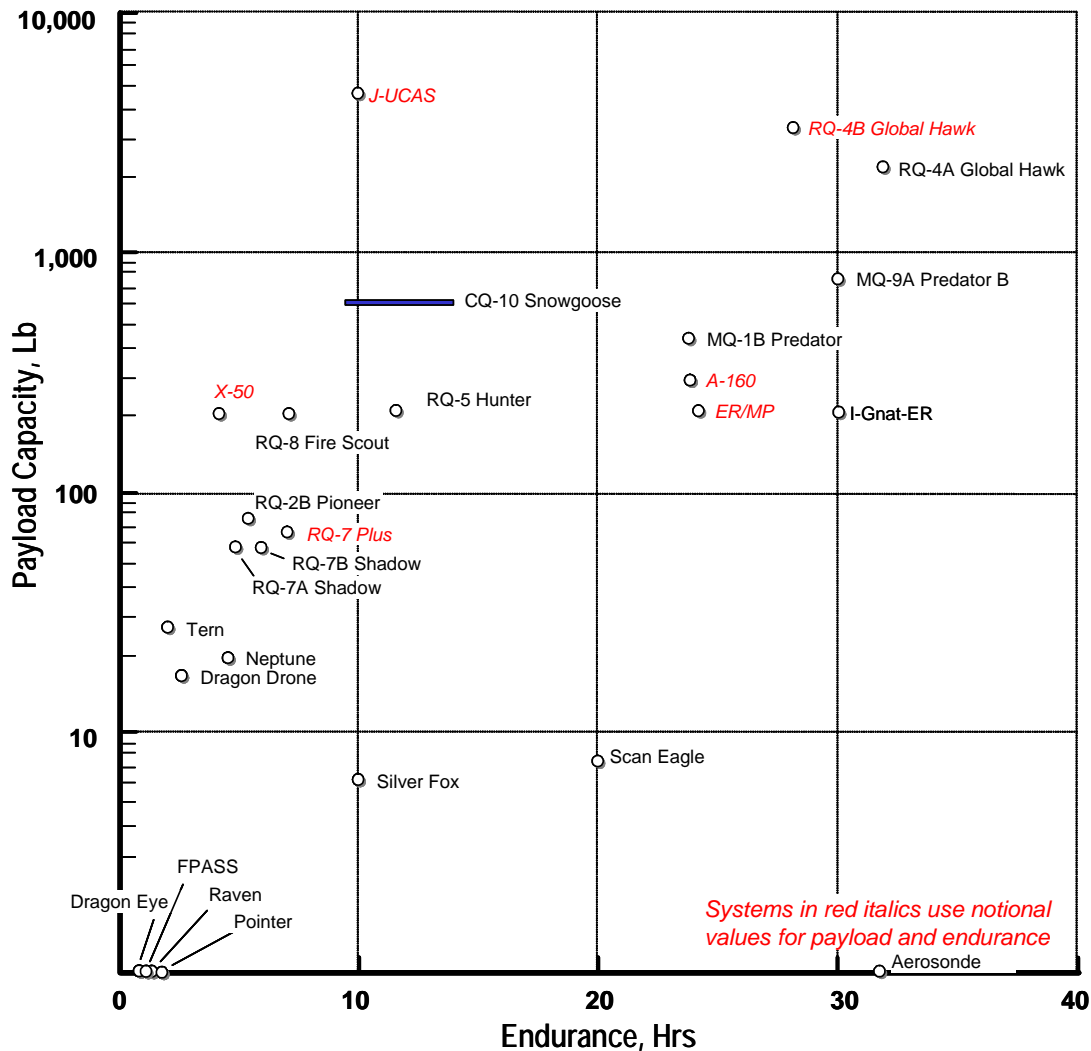

FIGURE 4.4-1. UA PAYLOAD CAPACITY VS. ENDURANCE.

#### 4.4.1 Sensors

Requirements for sensing payloads on UA extend not just to intelligence collection and reconnaissance surveillance and target acquisition to provide operations support, but also to weapons delivery, due to their reliance on detecting and identifying the target to meet rules of engagement (ROE) constraints and to improve aim point accuracy. The dominant requirement for sensing is for imaging (visible, infrared, and radar), followed by signals (for the SIGINT and SEAD missions), chemical (WMD), biological (WMD), radiological (WMD), meteorological (METOC), and magnetic (anti-submarine warfare (ASW) and MCM). Figures 4.4-2 through 4.4-6 depict expected developments in imaging, signals, and measurements and signatures intelligence (MASINT) sensors over the next 20 years by technology and by system, as well as describing the regimes in which such sensors must perform, the enablers necessary to improve present capabilities, and the missions for which each is applicable. Figure 4.4-7 then forecasts developments by sensor type between now and 2015.

**Recommended Investment Strategy:** See “goals” developed in Appendix B.

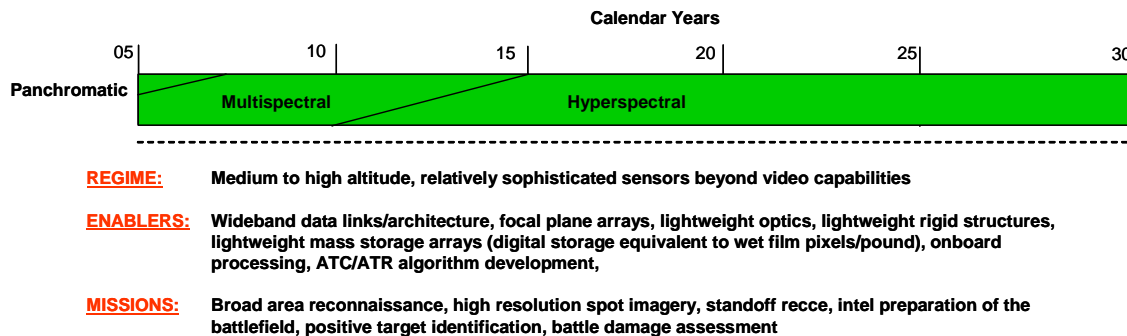

FIGURE 4.4-2. STILL IMAGERY SENSOR TECHNOLOGY FORECAST.

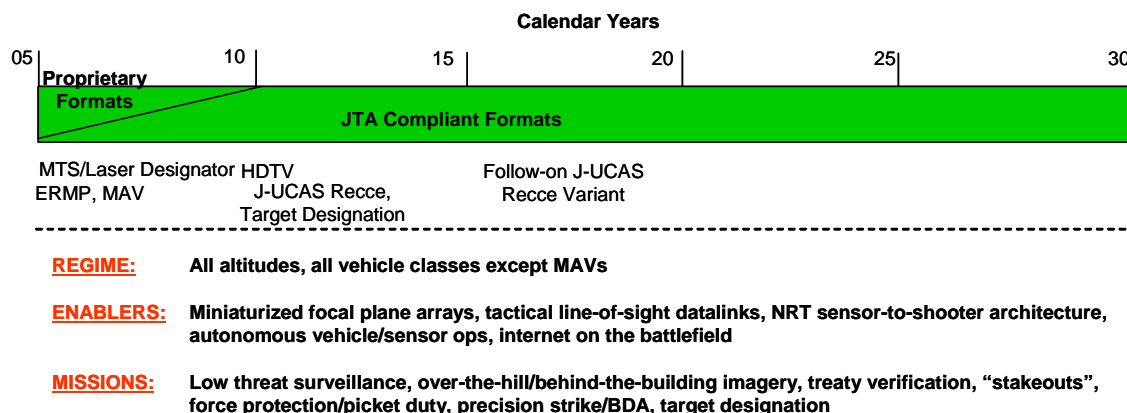

FIGURE 4.4-3. MOTION/VIDEO IMAGERY SENSOR TECHNOLOGY FORECAST.

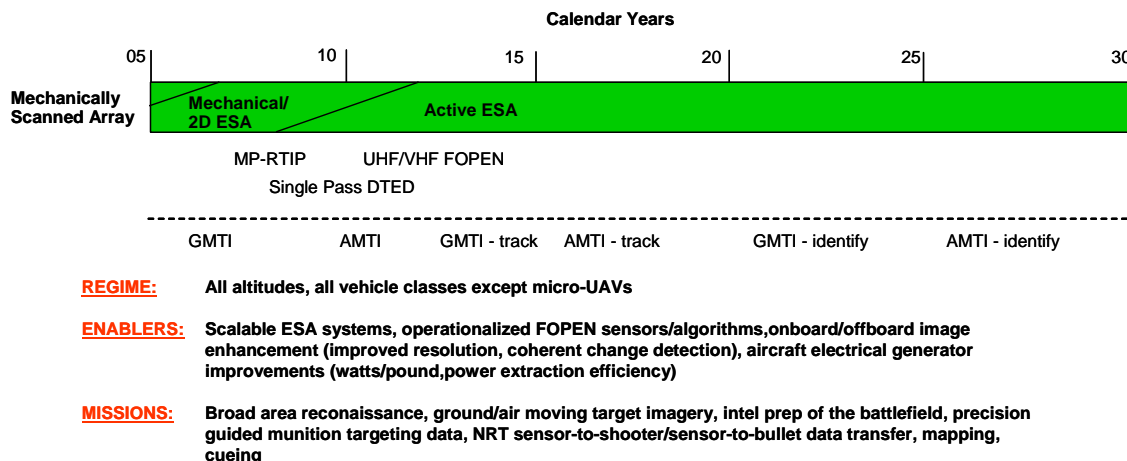

FIGURE 4.4-4. RADAR IMAGERY SENSOR TECHNOLOGY FORECAST.



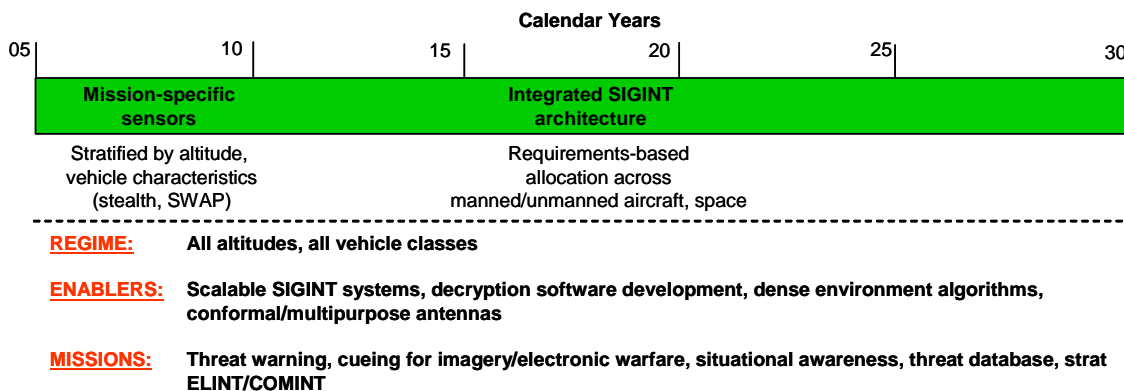

FIGURE 4.4-5. SIGINT SENSOR TECHNOLOGY FORECAST.

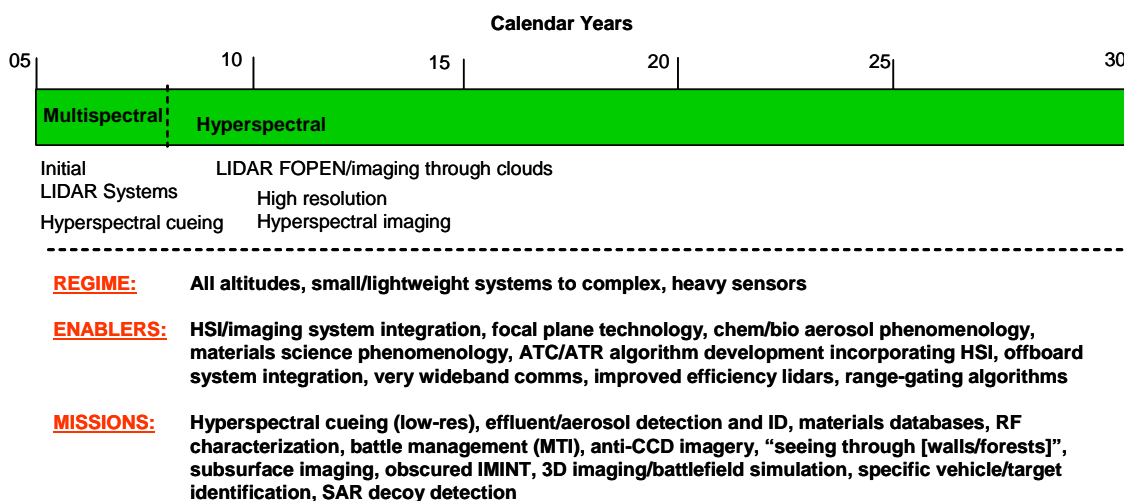

FIGURE 4.4-6. MASINT SENSOR TECHNOLOGY FORECAST.

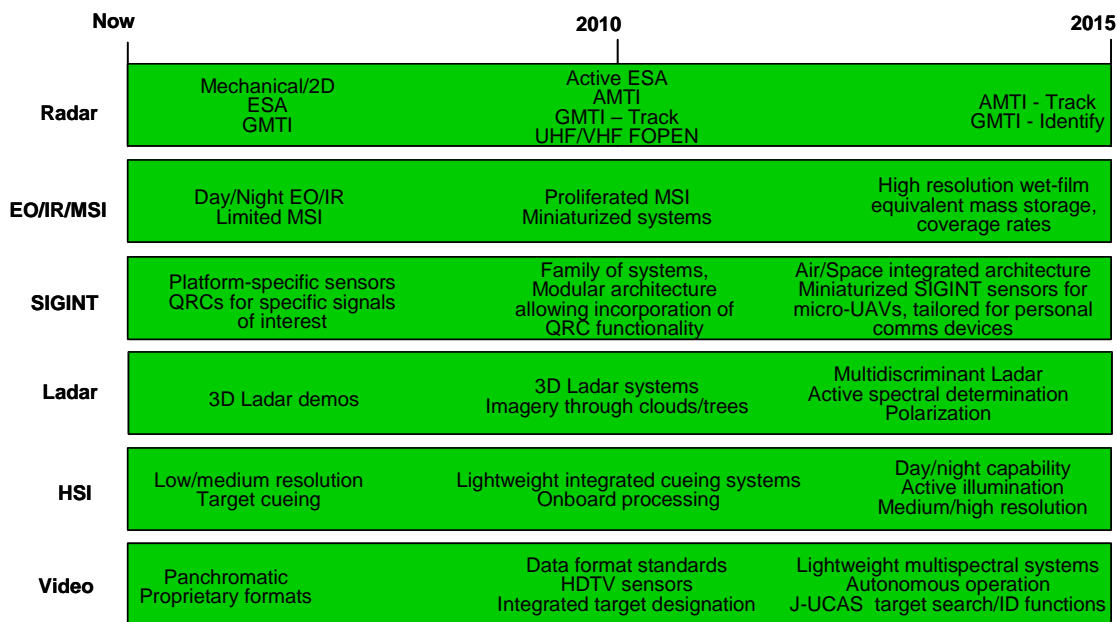

FIGURE 4.4-7. FORECAST SENSOR CAPABILITIES.

#### **4.4.2 Communication Relay**

By 2010, existing and planned capacities are forecast to meet only 44 percent of the need projected by Joint Vision 2010 to ensure information superiority. A separate study, Unmanned Aerial Vehicles as Communications Platforms, dated November 4, 1997, was conducted by OSD (C3I). Its major conclusions regarding the use of an UA as an airborne communication node (ACN) were:

- Tactical communication needs can be met much more responsively and effectively with ACNs than with satellites.
- ACNs can effectively augment theater satellite capabilities by addressing deficiencies in capacity and connectivity.
- Satellites are better suited than UA for meeting high capacity, worldwide communications needs.

ACNs can enhance intra-theater and tactical communications capacity and connectivity by providing 1) more efficient use of bandwidth, 2) extending the range of existing terrestrial LOS communications systems, 3) extending communication to areas denied or masked to satellite service, and 4) providing significant improvement in received power density compared to that of satellites, improving reception and decreasing vulnerability to jamming.

DARPA's AJCN is developing a modular, scalable communication relay payload that can be tailored to fly on a RQ-4/Global Hawk and provide theater-wide support (300 nm diameter area of coverage) or on a RQ-7/Shadow for tactical use (60 nm diameter area). In addition to communications relay, its intended missions are SIGINT, electronic warfare, and information operations. Flight demonstrations began in 2003, and the addition of a simultaneous SIGINT capability is planned by 2010.

#### **4.4.3 Weapons**

If combat UA are to achieve most of their initial cost and stealth advantages by being smaller than their manned counterparts, they will logically have smaller weapons bays and therefore need smaller weapons. Smaller and/or fewer weapons carried per mission means lethality must be increased to achieve equal or greater mission effectiveness. Achieving lethality with small weapons requires precision guidance (in most cases) and/or more lethal warheads. Ongoing technology programs are providing a variety of precision guidance options; some are in the inventory now. With the advent of some innovative wide kill-area warheads, hardening guidance systems, i.e., resistance to GPS jamming, appears to be the greatest technology requirement. A potentially significant advantage to smaller more precise weapons and penetrating launch platforms such as J-UCAS is the reduction in collateral damage. In some cases these platform and weapons combinations could reduce an adversary's ability to seek sanctuary within non-combatant areas. The Air Force Air Armament Center's SDB is half the weight of the smallest bomb the Air Force uses today, the 500 pound Mark 82. Its 250 pound class warhead has demonstrated penetration of one meter of reinforced concrete covered by one meter of soil. The Air Force hopes to deploy it by 2007 on the F-15E, followed by deployment on several other aircraft, including the J-UCAS and MQ-9.

#### **4.4.4 Payload Cost Control**

Table 4.3-2 provides the payload capacities used in Figure 4.3-4, which shows current DoD UA cost approximately \$8,000 per pound of payload capacity (sensors), a comparable number to the payload capacity of the JSF, which is \$7,300 per pound (weapons). This same capability metric applied to J-UCAS is \$5,500 per pound of payload (weapons). As UA become smaller, or stealthier, the standoff range of sensor systems may be reduced. Reduced sensor standoff capability coupled with more use of COTS systems can have a significant impact on some sensor packages for some classes of UA.



**5.0 OPERATIONS**

**5.1 TRAINING**

All DoD UAS operating today employ contractors to conduct the majority of their UAS training requirements. With the exception of the Army's Hunter and Shadow training programs, each UAS has a dedicated training program, underscoring the lack of interoperability among these systems in the field. The students in these courses range from experienced rated officers as pilots to recent enlistees as airframe maintainers.

**5.1.1 Current Status of Training**

System/Course	Service	Location	Duration	Throughput	Flt Hours	Staff
<b>Global Hawk</b>	Air Force	Beale AFB, CA				10
Pilot			26 weeks	48/yr	32	
Sensor Operator			12 weeks	18/yr	48	
Maintenance			5 weeks	77/yr*		
<b>Hunter</b>	Army	Ft Huachuca, AZ				300**
Internal Pilot			24 weeks	40/yr	21.5	
External Pilot			16 weeks	4/yr	30	
Maintenance			10 weeks	20/yr		
Technician			11 weeks	20/yr		
<b>Pioneer</b>	Navy	OLF Choctaw, FL				37*****
Mission Commander			3 weeks	17/yr	10	
External Pilot			17 weeks	24/yr	102***	
Internal Pilot/Payload Operator			14 weeks	40/yr	56	
Mechanical Maintenance			7 weeks	18/yr		
Technical Maintenance			9 Weeks	24/yr		
<b>Predator</b>	Air Force	Indian Springs AFAF, NV				22
Pilot			13 weeks	48/yr	38	
Sensor Operator			14 weeks	48/yr	37.5	
Maintenance			4 weeks	95/yr****		
<b>Shadow</b>	Army	Ft Huachuca, AZ				300**
Operator			24 weeks	240/yr	14.5	
Maintenance			8 weeks	40/yr		
Technician			9 weeks	40/yr		

\*Number of graduates is total from the seven Global Hawk Maintenance courses. Duration is average length of the seven courses.  
 \*\*Total staff supporting Hunter and Shadow instruction at the U.S. Army UAS Training Center.  
 \*\*\*Consists of some 80 hours flying subscale RC models plus 22 hours flying the Pioneer.  
 \*\*\*\* Number of graduates is total from the five Predator Maintenance courses. Duration is average length of the five courses.  
 \*\*\*\*\*Total staff supporting Pioneer training at OLF Choctaw.

**5.1.2 Training Issues**

1. Although a spiral acquisition approach is favored for most UAS programs, it imposes an unrecognized burden for UAS trainers: always being one or more steps out of phase with the capabilities being incrementally fielded. This requires additional training (i.e., cost) at the unit level after the student completes initial training.
2. Current ground stations are not designed to be dual capable for use in both controlling actual

missions and conducting simulated flights for training. This drives added product support costs for dedicated simulators and task trainers by requiring more numerous and higher fidelity simulators and trainers.

3. The current and projected OPTEMPO associated with the Global War On Terrorism (GWOT) does not allow systems to be taken off-line for extended periods of time in order to implement hardware and software improvements and to train operators on the new capabilities.
4. Most UAS maintenance training lacks dedicated maintenance trainers as well as digital technical orders and manuals with embedded refresher training. This results in factory representatives having to be fielded at most UA operating sites and to deploy to war zones to compensate for inadequate training.

### 5.1.3 Training Goals

1. Future ground stations should be required to be capable of conducting actual and simulated flights with negligible configuration changes required. (This will not preclude the requirement for stand alone full mission simulation devices of part task trainers due to high usage mission system time approaching 24/7 for some systems.)
2. OPTEMPO associated with GWOT demands that training be streamlined, especially “difference” training associated with system upgrades at forward operating locations. Web-based training should be considered and modular training packages should be created to allow users to train in blocks as time permits and as the mission allows.
3. UAS maintenance courses should be provided with dedicated versions of currently fielded systems and digital technical orders with embedded refresher training.
4. Control maintenance training costs. Consider the use of contractors to maintain systems that require unique and costly training as an alternative to training military personnel.

## 5.2 OPERATIONAL CONCEPTS DEVELOPMENT—PARTICIPATING AGENCIES

The potential for using UAS in new and innovative ways has long been acknowledged by many in the military establishment. It is the function of the Service battle labs to convert such assumptions into demonstrations of practical application. Originally an Army concept (1992), battle labs have been established by the Services to address, in the Army’s words, “*categories of military activity where there appears to be the greatest potential for change from current concepts and capabilities, and simultaneously, the areas where new requirements are emerging.*” The dynamic nature of these emerging requirements underscores the importance of continued funding for these organizations. UAS employment has figured prominently in the short history of these organizations.

### 5.2.1 Army

The Army’s *Advanced Aviation Technology Directorate (AATD)*, an element of the U.S. Army Aviation and Missile Command’s Aviation & Missile Research, Development, & Engineering Center, is located at Ft Eustis, VA. AATD is focused on developing, integrating, and demonstrating new technologies for future UAS, specifically the integration of manned and unmanned aviation. It operates four Vigilante UA testbeds and is in the process of converting an AH-1F Cobra into its optionally piloted unmanned combat airborne demonstrator (UCAD). It is also developing the Wing Store UA (WSUA) for launch from 2.75-inch rocket pods carried on helicopters.

The Army’s *Night Vision Electronic Sensors Directorate (NVESD)* at Ft Belvoir, VA, employs six Pointers, six Night Hawks, two Flight Hawks, and one Setter mini-UA, as well as two Camcopter rotary wing UA, as testbeds for evaluating various night vision and mine countermeasure sensors. NVESD also assumed responsibility for developing the initial Dragon Warrior prototype, the Sikorsky Cypher II, from MCWL in late 2000 for further testing and is currently helping develop the Buster mini-UA.

Although none of its six battle labs begun in 1992 is dedicated to UAS, the majority of the Army’s battle

labs have been involved in exploring various UAS operational concepts. The *Air Maneuver Battle Lab* at Ft. Rucker, AL, operates some 30 Exdrones for developing combined UA/helicopter tactics. The *Dismounted Battle Space Battle Lab* at Ft. Benning, GA, working in concert with the Marine Corps Warfighting Lab, has evaluated UA (Camcopter and Pointer) and MAV in urban warfare scenarios at the military operations in urban terrain (MOUT) McKenna Facility. The *Mounted Maneuver Battle Lab* at Ft. Knox, KY, focuses on brigade-level-and-below and has an extensive resume of involvement with small UA for the scouting role and with UA modeling. *TRADOC's Systems Manager (TSM)* for UAS at Ft. Rucker, AL, is the Army's central manager for all combat development activities involving UAS.

### 5.2.2 Navy and Marine Corps

The *Naval Research Laboratory (NRL)* in Washington, DC, has a history of exploring new aerodynamic and propulsion concepts for maritime UAS. Among its innovative UAS concepts have been in-flight deployable wings, hovering tethered ship decoys, and advanced miniature electric motors. The NRL has built and flown over a dozen different, original small and MAV designs in recent years.

The *Naval Air Warfare Center Aircraft Division (NAWC/AD)* at NAS Patuxent River, MD, maintains a small UAS test, development, and demonstration team at Webster Field, MD that operates a fleet of various types of small UA for testing and to assist conops development. NAWC/AD's maritime unmanned development and operations (MUDO) team has a few Exdrones, 3 Aerolights, 2 Aeroskys, and 1 Aerostar. MUDO managed the evolution of the Exdrone into the Dragon Drone for use by the Marine Corps Warfighting Lab (MCWL). It has also supported the Maritime Battle Center during recent Fleet Battle Experiments by providing small UAS and operations expertise.

The *Marine Corps Warfighting Laboratory* was created at Quantico, VA, in 1995. Responsible for developing new operational concepts, tactics, techniques, procedures, and technologies to prepare Marines for future combat. It has participated in UAS development for integration into battalion-level-and-below forces. In addition to integrating Dragon Drone UA into its recent series of limited objective experiments (LOEs) supporting capable Warrior, MCWL has funded development of Dragon Warrior and Dragon Eye prototypes, each tailored to specific requirements supporting the Operational Maneuver From The Sea (OMFTS) concept.

The *Naval Strike and Air Warfare Center (NSAWC)* at NAS Fallon, NV, began supporting concept of operations development for integrating *RQ-1 Predators* into Fleet training exercises in 1998. To date, these efforts have focused on the time critical targeting and battlespace dominance missions. NSAWC participated in the naval utility evaluation of the RQ-4 Global Hawk during its ACTD by serving as a node to receive imagery during Global Hawk's flight to Alaska in 1999. In 2001, NSAWC completed a naval tactics, techniques, and procedures document entitled "UAV Integration into Carrier Air Wing Operations" (NTTP 3-01.1-02) which can be accessed at [www.nsawc.smil.mil](http://www.nsawc.smil.mil).

The Naval Warfare Development Command's *Maritime Battle Center (MBC)*, established at Newport, RI, in 1996, conducts a fleet battle experiment (FBEs) each year to explore new technologies and operational concepts in both live and virtual scenarios. UAS have participated in FBE-Echo (Predator in 1999), FBE-Hotel (Aerolight, Pioneer, and Dakota II in 2000), FBE-India (Aerolight in 2001), and FBE-Juliet (Sentry and Pioneer in 2002).

### 5.2.3 Air Force

AFRL is actively pursuing UAS-applicable technologies for both specific UAS programs and for unmanned flight in general. Its Air Vehicles group is exploring autonomous see and avoid and flight control systems. Its Sensors Directorate is developing a more capable, smaller radar and electro-optical capabilities. AFRL has contracted a concept development study for the Sensorcraft concept, an UA optimized for the sensor suite it would carry.

The Air Force relocated its *UAV Battlelab* to Indian Springs AFAF, NV, in 2004. Established in 1997 to

explore and demonstrate the worth of innovative UAS operational concepts (as distinct from new systems or tactics) in key emerging areas, its goal is to create opportunities, with minimal investment, for the Air Force to impact current UAS organizations, doctrine, training, and future requirements and acquisitions. The Battlelab conducts four to six "experiments" annually, employing a variety of UA and UA surrogates. Notable firsts among its efforts have been applying the traffic collision/avoidance system (TCAS) to better integrate manned and unmanned flight operations; evaluating UA to supplement base security forces (in conjunction with the Air Force Force Protection Battlelab); using UA as the "eyes" for an E-8/joint surveillance, targeting, and attack radar system (JSTARS) in coordinated SCUD missile hunts; and proving the military utility of real time UA reconnaissance support to special tactics teams.

*Air Force Special Operations Command (AFSOC)* at Hurlburt Field, FL acquired 15 Exdrones from NAWC/AD in 2000. Operated by the 720<sup>th</sup> Special Tactics Group, they are used to explore UAS concepts of operation and special payloads for special operations forces. AFSOC also sponsored, in conjunction with the UAV Battlelab, a demonstration of controlling an UA from an airborne MC-130 and is currently working the Sky Tote concept for resupplying Special Forces in the field.

### 5.2.4 Joint/Other

*USJFCOM* has statutory responsibility - through the 2002 National Defense Authorization Act (Public Law 107-107, Section 261) - to establish and operate a flight activity capability known as the Joint Operational Test Bed System (JOTBS). The mandate for this capability is to "evaluate and ensure the joint interoperability of unmanned aerial vehicle systems." Per the mandate, JOTBS experiments are not constrained by Service policy or doctrine. The JOTBS capability is based at Fort Huachuca, AZ and is managed out of USJFCOM headquarters in Norfolk, VA. JOTBS capability consists of a Joint Mission Support Module containing all the required communications and mission coordination capabilities with which to coordinate and conduct experiments, integrate other capabilities on a need basis, a Predator modular ground control station, a Predator portable ground control station, schedule priority for two Navy Predator (RQ-1A) air vehicles located at the Naval Postgraduate School, electro-optical/infrared sensor ball payloads, and a team of UAS subject matter experts. JOTBS experimentation produces potential materiel and non-materiel solution sets that are coordinated through Doctrine, Operations, Training, Material, Leadership, Personnel and Facilities (DOTMLPF) Change Recommendation (DCR) packages within the JCIDS process. To date, JOTBS focus has been in the Battlespace Awareness Functional Capability domain and resulted in improved integrated architecture solutions for coherent operation of multiple UAS and sensor types.

The *Joint Technology Center/System Integration Laboratory (JTC/SIL)* was established in 1996 at the Redstone Arsenal in Huntsville, AL. Its mission is to provide technical support for virtual prototyping, common software and interfaces, software verification and validation, interactive user training, and advanced warfighting experiments (AWEs) for a broad variety of tactical and strategic reconnaissance assets, as well as C<sup>4</sup>I systems and interfaces. It has focused on two programs supporting UAS, the TCS and the multiple unified simulation environment (MUSE). MUSE is being used to explore operational concepts, train for Army's Tactical UAV, and to simulate UAS in computer assisted exercises.

Although neither a joint nor a Defense Department organization, the U.S. Coast Guard has been very active in exploring potential applications of UAS to their missions. Seven UAS experiments have been sponsored recently by the *Coast Guard Research and Development Center (RDC)* at Groton, CT. These have included alien and drug interdiction along the Texas coast and in the Caribbean, UA launch and recovery systems suspended beneath a parasail as a technique to allow UA operations from otherwise non-air-capable cutters, a test of the utility of UA to locate and identify various types of boats in open water, and evaluations of UA in the fisheries protection role off Alaska.

**5.3 OPERATIONS**

**5.3.1 Current Status of Operations**

As of mid-FY04, the U.S. military had some 150 UA (33 systems) deployed in operational units, along with an equivalent number of small, hand-launched UA in small tactical and special operations units. The peak of OIF (April 2003) saw 70 UA (14 systems) of five types (Global Hawk, Hunter, Pioneer, Predator, and Shadow) deployed forward in support of the GWOT. A similar number of small UA of six types (Dragon Eye, FPASS, Silver Fox, Pointer, Tern, and Raven) were also deployed in Iraq and Afghanistan at that time. Today's UA inventory (see Table 5.3-1) is based from coast to coast (see Figure 5.3-1) and, with few exceptions, conducts proficiency flights in restricted airspace. In 2003, the Air Force received a "national certificate of authorization (COA)" allowing Global Hawk to fly in unrestricted airspace; however, flights require five days notice to the FAA.

**TABLE 5.3-1. CURRENT UAS INVENTORY.**

System	Unit	Base	No. of Systems
Global Hawk	12 Recon Sqdn	Beale AFB, CA	1 (51 aircraft planned)
Hunter	1 MI BN	Hoenfels, Germany	1 (6 aircraft)
	15 MI BN	Ft. Hood, TX	1 (6 aircraft)
	224 MI BN	Savannah, GA	1 (6 aircraft)
Pioneer	VMU-1	Twenty Nine Palms MCAS, CA	1 (5 aircraft)
	VMU-2	Cherry Point MCAS, NC	1 (5 aircraft)
	Fleet Composite Squadron Six	Paxtuxent River, MD	1(3 aircraft)
Predator	11 Recce Sq	Indian Springs AAF, NV	5 (20 aircraft)
	15 Recce Sd	"	5 (20 aircraft)
	17 Recce Sq	"	2 (12 aircraft)
Shadow	3 Bde, 2 ID	Ft. Lewis, WA	1 (4 aircraft)
	1 Bde, 25 ID	"	1 (4 aircraft)
	1 Bde, 1st Cav	Ft. Hood, TX	1 (4 aircraft)
	2 Bde, 1st Cav	"	1 (4 aircraft)
	3 Bde, 1st Cav	"	1 (4 aircraft)
	1 Bde, 82 Abn	Ft. Bragg, NC	1 (4 aircraft)
	2 Bde, 82 Abn	"	1 (4 aircraft)
	2 Bde, 1 ID	Germany	1 (4 aircraft)
	3 Bde, 1 ID	"	1 (4 aircraft)
	1 Bde, 2 ID	Korea	1 (4 aircraft)
	2 Bde, 2 ID	"	1 (4 aircraft)
	1 Bde, 4 ID	Ft. Hood, TX	1 (4 aircraft)
	2 Bde, 4 ID	"	1 (4 aircraft)
	29 ID (PA NG)	Indian Town Gap, PA	1 (4 aircraft)
	56 Bde (MD NG)	Baltimore, MD	1 (4 aircraft)
	172 SIB	Ft. Wainwright, AK	1 (4 aircraft)
	1 – 4 UA 3 ID	Ft. Stewart, GA	4 (16 aircraft)

Note: Small UAVs are not included as the number of units having hand launched systems are too numerous to mention.



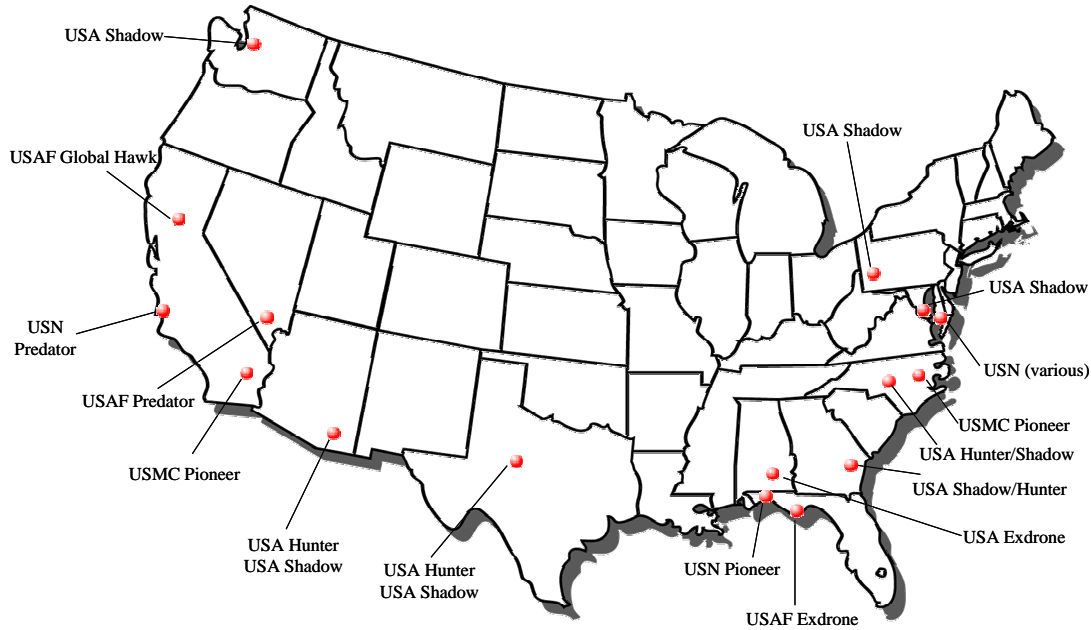

FIGURE 5.3-1. LOCATIONS OF U.S.-BASED DoD UAS.

### 5.3.2 Operations Issues

UAS operations in the GWOT have revealed the following issues:

1. The low density/high demand nature of the limited UAS force and the operational demands placed on it created a conflict in priorities between employing UAS in its two key roles, sensing and shooting. In both Afghanistan and Iraq, Predators were tasked to find targets, designate them for manned strike, and strike them themselves. Both the limited number of weapons carried and the coordination time required to obtain permission to employ them subtracted from UA availability to pursue mobile targets, a key concern of intelligence staffs.
2. Weather, in particular high winds, posed a major constraint on UA operations due to their lighter weights and high-aspect ratio wings compared to those of manned aircraft. Winds up to 70 knots in the SWA theater significantly reduced the availability of most UA, and the accompanying dust storms impacted their ability to use EO sensors effectively; however, Global Hawk, carrying an EO/IR/SAR combined sensor, was still able to perform effectively during dust storms.
3. Despite having the capability to operate multiple UA per system simultaneously, the limited number of frequencies available often restricted the number to one UA airborne at a time.
4. Integration of unmanned aviation into the national airspace system is needed to enable file and fly operations by UA to improve their responsiveness and fidelity of training.
5. The dynamic nature of the joint operational environment for which UAS are employed in Afghanistan and Iraq indicate a need for centralized command and control to ensure functional integration (intel, ops and communications) that prioritizes UA sensing operations support.
6. A comprehensive and integrated dissemination architecture is needed to optimize bandwidth usage and maximize requirement satisfaction.
7. A net-centric approach to UAS integration / interoperability is needed to provide situational awareness at all command echelons. Consistent with the DoD's Net-Centric Data Strategy, there should be additional capability for archiving and discovery of full motion video collected by UAS. UA positional and sensor pointing information enable enhanced airspace and sensor management.
8. Frequency interference (loss of UA link) was more often from friendly than hostile sources.
9. Urban combat is hostile to high bandwidth wireless data communications and can result in loss of connectivity even at short distances. This effect is compounded by short LOS distances, making visual reconnaissance difficult. Urban combat terrain is also rapidly changing, and pre-conflict

battlespace awareness can become useless unless continually refreshed.

### **5.3.3 Operations Goals**

1. Acquire more multi-mission (ISR and strike) capable UA, each capable of employing a greater number and variety of weapons.
2. Provide more bandwidth and frequency agility for UAS operations.
3. Implement a file and fly process in applicable DoD and FAA regulations for allowing UA into the NAS.
4. For small UAS, develop FAA approved procedures to support operations in the NAS.
5. Development will need to be made in a new class of autonomous platforms that can function at low altitudes in congested and obstacle rich airspaces. Development of this class of small, low altitude, autonomous platforms and the ability to coordinate their operation are seen as essential tools in addressing the difficulties with urban combat.

## **5.4 WEAPON DELIVERY**

### **5.4.1 Weaponization**

Unmanned and manned aircraft share the same considerations when being certified to carry weapons (or more generally, stores)--loads on the aircraft and the store, aircraft flutter, aircraft stability and control, safe store separation, and any impact on store ballistics or its fuzing. Stores certification on unmanned aircraft involves two additional considerations, EMI/EMC with the UA's greater transmissions and providing an independent path to arm and safe weapons absent a pilot in the cockpit with a master arm switch. The EMI/EMC issues are addressed by extensions of existing SEEK EAGLE testing to cover the UA's more numerous frequencies. Providing a substitute means to safe weapons, i.e., an alternative master arm switch, is a concern of the Non-Nuclear Munitions Safety Board (NNMSB). It addresses how to remotely arm a weapon as well as the more difficult issue of how to return the master arm from on-to-off following weapon release or in the event of lost link. To date, company proprietary, system-specific software has been used to provide this function.

### **5.4.2 Weaponization Issues**

1. SEEK EAGLE, an Air Force chartered organization that certifies aircraft-stores for all weapons, may impose unnecessary testing on UA weapon systems, especially where risk to aircrew is a factor. This could impact UAS development costs and schedules.
2. The proliferation of system-specific Master Arm software routines will greatly complicate stores certification on various types of UA.

### **5.4.3 Weaponization Goals**

1. SEEK EAGLE testing criteria should be examined from the perspective of employing stores from unmanned aircraft and revised as necessary.
2. A standard for Master Arm software should be developed and weaponized UA required to comply with it.

## **5.5 OPERATING AND SUPPORT COSTS**

Seventy percent of non-combat aircraft losses are attributed to human error, and a large percentage of the remaining losses have this as a contributing factor. Although aircraft are modified, training emphasized, and procedures changed as a result of these accidents, the percentage attributed to the operator remains fairly unchanged. Five factors should combine in unmanned operations to significantly reduce the human error percentage.

First, UA today have demonstrated the ability to operate completely autonomously from takeoff through roll out after landing; Global Hawk is one example. Software-based performance, unlike its human counterpart, is guaranteed to be repeatable when circumstances are repeated. With each UA accident, the

aircraft's software can be modified to remedy the situation causing the latest mishap, "learning" the corrective action indelibly. Although software maturity induces its own errors over time, in the long-term this process could asymptotically reduce human-error induced losses to near zero. Losses due to mechanical failures will still occur because no design or manufacturing process produces perfect parts.

Second, the need to conduct training and proficiency sorties with unmanned aircraft actually flying could be reduced in the near term with high fidelity simulators. Such simulations could become indistinguishable from actual sorties to the UA operator with the use of virtual reality-based simulators, explored by AFRL, and physiologically-based technology, like the Tactile Situation Awareness System (TSAS). The Navy Aerospace Medical Research Laboratory (NAMRL) developed TSAS to reduce operator saturation by visual information. It has been tested in various manned aircraft and has potential applicability for UA operators. The system uses a vest with air-actuated tactors to tap the user in the direction of drift, gravity, roll; the tempo of the tapping indicates the rate of drift. Results have shown that use of the TSAS increases operator situational awareness and reduces workload.

Third, UA control stations could double as simulators to perform mission rehearsal thus eliminating the expense of developing and maintaining separate simulators, as is the case for manned aircraft. However, when numbers of ground stations are determined to meet operational requirements, adding training requirements will increase that number since simultaneous use in operations and for simulation may not be consistent with flight certification and airworthiness criteria.

Fourth, with such simulators, the level of flying training required by UA can be reduced, potentially resulting in reduced maintenance hours, fewer aircraft losses, and lowered attrition expenditures. Of 301 total U.S. F-16 losses to date, 6 have been in combat and the rest (98 percent) in training accidents. While some level of actual UA flying will be required to train manned aircraft crews in executing cooperative missions with UA, a substantial reduction in peacetime UA attrition losses can probably be achieved.



## 6.0 ROADMAP

This Section brings together the requirements and desired capabilities (Section 3) with emerging technological (Section 4) and operational opportunities (Section 5) in an effort to stimulate the planning process for UAS development over the next 25 years. It attempts, through a limited number of examples, to demonstrate a process for selecting opportunities for solving selected shortfalls in capability and incorporating these solutions in Service UAS programs (see Figures 6.1-1 and 6.2-1). Two Roadmaps, one addressing technology-driven capabilities (Section 6.1) and the other operations-driven missions (Section 6.2), provide guidance for UAS development efforts by the Services and industry. Goals for unmanned aviation to achieve over the next 25 years are then provided (Section 6.3), and their need to work in concert with unmanned ground and sea vehicles described (Section 6.4). The key question addressed in this chapter is: *When will the capabilities required to enable the theater commanders' requirements become available?*

### 6.1 UAS CAPABILITIES ROADMAP

To relate the priorities expressed by the COCOMS in Section 3 to the technologies coming available within the next 25 years (Section 4), examples of *capability metrics* (see Table 6.1-1) were devised for this Roadmap. They identify timeframes for anticipating future capabilities to satisfy the warfighters' requirements. All references to years are for dates when these capabilities are expected to become available for fielding based on the technology trends developed in Section 4 and the appendices. Some of the capabilities described have already been demonstrated in labs; others, primarily in the communications and processing areas, will be driven by commercial applications.

**TABLE 6.1-1. EXAMPLE CAPABILITY METRICS.**

Operational Requirement* (Section 3)	Technology Requirement (Section 4)	Example Capability Metrics	
			Availability Timeframe
BA, FL	Endurance	Field a heavy fuel-powered tactical UA	2005-10
BA	''	Field fully automated aerial refueling capability	2010-15
BA	''	Achieve 40% increased time-on-station with same fuel load	2015-20
FP	Signature	Field an UA inaudible from 500 to 1,000 ft slant range	2005-10
BA, FA	Resolution	Field a sensor for detecting targets under trees	2005-10
FP	''	Distinguish facial features (identify individuals) from 4 nm	2005-10
BA, FA	''	Achieve 3 inch resolution in SAR resolution over a 20 nm wide swath	2010-15
BA	Data Rate	Relay entire COMINT spectrum in real time	2005-10
BA	''	Relay entire ELINT spectrum in real time	2025-30
BA, FA	''	Relay 100-band hyper-spectral imagery in real time	2010-15
BA, FA	''	Relay 1,000-band ultra-spectral imagery in real time	2025-30
BA, FA	Algorithm Processor	Automatic Target Recognition capability for large numbers of military vehicles	2005-10
C2	Processor Speed	Provide human-equivalent processor speed and memory in PC size for airborne use	2025-30
BA, FP	''	Map surf zone sea mines in real time	2015-20
BA, FA, FL	''	Reduce DTED level 5 data in real time	2020-25
* Based on Joint Functional Capabilities identified in COCOM IPLs.			
BA = Battlespace Awareness; FL = Focused Logistics; FP = Force Protection; C2 = Command and Control FA = Force Application			

By bringing together a plot of the predicted appearance of the listed capabilities in Table 6.1-1 with the timeline of current/planned DoD UAS programs (shown earlier in Figure 2.0-1), a Roadmap of opportunities for applying emerging capabilities to forthcoming UAS is created. The upper half of Figure

## UAS ROADMAP 2005

6.1-1 plots the predicted appearance of these capabilities over the next 25 years, with the date of each centered within a 5-year window of estimated initial availability for fielding. As an example of its use (see dotted lines on Figure 6.1-1), the information processing speed needed to extract the presence of sea mines in surf zones in real time from UA video (some 1.8 THz) should become available between 2015 and 2020, which corresponds to the planned introduction of the naval variant of J-UCAS, making this a reasonable capability to express as a requirement for it, if desired.

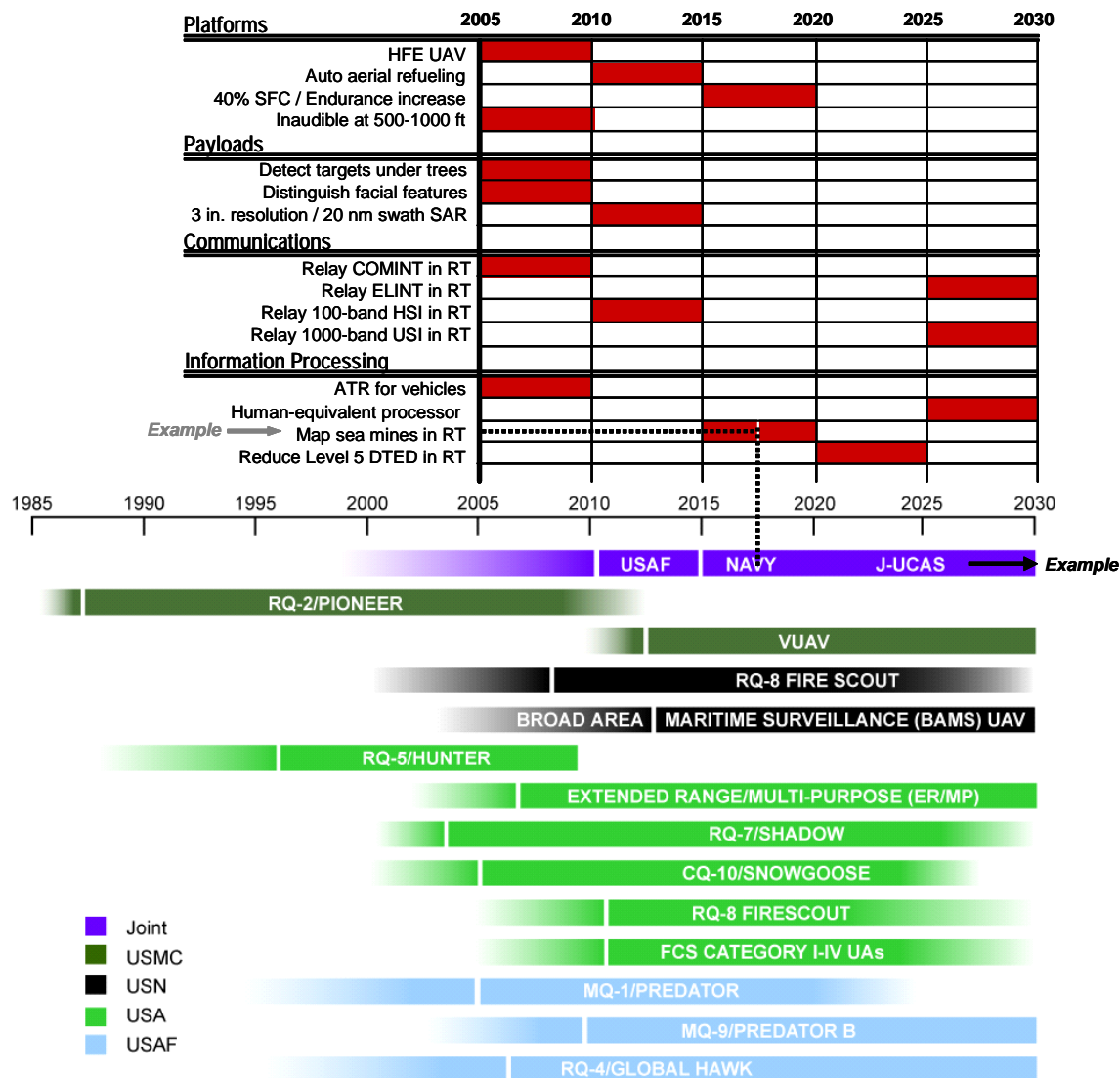

FIGURE 6.1-1. UAS CAPABILITIES ROADMAP.

## 6.2 UAS MISSIONS ROADMAP

Unmanned aviation has historically been limited to the reconnaissance (Firebee, Global Hawk) and strike (DASH, Predator) missions. Reconnaissance is now a well-established mission for UAS, complementing manned aircraft in this role. Lessons learned from these ISR platforms point the way to concepts of operations (CONOPs) that, to some extent, have already brought advantages to the Services and Combatant Commanders. Aircraft with inhuman endurance bring persistent surveillance at reduced sortie levels. Fewer flight hours are “lost” due to reduced time otherwise needed for transit time in shorter

range/endurance aircraft. Fewer take offs and landings mean reduced wear and tear, and exposure to historical risks of mishaps. Ground operating tempo benefits from the reduced sortie generation. The ability to operate in distant theaters with ground stations at CONUS garrison bases means many crews fly operational missions without deploying forward. This, in turn, reduces forward footprints, support costs, and demands on force-protection authorities. Crew duty periods are now irrelevant to aircraft endurance since crew changes can be made on cycles based on optimum periods of sustained human performance and attention. The personnel impacts can additionally ripple through the Services to positive effect. Fewer deployments reduce family stress and mean better retention for highly trained crews reducing pipeline-training costs. High-endurance unmanned aviation enables CONOPs attributes that can't be fully reflected in aircraft unit costs. But they enable a future where counter-air operations, similar to Deny Flight, Northern and Southern Watch, may quite conceivably be supported by crews, operational staffs and CAOCs that substantially remain in either CONUS or established headquarters far away from the point of intended operational effects. The J-UCAS program, now focused on developing a net-centric strike capability, will mark another step toward just such a future. As shown in the "UAS Missions Roadmap" (Figure 6.2-1), two major 'families of missions,' one emphasizing payload capacity and persistence and the other autonomy, survivability, and weapons employment, need to drive UAS design and development over the next 25 years. A start in these two directions has been made, as shown by the examples of ongoing UAS programs that may eventually supplement manned aircraft in the roles shown in Figure 6.2-1.

The first family of missions (shown in the upper half of Figure 6.2-1) employs endurance UA as communication relays, SIGINT collectors, tankers, maritime patrol aircraft, and, eventually, airlifters. Design-wise, these roles may use one common platform or different ones, but they must provide significant payload capacities (power as well as weight) and endurances greater than 24 hours. The DARPA Adaptive Joint C4ISR Node (AJCN), with the potential to deploy a Global Hawk-based communication relay payload in the 2005-2010 timeframe, represents a significant step in the "payload with persistence" direction for UA. From there, the mission similarities of the AJCN and the Global Hawk imagery reconnaissance UA could be combined in an unmanned SIGINT collection platform by placing the mission crews ("backend") of the Rivet Joint, ARIES II, and Senior Scout aircraft in vans on the ground, as is accomplished for U-2 SIGINT missions today. The maritime patrol mission could be transitioned to UA in much the same way as for SIGINT collectors, by relocating the mission crew to the ground, as is planned in the Navy's Tactical Support Centers (TSCs) for the BAMS UA. The profile for aerial refueling, long duration orbits along the periphery of hostilities, resembles that of the SIGINT collection mission but adds the complexity of manned (receiver) and unmanned (refueler) interaction. Unmanned airlift hinges on overcoming a psychological and a policy barrier, the former being that of passengers willing to fly on a plane with no aircrew and the latter on foreign countries allowing access to their airports by robotic aircraft. An interim step to unmanned airlift could be manned aircraft that have the option of being unmanned. The technology to fly and taxi the large robotic aircraft required for such missions has been demonstrated; NASA flew an unmanned Boeing 720 in 1985, and Global Hawk routinely taxis at Edwards AFB.

The second family of missions (lower half of Figure 6.2-1) for future UA employs them in weapon delivery roles, graduating from electronic warfare to air-to-ground to air-to-air in complexity. The aircraft now in test for the J-UCAS program are just a start. Progress in the weapon delivery direction for UA, because of the large number of decisions in a short span inherent in these missions, hinges on development of increasing levels of autonomy (see Section 4.1).

# UAS ROADMAP 2005

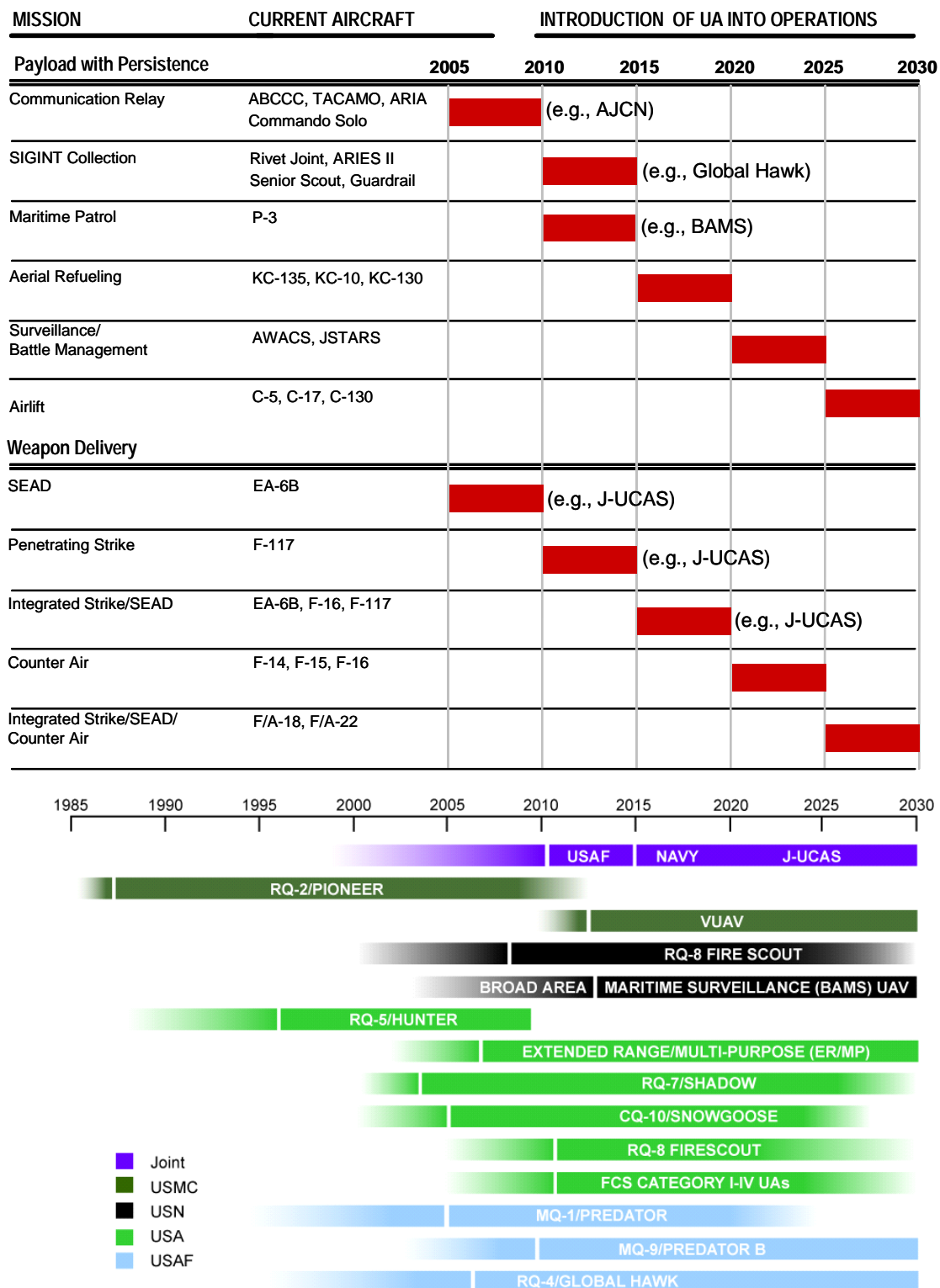

**FIGURE 6.2-1. UAS MISSIONS ROADMAP.**

## 6.3 GOALS FOR UNMANNED AVIATION

The following goals are consistent with the current SPG and are intended to promote transformational, interoperable, cost-effective unmanned aircraft across the Services. The goals that follow are at a detail

level below that appropriate for the SPG and may cut across existing Service acquisition programs and research projects. The SPG will always take precedence, however this document will be used to provide additional definition and guidance for UAS acquisition and research.

1. Develop and operationally assess for potential fielding a joint unmanned combat aircraft system capable of performing SEAD/Strike/Electronic Attack/ISR in high threat environments. (OSD, USAF, USN)
2. Field secure Common Data Link (CDL) communications systems for aircraft control and sensor product data distribution for all tactical and larger UA, with improved capability to prevent interception, interference, jamming, and hijacking. Migrate to JTRS/SCA compliant capability when available. (OSD, USA, USAF, USN, USMC)
3. Ensure compliance with the existing NGA meta data standard for all full motion video capable UA. Operationally demonstrate and field near real time (<3 minutes) UAS meta data derived targeting capability for coordinate seeking weapons. (OSD, USAF, USA, USN, USMC)
4. Foster the development of policies, standards, and procedures that enable safe, timely, routine access by UA to controlled and uncontrolled airspace, to include:
  - promoting the development, adoption, and enforcement of industry-wide airworthiness standards for the design, manufacturing, testing, and employment of UAS (OSD)
  - coordinating with FAA procedures for operating DoD UA in unrestricted airspace comparable to those of manned counterparts (i.e., aircraft, light-sport aircraft, and radio-controlled model aircraft) (OSD)
  - developing and fielding the capability for UA to “see” and autonomously avoid other aircraft providing an equivalent level of safety to comparable manned systems (USAF, USA, USN, USMC)
5. Improve Combatant Commander UAS effectiveness through improved joint service collaboration. (OSD, JFCOM, USAF, USA, USN, USMC)
6. Develop and field reliable propulsion alternatives to gasoline-powered internal combustion engines on UA, specifically their replacement with heavy fuel engines. (OSD, USAF, USA, USN, USMC)
7. Improve adverse-weather UA capabilities to provide higher mission availability and mission effectiveness rates. (OSD, USAF, USA, USN, USMC)
8. Ensure standardized and protected positive control of weapons carried on UA. Develop a standard UAS architecture including weapons interface for all appropriate UA. (OSD, USAF, USA, USN, USMC)
9. Support rapid integration of validated combat capability in fielded/deployed systems through a more flexible test and logistical support process. (OSD, JFCOM, USAF, USA, USN, USMC)

### 6.4 FUTURE DIRECTIONS

Although this Roadmap is specifically focused on the Department’s UAS development and fielding efforts, a much larger perspective is emerging requiring a guiding document similar to the UAS Roadmap. This larger perspective is to encompass all unmanned systems, whether UA, Unmanned Ground Vehicles (UGVs), or Unmanned Marine Vehicles (UMVs). This family of emerging technology and capability shares many similar attributes and will in all likelihood operate in close coordination, even



as a team. Many of the efforts within the UA realm have equal interest and application for other unmanned systems within the Department. To facilitate coordinated future development of technologies and common operational issues, related unmanned systems Roadmap documents are posted at the following locations:

- UGVs are addressed in the Joint Robotics Master Plan at [http://www.jointrobotics.com/activities\\_new/masterplan.shtml](http://www.jointrobotics.com/activities_new/masterplan.shtml)
- UMVs are addressed in the Navy Unmanned Underwater Vehicle (UUV) Master Plan at NIPRNET [http://www.onr.navy.mil/02/baa/expired/2001/baa01\\_012/pip/docs/uuvmp.pdf](http://www.onr.navy.mil/02/baa/expired/2001/baa01_012/pip/docs/uuvmp.pdf)

The requirement for interoperability *among* UA is equally important for *between* UA and manned systems as well as other unmanned system types. The need for an UA to communicate and interact with a UGV is not far off. The Army's FCS program is exploring such concepts. In all likelihood, future UUVs may themselves deploy UA to extend their capabilities and improve overall system performance. Small UA that become unattended ground sensors will blur the distinction between the classes of unmanned systems. These simple examples argue that, to the maximum extent possible, the common UA vehicle interface now in development should be investigated for applicability to other unmanned systems. The ultimate goal is seamless integration into the battlespace of humans and unmanned, UA or otherwise, systems.

Broad efforts to establish and expand interoperability and standardization will support overall unmanned systems interoperability. Global Information Grid initiatives will establish communications standards and provide infrastructure and components to support net-centric sharing of data among platforms. Joint Command and Control interfaces will provide standard message sets and procedures for exchange of situational awareness and taskings among unmanned systems platforms. ISR and other application specific data and product standards will further support the exchange of relevant information, with horizontal fusion initiatives in particular providing a major multiplier effect through a coordinated application of resources across diverse platforms. Unmanned systems developers must engage and build upon these broader efforts to provide the greatest level of interoperability, as required to support unified operations.

Several ongoing service and industry activities are specifically focused on unmanned systems interoperability. For example, the Joint Robotics Program (JRP) is focusing on the technology required to enable tightly coupled UA and UGV assets to deliver a significant portion of the warfighting capability envisioned for the Army's FCS. The JRP has established a working group and produced a draft Joint Architecture for Unmanned Systems (JAUS). Initially developed to support ground systems, the JAUS architecture has been expanded to extend across the full spectrum of unmanned systems. Several DARPA ATDs are focusing on the integration of UGVs and UA. In general, efforts to integrate across the unmanned systems domain to date have been very limited.

The Department is taking a much broader view of the entire unmanned systems landscape and the opportunities that exist for military transformation. Clearly this is a technology realm that is difficult to predict. However, several overarching concepts seem to appear.

- Integration within unmanned systems (and with manned systems) will be high, necessitating a greater degree of interoperability from the outset, not added later as an afterthought.
- The trade space between capability and cost will become much greater, offering a wider range of options, but producing much more complex and integrated systems, challenging our current "platform" focus on weapons acquisition.
- Unmanned systems may be grouped more by technology, and less by traditional classifications; i.e. small UA may have more in common with UGVs than with larger UA

- Unmanned systems needs a Roadmap to focus development and employment and maintain critical interfaces with both manned and other unmanned systems.

It is the goal of the Department to develop a broad Unmanned Systems Roadmap that serves as an umbrella document covering all unmanned systems roadmaps, including this document, to assure appropriate interfaces are maintained. This will be a challenge. However, to do otherwise squanders a tremendous opportunity to transform the United States' military capability to allow more precise, lethal, and rapid employment of force with reduced risk to humans at lower acquisition and sustainment costs.





# Appendices





## APPENDIX A: MISSIONS

### OVERVIEW

This appendix will review the use of Unmanned Aircraft (UA) platforms across many mission areas. Each mission area review has a summary that includes objectives and guidance for critical technology research and development. The reader should also perceive the following themes:

- UA have matured to the point where one no longer needs to “look for niche missions.” United States aerospace and software industries are world leaders. The U.S. can develop a UA to accomplish almost any mission imaginable. Instead of asking, “Can we find a mission for this UA?” one will ask “Why are we still doing this mission with a human?” The correct course of action will be determined by the analysis of the available capabilities to achieve the desired effect and best value for each mission.
- Look for commercial answers to achieve the best value and satisfy Strategic Planning Guidance (SPG). A 50 percent solution tomorrow is often better than a 70-80 percent solution in three years and better than a 95 percent solution in 10 years. Commercial solutions avoid using defense development dollars, which provides the opportunity for other developments, and offers the concept of “consumable logistics.” The theory being “Why pay for any significant sustainment when you can buy a new and improved item three years from now (e.g., desktop computer, VCR, toaster, vacuum cleaner, DVD player)?”
- Systems engineering principles must be applied to any government developed solution. Designs and trades start with understanding the desired effect. Ensure the development of any UA platform starts first with a thorough understanding of the mission it will accomplish. Do NOT make a UA, and then find a mission for it. Do NOT design a low-observable aircraft, and then try to figure out how to make it do a strike or suppression of enemy air defense (SEAD) mission.
- Continued miniaturization is resulting in a migration of capability from larger to smaller platforms. For instance, the sensor capabilities first demonstrated on the RQ-1A Predator in 1994 are now available on the RQ-7 Shadow. Moore’s Law “like” evolution will continue to push more capability to smaller and smaller platforms as progress is made through the next two decades.
- Small UA have the potential to solve a wide-variety of difficult problems that may be unaffordable by trying to find solutions with traditionally larger platforms.

The UA platform is the most apparent component of a modern UA system and in most cases can be considered the “truck” for the payload. Platforms can vary in size and shape from the Micro Air Vehicle (MAV) with a wingspan of inches, to behemoths with wingspans greater than 100 feet. Platforms accommodate the payload requirements, e.g. size, weight, and power; and platforms are designed with the capabilities required for the environment in which it will operate. Speed, endurance, signature, survivability and affordability are factored together to provide integrated solutions to meet mission requirements.

While the platform is the most visible component of a UA system, in the broad perspective, the platform needs to become less of a long-term sustainable resource. Replacement or modification of platforms are expected to increase as more emphasis is placed on spiral acquisition and integrated capabilities. It is unlikely that sustaining UA airframes for more than a few decades will be cost effective. Where appropriate, the Department of Defense (DoD) will encourage the treatment of UA systems as consumables. This could avoid the establishment of large sustainment structures. If users can adapt tactics and doctrine to accommodate a commercially available item, then this can provide DoD with affordable alternatives to the legacy cycle of develop-produce-sustain.

Legacy and contemporary use of UA platforms have established two intrinsic advantages DoD will continue to capitalize on when solving mission area problems. First, the UA can provide a level of persistence that far exceeds the human capacity to endure. Second, removing the human from the aircraft

provides options for risk taking and risk avoidance not previously available. Combined, these tenets continue to offer transformational opportunities. “Cost” can no longer be considered an advantage unique to any unmanned vehicle. History has taught that if UA are going to fly regularly in any nation’s controlled airspaces, then those UA must functionally meet the same “reliability” standards as manned aircraft. As a result, the cost per pound of unmanned becomes practically the same as manned. However, this implies if a “class” of UA does not have to fly in controlled airspace, and thus does not need to be certified to the same reliability levels, then the advantage in the design process results in cost/pound production savings. This appears to be applicable to some small UA, and potentially all of the MAVs. It suggests a potential for staggering life-cycle cost savings if the procurement of these aircraft can be treated as a consumable item.

### **MISSION**

UA have “turned the corner” with regard to mission application. DoD no longer needs to search for niche missions for UA. Supported by government laboratory research, the U.S. aerospace and software industries are world leaders and understand the science, engineering, and art required to develop and produce world-class UA capabilities. For the next 25 years, DoD will focus the labs and industry on the following mission areas: intelligence, surveillance, and reconnaissance (ISR), SEAD, destruction of enemy air defense (DEAD), electronic attack (EA), anti-surface ship warfare, anti-submarine warfare, mine warfare, ship to objective maneuver, communications relay, and derivations of these themes. Offensive and defensive counter air and airlift missions will remain on the “to do” list, awaiting improvements in autonomy and cognitive capabilities.

### **Intelligence, Surveillance and Reconnaissance**

“*Strategic Planning Guidance for Fiscal Years 2006-2011*,” places a premium on the ISR mission area to enable successful strategies against “irregular” and “catastrophic” threats. The unique advantages of UA will provide a growing contribution to success in these areas.

The airborne ISR mission can be divided into three distinct segments: “standoff,” where collections are made while recognizing the sovereign airspace of other countries; “over flight,” where ISR platforms fly in the sovereign airspace of another nation, with or without consent, but at low risk to the mission; and finally, “denied,” which is similar to “over flight” except the nation-state being flown against possesses a credible capability to deny access to their territory. Space assets are usually employed globally in “denied” access roles; however space assets cannot conduct “unwarned” collection. This means adversaries know when satellites will come above the horizon, and take appropriate action to deny collection opportunities. Only aircraft currently possess the ability to show up at a specific time, (unwarned). Together space and airborne systems provide a collection architecture that can compliment each other to fill gaps and provide information dominance. The UA advantages of “persistence” and “no human on-board” provide significant opportunities to achieve to an “unwarned” collection capability. This addresses the portion of the problem relating to getting an asset in position to collect. However, there remain other serious ISR problems before a total solution exists.

Even if DoD can get a collection asset in the right position to collect, the problem still remains of trying to discriminate camouflaged and deeply buried targets. Small UA may provide answers where large platforms with large expensive sensors cannot. New capabilities and/or new paradigms will need to be explored. At the same time, integration of new capabilities with the Global Information Grid and with multi-national programs into a net-centric force will be mandated. As new capabilities are developed for these difficult problems, proper systems engineering principles must be applied to achieve the best value. DoD must emphasize development as a “system,” and not as an aircraft in search of a mission. System trade-space must be understood at the beginning. A robust design that can accommodate a wide variety of simultaneous sensors may be very flexible, but it could also be extremely expensive to produce and sustain. Trade studies need to be made between these robust concepts and cheaper “dedicated” capability concepts. The later affords commercial industry an opportunity to provide alternative solutions that can

be treated more like a consumable, thus providing an opportunity to significantly reduce overall life-cycle costs to DoD. Greater strategic potential lies in an 80 percent solution now, rather than in a 95 percent solution many years from now. Quicker solutions using less fiscal resources afford investment opportunities in other areas that promote the potential for further strategic advantage.

- Stand-off. During peacetime, the majority of airborne land and littoral ISR missions are accomplished using standoff techniques. The standoff mode is also used during military operations when the risk is too great to expose platforms to a high probability of loss, or political sensitivities mandate constraint. Standoff UA designs need to emphasize the attribute of long endurance in order to achieve the effect of persistence. If broad area coverage and/or extremely long-range sensor performance is required, then high altitude capability must also be emphasized. Otherwise altitude performance should be dictated by the other requirements factors. Additionally, while it is possible to equip a large UA with an impressive suite of imagery and signals intelligence sensors simultaneously, the question must be asked if this is the most efficient way to achieve the desired effect. Lastly, while imagery, signals and measurement sensors generally have performed well in the standoff role, they face limitations against weak signals and very high resolution imagery requirements. Weak signals are extremely difficult, expensive and possibly unaffordable for stand-off platforms to collect. These type sensors should be employed on platforms that can get close to, or over fly the targets, which can substantially reduce the complexity and cost of the sensing technology used. Alternatively, small UA could be deployed to get in close and collect the very high resolution imagery and achieve greater success against the weak signals.
- Overflight. As discussed above, there are some cases where over-flight for collection purposes are required. This can occur during peacetime where political conditions support such missions such as, maritime surveillance, peacekeeping or GWOT, or in combat where a sufficient reduction in hostile air defenses has occurred. There is no over-arching set of capabilities required for overflight, as there is in the stand-off or denied access roles. If persistence is desired, then typically this would be achieved via long-endurance attributes between airframe shaping and engine choice. Altitude would likely be dictated by the mission equipment being employed. For collections against very faint signals, or requiring very high degrees of resolution, then medium to low altitude UA are probably the better choices. However, this introduces weather as a design consideration since medium to low altitude aircraft must operate in areas often plagued with icing and turbulence. Once again, small UA should be considered in trade analysis because they can maneuver “under the weather” as well as get very close and use low cost technology to get high resolution results.
- Denied access. In limited cases, access to denied areas is required to support combat or national requirements. Generally this is achieved from space; however it is advantageous to have an airborne penetrating capability that arrives “unwarned” to prevent an adversary from denying collection due to the predictable nature of orbiting systems. Previously, the DoD used manned platforms, most notably the U-2 and SR-71 although many other manned platforms of various types have been used on occasion. Clearly the disadvantage of manned platforms in a denied access collection role is the potential for loss of the aircrew and the diplomatic situation that would result (e.g., EP-3 incident). As a result, UA are better suited to this mission area and have seen limited action in the past (e.g., D-21 and AQM-34 Firebee drones). In the 1990s, the DarkStar UA system was developed using a different design philosophy than its predecessors. However, it never reached operational capability. system was developed and operated in this environment. The DarkStar’s primary platform attribute, survivability, must be the primary one of any UA designed for use in denied airspace. Generally this dictates reduced signature with considerations for operating speed and altitude. Designing an ISR system to operate in the denied environment is more difficult than designing a strike system because the ISR system will complicate signature reduction by the incorporation of sensor apertures in numerous places across the platform. The design of such platforms will have to strictly adhere to system design principles and trades to achieve the desired effect when employed. The 2003 Defense



Science Board and 2003 Air Force Scientific Advisory Board results both observed that a UA capable of unwarned collection is needed by DoD.

ISR summary. UA have an established and growing track record supporting the ISR mission area. Reconnaissance UA have been used to experiment and bridge into other mission areas (such as strike – see next Section). Endurance will always be a hallmark of the UA design when supporting ISR; however the “denied access” mission will require some design trades against the endurance principle. The concept of using miniature UA to conduct collection against weak signals or obtain very high resolution results is an emerging capability that deserves increased emphasis. Next, trade studies need to be conducted to determine if multi-mission, versus dedicated mission, platform designs are the most cost effective approach for every application. Lastly, opportunities must be sought to take advantage of the growing commercial market to solve DoD problems.

### **Strike/Suppression of Enemy Air Defense**

Actions in Operation ENDURING FREEDOM (OEF) and Operation IRAQI FREEDOM (OIF) have shown the value of arming UA. Lightweight weapons on long endurance platforms like the MQ-1 Predator make possible rapid reaction to fleeting targets, a mission that is more accurately termed “armed reconnaissance” and can be considered a sub-set of the Strike mission, possibly the first example of “persistent strike.” This capability plays more on the endurance and surveillance capability of the UA than on its weapons prowess. However, UA are being developed to carry greater payload load-outs, with greater variety to offer greater strike flexibility to warfighters. The Air Force’s MQ-9 Predator development is an example of a movement in a direction of greater weapons capability while retaining its reconnaissance and endurance capabilities. This kind of armed reconnaissance or persistent strike capability is crucial in executing GWOT missions. Strategic Planning Guidance has made reducing risk in GWOT its top priority.

The joint Air Force-Navy development of J-UCAS is the first example of a net-centric UA system where significant weapons employment flexibility is a design requirement. Besides the strike mission, the J-UCAS program will provide a UA capable of operating in the SEAD role. The SEAD role will also emphasize survivability as a key design requirement. As opposed to the armed reconnaissance or strike against lightly defended targets, the SEAD mission makes significantly greater survivability demands on UA developers because of its intended use in denied airspace. Understanding the design trades required to develop an effective capability is critical to holding down acquisition costs. A robust system engineering effort is paramount.

UA have two attributes that are attractive for the SEAD, strike, and armed reconnaissance missions when compared to manned assets:

- Eliminate risk of the loss of an aircrew
- Potential for greater survivability by reducing signatures through optimal shaping not possible with traditional manned aircraft design and through greater maneuverability (beyond human tolerance)

These attributes can be used to improve operational effect, or reduce cost while maintaining the same level of operational effect. The Strategic Planning Guidance specifically directs acceptance of “...increased risk and/or undertake initiatives to achieve substantial savings...” However, before UA can be used to improve effect or lower cost in the strike/SEAD mission area, there are several challenges that must be met:

1. Rules of engagement (ROE) considerations that may require the intervention of a human operator.
2. The prosecution of advanced integrated air defense systems (IADS) targets and time critical targets through an as yet unperfected automatic targeting and engagement process or by a human operator outside the vehicle.

3. The integration, interoperability, and information assurance required to support mixed manned/unmanned force operations.
4. Secure, robust communications capability, advanced cognitive decision aids, and mission planning.
5. Adaptive autonomous operations and coordinated multi-vehicle flight.

Strike, persistent strike and armed reconnaissance missions may be against heavily or a lightly defended targets. The level of threat determines which UA attribute is most influential in the design. If the requirement is to engage and defeat lightly defended targets, then a conventionally designed UA would stress payload and aero performance to achieve the most efficient “kill” capability. The ability to provide a persistent threat against adversaries will stress endurance as a design feature in the lower threat environments. If prosecution of highly defended targets is required, then a design stressing survivability is paramount, and often will trade away payload and aerodynamic performance to achieve greater certainty of success against highly defended targets. This trade is required to ensure “anti-access” targets (targets that deny use of conventional joint force assets) are eliminated early in a campaign so the Joint Force Commander can use the full range of forces at his disposal and achieve desired effects as swiftly as possible. (Strategic Planning Guidance: “Swiftly defeat adversaries in overlapping military campaigns while preserving for the President the option to call for a more decisive and enduring result in one of the two.”)

UA would be used against heavily defended targets for two reasons. First, a UA can theoretically achieve levels of survivability that manned aircraft cannot. Signature control without the need for human caretaking becomes less difficult, and maneuverability could be increased beyond human tolerances should that be required to enhance survivability. The design driver for this case is survivability, however it is achieved. If such survivability measures fail, the use of a UA removes the risk of losing a human life.

Previously, DoD has tended toward multi-mission configurations where one platform would accomplish both/many missions (e.g., the multi-mission platform). It should be noted that a UA designed to be cost effective for both lightly and heavily defended targets would be of sufficient size that it would no longer be a low cost solution. A trade analysis would be required to determine if one multi-mission UA should be procured, or if a range of separate UA for each mission is a better value.

If a UA are to reduce the numbers of manned strike assets required, it will have to offer a weapons compatibility mix similar to that of manned strike assets in order to keep overall armament development and support costs low. Additionally, UA must be examined for every opportunity to further reduce operations and support costs. Operational data is available for many UA as a result of OEF and OIF. Analysis is required to determine where savings can be achieved, or how they could be achieved if proper Doctrine, Organization, Training, Materiel, Leadership, Personnel and Facilities (DOTMLPF) is applied. J-UCAS should conduct such an analysis as part of its Operational Assessment to ensure the program implements these lessons learned during its system development and demonstration phase.

SEAD may be analyzed as two different types of missions. The first is pre-emptive SEAD, in which a pathway is cleared prior to the ingress of strike aircraft. The other type is reactive SEAD, in which the SEAD asset must react rapidly to “pop-up” enemy air defense threats during the execution of a strike. Since closing with that threat will be required, the survivability of the vehicle must be assured through a combination of speed, stealth technology, and/or high maneuverability.

Execution of both the pre-emptive and the reactive SEAD mission imply several critical design criteria for the UA platform and mission control system. These attributes would be similar to those of a UA in a strike roll against heavily defended targets. UA accomplishing pre-emptive SEAD missions would also be expected to possess the following system characteristics:

- Extremely high mission reliability, as follow-on force assets (many of which will be manned) will depend upon the protection of a SEAD UA asset.

- Battle damage assessment (BDA) so operational commanders can properly determine whether strike “go/no-go/continue” criteria have been met.
  - If BDA is organic this reduces the reliance on other systems outside the SEAD UA platform, but puts other design requirements on the SEAD UA that complicate signature control.
  - If BDA is not organic then this simplifies the SEAD UA design requirements, but complicates the integration of other ISR capabilities as a family of systems attempting to achieve effect in the SEAD mission.
- Weapons optimized for concept of employment. If using direct attack munitions (short range), then a robust signature reduction design, or stand-off weapons with appropriate support from on-board or off-board sensors to find, fix, track and target intended threats must be employed.
- The use of direct attack munitions is a major cost avoidance compared to the integration and use of stand-off weapons.
- However, stand-off weapons provide an opportunity to relax signature design requirements and thus avoid significant low-observable costs.

Execution of the reactive SEAD mission implies further design criteria:

- Enemy defensive systems’ operations must be detected rapidly implying an onboard capability to detect threats, or a well integrated system of systems.
- Reaction time from detection to neutralization of the enemy defenses must be very short (seconds).
- When using weapons to neutralize defenses, the flight time of the weapon must be reduced by the ability to stand in close to the target (high survivability) or by the use of a high-speed weapon.
- Robust, anti-jam, data links are required.
- Reactive SEAD will require low latency human interaction with the system – or high autonomy within the system for determination of ROE criteria.
- Reactive SEAD implies the integration of manned and unmanned aircraft in a single strike event.

Strike/SEAD summary. The era of UA contribution to strike missions has arrived and SEAD missions are just dawning with the J-UCAS program. Availability will add new options in the application of force, and promises to reduce the cost of our armed forces. It should be noted, that for the foreseeable future UA are not a complete replacement for manned aircraft. UA can bring enhancements to mission capability (e.g. risk-free close approach to heavily defended targets) but will continue to only satisfy a portion of the many missions strike assets cover. Close air support is an example of one such area where the use of a UA to deliver ordnance in very close proximity to friendly forces will face technical, employment, and cultural barriers that imply that manned aircraft programs must continue to provide the solution, at least for the near- and mid-term. There will be an impact on the total numbers of manned systems that must be acquired.

### **Electronic Attack**

EA is the use of electromagnetic energy to prevent or reduce an enemy’s effective use of the electromagnetic spectrum and employment of weapons that use either electromagnetic or directed energy as their primary destructive mechanism. Many of the attributes that make UA attractive for SEAD also make them attractive for the EA mission because UA can theoretically achieve levels of survivability that manned aircraft cannot. Signature control without the need for human caretaking becomes less difficult. Additionally, maneuverability could be increased beyond human tolerances to enhance survivability. Finally, as stated before, should survivability measures fail, the use of an unmanned system removes the risk of losing a human life – arguably one of the strongest reasons for using a UA in a combat situation. Many challenges remain for developers and tacticians, but the EA mission is being considered for both the Air Force’s and Navy’s J-UCAS. EA concepts of employment may include jamming or employment

of expendables. In developing unmanned systems for the EA mission, the following attributes are being considered:

- The ability to build a very stealthy unmanned vehicle could mean closer approaches to targeted systems, requiring less radiated power to complete the EA mission, and the ability to detect and exploit much lower levels of targeted system radiation.
- The potential use of high power directed energy (DE) weapons or electro-magnetic pulse (EMP) weapons in future EA missions argues for the use of an unmanned platform, since the weapon may pose a significant risk to the crew of any delivery vehicle.

The use of unmanned systems in the EA mission also brings several challenges:

- When using EA to neutralize defenses in support of manned strike forces it will be critical for the SEAD UA to be within sufficient range to be effective. A trade-off between EA effectiveness and survivability needs to be fully understood in a systems engineering trade.
- An UA is more dependent upon outside communications than manned systems. Self-jamming (interference with command and control communications by electronic attack emissions) could limit the ability to change the unmanned system's planned mission once the electronic attack has begun.
  - The potential for self-jamming and increased vulnerability due to a dependence upon communications mean a great degree of autonomy will be required in the unmanned EA system.
- A manned EA aircraft provides the ability for a trained crew to evaluate large amounts of tactical data on the threat environment and to change the mission plan as required for strike support. The appearance of previously unknown threat defensive system modes, frequencies, or tactics may only be detected by the human operator's ability to recognize patterns in the context of previous experience – a very difficult, and as yet undeveloped, ability for autonomous systems.
  - Without the development of autonomous EA operating capability, the transmission of large amounts of data, describing the tactical environment, must be provided to remote human operators in real time. These large transmissions would be limited by available bandwidth and self-jamming and could increase the unmanned system's vulnerability.
- A signature-controlled vehicle loses the advantage of stealth when radiating. "Home On Jam" threat systems could put the unmanned EA aircraft at risk.
- Execution of the Electronic Attack mission implies several critical design criteria and questions for the unmanned platform and mission control system:
  - Mission reliability must be extremely high, as manned assets will depend upon the UA for protection.
  - The trade-off between effective apertures for the radiation of jamming electronic energy will have to be balanced against the negative impact on the signature and survivability of the unmanned system.
  - The EA mission will require a highly autonomous system that can operate and handle aircraft-related and mission-related contingencies while unable to communicate with the mission control system (due to self-jamming and covert operations).
- Reaction time from detection to neutralization of the enemy defenses must be very short.
  - Enemy defensive system operations must be detected and countered rapidly.
  - When using EA to neutralize defenses in support of manned strike forces, it will be critical for the UA to be within sufficient range to be effective. A trade-off between EA effectiveness and survivability needs to be fully explored.
- The EA mission implies the integration of manned and unmanned aircraft in a single strike event.
- Robust, anti-jam data links are required.

- The amount of energy required for effective EA is large unless the delivery platform is in very close proximity. The ability to generate this large amount of power could drive up aircraft size and cost. In addition, an aircraft small enough to be unobserved in close proximity to the target may not have the mobility (speed and range) to close the target or to persist in the target area for a sufficient amount of time. These considerations argue for the use of expendable jammers from unmanned aircraft as one means of delivering low cost EA performance.

Electronic Attack summary. DoD is advancing the development of an EA UA capability. Initial study indicates that there are both significant potential unmanned system strengths and significant challenges to be overcome for this mission. New unmanned systems will add new options in the application of force, and promises to both reduce the cost of our armed forces and to decrease the risk of friendly losses. It should be noted, that unmanned EA systems are not a complete replacement for manned EA aircraft. An unmanned EA aircraft can bring enhancements to mission capability (e.g. risk-free close approach to heavily defended targets) but will not have the autonomy required to completely replace manned systems in the foreseeable future. Research in autonomy will remain an emphasis area.

### **Network Node/Communications Relay**

It is anticipated that communication relays will need to exist in a multi-tiered structure. For example, to create a wide communications footprint, the UA platform must have a capability of extremely long endurance, high altitude, and generate adequate power. It would provide an airborne augmentation to current tactical and operational beyond line-of-sight and line-of-sight retransmission capability. A more focused footprint to support brigade and below combat elements will require tactical communication relays to address urban canyon and complex terrain environments. Support of the communications relay mission will require continuous coverage in a 24 hour period, and sufficient redundancy to meet “assured connectivity” requirements. Additionally, UA must be capable of relaying VHF-AM radio voice communications using an International Civil Aviation Organization (ICAO) standard and recommended procedures (SARPs) compliant radio operating with 8.33 kHz channel spacing from the control station to airspace controller communication (threshold).

The “shoulds and should nots” of an airborne communication node payload will be established by requirements documentation and approved in the Joint Staff requirements process. Any airborne communications node is likely to be a “Joint Program” due to the broad user base accessed by such systems. The inclusion of legacy formats and architectures will be established in any approved requirements document and receive input from the Assistant Secretary of Defense for Network Integration.

Network node/comms relay summary. Payload requirements must be defined and meet all interoperability and network centric standards. Platform must stress availability of electrical power to provide sufficient throughput capacity that supports modern warfare requirements. Technology push in power extraction apertures and auxiliary power production needs to be emphasized.

### **Aerial Delivery/Resupply**

The Special Operations community has been the leading advocate for using UA to delivery leaflets for its psychological operations (psyops), as well as to resupply its forces in the field. Dispensing leaflets has traditionally been performed from C-130s, but the altitudes required to ensure aircrew safety tend to scatter the leaflets over a wide area and reduce their effectiveness. Small SOF teams have to carry all of their equipment and supplies on their backs when they deploy, and the weights of dense materials (water, bullets, batteries) greatly reduce their mobility. USSOCOM has explored using UA for both of these aerial delivery/resupply missions.

To address its psyops mission, USSOCOM developed the CQ-10 SnowGoose unmanned, powered, guided parasail (see section 2.3.5), capable of delivering 575 lb of leaflets with a 3-hour endurance, during the successive Wind Supported Aerial Delivery System (WSADS) and Air-Launched Extended

Range Transporter (ALERT) ACTDs. The CQ-10 became operational in 2005, addressing a USSOCOM Operation Capability Requirement dating back to 1996 and recurrent IPL priorities. Its six cargo bins can also be used to deliver resupplies. Although the CQ-10 can take off from the ground and can fly round-trip psyops missions, it is primarily a one-way delivery system when used for resupply. A second UA project, Skytote, was a joint AFSOC and AFRL SBIR effort with AeroVironment to develop a returnable VTOL UA for the resupply mission.

The requirements for the aerial delivery/resupply mission by UA--payload capacity, low signature, and precision, unaided 'spot' landing capability--differ from the emphasis placed on endurance and sensors for most other UA. Besides the obvious requirement for a high payload fraction (41 percent of gross weight for the CQ-10), USSOCOM's needs require a low probability of detection to avoid compromising the presence of the SOF team in denied regions, all-weather/night operation, precision landing to allow delivery to small SOF boats or into confined spaces, unaided landing to avoid imposing added training or compromising emissions, good standoff range to ensure aircrew safety, and low cost to allow for disposal if one-way resupply is tasked.

In addition to USSOCOM, both the Army and Marine Corps have explored using UA to deliver material in high threat/risk environments. The Army's Medical Corps examined employing small UA to deliver urgent medical supplies to forward areas in a recent ACTD (Quick Meds). The Marine Corps converted a K-Max helicopter to unmanned operation for its Broad-area Unmanned Responsive Resupply Operations (BURRO) project that tested ship-to-shore and ship-to-ship resupply in 2000-2002. Both projects demonstrate that, as forces transition to being more mobile and independent (i.e., less tied to traditional logistics chains), UA offer a viable solution to their accompanying requirement for just-in-time logistics.

Aerial delivery/resupply summary. Covert delivery of supplies into denied areas certainly qualifies as an ideal mission for UA under the 'dangerous' rubric. The mission requirements to fly low and quietly to avoid detection over significant standoff distances and land unaided and precisely can be met with available technologies. Future technology could best be applied to reducing such systems' probability of detection. In the larger sense, UA could serve as a transformation enabler for the focused logistics needed by future forces.





## APPENDIX B: SENSORS

### OVERVIEW

Sensors now represent one of the single largest cost items in an unmanned aircraft; for example, the MTS-A EO/IR sensor, currently being retrofitted to the MQ-1 Predator aircraft, costs nearly as much as the aircraft alone. In a similar fashion, today Global Hawk's RQ-4 Block 10 Integrated Sensor Suite (ISS) represents over 33 percent of the aircraft's total cost; with the integration of a multi-int sensor package into the RQ-4 Block 20 model of Global Hawk, the estimated percentage rises to 54 percent. More demanding operational information needs, such as identifying an individual from standoff distances or detecting subtle, man-made environmental changes that indicate recent enemy activity, demand a higher level of performance than that provided by the current generation of fielded UA sensors. At the same time the demands placed on UA sensors increase, with commensurate cost increase, UA are also being employed in those exact situations where UA *should* be used – where there is significant risk for loss of the sensor. As the demand for sensor performance continues to grow, coupled with operational risk to the platform, the need to take steps to control cost growth, as well as to efficiently plan future sensor payloads that take advantage of commonality wherever possible, becomes a “must” for UA acquisition.

Ideally, wherever possible, different UA should use the same sensor systems for similar mission requirements. When actual system commonality is not possible, perhaps due to size, weight, or power considerations, commonality at the high valued subcomponent level, such as focal arrays, optics, apertures (antennas) or receive/transmit elements for radar systems, can reduce overall sensor costs by increasing the quantity buys of these critical, often high cost items.

Regardless of sensor or subcomponent commonality, it is imperative that sensors produce data and relevant metadata in a common, published, accepted format, in compliance with DoD's Network Centric Data Strategy, to maximize the utility of the products from UA. OSD is keenly interested that the Services take steps to bring existing UA systems into compliance with existing data standards to enable the application of net-centric operational concepts. An emphasis on system commonality and compliance with data standards will maximize the return on investment that new generation sensors represent.

While improved sensor technology provides new mission capabilities, such as the rapid, accurate mapping of terrain from UA-borne Interferometric Synthetic Aperture Radars (IFSAR) or detection of recent human activity from stand off ranges using video-based object level change detection or radar-based coherent change detection, the value of this new data is enhanced by integrating or fusing it with other information sources, demanding a need to share product over potentially large geographic distances. Similarly, both OEF and OIF have demonstrated the operational benefits of performing missions using “reachback”; that is, launching the UA in theater, but actually flying the mission and retrieving the sensor's data from back in CONUS. As DoD's Global Information Grid (GIG) initially provides the transport layer communications resources in support of this operational concept (see Appendix C), sensors need to be developed with the idea in mind to combine sensor products together in innovative, novel, and perhaps currently unanticipated ways to perform the more demanding mission facing DoD forces today. With the continuing advances in on-board processing capabilities, it will become necessary to ensure that data from UA sensors are posted at the appropriate phases of processing to the GIG to enable other users to take advantage of the collected product and not restrict them to only using the processed product. It is the intent of OSD to work with the Services to help integrate UA data and data processing capabilities into the GIG, as it matures, while keeping sensor costs in check through coordinated development and acquisition plus adherence to common standards.

This appendix first reviews and defines the attributes associated with UA sensor systems, and then considers sensor technologies that will mature over the next 25 years and offer promise for UA applications. It also accounts for enabling technologies that will allow UA to fully exploit current and emerging sensor capabilities.



### Existing Sensors

Most current sensor programs are either flying on manned platforms, or are on a mix of manned and unmanned aircraft. Since there is very little that makes a sensor inherently “manned” or “unmanned”, this appendix contains both types. Very large, complex sensors flying on dedicated multiengine aircraft are not considered.

#### ***Video/Electro-Optic/Infrared (EO/IR) Sensors***

- Video. AF Predator and Army Hunter use real-time video systems mounted in turrets. While initial systems were derivatives of commercial products, retrofit with sensors and designators specific to military applications is underway. The Air Force is integrating the MTS-A EO/IR laser target designators/illuminators into Predator; in the same vein, the Army is planning to integrate a designator into Shadow (RQ-7B).
- Global Hawk Integrated Sensor Suite. The ISS consists of a SAR imaging radar with Ground Moving Target Indicator (GMTI) mode and an EO/IR sensor that produces still imagery.
- Senior-Year Electro-optical Reconnaissance System (SYERS 2), formerly SYERS P3I. Dedicated EO sensor carried by the U-2. A high resolution line scanning camera with a 7-band multispectral capability is in production.
- Advanced EO/IR UA sensor. A high resolution, highly stabilized EO/IR sensor being developed for Army UA by the Army’s Night Vision Electronic Sensors Directorate. It consists of a multi field-of-view sensor that will provide greater standoff ranges and highly stabilized gimbals that allow for an increase in the area of coverage. Its all digital output is Joint Technical Architecture (JTA) compliant.

#### ***Synthetic Aperture Radar (SAR)***

- Advanced Synthetic Aperture Radar System (ASARS 2A). Dedicated U-2 imaging SAR, capable of 1 foot resolution.
- Global Hawk ISS Radar. Dedicated Global Hawk, SAR capable of spot, search, and GMTI modes; 1-foot resolution.
- LYNX. A tactical radar, deployed in various configurations on both manned and unmanned aircraft, most recently on the Army’s I-GNATs. LYNX has a resolution of 4 inches in the spotlight mode, and provides GMTI and coherent change detection capabilities.
- TESAR. Tactical Endurance Synthetic Aperture Radar (TESAR) is a strip mapping SAR providing continuous 1 foot resolution imagery. TESAR is flown on Predator.
- Tactical UAV radar (TUAVR). A 63-pound SAR/MTI radar for use on Army UA. Provides 1 foot resolution imagery in strip and spotlight modes and an integrated GMTI capability. The radar has been demonstrated on Hunter UA.
- MISAR. Developed by EADS, this small, Ka-band radar weighs approximately 10 pounds. It has been demonstrated on the German LUNA UA as well as on U.S. helicopters.

#### ***Signals Intelligence (SIGINT)***

While there are many fielded SIGINT systems on airborne platforms today, most are designed specifically for the platform on which they are employed. Current UA operations have used “clip-in” kits, basically unique systems developed for a specific application; fortunately, many of these systems are reprogrammable and have the potential to be used for other applications.

#### ***Wet Film***

The U-2 maintains a medium resolution wet film capability with the Optical Bar Camera. Advantages of wet film include very high information density and releasability to non-DoD users. Broad area synoptic coverage is still the exclusive purview of wet film systems; without efficient digital mass storage devices, electronic sensors do not have the ability to capture imagery of broad areas nearly instantaneously, as wet

film can. Primary drawbacks to wet film are the lack of a near-real-time capability and the extensive processing facility needs. Improvements to film processing recently have drastically reduced the requirements for purified water, and the post-processing hazardous material disposal problem, but it still poses a requirement for specialized ground handling equipment. USAF will terminate funding for Optical Bar Camera operations and maintenance in FY08.

### **EMERGING TECHNOLOGIES**

Multispectral/Hyperspectral Imagery (MSI/HSI). Multispectral (tens of bands) and hyperspectral (hundreds of bands) imagery combine the attributes of panchromatic sensors to form a literal image of a target with the ability to extract more subtle information. Commercial satellite products (such as land remote-sensing satellite (LANDSAT) or Systeme pour l'observation de la terre (SPOT)) have made multispectral data a mainstay of civil applications, with resolution on the order of meters or tens of meters. Systems designed for military applications are beginning to be tested and in some cases fielded. Military applications of HSI technology provide the promise for an ability to detect and identify particulates of chemical or biological agents. Passive HSI imaging of aerosol clouds could provide advance warning of an unconventional attack. The obvious application for this technology is in the area of battlefield reconnaissance as well as homeland defense. Though this technology is less mature than HSI as an imaging system, it should none the less be pursued as a solution to an urgent national requirement. HSI also provides an excellent counter to common camouflage, concealment, and denial (CCD) tactics used by adversaries.

Presently, the U-2's SYERS 2 is the only operational airborne military multi-spectral sensor, providing 7 bands of visual and infrared imagery at high resolution. A prototype hyperspectral imager, the Spectral Infrared Remote Imaging Transition Testbed (SPIRITT), is in work at the Air Force Research Laboratory. This sensor is intended for testing on larger high altitude platforms such as Global Hawk, but could also be carried on the MQ-9 Predator. USAF has also demonstrated a near visual/visual band hyperspectral system in the TALON RADIANCE series of demonstrations, focused primarily on solving the "tanks-under-trees" problem.

The Army's Night Vision and Electronic Sensors Directorate (NVESD) is preparing to demonstrate a TUAV-class EO/IR sensor with minor modifications to give it multispectral capability. In addition, NVESD is developing the daytime Compact Army Spectral Sensor (COMPASS) and the day/night Hyperspectral Longwave Imager for the Tactical Environment (HyLITE) specifically for UA platforms at the brigade and division level.

The Naval Research Laboratory (NRL) developed the WAR HORSE visible/near-infrared hyperspectral sensor system, which has been demonstrated on the Predator UA. More recently NRL had developed a complementary short-wave-infrared hyperspectral sensor and has demonstrated the sensor on a UA surrogate platform (Twin Otter).

Other short- and long-wave infrared hyperspectral sensors are currently under development to provide a high-altitude stand-off capability for larger manned and unmanned platforms. DoD believes that hyperspectral imagery offers enormous promise.

HSI phenomenology/ground truth. The primary difficulty holding MSI/HSI sensors back from widespread employment is the lack of/fragility of the spectral signatures available to identify targets/phenomenology over a broad range of environmental and operational options. While there have been very successful demonstrations illustrating the wide ranging potential of the technology, many of these demonstrations relied on employment under specific illumination conditions (i.e., fly at nearly the same time each day, restrictions on cloud cover) and often required nadir operations to ensure uniform pixel shape although TALON RADIANCE has demonstrated off-nadir operation. Deviation from these constraints has historically resulted in unacceptable false alarm rates for target detection applications. To achieve even the results obtained to date, substantial on-board processing or a large data transfer capability to the ground processing element is necessary.

Civil and commercial work with multi- and hyperspectral imagery has built a phenomenology library that will greatly simplify introduction of these sensors onto manned and unmanned aircraft. Some data already exists in open or commercial venues to build characterization databases in anticipation of the sensors coming online over the next decade. To realize the benefits of hyperspectral imaging, DoD encourages the Services to characterize areas of interest with a view toward optimizing spectral band selection of dedicated military sensors. This will allow the development community to take advantage of recent advances in on-board processing capabilities and use products available now and in the near future. In a similar fashion, emphasis on developing signature processing systems, which take into account environmental (illumination) issues as well as non-uniform pixel size should also be investigated. This intelligence product represents an area in which characterization and processing of the data will be significantly more challenging than just building and operating the sensor.

**SAR enhancements.** SAR improvements are changing the nature of the product from simply an image or an MTI map to more detailed information on a target vehicle or battlefield. Current SAR systems can perform limited coherent change detection (CCD) showing precise changes in a terrain scene between images. Use of phase data can improve resolution without requiring upgrades to the SAR transmitter or antenna, through data manipulation with advanced algorithms. These and other advanced SAR techniques require access to the full video phase history data stream and are often very processing intensive. As processor capability continues to grow exponentially (Moore's Law), many of these capabilities will be automatically available on-board the sensor (such as Lynx's generation of CCD images); however, others will continue to require processing power or classified techniques that exceed the capacity of our current on-board systems. To take full advantage of these techniques, UA must plan for communications architectures capable of moving the required amount of data to the network for distribution and processing (see Appendix C). While modern intelligence collection places a premium on real-time data availability, on-board mass storage of data could at least allow post-mission application of advanced data handling procedures requiring full phase history information.

The Multi-Platform Radar Technology Insertion Program (MP-RTIP) should result in a more capable SAR active electronically steered antenna (AESA) within this decade. Larger UA, such as Global Hawk for the Air Force and potentially for the Navy's Broad Area Maritime Surveillance (BAMS) role, are one intended recipient of this technology. AESA permits mission expansion into an air surveillance role, as air-to-air operation is easily accomplished using AESA technology. In a similar fashion, maritime modes of operation, such as inverse SAR (ISAR) image generation of ships at sea, may be employed with good results. Combined with conformal antennas, large AESA-based SAR systems may be able to achieve greater imaging and MTI capabilities as well as more specialized missions, such as single pass interferometric SAR.

At the opposite end of the spectrum, vendors are taking advantage of the decreasing cost of radio frequency (RF) technologies applicable to radar systems (driven primarily by the telecommunications industry), to develop versions of sensors for tactical and lower payload class aircraft. For example, the MISAR system is capable of imaging truck-sized targets at approximately 3.5 km slant range, from a tactical class platform, even though the sensor is in the 10-pound weight class. While MISAR currently does not form images on-board, there is fundamentally no reason this capability could not be integrated within a reasonable weight margin, permitting consumers of the raw data to tap the unformed image information from the raw feed, while tactical users could receive a formed image – both from the same platform.

**UHF/VHF Foliage Penetration (FOPEN) SAR.** In FY-97 DARPA, the Army and the Air Force began a program that designed, fabricated and demonstrated a dual-band VHF/UHF radar with real-time onboard image formation processing. The VHF/UHF SAR hardware is currently being flown on an Army-owned RC-12 aircraft. The system was developed to target multiple platforms with little modification; one such system is the Global Hawk UA. The sensor development program ended in 2003. In FY03, DARPA began the Wide-Area All-Terrain Change Indication and Tomography (WATCH-IT) program to enhance,

mature, and integrate exploitation technologies. The WATCH-IT program developed robust low false alarm density change detection software to detect vehicles and smaller targets under foliage, under camouflage and in urban clutter, and developed tomographic (3D) imaging to detect and identify targets that have not relocated. DARPA demonstrated the capability of VHF/UHF SAR for building penetration, urban mapping and performing change detection of objects inside buildings. Terrain characterization technologies were also developed, including the abilities to rapidly generate bald-earth terrain height estimates and to classify terrain features from multipass VHF/UHF SAR imagery. In September 2004, DARPA demonstrated real-time onboard change detection (vehicles and IEDs) and rapid ground-station tomographic processing, as well as rapid generation of bald earth digital elevation models (DEMs) using stereo processing. In parallel, the Air Force Targets Under Trees (TUT) program enhanced the VHF SAR by adding a 10-km swath width VHF-only mode, developing a real-time VHF change detection capability and integrating FOPEN products into the targeting chain. In the summer of 2004, the VHF/UHF SAR participated in the Combined Joint Task Force Exercise (CJTTFEX-04) and the Joint Expeditionary Forces Experiment (JEFX04). The system demonstrated real-time VHF-change detection and validated the ability of VHF/UHF SAR to operate with other sensors. TUT provided real-time VHF change detection cues to the Combined Air Operations Center (CAOC) and successfully tasked another sensor in real time (a Predator surrogate with an EO/IR package) to prosecute mobile relocatable targets.

Light Detection and Ranging (LIDAR) FOPEN. Also known as LADAR (Laser Detection and Ranging). Use of LIDAR is another method that offers the possibility of imaging through forest canopy. In current and projected tests, an imaging LIDAR sensor on an aircraft takes several fore-and-aft cuts at a given area of interest as the aircraft moves, allowing the sensor to “integrate” an image over time. Initial coverage rates are far less than typical SAR or EO capabilities, but planned systems at this point are for demonstration purposes only.

LIDAR imaging. LIDAR may be used to image through an obscuration as well. By using a precision short laser pulse and capturing only the first photons to return, a LIDAR image can be formed despite the presence of light-to-moderate cloud cover, dust, or haze. LIDAR can be used to simultaneously image through cloud and foliage. LIDAR also provides the capability of rapidly producing high resolution terrain elevation and mapping information as demonstrated by systems in the Urban Recon ACTD, with elevation accuracies measured in single digit centimeters for relative accuracy and tens of centimeters for absolute elevation accuracy. This type of information is particularly useful in urban operations.

LIDAR aerosol illumination. The task of detecting and identifying chemical or biological agents can be aided with active LIDAR illumination of the target area. Exciting a particulate or gas cloud with a laser simplifies the “fingerprinting” necessary to identify the specific substance. Used in conjunction with a hyperspectral imager, LIDAR can provide faster and more precise identification.

SIGINT way ahead. Although the Joint SIGINT Avionics Family program failed to produce a low band subsystem, the high band subsystem is producible and effective and will form the backbone of near term electronic intelligence systems. USAF’s Advanced Signals Intelligence Payload (ASIP) program extends the high band subsystem architecture into the low band target area of the RF spectrum. The target platforms are the U-2 and Global Hawk.

In the near term, federated systems, developed to add specific capabilities to manned aircraft, will be used to provide an initial SIGINT capability on UA such as Global Hawk. These “clip-in” systems, primarily developed by/for NSA, have been successfully employed on platforms such as the U-2 and RC-135 Rivet Joint. A loose federation of these “clip-ins” coupled with an ESM suite such as the LR-100, demonstrated on Global Hawk as part of the Australian TANDEM THRUST exercise, can provide the basis of an interim capability until a low band alternative is developed. A primary task for SIGINT on UA such as Global Hawk will be cross cueing the on-board imagery sensors.

The Army is presently developing the Tactical SIGINT Payload (TSP), as scalable SIGINT payload, for inclusion on the Unit of Action UA. The primary mission of TSP will be to rapidly map RF emitters on

the battlefield to increase the commander's situational awareness, with a limited exploitation capability. These emitter locations will then be used to cue other ISR sensors in order to reduce their search times. TSP is an excellent example of reprogrammable technology (software definable systems) enabling rapid inclusion of new target types and capabilities.

Nuclear detection systems. Use of endurance UA outfitted with nuclear material detectors could play a key role in homeland defense over the next 25 years. Depending on the characteristics of the detection systems, either an aerostat or a Global Hawk-like long dwell aircraft could be the host platform. DoD strongly supports work to develop and refine these detectors, with an emphasis on increased sensitivity and long-range effectiveness.

### **ENABLING TECHNOLOGIES**

HDTV video format. High definition television (HDTV) is becoming the industry standard format for video systems of the type flown on DoD tactical and medium altitude endurance UA. The JTA specifies that motion video systems should be based upon digital standards; to date, no fielded system complies. HDTV standards represent a fundamental shift in video technology – from an interlaced image, where a scene is scanned in two, temporally separate steps and recombined to form a full image, to a progressive scanning and display process, where an entire scene is scanned and reproduced in one step. Progressive scanning eliminates temporal skewing and is the underpinning to advanced video processing techniques. Initial analysis indicates that moving to the HDTV-specified formats and compression methods will result in an increase of about 2 NIIRS in image quality as compared to the current MQ-1 Predator video output. This increased resolution provides analysts with the advantage of the additional context provided by motion video coupled with image quality equal to some of the better digital framing cameras currently fielded.

While digital sensors have historically been large and expensive, technology has significantly improved options in both of these areas. Even though there are now focal array (camera) assemblies at even the high end of the digital television spectrum that will fit in small turrets, new optical systems are needed to fully exploit the capabilities of these imagers. Although some growth in turret size must be accommodated to take full advantage of the resolution these sensors offer, a challenge to industry will be to maximize optical performance in physically small turrets.

Standards. Currently, fielded video systems and data transfer protocols are not standardized; many are proprietary systems that are not interoperable. In addition, the increased amount of data generated by a digital video system may require additional bandwidth to move the data from the aircraft. Establishment of a common format allows COTS interoperability and insures that ground terminals will be able to interpret video data regardless of the aircraft providing that data. Equally as important, using a digital format reduces the deleterious effects of repeated image conversion from analog to digital and back along the image exploitation chain, improving overall image quality at the receiving station. Similarly, tagging the video frames with timely and complete metadata enables the opportunity to provide automatically generated precision geo-coordinates (PGM quality). A Department objective is to ensure compliance with the existing DoD/IC Motion Imagery Standards Board metadata standard and profiles for all full motion video capable UA.

Timely, accurate, and complete metadata, as well as HDTV-enabled sensors will significantly improve not only the timeliness of PGM- quality coordinate generation (GRIDLOCK ACTD) but the quality of the data as well. The rapid, automatic geo-registration of imagery to NGA's Digital Point Positioning Data Base (DPPDB), as developed by the GRIDLOCK ACTD, allows for the extraction of highly accurate coordinates from video imagery in times on the order of 1 minute. The GRIDLOCK process was successfully demonstrated using Global Hawk SAR imagery during JEFX04 and work is on-going to integrate Predator's MTS into the catalog of validated sensors. GRIDLOCK's capabilities, when enhanced by high resolution digital motion video, will provide the warfighter with the capability to provide targeting information for coordinate seeking weapons in near real time. Services and agencies

should be encouraged to initiate (continue) digital video sensor demonstration efforts with the objective of having all motion video sensors (new, replaced or repaired) produce progressive scan, digital video and standards compliant metadata. A limited operational capability is desired by as soon as possible.

Focal plane array and stabilization technologies. Small and micro UA place a premium on high performance components that make as little demand as possible on power, weight and volume. The commercial market for focal plane arrays in consumer goods has increased vastly over the last three years; the top-of-the-line digital cameras only recently reached the megapixel mark, and now stores routinely offer 5 megapixel cameras as well as handheld high definition digital video recorders.

While commercial products may emphasize only some of the spectral bands of interest for military applications, the trend toward more capable systems requiring less battery power and fitting into handheld cameras can only benefit DoD. The Services should expect vendors to capitalize on this trend and work to insure that military needs (such as infrared sensitivity, environmental tolerance, and ruggedness) are represented wherever possible.

Digitally based (single conversion on the array) technology significantly improves the quality of the information in the data chain, eliminating image degradation from repeated analog-digital-analog conversions. For this reason, multispectral versions of digital focal arrays are critical. Additionally, common focal arrays between sensors/platforms are desirable. Service (labs) should be encouraged to initiate digital multispectral still/video focal array programs with the goal of demonstrating a Predator-class high resolution digital IR system within the next few years.

As with high resolution motion video and timely and complete metadata, image stabilization is critical to obtaining usable information. Technology improvements in stabilization technology (electromechanical and electromagnetic) permit nominal sensor mounting systems to achieve stabilization accuracies in the tens of micro radians. Similarly, high end stabilization systems are capable of stabilization accuracies on the order of two micro radians, providing virtually a metric sensor capability (ability to generate precision geo-coordinates from sensor measurements when coupled with accurate High Resolution Terrain Information, taken from pre-populated databases or derived from on-board sources such as a LIDAR); however, both classes of stabilization systems are too costly to employ on lower end UA platforms (sub-Shadow class, such as XPV-1, Raven), which tend to be somewhat unstable platforms for strapdown sensors. To compensate for the lack of low cost, mechanically stabilized sensor mounts, digitally based (non-mechanical) stabilization systems have been demonstrated with limited operational success, due to human factors constraints. To fully exploit the new generation of imaging systems on the rapidly proliferating class of small/low cost platforms, specific efforts resulting in the development of a low cost, steerable (turret) sensor stabilization system for small and sub-tactical class platforms is highly desired by the Department.

Flexible conformal antennas. There are numerous commercial and government programs to develop affordable conformal SAR antennas for use on a variety of aircraft. Their eventual availability will allow UA to more effectively use onboard payload space; currently, a SAR antenna (mechanically-steered antenna (MSA) or electronically-steered antenna (ESA)) may be the core parameter around which the rest of the aircraft, manned or unmanned, is designed. Conformal antennas will allow larger apertures using the aircraft's skin. Agile antennas will be able to perform more than one function, so a single antenna (covering a large portion of the aircraft's exterior) can serve the data link needs as well as acting as imaging radar. On larger aircraft like Global Hawk or MQ-9 Predator, conformal antennas mounted near the wingtips will enable single pass interferometric SAR data collection, leading to swift production of precise digital terrain maps.

Sensor autonomy/self cueing. One of the key attributes that some UA offer is very long endurance, much longer than is practical for manned aircraft. While it may be possible to maintain 24-hour battlefield surveillance with a single aircraft, the system will only reach its full potential when it is doing part of the work of the intelligence processing facility to alleviate manpower needs. A number of image/signal

processing and network collaborative technology developments will facilitate the ability to automate sensor operation, at first partially and over time leading to nearly total sensor autonomy.

Current operations for large ISR platforms – Global Hawk and the U-2, for instance – focus on collection of a preplanned target deck, with the ability to retarget sensors in flight for ad hoc collection. This is suitable for today's architecture, but proliferation of UA with a range of different capabilities will stress the exploitation system beyond its limits. Long dwell platforms will allow users to image/target a collection deck initially and then loiter over the battlefield looking and listening for targets that meet a predetermined signature of interest. While automatic target recognition (ATR) algorithms have not yet demonstrated sufficient robustness to supplant manned exploitation, automatic target cueing (ATC) has demonstrated great utility. OSD strongly encourages the Services to invest in operationalizing ATC in emerging UA sensor tasking and exploitation. Sensor modes that search for targets autonomously that meet characteristics in a target library, or that have changed since the time of last observation, or that exhibit contrast with surroundings can be used to cue an operator for closer examination. Advances in computer processing power and on-board memory have made, and will continue to make, greater autonomy possible. In a similar fashion, different sensor systems on board a single aircraft may also be linked, or fused, in order to assist in the target determination problem. Combining sensor products in novel ways using advanced processing systems on board the aircraft will help solve the sensor autonomy problem as well.

Smaller UA operating with minimal data links, or in swarms, need this ability even more. The ability to flood a battlespace with unmanned collection systems demands autonomous sensor operation to be feasible. While the carriage of multiple sensors on a single, small UA is problematic, networks of independent sensors on separate platforms that can determine the most efficient allocation of targets need to be able to find, provisionally identify, and then collect definitive images to alert exploiters when a target has been found with minimal if any human initiative. The desired end state will be achieved when manned exploitation stations – whether a single Special Forces operator or a full deployable ground station – are first informed of a target of interest when a sensor web provides an image along with PGM quality coordinates. This technology is available currently, and needs to be applied to this particular task – which will involve a radical change in ground exploitation infrastructure and mindset, akin to the change in taking a man out of the cockpit.

Air vehicle autonomy. Along with sensor autonomy, swarming UA will require the ability to self-navigate and self-position to collect imagery and signals efficiently. While aircraft autonomy is dealt with elsewhere in the Roadmap, it is identified here as critical to fully exploit sensor capabilities and keep costs and personnel requirements to a minimum.

Lightweight, efficient power supplies. In the near term, UA will be more power limited than manned aircraft, particularly in the smaller size classes. Every component of the aircraft, sensor, and data link strives for small size, weight, and power consumption. For MAV, batteries with high power/weight ratios are important to maximize sensor capability and endurance. Larger aircraft need to extract power from the engine to generate AC and DC power for sensor and data link operation. Industry is encouraged to refine methods of drawing power from the engine to reduce mechanical inefficiencies and losses with traditional airframe-mounted electrical and hydraulic drive systems. Services should consider power requirements, including prudent margin to allow future sensor and mission growth and total power generated as a fraction of system weight, when developing unmanned aircraft (see Appendix A).

Lightweight optics and support structures. In keeping with the need to reduce aircraft weight, lightweight optics and optical support structure will enable small aircraft to carry the best possible EO/IR sensors. The use of composite materials for optical enclosures results in very stiff but light sensor housings that are capable of maintaining tight tolerances over a range of temperatures and operating conditions. Optical elements themselves must also be designed for low weight. This becomes more important in larger sensors with multiple glass elements; even in medium to large UA such as MQ-9 Predator and Global Hawk, EO/IR sensor characteristics can limit the ability to carry multiple payloads simultaneously.

Contractors have put a great deal of work into reducing optical sensor weight; the Services should capitalize on this work by adapting existing sensors for new vehicle applications wherever possible, to avoid the costly solution of sensors designed for single vehicle applications.

Communication. Data links that are designed for small aircraft applications are already proliferating in U.S. and foreign UA systems. Israel in particular has long recognized the need for effective line-of-sight and beyond-line-of-sight real time links to make effective use of sensor data from UA communications, but the importance of a family of small JTRS-and Software Communications Architecture (SCA)-compliant, network-enabled communications packages must be emphasized specifically as a sensor enabler. As a near term solution, an SCA-compliant version of the common ISR family of data links, Common Data Link (CDL), generated by a JTRS communications unit, should be the link of choice for all UA platforms at and above the tactical class.

In addition to the need for smaller tactical data links, large aircraft carrying sophisticated sensors will need high capacity data transfer systems, particularly in over-the-horizon roles. Current data capacities of 274 Mbps are stressed when carrying multiple sensors simultaneously. Classes of sensors that particularly tax links are radar imagers when full phase history is sent to a ground station for post processing and multispectral sensors with high resolution and wide fields of view. Hyperspectral data has the potential to vastly outstrip current data rates provided over existing links and most satellite and ground communication networks. If all (or many) bands of hyperspectral data must be downlinked, there will be no ability to operate any other sensors on the aircraft in near-real-time. Data rates in excess of 1 Gbps, using other than RF links (specifically laser communication), will be needed to exploit sensor capabilities, as well as to reduce RF spectrum saturation, in the near term.

Swarms of UA carry additional communications needs. Effective distributed operations require a battlefield network of sensor-to-sensor, sensor-to-shooter, and UA-to-UA communications to allocate sensor targets and priorities and to position aircraft where needed. While the constellation of sensors and aircraft needs to be visible to operators, human oversight of a large number of UA operating in combat must be reduced to the minimum necessary to prosecute the information war. Automated target search and recognition will transfer initiative to the aircraft, and a robust, anti-jam communications network that protects against hostile reception of data is a crucial enabler of UA swarming.

To effectively address the aforementioned issues, fully and rapidly integrating UA and their payloads (sensors) into the GIG is paramount. OIF provides the best example of this combat need, as demonstrated with the rapid development and fielding of the ROVER terminal family, enabling the AC-130 Gunship and dismounted ground units to directly receive Predator motion video. The communications issue is addressed in Appendix C of this Roadmap; however, to facilitate this integration sensors should be designed with GIG directed concepts and standards in mind. This implies migrating away from proprietary data formats, sensor control methods, and analog electrical interfaces, and adopting on-sensor generated digital data, formatted for transmission/reception over IPv6 networks, common, network-enabled electrical interfaces, such as Gigabit Ethernet, and adoption of standardized sensor control messages, such as the Future Combat Systems' (FCS) in-development Sensor Interface Protocol (SIP). Services (labs) and industry should be encourage to demonstrate a truly IPv6 compliant motion video sensor system, to include indigenous generation of digitally formatted HD video in an IP compliant video format, using a standardized network interface..

Mass data storage. Onboard storage of sensor data in the terabyte class should be a goal to exploit manned and unmanned sensor data. Storage of complex imagery or phase history of radar data onboard can substitute for the extremely wideband data links required for near-real-time relay. Similarly, storage of the full output of a hyperspectral sensor will allow transmission of selected bands during a mission and full exploitation of data post-mission. The stored data is crucial in building an HSI phenomenology database to select the right diagnostic bands in the first place.



The goal for onboard mass data storage should be to replicate the capability of wet film for broad area synoptic coverage. Current medium resolution film cameras operating at high altitude can image over 17,500 square nautical miles in stereo on a single mission of a few hours, a capability unequalled by airborne digital sensors at this time. A 1.4 Terabyte storage capability coupled with an imagery index system and IP-enabled interface has been demonstrated on Global Hawk. Known as the Advanced Information Architecture (AIA), this system permitted the capture of over 3 days of full resolution Global Hawk imagery and enabled users to access the imagery using internet search tools. The storage system and IP server were constructed using COTS components and integrated into the existing space allocated to the DCRSi recorder suite, using a DCRSi system interface so that no change to the Global Hawk operational software was required, with space remaining to also integrate a line-of-sight UHF access system to permit operators to receive imagery without the need to go through a dedicated ground station. AIA's design around COTS components and IP-enabled interfaces will make the transition to solid-state memory arrays, when they become cost effective, a relatively easy upgrade. The Department highly encourages demonstrations such as AIA, on-board mass storage systems based on STANAG 4575 (NATO Advanced Data Storage Interface), supporting both sensor data archiving and the dissemination of data to users upon demand, in accordance with DoD's TPPU concept.



## **APPENDIX C: COMMUNICATIONS**

### **INTRODUCTION**

This appendix guides industry and the Services on an UA communications migration path toward improved interoperability. Service acquisition functions include requirements offices, program offices, acquisition managers, program managers, and research and development programs. Service operators include operational units, and demonstration activities. Industry includes developers, manufacturers, and professional standards groups. This appendix provides a reference to existing and binding policy and standards. It also provides time frames for implementation of various capabilities.

### **Overview**

The information environment has changed fundamentally over the last 10 years. More importantly it will continue to change. The Services, in partnership with industry, must develop and field interoperable UA systems that can adapt to the evolving information environment.

The challenge remains to link disparate systems, effective in their own right, but evolving separately over time, to form a cohesive collaborative information environment. To this end, DoD has invested in its own version of the internet, the GIG. The GIG, defined as virtually all DoD information technology infrastructure, exists to provide the timely and accurate information that war fighters need to assure victory. All DoD Systems shall be able to interact with the GIG. New UA systems shall be developed to comply with the GIG architecture from the outset. At a minimum, web enabled interfaces for legacy UAV systems would need to be created for the system to be recognized as an entity on the GIG. By connecting to the network, UAS become part of that network.

Everyone on the GIG will become both a producer and a consumer of information. The concept of sensor will extend to virtually every piece of equipment capable of sensing and passing data, from orbiting satellites to an individual soldier's gun sights. This information must flow seamlessly, with minimal human intervention, to unanticipated users as well as well defined, known users, to support both foreseen and unforeseen information requirements.

The two overarching requirements for next generation UA communications are 1) connect to the GIG, and 2) comply with spectrum utilization policy. To connect to the GIG, UA programs must take full advantage of DoD programs and initiatives to achieve net-centricity: net enabled CDL, JTRS, Transformational Satellites (TSAT), High Assurance Internet Protocol Encryption (HAIPE), and the Defense Information Systems Agency (DISA) metadata registry. UA communications must provide secure, reliable access to all UA capabilities across the entire DoD enterprise. Initially, efforts must focus on common interfaces for sensor control and dissemination via the GIG. As new payloads and weapons are introduced, such as communications relay packages, electronic warfare suites, and guided weapons, web enabled interfaces must be developed to allow control and employment from any authorized node. The vision is a ubiquitous network where every entity exists as a node and can share and use any data produced by any other node, anytime.

For complete information regarding the GIG, refer to the GIG Architecture and the GIG Enterprise Services website at <https://ges.dod.mil/>.

### **EXPERIENCE**

A review of operations in support of recent conflicts serves to illustrate current communications capabilities for two UAS, Global Hawk and Predator. They employed a mix of dedicated point-to-point communications and networked communications. Many of the networked communications were IP based, approaching net-centric capabilities. Examples of network capabilities include posting images to an Image Product Library (IPL), which implements the Task, Post, Process, Use (TPPU) model, and the widespread use of secure internet chat.

A cursory review of current methods for radio development and deployment highlights the need for a more flexible, joint approach to procuring interoperable radio systems.

### Global Hawk

The RQ-4 Global Hawk system consists of the aircraft, Launch and Recovery Element (LRE) and Mission Control Element (MCE). The LRE controls the aircraft via line-of-sight (LOS) CDL, LOS ultra high frequency (UHF), and beyond line-of-sight (BLOS) UHF radios. The LRE has no provision for sensor control or product receipt. The MCE contains all of the aircraft control functions of the LRE. In addition, the MCE provides for sensor control as well as receipt and dissemination of the product. The MCE maintains situational awareness. MCE aircraft command and control is accomplished using narrow band LOS UHF radio and UHF satellite communications (SATCOM), with Inmarsat as a back up command and control link. The LOS CDL as well as Ku-band SATCOM provide command and control channels as well. Sensor data flows from the aircraft to the MCE via either LOS CDL or Ku-band SATCOM.

Global Hawk provided extensive mission support during OEF in Afghanistan. The LRE launched the Global Hawk from a forward operating location. Shortly after launch, the LRE transferred mission control to the forward-deployed MCE. During combat operations, Global Hawk initially flew a preplanned mission, but quickly transitioned to an ad-hoc operation. For a more complete understanding of preplanned, replanned, ad hoc and autonomous missions, refer to the section entitled *UA Actions*. Global Hawk transmitted images to the MCE via commercial Ku-band SATCOM at 20 Mbit/s. The MCE then routed the imagery to the collocated forward exploitation element or to a wide area network (WAN) inject point to access a fiber optic landline to the Continental United States (CONUS) based reach-back facility. The CONUS based exploitation center processed the imagery and forwarded products via Ku-band SATCOM at 6-8 Mbit/s to a high-capacity image product library or directly to the CAOC for use in current operations. The Distributed Common Ground System (DCGS) supported the exploitation effort.

Operators used the experience gained from Global Hawk activities in OEF to streamline operations during OIF. Again, the LRE launched the aircraft from a forward operating location; however, all operations were performed using reach-back to the MCE located in the CONUS, not forward deployed. Communication between the MCE at Beale AFB, the CAOC, and the aircraft used a combination of WAN landline and commercial Ku-band SATCOM (with transmission rates from 20-40 Mbit/s). Inmarsat was the redundant C2 link. Global Hawk again flew both preplanned and ad hoc missions in theater. It used Ku-band SATCOM for both command and control and imagery dissemination to the CONUS based MCE. WAN landline provided communications between the MCE and the analysts. Analysts searched for ad hoc targets and passed them directly to the CAOC via Ku-band SATCOM. If determined to be time-critical, targets were passed to in-flight fighters/bombers via Link-16 message. Figure C-1 depicts the Global Hawk communications architecture for both deployed and in garrison operational modes.

“Secure Chat” via Secret Internet Protocol Router Network (SIPRNET) was established between the Global Hawk pilot/sensor operator, the Global Hawk liaison officer at the CAOC, and the Intelligence Mission Operations Commander at the exploitation center. This provided situational awareness and enabled command of the mission in response to ongoing operations and other emerging requirements.

### Predator

The Predator system consists of the aircraft, a Ground Control Station (GCS), and a Launch and Recovery Element (LRE). The GCS consists of flight control equipment, sensor control equipment, LOS data link, VHF/UHF radio and Ku SATCOM data link. The LRE contains a subset of the GCS equipment, the minimum required for launch and recovery. Predator pilots manipulate aircraft flight controls in real time using the LOS data link to accomplish takeoffs and landings. Once airborne, the pilot couples the autopilot to the navigation system, and the aircraft navigates to selected waypoints. The Predator LRE has no BLOS communications, so it must maintain LOS until it transfers control to the GCS. The pilot in the GCS controls the Predator remotely via Ku-band SATCOM and receives the sensor products via the same link.

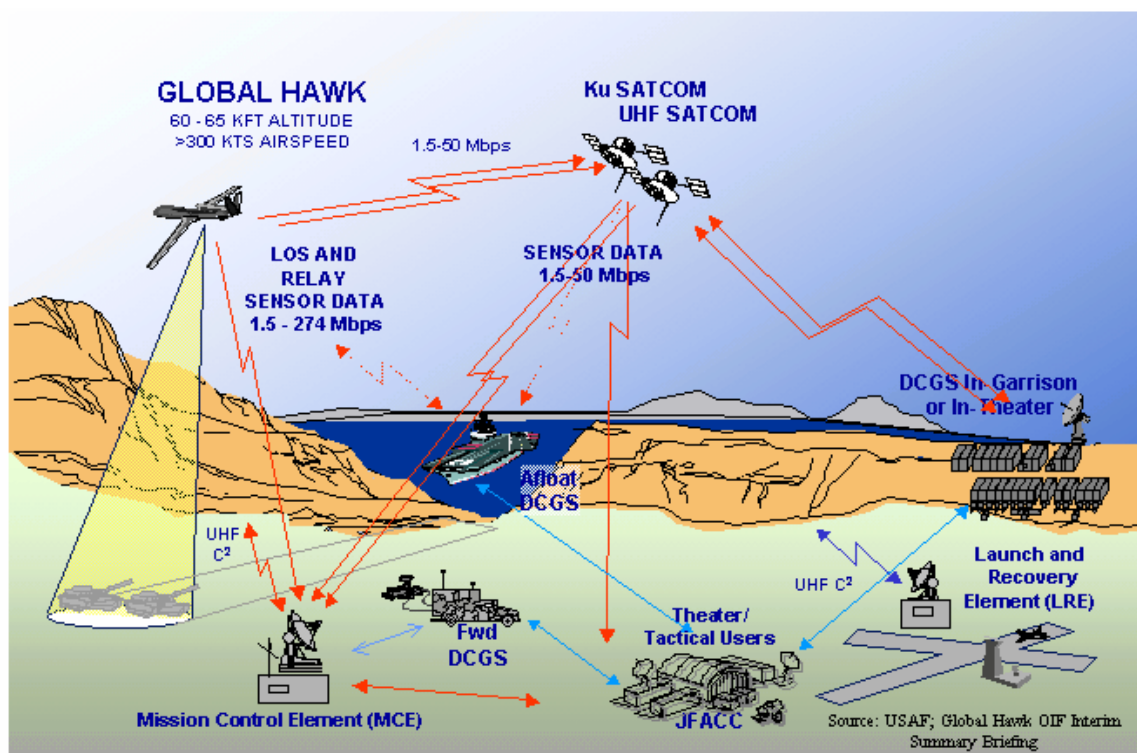

**FIGURE C-1. GLOBAL HAWK COMMUNICATIONS ARCHITECTURE.**

The Predator provided nearly continuous 24-hour coverage of key target locations in support of Joint Forces Commander (JFC) objectives in both the OEF and OIF. Missions included ISR, Special Operations Forces (SOF) Direct Support, Close Air Support (CAS), urban CAS, Kinetic Intercept (KI), Combat Search and Rescue (CSAR), and Strike Control and Reconnaissance (SCAR).

During OEF, the Predator system prosecuted the Global War on Terrorism from a fully operational deployed GCS. Remote split operations (RSO) (geographically separated GCS control of the Predator) enhanced Predator capability in the OEF area of responsibility (AOR) and enabled the launch of an additional aircraft to support simultaneous or high priority operations. A key element of RSO was the intensive use of secure internet “chat.” Chat was initially established between two geographically separated GCSs to improve secure communication connectivity. Chat rooms were subsequently established as a means of communications between the tasking authority, command and control units and flight crew.

OIF also saw extensive use of Predator remote split operations where flights launched by the forward deployed LRE were then handed over to Nellis AFB operators. The Predator LRE operated from two forward operating locations, and demonstrated flexible flying operations that included an aircraft “divert” and aircraft intra-theater deployment capability using the two LREs. The Predator system demonstrated “surge” operations by simultaneously controlling four airborne Predators for seven days before weather forced the first cancellation. Most importantly, the Predator successfully operated across the entire spectrum of the find, fix, track, target, engage, and assess (F2T2EA) kill chain.

While operations were effective, communications support was not ideal. UHF communications between Predator operations control at Nellis AFB and Airborne Warning and Control System (AWACS), Air Support Operations Center (ASOC), and Direct Air Support Center (DASC) controllers were poor, resulting in a reduced real time deconfliction capability and reliance on the CAOC-based Predator liaison officers (LNO) to deconflict and to coordinate airspace and attack procedures. CAOC LNOs had to provide direct phone numbers and chat rooms to the GCS due to limited access to secure

communications. The LRE also had poor secure communications capability due to their austere locations. Many missions had to be coordinated in the clear using brevity codes. Dissemination of Predator real time video Moving Picture Experts Group (MPEG) clips, greater than 5 minutes in duration, was not possible due to e-mail file limitations. The USAF developed a technical solution for this problem to capture and archive video for the Combined Forces Air Component Commander (CFACC).

Figure C-2 illustrates the Predator operating in a deployed mode. It maintains contact with its GCS through a line of sight data link or via over the horizon Ku-band satellite link to the Predator Primary Satellite Link (PPSL). Video feeds are then piped out to the DCGS and the Air Operations Center (AOC) through theater communications or the Defense Information Services Network (DISN). Video is also broadcast to a virtually unlimited number of users through the Global Broadcast Service (GBS) via the GBS inject facility.

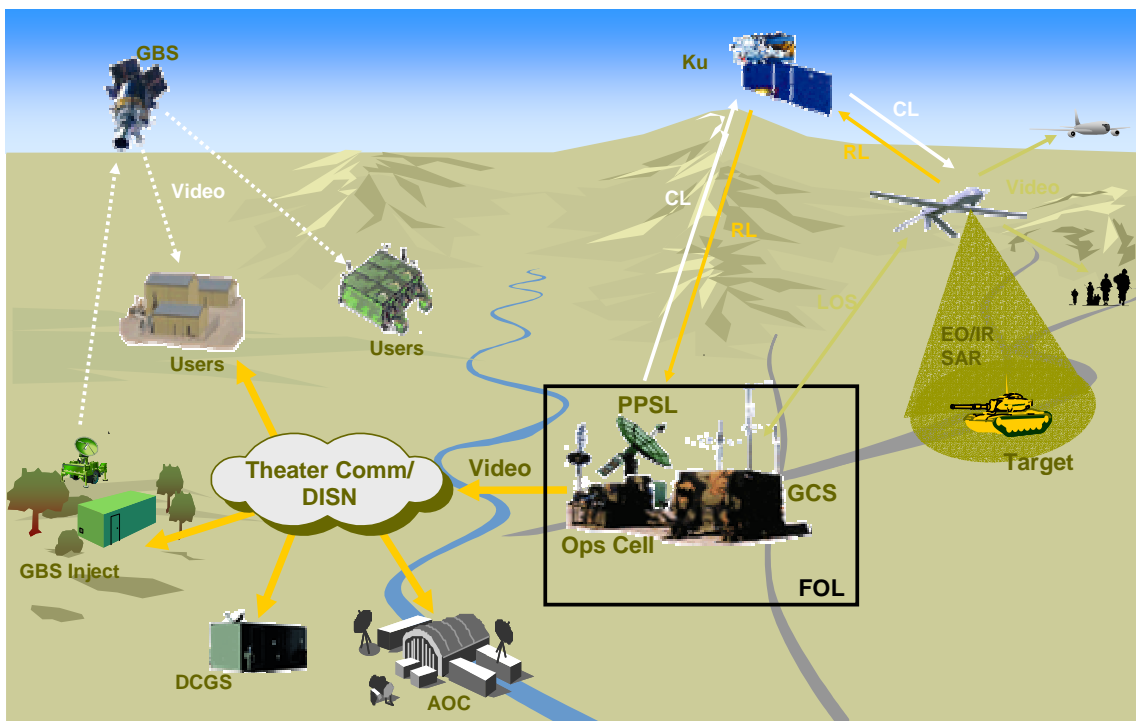

**FIGURE C-2. PREDATOR OPERATING IN DEPLOYED MODE.**

Figure C-3 illustrates, the Predator communications architecture during RSO. In this mode, the LRE controls the Predator via line of sight data link for launch and recovery. After take off, the GCS assumes control via Ku-band SATCOM link and DISN Asynchronous Transfer Mode (ATM) Services (DATMS) network. Sensor product is then passed to the DCGS and the GBS inject point via DATMS.

**Radios**

Every aspect of military operations depends on wireless voice and data communications. Over the years many non-interoperable systems were built and fielded to meet a broad range of specific Service requirements.

While providing much needed capability, this approach created problems. Dissimilar hardware has complicated spares provisioning and radio maintenance. Specialized receiver/transmitter units could only communicate with compatible radios. This impacted Joint Operations where communications and collaboration are needed to enable important new capabilities that often result from unprecedented but innovative combinations of disparate forces.

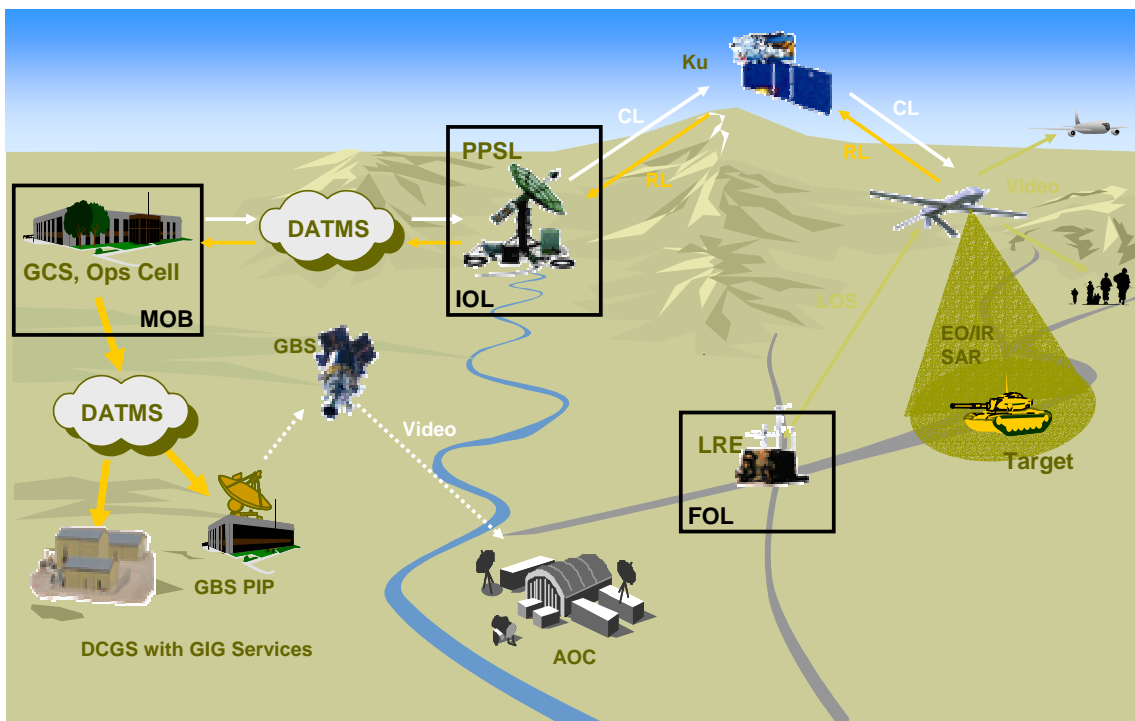

**FIGURE C-3. PREDATOR REMOTE SPLIT OPERATIONS.**

DoD needs a new radio development process to improve flexibility and interoperability, and to streamline logistic support to DoD radios across the defense enterprise.

**Lessons Learned**

UA operations in Afghanistan and Iraq highlighted and validated the following needs:

- Real time and near real time video broadcast
- Real time secure collaborative communications
  - Voice over IP
  - Voice telephone
  - SIPRNET chat
- Access to systems data, independent of system control, available to a large number of users
- SATCOM reach back for BLOS command and control and product dissemination

Broad experience with military radios and joint operations highlighted the need for an enterprise wide approach to the development and fielding of interoperable, software defined radios based on a common set of hardware components.

**VISION**

The vision for UA communications takes into account the documented need for broadband, broad based, seamless information sharing and the lessons learned from operational experience. This section will outline the UA communications themes, highlight and describe the current programs and DoD initiatives that most directly impact UA communications, provide a functional model for modularized UA design, and identify impediments to achieving net-centricity. The vision for UA communications is an evolution from a dedicated circuit to a web enabled interface over the next 10-15 years. Figure C-4 illustrates this vision.

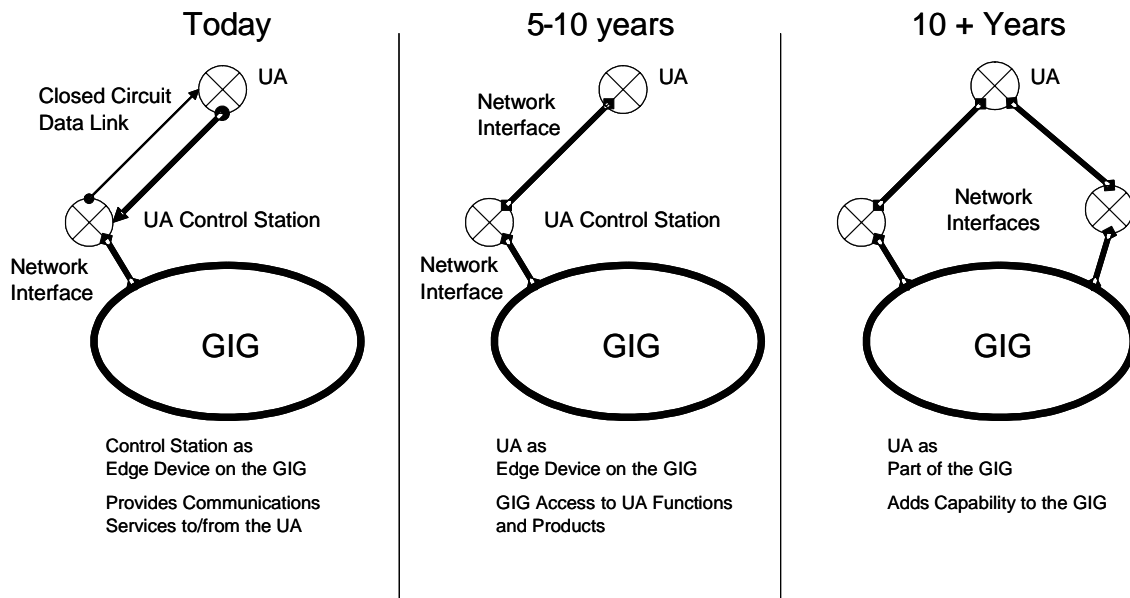

**FIGURE C-4. UA PROGRESSION FROM CIRCUIT BASED TO NET-CENTRIC COMMUNICATIONS.**

**Themes**

The following “Communications Themes” set the tone for this section and are provided to guide new systems development and legacy system migration.

- Implement an Internet Protocol (IP) based UA networking architecture
- Migrate point-to point circuits to an IP based network
- Register all data with the DISA metadata repository
- Implement network access and connectivity via JTRS enabled terminals, evolutionary terminal acquisition
- Provide timely, reliable, secure transmission of large quantities of data with eventual migration to SCA compliant CDL, JTRS and Family of Advanced Beyond Line-of-Sight Terminals (FAB-T)
- Provide assured, direct connectivity into the Transformational Communications System (TCS) space backbone

UA networking will incorporate the following major functional areas.

- Routing. mobile ad-hoc routing, traditional routing, and global connectivity
- Mobility and IPv6. mobility services for both user hosts and networks
- Quality of Service (QoS)/Class of Service (COS). guaranteed and differentiated services for user networks
- Network Management. management of mobile nodes and integration with other GIG network management systems
- Information Assurance (IA). IP network security

**DoD INITIATIVES**

The DoD is transforming from a hierarchical, point-to-point (circuit switched) architecture to horizontally integrated, net-centric operational model. The highly successful, DoD mandated CDL program will contribute significantly to UA communications for the foreseeable future, transitioning to this net-centric configuration in the coming years. In addition, DoD has sponsored six key technology initiatives: JTRS, GIG Bandwidth Expansion (GIG-BE), Transformation Communications Architecture (TCA) SATCOM

(TSAT), Net-Centric Enterprise Services (NCES), IA programs, and Horizontal Fusion. Three of these initiatives directly impact UA development and deployment. The guidance in this appendix presumes their successful execution:

- JTRS. successfully deploys
- TSAT. constellation launches on schedule
- IA. HAIPE. a key web enabled encryption device successfully enables GIG Red Edge/Black Core

The heart of the new net-centric model is the IP and networking services layer functionality, which will provide significantly improved communications modes (transport). This layer will provide the information services and applications needed to ensure timely, accurate, and secure discovery of and access to the information needed by the war fighter. Drawing on these services, the end user will receive information in the format and time of his choosing (Smart Pull).

### **Common Data Link**

Today's CDL provides the only means to meet ongoing, wide band, communications requirements. CDL is the DoD mandated standard for wireless data link communications of high capacity airborne ISR sensor data. Data link interoperability is governed by compliance with CDL specifications that address waveforms, associated protocols, and external (platform/sensor/network) interfaces. CDL is a full duplex, although asymmetric, wide-band data link that connects the UA to its control station either directly or via SATCOM. The control station generally transmits command and control data at 200Kbit/s and receives sensor product at up to 274 Mbit/s.

Information exchanges occur primarily between the UA, its control station, and specially designed external interfaces, such as Air Traffic Control voice radio and video feeds. UA products, after being processed, flow to external nodes from the control station servers through network connections. In its current form CDL provides a closed circuit between the UA and its control station, carrying commands, status, and sensor products. The control station, as an edge device on the GIG then provides this information to the user community, while keeping the UA isolated from the GIG. CDL equipped UA must transition from a closed circuit, merely using communications services, to a network node, actually providing communications services.

The first step to achieving net-centricity involves net enabling the interfaces. This means creating IP based network connections and routers between UA subsystems and the on board data link with corresponding network interfaces between the control station data link, control station subsystems, and the GIG. This changes the paradigm from that of a closed circuit to that of a network node. Functions and products of UA implemented as network nodes would be accessible to other authorized nodes on the GIG, not just to the control station. The UA itself becomes an edge device on the GIG.

The second step involves UA that can connect directly to more than one node on the GIG. During times when the demand on the data links is low, such as during cruise portions of the mission, UA capable of connecting to more than one node, can act as network routers, passing internet data packets between the multiple connected nodes. In this way UA can contribute their unused bandwidth to the overall carrying capacity of the GIG, Figure C-4 illustrates this transition. The next several paragraphs describe current and future CDL programs and some IP convergent strategies.

Baseline Common Data Link. The program originated in 1979 as a collaborative effort between the USAF, Assistant Secretary of Defense (ASD), and the National Security Agency (NSA) in support of the U-2 collection mission. Success onboard this and other platforms subsequently resulted in the Office of the ASD (OASD)/Command, Control, Communications, and Intelligence (C3I) issuing a December 1991 policy memorandum mandating CDL as the DoD interoperability standard for LOS communications of airborne ISR sensor data to surface-based (land/sea) processing terminals. A June 2001 policy update further extended the CDL standard to include air-to-air and BLOS relayed ISR applications.



CDL terminals typically support full duplex, jam-resistant, secure digital communications in either X or Ku-band at selectable data rates ranging from 0.2-2 Mbit/s on the forward link (command/control data) and with return link (sensor data) rates from 10-274 Mbit/s. In recent years, CDL applications have been extended to a variety of manned and unmanned tactical platforms, fueled by affordability advances led by the tactical common data link (TCDL) program which introduced intermediate-level performance and interoperability at the lower (< 45 Mbit/s) CDL data rates. Continuing advances and leveraging of commercial microelectronics have since extended similar technology-cost advantages to full-rate CDL applications. Although most CDL applications employ point-to-point radio links between the ISR collection platform and processing terminal, emerging applications entail point-to-multipoint (simplex/broadcast) operations to multiple receive-only terminals. Additional ongoing CDL capability enhancements include:

- Increased forward and return link data rates (up to 45 Mbit/s, 1096 Mbit/s respectively) to address evolving forward link applications and bandwidth demands posed by high performance hyper-spectral and multi-sensor platforms.
- Enhanced point-to-multipoint capabilities providing full duplex, low-latency network communications between a central (collection or fusion) node and its multiple (sensor or user) client nodes.
- Advanced Waveforms providing variable bandwidth on demand (ranging from 10Kbit/s – 274 Mbit/s), optimized for IP-based data transfer, and enhanced RF link range/weather/jamming performance.
- System architecture/software migration to JTRS SCA compliance. Although envisioned objective capabilities pose software/waveform portability and interoperability advantages, current JTRS technology base and associated performance does not currently meet user and system throughput requirements.
- Transition to IP-based user interfaces. Historically, CDL based systems were not networked on either the air or surface ends of the link. The approach taken by the platform/ integrating contractor towards integration of multiple sensors/functions into the CDL interface would generally entail optimization for the specific program application, although often at the expense of compounding or precluding interoperability with other programs/Services. Custom conventions generally would entail the methods by which multi-sensor data would be multiplexed external to CDL and bit-stuffing or other means by which the aggregate would be bandwidth matched to the one or multiple CDL synchronous channels. The recent trend within CDL, now motivated by the OSD mandate, requires the provision of an IP-based CDL user interface to the platform. This should effectively eliminate custom platform integration conventions helping to establish CDL as part of a seamless GIG communications infrastructure.

### ***Variant CDL Program Descriptions***

Tactical Common Data Link. Provides simplex or, full duplex, and jam-resistant links for tactical UA and other applications, with initial prototype demonstrations supporting 200 Kbit/s forward link and 10.7 Mbit/s return link rates. Ongoing developments are currently expanding to full rate capabilities (up to 45 Mbit/s forward link and 274 Mbit/s return link). The Army's Tactical Unmanned Aerial Vehicle (TUAV) Operational Requirements Document (ORD) requires TC DL, as does Fire Scout. Both the Army and the CDL Program Office are pursuing miniaturization of the TC DL for tactical UA applications.

Multi-Role – TC DL (MR-TC DL). Flexible, scaleable, modular, and programmable data link that can be reconfigured through software programmable subsystems and plug-and-play modules for a variety of missions and applications. MR-TC DL will be interoperable with the existing CDL systems and provide a wideband “clear channel” for bandwidth-on-demand requirements of future applications. Through IP networking, and SCA modularity, MR-TC DL will provide a full mesh, self-healing network that will strengthen the Army Intelligence Community’s ability to allow the Army Knowledge Enterprise

Architecture, GIG, DCGS, Warfighter Information Network-Tactical (WIN-T), JTRS, and the family of CDLs to communicate and disseminate information across the Army, Joint, Allied, and Coalition ISR air, ground, and space functional areas. The MR-TCDL system will be capable of interoperating in Multi-Connect/Direct-Connect RF topologies, and will provide a complimentary wideband RF network backbone that is fully compatible and interoperable with the emerging Multi-Platform CDL (MP-CDL) network topology.

Multi-Platform Common Data Link. Network-based application of the standard DoD data link for the dissemination of ISR data. The airborne MP-CDL will be the first fully networked CDL the military has deployed with the capability to communicate from the aircraft to as many as 30 active, airborne- and/or ground-networked platforms at one time (threshold). MP-CDL can be used to relay information from one aircraft to another or to ground stations in the network. It is a wideband, jam resistant, IP enabled data link that includes a wideband mobile router running commercial off-the-shelf (COTS) protocols (IPv4/RIP/DHCP) and a network manager using simple network management protocol (SNMP). The MP-CDL system provides for extensive future growth capabilities including additional channels, wideband (274 Mbit/s) SATCOM, higher data rates (548 Mbit/s and 1Gbit/s), and advanced networking protocols. The flexibility and interoperability of the MP-CDL system will provide the net-centric warfighter multiple communications capabilities, ultimately extending the edge of the Global Information Grid through the command and control and ISR assets to the shooter.

### **Joint Tactical Radio System**

JTRS will promote interoperability, streamline logistics across the Services, and reduce radio maintenance costs, through the development and fielding of software defined radios. The JTRS Joint Program Office (JPO) will oversee Service-led development and procurement of JTRS hardware and software, including the software-defined waveforms, which will define the functionality of these new radios. The new radios will match the size, weight, power, and interface requirements of legacy radio systems that they are designed to replace.

The SCA governs the structure and operation of the JTRS, enabling programmable radios to load waveforms, run applications, and be networked into an integrated system. For complete information on this key standard see the Software Communications Architecture Specifications, MSRC-5000SCA. The complete software specification along with Application Program Interface (API) and Security supplements can be downloaded from the JTRS website:

[http://jtrs.army.mil/sections/overview/fset\\_overview.html](http://jtrs.army.mil/sections/overview/fset_overview.html).

JTRS employs an evolutionary acquisition approach, which provides for multiple procurements with increasing capability and functionality over the life of the program. Rather than delay fielding until systems meet all requirements, initial capabilities are fielded as soon as possible, with new capabilities added as they mature. JTRS evolution can be viewed as three distinct phases: Near-Term, Mid-Term, and Long-Term.

Near-Term 2004-2007. This phase provides the warfighter with a foundation for future capabilities as JTRS compliant equipment is developed and fielded. During the near-term, JTRS will provide interoperability within each cluster and with all other clusters. Routing and retransmitting through dedicated JTRS nodes will provide interoperability with legacy radios and networks during the transition to full JTRS fielding.

Mid-Term 2007-2012. In the mid-term, tactical networks will use new JTRS capabilities, including the Wideband Networking Waveform (WNW) and enhanced network, spectrum and security management. Mid-term JTRS will also provide route and retransmission between JTRS and legacy networks.

Long-Term 2012-2030. Over the long-term, JTRS will provide a fully integrated information system network to include active and passive information operations management across the joint and combined environments. The system will include a self-establishing and self-healing "smart" network, which will automatically manage the RF domain.

JTRS Groupings. Service acquisition requirements for JTRS are grouped according to similarity of requirements and fielding schedules. These groups are currently referred to as “clusters.” Of special interest to the UA community are Cluster 1 and Cluster AMF, which provide airborne secure voice and data communications.

- Cluster 1. Provides a multi-channel software programmable, hardware-configurable digital radio networking system, and supports requirements from the Army Aviation Rotary Wing, Air Force Tactical Control Party (TACP), and Army and USMC Ground Vehicular platforms. In FY07, the Navy will begin fielding an SCA compliant CDL (TCDL), using a JTRS Cluster 1 terminal equipped with a high-band module.
- Cluster AMF. The Cluster 3 (Maritime/Fixed station) and Cluster 4 (Airborne) programs merged to form the JTRS Airborne, Maritime, and Fixed Station (AMF) cluster. AMF will provide SCA compliant airborne, maritime and fixed station JTRS hardware suites for all services enabling seamless connectivity to the GIG. Block 2 will provide for narrowband and wideband requirements, including the JTRS WNW.

### JTRS Features

- Open, flexible, extensible, and modular networks with both Red side and Black side services
- Well-defined interfaces for third party augmentation
- Interoperability with other GIG networks (TSAT, GIG-BE) in a coordinated approach across all Services
- WNW, a self-organizing, self-healing network

### **Wideband Networking Waveform**

Several networking radios exist today, securely moving voice and data between airborne and ground elements. Some examples are the Single Channel Ground and Airborne Radio System (SINCGARS), Enhanced Position Location Reporting System (EPLRS), and Link 16. SINCGARS is a self-organizing, self-healing, IP based network. Data is routed from radio to radio on the net, until it reaches its final destination. SINCGARS’s comparatively low data rate, 500bit/s to 15Kbit/s, while adequate to support a sub network of limited size, cannot adequately connect multiple subnets forming a larger, battlefield internet.

The JTRS WNW, one of many JTRS waveforms, along with a suitably configured JTRS radio, will provide the required broadband backbone to connect subnets such as SINCGARS. A WNW equipped UA, acting as an airborne backbone, would significantly increase the data throughput of a collection of SINCGARS subnets. The WNW threshold data throughput rate is 2 Mbit/s. Its objective throughput rate is at least 5 Mbit/s. WNW will be able to tailor its transmission data rate to match the receiving radio data capacity.

In addition to providing a backbone, linking ground based, battlefield subnets, WNW creates airborne and ship borne extensions to the GIG, supporting free flow of data through a dynamic, adaptable, IP-based wireless network. The WNW routing capability will support constantly changing network topologies as well as radio silent (receive only) nodes.

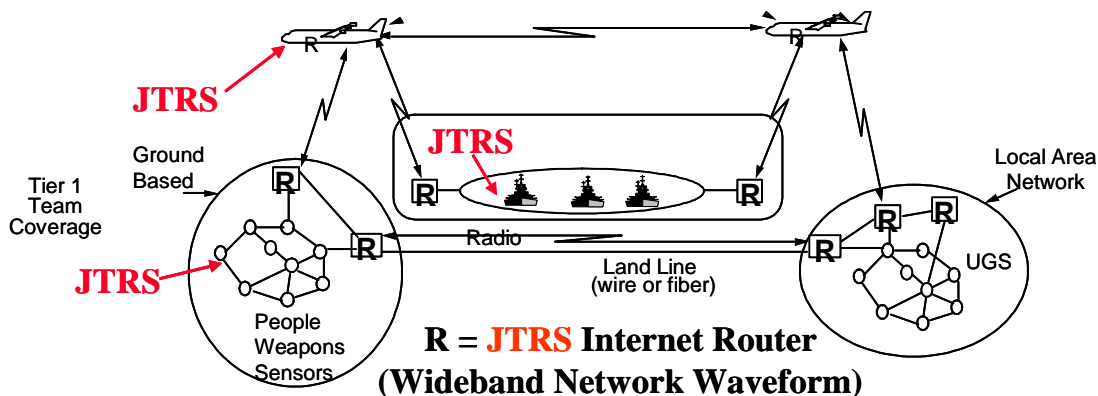

FIGURE C-5. JTRS GROUND AND AIRBORNE NETWORKS.

Figure C-5 illustrates a high level view of JTRS enabled ground and airborne networks. Table C-1 provides a summary of WNW features.

TABLE C-1. WNW FEATURES.

Data throughput – Threshold/Objective		>2 Mbit/s->5 Mbit/s
Frequency Range		225-400 MHz
Transmission Ranges (kilometers/nautical miles)	Air-to-Air	370/200
	Air-to-Ground	370/200
	Ground-to-Ground	10/5.4
	Ship-to-Ship	28/15
	Ship-to-Shore	28/15

**Transformational Communications Architecture**

Recent experience in Afghanistan and Iraq, operating Predators and Global Hawks, underscored the critical role SATCOM plays in providing over the horizon UA command and control as well as sensor product dissemination. DoD owned SATCOM assets, however, could not support the high data rates required to move imagery products.

DoD leased SATCOM channels from commercial vendors to make up for the shortfall in DoD controlled SATCOM capacity, which exposed the UA operations to some elements of risk.

- DoD faces increasing competition for available SATCOM channels from the private sector
- SATCOM channels are not always available in the required location
- Private vendors have the option to refuse service to the U.S.

The FY2002 DoD Transformational Communications Study identified the need to vastly improve military communication systems and reduce reliance on foreign commercial SATCOM vendors; as a next step in the improvement process, they developed the TCA. The defined architecture should support: protected tactical services as a follow-on to the MILSTAR and Advanced Extremely High Frequency AEHF programs; wideband services as a replacement or follow-on for the Defense Satellite Communications System (DSCS), GBS, and Wideband Gapfiller System (WGS); protected strategic services as a follow-on to the MILSTAR, Interim-Polar and AEHF programs; data relay/retrieval and command forwarding services support for satellites and high-altitude aircraft and UA; and narrowband services to support mobile and handheld services as a replacement or follow-on for the UHF Follow-On (UFO) mission area.

The TCA expresses a framework for seamless, IP based orbiting communications systems with an interface to the terrestrial component of the GIG, GIG-BE, through teleports. The TCA provides an orbiting network of optical and RF communications relays using Internet routers moving information between ground, air, and space nodes. Figure C-6 shows the TCA constellation of satellites, its

connectivity to GIG-BE via teleports and direct connectivity to manned and unmanned airborne platforms.

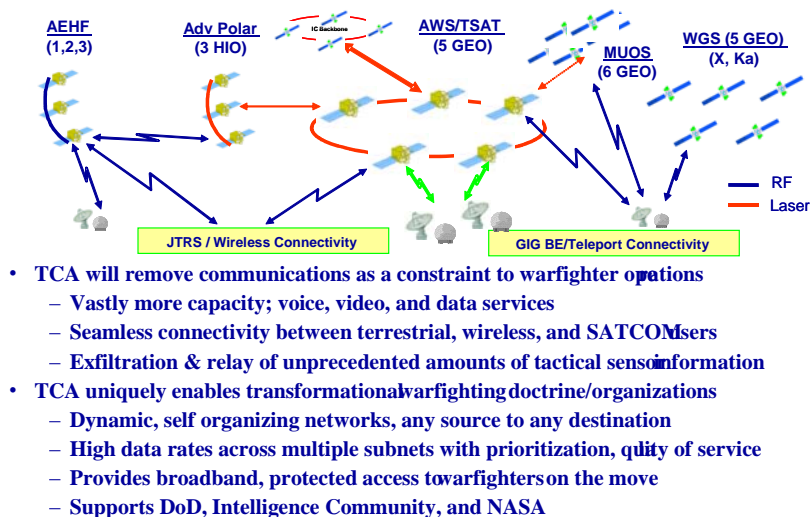

FIGURE C-6. THE TRANSFORMATIONAL COMMUNICATIONS ARCHITECTURE.

MILSATCOM through 2015. Under the current schedule WGS, DSCS, and GBS Phase II deployment begins in 2005. Advanced EHF satellite deployment begins in 2005, as well. However, Mobile User Objective System (MUOS) deployment does not begin until 2008, which will require commercial augmentation.

### LaserComm

Airborne and orbiting optical data links, or LaserComm, will offer data rates two to five orders of magnitude greater than those of the best future RF systems, and provide a direct connection between high flying UAs, such as Global Hawk, and TSAT in the 2013 time frame. Key technical challenges remain, however. Pointing, Acquisition, and Tracking (PAT) technologies, that ensure the laser link was both acquired and maintained have not yet been perfected. Although LaserComm could surpass RF in terms of airborne data transfer rate, RF will continue to dominate at the lower altitudes for some time into the future because of its better all-weather capabilities.

### Information Assurance

IA protection is required in each GIG domain (information, communications, and management and control). The GIG features a protected black core supporting multiple security levels with edge-to-edge protection for information flows (Figure C-7). Key security features will include: authentication/encryption; network control policy functions; packet header masking on high-risk communications; and dynamic intrusion/attack detection and reaction capability.

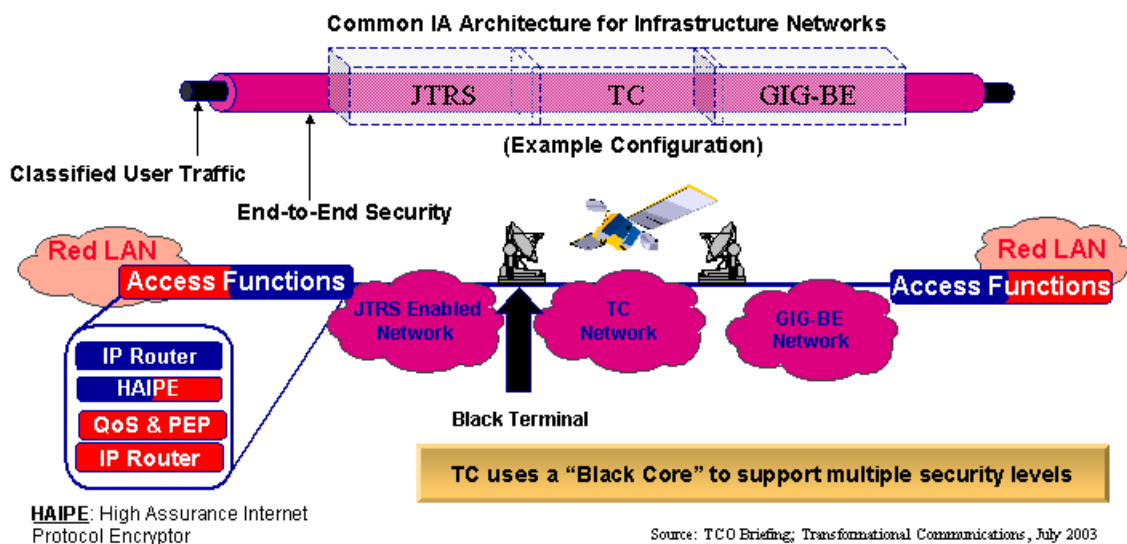

FIGURE C-7. BLACK TRANSPORT EDGE-TO-EDGE.

### DoD Net-Centric Data Strategy

For data from one computer or software application to be useable in a different computer or software application, that data must be in a format that is compatible to both. Traditionally, DoD has accomplished this compatibility through data administration, standardizing and controlling data element definitions and structures across the DoD enterprise. This approach proved too cumbersome, in part due to the constantly evolving technology and in part due to the sheer scope of the enterprise.

DoD/CIO has since published an updated approach to achieving data interoperability called the DoD Net-Centric Data Strategy. This approach expands the focus beyond mere standardization of format, to making data visible and accessible across the network. It recognizes that in addition to predefined sets of users, there will be unanticipated users requiring access to the data. The key tenet to this strategy is the development, registration and publication of metadata. This allows developers full access information about data made available and simplifies the creation of interfaces to feed the data to various applications. Complete information regarding the DoD Net-Centric Data Strategy is available at the DoD Metadata Registry and Clearing house at <http://diides.ncr.disa.mil/mdregHomePage/mdregHome.portal>.

### UA SYSTEMS ENGINEERING

Implementing network interfaces between all UA systems and subsystems provides three key benefits: (1) connects the UA to the GIG through either legacy, current, or programmed physical links - copper wire, optical fiber, RF, laser (2) enhances the GIG's aggregate data handling capacity, and (3) facilitates separating UA functions, making it easier to create modular plug and play components.

### Separate Physical Connection From Transport Protocol

UA systems do not have to wait until a net-centric wireless technology is fielded to connect to the GIG. The physical connection between two nodes, be it wire, radio waves or light, merely transfers a signal from one point in space to another. Embedded in that signal is the sequence of ones and zeros that constitute the data being passed. IP based network connections can be implemented using any physical connection. This makes it possible to connect legacy systems to the GIG by replacing tightly coupled, unique data transfer implementations with IP based network connections. Creating an IP network based transport layer separates the data transfer protocols from the physical connection and integrates UA into the GIG regardless of the wireless technology employed (C-band, CDL, JTRS, LaserComm).

### Contribute to the GIG's Aggregate Bandwidth

Currently, UA communicate with their respective control elements via dedicated, point-to-point data links. These data links provide continuous information handling capacity between the nodes, up to the maximum data rate supported. During long cruise segments of a mission, however, traffic across the dedicated link may drop to nearly zero. The closed system design precludes other users from taking advantage of the unused bandwidth.

Implementation of an IP based, packet switched network interface, between UA systems with multiple data links, control elements and other nodes, provides a path through the UA communications links through which routers can pass packets during lulls in the primary system's communications needs. Each UA system adds its individual throughput capacity to the larger network. Access priority can be controlled using QoS and COS technologies as defined by IEEE standard 802.1p giving top priority to the primary system's communications requirements. Looking at the operating theater's communications infrastructure as a whole, it becomes clear that implementing networked interfaces for all communications links, not just UA, significantly increases data handling in theater, with no compromise to the data needs of the primary system.

### Separate UA Functions

In addition to migrating point to point links to network interfaces, UA components and functions must be separated, modularized and connected using network interfaces. In keeping with the net-centric approach to system design, Figure C-8 illustrates one approach to separating and modularizing UA components and functions, within the UA. The platform's local area network (LAN) connects sensors, sensor management, and flight management units. The communications equipment connects to the WAN traffic manager and links the platform LAN to other Local Area Networks. Within the control station (ground, afloat, or airborne) the same approach applies. Consoles connect to the LAN, and the communications equipment provides pathways between that LAN and other LAN segments.

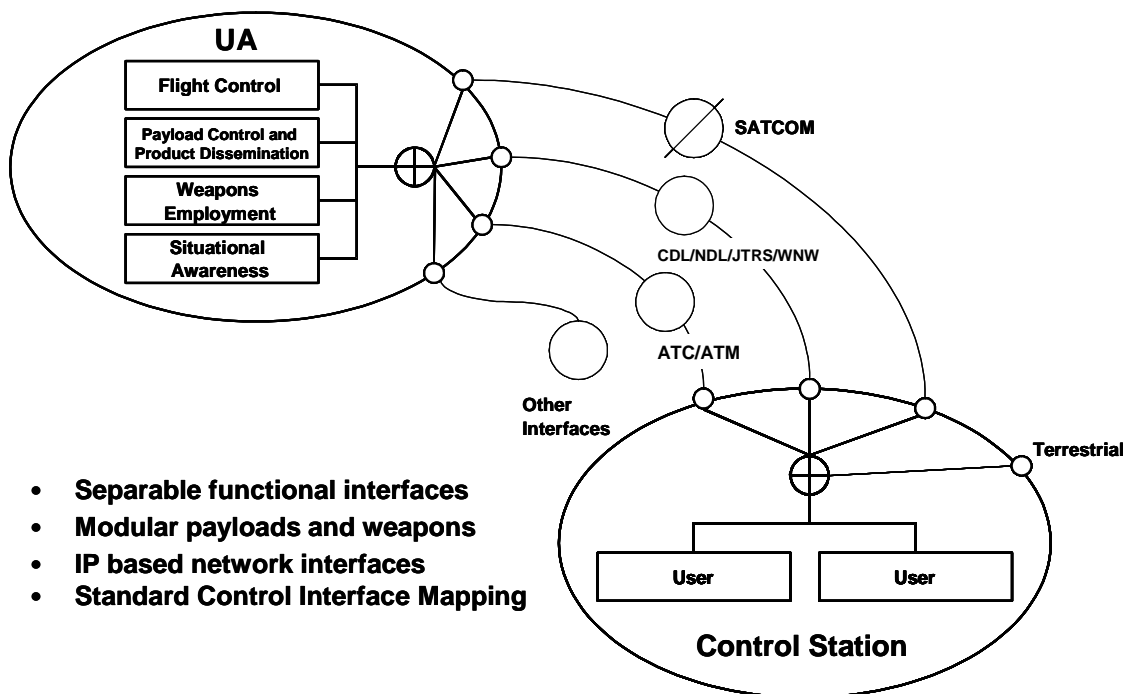

FIGURE C-8. AIRCRAFT SYSTEMS ENGINEERING MODEL – IP FRIENDLY NETWORK INTERFACES.

Communications and infrastructure requirements for all UAS will be defined in terms of four key functional interfaces.

- Aircraft Control, everything but payloads and weapons.
- Payload, product and control.
- Weapons, kinetic and electronic.
- Situation Awareness.

These four functional interfaces and their corresponding processes must be distinct and accessed separately (Figure C-8). One overall aircraft design goal would be to allow changes to payloads without requiring recertification of the flight control system software. Another would be to provide security to the various functions and subsystems: weapons security, aircraft security, and payload security. Secure methods must be developed that allow machine to machine sensor tasking, while precluding inadvertent automatic weapons employment through an aircraft control or payload control interface.

### **Aircraft Control Function**

UA control applications can and should be designed with net-centricity in mind. Rather than stand alone applications, installed on custom equipment, UA controls can be designed and deployed as network services, accessed by general purpose computers, and interfaced through the GIG via TCP/IP.

### **Payload Function**

The word “payload” refers to all UA functions that are not aircraft command and control, not weapons employment, and not situation awareness. Currently this includes an array of electro optical sensors, synthetic aperture radar, signals intelligence sensors, and communications relay equipment. Electro optical sensors collect both still and motion imagery. These include visible, infra red, multi-spectral and hyper spectral sensors.

Many current UA payloads require extensive custom interfaces to integrate sensors, platforms and control stations. Changes in payload and aircraft configuration ripple across many systems and subsystems in some cases requiring recertification of flight control mechanisms. Future UA payloads must be modular, which means independent of and separable from the UA, especially the UA’s flight critical systems. This can be accomplished by implementing the following in all new payload designs (see Appendix E)

- Standard physical interfaces. includes mounting brackets and electrical/electronic connectors
- Standard product format. imagery, SIGINT, communications relay
- Standard control interface mapping. assigning corresponding functions on different UA systems to the same keyboard commands

### **Weapons Function**

The weapons function includes dropping bombs, launching missiles and conducting information operations. The weapons function must be isolated from payload and platform control to preclude inappropriate access to weapons functions, and subsequent accidental employment, through non-weapons functions interfaces. The weapons function must support common message sets such as those described in MIL-STD-1760.

### **Situation Awareness Function**

The situation awareness function provides situation awareness from two perspectives: that of the UA operator and that of other operators in the airspace. The UA Interoperability Integrated Product Team identified a set of data elements required to support situation awareness. It also identified the need to register these data elements with the DISA metadata registry to support Extensible Markup Language (XML) tagging. The data types and units are based on the international standard for units (SI) and are the same as data elements defined in NATO STANAG 4586. The situation awareness function supports capabilities provided by:

- Link 16
- Integrated Broadcast System (IBS)



- Situational Awareness Data Link (SADL)
- Single Integrated Air Picture (SIAP)
- Air Traffic Control (ATC) Identification Friend or Foe (IFF), expanded Mode S

Link 16 provides real time situation awareness of events taking place beyond the range of an aircraft's onboard sensors. Air Force AWACS and Joint STARS, plus the Navy Hawkeye, maintain the data transmission of an integrated picture to all nodes on the network via Link 16. The current system is closed. It is not IP base or web enabled.

IBS integrates the Tactical Intelligence Exchange System (TRIXS), Tactical Related Applications (TRAP), the TRAP Data Distribution System (TDDS), the Tactical Information Broadcast System (TIBS), the Global Command and Control System's (GCCS) Near Real Time Dissemination (NRTD) interface into a single situation awareness broadcast. SADL links U.S. Air Force close air support aircraft with the U.S. Army's EPLRS. The SIAP is the air component of the Common Tactical Picture that is generated and distributed by the various sensors and command and control systems. The IFF Mode S is a secondary surveillance and communication system, which supports Air Traffic Control.

### CHALLENGES

#### Impediments to Networked UA Communications

As the Services and industry work to make the ubiquitous network a reality, individual programs will have to address a number of complex issues. While the solutions to these issues may be highly tailored to individual program requirements, they must draw on GIG standards to assure seamless connectivity and broad based information sharing. Current data link systems focus on aircraft and sensor technology rather than network based interfaces, and often use unique formats for data transfer. The resultant, tightly coupled interfaces preclude broad interoperability.

Traditional circuit based systems have enjoyed success over the years. Many users expect circuit functionality and performance to be emulated in an IP environment. While dedicated circuits offer performance precisely tailored to the operational requirement, they represent single points of failure and often have limited interoperability/flexibility due to optimization for specialized applications. Sized for peak demand, point-to-point circuits are not always required to operate at full capacity. Due to being closed circuits, however, their surplus bandwidth is not available to external users.

#### Frequency Spectrum Considerations and Bandwidth Constraints

Many UAS use COTS data link equipment that offers the developers reduced costs for the equipment and shorter development periods. Problems associated with using commercial RF for military applications include being designed within the U.S. authorized spectrum, which means that they are given the "lowest" priority within the United States and its Possessions (US&P). As a result, use of these frequencies may be prohibited in some countries. The use of COTS usage for proof of concept is OK acceptable on a temporary basis, but the strong consideration must be given system must be replaced with selecting a material solution that truly takes spectrum supportability into account. equipment that operates in the This includes considering equipment designed to operate in properly allocated band before field testing and especially before entering formal development or large numbers are procured. Such replacement efforts need to be programmed into the transition plan from ACTDs into a normal acquisition program.

#### *RF spectrum challenges for UAS*

- Spectrum use is controlled internationally by treaties and within the US&P by laws and regulations.
- Those treaties, laws, and regulations have divided the spectrum by type of service use, (e.g., radio navigation, aeronautical mobile, fixed-satellite, and mobile satellite), by user (e.g., Government and non-government), and by region (1) Europe, Africa, Former Soviet Union, and Near East; (2) Western Hemisphere; and (3) Far East and Western Pacific.

- Any new federal government system that seeks to use a portion of the spectrum must seek both a frequency allocation and a frequency assignment. Normally, new systems can not interfere with older systems with prior equal or higher status (e.g., primary or secondary) assignment.

If a new system does not conform with the existing treaties, laws and regulations, it can only operate on a “not to interfere basis” (NIB) with other approved systems.

The DoD Policy on Electromagnetic Spectrum – Management and Use (DoDD 4650.1) provides specific requirements that program offices must meet when developing and using RF systems. It states, “Spectrum-dependent equipment or systems shall not be developed or procured without reasonable assurance that required electromagnetic spectrum is, or shall be, available to support the development, testing, and operation of that equipment or system.”

DoDD 4650.1 further states that “No spectrum-dependent ‘off-the-shelf’ system shall be purchased or procured without the assurance that spectrum supportability has been, or can be obtained.”

Finally, DoDD 4650.1 requires the acquisition community to insure compliance with supportability requirements and to provide oversight to the process prior to and through the development, test and evaluation phases of a system. Since systems are designed within the U.S., they must meet U.S. requirements, and since there is no way of predicting where they may be used “outside the U.S.,” it is necessary to consider the potential limitations of International Law/International Treaties on the development of unmanned aircraft systems. Spectrum flexibility in development must be a consideration, or International Law must accommodate use of military systems regardless of the country of origin.

### ***Disadvantaged Users***

Across the internet, people enjoy a range of access performance, from low end analog modem connections, to gigabit interfaces. Those with lower performance interfaces generally recognize the limitations of their equipment and take advantage of services that are sized to fit their data handling capacity. Content providers similarly recognize that many users will continue to access their services through low performance connections and offer their services with options to tailor the content to meet the user’s capability. Defense content providers have the same requirement, to make their products accessible to the entire range of connection performance.

### **THE WAY AHEAD**

Current UA communications capabilities must evolve into the future DoD net-centric vision. Current UA support to the war fighter should be sustained while making the transition, but every effort must be made to make the transition as soon as possible. This section outlines practical guidelines to enable the future vision, including a summary of DoD written guidance, the DoD investments intended to produce common hardware and software to facilitate communications mechanisms across UA weapon systems, and the key leadership actions that can be taken right now to realize the net-centric vision soonest. The following summary of direction to the Services and to industry is intended to be the roadmap to guide the UA community’s transition to net-centricity.

### **DoD Guidance**

There is already a body of written DoD direction that must be complied with while designing, building, fielding and sustaining UA systems. OSD publishes policy guidance in the form of Memoranda, Directives, and Instructions. This section provides the major policy statements that address UA communications. It also provides sources for applicable standards. While policy establishes the “what” of the guidance, standards establish the “how,” and support policy with implementation guidelines and technical instructions.

### ***Policy***

Policy statements are organized into two groups. The first group directs transformation to a net-centric force that universally operates on the GIG, providing direction for creating the GIG and the mechanisms to enable information to flow freely across it. This includes implementation of interoperable transport

layers (IPv6), deployment of the TCA and transformation of circuit based DISN communications links to IP based services.

Although smaller, the second group provides radio telecommunications guidance that enables wireless connectivity to the GIG and is binding on all UA communications systems and waveforms. While current UA systems support the warfighter through the common data link effort, implementation of common and more flexible physical links with the JTRS program will be the next step. Guidance that implements the GIG consist of:

- DoD Directive 8100.1, GIG Overarching Policy, dated September 19, 2002.
- DoD Chief Information Officer (CIO) Guidance and Policy Memorandum (G&PM) No. 11-8450, DoD GIG Computing, dated April 6 2001.
- DoD CIO Memorandum, Subject: Net-Centric Data Strategy: Visibility-Tagging and Advertising Data Assets with Discovery Metadata, dated October 24, 2003.
- DoD Memorandum, Subject: Internet Protocol Version 6 (IPv6), dated June 9, 2004.
- Chairman of the Joint Chiefs of Staff Instruction 6212.01C, Interoperability and Supportability of Information Technology and National Security Systems, dated November 20, 2003.

Guidance that implements radio communications:

- OSD Memorandum, Subject: RF Equipment Acquisition Policy, dated June 17, 2003.
- OSD Memorandum for Secretaries of the Military Departments, Subject: JTRS, dated August 12, 2004.
- ASD Memorandum, Subject: CDL Policy, dated June 19, 2001.
- ASD Memorandum, Subject: C3I Tactical Data Link Policy, dated October 18, 1994.

### Standards

Standards support policy by providing technical information in sufficient detail to guide system and subsystem acquisition and development. These standards are mandatory for DoD weapon systems, including UAS, and are only waived in exceptional circumstances. Table C-2 lists the key standards and sources for standards.

The “source” column contains hyperlinks to the websites hosting the information. For detailed information regarding a standard or source of standards, follow the respective link. Some websites will require a user ID and password for access. Appendix E discusses standards that apply to various system implementations.

### ENABLING PROGRAMS

Along with written guidance above, the DoD has invested in common products with the expectation that they be used to a maximum extent possible. This is to correct the weakness from past experience where each developing UA would invest in its own unique communication mechanism or design a system architecture that drove unique communication solutions. While the capabilities and schedules of these common-use programs may change, the following represents the best knowledge as of the time of this writing. UA programs should seek to synchronize their systems with the milestones of the applicable programs: CDL, JTRS, TSAT, FAB-T and HAIPE.

In the area of net-centricity, GIG capabilities will not come on line simultaneously but will ramp up in a series of spirals. Once fielded, these capabilities will continue their evolution. Figure C-9 illustrates the spiral approach to achieving the net-centric force. Spiral 1, 2006, connects UA to the net and bridges gaps between legacy systems resulting from nonstandard data structures and transport mechanisms. Transition to IP based transport and metadata registration constitutes foundation elements to this strategy. Spiral 1 also introduces JTRS in a move toward a more flexible, interoperable system of software defined tactical radios and dynamic wireless networks. Spiral 2, 2008, leverages advances in net-centric

communications, providing more robust connectivity between nodes and more efficient use of all available bandwidth. In Spiral 2, UA become an integral part of the net, with their excess bandwidth being made available to the GIG, improving the overall flow of data. Spiral 3, 2012, introduces the TSAT and its space born network of optical and RF receiver/transmitters and routers. It also adds new broadband connectivity between SATCOM and UA through the insertion of optical (laser) data link technology. Teleports connecting the SATCOM constellation to the GIG-BE fiber backbone complete the circuit and provide truly global communications. By spiral 4, 2016, the GIG has become the envisioned ubiquitous network, providing information on demand to warriors on the move, transparently and seamlessly.

**TABLE C-2. KEY SOURCES FOR COMMUNICATIONS STANDARDS.**

Title	Source
<b>Global Information Grid</b>	
Global Information Grid Architecture	<a href="https://disain.disa.mil/ncow.html">https://disain.disa.mil/ncow.html</a>
Net-Centric Operations Warfare Reference Model	<a href="https://disain.disa.mil/ncow.html">https://disain.disa.mil/ncow.html</a>
Joint Technical Architecture	<a href="http://disronline.disa.mil">http://disronline.disa.mil</a>
Global Information Grid Capstone Requirements Document	<a href="https://jrockmids1.js.smil.mil/guestjrcz/gRequirement.ReqDetails?pId=5027">https://jrockmids1.js.smil.mil/guestjrcz/gRequirement.ReqDetails?pId=5027</a> (SIPRNET)
DoD Net-Centric Data Strategy	<a href="http://www.defenselink.mil/nii/org/cio/doc/Net-Centric-Data-Strategy-2003-05-092.pdf">http://www.defenselink.mil/nii/org/cio/doc/Net-Centric-Data-Strategy-2003-05-092.pdf</a>
DoD Discovery Metadata Specification (DDMS)	<a href="http://diides.ncr.disa.mil/mdregHomePage/mdregHome.portal">http://diides.ncr.disa.mil/mdregHomePage/mdregHome.portal</a>
DoD Metadata Registry and Clearinghouse	<a href="http://diides.ncr.disa.mil/xmlreg/user/index.cfm">http://diides.ncr.disa.mil/xmlreg/user/index.cfm</a>
Key Interface Profiles	<a href="http://kips.disa.mil">http://kips.disa.mil</a>
Information Assurance Support Environment	<a href="http://iase.disa.mil/">http://iase.disa.mil/</a>
Net-Centric Checklist	<a href="http://www.dod.mil/nii/org/cio/doc/NetCentric_Checklist_v2-1-3_May12.doc">http://www.dod.mil/nii/org/cio/doc/NetCentric_Checklist_v2-1-3_May12.doc</a>
<b>Radio Telecommunications</b>	
Joint Spectrum Center Documents and Publications	<a href="http://www.jsc.mil/Documents/Documents.asp">http://www.jsc.mil/Documents/Documents.asp</a>
NTIA Manual of Regulations & Procedures for Federal Radio Frequency Management	<a href="http://www.ntia.doc.gov/osmhome/redbook/redbook.html">http://www.ntia.doc.gov/osmhome/redbook/redbook.html</a>
Software Communications Architecture	<a href="http://jtrs.army.mil/sections/overview/fset_overview.html">http://jtrs.army.mil/sections/overview/fset_overview.html</a>
JTRS Reference Documents	<a href="http://jtrs.army.mil/sections/referenceddocuments/fset_referenceddocuments.html">http://jtrs.army.mil/sections/referenceddocuments/fset_referenceddocuments.html</a>
<b>Industry Best Practices</b>	
World Wide Web Consortium	<a href="http://www.w3.org/">http://www.w3.org/</a>
Catalog of Object Management Group Specifications	<a href="http://www.omg.org/technology/documents/spec_catalog.htm">http://www.omg.org/technology/documents/spec_catalog.htm</a>
NATO ISR Interoperability Architecture	<a href="http://www.nato.int/structur/AC/224/ag4/ag4.htm">http://www.nato.int/structur/AC/224/ag4/ag4.htm</a>

**CDL**

While the future of wide band data links ( $\geq 274$  Mbit/s) is unclear, it will certainly involve a JTRS/SCA compliant solution. Two potential directions are evident at this time, either an enhancement to the WNW, or an SCA compliant iteration of the CDL managed under the auspices of the JTRS program office. Regardless, the final solution will become part of the JTRS set of software defined radios.

WNW is currently envisioned as a 2-10 Mbit/s, self organizing network, initially acting as a backbone connection for self organizing ground and airborne networks, eventually replacing all ground and airborne networking radios. For WNW to become the migration path for CDL wide band (>274 Mbit/s) applications, however, high-powered, directional JTRS hardware would have to be developed and fielded. In addition, a WNW waveform, capable of supporting such data rates would have to be developed, integrated, tested and fielded. Current funding does not support this approach.

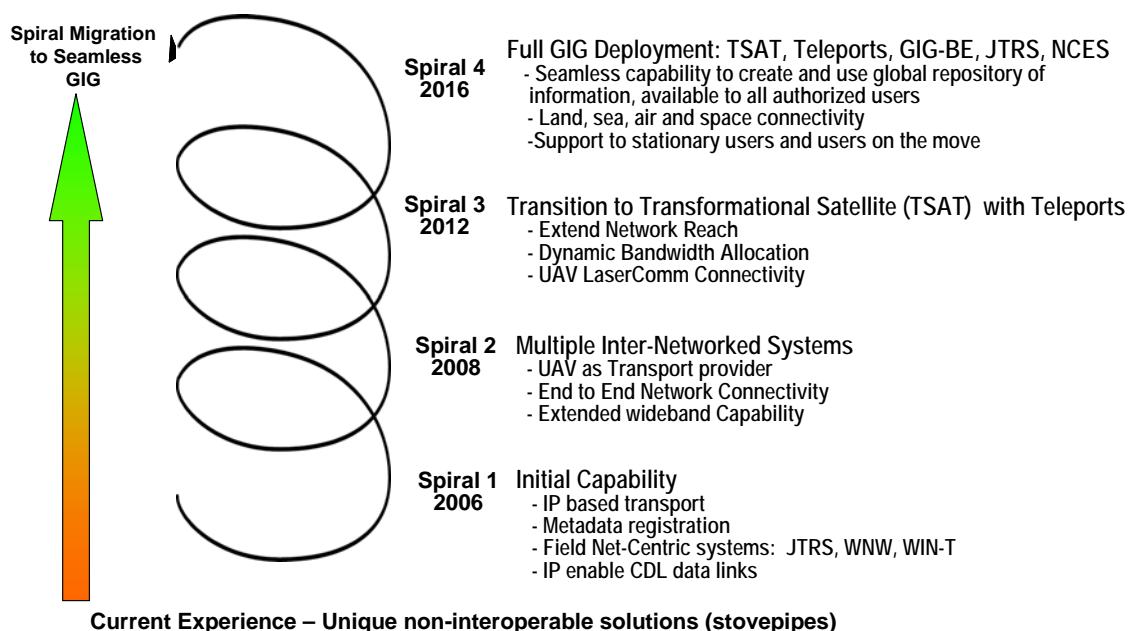

**FIGURE C-9. SPIRALED STAGES TO A UA COMMUNICATIONS NETWORK.**

Another possible direction would be, in keeping with currently published and supported OSD guidance, continuing to evolve the CDL specification using existing processes. Initial tasks would be to migrate to a net-centric footing, by isolating the data and transport layers from the physical connection, making CDL a wideband, point to point, network connection, vice the tightly coupled closed circuit it is today. Evolving software defined hardware components and supporting wideband waveforms would come next bringing the CDL into SCA compliance, making it part of the family of JTRS solutions. Current funding, however, does not support this approach either.

Regardless of which direction future CDL programming takes, however, one imperative remains clear. Systems that need a CDL for wideband data exchanges, must submit their specific performance requirements to the JTRS program office to help guide future wide band data link procurement efforts. Figure C-10 illustrates these two potential directions.

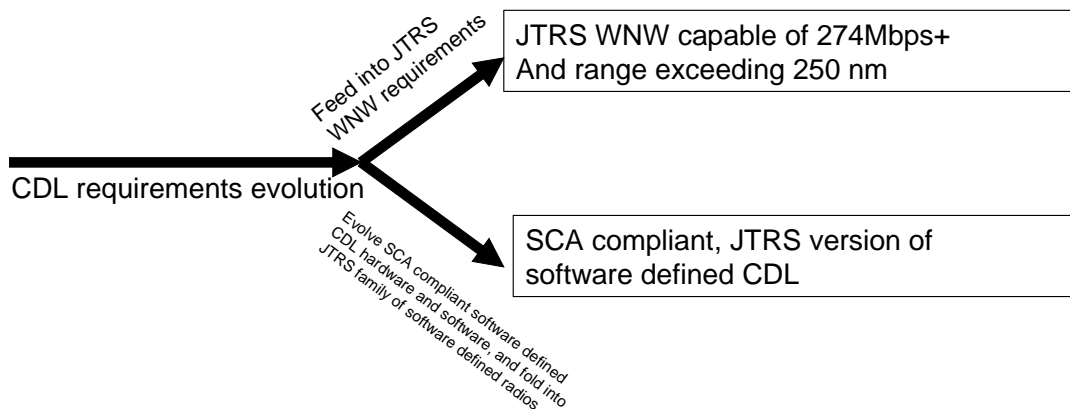

**FIGURE C-10. POTENTIAL CDL MIGRATION PATHS.**

**JTRS**

The Joint Tactical Radio System program addresses legacy radio problems (refer to the section entitled Radios) through a two-pronged approach: software and hardware. First, the SCA, written for the JTRS program, specifies guidelines for developing software-defined waveforms. The Object Management Group (OMG) has adopted the SCA as an industry standard. In addition to software, JTRS certified hardware is being developed that can import software-defined waveforms and communicate using them.

The JTRS program will oversee development of a family of software-defined radios, based on a set of common hardware components and software applications. All UA programs that require radios must synchronize purchases with the JTRS schedule. In cases where JTRS radios are not yet available, these programs must obtain a waiver, procure the minimum required number of legacy radios, and have a migration plan to procure and install JTRS counterparts as they become available.

Figure C-11 shows IOC dates for key UA related JTRS programs. Cluster 1 and the MIDS JTRS should reach IOC in 2007. USN/USA will demonstrate and begin fielding Fire Scout with an integrated SCA compliant CDL (TCDL), using a JTRS Cluster I terminal equipped with a high-band modem module. AMF JTRS is expected to reach IOC in 2009. This schedule may change, but it remains a requirement for UA programs to coordinate all future radio purchases with the JTRS program office. For more detailed information about JTRS Clusters refer to the section entitled “Joint Tactical Radio System.” Additional information about the JTRS program and means of contact can be found at <http://jtrs.army.mil/index.htm>.

UA Related Program Schedules

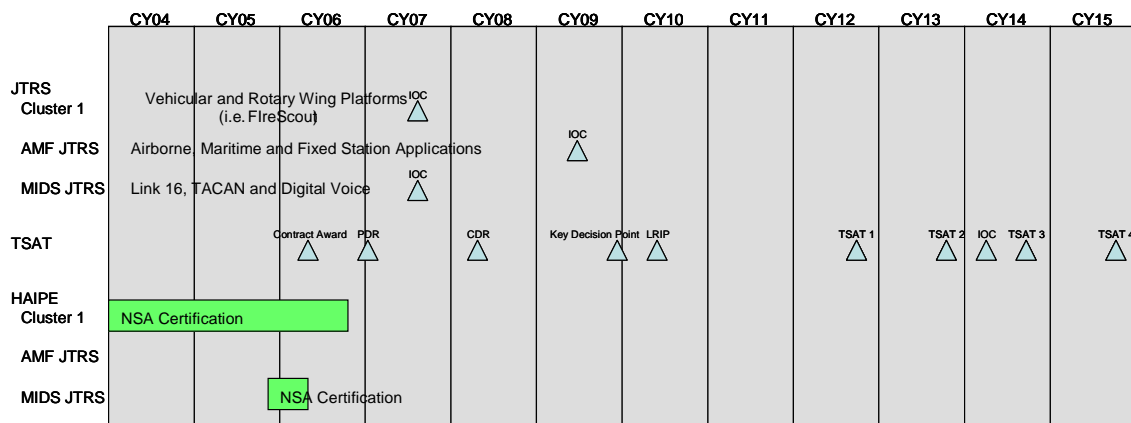

FIGURE C-11. CONSOLIDATED HIGH LEVEL PROGRAM SCHEDULE.

TSAT

DoD relies extensively on SATCOM for UA command and control as well as product dissemination. Reliance on foreign commercial vendors, however, entails some risk. A government owned, broadband, SATCOM constellation will reduce reliance on commercial SATCOM and provide more available and cost effective BLOS communications support to UA operations. For a more complete description of current UA communications, refer to the section entitled “Historical Perspective,” and its discussions of Global Hawk and Predator operations.

The TSAT constellation implements the space borne component of the GIG, moving data globally through an orbiting optical and RF based network. The first TSAT is scheduled for launch in FY13 (CY12). An additional TSAT will be launched each year until all 5 TSAT systems are established in their geosynchronous orbits (Figure C-11). TSAT will connect to the terrestrial backbone via teleports located at strategic points throughout the globe. TSAT will be transparent to most GIG users, and be experienced simply as a high data rate transfer capability.

UAS, such as Global Hawk and Predator, will connect to TSAT directly through the FAB-T, which include both RF and Optical data links.

High Assurance Internet Protocol Encryption Devices

The principal objective of Information Assurance is to assure access to authorized users while denying access to unauthorized users. For example, imagery exploiters and operations center personnel may need UA data, but a medical technician does not. Historically the separation has been accomplished through physically securing the classified networks, and encrypting the information as it leaves the protected facility. Circuits that transfer unencrypted classified information are designated red in security accreditation plans. Circuits carrying unclassified information or encrypted classified information are designated black. Open connections between red circuits and black circuits are prohibited. This principle of red/black separation guides the design and implementation of classified information processing facilities.

A variation on the idea of red/black separation, and a fundamental tenet of the GIG, is the concept of red edge/black core. Information created in classified enclaves (red edge) is encrypted and sent across the GIG as unclassified (black core) information. This concept allows all information to traverse the web through any available series of networks, regardless of encryption schemes employed.

Some daunting architectural challenges must be overcome in order to achieve red edge/black core. One issue has to do with embedded enclaves, which under the current architecture would require successive

decryption and encryption across the GIG. This would increase latency and add potential points of failure to the path.

NSA oversees development of HAIPE devices and the HAIPE Interoperability Specification (HAIPIS). The HAIPE device will be installed between a classified (red) processing node or network and the unclassified (black) networks of the GIG. Ultimately, HAIPE devices will be integrated into all systems, pushing the red boundary as close to the classified source as possible. UA sensors will be an important source of such classified information (i.e. imagery, SIGINT, MASINT). Therefore, UA systems that create classified information must integrate HAIPE devices as they become available.

### NEXT STEPS

Aside from written guidance and existing programs meant to bring UA communications into the net-centric vision, specific steps can be taken now, to eliminate obstructions to broad based information sharing and facilitate UA systems integration into the GIG. Some of the actions have been noted earlier in the text but are repeated here for emphasis and to provide a consolidated list. Failure to implement any of these will significantly limit a UA system's ability to share information across the GIG.

- Embrace DoD approved net-centric products. Focus resources on moving toward GIG compliance rather than justifying waiver requests for legacy hardware and software.
- Develop Net-Ready Key Performance Parameters (NR-KPP).
- Perform GIG Capstone Requirements Document (GIG CRD) crosswalk as specified in the GIG CRD.

The following measures should be initiated as soon as possible to eliminate existing and programmed obstructions to information flow across the GIG.

- Implement IP transport layer in all UA systems, including legacy data links, to the maximum extent practical.
  - Comply with the IPv6 mandate.
  - Implement IP based network interfaces between sensors, control elements, and the GIG.
  - Apply the Aircraft Systems Engineering Model to all new UA designs and modifications.
  - Insure clear separation between key functional components: aircraft control, payload control, weapons employment, and situational awareness reporting.
  - Separate data, application, and transport layers of the onboard UA communications architecture.
- Develop and register legacy and developing system metadata descriptions using DISA's DoD Metadata Registry and Clearinghouse. This exposes data and data characteristics to all interested/authorized users, both intended and unintended, and greatly simplifies development of interfaces to disparate sources of data.
- Migrate from legacy radios to JTRS compliant clusters.
  - Comply with the SCA, use or develop software-based waveforms for all RF and optical physical interfaces.
  - Coordinate all future radio procurements with the JTRS Joint Program Office.
  - Procure JTRS compliant hardware when available.
  - Procure SCA compliant software when available.
  - Make maximum use of the capabilities provided by JTRS compliant hardware and SCA compliant software.
- Follow Spectrum Use Policy.
  - Transition to IP based wireless connections in the near term.
  - Establish and meet firm transition dates from non-DoD approved spectrum to DoD spectrum recommendations.



- Ensure systems are developed to operate in authorized spectrum anywhere in the world.

End goal: All RF based systems use spectrum appropriate to their size, class and individual requirements.



**APPENDIX D: TECHNOLOGIES**

**PROPULSION**

**Turbine**

UA are rapidly being developed for eventual integration into the Army, Naval and Air Force fleets. Today's battlefield contains aircraft that have two classes of turbine engines: 1) man-rated for manned platforms and 2) expendables for cruise missiles. UA service has brought about a third limited-life class, which must support the unique role of UA. The current development of systems, such as Global Hawk and J-UCAS, which occupy ISR, SEAD and deep strike missions, have shown that existing "off-the-shelf" propulsion systems are placed under such heavy demands that mission capability and operational utility can be severely limited. Future UA will address combat scenarios and are projected to require even greater demands for better fuel consumption, thrust, power extraction, cost, low signature and distortion tolerance.

- Integrated High Performance Turbine Engine Technology (IHPTET) program. The IHPTET program is a joint service, NASA, DARPA and industry initiative that began in 1988. It is a three-phase program with goals of doubling propulsion capability by 2005. IHPTET is also the cornerstone of U.S. military turbine engine technology development. One of the three IHPTET classes of engines is the Joint Expendable Turbine Engine Concept (JETEC) program. This joint Air Force/Navy effort, will demonstrate several key UA-applicable technologies including advanced aerodynamics, lubeless bearings, high-temp low cost hot Sections, and low-cost manufacturing techniques. Using data from laboratory research, trade studies, and existing systems, the payoffs/tradeoffs for each of the critical technologies will be analyzed in terms of engine performance, cost, and storability. (See Figure D-1 and Figure D-2.)

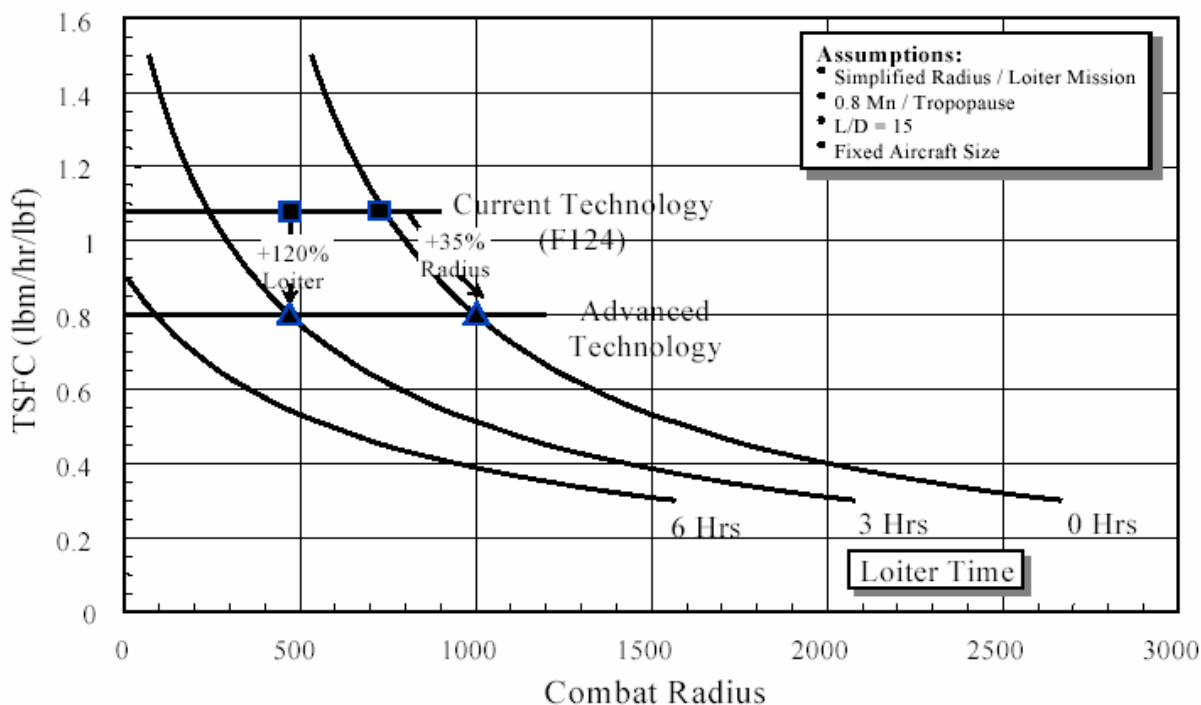

**FIGURE D-1. PERFORMANCE PAYOFF OF A NOTIONAL COMBAT UA UTILIZING TECHNOLOGIES FROM THE JETEC PHASE III GOALS.**

Reducing production and development costs may be the most critical effort for UA engine designers. These reductions can be achieved through various means such as advancements in manufacturing

techniques, unique component designs, and multi-use applicability. Advanced manufacturing techniques can greatly reduce tooling cost and fabrication time. For example, resin-transfer molding for outer mold casing components can reduce production cost up to 40% over conventional lay-up techniques. JETEC is pursuing this and several other fabrication concepts including gang milling, high-speed milling, bonded castings, bonded disks, metal-injected moldings and inertial welding.

Unique component designs must be pursued to allow UA engines to provide a high level of sophistication while minimizing cost. Since part count is a major determinant of production cost, design features such as drum turbo-machinery, slinger combustors, threaded casings, and integral blisks can reduce part count by an order of magnitude. Low cost seals such as brush and finger designs have shown great promise for replacing large, expensive labyrinth-type seals.

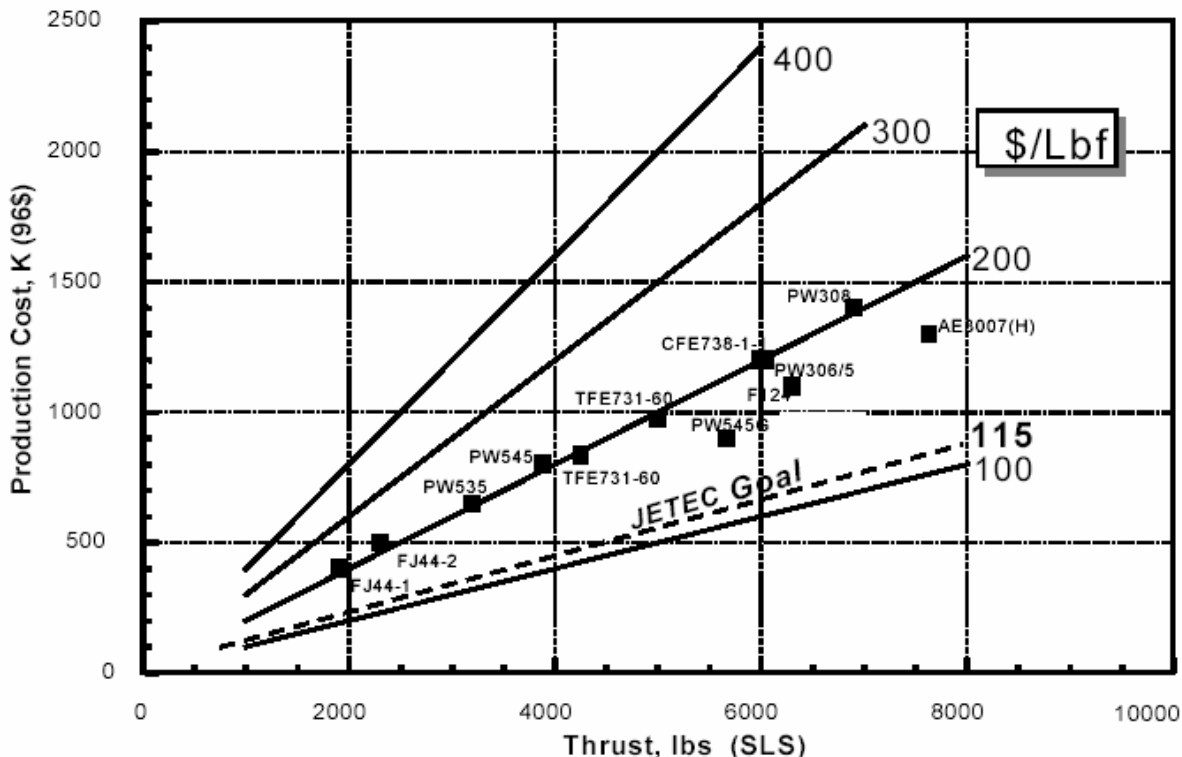

FIGURE D-2. JETEC COST GOAL IN COMPARISON TO EXISTING SYSTEMS.

Development costs can inhibit a buyer from pursuing a new engine design. This leaves only off-the-shelf systems that typically have less than optimal performance and/or cost for UA. These penalties can come in the form of increased maintenance, decreased range or speed, increased production costs, or decreased low observable (LO). To counter this and minimize development costs, industry must examine multi-use concepts where a common-core can be incorporated into UA and commercial propulsion systems such as general aviation, business jet, and helicopter gas generators. The payoffs are enormous for both communities – decreased cost to the military and increased technology for the civilian sector.

- Versatile Affordable Advanced Turbine Engines (VAATE). As currently planned, the DoD/NASA/DOE VAATE initiative is ramping up over the next several years, and will follow and build upon the IHPTET effort. Unlike IHPTET, which focused heavily on performance, VAATE will build upon the technology advances of IHPTET, and concentrate on improving aviation, marine and even ground-power turbine engine affordability, which proponents define as capability divided by cost. VAATE's affordability orientation will look at technologies cutting engine development, production and maintenance costs. The balance of the VAATE affordability improvements will come from performance capabilities--technologies associated with boosting thrust and cutting weight and

specific fuel consumption. VAATE also emphasizes improvements to installed performance, addressing overall performance improvements in addition to engine component technologies.

- VAATE is a two-phase program with specific goals. By the end of phase 1 in 2010, a six fold improvement in affordability will be demonstrated, and at the end of phase 2 in 2017, a ten-fold improvement in affordability will be demonstrated. Baselines for the effort are current state-of-the-art power plants such as the Honeywell F124 used in the Boeing X-45A UCAV Demonstrator.
- VAATE work will be concentrated into three focus areas and two pervasive areas. Focus areas will include durability; work on a versatile core, and intelligent engine technologies. Pervasive areas, which are really incubators for hatching ideas that should be included in the VAATE focus areas, will be segregated into the categories of high-impact technologies and UA.

### Propulsion – Internal Combustion

Reciprocating internal combustion gasoline engines are widely used in fixed wing UA with take-off gross weights less than 2,000 pounds. This is true among legacy UA, (Pioneer, Shadow 200, and Predator) and numerous demonstration aircraft from both industry and government laboratories where two and four cycle engines are used. While either cycle offers advantages and disadvantages, the demonstrated lower cost and better efficiency of these engines precludes developing turbo-shaft engines to meet the engine needs for UA in these size classes. However, these engines do not meet the requirements for a common battlefield fuel as defined in DoD 4000. In addition, the engines tend to fall short in reliability/durability as compared to man-rated aircraft engines, making them less attractive to warfighters who rely heavily on the data received from their UA payloads to make real-time decisions. Future small UA will continue to utilize these low cost, gasoline engines unless significant advances are made. Two potential areas are weight reduction for true diesel cycle engines and successful modification of existing gasoline engines to burn jet propellant (JP) fuels with increased reliability.

True diesel cycle engines had been precluded up to this time due to significantly higher engine weight as compared to most gasoline engines. However, the advent of turbo-diesel technologies over the last few decades, along with continuing development work with engine manufacturers to reduce the weight of diesel engines has advanced the possibility of diesel engines being used by light aircraft. For example, the Thielert Group in Germany has worked for many years to qualify several of their engines with the European Aviation Safety Agency (EASA), for use in general aviation aircraft. Their efforts have recently proven fruitful with certifications to operate their Centurion 1.7 engine on Cessna 172 aircraft, and soon this same engine will be certified for the Piper Warrior III. Both the government and industry are already evaluating an application of this type on the MQ-1 Predator to determine what “actual” performance results would be realized when installed.

Technology outlook. The use of both motor gasoline and aviation gasoline in small UA is undesirable, because it is both unsafe (JP fuels have higher flashpoints than gasoline, making them more tolerant of explosive combustion situations) and logistically difficult to support. There are currently several ongoing efforts to develop small JP5/8 fuel burning engines in the power classes and power to weight ratios being discussed here, including lightweight versions for aviation applications. For example, the opposed cylinder (OPOC) engine development program (FEV Engine Technology, Inc.) is developing a light weight, high powered diesel engine that is being sized for the A160. In addition, Nivek R&D, LLC, is developing a lightweight six-cylinder diesel engine for the A-160.

- Reliability. Reliability of current low cost two and four-cycle UA engines are on the order of a few hundred hours, sometimes less. This shortcoming, when compared to turbine engines, is often overlooked due to the low cost of reciprocating engines. However, good engine reliability has proven to be a significant factor in user acceptance of UA. Nevertheless, most UA demonstrations, and even development programs do not stress reliability in the design process, nor prove reliability in their development, many times resulting in disappointing results in extensive flight and operational testing.

Developing reliability in a small HFE will present a large challenge due to the differences in combustion and lubrication between JP fuels and gasoline, and the duty cycles imposed on them for UA use.

- Efficiency, brake specific fuel consumption, (BSFC) and power-to-weight ratio. One of the most desirable traits for any UA is persistence, and engine fuel efficiency has a major influence on the number of UA required for a given time on target coverage. Current gasoline two cycle engines have relatively poor efficiency, while four stroke engines are better but at the cost of increased engine weight. Both engines are significantly better than small gas turbines in this power class. As a result, any effort to develop HFEs will place a large emphasis on efficiency. A HFE that operates on a true diesel cycle could double the endurance of a given UA, which normally uses a two-stroke gasoline engine. Currently, two cycle engines tend to be used extensively in small UA, particularly in demonstration efforts. They provide the UA designer a low cost and lightweight, yet powerful engine, providing significant capability per dollar. This is known as the power-to-weight ratio. Due to low cycle efficiency their BSFCs tend to be high, resulting in aircraft with limited endurance capabilities. Existing gasoline engines converted to operate on heavy fuels would not have significantly improved BSFCs, but would improve the logistics footprint by operating with a common fuel. True diesel cycle engines would offer greatly reduced BSFCs, but technological advances are required to reduce the weight of these engines to get them near the same mass as gasoline engines. The technological advances to bring two-cycle engine efficiencies up to HFE levels are equally complex.
- Technology challenges. There are two approaches to using JP fuels in UA designed for lightweight gasoline engines; converting an existing gasoline engine to operate satisfactorily on JP fuels, or developing a true diesel engine light enough to be substituted for an existing gasoline engine. Depending on the approach chosen there are different technology challenges associated with each:
  - Conversion – This approach will yield an engine of similar efficiency to the current gasoline engines (no improvement in BSFC) but will be close in power to weight and minimize integration efforts. Challenges include designing a combustion system that effectively burns JP fuels without using a diesel cycle, and obtaining acceptable engine reliability while using JP fuels.
  - Light-weight Diesel – This approach will yield an engine of much greater efficiency than current gasoline engines but a significant technology challenge will be weight reduction in order to even approach that of current gasoline UA engines while maintaining reliability.
    - Advancements in materials are needed to allow development of diesel engines to approach the power to weight ratios of gasoline engines. The high cylinder pressures associated with the diesel cycle will require advanced materials not presently found in reciprocating engines. Concurrently, dynamic components such as crankshafts, connecting rods and bearings also need improved weight to strength/wear for suitable use in aviation engines.
    - Weight reductions in the area of diesel fuel systems and ancillary components will also be required. This includes the fuel injection system, turbochargers, intercoolers, scavenge pumps, cooling systems. Increasing efficiency requires advanced fuel system components such as lightweight high-pressure pumps/fuel injectors and advanced fuel control techniques such as rate shaping. These systems are required for diesel cycle engines operating on JP fuels.
- Shortcomings of Current Approaches. The ongoing development of the OPOC engine shows significant promise for meeting the need for a low cost heavy fuel engine. Other proposed solutions, such as low pressure diesels and modified two cycle gas engines have been without merit to date. To ensure the provision of reliable, efficient, lightweight JP burning engines for aviation use, additional in depth technology programs must be pursued. The resulting influence on UA designs (and their inherent capability) of the different design approaches is depicted in Figure D-3. Without an in-depth

technology program the best that can be hoped for are mediocre solutions that meet some of our requirements, but fall significantly short in providing the true solution needed.

**Propulsion – Electric and Alternative Technologies**

Many of the smaller UA (mini- and micro-UA) use battery power instead of two-cycle engines. Low noise signature makes these electric drives attractive in many situations, despite the low efficiency and low power-to-weight ratios compared to reciprocating engines. Recent improvements in the ability to re-charge lithium based batteries have resulted in significant logistics improvements for users in the field. Further improvements are needed in power-to-weight ratios for the next generation of batteries to improve the performance and endurance of these small platforms on a single charge. Currently, most battery-operated MAV have a fraction of an hour of endurance, while mini-UA fair only slightly better, only because they can carry larger numbers of the same lithium-based batteries.

Future-looking efforts for UA propulsion include the use of fuel cell- or nuclear-based power schemes. NASA has pushed fuel cell development for use in UA and by the Army's Natick Laboratory for soldier systems (i.e., small scale uses), and specific energy performance is approaching that of gasoline engines. The gaseous hydrogen fuel cells being used on NASA's Helios UA in 2003 have over 80 percent of the specific energy of a two-cycle gasoline engine (500 vice 600 Watt hours/kilogram) and 250 percent that of the best batteries (220 W hr/kg); further improvement is anticipated when liquid hydrogen fuel cells are introduced. Still in development by NASA are regenerative power systems combining solar and fuel cells in a day/night cycle to possibly permit flight durations of weeks or longer. Additionally, several commercial aviation initiatives are exploring fuel cells for both primary propulsion and auxiliary power units (APUs), see Figure D-4. In the nuclear arena, the Air Force Research Laboratory has studied the feasibility of using a quantum nucleonic reactor (i.e., non-fission) to power long endurance UA. However this remains a concept study, no prototypes or flight worthy hardware are currently planned.

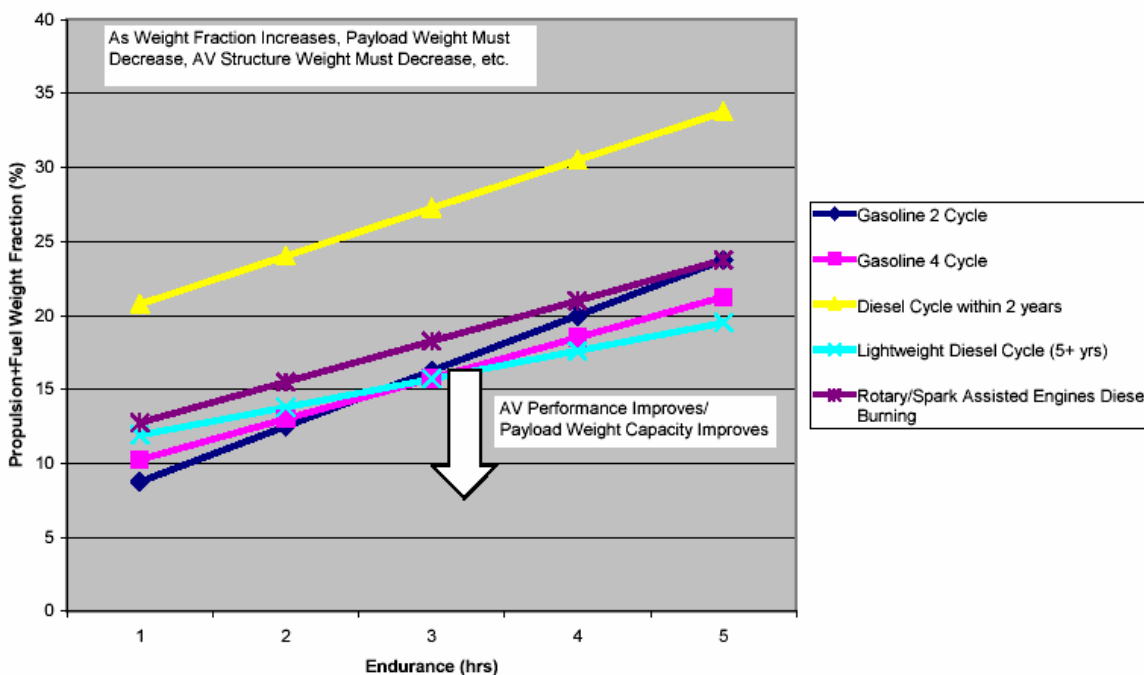

**FIGURE D-3. ENGINE EFFECTS ON TAKE-OFF GROSS WEIGHT FOR A DESIRED MISSION ENDURANCE.**

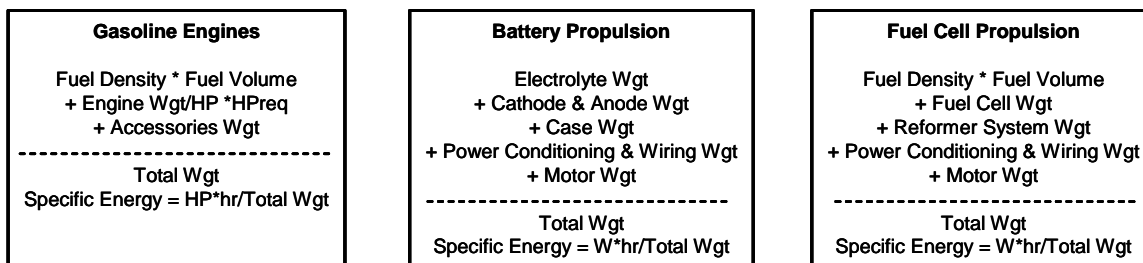

FIGURE D-4. SPECIFIC ENERGY CALCULATION.

### Propulsion - Hovering

The ability to take-off and land vertically can provide added operational benefits, such as being able to operate from a forward arming and refueling point with manned assets or from other unimproved areas. DARPA currently has several joint programs with the Army developing vertical take-off and landing UA. These include the small OAV and MAV ACTD, which are pursuing ducted fan aircraft with the ability to hover and fly in forward flight efficiently, as well as the much larger A160 advanced unmanned helicopter program. Other aircraft, such as the RQ-8 Fire Scout are also being developed for a VTOL capable UA. A goal of the small UA DARPA programs is to field aircraft with the ability to "Perch and Stare." Conceptually, this would enable the UA to land in a place that it can observe the scene where enemy activity is of interest. The purpose of this capability would be for the small UA to observe movement (change detection) and notify the human user by sending a picture of the object that has moved (changed). This reduces the fuel required to operate and increases the time on station significantly and eliminates the users need to "watch" the video screen. This concept does not need to send pictures unless requested or movement is detected, which would further reduce power consumption and increase endurance.

### Aircraft Structures

Mission, environment and intended aircraft performance attributes are key drivers for UA structures in the same sense as for manned aircraft. At one end of the "UA spectrum" aircraft such as the Finder and Dragon Eye diminish the need for durable structures. This is contrasted with Global Hawk class UA where individual airframes are planned to be in the Service force structure for periods comparable to traditional manned systems.

Similarly, environmental requirements drive interest in aircraft structures in three basic directions. UA primarily intended for tactical use in the close vicinity of ground forces dedicated to force-protection missions will have modest requirements for systems redundancy. For UA intending to be certified to fly in civil airspace, the recognition of redundancy requirements is a factor for the development of systems and integration for the entire aircraft. This tends to drive up the scale of the aircraft and the structures needed to host capabilities and multiple systems needed to support larger scale performance for endurance, altitude and extended reliability. The need for a capability to operate and survive in high-threat areas adds the need for signature control, which becomes a consideration for structures planning.

- Wing. Keeping targets of intelligence interest under constant and persistence surveillance is increasingly valued by operational commanders. This, in turn, drives interest in wing designs that can bring the greatest possible measure of endurance to collection platforms. Technologies being investigated to increase wing performance include airfoil-shape change for multipoint optimization, and active aero elastic wing deformation control for aerodynamic efficiency and to manage structural loads. Research needs to be expanded in the area of Small Reynolds Number to improve the stability of small UA. This is especially true for the mini- and micro-UA classes using high aspect ratio wings. These platforms suffer lateral stability problems in even lightly turbulent air, which induces sensor exploitation problems and exacerbates the task of the aircraft/sensor operator. Research and development work with membrane wing structures appears to offer a passive mechanism to reduce

the effect of small Reynolds Numbers on lateral stability. More work needs to be accomplished to expand this work to high aspect ratio wings.

- Apertures. The demand for increasingly sophisticated sensor and communications systems on airborne platforms continues to grow in the face of stringent space, weight and power (SWaP) constraints. This tension results in the desire to reduce the number of sensors and required antenna systems by combining functions and sharing components. Reducing costs and SWaP demands on platforms is key to controlling the size and costs of the sensors themselves. The importance of setting rigorous requirements to specify apertures is a factor in sizing the collection platform itself. A robust systems engineering regimen is required that recognizes the “function” required of the UA, and builds a “system,” rather than building a UA then trying to “shoe-horn” in a capability (e.g., if you want an ISR UA, start the design process as an ISR system, not a UA system). Consolidating capabilities on a single platform is envisioned in the multi-sensor command and control constellation (MC2C) program. The MC2C concept is, in effect, another means of aperture management. However, the constellation will include associated high- and low-altitude unmanned aircraft where collection systems can be integrated providing far more capability than any single platform. This also affords the opportunity to “net” multiple apertures from widely separated platforms into a single system bringing the attributes of ground-based multi-static systems into the airborne environment.
- Lightweight structures. Military aspirations for extended range and endurance face the technical challenge of reducing gross weight. Advancing technology in materials as well as increasing the affordability of composite structures is being addressed in Service laboratories. In addition to the airframe, weight issues at the component level such as heat exchangers, sensors and antennas are research priorities. Weight can also be reduced by using aircraft structure and skin components to perform multiple functions such as fault detection and as an adjunct to RF capabilities. In the future, manufacturers will have new tools to integrate in their design processes to achieve the best possible performance. Some of the tools that show promise for lightweight structures are thermoset and thermoplastic resin matrix materials in advanced composites as well as fiber reinforced plastics structures.

### **Aircraft Onboard Intelligence**

- Onboard intelligence. The more intelligence ‘packed’ into the UA, the more complicated the task it can be assigned, and the less oversight required by human operators. The industry must continue efforts to increase intelligence of these aircraft, which means the Services must not only look at their intelligent systems investment portfolios, but also assess the best way to package the improvements.
- Teaming/swarming. Getting groups of UA to team (and small UA to swarm) in order to accomplish an objective will require significant investments in control technologies (distributed control technologies for swarming). Technology thrusts are to not require huge computational overhead or large communications bandwidth. Technology areas, such as bio-inspired control, offer paths to do such distributed control, but are now just coming out of the 6.1 world into 6.2. More work needs to be completed toward maturing these technologies via demos in the near term to show utility to the warfighter. This would take the aircraft from an ACL of 2 to 6.
- Health Management (ACL 2). Small UA are looked at as expendable; however, must still be able to fulfill a mission. Health management technologies need to be integrated to ensure that they are ready to go for the next mission, as well as to let the operator know that they will not be able to complete the current mission so that other assets can be tasked. These technologies are available; but just need to be modified to operate in the small UA system environment.
- Collision Avoidance. Collision avoidance will be required for any UA that plans to regularly use a nation’s controlled airspace. Collision avoidance technology is currently in development for large UA (such as AFRL’s Auto-aircraft Collision Avoidance System (ACAS)). However, these technologies or their current alternatives in the civil market (TCAS) are not well suited for direct application to small UA. Research is required into concepts of operation, sensors, and algorithms to



ensure safe small UA operation in support of civil operations or in support of a combined arms task force.

- Affordability. Affordability cannot be ignored. Just as technology might determine whether a system is practical, affordability determines whether a system is purchased. Lower costs for UA can determine the operational employment concepts. For example, if the cost to replace a UA is low enough, an item can become “attributable,” and even “expendable.” Small UA can benefit significantly from appropriate application of the technology as it relates to production costs.
- Sensing. Sensing covers a significant set of issues from ISR to auto-target recognition to “see and avoid (S&A).” Improvements in miniaturization will push capability into smaller and smaller packages as time progresses. Already the capability available in a MQ-1Predator of ten years ago is available in the Shadow 200. This will continue with the potential for greater capabilities to migrate into the mini-UA and MAV. Such a transition must continue to be supported in order to improve product quality to the lowest levels. Affordability of this migration will also be important and tied to capabilities available in the commercial sector.

### **Ground Station Command, Control, and Communications (C3)**

As the capabilities of the UA continue to improve; the capability of the command and control (C2) infrastructure needs to keep pace. There are several key aspects of the off-board C2 infrastructure that are being addressed: a) man-machine interfaces, b) multi-aircraft C3, and c) target identification, weapons allocation and weapons release. The location of the C3 system can be on the ground, aboard ship, or airborne. The functions to be accomplished are independent of the location. UA hold the promise of reduced operating and support (O&S) costs compared to manned aircraft. There are only small savings by simply moving the man from the cockpit of a large aircraft to the off board C3 station. Currently, UA crews can consist of as many functions as sensor system operator, weapons release authority, communications officer, and a mission commander. All can be separate individuals. Applications to reduce these functional manpower positions into fewer positions are in its infancy. Improvements in aircraft autonomy to allow for fewer positions, or more aircraft controlled by the same positions are also in its infancy. One of the difficult issues being addressed is how the operator interacts with the aircraft: what information is presented to him during normal operations and what additional information is presented if an emergency occurs. Advanced interfaces are being explored in the DARPA UCAV programs. To date, the C3 stations being developed are aimed more at the test environment than the operational environment. The advanced interfaces take advantage of force feedback and aural cues to provide additional situational awareness to the system operators. Improvements should focus in the following areas:

- Evolving functions of the UA. The UA must improve to higher levels of autonomy and the human to higher levels of management. This would migrate operational responsibility for tasks from the ground station to the aircraft, the aircraft gaining greater autonomy and authority, the humans moving from operators to supervisors, increasing their span of control while decreasing the manpower requirements to operate the UA.
- Downsizing ground equipment. The control elements and functions of the early 1990s ground station equipment can now be accommodated into laptops. This trend will continue with miniaturization of processing and memory storage devices. Consolidation of capabilities into smaller packages reduces production costs, logistics footprint and sustainment support costs.
- Assured communication. The joint tactical radio system is expanding to encompass not only voice communications, but data links also. UA programs must assess their transition to the JTRS standard as technology becomes available through JTRS Cluster improvements. Since UA will become net-centric devices, UA programs must assess their vulnerabilities to network attack and provide appropriate levels of protection.
- Displays. As the human interfaces with the UA at higher levels, the human must trust the UA to do more. To develop and keep that trust, the human must be able to determine the intent of the UA.

Displays that show intent, as well as the algorithms which develop the intent, must be matured. Currently ground-breaking work in this area is being undertaken by J-UCAS and AFRL; work needs to be accomplished to migrate this technology to smaller and less expensive systems. These displays must also show the operator what is going on at a glance, and must fit into the lightweight system requirements as outlined above. Additionally, significant work has been accomplished to improve man-machine interfaces in non-UA programs and these improvements (such as tactile stimulation to improve situational awareness) need to be investigated as part of the UA C3 and ground control processes.

- **Voice Control.** One area that might not be receiving the attention it deserves is the capability to voice command the UA. Voice recognition technology has been around for years, but only recently has algorithm and hardware advances made it practical for small and critical applications. DoD Science and Technology (S&T) organizations continue to research and develop this technology. DoD programs can also begin taking advantage of developments in the commercial sector to have the operator interface with a UA via voice. Now is the time to harvest that research and apply it to reducing the complexity of command and control interfaces to small UA.
- **Multi-Vehicle Control.** Advancing the state of the art in all of the areas discussed above allow a single person to control multiple aircraft. Highly autonomous aircraft have reduced requirements for ground equipment and communications and can leverage advances in displays and voice control. The benefits of this are reduced manpower, reduced hardware (and therefore logistics), and increased effectiveness.

### **Flight Autonomy and Cognitive Processes**

Advances in computer and communications technologies have enabled the development of autonomous unmanned systems. The Vietnam conflict era remotely piloted vehicles (RPVs) were typically controlled by the manned aircraft that launched them, or by ground elements. These systems required skilled operators. Some of these systems flew rudimentary mission profiles based on analog computers, but they remained primarily hand flown throughout the majority of the mission profiles. In the 1970s the Air Force embarked on the Compass Cope program to develop a high altitude long-endurance system capable of reconnaissance at long range. The Compass Cope systems were still hand flown.

In 1988 DARPA developed the first autonomous UA, a high altitude long endurance UA called Condor, with a design goal of 150 hours at 60,000 feet. This aircraft was pre-programmed from takeoff to landing and had no direct manual inputs, e.g. no stick and rudder capability in the ground station. The system flew successfully 11 times setting altitude and endurance records. The level of autonomy in this aircraft was limited to redundancy management of subsystems and alternate runways. It demonstrated these features several times during the flight test program. Next came Global Hawk and DarkStar, which advanced autonomy almost to Level 3 (see Figure D-5); with real-time health and diagnostics and substantial improvements in adaptive behavior to flight conditions and in-flight failures.

The J-UCAS program is extending the work being accomplished by these programs, advancing the state of the art in multi-aircraft cooperation. Decisions include: coordinated navigation plan updates, communication plan reassignments, weapons allocations or the accumulation of data from the entire squadron to arrive at an updated situational assessment. Cooperation in this context applies to cooperative actions among the J-UCAS aircraft. They will have inter-aircraft data links to allow transfer of information between them and the manned aircraft. The information may include mission plan updates, target designation information, image chips and possibly other sensor data. Key mission decisions will be made based on the information passed between the systems. The J-UCAS will still have all of the subsystem management and contingency management autonomous attributes as the previous generation of UA systems. The J-UCAS program plans to demonstrate at least level 6 autonomy. Figure D-5 depicts where some UA stand in comparison to the ten levels of autonomy.

**UA RESEARCH AND DEVELOPMENT EFFORTS**

In response to this Roadmap’s data call, the services and other DoD agencies identified approximately 101<sup>1</sup> funded research and development (R&D) programs and initiatives developing technologies and capabilities either for specific UA (UA “specific” programs) or broader programs pursuing technologies and capabilities applicable to manned as well as unmanned aviation (UA “applicable”). The total PB05 research investment across the DoD was approximately \$2,553 M, of which approximately \$1,216 M (48%) was in UA specific programs, and \$1,337 M (52%) in UA applicable programs. In the latter category, spending was primarily in the areas of platform, control and payload/sensors R&D, whereas the bulk of the spending in the former UA specific category was in broad technology initiatives and weaponization.

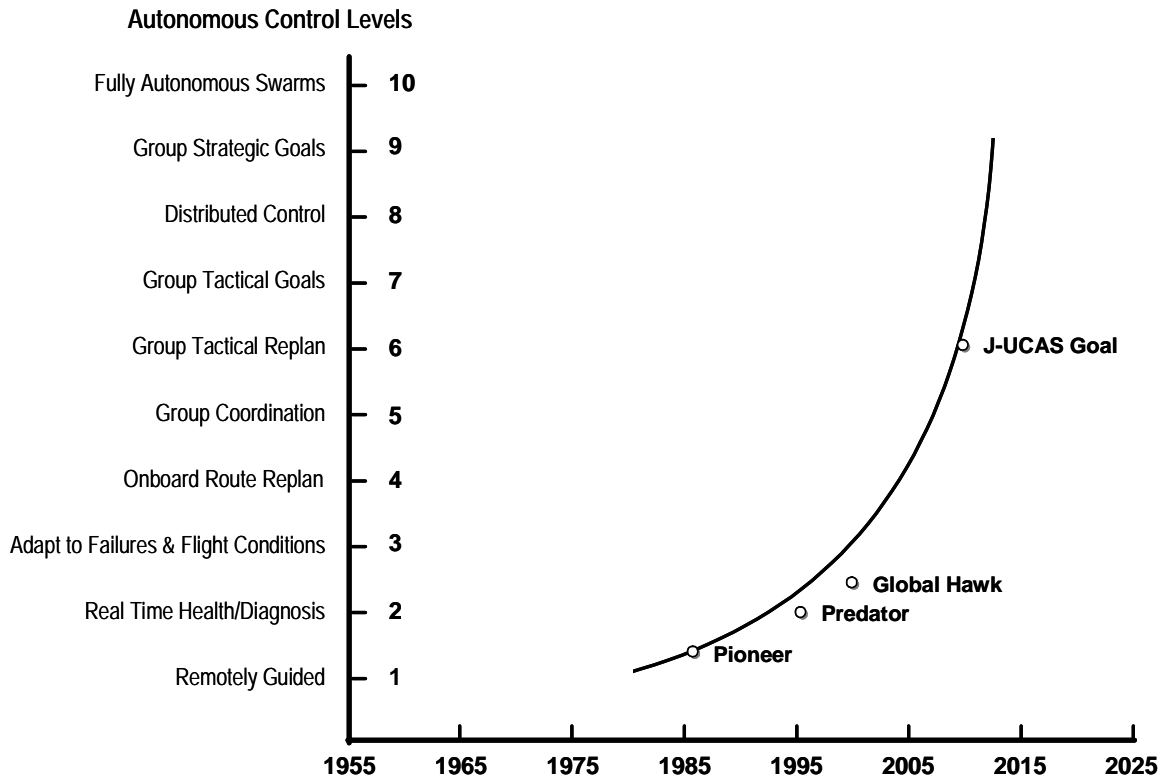

**FIGURE D-5. AUTONOMOUS CAPABILITY LEVELS (ACLs).**

Weapons and targeting R&D constituted 61% of all UA specific R&D program spending. Specific investment was broken out by broad technology areas as follows:

- 27 % (\$692.46 M) was in platform-related enhancements,
  - of this, 5% was UA specific and 95% was UA applicable R&D
- 14 % (\$353.63 M) in control technologies (to include autonomy),
  - 32% UA specific, 68% UA applicable R&D
- 19 % (\$496.95 M) in sensors and other payloads,
  - 12% UA specific, 88% UA applicable R&D

<sup>1</sup> Note – Figures and percentages used in this chapter’s discussions are approximations due to incomplete data receipt.

**UAS ROADMAP 2005**

29 % (\$747.3 M) in the area of weapons and targeting,

- 100% UA specific R&D

10 % (\$261.85 M) in broad R&D efforts.

- 100% UA specific R&D

Unlike last year, there were no specific R&D efforts in processing identified to the Task Force. Overall, the lack of specific investment in processing technologies is reflective of the dominance of commercial influence in new developments in the communications and information processing fields, clear examples of how the Department is benefiting from “spin-on” technology. These trends can be expected to continue and should continue to be leveraged as the Department considers its long-term R&D investment strategy, see Table D-1.

**TABLE D-1. FUTURE FUNDING OF DOD.**

	Laboratory Initiative	Target UA(s)	TRL Goal	Budget Years	Funding
<b>Air Force Research Laboratory</b>					
	Efficient Aerostructures Technology		6-FY13	FY04-09	\$78.5 M
Materials	Aero-morphing Hunter/Killer		6-FY10	FY04-09	\$49.7 M
	Composites Affordability Initiative (CAI)		6-FY05	FY04-05	\$8.2 M
	Affordable Composite Structures		6-FY12	FY04-09	\$30.9 M
	Full Spectrum Protection (FSP)		6-FY14	FY06-14	\$41.5 M
Survivability	Multiple Independent Levels of Security/Safety (MILS)		6-integrated system by FY09	FY03-06	\$4.2 M
	Survivable Integrated Inlet		6-FY07	FY04-09	\$11.7 M
Propulsion & Power	JP-8+100 Low Temperature Fuel (JP-8+100LT)	Global Hawk	6-FY07	FY04-08	\$3.1 M
	Propulsion for J-UCAS	J-UCAS	6-FY06	FY03-06	Navy \$11.6 M AF \$1.2 M
	High Altitude Performance Improvements for the Global Hawk Engine	Global Hawk	5-FY06	FY03-06	\$0.8 M
	High Altitude Power Improvements for the Global Hawk Engine	Global Hawk	6-FY06	FY02-06	\$ 8.2 M
	Small High Bypass TurboFan for Small UA		6-FY05	FY01-05	\$15 M
	Propulsion for J-UCAS	J-UCAS	6-FY06	FY03-05	AF - \$ .8 M, Navy - \$2.4 M
	Propulsion for J-UCAS	J-UCAS	6-FY09	FY05-09	\$7.7 M
	Directed Energy Components		6-FY13	FY08-13	\$31.5 M
Weapons & Targeting Technology	High Capacity Information Connectivity for Aerospace Platforms (HICAP)		6-FY05	FY01-05	\$2.6 M
Sensing Technology	Polarimetric Imaging Laser Radar (PILAR)		6-FY05	FY04-05	\$6.0 M

**UAS ROADMAP 2005**

	Laboratory Initiative	Target UA(s)	TRL Goal	Budget Years	Funding
	SPEctrally Aided Reconnaissance (SPEAR)		6-FY08	FY01-06	\$7.7 M
	Spectral Infrared Remote Imaging Transition Testbed (SPIRITT)		6-FY05	FY01-07	\$52.0 M
	X-Band Thin Radar Array		6-FY07	FY04-06	\$9.7 M
	Active Electronically Scanned Array (AESA)		5-Conformal Arrays by FY11	FY05-11	\$7.8 M
	Affordable Data links Components		6-FY14	FY06-14	\$44.9 M
	Structural Array Multi-Int TBM, DCA, Foliage Penetration (FOPEN), Electronic Attack (EA) Military Capability Technology		6-FY13	FY04-09	\$87.3 M
	Urban Ops Situation Awareness Technology		6-FY15	FY04-09	\$19.3 M
Control Technology	Validation and Verification (V&V) of Flight Critical Intelligent Software		6-FY11	FY04-09	\$57.8 M
	Automated Aerial Refueling		6-FY11	FY04-09	\$53.3 M
	Multi-ship Flight Management		5-FY07 (not to be matured to TRL 6 as standalone technology)	FY04-09	\$2.6 M
	Multi-UA Distributed Control		6-FY12	FY04-09	\$19.3 M
	High-EMI (Electromagnetic Interference) Tolerant Control Hardware Flight Test		6-FY08	FY04-09	\$34.3 M
	Limited Field of Regard (FOR) Detect and Avoid (DAA)		6-Integrated System by FY07	FY04-09	\$6.8 M
	Multi-vehicle S&A		6-Integrated System by FY10	FY04-09	\$18.4 M
	Non-GPS Navigation, Landing, and Ground Operations		6-Integrated System by FY10	FY04-09	\$12.11 M
	Open Architecture, Highly Reliable Vehicle Management Systems		5-Integrated System by FY07 (not to be matured to TRL 6 as standalone technology)	FY04-09	\$2.5 M
	Health Management & Adaptive Control		5-FY07	FY04-09	\$74.3 M
	Autonomous Terminal Area and Ground Operations		6-FY13	FY04-09	\$37.1 M

**UAS ROADMAP 2005**

	Laboratory Initiative	Target UA(s)	TRL Goal	Budget Years	Funding
	Advanced Decision Support Interfaces for Intelligent Semi-Autonomous Vehicles		6-FY07	FY03-07	\$10.7 M
	Heterogeneous Urban RSTA Team (HURT)		6-Integrated System by FY09	FY05-09	\$40.0 M
<b>Army Research Laboratory</b>					
CERDEC	Mission Equipment Package for Class II UA		5	FY04-07	\$35.3 M
	Mission Equipment Package for Class I UA		6	FY06-08	\$16.2 M
	Networked Sensor for the Future Force (NSfFF)		6	FY04-06	\$8.9 M
	Third Generation Infrared Technology		6	FY04-08	\$23.2 M
	Eye in the Sky		6	FY05-09	\$66.1 M
	Electronic Support for the Future Force		5	FY05-07	\$4.6 M
AMRDEC	Precision Autonomous Landing Adaptive Control Experiment (PALACE)		5	FY03-05	\$2.6 M
	Manned Unmanned Common Architecture Program (MCAP)		7	FY03-05	\$18.6 M
	Manned Unmanned Rotorcraft Enhanced Survivability (MURES)		5	FY04-07	\$15.6 M
	Unmanned Autonomous Collaborative Operations (UACO)		6	FY04-07	\$35.7 M
	Small Heavy Fuel Engine (SHFE)		6	FY04-07	\$42.8 M
<b>Office of Naval Research</b>					
	Autonomous Operations Future Naval Capability, UA Propulsion		6	FY02-07	\$23.7 M
	Control Technologies/UA specific S&T		6	FY02-07	\$24.9 M
	Sensors and Other Payloads/ UA Specific S&T	Silver Fox	8	FY04-05	\$7 M
	High Altitude Airborne Relay and Router Package		7	FY05-07	\$28.8 M
	Airborne Communications Package (ACP)		7	FY03-06	\$16.4 M
	Airborne Magnetic Detection System UA Test Platform		7	FY04-06	\$.75 M
	Air Launched Integrated Countermeasures, Expendable (ALICE)		3/4	FY01-05	\$3.3 M
	Survivable Autonomous Mobile Platform, Long Endurance (SAMPLE)		2/3	FY04-05	\$3.1 M
	Miniature Digital Data Link	Dragon Eye	6	FY05	\$.75 M

**UAS ROADMAP 2005**

	Laboratory Initiative	Target UA(s)	TRL Goal	Budget Years	Funding
	Broad S&T Efforts/UA specific S&T	J-UCAS	6	FY02-04	\$141.7 M
	Situational Awareness/Sensor Processing		6	FY02-05	\$13.1 M
	Multi-Vehicle Networking & Communications		6	FY02-07	\$8.6 M
	Marine Air-Ground Task Force (MAGTF) Command and Control-Innovative Relays		7	FY04-07	\$8.2 M
Special Projects, UA S&T-Related	Flight Inserted Detection Expendable for Reconnaissance (FINDER)	USAF Predator	6	FY01-05	\$7.1 M
	Scientific Payload Insertion Device Electric Rotor (SPIDER)		5	FY04	\$1.1 M
	Office of Naval Research (ONR) Manufacturing Technology (MANTECH) Joint Unmanned Combat Air System (J-UCAS) Systems Design and Manufacturing Development (SDMD) Project		6	FY03-07	\$8.6 M
<b>Defense Advanced Research Projects Agency</b>					
	Canard Rotor/Wing (CRW) Program	CRW	5	FY03-07	\$45.28 M
	A-160 Hummingbird Program	A-160 Hummingbird	6	FY03-07	\$43.65 M
	Heavy Fuel Engine	A-160 Hummingbird		FY04-07	\$20.5 M
	Advanced Concept Technology Demonstration (ACTD)	Micro Air Vehicle	7	FY02-06	\$70.5 M
	OAV II Program	Organic Air Vehicle (OAV)	6	FY04-07	\$53.4 M Joint Army/DAR PA funding
	Wasp Program	Wasp MAV	8/9	FY04-05	\$5.9 M
	Long Gun		5/6	FY04-06	\$18.25 M Joint Army/DAR PA funding
	Cormorant Unmanned Air Vehicle Program		TBD	FY04-07	\$23.8 M
	DP-5X program			FY04-06	\$14.7 M Joint Army/DAR PA funding

## APPENDIX E: INTEROPERABILITY STANDARDS

### OVERVIEW

For U.S. Forces to counter current and future threats successfully, they must operate worldwide with speed, agility, and flexibility. Key to achieving this required level of responsiveness is providing the quality, shared situation awareness, and understanding necessary to make sound individual and collective judgments. This goal, in turn, requires interoperability, or the ability of systems, units, or forces to provide data, information, materiel, and services to and accept the same from other systems, units, or forces and to use the data, information, materiel, and services so exchanged to enable them to operate effectively together. Interoperability includes both the technical exchange of information and the end-to-end operational effectiveness of that exchange of information as required for mission accomplishment. The Global Information Grid (GIG)—a seamless, common-user, information infrastructure—will be the foundation for information superiority by providing the enterprise-wide information services for the DoD command, control, communications, computers, intelligence, surveillance, and reconnaissance (C4ISR) systems.

UA systems have the potential for being connected to the edge of the GIG, and for this reason networking capabilities must be implemented in UA systems. Integration of UA into the GIG will require that they adhere to open standards that facilitate their interoperability. Networking capabilities, although they may be considered as operationally integral to a particular UA system, actually are implemented through standards, protocols, and methods external to the data link itself (i.e., at layers three through seven of the open systems interconnect (OSI) networking model). This protocol provides the interworking between transport protocol class 0 (TP0) and TCP transport service necessary for OSI applications to operate over IP-based networks.

The intent of the standards Section of the UA Roadmap will be to, discuss the preferred framework and methodology for establishment of interoperability within the UA domain where practical, specify those specific standards, which are the basis of UA interoperability, and which OSD expects to be implemented. Appendix E will also cover current and emerging standardization efforts. Development of the Roadmap has led to identification of roadblocks or impediments to implementation of the current philosophy of UA interoperability. Future actions will be recommended in order to address these impediments, allowing the continued evolution of interoperability among UA and improving the interoperability between UA and the broader warfighter community.

### Changes Supporting the DoD's Transformation Objectives

To support the DoD's transformation objectives, several key information technology (IT) processes, programs, and related documents have been recently updated. The joint capabilities integration and development system (JCIDS) (CJCSI 3170.01D and CJCSM 3170.01A) restructured the requirements process used to assess existing and proposed capabilities with respect to future joint operational concepts (JOCs), joint functional concepts (JFCs), and mission area integrated architecture. The JCIDS was developed in coordination with the release of the new DoD 5000 (DoDI 5000.2) Defense acquisition system series to ensure integration of the capabilities development and acquisition processes through the use of integrated architectures, including the GIG integrated architecture. DoDD 4630.5 and DoDI 4630.8 establish the responsibilities of the CIO and other components for information interoperability. These directives reference the use of an integrated set of DoD enterprise architectures. Integrated architectures describe relationships between tasks and activities that generate effects on enemy forces and their supporting operations. The directives specify that integrated architectures must have three views: operational, systems, and technical, as defined in the architecture framework. In accordance with DoDI 5000.2 and DoDI 4630.8,—having a technical view derived from the standards and guidelines contained therein—is required at all program milestone decisions. CJCSI 6212.01C defines the net-ready key performance parameter (KPP) which is based on the use of the GIG integrated architecture. The net-ready



KPP will be used to assess net readiness, information assurance requirements, and both the technical exchange of information and the end-to-end operational effectiveness of that exchange.

### **IT Standards Profile**

The Department of Defense Information Technology Standards Registry (DISR) replaces the Joint Technical Architecture (JT A). The DISR provides DoD systems with the basis for seamless interoperability. In DISRonline, the Joint Technical Architecture (JTA) document was parsed and populates an Oracle database that serves as the back-end repository for all of the web-based applications. It defines the DISR services and standards applicable to all DoD information technology (IT) systems. The DISR is mandated for the management, development, and acquisition of new or improved IT systems throughout DoD. Standards and guidelines in the DISR are stable, technically mature, and publicly available. The standards selected are essential for providing interoperability and net-centric services across the DoD enterprise and are consistent with the GIG architecture. *These standards do not include vendor-unique standards.* <http://disronline.disa.mil>.

The command, control, communications, and computer systems directorate of the joint staff (J-6) interoperability and supportability tool supported by JCPAT-E enables component program managers (PM) to develop IT Standards Profiles IAW the DOD IT Standards Registry (DISRonline). The IT standards profile is required as a supporting JCIDS predecessor document for capability development document and CPDs. The standards profile generated by the DISRonline shall be submitted with its related CDDs, and CPDs to the KM/DS during the JCIDS process, and the ISP.

The JCIDS predecessor requirement mandates the use of the J6 interoperability and supportability tool access, use of the JCPAT-E registration number for IT and NSS, and development of IT standards profile by component PMs.

Supported by the J-6 interoperability and supportability tool, DISR online enables system developers to identify applicable DISR standards and provides users with an easy method to identify the applicable DOD standards needed and to build an IT system Standards Profile through analysis of the IT and NSS capability/system requirements. The J-6 interoperability and supportability tool may be accessed via the SIPRNET at <http://jcpat.ncr.disa.smil.mil>.

### **Open Systems Interconnection/STANAG 4250**

The NATO reference module for open systems interconnection is defined in STANAG 4250. This model is based on the ISO open systems interconnect model, using seven layers to define the elements of the interface protocol. The lowest level is the physical layer, defining the physical and electrical parameters of the actual connection. The highest layer defines the support for the applications that use the data being transported across the interface. The next part of the Standards appendix will describe standards for OSI.

## **NETWORK STANDARDS**

The transport infrastructure is a foundation for net-centric transformation in DoD and the intelligence community (IC). To realize the vision of a global information grid, ASD/NII has called for a dependable, reliable, and ubiquitous network that eliminates stovepipes and responds to the dynamics of the operational scenario—bringing power to the edge. To construct the transport infrastructure DoD will:

- Follow the Internet Model
- Create the GIG from smaller component building blocks
- Design with interoperability, evolvability, and simplicity in mind

### **The Transport layer (OSI Layer 4)**

The OSI reference model transport layer (layer 4) defines the rules for information exchange and manages end-to-end delivery of information within and between networks, including making provision for error recovery and flow control. It also repackages long messages when necessary into smaller packets for transmission and, at the receiving end, rebuilds packets into the original message. Depending upon which

layer 4 protocol is in use, the receiving terminal's transport layer may send acknowledgments of receipt of packets. Two layer 4 protocols are recommended and both should be present on both the transmitting and receiving platforms. The receiver should be able to determine which protocol the transmitting system utilized by the information in the packet header.

- User datagram protocol (UDP), IETF Standard 6, IETF RFC 768. This is a mandated standard identified in the DISR. UDP is used when transport layer delivery assurance of packets sent over the data link is not required (e.g., in the transmission of video frames, a condition where tolerance of errors and/or missing frames is high and low latency is important).
- Transport control protocol (TCP), IETF Standard 7, IETF RFC 793. This is a mandated standard identified in the DISR. The TCP [RFC 761] provides a connection oriented reliable byte stream service. TCP is a bi-directional protocol, which has no concept of messages. Any framing has to be added at the application level. TCP contains an acknowledgement scheme which makes it reliable (bytes are delivered correctly and in order) and which implements flow control.

### **The Network Layer (OSI Layer 3)**

In the OSI reference model, the network layer (layer 3) provides a means for addressing messages and translating logical addresses and names into physical addresses. It also provides a means for determining the route from the source to the destination computer and manages traffic problems, such as switching, routing, and controlling the congestion of data packets. The ubiquitous standard for layer 3 networking is the Internet Protocol (IP). IP version 4 (IPv4) is currently in widespread usage. IP version 6 (IPv6) is an emerging standard that is in development, and mandated for DoD usage with a transition completion goal of 2008, per DoD-CIO memoranda dated 9 June 2003.

- IP, IETF Standard 5, IETF RFCs 791, 792, 950, 919, 922, 1112. This is a mandated standard identified in the DISR.

### **INTERNET STANDARDS**

- Hypertext transfer protocol (HTTP) Version 1.1, internet engineering task force (IETF) request for comment (RFC) 2616. HTTP shall be the main protocol used for web browsing. This is a mandated standard identified in the DISR.
- Hypertext markup language (HTML) 4.01, world wide web consortium (W3C) recommendation. This is a mandated standard identified in paragraph 2.5.4.1 – as of volume I of the JTA.
- File transfer protocol (FTP), IETF Standard 9, IETF RFC 959. This is a mandated standard identified in the DISR
- Simple mail transfer protocol (SMTP), IETF RFCs 1870, 2821. This is a mandated standard identified in the DISR
- Multi-purpose internet mail extensions (MIME), IETF RFCs 2045-2049. This is a mandated standard identified in the DISR
- Uniform resource locator (URL), uniform resource identifier (URI), IETF RFCs 1738, 1808, 1866. IETF RFC 1738 is mandated in the DISR
- Unicode universal character set, international organization for standardization (ISO) 10646, “universal multiple-octet coded character set (UCS)”, IETF RFC 2277 <http://unicode.org>. This is a mandated standard identified in the DISR

### **INTERNETWORKING (ROUTER) STANDARDS**

Routers are used to interconnect various sub networks and end-systems. Protocols necessary to provide this service are specified below. IETF RFC 1812 is an umbrella standard that references other documents and corrects errors in some of the referenced documents. The DISR mandates the following standards.

- IETF RFC 1886, DNS Extensions to Support IPv6, December 1995.
- IETF RFC 3152, Delegation of IP6.ARPA, August 2001.

### **Local Area Network Access**

While no specific LAN technology is mandated, the following is required for interoperability in a joint environment. This requires provision for a LAN interconnection. Ethernet, the implementation of carrier sense multiple access with collision detection (CSMA/CD), is the most common LAN technology in use with TCP/IP. The hosts use a CSMA/CD scheme to control access to the transmission medium. An extension to Ethernet, fast Ethernet provides interoperable service at both 10 Mbps and 100 Mbps. Higher-speed interconnections are provided by 100BASE-TX (two pairs of category 5 unshielded twisted pair, with 100BASE-TX auto-negotiation features employed to permit interoperation with 10BASE-T). The following standards are mandated as the minimum set for operation in a Joint Task Force for platforms physically connected to a Joint Task Force LAN.

- ISO/IEC 8802-3:2000 (IEEE Std. 802.3, 2000 Edition).

Gigabit Ethernet extends the speed of the Ethernet specification to 1 Gbps. Gigabit Ethernet is used for campus networks and building backbones. While no specific LAN/CAN technology is mandated, when using Gigabit Ethernet (1000 Mbps service) over fiber or Category 5 (CAT5) copper cabling, the following physical layer and framing standard is mandated:

- ISO/IEC 8802-3:2000 (IEEE Std. 802.3, 2000 Edition).

### **DATA LINK STANDARDS**

#### **Common Data Link/STANAG 7085**

In 1991, and again in 1994, the Assistant Secretary of Defense (ASD) for command, control, communications, and intelligence (C3I), now ASD for networks and information integration (NII), mandated the use of common data link (CDL)<sup>1</sup> for wideband transmission of imagery and signals intelligence data from airborne intelligence, surveillance, and reconnaissance (ISR) platforms to ground processing facilities.<sup>2</sup> ASN(C3I) updated these memoranda on 19 June 2001<sup>3</sup>, directing the use of CDL for all wideband ISR Air-to-Air and Air-to-Ground (but not Air-to-Satellite) data links.

Basic CDL is a full-duplex, jam resistant spread spectrum, point-to-point digital link. The uplink operates at 200 Kbps, 400 Kbps, 2 Mbps, 10.71 Mbps, 22.4 Mbps, or 45 Mbps. The downlink can operate at 10.71 Mbps, 22.4 Mbps, 45 Mbps, 137 Mbps, or 274 Mbps. In addition, rates of 548 Mbps and 1096 Mbps may be supported in the future. A Time Division Multiplexer (TDM) scheme is incorporated in the specification. This allows each CDL system to be configured to support many platforms, sensor systems, and remote control & reception systems. While this has allowed many applications of CDL to succeed as individual systems, it has resulted in a host of systems that cannot share capabilities because of the unique applications of configuration.

As the number of systems using CDL are developed and fielded, this issue has continued to grow. Use of motion imagery and other data collected by manned and unmanned sensor platforms has become increasingly important to the war fighter, the proliferation of sensors and platforms that use CDL has raised the military Services' interest in assuring interoperability.

---

<sup>1</sup> "CDL" denotes a family of full-duplex, jam-resistant, point-to-point microwave communication links developed by the US Government and used in imagery and signals intelligence (SIGINT) collection systems. CDL is defined by the *Common Data Link Waveform Specification, Revision F, November 2002*. In a 1996 affordability initiative to broaden potential CDL applications, the Defense Airborne Reconnaissance Office (DARO) and the Defense Advanced Research Projects Agency (DARPA) developed a narrow-band version of CDL (at that time limited to data rates up to 10.71 Mbps), which was designated Tactical Common Data Link (TCDL). TC DL is evolving into a full-bandwidth (up to 274 Mbps) technology that is light-weight and relatively low-cost, is fully compliant with the CDL specifications, but may not be as feature-rich or environmentally capable as traditional CDL systems.

<sup>2</sup> ASD (C3I) Memorandum, *Common Data Link (CDL) Policy*, 18 October 1994.

<sup>3</sup> ASD(C3I) Memorandum, *Common Data Link (CDL) Policy*, 19 June 2001

The family of standard CDL waveforms<sup>4</sup> provides an exceptional range of features that allow CDL to be tailored to meet many program, platform, and operational needs. Because of this flexibility, a transmitting terminal and an associated receiving terminal may both be compliant with the CDL Waveform Specification, but may not be interoperable because they are designed or configured to conform to different parts of the specification. The need to standardize the user systems interface to the communications system has resulted in the approval of Annex B of the CDL specification. The following section describes the key parts of Annex B.

### **STANAG 7085 (Interoperable Data Links for Imaging Systems)**

The CDL specification has been made available to NATO in the form of STANAG 7085. STANAG 7085 is currently based on Revision E of the CDL Specification. Release of the newer Revision F to NATO is in progress.

### **CDL Terminal Interoperability**

In the OSI reference model, the physical layer (layer 1) provides the physical means for transmitting digital data from one computer to another and regulates the transmission of the stream of data over a physical medium. In CDL terms, the physical layer is composed of a pair of radio terminals (e.g., an airborne terminal and a surface terminal, or two airborne terminals) and the complex radio waveform that establishes the link between the two terminals. Interoperability profile compliant systems will use the CDL Spec Annex B to define the physical layer. In addition, compliant systems will implement one or more external IEEE 802.3 100BaseTX Ethernet ports for interconnection with external Ethernet-based local area networks.

### **Data Signal Framing**

The OSI reference model *data link layer* (layer 2) establishes the procedures and protocols for transmitting data over the physical layer. Among these functions is packaging the bits into packets, cells, or frames for transmission, and for recovering the data at the receiving terminal. Layer 2 protocols have means for detecting and correcting errors that may occur during transmission. In the CDL context, layer 2 also provides a means for the receiving terminal to identify the beginning of a frame of data in the unbroken stream of bits received over the link. CDL layer 2 networking protocols are specified in appendix II and annexes A, B, C, and D of the CDL waveform specifications. Annex A details the ATM/CTFF framing procedure used by some CDL systems. Annex B details the Ethernet/GFP framing procedure.

No changes are required in the Ethernet or GFP protocols (Layer 2) to support either IPv4 or IPv6 (Layer 3). Only the IPv4 Header Compression (Layer 3) feature will have to be turned off or updated to support the new IPv6 header compression scheme if desired.

### **Data framing with Ethernet**

Interoperability profile compliant systems will, as a minimum, implement layer 2 framing of data using IEEE 802.3 100BaseTX Ethernet (up to 100 Mbps), as defined in the CDL waveform specifications, appendix II, annex B. Further, interoperability profile compliant systems will implement the specific Ethernet datagram structure defined in annex C. These requirements, however, do not preclude system architectures from implementing additional layer 2 framing procedures.

### **Generic Framing Procedure (GFP)**

Standards Profile compliant systems will as a minimum implement international telecommunications union (ITU) generic framing procedure as defined in the CDL waveform specifications appendix II,

---

<sup>4</sup> Defined in *Waveform Specification for the Common Data Link (CDL), Specification Number 7681990, Revision F*, available through the Air Force Aeronautical Systems Center (ASC/RAJD).

annex B. GFP provides a simple and highly efficient means of transmitting asynchronous Ethernet (and other framing procedures) over the synchronous CDL channel. The key to GFP efficiency is derived from the means utilized to identify the start of data frames in the continuous serial bit stream received over CDL.

### ***Media Access Control Addressing***

Interoperability profile compliant systems will implement media access control addressing as defined in the CDL waveform specifications, appendix II, and annex B.

### ***External Network Interface***

The Ethernet port is expected to facilitate “plug and play” interconnection and interoperation of systems with Ethernet-based local area networks on board aircraft and surface vessels.

### ***Interoperability Outside the Data Link***

Defense transformation, and more specifically the development of the GIG, is built on the concept of information system networking. CDL systems have the potential for being connected to the edge of the GIG, and for this reason networking capabilities are being implemented in CDL-based transmission systems. Networking capabilities, although they may be considered as operationally integral to a particular CDL system, actually are implemented through standards, protocols, and methods external to the data link itself (i.e., at layers 3 through 7 of the OSI networking model). Networking standards are an important consideration in the overall interoperability of UA systems and are discussed in the previous Section. Systems will as a minimum implement a user interface based on IP packets and IP addressing as needed to support the specific program network addressing requirements. Implementation of IP and IP addressing should conform to the CDL waveform specifications, appendix II.

CDL will have an expanding role as the intelligence community and the entire DOD migrate toward network-centric warfighting capabilities. Although CDL has been used traditionally as a point-to-point ISR data link, the CDL waveform standard revision F, along with future revisions, will include the necessary networking and interface standards to better assure end-to-end interoperability. Improved ISR end-to-end interoperability facilitates integration across all ISR assets supporting the warfighter.

In parallel, the U.S. has cooperated with NATO to develop STANAG 7085 which embodies the CDL specification. Additionally, it should be noted that STANAG 7085/CDL is a key component of interoperability for CIGSS/DCGS.

While the CDL specification and STANAG 7085 define the basic requirements for interoperability, the numerous options available within the standard allow for non-interoperable implementations that are all compliant. A set of profiles is being developed within the NATO community to provide more specific guidance for users of CDL systems. Developers will adopt one of the profiles whenever possible to minimize the proliferation of compliant, but non-interoperable data link systems.

Any UA system supporting data rates over 10Mb/s will implement and support CDL version F. This includes the current UA systems: Shadow 200, Pioneer, MQ-1 Predator, MQ-9 Predator, and Global Hawk.

### ***Link 16***

Link 16 is an encrypted, jam-resistant, nodeless tactical digital data link network established by joint tactical information distribution system (JTIDS)-compatible communication terminals that transmit and receive data messages in the tactical data information link (TADIL) J message catalog. Link 16 can provide a range of combat information in near-real time to U.S. and NATO allies’ combat aircraft and C2 centers. The TADIL J messages and protocols are defined in STANAG 5516, while the communication element is defined in STANAG 4175. Operating procedures are defined in allied data publication-16 (ADatP-16) or alternatively in the joint multi-TADIL operating procedures (JMTOP) (Chairman Joint Chiefs of Staff Manual CJCSM 6120.01).

### ***Military Satellite Communications***

Military satellite communications (MILSATCOM) systems include those systems owned or leased and operated by DoD and those commercial satellite communications (SATCOM) services used by DoD. The basic elements of satellite communications are a space segment, a control segment, and a terminal segment (air, ship, and ground). An implementation of a typical satellite link will require the use of satellite terminals, a user communications extension, and military or commercial satellite resources. For information on MILSATCOM standards go to: <https://disain.disa.mil/sisc/>. A brief description of the categories and types of SATCOM links and standards follows.

The basic categories of SATCOM are:

- Narrow Bandwidth (NB): <= 64 kbps
- Wide Bandwidth (WB) : >= 64 kbps
- Unprotected: Not Anti-Jam or Low Probability of Intercept
- Protected: AJ and/or LPI
- Commercial: Non-government owned or operated
- Government/Military Government owned and operated

#### Military Ultra High Frequency (UHF) (Narrow Bandwidth)

- NB, Military service
- Transponded 5 and 25 kHz channels
- Complete transition to DAMA based services is mandated, and in process
- For 5-kHz or 25-kHz single-channel access service supporting the transmission of either voice or data: MIL-STD-188-181B, Interoperability Standard for Single Access 5-kHz and 25-kHz UHF Satellite Communications Channels, 20 March 1999.
- For 5-kHz Demand Assigned Multiple Access (DAMA) service, supporting the transmission of data at 75 to 2400 bps and digitized voice at 2400 bps: MIL-STD-188-182A, Interoperability Standard for 5-kHz UHF DAMA Terminal Waveform, 31 March 1997, with Notice of Change 1, 9 September 1998; and Notice of Change 2, 22 January 1999.
- For 25-kHz Time Division Multiple Access (TDMA)/DAMA service, supporting the transmission of voice at 2,400, 4,800, or 16,000 bps and data at rates of 75 to 16,000 bps: MIL-STD-188-183A, Interoperability Standard for 25-kHz TDMA/DAMA Terminal Waveform, 20 March 1998, with Notice of Change 1, 9 September 1998.
- For data controllers operating over single-access 5-kHz and 25-kHz UHF SATCOM channels: MIL-STD-188-184, Interoperability and Performance Standard for the Data Control Waveform, 20 August 1993, with Notice of Change 1, 9 September 1998. This standard describes a robust link protocol that can transfer error-free data efficiently and effectively over channels that have high error rates.
- For MILSATCOM equipment that control access to DAMA UHF 5-kHz and 25-kHz MILSATCOM channels: MIL-STD-188-185, DoD Interface Standard, Interoperability of UHF MILSATCOM DAMA Control System, 29 May 1996, with Notice of Change 1, 1 December 1997; and Notice of Change 2, 9 September 1998.

#### Military Wide Bandwidth, Unprotected

- The standard waveform is described in MIL-STD-188-165A, with revision B currently in staffing. It supports data rates from 64 kbps to 155 Mbps. This specification is compliant with the requirements for use of commercial WB systems.
- The Earth Terminal specification is MIL-STD-188-164, which describes ground, air, and surface terminal parameters.

## **UAS ROADMAP 2005**

---

- The Defense Satellite Communications System (DSCS) consists of multiple X-Band transponder satellites that provide world wide coverage between 65 N and 65 S.
- The Wideband Gapfiller System (WGS) is the replacement system for DSCS and is expected to field the first three satellites beginning in 2005 and ending in 2007. Satellites 4 and 5 are tentatively scheduled for 2010 and 2011. This system will continue the X-Band capability of DSCS and add a Military Ka-Band capability. Note that Military and Civilian Ka-Bands are different.

### Military Narrow and Wide Bandwidth, Protected

- The standard waveforms are described in MIL-STD-1582D and MIL-STD-188-136A.
- The waveforms are currently restricted to Extremely High Frequency (EHF), however are evolving to allow application to Military X and Ka-Bands at a future date.
- The current EHF system, Milstar, is in its third generation. This system provide Low Data Rate (LDR) services, from 75 bps to 2.4 kbps. Medium Data Rate (MDR) services operate from 4.8 kbps to 1.544 Mbps.
- The Advanced EHF (AEHF) system will extend the life of Milstar and add High Data Rate (HDR) services.
- Transformational Satellite (T-SAT) will ultimately merge the capabilities of the WGS and the EHF series of systems. It will use a protected waveform and support both EHF and Military Ka-Band spectrum.

### Commercial Narrow Bandwidth

- INMARSAT Satellite Telephone services
- GlobalStar Satellite Telephone services
- Iridium Satellite Telephone services

### Commercial Wide Bandwidth

- The standard waveform is described in MIL-STD-188-165A, with revision B currently in staffing. It supports data rates from 64 kbps to 155 Mbps. This specification is compliant with the requirements for use of military WB unprotected systems.
- Commercial WB services are available in the C, X, Ku, and Civilian Ka-Bands.

## **DATA STANDARDS**

The *DoD Net-Centric Data Strategy* is a key enabler of the DoD's transformation by establishing the foundation for managing the Department's data in a net-centric environment. Key attributes of the strategy include:

- Ensuring data are visible, accessible, understandable, and trustable when needed and where needed to accelerate decision-making
- "Tagging" of data (intelligence, non-intelligence, raw, and processed) with metadata to enable discovery by known and unanticipated users in the enterprise
- Posting of data to shared spaces for users to access except when limited by security, policy, or regulations

Data standards are intended to ensure that data from on-board sensors and payloads can be processed and interpreted by any user. Some of the categories of data standards include still imagery, motion imagery, signals, radar complex or video phase history data, hyper spectral imagery data, acoustic, chemical detection, biological detection, and nuclear detection weapons data.

### **DoD Discovery Metadata Specification**

Interoperability between UA systems, and between UA and other platform types will only be accomplished when all platforms share the same common format for metadata. The DoD discovery metadata specification (DDMS) defines discovery metadata elements for resources posted to community and organizational shared spaces. “Discovery” is the ability to locate data assets through a consistent and flexible search. The DDMS specifies a set of information fields that are to be used to describe any data or service asset that is made known to the enterprise, and it serves as a reference for developers, architects, and engineers by laying a foundation for discovery services. Accordingly, the near-term goal of the DDMS, coupled with DoD policy and guidance, is to facilitate enterprise discovery of data assets at the summary, or macro level. The DDMS will be employed consistently across DoD’s disciplines, domains and data formats.

### **STANAG 4586 (Standard Interfaces of UAV Control System)**

STANAG 4586 defines the architectures, interfaces, communication protocols, data elements, message formats and identifies related STANAGs with which compliance is required to operate and manage multiple legacy and future UA in a complex NATO combined/joint services operational environment. The UCS architecture encompasses the core UCS to handle UA common/core processes, the data link interface to enable operations with legacy as well as future UA systems, the command control and interface for UA and UA payload data dissemination to support legacy and evolving NATO C4I systems and architectures, and the HCI requirements to support the interface to the UA system operators. Five levels of interoperability are defined to accommodate operational requirements. This STANAG contains the messages which support the EO/IR, SAR, communications relay, and stores (e.g., weapons, payloads.) across the data link interface (DLI). As additional payloads are defined, the STANAG will be updated to incorporate those payloads.

### **NATO ISR Interoperability Architecture**

The NATO ISR interoperability architecture includes a number of standards that are applicable to ISR systems. These standards cover the critical interfaces in the ISR data chain. It should be noted that while these standards are published by NATO, they were all initiated by U.S. activities, and in many cases are directly compatible with current U.S. standards.

### **STANAG 4545 (Secondary Imagery Format)**

A still imagery format has been in place since the late 1980s. The original format was developed for national imagery and was given the name: national imagery transmission format (NITF). NITF 2.1 (MIL-STD 2500B change notice 2) is the current version of the standard and is equivalent to the NATO Secondary Imagery Format (NSIF - STANAG 4545). Over the years the format has been extended to airborne imagery. The standard addresses still imagery taken from EO/IR/Radar sensors.

NITF/NSIF also prescribes the compression standards for this imagery. JPEG is the primary compression used for imagery but there are other compression standards that may be used for specific and unique applications (e.g. lossless JPEG, vector quantization). NIMA has proposed the implementation of JPEG 2000 in a next version of the NITF/NSIF standard. JPEG 2000 should support new CONOPS for how NITF/NSIF is to be used. NITF/NSIF also implements data extensions to support the transmission of GMTI data. This extension is unique but was developed to enhance interoperability through the use of an existing standard and applications. The extension is based on the GMTI STANAG 4607.

It should be noted that both NITF and NSIF are being migrated to a common international standard. ISO/IEC 12087-5, the basic image interchange format (BIIF) was created as a superset of NITF/NSIF. NATO has developed a profile of BIIF that matches the current requirements identified in NITF/NSIF and the profile has been ratified and published by ISO.

All UA systems supporting still imagery (EO/IR/MSI/HSI/radar) will comply with the most recent version of NITF/NSIF.



***STANAG 4559 (Standard Image Library Interface)***

This standard establishes the requirements for interfacing to heterogeneous imagery libraries. Image Libraries supporting NATO will provide imagery, geospatial information, and product storage mechanisms, which allow users to determine the availability of data and products, and provide the tools to access and retrieve them in a timely manner. A standard interface will enable users to quickly find an image, or information needed to conduct rapid operational missions. Image libraries and the NSIL Interface are envisioned as an augmentation to existing RFI procedures and not as a replacement. There may exist policies (Host Nation) or security and operational restrictions that impose limits on user access. However, technical interfaces will support all authorized users with access to imagery information. The overall goal is for intelligence analysts, imagery analysts, cartographers, mission planners, simulations and operational users, from NATO countries, to have access, from a single workstation, to needed information in a timely manner.

***STANAG 4607 (Ground Moving Target Indicator Format)***

The GMTI standard defines the data content and format for the products of ground moving target indicator radar systems. It also provides the mechanism to relay tasking requests back to the sensor system. The format is scalable to allow all types of radar systems to use the format and tailor the data flow to the capabilities of the sensor and the available communications channels. Smaller systems can use the basic capabilities of the format to transmit only moving target reports. Larger, more capable systems can use the same format for the moving target reports, and also provide high range resolution data, and other products of extended processing of the radar returns. The format is also designed to be encapsulated in either STANAG 4545 or STANAG 7023 data files, allowing users with multiple data types to use the GMTI format for the GMTI data, and the other STANAGs for imagery, graphics, and/or text data, all within a common data stream.

***STANAG 4609 (Digital Motion Imagery Format)***

In 1998, the National Imagery and Mapping Agency (NIMA) chartered the Motion Imagery Standards Board (MISB) to develop a motion imagery standards profile (MISP). The current version is MISP 2.0a. This standard is completely based on commercial standards, specifically MPEG-2. Instead of having to depend on government-sponsored developments for motion imagery processing, this standard promotes the use of commercial applications and hardware. In addition, in 2001 NIMA also began to lead the STANAG process to develop a NATO digital motion imagery STANAG. The MISP serves as the master baseline standards document. STANAG 4609 has been specifically based on MISP2.0a to facilitate NATO acceptance of motion imagery standards. STANAG 4609 will replace MISP 2.0a as the operative digital motion imagery standard for the U.S. Currently MISP2.0a mandates the migration and development of video systems to a fully digital format typically referred to as HDTV.

***STANAG 7023 (Primary Image Format)***

STANAG 7023 is the NATO primary image format. This format is intended for applications that require real-time recording or data link transmission of sensor data with little or no processing. STANAG 7023 was initiated by the U.S. as the format for the ATARS program. As the ATARS program was redirected, the format was changed, and U.S. interest in STANAG 7023 disappeared. However, many NATO nations (particularly the UK, France, Germany, and Denmark) have developed systems that implement the format. In order for U.S. ground systems to be interoperable with the NATO systems, the U.S. will have to implement the format for exploitation. In addition, it may be desirable to use this format in those applications where size, weight, and power (SWAP) constraints preclude on-board processing of sensor data into NITF/NSIF formatted files.

***Other Data Types***

Adoption of the following three STANAGS, 3809, 5500, and 7074, is mandatory for the success of UA system interoperability and will be required in UA systems where applicable. Adoption of the last two, STANAGs 3377 and 4250, is not mandatory but is encouraged.

***STANAG 3809 (Digital Terrain Elevation Data)***

STANAG 3809 provides the format for digital terrain elevation data (DTED) geographic information data exchange. This data is used for a number of different applications, including mission planning, mapping, and ISR sensor visibility calculations. All exchange of DTED data should be accomplished using STANAG 3809.

***STANAG 5500 (Message Text Formatting System)***

The NATO message text formatting system (ADatP-3) provides the format for digital messages usable by ADP systems. A number of different message types are defined and encoded so that recipient systems can interpret each.

***STANAG 7074 (Digital Geographic Information Exchange Standard)***

Digital geographic information exchange standard (DIGEST Version 1.2a) is the standard used to define all types of geographic data. This format is compatible with STANAG 4545, and some of the extensions defined in STANAG 7074 are used by STANAG 4545 to incorporate precision geographic information.

***STANAG 3377 (Air Reconnaissance Intelligence Report Forms)***

Air Reconnaissance Intelligence Report Forms are included in STANAG 3377. These forms are used to report the results of imagery interpretation and include forms for rapid exploitation, detailed exploitation, and radar analysis. This standard provides both the free text and automated data processing forms of each of the forms.

**Other Data Formats**

Digital feature analysis data (DFAD) is data that describes the surface features of the terrain. This allows a more complete analysis of terrain than is available through the use of elevation data alone. Feature analysis includes both the natural surface and man-made features. The World Geodetic System - 84 (WGS-84), contained in MIL-STD-2401, provides the reference ellipsoid for use in elevation calculations. In some cases, the ellipsoid is modified with variations of the gravitational vector through the designation of a reference geoid as well. In either case, developers should take care to ensure that metadata specifications are properly followed with respect to using the proper elevation reference.

**IMINT Aircraft Collections Requirement Message (ACRM)**

This standard for ACRMs is designed to provide a common data structure and format to facilitate the automatic ingestion of IMINT collection tasking from theater collection management tool(s) to mission and/or sensor planners. The ACRM standard will provide community-acceptable field names, data structures, and format(s). Using the standard, developers can create compatible profiles for their individual applications and systems to automatically ingest collection requirements and tasking information.

The standard will provide a menu of all the potential fields necessary for various airborne IMINT collections. Not all fields will necessarily be used in any one ACRM application. Each developer can include those fields necessary for their system/platform in their particular profile. A single standard for ACRMs will:

- Eliminate the creation of multiple one-to-one unique interfaces between collection management tools and mission and sensor planners
- Facilitate interoperability by enabling a standards based approach to collection management
- Streamline the tasking process so that users (who have an application for automatic ingestion developed from the standard) do not have to re-type collection tasking information into their sensor and/or mission planning systems

### **Information Security**

Information Assurance is defined as measures taken to protect and defend our information and information systems to ensure confidentiality, integrity, availability, and accountability, extended to restoration with protect, detect, monitor, and react capabilities.

#### **Secure Web Browsing**

This service identifies the protocol used to provide communications privacy over a network. The protocol allows applications to communicate in a way designed to prevent eavesdropping, tampering, or message forgery in e-mail packages. World Wide Web (WWW) services provide abilities for navigation and data transport across the Internet. The protocol encapsulates various higher-level protocols and is application independent.

Web browsers and web servers must first attempt to use transport layer security (TLS), then use secure socket layer (SSL) 3.0 if TLS is not supported. It is expected that SSL 3.0 will not be supported in the future. The following standards are both mandated for securing the communications of web browsers and web servers:

- SSL Protocol, Version 3.0, 18 November 1996. [SUNSET] This standard will be deleted when commercial Web servers employed by DoD and the IC community support TLS.
- IETF RFC 2246, the TLS Protocol Version 1.0, January 1999.

#### **Secure Messaging**

This service applies to the use of security implementations for the defense message system (DMS), the access control capabilities for communications with allied partners and for e-mail. For systems required to interface with the DMS Release 3.0 for organizational messaging, the following standard is mandated:

- Fortezza Interface Control Document, Revision P1.5, 22 December 1994. [SUNSET] This standard will be deleted when GIG enterprise services (GES) can provide secure messaging confirmation, to include authentication, delivery and encryption. Allied communications publication (ACP) 120 was developed to take advantage of X.509 version 3 certificates, in particular the subject Directory Attribute extension that contains the clearance attribute or the security label. This security label provides for access control based not only on hierarchical classification, but also for compartments, categories, and citizenship.
- For DoD message systems required to process both unclassified and classified organizational messages using DMS Release 3.0, the following messaging security protocol is mandated.
- ACP-120, Allied Communications Publication 120, Common Security Protocol (CSP), Rev A, 7 May 1998. [SUNSET] This standard will be deleted when GES can provide secure messaging confirmation, to include authentication, delivery and encryption.

To support the access control capabilities of ACP 120, the following security label standards are mandated:

- ITU-T Recommendation X.411 (1999)/ISO/IEC 10021-4:1999, Information Technology – Open Systems Interconnection – Message Handling Systems (MHS) – Message Transfer System: Abstract Service Definition Procedures. [SUNSET] This standard will be deleted when GES can provide secure messaging confirmation, to include authentication, delivery and encryption.
- ITU-T Recommendation X.509 (2000)/ISO/IEC 9594-8:2001, Information Technology – Open Systems Interconnection – The Directory: Public Key and Attribute Certificate Frameworks, 2001, with Technical Corrigendum 1:2002, and Technical Corrigendum 2:2002.
- ITU-T Recommendation X.481 (2000)/ISO/IEC 15816-12:2000, Information Technology – Security Techniques – Security Information Objects for Access Control. [SUNSET] This standard will be deleted when GES can provide secure messaging confirmation, to include authentication, delivery and encryption.

- SDN.706, X.509 Certificate and Certificate Revocation List Profiles and Certification Path +Processing Rules, Revision D, 12 May 1999. [SUNSET] This standard will be deleted when GES can provide secure messaging confirmation, to include authentication, delivery and encryption.
- SDN.801, Access Control Concept and Mechanisms, Revision C, 12 May 1999. [SUNSET] This standard will be deleted when GES can provide secure messaging confirmation, to include authentication, delivery and encryption.

The secure/multipurpose internet mail extensions (S/MIME) v3 protocol suite provides application layer privacy, integrity, and non-repudiation (proof of origin) security services for messaging (e-mail). Three internet engineering task force (IETF) RFCs—RFC 2630, RFC 2632, and RFC 2633—provide the core security services listed above. For individual messages that use certificates issued by the DoD public-key infrastructure (PKI) to protect unclassified, sensitive information or sensitive information on system high networks the following standards are mandated:

- IETF RFC 2630, Cryptographic Message Syntax, June 1999. [SUNSET] This standard will be deleted when new standards are selected as part of the development of the IA component of the GIG architecture.
- IETF RFC 2632, S/MIME Version 3 Certificate Handling, June 1999.
- IETF RFC 2633, S/MIME Version 3 Message Specification, June 1999.

IETF RFC 2634 provides optional enhanced security services, which are signed receipts (non-repudiation—proof of receipt), security labels, secure mailing lists, and signing certificates. For enhanced security services, the following standard is mandated:

- IETF RFC 2634, Enhanced Security Services for S/MIME, June 1999.

### ***Cryptographic Security Services***

To support interoperability using encrypted messages, products must share a common communications protocol. This protocol must include common cryptographic message syntax, common cryptographic algorithms, and common modes of operation (e.g., cipher-block chaining). The mechanisms to provide the required security services are as follows.

### ***Encryption Algorithms***

Encryption algorithms are a set of mathematical rules for rendering information unintelligible by affecting a series of transformations to the normal representation of the information through the use of variable elements controlled by a key.

The following standard is mandated when the security policy or the program security profile requires this level of protection, and Fortezza applications are in use:

- SKIPJACK and KEA Algorithm Specification, Version 2.0, NIST, 29 May 1998. [SUNSET] This standard will be deleted when AES becomes the mandated standard.

For those systems required or desiring to use a cryptographic device to protect privacy-act information and other unclassified information not covered by the Warner Amendment to Public Law 100-235, the following standard is mandated:

- FIPS PUB 46-3, Data Encryption Standard, 25 October 1999. [SUNSET] This standard will be deleted when AES becomes the mandated standard.

### ***Signature Algorithms***

A signature algorithm is an algorithm developed to assure message-source authenticity and integrity. The intent of the signature is to provide a measure of assurance that the person signing the message actually sent the message that is signed, and that the content of the message has not been changed. The following standard is mandated when the security policy or program-security profile requires this level of protection:

- FIPS PUB 186-2, Digital Signature Standard (DSS) Digital Signature Algorithm (DSA), 27 January 2000.

### **Signals Intelligence (SIGINT)**

Many standards applicable to UA SIGINT data are addressed in Section 4 of the Joint Airborne SIGINT Architecture (JASA) Version 2.0. Due to programmatic issues leading to cancellation of JSAF, the JASA is being reviewed for future applicability and necessary changes. However, NATO Air Group IV has initiated a study to examine the use of ELINT and ESM data within the community with an aim to standardize the data formats of both aspects of electromagnetic collection.

### **Human Computer Interface**

The objective of system design is to ensure system reliability and effectiveness. To achieve this objective, the human must be able to effectively interact with the system. Operators, administrators, and maintainers interact with software-based information systems using the system's HCI. The HCI includes the appearance and behavior of the interface, physical interaction devices, graphical interaction objects, and other human-computer interaction methods. A good HCI is both easy to use and appropriate to the operational environment. It exhibits a combination of user-oriented characteristics such as intuitive operation, ease and retention of learning, facilitation of user-task performance, and consistency with user expectations. The need to learn the appearance and behavior of different HCIs used by different applications and systems increases both the training burden and the probability of operator error. Interfaces that exhibit a consistent appearance and behavior both within and across applications and systems are required.

When developing DoD automated systems, the GUI shall be based on one commercial user interface style guide consistent with 5.6.1. Hybrid GUIs that mix user interface styles (e.g., Motif with Microsoft Windows) shall not be created. A hybrid GUI is composed of toolkit components from more than one user interface style. When selecting commercial off-the-shelf (COTS)/government off-the-shelf (GOTS) applications for integration with developed DoD automated systems, maintaining consistency in the user interface style shall be a goal. An application delivers the user interface style that matches the host platform (i.e., Motif on a UNIX platform and Windows on an NT platform). This style conforms to commercial standards, with consistency in style implementation regardless of the development environment used to render the user interface. Applications that use platform-independent languages (such as Java) deliver the same style as the native application on the host platform.

### **FLIGHT OPERATIONS STANDARDS**

Flight operations standards are those standards required to operate the UA in the real world airspace occupied by both manned and unmanned aircraft. These include the standards for flight clearance, operations with air traffic control, aircraft certification standards, aircrew training requirements, etc. While many of these standards will parallel those used by manned aircraft, they must all be tailored to the specific environment of the unmanned platform. The details of these standards can be found in the DoD Airspace Integration Instruction, appendix F of this Roadmap.

### **UA OPERATIONS STANDARDS**

UA Operation Standards deal with the control of UA operations, including mission planning and sensor control. This regime includes appropriate standardization efforts for mission planning and air vehicle/sensor control.

Multiple levels of interoperability are feasible among different UA systems. Improved operational flexibility can be achieved if the UA systems support appropriate levels of UA system interoperability defined in the STANAG 4586.

<b>Level 1:</b>	Indirect receipt/transmission of UA related payload data. . (provided by other standards in the NIIA - STANAG 4586 not required)
<b>Level 2:</b>	<i>Direct receipt of ISR/other data where “direct” covers reception of the UA payload data by the UCS when it has direct communication with the UA</i> (provided by other standards in the NIIA - STANAG 4586 not required)
<b>Level 3:</b>	<i>Control and monitoring of the UA payload in addition to direct receipt of ISR/other data</i> . (handover of sensor control as defined in STANAG 4586).
<b>Level 4:</b>	<i>Control and monitoring of the UA, less launch and recovery</i> (handover of air vehicle control as defined in STANAG 4586).
<b>Level 5:</b>	<i>Control and monitoring of the UA (Level 4), plus launch and recovery functions</i>

The interoperability levels defined above can be achieved through the standardization of interfaces between the UA airborne elements and the UCS, between the air vehicle elements and external C4I elements, and between the UCS and external C4I Systems. In order to achieve interoperability, the UCS Architecture and interfaces must support the appropriate communication protocols and message formats for legacy as well as new UA systems. Level 2 and above (2+) of interoperability requires the use of a ground data terminal (GDT) that is interoperable with the air data terminal (ADT), as defined in CDL/STANAG 7085 (e.g., connectivity between the GDT and ADT is prerequisite for level 2+ interoperability). At all levels, the data formats and data transfer protocols must also comply with the NIIA standards. For level 1 or level 2, the NIIA standards for data format and data transfer provide the required interface requirements. For levels 3 and above, STANAG 4586 provides the sensor and airborne platform control functionality for the higher levels.

There are already a number of existing or emerging STANAGs that are applicable to UA systems. They provide standards for interoperable data link (STANAG 7085), digital sensor data between the payload and the AV element of the data link (STANAG 7023, 4545), and for on board recording device(s) (STANAG 7024, 4575). Additionally, the STANAG 4586, unmanned control system (UCS), describes interfaces applicable to ground control stations and air vehicles, to include air vehicle control. Although somewhat limited as to broad mission area application, this STANAG contains an interface description, the DLI, which provides an excellent starting point for the development of a robust air vehicle interface, to include vehicle control functions. Thus, the approach to achieving the desired level of UA interoperability is based on compliance with existing standards or establishing new standards for a number of UA functions.

- An open network architecture using industry standards including internet protocol, Ethernet and generic framing procedure.
- A data link system(s) that provides connectivity and interoperability between the UCS and the AV(s). The data link system(s) must accommodate legacy as well as future systems. STANAG 7085, Interoperable Data Links for Imaging Systems, specifies a data link system that would provide the required connectivity and interoperability. The data link must just provide for transmission of data over the RF link, not be the interface for the sensor and flight management functions or do routing functions.
- Format for payload/sensor data for transmission to the UCS via the data link and/or for recording on the on-board recording device. STANAG 7023, NATO Primary Image Format Standard, with addition for non-imagery sensors, (e.g., electronic support measures (ESM)), and STANAG 4545, NATO Secondary Imagery Format, are the required data formats for imagery. If GMTI data is to be used, STANAG 4607 defines the required format, and STANAG 4609 defines the format for digital motion imagery.
- Recording device for on board recording of sensor data, if required, STANAG 7024, Imagery Air Reconnaissance Tape Recorder Standard, and STANAG 4575, NATO Advanced Data Storage Interface, specify standard recording devices and interface respectively.

- A standard describing the interfaces and messages necessary to control an air vehicle. A starting point for this activity is the DLI segment of STANAG 4586.

### PROCESS FOR SELECTING STANDARDS

UA standards are usually selected for implementation by a development program from those in the DISR. New standards are added to the DISR periodically and existing ones updated based on technological advancement. However, the DISR is very broadly written to encompass the full range of interoperability needs. Therefore, subsets must be chosen for specific mission areas, such as UA. Additionally, some needed standards are not specifically included in the DISR, due to time lag as new technologies emerge or due to lack of specificity for lower level protocols. Currently, there is not a formal process in-place for choosing subsets of the DISR standards for UA application except during development of the UA Roadmap. The fundamental criterion for standards selection should be whether or not the proposed standard will improve UA systems interoperability.

The following criteria must be considered the minimal set required for interoperability or reuse:

- Standards are technically mature and stable
- Technically implemental
- Publicly available
- Consistent with law, regulation, policy, or guidance documentation
- Preferred standards are those that are commercially supported in the marketplace with several validated implementations by multiple vendors (e.g., mainstream products)

### Standards Compliance

A formal standards process must be put in-place for choosing subsets of the DISR standards for UA application and feed development of the UA Roadmap. Wherever possible, this must be worked as part of broader manned aviation, ISR and strike community activities.



## APPENDIX F: AIRSPACE

### OVERVIEW

The OSD vision is to have “File and Fly” access for appropriately equipped UA systems by the end of 2005 while maintaining an equivalent level of safety (ELOS) to aircraft with a pilot onboard. For military operations, UA will operate with manned aircraft in and around airfields using concepts of operation that make on- or off-board distinctions transparent to air traffic control authorities and airspace regulators. The operations tempo at mixed airfields will not be diminished by the integration of unmanned aviation.

### Background

Because the current UA systems do not have the same capabilities as manned aircraft to safely and efficiently integrate into the National Airspace System (NAS), military UA requirements to operate outside of restricted and warning areas are accommodated on a case-by-case basis. The process used to gain NAS access was jointly developed and agreed to by the DoD and FAA in 1999. Military operators of UA are required to obtain a Certificate of Authorization (COA) from the Federal Aviation Administration. The process can take up to 60 days, may vary among the FAA’s nine regional authorities, and because UA do not have a “see-and-avoid” (S&A) capability, may require such additional and costly measures as providing chase planes and/or primary radar coverage. COAs are typically issued for one-time events, limited to specific routes or areas, and are valid for no more than one year. An exception is the National COA that was issued to the Air Force for Global Hawk operations in the NAS.

With a COA, the UA is accommodated into the system when mission needs dictate, but because the UA lacks the ability to operate as a manned aircraft it is segregated from manned aviation rather than integrated with it. As the DoD CONOPS for UA systems mature, and as we ensure the airworthiness of our UA systems, we will look toward developing new procedures to gain access to the NAS. Toward that end, the DoD and FAA have agreed to review the current guidance contained in FAA Order 7610.4, Military Operations for Remotely Operated Aircraft (ROA), and will refine or replace the COA process, if mutually beneficial to both DoD and FAA.

From the DoD perspective, three critical issues must be addressed in order to supplant the COA process: UA reliability, FAA regulations, and a S&A capability. Focusing on the regulatory aspect, air traffic management procedures must be addressed with the FAA. Aircraft airworthiness certification and aircrew qualification standards must be addressed in parallel within DoD.

OSD and FAA, working through the DoD Policy Board on Federal Aviation (PBFA), are engaged in establishing the air traffic regulatory infrastructure for integrating military UA into the NAS. By limiting this effort’s focus to traffic management of domestic flight operations by military UA, it is hoped to establish a solid precedent that can be extended to public and civil UA domestically, and to civil and military flights in international and non-U.S. airspace. As depicted in Figure F-1, this initiative (shown by the lower-left block below) is intended to serve as the first brick in the larger, interwoven wall of regulations governing worldwide aviation. Precepts include:

- Do no harm. Avoid new initiatives; enacting regulations for the military user that would adversely impact 1) the Services’ right to self-certify aircraft and aircrews, 2) air traffic control practices or procedures, or 3) manned aviation CONOPS or TTPs; or unnecessarily restrict civilian or commercial flights. Where feasible, leave “hooks” in place to facilitate the adaptation of these regulations for civil use. This also applies to recognizing that “one size does NOT fit all” when it comes to establishing regulations for the wide range in size and performance of DoD UA.
- Conform rather than create. Interpret the existing Title 14 Code of Federal Regulations (CFR) (formerly known as Federal Aviation Regulations, or FARs) to also cover unmanned aviation and avoid the creation of dedicated UA regulations as much as possible. The goal is to achieve transparent flight operations in the NAS.



- Establish the precedent. Although focused on domestic use, any regulations enacted will likely lead, or certainly have to conform to, similar regulations governing UA flight in ICAO and foreign (specific countries’) airspace.



**FIGURE F-1. JOINT FAA/OSD APPROACH TO REGULATING UA.**

Before the vision of “file and fly” can occur, significant work must be accomplished in the mutually dependent areas of UA reliability, regulation, and an S&A capability.

**RELIABILITY**

UA reliability is the first hurdle in airspace considerations because it underlies UA acceptance into civil airspace—whether domestic, international, or foreign. Historically, UA have suffered mishaps at one to two orders of magnitude greater than the rate (per 100,000 hours) incurred by manned military aircraft. In recent years, however, flight experience and improved technologies have enabled UA to continue to track the reliability of early manned military aircraft with UA reliability approaching an equivalent level of reliability to their manned military counterparts (see Figure F-2). For more information on UA reliability, reference Appendix H of this UA Roadmap, or see the *2003 OSD UAV Reliability Study*.

**REGULATION**

Regulation: Air Traffic Operations. The FAA's air traffic regulations are meant to ensure the multitude of aircraft flown in the NAS are operated safely and pose no hazard to people or property on the ground or in the air. FAA’s air traffic management focus is on the day-to-day operation of the system and the safe, expeditious movement of air traffic. Aircraft are separated by time, altitude, and lateral distance. Additionally, classes of airspace are established that include specific requirements for aircraft equipage, pilot qualifications and flight plan filing. Regardless of the class of airspace aircraft are operating in, pilots are required to S&A other air traffic. This requirement exists even when ground controllers provide traffic advisories, or where an onboard collision avoidance system, such as the Traffic Alert and Collision Avoidance System (TCAS), is required. S&A is a key issue in allowing UA into civilian airspace and is discussed in detail in a following Section.

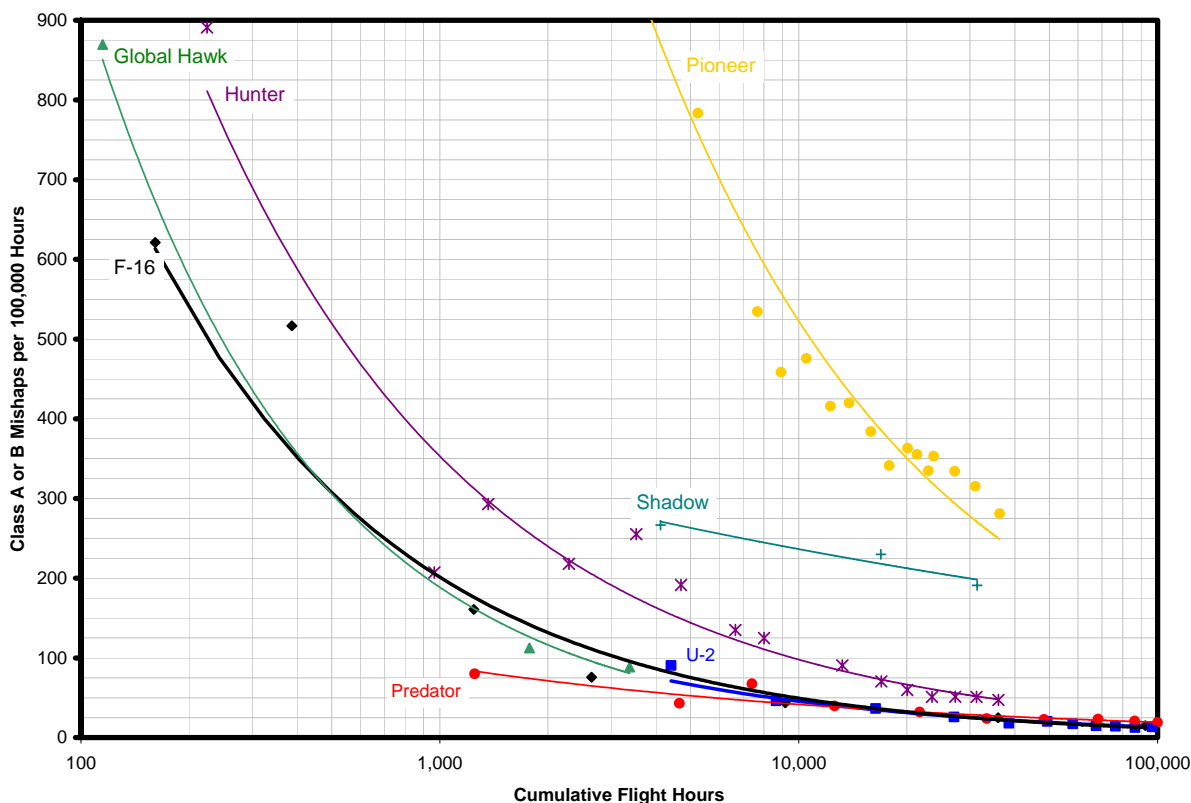
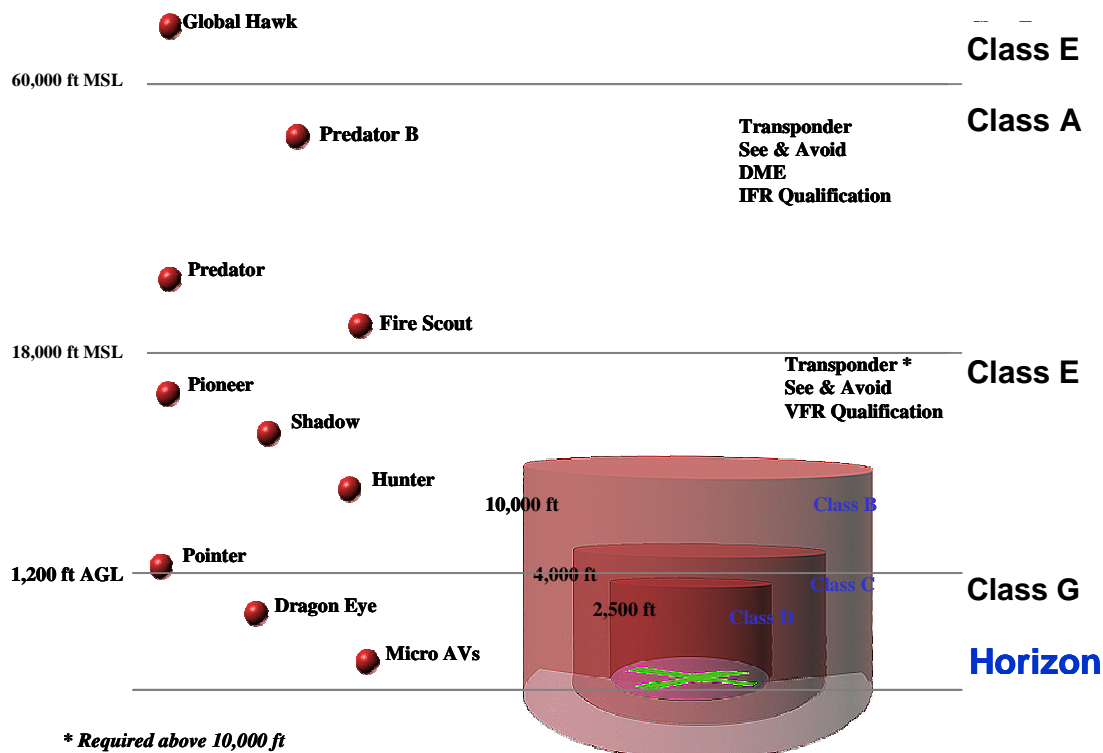

**FIGURE F-2: U.S. MILITARY AIRCRAFT AND UA CLASS A MISHAP RATES (LIFETIME), 1986-2003.**

There are six defined classes of airspace in the U.S. that are controlled in various degrees by the ATC infrastructure. Because these classes are referenced throughout this document, a brief discussion is useful.

- Class A airspace exists from Flight Level (FL) 180 (18,000 feet Mean Sea Level (MSL)) to FL600 (60,000 feet MSL). Flights within Class A airspace must be under Instrument Flight Rules (IFR) and under the control of ATC at all times.
- Class B airspace surrounds several major airports (generally up to 10,000 feet MSL) to reduce mid-air collision potential by requiring ATC control of IFR and VFR (Visual Flight Rules) flights in that airspace.
- Class C airspace surrounds busy airports (generally up to 4,000 feet AGL) that do not need Class B airspace protection, and requires flights to establish and maintain two-way communications with ATC while in that airspace. ATC provides radar separation service to flights in Class C airspace.
- Class D airspace surrounds airports (generally up to 2,500 feet AGL) that have an operating control tower. Flights in Class D airspace must establish and maintain communications with ATC, but VFR flights do not receive separation service.
- Class E airspace is all other airspace in which IFR and VFR flights are allowed. Although Class E airspace can extend to the surface, it generally begins at 1200 feet AGL, or 14,500 MSL, and extends upward until it meets a higher class of airspace (A-D). It is also above FL600.
- Class G airspace (there is no Class F airspace in the U.S.) is also called uncontrolled airspace because ATC does not control aircraft there. Class G airspace can extend to 14,499 feet MSL, but generally exists below 1200 feet AGL, and below Class E airspace.

Accordingly, Classes B, C, and D relate to airspace surrounding airports where increased mid-air collision potential exists; Classes A, E, and G primarily relate to altitude, and the nature of flight operations that commonly occur at those altitudes. ATC provides separation services to all flights in Classes A, B, and C. They provide it to some flights in Class E, and do not provide service in Class G. Regardless of the class of airspace, or whether ATC provides separation services, pilots are required to “S&A other aircraft” whenever weather permits. Figure F-3 depicts this airspace with representative UA.



**FIGURE F-3. UA AND AIRSPACE CLASSES OF THE NATIONAL AIRSPACE SYSTEM<sup>1</sup>.**

It is clear that some taxonomy for UA is needed to define their operating privileges, airworthiness standards, operator training and certification requirements, and their place in the right-of-way rules. Although public (e.g., U.S. military) aircraft are to some degree exempt from a number of FAA regulations such as airworthiness and pilot certification, certain responsibilities still exist.

- Meeting equivalent airworthiness and operator qualification standards to operate in the NAS
- Conforming to FAA traffic regulations (S&A, lighting, yielding right-of-way) when operating outside of restricted airspace
- Complying with international (ICAO and foreign) regulations when transiting their airspace, regulations which often take those of the FAA as precedents

Military UA with a need to routinely operate outside of restricted airspace or in international airspace must therefore make themselves transparent to air traffic management authorities. In large part, this means *conforming by exemption* to 14 CFR Part 91 for the larger UA, such as the Air Force's Global

<sup>1</sup> The FAA is moving toward a two-class structure for the NAS, “terminal” and “enroute.” Terminal will subsume Class B, C, and D airspace, and Enroute will include Class A, E, and G airspace.

Hawk and Predator, *as do manned military aircraft*. This plan calls for these UA (Cat III) to be treated similarly as manned aircraft.

The FAA recently approved a light-sport category in the regulations, and does not require either airworthiness or pilot certification (similar to Part 103 aircraft) for certain uses and limited operations. These aircraft achieve an equivalent level of safety to certificated aircraft with a slightly lower level of reliability. There are also many restricted category aircraft that perform special purpose operations. A number of U.S. military UA (U.S. Navy's Pioneer, U.S. Army's Shadow and Hunter) share similar characteristics and performance. This plan calls for these UA (Cat II) to be treated similarly to ultralights, light-sport, or restricted category aircraft.

As a final case with application to UA, the FAA has chosen not to explicitly regulate certain other aircraft, such as model rockets, fireworks, and radio-controlled (RC) model aircraft. 14 CFR Part 101 specifically exempts smaller balloons, rockets and kites from the regulation and AC 91-57 addresses RC model airplanes, but is advisory only. These systems are omitted from the regulations. All three U.S. Military Departments currently employ UA in the same size, weight, and performance regimes as those of RC models (e.g., Pointer/Raven for the Army and Air Force, and Dragon Eye for the Marine Corps). This plan calls for small UA similar to RC model aircraft (and operated similarly) (UA (Cat I)) to be treated similarly to RC model aircraft. This discussion provides divisions, based on the existing regulatory FAA infrastructure, into which all current military UA can be placed. This is depicted with example UA types in Table F-1.

**TABLE F-1. ALIGNMENT OF UA CATEGORIES WITH FAA REGULATIONS.**

		Certified Aircraft / UA (Cat III) <sup>2</sup>	Non-Standard Aircraft / UA (Cat II)	RC Model Aircraft / UA (Cat I)
FAA Regulation		14 CFR 91	14 CFR 91, 101, and 103	None (AC 91-57)
Airspace Usage		All	Class E, G, & non-joint-use Class D	Class G (<1200 ft AGL)
Airspeed Limit, KIAS		None	NTE 250 (proposed)	100 (proposed)
Example Types	Manned	Airliners	Light-Sport	None
	Unmanned	Predator, Global Hawk	Pioneer, Shadow	Dragon Eye, Raven

The terms within Table F-1 are further defined below.

- **UA – Cat III:** capable of flying throughout all categories of airspace and conforms to Part 91. (i.e., all the things a regulated manned aircraft must do including the ability to S&A). Airworthiness and operator certification are required. UA are generally built for beyond line-of-sight operations. Examples: Global Hawk, Predator
- **UA – Cat II:** non-standard aircraft that perform special purpose operations. Operators must provide evidence of airworthiness and operator qualification. Cat II UA may perform routine operations within a specific set of restrictions. Examples: Pioneer, Shadow
- **UA – Cat I:** analogous to RC models as covered in AC 91-57. Operators must provide evidence of airworthiness and operator qualification. Small UA are generally limited to visual line-of-sight operations. Examples: Pointer, Dragon Eye

It is important to note that the FAA uses the term “category” in two different ways (14 CFR 1). As used with respect to the certification, ratings, privileges, and limitations of airmen, the term “category” means a broad classification of aircraft. Examples include airplane, rotorcraft, glider, and lighter-than-air. As used with respect to the certification of aircraft, the term “category” means a grouping of aircraft based upon intended use or operating limitations. Examples include transport, normal, utility, acrobatic,

<sup>2</sup> Some Cat III may only be certified to operate under VFR.

limited, restricted, and provisional. When discussing right-of-way rules in 14 CFR 91.113, however, the FAA uses non-mutually exclusive categories such as balloon, glider, airship, airplane, rotorcraft, and engine-driven aircraft for determining which flight has the right-of-way. 14 CFR 103 requires ultralights to yield the right-of-way to all other manned aircraft. Similarly, the FAA provides avoidance (right-of-way) advice for RC model aircraft in an Advisory Circular.

It is envisioned, then, that UA could be assigned their own category in order to facilitate the development of regulations for air operations, airworthiness, operator certification, and right-of-way rules. The UA category may be exclusive of certain UA in the same way that model airplanes are omitted from current regulations; and some UA may be regulated separately, as ultralights, light-sport, or restricted category aircraft are currently.

In addition to regulatory changes necessary for routine operation of military UA in civil airspace, changes to several other documents, such as Advisory Circulars and FAA Order 7610.4K (Special Military Operations), will be required.

### **Regulation: Airworthiness Certification**

The FAA's airworthiness regulations are meant to ensure that aircraft are built and maintained so as to minimize their hazard to aircrew, passengers, and people and property on the ground. Airworthiness is concerned with the material and construction integrity of the individual aircraft and the prevention of it coming apart in mid-air and/or causing damage to persons or property on the ground. Over the 19 year period from 1982 to 2000, an annual average of 2.2 percent of all aviation fatalities involved people being hit by falling parts of aircraft. A UA that must be available for unrestricted operations worldwide (e.g., Global Hawk) in all classes of airspace compels consideration for the safety of people on the ground. The operational requirements for UA operation in civil airspace means flight over populated areas must not raise concerns based on overall levels of airworthiness, therefore, UA standards cannot vary widely from those for manned aircraft without raising public and regulatory concern.

FAA regulations do not require "public aircraft" (ones government-owned or operated) to be certified airworthy to FAA standards. Because most non-military public aircraft are versions of aircraft previously certified for commercial or private use, however, the only public aircraft not related to FAA certification standards in some way are almost always military aircraft. Instead, these aircraft are certified through the military's internal airworthiness certification/flight release processes. A Tri-Service memorandum of agreement describes the responsibilities and actions associated with mutual acceptance of airworthiness certifications for manned and unmanned aircraft systems within the same certified design configuration, envelope, parameters, and usage limits certified by the originating Service.

Similarly to manned military aircraft, unmanned military aircraft will also be subject to the airworthiness certification/flight release process (the Global Hawk is currently undergoing this process).

### **Regulation: Crew Qualifications**

The FAA's qualification standards (14 CFR Parts 61, 63, 65, and 67) are meant to ensure the competency of aircrew and aircraft maintainers. As in the case of airworthiness certification, these Parts do not pertain to military personnel who are certified in a similar, parallel process. DoD and FAA have signed a memorandum of agreement through which DoD agrees to meet or exceed civil training standards, and the FAA agrees to accept military rated pilots into the NAS. These factors indicate a certain minimum knowledge standard is required of all pilots-in-command in order to operate aircraft in the NAS.

*Each Service identifies what and how it will operate and create the training programs necessary to safely accomplish the missions.* Some of the UA-related training is a fundamental shift away from the skills needed to fly a manned aircraft (e.g., ground-based visual landing). These differences can relate to the means of landing: visual remote, aided visual, or fully autonomous. They may also relate to different interface designs for the UA functions, or the level of control needed to exercise authority over an aircraft based on its autonomous capability. As a result, the Services will have minimum standards for

knowledge skills required of UA operators operating in the NAS; this minimum standard may differ for given classes of UA. UA operators<sup>3</sup> will be expected to conform to these requirements.

Another issue that arises is when civilian pilots, such as those working for an aircraft manufacturer building UA for the military, need to fly their company's product during the performance of a military contract, such as for test, production delivery, and acceptance (DD Form 250) flights. The Defense Contract Management Agency (DCMA), which is responsible for such activities leading up to the acceptance of aircraft by the government, has established a policy letter (DCMA Instruction 8210.1, dated 13 November 2002) requiring all contractor UA operators to hold a current FAA Private or Commercial Pilot and Instrument rating to fly outside of restricted or warning areas. This policy has already been waived in certain conditions when the operator training and currency requirements have been found adequate for the operation. Qualification standards for non-military UA operators and maintainers will eventually need an FAA rating that reflects the type of aircraft they are operating.

### **SEE AND AVOID PRINCIPLE**

A key requirement for routine access to the NAS is UA compliance with 14 CFR 91.113, "Right-of-Way Rules: Except Water Operations." This is the Section that contains the phrase "see and avoid," and is the primary restriction to normal operations of UA. The intent of "see and avoid" is for pilots to use their sensors (eyes) and other tools to find and maintain situational awareness of other traffic and to yield the right-of-way, in accordance with the rules, when there is a traffic conflict. Since the purpose of this regulation is to avoid mid-air collisions, this should be the focus of technological efforts to address the issue as it relates to UA rather than trying to mimic and/or duplicate human vision. In June 2003, USAF's Air Combat Command (ACC) sponsored a joint working group to establish and quantify a S&A system capability for submission to the FAA; their White Paper, See and Avoid Requirement for Remotely Operated Aircraft, was released in June 2004.

Relying simply on human vision results in mid-air accounting for an average of 0.8 percent of all mishaps and 2.4 percent of all aviation fatalities incurred annually (based on the 3-year average from 1998 to 2000).<sup>4</sup> Meaningful S&A performance must alert the UA operator to local air traffic at ranges sufficient for reaction time and avoidance actions by safe margins. Furthermore, UA operations BLOS may require an automated S&A system due to potential communications latencies or failures.

The FAA does not provide a quantitative definition of S&A, largely due to the number of combinations of pilot vision, collision vectors, sky background, and aircraft paint schemes involved in seeing oncoming traffic. Having a sufficient field of regard (FOR) for a UA S&A system, however, is fundamental to meeting the goal of assured air traffic separation. The FAA does provide a cockpit field of regard recommendation in its Advisory Circular 25.773-1, but the purpose of AC 25.773-1 does not specifically mention S&A.

Although an elusive issue, one fact is apparent. The challenge with the S&A issue is based on a capability constraint, not a regulatory one. Given the discussions in this and other analyses, a possible definition for S&A systems emerges: S&A is the onboard, self-contained ability to

- Detect traffic that may be a conflict
- Evaluate flight paths
- Determine traffic right-of-way
- Maneuver well clear according to the rules in Part 91.113, or

---

<sup>3</sup> *NOTE:* UA operators may, or may not, be "rated pilots." For this Airspace Integration Plan, "operator" is the generic term to describe the individual with the appropriate training and Service certification for the type of UA being operated, and as such, is responsible for the air vehicle's operations and safety.

<sup>4</sup> National Transportation Safety Board aviation statistics.

- Maneuver as required in accordance with Part 91.111.

The key to providing the "equivalent level of safety" required by FAA Order 7610.4K, Special Military Operations for Remotely Operated Aircraft, is the provision of some comparable means of S&A to that provided by pilots onboard manned aircraft. The purpose of S&A is to avoid mid air collisions, and this should be the focus of technological efforts to address S&A (rather than trying to mechanize human vision).

From a technical perspective, the S&A capability can be divided into the detection of oncoming traffic and the execution of a maneuver to avoid a midair. The detection aspect can be further subdivided into passive or active techniques applicable in cooperative or non-cooperative traffic environments.

The *active cooperative* scenario involves an interrogator monitoring a sector ahead of the UA to detect oncoming traffic by interrogating the transponder on the other aircraft. Its advantages are that it provides both range and bearing to the traffic and can function in both visual and instrument meteorological conditions (VMC and IMC). Its disadvantages are its relative cost. Current systems available in this category include the various Traffic-alert and Collision Avoidance Systems (TCAS).

The *active non-cooperative* scenario relies on a radar- or laser-like sensor scanning a sector ahead of the UA to detect all traffic, whether transponder-equipped or not. The returned signal provides range, bearing, and closure rate, allowing prioritization of oncoming traffic for avoidance, in either VMC or IMC. Its potential drawbacks are its relative cost, the bandwidth requirement to route its imagery (for non-autonomous systems), and its weight. An example of an active, non-cooperative system that is currently available is a combined microwave radar and infrared sensor originally developed to enable helicopters avoid power lines.

The *passive cooperative* scenario, like the active cooperative one, relies on everyone having a transponder, but with everyone's transponder broadcasting position, altitude and velocity data. Its advantages are its lower relative cost (no onboard interrogator required to activate transponders) and its ability to provide S&A information in both VMC and IMC. Its disadvantage is its dependence on all traffic carrying and continuously operating transponders. In this scenario, UA should have the capability to change transponder settings while in flight.

The *passive non-cooperative* scenario is the most demanding one. It is also the most analogous to the human eye. A S&A system in this scenario relies on a sensor to detect and provide azimuth and elevation to the oncoming traffic. Its advantages are its moderate relative cost and ability to detect non-transponder equipped traffic. Its disadvantages are its lack of direct range or closure rate information, potentially high bandwidth requirement (if not autonomous), and its probable inability to penetrate weather. The gimbaled EO/IR sensors currently carried by reconnaissance UA are examples of such systems, but if they are looking at the ground for reconnaissance then they are not available to perform S&A. An emerging approach that would negate the high bandwidth requirement of any active system is optical flow technology, which reports only when it detects an object showing a lack of movement against the sky, instead of sending a continuous video stream to the ground controller. Imagery from one or more inexpensive optical sensors on the UA is continuously compared to the last image by an onboard processor to detect minute changes in pixels, indicating traffic of potential interest. Only when such objects are detected is their bearing relayed to the ground.

Once the "see" portion of S&A is satisfied, the UA must use this information to execute an avoidance maneuver. The latency between seeing and avoiding for the pilot of a manned aircraft ranges from 10 to 12.5 seconds according to FAA and DoD studies<sup>5</sup>. If relying on a ground operator to S&A, the UA incurs the same human latency, but adds the latency of the data link bringing the image to the ground for a

---

<sup>5</sup> Tyndall Air Force Base Mid-Air Collision Avoidance Study; FAA P-8740-51; see also Krause, [Avoiding Mid-Air Collisions](#), p. 13

decision and the avoidance command back to the UA. This added latency can range from less than a second for line-of-sight links to more for satellite links.

An alternative is to empower the UA to autonomously decide whether and which way to react to avoid a collision once it detects oncoming traffic, thereby removing the latency imposed by data links. This approach has been considered for implementation on TCAS II-equipped manned aircraft, since TCAS II already recommends a vertical direction to the pilot; but simulations have found the automated maneuver worsens the situation in a fraction of the scenarios. For this reason, the FAA has not certified automated collision avoidance algorithms based on TCAS resolution advisories; doing so would set a significant precedent for UA S&A capabilities.

The long-term FAA plan is “to move away from infrastructure-based systems towards a more autonomous, aircraft-based system” for collision avoidance<sup>6</sup>. Installation of TCAS is increasing across the aviation community, and TCAS functionality supports increased operator autonomy. Research and testing of Automatic Dependent Surveillance-Broadcast (ADS-B) may afford an even greater capability and affirms the intent of the aviation community to support and continue down this path. Such equipment complements basic S&A, adds to the situational awareness, and helps provide separation from close traffic in all meteorological conditions.

### COMMAND, CONTROL, COMMUNICATIONS

Data Link Security. In general, there are two main areas of concern when considering link security: inadvertent or hostile interference of the uplink and downlink. The forward (“up”) link controls the activities of the platform itself and the payload hardware. This command and control link requires a sufficient degree of security to insure that only authorized agents have access to the control mechanisms of the platform. The return (“down”) link transmits critical data from the platform payload to the warfighter or analyst on the ground or in the air. System health and status information must also be delivered to the GCS or UA operator without compromise.

Redundant/Independent Navigation. The air navigation environment is changing, in part, because of the demands of increased traffic flow. Allowances for deviation from intended flight paths are being reduced. This provides another means for increasing air traffic capacity as airways and standard departures and approaches can be constructed with less separation. As tolerances for navigational deviation decrease, the need to precisely maintain course grows. All aircraft must ensure they have robust navigational means. Historically, this robustness has been achieved by installation of redundant navigational systems. The need for dependable, precise navigation reinforces the redundancy requirements.

While navigation accuracy and reliability pertain to military operations and traffic management, current systems are achieving the necessary standard without redundancy, and without reliance on ground based navigation aids. The *Federal Radionavigation Plan*, signed March 2002, establishes the following national policies:

- Unaugmented, properly certified GPS is approved as a primary system for use in oceanic and remote airspace.
- Properly certified GPS is approved as a supplemental system for domestic en route and terminal navigation, and for non-precision approach and landing operations.
- The FAA’s phase-down plan for ground-based NAVAIDS retains at least a minimum operational network of ground-based NAVAIDS for the foreseeable future.
- Sufficient ground-based NAVAIDS will be maintained to provide the FAA and the airspace users with a safe recovery and sustained operations capability in the event of a disruption in satellite navigation service.

---

<sup>6</sup> 2001 *Federal Radionavigation Systems Plan*



These policies apply, as a minimum, to all aircraft flying in civil airspace. With GPS, the prospect for relief of some redundancy requirements in manned aviation may be an option in the future. However, UA have a diminished prospect for relief since, unlike manned aircraft, a UA cannot readily fallback on dead reckoning, contact navigation, and map reading in the same sense that a manned aircraft can.

Autonomy. Advances in computer and communications technologies have enabled the development of autonomous unmanned systems. With the increase in computational power available, developmental UA are able to achieve much more sophisticated subsystem, guidance, navigation and control, sensor and communications autonomy than previous systems. Global Hawk is capable of Level 2-3 autonomy today. Its airborne systems are designed to identify, isolate, and compensate for a wide range of possible system/sub-system failures and autonomously take actions to ensure system safety. Preprogrammed decision trees are built to address each possible failure during each part of the mission.

One of the most difficult aspects of high levels of autonomy is ensuring that all elements remain synchronized. Verifying that 1) all messages are received, 2) all aircraft have correctly interpreted the messages, and 3) the entire squadron has a single set of mission plans to execute will be a key accomplishment. Once developed, such reliable, highly autonomous UA systems should facilitate integration into the FAA's Joint Air Traffic Management Vision.

Lost Link. In the event of lost command and control, military UA are typically programmed to climb to a pre-defined altitude to attempt to reestablish contact. If contact is not reestablished in a given time, the UA can be pre-programmed to 1) retrace its outbound route home, 2) fly direct to home, or 3) continue its mission. With respect to lost communications between the GCSs and the UA, or the UA and ATC, however, there is no procedure for a communications-out recovery. Examination of a lost link scenario illustrates that this communications issue can become a critical UA failure mode, if left unaddressed.

NORDO (No Radio) requirements are well documented in 14 CFR 91.185. Remarkably, most lost link situations bear a striking resemblance to NORDO, and UA would enhance their predictability by autonomously following the guidance. The one exception to this case is the VFR conditions clause. UA, even with an adequate S&A system (autonomous), would enhance overall safety by continuing to fly IFR. Should normal ATC-voice communications fail, the FAA also has the capability to patch airspace users through to the controlling ATC authority by phone at any time.

### **FUTURE ENVIRONMENT**

The migration of the NAS from ground based traffic control to airborne traffic management, scheduled to occur over the next decade, will have significant implications for UA. S&A will become an integrated, automated part of routine position reporting and navigation functions by relying on a combination of ADS-B and GPS. In effect, it will create a virtual bubble of airspace around each aircraft so that when bubbles contact, avoidance is initiated. All aircraft will be required to be equipped to the same level, making the unmanned or manned status of an aircraft transparent to both flyers and to the FAA.

Finally, the pejorative perception that UA are by nature more dangerous than manned aircraft needs to be countered by recognizing that UA possess the following inherent attributes that contribute to flying safety:

- Many manned aircraft mishaps occur during the take-off and landing phases of flight, when human decisions and control inputs are substantial factors. Robotic aircraft are not programmed to take chances; either preprogrammed conditions are met or the system goes around.
- Since human support systems are not carried, mishaps from failed life support systems will not occur.
- Smoke from malfunctioning, but non-vital, onboard systems does not pose the same threat of loss, since smoke in the cockpit of a manned aircraft can distract pilots and lead to vision obscuration.
- Automated take-offs and landings eliminate the need for pattern work, resulting in reduced exposure to mishaps, particularly in the area surrounding main operating bases.

**OSD ROADMAP GOALS FOR INTEGRATING UA INTO CIVIL AIRSPACE**

1. Implement an airspace regulatory environment that encourages the safe use of UA in unrestricted airspace.
2. Improve the flight reliability of UA so as to equal or better that of their manned counterparts.
3. Secure the control and sensor/relay communications sent to and from UA.
4. Coordinate revising FAA Order 7610.4 to replace the requirement for using the COA process for all UA with one for using the DD175 form for qualifying UA (Cat III).
5. Work with the FAA to define appropriate conditions and requirements under which a single pilot would be allowed to control multiple airborne UA simultaneously.
6. Document and disseminate any UA-unique lessons learned from certifying the RQ-4 Global Hawk as airworthy. Formal documentation as a DoD Instruction for guiding future UA airworthiness certifications should be considered.
7. Ensure Service efforts for developing and evaluating automated S&A and collision avoidance systems are coordinated and non-duplicative.
8. Equip DoD UA intended for IFR operations with a stand-alone, hot backup, ground-based navigation system and establish a standardized lost link procedure.





**APPENDIX G: TASK, POST, PROCESS, AND USE CONSIDERATIONS**

Please see the Office of the Under Secretary of Defense for Intelligence's *Intelligence, Surveillance and Reconnaissance Roadmap*.

The National Geospatial-Intelligence Agency has developed and implemented a community airborne library architecture (CALA) as a central repository for airborne imagery. CALA operates in a web-enabled environment making data/imagery to users in multiple security domains.





## APPENDIX H: RELIABILITY

### OVERVIEW

The combined U.S. military UA fleet (Pioneers, Hunters, Predators, Global Hawks, and others) reached the 100,000 cumulative flight hour mark in 2002. Through 2004, this number has accelerated past 150,000 hours. *This experience has provided quantifiable dividends in system reliability.* Reliability is at the core of achieving routine airspace access, reducing acquisition system cost, and improving mission effectiveness for UA. Although it took the fleet of military UA 17 years to reach the 100,000 flight hour milestone, this appendix highlights the first comprehensive study<sup>1</sup> to formally address the reliability issue for these increasingly utilized military assets. UA reliability is important because it underlies their *affordability, availability, and acceptance.*

Affordability. The reliability of the DoD's UA is closely tied to their affordability primarily because the Department has come to expect UA to be less expensive than their manned counterparts. This expectation is based on the UA's generally smaller size (currently a savings of some \$1,500 per pound) and the omission of those systems needed to support a pilot or aircrew, which can save 3,000 to 5,000 pounds in cockpit weight. Beyond these two measures, however, other cost saving measures to enhance affordability tend to impact reliability. System affordability has to be weighed against airworthiness and life-cycle costs (LCC). The demands of certification will tend to increase unit costs, perhaps beyond popular expectations. While attention needs to be directed at ways to increase reliability under cost constraints, additional up front investment has the prospect of lower LCC through reduced attrition from service-life extension and fewer mishap losses, in turn driving down requirements to acquire attrition reserves.

Availability. With the removal of the pilot, the rationale for including the level of redundancy, or for using man-rated components considered crucial for his safety, can go undefended in UA design reviews, and may be sacrificed for affordability. Less redundancy and lower quality components, while making UA even cheaper to produce, mean they become more prone to in-flight loss and more dependent on maintenance, impacting both their mission availability and ultimately their LCC.

Acceptance. Finally, improving reliability is key to winning the confidence of the general public, the acceptance of other aviation constituencies (airlines, general aviation, business aviation, etc.), and the willingness of the FAA to regulate UA flight. Regulation of UA is important because it will provide a legal basis for them to operate in the National Airspace System for the first time. This, in turn, should lead to their acceptance by international and foreign civil aviation authorities. Such acceptance will greatly facilitate obtaining overflight and landing privileges when larger, endurance UA deploy in support of contingencies. Regulation will also save time and resources within both the DoD and the FAA by providing one standardized, rapid process for granting flight clearances to replace today's cumbersome, lengthy (up to 60 days) authorization process. A third benefit of regulation is that it could potentially lower production costs for the military market by encouraging the use of UA in civil and commercial applications. This overview presents reliability from several perspectives commonly used in reliability analysis.

Reliability is the probability that an item will perform its intended function for a specified time under stated conditions. It is given as a percentage which represents the probability that a system or component will operate failure-free for a specified time, typically the mission duration. It relates closely to Mean Time Between Failure (MTBF).

Mean Time Between Failure. describes how long a repairable system or component will continue to perform before failure. For non-repairable systems or components, this value is termed Mean Time To Failure (MTTF).

---

<sup>1</sup> UA Reliability Study, Office of the Secretary of Defense(Acquisition Technology, and Logistics)

Availability is a measure of how often a system or component is in the operable and committable state when the mission is called for at an unknown (random) time. It is measured in terms of the percentage of time a system can be expected to be in place and working when needed, or mission available rate (MAR) in percent.

Class A Mishap Rate is the number of accidents (significant aircraft damage or total loss) occurring per 100,000 hours of fleet flight time. In cases where a UA fleet has not accumulated this amount of flying time, its MR represents its extrapolated losses to the 100,000 hour mark. It is expressed as mishaps per 100,000 hours. It is important to note that this extrapolation does not reflect improvements that should result from operational learning or improvement in component technology.

Maintenance cancellations/aborts were broken out into failures of the aircraft's major subsystems. Use of these failure modes lead to a higher fidelity representation of the aircraft's reliability. In order to make uniform comparisons between systems, the following definitions were used to categorize areas of system failure leading to mission aborts or cancellations.

Power/Propulsion (P&P). Encompasses the engine, fuel supply, transmission, propeller, electrical system, generators, and other related subsystems on board the aircraft.

Flight Control. Includes all systems contributing to the aircraft stability and control such as avionics, air data system, servo-actuators, control surfaces/servos, on-board software, navigation, and other related subsystems. Aerodynamic factors are also included in this grouping.

Communication. The data link between the aircraft to the ground.

Human Factors/Ground Control. Accounts for all failures resulting from human error and maintenance problems with any non-aircraft hardware or software on the ground

Miscellaneous. Any mission failures not attributable to those previously noted, including airspace issues, operating problems, and other non-technical factors. Because operating environments are not uniform as a variable affecting the data, weather was excluded as a causal factor in this study.

### **Data and Trends**

Figure H-1 shows the Class A Mishap Rate per 100,000 hours versus cumulative flight hours for the Global Hawk, Predator, Hunter, and Pioneer fleet for the period 1986 through 2003. Class A mishaps are those aircraft accidents resulting in loss of the aircraft (in Naval parlance, "strike"), human life, or causing over \$1,000,000 in damage<sup>2</sup>. These data show a mishap rate (i.e., Class A accidents per 100,000 hours of flight) of 20 for Predator, 47 for Hunter (24 since the major reliability improvements in 1996), 88 for Global Hawk, 281 for Pioneer, and 191 for Shadow. For comparison to two manned military aviation mishap rates, the U-2 and F-16 have cumulative Class A mishap rates of 6.8 and 4.1 per 100,000 hours, respectively. Comparing to non-military aircraft, general aviation suffers about 1 Class A mishap per 100,000 hours, regional/commuter airliners about a tenth of that rate, and larger airliners about a hundredth of that rate.

With the exception of Pioneer and to a lesser extent Shadow, these statistics make it apparent that the reliability of UA is tracking that of early manned military aircraft, and maturing to approach an equivalent level of reliability to their manned military counterparts. Specifically, the early Pioneers (as discussed later in this appendix) had an analog air data system, problems with ship-board EMI, and generally suffered from poor design practices. (A planned conversion to a more reliable engine for the Pioneer never took place.) Compared to this low benchmark, the Hunter program has seen continuous reliability enhancements from efforts initiated in the mid-1990's to improve hardware and maintenance. Not surprisingly for the higher-end systems, the Predator has enjoyed relatively high and stable reliability

---

<sup>2</sup> Per OPNAV Instruction 3750.6R, "Loss of a UAV is not a Class A unless the cost is \$1,000,000 or greater." All Pioneer mishaps discussed are therefore Class B Mishaps.

## UAS ROADMAP 2005

throughout its ACTD to operational phases, and the Global Hawk appears to be tracking the reliability of its manned counterpart, the U-2.

The reliability trends calculated during these flight hours are detailed in Tables H-1 and H-2. Following these data is a discussion about the individual UA systems and how their fielding and operation contribute to the reliability data.

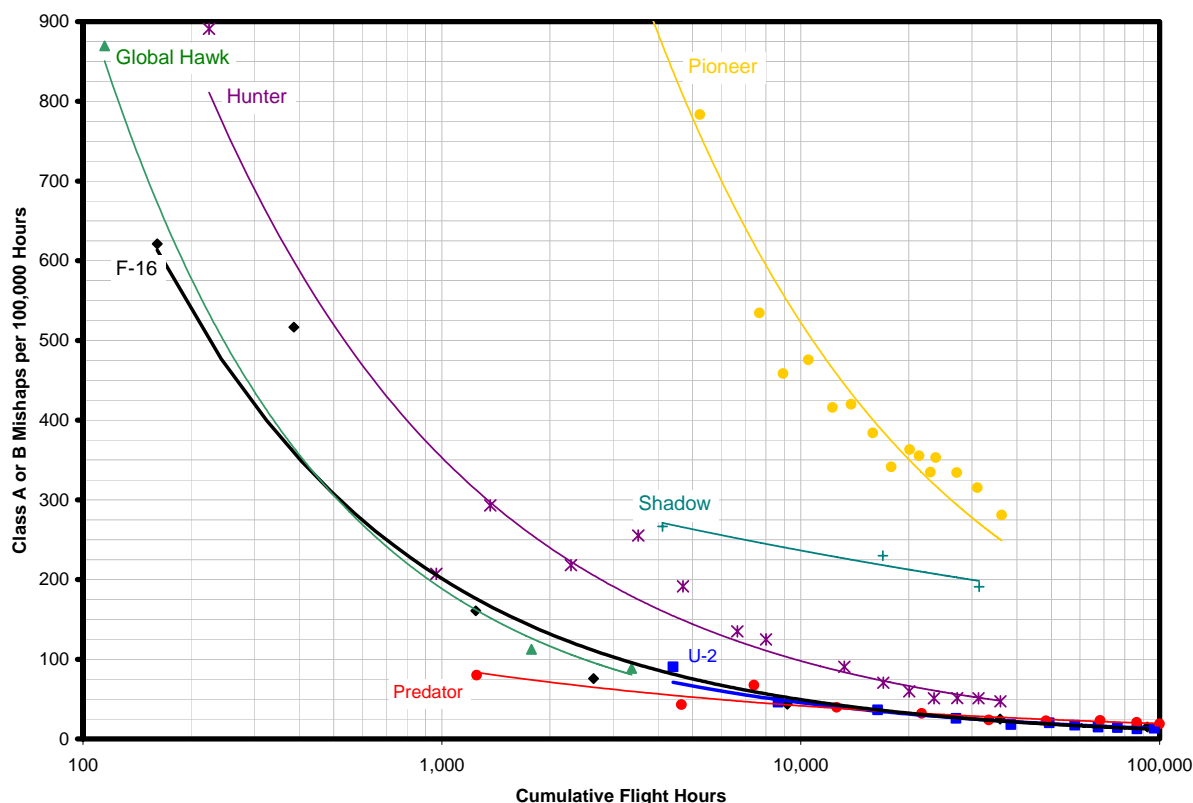

FIGURE H-1. U.S. MILITARY AIRCRAFT AND UA CLASS A MISHAP RATES (LIFETIME), 1986 – 2004.

TABLE H-1. SUMMARY OF UA RELIABILITY FINDINGS.

		MTBF (hrs)	Availability	Reliability	Mishap Rate per 100,000 hrs (Series)	Mishap Rate per 100,000 hrs (Model)
RQ-1A/ Predator	Requirement	n/a	n/a	n/a	n/a	20
	Actual	32.0	40%	74%	43	
MQ-1B/ Predator	Requirement	40	80%	70%	n/a	281
	Actual	55.1	93%	89%	17	
RQ-2A/ Pioneer	Requirement	25	93%	84%	n/a	47
	Actual	9.1	74%	80%	363	
RQ-2B/ Pioneer	Requirement	25	93%	84%	n/a	47
	Actual	28.6	78%	95%	179	
RQ-5/ Hunter (pre-1996)	Requirement	10	85%	74%	n/a	47
	Actual	n/a	n/a	n/a	255	
RQ-5/ Hunter (post-1996)	Requirement	10	85%	74%	n/a	47
	Actual	21.2	99%	97%	24	
RQ-7/ Shadow	Actual	n/a	85%	98.8%	191	191



Table H-1 summarizes the reliability metrics for all military UA examined in this study. With respect to the required values as outlined in the operational requirements and specifications, green and red signify instances in which the actual values meet or fall short of the requirements, respectively. In the case of the mishap rate per 100,000 hours, no requirements were identified. In addition, requirements are not available for the RQ-1A/Predator due to their development after concluding its ACTD (discussed later in this appendix), nor are they available for the Global Hawk due to relatively low flight hours.

The mishap rate per 100,000 hours is presented in two ways. The model/series mishap rate illustrates “before and after” gains made in reliability and operations between subsequent versions of the same UA model. The model mishap rate is a snapshot of the combined performance of all versions of each UA model. It incorporates all mishaps over that fleet’s cumulative flight hours.

In all cases except for the RQ-2/Pioneer, the UA systems examined in this study exceed operational requirements. The shortfalls in the RQ-2A reliability performance (shown in red) were amended with the next generation RQ-2B with the exception of the availability metric. Table H-2 presents the failure modes analysis for each UA model.

**TABLE H-2: SUMMARY OF UA FAILURE MODE FINDINGS**

		Power/ Propulsion	Flight Control	Comm	Human/ Ground	Misc
<b>Aircraft</b>	<b>RQ-1A/ Predator</b>	23%	39%	11%	16%	11%
	<b>MQ-1B/ Predator</b>	53%	23%	10%	2%	12%
	<b>RQ-2A/ Pioneer</b>	29%	29%	19%	18%	5%
	<b>RQ-2B/ Pioneer</b>	51%	15%	13%	19%	2%
	<b>RQ-5A/ Hunter*</b>	38%	5%	31%	7%	19%
	<b>RQ-7/ Shadow</b>	38%	0%	0%	38%	24%

\* The vast majority of all Hunter aborts (58 percent) were due to weather.

There are several noteworthy trends from the summary data in Table H-2.

- The failure due to Human/Ground related issues is significantly lower for the MQ-1B Predator. This may be largely due to the increased use of simulators for Predator training, as well as enhancements made in situational awareness.
- Integration of a more complex solution for over-the-horizon ATC communication via the ARC-210 radio did not increase the share of mishaps due to communication hardware and software failures for the RQ-1.
- The trends in the MQ-1/Predator and RQ-2/Pioneer failures due to Power/Propulsion are very similar. The share is in the 20-30 percent range (23 percent and 29 percent, respectively) for the early, A-model systems, but doubles to the 50 percent range (53 percent and 51 percent respectively) in the later models. MQ-1 Block 30 upgrades address this issue.
- The trends in the MQ-1/Predator and RQ-2/Pioneer failures due to Flight Control issues are also very similar. From the A-model to the B-model, the share decreases by over one-half (39 percent to 23 percent and 29 percent to 15 percent, respectively). This may be attributed to a better understanding of the aircraft aerodynamics and flight control as well as self-imposed flight restrictions for certain operating environments.
- Despite any noticeable shifts of failure modes among the aircraft from the early to the late model, the reliability trends for the UA continued to be positive. This indicates an awareness of, and attention to, system deficiencies on the part of the designers and operators.

The average values for the failure modes for all five subsystems are presented in Figure H-2. This view of the Predator, Pioneer, and Hunter UA fleet provides a good introduction into a similar perspective on foreign UA reliability.

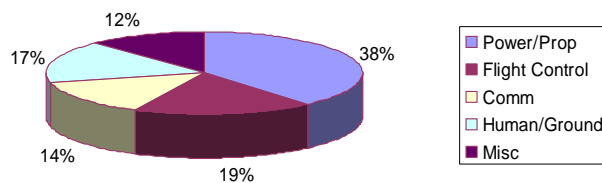

**FIGURE H-2. AVERAGE SOURCES OF SYSTEM FAILURES FOR U.S. MILITARY UA FLEET (BASED ON 194,000 HRS).**

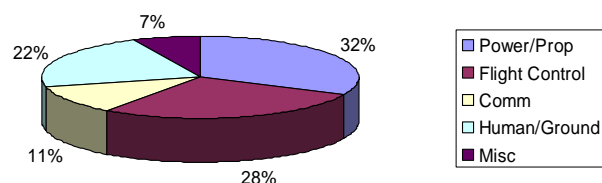

**FIGURE H-3. AVERAGE SOURCES OF SYSTEM FAILURES FOR IAI UA FLEET (BASED ON 100,000 HRS).**

Israeli Defense Forces have also accumulated over 100,000 hours of operational flight experience with their UA. The manufacturer of most of these UA, Israeli Aircraft Industries (IAI), has documented the causes of failures across the past 25 years of this experience and made recommendations for improving reliability based on this analysis. Of current U.S. UA systems, both the Pioneer and the Hunter originated as IAI designs, and the Shadow evolved from the Pioneer’s design. For these three reasons, any examination of U.S. UA reliability would be incomplete without examining the reliability of their Israeli counterparts and predecessors.

The data trends derived from the U.S. UA operations summarized in Figure H-2 are remarkably similar (within 10 percent) to that of the Israeli UA fleet for all failure modes. With twice as many flight hours for the U.S., it is not surprising that the share of failures due to flight control is less. Given that the IAI data is also based on a substantial number of flight hours as well, one can argue that the U.S. is facing the same technical and operational problems of other operators. Furthermore, because manufacturing techniques and supply quality differ from one country to the next, it is interesting to ask the question “Why are the failures modes still similar?” One answer points to external factors and the operating environment itself, including weather and the low Reynolds number flight regime.

**MQ-1 and MQ-9/Predator**

RQ-1A. The Predator experienced low mission completion rates during its initial deployment in the Balkans in 1995-1997. While the primary causal factor was weather, system failures did account for 12% of the incomplete missions. Mission-level operational data from the system deployed in Hungary was used to perform a limited assessment of system reliability based on data covering missions from March 1996 through April 1997.

Out of the 315 Predator missions tasked during that timeframe, weather and system cancellations kept nearly two-thirds on the ground (60 percent). Of the remaining missions that were launched, slightly under one half were subsequently aborted. These aborts were due to system (29 percent), weather (65 percent), and operational issues (6 percent) that included airspace conflicts, operator errors, and crew duty limitations.

Data indicates that 38 missions (12 percent) were scrubbed due to system failures, an additional 18 system aborts (6 percent) that did not result in mission cancellation (due to launch of another aircraft or weather hold), and other issues which kept the Predator on the ground 6 times (2 percent). Out of this

total of 62 sorties affected by mission aborts or cancellations due to maintenance, operations, or human errors, the systems' failure breakout data is provided in Table H-2.

MQ-1B. The Predator transition into production led to some problems which affected aircraft reliability. As the first ACTD program to transition to production, the Predator established the precedent, as well as the lessons learned, for the transition process. First, nearly continuous deployment commitments since March 1996 have delayed operational testing. Second, development of the ORD, usually produced early in a program to guide system design, was not begun until after the ACTD ended (indicated by the N/A in Table H-1) Third, additional challenges to system reliability were introduced, such as the addition of a wing deicing system (glycol-weeping wings) as well as a redesigned control station for greater portability.

Since this rocky start, the Predator fleet has logged over 100,000 hours (as of October 2004) and has "come of age" during Operations ENDURING FREEDOM and IRAQI FREEDOM. As a result of its unorthodox transition process, however, Predator reliability issues were discovered and addressed during operations around the world. Although the system still experiences reliability issues and aircraft losses, its performance during these operations has been remarkably good when compared to those outlined in the ORD.

The data in Table H-1 and H-2 represents all mission aborts (on the ground and in-flight) for all MQ-1B systems between January 1997 and June 2002. The share of power/propulsion failure modes has doubled in the MQ-1B compared to the MQ-1A. The Predator program office acknowledged that the engine is the primary reliability issue.

The primary distinguisher between the MQ-1A and MQ-1B models is the Rotax 914 turbocharged engine, which replaced the smaller Rotax 912 model, and was implemented primarily to increase the Predator's speed. With the new engine, a variable pitch propeller was also added. The data over this five-year period indicates that the new variable pitch propeller accounted for 10 percent of all power/propulsion aborts, while the engine made up nearly 70 percent. This is accompanied by a corresponding reduction in flight control failures as well as a large decrease in malfunctions attributable to human errors and operations and hardware on the ground. This does not necessarily mean that powerplant-related failures have increased in the MQ-1B model, but that reliability improvements made in other areas (communications) have made a comparatively greater impact on system reliability.

The significant decline in human and ground related errors (from 16 percent to 2 percent) is attributed to a concerted training effort according to one Predator operator. Enhancements in situational awareness also played a role in this positive trend. For example, periodic automated updates of the weather are supplied to the control station. A VHF/UHF ARC-210 radio has also been added to provide voice relay capability to the MQ-1B pilot, enabling direct, over the horizon communication with ATC authorities in the area of flight. An APX-100 Identification, IFF/Selective Identification Feature (SIF) Mode 4 transponder was added to further facilitate coordination with AWACS flight controllers. Air Force Portable Flight Planning Software (PFPS), an offshoot of the Air Force Mission Support System (AFMSS), is another tool defined in the Block 1 upgrade in which threat and mission planning information can now be passed directly to the Predator system. The percentage of communications and flight control failures remained virtually unchanged between the two models. Note: The RQ-1B became designated as the MQ-1B in 2002, after it acquired the ability to carry weapons.

MQ-9. To address certain reliability issues which arose during MQ-1B operations, the MQ-9 Predator system, now denoted MQ-9A, is scheduled to undergo specific modifications from its predecessors designed to enhance reliability. Specifically, the MQ-9 will have actuators with an MTBF of 2,000 hours, which is over an order of magnitude improvement over the actuator MTBF of 150 hours on the earlier Predator models. There will be a triplex (double redundant) flight control system, and the control surfaces survivability will increase with two rudders, four ailerons, and four elevators. The overall objective failure rate for the MQ-9 is on the order of  $10^{-5}$ , or 1 in 100,000 hours of flight, a value equal to

that for a number of mature manned aircraft. For a typical 15 hour flight, this translates to an operational reliability of over 99.99 percent.

### **RQ-2/Pioneer**

RQ-2A. The reliability analysis for early-model Pioneers is based on statistical data gathered between September 1990 and April 1991 from three Marine, two Navy, and one Army Pioneer unit (total of six systems) while deployed in the Persian Gulf theater in support of Operations Desert Shield and Desert Storm. Although known as the Option II+ version of Pioneer at that time, this model was subsequently designated as the RQ-2A. At the time of this data, it had been in service with the Navy for four years, the Marines for three, and the Army for one. By this time, it had already incorporated a number of reliability improvements to its original, imported version.

With respect to its Operational Requirements Document, the early model Pioneer achieved less than desired reliability metrics. This could be due to one of several factors. First, the Pioneer was purchased from Israel as a non-developmental system in an accelerated procurement. Once in operation, Navy and Marine users quickly identified several deficiencies that contributed to unreliability. General Charles C. Krulak, then Commandant of the U.S. Marine Corps noted “the Pioneer does not have an automatic take-off, landing, or mission execution capability and that has led to a high accident rate.” Shipboard electromagnetic interference caused several crashes, and the engines were thought to be too small and easily overstressed. In addition to the need for a more reliable engine, the Marine Corps users also felt that the system needed a smaller logistical footprint and a longer endurance.

RQ2-B. The currently fielded version of Pioneer, the RQ-2B, is essentially a digital version of its analog predecessor, with the major distinction being the replacement of the analog air data system with the digital Modular Integrated Avionics Group (MIAG). RQ-2Bs are modifications of the existing RQ-2A airframes, rather than new production. All twenty-five operational (out of 49 existing) RQ-2As have been converted to RQ-2Bs.

The reliability analysis for later model Pioneers is based primarily on the Marine Pioneer squadrons’ (VMU-1 and VMU-2) operations in the late 1990’s. The reliability data for the RQ-2B is derived from two sources: maintenance aborts and in-flight aborts. Each offers a somewhat different perspective on the reliability of the overall aircraft. In a distribution closely resembling that of the Predator RQ-1A data, the majority of the failures (66 percent) are attributable to the combination of malfunctions in flight control, power, and propulsion. The breakout in the flight critical systems is roughly 25 percent flight control failures and 75 percent power and propulsion failures. (Recall the corresponding RQ-2A data showed failures due to power and propulsion and flight control equally divided.) This suggests an improvement in the flight control system of the Pioneer over time, or perhaps a shift in emphasis from power and propulsion concerns. The latter is unlikely, however, given that the planned (1997) conversion from the Sachs to the more reliable Quattra engine was never accomplished.

### **RQ-5/Hunter**

Following three crashes in close succession in August-September 1995, OSD terminated the RQ-5/Hunter program after LRIP completion by deciding to not award a full rate production contract. Seven systems of eight aircraft each were delivered between April 1995, and December 1996. A total of 62 aircraft were built by IAI/Malat and assembled by TRW, now Northrop Grumman Corporation. Since that redirection, however, the Hunter program has made numerous component quality related improvements and been used to demonstrate a wide variety of payloads including SIGINT, chemical agent detection, and communication relay for UA use. It has supported National Training Center exercises and NATO operations in Kosovo, and it recently served as the surrogate TUA for the Interim Brigade Combat Team at Ft Lewis, Washington.

The acquisition of the Hunter system by the Army presents a case study in the peril of ignoring, and the benefits of overcoming, reliability problems. During system acceptance testing in 1995, three Hunter aircraft were lost within a 3 week period, contributing to a decision to terminate full rate production.

Wanting to benefit as much as possible from its substantial investment in the Hunter, its Program Management Office and the prime contractor (TRW) performed an end-to-end Failure Mode Effect and Criticality Analysis (FMECA) and a Fishbone Analysis on each of the critical subsystems. An interconnected network of failure analysis and corrective action boards was implemented with the authority to direct design changes to Hunter. Failures of its servo actuators, the leading culprit for the series of crashes, were identified, and their MTBF increased from 7800 hours to 57,300 hours, a sevenfold improvement. Other key components received focused attention including the data link and engine.

Hunter returned to flight status three months after its last crash. Over the next two years, the system’s MTBF doubled from four to eight hours and today stands at over 21 hours. The aircraft itself achieved its required MTBF of ten hours in 1998, and today that figure stands close to 26 hours. Prior to the 1995 stand down and failure analysis, Hunters were experiencing a mishap rate of 255 per 100,000 hours; afterwards (1996-2005) the rate was 24 per 100,000 hours. Initially canceled because of its reliability problems, Hunter has become the standard to which other UA are compared in reliability.

In addition to the reliability data shown in Table H-1, an in-house reliability assessment performed by the prime contractor for the period of 1995 through 2005 found an availability of 0.991. The calculated reliability per mission was 97 percent.

The failure modes analysis in Table H-2 is built on data from December 20, 1995 to June 15, 2005. This data shows that Hunter’s non-weather related failures were led by power and propulsion issues (38 percent). This concentration is a shift from the more evenly distributed failure mode breakout shown during a 2003 reliability assessment (*2003 OSD UAV Reliability Study*). This follows in the trend of the Predator and Pioneer systems, which also suffer failures due primarily to power and propulsion. The 19 percent of failures attributed to “Miscellaneous” includes malfunctions with the flight termination system and parachute aircraft recovery system.

The high mishap rate of the early Hunters is comparable to that of the early Pioneers and, based on that similarity can be largely attributed to poor Israeli design practices for their UA in the 1980s. The significant improvement in Hunter’s mishap rate achieved since the mid-1990s is reflective of (1) joint government/contractor-focused oversight, (2) a rigorous review and analysis process being put in place, and (3) qualitative improvements in a number of failure-critical components (servo-actuators, flight control software).

**TECHNOLOGY ENHANCING SOLUTIONS**

To address the reliability shortcomings identified above, examples of current and developmental technologies are presented in Table H-3. These technologies – provided in detail in the full Reliability Study – are provided as examples of solutions which have the potential to significantly enhance UA reliability. Technology areas for each of the major failure modes are presented at three levels of cost/complexity.

**TABLE H-3. TECHNOLOGY TO ENHANCE UA RELIABILITY.**

	Low Level COTS	High Level COTS	Next Generation
<b>Power and Propulsion</b>	Lighter (Boralyn Molded) Engine Block	Heavy Fuel Engine	Fuel Cell Technology
<b>Flight Control</b>	Higher Frequency Flight Control System	Advanced Digital Avionics System	Self-Repairing “Smart”Flight Control System
<b>Communications</b>	Better Environmental Control	Electronically Steered Arrays	Film and Spray-On Antennas
<b>Human/Ground</b>	Enhanced Pilot Training	Auto Take-Off and Recovery	Enhanced Synthetic Vision

**RECOMMENDATIONS**

Based on the preceding reliability data and trends analysis, it is possible to distill a focused set of recommendations which will have a measurable impact on UA reliability growth.

- Introduce joint standardization of reliability data tracking for operational UA systems.
- Data collection for this study provided insight into an inconsistent (and at times inaccurate and incomplete) reporting framework for tracking the reliability growth of various UA fleets. This makes it particularly difficult to gauge not only the reliability of one system, but also any trends across system and Service lines. A single format, with jointly agreed definitions for data fields for key reliability metrics, needs to be developed and implemented.
- Perform a cost-benefit trade study for incorporating/retrofitting some or all of the MQ-9 Predator's reliability enhancements into production MQ-1 Predator models.
- Perform cost-benefit trades for low and high level COTS approaches identified in Table H-3 to improve reliability for each fielded UA system.
- Develop and implement a Reliability Specifications Standard for UA design.

*Design changes can cost 1,000 and 10,000 times more at the LRIP and final production phases, respectively, than the same change would during product design. As a result, cost increases at the early stage (for reliability downstream) can in most cases be justified.*

- Incorporate the emerging technologies identified in Table H-3 into the Defense Technology Objectives and the Defense Technology Area Plan.
- Encourage more research into low Reynolds number flight regimes.

*Just as UA come in many categories, so too do the flight environments in which they operate. As a result, Reynolds number effects must be better understood to provide insight into such areas as (1) steady and unsteady flow effects, (2) three-dimensional laminar/turbulent flow transition, and (3) ideal airfoil and wing geometries at Reynolds and Mach numbers which encompass the spectrum of UA flight profiles.*

*Investments in low Reynolds number engine components are also critical. Turbo machinery for UA at low speeds or high-altitudes face flight environments which are different than those to which modern propulsion has traditionally catered. Heat rejection, turbine and compressor tip losses, and low dynamic pressures are a few of the factors which can degrade the performance of a small propulsion system at these low Reynolds number conditions.*

- Investigate the potential role of advanced materials and structures for enhancing UA reliability and availability.

*High temperature materials and light-weight structures can offer significant weight savings for UA airframes. On the horizon, smart materials such as shape memory alloys will offer alternatives to the servos, flight control surfaces, and even de-icing systems of existing aircraft designs, which in turn will reduce components count and increase reliability.*

- Incorporate and/or develop all-weather practices into future UA designs.

*Icing has been a primary factor in at least two Hunter mishaps and three Predator losses. UA cold weather tolerance, as well as operation in precipitation and suboptimal wind conditions, should be a focus for UA designers to enhance UA reliability and availability in real world operations.*

Improving UA reliability is the single most immediate and long-reaching need to ensure their success. Their current levels of reliability impact their operational utility, their acquisition costs, and their acceptance into airspace regulations. The value of making reliability improvements must be weighed against not only acquisition cost, as is traditionally the case, but also against the less quantifiable returns to be gained by a commander. As a critical resource to the commander, UA must be available when they are called upon and have the ability to operate freely and respond quickly in any airspace. The recommendations of this study are structured to ensure that this occurs.



**APPENDIX I: HOMELAND SECURITY**

**OVERVIEW**

The Department of Homeland Security (DHS) and DoD’s Northern Command (NORTHCOM) share responsibility for defending the United States against terrorist attacks. In addition, DHS has a number of law enforcement functions not shared with NORTHCOM. DHS identified unmanned aircraft as a high-interest enabler for its homeland security and law enforcement functions within months of its formation in November 2002. In May 2003, the Secretary of Homeland Security directed a demonstration for evaluating UA utility in border surveillance be conducted, resulting in Operation Safeguard that fall. DHS also established an internal UA Working Group under its Border and Transportation Security (BTS) Directorate’s Office of Science and Technology in 2003 to explore roles and define requirements that UA could potentially fulfill throughout DHS. Its first study, Unmanned Aerial Vehicle Applications to Homeland Security Missions (March 2004), addressed UA’s potential applicability to border security, Coast Guard missions, critical infrastructure security, and monitoring transportation of hazardous materials.

Subsequently, the Working Group examined the cost effectiveness of various size UA compared to that of manned aircraft and ground sensor networks in selected DHS environments. In performing this analysis, 45 functional capabilities that DHS/BTS is required to perform were examined in the nine environments in which DHS operates; UA were assessed to be potential contributors in ten of the 45 capabilities (see Table I-1).

**TABLE I-1. DHS/BTS CAPABILITY REQUIREMENTS APPLICABLE TO UA.**

Functional Area	Functional Capability for UA
Surveillance and Monitoring	Visual Monitoring
	Non-Visual Monitoring
	Suspect/Item Geolocation
	Communications Interception
Communications and Information Mgmt	Tactical Situational Awareness
Apprehension/Detection/Seizure/Removal	Pursuit management and Prevention
Targeting and Intelligence	Intelligence Support to Command
Deterrence	Visible Security Systems
	Specialized Enforcement Operations
Officer Safety	Use of Safety and Emergency Equipment

In addition to Operation Safeguard, DHS organizations have conducted a number of other demonstrations using UA in different roles and environments (see Table I-2). These demonstrations have built on previous experiences with UA learned by DHS’ legacy organizations over the past decade (see Figure I-1). Collectively, these demonstrations have served to educate DHS on the strengths and limitations of UA and support its decision to focus efforts on a Homeland Security UAV (HSUAV), a medium/high altitude endurance UA capable of supporting multiple DHS organizations across a variety of applications and environments. Although the concept for its operation is still being developed, HSUAV will likely be embedded in one of the aviation-using elements of DHS, who will assume responsibility for operating and maintaining it. The primary aviation-using organizations within DHS are the Coast Guard, Customs and Border Protection (CBP), and Counter Narcotics Office, who together operate a mixed fleet of some 170 fixed-wing aircraft and 240 helicopters. The air assets of Immigration and Customs Enforcement (ICE) were combined under CBP in November 2004.



**TABLE I-2. PAST AND PLANNED DHS-SPONSORED UA DEMONSTRATIONS.**

Demonstration	Location	UA Used	Sponsor (Support)	Dates	Sorties Flown	Hours Flown
Operation Safeguard	Gila Bend, AZ	Predator B	ICE (Air Force)	03	15	106
Alaska Demo Phase 1	King Salmon, AK	Predator	USCG (Navy)	Nov 03	5	35
Alaska Demo Phase 2	King Salmon, AK	Altair	USCG (NASA)	Aug 04	3	36
	Wallops Is, VA	Aerosonde	USCG (NASA)		Ongoing	Ongoing
ABCI	Sierra Vista, AZ	Hermes 450	CBP (Navy)	Jun-Sep 04	65	590.1
ABCI Follow-on	Sierra Vista, AZ	Hunter	CBP (Army)	Nov 04-Jan 05	41	329.1
<i>Northern Border Eval</i>	<i>Grand Forks, ND</i>	<i>Altair</i>	<i>CBP</i>	<i>Winter 05</i>	<i>TBD</i>	<i>TBD</i>
<i>Alaska Demo Phase 3</i>	<i>King salmon, AK</i>	<i>Altair</i>	<i>USCG (NOAA)</i>	<i>Summer 05</i>	<i>TBD</i>	<i>TBD</i>
<i>Coastal Areas</i>	<i>Raimey, PR</i>	<i>TBD</i>	<i>CBP</i>	<i>Summer 05</i>	<i>TBD</i>	<i>TBD</i>

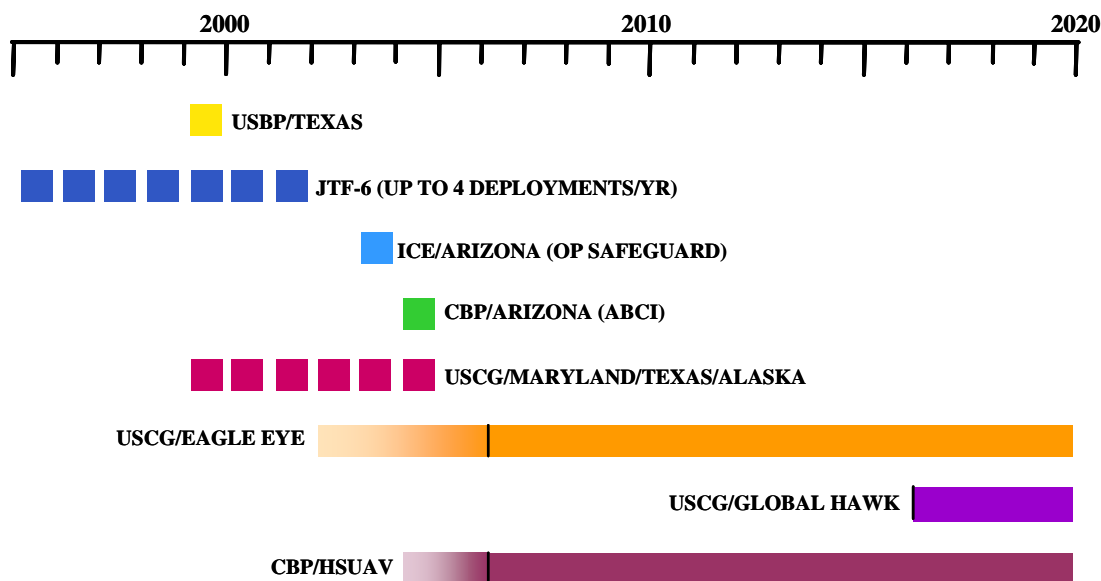

**FIGURE I-1. UA ACTIVITIES AND PROGRAMS IN SUPPORT OF HOMELAND SECURITY.**

**COAST GUARD**

Coast Guard acquisition plans for UA were in place prior to the formation of DHS as part of its Deepwater recapitalization program. Deepwater calls for acquiring 69 Bell Textron Eagle Eye ship-based tiltrotor UA starting in 2006 and leasing up to seven land-based Global Hawks in 2016. The Coast Guard began conducting a series of experiments in 1999 that have involved small (30-pound Aerosonde) to large (7,000-pound Altair) UA operating from vessels and from land (see Figure I-1 and Table I-1). These experiments have been helpful in defining concepts of operation for employing future UA and their sensors in roles varying from port security to open ocean fisheries protection and in environments from the Gulf coast to Alaska.

### **CUSTOMS AND BORDER PROTECTION**

The CBP has been gaining experience with UA since the 1990s through cooperative use of Navy and Marine Corps Pioneers, and Army Hunters, during their units' deployments in support of JTF-6. These 2-week-long deployments have occurred one or more times annually to provide added night surveillance capability along the U.S. southern and northern borders. CBP officers have been integrated into these operations, with a CBP officer sitting in the UA GCS during missions and directing agents to activities found by the UA's sensors. In April 1999, the then-USBP sponsored an evaluation of four types of UA (fixed-wing, helicopter, hand-launched, and powered parafoil) near Laredo, Texas. The results of the 36 sorties flown convinced the USBP that small UA did not fully meet their needs, although cooperation with the Pioneer deployments continued. CBP use of a medium altitude endurance UA (Hermes 450) during the 2004 Arizona Border Control Initiative (ABCI) proved more successful and led to follow-on use of a similar UA (Hunter) to patrol the southern border at night.

### **IMMIGRATION AND CUSTOMS ENFORCEMENT**

The Air and Marine Operations (AMO) branch of ICE sponsored Operation Safeguard in 2003 in response to the Secretary of Homeland Security's May 2003 direction to evaluate UA for DHS applications. During the 14 days of Safeguard, an Air Force MQ-9 Predator B flew 15 missions from Gila Bend, AZ, contributing to the capture of 22 illegal aliens, 3 vehicles, and 2300 pounds of marijuana. This provided DHS with its initial experience with a medium altitude (17,000 feet) endurance UA, and Predator B proved to be a complementary adjunct to AMO's helicopters in detecting and apprehending criminals along the southern border.





**APPENDIX J: UNMANNED GROUND VEHICLES**

**JOINT ROBOTICS PROGRAM (JRP)**

**Origins and UGV Focus**

In 1990, at the direction of the Senate Appropriations Committee, the Office of the Secretary of Defense (OSD) consolidated all of the Services' Unmanned Ground Vehicle (UGV) projects into the Joint Robotics Program (JRP). The consolidation allowed OSD to focus the efforts in a single point of responsibility for the management of funding, to coordinate technology thrusts for research and development, to identify and resolve common issues, and to leverage the synergy of the projects. OSD was expected to provide policy and program direction. The FY1990 language stated that OSD should oversee a consolidated program, concentrate on establishing definitive, robotics operational requirements and pursue critical technologies to satisfy these requirements.

In FY2003, Congress reaffirmed the program direction and continuing OSD oversight by providing an additional \$24 M in funding and emphasizing the need to "expeditiously test, produce, and field technologically mature robots and other unmanned vehicles for use in combat." In FY2004, Congress added \$12.6 M in additional funding to sustain and accelerate program objectives (see Figure J-1). FY2005 Congressional adds showed continued interest in unmanned systems by increasing the President's Budget by \$30 M to \$55 M. Additionally, Congress, through the FY2005 Authorization, required that OSD report on the need for one or more national centers of excellence for unmanned aircraft and ground vehicles, further reinforcing their interest in the long term infrastructure investment strategy of OSD.

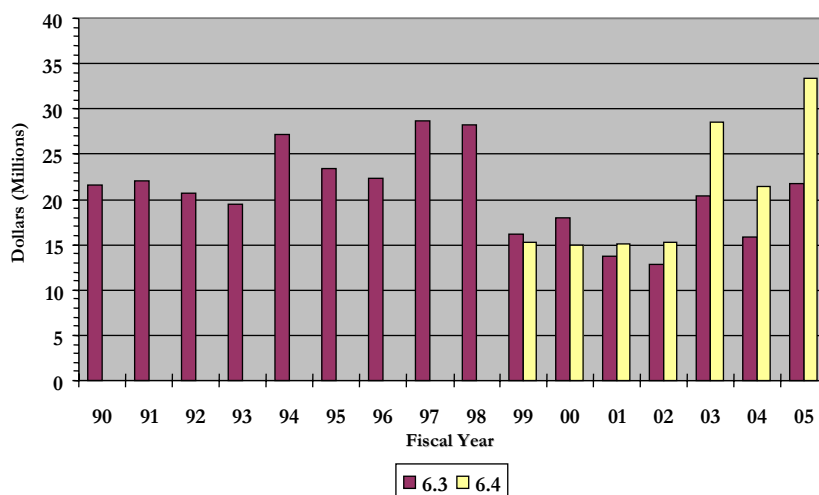

**FIGURE J-1. JRP FUNDING HISTORY.**

**Program Structure**

The current management structure of the JRP is shown below in Figure J-2. The JRP stresses cooperation among program managers (who represent all four Services), the elimination of duplicative efforts, and ensures information sharing among the geographically dispersed offices. For more information about the Joint Robotics Program, see the website at: <http://www.jointrobotics.com>.

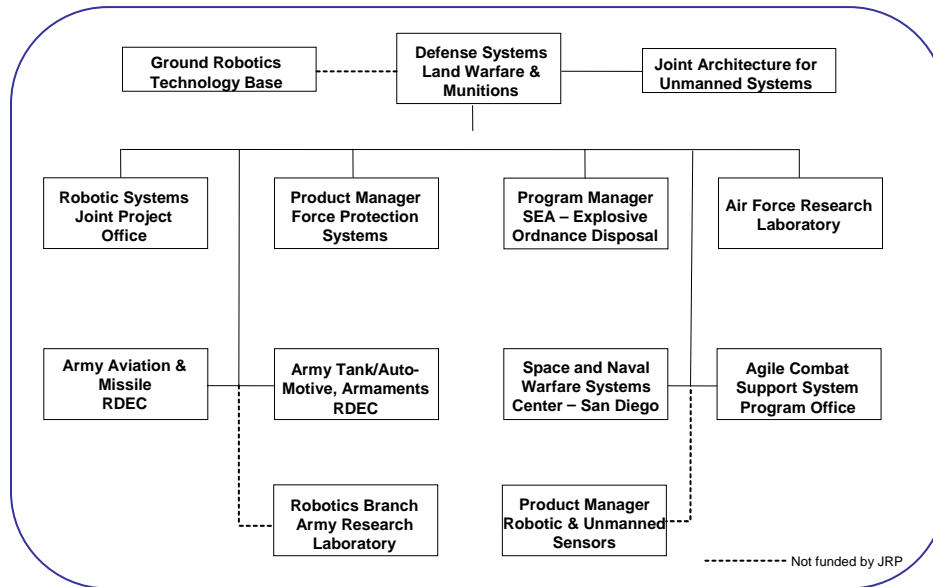

**FIGURE J-2. JRP MANAGEMENT STRUCTURE.**

**UGVs in Joint Warfighting and Transformation**

The Services have recognized a critical warfighting role for both current and future unmanned ground systems. More robotic systems are being deployed today than ever before and the trend continues to rise. Service transformation plans, as well as current operations in the Global War on Terror (GWOT) feature unmanned systems prominently. The Services continue to develop overarching warfighting concepts that depend on unmanned systems (air, ground, marine) working collaboratively to achieve success on tomorrow’s battlefields. These systems, as articulated in the programs below, are envisioned to contribute to increased mission effectiveness and are planned for integration into Service force structures:

- Joint Service – Man-Transportable Robotic System (MTRS)
- Army – Future Force: Future Combat Systems (FCS)
- Marines/Navy – Autonomous Operations: Gladiator Tactical Unmanned Ground Vehicle (TUGV)
- Air Force – Air Expeditionary Warfare: Robotics for Agile Combat Support and the Airborne Explosive Ordnance Disposal Concept

The GWOT has created urgent and compelling worldwide requirements for UGVs. The JRP is responding to the UGV requirements by deploying unmanned countermine, Explosive Ordnance Disposal (EOD), and reconnaissance systems to support our troops in the Balkans and in Operations ENDURING FREEDOM and IRAQI FREEDOM. Prototype and fielded UGVs participated in and are essential tools in completing dangerous missions in support of our forces in Afghanistan and in Iraq. As our forces in Iraq have transitioned to counter-insurgency operations, requirements for UGVs to assist in neutralizing Improvised Explosive Devices (IEDs) have increased dramatically. The JRP is meeting the needs around the globe with a combination of All-purpose Remote Transport Systems (ARTS), Remote Ordnance Neutralization Systems (RONS), Mini-Flails, Panthers, prototypes, and commercial off-the-shelf (COTS) systems, including over 200 new systems to Central Command in FY2004 alone. These systems are providing the Services with unmanned force protection, EOD, and countermine capabilities.

**Joint Robotics Programs of Record**

**Remote Ordnance Neutralization System (RONS)  
Continuous Improvement Program (CIP)**

**User Service:** Air Force/Army/Navy/Marine Corps

**Manufacturer:** Northrop Grumman (REMOTEC)

**Inventory:** 271 delivered/ available through GSA

**Background:** RONS is a fielded Joint Service EOD robotic system used by EOD technicians in each of the military Services. It complements and augments the EOD technician when performing reconnaissance, access, render safe, pick-up and carry away, and disposal during extremely hazardous missions involving unexploded ordnance (UXO) and IEDs. Current systems inventories of latest Mk 3, Mod 0 RONS include: Air Force -137, Army-72, Navy-33, and Marine Corps-29. The RONS has been made interoperable with many EOD tools and chemical and nuclear detectors over the past several years through a Continuous Improvement Program (CIP). The CIP effort works with EOD users to improve and expand the mission capability of the system through incremental improvements. FY2005 will see the integration of the Joint Chemical Agent Detector (JCAD) with the RONS and the integration of a night vision capability.



**Characteristics:**

RONS	
Size	36" x 29" x 61"
Weight	600 lb
Max Payload	60 lb on arm

**Performance:**

Endurance	2 hours against realistic mission profile
Control - Radio	1,000 meters
Control – Fiber Optic	760 meters
Interoperability	Standalone system, RS-232 payloads

**All-Purpose Remote Transport System (ARTS)**

**User Service:** Air Force

**Manufacturer:** Applied Research Associates, Inc.

**Inventory:** 73 delivered by FY2006

**Background:** ARTS is a fielded Air Force EOD robotic system employed by EOD technicians for active range clearance and disruption of large vehicle IEDs. ARTS is a self-propelled, remotely operated platform used to transport specialized (EOD) tools and equipment. Missions include airfield clearance, sub-surface UXO and mine excavation, remote movement of obstructions, WMD extraction and isolation, Standoff Munitions Disruption (SMUD) operations, and reconnaissance. The ARTS was instrumental in clearing Iraqi airfields at Baghdad and Talil for safe usage by multi-Service and multi-national forces. Addition of the Airborne REDHORSE mission enhanced the mission capability through certification for airdrop and helicopter sling load. Production is scheduled to be completed in FY2006. Planned low cost improvements to enhance the ARTS' existing capabilities include System Design and Development (SDD) of a trailer in FY2005, Joint Architecture Unmanned Systems (JAUS) experimentation (see page J-8), and a Radio Replacement Study. ARTS improvement programs will sustain full mission capability through the system's life cycle.



**Characteristics:**

ARTS	
Size	113" x 64" x 78"
Weight	8,100 lb
Max Payload	3500 lb

**Performance:**

Endurance	6-8 hrs
Control – Radio	(Primary) – 1½ mile range
Control – Fiber Optic	(Alternate) – 1½ mile range
Interoperability	JAUS compatible beginning FY2003

**Mobile Detection Assessment Response System-Expeditionary (MDARS-E)**

**User Service:** Army/Navy/Air Force

**Manufacturer:** TBD

**Inventory:** TBD

**Background:** MDARS-E will provide Army, Navy, and Air Force users with a deployable semi-autonomous robotic platform for intruder detection and assessment, persistent surveillance, route reconnaissance, and sea and airport security capabilities. The system will be JAUS compliant for command and control purposes and is the UGV platform for the Family of Integrated Rapid Response Equipment (FIRRE) program.



Provides a scalable, modular UGV for a variety of missions under the FIRRE program. Program plans include Limited DT/OT and Safety Release in March 2005, SDD Contract award in June FY2006, and a Milestone B (SDD) decision scheduled for August FY2006. A Milestone C (production decision) is scheduled for August FY2008.

**Characteristics:**

MDARS-E	
Size	98"x62.5"x46"
Weight	2640 lb
Max Payload	300 lb

**Performance:**

Endurance	12 hrs
Control – Ethernet Semi-Autonomous	Up to 6.2 miles with relays
Control – Teleoperation	Up to 6.2 miles with relays
Interoperability	Planned JAUS compatibility

**Gladiator Tactical Unmanned Ground Vehicle (TUGV)**

**User Service:** Marine Corps

**Manufacturer:** TBD

**Inventory:** TBD

**Background:** Gladiator is an armored, unmanned, teleoperated/semi-autonomous ground vehicle for remoting combat tasks to reduce risk and neutralize threats. Gladiator is a multi-function robotic system that provides unmanned scouting capability, remotely employing lethal direct fire weapons, the



## UAS ROADMAP 2005

Anti-Personnel/Obstacle Breaching System (APOBS), Light Vehicle Obscurant Smoke System (LVOSS), and non-lethal area denial and crowd control weapons. Program plans include a Milestone B decision in 1Q FY2005, a Milestone C in 2Q FY2007, and First Unit Equipped (FUE) in 3Q FY2009. Procurements to be funded by USMC beginning FY2007. Gladiator will be JAUS compliant.

### **Explosive Ordnance Device (EOD) Man-MTRS**



**MTRS PackBot EOD**



**MTRS TALON**

**User Service:** Army/Navy/Air Force/Marine Corps

**Manufacturer:** TBD

**Inventory:** Planned: Army-461, Navy-220, Air Force-140, Marine Corps-73

**Background:** MTRS consists primarily of an Operator Control Unit (OCU) and a teleoperated vehicle. The system components will be small and light enough to be carried as a single load by a two-person team for 500 meters over semi-rugged terrain. The primary mission is reconnaissance, and the system will be enhanced to perform other EOD tasks. Plans include development of two configurations of modified commercial systems to perform recon for EOD missions, with an upgrade path for adding capability to perform disruption, disposal, and render-safe procedures, and nuclear, chemical and biological agent detection. The MTRS system is required to be JAUS compliant. CENTCOM has a validated Operational Needs Statement (ONS) for 162 systems that will be at least partially filled by approved MTRS configurations. The first production configuration was received in January 2005. Program plans include: a Final Production Decision for both configurations by May 2005, and production deliveries of the second MTRS configuration by July 2005.

#### **Characteristics:**

	MTRS PackBot EOD	MTRS TALON
Size	31"x20"x15" (vehicle)	33"x23"x25" (vehicle)
Weight	135 lb (includes vehicle, OCU, and batteries)	165 lb (includes vehicle, OCU, and batteries)
Max Payload	10 lb	10 lb

#### **Performance:**

Endurance	2 hours against realistic mission profile	4 hours against realistic mission profile (lithium batteries)
Control – Radio	800 meters	800 meters
Control – Fiber Optic	200 meters	200 meters
Interoperability	JAUS, RS-232 payloads, USB payloads	JAUS, RS-232 payloads, USB payloads

### **Future Focus for the Joint Robotics Program and UGVs**

In order to maintain its posture to respond to future robotic requirements, the JRP has initiated efforts such as the JAUS, National Unmanned Systems Experimentation Environment (NUSE<sup>2</sup>), and the development and maintenance of a unmanned systems Critical Technology Matrix. Each of these efforts recognizes that the robotics development infrastructure must support the entirety of the unmanned



systems domain to provide the advanced interoperable systems that future warfighting concepts demand. The JAUS is currently in transition to the Society of Automotive Engineers (SAE) under their Aerospace Council. This transition will provide the critical linkage between government and industry to insure that future military unmanned systems are able to capitalize on the innovation of industry while maintaining military interoperability requirements. NUSE<sup>2</sup> was initiated in FY2004 to focus resources in academia, industry, and the government to develop a national robotic experimentation infrastructure focused on creating standards for robotics experimentation, involving users in early hardware development, and creating modeling and simulations necessary to validate design concepts and accelerate programs. The Critical Technology Matrix was developed and is maintained to provide a consistent and current message to robotics technology developers. Its purpose is to facilitate the dialog between the JRP and the technology base. It will ensure that the JRP is positioned to assess and transition mature technologies and is able to influence the investment focus of the technology base. Each of these efforts is undertaken with the objective to support the Service transformation plans and provide the warfighting capabilities of tomorrow.

For a number of years, the goal of the JRP has been to develop a diverse family of UGVs and to foster Service initiatives in ground vehicle robotics to meet evolving requirements for greater mission diversity and increasingly more autonomous control architectures, which can and will include UA in networked architectures (see Figures J-3 and J-4). This goal is being realized not only through the operational employment of UGVs, but also through a consensus that the structure and operations of future forces will require a diverse set of UGVs working collaboratively with UA and other unmanned systems. This consensus has received concrete expression in the generation of UGV requirements, the increased Service investment in UGV development and procurement, and the increased investment in ground vehicle robotic technology being made by DoD labs and research institutions.

Work to date suggests that the future UGV family will vary in size, operational uses, and modes of control:

- Size will vary from very large (the Abrams Panther mine proofing system and the Automated Ordnance Excavator), through large (ARTS and various bulldozers), through medium (Mobile Detection Assessment Response System-Expeditionary (MDARS-E), Mini-Flail, Gladiator), to small man-portable robotic systems (EOD Device MTRS, Omni-Directional Inspection System (ODIS), and others).

A variety of potential UGV applications to land combat operations can increase mission performance, combat effectiveness, and personnel safety. These include:

- Detection, neutralization, and breaching of minefields and other obstacles
- Reconnaissance, Surveillance, and Target Acquisition (RSTA) UXO
- UXO clearance
- EOD
- Force protection
- Physical security
- Logistics
- Firefighting
- Urban warfare
- Weapons employment
- Contaminated area operations/denied areas
- Peacetime applications include the use of small, man-portable systems for earthquake search and rescue and law enforcement operations

**UAS ROADMAP 2005**

The UGV family will also use a variety of control modes ranging from teleoperation through various degrees of UGV responsibility for its own control, as well as interoperating with UA with similar mission profiles. There will also be specialized modes of control such as leader-follower and road following. Other specialized navigation systems will be used such as differential global positioning system.

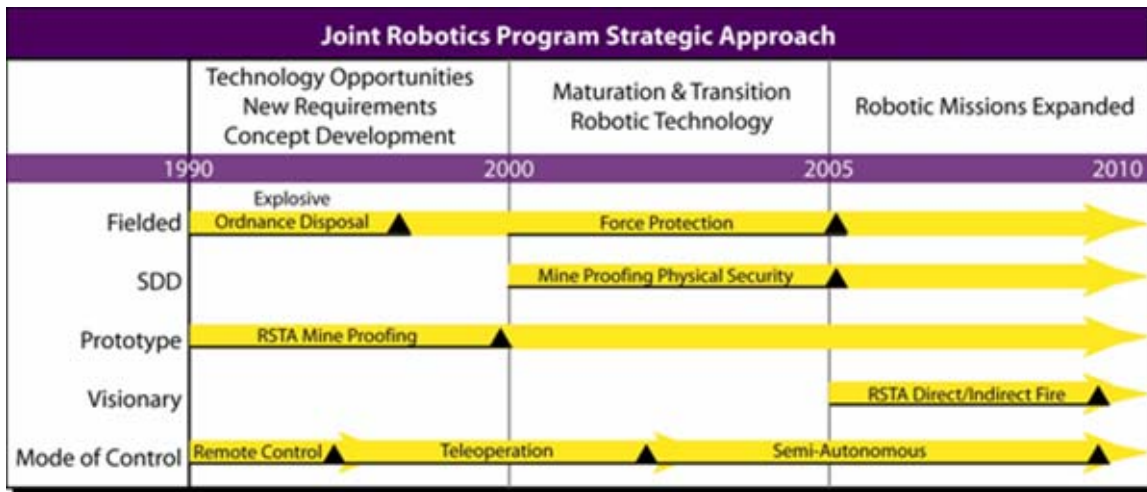

FIGURE J-3: JRP STRATEGY AND EVOLVING ROBOTICS REQUIREMENTS.

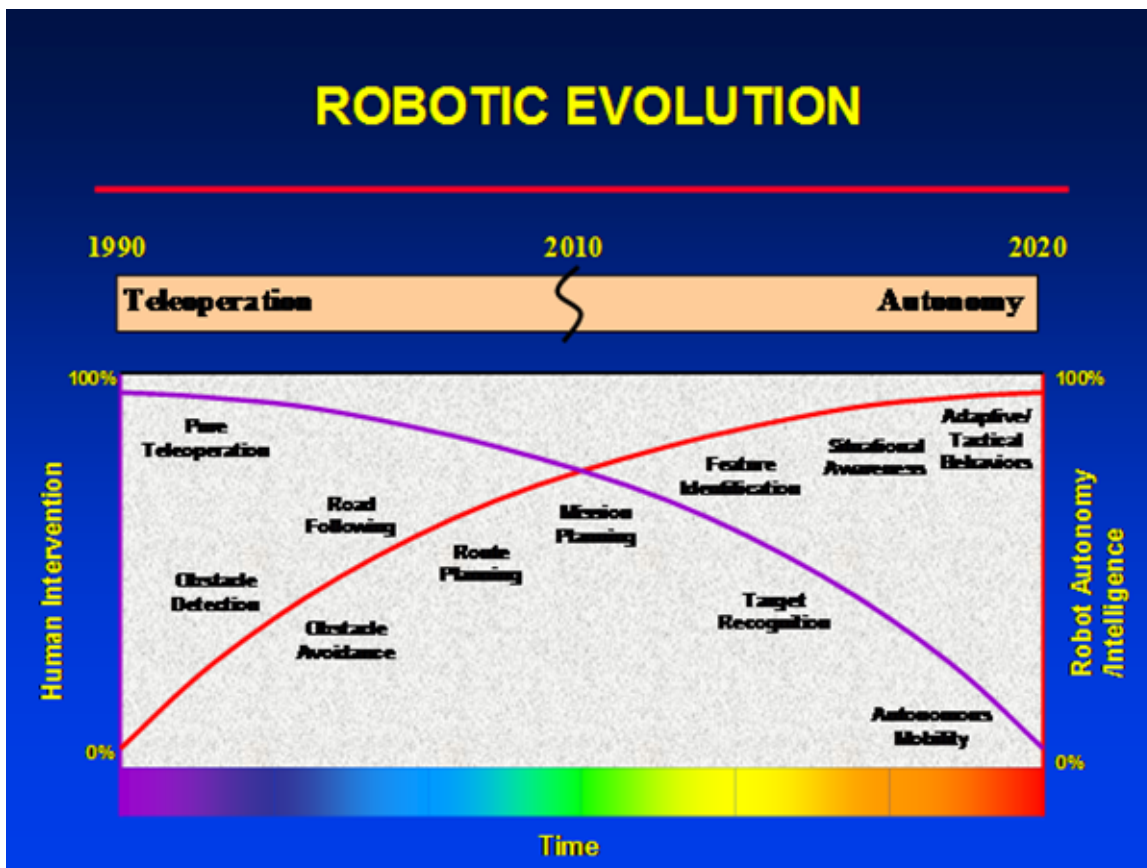

FIGURE J-4: ROBOTIC EVOLUTION.

### **UA Related Programs within the JRP**

The JRP community has recognized that our future forces will require unmanned systems of all types (ground, sea, and air) with complementary capabilities, that are interoperable, can communicate with each other, and can cooperate effectively to accomplish the myriad of missions assigned to them. JRP developers have made inroads into addressing these future needs by exploring technologies necessary to allow seamless command and control architectures capable of controlling multiple unmanned systems in all operating environments as well as specific applications of UA and Unmanned Marine Vehicles (UMV) working collaboratively and cooperatively with UGV. The JRP has focused upon implementing a joint architecture (JAUS) that can potentially enable interoperability between all types of unmanned systems. Research programs such as Collaborative Engagement Experiment (CEE), UA-UGV Cooperative Development, and the Joint Unmanned Systems Common Control Advanced Concept Technology Demonstration (ACTD), described below are pushing the technology limits of today's systems and are key examples of the emerging convergence and potential of UA and UGV common solutions.

#### ***Joint Architecture for Unmanned Systems***

**Background:** JAUS was initially conceived as JAUGS (Joint Architecture for Unmanned Ground Systems) in the mid-1990s to specify common data and message format interfaces. This allowed for interoperability among different robotic systems, controllers, and payloads.

The focus of JAUGS was basic interoperability of mobile ground robots, specifically those with military application. An OSD chartered working group was formed to include military, industry and academic robotic organizations. As the architecture and the working group grew, so did the scope of JAUGS and ultimately the charter was changed to address all classes of unmanned systems — thus JAUS.

The OSD JRP and the Army's FCS have directed use of JAUS in their unmanned programs. Additionally, Naval Systems Warfare Center's Joint Unmanned Systems Common Control (JUSC<sup>2</sup>) ACTD is studying the use of JAUS with UMVs. JAUS is currently transitioning into an SAE Aerospace Council commercial standard. For further information: <http://www.jauswg.org/>.

#### ***Collaborative Engagement Experiment (CEE)***

**Background:** Recent combat performances of unmanned systems have energized our leaders, both military and civilian, like few previous technologies. This, combined with the trend of increasing autonomous single robots and the introduction of multiple robot control, gives rise to the need to investigate collaborative robot teaming. Collaboration is defined as the ability for two or more robots to plan, coordinate, and execute a task or mission. Collaborative robot teams have the potential to provide a substantial combat multiplier for future warfighters while providing force conservation and increased survivability.

Teaming of unmanned systems of systems requires appropriate operational procedures, technical interfaces and protocols, and distributed planning technologies. Few of these have been developed for the conduct of collaborative engagement. The challenge is to establish the operational and technical knowledge of collaborative robot teams in order to support future capabilities.

CEE is a multi-phased joint program to develop and transition collaborative engagement capability products to the user. The program will conduct appropriate experiments to support the development of CONOPS; Tactics, Techniques, and Procedures (TTPs); architecture development; and technical assessments. These will identify and ultimately resolve technical risks, provide direction for assessing on-going science and technology initiatives, and update architectures necessary to accomplish collaborative engagement operations. Results will be incorporated for user support in the development of Collaborative Engagement CONOPS and TTPs.

#### ***Cooperative Unmanned Ground Attack Robot (COUGAR)***

**Background:** COUGAR is a multi-phase 6.2 program at U.S. Army Aviation and Missile, Research, Development, and Engineering Center (AMRDEC) to investigate technologies to support robot lethality.

## UAS ROADMAP 2005

---

In Phase I, an experimental unmanned vehicle-based robot with a RSTA package and a Javelin missile were demonstrated. The culminating demonstration was completed in FY2002 with the successful launch of 19 Light Anti-armor Weapon (LAW) rockets and one Javelin missile. Phase II of the demonstration occurred in FY2003, successfully firing three Javelin missiles, three Hellfire missiles, and over 500 7.62 mm rounds from the M240 machine gun. Phase III involved firing a Mk-19 Grenade Launcher from a HMMWV-based robot while it was teleoperated (shoot on the move). Coordinates of the target, provided by a small unmanned aircraft were fed into the system, which then calculated the firing solution and engaged the target. The Phase III experiment occurred in September 2004.

### **UA-UGV Cooperative Development**

**Background:** The UA-UGV cooperative development program is a USAF robotics R&D effort to develop and extend technologies to enhance UA/UGV capabilities through cooperative behaviors. This initiative captures the lessons learned in the 2003 STORK demonstration and seeks to advance the combined potential of UA and UGVs interoperating together in a common network to increase mission effectiveness. Planned development includes: (1) a JAUS/NATO STANAGS-compliant UA, (2) enhanced teleoperation and autonomy of low-cost rotary-wing UA, (3) an aerial communications relay to extend the radio range of UGVs, (4) insertion of aerial imagery into UGVs for map/model building and situational awareness, (5) precision UGV marsupial emplacement/recovery using a rotary-wing UA, (6) terrain modeling for UGV path planning – adapting existing technology to JAUS-compatibility, and (7) visual recognition for obstacle avoidance/intruder detection. A range of JAUS compliant UA/UGV platforms are envisioned. A summary of two potential platforms follows:

#### **Characteristics of Possible Platforms:**

	R-Max UA		ARTS UGV
Size	12' x 2' x 3.5'	Size	9.5' x 5.5' x 6.5'
Main Rotor Diameter	10 ft	Weight	8100 lb
Tail Rotor Diameter	21 in	Ground Clearance	14 in

#### **Performance of Possible Platforms:**

Maximum Payload	68 lb	Maximum Payload	3500 lb
Flight Duration	60 mins	Endurance	6-8 hrs
Line of Sight Distance	492 ft	Maximum Speed	8 mph
		Track Ground Pressure	~2 PSI
		Line of Sight Distance	1.5 miles

### **UGV-UA Cooperative Development at SPAWAR Systems Center San Diego**

The UGV-UA cooperative development efforts at SPAWAR Systems Center San Diego (SSC-SD) are designed to take advantage of the 20 years of experience in ground and air unmanned systems, and the current SSC SD products including Multi-robot Operator Control Unit (MOCU) and MDARS-E. Development is taking place in several areas.

The first area is the development of an Autonomous UAV Mission System (AUMS) for Vertical Takeoff and Landing UA. The goal of the system is to allow a UA to be launched, recovered, and refueled by a host or stand-alone platform in order to provide force extension through autonomous aerial response. The recovery capability will be an integration of vision technologies from Carnegie Mellon University and the Jet Propulsion Laboratory as well as GPS technology from Geodetics, Inc. The system will operate with different manned and unmanned vehicles and will use the JAUS protocol and the SSC-SD MOCU command and control interface. AUMS may be modified for use by multiple ground and air platforms.

Some of the near-term UA missions include reconnaissance, RF communications relays, overhead visual GPS augmentation, surveillance, psychological operations, and mine detection. Future uses include target designation and payload dispersal (i.e., submunitions, ThrowBots, sensors). Other benefits are seen in the

## UAS ROADMAP 2005

mission flexibility that allows the UA to be launched from one type of system and captured by another (i.e., launched from an UGV and recovered by a HMMVW). The decrease in time and personnel required to refuel a UA between mission operations leads to an increase in the number of missions a UA can complete in a given period of time.

The second area of development, JAUS-compliant UA, compliments the AUMS project and is producing its own results. SSC-SD is establishing partnerships with Allied Aerospace, Northrop Grumman, Tyndall Air Force Research Laboratory (AFRL), Idaho National Engineering and Environmental Laboratory (INEEL) and Rotomotion, LLC, to develop JAUS VTOL UA platforms. These platforms will not only be used in the AUMS development, but will also be used for experiments, demonstrations and testing involving UGV-UA cooperation concepts. The table below lists some of their characteristics.

The third area of development is UGV-UA collaboration behaviors. Several application areas that will be explored include: (1) countermine operations, (2) IED detection, (3) precision targeting using aerial sensors, (4) CBRN contamination, (5) meteorological sensors, (6) communication relays and (7) ThrowBot delivery to areas outside range of manual deployment. SSC-SD will partner with other government agencies and industry to conduct experiments and demonstrations.



**Yamaha RMAX Type II**



**Allied Aerospace  
iSTAR**



**Rotomotion Twin**

### Characteristics of Possible Aircraft:

	Allied Aerospace iSTAR Ducted Fan	Yamaha RMAX Helicopter	Rotomotion Twin Helicopter
Size	44" H x 29" W	12' x 2' x 3.5'	64" x 20" x 25"
Main Rotor Diameter		10 ft	72 in
Tail Rotor Diameter		21 in	14 in

### Performance of Possible Aircraft:

Maximum Payload	10 lb	68 lb	20 lb
Flight Duration	30 – 45 mins	60 mins	40 – 90 mins
Line of Sight Distance		2600 ft	900 ft

### **Joint Unmanned Systems Common Control (JUSC<sup>2</sup>) ACTD**

Naval Surface Warfare Center (NSWC) Panama City has a long history of unmanned systems' RDT&E, as well as support of unmanned systems acquisition programs, dating back to the 1960s with the rapid response development and fielding of a number of unmanned marine vehicles for riverine operations during the Vietnam conflict.

A large number of unmanned systems' RDT&E and support of acquisition programs for Unmanned Surface Vehicles (USV), Unmanned Underwater Vehicles (UUV), UGVs, and UA are ongoing at NSWC-Panama City today. One ongoing task in particular that impacts UA is the JUSC<sup>2</sup> ACTD, which started in FY04. JUSC<sup>2</sup> is developing an open architecture that allows for the concurrent management of large numbers of unmanned systems of all types in a scaleable and expandable manner that will provide an affordable capability to insert new autonomous control technologies and unmanned vehicle advances as they emerge. The Operational Manager of JUSC<sup>2</sup> is U.S. Joint Forces Command, the Technical Manager

## UAS ROADMAP 2005

---

is NSWC Panama City, and the transition Manager is NAVSEA PMS 420, the Littoral Combat Ship (LCS) Mission Modules Program Office.

JUSC<sup>2</sup> will provide the LCS a capability to concurrently operate a large number of unmanned systems specifically of interest to the Navy, including USVs; UUVs ; and UA. Additionally, JUSC<sup>2</sup> will provide the interfaces and means for LCS to also operate the Army's Shadow 200 UA at LVL 4/5 and the USAF Predator B UA (actually a surrogate - most likely General Atomics I-GNAT) at LVL 3 via a STANAG 4586 compliant Common Unmanned systems Control Station (CUCS).

Finally, JUSC<sup>2</sup> will also provide a means for LCS to operate Army and USAF (as well as Navy) UGVs via a JAUS-compliant common control system developed by USAF (AFRL - Tyndall). By applying both JAUS and STANAG 4586 to a large number of unmanned vehicles, JUSC<sup>2</sup> will demonstrate that the Navy can use Army and USAF UA and UGVs, and that other services in littoral or riverine situations can take control of and use Navy unmanned vehicles, such as USVs and potentially UUVs and UGVs.

The JUSC<sup>2</sup> ACTD has a prototype system called Unmanned Vehicles Common Control (UVCC) installed onboard HSV-2 SWIFT. UVCC v8.1a, which was tested on HSV-2 in FY04, was delivered to the LCS Flight 0 prime contractors on 18 August 2004. This initial spiral provides interfaces to USVs and UUVs. A second spiral, UVCC v8.2, was installed onboard HSV-2 in September 2004. This second spiral adds an interface for Fire Scout VTUAV via the Tactical Control System (TCS). JUSC<sup>2</sup> will be completed with a full at-sea demonstration during JFTX-07 in early FY2007. Transition will then continue under the LCS acquisition program.





## APPENDIX K: SURVIVABILITY

### OVERVIEW

As UA use proliferates into an ever-increasing sphere of combat applications and becomes progressively more important to the war fighter, mission effectiveness and by extension combat survivability becomes increasingly critical. It is thus imperative that the survivability of a UA is a key consideration during the system design process. Unmanned aircraft are but one component within an unmanned aircraft system (UAS). To address the survivability of only the UA only partially addresses the survivability of the total system, although, at the present time, the emphasis on UAS survivability is focused on reducing the susceptibility of the aircraft. Future efforts should concentrate on reducing the total system susceptibility and vulnerability.

### Terms specific to UA Survivability

- Survivability. The capability of an aircraft to avoid or withstand a man-made hostile environment
- Susceptibility. The inability of an aircraft to avoid the threats in a man-made hostile environment
- Vulnerability. The inability of an aircraft to withstand a man-made hostile environment.
- Expendable. The UA is minimally survivable. Loss of the UA has minimal cost and operational impact; the UA can be quickly replaced or is not critical to operational success.
- Attritable. The UA is somewhat survivable. Loss of the UA will have moderate cost and/or operational impact, but the operational benefits outweigh the potential risks.
- Survivable. The UA is highly survivable. Loss of the UA will have a significant cost and/or operational impact.

### UA SURVIVABILITY IN COMBAT

UA have been used in combat since 1944 when the TDR-1 assault drone, guided by a pilot in the loop using television, was used to drop bombs on Japanese positions in the Pacific. Its operating unit lost three out of 50 aircraft during its two months of service due to hostile fire. Later, during the Vietnam War, the AQM-34 was used to collect reconnaissance data. Limited data from 1964-1989 show UA combat loss rates of 3.9/year during the Vietnam conflict (1964-69), 4.5/year in the Bekka Valley conflict (1981-82) and 1/year over the period of the Angolan Border War (1983-87).

A more complete data set, including non-combat losses, is available for the period of 1991-2003, which covers the major conflicts Desert Storm (1991), Allied Force (1999) and OEF and OIF (2001-2003). Over that 13-year period 185 UA losses were recorded, an average of 14.2 per year. Considering the specific periods of major conflict; 20 RQ-2 Pioneer UA were lost in Desert Storm over a period of less than a year, 18 were combat losses and two were non-combat losses. In Operation Allied Force in Kosovo, 45 UA of various types were lost. Of the 45 losses, 26 were combat and 19 were non-combat. Data available from OEF and OIF over the period of 2001-2003 show a substantial decrease in UA loss rates, with an average of 2.0 combat losses and 2.7 non-combat losses per year over the three-year period.

The threats encountered by UA since the 1960s have evolved over time. In the Vietnam War, the principal threat to the A/BQM-34 was Soviet MiG fighter aircraft. In the 1980s conflicts in Syria and Angola, the Soviet SA-3, -6, and -8 surface-to-air missiles were the principal threat. While in more recent conflicts combat UA losses have been attributed primarily to small arms, air defense artillery, and unspecified ground fire. Any number of tactical, strategic, technological, and political factors will continue to affect the threats UA face in the future.

In addition to lethal threats, there exist non-lethal threats based in electronic warfare or information warfare techniques. Both active and passive techniques can degrade or deny the ability of a UA to fulfill its intended mission. UA systems are susceptible to hostile actions against their electronic systems and subsystems, communications data links, GPS systems, and their command and control data links. These hostile actions can be active, as in the case of jamming, meaconing, or deception, or passive, as in the



case of interception and exploitation of the data collected by the UA. All classes of UA are susceptible to non-lethal threats.

While UA have been used in combat since the Vietnam War, combat and non-combat loss data is notably sparse. With the proliferation of militarized UA in the last decade it is likely that a significant portion of the information about UA combat experience is widely dispersed and undocumented. In addition, the limited data that is readily available does not provide insight on subsystem/damage mode contribution to combat loss or characterize the damage inflicted on UA that have returned from combat missions. Data of this type regarding combat damage to manned aircraft since Vietnam have proven invaluable in understanding the vulnerability of the aircraft and mitigating the threat. The systematic collection of equivalent data for unmanned aircraft would be of equal benefit.

### **SURVIVABILITY AS A SYSTEMS DESIGN DISCIPLINE**

DoD systems are intended to accomplish their mission in “a man-made hostile threat environment.” In order to be mission effective, survivability must be considered; survivability becomes one of the design factors in achieving the most mission effective system at the lowest cost.

Is it less costly to procure many inexpensive expendable UA, a few more expensive attritable UA, or even fewer more expensive but more survivable UA? For manned systems, loss of human life is a consideration that pushes the systems to a higher level of survivability. For unmanned systems this is not the case. However, DoD UA still need to be effective and able to accomplish their missions in hostile environments. To achieve that, survivability must be part of the design process. The extent that survivability will be included in a design is dependant on many factors including the mission(s) to be accomplished, the criticality of those mission(s), the threat environment that will be encountered, and the number of assets available taking into account the UA aircraft as well as the payload. To perform a non-critical mission in a low threat environment other aspects of the design (e.g., cost, range, or payload) will take precedence over survivability features. This may also be true if a large number of expendable assets are available to perform the mission. If one or more of the assets are destroyed, the mission can still be accomplished at lower life-cycle cost. A more critical mission in a higher threat environment increases the importance of survivability design features. If few assets are available, completing the mission the first time and with a single vehicle may be imperative. It is important to weigh all the factors in determining how “survivable” a UAS must be to fulfill its specified functional capability.

By considering survivability early in the design process one can make design trade-offs and minimize the potential cost and performance impacts. Modifications later in the design cycle will always come with increased cost and performance penalties. If survivability is considered early in the design process there are “no cost” design practices that will enhance a system’s survivability. An example is the placement of critical systems to shield them from ground fire. No matter what decisions are made, considering all facets of the design early will decrease the overall system life-cycle cost. For combat aircraft, survivability must be a part of the trade space.

### **UNMANNED AIRCRAFT SYSTEM SURVIVABILITY CONSIDERATIONS**

Regardless of size or cost, all UAS have the following functional components: (1) one or more aircraft, (2) a system for command and control of the aircraft and associated payloads, (3) payload(s) and (4) a means of disseminating the information obtained by the payload. Each of these functional components is addressed separately below.

#### **Aircraft**

UA range in size from under one foot flying at 100 feet at 20 knots to those with wingspans over 130 feet flying at 60,000 feet at 340 knots. A standard survivability approach will not work for all aircraft because of this wide range of sizes and performance. Passive susceptibility reduction measures, such as visual and acoustic signature reduction, may be the only way to increase the survivability of small aircraft due to their limited size. Larger aircraft can support the introduction of active susceptibility reduction measures

such as flares, chaff, other decoys, and/or traditional aircraft vulnerability reduction design concepts. The cost and intended purpose of the unmanned aircraft system will inform the decision to invest in the survivability of the aircraft.

### **Command and Control System**

All current UAS have a command and control system for preprogramming the flight and/or direct remote piloting. The sophistication of the command and control system varies, but generally consists of uplink and downlink communications, navigation equipment and Global Positioning System, applications software to control the aircraft and the payload. These links may be encrypted, but often are not. UAS have a ground station that may range from a laptop in the hands of a soldier or Marine in contact with hostile forces to a fixed plant installation within the continental United States. The physical threat to the ground station varies according to size and employed location. The uplink transmits command and control information from the ground station to the UA while the downlink provides health and status information from the UA to the operator. Information for the control of the payload can also be transmitted in the downlink. Generally, these communications channels emit continuously, thereby allowing radio direction finding techniques to be employed against the ground station and its UA. Depending upon the UAS, the command and control links may be interleaved with the payload (i.e., information dissemination) data link or there may be two separate links.

Data links are susceptible to jamming and intrusion by hostile forces. Jamming may degrade the ability of the system to transmit signals between the ground station and the UA, especially if the antenna on the UA is omni-directional, vice steerable. UA operating within radio line of sight from their control stations are more likely to use an omni-directional antenna approach, while UA operating through communication satellites are more likely to employ a steerable dish antenna with a relatively narrow beam. Unintentional jamming from friendly or neutral communications emitters may also degrade the UA's capabilities. Hostile forces may intrude into either the C2 or the data link in order to take over the UA or degrade the UA control or payload data reception so that it cannot carry out its intended mission.

Navigation equipment, often augmented by GPS, and mission management software provide the UA the capability to fly a given route and collect the desired information. Because such navigation systems are dependent upon receiving GPS satellite signals, any denial of GPS service will impact the mission effectiveness of the UA, perhaps even causing its loss. Although events like the jamming or destruction of a GPS satellite are beyond the control of the UA operator, that jamming or destruction would essentially bring most UA operations to a rapid halt.

Finally, the mission management software can be affected through several means either before or after the aircraft is launched. Viruses, Trojan horses, and other hostile software agents can infect the UAS' software and keep the system from fulfilling its mission.

### **Payloads**

Payloads vary according to UA type and mission, with the overwhelming majority of UA payloads being imaging payloads; therefore this discussion will be limited to imaging payload survivability. Payloads can be either external, as in a ball or pod that hangs from the aircraft, or internal. In smaller, less expensive UAS, locating the payload internally does not dramatically decrease vulnerability. Payloads are generally not specifically targeted in the smaller aircraft because it is just as easy to destroy or degrade the UA itself.

Payloads are susceptible to physical threats; even though the payload is not likely to be targeted specifically it may suffer collateral damage from an attack on the UA. Passive payloads may be degraded by electronic attack, but a relatively long dwell time is required to cause permanent damage. However active sensors, such as radars, are more susceptible to electronic attack. Even a short-term attack can cause significant long-term damage.

### Dissemination Means

UAS normally disseminate information via data links. Depending upon the system, information may be processed onboard the aircraft or transmitted to the ground for processing. In either case, the communications channel is susceptible to detection, radio direction finding, intercept, and electronic attack efforts. If the UA is transmitting a live video feed, the communication channel is likely to be wideband and continually emitting. Encryption of the data links would reduce the possibility of successful intercept and exploitation. Depending upon the UA system, the dissemination data links and the command and control links may share the same frequencies and be interwoven through multiplexing schemes.

The data links and the transmit and receive equipment associated with the dissemination of information are susceptible and vulnerable to the same efforts that threaten the command and control links. The dissemination data links on larger aircraft should be encrypted, as they are more likely to be relaying data that are of interest to higher echelons. Conversely, handheld/small and tactical UA may not require encryption devices because it is harder to intercept their dissemination signals (closer to the ground station and flying at lower altitudes) and because the information they collect and disseminate is highly perishable.

### SURVIVABILITY CLASSIFICATIONS

When considering airframe survivability, it is useful to divide UA into three categories (small, medium, and large) based on size, speed, and operational altitude. These categories are useful for considering the likely threat environment and application of susceptibility and vulnerability reduction techniques, but should not be applied rigidly. While categories are useful for providing guidelines, each UA is unique and survivability should be considered in the context of its specific design and mission. These survivability categories are not intended to establish recognized UA classifications.

- Small. UA with a gross weight less than 500 pounds, a wingspan of 20 feet or less and that operate at altitudes below 10,000 feet and 100 knots. These UA generally support tactical requirements and range from man-portable up to trucked systems. Examples include the Raven, Dragon Eye, Pioneer and Shadow.
- Medium. UA with a gross weight between 500 and 5,000 pounds., a 20-60 feet wingspan and generally operate at altitudes of 10,000-30,000 feet and below 250 knots. These UA primarily support tactical engagements, but may also address operational (theater) or strategic requirements. The systems are airlifted or transported in specialized containers. Examples include the Predator and Fire Scout UA.
- Large. UA with a gross weight above 5,000 pounds, wingspan longer than 60 feet and that operate above 25,000 feet and 250 knots. These UA are generally considered operational (theater) or strategic assets. These systems can self deploy or, as with Global Hawk, can operate from CONUS. UA with a mission to deliver ordnance in high-density threat environments, such as the J-UCAS, will operate from remote bases to support tactical requirements.

### THREATS BY SURVIVABILITY CLASSIFICATION

To credibly assess the threat a UA will face one must consider the entire system, including the ground station and data link as well as the aircraft. One must also consider the entire spectrum of threat types, including directed energy weapons (DEW) and nuclear, biological and chemical (NBC). A basis for starting a general threat analysis is to consider the types of threats and the likelihood each could engage each UA category Tables K-1 and K-2). For a detailed threat analysis, a UA must be assessed individually based on its specific design, mission, and mode of operation.

**TABLE K-1. SURVIVABILITY CLASSIFICATION LETHAL THREAT MATRIX.**

Survivability Category	Ground Fire	Air Defense Artillery	Shoulder Launched Missiles	RF Missiles	Air-to-Air Missiles	Laser	NBC
Small	✓					✓	✓
Medium	✓	✓	✓	✓		✓	
Large – Low Altitude	✓	✓	✓	✓	✓	✓	
Large – High Altitude				✓	✓		

**TABLE K-2. SURVIVABILITY CLASSIFICATION NON-LETHAL THREAT MATRIX.**

Survivability Category	Jamming	Deception	Meaconing	Intrusion and Exploitation
Small	✓	✓		
Medium	✓	✓	✓	✓
Large – Low Altitude	✓	✓	✓	✓
Large – High Altitude	✓	✓	✓	✓

**SURVIVABILITY DESIGN FEATURES BY SURVIVABILITY CATEGORY**

Survivability design features should be considered with respect to an UA’s size, required mission and the potential threat environment. Table K-3 is a partial list of potential survivability features and the class of platform they may be most applicable to. The features cover both susceptibility reduction and vulnerability reduction. These potential survivability design features should be considered in the systems engineering design process to develop the most effective UA for the lowest life cycle cost.

**TABLE K-3. SURVIVABILITY DESIGN FEATURES BY SURVIVABILITY CLASSIFICATION.**

Survivability Design Feature	Survivability Category of UA
Mission Planning/Tactics	All
Acoustic Signature Reduction	Small
IR Signature Reduction	Small, Medium, Large
RF Emission Signature Reduction	Large
RF Signature Reduction	Medium, Large
Visual Signature Reduction	Small, Medium
Dry Bay Foam	Large
Fire Shielding	Large
Redundancy and Separation	Medium, Large
Distributed Fire Suppression	Large
Fire Walls	Large
Powder Panels (Fire Suppressant)	Large
Fuel System Management	Medium, Large
Hydrodynamic Ram Protection	Large
Fuel Tank Ullage Inerting	Large
Fuel Tank Ullage Protection	Large
Fuel Tank/Line Self-sealing	Large

**AIRCRAFT SURVIVABILITY RESOURCES**

Department of Defense	Department of Homeland Security
<b>Army</b>	<b>Transportation Security Administration (TSA)</b>
U.S. Army Aviation Applied Technology Directorate (AATD) Ft. Eustis, VA Phone: (757) 878-5609 / DSN 937 <a href="http://www.aatd.eustis.army.mil">http://www.aatd.eustis.army.mil</a>	<b>FAA</b>
U.S. Army Research Laboratory (ARL) Survivability/Lethality Analysis Directorate Aberdeen Proving Ground, MD 21005 Phone: (410) 278-5052 / DSN 298 <a href="http://www.arl.army.mil/slad">http://www.arl.army.mil/slad</a>	Fire Safety Branch AAR-440 William J. Hughes Technical Center - AAR 440 Atlantic City International Airport, NJ 08405 Phone: 609-485-5620 <a href="http://www.fire.tc.faa.gov">http://www.fire.tc.faa.gov</a>
<b>Air Force</b>	<b>Other Resources</b>
Aerospace Survivability & Safety Flight 46 OG/OGM/OL-AC 46th Test Wing Wright-Patterson Air Force Base, OH 45433 Phone: (937) 255-2237 x213 / DSN 785 <a href="http://assf.wpafb.af.mil">http://assf.wpafb.af.mil</a>	Survivability/Vulnerability Information Analysis Center 46 OG/OGM/OL-AC/SURVIAC 2700 D Street Bldg. 1661 Wright-Patterson AFB, OH 45433-7605 Phone: (937) 255-4840 / DSN 785 <a href="http://iac.dtic.mil/surviac">http://iac.dtic.mil/surviac</a>
<b>Navy</b>	
Naval Air Systems Command (NAVAIR) Survivability & Threat Lethality Division (4.9.6) Phone: (301) 342-0142 / DSN 342 Patuxent Naval Air Station	American Institute of Aeronautics and Astronautics (AIAA) Survivability Technical Committee <a href="http://www.aiaa.org/tc/sur">http://www.aiaa.org/tc/sur</a>
Naval Research Laboratory 4555 Overlook Ave., SW Washington DC, 20375	The Aircraft Survivability Education <a href="http://aircraft-survivability.com">http://aircraft-survivability.com</a>
<b>Joint</b>	
Joint Aircraft Survivability Program Office 200 12 <sup>th</sup> Street S. Arlington, VA 22202 Phone: (703) 607-3509 / DSN 327 <a href="http://jas.jcs.mil">http://jas.jcs.mil</a>	The Fundamentals of Aircraft Combat Survivability Analysis and Design, Second Edition, AIAA Education Series, Robert E. Ball, Ph.D., 2003. (Available through SURVIAC)

