



***Plumbing, Heating, Cooling, Refrigeration
and Electrical Distributors***

Product Catalog

***32 Locations Serving Western, Central
New York and Northern Pennsylvania***



An Employee-Owned Company



www.irrsupply.com



Better Service Thru Better People





**Plumbing, Heating, Cooling, Refrigeration
and Electrical Distributors**

Our Company

Since our inception over 145 years ago, Irr Supply Centers has prided itself on delivering the highest quality and best value to our customers. This philosophy has helped us grow into a regional industry leader. We have 32 locations distributing a wide range of plumbing, heating, cooling, electrical and refrigeration products across Upstate New York and Northern Pennsylvania.

We also operate 6 Visionary Baths & More Kitchen and Bath Selection Centers. Each location features a state-of-the-art showroom for upscale plumbing products. At Visionary Baths showrooms, highly trained design specialists assist customers in premium product selection.

At Irr Supply our motto is "**Service Starts Here**". All of our employees believe in our mission to be the most successful distributor in the markets we serve by adding superior value to the products we sell. They are committed to the principle that customer service is our most important product and the lifeblood of our business.

As our many satisfied customers have come to know, Irr Supply offers not only products and services you can depend on, but also convenient, cost-effective partnerships that will help your business grow.

Thank you for the opportunity to service your needs.

Sincerely,

A handwritten signature in black ink that reads "Michael P. Duffy". The signature is written in a cursive style with a large, looped "D" at the end.

Michael P. Duffy
President



Better Service Thru Better People



An Employee Owned Company





**Plumbing, Heating, Cooling, Refrigeration
and Electrical Distributors**

Why Irr Supply is the Smart Choice

Over 145 years of doing business with integrity.

32 convenient locations serving Western and Central New York and Northern Pennsylvania.

A full line distributor to meet all of your Plumbing, HVAC, Refrigeration and Electrical needs.

24 hour emergency service available to contractors.

Delivery to the job site available.

"Service Starts Here" is not just a motto - it's how we do business.

Expert technical support to help you troubleshoot service problems.

For your convenience, customer e-commerce solutions available.

Customer training on key aspects of your business.

Two regional distribution centers servicing our branches daily.

The buying power to be price competitive.

Advertising and promotional support to help your business grow.

Monthly and seasonal promotions featuring products you need everyday.

Special orders - If you need it we can get it promptly!

Six Visionary Baths & More Plumbing Showrooms - Professionally staffed to assist you and your customers with design and selection. www.visionarybaths.com

Annual Irr Supply Trip Incentive Program - An exciting new destination every year!



Better Service Thru Better People

 An Employee Owned Company 



*Plumbing, Heating, Cooling,
Refrigeration and Electrical
Distributors*



*Doing
Business
With
Integrity
Since 1864*





**Plumbing, Heating, Cooling, Refrigeration
and Electrical Distributors**

Our Service Guarantee

Because your time is money, we at Irr Supply will guarantee the timeliness of our service as follows:

- 1) We promise to have your "Order Express" order pulled, packed and ready for pick up at our "Order Express" counter within 1 hour or less.
- 2) We promise to arrive with your delivery as agreed (weather permitting) within 1 hour of our commitment.
- 3) We promise to promptly and courteously process your returns and claims in accordance with our claims policy. In most instances, we will issue your credit within 3 business days, upon return of the product and all information required by the manufacturer.

When we at Irr Supply say that your satisfaction with our products and services is guaranteed, we mean it. If we fail to keep these commitments, we will give you a \$25.00 credit, *no arguments!* We guarantee it!

A handwritten signature in black ink, appearing to read "Michael P. Duffy".

Michael Duffy
President



Better Service Thru Better People



An Employee Owned Company





Plumbing, Heating, Cooling, Refrigeration, and Electrical Distributors



An Employee Owned Company



www.irrsupply.com

Better Service Thru Better People

SERVING WNY & NORTHERN PA

R	BATAVIA	29 Evans St, 14020	585-343-5085
	BUFFALO	1572 Main St, 14209	716-882-2100
R	BUFFALO	400 Smith St, 14210	716-826-3400
	BUFFALO	1674 Kenmore Ave, 14216	716-876-7225
	BUFFALO	2477 Broadway, 14227	716-895-1200
	CLARENCE	5605 Harris Hill Rd, 14221	716-741-4124
	DEPEW	5635 Transit Rd, 14043	716-684-5800
	DERBY	1695 Overhead Rd, 14047	716-627-2364
	EAST AURORA	558 Buffalo Rd, 14052	716-652-2900
	ERIE, PA	1108 West 12th St, 16501	814-454-8100
R	ERIE, PA	1645 West 26th S, 16508	814-455-8026
	FREDONIA	186 East Main St, 14063	716-673-1300
	JAMESTOWN	2184 Foote Ave Ext, NYS Rt 60, 14701	716-484-9166
R	KENMORE	1667 Military Rd, 14217	716-871-8970
	LOCKPORT	6707 Lincoln Ave, 14094	716-433-1777
	NIAGARA FALLS	8890 Porter Rd, 14304	716-297-9400
	NORTH TONAWANDA	908 Niagara Falls Blvd, 14120	716-694-4800
R	OLEAN	631 North Union St Ext, 14760	716-372-2191
	ORCHARD PARK	3689 California Rd, 14127	716-662-4906
	ROCHESTER	1800 E Main St, 14609	585-288-6880
R	ROCHESTER	845 Maple St, 14611	585-235-2030
	SPRINGVILLE	10211 Edies Rd, 14141	716-592-5112

SERVING CENTRAL NY & NORTHERN PA

	AUBURN	1 Lexington Ave, 13021	315-252-7581
R	BINGHAMTON	59 Chenango Bridge Rd, 13901	607-772-0222
	ENDICOTT	24 Delaware Ave, 13760	607-754-4404
R	ELMIRA	1006 Sullivan, 14901	607-734-2246
R	GENEVA	1902 State Route 14, 14456	315-789-4944
	HORSEHEADS	811 South Main St, 14845	607-739-5658
R	ILION	143 Central Ave, 13357	315-894-5669
	LIVERPOOL	118 Salina St, 13088	315-451-3200
	ONEONTA	5 Commercial Dr, 13820	607-432-4433
R	SYRACUSE	112 Plum St, 13204	315-476-7429

R - Offers Full Line of Refrigeration Products

Premier Kitchen and Bath Selection Centers

visionary baths
and more

www.visionarybaths.com

1 Lexington Ave
Auburn, NY 13021
315-252-7581

59 Chenango Bridge Rd
Binghamton, NY 13901
607-772-6205

908 Niagara Falls Blvd
No. Tonawanda, NY 14120
716-692-3200

5 Commercial Drive
Oneonta, NY 13820
607-432-4433

3689 California Rd
Orchard Park, NY 14127
716-667-2700

5605 Harris Hill Rd
Williamsville, NY 14221
716-741-4131

Table of Contents



www.irrsupply.com

Table of Contents

Plumbing

1- 377

Residential Hot Water Heaters	1- 18
Commercial Hot Water Heaters	19 - 26
Hot Water Heater Parts	27 - 31
Freeze Protection	32 - 33
Water Systems	34 - 45
Water System Accessories	46 - 62
Plumbing Valves	63 - 80
Water Service Valves	81 - 82
Well Tanks	83 - 84
Pumps	85 - 105
Drainage	106 - 109
Kitchen & Bar Faucets	110 - 123
Laundry Faucets	124
Lavatory Faucets	125 - 137
Tub & Shower Faucets	138 - 158
Commercial Faucets	159 - 166
Tub & Shower Accessories	167 - 175
Faucet Parts & Accessories	176 - 190
Disposers & Hot Water Makers	191 - 194
Kitchen Sinks	195 - 199
Lavatories	200 - 208
Toilets & Urinals	209 - 225
Whirlpools, Tubs & Modules	226 - 252
Laundry Tubs & Accessories	253 - 254
Fixture Parts & Accessories	255 - 259
Water Coolers	260
Plumbing Chemicals	261 - 268
Plumbing Specialties	269 - 304
Cast Iron Specialties	305 - 310
Lead - Solders	311 - 313
Welding Gases	314
Power Tools	315 - 318
Hand Tools	319 - 352
Sewer Cleaning Tools	353 - 360
Fasteners	361 - 363
Plumbing Sundries	364 - 377

Table of Contents



www.irrsupply.com

Table of Contents

Pipe & Fittings **378 - 481**

Black Pipe & Fittings	378 - 383
Galvanized Pipe & Fittings	384 - 387
Brass Pipe & Fittings	389 - 396
Copper Pipe & Fittings	397 - 412
Plastic Pipe & Fittings	413 - 433
Cast Iron Pipe & Fittings	434 - 437
Flexible Tubing & Fittings	438 - 441
PEX Tubing & Fittings	442 - 460
Press System Fittings	461 - 463
Corrugated Pipe & Fittings	464
Geothermal Pipe & Fittings	465 - 466
Pipe Accessories	467 - 473
Flexible Couplings	474 - 478
Water Service Fittings	479 - 481

Heating/Cooling **482 - 859**

Cooling	482 - 532
Heating	533 - 578
Mini-Splits	579 - 588
Residential Boilers	589 - 616
Commercial Boilers	617 - 623
Indoor Air Quality	624 - 638
Flexible Duct	639
Residential Baseboard	640 - 647
Thermostats	648 - 657
Universal Controls	658 - 688
OEM Controls	689
Oil Controls & Accessories	690 - 707
Motors	708 - 718
Testing/Installation	719- 730
Sheet Metal Fittings	731 - 761
Venting	762 - 773
Register, Grilles, Diffusers	774 - 779
Condensate Pumps	780 - 781
Hydronics	782 - 817



Heating/Cooling - Continued

Fireplaces	818 - 821
A/C Sundries	822 - 828
HVAC Sundries	829 - 848
HVAC Electrical	849 - 859

Refrigeration

860 - 962

Reach-In Refrig/Freezers	860
Ice Machines	861 - 878
Refrigeration Condensing Units	879 - 886
Refrigerants, Oils & Recovery	887 - 889
Compressors	890 - 895
Refrigeration Controls	896 - 912
Filter Driers, Shells, Core	913 - 918
Sightglass	919
Capacitors	920 - 922
Chemicals	923 - 927
Fan Blades & Accessories	928 - 930
V-Belts	931 - 932
Tools	933
Refrigeration Valves	934 - 942
TXV's, Parts, Accessories	943 - 952
Refrigeration Sundries	953 - 962

Electrical

963 - 1075

Light Bulbs	963 - 967
Wiring Devices	968 - 989
Grounding	990
Lighting	991 - 1005
EMT Conduit & Fittings	1006 - 1007
Rigid/IMC Conduit & Fittings	1008 - 1010
PVC Conduit & Fittings	1011 - 1013
Flexible Conduit & Fittings	1014 - 1016
Hangers & Supports	1017 - 1021
Junction & Device Boxes	1022 - 1033
Wire, Cable & Accessories	1034 - 1040

Table of Contents



www.irrsupply.com

Table of Contents

Electrical - Continued

Electrical Connectors	1041 - 1050
Electrical Tape & Sealants	1051 - 1052
Power Distribution	1053 - 1066
Power Distribution Accessories	1067 - 1068
Fuses & Generators	1069 - 1071
Installation	1072
Electrical Sundries	1073 - 1074

Water Heaters

ProMax® Residential Gas Water Heater

- FVIR Compliant
- Push-button piezo igniter on Flammable Vapor Ignition Resistant™ FVIR System
- DynaClean™ diffuser dip tube
- Tamper resistant brass drain valve
- Coregard™ aluminum anode with stainless steel core
- Advanced PEX cross-linked polymer dip tube
- Eco Friendly Green Choice™ reduced NO_x burner
- Tamper-resistant brass drain valve
- Water connections - 3/4" on all models
- Heat trap nipples supplied on all models
- CSA Certified & ASME Rated T&P relief valve



Residential Hot Water Heaters

LP Models Available

Tall Model ProMax® Gas - 6-Year Tank/6-Year Parts Limited Warranty

Part #	Mfg #	Gal Cap	Input BTUH	Gas Type	Vent Size	Dimensions Ht (Top Draft Hood) x Dia	Approx Ship Wt	Price
AOSGCV30	GCV-30	30	35,500	NG	3" or 4"	61-1/2" x 16"	112 lbs	CALL
AOSGCV40	GCV-40	40	40,000	NG	3" or 4"	61-3/4" x 18"	138 lbs	CALL
AOSGCV50	GCV-50	50	40,000	NG	3" or 4"	60-3/4" x 20"	153 lbs	CALL
AOSGCV50LP	GCV-50LP	50	37,000	LP	3" or 4"	60-3/4" x 20"	153 lbs	CALL

Short Model ProMax® Gas - 6-Year Tank/6-Year Parts Limited Warranty

Part #	Mfg #	Gal Cap	Input BTUH	Gas Type	Vent Size	Dimensions Ht (Top Draft Hood) x Dia	Approx Ship Wt	Price
AOSGCVL30	GCVL-30	30	35,500	NG	3" or 4"	50" x 18"	112 lbs	CALL
AOSGCVL40	GCVL-40	40	40,000	NG	3" or 4"	51-1/2" x 20"	135 lbs	CALL
AOSGCVL40LP	GCVL-40LP	40	36,000	LP	3" or 4"	51-1/2" x 20"	135 lbs	CALL

Short Model ProMax® Gas - 10-Year Tank/6-Year Parts Limited Warranty

Part #	Mfg #	Gal Cap	Input BTUH	Gas Type	Vent Size	Dimensions Ht (Top Draft Hood) x Dia	Approx Ship Wt	Price
AOSXCVL40	XCVL-40	40	40,000	NG	3" or 4"	51-1/2" x 20"	135 lbs	CALL

Prices & Specifications are Subject to Change.

Water Heaters

Residential Hot Water Heaters

ProMax® Power Direct Vent Residential Gas Water Heater

6-Year Tank/6-Year Parts Limited Warranty

- FVIR technology
- 2-Pipe closed combustion
- Combined horizontal & vertical venting and air intake runs up to 45' (including one 90° elbow)
- Intelli-Vent™ gas control valve with silicon nitride hot surface igniter
- Tamper resistant brass drain valve
- Quiet modular blower equipped with 110/120V electrical system (rating 3 amps or less), 6' cord, std 3-prong male connector
- Eco Friendly Green Choice™ low-NO_x burner
- Blue Diamond® glass coating
- Coregard™ aluminum anode with stainless steel core
- Heat trap nipples installed (3/4" male connection)



Part #	Mfg #	Gal Cap	Input BTUH	Gas Type	Vent Size	Dimensions Ht (Top of Blower Outlet) x Dia	Approx Ship Weight	Price
AOSGPD40	GPD-40	40	40,000	NG	3"	57" x 21"	224 lbs	CALL

ProMax® +PLUS High Efficiency Residential Gas Water Heater

- FVIR System
- Push-button piezo igniter on Flammable Vapor Ignition Resistant™ FVIR System
- 2" Thick foam insulation
- DynaClean™ diffuser dip tube
- Advanced PEX cross-linked polymer dip tube
- Tamper resistant brass drain valve
- Coregard™ aluminum anode with stainless steel core
- External heat traps
- 3/4" Water connection
- Eco Friendly Green Choice™ low-NO_x burner
- CSA Certified & ASME Rated T&P relief valve
- .62 Energy factor



ProMax® Plus High Efficiency - 6-Year Tank/6-Year Parts Limited Warranty

Part #	Mfg #	Gal Cap	Input BTUH	Gas Type	Vent Size	Dimensions Ht (Top Draft Hood) x Dia	Approx Ship Wt	Price
AOSGVR40	GVR-40	40	40,000	NG	3" or 4"	61-3/4" x 20"	150 lbs	CALL
AOSGVR50	GVR-50	50	40,000	NG	3" or 4"	61" x 22"	165 lbs	CALL

All Items May Not Be Stocked In All Branches

Water Heaters

ProMax® +PLUS High Recovery Residential Gas Water Heater

- FVIR System
- Push-button piezo igniter on Flammable Vapor Ignition Resistant™ FVIR System
- DynaClean™ diffuser dip tube
- Advanced PEX cross-linked polymer dip tube
- Tamper resistant brass drain valve
- Coregard™ aluminum anode with stainless steel core
- Eco Friendly Green Choice™ low-NO_x burner
- 3/4" Water connection on 30, 40, 50 & 65 gallon tanks
- 1" Water connection on 75 gallon tank
- CSA Certified & ASME Rated T&P relief valve



Residential Hot Water Heaters

ProMax® Plus High Recovery - 6-Year Tank/6-Year Parts Limited Warranty

Part #	Mfg #	Series	Gal Cap	Input BTUH	1st Hour Recovery	Gas Type	Vent Size	Dimensions Ht (Top Draft Hood) x Dia	Approx Ship Wt	Price
AOSGCVX50	GCVX-50	100/101	50	65,000	93	NG	4"	63-7/8" x 22"	195 lbs	CALL
AOSFCG75	FCG-75 *	300/301	74	75,100	-	NG	4"	61" x 26-1/2" *	275 lbs	CALL
AOSFCG75LP	FCG-75LP *	300/301	74	75,100	-	LP	4"	61" x 26-1/2" *	275 lbs	CALL

* Not FVIR construction, not Energy Star qualified

ProMax® Plus High Recovery - 10-Year Tank/6-Year Parts Limited Warranty

Part #	Mfg #	Series	Gal Cap	Input BTUH	1st Hour Recovery	Gas Type	Vent Size	Dimensions Ht (Top Draft Hood) x Dia	Approx Ship Wt	Price
AOSXCVT50	XCVT-50	100/101	50	50,000	90	NG	4"	60-7/8" x 20"	172 lbs	CALL

For instructions as to proper installation, servicing, and troubleshooting, please refer to the Manufacturer's literature.

Water Heaters

Residential Hot Water Heaters

Conservationist® High Recovery Residential Gas Water Heater

10-Year Tank/10-Year Parts Limited Warranty

- FVIR system
- 2" Thick CFC-free foam insulation, with external traps
- High recovery, premium high efficiency
- Push-button piezo igniter
- DynaClean™ II automatic sediment-cleaning system
- Tamper resistant brass drain valve
- Coregard™ magnesium anode with stainless steel core
- Blue Diamond™ glass coating
- Heat trap nipples (3/4" male)
- Water connections: 3/4" male on all models
- Eco Friendly Green Choice™ low-NO_x burner
- CSA Certified & ASME Rated T&P relief valve



Tall Model Conservationist® Gas - Series 200/201

Part #	Mfg #	Gal Cap	Input BTUH	Gas Type	Vent Size	Dimensions Ht (Top Draft Hood) x Dia	Approx Ship Wt	Price
AOSXGV40	XGV-40	40	40,000	NG	3 or 4"	63-3/4" x 20"	150 lbs	CALL
AOSXGV50	XGV-50	50	40,000	NG	3 or 4"	61" x 22"	165 lbs	CALL

Effex™ High Efficiency Atmospheric Gas Water Heater - Series 100

6-Year Tank/6-Year Parts Limited Warranty

- FVIR technology to meet ANSI Z21.10.1 and CSA Standards 4.1
- .70 Energy factor pressurized combustion system
- Easily connects to existing B-Vent when replacing standard atmospheric vent heaters
- Fan-assisted, Category 1 Appliance
- 24V Electronic controls
- Electronic ignition hot surface igniter
- LCD User interface
- Powered anode rod
- Tamper-resistant brass drain valve
- DynaClean™ diffuser dip tube
- 2" Foam insulation
- 3/4" Water connections on all models
- Not available in LP gas
- Meets energy-efficiency requirements for most gas utility rebate programs and meets Energy Star® requirements
- Eco Friendly Green Choice™ low-NO_x burner
- CSA Certified and ASME Rated T&P relief valve



Part #	Mfg #	Gal Cap	Input BTUH	Gas Type	Vent Size	Dimensions Ht (Top of Draft Hood) x Dia	Approx Ship Weight	Price
AOSGAHH50	GAHH50	50	40,000	NG	3" or 4"	60-5/8" x 22"	171 lbs	CALL

All Items May Not Be Stocked In All Branches

Water Heaters

ProMax® Power Vent Residential Gas Water Heater

6-Year Tank/6-Year Parts Limited Warranty

- 40 & 50 Gallon models equipped with FVIR design
- 40 & 50 Gallon models vent using 2", 3" or 4" Sch 40 PVC, CPVC or ABS pipe
- System versatility allows combined horizontal & vertical vent runs up to 120 equivalent feet with 3" pipe, up to 160 equivalent feet with 4" pipe on 40,000 BTU & 50,000 BTU models
- All models supplied with termination elbow & screens
- Exclusive power vent blower
- Intelli-Vent™ gas control
- Hot surface ignition
- Eco Friendly Green Choice™ low-NO_x burner
- PermaGlas® glass coating
- Coregard™ aluminum anode with stainless steel core
- DynaClean™ diffuser dip tube
- Tamper resistant brass drain valve
- 3/4" Male water connections for all models except 74 gallon (1" Male)
- CSA Certified & ASME Rated T&P relief valve



Residential Hot Water Heaters

Part #	Mfg #	Gal Cap	Input BTUH	Gas Type	Vent Size	Dimensions Ht (Top Draft Hood) x Dia	Approx Ship Wt	Price
AOSGPVH40	GPVH-40	40	40,000	NG	2", 3" or 4"	63" x 18-1/2"	157 lbs	CALL
AOSGPVH40LP	GPVH-40LP	40	40,000	LP	2", 3" or 4"	63" x 18-1/2"	157 lbs	CALL
AOSGPVH50	GPVH-50	50	40,000	NG	2", 3" or 4"	65" x 20"	177 lbs	CALL
AOSGPVH50LP	GPVH-50LP	50	40,000	LP	2", 3" or 4"	65" x 20"	177 lbs	CALL
AOSGPS75	GPS-75 *	74	80,000	NG	3" or 4"	66" x 25-12" *	245 lbs	CALL

* Not FVIR construction, not Energy Star qualified

Vertex™ Power Vent Residential Gas Water Heater

6-Year Tank/6-Year Parts Limited Warranty

- 90% thermal efficiency
- Helical internal heat exchanger
- Power vents using Sch 40 PVC pipe:
 - Combined vertical and horizontal vent runs terminating through an outside wall
 - 2" Pipe vents up to 25 equivalent feet
 - 3" Pipe vents up to 65 equivalent feet
 - 4" Pipe vents up to 128 equivalent feet
- Modular blower
- Side-mounted hot and cold recirculating taps
- Intelli-Vent™ gas control
- PermaGlas® Ultra Coat™ glass lining
- (2) Heavy-duty anode rods
- Eco Friendly Green Choice™ low-NO_x burner
- Maximum hydrostatic working pressure: 150 psi
- Inlet & outlet connections: 3/4" Male
- Circulation loop connections: 3/4" Female
- CSA Certified & ASME Rated T&P valve



"Endless Hot Water for Showers"

Part #	Mfg #	Gal Cap	Input BTUH	Gas Type	Dimensions Ht (w/Draft Hood) x Dia	Approx Ship Wt	Price
AOSGPHE50	GPHE-50	50	76,000	NG	70-5/8" x 22"	210 lbs	CALL

Prices & Specifications are Subject to Change.

Water Heaters

Residential Hot Water Heaters

Voltex™ Hybrid Electric Heat Pump Water Heater

10-Year Tank/10-Year Parts Limited Warranty

- High capacity storage tank
- 2.4 Energy Factor conserves energy and meets ENERGY STAR® requirements
- Select from Efficiency, Hybrid, or Conventional Electric modes to match heating requirements to environmental conditions - vacation mode protects system components from freeze damage
- Hybrid mode automatically adjusts between compressor and element, depending upon heat requirements
- Back-up electric elements 240V/2000W lower and 240V/4500W upper
- Electronic user interface
 - Large LCD temperature display
 - Mode icons to clearly indicate operating mode
 - Individual backlit buttons for mode selection: Efficiency, Hybrid, Electric, Vacation
 - (3) Line display communicates current status and displays error message when applicable
 - Safety lock
- Powered anode
- Dehumidification
- Washable heat pump filter easily removed for cleaning
- 2" Environmentally friendly non-CFC foam insulation
- Child resistant brass drain valve
- Coefficient of performance (COP) 3.1
- Qualifies for 2010 Federal Tax Credit of up to \$1,500
- CSA Certified & ASME Rated T&P relief valve



Part #	Mfg #	Gal Cap	EF Mode	EF Hybrid Mode	EF Elec Mode	1st Hr Efficiency Mode	1st Hr Hybrid Mode	1st Hr Elec Mode	Dimensions Ht x Dia	Approx Ship Weight	Price
AOSPHPT60	PHPT-60	60	2.4	2.3	.88	51 gph	68 gph	66 gph	67-1/3" x 24-1/2"	365 lbs	CALL
AOSPHPT80	PHPT-80	80	2.3	2.3	.85	70 gph	84 gph	76 gph	81-1/2" x 24-1/2"	410 lbs	CALL

Check our website for special promotions!
www.irrsupply.com

Water Heaters

ProMax® Residential Electric Water Heater

- Low-watt density copper lower element, high-watt density copper upper element
- Thick CFC-free foam insulation
- DynaClean™ diffuser dip tube
- Coregard™ aluminum anode with stainless steel core
- Tamper resistant brass drain valve
- Factory-installed heat trap nipples (3/4" male connection)
- All water connections 3/4" NPT
- Top connect models available
- CSA Certified & ASME Rated T&P relief valve



ECT



ECS/ECL

Residential Hot Water Heaters

Tall Model ProMax® Electric - 6-Year Tank/6-Year Parts Limited Warranty

Part #	Mfg #	Gal Cap	Voltage	Input (kW)	Energy Factor	Dimensions Ht x Dia	Price
AOSECT40	ECT-40	40	240	4.5	.92	59-1/2" x 18"	CALL
AOSECT52	ECT-52	50	240	4.5	.91	54" x 20"	CALL
AOSECT66	ECT-66	66	240	4.5	.88	60-1/4" x 20-1/2"	CALL
AOSECT80	ECT-80	80	240	4.5	.86	60-1/2" x 22-1/2"	CALL
AOSECT120	ECT-120	119	240	4.5	.81	64-1/4" x 28"	CALL

Tall Model ProMax® Electric - 10-Year Tank/6-Year Parts Limited Warranty

Part #	Mfg #	Gal Cap	Voltage	Input (kW)	Energy Factor	Dimensions Ht x Dia	Price
AOSPCT30	PCT-30	30	240	4.5	.93	46-1/2" x 18"	CALL

Short Model ProMax® Electric - 6-Year Tank/6-Year Parts Limited Warranty

Part #	Mfg #	Gal Cap	Voltage	Input (kW)	Energy Factor	Dimensions Ht x Dia	Price
AOSECS30	ECS-30	30	240	4.5	.93	36-1/2" x 20-1/2"	CALL
AOSECS40	ECS-40	40	240	4.5	.92	44" x 20-1/2"	CALL

Lowboy ProMax® - 6-Year Tank/6-Year Parts Limited Warranty

Part #	Mfg #	Gal Cap	Voltage	Input (kW)	Energy Factor	Dimensions Ht x Dia	Price
AOSECL30	ECL-30	30	240	4.5	.93	30" x 22"	CALL

Prices & Specifications are Subject to Change.

Water Heaters

Residential Hot Water Heaters

ProMax® Energy Saver Electric
Lowboy Top Connect ProMax® Energy Saver Electric



Part #	Mfg #	Gal Cap	Voltage	Input (kW)	Energy Factor	Dimensions Ht x Dia	Price
AOSEJCT20	EJCT20	19.9	120	2.5	--	31-5/8" x 16"	CALL
AOSEJCT20240	EJCT20	19.9	240	6.0	--	31-5/8" x 16"	CALL

Lowboy Side Connect ProMax® Energy Saver Electric
6-Year Tank/6-Year Parts Limited Warranty

- Designed for installation under a counter, in a crawl space or in other tight spaces
- Single heating element
- Foam insulation to protect from heat loss
- T&P supplied
- Single heating element



Part #	Mfg #	Gal Cap	Voltage	Input (kW)	Energy Factor	Dimensions Ht x Dia	Price
AOSEJCT30	ECJ30	30	240	4.5	.93	30" x 22-3/4"	CALL

ProMax® Specialty Electric Water Heaters

- CSA Certified & ASME Rated
- Non-CFC Foam insulation
- Certified to UL 174 for household electric water heaters

Compact ProMax® Specialty Electric
6-Year Tank & 6-Year Parts Limited Warranty

- Designed for installation under a counter, in a crawl space or other tight spaces
- Single heating element
- Tamper resistant brass drain valve
- CSA Certified & ASME Rated T&P relief valve



Part #	Mfg #	Gal Cap	Voltage	Input (kW)	Energy Factor	Dimensions Ht x Dia	Approx Ship Wt	Price
AOSEJCS6	EJC-6	6	120	1.65	--	15-1/4" x 14-1/4"	31 lbs	CALL
AOSEJCS10	EJC-10	10	120	1.65	--	18-1/4" x 16"	45 lbs	CALL
AOSEJCS20	EJCS-20	19	120	2.5	--	24-3/4" x 18"	65 lbs	CALL

All Items May Not Be Stocked In All Branches

Water Heaters

Defender Safety System® Atmospheric Vent Energy Saver Residential Gas

- Bradford White Icon System
- Vitraglas® lined tank
- Magnesium anode rod
- Advanced ScreenLok® Technology Flame Arrestor Design
- Resettable thermal switch
- 3/4" NPT Installed true dielectric fitting water connections
- Pedestal base
- Sight window
- Flue baffle
- Factory installed Hydrojet® Total Performance System
- Factory installed heat traps
- 3" x 4" "Snap Lock" Draft Diverter—Allows either 3" or 4" vent connections with inputs of 40,000 BTU/Hr or less
- All sizes come standard with special tapping on side of tank
- Fully Automatic Controls
 - Automatic temperature selection at your fingertips
 - Built-in energy cut-off switch prevents abnormally high water temperature for extra safety
 - Built-in gas pressure regulation
 - Brass drain valve



Residential Hot Water Heaters

6-Year Limited Warranty on Steel Tank, 6-Year Limited Warranty on Parts

- 1" Non-CFC foam insulation
- Propane models feature a titanium stainless steel propane burner
- T&P Valve included

Part #	Mfg #	Gas Type	Gallons	Input BTUH	Height to Flue Conn	Diameter	Vent Size	Ship Weight	Price
BRWMI30T6FBN	M-I-30T6FBN	NG	30	32,000	59-1/8"	16"	3" or 4"	104 lbs	CALL
BRWMI30S6FBN	M-I-30S6FBN	NG	30	30,000	48-3/8"	18"	3" or 4"	100 lbs	CALL
BRWMI30S6FCX	M-I-30S6FCX	LP	30	26,000	48-3/8"	18"	3" or 4"	100 lbs	CALL
BRWMI40T6FBN	M-I-40T6FBN	NG	40	40,000	59-3/8"	18"	3" or 4"	120 lbs	CALL
BRWMI40S6FBN	M-I-40S6FBN	NG	40	40,000	50"	20"	3" or 4"	128 lbs	CALL
BRWMI40S6FCX	M-I-40S6FCX	LP	40	38,000	50"	20"	3" or 4"	128 lbs	CALL
BRWMI50S6FBN	M-I-50S6FBN	NG	50	40,000	59-5/8"	20"	3" or 4"	145 lbs	CALL
BRWMI50S6FCX	M-I-50S6FCX	LP	50	36,000	59-5/8"	20"	3" or 4"	145 lbs	CALL
BRWMI50S4S6FBN	M-I-50S4S6FBN	NG	50	50,000	58-1/2"	20"	4"	150 lbs	CALL

Standard Energy Saver - Not Defender Safety System

Part #	Mfg #	Gas Type	Gallons	Input BTUH	Height to Flue Conn	Diameter	Vent Size	Ship Weight	Price
BRWMI75S6BN	M-I-75S6BN	NG	75	76,000	62-3/8"	24"	4"	238 lbs	CALL
BRWMI75S6CX	M-I-75S6CX-77	LP	75	76,000	62-3/8"	24"	4"	238 lbs	CALL

Products for Wholesale Trade Only

Prices & Specifications are Subject to Change.

Water Heaters

Residential Hot Water Heaters

Defender Safety System® High eF Damper Atmospheric Vent Energy Saver Residential Gas

6-Year Limited Warranty on Tank, 6-Year Limited Parts Warranty

- Automatic flue damper
- Vitraglas® lined tank
- 2" Non CFC foam insulation
- Magnesium anode rod
- Honeywell self diagnostic electronic gas control
- 3/4" NPT Water connections
- Resettable thermal switch
- Advanced ScreenLok™ technology flame arrestor
- 3" x 4" "Snap-Lock" draft diverter
- Pedestal base
- Sight window
- Factory installed Hydrojet® sediment reduction system
- Brass drain valve
- Energy Star® qualified
- T&P Valve included



Part #	Mfg #	Gas Type	Gallons	Input BTUH	Height to Flue Conn	Diameter	Vent Size	Ship Weight	Price
BRWD4403S6FBN	D-4-403S6FBN	NG	40	38,000	55-3/4"	22"	3" x 4"	151 lbs	CALL
BRWD4504S6FBN	D-4-504S6FBN	NG	50	40,000	64-1/2"	22"	3" x 4"	170 lbs	CALL

High Performance Atmospheric Vent Energy Saver Residential Gas

6-Year Limited Warranty on Steel Tank, 6-Year Limited Warranty on Parts

- Vitraglas® lined steel tank
- Non-CFC foam insulation (GX-2 has 2", GX-1 has -1")
- (2) Magnesium anode rods
- Side connections allow for space heating applications
- Optimizer™ Temperature Control system
- Factory installed Hydrojet 2™ Total Performance System
- "Snap Lock" draft diverter
- Helical fin flue
- Fully automatic controls
 - Built-in energy cut off
 - Built-in gas pressure regulation
- Brass drain valve
- T&P Valve installed

* LP Available



Part #	Mfg #	First Hour Delivery	Gallons	Input BTUH	Height to Flue Conn	Diameter	Vent Size	Ship Weight	Price
BRWGX225S6BN	GX-2-25S6BN	84	25	78,000	58-1/2"	18"	4"	150 lbs	CALL
BRWGX155S6BN	GX-1-55S6BN	86	55	80,000	59-5/8"	22"	4"	200 lbs	CALL

All Items May Not Be Stocked In All Branches

Water Heaters

Defender Safety System® Direct Vent Energy Saver Residential Gas (FVIR)

6-Year Limited Warranty on Steel Tank, 6-Year Limited Warranty on Parts

- Piezo igniter
- Closed combustion—all air for combustion is taken directly from the outside
- 1" Non-CFC foam insulation
- Vitraglas® lined tank, factory installed Hydrojet® Total Performance System
- Reinforced seals
- Magnesium anode rod
- 3/4" NPT True dielectric fitting water connections
- Co-axial—rotational venting at top of unit
- Factory installed heat traps
- No electrical power necessary
- Sight window
- Design certified by CSA International (formerly AGA/CGA)
- Brass drain valve
- T&P Valve included



Horizontal Vent Kit shipped with unit, allows 13-3/4" to 23-11/16" max horizontal distance to vent terminal from side of jacket

Residential Hot Water Heaters

Part #	Mfg #	Gas Type	Gallons	Input BTUH	Height to Center of Vent	Diameter	Vent Size	Ship Weight	Price
BRWDS140S6LN	DS1-40S6FBN	NG	40	38,000	63-1/4"	20"	3" - 5"	169 lbs	CALL

Through-The-Wall Energy Saver Residential Gas Power Vent Water Heater

6-Year Limited Warranty on Steel Tank, 6-Year Limited Warranty on Component Parts

- Spark-to-pilot ignition system (110 VAC required to heater)
- Defender Safety System®
- Advanced ScreenLok® flame arrestor
- Flammable vapor sensor
- Pedestal base
- Maintenance free
- Sight window
- Power vented water heater
- Powerful blower motor
- Vitraglas® lining
- Magnesium anode rod
- Factory installed Hydrojet® Total Performance System and heat traps
- Water Connections - 3/4"NPT factory installed true dielectric fittings
- 1" Non-CFC Foam insulation
- Electronic gas control valve
- Brass drain valve
- Stainless steel flue baffle
- T&P Valve included



TTW®1 Energy Saver

Part #	Mfg #	Gas Type	Gallons	Input BTUH	Height to Flue Conn	Diameter	Vent Size	Ship Weight	Price
BRWM1TW40S6FBN	M-1-TW-40S6FBN	NG	40	40,000	56-1/2"	20"	2"	135 lbs	CALL
BRWM1TW50S6FBN	M-1-TW-50S6FBN	NG	50	40,000	57-3/8"	22"	2"	160 lbs	CALL
BRWM1TW40S6FCX	M-1-TW-40S6FCX	LP	40	38,000	56-1/2"	20"	2"	135 lbs	CALL
BRWM1TW50S6FCX	M-1-TW-50S6FCX	LP	50	38,000	57-3/8"	22"	2"	160 lbs	CALL

Prices & Specifications are Subject to Change.

Water Heaters

Residential Hot Water Heaters

Energy Saver Through-The-Wall Residential Gas

- Defender safety system®
- Power vented
- Electronic ignition system
- Vertical venting
- Vitraglas® lined tank
- Factory installed Hydrojet® total performance system
- Magnesium anode rod
- Full automatic controls
- Brass drain valve
- CSA Design certification
- T&P Valve included



Venting Not Included

TTW®2 Energy Saver

- 2" Non-CFC foam insulation
- Factory installed Hydrojet® Total Performance System
- Defender Safety on 50 gallon and 65 gallon models

Part #	Mfg #	Gas Type	Gallons	Input BTUH	Height to Flue Conn	Diameter	Vent Size	Ship Weight	Price
BRWM2TW50T6FBN	M-2-TW-50T6FBN	NG	48	67,000	65-7/8"	22"	3"	188 lbs	CALL
BRWM2TW50T6FCX	M-2-TW-50T6FCX	LP	48	60,000	65-1/8"	22"	3"	188 lbs	CALL

Standard - Not Defender Safety System

Part #	Mfg #	Gas Type	Gallons	Input BTUH	Height to Flue Conn	Diameter	Vent Size	Ship Weight	Price
BRWM2TW75T6BN	M-2-TW-75T6BN	NG	75	76,000	68-3/8"	26"	3"	257 lbs	CALL
BRWM2TW75T6CX	M-2-TW-75T6CX	LP	75	75,500	68-3/8"	26"	3"	257 lbs	CALL

Water Heaters

High Performance TTW® Energy Saver Residential Gas

6-Year Limited Warranty on Steel Tank, 6-Year Limited Warranty on Parts

- Vitraglas® lined steel tank
- Non-CFC foam insulation (GX-2 has 2", GX-1 has -1")
- (2) Magnesium anode rods
- 3/4" NPT Side connections
- Advanced temperature control system
- Factory installed Hydrojet 2™ Total Performance System
- Integrated mixing device
- Helical fin flue
- Honeywell self diagnostic electronic gas control
- Powerful blower motor
- Flammable vapor sensor
- Pedestal base
- Brass drain valve
- T&P Valve installed

* LP Available

BRADFORD WHITE
ICON
System™



Residential Hot Water Heaters

Part #	Mfg #	Gas Type	Gallons	Input BTUH	Height to Flue Conn	Diameter	Vent Size	Ship Weight	Price
BRWGX1TW55S6BN	GX-1-TW55S6BN	NG	55	78,000	63-3/4"	22"	3"	215 lbs	CALL

Manufactured Home Energy Saver Gas Water Heaters

6-Year Limited Warranty on Steel Tank, 6-Year Limited Warranty on Parts

- Vitraglas® lined tank
- 1" Non-CFC foam insulation
- Magnesium anode rod
- Direct vent / closed combustion
- 3/4" NPT True dielectric fitting water connections
- Factory installed heat traps
- Closed combustion vent kit package for installation flexibility
- Flue baffle
- Fully automatic controls
 - Built-in energy cut off
 - Built-in gas pressure regulation
- Brass drain valve
- Vent sold separately
- T&P Valve installed

Vent Not Included



Part #	Mfg #	Gas Type	Gallons	Input BTUH	Height to HW Connections	Diameter	Vent Size	Ship Weight	Price
BRWMIIMS30T6LX	M-I-MS-30T6LX-77	LP	30	30,000	58-3/8"	16"	3"	106 lbs	CALL
BRWMIIMS40T6LX	M-I-MS-40T6LX-77	LP	40	30,000	58-7/8"	18"	3"	126 lbs	CALL

Prices & Specifications are Subject to Change.

Water Heaters

Residential Hot Water Heaters

Combi2™ TTW® Power Vent Energy Saver Residential Gas

10-Year Limited Warranty on Tank and Heat Exchanger, 6-Year Limited Warranty on Parts

- Internal double wall heat exchanger
- Low heat exchanger head loss
- Vitraglas® lined tank
- 2" Non-CFC foam insulation
- Magnesium anode rod
- Honeywell self diagnostic electronic gas control
- 3/4" NPT True dielectric fitting water connections
- Factory installed Hydrojet® Total Performance System
- Integrated mixing device
- Heat exchanger - UltraCoil® Heat Transfer System
- Brass drain valve
- Defender Safety System® models include (50T model only):
 - Advanced ScreenLok® flame arrestor design
 - Flammable vapor sensor
 - Sight window
- T&P Valve installed



Part #	Mfg #	Gas Type	Gallons	Input BTUH	Height to Water Conn	Diameter	Weight	Price
BRWCDW2TW50T10FBN	C-DW2-TW-50T10FBN	NG	45	67,000	65-7/8"	22"	245 lbs	CALL
BRWCDW2TW50T10FCX	CDW-2-TW-50T10FCX	LP	45	60,000	65-7/8"	22"	245 lbs	CALL

Powerstor2™ Series® Double-Wall Indirect Residential Gas

Limited Lifetime Warranty on Steel Tank and Heat Exchanger, 6-Year Limited Warranty on Parts

- Vitraglas® lined tank
- 2" Non-CFC foam insulation
- (3) Protective anode rods
- 1" NPT Female supply and return connections located on the front for both the boiler supply and boiler return
- Factory installed nipples
- Factory installed Hydrojet® Total Performance System
- Heat exchanger – single wall 1-1/2" glass coated (Vitraglas®) steel
- Stand-by heat loss—less than 1/2°F per hour
- Fully automatic controls:
 - Immersed Honeywell aquastat
- Brass drain valve
- T&P Valve included - opening on side of tank



Part #	Mfg #	Gas Type	Gallons	Min Heat Req BTUH	Height to Water Conn	Diameter	Weight	Price
BRWDW240L	DW-2-40L	NG	38	65,000	41-7/8"	22"	180 lbs	CALL
BRWDW250L	DW-2-50L	NG	48	65,000	47-1/4"	22"	192 lbs	CALL

All Items May Not Be Stocked In All Branches

Water Heaters

Aero® Series Energy Saver Residential Oil-Powered Water Heaters

6-Year Limited Warranty on Steel Tank, 2-Year Limited Warranty on Parts and Burner

- 120/1/60 Beckett burner
- Vitraglas® lined tank
- 1" Non-CFC foal insulation
- (2) Magnesium anode rods
- 3/4" NPT True dielectric fitting water connection
- Compatible with biofuel
- Factory installed Hydrojet® Total Performance System
- Flexible stainless steel baffle
- Dual immersion aquastat
- Ceramic fiber combustion chamber
- Lowest operating cost
- High recovery rates
- Brass drain valve
- T&P Valve installed



Residential Hot Water Heaters

Part #	Mfg #	Gallons	Input MBTUH	Firing Rate	Height to Flue Connection Diameter	Vent Size	Weight	Price	
BRWCF326	CF-32-6	32	91/105	.65/.75	51-1/8"	20"	6"	215 lbs	CALL
BRWCF506	CF-50-6	50	105/119	.75/.85	60-3/16"	22"	6"	275 lbs	CALL
BRWRF306	RF-30-6	30	119	.85	47-7/8"	23-3/16"	6"	250 lbs	CALL
BRWRF30SX6	RF-30SX-6	30	119	.85	42-3/16"	24-3/4"	6"	210 lbs	CALL
BRWRF506	RF-50-6	50	175/189	1.25/1.35	60-7/8"	26-1/2"	7"	360 lbs	CALL

CF = Center Flue
RF = Rear Flue

Energy Saver Residential Electric Water Heaters

6-Year Limited Warranty on Tank, 6-Year Limited Warranty on Parts

- 2" Non-CFC foam insulation
- Hydrojet® total performance system
- Direct heat transfer with immersed screw-type elements
- Equipped with heat traps
- Tamper-proof brass drain valve
- All residential storage models meets or exceeds efficiency requirement of the Dept of Energy
- T&P Valve included - special tapping on top of tank



Part #	Mfg #	Gallons	Electrical	Watts	Height to Top of Heater	Diameter	Ship Weight	Price
BRWM230R6DS	M-2-30R6DS	30	240/1	(2) 4500W	47-3/16"	18"	85 lbs	CALL
BRWM240S6DS	M-2-40S6DS	40	240/1	(2) 4500W	46-7/8"	20"	103 lbs	CALL
BRWM250S6DS	M-2-50S6DS	50	240/1	(2) 4500W	46-1/2"	22"	130 lbs	CALL
BRWM250T6DS	M-2-50T6DS	50	240/1	(2) 4500W	57-1/2"	20"	123 lbs	CALL
BRWM265R6DS	M-2-65R6DS	65	240/1	(2) 4500W	59-1/4"	22"	156 lbs	CALL
BRWM280R6DS	M-2-80R6DS	80	240/1	(2) 4500W	59-1/4"	24"	183 lbs	CALL

Prices & Specifications are Subject to Change.

Water Heaters

Residential Hot Water Heaters

Lowboy Electric Energy Saver

6-Year Limited Warranty on Tank, 6-Year Limited Warranty on Parts

- 2" Non-CFC foam insulation (M-1 models have 1")
- Hydrojet® total performance system
- Direct heat transfer with immersed screw-type elements
- Equipped with heat traps
- Tamper-proof brass drain valve
- (2) 4500W Elements
Requires 30 Amp breaker
- All residential storage models above 20 gallon capacity meets or exceeds efficiency requirement of the Dept of Energy
- T&P Valve included - side T&P standard, optional top available



Part #	Mfg #	Gallons	Electrical	Watts	Height to Top of Heater	Diameter	Ship Weight	Price
BRWM230L6DS	M-2-30L6DS	30	240/1	(2) 4500W	30"	22"	96 lbs	CALL
BRWM240L6DS	M-2-40L6DS	40	240/1	(2) 4500W	32-1/8"	24"	121 lbs	CALL
BRWM250L6DS	M-2-50L6DS	47	240/1	(2) 4500W	32-1/8"	26"	143 lbs	CALL

Residential Utility Electric Water Heater

6-Year Limited Warranty on Steel Tank and Parts

- Fully automatic controls
- Single, screw-in type element
- Vitraglas® lining
- 3/4" Water connections
- M-1 Units have 1" Non-CFC foam insulation
- Single phase operation only
- T&P Valve included - special tapping on side of tank



Part #	Mfg #	Gallons	Electrical	Watts	Height to Top of Heater	Diameter	Ship Weight	Price
BRWMI6U6SS	M-1-6U6SS-77	6	120/1	1500W	16-1/2"	14"	33 lbs	CALL
BRWMI12UT6SS	M-1-12UT6SS-77	12	120/1	1500W	16-7/8"	18"	48 lbs	CALL
BRWMI20U6SS	M-1-20U6SS-77	19	120/1	1500W	24-3/4"	18"	59 lbs	CALL

All Items May Not Be Stocked In All Branches

Water Heaters

Ariston Electric Mini Tank Water Heaters

8-Year Warranty on Tank

- Supplies 6.8 gph recovery at 90°F rise
- Built with titanium for longer life
- 120V
- Mounts on wall or floor
- Meets ASHRAE 90.1 standard
- Operating pressure: 150 psi
- Heating capacity: 1,500W



T&P Relief valve installed on GL2.5Ti & GL4Ti, included on GL8Ti

Part #	Mfg #	Gallons	Price
CECGL25	GL2.5Ti	2.5	CALL
CECGL4	GL4Ti	4.0	CALL
CECGL6	GL8Ti	8.0	CALL

Residential Hot Water Heaters



Residential Tankless Water Heaters

NRC98 Series Residential Condensing Tankless Water Heater

- Output temperature settings: 100° to 140°F (5°F intervals - 9 options)
- Capacity range: 0.5 gpm to 9.8 gpm
- Direct electric ignition
- Quick-connect
- Venting options: available as an indoor direct vent (-DV) model which includes special plastic flue adapters that are compatible with both 3" or 4" Schedule 40 and 80 PVC/CPVC pipe
- Includes remote thermostat attached to the front panel
- Safety devices: flame sensor, overheat protection device, lighting protection device, freeze protection, condensate overflow
- Temperature lockout
- Condensate overflow monitoring system
- 3/4" Water inlet, outlet and gas
- Available in natural gas or propane
- 12-Year limited heat exchanger warranty
- 5-Year limited parts warranty



Other Models Available

NORN98 NORN71
 NORNC111 NORNR66

Part #	Mfg #	Use	Max BTUH	Venting Type	Gas Type	Dimensions H x W x D	Approx Wt	Price
NORNRC98DV	NRC98-DV	Indoor	180,000	Direct Vent	NG	25.5" x 18.3" x 9.8"	60.4 lbs	CALL
NORNRC98DVLP	NRC98-DV-LP	Indoor	180,000	Direct Vent	LP	25.5" x 18.3" x 9.8"	60.4 lbs	CALL

Prices & Specifications are Subject to Change.

Noritz Water Heater Parts

Residential Hot Water Heaters

Isolation Valves

Part #	Mfg #	Description	Price
NORIKWV4	IK-WV-1	Isolator Kit for N-075 w/(1) Full Port Isolation Valve & (1) Pressure Relief Valve	CALL
NORIKWV5	IK-WV-2	Isolator Kit for N-093 w/(2) Full Port Isolation Valves & (1) Pressure Relief Valve	CALL
NORIKWV6TH	IK-WV-6-TH	Threaded Isolator Valve Kit for NC380	CALL

Venting

Direct Vent - Concentric Venting

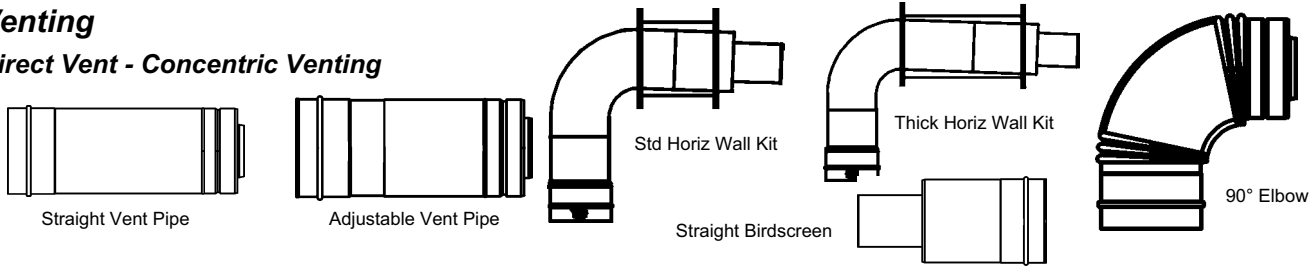

Part #	Mfg #	Description	Price
NORCVP11ADJ	CVP-11ADJ	11" Adjustable Vent Pipe	104.86
NORCVP24STR	CVP-24STR	24" Straight Vent Pipe	79.20
NORCVP36STR	CVP-36STR	36" Straight Vent Pipe	96.52
NORCDTV	CDT-V	Concentric Vertical Drain Tee	88.06
NORCVKH	CVK-H	Standard Horizontal Wall Kit for 5.8" - 13.2"	161.70
NORCVKH2	CVK-H2	Thick Horizontal Wall Kit for 10.3" - 17.8"	178.20
NORCVKV	CVK-V	Concentric Vent Kit	627.36
NORCVP90ELB	CVP-90ELB	90° Elbow	81.04
NORCVTS	CVT-S	Straight Birdscreen	102.00

PVC Venting

Part #	Mfg #	Description	Price
NORVT4PVCS	VT4-PVCS	4" Birdscreen for PVC	36.68
NORVP4ADAPTPVC	VP4-ADAPT-PVC	4" PVC Adapter	93.68
NORVP4X3ADAPTPVC	VP4X3-ADAPT-PVC	4" x 3" PVC Adapter	80.71

Stainless Steel Vent Termination Kits

- N-Vent
- 4" Diameter
- Easy Installation

Direct Vent Short Termination

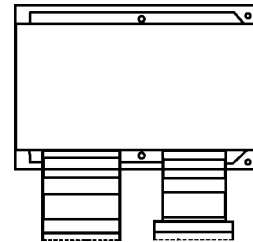

Part #	Mfg #	Size	Wall Thickness	Price
NORVT4TS8	VT4-TS-8	4"	5.1" - 8.3"	CALL
NORVT4TS14	VT4-TS-14	4"	8.3" - 14.6"	CALL

Parts & Accessories

Part #	Mfg #	Description	Price
NOREGBD032	EGBD032	Water Inlet Filter	CALL
NORRC7649M	RC-7649M	Remote Controller	CALL

All Items May Not Be Stocked In All Branches

Commercial Water Heaters

Conservationist® BT Commercial Gas Water Heater

- 3-Year warranty on tank assembly
- 80% Thermal efficiency
- PermaGlas® glass lined tank, foam insulation
- Hand-hole cleanout on BT80 and BT100
- Fully automatic controls
 - Automatic safety shutoff gas if pilot is extinguished
 - High temperature energy cutoff (ECO)
- CoreGard™ anode rod with stainless steel core
- Draft diverter
- Gas pressure regulator
- Piezo igniter - natural gas only
- Anodic protection
- Max working pressure 150 psi
- CSA Certified & ASME Rated T&P relief valve



Part #	Mfg #	Gal Cap	Input BTUH	Gas Type	Vent Size	Dimensions Ht (Incl Draft Hood) x Dia	Approx Ship Wt	Price
AOSBT65	BT-65	65	65,000	NG	4"	65" x 24"	240 lbs	CALL
AOSBT80	BT-80	74	75,100	NG	4"	61-1/8" x 26-1/2"	275 lbs	CALL
AOSBT100	BT-100	98	75,100	NG	4"	69-3/4" x 26-1/2"	350 lbs	CALL
AOSBT100LP	BT-100LP	98	75,100	LP	4"	68-5/8" x 27-3/4"	350 lbs	CALL

Master-Fit® Commercial Gas Water Heater with Automatic Flue Damper

- 3-Year limited warranty on tank assembly
- 80+% Thermal efficiency
- Factory installed draft diverter & flue damper
- Water connections on top, front & rear
- Eliminator™ self-cleaning system
- Intermittent electronic ignition
- PermaGlas® UltraCoat™ lined tank, foam insulation
- Fully automatic control switch safety shutoff
- Hand-hole cleanout allows easy cleaning
- CoreGard™ long-life, SS core anode rods
- Factory installed & tested draft diverter
- Gas pressure regulator and pilot filter
- Cathodic protection
- CSA Certified & ASME Rated T&P relief valve

MasterFit



Part #	Mfg #	Gal Cap	Input BTUH	Gas Type	Vent Size	Dimensions Ht to Top Vent Connect x Dia	Approx Ship Wt	Price
AOSBTR120	BTR-120	71	120,000	NG	5"	69-3/4" x 27-3/4"	400 lbs	CALL
AOSBTR154	BTR-154	81	154,000	NG	6"	73" x 27-3/4"	470 lbs	CALL
AOSBTR197	BTR-197	100	199,000	NG	6"	75" x 27-3/4"	603 lbs	CALL
AOSBTR199	BTR-199	81	199,000	NG	6"	67-1/2" x 27-3/4"	470 lbs	CALL
AOSBTR250	BTR-250	100	250,000	NG	6" or 8" *	72" x 30-1/4"	630 lbs	CALL
AOSBTR251	BTR-251	65	251,000	NG	6" or 8" *	75" x 27-3/4"	750 lbs	CALL
AOSBTR275	BTR-275	100	275,000	NG	6" or 8" *	72" x 30-1/4"	630 lbs	CALL
AOSBTR365	BTR-365	85	365,000	NG	8"	79-1/2" x 27-3/4"	725 lbs	CALL
AOSBTR500	BTR-500	85	500,000	NG	8"	82-1/4" x 27-3/4"	820 lbs	CALL

Prices & Specifications are Subject to Change.

Commercial Hot Water Heaters

Commercial Water Heaters

Cyclone HE™ Power Vent Commercial Gas Water Heater

- 3-Year limited warranty
- 90% Thermal efficiency
- Versatile power-vent design
 - Uses PVC, CPVC or ABS pipe for intake & exhaust
 - 2" pipe vents up to 25 equivalent feet
 - 3" Pipe vents up to 65 equivalent feet
 - 4" Pipe vents up to 128 equivalent feet
- Helical internal heat exchanger
- Modular blower
- 22" Diameter tank with high output takes less space
- Side-mounted hot and cold recirculating taps
- Intelli-Vent® gas control
- Silicon nitride hot surface igniter
- Advanced electronics for more precise control of water temp
- PermaGlas® UltraCoat™ glass lining
- (2) Heavy-duty anode rods
- Green Choice® gas burner reduces NOx emissions
- Maximum hydrostatic working pressure: 150 psi
- 1/2" NPT gas inlet
- 3/4" Female NPT side inlet and outlet
- 3/4" Male NPT top inlet and outlet
- CSA Certified & ASME Rated T&P relief valve



Commercial Hot Water Heaters

Part #	Mfg #	Gal Cap	Input BTUH	Gas Type	GPH 100°F Rise	Dimensions Ht x Dia x Depth	Approx Ship Wt	Price
AOSBTX80	BTX-80	50	76,000	NG	83	68-1/4" x 27"	210 lbs	CALL

Let us know how we may best serve you. Suggestions help us improve.

Commercial Water Heaters

Cyclone® Xi BTH Direct Vent Commercial Gas

- 3-Year limited warranty on tank assembly
- Up to 96% thermal efficiency
- Submerged combustion chamber with Helical Heat Exchanger coil
- Top mounted burner & top mounted burner work together to minimize calcium/lime accumulation
- PermaGlas® UltraCoat™ glass lining
- Non-sacrificial free powered anode rods
- Intelligent Control System with LCD display
 - Precise temperature control
 - Built-in diagnostics
 - Run history information
 - Network ready for future remote monitoring
 - iCOMM™ compatible
- Venting versatility
 - Conventional & sealed-combustion power-venting (vertical or sidewall)
 - Direct vent intake & exhaust pipe can terminate separately outside building through single opening using concentric vent assembly
 - Uses PVC, CPVC or ABS pipe for intake & exhaust
- Space-saving design
 - Top cover has rear cut-away for easy access to serviceable parts
 - 0" Installation clearances on sides & rear, 2" installation clearance on top, 4" alcove installation clearance in front of unit
 - 0" Clearance to combustibles (walls, floor, etc)
- CSA Certified & ASME Rated T&P relief valve



Commercial Hot Water Heaters

Cyclone Xi™ Direct Vent Gas Water Heater - up to 96% Thermal Efficiency

Part #	Mfg #	Gal Cap	Input BTUH	Gas Type	Thermal Efficiency	Dimensions Ht x Dia	Approx Ship Wt	Price
AOSBTH120	BTH-120	60	120,000	NG	95%	55-1/2" x 27-3/4"	460 lbs	CALL
AOSBTH150	BTH-150	100	150,000	NG	95%	75-1/2" x 27-3/4"	555 lbs	CALL
AOSBTH199	BTH-199	100	199,900	NG	95%	75-1/2" x 27-3/4"	555 lbs	CALL
AOSBTH250	BTH-250	100	250,000	NG	95%	75-1/2" x 27-3/4"	555 lbs	CALL

ASME Cyclone® Xi BTH Direct Vent Commercial Gas Water Heater - up to 96% Thermal Efficiency

Part #	Mfg #	Gal Cap	Input BTUH	Gas Type	Thermal Efficiency	Dimensions Ht x Dia	Approx Ship Wt	Price
AOSBTH150A	BTH-150A	100	150,000	NG	95%	75-1/2" x 27-3/4"	595 lbs	CALL
AOSBTH199A	BTH-199A	100	199,900	NG	95%	75-1/2" x 27-3/4"	595 lbs	CALL
AOSBTH300A	BTH-300A	130	300,000	NG	96%	75-1/2" x 33-1/8"	855 lbs	CALL
AOSBTH500A	BTH-500A	130	499,900	NG	95%	75-1/2" x 33-1/8"	855 lbs	CALL

Prices & Specifications are Subject to Change.

Commercial Water Heaters

Conservationist® HW Copper Heat Exchanger Commercial Gas Boiler

- 10-Year limited warranty on coil, heat exchanger or burner (Hydronic heating applications)
- 5-Year limited warranty on coil, heat exchanger or burner (Domestic hot water supply)
- Up to 82% thermal efficiency hot water supply & hydronic heating boilers
- All non-ferrous water ways
- Low profile diverter
- Efficient copper coil combustion chamber
- High efficiency stainless steel burner
- Forced water circulation improves system efficiency
- Automatic safety controls and electronic switch
- Thermal balancer (Model HW200)
- Working pressure: 160 psi



125 psi Pressure Relief Valve Conservationist® Boiler

Part #	Mfg #	Input BTUH	Output BTUH	Gas Type	Vent Size	Dimensions Flue Ht x Width x Depth	Approx Ship Wt	Price
AOSHW120	HW-120M *	120,000	99,840	NG	6"	49-3/8" x 20-3/4" x 26-11/16"	120 lbs	CALL
AOSHW200	HW-200M	199,000	162,185	NG	7"	53-1/4" x 20-3/4" x 26-11/16"	165 lbs	CALL

* Does not include thermal balancer

50 psi Pressure Relief Valve Conservationist® Boiler

Part #	Mfg #	Input BTUH	Output BTUH	Gas Type	Vent Size	Dimensions Flue Ht x Width x Depth	Approx Ship Wt	Price
AOSHW300	HW-300	300,000	247,200	NG	8"	65" x 25-1/4" x 29-5/8"	240 lbs	CALL
AOSHW420	HW-420	420,000	344,400	NG	10"	57-1/8" x 27" x 31-1/2"	291 lbs	CALL
AOSHW520	HW-520	520,000	429,000	NG	10"	68-5/16" x 27" x 36-1/2"	361 lbs	CALL
AOSHW670	HW-670	660,000	543,800	NG	12"	67" x 27" x 36-1/2"	361 lbs	CALL

Storage Tanks

Uninsulated Vertical/Horizontal Storage Tank

- NSF-Approved glass-lined tank
- Designed and recommended for systems with operation temperatures up to 180°
- Magnesium anodes
- Shipped factory standard with leg sockets for vertical installation, but designed to have proper inlet/outlet openings for horizontal installation
- 5-Year limited tank warranty



Part #	Mfg #	Gallons	Dimensions (Dia x OAL)	Working Pressure	Approx Ship Wt	Price
AOST120S	T-120S	120	24-1/4" x 65"	150 psi	287 lbs	CALL
AOST200S	T-200S	200	30" x 72"	150 psi	460 lbs	CALL

All Items May Not Be Stocked In All Branches

Commercial Water Heaters

Insulated/Jacketed Storage Tank

- Ideal for glass-fired copper heat exchanger equipment for storage of any potable water at temperatures up to 180°F
- Fitting locations designed to meet normal installations plus those for AO Smith Cer-Temp 80® and Shure-Temp piping methods
- Glass-lined tank
- Heavy gauge steel jacket
- High-density fiberglass insulation
- Magnesium anode
- Threaded openings for thermometer, relief valve, 2" recirculation lines, tankstat & drain valve
- 5-Year limited warranty on tank



Part #	Mfg #	Gallons	Dimensions (Dia x OAL)	Working Pressure	Price
AOSTJV120M	TJV-120M	119	32" x 77"	160 psi	CALL
AOSTJV200M	TJV-200M	175	32" x 77"	160 psi	CALL

Commercial Hot Water Heaters



Better Service Thru Better People

Commercial Water Heaters

Defender Safety System® Light Duty Atmospheric Vent Energy Saver Commercial Gas

3-Year Limited Warranty on Tank, 1-Year Limited Parts Warranty

- Piezo ignition
- Vitraglas® lined tank
- 2" Non CFC foam insulation (65T-65 has 1")
- Magnesium anode rod
- Gas connection diameter is 1/2"
- Resettable thermal switch
- Side connections for space heating
- Advanced ScreenLok™ technology flame arrestor
- Pedestal base
- Sight window
- Factory installed Hydrojet® sediment reduction system
- Brass drain valve
- T&P Valve included



75T and 100T

Part #	Mfg #	Gas Type	Gallons	Input BTUH	Height to Flue Conn	Diameter	Vent Size	Ship Weight	Price
BRW75T80B3N	75T-80B-3N	NG	75	76,000	63-3/4"	26"	4"	294 lbs	CALL
BRW100T88B3N	100T-88B-3N	NG	100	85,000	68-5/8"	28-1/4"	4"	420 lbs	CALL
BRW75T80B3X	75T-80-3X	LP	75	76,000	63-3/4"	26"	4"	294 lbs	CALL

Commercial Hot Water Heaters

Energy Saver Flue Damper Electronic Ignition Commercial Gas

3-Year Limited Warranty on Tank, 1-Year Limited Parts Warranty

- Electronic ignition
- Automatic flue damper
- Honeywell integrated control with digital display provides temperature control, diagnostic codes & system ignition functions
- Vitraglas® lined tank
- Non-CFC foam insulation
- Magnesium anode rods
- Factory installed Hydrojet® Sediment Reduction System
- Hand hole cleanout
- Flue damper
- Adjustable electronic thermostat
- Tamper-proof brass drain valve
- T&P Valve installed



Part #	Mfg #	Gas Type	Gallons	Input BTUH	Height to Top of Vent	Diameter	Vent Size	Ship Weight	Price
BRWD75T3003N	D-75T-300-3N	NG	75	300,000	75-7/8"	28-1/4"	7"	590 lbs	CALL
BRWD80T1993N	D-80T-199-3N	NG	80	199,999	71-7/8"	28-1/4"	6"	540 lbs	CALL
BRWD100S1993N	D-100S-199-3N	NG	100	199,999	76-3/4"	28-1/4"	6"	667 lbs	CALL

All Items May Not Be Stocked In All Branches

Commercial Water Heaters

eF Series® Ultra High Efficient Commercial Gas Water Heaters

3-Year Limited Warranty on Tank, 1-Year Limited Parts Warranty

- Thermal efficiency up to 99.1%
- Honeywell integrated control with digital display provides temperature control, diagnostic codes & system ignition functions
- Direct spark ignition
- Non-CFC foam insulation
- Vitraglas® lined tank
- Factory installed Hydrojet® Sediment Reduction System
- (3) Pass flue system
- Submerged combustion chamber
- Zero inch clearance
- (4) Magnesium anode rods
- Hand hole cleanout
- Manual reset Energy Cut Off
- Tamper-proof brass drain valve
- T&P Valve installed

* LP Available



Part #	Mfg #	Gas Type	Gallons	Input BTUH	Height to Top of Heater	Diameter	Vent Size	Ship Weight	Price
BRWEF60T125E3N	EF-60T-125E-3N	NG	60	125,000	57"	28-1/4"	3" or 4" PVC	570 lbs	CALL
BRWEF60T199E3N	EF-60T-199E-3N	NG	60	199,999	57"	28-1/4"	3" or 4" PVC	570 lbs	CALL
BRWEF100T199E3N	EF-100T-199E-3N	NG	100	199,999	77-5/8"	28-1/4"	3" or 4" PVC	900 lbs	CALL

Commercial Hot Water Heaters

Aero Series Energy Saver Commercial Oil-Powered Water Heater

3-Year Limited Warranty on Steel Tank, 1-Year Limited Warranty on Parts and Burner

- 120-1-60 Beckett burner
- Compatible with biofuel
- Vitraglas® lined tank
- 1" Non-CFC foam insulation on CF models
- Fiberglass insulation on RF models
- (2) Magnesium anode rods on CF models, (1) magnesium anode rod on RF models
- Factory installed Hydrojet® Total Performance System
- Flexible stainless steel baffle
- Dual immersion aquastat
- Ceramic fiber combustion chamber
- Lowest operating cost
- High recovery rates
- Brass drain valve
- T&P Valve installed on CF Models, included with RF Models



Part #	Mfg #	Gas Type	Gallons	Input BTUH	Height to Flue Conn	Diameter	Vent Size	Ship Weight	Price
BRWCF703	CF-70-3	70	119	0.85	65-15/32"	24"	6-1/2"	290 lbs	CALL

CF = Center Flue; RF = Rear Flue

Prices & Specifications are Subject to Change.

Commercial Water Heaters

Dairy Barn Energy Saver Commercial Electric

3-Year Limited Warranty on Tank, 1-Year Limited Parts Warranty

- Fully automatic controls
- Direct heat transfer with immersed elements
- Factory Installed Hydrojet® total performance system
- Vitraglas® lining
- 2" Non-CFC foam insulation
- 3/4" NPT True dielectric water connections
- Factory installed heat traps
- Magnesium anode rod
- 4" Leg kit
- Simultaneous and non-simultaneous operation available
- Low restriction tamper proof brass drain valve
- T&P Valve installed



Commercial Hot Water Heaters

Part #	Mfg #	Gallons	Electrical	Watts	Height Floor to Hot Water Conn	Diameter	Weight	Price
BRWDB80R3DS	DB-80R3DS	80	240V	4500W	64-5/8"	24"	190	CALL

Refer to the Branch listings in the front of this book to find the Irr Supply Center location nearest you!

Water Heater Parts

Temperature Controls

White Rodgers®

- Safe lighting features permits lighting w/o danger of main gas flow
- 100% Gas shutoff if pilot fails

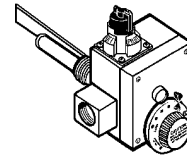

Part #	Mfg #	Description	Price
AOS23736	9004703105	3-1/2" NG Manifold	118.80

Blower Assemblies

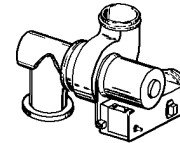

Part #	Mfg #	Description	Price
AOS9004316005	9004316005	Blower Assembly f/GPSH/GPVH 40,20	400.80
AOS182775	9004434105	Blower Assembly Series 234/5	586.90

Anode Rods

Part #	Mfg #	Description	Price
AOS9001829005	9001829005	32" Magnesium Anode Rod	43.00

Gas Valves

Part #	Mfg #	Description	Price
AOS9003638005	9003638005	Gas Valve for GCVX50	141.50
AOS9004240005	9004240005	Combination NG Gas Valve for GPVH *	415.60
AOS9004312005	9004312005	NG Gas Valve for GPSH40/50 Series 200/201	343.60
AOS183082	9004440105	NG Gas Valve SV for FPSH Series 250/251	424.60
AOS182791-4	9003407005	NG Valve for GCV/FCV-30/40/50 & GCVL/FCVL-30/40 & FCG-30/40/50	134.00
AOS9005112005	9005112005	LP Gas Valve for GPSH/GPVH 40,50 Series 200/20	389.20
AOS9006655005	9006655005	NG Gas Valve for New GCVL Series 200	142.80

Pilot Burners

Part #	Mfg #	Description	Price
AOS183824-190	9003542005	190° NG Pilot Assembly FCVL40, FCV40	54.10

Hot Surface Igniters

Part #	Mfg #	Description	Price
AOS183267	183267	Hot Surface Igniter	132.70
AOS9003626005	9003626005	Hot Surface Ignition Assembly NG 75	113.30
AOS9005958005	9005958005	Hot Surface Igniter Assembly f/GPVH40	92.20
AOS9006101205	9006101205	Hot Surface Igniter f/BTH	132.00

Hot Water Heater Parts

Prices & Specifications are Subject to Change.

Water Heater Parts

Water Heater Parts

Part #	Mfg #	Description	Price
AOS183523-39	9003892005	33" Aluminum Anode Plug	30.70
AOS21062-45	9005885105	45" Dip Tube	14.70
AOS9006029015	9006029015	Flammable Vapor Sensor w/Bracket	60.70
AOS9006432005	9006432005	NG Gas Valve Control Kit for GVCA30,40	114.80
AOS9006604005	9006604005	LP Gas Valve Control Kit for GVCA30,40	204.60

Screw-In Adapter Kit

Part #	Mfg #	Description	Price
WHPADP	9004704115	Screw-in Adapter Kit for 4-Bolt Style, Square Flange	24.04



Icon System™ Gas Valve

- Advanced temperature control
- Exclusive performance software
- Intelligent diagnostics - green LED light prompts installer during start-up; (10) diagnostic codes to assist in troubleshooting
- Pilot-on-Indication flashing green LED provides positive indication pilot is on
- Millivolt powered, no external electricity required
- Separate immersed thermowell
- Integrated piezo igniter built into the control



Part #	Mfg #	Description	Price
BRW2394746301	239-47463-01	NG Icon Gas Valve Complete	206.32
BRW2394746501	239-47465-01	LP Icon Gas Valve Complete	271.58
BRW2334784505	233-47845-05	NG Icon Pilot Assembly	31.58

ICON Accessory Package

Part #	Mfg #	Description	Price
BRW2394787200	239-47872-00	Accessory Module, Plug-in Transformer, Wire Harness & Mounting Hardware	112.79
BRW2394787400	239-47874-00	Leak Sensor with Wire Harness, Rubber Dam & Mounting Hardware	77.90
BRW2394788700	239-47887-00	Inlet Shut-off Valve with Wire Harness & (2) 3/4" to 1" NPT Bushing	151.58
BRW2394788100	239-47881-00	Programmable LCD Digital Control w/Mounting Assy, Wire Harness, Integrated Mixing Device & Mounting Hardware	273.68
BRW265474390732	265-47439-07-32	Icon NG Burner Assembly for MI403	64.25
BRW265474401150	265-47440-11-50	Icon LP Burner Assembly for MI403S	76.15
BRW265474390432	265-47439-04-32	Icon NG Burner Assembly for MI40T	64.15

Vent Kits

Part #	Mfg #	Description	Price
BRW2393702201	239-37022-01	12" Clearance Vent Kit Package Includes: Roof Jack, Air Intake Tube & Instructions	271.90
BRW2393702202	239-37022-02	18"/32" Clearance Vent Kit Package Includes: Roof Jack, Air Intake Tube & Instructions	282.94

All Items May Not Be Stocked In All Branches

Water Heater Parts

Vent Kits (Continued)

Part #	Mfg #	Description	Price
BRW2393702203	239-37022-03	32"/60" Clearance Vent Kit Package Includes: Roof Jack, Air Intake Tube & Instructions	327.16

Bradford White Parts & Accessories

Anode

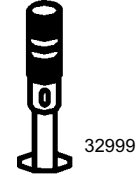

Part #	Mfg #	Description	Price
BRW2243273181	224-32731-81	Magnesium Anode	26.11
BRW2243299906	224-32999-06	Hot Water Outlet Anode Aluminum	31.16
BRW2243299922	224-32999-22	Aluminum Anode Rod for M-I-TW30-1/2"	19.04
BRW2244777604	224-47776-04	Anode	38.38
BRW2244777612	224-47776-12	Magnesium Anode Rod less Heat Trap Insert	29.06

Aquastat

Part #	Mfg #	Description	Price
BRW2333972300	233-39723-00	Honeywell Aquastat for Oil Heaters	223.38
BRW2334603800	233-46038-00	Dual Aquastat for CF32-6,50-6,70-3	194.71

Blowers

Part #	Mfg #	Description	Price
BRW2654558400	265-45584-00	Exhaust Blower for M-I-TW	336.55
BRW2654720000	265-47200-00	TTW@1 Universal Service Replacement Blower Kit for MITW, MITW-10, MITW-12 through MITW-15	385.32

Burners

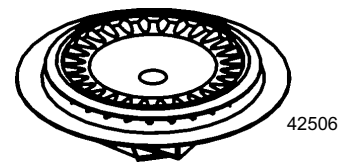

Part #	Mfg #	Description	Price
BRW2284250600	228-42506-00	NG Burner Only	11.16

Elements

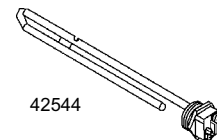

Part #	Mfg #	Description	Price
WHPE2524S	265-34402-24	2500W 240V Screw-In(SI) High Watt Element	24.64
WHPE1512S	265-42540-02	1500W 120V SI Element	23.48
WHPE2012S	265-42540-04	2000W 120V SI Element	24.64
WHPE2512S	265-42540-05	2500W 120V SI Element	25.06
WHPE1524S	265-42544-01	1500W 240V/ 1000 208V SI Element	23.48

Prices & Specifications are Subject to Change.

Water Heater Parts

Bradford White Parts & Accessories (Continued)

Elements

Part #	Mfg #	Description	Price
WHPE2024S	265-42544-03	2000W 240V Screw-In(SI) High Watt Element	24.64
WHPE4524SPK	265-48642-00	4500W 240V Screw-In(SI) High Watt Element 2/Pk	39.86

Incoloy Heating Element

Part #	Mfg #	Description	Price
WHPE4524IS	265-42545-07	4500W 240V Incoloy	61.56

ICON Oil Controls

Part #	Mfg #	Description	Price
BRWCF32BURNER	228-44392-01	Beckett Burner with Dual Aquastat for CF-32-6	1008.52
BRWRF30BURNER	228-44392-07	Beckett Burner with Dual Aquastat for RF-30-6 and RF-30SX-6	1257.08
BRWCF50-70BURNER	288-44392-03	Beckett Burner for CF50/CF70	1008.52

Igniters

Part #	Mfg #	Description	Price
BRW2394091800	239-40918-00	HSI Igniter	74.24
BRW2654554300	265-45543-00	HSI Igniter	50.15

Ignition Modules

Part #	Mfg #	Description	Price
BRW2434138300	243-41383-00	Honeywell Ignition Module Kit for TW & 24V	113.44
BRW2394138300	239-41383-00	Ignition Module Kit	383.81

Inlet Tubes



39625

Part #	Mfg #	Description	Price
BRW2293632010	229-36320-10	36-1/2" x 3/4" Dip Tube	7.71
BRW2293962503	229-39625-03	Dip Tube f/40gal Short	5.43
BRW2293962507	229-39625-07	40-1/2" MIP Dip Tube	5.43

Pilot Assemblies

Part #	Mfg #	Description	Price
BRW2334129701	233-39761-00	Pilot Assembly for NG Spark Ignition	33.07
BRW2334087702	233-40877-03	LP Pilot Assembly for M-II-TW75	69.16
BRW2334565305	233-45653-05	NG Pilot Assembly	78.93
BRW2334627703	233-46277-03	NG Pilot Assembly	44.22

All Items May Not Be Stocked In All Branches

Water Heater Parts

Pressure Switch

Part #	Mfg #	Description	Price
BRW2393978700	239-39787-00	Pressure Switch	64.92
BRW2394546000	239-45460-00	Pressure Switch	32.74
BRW2394781501	239-47815-01	Pressure Switch for GX1TW	22.83

Sensor

Part #	Mfg #	Description	Price
BRW2394556000	239-45560-00	Sensor	38.01

Thermostat

Part #	Mfg #	Description	Price
BRW2654618101	265-46181-01	NG Gas Thermostat	130.53
BRW2654618201	265-46182-01	LP Gas Thermostat	168.00

Therm-O-Disc Thermostat for Electric Water Heater

Part #	Mfg #	Description	Price
WHPTSCOM	265-40694-00	Thermostat with High Limit (89T13)	57.00

Valve

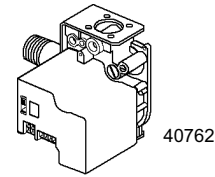

Part #	Mfg #	Description	Price
BRW2224076201	222-40762-01	NG Gas Valve	150.32
BRW2224076202	222-40762-02	LP Gas Smart Valve	165.90
BRW2394561401	239-45614-01	Gas Valve for M1TW50LP	180.21
BRW2394561301	239-45613-01	NG Gas Valve	175.83
BRW2394746302	239-47463-02	Icon NG M4 Res Gas Valve Assembly Kit	212.63
BRW2394785100	239-47851-00	Universal Icon NG Valve for Res	248.42
BRW2394786500	239-47865-00	Integrated Mixing Device for GX1,2	172.42
BRW2654025112	265-40251-12	NG Gas Valve Combo for GX225S6BN	119.35
BRW2654561401	265-45614-01	LP Gas Control Valve Kit for PV	158.70
BRW2654744401	265-47444-01	NG Gas Valve Combo for GX155S6BN	152.19

Warranty Upgrade

Part #	Mfg #	Description	Price
BRWWARRANTY	238-43329-00	10-Year Level 1 Warranty Upgrade	200.00
BRWWARRANTY2	238-44332-00	10-Year Level 2 Warranty Upgrade	315.79

Water Heater Part

Part #	Mfg #	Description	Price
BRW2394561302	239-45613-02	Gas Control Kit	177.10
BRW2653589712	265-35897-12	SI Element Wrench	10.11

Prices & Specifications are Subject to Change.

Freeze Protection

Freeze Free® Pipe Freeze Prevention

- Power indicator light
- Grounded 30" cord set
- Requires less heating cable
- Pipe mounting brackets
- UL listed
- Easy to install
- Operates on 124V AC
- Cut to exact length needed
- Protects plastic or metal water pipes to -60°F

Part #	Mfg #	Description	Price
HETRL100	2102	100' Freeze Free Cable	2.38
HETRL300	2302	300' Freeze Free Cable	2.33

Heat Tape

- Constant wattage pipe tracing: 120 VAC
- Water pipe heating cable with therr
- Tough PVC inner insulation
- Continuous ground braid
- Weather resistant PVC (high-low temperature) outer jacket
- 2' 18/3 Cold lead with grounded plug



Part #	Mfg #	Length	Watts	Price
HETCABLE6	AHB-016	6'	42	31.28
HETCABLE9	AHB-019	9'	63	32.84
HETCABLE12	AHB-112	12'	84	35.94
HETCABLE15	AHB-115	15'	105	37.35
HETCABLE18	AHB-118	18'	126	39.60
HETCABLE24	AHB-124	24'	168	42.40
HETCABLE30	AHB-130	30'	210	45.38
HETCABLE60	AHB-160	60'	420	67.58

EH38- Thermostatically Controlled Device

Current Tap

- Self-regulating heating cables
- Always energized
- Extends cable life
- Reduces risk of frozen pipes
- Easy installation



Part #	Mfg #	Description	Price
HETSTAT	EH38	Thermostatically Controlled Device	50.96

Pro Pack

Part #	Mfg #	Description	Price
HETPRO50	PRO-50	Pro Pack 50' Roll Heat; Cable, HCA Tape, Ends	384.96

Fused Plug Kits

- For use w/Freeze Free system
- Built-in fast reaction 10A fuse
- Power indicator light
- Grounded 30" cord set
- Requires less heating cable
- Pipe mounting brackets
- UL listed
- Easy to install
- Operates on 124V AC
- Cut to exact length needed
- Protects plastic or metal water pipes to -60°F
- 3 Watts per foot



FreezeFree® Self-Regulating Cable

Part #	Mfg #	Kit Contains:	Price
HETCON	10802	Plug, Gel End Seal & Instruction Sheet	37.98

Gardian Heating Cables

Gardian - 6 Watts/Foot

- Preassembled & self-regulating
- 120V Cable includes 30" power cord & plug
- 240V Cable is hard-wired
- Maximum exposure temperature: 150°F



Part #	Mfg #	Volts	Length	Price
RACW516P	W51-6P	120V	6'	126.32
RACW5112P	W51-12P	120V	12'	159.94
RACW5118P	W51-18P	120V	18'	200.84
RACW526L	W52-6L	240V	6'	131.96
RACW5212L	W52-12L	240V	12'	173.96
RACW5218L	W52-18L	240V	18'	214.40

WinterGard Heating Cables

WinterGard Plus - 6 Watts/Foot

- Self-regulating
- Braided metal shield only
- Maximum exposure temperature: 150°F

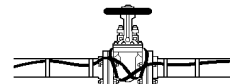

Part #	Mfg #	Volts	Length	Price
RACH611050	H611-050	120V	50'	385.32

Freeze Protection

All Items May Not Be Stocked In All Branches

Freeze Protection

WinterGard Wet - 6 Watts/Foot

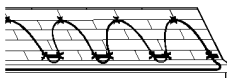

- Self-regulating
- Waterproof polyolefin outer jacket over metal shield
- Maximum exposure temperature: 150°F

Part #	Mfg #	Volts	Length	Price
RACH612050	H612-050	120V	50'	481.66
RACH612250	H612-250	120V	250'	9.64
RACH622050	H622-050	240V	50'	545.88
RACH622250	H622-250	240V	250'	10.92

WinterGard Component Kit



H900

Part #	Mfg #	Description	Price
RACH900	H900	Hard Wire Power Connection Kit	55.16
RACH910	H910	Waterproof Splice & Tee Kit	30.48

FreezGard Self-Regulating Crankcase Heaters

- Comes with a flexible lockstrap & prestripped 28" cold leads for easy connection & hard-wiring
- Power at 50°F: 32 watts
- Power at 0°F: 60 watts
- Cold lead wire gauge (AWG): 18
- Cable width*: .540 (1.37)
- Cable thickness*: .165 (0.42)
- Cable length*: 48 (122)
- Cold lead length*: 28 (71)
- Max exposure temp: 185°F (85°C)
- Insulation jacket type: Modified polyolefin
- Girth (wraparound) dimension*: 40 (102) or less circumference



Part #	Mfg #	Description	Price
RACCCH1C	CCH-1C	120V	110.40
RACCCH2C	CCH-2C	240V	110.40

*Dimensions in inches (Centimeters)



Better Service Thru Better People



Freeze Protection

Water Filter Systems

Water Systems

Whole-House Water Filter Systems

Standard Diameter Plastic Filter Housing

- Cold water application
- Conforms to public health requirements for water purification
- Pressure tested high-impact plastic
- "Aqua-Grip" filter wrench included
- Universal replacement cartridges available in different grades of porosity
- 10-Year limited warranty

Universal Valve-In-Head Plastic Filter Housing - Single Cartridge - (for 1-2 Bathroom Homes)

- Includes AP110 dirt/rust/sediment cartridge
- Cold water applications
- Built in shut-off valve with pressure relief
- Pressure tested, high impact plastic design
- Aqua-Grip filter wrench included
- Made from FDA CFR-21 compliant materials
- 10-Year limited warranty



Part #	Mfg #	Housing	Pipe Conn	Dimensions H x Dia	Approx Weight	Max Flow Rate	Price
AQUAP101T	55300-02 (AP101T)	Clear	3/4" NPT	14-1/4" x 4-9/16"	3.25 lbs	8 gpm	190.33

Big Aqua 800 Series Large Diameter Plastic Housing - (1) Cartridge Height

- Applications: sediment and rust, chlorine taste & odor
- Ideal for larger homes and commercial applications
- Cold water applications
- Built-in pressure relief
- Accepts AP800 Series sediment cartridges
- Aqua-Grip filter wrench included for fast and easy housing sump removal for changing cartridges
- Maximum temperature: 100°F
- Maximum pressure: 100 psi
- 10-Year limited system warranty
- Suffix:
 - C Suffix denotes Complete Series, including housing, bracket, wrench & AP810 cartridge
 - T Suffix denotes transparent sump



Part #	Mfg #	Housing	Pipe Conn	Dimensions H x Dia	Approx Weight	Flow Rate	Notes	Price
AQUAP801	55857-01 (AP801)	Blue	1" NPT	13-15/16" x 7-5/16"	7 lbs	20 gpm	Less Cartridge	148.44

Large Diameter Whole House Replacement Cartridge

Dirt/Rust/Sediment Removal

- Cold water up to 100°F
- Cartridge dimensions: 19-7/8" high x 4-5/7" diameter

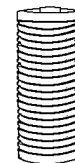

Part #	Mfg #	Load	Water	Micron Rating	Flow Rate	Pkg/Qty	Price
AQUAP810	55779-15 (AP810)	Normal	Cold	5	20 - 28 gpm	1	48.04

All Items May Not Be Stocked In All Branches

Water Filter Systems

Water Systems

Universal Size Dirt/Rust/Sediment Removal Replacement Cartridge for Whole House Systems

- For models AP101T or AP101S
- Hot and cold water (up to 170°F)
- Single action for sediment reduction
- 9-3/4" High x 2-5/8" diameter
- Made from FDA (CFR21) compliant materials



Part #	Mfg #	Load	Water	Micron Rating	Max Flow Rate	Pkg/Qty	Price
AQUAP110	56204-04 (AP110)	Normal	Hot/Cold	5	8 gpm	2	36.45
AQUAP124	55424-21 (AP124)	Heavy	Hot/Cold	50	8 gpm	2	42.39

AP-902/903/904 Single Cartridge Whole House Water Filtration System

- 304 Stainless steel head allows for "sweat in place" installation and is a non-corrosive material
- 1" Inlet and outlet connections for easy installation and high flow rates up to 20 gpm
- Tested and rated to 20 gpm flow rate
- Sanitary Quick Change (SQC) design for fast easy cartridge change-outs without a filter wrench
- Rated for 100,000 gallons or 1 year of normal water conditions
- Pressure range: 25 - 125 psi
- Dimensions: 25-1/16"H x 4-1/2"D
- 10-Year limited system warranty
- 25-Year limited stainless steel head warranty



Part #	Mfg #	Reduction Claims	Service Flow Rate	Temp Range	Repl Cartridge	Price
AQUAP902	56211-01 (AP902)	Sediment	20gpm	40-100°F	AP910R	382.02
AQUAP903	56211-02 (AP903)	Sediment, Chlorine, Odor	20gpm	40-100°F	AP917R	454.84
AQUAP904	56211-04 (AP904)	Sediment, Chlorine, Odor, Scale Inhibitor	20gpm	40-100°F	AP917HD	516.94

Drinking Water Filter Systems

AP-DWS1000 Dual Stage Carbon Block Filtration System

- Reduces sediment, chlorine taste & odor, lead, protozoan cyst & VOCs leached from soils into water
- (2) Cartridge system
- Dedicated faucet included with system
- Automatic shut-off after 625 gallons
- Flow rate up to 0.5 gallons per minute
- Installation hardware, faucet & pipe connections included
- Uses APDW80/90 replacement cartridges
- 10-Year limited system warranty



Part #	Mfg #	Pipe Conn	Dimensions H x Dia	Approx Weight	Max Flow Rate	Price
AQUAPDWS1000	55831-01 (APDWS1000)	1/4" Tubing	15-1/2" x 4-1/2"	7 lbs	0.5 gpm	565.83

Prices & Specifications are Subject to Change.

Water Filter Systems

Water Systems

Under-Sink Full Flow Compact Filter System

- Includes sediment filter
- Applications: dirt, rust, taste, and odor
- Compact dual action filter
- Multi-stage filtration process
- Effective filter protection for up to 2,000 gallons
- Cold water applications
- Pressure tested high-impact plastic
- Uses AP217 replacement cartridges
- 10-Year limited system warranty



Part #	Mfg #	Housing	Pipe Conn	Dimensions H x Dia	Approx Weight	Max Flow Rate	Price
AQUAP200	55289-01 (AP200)	Opaque	3/8" NPT	9-3/16" x 6-3/32"	2.75 lbs	2 gpm	182.22

Replacement Cartridge for Drinking Water System Filter



AP117



AP217



AP517

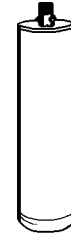

APDW85

Part #	Mfg #	Description	Price
AQUAPDW8090	55851-02	AP-DWS80/90 Fits AP-DWS1000, 2 Cartridge Set	192.68
AQUAP917R	56210-03 (AP917R)	AP917R 5 Micron Fits AP903	271.19
AQUAP117	55417-05 (AP117)	Fits AP51T and all Standard Aqua-Pure Whole-House Filters for Chlorine/Odor/Sediment Reduction, 2/Pk	85.86
AQUAP217	46290-02 (AP217)	Fits AP200, Double Action for Chlorine/Taste/Odor/Sediment Reduction	105.65
AQUAP517	AP517-01	Fits AP500, AP510, AP-OWS250	98.26
AQUAPDW85	55844-08 (APDW85)	Fits AP-DWS750	71.34
AQU3MFF101	3MFF101	0.5 Micron Fits 6DWP0	341.96

AP Easy Cyst-FF Under Sink Full Flow Drinking Water System

- Removes 99.95% of filterable parasitic cysts
- Reduces lead, chlorine taste & odor, sediment, and scale
- 2,000 Gallon cartridge life
- Built-in bypass valve
- Everything included -- no additional parts needed for most installations
- NSF Tested & Certified
- NSF 42 and 53 Certified
- Fits 3/8" Copper or plastic water line



Part #	Mfg #	Pipe Conn	Dimensions H x Dia	Approx Weight	Max Flow Rate	Price
AQUAPEASYCYSTFF	56092-23 (AP EASY CYST-FF)	3/8" OD Quick Connect	11-7/8" x 3-1/4"	2.2 lbs	2.0 gpm	143.81

All Items May Not Be Stocked In All Branches

Water Filter Systems

AP Easy CS-S Under Sink Full Flow Drinking Water System

- Applications: sediment, rust, chlorine, taste, and odor
- 750 Gallon cartridge life
- Includes built-in bypass valve, lead-free faucet, & AquaPure C-CS-S filter cartridge



Part #	Mfg #	Pipe Conn	Dimensions H x Dia	Approx Weight	Max Flow Rate	Price
AQUAPEASYCS-S	56179-05 (APEASYCSS)	1/4" OD Quick Connect	10-1/2" x 2-3/8"	2.2 lbs	0.5 gpm	185.94

AP Easy Complete Under Sink Full Flow Drinking Water System

- Reduces chlorine taste and odor, lead, parasitic protozoan cyst, VOC's, mercury turbidity and asbestos
- 750 Gallon cartridge life
- Includes built-in bypass valve
- Includes AquaPure C-Complete filter cartridge
- 1/4" Quick connect for undersink Installations

Part #	Mfg #	Pipe Conn	Dimensions H x Dia	Approx Weight	Max Flow Rate	Price
AQUAPEASYCOM	56179-04 (AP EASY Complete)	1/4" OD Quick Connect	12-1/2" x 2-3/8"	2.2 lbs	0.75 gpm	249.98

Replacement Filter for AP Easy Full Flow Drinking Water System

Part #	Mfg #	Description	Price
AQUCCSS	56180-09 (C-CS-S)	Replacement Filter for AP Easy CS-S	56.71
AQUCCYSTFF	56104-28 (C-CYST-FF)	Replacement Filter for AP Easy CYST-FF	75.17
AQUCCOMPLETE	56180-07 (C-Complete)	Replacement Filter for AP Easy Complete	120.75

Reverse Osmosis Systems

Under-Sink Reverse Osmosis System

- Universal system design
- Advanced automatic shut-off valve
- May be used on chlorinated or non-chlorinated water
- Includes lead-free faucet



Part #	Mfg #	Pipe Size	Purification Assembly	Storage Tank	Approx Weight	Storage Tank Capacity	Price
AQUAPRO5500	55982-01 (APRO5500)	1/4" Tubing	16"L x 7"W x 16"H	10-3/4"D x 15-1/4"H	27 lbs	2.4 gal	798.77

Prices & Specifications are Subject to Change.

Water Filter Systems

Water Systems

Hot Water Protectors

Hot Water Scale/Corrosion Protection Filter

- Inhibits scaling and corrosion in hot water systems
- Dirt, rust, and scale protection
- High capacity change every 4-6 months
- Comes with AP431 cartridge
- 1-Year limited warranty



Part #	Mfg #	Pipe Conn	Dimensions H x Dia	Approx Weight	Max Flow Rate	Price
AQUAP430	AP430	3/4"	10-1/4" x 2-3/4"	2.3 lbs	6 gpm	120.67

Replacement Scale Inhibitor Cartridge for Hot Water Protection

- Extends the life of hot water systems by inhibiting corrosion of your plumbing fixtures
- Filters inhibit scaling



Part #	Mfg #	Description	Price
AQUAP431	AP431	6 gpm Fits AP430	49.56

Refrigerator Filters

Ice Maker Filter

- Applications: chlorine, taste, odor, and scale build up
- Attaches to water line that feeds refrigerator
- Quick connect fittings
- 5 Micron rating nominal
- Food grade scale inhibitor
- Maximum operating temperature: 100°F
- Maximum pressure: 125 psi
- Replace every 6 months
- 1-Year limited warranty



Part #	Mfg #	Pipe Conn	Dimensions H x Dia	Approx Weight	Max Flow Rate	Price
AQUAP717	55513-01 (AP717)	1/4"	8-1/4" x 2-5/16"	1 lb	0.5 gpm	44.99

Water Filter Systems

Water Systems

Whole-House Water Filter Systems

Heavy-Duty 304 Stainless Steel Filter Housing

- Brass head rated to 300 psi maximum operating pressure
- Hot and cold water applications
- High temperature rating to 200°F
- "Sure-Seal" ring nut connector with tightening tool
- Manufactured from FDA CFR-21 compliant material
- System tested and certified by NSF International
- 10-Year limited warranty



Automatic Sulfur Reduction Filter

- Delivers a fully automatic and highly dependable control valve
- Patented one-piece semi-transparent fiberglass mineral tank

Part #	Mfg #	Media Cu Ft	Mineral Tank	Min Space H x W x D	Service Flow Rate	Backwash Flow Rate	Price
MCCCSX100	CSX100	1.0	8" x 44"	53" x 10" x 16"	3 gpm	5.3 gpm	3414.45

Acid Neutralizers

Acid Neutralizer Filter

- Raises pH of acidic water
- Helps prevent blue/green stains on fixtures
- Aids in protecting copper plumbing systems
- Calcium carbonate media bed
- 1"NPT Inlet/outlet
- 1 Cubic foot media
- 5-Year limited warranty



Part #	Mfg #	Description	Price
MCCUN1001	APUN101	Upflow Neutralizer Filter	959.19

Filter Media



Part #	Mfg #	Description	Price
MCCN050P	N-050P	1/2 cu ft Acid Neutralizer Media	92.14
MCCF050P	F-050P	1/2 cu ft AG Filter Media for ABF & NBF Series Backwash Filters	71.94
MCCMC050P	MC-050P	1/2 cu ft Chem-Free Iron Removal Filter Media	78.94
MCCPHPLUS	PH PLUS	4# pH Adder Media for Chem-Free Iron Filter	40.42
MCCSX10P	SX10-P	1 cu ft Sulfur Reduction Filter Media	195.54
MCCSS0104	SS0104	(4) 1 gal Sul-X Sulfur Reduction Filter Solution Media	69.60
MCCA050P	MC-050P	1/2 cu ft Iron Resin	74.00
MCCCH050P	H-050P	1/2 cu ft High Cap Resin	105.06

Prices & Specifications are Subject to Change.

Water Filter Systems

Water Systems

Residential Water Softeners

CWS Electronic Residential Water Softener

- Superior capacity brine tank
- Patented one-piece resin tank
- Programmed for metered regeneration, but can be converted to time clock regeneration
- System settings remain even after power outages
- 1" NPT Connections
- 5-Year limited warranty



Part #	Mfg #	Media	Max Salt Capacity (Grains)	Operating Flow GPM	Price
MCCMCWS100ME	CWS100ME	1.0 cu ft	30,000	11.2	1884.90
MCCMCWS150ME	MCWS150ME	1.5 cu ft	45,000	14.0	2054.85
MCCMCWS200ME	MCWS200ME	2.0 cu ft	60,000	15.0	2219.65

CWS Electronic Residential Rustbuster Iron Reduction Water Softener

- Addresses staining of laundry, sink, tub and toilet
- For timer regeneration
- Effectively removes up to 15 ppm of iron
- 1" NPT Connections
- Fine mesh



Part #	Mfg #	Media	Max Salt Capacity (Grains)	Operating Flow GPM	Price
MCCWSX100ME	CWSX100ME	1.0 cu ft	30,000	15	2023.95

Iron Removal Systems

APIF Iron Removal System

- Iron reduction filters
- Chemical free oxidation of iron
- Unique bypass valve
- One-piece semi-transparent mineral tank



Part #	Mfg #	Nom Capacity ppm/gal	Dimensions H x Dia	Media Cu Ft	Flow Rates (GPM)			Price
					Cont	Service	Backwash	
MCCMCIF1001	APIF100	30,000	53" x 10"	1	3	6	5.3	1652.66
MCCMCIF1501	APIF150	45,000	63" x 10"	1.5	3	7	5.3	1822.61

Water Filter Systems

Backwashing Filters

CBF Backwash Filter System

- Smart electronics with backup
- Self-leveling base compensates for unlevel floors
- Quick and easy installations
- Limited lifetime warranty



Water Systems

Part #	Mfg #	Media Cu Ft	Media Included	Service Flow Rate	Backwash Flow Rate	Space Required	Case Wt	Price
MCCNBW1001	CBF100	1	No	3 gpm	5.3 gpm	10" x 15" x 53"	53 lbs	1405.28

Chlorine Solution Tanks

Part #	Mfg #	Description	Price
MCCST15	ST15	15 gal 16" x 21" Solution Tank	160.58
MCCST30	ST30	30 gal 18" x 33" Solution Tank	196.86

Water Treatment Parts & Accessories

Part #	Mfg #	Description	Price
MCCHC10	HC10	1" Hydrocharger	130.30
MCCIRONX24	IX-2412	24 oz Iron-X Water Softener & Rust Cleaner	22.82
MCCIRONX5	IX-8006	5 lb Iron-X Water Softener & Rust Cleaner	30.32
MCCQC20	QC-20	20# Coarse Quartz Gravel	48.60

Drinking Water Filter Systems

Replacement Cartridge for Drinking Water System Filter

Part #	Mfg #	Description	Price
CFSHF25S	56152-03 (HF25-S)	Fits ICE125-S, 1 Micron, Reduces Chlorine Taste & Odor, Sediment and Scale	90.50
CFSHF40S	56133-05 (HF40-S)	Fits ICE140-S, 0.2 Micron, Reduces Cyst, Bacteria, Sediment, Chlorine and Scale	166.62
CFSHF45S	56133-09 (HF45-S)	Fits ICE145-S, 3 Micron, Reduces Sediment, Chlorine Taste & Odor and Scale	158.26
CFSHF65S	56134-09 (HF65-S)	Fits ICE165-S, 3 Micron, Reduces Sediment, Chlorine Taste & Odor and Scale	213.50

Prices & Specifications are Subject to Change.

Water Filter Systems

Water Systems

Commercial Water Filter Systems

ICE125-S Single Cartridge Filtration System

- For commercial cubers and flakers
- Valve-in-head design
- Reduces sediment and chlorine taste & odor
- Built-in scale inhibition
- Flow rate up to 1.5 gallons per minute



Part #	Mfg #	Pipe Conn	Micron Rating	Capacity	Replacement Cartridge	Price
CFSICE125S	56160-04 (ICE125-S)	3/8" FNPT	1.0	10,000 gal	HF25-S	300.00

ICE145-S Single Cartridge Filtration System

- For commercial cubers and flakers
- Valve-in-head design
- Reduces sediment, chlorine taste & odor and scale
- Built-in scale inhibition
- Flow rate up to 2.1 gallons per minute



Part #	Mfg #	Pipe Conn	Micron Rating	Capacity	Replacement Cartridge	Price
CFSICE145S	56162-04 (ICE145-S)	3/8" FNPT	3.0	25,000 gal	HF45-S	392.08

Service Filter

- For ice machines
- Granular activated charcoal
- Built-in scale inhibition



Part #	Mfg #	Description	Price
CFS420IMF	55609-04 (CFS420IMF)	Drop-In Filter, Filters Scale and Sediment to 5 Micron Level	69.20

Water Filter Systems

Retrofit Replacement Cartridges

Series 9000 Everpure Filter System Replacement Cartridge



Part #	Mfg #	Description	Price
CFS9112	55892-03 (CFS9112)	1.5 gpm, 1 Micron Rating, 10,000 gal Capacity	89.02
CFS9112S	55892-01 (CFS9112-S)	1.5 gpm, 1 Micron Rating, 10,000 gal Capacity with Scale Inhibitor	98.00
CFS9720S	55890-01 (CFS9720-S)	1.5 gpm, 5 Micron Rating, 4,800 gal Capacity Fits InSurelce 2000/4000, MC, MH, XC, CV, BH, and MCP	82.00
CFS9812X	56012-01 (CFS9812X)	0.5 Micron Rating, 9,000 gal Capacity, Cyst Reduction, Replaces Insurelce 2000/4000, MC, MH, XC, BH, and MCP	91.26
CFS9812XS	56012-03 (CFS9812XS)	0.5 Micron Rating, 9,000 gal Capacity, Cyst Reduction with Scale Inhibitor	100.02
CFS9812ELXS	56012-07 (9812-ELXS)	0.5 Micron Extended Length	120.80

Series 8000 Sanitary Quick Change Cartridge



Part #	Mfg #	Description	Price
CFS8112ELS	55817-27 (CFS8112-ELS)	1.5 gpm, 1 Micron Rating, Extended Length, 14,000 gal Capacity, Fits System One & Ice Assure Systems	117.68
CFS8112S	55817-08 (CFS8112-S)	1.5 gpm, 1 Micron Rating, 10,000 gal Capacity with Scale Inhibitor	97.02
CFS8720S	55893-01 (CFS8720-S)	1.5 gpm, 5 Micron Rating, 4,800 gal with Scale Inhibitor	80.78
CFS8812XS	56011-03 (CFS8812X-S)	0.5 Micron Rating, 9,000 gal f/Sediment, Taste & Odor, Fits System One and Ice Assure Systems	99.12
CFS8812ELXS	56011-07 (8812-ELXS)	0.5 Micron Extended Length, Fits Ice Assure Systems	118.42

Dual Port System Filter Cartridge

Part #	Mfg #	Description	Price
CFS8000SK	55854-06 (CFS8000-SK)	Scale Inhibitor Replacement Cartridge for DP-3C System	76.36

Softening Replacement Cartridge



Part #	Mfg #	Description	Price
CFSSWC1350C	55992-07 (SWC-1350-C)	5 Micron, 1,100 Grains Capacity, Head Softening, Fits CFS6090, CFS6090-C, CFS6135	87.72

Prices & Specifications are Subject to Change.

Water System Accessories

Water Systems

Ultraviolet Water Systems

TrojanUVMax™ D4 Plus Ultraviolet Water System

- Ultraviolet sterilization system
- Generates UV light from a low-pressure, high-output lamp
- Sensor with diagnostic test
- Diagnostic display, UV lamp age
- Sensor test button, lamp timer reset button, mute button
- Install vertically
- 10-Year warranty on UV chamber
- 3-Year full non-prorated warranty against manufacturer's defects on the power supply and all electrical components
- 1-Year warranty on lamps and sensors



Part #	Mfg #	Description	Price
TROUVMAXDPLUS	650695	7 - 16 gpm, 3/4" NPT	1355.00

TrojanUVMax™ Ultraviolet Water System

- Ultraviolet sterilization system
- UV Light is generated from a low-pressure high-output lamp
- 120V, 60Hz, 3/4"NPT



Part #	Mfg #	Description	Price
TROUVMAXD	650375	UVMax-D 10 gpm; 30k Dose	867.00

TrojanUVMax™ Integrated Home System

- Comes equipped with a UV and filters
- 120-240V, 50-60Hz, 3/4" NPT
- cUL Listed



Part #	Mfg #	Description	Price
TROIHS12D4	IHS12-D4	Combination UV, Sediment, and Carbon System	1394.49

Ultraviolet Bulb

Part #	Mfg #	Description	Price
TROLAMPD4	602805	Ultraviolet Lamp for Max D4	196.50

Water Filter Systems

Water Systems

Reverse Osmosis Systems

Zero Waste Reverse Osmosis System

- 4-Stage; produces 50 gallons per day
- (1) 1 Micron sediment filter
- (1) Carbon block filter
- (1) 10" Inline carbon final filter
- 3/8" Solid brass high flow faucet
- No airgap required
- 3 Gallon steel water storage tank
- NSF Certified Standard 58; IAPMO Certified
- Patented zero waste design



Part #	Mfg#	Order #	Description	Price
WATZRO4	ZRO-4	500026	4-Stage	1152.04

ZRO-4 Replacement Filter Kit

- (1) 10" - 5 Micron sediment filter
- (1) 10" - 5 Micron carbon block filter
- (1) 50 Gallon per day TFC membrane
- (1) 10" Inline GAC final filter



Part #	Mfg#	Description	Price
WATZROFILTER	0500340	Complete	181.42

Water System Accessories

Water Softener Salt



Part #	Mfg #	Description	Price
SOS50	SOS50	50# Bag Solar Salt	14.02
SOS80	SOS80	80# Bag Solar Salt	21.26
SOSSOFTOUCH	SOFTOUCH	40# Bag Softouch Potassium Chloride	57.84

Dry Chlorinator Pellets

- Usable for shock treatment or everyday chlorination
- 70% Concentrated

Calcium Hypochlorite Pellets



Pentair Water



Part #	Mfg #	Description	Price
AUTCP14	1045009	14# Pellets	141.58
AUTCP35	1045008	35# Pail Pellets	311.34

Sanitizer Tablets



Pentair Water



Part #	Mfg #	Description	Price
AUTCP4	1045011	4# Jar Chlorinator Sanitizer Tablets	41.30



Ice Machine Filters

Micro-Plus® Ice Machine Filter Cartridge

- Complete all-in-one filter for ice machines, coffee urns & brewers
- Scale control
- Taste & odor control
- Filters down to 20 microns
- 1/4" FPT Connections



4612-W3

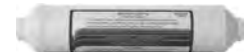

4613-Y8



4614-Y8

Part #	Mfg #	Description	Price
CAL4615W3	4615-W3	Micro-Plus® 2	58.64
CAL4612W3	4612-W3	Micro-Plus® 4	96.04
CAL4613Y8	4613-Y8	Micro-Plus® 8	140.04
CAL4614Y8	4614-Y8	Micro-Plus® 16	197.68

Nu-Plus® Everpure® E-Series

nu-i2000² and nu-i4000²

- Precoat submicron filtration reduces particles as small as 1/2 micron along with chlorine and other offensive contaminants
- Feed of 6R Micromet® inhibits scale build-up cause by dissolved minerals
- Micro-Pure® II antibacterial protection
- NSF Certified



4621-10



4621-11

Part #	Mfg #	Capacity	Price
CAL462110	4621-10	9,000 gal, 750 lbs for Cubers, 1,500 lbs for Flakers	125.78
CAL462111	4621-11	12,000 gal, 1,000 lbs for Cubers, 2,000 lbs for Flakers	142.36

Water Filters

7CB5S

- Can be used for fountain beverage applications
- Taste and odor, chlorine reduction
- Scale control
- Particulate reduction to 5 micron
- Problem solving cartridge for high particulate or low flow water pressure areas
- NSF Certified



Part #	Mfg #	Capacity	Price
CAL961816	9618-16	10,000 gal	117.60

nu-MC² and nu-XC²

- Pre-coat submicron filtration reduces particles as small as 1/2 micron
- Micro-Pure®II antibacterial protection
- Reduces objectionable tastes and odors
- Cyst reduction
- NSF Certified



Part #	Mfg #	Capacity	Price
CAL462120	4621-20	9,000 gal	112.66

Everpure 4-C Cartridge

- Same filtration as MC but 1/3 of gallon capacity

QC71 Single Head

- Ideal for all Nu-Plus E Series filters
- Built-in shut off, flushing valve
- Outlet pressure gauge included on the mounting bracket



Part #	Mfg #	Description	Price
CAL462101	4621-01	3/8" NPT Single Head	315.54

QC71 Twin Parallel Head

- Dual filter head
- Parallel plumbed for two Nu-Plus E Series filters
- Built-in shut off, flushing valve
- Outlet pressure gauge included on the mounting bracket



Part #	Mfg #	Description	Price
CAL462102	4621-02	Twin Parallel Head	559.78

Nu-Plus EC10 Coarse Prefilter

- 10" Clear housing, including large capacity 10" replaceable prefilter cartridge
- Filters out larger dirt and rust particles
- Extends the life of submicron carbon filters



Part #	Mfg #	Description	Price
CAL462142	4621-42	10" Housing and Filter	126.48

Nu-Plus EC110 Cartridge

- 10" 10 Micron nominal sediment filter
- Filters out larger dirt and rust particles
- Extends the life of submicron carbon filters



Part #	Mfg #	Description	Price
CAL462141	4621-41	10" Sediment Filter	6.46

Nu-Plus EC210 Cartridge

- 20" 10 Micron nominal sediment filter
- Filters out larger dirt and rust particles
- Extends the life of submicron carbon filters



Part #	Mfg #	Description	Price
CAL462143	4621-43	20" Sediment Filter	13.52

Nu-Plus BH² Everpure Cartridge

- Premium quality water for ice and coffee applications
- Designed for applications where the i-20002 is too long
- NSF Certified under NSF/ANSI standard 42 & 53
- Precoat submicron particulate reduction
- Inhibits scale formation
- Taste & odor reduction



Part #	Mfg #	Description	Price
CAL462112	4621-12	Filter	98.14

Water System Accessories

Water System Accessories

Dickens Pitless Adapters

- Precision machined all red brass castings with neoprene o-ring
- Chamfered slide & wrench grip on ell
- Built-in lowering eyelet
- Large inner & outer rubber gaskets
- Pressure tested to 150 psi

Model JR-S-10



Part #	Mfg #	Discharge & Supply Pipe Size	Price
DICJRS10	952156	1"	87.54

Model LD-2-X

Part #	Mfg #	Discharge & Supply Pipe Size	Price
DICLD2X	952150	1-1/4" Upper 1" Lower	308.78

Model LD-S-12

Part #	Mfg #	Discharge & Supply Pipe Size	Price
DICLDS12	952112	1-1/4"	200.04

Model S-20

Part #	Mfg #	Discharge & Supply Pipe Size	Price
DICS20	952020	2"	402.56

Dickens Aluminum Well Caps

CC Style Aluminum Well Cap

- Cast aluminum alloy 319 - will not crack or warp
- Fitted for 1" conduit
- (3) Square head stainless steel cup point set screws
- Designed for 1/64" clearance fit to prevent foreign mater intrusion

Part#	Mfg #	Size	Price
DICCC6	952708	6"	32.88
DICCC8	952712	8"	60.46

Insert Fittings

Male Adapter



Part#	Mfg #	Size	Price
DICMA75100	952228	3/4" x 1"	14.30



Access Fittings

- Low cost port for refrigeration servicing
- 1/4" SAE Male flare access ports, quick seal cap and stainless and brass special refrigeration valve core

Threaded Tee



Part #	Mfg #	Description	Price
VITBMA14	VT28-4-4	1/4" Brs MIP x 1/4"OD Barb	2.62
VITBMA38	VT28-6-4	3/8" Brs MIP x 3/8"OD (1/4"ID) Barb	3.76

THANK YOU!
We appreciate your business

Well System Accessories

Dole Flow Control Valves

- Prevents over-pumping of low yield wells
- Installs in the discharge line between check valve and pressure drop range
- Self cleaning
- Maximum system pressure is 200 PSI

Part #	Mfg #	Description	Price
HARDV50	GC5.0	5 gpm 3/4" FIP x 3/4" FIP	54.78

Relief Valves

Relief Valves - RV - Domestic

- Heavy duty bronze for shallow, deep well and submersible pumps
- Spring loaded and set under pressure at 75 lbs, not adjustable
- 1/2" Discharge
- ISO 9001



Part #	Mfg #	Size	PSI	Price
HARRV50	RV50	1/2" x 1/2"	75	17.12
HARRV75	RV75	3/4" x 1/2"	75	17.68

Air Volume Controls

Brady Air Volume Control Features:

- Maintains water flow-stretches pump life
- Repairable & disposable offering
- Diaphragm-type air volume control maintains correct proportions of air & water in jet water systems
- Die cast, 96% zinc



Disposable Brady Air Volume Control

Part #	Mfg #	Tank Cap	Tank Conn	Pump Conn	Price
HARAV100	AV100	120	3/8" MPT	1/4" MCompr	37.86

Tank Accessories

Mounting Bracket

- Elevates pump out of corrosive atmosphere
- Rubber protectors on the pump stand legs prevent scratching of the tank



Part #	Mfg #	Description	Price
HARPMB1	PMB1	Gray Pump Mounting Bracket	22.60

Water System Accessories

Well System Accessories

Air Valve

- Used for reciprocating & submersible pumps to admit air to the system
- Used for charging applications
- Available in long & short patterns
- Light spring



Part #	Mfg #	Description	Price
HARSN18	SN18	1/8" Air Valve	2.24
HARSN25	SN25	1/4" Long, Air Valve	3.00

Submersible Installation Accessories

Deluxe PVC Torque Arrestor

- Molded from PVC
- Field adjustable to hold pump centered in well
- Fits all well casings from 4" - 8" ID
- Securely fastened to 1" or 1-1/4" drop pipe
- Includes Ideal stainless steel clamps



Part #	Mfg #	Description	Price
HARTA48	TA48	Bagged w/2 Clamps	12.50

Submersible Cable Guard

- Self-clamping or snap-in units
- Keeps power cable from abrading against the casing or natural side of the well
- A minimum of 3 - 5 should be used
- Adjustable for use in 4", 5" & 6" wells
- Made of polyethylene & will float

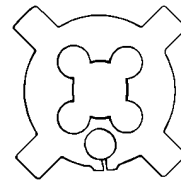

MG6



WG-100

Part #	Mfg #	Description	Price
HARMG6	MG6	Snap-In w/Hole, Fits 4" - 6" Casing	0.76
HARWG100	WG-100	1" Self Clamping, Fits 4" - 6"	2.70

Submersible Rope

- Custom extruded from tough polypropylene fiber (fiber that is highly resistant to chafing, abrasion & corrosion)
- Plastic reels



Part #	Mfg #	Color	Length	#	Price
HARMR25	MR25-500	Blue/Wht	500' Per Foot	1,000#	0.06

All Items May Not Be Stocked In All Branches

Well System Accessories

Pressure Gauges



Part #	Mfg #	Description	Price
HARPG100	IPG1002-4L	1/4" x 2" 100# Steel Case Dry	5.44
HARPG200	IPG2002-4L	1/4" x 2" 200# Steel Case Dry	5.44

Tank Fittings

Tank Tee Kit

Part #	Mfg #	Description	Price
HARTTKIT1	TTP1	1" with 30/50 Prs Switch	111.24
HARTTKIT1U	TTP-1U	1" w/Union w/30/50 Prs Switch	152.60
HARTTKIT2	TTP2	1" w/30/50 Prs Switch w/1" Check Valve	137.74
HARTTKIT2U	TTP-2U	1" w/Union & Check Valve & 30/50 Prs Switch	185.56
HARTTKIT3	TTP3	1" w/30/50 Low Water Cut-Off Prs Switch	120.10
HARTTKIT4	TTP4	1" w/Low Water Cut-Off & 1" Check Vlv	155.54
HARTTKIT5	TTP5	1-1/4" w/30/50 Prs Switch	138.76

Water System Accessories

Tank Crosses

Tank Cross - Long Cast Bronze

- Internal & external threads
- (1) 1/2" Drain port
- (2) 1/4" Top ports



Part #	Mfg #	Description	Price
HARTTBF1143-16	CHC125BF16	1-1/4" x 16" Bronze Cross Fab	77.12

"E" Series Tank Cross with Union Disconnect

- Metal to metal ball joint seal
- Internal & external threads
- (2) Drain ports
- (2) 1/4" Top ports



Part #	Mfg #	Description	Price
HARTTBUN14	CIC100BU	1" x 11" Bronze Cross	67.32

Well System Accessories

Drive Well Point Supplies

Galvanized Drive Couplings

- Heavy pattern with deep recess
- Assures proper driving of well points & standard pipe
- Taper tapped, reamed & drifted
- Imported



Part #	Mfg #	Pipe Size	Length	Price
HARDC125C114	DC125C	1-1/4"	2-3/4"	7.10

Insert Fittings

Cast Bronze Rope Insert Adapter (INS x MIP)

Part #	Mfg #	Size	Style	Price
HARBD100	RBRA 1	1" x 1"	Round w/Rope Eye	15.04

Water Systems Parts & Accessories

Tank Cross & Tee

- Internal & external threads reduce fittings needed & installation time
- Reduces turbulence & water logging in tanks without separate air chambers

Long Fabricated Bronze Cross for Fixed Diaphragm Tank

- One 1/2" drain port, two 1/4" top ports



Part #	Mfg #	Overall Length	Tank Conn	Leg Conn	Price
HARTTBF13	CHC100BF	11"	1"	1" x 3/4"	60.82

Long Bronze Fabricated Safety Cross

- Ports:

Drain	Top
- CIC100BF (2) 1/2"	(2) 1/4"
- CIC125BF (2) 3/4"	(2) 1/4"



Part #	Mfg #	Overall Length	Tank Conn	Leg Conn	Price
HARTTBF14	CIC100BF	11"	1"	1" x 3/4"	60.06
HARTTBF1144	CIC125BF	14"	1-1/4"	1-1/4" x 1"	74.26

Well System Accessories

Brass Pitless Adapter

- Cast from bronze to insure long life
- PT900 supports installations up to 2,000 lbs
- PT800 supports installations up to 900 lbs
- Extended casing nipple makes installation easy
- Rubber inner & outer casing gaskets for certified & approved water tight seal from ground water contamination
- Built-in lowering eyelet for easier installation
- One unit fits 5" - 7" well casing
- Nominal well casing ID is 5"
- All PT Series adapters are certified & approved watertight to PAS-97 standards



Part #	Mfg #	Drop Pipe Size	Well Casing OD	Max Load Cap	Price
HARPT800	PT800	1"	8"	900 lb	79.04
HARPT825	PT825	1-1/4"	8"	2,000 lb	145.66
HARPT900	PT900	1" & 1-1/4" (2)	7"	900 lb	394.64

C56V Cast-Iron Well Cap

- Heavy cast-iron construction
- Quick installation
- Blue paint finish for easy site location
- Includes assembly bolts
- Individually packaged
- Fits 5-5/8" & 6" well casing
- 1" Conduit opening
- Imported



Part #	Mfg #	Description	Price
HARC56	C56V	5-5/8", 6", 6-1/4" Multi-Size Well Cap w/1" Conduit Opening & Assembly Bolts	27.72

Well Cap Accessory

Cast Aluminum Well Cap

- Vermin-proof
- All stainless bolts and ground screws
- Molded 3/16" gasket



Part #	Mfg #	Description	Price
HARAWTC6	AWTC6	6" Aluminum Watertight Vermin-Proof Cap	104.54

Cast Iron Watertight Well Cap

- WC6 Fits 6" and 6-1/4"ID (6-5/8"OD) well casing
- Wide rubber gasket
- Blue powder coat paint finish
- Includes all hardware



Part #	Mfg #	Description	Price
HARWC6	WC6	6" Cast Iron Watertight	65.50

Water System Accessories

Prices & Specifications are Subject to Change.

Well System Accessories

Pump Accessories

Square D Pressure Switches

- Designed for the control of electrically driven water pumps
- Diaphragm actuated
- Differential increases with range
- Contacts open on increased pressure
- General purpose enclosure NEMA Type 1



Part #	Mfg #	Description	Price
HARPS2040	9013FSG2 20/40	110/220V 20/40 Std Pump	32.08
HARPS3050	9013FSG2 30/50	110/220V 30/50 Std Pump	32.08
HARPS4060	9013FSG2 40/60	110/220V 40/60 Std Pump	32.08
HARPSLWCO2040	9013FSG2M4 20/40	230V 20/40 Std Pressure	42.54
HARPSLWCO3050	9013FSG2M4 30/50	230V 30/50 Std Pressure	42.54

Pressure Switches

- Designed for the control of electrically driven water pumps



Part #	Mfg #	Description	Price
HARPS2040I	PS2040	20/40 Pressure Switch	16.34
HARPS3050I	PS3050	30/50 Pressure Switch	16.34
HARPSLWCO3050I	PS3050M4	30/50 LWCO Pressure Switch	17.32

Installation Accessories

Heat Shrink & Splice Kits

Heat Shrink Kit Features:

- Excellent dielectric strength & can be shrunk over a large diameter connector down to small diameter effectively



Part #	Mfg #	Description	Price
HARHS3	HS3	Splicing Kit for Wire Sizes #14, #12, #10 w/3 Tubes & 3 Butt Connectors	3.90

Compression Kit Features:

- Molded from high impact resistant polycarbonate
- No water absorption characteristics
- Available in 2, 3 & 4-wire kits
- No grease tape or epoxy needed
- Resists moisture, fungus & weathering



Part #	Mfg #	Description	Price
HARSK3	SK3	2-Wire Splicing Kit w/3 Tubes & 3 Butt Connectors	6.66

All Items May Not Be Stocked In All Branches

Well System Accessories

Tape, Sealants & Chemicals

General Purpose Electrical Tape

AWT60 Features:

- 0°F - 176°F Temperature range
- 7 mil Thick
- Black vinyl
- Tested to ASTM D-1000, UL & CSA listed



Part #	Mfg #	Width	Length	Price
HARAWT60	AWT60	3/4"	60'	2.04
HARAWT60-2	AWT60-2	2"	60'	5.82

Fasteners

Ideal Hy-Gear® Worm Drive Stainless Steel Clamp



Part #	Mfg #	Description	Price
HAR5056	5056	3" - 4" Dia 50 Series w/5/16" Hex Head	2.14
HAR5072	5072	3" - 5" Dia 50 Series w/5/16" Hex Head	2.46
HAR6810	6310	1/2" - 1-1/16" Dia 63 Series w/5/16" Hex Head	2.04
HAR6816	6316	11/16" - 1-1/2" Dia 63 Series w/5/16" Hex Head	2.06
HAR6820	6320	3/4" - 1-3/4" Dia 63 Series w/5/16" Hex Head	2.10
HAR6416	6416	11/16" - 1-1/2" Dia 64 Series w/3/8" Hex Head	1.90
HAR6444	6444	2-1/4" - 3-1/4" Dia 64 Series w/3/8" Hex Head	2.84
HAR6808	6808	7/16" - 1" Dia 68 Series w/5/16" Hex Head	2.04
HAR6812	6812	1/2" - 1-1/4" Dia 68 Series w/5/16" Hex Head	2.06
HAR6824	6824	1" - 2" Dia 68 Series w/5/16" Hex Head	2.10
HAR6832	6832	1-1/2" - 2-1/2" Dia 68 Series w/5/16" Hex Head	2.12
HAR6836	6836	1-3/4" - 2-3/4" Dia 68 Series w/5/16" Hex Head	2.22
HAR6852	6852	2-3/4" - 3-3/4" Dia 68 Series w/5/16" Hex Head	2.98
HAR6864	6864	2-1/2" - 4-1/2" Dia 68 Series w/5/16" Hex Head	3.28
HAR6880	6880	3-1/2" - 5-1/2" Dia 68 Series w/5/16" Hex Head	3.54

Ideal Micro-Gear® Worm Drive Stainless Steel Clamp



Part #	Mfg #	Description	Price
HAR6202	6204	1/4" - 5/8" Dia 62P Series w/1/4" Hex Head	1.24

Water System Accessories

Well System Accessories

Hydrants

Frost Proof Yard Hydrants

- Shut-off valve operates below the frost line
- Pistol type handle eliminates pinching
- Can be padlocked
- Wheel handle controls water flow
- Solid brass rod will not rust or cut into packing
- Water in standpipe drains out when hydrant is off
- Brass nozzle threaded for standard 3/4" hose coupling
- Inner ports removable without digging
- Maximum pressure: 80 psi
- Made in USA

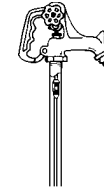

Water System Accessories

Part #	Mfg #	Bury Depth	Overall Length	Price
HARH803	H803	3'	65-1/2"	150.74
HARH804	H804	4'	77-1/2"	161.56
HARH805	H805	5'	89-1/2"	172.40
HARH806	H806	6'	101-1/2"	186.02

Yard Hydrant Repair Kit

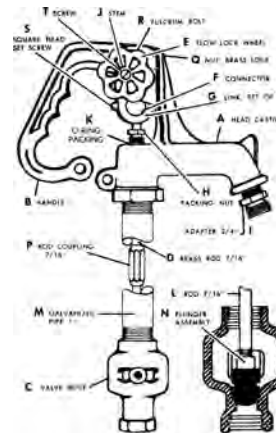

Part #	Mfg #	Description	Price
HAR840	840	Complete Head Assembly for H800 Series Hydrants	79.34
HAR850	H850	Yard Hydrant Parts Kit (Incl: F,G,H,K,N,Q,R,S)	38.62

Check Valves

Simmons Lead Free Brass Check Valve

- Silicon bronze cast body and poppet
- Buna-N O-ring, stainless steel spring, washer and lock nut
- 400 PSI (WOG working pressure)
- Made in U.S.A.



Part #	Mfg #	Simmons #	Size	Price
HARCVSP12	LF5100 1/2	501SB	1/2"	44.62
HARCVSP34	LF5100-3/4	502SB	3/4"	45.18
HARCVSP1	LF5100-1	503SB	1"	47.56
HARCVSP114	LF5100-1-1/4	504SB	1-1/4"	65.20

All Items May Not Be Stocked In All Branches

Well System Accessories

Check Valves (Continued)

Simmons Lead Free Brass Check Valve

Part #	Mfg #	Simmons #	Size	Price
HARCVSP112	LF5100-1-1/2	505SB	1-1/2"	91.12
HARCVSP2	LF5100-2	506SB	2"	147.42

Simmons Lead Free Brass Check Valve Control Center

- Silicon bronze components
- Made in U.S.A.



Simmons

Part #	Mfg #	Simmons #	Size	Price
HARCC1	LF5100C-1	601SB	1"	65.28
HARCC114	LF5100C-1-1/4	601SB	1-1/4"	84.54

Swing Check Valves

Threaded Brass Swing Check Valves

- Working pressure non-shock: 200 PSI WOG
- Test pressure: 110 psi (shell), 40 psi (seat)
- Brass disc
- Imported



Part #	Mfg #	Size	Price
HARCV12T	HSCV50T	1/2" IPS	17.68
HARCV34T	HSCV75T	3/4" IPS	20.66
HARCV1T	HSCV100T	1" IPS	27.56
HARCV114T	HSCV125T	1-1/4" IPS	42.88
HARCV112T	HSCV150T	1-1/2" IPS	54.10
HARCV2T	HSCV200T	2" IPS	83.30
HARCV212T	HSCV250T	2-1/2" IPS	163.32
HARCV3T	HSCV300T	3" IPS	220.56

Sweat Brass Swing Check Valve

- Working pressure non-shock: 200 PSI WOG
- Heavy duty cast brass construction
- Imported
- ISO 9001



Part #	Mfg #	Size	Price
HARCV12S	HSCV50S	1/2" CxC	17.80
HARCV34S	HSCV75S	3/4" CxC	21.26
HARCV1S	HSCV100S	1" CxC	28.06
HARCV114S	HSCV125S	1-1/4" CxC	46.18
HARCV112S	HSCV150S	1-1/2" CxC	53.38
HARCV2S	HSCV200S	2" CxC	89.18

Prices & Specifications are Subject to Change.

Well System Accessories

Foot Valves

Lead Free Brass Foot Valve

- 400 psi Working pressure
- Silicon bronze cast body and poppet
- Stainless steel perforated screen
- Made in U.S.A.



Simmons

Part #	Mfg #	Simmons #	Size	Price
HARFV34	LF5000S-3/4	452SB	3/4"	39.80
HARFV1	LF5000S-1	453SB	1"	44.22
HARFV114	LF5000S-1-1/4	455SB	1-1/4"	53.32
HARFV112	LF5000S-1-1/2	456SB	1-1/2"	86.14
HARFV2	LF5000S-2	457SB	2"	136.62

Water System Accessories

Water Filtration

Vu-Flow T Style Sand Separator Filter

- "Spin-out" action separates heavier than water particles away from screen into chamber
- Screen portion of element removes lighter than water particles
- Extended sump provides greater collection area for sediment
- Supplied with a 1/2" MPT ball style purge valve
- Maximum pressure: 150 psi @ 73°F



VU-FLOW

IPS x IPS (Male Thread 3/4" Only)

Part #	Mfg #	Inlet/Outlet	Mesh #/Size	Mesh Opening	Price
HARPFSS75250ESP	NT75SO-250P	3/4" x 3/4"	250(61mic)	0.0024	115.96

Sump & Sewage Accessories

SPDK Sump Pump Discharge Kits

- 24' Corrugated polyethylene tubing with 8' cutting intervals
- 1-1/4" Full size plastic male adapter with stainless steel clamp
- Pump not included

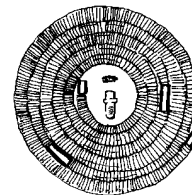

Part #	Mfg #	Description	Price
HARSPK112	SPDK-150M	Reducing Male Adapter 1-1/2" MIP x 1-1/4" INS to Fit 1-1/2" Female Discharge	16.04

Water System Accessories

Chem-Tech Chemical Feed Pumps

Series 100 Chemical Feed Pump

- Positive displacement diaphragm metering pump
- Operating pressure up to 100 PSI
- Life-time lubricated, sealed and self-maintaining gear train
- Four ball valve design
- Strong chemical resistant, flame retardant housing
- Metal reinforced, short-stroke diaphragm
- Injection back pressure valve assembly
- Bleed valve assembly
- 1/2"OD Tube size
- UL and CSA Approved for outdoor and indoor
- Manufactured in ISO9002 facility



Part #	Mfg #	Description	Price
CFPP130115V	030-115	115V 30 gal Feed Range	595.68
CFPP130230V	030-230	230V 30 gal Feed Range	625.62

**Water System
Accessories**

***We are continually adding new products.
Please call us with your inquires.***

Water System Accessories

Insert Fittings

Cast Bronze Coupling (INS x INS)



Part #	Mfg #	Size	Style	Price
INFBCPLG12	RBC1/2	1/2" x 1/2"	Hex	7.76
INFBCPLG34	RBC3/4	3/4" x 3/4"	Hex	11.17
INFBCPLG1	RBC1	1" x 1"	Hex	15.33
INFBCPLG114	RBC11/4	1-1/4" x 1-1/4"	Hex	22.34
INFBCPLG112	RBC11/2	1-1/2" x 1-1/2"	Hex	23.27
INFBCPLG2	RBC2	2" x 2"	Hex	32.93

Cast Bronze Elbow (INS x INS)



Part #	Mfg #	Size	Price
INFB901	RBE1	1" x 1"	23.89
INFB90114	RBE11/4	1-1/4" x 1-1/4"	37.36

Cast Bronze Tee (INS x INS)



Part #	Mfg #	Size	Price
INFBT1	RBT1	1" x 1"	26.67

Cast Bronze Male Insert Adapter (INS x MIP)



Part #	Mfg #	Size	Style	Price
INFBMA12	RBMA1/2	1/2" x 1/2"	Hex	7.92
INFBMA34	RBMA3/4	3/4" x 3/4"	Hex	10.58
INFBMA1	RBMA1	1" x 1"	Hex	16.21
INFBMA114-1	RBMA11/4X1	1-1/4" x 1"	Hex	19.70
INFBMA114	RBMA11/4	1-1/4" x 1-1/4"	Hex	21.12
INFBMA112	RBMA11/2	1-1/2" x 1-1/2"	Hex	25.61
INFBMA2	RBMA2	2" x 2"	Hex	43.96

Cast Bronze Female Insert Adapter (INS x FIP)



Part #	Mfg #	Size	Style	Price
INFBFEA34	RBFA3/4	3/4" x 3/4"	Round	22.40
INFBFEA1	RBFA1	1" x 1"	Round	19.53
INFBFEA114	RBFA11/4	1-1/4" x 1-1/4"	Round	24.64

Cast Bronze Hydrant Elbow (INS x MIP)



Part #	Mfg #	Size	Price
INFBHE34	RBHE3/4	3/4" x 3/4"	13.88
INFBHE1-34	RBHE1x3/4	1" x 3/4"	19.27

Cast Bronze Hydrant Tee (INS x MIP)



Part #	Mfg #	Size	Price
INFBHT1-34	RBHT1x3/4	1" x 3/4"	26.18

Red Brass Insert Coupling (INS x INS)



Part #	Mfg #	Size	Price
INFDBCPLG12	B10-1/2	1/2"	20.76
INFDBCPLG34	B10-3/4	3/4"	23.36
INFDBCPLG1	B10-1	1"	34.84
INFDBCPLG114	B10-11/4	1-1/4"	53.33

Red Brass Insert Coupling (MIP x INS)



Part #	Mfg #	Size	Price
INFDBMA12	B12-1/2	1/2"	15.71
INFDBMA34	B12-3/4	3/4"	19.67
INFDBMA1-34	B74-1X34	3/4" x 1"	35.96
INFDBMA1	B12-1	1"	25.57
INFDBMA114	B12-11/4	1-1/4"	45.73
INFDBMA112	B12-11/2	1-1/2"	55.76
INFDBMA2	B12-2	2"	73.00

Red Brass Insert Coupling (FIP x INS)

Part #	Mfg #	Size	Price
INFDBFEA1	B90-1	1"	48.76

PVC Insert Fitting

Part #	Mfg #	Description	Price
INFPF9034-12	1407-101	3/4" x 1/2" PVC Female 90° Elbow (INSxFIP)	1.75
INFPFEA12	1435-005	1/2" PVC Female Adapter (INSxFIP)	3.38
INFPMA1-34	1436-102	1" x 3/4" PVC Male Adapter (INSxMIP)	2.48
INFPMA112-114	1436-212	1-1/2" x 1-1/4" PVC Male Reducer (MIPxINS)	3.45

All Items May Not Be Stocked In All Branches

Water System Accessories

Nylon Insert Fitting

Nylon Plug



Part #	Mfg #	Description	Price
INFNT12	N401-005	1/2" Nylon Tee	1.69
INFNT34	N401-007	3/4" Nylon Tee	2.00
INFNT1	N401-010	1" Nylon Tee	3.18
INFNT114	N401-012	1-1/4" Nylon Tee	5.45
INFNT112	N401-015	1-1/2" Nylon Tee	7.71
INFNT2	N401-020	2" Nylon Tee	10.42
INFN9012	N406-005	1/2" Nylon 90° Elbow	1.44
INFN9034	N406-007	3/4" Nylon 90° Elbow	1.64
INFN901	N406-010	1" Nylon 90° Elbow	2.00
INFN90114	N406-012	1-1/4" Nylon 90° Elbow	3.36
INFN90112	N406-015	1-1/2" Nylon 90° Elbow	5.13
INFN902	N406-020	2" Nylon 90° Elbow	6.85
INFNM9012	N413-005	1/2" Nylon Male 90° Elbow	2.52
INFNM9034	N413-007	3/4" Nylon Male 90° Elbow	3.50
INFNM901	N413-010	1" Nylon Male 90° Elbow	4.94
INFNM90114	N413-012	1-1/4" Nylon Male 90° Elbow	6.48
INFNM90112	N413-015	1-1/2" Nylon Male 90° Elbow	9.64
INFNCPLG12	N429-005	1/2" Nylon Coupling	0.87
INFNCPLG34	N429-007	3/4" Nylon Coupling	1.02
INFNCPLG1	N429-010	1" Nylon Coupling	1.34
INFNCPLG114	N429-012	1-1/4" Nylon Coupling	2.44
INFNCPLG112	N429-015	1-1/2" Nylon Coupling	3.28
INFNCPLG2	N429-020	2" Nylon Coupling	4.16
INFNMA12	N436-005	1/2" Nylon Male Adapter	0.87
INFNMA34	N436-007	3/4" Nylon Male Adapter	1.07
INFNMA1	N436-010	1" Nylon Male Adapter	1.34
INFNMA114	N436-012	1-1/4" Nylon Male Adapter	2.16
INFNMA112	N436-015	1-1/2" Nylon Male Adapter	3.11
INFNMA2	N436-020	2" Nylon Male Adapter	4.88

Steel Insert Fitting

Part #	Mfg #	Description	Price
INFGCPLG12	S10-1/2	1/2" Steel Coupling	3.94
INFGCPLG34	S10-3/4	3/4" Steel Coupling	4.68
INFGCPLG1	S10-1	1" Steel Coupling	6.15
INFGCPLG114	S10-11/4	1-1/4" Steel Coupling	8.98
INFGCPLG112	S10-11/2	1-1/2" Steel Coupling	10.04

Insert Fittings (Continued)

Steel Insert Fitting

Part #	Mfg #	Description	Price
INFGCPLG2	S10-2	2" Steel Coupling	18.50
INFGMA12	S12-1/2	1/2" Steel Male Adapter	4.36
INFGMA34	S12-3/4	3/4" Steel Male Adapter	4.55
INFGMA1	S12-1	1" Steel Male Adapter	5.82
INFGMA112	S12-11/2	1-1/2" Steel Male Adapter	9.14
INFGMA114	S12-11/4	1-1/4" Steel Male Adapter	7.37
INFGMA2	S12-2	2" Steel Male Adapter	13.56
INFGMA114-1	S38-1 1/4 X 1	1-1/4" x 1" Galv Steel Male Adapter	23.23
INFGWSE1	S99-1	1" Steel Well Seal Elbow	24.49

Stainless Steel Insert Fitting

Part #	Mfg #	Description	Price
INFSSMA1	SSMA1	1" Stainless Steel Male Adapter	12.30
INFSSMA114-1	SSMA-1-1/4X1	1" x 1-1/4" Stainless Steel Male Adapter	14.71
INFSSMA114	SSMA1 1/4	1-1/4" Stainless Steel Male Adapter	16.47

Pentek Filter Cartridges



String Wound Sediment Cartridge

- String wound polypropylene
- Ideal for fine sediment reduction, including sand, silt, scale and rust
- Compatible with most acids, alkalies, corrosive fluids and gases
- FDA Polypropylene core
- Maximum temperature is 180°F
- General purpose filtration



Part #	Mfg #	Description	Price
PURSW05	PFWP5	5 Micron 9-7/8"L 2-3/8" Dia Std Housings	6.00
PURSW20	PFWP20	20 Micron 9-7/8"L 2-3/8" Dia Std Housings	5.46
PURSW05BB	PFWP5BB97P	5 Micron 9-7/8"L 4-1/2" Dia Lg Dia Housings	27.86

Prices & Specifications are Subject to Change.

Water System Accessories

Filtration

Granulated Activated Carbon Cartridge

- For removal of taste, odor, organic chemicals and chlorine

Part #	Mfg #	Description	Price
PURGAC10	EFGAC10	2-1/2" x 9-3/4" for Slim Std Housing	18.36
PURPCW25BB	EFGACBB	4-1/2" x 9-3/4" for Large Dia Housing	55.86

EFW Series Economy Sediment Filter Cartridge

- Excellent depth filtration
- FDA Grade polypropylene fibers
- Polypropylene center tubes
- For temperature to 140°F



Part #	Mfg #	Description	Price
PURSW052	EFWP5-20	5 Micron 20"L 2-1/2" Dia Std/Slim Housings	21.60

MacClean Filter Cartridge

Part #	Mfg #	Description	Price
PURILTO2	H20H-10	Taste-X Filter w/1/4" Ftgs - MacClean	39.78

Large Diameter Housing

- With pressure relief for 4-1/2"OD cartridges
- NSF Listed, FDA grade 100% polypropylene
- EPDM O-ring seals
- Rated for temperatures to 125°F and pressures to 125 PSI



Part #	Mfg #	Description	Price
PURFHO234	EH75B20P	3/4" x 20" Blue Housing	95.76
PURFHOB01	CF82N	1" x 10" MacClean	173.50

EH Series Filter Housing Kit

- Complete with mounting bracket (with stainless steel screws) and sump removal wrench



Part #	Mfg #	Description	Price
PURFHT34	EFHP75CSLWP	3/4"x10" Clear Slim Housing for 2-1/2"OD Cartridges	56.12
PURFHT34VSS	EFHP75VCP	3/4"x10" Clear Slim VIH Housing for 2-1/2"OD Cartridges	102.30



UV Parts and Accessories

Part #	Mfg #	Description	Price
ULVSVBALLAST	4-1201	4-1514 Ballast for SV7/10 Ideal Horizons	167.60
ULVSVLAMP	42005	SV7/10 Replacement Lamp for UV Filters	106.00
ULVAQ35492	AQ35492	Quartz O-Ring for GU10P	25.10
ULVAQ36648	AQ36648	Quartz O-Ring for GU10P	98.42
ULVAQ38382	AQ38382	Control for DLR2AP	634.42
ULVDLR2LAMP	NLR1845WS-AQ37086	Replacement Lamp for GU10PNLR1845WS	186.36
ULVSVQUARTZ	QTZD007	SV-7/10 Quartz Replacement Ideal Horizons ST00	53.82



Touch-Flo® Faucets

Touch-Flo® Short Reach Faucet

- 5" Height, 3" reach
- Unbreakable celcon handle
- 1/4" Compression input
- Adapters available for 3/8" & 1/2"
- 7/16" Hole required for installation



Part #	Mfg #	Description	Price
TOF03CP	0-3/CH	Chrome Gooseneck	62.70

Plumbing Valves

Ball Valves

HMIP PVC Ball Valves



Part #	Mfg #	Description	Price
P40BV12	HMIP50S	1/2" S x S	8.54
P40BV34	HMIP75S	3/4" S x S	11.46
P40BV1	HMIP100S	1" S x S	11.60
P40BV114	HMIP125S	1-1/4" S x S	18.38
P40BV112	HMIP150S	1-1/2" S x S	23.47
P40BV2	HMIP200S	2" S x S	32.01

PVC Ball Valves

PVC Schedule 80 Ball Valve (SOC)



Part #	Size	Price
P80BV12	1/2"	3.68
P80BV34	3/4"	4.69
P80BV1	1"	6.72
P80BV114	1-1/4"	10.39
P80BV112	1-1/2"	30.85
P80BV2	2"	19.39



CPVC Valves

CPVC Globe Stop Valves (Slip x Slip)

Part #	Size	Price
CPVSV12	1/2"	6.58
CPVSV34	3/4"	7.35

CPVC Compact Ball Valve (Soc x Soc)



Part #	Size	Price
CPVBV12	1/2"	9.77
CPVBV34	3/4"	12.16

CPVC Stop & Waste Valve (Soc x Soc)

Part #	Size	Price
CPVSW12	1/2"	7.49
CPVSW34	3/4"	7.36

CPVC Commercial Lo-Torque Ball Valve (CTS Hub x CTS Hub)

- Red handle

Part #	Size	Price
CPVBVC12	1/2"	6.87
CPVBVC34	3/4"	8.25
CPVBVC1	1"	10.14
CPVBVC112	1-1/2"	21.60
CPVBVC2	2"	37.60



Balancing Valves

RPV Series Residential Purge and Balancing Valve

- For start-up purging & balancing of hydronic heating loops
- Rugged, dual-ball valve design
- Purges 500' loop in 10 seconds
- Accurate balancing & drip tight shutoff
- Maximum inlet temperature 250°F
- Maximum working pressure: 50 psi
- 180° Relief port



Part #	Mfg #	Model	Size	Option	Price
WATRPV34S	0207510	RPV-S	3/4"	Swt	49.60
WATRPV1S	0207514	RPV-S	1"	Swt	83.60

PB56 Model Purge and Balancing Valve

- For exceptionally high capacity purging
- Self-contained, tight-seating ball type
- Balancing adjustment, bronze body
- 3/4" Inlet x outlet solder with 3/4" male hose thread connection for blow-off
- Maximum temperature: 250°F
- Maximum pressure: 50 psi



Part #	Mfg #	Model	Size	Price
WATPB5634	0207500	PB56	3/4"	42.25

Balancing Valves

Alliance Anti-Sweat Temperator Valve

- For water closet tanks
- Solid cast brass body
- 3/8"-18 NPT Male taper thread



Part #	Mfg #	Description	Price
CEB555D	0555-D	Valve with Drain	44.50

Plumbing Valves

Prices & Specifications are Subject to Change.

Plumbing Valves

Water Pressure Regulators

25AUB Series Water Pressure Reducing Valve (FNPT Union Inlet x FNPT Outlet)

- Bypass capability
- Standard capacity water pressure regulators
- Provides accurate water pressure control for residential and commercial
- Stainless steel integral strainer
- High temperature resistant diaphragm
- Renewable stainless steel seat
- Serviceable in-line
- Temperature range: 33° - 160°F
- Maximum working pressure: 300 psi
- Adjustable reduced pressure range: 25 - 75 psi
- Standard reduced pressure setting: 50 psi
- Suffix Option:
 - Z3 = Sealed spring cage, corrosion-resistant adjusting and cage screws for waterworks installations



Part #	Mfg #	Model	Size	Option	Price
WAT25AUB12	0068524	25AUBZ3	1/2"	Z3	189.00
WAT25AUB34	0069717	25AUBZ3	3/4"	Z3	206.80
WAT25AUB1	0069974	25AUBZ3	1"	Z3	273.15
WAT25AUB112	0070322	25AUBZ3	1-1/2"	Z3	815.65
WAT25AUB2	0070336	25AUBZ3	2"	Z3	1286.50

N55B Series Water Pressure Reducing Valve (FNPT Union Inlet x FNPT Outlet)

- Integral stainless steel strainer with built-in bypass
- Bypass feature controls thermal expansion pressure if inlet pressure is less than 150 psi
- Thermoplastic seat and cage
- Bronze body construction
- Serviceable in-line
- Sealed spring cage on all models for waterworks pit installations
- Maximum working pressure: 400 psi
- Adjustable reduced pressure range: 25 - 75 psi
- Standard reduced pressure setting: 50 psi



N55BM1

Part #	Mfg #	Model	Size	Price
WATN55BU34	0007712	N55BUM1	3/4"	150.30

ASME Steam Boiler Safety Valves

ASME Steam Safety Relief Valves (MNPT Inlet x FNPT Outlet - Drain)

- ASME Section IV
- For low pressure steam heating equipment
- Non-sticking Teflon® disc
- Seat located above drain
- Standard relief set pressure: 15 psi



Part #	Mfg #	Model	Size	Discharge Cap @ 15 psi	Price
WAT31534	0342615	315-M1	3/4" x 3/4"	375lbs/hr	84.20
WAT41534	0346045	415-M1	3/4" x 3/4"	450lbs/hr	118.20

All Items May Not Be Stocked In All Branches

Plumbing Valves

ASME Hot Water Boiler Relief Valves

Boiler Pressure Relief Valve

- ASME Section IV
- For hot water heating and supply boilers
- Pressure protection only
- Standard pressure relief setting: 30 psi



174A Bronze Body (FNPT Inlet x Outlet - Drain)

Part #	Mfg #	Model	Size	PSI	Price
WAT174A3430	0274428	174A	3/4"	30	108.80
WAT174A3450	0274513	174A	3/4"	50	119.55
WAT174A34125	0274751	174A	3/4"	125	119.55
WAT174A34150	0274836	174A	3/4"	150	119.55
WAT174A130	0274934	174A	1"	30	231.90

374A Iron Body with Bronze Inlet (FNPT Inlet x Outlet)

- 550,000 BTUH Rating

Part #	Mfg #	Model	Size	PSI	Price
WAT374A34	0358553	374A	3/4"	30	61.00

T&P Safety Relief Valves

Self-Closing T&P Valve

- For hot water storage tanks and heaters
- Thermo-bonded (non-metallic) protective coating on thermostat
- Fully automatic, includes test levers
- Bronze body with stainless steel spring

100XL Series ASME (MNPT Inlet x FNPT Outlet)

- ASME Section IV
- For tanks and heaters with extra thick insulation, use Watts L100XL or LL100XL
- For new generation water heaters containing extra thick insulation, send for literature ES-SL100XL/LLL100XL
- Prefix option:
 - L has extended inlet shanks for water heaters with extra thick insulation
- Suffix option:
 - XL-8 With 8" extension thermostat



Part #	Mfg #	Model	Size	PSI	Price
WATTP150L	0066133	L100XL3	3/4"	150	40.35
WATTP150	0066100	100XL4	3/4"	150	21.80
WATTP175	0066103	100XL4	3/4"	175	38.40
WATTPL150	0066110	100XL8	3/4"	150	24.30

Plumbing Valves

Plumbing Valves

40 Series ASME Automatic Reseating T&P Valves

- ASME Section IV
- For hot water supply tanks and heaters
- Fully automatic, tamper-resistant bonnet screws
- Series 40 and 140 feature unique thermostat with special thermo-bonded coating
- Series 140 sizes 1" and above are standardly furnished with stainless steel thermostat tube
- Bronze body construction
- Suffix Option:
 - XL = Test lever and extension thermostat



ASME (MNPT Inlet x FNPT Outlet)

Part #	Mfg #	Model	Size	PSI	Price
WAT40XL34	0156731	40XL5	3/4"	150	177.65
WAT40XL1	0163725	40XL4	1"	150	281.20

Pressure Relief Valves

Poppet Type Water Heater Pressure Relief Valves

- For protection against excessive pressure and pressure emergency conditions
- Fully automatic, includes test levers

3L ASME (MNPT Inlet x FNPT Outlet)

- Used in conjunction with Model 210 Gas Shut-off Valve on gas water heaters to shut off gas to heater at 210°F



Part #	Mfg #	Model	Size	PSI	Price
WAT3L	0011917	3L	3/4"	150	53.20

Water Heater Pressure Relief Valves

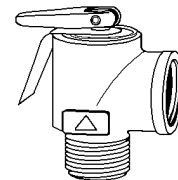

Part #	Mfg #	Model	Size	PSI	Price
WAT33534	0342670	335	3/4"	30	59.55
WATM33534	0342671	M335M1	-	30	59.55

Plumbing Valves

Plumbing Valves

Backflow Preventers

007 Double Check Valve Assemblies

- Protect potable water supplies in accordance with national plumbing codes
- For non-health hazard cross connections and continuous pressure applications
- Top entry
- Replaceable seats and seat discs
- Modular construction, compact design
- Max working pressure: 175 psi
- 1/2"-1" Tee handles
- Suffix Option:
 - QT = 1/4-Turn ball valves



007M2QT/007M3Q

007 Temperature Range: 33° - 180°F

- Cast bronze body

Part #	Mfg #	Model	Size	Option	Price
WAT007M1QT34	0062020	007M3QT	3/4"	QT	427.80
WAT007M1QT1	0062306	007M1QT	1"	QT	485.30
WAT007M2QT112	0062616	007M2QT	1-1/2"	QT	899.10
WAT007M1QT2	0062427	007M1QT	2"	QT	1008.05

009 Series RPZ Backflow Preventer

- Protection from high hazard cross-connections or containment at the service line entrance
- For continuous pressure use; protects against both back siphonage and back pressure backflow
- Modular construction, replaceable seats
- Captured springs
- (2) In-line independent check valves with intermediate relief valve
- Protects potable water supplies in accordance with national plumbing codes and water utility authority requirements
- Standard ball type test cocks
- Maximum working pressure: 175 psi
- Suffix options:
 - QT = 1/4-Turn full port resilient seated bronze valve shut-offs



Part #	Mfg #	Model	Size	Option	Price
WAT009QT34	0063030	009M3QT	3/4"	QT	746.85
WAT009QT1	0063020	009M2QT	1"	QT	882.10
WAT009QT114	0062920	009M2QT	1-1/4"	QT	1383.70
WAT009QT112	0062921	009M2QT	1-1/2"	QT	1448.85
WAT009QT2	0063010	009M2QT	2"	QT	1719.20

Repair Kit for Series 009

1/4" to 1/2" Repair Kit for Series 009

Part #	Mfg #	Model	Part	Price
WATRK009M2RT114-112	0887309	RK009M2RT	Complete Rubber	96.70

Plumbing Valves

3/4" Repair Kit for Series 009

Part #	Mfg #	Model	Part	Price
WATRK009M2RT34	0886999	RK009M2RT	Total Rubber	62.55

3/4" to 1" Repair Kit for Series 009

Part #	Mfg #	Model	Part	Price
WATRK009RT34-1	0887182	RK009RT	Total Rubber	65.10

1" Repair Kit for Series 009

Part #	Mfg #	Model	Part	Price
WATRK009M2RT1	0887787	RK009M2RT	Total Rubber	62.55

1-1/4" to 2" Repair Kit for Series 009

Part #	Mfg #	Model	Part	Price
WATRK009RT114-2	0887185	RK009RT	Total Rubber	135.80
WATRK009M1RT114-2	0887280	RK009M1RT	Total Rubber	104.85

2" Repair Kit for Series 009

Part #	Mfg #	Model	Part	Price
WATRK009M2RT2	0887547	RK009M2RT	Total Rubber	97.85

909 Series RPZ Backflow Preventer - Bronze Sizes 3/4" - 2"

- For health hazard cross connections and continuous pressure applications
- Unique patented "air-in/water-out" design
- Provides protection in cross-connection control and containment for cold and hot water installations
- Bronze body construction
- Replaceable seats
- Ball valve test cocks
- Captured spring assemblies
- Sizes 3/4" - 1", female threaded NPT valve body connections; sizes 1-1/4" - 2", male threaded NPT valve body connections
- 3/4" and 1" Shut-offs have tee handles
- Temperature range: 33° - 110°F continuous, 140°F intermittent
- Maximum working pressure: 175 psi
- Suffix Option:
 - QT = 1/4-Turn full port resilient seated bronze valve shutoffs



909QT

Part #	Mfg #	Model	Size	Option	Price
WAT909QT34	0387121	909QT	3/4"	QT	1256.55
WAT909QT1	0387129	909QT	1"	QT	1483.10
WAT909QT114	0385717	909M1QT	1-1/4"	QT	2327.70
WAT909QT112	0385718	909M1QT	1-1/2"	QT	2509.90
WAT909QT2	0385719	909M1QT	2"	QT	2890.65

Plumbing Valves

Repair Kits for Series 909



RK909M1RT

3/4" to 1" Repair Kit for Series 909

Part #	Mfg #	Model	Part	Price
WATRK909RT34-1	0887130	RK909RT	Complete Rubber	69.25

1-1/4" to 2" Repair Kit for Series 909

Part #	Mfg #	Model	Part	Price
WATRK909RT114-2	0887144	RK909M1RT	Complete Rubber	106.80

2-1/2" to 3" Repair Kit for Series 909

Part #	Mfg #	Model	Part	Price
WATRK909RT212-3	0887750	RK909RT	Complete Rubber	306.70

4" Repair Kit for Series 909

Part #	Mfg #	Model	Part	Price
WATRK909RT4	0887751	RK909RT	Complete Rubber	405.35

4" & 6" Repair Kit for Series 909

Part #	Mfg #	Model	Part	Price
WATRK909RV4-6	0887232	RK909RV	Rubber Parts	228.10

6" Repair Kit for Series 909

Part #	Mfg #	Model	Part	Price
WATRK909RT6	0887752	RK909RT	Complete Rubber	425.45

9D Series Dual Check Valve with Intermediate Atmospheric Vent Backflow Preventer

- Continuous pressure applications
- Maximum temperature: 250°F
- Maximum pressure: 175 psi
- Minimum pressure: 25 psi



Part #	Mfg #	Model	Size	Price
WAT9D12	0061935	9DM3	1/2"	156.90
WAT9D34	0061888	9DM2	3/4"	159.45

Plumbing Valves

Prices & Specifications are Subject to Change.

Plumbing Valves

7 Series Dual Check Backflow Preventer

- For use at the drinking water supply service entrance or with individual outlets
- For non-health hazard residential water system containment and continuous pressure applications
- Brass body construction
- Uses two compact replaceable check modules
- Buna-N seals and stainless steel springs
- Can be installed vertically or horizontally



Part #	Mfg #	Model	Size	Conn	Price
WAT712	0061783	7U22	1/2"	Union	109.40
WAT734	0061791	7U22	3/4"	Union	117.80
WAT71-34	0061814	7U43	1" x 3/4"	F Mtr x MNPT	126.75
WAT71	0061793	7U22	1"	Union	129.85

Vacuum Breakers

288A Series Anti-Siphon Irrigation Vacuum Breaker (FNPT)

- To prevent back siphonage of contaminated water into potable water supply
- Health hazard cross-connections not subject to continuous pressure
- Maximum temperature: 180°F
- Maximum working pressure: 125 psi



Part #	Mfg #	Model	Size	Finish	Price
WAT288A12	0336400	288A	1/2"	Plain Brass	65.20
WAT288A34	0336410	288A	3/4"	Plain Brass	77.10
WAT288A1	0336416	288A	1"	Plain Brass	120.40

Plumbing Valves

8 Series Hose Connection Vacuum Breaker

- Health hazard, back siphonage protection, non-continuous supply
- Brass bodies
- For attaching to sill cocks and other hose connections
- 3/4" Hose thread female inlet x 3/4" hose thread male outlet connection

8 Removable Non-Draining Vacuum Breaker (FHT x MHT)

- Secured with allen wrench



Part #	Mfg #	Model	Size	Finish	Price
WAT8	0061982	8	3/4"	RB	45.00

8A Non-Removable Drainable Vacuum Breaker (FHT x MHT)

- Should only be installed on approved sillcocks containing at least 4 full threads



Part #	Mfg #	Model	Size	Finish	Price
WAT8A	0061877	8A	3/4"	RB	47.10

All Items May Not Be Stocked In All Branches

Plumbing Valves

NF8 Manual Draining for Freeze Conditions Vacuum Breaker (FHT x MHT)

- Especially made for wall and yard hydrants



Part #	Mfg #	Model	Size	Finish	Price
WATNF8	0061854	NF8	3/4"	RB	63.30

Air Gaps

- For use with backflow preventers on horizontal installations
- Can be easily mounted to body



Part #	Mfg #	Model	Size	Price
WATAGA	0881399	909AGA	1/2"	51.60
WATAGC	0881376	909AGC	3/4" - 1"	63.95
WATAGF	0881378	909AGF	1-1/4" - 3"	130.05
WATAGK	0881385	909AGK	4" - 6"	263.20

Tempering/Mixing Valves

1170 Series Hot Water Temperature Control Valve

- Mixes hot and cold water in domestic hot water systems to reduce temperature of the hot water supply
- Double throttle design
- Restricts water flow upon loss of cold water
- ASSE 1017 Listed, CSA B-125 certified
- Maximum pressure: 150 psi
- Maximum temperature: 200°F
- Suffix Option
 - US = Union solder connections



Part #	Mfg #	Model	Size	Option	Price
WAT1170US34	0206013	1170US	3/4"	US	192.00

L111 Series Thermostatic Mixing Valve (FNPT)

- Maintains desired mixed water temperature at point of use for single showers or lavatories
- Brass body with polyetherimide control cartridge and polypropylene tamper-resistant cover
- Wall-mount style
- Maximum pressure: 125 psi
- Temperature range: 80° - 120°F



Part #	Mfg #	Model	Size	Price
WATL111	0915226	L111	1/2"	259.90

Plumbing Valves

Prices & Specifications are Subject to Change.

Plumbing Valves

70A Series Hot Water Extender Tempering Valve

- For residential installations, mixes cold and hot water to extend capacity of water heater, storage tanks and hot water boiler tankless heaters
- All brass or bronze construction, high capacity
- Adjustable knob for temperature control
- Low pressure drop



70A - Temperature Range 120°-160°F

Part #	Mfg #	Model	Size	Connection	Price
WAT70A12	0215462	70AF	1/2"	Swt	117.15
WAT70A34	0215500	70A	3/4"	Swt	143.30

70A - Low Temperature Range 100°-130°F

Part #	Mfg #	Model	Size	Connection	Price
WATL70A12	0215467	L70AF	1/2"	Swt	145.05
WATL70A34	0215515	L70A	3/4"	Swt	168.10

Series 70A Repair Kit

Part #	Mfg #	Model	For Use With:	Price
WAT70ARK	0869100	70ARK	70A	30.65

Under Sink Guardian™ Professional USG-P Series Thermostatic Mixing Valve (Male Comp)

- Bronze body
- Built-in check valves
- Includes tamper resistant locking cap
- Maintains mixed water temperature to ± 3°F up to 120°F
- ASSE 1016 Listed



Part #	Mfg #	Model	Size	Price
WATUSG	0204132	USG-P-M1	3/8"	68.05

Commercial Y-Strainers

Bronze Y-Type Strainer

- For liquid or steam service to protect valves or similar controls from foreign matter
- Sizes 1/4" - 2-1/4" have 20 mesh strainer, 3" has 3/64" perforated screen, 4" has 1/8" perforated screen

777SI - Tapped Retainer Cap and Closure Plug (FNPT)

- 1/2" - 2" Rated 400 psi WOG/125 psi WSP
2-1/2" and 3" rated 300 psi WOG/125 psi WSP
- Closure plug included



Part #	Mfg #	Model	Size	Price
WAT777SI12	0379081	777SI	1/2"	73.50
WAT777SI34	0379082	777SI	3/4"	89.70
WAT777SI1	0379083	777SI	1"	107.15
WAT777SI114	0379084	777SI	1-1/4"	135.45
WAT777SI112	0379085	777SI	1-1/2"	185.90
WAT777SI2	0379086	777SI	2"	283.55

All Items May Not Be Stocked In All Branches

Plumbing Valves

Boiler Feed Water Pressure Regulators

High Capacity Feed Water Pressure Regulator

- Iron and bronze body
- Tight seating check valve
- Purge lever for manual purging
- Stainless steel strainer
- Maximum pressure: 100 psi
- Provides make-up water to the system in the event of system leaks
- For use in commercial and residential hydronic heating systems to fill the boiler and piping system with water, and to maintain water pressure in the system at all times



Part #	Mfg #	Model	Size	Inlet Conn	Price
WATS1156F	0386450	S1156F	1/2"	Union SWT	101.45
WAT1156F	0386425	1156F	1/2"	Threaded	93.65

* Bronze body

2000 Series Hydronic 2-Way Universal Flow Check

- For forced hot water heating systems to provide positive gravity shut-off when circulator is not running

2000S-M5 - Straight Pattern, Bronze Body (Swt)

Part #	Mfg #	Model	Size	Price
WAT2000S34	0856763	2000SM5	3/4"	101.55
WAT2000S1	0856764	2000SM5	1"	112.85

Dielectric Unions

3000 Series Dielectric Union/Fitting

- Protects against destructive effect of galvanic and stray current corrosion
- For residential, commercial and industrial

FIP x Swt Dielectric Union



Part #	Mfg #	Model	Size	Price
WATDUN12	0821400	3001A	1/2"	10.50
WATDUN34	0821405	3001A	3/4"	10.50
WATDUN1	0821410	3001A	1"	23.65
WATDUN114	0821420	3001A	1-1/4"	38.95
WATDUN112	0821425	3001A	1-1/2"	56.85
WATDUN2	0821430	3001A	2"	80.05
WATDUN34-12	0821711	3002	3/4" x 1/2"	13.55

Plumbing Valves

Service Starts Here at Irr Supply!

Over 140 years of doing business with integrity.

Prices & Specifications are Subject to Change.

Plumbing Valves

Bronze Ball Valves

B6000 Series Bronze Standard Port Ball Valve

- Two-piece ball valves for residential, commercial and industrial applications
- Suitable for full range of liquids and gases
- Sizes up to 3" have glass reinforced Durafill seats; 4" has virgin PTFE seats
- Pressure rating:
1/4" to 3" sizes 150 psi WSP/600 psi WOG (non-shock)
4" size 125 psi WSP/400 psi WOG
- Suffix Option:
CC = 3/4" Hose thread outlet

B6000 Ball Valve (FNPT)



Part #	Mfg #	Model	Size	Opt	Price
WATB600014	0393000	B6000	1/4"	-	21.85
WATB600012	0393040	B6000	1/2"	-	21.85
WATB600034	0891931	B6000M2	3/4"	-	35.65
WATB6000CC34	0898117	B6000CC	3/4"	CC	50.90

IT6300/IS6301 Series Brass Ball and Waste Full Port Ball Valve

- Two-piece, side drain port
- For draining or venting of downstream line when valve is in the closed (off) position
- Pressure rating: 600 psi WOG (non-shock)
- Virgin PTFE valve seats
- Blow-out proof, pressure retaining stem

IT6300 Ball Valve (FNPT)

Part #	Mfg #	Model	Size	Price
WATBBV12T	0820925	IT6300	1/2"	15.38
WATBBV34T	0820926	IT6300	3/4"	45.85
WATBBV1T	0820927	IT6300	1"	31.06

IS6301 Ball Valve (Swt)



Part #	Mfg #	Model	Size	Price
WATBBV12S	0820931	IS6301	1/2"	15.38
WATBBV34S	0820932	IS6301	3/4"	45.85
WATBBV1S	0820933	IS6301	1"	31.06

Brass Ball Valves

FBV-3C/FBVS-3C Series Brass Full Port Ball Valve

- Two-piece construction
- Excellent for throttling and balancing applications
- For non-abrasive liquids or gases
- Temperature range: 40° - 450°F

FBV-3C Ball Valve (FNPT)

- UL Approved and NSF/ANSI 61/8 certified for 1/4" to 2"
- UL/FM Approved
- NSF/ANSI Certified
- ASME B16.33, CSA approved for 1/2" to 2"
- Sizes up to 2" 150 psi WSP/ 600 psi WOG
- Sizes 2-1/2" and 3" rated 600 psi WOG/125 psi WSP



Part #	Mfg #	Model	Size	Price
WATBV14T	0547100	FBV3C	1/4"	15.50
WATBV38T	0547101	FBV3C	3/8"	15.50
WATBV12T	0547102	FBV3C	1/2"	17.55
WATBV34T	0547103	FBV3C	3/4"	21.15
WATBV1T	0547104	FBV3C	1"	47.10
WATBV114T	0547105	FBV3C	1-1/4"	56.55
WATBV112T	0547106	FBV3C	1-1/2"	68.55
WATBV2T	0547107	FBV3C	2"	105.40
WATBV212T	0547108	FBV3C	2-1/2"	325.70
WATBV3T	0547109	FBV3C	3"	462.65

FBVS-3C Ball Valve (Swt)

- UL/FM Approved and NSF/ANSI 61/8 certified for 1/2" to 2"
- Sizes up to 2" rated 150 psi WSP/ 600 psi WOG
- Sizes 2-1/2" and 3" rated 400 psi WOG/125 psi WSP



Part #	Mfg #	Model	Size	Price
WATBV12S	0547110	FBVS3C	1/2"	17.55
WATBV34S	0547111	FBVS3C	3/4"	21.15
WATBV1S	0547112	FBVS3C	1"	47.10
WATBV114S	0547113	FBVS3C	1-1/4"	56.55
WATBV112S	0547114	FBVS3C	1-1/2"	68.55
WATBV2S	0547115	FBVS3C	2"	105.40
WATBV212S	0547116	FBVS3C	2-1/2"	325.70
WATBV3S	0547117	FBVS3C	3"	462.65

Plumbing Valves

Plumbing Valves

WBVC Series Brass Standard Port Ball Valve

- For full range of gases and liquids on commercial residential and industrial applications

WBVC Ball Valve (Comp)

- Pressure rating: 400 psi WOG/ 150 psi WSP



Part #	Mfg #	Model	Size	Price
WATBVC12	0545305	WBVC	1/2"	21.30
WATBVC34	0545306	WBVC	3/4"	29.20

Commercial Brass Gate Valves

Brass Gate Valve

- Non-rising stem (NRS)
- For shut-off service
- Pressure rating: 200 psi WOG
- Maximum temperature: 180°F



WGV - Round Handle (FNPT)

Part #	Mfg #	Model	Size	Price
WATGV12T	0770010	WGV	1/2"	14.10
WATGV34T	0770030	WGV	3/4"	18.60
WATGV1T	0770050	WGV	1"	23.60
WATGV114T	0770070	WGV	1-1/4"	34.55
WATGV112T	0770090	WGV	1-1/2"	43.10
WATGV2T	0770110	WGV	2"	63.20

WGVS - Round Handle (Swt)

Part #	Mfg #	Model	Size	Price
WATGV12S	0760010	WGVS	1/2"	18.78
WATGV34S	0760031	WGV-1 (Obsolete)	3/4"	8.00
WATGV1S	0760050	WGVS	1"	27.00
WATGV114S	0760070	WGVS	1-1/4"	39.45
WATGV112S	0760090	WGVS	1-1/2"	49.45
WATGV2S	0760110	WGVS	2"	72.40

Washing Machine Valves

2-M2 Series Washing Machine Water Shut-Off Valve

- Manually eliminates water pressure on supply hoses and prevents catastrophic water damage
- Controls hot and cold simultaneously
- Maximum pressure: 150 psi
- Maximum temperature: 180°F
- Bronze body, single lever on-off
- Dual copper adapters



Dual Elbow Adapter for 1/2" Swt or 1/2" Comp

Part #	Mfg #	Model	Size	Price
WAT2	0006644	2M2	1/2"	67.40

Dual Straight Adapter for 1/2" MNPT or 1/2" Swt

Part #	Mfg #	Model	Size	Price
WAT2T	0006643	2TM2	1/2"	67.40

Repair Kit For Series 2-M2 Valve

Part #	Mfg #	Model	Size	Price
WAT2RK	0862000	2M2RKT	1/2"	15.80

Wall Hydrants

Frost-Proof Automatic Draining Wall Hydrant

- Provides freeze protection for external water supply
- 3/4" Hose outlet
- Residential and light commercial



FHB-1 For Wall Sizes 4" to 14" (1/2" Copper or 1/2" MIPS)

- Includes backflow preventer

Part #	Mfg #	Model	Size	Price
WATFHB6	0723011	FHB1	6"	55.55
WATFHB8	0723012	FHB1	8"	56.35
WATFHB10	0723013	FHB1	10"	58.25
WATFHB12	0723014	FHB1	12"	60.05
WATFHB14	0723015	FHB1	14"	62.50

FHB-1-PEX for Wall Sizes 4" to 14" (1/2" PEX)

- Includes backflow preventer

Part #	Mfg #	Model	Size	Price
WATFHBPEX6	0723026	FHB1PEX	6"	66.18
WATFHBPEX8	0723027	FHB1PEX	8"	67.14
WATFHBPEX10	0723028	FHB1PEX	10"	69.42
WATFHBPEX12	0723029	FHB1PEX	12"	60.05

Plumbing Valves

Prices & Specifications are Subject to Change.

Plumbing Valves

FH Frost-Proof Automatic Draining Wall Hydrant

- Provides freeze protection for external water supply
- Brass body with nickel-plated finish
- Steel handwheel
- 3/4" Hose outlet
- Positive seat water shutoff
- Residential and light commercial



FH-1 For Wall Sizes 4" to 14" (1/2" Copper or 1/2" MIPS)

Part #	Mfg #	Model	Size	Price
WATFH6	0723161	FH-1-M1	6"	32.70
WATFH8	0723162	FH-1-M1	8"	33.40
WATFH10	0723163	FH-1-M1	10"	34.75
WATFH12	0723164	FH-1-M1	12"	35.60
WATFH14	0723165	FH-1-M1	14"	36.85

FH-1-PEX for Wall Sizes 4" to 14" (1/2" PEX)

Part #	Mfg #	Model	Size	Price
WATFHPEX6	0723036	FH-1-M1-PEX	6'	32.70
WATFHPEX8	0723037	FH-1-M1-PEX	8'	49.50
WATFHPEX12	0723039	FH-1-M1-PEX	12'	52.74



Outdoor Frost-Free Sill Faucets

Single-Handle Outdoor Sillcock

- Frost free
- Anti-siphon
- Adjustable temperature limit stop
- Cartridge is serviceable from outside
- Flow rate: 12 gpm
- 1/2" CC & PEX/CPVC connection
- Third party certified to CSA B-125.1, ASME A112.18.1M, ASSE 1019
- Lifetime limited warranty against leaks and drips



Part #	Mfg #	Description	Price
MOEHC400508	HC400508	8" Polished Chrome	109.90
MOEHC400512	HC400512	12" Polished Chrome	118.65

Heating Valves

Hot Water Radiator Angle Valve - Brass

- Includes nut and tailpiece



Part #	Mfg #	Size	Price
WATRVH12	AHV-0500	1/2" FIP	36.90
WATRVH34	AHV-0750	3/4" FIP	43.20
WATRVH1	AHV-1000	1" FIP	60.95
WATRVH114	AHV-1250	1-1/4" FIP	80.95
WATRVH12S	AHV-0500C	1/2" Solder	39.10
WATRVH34S	AHV-0750C	3/4" Solder	44.95

Steam Radiator Angle Valve - Heavy Pattern

- Bronze
- Includes nut and tailpiece
- 15 WSP - 60 WOG
- ISO 9002



Part #	Mfg #	Size	Price
WATRVS12	BARV-0500	1/2" FIP x Male Union	39.55
WATRVS34	BARV-0750	3/4" FIP x Male Union	47.40
WATRVS1	BARV-1000	1" FIP x Male Union	56.65
WATRVS114	BARV-1250	1-1/4" FIP x Male Union	72.05
WATRVS112	BARV-1500	1-1/2" FIP x Male Union	107.55

Union Elbow - Brass

- Includes nut and tailpiece



Part #	Mfg #	Size	Price
WATRU12	ENT-050	1/2" FIP x 1/2" MIP	19.90
WATRU34	ENT-075	3/4" FIP x 3/4" MIP	25.85
WATRU1	ENT-100	1" FIP x 1" MIP	41.85
WATRU114	ENT-125	1-1/4" FIP x 1-1/4" MIP	64.80
WATRU12S	ENT-050C	1/2" Swt x Swt x 1/2" MIP	19.90
WATRU34S	ENT-075C	3/4" Swt x Swt x 3/4" MIP	25.85

Plumbing Valves

Plumbing Valves

Biltmore

Series 900 Pressure Balancing Valve

- ABS Faceplate with color-coded graphics, lever handle
- Chrome plated



Part #	Mfg #	Description	Price
POWP905H7W	P905H7W	1/2" Cop T&S w/24" Bar & Vacuum Breaker	319.60

HydroGuard® Thermostatic Tempering Valves

e480 Series Under-the-Counter Combination for Low Flow Control

- Designed for lavatory applications where the temperature of hot water must be controlled for safe use
- Advanced thermal actuator
- Solid brass construction
- Adjustable temperature selection with locknut
- Integral checks & screen prevent cross-flow and contamination
- Maximum operating pressure: 125 psi
- Maximum hot water temperature: 180°F



Part #	Mfg #	Union Connections	Price
POWE48010	E480-10	3/8" Comp Rough Bronze	127.90

LM490 Series - For Hot Water Heater & Multiple Lavatory Installations

- Solid brass construction
- Adjustable temperature selection with lock down
- Integral checks & screen prevent cross-flow and contamination
- Maximum operating pressure: 125 psi
- Maximum hot water temperature: 200°F
- -10 Model temperature adjustment: 60°-120°F
- -1 Model temperature adjustment: 90°-160°F



Part #	Mfg #	Union Connections	Price
POWLM49110100	LM491-10100	3/4" Female NPT Union	136.60



Bronze Check Valves

S-413-Y 125# Bronze Check Valve (Swt x Swt)

- Horizontal swing
- Regrinding type
- Y-Pattern
- Renewable steam seat & disc
- 200 psi Non-shock cold working pressure



Part #	Mfg #	Size	Price
NIBS413Y12	S-413-Y	1/2"	64.00
NIBS413Y34	S-413-Y	3/4"	92.00
NIBS413Y1	S-413-Y	1"	128.00
NIBS413Y114	S-413-Y	1-1/4"	179.00
NIBS413Y112	S-413-Y	1-1/2"	210.00

T-433-Y 150# Bronze Check Valve (FNPT x FNPT)

- Horizontal swing
- Regrinding type
- Y-Pattern
- Renewable steam seat & disc
- 300 psi Non-shock cold working pressure



Part #	Mfg #	Size	Price
NIBT413Y12	T-433-Y	1/2"	163.26
NIBT413Y34	T-433-Y	3/4"	93.00
NIBT413Y1	T-433-Y	1"	111.00
NIBT413Y114	T-433-Y	1-1/4"	169.00
NIBT413Y112	T-433-Y	1-1/2"	197.00
NIBT413Y2	T-433-Y	2"	237.00

T-480 Bronze Ring Check Valve (FNPT x FNPT)

- Inline lift type
- Resilient discs
- Spring actuated
- Bar saturated steam: 125 psi/9
- Bar non-shock cold working pressure: 200 psi/14



Part #	Mfg #	Size	Price
NIBT48012	T-480	1/2"	36.45
NIBT48034	T-480	3/4"	44.78
NIBT4801	T-480	1"	56.57
NIBT480114	T-480	1-1/4"	76.58
NIBT480112	T-480	1-1/2"	77.52
NIBT4802	T-480	2"	121.19

Plumbing Valves

Prices & Specifications are Subject to Change.

Plumbing Valves

S-480 Bronze Ring Check Valve (Swt x Swt)

- Inline lift type
- Resilient discs
- Spring actuated
- Bar saturated steam: 125 psi/9
- Bar non-shock cold working pressure: 200 psi/14



Part #	Mfg #	Size	Price
NIBS48012	S-480	1/2"	39.72
NIBS48034	S-480	3/4"	45.62
NIBS4801	S-480	1"	62.65
NIBS480114	S-480	1-1/4"	71.76
NIBS480112	S-480	1-1/2"	93.76
NIBS4802	S-480	2"	134.87



Angle Sillcock Valves

Angle Sillcock Valve - Basics (FIP x Hose)

- 125# WOG to 180°F



Part #	Mfg #	Size	Price
NIB6312	206T03	1/2"	9.16
NIB6334	206T04	3/4"	5.76

Angle Sillcock Valve - Basics (C x Hose)

- 125# WOG to 180°F



Part #	Mfg #	Size	Price
NIB76312	206C03	1/2"	10.52
NIB76334	206C04	3/4"	5.98

Boiler Drain Valves - Bronze

72 Boiler Drain Valve - Basics™ (C x Hose)

- 125# WOG to 180°F



Part #	Mfg #	Size	Price
NIB7212	72 1/2	1/2"	12.47
NIB7234	72 3/4	3/4"	11.87

Boiler Drain Valve - Basics™ (FIP x Hose)

- 125# WOG to 180°F



Part #	Mfg #	Size	Price
NIB7312	205FF3	1/2"	4.32
NIB7334	205FF4	3/4"	4.99

Boiler Drain Valve - Basics™

- 125# WOG to 180°F



Part #	Mfg #	Size	Price
NIB7412	205F03	1/2" MIP(Cpr) x H	8.60
NIB7434	205F04	3/4" MIP x H	9.24

Stop & Waste Valves - Bronze

Stop & Waste Valve - Basic™ (FIP x FIP)

- 125# WOG to 180°F



Part #	Mfg #	Size	Price
NIB7612	202T03	1/2"	5.10
NIB7634	202T04	3/4"	6.09

Plumbing Valves

Plumbing Valves

Stop & Waste Valve - Basic™ (C x C)

- 125# WOG to 180°F



Part #	Mfg #	Size	Price
NIB72612	202C03	1/2"	10.12
NIB72634	202C04	3/4"	13.84

4776 CPVC Stop & Waste Valve (CPVC x CPVC)



Part #	Mfg #	Size	Price
NIB447612	4476 1/2	1/2"	20.25
NIB447634	4476 3/4	3/4"	27.86

Stop Valves - Bronze

Stop Valve - Basic™ (C x C)

- 125# WOG to 180°F



Part #	Mfg #	Size	Price
NIB72512	201C03	1/2"	9.00
NIB72534	201C04	3/4"	10.66

Water Meter Valves

578-17 Angle Stop & Waste Water Meter Valve (Flr x FIP)



Part #	Mfg #	Size	Price
NIB5781734	578-17 3/4	3/4"	49.16

Water Meter Valves (Continued)

578-17 Angle Stop & Waste Water Meter Valve (Flr x FIP)

Part #	Mfg #	Size	Price
NIB5781734-12	578-17 3/4X1/2	3/4" x 1/2"	38.58
NIB578171-34	578-17 1X3/4	1" x 3/4"	71.42



Ball Valves

Full Port Ball Valves

600# PSI In-Line Crimp x Crimp



Part #	Mfg #	Order #	Size	Price
PEXBV12	WPBV-08	0650492	1/2" PEX	6.40
PEXBBV12	WPBVD-08	0650495	1/2" PEX w/Waste Drain	14.45
PEXBV34	WPBV-12	0650493	3/4" PEX	10.35
PEXBBV34	WPBVD-1208	0650496	3/4" PEX w/Waste Drain	22.60
PEXBV1	WPBV-16	0650494	1" PEX	18.80

Boiler Drains

BT Series 1/4-Turn Boiler Drain Shut-Off

- 3/4" Hose thread connection on outlet
- Brass body construction
- Tee handle with positive shutoff
- Adjustable Teflon® stem packing
- Maximum pressure: 200 psi



Part #	Mfg #	Model/Size	Price
WATBDQT12	0820955	BD-QT1/2" Dual Pattern, MIP or Solder	11.25
WATBDQT34	0820956	BD-QT1/2" MNPT	14.15

Plumbing Valves

Plumbing Valves

CimPRESS™ Valves

CimPRESS™ ASC Full Port Ball Valve

- Installs quickly and easily with standard press tools
- Flame free installation
- Patented O-ring design
- Suitable for plumbing and heating applications
- Suitable for applications of up to 50% glycol/water mixture
- Made of DZR brass



Part#	Mfg#	Size	Price
RPPBV12	1220-04	1/2"	15.15
RPPBV34	1220-06	3/4"	19.39
RPPBV1	1220-07	1"	26.59
RPPBV114	1220-08	1-1/4"	51.34
RPPBV112	1220-09	1-1/2"	76.58
RPPBV2	1220-10	2"	106.44



Wall Faucets

Models 22/V22 Hot and Cold Wall Faucet

- 3/4" Male hose thread nozzle
- Permanent stainless steel seat will not wire draw
- EPDM Packing to prevent leaking
- No lead solder
- Standard "O" seat washer
- Power-coated die cast aluminum oval handle
- Maximum pressure: 125 psi
- Maximum temperature: 120°F
- Full circle threads on valve body and retainer
- Internal, resetting pressure relief valves prevents casing tube from bursting in freezing conditions even if a hose is unintentionally left on
- Built-in vent float style vacuum breaker
- Faucet drains automatically when hose is removed



1/2" MIP x 1/2" Female Copper Water Inlet

Part #	Mfg #	Thickness	Price
WOO228CP	22CP8	8"	123.30
WOO2212CP	22CP12	12"	131.80



Hydrants

- Hardened bronze operating stem & neoprene plunger
- Unique self draining vandal resistant integral vacuum breaker protects from anti-siphon conditions
- Polished chrome plating on face plate
- Heavy duty brass casing
- 3/4" Female, 1" male IPS combination

MHY-90 Anti-Contamination Wall Faucets

- Heavy-duty brass casing
- 3/4" Male hose connection
- Vandal-resistant anti-siphon vacuum breaker



Part #	Mfg #	Finish	Handle	Connect	Price
MIFHY9120	MHY-9120	Rgh CP	Clr Plstc	1/2" FIP	46.98



Non-Freeze Wall Hydrants

- Chrome face
- Integral vacuum breaker
- Wall thicknesses available: 4", 6", 8", 10", 12", 14", 16", 18", 20", 22" or 24"
- 3/4" Hose connection, 3/4" x 1" male pipe connection
- All bronze head, seat casing and internal working parts
- Bronze wall casing & loose key



Part #	Mfg #	Wall Thickness	Price
WADHY4204	HY-420-4	4"	239.76
WADHY4206	HY-420-6	6"	239.76
WADHY4208	HY-420-8	8"	239.76
WADHY42010	HY-420-10	10"	254.42
WADHY42012	HY-420-12	12"	254.42
WADHY42014	HY-420-14	14"	254.42

Hydrant Parts and Accessories

Part #	Mfg #	Description	Price
WADHY1	HY-1	Replacement Key	21.00
WADHY725B	HY-725-B-1	Nickel Bronze Hydrant Box Only for HY-725	312.00
WADHY420CIA	HY420-CIA	Complete Internal Assembly Repair Kit	295.00

Plumbing Valves

Water Meters

PMM® Water Meters

- Hydrodynamically cushioned design
- Hermetically sealed
- Unique locking system prevents customer removal of the register to obtain free water
- High-strength magnets will eliminate "drive slip"



Part #	Mfg #	Meter Size	Max Pressure Loss	Meter Registration	Options	Price
ROLPM58	5/8X3/4PMM	5/8" x 3/4"	14.0 psi @ 20 gal/min	Gallons	DR	215.34
ROLSRIIDR1	1PMM	1"	14.0 psi @ 50 gal/min	Gallons	DR	483.74

Sensus Meter Parts

Part #	Mfg #	Description	Price
ROLCONN1	SNCONN 1	1" Connections for Water Meters Per/Each	28.08
ROLCONN58-34	SNCONN 5/8 X 3/4	5/8" x 3/4" Connections for Water Meters Per/Each	20.30



Meter Valves

Angle Plug Lockwings (Tube Comp x Meter)



Part #	Mfg #	Size	Price
AYMAMVC34	4602T	3/4"	86.14
AYMAMVC1	4602T	1"	122.88
AYMAMVC1-34	4602T	1" x 3/4"	99.32

Plumbing/Water Valves

Angle Stop & Waste Valves (Copper Flr x FIP)



Part #	Mfg #	Size	Price
AYMAMVFL34	2025	3/4" x 3/4"	28.11
AYMAMVFL1-34	2025	1" x 3/4"	52.82
AYMAMVFL1	2025	1" x 1"	54.00

Water Service Valves

Prices & Specifications are Subject to Change.



www.irrsupply.com

Water Service Valves

Plumbing Gas Valves

Gas Stop Valves - Domestic

Bronze Flat/Tee Head w/Check - 2 psi - (FIP x FIP)

- Plug style



Part #	Mfg #	Size	Price
GAC38	10596	3/8"	16.53
GAC12	10596	1/2" CSA Approved	14.77
GAC34	10596	3/4" CSA Approved	18.14
GAC1	10596	1"	34.94
GAC114	10596	1-1/4"	50.21
GAC112	10596	1-1/2"	71.12
GAC2	10596	2"	116.14

Forged Brass Low Pressure Gas Valve - Ball Style (FIP x FIP)

- Threaded
- Constructed of heavy-duty forged brass
- Designed for residential, industrial, and commercial use in low pressure gas applications
- Blow out proof stem



Part #	Mfg #	Size	Price
GAC12L	10710	1/2"	9.67
GAC34L	10710	3/4"	14.27
GAC1L	10710	1"	16.34

Quality people, quality products, excellent service.

Water Service Valves

All Items May Not Be Stocked In All Branches

Tanks

Well Tanks

Pressure & Retention Tanks

Hydro Pro™ Diaphragm Pressure Water System Tanks

- Deep drawn steel shell with inner shell
- Heavy-duty diaphragm
- Appliance appearance exterior finish
- Maximum temperature rating: 140°F

Hydro-Pro™ In-Line Tanks

- Durable polypropylene interior tank lining
- Maximum working pressure: 125 psi



Part #	Mfg #	Total Volume	Description (Drawdown @ 30/50 PSIG)	Price
GOUV6P	V-6P	2.0 gal	0.6 gal Draw Down In-Line Model	104.00
GOUV15P	V-15P	4.5 gal	1.4 gal Draw Down In-Line Model	136.00
GOUV25P	V-25P	8.2 gal	2.6 gal Draw Down In-Line Model	219.00

Hydro-Pro™ Stand Tanks

- Durable polypropylene interior tank lining
- Maximum working pressure: 125 psi



Part #	Mfg #	Total Volume	Description (Drawdown @ 30/50 PSIG)	Price
GOUV45	V-45	13.9 gal	4.3 gal Draw Down Stand Model	313.00
GOUV60	V-60	19.9 gal	6.1 gal Draw Down Stand Model	395.00
GOUV80EX	V-80EX	25.9 gal	7.7 gal Draw Down Stand Model	501.00
GOUV100	V-100	31.8 gal	9.9 gal Draw Down Stand Model	606.00
GOUV100S	V-100S	31.8 gal	9.9 gal Draw Down Stand Model	635.00
GOUV140	V-140	45.2 gal	13.9 gal Draw Down Stand Model	732.00
GOUV200	V-200	65.1 gal	20.0 gal Draw Down Stand Model	823.00
GOUV250	V-250	83.5 gal	25.9 gal Draw Down Stand Model	1002.00
GOUV260	V-260	84.9 gal	26.2 gal Draw Down Stand Model	1044.00
GOUV350	V-350	115.9 gal	35.9 gal Draw Down Stand Model	1526.00

Hydro-Pro™ Mounted Pump Tanks

- Fusion bonded polymeric interior tank lining
- Maximum working pressure: 100 psi
- Pre-Charged at 18 psi



Part #	Mfg #	Total Volume	Description (Drawdown @ 30/50 PSIG)	Price
GOUV45MP	V-45MP	13.9 gal	4.3 gal Draw Down Mounted Pump Model, 3/4" NPTF Connection	425.00
GOUV60MP	V-60MP	19.9 gal	6.1 gal Draw Down Mounted Pump Model, 3/4" NPTF Connection	439.00

Hydro-Pro™ Buried Tanks

Part #	Mfg #	Total Volume	Description (Drawdown @ 30/50 PSIG)	Price
GOUV60B	V-60B	19.9 gal	6.1 gal Draw Down Buried Model	468.00

Prices & Specifications are Subject to Change.

Tanks

Residential Captive Air Tanks

- Durable blow-molded interior air cell is fully replaceable and constructed of heavy-gauge engineered polymer
- 1-Piece, seamless inner shell molded of premium high-density polyethylene
- Bottom inlet/outlet assembly is custom molded of high-impact PVC
- Sturdy molded polymeric base is corrosion and impact proof
- Outer shell is a composite of continuous fiberglass strands sealed with high-grade epoxy resin
- Replaceable Air Cells
- WellMate Residential Captive Air tanks are listed under ANSI/NSF Standard 61 for water system components
- Light Weight
- 5-Year factory backed warranty



WM™ - Series

- For new and replacement installations for residential, light commercial and pressure boosting applications

Part #	Mfg #	Tank Vol	Max Working Pressure	Draw Down 30 / 50 Settings	Dimensions	System Connection	Weight	Price
WELWM6	CH30840	19.8 gal	100 psi	5.9 gal	16" x 32"	1" MIP	17.75 lbs	321.80
WELWM9	CH30854	29.5 gal	100 psi	8.9 gal	16" x 44"	1" MIP	24.75 lbs	534.96
WELWM12	CH30866	40.3 gal	100 psi	12.1 gal	16" x 57"	1" MIP	30 lbs	494.24

Low-Profile™ - Series

- For height restricted applications such as mobile homes, crawl spaces and closets

Part #	Mfg #	Tank Vol	Max Working Pressure	Draw Down 30 / 50 Settings	Dimensions	System Connection	Weight	Price
WELWM6LP	CH31850	19.3 gal	100 psi	5.8 gal	24" x 20-1/2"	1" MIP	22.75 lbs	518.50

UT™ Series Residential Retention Tanks

- 1/4" Socket connections
- 1-Piece, seamless inner shell molded of premium high-density polyethylene
- Sturdy molded polymeric base
- Outer shell is a composite of continuous fiberglass strands sealed with high-grade epoxy resin
- Blowdown valve for easy removal of sludge from tank bottom
- Hydropneumatic Convertible - optional air volume control assembly and micronizer provide for quick and easy tank conversion
- Higher performance when adapted for hydropneumatic applications, the Universal Series provides 50% more drawdown than similarly sized conventional tanks
- Inlet/Outlet PVC Pipe Connections - allow straight through T connection on bottom of tank for ease of piping.
- Light weight
- 5-Year factory backed warranty



Part #	Mfg #	Tank Vol	Max Working Pressure	Dimensions	System Connections	Weight	Price
WELUT40	CH31301	40 gal	75 psi	16" x 56-1/2"	1-1/4" Socket	28 lbs	470.64
WELUT40SQ	CH31433	40 gal	75 psi	21" x 35-1/4"	1-1/4" Socket	33 lbs	521.14
WELUT80	CH31309	80 gal	75 psi	21" x 62"	1-1/4" Socket	43 lbs	821.92
WELUT120	CH31312	120 gal	75 psi	24" x 72-1/2"	1-1/4" Socket	63 lbs	1085.26

Air Volume Controls

Part #	Mfg #	Description	Price
WELCH20289	CH20289	HP 9 AVC Assembly Quick Connect for UT-40	159.06
WELCH20290	CH20290	HP 18 AVC Assembly Quick Connect for UT-80	159.06

All Items May Not Be Stocked In All Branches

Well Tanks

Pumps & Accessories

Submersible Sewage Pumps

Model 3696 Series SB Bruiser® Submersible Sewage Pump

- 60Hz, 4" Motor size
- Left hand casing thread
- Field serviceable
- Discharge head
- Motor adapter
- Hex shaft design
- Inlet strainer
- Built-in surge arrestor
- Stainless steel casing
- Powered for continuous operation



Part #	Mfg #	HP	Voltage/Phase/Wire	GPM	Notes	Price
BRU7SB05422	7SB-05422C	1/2	230v/1ph/2w	7	with CentriPro Motor	581.00
BRU7SB07422	7SB-07422C	3/4	230v/1ph/2w	7	with CentriPro Motor	741.00
BRU10SB05421	10SB-05421C	1/2	115v/1ph/2w	10	with CentriPro Motor	518.00
BRU10SB05422	10SB-05422C	1/2	230v/1ph/2w	10	with CentriPro Motor	523.00
BRU10SB07422	10SB-07422C	3/4	230v/1ph/2w	10	with CentriPro Motor	644.00

Shallow Well Jet Pumps

Model JS+

- 60Hz, Single phase
- Specifically designed for homes, cottages, booster service
- Built-in overload with automatic reset
- Stainless steel shaft
- Integral shallow well adapter built into the casing, which eliminates the need for a separate shallow well adapter
- Back pullout design allows disassembly of pump for service without disturbing piping
- Two compartment motor for easy access to motor wiring and replaceable components
- Nozzle clean out plug in shallow well adapter
- Corrosion resistant, engineered plastic tubing and fittings are easily removed for cleaning



Part #	Mfg #	HP	Voltage	Price
GOUJ5S	J5S	1/2	115/230	554.00
GOUJ5SH	J5SH	1/2	115/230	554.00
GOUJ7S	J7S	3/4	115/230	681.00
GOUJ10S	J10S	1	115/230	748.00
GOUJ15S	J15S	1-1/2	115/230	964.00

Pumps

Pumps & Accessories

Convertible Jet Pumps

Model J+

- 60Hz, Single phase
- Specifically designed for homes, farms, cottages, booster service
- Built-in overload with automatic reset
- Stainless steel shaft
- Integral shallow well adapter built into the casing, which eliminates the need for a separate shallow well adapter
- Back pullout design allows disassembly of pump for service without disturbing piping
- Two compartment motor for easy access to motor wiring and replaceable components
- Nozzle clean out plug in shallow well adapter
- Corrosion resistant, engineered plastic tubing and fittings are easily removed for cleaning



Part #	Mfg #	HP	Voltage	Price
GOUJ5	J5	1/2	115/230	645.00
GOUJ7	J7	3/4	115/230	778.00
GOUJ10	J10	1	115/230	838.00

Convertible Pump and Tank Packages

Model J05

- 60Hz
- Specifically designed for homes, farms, cottage water systems and booster service
- Built-in overload with automatic reset
- Stainless steel shaft
- Back pullout design
- Two compartment motor
- Corrosion resistant
- Pipe connections: 1" NPT pressure, 1-1/4" NPT suction, 1" NPT discharge
- AS4FX Pressure switch
- Max working pressure: 100 psi and maximum temperature: 120°F
- Shallow well package (FH5) or deep well package required



Part #	Mfg #	HP	Voltage	Tank	Price
GOUJ05K	J05K	1/2	115/230	w/14 gal V45MP Xtrol Tank	1243.00
GOUJ05L	J05L	1/2	115/230	w/20 gal V60MP Xtrol Tank	1323.00
GOUJ05LT	J05LT	1/2 Hp Replacement Pump for J05K, J05L			807.00

All Items May Not Be Stocked In All Branches

Pumps & Accessories

Submersible Pumps

Model GS

- 60Hz, 4" Motor size
- CCW rotation
- Field serviceable
- Sand resistant construction
- Discharge head
- Check valve
- Motor adapter
- Stainless steel casing
- 1-1/4" Discharge connection
- Powered for continuous operation



Part #	Mfg #	HP	Electrical	GPM	Notes	Price
GOU5GS05422	5GS-05422C	1/2	230/1ph/2w	5	CentriPro Motor	975.00
GOU5GS07422	5GS-07422C	3/4	230/1ph/2w	5	CentriPro Motor	1209.00
GOU5GS10422	5GS-10422C	1	230/1ph/2w	5	CentriPro Motor	1361.00
GOU7GS05421	7GS-05421C	1/2	115/1ph/2w	7	CentriPro Motor	864.00
GOU7GS05422	7GS-05422C	1/2	230/1ph/2w	7	CentriPro Motor	864.00
GOU7GS07422	7GS-07422C	3/4	230/1ph/2w	7	CentriPro Motor	1080.00
GOU7GS10422	7GS-10422C	1	230/1ph/2w	7	CentriPro Motor	1236.00
GOU10GS05412	10GS-05412C	1/2	230/1ph/3w	10	CentriPro Motor	786.00
GOU10GS05421	10GS-05421C	1/2	115/1ph/2w	10	CentriPro Motor	761.00
GOU10GS05422	10GS-05422C	1/2	230/1ph/2w	10	CentriPro Motor	761.00
GOU10GS07422	10GS-07422C	3/4	230/1ph/2w	10	CentriPro Motor	999.00
GOU10GS07432	10GS-07432C	3/4	230/3ph/2w	10	CentriPro Motor	962.00
GOU10GS10422	10GS-10422C	1	230/1ph/2w	10	CentriPro Motor	1141.00
GOU18GS07422	18GS-07422C	3/4	230/1ph/2w	18	CentriPro Motor	1006.00
GOU18GS10422	18GS-10422C	1	230/1ph/2w	18	CentriPro Motor	1121.00

Pumps

Model GS 4" Pump Ends

Part #	Mfg #	HP	GPM	Price
GOU5GS15	5GS15	1-1/2	5	1010.00

Sump Pumps

Model CVP03 Residential Wastewater Vertical Sump Pump

- 60Hz, Single phase
- Side suction positioning
- Corrosion resistant cast iron construction
- Heavy duty 8' 3-wire power cord
- Float actuated switch
- For basement draining, water transfer, dewatering
- Maximum temperature: 160°F
- 12" or Larger sump diameter
- Powered for continuous operation



Part #	Mfg #	HP	Electrical	Price
GOU CVP03	CVP03	1/3	115-1-60	273.00

Prices & Specifications are Subject to Change.

Pumps & Accessories

Model LSP Filtered Effluent Submersible Sump Pump

- 60Hz, Single phase
- Specifically designed for use in basement draining, water transfer, and dewatering
- Corrosion resistant construction
- Glass-filled thermoplastic impeller and casing
- Built-in thermal overload protection
- Air filled motor design - permanently lubricated ball bearings
- Switch easily removed for direct operation
- Adjustable float switch
- SS Motor, motor shaft, pump shaft, casing, and fasteners
- Light weight, portable and compact
- Maximum temperature: 104°F
- Powered for continuous operation



Part #	Mfg #	HP	Voltage	Notes	Price
GOULSP03	LSP0311AT	1/3	115	Piggy-Back Replaceable Float Switch	291.00

Model SP02 Submersible Sump Pump

- Single phase
- Specifically designed for use in basement draining, water transfer, and dewatering
- Air filled motor design
- Glass-filled thermoplastic impeller and casing
- Built-in overload protection with automatic reset
- Built in vertical switch for tight installations
- Stainless steel shaft
- Light weight, portable and compact
- Maximum temperature: 104°F
- Designed for continuous use when completely submerged



Part #	Mfg #	HP	Voltage	Description	Price
GOUSP025V	SP025V	1/4	115	1-1/2" NPT Discharge	208.00

Grinder Pumps

Model RGS Grinder Pump

- 60Hz, Single phase
- Designed for high head sewage applications where a gravity system is not practical
- Ideal for pressure sewage systems
- Capable of grinding domestic sewage in individual residential applications
- Anti-roping design cutter system
- Silicon bronze semi-open impeller
- Pump-out vanes for mechanical seal protection
- Cast iron volute type casing
- Designed for continuous operation



Part #	Mfg #	HP	Voltage	Notes	Price
GOURGS2012	RGS2012	2	208/230	20' Power Cord with Bare Leads	2167.00

All Items May Not Be Stocked In All Branches

Pumps

Pumps & Accessories

Submersible Effluent Pumps

Model 3871 Series EP04/EP05

- Single phase
- Specifically designed for use in effluent systems, homes, farms, heavy duty sump, water transfer, and dewatering
- Thermoplastic, semi-open, pump out veins (EP04)
- Thermoplastic enclosed design (EP05)
- Cast iron motor housing
- Float switch
- Thermoplastic motor cover
- Silicon carbide seal faces
- Stainless steel shaft
- Temperature: 104°F continuous, 140°F intermittent
- Powered for continuous operation



Part #	Mfg #	HP	Voltage	Notes	Price
GOUEP0411A	EP0411A	0.4	115	Piggyback Float Switch, Wide Angle	352.00
GOUEP0412	EP0412	0.4	230	Plug, No Float Switch	350.00
GOUEP0511AC	EP0511AC	1/2	115	Piggyback Float Switch, Wide Angle	411.00

Model 3885 Series WE

- Specifically designed for use in homes, farms, motels, schools, industry, hospitals, and effluent systems
- Cast iron, semi-open, non-clog impeller
- Pump-out veins
- Built-in overload protection with automatic reset
- Cast iron casing
- Silicon carbide seal faces
- Stainless steel shaft
- Temperature: 104°F continuous, 140°F intermittent
- Designed for continuous operation when fully submerged



Part #	Mfg #	HP	Volts-Phase	RPM	Power Cable	Price
GOUWE0311L	WE0311L	1/3	115-1	1750	16/3	722.00
GOUWE0511HH	WE0511HH	1/2	115-1	3450	14/3	967.00
GOUWE0512HH	WE0512HH	1/2	230-1	3450	16/3	987.00
GOUWE0512H	WE0512H	1/2	230-1	3450	16/3	987.00
GOUWE1012H	WE1012H	1	230-1	3450	14/3	1280.00
GOUWE1034HJ	WE1034HJ	1	460-3	3450	100' 14/4 Cord	1567.00
GOUWE1534HHJ	WE1534HHJ	1-1/2	460-3	3450	100' 14/4 Cord	1747.00

Pumps

Pumps & Accessories

Model ST31 SumpThing™

- Single phase, 60 hertz
- Specifically designed for use in basement draining, water transfer, dewatering, and effluent transfer
- Thermoplastic impeller and cover
- Built-in thermal overload protection with automatic reset
- Quick disconnect cord assembly
- Corrosion resistant construction
- Cast iron body
- Replaceable power cover
- Built-in vent hole
- Heavy-duty, portable, and compact
- 10' Cord
- 1/2" Maximum solids size
- Designed for continuous operation



Part #	Mfg #	HP	Voltage	Float Switch Style	Price
GOUST31AV	ST31AV	1/3	115	Built-In Vertical	230.00

Submersible Sewage Pumps

Model 3872 Series WW05 Submersible Sewage Pumps

- 60Hz, Single phase
- Specifically designed for use in residential sewage systems, dewatering and water transfer
- Glass-filled thermoplastic impeller
- Pump-out veins
- Thermoplastic motor cover
- Cast iron motor housing
- Temperature: 104°F continuous, and 140°F intermittent
- Stainless steel shaft



Part #	Mfg #	HP	Voltage	Notes	Price
GOUWW0511	WW0511	1/2	115	No Switch, 10' Cord	549.00
GOUWW0511A	WW0511A	1/2	115	Piggyback Wide-Angle Float Switch w/10' Cord	585.00
GOUWW0511AC	WW0511A-C	1/2	115	Piggyback Wide-Angle Float Switch w/20' Cord	614.00

Model 3886 Series WS-B Submersible Sewage Pumps

- 60Hz, Single phase
- Specifically designed for use in homes, sewage systems, dewatering/effluent, and water transfer
- Cast iron, semi-open, non-clog impeller
- Cast iron casing
- Stainless steel shaft
- Designed for continuous operation when fully submerged



Part #	Mfg #	HP	Voltage-Phase	Notes	Price
GOUWS0511B	WS0511B	1/2	115-1	NEMA 3-Prong Grounding Plug	848.00
GOUWS0512B	WS0512B	1/2	230-1	NEMA 3-Prong Grounding Plug	879.00

All Items May Not Be Stocked In All Branches

Pumps

Pumps & Accessories

Model 3887 Series WS-BF Submersible Sewage Pumps

- 60Hz, Single phase
- Specifically designed for use in homes, sewage systems, dewatering, water transfer, light industrial, commercial applications
- Cast iron, enclosed, non-clog impeller
- Cast iron flanged casing
- Silicon carbide seal faces
- Corrosion resistant stainless steel shaft
- Temperature: 104°F continuous, and 140°F intermittent
- Designed for continuous operation when fully submerged



Part #	Mfg #	HP	Voltage-Phase	Notes	Price
GOUWS0512BF	WS0512BF	1/2	230-1	20' Power Cable	1016.00
GOUWS0712BF	WS0712BF	3/4	230-1	20' Power Cable	1318.00
GOUWS1012BF	WS1012BF	1	230-1	20' Power Cable	1379.00

Wastewater Packages

Vortex Wastewater Package with PV Vortex Pump

- 60Hz
- Ribbed 23" diameter x 30" high polyethylene basin with 4" slip type inlet hub and pump torque stop insert
- 18" Structural foam cover with bolts, sealing tape and (2) 2" and (1) 3" vent and discharge grommets
- 2" Diameter x 30" long schedule 40 PVC discharge pipe



Part #	Mfg #	Description	Price
GOUGWP1131	GWP1131	1/2 hp 115V 24.8 gal Basin w/PV51P1F Pump and A9-2PH 2" Rubber Sleeve Check Valve	793.00

Vortex Wastewater Package with WW05 Pump

- 60Hz
- Roll top 18" diameter x 30" high polyethylene basin with 4" slip type inlet hub and pump torque stop insert
- 18" Structural foam cover with bolts, sealing tape and (2) 2" and (1) 3" vent and discharge grommets
- 2" Diameter x 30" long schedule 40 PVC discharge pipe



Part #	Mfg #	Description	Price
GOUGWP2131	GWP2131	1/2 hp 115V 14 gal Basin w/WW0511AC Pump and A9-2PH 2" Rubber Sleeve Check Valve	784.00

AquaBoost™ II Variable Speed Controllers

- Constant pressure booster system
- Increase water pressure when demand is high



Part #	Mfg #	Description	Price
GOU1AB2LB1035	1AB2LB1035	1 hp 4.2 Amp 208/230V AquaBoost II System w/LB1035 SS Jet Pump	1470.00

Prices & Specifications are Subject to Change.

Pumps

Pumps & Accessories

CentriPro Aquavar SOLO™ Controllers

Part #	Mfg #	Description	Price
GOUBF20	BF20	1/2 - 2 hp Balance Flo Pump Controller w/Sensor (Obsolete)	1180.00

CentriPro PumpSaver® Plus Pump Protector

- Calibrates any submersible or centrifugal pump to jobsite conditions (voltage and current)
- Micro-controller



Part #	Mfg #	Description	Price
GOU1113RL	1113RL	1/3 - 1 hp 115V Installed in NEMA 3R Enclosure	253.00
GOU233153RL	233153RL	1/3 - 1-1/2 hp 230V Installed in NEMA 3R Enclosure	253.00

Repair Parts & Accessories

Part #	Mfg #	Description	Price
GOUFH5	FH-5	1/2 hp Shallow Well Adapter	64.00
GOUFT408	FT4B-08	1/2 hp 60-90' Deep Jet	133.00

Pumps



Pump Cables



Standard Twisted Pump Cable (PVC)

- With ground

Part #	Mfg #	Wire GA	Wire Type	Length (Ft)	Price
ELEWW12-2PVC	42258-XX-30	12/2	Solid	500'	CALL
ELEWW12-3PVC	42358-XX-30	12/3	Solid	500'	CALL
ELEWW10-3PVC	42359-XX-30	10/3	Solid	500'	CALL

Standard Twisted Pump Cable (Neoprene)

- With ground

Part #	Mfg #	Wire GA	Wire Type	Length (Ft)	Price
ELEWW12-2NEO	45258-XX-30	12/2	Solid	500'	CALL
ELEWW12-3NEO	45358-XX-06	12/3	Solid	500'	CALL

Irrigation Cables

Standard UF-B Flat Parallel Underground Feeder

- Multi-color, PVC insulation

Part #	Mfg #	Wire GA	Wire Type	Length (Ft)	Price
ELEWW12-2UF	55562-XX-09	12/2 w/12 Gr	Solid	500'	CALL

All Items May Not Be Stocked In All Branches

Pumps & Accessories

"Old Faithful" Dewatering & Sump Pedestal Pump

"82" Cast Iron Sump Pedestal Pump

- 41 gpm @ 10' Head
- Passes 1/2" spherical solids
- Non-clogging thermoplastic impeller
- 1-1/2" FPT Discharge
- Float operated
- 1/3 hp



Part #	Mfg #	Description	Cord	Price
ZOEM82	M82	115V Auto	7-1/2'	178.00

311 "Mighty Mover" Non-Submersible Portable Dewatering Pump

- 337 gph @ 1' Head
- Non-solids handling
- Lifts water from 15' below pumping level
- Garden hose connections
- Self-priming 7' or less above liquid
- 90-Day warranty or 6-months from date of manufacture



Part #	Mfg #	Description	Cord	Price
ZOE311	311-0002	115V Auto	6'	118.00

Floor Sucker Series Utility Pump

"42" Indoor/Outdoor Utility Pump

- 660 gph @ 10' Head
- Non-solids handling
- Adaptable for use with standard garden hose (fitting included), 1" NPT pipe, or 1-1/4" slip fit (use discharge hose kit P/N 1010-0117)
- Fully or partially submersible
- 1/6 hp



Part #	Mfg #	Description	Cord	Price
ZOE42	42-0007	115V Manual	9'	109.00

"Mighty-Mate" Submersible Effluent or Dewatering Pump

"53" Cast Iron Submersible Pump

- 34 gpm @ 10' Head
- Passes 1/2" spherical solids
- Non-clogging vortex impeller
- 1-1/2" NPT Discharge
- Float operated
- 3/10 hp



Part #	Mfg #	Description	Cord	Price
ZOEM53	M53	115V Auto	9'	197.30

* 3-Year Extended Warranty

Utility/Dewatering Pump

314 "High Capacity" Water Mover Cast Iron Portable Non-Submersible Dewatering Pump

- 1230 gph @ 10' Head
- Non-solids handling
- Engineered thermoplastic impeller
- Includes 3/4" NPT garden hose adapters, suction screen & extra set of brushes, 9' power cord
- 1/2 hp
- 1-Year limited warranty



Part #	Mfg #	Description	Cord	Price
ZOE314	314-0002	115V Auto	9'	232.00

"Mighty Mate" with Piggyback Variable Level Float Switch



Part #	Mfg #	Description	Cord	Price
ZOEN53	BN53	115V Manual	15'	229.30

Pumps

Pumps & Accessories

"Flow-Mate" Submersible Effluent or Dewatering Pump

"98" Cast Iron Submersible Pump

- 72 gph @ 10' Head
- Passes 1/2" spherical solids
- Vortex impeller design
- 1-1/2" NPT Discharge
- Float operated
- 1/2 hp



Part #	Mfg #	Description	Cord	Price
ZOEM98	M98	115V Auto	15'	299.00

With Piggyback Variable Level Float Switch

- Includes 1-1/2" x 2" PVC adapter



Part #	Mfg #	Description	Cord	Price
ZOEN98	BN98	115V Manual	15'	316.30

"137" Cast Iron Submersible Pump

- 79 gph @ 10' Head
- Passes 5/8" spherical solids
- Non-clogging vortex impeller
- 1-1/2" NPT Discharge
- Float operated
- 1/2 hp



Part #	Mfg #	Description	Cord	Price
ZOEM137	M137	115V Auto	10'	449.00

Oil Smart® System Submersible Dewatering Pump

Oil Smart® Submersible Dewatering System

- Includes pump, switch and alarm
- 115V Single phase
- Non-clogging vortex impeller
- 1-1/2" NPT Discharge
- Automatic reset thermal overload protected
- Audible and light alarms with dry contacts
- Differentiates oil and water
- 20' Piggyback electrical supply cord



Part #	Mfg #	Solids	HP	Price
ZOE940-0007	940-0007	3/4"	1/2	2536.00

Sewage Waste Pumps

266 "Waste-Mate" Cast Iron Submersible Sewage/Effluent*/Dewatering Pump

- 89 gpm @ 10' Head
- Passes 2" spherical solids
- Non-clogging vortex impeller
- 2" NPT Discharge
- Float operated, submersible (NEMA 6) 2-pole switch
- 1/2 hp



"Waste-Mate" with Piggyback Variable Level Float Switch



Part #	Mfg #	Description	Price
ZOEBN266	266-0005	115V Auto	433.00

Pumps

Pumps & Accessories

267 "Waste-Mate" Cast Iron Submersible Sewage/Effluent*/Dewatering Pumps

- 89 gpm @ 10' of head
- Passes 2" spherical solids
- Non-clogging vortex impeller
- 2" NPT Discharge
- Float operated
- 1/2 hp



Part #	Mfg #	Description	Cord	Price
ZOEM267	M267	115V Auto	10'	468.00
ZOED267	267-0003	230V Auto	10'	545.00

267 "Waste-Mate" with Piggyback Variable Level Float Switch



Part #	Mfg #	Description	Cord	Price
ZOEN267	BN267	115V Manual	15'	453.00

Qwik Jon® System

Qwik Jon® System

- Includes:
 - Qwik Jon tank
 - Lid & gasket
 - 2" Solids-handling Zoeller-built pump
 - Floor flange extender kit with wax rings
 - Check valve
 - Discharge pipe to lid
 - Qwik Jon fittings & hardware
 - Installation instructions

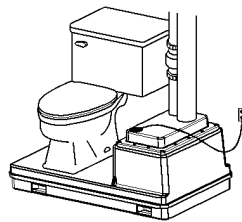

Part #	Mfg #	Pump	Power	Price
ZOE100	100-0005	WM264	0.4hp /115V	914.00

Qwik Jon® Ultima 202 Sewage Removal System

- Includes
 - Tank, lid & gasket
 - Tank, mini-grinder pump and a comfort height, ADA compliant toilet with elongated bowl
 - 1/2 HP Mini-grinder pump
 - Back-flow device (check local codes)
 - 1" Discharge & 1-1/2" vent
 - Hardware & installation instructions.



Part #	Mfg #	Description	Price
ZOE202	202-0005	1/2 Hp 115V w/White ADA Rear Outlet Elong Closet	1098.00

Drain Pump Series

Laundry Pump Series

- 115V
- Includes:
 - Automatic pumps with tank cord seals & hardware
 - Polypropylene basin & lid
 - Internal discharge pipe to lid
 - Check valve
- Models 104 & 132 are not IAPMO approved

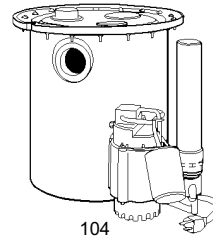

104



105

Part #	Mfg #	Includes Pump:	Price
ZOE104	104	M72, Less Check Valve	259.00
ZOE105	105	M53	299.00
ZOE132	132-0001	M72	299.00

Pumps

Pumps & Accessories

Backup Systems

Aquanot® Flood Alert® High Water Alarm

- Operates on (3) AAA batteries
- Low battery alarm
- On/off silence switch
- Stainless steel sensor contacts
- 5' of Lead wire
- 12-Month limited warranty



Part #	Mfg #	Description	Price
ZOE100763	10-0763	High Water Alarm	37.70

Basement Sentry™ 12V Back-up System

- For clear water
- Includes Non-corrosive pump, self-contained 10 amp battery recharger, pump alarm, battery case, fittings
- Battery burn-out and overcharge protection
- Not recommended for installation with over 12' total dynamic head



Part #	Mfg #	Description	Price
ZOE507	507-0005	Adapt Check Valve to Pipe	353.00

Home-Guard Max Pump Back-up System

- Water powered emergency back-up sump pump system
- Anticorrosive PVC construction
- Performs at 80 psi
- Removes up to 2 gallons per gallon used
- 2-Year limited warranty



Part #	Mfg #	Description	Price
ZOEHOMEGUARDMAX	503-005	Water Operated Sump Pump Back-up	217.00
ZOEHOMEGUARDMAXA	503-007	Water Operated Sump Pump Back-up w/Alarm	350.00

Simplex Sewage Package System - Indoor

Simplex 2" Vent Job-Ready Sewage Package Indoor System

- 2" PVC Discharge pipe, 30" long
- Pump passes 2" spherical solids



18" x 30" Basin

Part #	Mfg #	Pump Basin	Price
ZOE912-0005	912-0005	BN264 Std Poly Struct Foam	554.00

Preassembled Sump Pump System

900 Series Sump Pump

- Includes:
 - Pump switch is installed 180° from inlet
 - Discharge pipe is plumbed with a predrilled 3/16" vent hole
 - Electrical cord seal is installed in cover
 - Cover is sealed and bolted down
 - Basin is filled with environmentally safe peanuts for safe transit - just add water and they dissolve
 - Automatic cast iron or thermoplastic pump with tank and all hardware
 - 18" x 22" Basin with 4" inlet
 - Deluxe unit has a Radon approved basin and cover for Radon prevention
 - Standard and economy models use a polyethylene basin and cover
 - Deluxe cover has a 3" vent, 1-1/2" discharge
 - Standard and economy covers have a 2" vent and 1-1/2" discharge
 - Fast, easy and job ready



Part #	Mfg #	Pump Type	Wt	Price
ZOE900	900-0001	M53 Deluxe	48 lbs	374.00

Pumps

Pumps & Accessories

Scale Removal Systems

109 Series Scale Removal System

- Removes line build-up in tankless water heating units
- Preassembled with hoses, tank, pump and fittings
- Internal reusable filter sock
- Meets flushing requirements for tankless water heater systems
- Pump: 1/6 HP, 3.0 FLA, 345 watts, 115V, air-filled (no oil), quiet submersible
- 5 Gallon polyethylene tank and lid with stainless steel hardware
- 3/4" Stainless steel braided flush lines
- Stainless steel handles
- Corrosion resistant
- 3 Gallons per minute recirculation rate



Part #	Mfg #	Description	Price
ZOE109	109-0005	109 SRS Scale Removal System	328.00

On-Site Wastewater Products

"WW" Residential Effluent Septic Tank Filters

- Twice the filtration area of most filters
- 100% Submerged filter area for 100% filtration
- Removes solids larger than 1/16" from effluent
- For single family home application
- Fits any 4" sanitary tee

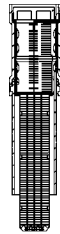

Part #	Mfg #	Size	Price
ZOEFILTER	170-0078	3"	67.26

"Full-Flow" Unichecks

Cast Iron Slip x Slip Unions

- Checks backflow of water & sewer gas
- Neoprene gasket & flapper, weighted with heavy stainless steel metal backing plates & stainless steel rivet
- Reduces motor and pump noise
- Stops electrolysis
- Vertical or horizontal installation



Part #	Mfg #	Size	Price
ZOE300151	30-0151	2"	58.80

PVC Slip x Slip Union

- Checks backflow of water and sewer gas
- Flapper bends over radius - no sharp 90° edges - lengthens life of flapper hinge
- PVC Plastic check body bolted together
- Vertical or horizontal installation



Part #	Mfg #	Size	Price
ZOE300181	30-0181	1-1/2" or 1-1/4"	17.38

Sewage Package Systems

910 Simplex and Duplex Sewage Package System

- Ideal for homes, farms, trailer courts, motels, restaurants and institutions where drain facilities are below existing sewer lines
- 135°F Maximum rated temperature
- Includes:
 - (2) Automatic model pumps
 - (1) 10-0804 Smart Pak Residential Alternator with alarm
 - (1) 31-1105 30" x 36" Polyfoam basin with 2" vent/discharge
 - (2) 30-0101 Tri-Check® valves



Part #	Mfg #	Description	Price
ZOE910	910-0031	1/2 hp 2" Sewage Ejector Package	626.36

912 Sewage Package System

- Includes:
 - (1) 2" Solids sewage ejector
 - (1) 24" x 24" Poly molded basin
 - (1) PSF Cover with 2V2D
 - Internal 2" PVC discharge pipe



Part #	Mfg #	Description	Price
ZOE912-0115	912-0115	.4 hp Preassembled Pkg w/BN264	592.00
ZOE912-0017	912-0117	.5 hp Preassembled Pkg w/BN266	615.00

Pumps

Pumps & Accessories

Back-Up Sump Pumps

Premium Water Powered Backup Sump Pump System - Basepump

- No battery, no charger
- Automatic, independent system from the primary sump pump
- Mounted on ceiling
- Includes:
 - Basepump ejector - polypropylene
 - One-way check valve
 - Mounting clamps and screws
 - Discharge relief tee
 - Nylon cable tie straps, PVC fittings
 - 6 Feet of flexible PVC discharge hose
 - Float unit
 - Hydraulic transfer tube
 - Suction screen
 - Instructions

Basepump

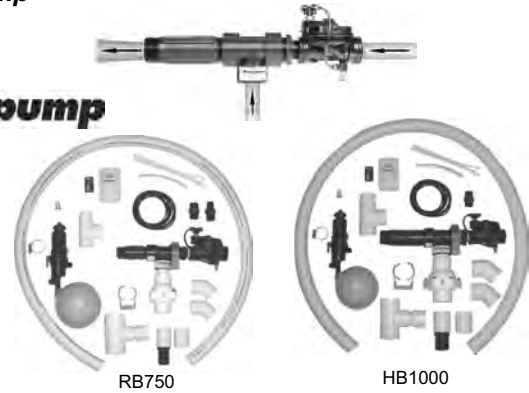

Pumps

Part #	Mfg #	Gal/Hr 10' Lift @40 lbs PSI	City Water Used GPM	Description	Price
BAPRB750	RB750	750	7	Residential	548.96
BAPHB1000	HB1000	1,000	10	Commercial	659.92

We have 32 convenient locations proudly serving Western NY, Central NY, and Northern Pennsylvania.



www.irrsupply.com

Pumps & Accessories

Sump Pumps

Guardian® Back-Up Sump Pump

- Emergency water powered back-up
- Designed for intermittent or continuous use
- Made with high quality brass and PVC for corrosion resistance
- Model 747H20RR (radon ready) allows operating valve to be installed under cover for applications where sump lid must be sealed



Part #	Mfg #	Description	Price
AYMGUARDIAN	747H20	Guardian Sump Pump	553.75

Water Pumps

DuraMAC Booster Pump

- Water pressure boosting system for residential or light commercial applications
- Digital control with 3 modes of operation
- Stainless steel and no-lead brass connections
- 2 Gallon pressure tank
- TEFC Single-phase motor
- Electronics separated and sealed from waterway
- Pressure gauge included
- No-lead brass check valve included
- Dry-run protection



Part #	Mfg #	Pump Boost	HP	Max Incoming Pressure	Price
AYMDURAMAC35	17035R020 PC1	35 psi	1/2	45 psi	1258.00
AYMDURAMAC52	17052R020 PC1	52 psi	3/4	28 psi	1412.00



Sump Pumps

101 Series Pedestal Sump Pump

- Cast iron construction, epoxy powder coated
- Stainless steel rotor shaft
- Zinc coated steel column
- Adjustable level control
- Double inlet screening
- 8' 3-Wire power cord and ground plug
- 1-1/4" Discharge size
- 1/3 hp, 60Hz, 1725 rpm, PSC
- 2-Year warranty



Part #	Mfg #	Description	Price
LIB101	101	1/3hp Upright	218.00

230 Series Aluminum Submersible Sump Pump

- Polypropylene and powder-coated aluminum construction
- Stainless steel rotor shaft
- Vortex-style impeller of high temp engineered thermoplastic
- 3/8" Solids handling
- 10' Quick-disconnect power cord
- 1-1/2" Discharge size
- 1/3 hp, 60Hz, 3450 rpm
- 2-Year warranty



Part #	Mfg #	Description	Price
LIB237	237VFM	115V Auto, Vertical Magnetic Float	184.00

250 Series Cast Iron Submersible Sump Pump

- 1/2" Solids handling
- Vortex engineered polymer impeller
- 1-1/2" Discharge size
- 10' Cord
- 1/3 hp Motor, oil filled with thermal overload protection
- 2-Year warranty



Part #	Mfg #	Description	Price
LIB257	257VMF	115V Auto, Vertical Magnetic Float	191.00

Pumps

Prices & Specifications are Subject to Change.

Pumps & Accessories

SumpJet™ Water Powered Back-Up Sump Pump

- Powered by municipal water supply and requires no electricity
- Removes 2 gallons of sump water per 1 gallon used
- Built-in backflow prevention
- Built-in screen with removable foot valve
- 1-1/2" Discharge
- 3/4" NPT Water inlet connection with optional hose connector included
- 2-Year warranty



Part #	Mfg #	Description	Price
LIBSJ10	SJ10	Water Powered Back-Up Pump	230.00
LIBSJ10A	SJ10A	Water Powered Back-Up Pump with Alarm	415.00

Drain Pumps

404 Drain Pump

- Fully automatic operation
- Oil-filled, hermetically sealed motor
- 25 gpm @ 10' Head
- 3/8" Solids handling
- 10' 3-Wire power cord with grounded plug
- Maintenance-free, permanently lubricated sealed bearings
- 1/3 hp
- 2-Year warranty



Part #	Mfg #	Description	Price
LIB404	404	115V, 1-1/2" FPT Inlet, Discharge and Vent	302.00

AscentII™ Macerating Toilet System

- Powerful and quiet RazorCut™ macerator pumps waste up to 25' vertically and 150' away from soil stack, stainless steel blades
- 1/2 hp, 115V Operation
- White toilet with matching white pipe connectors
- 1.28 Gallons per flush, HET
- Accepts additional fixtures such as a lavatory and shower
- Includes flush valve kit, toilet seat
- 3-Year warranty



Part #	Mfg #	Description	Price
LIBASCENTIIESW	ASCENT II ESW	Complete System: Macerator, Elongated Toilet, Flush Valve & Hardware Kit, White	1178.00
LIBASCENTIIIRSW	ASCENT II RSW	Complete System: Macerator, Round Toilet, Flush Valve & Hardware Kit, White	1128.00

Utility Pumps

260 Model Submersible Utility Pump

- Pumps down to within 1/8" of base
- 1-1/4" Discharge with 5/8" garden hose adapter
- 1/6 hp
- 2-Year warranty



Part #	Mfg #	Description	Price
LIB260	260	115V, Non-Automatic	112.00

331 Model Cast Aluminum Portable Transfer Pump

- Maximum discharge head of 105'
- Glass reinforced thermoplastic impeller
- 20' Cord
- 1/2 hp, 8A, 60Hz, 7500 rpm
- 2-Year warranty



Part #	Mfg #	Description	Price
LIB331	331	115V, Maximum Suction Lift of 15'	281.00

Pumps

Pumps & Accessories

Sewage Basins

Corrugated Tapered Wall Poly Sump Basin



Shown with Lid

Part #	Mfg #	Size	Capacity	Price
TPPBC18-30	B2400TL	18" x 30"	34 gal	66.66

Rolled Top Poly Basin

- Extra-high roll top helps prevent debris from entering basin during installation
- B41001RT Includes 4" inlet grommet



Part #	Mfg #	Size	Capacity	Price
TPPBPRT30-36	B41001RT	30" x 36"	108 gal	368.66

Economy Basin

- Side-vent design



Part #	Mfg #	Size	Capacity	Price
TPPBP18-22	B2200	18" x 22"	22 gal	30.92

Structural Foam Basin

- Increased volume capacity
- Less cycling time



Part #	Mfg #	Size	Capacity	Price
TPPFP18-30	M3-24001	18" x 30"	30 gal	107.38

Sewage Basin Covers

Item #	Mfg #	Description	Price
TPPLP18	C18LPN	Plastic Economy Slotted Cover f/Polyethylene Recess Roll Top Sump Basin	34.16
TPPLS18	C18TS	18" 2-Pc Simplex Steel Cover	73.62
TPPLC18WP	C18WP	18" Solid Poly Cover	44.44
TPPLC18	C23STL	TOPP Locking Slotted Poly Cover for B2300TL	26.26
TPPLS30ACC	C30DSA	1-4" Thick Duplex Black Epoxy Steel Cover for Standard 30" Rnd Basins w/(2) Access Plates & (1) Blank Inspection Plate, 73 lbs	667.08

Sewage Basin & Cover Combinations

Foam Basin with Simplex Steel Lid

- Includes:
 - M324001: 18" x 30" Foam basin
 - C18TS: 18" 2-pc Simplex steel lid

Part #	Mfg #	Description	Price
TPPKF18-30	M3-24TS-015 5S	18" x 30" Foam Basin w/2-Piece Simplex Steel Lid	180.78

Poly Basin with Lid

- Includes:
 - B2200 - 18" x 22" Economy basin
 - C18LPN - Plastic economy slotted cover

Part #	Mfg #	Description	Price
TPPKP18-22	TPPBP18-22 & TPPLP18	18" x 22" Poly Basin w/Lid	63.52

Pumps & Accessories

SJE Pumpmaster® Pump Switch

- Automatic controls of pumps in potable water, water and sewage applications
- Adjustable pumping range 7" to 36"
- Not affected by rotation or turbulence
- Includes standard mounting clamps
- UL Listed for use in water & sewage
- CSA Certified
- 3-Year limited warranty



SJE Pumpmaster® Pump Switch with Plug

- D - Pump down
- U - Pump up

Part #	Mfg #	Model	VAC	Cord	Price
SJE15PMD1WP	1002715	15PMD1WP	120	15'	91.86
SJE15PMD2WP	1002717	15PMD2WP	230	15'	96.62
SJE15PMU1WP	1002721	15PMU1WP	120	15'	91.86
SJE15PMU2WP	1002723	15PMU2WP	230	15'	96.62

SJE Pumpmaster® Plus Pump Switch

- Automatic controls of pumps in potable water, water and sewage applications
- Adjustable pumping range 7" to 36"
- Not affected by rotation or turbulence
- Heavy-duty contacts
- Includes standard mounting clamps
- Passed NSF Std 61 protocol by an approved Water Quality Association laboratory
- UL Listed for use in water & sewage
- CSA Certified
- 3-Year limited warranty



SJE Pumpmaster® Plus Pump Switch with Plug

Part #	Mfg #	Model	VAC	Cord	Price
SJE15PMPD1WP	1003243	15PMPD1WP	120	15'	122.48
SJE15PMPD2WP	1003245	15PMPD2WP	230	15'	125.56

SJE Pumpmaster® Plus Pump Switch Less Plug

- D - Pump down
- U - Pump up

Part #	Mfg #	Model	VAC	Cord	Price
SJE15PMPDWOP	1003247	15PMPDWOP	120/230	15'	113.86
SJE15PMPUWOP	1003253	15PMPUWOP	120/230	15'	113.86

Pumps

Pumps & Accessories

Control Panels

Model 112 Single Phase Simplex Control Panel - NEMA 4X

- Controls one 120, 208, or 240 VAC single-phase pump in pump chambers, sump pump basins, irrigation systems and lift stations
- 8" x 8" x 4" Ultraviolet stabilized thermoplastic enclosure
- Magnetic motor contactor
- HOA switch
- Three 20' Sensor Float® control switches
- Red alarm beacon, alarm horn
- Exterior horn test/normal/silence switch
- Horn silence relay
- Weatherproof, NEMA 4X enclosure rating
- UL Listed; CSA Certified
- 3-Year limited warranty



Part #	Mfg #	VAC	FLA	Circuit Breaker	Price
SJESIMPNEMA4	1121W110H	120/208/240	7-15	No	808.62

Model 112 Single Phase Simplex Control Panel - NEMA 1

- Controls one 120, 208, or 240 VAC single-phase pump in pump chambers, sump pump basins, irrigation systems and lift stations
- 8" x 8" x 4" Steel enclosure
- Magnetic motor contactor
- HOA switch
- Three 20' Sensor Float® control switches
- Door mounted indicator of alarm conditions
- Internally mounted buzzer
- Exterior test/normal/silence switch
- Horn silence relay
- UL Listed; CSA Certified
- 3-Year limited warranty



Part #	Mfg #	VAC	FLA	Circuit Breaker	Price
SJESIMPNEMA1	11211110H	120/208/240	7-15	No	720.86

Model 122 Single Phase Duplex Control Panel - NEMA 4X

- Controls two 120, 208, or 240 VAC single-phase pump in water and sewage installations
- Alternating action equalizes pump wear
- Provides override control should either pump fail
- Alarm switch - audio/visual alarm system
- 12" x 10" x 6" Ultraviolet stabilized thermoplastic enclosure
- Magnetic motor contactor
- HOA switches
- Three 20' Sensor Float® control switches
- Red alarm beacon, alarm horn
- Exterior horn test/normal/silence switch
- Weatherproof, NEMA 4X enclosure rating
- UL Listed; CSA Certified
- 3-Year limited warranty



Part #	Mfg #	VAC	FLA	Circuit Breaker	Price
SJEDUPNEMA4	1221W110H	120/208/240	7-15	No	1225.46

Pumps

Prices & Specifications are Subject to Change.

Pumps & Accessories

Model 122 Single Phase Duplex Control Panel - NEMA 1

- Controls two 120, 208, or 240 VAC single-phase pump in water and sewage installations
- Alternating action equalizes pump wear
- Provides override control should either pump fail
- Alarm switch - audio/visual alarm system
- 12" x 10" x 6" Steel enclosure
- Magnetic motor contactor
- HOA switches
- Three 20' Sensor Float® control switches
- Door mounted indicators
- Internally mounted buzzer for alarm conditions
- Exterior horn test/normal/silence switch
- Indoor NEMA 1 enclosure rating
- UL Listed; CSA Certified
- 3-Year limited warranty



Part #	Mfg #	VAC	FLA	Circuit Breaker	Price
SJEDUPNEMA1	12211110H	120/208/240	7-15	No	1107.92

Tank Alarm Systems

Tank Alert® AB Alarm System

- Liquid level alarm system with auto reset and battery backup for indoor use
- NEMA 1 Enclosure
- Automatic alarm reset
- Can be used w/any UL listed/recognized switching mechanism rated to include 1 amp, 9 vDC load
- Includes SJE SignalMaster® control switch with 15' of cable
- 120 VAC
- UL Listed; CSA Certified
- 3-Year limited warranty



Part #	Mfg #	Model	Description	Price
SJETANKALERTAB	1011422	TAAB-01H	15' SJE Sensor Float High	155.56

Pumps

Pumps & Accessories

Waste Water Pumps

LTA Direct Mount Pump

- Pressure activated switch turns pump on when water enters tub
- Corrosion resistant
- Integral junction box
- 8' Cord & plug
- Mounts directly to sink tailpiece
- No traps required

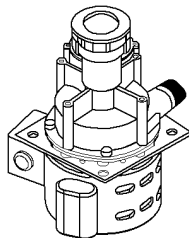

Part #	Mfg #	Description	Price
HALLTA1	LTA-1	Automatic Laundry	354.79

LTP Medium Capacity Reservoir Pump

- Designed for laundry & wet bar applications
- Primarily used where sink or appliance is below the plumbing drain
- Fits under utility sinks
- Suds proof 2 gallon reservoir
- 8' Cord & plug



Part #	Mfg #	Description	Price
HALLTPL	LTP-L-1	1/4 hp, 115 VAC, 5A	428.69

LTS High Capacity Reservoir Pump

- Snap-action switch
- Suds-proof reservoir, can be used as laundry tray pump
- 1/3 HP, 1750 RPM Motor
- 1-1/2" FNPT Inlet, 1" FNPT outlet
- 14" Max head, 180°F max temp
- Integral junction box
- 8' Cord & plug



Part #	Mfg #	Description	Price
HALLTS1	801285	115V	495.18

Switches



Part #	Mfg #	Description	Price
HALL111A	610053	L-11-1A Switch/Float Assembly for Laundry Pumps	112.41
HALLTASWITCH	610102	Switch f/LTA-1 f/Pumps Produced After 2/2007	74.34



Check Valves

1500 Series Sch 40 PVC Swing Check Valve

- No metallic parts, corrosion resistant
- Full flow design
- Angle seat and weighted flapper design for low pressure seal
- PVC weighted and shielded flapper will retain back pressure up to 125 PSI
- Ideal for close working areas, easy pipe alignment
- Compression ends can be used as union connections
- Designed for both horizontal and vertical usage
- Pressure rated 125 PSI @ 72°F



Part #	Mfg #	Description	Price
FLOCHK2	1500-20	2" Comp x Comp White	58.60

PVC Sump Check Valve



Part #	Mfg #	Description	Price
FLOCHK	SUMP CHECK	1-1/2" Comp	28.43

Pumps

THANK YOU!
We appreciate your business

Water Filter Systems

Standard Septic Tanks

- Polyethylene tank
- Septic system replacement and new home construction
- Not for drinking water
- One piece, seamless, watertight



Part #	Mfg #	Description	Price
WWPST500	41320	500 gal, 1 Comp	1214.22
WWPST1000	42248	1060 gal, 2 Comp	1781.94
WWPST1250	42256	1250 gal, 2 Comp	3219.74
WWPST1500	42275	1500 gal, 2 Comp	3830.82

Septic Tank Risers

- 24" ID Riser; watertight connection
- Extra-strong flat top design
- Anti-slip surface



Part #	Mfg #	Description	Price
WWPRISER6	63503	6" Septic Riser	128.18
WWPRISER12	63504	12" Septic Riser	135.30
WWPRISER18	63505	18" Septic Riser	146.00



On-Site Leaching Chambers

ARC™ Chamber

ARCCHAMBER



Part #	Mfg #	Description	Price
WWPARC18CHAMBER	ARCCHAMBER	5' Chamber for Leach Lines	36.22
WWPARC18ENDCAP	ARC18ENDCAP	End Cap for ARC 18	20.58

Drainage

Water Systems

Drainage and Septic Products by Meyers

Distribution Boxes

- Injection molded HDPE
- Speed leveler in each outlet
- Snap-in pipe seals
- Non-corrosive



Part #	Mfg #	Description	Price
WWPDB6	7HD2	6 Outlet/7 Hole Dist Box	95.56
WWPDB8	9HD2	8 Outlet/9 Hole Dist Box	95.56



Drainage Products

9" Catch Basin



Part #	Mfg #	Description	Color	Price
NDSBASIN	900	9" x 9" Catch Basin, (2) Openings	Black	37.16

9" Square Catch Basin Grate



Part #	Mfg #	Description	Color	Price
NDSGRATE	980	9" Square Grate	Black	48.00

Round Catch Basin Grate



Part #	Mfg #	Description	Color	Price
NDSRDG4	13	4" Round Grate	Green	5.66
NDSRDG6	50	6" Round Grate	Green	15.76
NDSRDG10	1050	10" Round Grate	Green	28.46

Drainage

Drainage

Universal Catch Basin Outlet



Part #	Mfg #	Description	Color	Price
NDSADAPT	1243	3" & 4" Universal Locking Outlet	Black	9.70
NDSPLUG	1206	6" Universal Plug Adapter	Black	7.76

Channel Drains & Accessories

Dura Slope™ Trench Drain System

- Flanges on bottom of channel provide lip for anchoring
- Lightweight 4 foot modular sections
- May be cut to any length

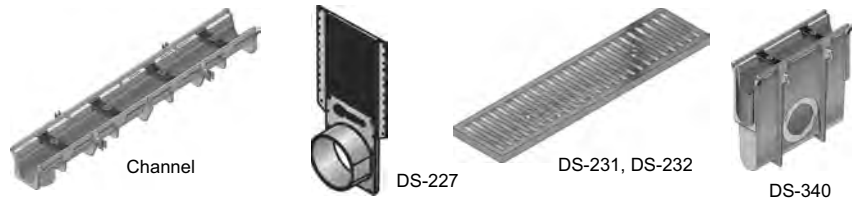

Part #	Mfg #	Description	Color	Price
NSDSDS091	DS-091	3.99" to 4.33" Deep Dura Slope Channel	Gray	150.26
NSDSDS092	DS-092	4.33" to 4.67" Deep Dura Slope Channel	Gray	150.26
NSDSDS093	DS-093	4.67" to 5.01" Deep Dura Slope Channel	Gray	150.26
NSDSDS094	DS-094	5.01" to 5.34" Deep Dura Slope Channel	Gray	150.26
NSDSDS094N	DS-094N	5.34" Deep Neutral Dura Slope Channel	Gray	150.26
NSDSDS095	DS-095	5.34" to 5.68" Deep Dura Slope Channel	Gray	150.26
NSDSDS096	DS-096	5.68" to 6.01" Deep Dura Slope Channel	Gray	150.26
NSDSDS097	DS-097	6.01" to 6.35" Deep Dura Slope Channel	Gray	150.26
NSDSDS097N	DS-097N	6.35" Deep Neutral Dura Slope Channel	Gray	150.26
NSDSDS098	DS-098	6.35" to 6.69" Deep Dura Slope Channel	Gray	150.26
NSDSDS099	DS-099	6.69" to 7.02" Deep Dura Slope Channel	Gray	150.26
NSDSDS100	DS-100	7.02" to 7.36" Deep Dura Slope Channel	Gray	150.26
NSDSDS100N	DS-100N	7.36" Deep Neutral Dura Slope Channel	Gray	150.26
NSDSDS101	DS-101	7.36" to 7.69" Deep Dura Slope Channel	Gray	150.26
NSDSDS102	DS-102	7.69" to 8.03" Deep Dura Slope Channel	Gray	150.26
NSDSDS103	DS-103	8.03" to 8.37" Deep Dura Slope Channel	Gray	150.26
NSDSDS103N	DS-103N	8.37" Deep Neutral Dura Slope Channel	Gray	150.26
NSDSDS104	DS-104	8.37" to 8.70" Deep Dura Slope Channel	Gray	150.26
NSDSDS105	DS-105	8.70" to 9.04" Deep Dura Slope Channel	Gray	150.26
NSDSDS106	DS-106	9.04" to 9.37" Deep Dura Slope Channel	Gray	150.26
NSDSDS106N	DS-106N	9.37" Deep Neutral Dura Slope Channel	Gray	150.26
NSDSDS107	DS-107	9.37" to 9.70" Deep Dura Slope Channel	Gray	150.26
NSDSDS108	DS-108	9.70" to 10.05" Deep Dura Slope Channel	Gray	150.26
NSDSDS109	DS-109	10.05" to 10.38" Deep Dura Slope Channel	Gray	150.26
NSDSDS109N	DS-109N	10.38" Deep Neutral Dura Slope Channel	Gray	150.26
NSDSDS110	DS-110	10.38" to 10.71" Deep Dura Slope Channel	Gray	150.26
NSDSDS111	DS-111	10.71" to 11.05" Deep Dura Slope Channel	Gray	150.26
NSDSDS112	DS-112	11.05" to 11.39" Deep Dura Slope Channel	Gray	150.26
NSDSDS113	DS-113	11.39" to 11.72" Deep Dura Slope Channel	Gray	150.26
NSDSDS114	DS-114	11.72" to 12.06" Deep Dura Slope Channel	Gray	150.26

Drainage

All Items May Not Be Stocked In All Branches

Drainage

Channel Drains & Accessories (Continued)

Dura Slope™ Trench Drain System

Part #	Mfg #	Description	Color	Price
NDSDS123	DS-123	Frame & End Cap Screws 12/Bag	Gray	0.50
NDSDS126	DS-126	Bottom Outlet Adapter	Gray	39.26
NDSDS224	DS-224	Universal End Cap	Gray	17.90
NDSDS227	DS-227	Universal End Outlet	Gray	19.52
NDSDS231	DS-231	2' Cast Iron Channel Grate	Black	72.26
NDSDS232	DS-232	2' Ductile Iron Channel Grate	Black	77.94
NDSDS340-2	DS-340	2' Outlet Catch Basin	Gray	163.96

SPEE-D® Channel Drain

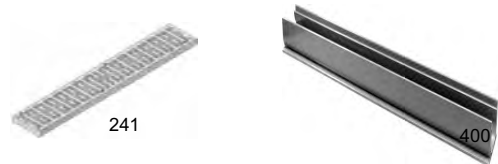

Part #	Mfg #	Description	Color	Price
NDSDG2-4	241	2' Channel Grate	Gray	42.88
NDSCD4	400	4' Channel Drain	Gray	79.32

SPEE-D™ Channel Accessory

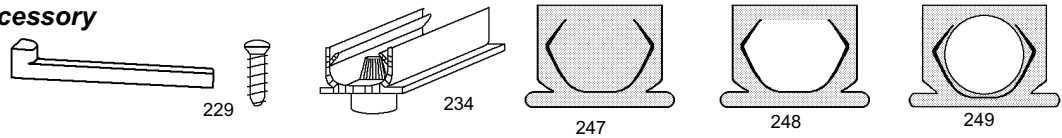

Part #	Mfg #	Description	Color	Price
NDSSCREW	229	Stainless Steel Screws	Steel	0.70
NDSCD2	234	2" Long Fabricated 3" & 4" Spigot Bottom Outlet w/Strainer	Gray	75.94
NDSCAP	247	Channel End Cap	Gray	11.66
NDSCPLG	248	Channel Coupling	Gray	11.16
NDSCAP3	249	3" & 4" End Outlet	Gray	12.92

Drainage

Kitchen/Bar Faucets

Single-Handle Kitchen Faucets

Allora® Diamond™ Series 1-Handle Pull-Down Spray Kitchen Faucet

- 9-7/8" Reach, 15-9/16" high spout swivels 360°
- 7-3/4" From deck to aerator
- Touch-Clean® pull-down two-function spray head with MagnaTite™ docking
- 24" Reach on pull out
- Hot/cold indicator
- Quick connect hoses
- 3/8" Compression fittings
- 2-1/2" Maximum deck thickness
- 32" Minimum supply lines below deck included
- DIAMOND™ Valve with Innoflex™ PEX waterways
- Lifetime finish and faucet warranty



Part #	Mfg #	Description	Handle(s)	Finish	Price
DEL989SSSDST	989-SSSD-DST	2-Hole, Pull-Down Spray, Soap Dispenser	ADA Lever	Stainless*	559.90

Classic 1-Handle Kitchen Faucet

- 8" Reach spout swivels 360°
- 3/8" OD Inlets
- Straight, staggered supply tubes on Model 100
- Deck thickness:
 - Model 100 - 1" maximum
 - Model 120 - 5/8" maximum



Part #	Mfg #	Description	Handle(s)	Finish	Price
DEL100	B1310LF	8"cc	ADA Lever	Chrome	98.35
DEL120	120	8"cc, 1/2" IPS Shanks	ADA Lever	Chrome	119.75

Classic Diamond™ Series 1-Handle Kitchen Faucet

- 8" Reach, 6-3/4" high spout swivels 170°
- 4-3/4" From deck to aerator
- Hot/cold indicators
- 3/8" Compression fittings
- 2-1/2" Maximum deck thickness
- 32" Minimum supply lines below deck included
- DIAMOND™ Valve with Innoflex™ PEX waterways



Part #	Mfg #	Description	Handle(s)	Finish	Price
DEL101DST	101-DST	1-Hole	ADA Lever	Chrome	109.75

* Brilliance® Anti-Tarnish Lifetime Finishes

All Items May Not Be Stocked In All Branches

Kitchen/Bar Faucets

Classic 1-Handle Kitchen Faucet with Side Spray

- 8" Reach spout swivels 360°
- 3/8" OD Inlets
- 1" Maximum deck thickness
- With side spray (white)



Part #	Mfg #	Description	Handle(s)	Finish	Price
DEL400	B4410LF	8"cc, White Side Spray	ADA Lever	Chrome	119.05

Collins™ Diamond™ Series 1-Handle Kitchen Faucet with Side Spray

- 9-3/16" Reach, 7-1/8" high spout swivels 180°
- 5-7/32" From deck to aerator
- Hot/cold indicator
- 3/8" Compression fittings
- 2-1/2" Maximum deck thickness
- 32" Minimum supply lines below deck included
- DIAMOND™ Valve with Innoflex™ PEX waterways



Part #	Mfg #	Description	Handle(s)	Finish	Price
DEL440DST	440-DST	8"cc, Side Spray	ADA Lever	Chrome	155.15

Leland® Diamond™ Series 1-Handle Pull-Down Spray Kitchen Faucet

- 9-1/8" Reach, 14-1/4" high, high-arc pull-down spout swivels 360°
- 7-1/4" From deck to aerator
- MagnaTite™ spray head docking
- 59" Long hose
- Hot/cold indicators
- 3/8" Compression fittings
- 2-1/2" Maximum deck thickness
- 32" Minimum supply lines below deck included
- DIAMOND™ Valve with Innoflex™ PEX waterways



Part #	Mfg #	Description	Handle(s)	Finish	Price
DEL978SSSDST	978-SSSD-DST	6"-16"ws, Pull-Down Spray, Soap Dispenser	ADA Lever	Stainless*	418.30

Visionary Baths & More Kitchen and Bath Design Centers

Professionally staffed to assist you and your customers with design and selection <http://www.visionarybaths.com>

Kitchen & Bar Faucets

* Brilliance® Anti-Tarnish Lifetime Finishes

Prices & Specifications are Subject to Change.

Kitchen/Bar Faucets

Leland® Diamond™ Series 1-Hdl Pull-Down Spray Kitchen Faucet

- 9-13/64" Reach, 14-7/8" high, high-arc pull-down spout swivels 360°
- 7-7/8" From deck to aerator
- Diamond embedded ceramic disc cartridge control mechanism
- MagnaTite™ spray head docking
- Quick Snap® connect hoses
- Hot/cold indicators
- 3/8" Compression fittings
- 2-1/2" Maximum deck thickness
- 33-1/2" and 35" Supply lines below deck included
- DIAMOND™ Valve with Innoflex™ PEX waterways
- WE (Water Efficient) model: 1.5 gpm @ 60 psi



Part #	Mfg #	Description	Handle(s)	Finish	Price
DEL9178SSDST	9178-SSDST	1h or 8"cc , Pull-Down Spray, Water Efficient	ADA Lever	Stainless*	320.85

Pilar® Diamond™ Series 1-Handle Pull-Down Spray Kitchen Faucet

- 10-5/8" Reach, 13-7/8" high, high-arc spout swivels 360°
- 8-1/4" From deck to aerator
- Touch2O™ Technology controls water flow
- MagnaTite™ spray head docking
- 54" Long hose
- Hot/cold indicators
- 3/8" Compression fittings
- 2-1/2" Maximum deck thickness
- 32" Minimum supply lines below deck included
- DIAMOND™ Valve with Innoflex™ PEX waterways



980T-SD-DST

Part #	Mfg #	Description	Handle(s)	Finish	Price
DEL980TSDDST	980T-SD-DST	6"-16", Pull-Down Spray, Soap Dispenser	ADA Lever	Chrome	525.00

Saxony® Diamond™ Series 1-Handle Pull-Out Spray Kitchen Faucet

- 9-1/2" Reach, 8-11/16" high spout swivels 120°
- 6-5/8" From deck to aerator
- 59" Long hose
- Hot/cold indicators
- 3/8" Compression fittings
- 2-1/2" Maximum deck thickness
- Includes optional 10-3/4" escutcheon
- 32" Minimum supply lines below deck included
- DIAMOND™ Valve with Innoflex™ PEX waterways



473-SD-DST

Part #	Mfg #	Description	Handle(s)	Finish	Price
DEL473SSSDST	473-SSSD-DST	2- or 4-Hole, Pull-Out Spray, Soap Dispenser	ADA Lever	Stainless*	444.70

* Brilliance® Anti-Tarnish Lifetime Finishes

All Items May Not Be Stocked In All Branches

Kitchen/Bar Faucets

Signature® Diamond™ Series 1-Handle Pull-Out Spray Kitchen Faucet

- 9" Reach, 8" high spout swivels 120°
- 6-5/8" From deck to aerator
- 59" Long hose
- Hot/cold indicator
- 3/8" Compression fittings
- 2-1/2" Maximum deck thickness
- Includes optional 10-3/4" escutcheon
- 32" Minimum supply lines below deck included
- DIAMOND™ Valve with Innoflex™ PEX waterways



470-DST

Part #	Mfg #	Description	Handle(s)	Finish	Price
DEL470DST	470-DST	1-Hole or 8"cc, Pull-Out Spray	ADA Lever	Chrome	271.95
DEL470SSDST	470-SS-DST	1-Hole or 8"cc, Pull-Out Spray	ADA Lever	Stainless*	367.80

Two-Handle Kitchen Faucets

Classic 2-Handle Kitchen Faucet

- 9" Reach spout swivels 360°
- Standard with 1/2" IPS shanks
- Clear knob handles have hot/cold handle indicators
- Spray mounts left or right
- 2.2 gpm @ 60 psi



2100



2400



2402



2402 LHP



Part #	Mfg #	Description	Handle(s)	Finish	Price
DEL2100	2100	8"cc	ADA Blades	Chrome	81.75
DEL2102	2102	8"cc	Clear Knobs	Chrome	81.75
DEL2400	2400	8"cc Side Spray	ADA Blades	Chrome	104.45
DEL2402	2402	8"cc Side Spray	Clear Knobs	Chrome	104.45
DEL2402LHP	2402-LHP	8"cc Side Spray	Less Handles	Chrome	98.00

Waterfall® Series 2-Handle Kitchen Faucet

- 9-1/2" Reach 11-1/4" high spout swivels 360°
- Matching spray mounts left or right
- 1/2" IPS shanks
- 2.0 gpm @ 60 psi
- Requires handles (separately)



2176 LHP



2476 LHP



2276 LHP

Part #	Mfg #	Description	Handle(s)	Finish	Price
DEL2176LHP	2176-LHP	8"cc	Less Handles	Chrome	153.40
DEL2476LHP	2476-LHP	8"cc Side Spray	Less Handles	Chrome	190.15
DEL2276LHP	2276-LHP	6"-16"ws Side Spray	Less Handles	Chrome	303.60

* Brilliance® Anti-Tarnish Lifetime Finishes

Prices & Specifications are Subject to Change.

Kitchen/Bar Faucets

Two-Handle Bar/Prep Faucets

Classic 2-Hdl Blade Bar/Prep Faucet

- 4-1/16" Reach, 10-3/4" high spout swivels 360°
- Deck mount, 2 or 3 holes
- All operating parts are replaceable from the top
- Hot and cold stems are interchangeable
- 1/2" 14 NPSM threaded male inlet shanks
- Control mechanism is a rotating cylinder type with stainless steel plate and 90° rotating
- Flow rate: 1.5 gpm @ 60 psi



Part #	Mfg #	Description	Handle(s)	Finish	Price
DEL2171LF	2171LF	4"cc, Low Flow	ADA Levers	Chrome	122.80

THE BOLD LOOK
OF **KOHLER**

Single-Handle Kitchen Faucets

Coralais® 1-Handle Kitchen Faucet

- 8-5/8" High swivel spout
- Metal construction
- Washerless ceramic valving
- Includes 10" escutcheon



K-15172-CP

Part #	Mfg #	Description	Handle(s)	Finish	Price
KOHK15172FTBN	K-15172-FT-BN	8"cc Matching Spray, 10" Spout Reach, Flex Supply	ADA Lever	Brushed Nickel*	278.30

Fairfax® 1-Handle Pull-Out Spray Kitchen Faucet

- 9" Reach, 8-3/8" high swivel spout
- Metal construction
- Washerless ceramic valving, flexible supplies
- MasterClean™ sprayface
- Integral vacuum breaker, aerator, & ergonomic sprayhead with touch control stream-to-spray adjustment
- Includes optional 10" escutcheon



Part #	Mfg #	Description	Handle(s)	Finish	Price
KOHK12177CP	K-12177-CP	1-Hole, Matching Pull-Out Spray	ADA Lever	Pol Chrome	306.20

Forté® 1-Handle Pull-Out Spray Kitchen Faucet

- 10-1/8" Reach swivel pull-out spray spout
- Metal construction
- Washerless ceramic valving, flexible supplies
- 10-1/2" Escutcheon for 3-hole installation
- 2" Diameter escutcheon for 1-hole installation



Part #	Mfg #	Description	Handle(s)	Finish	Price
KOHK10433CP	K-10433-CP	8"cc Pull-Out Spray	ADA Lever	Pol Chrome	268.15

* Brilliance® Anti-Tarnish Lifetime Finishes

All Items May Not Be Stocked In All Branches

Kitchen/Bar Faucets

Single-Handle Kitchen Faucets (Continued)

Forté® 1-Handle Pull-Out Spray Kitchen Faucet

Part #	Mfg #	Description	Handle(s)	Finish	Price
KOHK10433BN	K-10433-BN	8"cc Pull-Out Spray	ADA Lever	Brushed Nickel*	317.55
KOHK10433VS	K-10433-VS	8"cc Pull-Out Spray	ADA Lever	Stainless Steel	317.55

Karbon™ 1-Handle Articulating Deck-Mount Kitchen Faucet

- Spout reaches from less than 2" to over 13"
- Metal and carbon fiber construction
- 1-Piece, self-contained ceramic disc valve
- Flexible connections
- 2" Diameter remote joystick valve
- For countertop-mount installation



Part #	Mfg #	Description	Handle(s)	Finish	Price
KOHK6227C11VS	K-6227-C11-VS	Integral Sprayhead, w/Silver Tube	ADA Remote Lever	Stainless*	1440.90

Two-Handle Laundry Faucets

Trend® 2-Handle Laundry Faucet

- 5-1/2" Reach spout
- Brass construction
- Compression valving



Part #	Mfg #	Description	Handle(s)	Finish	Price
KOHK11935UCP	K-11935-U-CP	4"cc Threaded Spout	ADA Blades	Pol Chrome	66.60



Single Handle Kitchen Faucets

Symmetrix® 1-Hdl Kitchen Faucets

- Red & blue indicators
- Handle limit stops
- 8-3/4" Swing spout with aerator
- Ceramic control components
- Supply has 3/8" copper tubing
- Metal construction
- 2.2 gpm Standard flow rate



S-23



S-23-2

Part #	Mfg #	Description	Handle(s)	Finish	Price
SYMS23IPS	S-23-IPS	8"cc, 1/2" IPS Conn	ADA Lever	Chrome	110.36
SYMS232IPS	S-23-2-IPS	8"cc Side Hose & Spray, 1/2" IPS Conn	ADA Lever	Chrome	130.92

* Vibrant Limited Lifetime Finish

Prices & Specifications are Subject to Change.

Kitchen/Bar Faucets

Vella™ 1-Hdl Kitchen Faucet

- Pull-out spray spout, retractable 5' hose
- Spray to stream touch control
- Integral vacuum breaker
- Ceramic control components
- 1/2" IPS Connections
- Optional escutcheon included
- Metal construction
- 2.2 gpm Standard flow rate



Part #	Mfg #	Description	Handle(s)	Finish	Price
SYMS2610	S-2610	Single Hole or Three Hole w/Escutcheon	ADA Lever	Chrome	303.14



Single-Handle Kitchen Faucets

P4C 1-Handle Kitchen Faucet

- Stainless steel ball valve
- Maximum flow rate: 2.2 gpm @ 60 PSI



Part #	Mfg #	Description	Handle(s)	Finish	Price
PL4P4C140C	P4C-140C	8"cc 4-Hole, Matching Side Spray	ADA Lever	Chrome	67.61

Two-Handle Kitchen Faucets

P4C 2-Handle Kitchen Faucet

- Washerless cartridges
- Maximum flow rate: 2.2 gpm @ 60 PSI



Part #	Mfg #	Description	Handle(s)	Finish	Price
PL4P4C202C	P4C-202C	8"cc 3-Hole, Less Spray	Acrylic	Chrome	48.83
PL4P4C242C	P4C-242C	8"cc 4-Hole, Black Side Spray	Acrylic	Chrome	58.14

**Kitchen & Bar
Faucets**

Plumb4orce

Quality Equal to National Brands at an Affordable Price.

All Items May Not Be Stocked In All Branches



www.irrsupply.com

Kitchen/Bar Faucets

One-Handle Kitchen Faucets

- Limited lifetime warranty on Gerber PVD finishes
- 10-Year limited warranty on Compression/Washerless Cartridges
- Limited lifetime warranty on Ceramic Disc Cartridges
- 2-Year limited warranty on other parts

Elliptical 1-Hdl ADA Lever Kitchen Faucet - Ceramic Cartridge

- 10" Spout reach
- 1/4" Nominal copper tubes and 1/2" IPS compression adapters
- Brass escutcheon plate



40-100



40-400

Part #	Mfg #	Description	Holes	Finish	Price
GER40100	40-100	ADA Loop Lever, Ceramic Cartridge, Less Spray	3	Chrome	143.93
GER40400	40-400	ADA Loop Lever, Ceramic Cartridge, Black Spray	4	Chrome	181.43

Maxwell 1-Hdl ADA Lever Kitchen Faucet - Ceramic Cartridge

- Solid lever handle
- 8" Elliptical spout



40-120



40-122

Part #	Mfg #	Description	Holes	Finish	Price
GER40120	40-110	ADA Solid Lever, Ceramic Cartridge, Less Spray	3	Chrome	78.41
GER40122	40-112	ADA Solid Lever, Ceramic Cartridge, with Spray, Lead Free	4	Chrome	103.30

Two-Handle Kitchen Faucets

- Limited lifetime warranty on Gerber PVD finishes
- 10-Year limited warranty on Compression/Washerless Cartridges
- Limited lifetime warranty on Ceramic Disc Cartridges
- 2-Year limited warranty on other parts

Maxwell 2-Hdl ADA Kitchen Faucet - Ceramic Cartridge

- Tubular spout
- Cast brass underbody



42-115

Part #	Mfg #	Description	Holes	Finish	Price
GER42123	42-113	8"cc Metal Handles, Ceramic Cartridge	3	Chrome	82.54
GER42125	42-115	8"cc Metal Handles, Ceramic Cartridge, with Spray	4	Chrome	94.09

Bar Faucets

Gooseneck 2-Hdl Spout Bar Faucet - Ceramic Cartridge

- Cast brass underbody
- Maximum aerator: 2.2 gpm @ 60 psi
- Top-mount

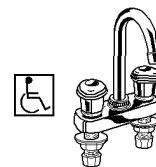

Part #	Mfg #	Description	Holes	Finish	Price
GER59900	59-900	4"cc ADA Hardwater® Handles, Ceramic Cartridge	3	Chrome	117.72

Kitchen & Bar Faucets

Prices & Specifications are Subject to Change.

Kitchen/Bar Faucets

Single-Handle Kitchen Faucets with Pull-Out Spray

Aberdeen® 1-Hdl Kitchen Faucets with Pull-Out Spray

- 8-1/2" Reach, 15" high full swing spout
- 1/2" IPS Connections
- Pullout spout includes 59" hose for added reach & convenience
- Independent pause button on pullout wand turns water off & on as needed
- Reliable, 1-piece washerless cartridge
- Integral vacuum breaker



Part #	Mfg #	Description	Handle(s)	Finish	Price
MOE7590CSL	7590CSL	8"cc Pull-Out Spray	ADA Lever	* Classic Stainless	568.00
MOE7590ORB	7590ORB	8"cc Pull-Out Spray	ADA Lever	Oil Rubbed Bronze	596.40

* Lifeshine® Anti-Tarnish Lifetime Finish

Arbor™ 1-Hdl High Arc Kitchen Faucet with Pull-Out Spray

- 15.90" Spout height; 360° rotation
- Hydrolock® quick connect installation
- 3/8" Compression connection
- Pullout spout includes 68" braided hose
- Aerated stream; pause function



Part #	Mfg #	Description	Handle(s)	Finish	Price
MOE7594CSL	7594CSL	1- or 3-Hole Pull-Out Spray	ADA Lever	* Classic Stainless	391.15

* Lifeshine® Anti-Tarnish Lifetime Finish

Camerist® 1-Hdl Kitchen Faucets with Pull-Out Spray

- 9" Reach, 10-3/4" high spout
- 1/2" IPS Connections, 8-1/2" supplies
- Hydrolock® quick connect installation
- 68" Hose, spout swings
- Aerated, rinse and veggie spray functions
- Pause button temporarily stops the flow of water
- Integral vacuum breaker



Part #	Mfg #	Description	Handle(s)	Finish	Price
MOE7545CSL	7545CSL	8"cc Pull-Out Spray	ADA Lever	* Classic Stainless	397.80
MOE7545ORB	7545ORB	8"cc Pull-Out Spray	ADA Lever	Oil Rubbed Bronze	417.65

* Lifeshine® Anti-Tarnish Lifetime Finish

Kitchen & Bar
Faucets

Kitchen/Bar Faucets

Extensa® 1-Hdl Kitchen Faucets with Pull-Out Spray

- 10-1/2" Reach spout
- 1/2" IPS Connections, 8-1/2" supplies
- Hydrolock® quick connect installation
- 59" Hose
- Integral vacuum breaker



Part #	Mfg #	Description	Handle(s)	Finish	Price
MOE7560C	7560C	8"cc Pull-Out Spray	ADA Lever	Chrome	381.70
MOE7560V	7560V	8"cc Pull-Out Spray	ADA Lever	Ivory	434.40
MOE7560W	7560W	8"cc Pull-Out Spray	ADA Lever	Glacier	434.40
MOE7560CSL	7560CSL	8"cc Pull-Out Spray	ADA Lever	* Classic Stainless	452.05
MOE7560BL	7560BL	8"cc Pull-Out Spray	ADA Lever	Matte Black	434.40

* Lifeshine® Anti-Tarnish Lifetime Finish

Integra® 1-Hdl Kitchen Faucets with Pull-Out Spray

- 1/2" IPS Connections
- Hydrolock® quick connect installation
- Spout rotation 145°
- 59" Nylon hose
- Includes optional escutcheon



Part #	Mfg #	Description	Handle(s)	Finish	Price
MOE67315C	67315C	1- or 3-Hole, Pull-Out Spray, Bulk (12/Pk)	ADA Lever	Chrome	201.40

Medora High Arc 1-Hdl Pull-Out Kitchen Faucets

- 8-3/32" Reach, 16" high spout
- 8-1/2" Supplies, 1/2" connection
- Hydrolock® quick connect installation
- 68" Whisper quiet flexible fiber hose



Part #	Mfg #	Description	Handle(s)	Finish	Price
MOE7599CSL	7599CSL	1-Hole Pull-Out Spray	ADA Lever	* Classic Stainless	595.25

* Lifeshine® Anti-Tarnish Lifetime Finish

Salora® 1-Hdl Kitchen Faucets with Pull-Out Spray

- 8" Reach spout
- 1/2" IPS Connections, 8-1/2" supplies
- 59" Hose
- Integral vacuum breaker



Part #	Mfg #	Description	Handle(s)	Finish	Price
MOE7570C	7570C	8"cc Pull-Out Spray	ADA Loop	Chrome	335.50

Kitchen & Bar Faucets

Prices & Specifications are Subject to Change.

Kitchen/Bar Faucets

Single-Handle Kitchen Faucets

Camerist™ 1-Hdl Kitchen Faucets

- 10" Reach spout
- 1/2" IPS Connections, 8-1/2" supplies



Part #	Mfg #	Description	Handle(s)	Finish	Price
MOE7840	7840	8"cc Matching Protege Side Spray	ADA Lever	Chrome	172.95
MOE7840CSL	7840CSL	8"cc Matching Protege Side Spray	ADA Lever	* Classic Stainless	257.45

* Lifeshine® Anti-Tarnish Lifetime Finish

Chateau® 1-Hdl Kitchen Faucets

- 9-1/2" Reach spout
- 1/2" IPS Connections, varying supplies



Part #	Mfg #	Description	Handle(s)	Finish	Price
MOE7425	7425	8"cc 4" Supply	ADA Lever	Chrome	110.15
MOE7437	7437	1-Hole, 8-1/2" Supply, Match Protege Spray	ADA Lever	Chrome	141.45
MOE7430	7430	8"cc 4" Supply, Match Protege Spray	ADA Lever	Chrome	138.60
MOE67430	67430	8"cc 4" Supply, Match Protege Spray, Bulk (12/Pk)	ADA Lever	Chrome	137.45

Legend® 1-Hdl Kitchen Faucets

- 9" Reach spout
- 1/2" IPS Connections (1/2" IPS adapters on 3/8" copper tube inlets for M 7231)



Part #	Mfg #	Description	Handle(s)	Finish	Price
MOE7310	7310	8"cc Black Protege Side Spray	ADA Lever	Chrome	233.70

Monticello® 1-Hdl Cathedral™ Spout Kitchen Faucets

- 10" Reach, 12" high Cathedral™ spout
- 1/2" IPS Connections, 8-1/2" supplies
- Swing spout



Part #	Mfg #	Description	Handle(s)	Finish	Price
MOE7730	7730	8"cc Matching Side Spray	ADA Lever	Chrome	285.90
MOE7730SL	7730SL	8"cc Matching Side Spray	ADA Lever	* Stainless	399.20

* Lifeshine® Anti-Tarnish Lifetime Finish

Kitchen & Bar Faucets

All Items May Not Be Stocked In All Branches

Kitchen/Bar Faucets

Vestige™ 1-Hdl Kitchen Faucets

- 1/2" IPS Connections will accept standard ball nose connection for 3/8" tubing



Part #	Mfg #	Description	Handle(s)	Finish	Price
MOE7065CSL	7065CSL	8"cc Matching Side Spray	ADA Lever	* Classic Stainless	474.50
MOE7065ORB	7065ORB	8"cc Matching Side Spray	ADA Lever	Oil Rubbed Bronze	498.00

* Lifeshine® Anti-Tarnish Lifetime Finish

Two-Handle Kitchen Faucets

Castleby™ 2-Hdl Kitchen Faucet

- 1/2" IPS Connections
- Aerator limited to 2.2 gpm
- Lifetime limited warranty
- 5-Year warranty if used in commercial installations



Part #	Mfg #	Description	Handle(s)	Finish	Price
MOE7905	7905	4"cc Side Spray	ADA Lever	Chrome	215.80

Chateau® 2-Hdl Kitchen Faucet

- 8-3/4" Reach spout
- 1/2" IPS Connections



Part #	Mfg #	Description	Handle(s)	Finish	Price
MOE7900	7900	8"cc	Clear Knob	Chrome	82.15
MOE7910	7910	8"cc Matching Protege Side Spray	Clear Knob	Chrome	105.05

Monticello® 2-Hdl Kitchen Faucets - Less ADA Lever Inserts

- 10" Reach, 12" high Cathedral™ swing spout
- 1/2" IPS Connections
- Small inserts recommended



Part #	Mfg #	Description	Handle(s)	Finish	Price
MOE7786	7786	8"cc Matching Protege Side Spray	Less ADA Lever Inserts	Chrome	360.05

Kitchen & Bar Faucets

Prices & Specifications are Subject to Change.

Kitchen/Bar Faucets

One-Handle Bar Faucets

Camerist™ 1-Hdl Bar Faucets with Pull-Down Spout

- 6" Reach, 10" high swing spout
- Hydrolock® quick connect installation
- 8-1/2" Supplies, 1/2" connections, 68" hose
- Aerated and rinse spray functions



Part #	Mfg #	Description	Handle(s)	Finish	Price
MOE5955CSL	5955CSL	4"cc	ADA Side Lever	* Classic Stainless	353.60

* Lifeshine® Anti-Tarnish Lifetime Finish

Two-Handle Commercial Pantry/Hospital Faucets

Sani-Stream® Metal 2-Hdl Commercial Bar & Sink Faucets

- 10-1/2" High spout
- 1/2" IPS Connections



Part #	Mfg #	Description	Handle(s)	Finish	Price
MOE8948	8948	4"cc, 8-7/8" Spout, Clinic	ADA 4" Wrist Blade	Chrome	137.90

Water Filtration Systems

Aquasuite™ ADA Under Sink Water Filtration System

- 4-9/16" Reach spout
- 1/2" IPS Connections
- Carbon block filter technology
- Lever style handle
- Dry change, Choiceflo filter included



Part #	Mfg #	Description	Handle(s)	Finish	Price
MOE77200CSL	77200CSL	1-Hole, 10-7/8" High Arc Spout	ADA Lever	* Classic Stainless	288.10

* Lifeshine® Anti-Tarnish Lifetime Finish

Kitchen & Bar
Faucets



www.irrsupply.com

Kitchen/Bar/Specialty Faucets

Kitchen Faucets

8" Centerset Top-Mount Kitchen Faucet

- Cast brass
- 8" D-spout
- 2.2 gpm Aerator
- Replaceable seats



Part #	Mfg #	Description	Price
CEB122A	0122-A	ADA Blade Hdls, CP	143.00

6" Centerset Top Mount Kitchen Faucet

- Cast brass
- 2.2 gpm Aerator
- Replaceable seats

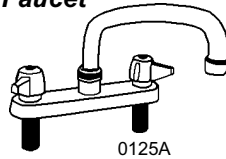

Part #	Mfg #	Description	Price
CEB125A	0125-A	8" Tube-Spout, ADA Blade Hdls, CP	125.00
CEB126A	0126-A	8" Tube-Spout, ADA Blade Hdls, Spray, CP	151.00

Bar Faucets

8" Centerset Wall-Mount Faucet

- 1/2"-14 NPT Male shank with adjustable flange
- 2.2 gpm Aerator
- Replaceable seats



Part #	Mfg #	Description	Price
CEB48TA	0048-TA	6" Tube Spout, Brass Soap Dish, ADA Blade Hdls, CP	143.00

Wall-Mount Faucet

- 6-1/2" to 9-1/2" Adjustable centers
- 1/2"-14 NPS Female inlets
- 2.2 gpm Aerator
- Replaceable seats



Part #	Mfg #	Description	Price
CEB48UA	0048-UA	6" Tube Spout, Brass Soap Dish, ADA Blade Hdls, CP	133.00

Dishwasher Faucets

Portable Dishwasher Faucet

- Rigid spout
- 1/2"-14 NPS Male shank x 1-7/8" long
- Replaceable seat
- Hot only



Part #	Mfg #	Description	Price
CEB282	0282	Canopy Hdl, CP	73.00



Basin Faucets

Heavy Basin Faucet

- Replaceable seats and stems
- Furnished with hot and cold buttons

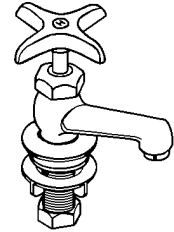

Part #	Mfg #	Description	Price
PLSBASINFCT	F39-001	Heavy Basin Faucet, CP	41.45

We appreciate your Business!

**Kitchen & Bar
Faucets**

Prices & Specifications are Subject to Change.

Laundry Faucets

Two-Handle Laundry Faucets

Classic 2-Handle Laundry Faucet - 6" Spout

- 6" Reach, 5-1/4" high spout swivels 360°
- 1/2" IPS Connection
- 1-1/8" Maximum deck thickness
- 1/8" Trap seal primer plug



Part #	Mfg #	Description	Handle(s)	Finish	Price
DEL2121	2121	4"cc, Spout with Hose Thread	ADA Blades	Chrome	93.50

Classic 2-Handle Laundry Faucet - 5-5/8" Spout

- 5-5/8" Reach, 6-1/2" high spout swivels 360°
- 1/2" IPS Connection
- 1-1/8" Maximum deck thickness
- 1/8" Trap seal primer plug



Part #	Mfg #	Description	Handle(s)	Finish	Price
DEL2131	2131	4"cc, Spout with Hose Thread	ADA Blades	Chrome	66.85
DEL2133	2133	4"cc, Spout with Stream Straightener	ADA Blades	Chrome	66.85

Bar/Laundry Faucets

4" Centerset Shell Type Bar/Laundry Faucets

- Cast brass underbody
- 2.2 gpm Aerator
- Replaceable seats



Part #	Mfg #	Description	Price
CEB94A	0094-A	6" Tube-Spout, ADA Blade Hdls, CP, Aerator	78.00
CEB94H	0094-H	6" Tube-Spout, ADA Blade Hdls, CP, Hose Thread	79.00

3-1/2" Centerset Laundry Faucets

- Cast brass
- 6" Tube spout with hose end
- Straddle legs
- 1/2"-14 NPSF Female coupling union connections



Part #	Mfg #	Description	Price
CEB465	0465	Aluminum Lever Hdls, RB	69.50
CEB466	0466	Rough Brass, w/1/2"Nom SWT Conn	62.00

Two-Handle Laundry Faucets

Clamp-On 2-Hdl ADA Metal Lever Laundry Faucet

- Cast brass body
- No aerator
- 5-3/8" Spout reach
- Rough brass finish



Part #	Mfg #	Description	Finish	Price
GER49530	49-530	ADA Levers, Compression Stems, Threaded Spout, IPS/Sweat	Rough Brass	59.42

* Brilliance® Anti-Tarnish Lifetime Finishes

All Items May Not Be Stocked In All Branches

Lavatory Faucets

Single-Handle Lavatory Faucets

Classic Series 1-Handle Lavatory Faucet

- 4-1/2" Reach, 5-1/8" high rigid spout
- 2-1/6" From deck to aerator
- 1-1/8" Maximum deck thickness
- Metal pop-up drain included
- Low flow rate: 1.5 gpm @ 60 psi



Part #	Mfg #	Description	Handle(s)	Finish	Price
DEL520MPU	B510LF	4"cc, Metal Pop-Up Drain	ADA Lever	Chrome	114.50

Classic Series Diamond™ Seal Technology 1-Handle Lavatory Faucet

- 5" Reach, 4-7/8" high rigid spout
- 1-11/16" From deck to aerator
- 3/8" Compression fittings
- 2" Maximum deck thickness
- 32" Minimum supply lines below deck included
- WaterSense® certified product
- DIAMOND™ Valve with Innoflex™ PEX waterways



Part #	Mfg #	Description	Handle(s)	Finish	Price
DEL501DST	501-DST	4"cc No Lift-Rod Hole	ADA Lever	Chrome	114.50
DEL522MPUDST	522-MPU-DST	4"cc Metal Pop-Up Drain	Clear Knob	Chrome	136.45

Innovations® Collection Diamond™ Seal Technology 1-Handle Lavatory Faucet

- 5-1/4" Reach, 3-7/8" high rigid spout
- 2-1/2" From deck to aerator
- Hot/cold indicators
- 2" Maximum deck thickness
- 32" Minimum supply lines below the deck included
- WaterSense® certified product
- DIAMOND™ Valve with Innoflex™ PEX waterways



Part #	Mfg #	Description	Handle(s)	Finish	Price
DEL540MPUDST	540-MPU-DST	4"cc Metal Pop-Up Drain	ADA Lever	Chrome	196.90

Lahara™ Bath Diamond™ Series 1-Handle Lavatory Faucet

- 5-1/2" Reach, 6" high rigid spout
- Hot/cold indicators
- 1/2" IPS Connection
- 1-3/16" Maximum deck thickness (1-9/16" with escutcheon)
- Includes optional escutcheon
- WaterSense® certified product
- DIAMOND™ Valve with Innoflex™ PEX waterways



Part #	Mfg #	Description	Handle(s)	Finish	Price
DEL538DST	538-DST	1- or 3-Hole, 50/50 Pop-Up Drain	ADA Lever	Chrome	185.30
DEL538RBDST	538-RB-DST	1- or 3-Hole, 50/50 Pop-Up Drain	ADA Lever	Venetian Bronze®	272.20
DEL538SSDST	538-SS-DST	1- or 3-Hole, 50/50 Pop-Up Drain	ADA Lever	Stainless*	248.10

* Brilliance® Anti-Tarnish Lifetime Finishes

Prices & Specifications are Subject to Change.

Lavatory Faucets

Single-Handle Specialty Faucets

Classic 1-Handle Swing Spout Faucet

- 4" Reach spout swivels 360"
- 2-1/4" From deck to aerator
- 3/8" OD Inlets
- Less pop up



Part #	Mfg #	Description	Handle(s)	Finish	Price
DEL570	570	1-Hole	ADA Lever	Chrome	138.30

Classic Single Handle Basin Faucet

- 4-1/4" Reach rigid spout
- 1-1/8" From deck to aerator
- 1/4-Turn handle stop
- 1/2" IPS Connection



2302LHP

Part #	Mfg #	Description	Handle(s)	Finish	Price
DEL2302LHP	2302LHP	1-Hole	Less Handle	Chrome	59.90

Two-Handle Lavatory Faucets

Classic 2-Handle Lavatory Faucet

- 3-7/16" Reach, 2-7/8" high rigid spout
- 1/2" IPS Connection
- 1-3/8" Maximum deck thickness
- Water efficient product



2520



2521-LHP



2522

Part #	Mfg #	Description	Handle(s)	Finish	Price
DEL2500	2500	4"cc Capped Lift-Rod Hole, Notched for Chain/Stopper	ADA Blade	Chrome	73.55
DEL2502	2502	4"cc Capped Lift-Rod Hole	Clear Knob	Chrome	73.55
DEL2520MPU	2520-MPU	4"cc Metal Pop-Up Drain	ADA Blade	Chrome	104.55
DEL2521LHP	2521-LHP	4"cc Metal Pop-Up Drain	Less Handles	Chrome	100.80
DEL2522MPU	2522-MPU	4"cc Metal Pop-Up Drain	Clear Knob	Chrome	104.55

Classic 2-Handle Widespread Lavatory Faucet

- 4-3/4" Reach, 2-9/16" rigid spout
- 1/2" IPS Connection
- 1-1/8" Maximum deck thickness
- Clear knob handles have hot/cold indicators
- Quick-Snap® installation
- WaterSense® certified product



3543 LHP



3544



Part #	Mfg #	Description	Handle(s)	Finish	Price
DEL3543LHP	3543-LHP	6"-16"ws Metal Pop-Up Drain	Less Handles	Chrome	181.30
DEL3544WFMPU	3544-WFMPU	6"-16"ws Metal Pop-Up Drain, Ftgs	Clear Knob	Chrome	204.25

* Brilliance® Anti-Tarnish Lifetime Finishes

All Items May Not Be Stocked In All Branches

Lavatory Faucets

Innovations® Series 2-Handle Lavatory Faucet

- 5-1/4" Reach, 3-7/8" high rigid spout
- 1/2" IPS Connection
- 1-3/8" Maximum deck thickness
- Hot/cold indicators
- WaterSense® certified product



Part #	Mfg #	Description	Handle(s)	Finish	Price
DEL2530LHP	2530-LHP	4"cc Metal Pop-Up Drain	Less Handles	Chrome	141.70
DEL2530PBLHP	2530-PBLHP	4"cc Metal Pop-Up Drain	Less Handles	Pol Brass*	244.35

Innovations® Series 2-Handle Widespread Lavatory Faucet

- 5-1/4" Reach, 3-7/8" high rigid spout
- 1/2" IPS Connection
- 1-1/8" Maximum deck thickness
- Scalloped handle bases
- Quick-Snap® installation
- WaterSense® certified product



3530 LHP



Part #	Mfg #	Description	Handle(s)	Finish	Price
DEL3530LHP	3530-LHP	6"-16"ws Metal Pop-Up Drain	Less Handles	Chrome	242.75

Victorian™ Collection 2-Handle Widespread Lavatory Faucet

- 5-1/8" reach, 5-15/16" high rigid spout
- 1/4-Turn handle stops
- 1/2" IPS Connection
- 1-1/4" Maximum deck thickness
- Self-locating scalloped handle bases
- WaterSense® certified product



3555-LHP

Shown in Chrome



Part #	Mfg #	Description	Handle(s)	Finish	Price
DEL3555RBLHP	3555-RBLHP	6"-16"ws Metal Pop-Up Drain	Less Handles	Venetian Bronze®	365.65

THE BOLD LOOK
OF **KOHLER**®

Single-Handle Lavatory Faucets

Coralais® 1-Handle Lavatory Faucet

- 4-1/4" Reach spout
- Solid brass construction
- Pop-up drain, 1-1/4" tailpiece
- Aerator



Part #	Mfg #	Description	Handle(s)	Finish	Price
KOHK15182FCP	K-15182-F-CP	4"cc Flexible Connections	ADA 3-1/4" Lever	Pol Chrome	139.70

* Brilliance® Anti-Tarnish Lifetime Finishes

Prices & Specifications are Subject to Change.

Lavatory Faucets

Lavatory Faucets

Fairfax® 1-Handle Lavatory Faucet

- 5" Reach spout
- Solid metal construction
- Washerless ceramic valving, flexible supplies
- Pop-up drain, 1-1/4" tailpiece
- Aerator



Part #	Mfg #	Description	Handle(s)	Finish	Price
KOHK12182CP	K-12182-CP	1-Hole	ADA Lever	Pol Chrome	192.10

Two-Handle Lavatory Faucets

Coralais® 2-Handle Centerset Lavatory Faucet

- Solid metal construction
- Pop-up drain, 1-1/4" tailpiece
- Aerator



Part #	Mfg #	Description	Handle(s)	Finish	Price
KOHK152414CP	K-15241-4-CP	4"cc 4-1/4" Spout	ADA Lever	Pol Chrome	128.30

Devonshire® 2-Handle Centerset Lavatory Faucet

- 4-3/4" Reach spout
- 1/4-Turn washerless ceramic disc valves
- Pop-up drain with lift rod and tailpiece
- Aerator



Part #	Mfg #	Description	Handle(s)	Finish	Price
KOHK393N4CP	K-393-N4-CP	4"cc	ADA Lever	Pol Chrome	146.80

Kelston® 2-Handle Lavatory Faucet

- 4-1/2" Reach spout
- Metal construction
- Pop-up drain with tailpiece
- 1/4-Turn washerless ceramic disc valve



Part #	Mfg #	Description	Handle(s)	Finish	Price
KOHK134904CP	K-13490-4-CP	4"cc	ADA Lever	Pol Chrome	169.45
KOHK134904BRZ	K-13490-4-BRZ	4"cc	ADA Lever	Oil-Rubbed Bronze	277.15
KOHK134914BN	K-13491-4-BN	8"-16"ws	ADA Lever	Brushed Nickel*	349.20

* Vibrant Limited Lifetime Warranty

All Items May Not Be Stocked In All Branches

Lavatory Faucets

Touchless Commercial Faucets

Commercial Gooseneck Touchless Electronic Lavatory Faucet

- Single-hole mounting
- 6-3/16" Reach swing spout
- Brass construction
- Above-counter battery and valve
- Vandal-resistant aerator
- 24" Flexible supply hoses
- Stationary gooseneck spout
- Less drain
- Includes two AA batteries



Part #	Mfg #	Description	Handle(s)	Finish	Price
KOHK13472CP	K-13472-CP	1-Hole, Mixer	Touchless	Pol Chrome	503.40



Lavatory Faucets

Shelf Back Lavatory Faucets

- Cast brass body
- Adjustable centers from 4" to 6"
- 2.2 gpm Aerator
- Replaceable seats
- Pop-up drain faucets include 17 gauge tailpiece



Part #	Mfg #	Description	Price
CEB1177DA	1177-DA	Metal Blade Hdls, Pop-Up, CP	150.50

45° Slant Back Lavatory Faucets

- Cast brass body
- Adjustable centers from 4" to 6"
- 2.2 gpm Aerator
- Replaceable seats
- Pop-up drain faucets include 17 gauge tailpiece



Part #	Mfg #	Description	Price
CEB1178DA	1178-DA	Metal Blade Hdls, Pop-Up, CP	189.00

* Vibrant Limited Lifetime Warranty

Prices & Specifications are Subject to Change.

Lavatory Faucets

Single Handle Lavatory Faucets

Symmetric® 1-Hdl Lavatory Faucets

- Red & blue indicators
- Handle limit stops
- Standard aerator 2.2 gpm flow rate
- 1/4-Turn ceramic control components
- 6-3/8" Copper tubing
- Metal construction



Part #	Mfg #	Description	Handle(s)	Finish	Price
SYMS200IPS	S-20-0-IPS	4"cc, 1/2" IPS Adaptors	ADA Lever	Chrome	105.62
SYMS202IPS	S-20-2-IPS	4"cc Pop-Up Drain & Lift Rod 1/2" IPS Connections	ADA Lever	Chrome	121.23

Winslet™ 1-Hdl Lavatory Faucet

- 1/4-Turn ceramic control components
- Braided hoses
- Includes lift rod with pop-up drain assembly
- 1.5 gpm Standard flow rate



Part #	Mfg #	Description	Handle(s)	Finish	Price
SYMSLS5112	SLS-5112	Single Hole	Lever	Chrome	374.90

Two Handle Lavatory Faucets

Ballina™ 2-Hdl Lavatory Faucet

- 1/4-Turn ceramic control components
- Braided hoses
- Includes lift rod with pop-up drain assembly
- 2.2 gpm Standard flow rate



Part #	Mfg #	Description	Handle(s)	Finish	Price
SYMSLW5212BBZ	SLW5212BBZ	8"cc Widespread	Lever	Brushed Bronze	614.75

Oxford™ 2-Hdl Lavatory Faucet

- 1/4-Turn ceramic control components
- Braided hoses
- Includes lift rod with pop-up drain assembly
- 2.2 gpm Standard flow rate



Part #	Mfg #	Description	Handle(s)	Finish	Price
SYMSLW4212ORB	SLW4212ORB	8"cc Widespread	ADA Lever	Oil Rubbed Bronze	591.14

Lavatory Faucets

Lavatory Faucets

Symmetrix® 2-Handle Lavatory Faucets

- 1/4-Turn ceramic control components
- Red & blue indicators
- 1/2" IPS Shanks
- Aerator with 2.2 gpm flow rate
- Metal construction



Part #	Mfg #	Description	Handle(s)	Finish	Price
SYMS2402	S-240-2	4"cc, Lift Rod, Metal Pop-Up Drain	Metal Insert Lever	Chrome	105.77
SYMS2402LCT	S-240-2-LCT	4"cc, Lift Rod, Metal Pop-Up Drain	Clear Acrylic	Chrome	105.77

Winslet™ 2-Handle Lavatory Faucet

- 1/4-Turn ceramic control components
- Braided hoses
- Includes lift rod with pop-up drain assembly
- 1.5 gpm Standard flow rate



Part #	Mfg #	Description	Handle(s)	Finish	Price
SYMSLW5112STN	SLW-5112-STN	8"cc	Lever	Satin Nickel	569.82



Single-Handle Lavatory Faucets

P4C 1-Handle Lavatory Faucet

- Stainless steel ball valve
- Maximum flow rate: 1.5 gpm @ 60 PSI



Part #	Mfg #	Description	Handle(s)	Finish	Price
PL4P4C500C	P4C-500C	4"cc Metal Pop-Up Drain	ADA Lever	Chrome	72.29

Two-Handle Lavatory Faucets

P4C 2-Handle Lavatory Faucet

- Washerless cartridges
- Maximum flow rate: 1.5 gpm @ 60 PSI



Part #	Mfg #	Description	Handle(s)	Finish	Price
PL4P4C402C	P4C-402C	4"cc Metal Pop-Up Drain	Acrylic	Chrome	55.38

Lavatory Faucets



www.irrsupply.com

Lavatory Faucets

One-Handle Lavatory Faucets

- Limited lifetime warranty on Gerber PVD finishes
- 10-Year limited warranty on Compression/Washerless Cartridges
- Limited lifetime warranty on Ceramic Disc Cartridges
- 2-Year limited warranty on other parts



Maxwell 1-Hdl ADA Lever Lavatory Faucet - Ceramic Cartridge

Part #	Mfg #	Description	Holes	Finish	Price
GER40133	40-143	4"cc ADA Lever Handle, less Pop-Up, Lead Free	3	Chrome	75.50
GER40145	40-145	4"cc ADA Lever Handle, Metal Pop-Up	3	Chrome	93.50

1-Hdl ADA Lever Lavatory Faucet - Ceramic Cartridge

- Brass escutcheon plate
- 4-7/8" Spout reach
- Maximum aerator: 2.2 gpm @ 60 psi
- Supplied with 1/4" nominal copper tubes with 1/2" compression tubes



Part #	Mfg #	Description	Holes	Finish	Price
GER40524	40-524	4"cc ADA Loop Lever, Metal Pop-Up	1 or 3	Chrome	162.51

Two-Handle Lavatory Faucets

- Limited lifetime warranty on Gerber PVD finishes
- 10-Year limited warranty on Compression/Washerless Cartridges
- Limited lifetime warranty on Ceramic Disc Cartridges
- 2-Year limited warranty on other parts



2-Hdl Lavatory Faucet - Ceramic Cartridge

- Solid brass casting
- Maximum aerator: 2.2 gpm @ 60 psi

Part #	Mfg #	Description	Holes	Finish	Price
GER53120	53-120	4"cc ADA Hardwater® Handles, Ceramic Cartridge, Metal Pop-Up	3	Chrome	132.23

Maxwell® 2-Hdl Lavatory Faucet - Ceramic Cartridge

- Brass and copper waterway
- Maximum aerator: 1.5 gpm @ 60 psi



Part #	Mfg #	Description	Holes	Finish	Price
GER43132	43-142	4"cc Acrylic Handles, Ceramic Cartridge, Brass Pop-Up	3	Chrome	70.23

Maxwell® 2-Hdl Lavatory Faucet - Ceramic Disc Cartridge

- All brass and copper waterways
- 4" Centers
- Maximum aerator: 1.5 gpm @ 60 psi
- Metal blade handles



43-145

Part #	Mfg #	Description	Holes	Finish	Price
GER43135	43-145	4"cc ADA Metal Fluted Handles, Ceramic Disc Cartridge, Brass Pop-up	3	Chrome	75.99

Lavatory Faucets

All Items May Not Be Stocked In All Branches

Lavatory Faucets

Single-Handle Lavatory Faucet Valve & Trim

Chateau® 1-Hdl Lavatory Faucets

- 1/2" IPS Connections



L4601, L64601



L4621, L64625



Knob Handle
Less Pop-Up

Part #	Mfg #	Description	Handle(s)	Finish	Price
MOEL4601	L4601	4"cc less Drain	ADA Lever	Chrome	111.95
MOEL4621	L4621	4"cc Drain	ADA Lever	Chrome	138.35
MOEL4625	L4625	4"cc Drain, 3/8" x 16" Tubing	ADA Lever	Chrome	138.35
MOE64601	64601	4"cc less Drain Bulk (12/Pk)	Knob	Chrome	100.00
MOEL64624	L64624	4"cc Drain, 3/8" x 16" Tubing, Bulk (12/Pk)	ADA Lever	Chrome	134.25
MOE4621	4621	4"cc 50/50 Pop-Up Drain	Knob	Chrome	138.35
MOE4625	4625	4"cc Pop-Up Drain, 3/8" x 16" Tubing	Knob	Chrome	138.35

Eva 1-Hdl High Arc Lavatory Faucets

- 3/8" IPS Connections
- Metal drain assembly
- Includes deckplate for 3-hole application



Part #	Mfg #	Description	Handle(s)	Finish	Price
MOE6400	6400	High Arc, Pop-Up Drain	Lever Handle	Chrome	192.10
MOE6400BN	6400BN	High Arc, Pop-Up Drain	Lever Handle	* Brushed Nickel	257.40

* Lifeshine® Anti-Tarnish Lifetime Finish

Villela™ 1-Hdl Lavatory Faucets

- 1/2" IPS Connections



Part #	Mfg #	Description	Handle(s)	Finish	Price
MOEL4721	L4721	4"cc Pop-Up Drain	ADA Lever	Chrome	171.20

M•PACT™ 2-Hdl Lavatory Rough-In Valves

- Choose the desired M•PACT™ Rough-In Valve that suits your needs
- Select the trim kit that includes spout, accents & handles to complete the faucet
- Upgrading the faucet is easy

Widespread 2-Hdl Lavatory Rough-In Valves

- Metal drain assembly
- Hydrolock™ quick connect installation



Part #	Mfg #	Description	Price
MOE69000	69000	8"-16"ws, 1/2" IPS, Bulk (6/Pk)	90.80

Prices & Specifications are Subject to Change.

Lavatory Faucets

Mini-widespread 2-Hdl Lavatory Rough-In Valves

- Metal drain assembly



Part #	Mfg #	Description	Price
MOE69300	69300	4"cc Mini-ws, 1/2" IPS, Bulk (6/Pk)	83.00

M•PACT™ 2-Hdl Lavatory Faucet Trim

- Choose the desired M•PACT™ Rough-In Valve that suits your needs
- Select the trim kit that includes spout, accents & handles to complete the faucet
- Upgrading the faucet is easy

90°™ 2-Hdl Low Arc Lavatory Faucet Trim

- Fits M•PACT™ system
- 1/2" IPS Connections
- Trim only, valve not included
- Use with 9000 or 69000 valve



Part #	Mfg #	Description	Handle(s)	Finish	Price
MOET6720	T6720	8"-16"ws, 1/2" IPS	ADA Lever	Chrome	277.50

90°™ 2-Hdl Low Arc Roman Tub Faucet Trim

- Fits M•PACT™ system
- Built-in diverter valve
- 1/2" IPS Connections
- Trim only, valve not included
- Use with 9992 or 9993 valve



Part #	Mfg #	Description	Handle(s)	Finish	Price
MOETS904	TS904	8"-16"ws, 1/2" IPS	ADA Lever	Chrome	622.40

Brantford™ 2-Hdl Lavatory Faucet Trim

- Fits M•PACT™ system
- 1/2" IPS Connections
- Trim only, valve not included



Part #	Mfg #	Description	Handle(s)	Finish	Price
MOET6620	T6620	8"-16"ws Drain Assembly	ADA Lever	Chrome	136.65
MOET6620BN	T6620BN	8"-16"ws Drain Assembly	ADA Lever	* Brushed Nickel	209.75
MOET6620ORB	T6620ORB	8"-16"ws Drain Assembly	ADA Lever	Oil Rubbed Bronze	230.70

* Lifeshine® Anti-Tarnish Lifetime Finish

Lavatory Faucets

Lavatory Faucets

Eva™ 2-Hdl Lavatory Faucet Trim

- Fits M•PACT™ system
- High arc spout
- Trim only, valve not included



Part #	Mfg #	Description	Handle(s)	Finish	Price
MOET6420	T6420	8"-16"ws Drain Assembly	ADA Lever	Chrome	136.65
MOET6420BN	T6420BN	8"-16"ws Drain Assembly	ADA Lever	* Brushed Nickel	209.75
MOET6420ORB	T6420ORB	8"-16"ws Drain Assembly	ADA Lever	Oil Rubbed Bronze	230.70

* Lifeshine® Anti-Tarnish Lifetime Finish

Icon™ 2-Hdl Lavatory Faucet Trim

- Fits M•PACT™ system
- 1/2" IPS Connections
- Metal drain assembly
- Laminar flow
- Trim only, valve not included



Part #	Mfg #	Description	Handle(s)	Finish	Price
MOETS6520	TS6520	8"-16"ws Pop-Up Drain	ADA Lever	Chrome	236.45
MOETS6520BN	TS6520BN	8"-16"ws Pop-Up Drain	ADA Lever	*Brushed Nickel	405.05

* Lifeshine® Anti-Tarnish Lifetime Finish

Kingsley™ 2-Hdl Lavatory Faucet Trim

- Fits M•PACT™ system
- 1/2" IPS Connectors
- Trim only, valve not included



Part #	Mfg #	Description	Handle(s)	Finish	Price
MOET6105BN	T6105BN	8"-16"ws Pop-Up Drain	ADA Lever	* Brushed Nickel	358.70
MOET6125	T6125	8"-16"ws Pop-Up Drain, High Arc Spout	ADA Lever	Chrome	240.75
MOET6125BN	T6125BN	8"-16"ws Pop-Up Drain, High Arc Spout	ADA Lever	* Brushed Nickel	412.45
MOET6125ORB	T6125ORB	8"-16"ws Pop-Up Drain, High Arc Spout	ADA Lever	Oil Rubbed Bronze	453.70

* Lifeshine® Anti-Tarnish Lifetime Finish

Monticello® Inspirations™ 2-Hdl Lavatory Faucet Trim

- M•PACT™ System
- Patented top mount installation
- 1/2" IPS Connections
- Trim only, valve not included



Part #	Mfg #	Description	Handle(s)	Finish	Price
MOET4560	T4560	4" Mini-ws Pop-Up Drain	ADA Lever	Chrome	161.95

Lavatory Faucets

Prices & Specifications are Subject to Change.

Lavatory Faucets

Monticello® Inspirations™ 2-Hdl Lavatory Faucet Trim

- M•PACT™ System
- Patented top mount installation
- 1/2" IPS Connections
- Trim only, valve not included



Part #	Mfg #	Description	Handle(s)	Finish	Price
MOET4570	T4570	8"-16"ws Pop-Up Drain	ADA Lever	Chrome	209.35
MOET4570BN	T4570BN	8"-16"ws Pop-Up Drain	ADA Lever	* Brushed Nickel	358.70

* Lifeshine® Anti-Tarnish Lifetime Finish

Two-Handle Lavatory Faucet Valve & Trim

Brantford™ 2-Hdl Lavatory Faucet Valve & Trim

- 1/2" IPS Connection
- Metal drain



Part #	Mfg #	Description	Handle(s)	Finish	Price
MOE6610	6610	4"cc Pop-Up Drain	ADA Lever	Chrome	136.00
MOE6610BN	6610BN	4"cc Pop-Up Drain	ADA Lever	* Brushed Nickel	188.25
MOE6610ORB	6610ORB	4"cc Pop-Up Drain	ADA Lever	Oil Rubbed Bronze	207.10

* Lifeshine® Anti-Tarnish Lifetime Finish

Chateau® 2-Hdl Centerset Lavatory Faucets

- 1/2" IPS Connections



Part #	Mfg #	Description	Handle(s)	Finish	Price
MOE4900	4900	4"cc	Knob	Chrome	75.35
MOE4920	4920	4"cc Pop-Up Drain	Knob	Chrome	110.10
MOE4925	4925	4"cc Pop-Up Drain	ADA Lever	Chrome	127.25

Chateau® 2-Hdl Widespread Lavatory Faucets

- 1/2" IPS Shanks



Part #	Mfg #	Description	Handle(s)	Finish	Price
MOE4945	4945	8"-16"ws, Pop-Up Drain	ADA Lever	Chrome	222.85

All Items May Not Be Stocked In All Branches

Lavatory Faucets

Eva™ 2-Hdl Lavatory Faucets

- Fits M•PACT™ system
- 1/2" IPS Connections
- Includes: metal drain assembly, valve
- High arc spout, lever handles



Part #	Mfg #	Description	Handle(s)	Finish	Price
MOE6410	6410	4"cc Drain, High Arc Spout	ADA Lever	Chrome	136.00
MOE6410BN	6410BN	4"cc Drain, High Arc Spout	ADA Lever	* Brushed Nickel	188.25
MOE6410ORB	6410ORB	4"cc Drain, High Arc Spout	ADA Lever	Oil Rubbed Bronze	207.10

* Lifeshine® Anti-Tarnish Lifetime Finish

Monticello® Popular Sets 2-Hdl Lavatory Faucets

- 1/2" IPS Connections



Part #	Mfg #	Description	Handle(s)	Finish	Price
MOE4551	4551	4"cc Drain	ADA Lever	Chrome	200.40

Commercial Faucets

Sani-Stream® All Metal 2-Hdl Commercial Lavatory Faucets

- 1/2" IPS Connections
- 1224 Washerless cartridge
- Includes stainless steel throat cover



8800



8810

Part #	Mfg #	Description	Handle(s)	Finish	Price
MOE8800	8800	4"cc less Drain	ADA Wrist Blade	Chrome	142.90
MOE8810	8810	4"cc Grid Strainer	ADA Wrist Blade	Chrome	163.90

Lavatory Faucets

Tub & Shower Valves & Trim

MultiChoice™ Universal Valves

Change the shower function, style & appearance without altering the plumbing behind the wall

- Includes 300 psi heat resistant pressure test cap
- Accepts single function, dual function or dual function thermostatic cartridge
- Accepts single function (13/14), dual function (17), or dual function thermostatic (17T) cartridge
- Back-to-back capability



Cartridge ships with trim - No need to worry about soldering & melting cartridge

Part #	Mfg #	Description	Price
DELR10000UNWS	R10000-UNWS	Universal Valve Body with Stops, MIP/Swt	62.05
DELR10000UNBX	R10000-UNBX	Universal Valve Body less Stops, MIP/Swt - Single Box Model	44.25
DELR10000PX	R10000-PX	Universal Valve Body less Stops, PEX	44.25
DELR10000PXWS	R10000-PXWS	Universal Valve Body with Stops, PEX	62.50

MultiChoice™ Universal Tub & Shower Valves and Trim

Addison™ Monitor® 17 Scald-Guard® with H2Okinetic® Technology 1-Handle Trim

- Fits MultiChoice™ universal valve
- Includes cartridge
- Handle adjusts volume
- Dial adjusts temperature
- Field adjustable to limit handle rotation into hot water zone
- Maximum handle rotation adjustable between 90° and 180°



Part #	Mfg #	Description	Handle(s)	Finish	Price
DELT17092	T17092	Valve Trim Only	ADA Lever	Chrome	156.65

Classic Monitor® 13 Series 1-Handle Trim

- Fits MultiChoice™ universal valve
- Includes cartridge
- Handle adjusts temperature
- Touch-Clean® showerhead
- Sweat onto 1/2" CWT or thread onto 1/2" IPS
- WaterSense® certified product



T13420



T13422



Part #	Mfg #	Description	Handle(s)	Finish	Price
DELT13420	T13420	Tub & Shower Trim, 5-1/2" Pull-Up Diverter Spout	ADA Lever	Chrome	99.20
DELT13422	T13422	Tub & Shower Trim, 5-1/2" Pull-Up Diverter Spout	Clear Knob	Chrome	99.20
DELT13422SOS	T13422-SOS	Tub & Shower Trim, 5-1/2" Pull-Up Slip-On Diverter Spout for 1/2" CWT	Clear Knob	Chrome	99.20
DELT13220	T13220	Shower Trim Only	ADA Lever	Chrome	79.40
DELT13222	T13222	Shower Trim Only	Clear Knob	Chrome	78.70

* Brilliance® Anti-Tarnish Lifetime Finishes

All Items May Not Be Stocked In All Branches

Tub & Shower Valves & Trim

Innovations® Monitor® 14 Scald-Guard® Series 1-Handle Trim

- Fits MultiChoice™ universal valve
- Includes cartridge
- Handle adjusts temperature
- Touch-Clean® showerhead
- Dual-spray function
- Sweat onto 1/2" CWT or thread onto 1/2" IPS
- Recommend Innovations® H74 metal lever handle & A74 accent



Part #	Mfg #	Description	Handle(s)	Finish	Price
DELT14430LHP	T14430-LHP	Tub & Shower Trim, 6" Pull-Down Diverter Spout	Less Handle	Chrome	145.85
DELT14430PBLHP	T14430-PBLHP	Tub & Shower Trim, 6" Pull-Down Diverter Spout	Less Handle	Pol Brass*	278.95
DELT14230LHP	T14230-LHP	Shower Trim Only	Less Handle	Chrome	118.45

Innovations® Monitor® 17 Series Scald-Guard® 1-Handle Trim

- Fits MultiChoice™ universal valve
- Includes cartridge
- Handle adjusts volume
- Dial adjusts temperature
- Hot/cold temperature indicator
- Handle includes metal lever accent
- Touch-Clean® showerhead
- Dual-spray function
- Sweat onto 1/2" CWT or thread onto 1/2" IPS
- Recommend Innovations A74 lever handle accents



Part #	Mfg #	Description	Handle(s)	Finish	Price
DELT17430	T17430	Tub & Shower Trim, 6" Pull-Down Diverter Spout	ADA Lever	Chrome	192.95
DELT17230	T17230	Shower Trim Only	ADA Lever	Chrome	175.75

Leland® Monitor® 14 Series Scald-Guard® 1-Handle Trim

- Fits MultiChoice™ universal valve
- Includes cartridge
- Handle adjusts temperature
- Touch-Clean® showerhead
- 5-1/2" Long spout for 1/2" CWT
- Recommend Leland® H777 porcelain lever or H778 metal lever handle



Part #	Mfg #	Description	Handle(s)	Finish	Price
DELT14478LHP	T14478-LHP	Tub & Shower Trim, Pull-Up Diverter Spout	Less Handle	Chrome	93.70

**Tub & Shower
Faucets**

* Brilliance® Anti-Tarnish Lifetime Finishes

Prices & Specifications are Subject to Change.

Tub & Shower Valves & Trim

Two-Handle Roman Tub Rough-In Valves

Universal Flexible 3-Hole Roman Tub Rough-In Valves

- Flexible deck or ledge mounting arrangement
- Self-locating basis
- Tighten/adjust from above deck
- Adjust to 2-1/4" maximum deck thickness or adjust to 2-1/4" maximum thickness after mud and tile
- No thick deck kit required



Part #	Mfg #	Description	Price
DELR2707	R2707	RT/Whirlpool Deck-Mount Rough-In Valve	110.20

Universal 4-Hole Roman Tub Faucet Rough-In Valves

- Flexible deck or ledge mounting arrangement
- Includes hand shower rough-in
- Self-locating bases
- Tighten/adjust from above deck
- Adjust to 2-1/4" maximum deck thickness or adjust to 2-1/4" maximum thickness after mud and tile
- No thick deck kit required



Part #	Mfg #	Description	Price
DELR4707	R4707	Universal Installation, Adjusts to 2-1/4" Max Deck Thickness, Flex Deck or Ledge-Mount	244.15

Two-Handle Roman Tub Trim Packs

Dryden® 2-Hdl Roman Tub with Handles - Trim Only

- Requires R4707 rough-in kit
- Rigid slip-on spout
- 9" Long, 7-3/4" high
- 4" From deck to aerator



Part #	Mfg #	Description	Handle(s)	Finish	Price
DELT4751	T4751	8"-16"cc, Handshower	ADA Lever	Chrome	406.10

Delta® Rough Valve Body

- 1/2" Rough-in
- Three port diverter rough
- For use with three or six function diverter
- Forged brass body



Part #	Mfg #	Description	Price
DELR11000	R11000	Three or Six Function 3-Port Diverter Rough	99.40

* Brilliance® Anti-Tarnish Lifetime Finishes

All Items May Not Be Stocked In All Branches

Tub & Shower Faucets

Tub & Shower Faucets**RSVP™ TempAssure® 60 Series Thermostatic Tub & Shower Trim**

- Order MultiChoice™ universal rough valve separately
- 2-Function push-button showerhead
- Tool for showerhead to showerarm assembly provided
- Lever volume control handle, temperature adjustment dial



Requires valve R60000-UNBX

Part #	Mfg #	Description	Handle(s)	Finish	Price
DELT60290PC	T60290-PC	Shower Trim Only	ADA Lever	Chrome	505.90

THE BOLD LOOK
OF **KOHLER****Tub & Shower Rough-In Valves****Ceramic Tub & Shower Rough-In**

- Wall-mount
- 10 gpm @ 45 psi
- Yoke with 8" centers
- Order trim separately



Part #	Mfg #	Description	Price
KOHK302K	K-302-K-NA	1/2" Washerless Ceramic, 2-Hdl	125.75

Rite-Temp® Pressure-Balancing Tub & Shower Rough-In

- Wall-mount
- 6 gpm @ 45 psi
- Order trim separately



K-304K

Part #	Mfg #	Description	Price
KOHK304K	K-304-K-NA	Universal Sweat/NPT Connections	107.95
KOHK304KS	K-304-KS-NA	Universal Sweat/NPT Connections, Screwdriver Stops	126.65

Rite-Temp® Pressure-Balancing Tub & Shower Rough-In

- Brass valve body
- Rite-Temp® pressure-balancing diaphragm design
- Integral diverter mechanism
- Designed for showerhead and handshower applications

Part #	Mfg #	Description	Price
KOHK11748K	K-11748-K	Pressure Balancing Valve without Screwdriver Stops	186.20

Tub & Shower
Faucets

Prices & Specifications are Subject to Change.

Tub & Shower Valves & Trim

Single-Handle Tub & Shower Trim

Kelston®™ Rite-Temp® 1-Handle Tub & Shower Trim

- Metal construction, brass valve bodies
- High-temperature limit stop
- Mixing valve cycles from cold to hot
- Lever handle
- For use with Rite-Temp® or HiFlow Rite-Temp® valves
- Heavy duty slip-fit clamp design



Part #	Mfg #	Description	Handles	Finish	Price
KOHKT134934CP	T13493-4-CP	Shower Trim Only	ADA Lever	Pol Chrome	127.55

MasterShower® Rough-In Valves

- Vibrant finishes have a lifetime limited warranty

MasterShower® XVII Thermostatic Rough-In Valves

- Wall-mount, single handle control
- Factory-calibrated comfort setting at 104°F
- Safety stop ensures temperature will not exceed 120°F
- Filter screens
- Integral stops



K-679-KS Valve for use with valve model K-681-K for volume control

Part #	Mfg #	Description	Price
KOHK679KS	K-679-KS-NA	1/2" NPT, less Volume Control, Thru Top Port 14.9 gpm @ 45 psi or Thru Bottom Port 17.2 gpm @ 45 psi	306.10

MasterShower® Volume Control Rough-In Valves

- Wall-mount
- 1/4-Turn washerless ceramic valve
- Designed for use with thermostatic mixer valves



K-671

Part #	Mfg #	Description	Finish	Price
KOHK681K	K-681-K-NA	1/2" NPT, 10 gpm @ 45 psi	-	72.85

MasterShower® 3-Way/2-Way Transfer Rough-In Valves

- Wall-mount
- Brass valve body
- Permits three outlets to be interconnected
- Selection of one or combination of two outlets
- Can be converted from three outlets (360° handle rotation) to two outlets (120° handle rotation)



Part #	Mfg #	Description	Price
KOHK728K	K-728-K	3/4 Wall-mount Three Way/ Two Way Transfer Valve	181.15

All Items May Not Be Stocked In All Branches

Tub & Shower Valves & Trim

Roman Tub Rough-In Valves

Ceramic High Flow Roman Tub Rough-In Valves

- Tub or deck-mount
- Order trim separately



K-301-K

Part #	Mfg #	Description	Price
KOHK300K	K-300-K-NA	1/2" Washerless Ceramic	146.70
KOHK301K	K-301-K-NA	3/4" Washerless Ceramic	342.95



Bath & Shower Fittings

3-Handle 11" Centerset Assemblies

- Cast brass bodies
- IP Unions

Tub & Shower

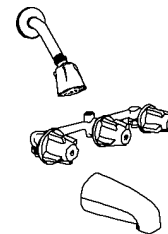

Part #	Mfg #	Description	Price
CEB971Z	0971-Z	1/2" IPS Zamak Spout	194.00

Valves

Self Closing Straight Stop

- Replaceable seat

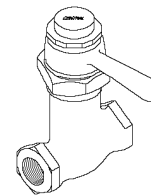

Part #	Mfg #	Description	Price
CEB331L12	0331-L1/2	1/2" - 14 NPS Female, Lever Hdl, CP	67.00

Self Closing Angle Stop

- Replaceable seat



Part #	Mfg #	Description	Price
CEB333L12	0333-1/2	1/2" - 14 NPS Female, 4-Arm Hdl, CP	68.50

**Tub & Shower
Faucets**

Prices & Specifications are Subject to Change.

Tub & Shower Valves & Trim

Single Handle Tub & Shower Systems

Temptrol® II (2000) Tub & Shower System

- Pressure-balancing mixing valve
- Adjustable stop screw to limit handle turn
- Clear-Flo showerhead with arm & flange
- Chrome tub spout



Part #	Mfg #	Description	Handle(s)	Finish	Price
SYM252LRX	25-2-LR-X	Tub & Shower with Diverter Tub Spout, Integral Stops	ADA Lever	Chrome	141.07

Temptrol® II Tub & Shower System

- Pressure-balancing mixing valve
- Adjustable stop screw to limit handle turn
- Clear-Flo showerhead with arm & flange



Part #	Mfg #	Description	Handle(s)	Finish	Price
SYMBP562IPS	BP-56-2-IPS	Tub & Shower, Diverter Tub Spout, 1/2" Fem IPS	ADA Lever	Chrome	106.23
SYMBP562X	BP-56-2-X	Tub & Shower, Diverter Tub Spout, Integral Svc Stops	ADA Lever	Chrome	119.54

Deluxe Temptrol Tub & Shower System

- Pressure-balancing mixing valve w/lever handle
- Adjustable stop screw to limit handle turn
- Clear-Flo showerhead with arm and flange
- Diverter tub spout



Part #	Mfg #	Description	Handle(s)	Finish	Price
SYMD962LAMXOP	D-96-2-LAM-X-OP	Tub & Shower Complete, Integral Svc Stops	Metal Finish Insert	Chrome	237.30

Allura™ 1-Hdl Tub & Shower System

- Temptrol pressure-balancing mixing valve
- Three mode shower head with arm and flange



Part #	Mfg #	Description	Handle(s)	Finish	Price
SYMS4702TRM	S-4702-TRM	Tub & Shower Trim	Lever	Chrome	149.23

All Items May Not Be Stocked In All Branches

Tub & Shower Valves & Trim

Ballina™ 1-Hdl Tub & Shower System

- Temptrol pressure-balancing mixing valve
- Three mode shower head with arm and flange



Part #	Mfg #	Description	Handle(s)	Finish	Price
SYMS5202BBZTRM	S5202BBZTRM	Tub & Shower Trim	Lever	Brushed Bronze	637.86

Oxford S-4202 - 1-Hdl Tub & Shower System

- Temptrol pressure-balancing mixing valve
- Secondary integral diverter control handle
- Single mode showerhead with arm and flange



Part #	Mfg #	Description	Handle(s)	Finish	Price
SYMS4202ORBTRM	S4202ORBTRM	Tub & Shower Complete	Lever	Oil Rubbed Bronze	657.90

Winslet™ 1-Hdl Tub & Shower System

- Temptrol pressure-balancing mixing valve
- Secondary integral diverter/volume control handle
- Single mode shower head with arm and flange



Part #	Mfg #	Description	Handle(s)	Finish	Price
SYMS5102STNTRM	S5102STNTRM	Tub & Shower Trim	Lever	Satin Nickel	637.86

Temptrol® Pressure-Balancing Mixing Valves

Part #	Mfg #	Description	Price
SYM4000XBODY	4000-X-BODY	Temptrol Pressure-Balancing Shower Valve less Trim with Integral Service Stops	140.71
SYMS862	S-86-2	Tub & Shower Valve with Integral Diverter & Volume Control	178.70
SYMS4002XBODY	S-4002-X-BODY	Temptrol Pressure-Balancing T&S Valve Only	147.90

**Tub & Shower
Faucets**

Tub & Shower Valves & Trim

Single Handle Shower Systems

S-96 - Temptrol® Shower System

- Features Temptrol® pressure-balancing mixing valve
- Integral volume control
- Clear-Flo showerhead with arm and flange
- Adjustable stop screw
- Wall connection and flange



Part #	Mfg #	Description	Handle(s)	Finish	Price
SYMS961	S-96-1	Shower Complete	Tri	Chrome	210.78

Allura™ 1-Hdl Shower System

- Temptrol pressure-balancing mixing valve
- Three mode shower head with arm and flange



Part #	Mfg #	Description	Handle(s)	Finish	Price
SYM4701TRM	4701-TRM	Shower Trim	Lever	Chrome	109.45

Ballina™ 1-Hdl Shower System

- Temptrol pressure-balancing mixing valve
- Three mode shower head with arm and flange



Part #	Mfg #	Description	Handle(s)	Finish	Price
SYM5201BBZTRM	5201BBZTRM	Shower Trim	Lever	Brushed Bronze	359.50

Oxford 4201 - 1-Hdl Shower System

- Temptrol pressure-balancing mixing valve
- Shower head with mounting bracket

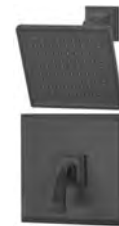

Part #	Mfg #	Description	Handle(s)	Finish	Price
SYM4201ORBTRM	4201ORBTRM	Shower Trim	Lever	Oil Rubbed Bronze	580.07

**Tub & Shower
Faucets**

All Items May Not Be Stocked In All Branches

Tub & Shower Valves & Trim

Winslet™ 1-Hdl Shower System

- Temptrol pressure-balancing mixing valve
- Single mode shower head with arm and flange



Part #	Mfg #	Description	Handle(s)	Finish	Price
SYM5101STNTRM	5101STNTRM	Shower Trim	Lever	Satin Nickel	359.40

Valves

Dual Outlet Levertrol Lever Diverter with Volume Control

- For tub outlet and shower outlet



Part #	Mfg #	Description	Finish	Price
SYM4458EBODY	4-458E-BODY	ADA Levertrol Triple Outlet Diverter	Chrome	47.43

Tools

Part #	Mfg #	Description	Price
SYMT35AB	T-35A/B	Hot & Cold Seat Removal Tool	19.25

**Tub & Shower
Faucets**

Visionary Baths & More Kitchen and Bath Design Centers

*Professionally staffed to assist you and your customers
with design and selection <http://www.visionarybaths.com>*

Tub & Shower Valves & Trim

Repair Parts

Safetymix® Pressure Balancing Mixing Valve 1960 To Present

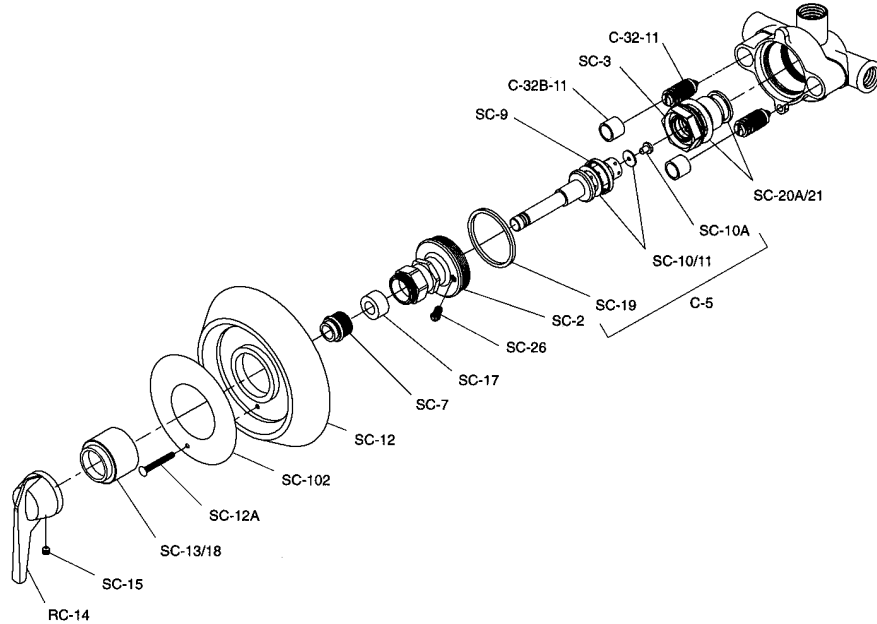

Part #	Mfg #	Description	Price
SYMC5	C-5	Flow Control Spindle	92.55

Temptrol® Pressure Balancing Mixing Valve 1968 To Present

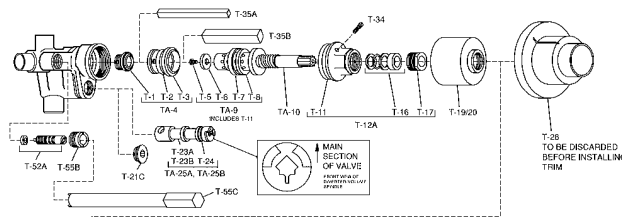

Part #	Mfg #	Description	Price
SYMTA4	TA-4	Hot & Cold Renewable Seat & Cold Seat O-Ring	38.55
SYMTA9	TA-9	Hot Washer Screw, Hot & Cold Washers, Cold Washer Retainer & Cap Gasket	5.70
SYMTA10	TA-10	Flow Control Spindle	63.45
SYMT30	T-30	Diverter/Volume Handle	11.45
SYMT31	T-31	Temperature Control Handle	18.45

All Items May Not Be Stocked In All Branches



www.irrsupply.com

Tub & Shower Valves & Trim

Single-Handle Tub & Shower Faucets

P4C 1-Handle Tub & Shower Faucet

- Washerless pressure balance valve
- Slip fit diverter spout
- CC and IP
- Less stops
- Maximum flow rate: 2.5 gpm @ 80 PSI



Part #	Mfg #	Description	Handle(s)	Finish	Price
PL4P4C730C	P4C-730C	Tub & Shower, Slip-Fit Diverter, 2.5 gpm	ADA Lever	Chrome	104.83



Tub & Shower Faucets & Trim

1-Hdl Shower Trim

- Order valve separately
- Solid brass lever handle
- 2.5 gpm Shower head



G9-120

Part #	Mfg #	Description	Finish	Price
GERG9120	G9-120	Loop Handle, Shower Only, Safetemp	Chrome	47.26

Safetemp II 1-Hdl Tub & Shower Trim

- Order valve separately
- Loop handle
- Slip/IPS combo spout
- Pressure compensations flow control
- Tub & shower trim kit



G9-131-82

Part #	Mfg #	Description	Finish	Price
GERG913182	G9-131-82	ADA Loop Handle, Tub & Shower, Sweat/IPS Spout, Trim Only	Chrome	54.53

Tub & Shower Faucets

Prices & Specifications are Subject to Change.



www.irrsupply.com

Tub & Shower Valves & Trim

2-Hdl Tub & Shower Faucet - 8" CC - Complete Valve & Trim - Ceramic Cartridge

- Cast brass body
- 2.5 gpm Maximum showerhead @ 80 psi
- Best for hardwater environments
- Ceramic disc cartridge
- 8"cc



Part #	Mfg #	Description	Finish	Price
GER58420	58-420	Tub & Shower, ADA Hardwater® Handles, IPS/Sweat, Slide Escutcheon, Ejector Tee	Chrome	158.88

3-Hdl Tub & Shower Faucet - 8" CC - Complete Valve & Trim - Ceramic Cartridge

- Cast brass body
- 2.5 gpm Maximum showerhead @ 80 psi
- Ceramic disc cartridge
- 8"cc



Part #	Mfg #	Description	Finish	Price
GER58520	58-520	Tub & Shower, ADA Hardwater® Handles, IPS/Sweat, Slide Escutcheon	Chrome	195.05

Tub & Shower Rough-In Valves Safetemp II Pressure Balance Valve



Part #	Mfg #	Description	Price
GERGS103	GS-103	IPS Rough-in Valve Only, Safetemp II Washerless Cartridge	114.49
GERGS105	GS-105	Sweat Rough-in Valve Only, Safetemp II Washerless Cartridge	114.49

All Items May Not Be Stocked In All Branches

Tub & Shower Valves & Trim

M•PACT® Tub & Shower Rough-In Valves

- Choose the desired M•PACT® Rough-In Valve that suits your needs
- Select the trim kit that includes spout, accents & handles to complete the faucet
- Upgrading the faucet is easy

ExactTemp® M•PACT® Thermostatic Pressure Balancing Rough-In Valve

- Thermostatic control for consistent water temperature day after day
- Temperature consistency and memory
- Temperature limit stops
- Vertical spa compatible
- Volume control
- Meets pressure-balancing safety codes
- Lifetime limited warranty



Part #	Mfg #	Description	Price
MOES3371	S3371	3/4" IPS with Stops	416.00

ExactTemp® M•PACT® Volume Control Valve

- Brass construction
- Precise flow control
- 3/4" IPS Connections



Part #	Mfg #	Description	Price
MOES3600	S3600	3/4" IPS Volume Control Valve	105.75

Posi-Temp® M•PACT® Pressure Balancing Cycling Rough-In Valve

- Temperature limit stops
- Cycling valve
- Meets pressure-balancing safety codes



62320



62370

Part #	Mfg #	Description	Price
MOE62320	62320	1/2" CC, #2520 Bulk (12/Pk)	92.25
MOE62370	62370	1/2" CC with Stops, #2570 Bulk (12/Pk)	112.10
MOE62380	62380	PEX Connection, Bulk (12/Pk)	92.25

Moentrol® M•PACT® Pressure Balancing Volume Control with Built-In Three Function Transfer Valve

- (2) Discreet functions, (1) shared function
- Pressure balancing
- Volume control



Part #	Mfg #	Description	Price
MOE3330	3330	1/2" CC with Stops	223.20

**Tub & Shower
Faucets**

Prices & Specifications are Subject to Change.

Tub & Shower Valves & Trim

Moentrol® M•PACT® Pressure Balancing Rough-In Valve

- Temperature memory
- Temperature limit stops
- Vertical spa compatible
- Volume control
- Meets pressure-balancing safety codes
- Lifetime limited warranty



Part #	Mfg #	Description	Price
MOE63170	63170	1/2" CC with Stops, #3570 Bulk (12/Pk)	150.70

M•PACT® One-Handle Tub & Shower Trim Kits

- Choose the desired M•PACT® Rough-In Valve that suits your needs
- Select the trim kit that includes spout, accents & handles to complete the faucet
- Upgrading the faucet is easy
- Stainless, Copper & Satine, Black Opal, Classic Gold faucets feature LifeShine® Non-tarnish finish

ExactTemp® Volume Control Valve Trim

- Fits M•PACT® system
- Lever handle to adjust volume
- 3/4" IPS Connections
- Matching tub & shower drains available



Part #	Mfg #	Description	Handle(s)	Finish	Price
MOETS3600	TS3600	Valve Trim Only	ADA Lever	Chrome	86.55

Brantford™ Posi-Temp® 1-Hdl Tub & Shower Trim

- Fits M•PACT® system
- Easy Clean® XLT single function showerhead, arm & flange
- 6-1/2" Slip fit diverter spout



Part #	Mfg #	Description	Handle(s)	Finish	Price
MOET2153	T2153	Tub & Shower Trim	ADA Lever	Chrome	86.80
MOET2153BN	T2153BN	Tub & Shower Trim	ADA Lever	* Brushed Nickel	173.35
MOET2153ORB	T2153ORB	Tub & Shower Trim	ADA Lever	Oil Rubbed Bronze	190.70
MOET62153	T62153	Tub & Shower Trim, Bulk 12/Pk	ADA Lever	Chrome	74.50
MOET2152	T2152	Shower Trim Only	ADA Lever	Chrome	59.60
MOET2152BN	T2152BN	Shower Trim Only	ADA Lever	* Brushed Nickel	131.40
MOET2152ORB	T2152ORB	Shower Trim Only	ADA Lever	Oil Rubbed Bronze	144.50
MOET62152	T62152	Shower Trim Only, Bulk 12/Pk	ADA Lever	Chrome	49.45

* Lifeshine® Anti-Tarnish Lifetime Finish

All Items May Not Be Stocked In All Branches

Tub & Shower Valves & Trim

Chateau Posi-Temp® Tub & Shower Trim - Bulk Packs (12)

- Fits M•PACT® system
- Adjustable temperature limit stop
- Single function showerhead, arm & flange
- 5-1/2" Slip fit diverter tub spout
- Order bulk M•PACT® valve separately



T183 Shown

TL183 Shown

Part #	Mfg #	Description	Handle(s)	Finish	Price
MOET183	T183	Tub & Shower Trim	Knob	Chrome	52.50
MOETL183	TL183	Tub & Shower Trim	ADA Lever	Chrome	52.50
MOETL182	TL182	Shower Trim Only	ADA Lever	Chrome	32.30

Eva™ Posi-Temp™ 1-Hdl Tub & Shower Trim Kit

- Fits M•PACT® system
- Easy Clean® XLT single function showerhead, arm & flange
- 7" Slip fit diverter tub spout
- Order M•PACT® valve separately



T2133

Part #	Mfg #	Description	Handle(s)	Finish	Price
moet2133	T2133	Tub & Shower Trim	ADA Lever	Chrome	86.80
MOET2133BN	T2133BN	Tub & Shower Trim	ADA Lever	* Brushed Nickel	173.35
MOET2132	T2132	Shower Trim Only	ADA Lever	Chrome	59.60
MOET2132BN	T2132BN	Shower Trim Only	ADA Lever	* Brushed Nickel	131.40

* Lifeshine® Anti-Tarnish Lifetime Finish

Icon™ Posi-Temp™ 1-Hdl Tub & Shower Trim

- Fits M•PACT® system
- Moenflo® XLT single-function showerhead, arm & flange
- 7-1/4" Slip-fit diverter tub spout
- Order M•PACT® valve separately



Part #	Mfg #	Description	Handle(s)	Finish	Price
MOETS2142	TS2142	Posi-Temp™ Shower Trim Only	ADA Lever	Chrome	144.60

**Tub & Shower
Faucets**

Tub & Shower Valves & Trim

Kingsley™ Posi-Temp™ 1-Hdl Tub & Shower Trim

- Fits M•PACT® system
- Moenflo® XL single function showerhead, arm & flange
- 6" Slip fit diverter tub spout
- Order M•PACT® valve separately



Part #	Mfg #	Description	Handle(s)	Finish	Price
MOET2113	T2113	Tub & Shower Trim	ADA Lever	Chrome	160.05
MOET2113BN	T2113BN	Tub & Shower Trim	ADA Lever	* Brushed Nickel	296.55
MOET2112BN	T2112BN	Shower Trim Only	ADA Lever	* Brushed Nickel	233.25

* Lifeshine® Anti-Tarnish Lifetime Finish

Kingsley™ Moentrol® 1-Hdl Trim

- Fits M•PACT® system
- Moenflo® XL single function showerhead, arm & flange
- Tub & Shower includes 6" slip fit diverter tub spout
- Order M•PACT® valve separately



Part #	Mfg #	Description	Handle(s)	Finish	Price
MOET3112BN	T3112BN	Shower Trim Only	ADA Lever	* Brushed Nickel	308.10

* Lifeshine® Anti-Tarnish Lifetime Finish

Kingsley® "Three-Function Transfer Valve" Moentrol® Trim Kits

- Fits M•PACT® system
- Lever handle diverter
- Knob handle to adjust temperature & volume
- Order M•PACT® valve separately



Part #	Mfg #	Description	Handle(s)	Finish	Price
MOET4111	T4111	Valve Trim Only	ADA Lever	Chrome	129.55
MOET4111BN	T4111BN	Valve Trim Only	ADA Lever	* Brushed Nickel	177.40

* Lifeshine® Anti-Tarnish Lifetime Finish

Monticello® Moentrol™ 1-Hdl Tub & Shower Trim

- Fits M•PACT® system
- Handle insert included
- Shower includes adjustable showerhead, arm and flange
- Tub & Shower includes 6" diverter tub spout
- Order M•PACT® valve separately



Part #	Mfg #	Description	Handle(s)	Finish	Price
MOET3124	T3124	Shower Trim Only	ADA Lever	Chrome	133.45

All Items May Not Be Stocked In All Branches

Tub & Shower Valves & Trim

Monticello® Posi-Temp® 1-Hdl Tub & Shower ADA Lever Trim

- Fits M•PACT® system
- Handle insert included
- Adjustable showerhead, arm & flange
- 6" Slip fit diverter tub spout
- Order M•PACT® valve separately



T2449

Part #	Mfg #	Description	Handle(s)	Finish	Price
MOET2449	T2449	Tub & Shower Trim	ADA Lever	Chrome	160.05
MOET2449BN	T2449BN	Tub & Shower Trim	ADA Lever	* Brushed Nickel	296.55
MOET2444	T2444	Shower Trim Only	ADA Lever	Chrome	125.85
MOET2444BN	T2444BN	Shower Trim Only	ADA Lever	* Brushed Nickel	233.25

* Lifeshine® Anti-Tarnish Lifetime Finish

Monticello® "Three-Function Transfer Valve" 1-Hdl Tub & Shower Trim

- Fits M•PACT® system
- Lever handle diverter
- Knob handle to adjust temperature & volume
- Order M•PACT® valve separately



Part #	Mfg #	Description	Handle(s)	Finish	Price
MOET4110	T4110	Valve Trim Only	Knob/Lever	Chrome	129.55

3-Function Transfer Valve Trim

- Metal construction
- Rotational control with 180° of rotation with stops



Part #	Mfg #	Description	Handle(s)	Finish	Price
MOET4171	T4171	Transfer Valve Trim	ADA Lever	Chrome	86.55

Villela™ Posi-Temp® 1-Hdl Tub & Shower Trim

- Fits M•PACT® system
- Shower includes single function showerhead, arm and flange



Part #	Mfg #	Description	Handle(s)	Finish	Price
MOETL2303	TL2303	Tub & Shower Trim	ADA Lever	Chrome	81.20
MOETL2302	TL2302	Shower Trim Only	ADA Lever	Chrome	55.80

**Tub & Shower
Faucets**

Prices & Specifications are Subject to Change.

Tub & Shower Valves & Trim

Single-Handle Tub & Shower Faucets with Valves

Chateau® Posi-Temp® Pressure Balancing 1-Hdl Tub & Shower Valve & Trim

- Pressure balancing cycling valve without volume control
- Adjustable temperature limit stop
- Single function showerhead, arm & flange
- 5-1/2" Slip fit diverter tub spout
- 4-Port



Part #	Mfg #	Description	Handle(s)	Finish	Price
MOE2353	2353	Tub & Shower, CC	Knob	Chrome	146.55
MOEL2353	L2353	Tub & Shower, CC	ADA Lever	Chrome	146.55
MOEL2353P	L2353P	Tub & Shower, CC	ADA Lever	* Pol Brass	310.00
MOEL2363	L2363	Tub & Shower, CC with Stops	ADA Lever	Chrome	167.40
MOE2352	2352	Shower Only, CC	Knob	Chrome	128.20
MOEL2352	L2352	Shower Only, CC	ADA Lever	Chrome	128.20
MOEL2362	L2362	Shower Only, CC with Stops	ADA Lever	Chrome	149.05
MOEL2361	L2361	Valve Only, CC	ADA Lever	Chrome	139.70

* Lifeshine® Anti-Tarnish Lifetime Finish

Legend® Moentrol® Pressure Balancing 1-Hdl Tub & Shower Valve & Trim

- Fits M•PACT® system
- 4-Port pressure balancing volume control valve with stops
- Adjustable temperature limit stop
- Single function showerhead, arm & flange
- 5-1/2" Slip fit tub spout



Part #	Mfg #	Description	Handle(s)	Finish	Price
MOEL3189	L3189	Tub & Shower, CC	ADA Lever	Chrome	251.35
MOEL3175	L3175	Shower Only, CC	ADA Lever	Chrome	221.80

Two-Handle Tub & Shower Faucets

Chateau® Standard 2-Hdl Tub & Shower Valve & Trim

- IPS Model includes union nut & adapter
- Easy Clean® showerhead, arm, & flange
- Diverter tub spout



Part #	Mfg #	Description	Handle(s)	Finish	Price
MOE2919	2919	Tub & Shower, CC	Acrylic Knobs	Chrome	143.75

All Items May Not Be Stocked In All Branches

Tub & Shower Valves & Trim

Three-Handle Tub & Shower Faucets

Chateau® Standard 3-Hdl Tub & Shower Valve & Trim

- Easy Clean® showerhead, arm & flange
- 5-1/2" Tub filler spout
- Includes ground joint



Part #	Mfg #	Description	Handle(s)	Finish	Price
MOE2995	2995	Tub & Shower, IPS	Knobs	Chrome	168.20

M•PACT® Vertical Spa Set Trim Kits

- Choose the desired M•PACT® Rough-In Valve that suits your needs
- Select the trim kit that includes spout, accents & handles to complete the faucet
- Upgrading the faucet is easy

Monticello™ Moentrol® "Three-Function Valve" Vertical Spa Trim

- Fits M•PACT® system
- Built-in three function transfer valve vertical spa set
- Matching tub & shower drains available
- (4) Small body sprays
- 3-Function transfer valve
- Adjustable showerhead, arm & flange
- Handle insert included
- Valve not included



Part #	Mfg #	Finish	Price
MOE243	243	Chrome	467.05

ioDigital™ Digital Spa & Shower Controls

- Dial in and maintain both temperature and flow with electronic precision



Part #	Mfg #	Description	Price
MOETS3415BN	TS3415BN	Brushed Nickel ioDigital Shower Digital Control	654.90

Tub & Shower Faucets

Tub & Shower Valves & Trim

M•PACT® Two-Handle Roman Tub Rough-In Valves

- Choose the desired M•PACT® Rough-In Valve that suits your needs
- Select the trim kit that includes spout, accents & handles to complete the faucet
- Upgrading the faucet is easy

M•PACT® Roman Tub 2-Handle Rough-in Valves

- No-cut spout shank
- Fits 3/16" to 4-1/4" deck thickness
- Uses Moen® 1248 cartridge
- Test plug included



9992

Part #	Mfg #	Description	Price
MOE4992	4992	1/2" CC Sweat Connections, Adjustable No-Cut Spout Shank	113.15
MOE9992	9992	1/2" CC Sweat Connections, Built-in Handshower Diverter	255.00

M•PACT® Two-Handle Roman Tub Faucets

- Choose the desired M•PACT® Rough-In Valve that suits your needs
- Select the trim kit that includes spout, accents & handles to complete the faucet
- Upgrading the faucet is easy

Brantford™ 2-Hdl Roman Tub Trim

- Fits M•PACT® system
- Valve 14-18 gpm maximum



Part #	Mfg #	Description	Handle(s)	Finish	Price
MOET933	T933	7" Spout	ADA Lever	Chrome	223.00

Chateau® 2-Hdl Roman Tub Trim

- Fits M•PACT® system
- Rough-in valve not included
- Deck-mount



Part #	Mfg #	Description	Handle(s)	Finish	Price
MOET990	T990	9" Spout	ADA Metal Lever	Chrome	216.25

Eva™ 2-Hdl Roman Tub Trim

- Fits M•PACT system
- Rough-in valve not included



T943

T944

Part #	Mfg #	Description	Handle(s)	Finish	Price
MOET943	T943	High Arc Spout	ADA Lever	Chrome	223.00
MOET943BN	T943BN	High Arc Spout	ADA Lever	* Brushed Nickel	341.70
MOET944BN	T944BN	High Arc Spout, Built-In Handshower Diverter	ADA Lever	* Brushed Nickel	454.25

* Lifeshine® Anti-Tarnish Lifetime Finish

All Items May Not Be Stocked In All Branches

Commercial Faucets

Single-Handle Commercial Lavatory Faucets

Delta® HDF® Diamond™ Series 1-Hdl Centerset Low Flow Lavatory Faucet

- Single handle lavatory deck faucets for exposed mounting on 3-hole sinks
- All metal fabricated body
- 5" Spout
- Vandal resistant aerator or spray outlet
- Heavy-duty commercial product
- 3/8" OD Straight, staggered copper supplytubes with 3/8" fittings
- Low flow rate: 1.5 gpm @ 60 psi
- HGM Suffix: flow rate: 0.5 gpm @ 60 psi



501



520



Part #	Mfg #	Description	Handle(s)	Finish	Price
DEL501LFHDF	501LF-HDF	3-Hole 4"cc, Less Pop-Up Drain	ADA Lever	Chrome	115.95
DEL520LFHDF	520LF-HDF	3-Hole 4"cc, Metal Pop-Up Drain	ADA Lever	Chrome	145.40

Two-Handle Commercial Lavatory Faucets

Centerset 2-Handle Heavy-Duty Commercial ADA Lavatory Faucet

- 3-7/16" Reach spout
- Hot/cold indicators
- Vandal-resistant handles
- Heavy-duty commercial product



2529HDF

Part #	Mfg #	Description	Handle(s)	Finish	Price
DEL2529HDF	2529HDF	4"cc Grid Strainer, No Lift-Rod Hole	ADA Wrist Blade	Chrome	158.55

Commercial Electronic Metering Lavatory Faucets

Delta® HDF® Commercial Electronic Metering Lavatory Faucet

- 5-1/4" Reach, 3-7/8" high rigid spout
- Hands-free operation
- Self-adaptive technology
- H2OPTICS™ technology
- No adjustments required
- No lift rod hole
- Battery powered
- Waterproof electronics
- 0.5 gpm Vandal-resistant spray outlet



Part #	Mfg #	Description	Handle(s)	Finish	Price
DEL591LGHGMHDF	591-LGHGMHDF	4"cc 4" Cover Plate	ADA Electronic	Chrome	442.85

Commercial Faucets

Prices & Specifications are Subject to Change.

Commercial Faucets

Delta® Commercial Lavatory Faucets

Teck® Commercial 2-Handle Centerset Faucets

- 4-1/2" Reach, 12" high rigid gooseneck spout
- Vandal-resistant ADA handles
- Cast brass body
- Hot/Cold handle indicators
- Tuf-Teck™ or Cer-Teck™ cartridges
- 1.5 gpm Aerator
- 1/2" IPS Shanks



Part #	Mfg #	Description	Handle(s)	Finish	Price
DEL27C4842	27C4842	4"cc less Pop-Up, Cer-Teck™	ADA Hooded Blade	Chrome	158.85

Teck® 86T Commercial 2-Handle Metering Faucet

- Cast brass body
- Vandal resistant handles
- Metering, slow-close lever style
- Hot/cold indicators
- 2.5 gpm Vandal-resistant outlet
- No lift rod hole



Part #	Mfg #	Description	Handle(s)	Finish	Price
DEL86T1153	86T1153	4"cc	ADA Lever	Chrome	243.65

MultiChoice™ Universal Tub & Shower Valves and Trim

HDF® Monitor® 13 Series Commercial 1-Handle Trim

- Fits MultiChoice™ universal valve
- Includes cartridge
- Handle adjusts temperature
- Hot/Cold temperature indicator
- Touchclean™ showerhead
- Sweat onto 1/2" CWT or thread onto 1/2" IPS



Part #	Mfg #	Description	Handle(s)	Finish	Price
DELT13491	T13491	Tub & Shower Trim, 5-1/2" Pull-Up Diverter Spout	ADA Lever	Chrome	106.15
DELT13291	T13291	Shower Trim Only	ADA Lever	Chrome	85.00
DELT13391	T13391	Valve Trim Only, Push Button Diverter	ADA Lever	Chrome	70.45

Commercial MultiChoice™ Universal Valves

- Includes R10000-UNWS with diverter valve rough-in from 190253A
- For use with MultiChoice™ Universal T13H series with diverter valve for dual showers
- Handle and flange ships with trim



Part #	Mfg #	Description	Price
DELR10700UNWS	R10700UNWS	Rough-in for T&S within Wall Diverter V&S	110.45

All Items May Not Be Stocked In All Branches

Commercial Faucets

Commercial MultiChoice™ Universal Valve Trim Packs

Commercial Teck™ ADA Tub & Shower Trim with Valve and Cartridge

- Red/blue label on escutcheon
- Vacuum breaker
- ADA Compliant, adjustable handshower slide or showerhead with arm and flange
- Vandal resistant blade handle
- Handle adjusts temperature
- Back-to-back capability
- 1/2" Universal inlets/outlets
- T13H1-2: Use R10000-UNWS Rough-in valve
- T13H3: Use R10700-UNWS Rough-in valve



Part #	Mfg #	Description	Handle(s)	Finish	Price
DELT13H153	T13H153	Shower Only, 24" Grab Bar, 70" Vinyl Hose, 2.5 gpm	ADA Lever Blade	Chrome	264.90
DELT13H333	T13H333	Shower Only, 24" Slide/Grab Bar, Diverter, Handshower, Push-Clean Showerhead, 2.5 gpm	ADA Lever Blade	Chrome	417.65



Metering Lavatory Faucets

Single-Handle Self-Closing Lavatory Faucets

- Cast brass body
- 1/2"-14 NPS Male shank x 2-1/4" long
- Replaceable seat



Part #	Mfg #	Description	Price
CEB255C	0255-C	Brass Cross Hdl, Cold, CP	68.00
CEB255H	0255-H	Brass Cross Hdl, Hot, CP	68.00

Service Sink Faucets

8" Centerset Heavy Duty Service Sink Faucets

- Cast brass
- 1/2" NPS Female inlet flanges
- 3/4" Hose thread on outlet & pail hook
- Replaceable seats



Part #	Mfg #	Description	Price
CEB51U	0051-URC	Rigid Spout, Pail Hook, Blade Hdls, RC	119.00

Commercial Faucets

* Brilliance® Anti-Tarnish Lifetime Finishes

Prices & Specifications are Subject to Change.



www.irrsupply.com

Commercial Faucets

Drinking Faucets

Bubbler Heads

- Cast brass
- Replaceable cartridge



Part #	Mfg #	Description	Price
CEB36012	0360	1/2" - 14 NPS Male Shank, Flange, CP	83.00
CEB36238	0362	3/8" - 18 NPS Female Thread	69.00

Stand Pipes

- With nut and flange



Part #	Mfg #	Description	Price
CEB34212	0342-1/2	1/2" - 14 NPT Taper Thread, CP	16.50



Single-Handle Lavatory Faucets

MeterMix® 1-Hdl Deck-Mount Lavatory Faucet with 4-3/4" Integral Cast Spout

- Solid brass body construction
- 1/2" NPSM Coupling nut for 3/8" or 1/2" flexible riser
- Mounting hardware included
- Integral check valves & filter screens



Part #	Mfg #	Description	Cartridge	Aerator	Finish	Price
CHF3300CP	3300-CP	Handle with Integral Temperature Control	MVP™	E2805	CP	316.27

Two-Handle Lavatory Faucets

2-Hdl Deck-Mount Faucet with 4" Integral Spout

- Solid brass body construction
- 1/2" NPSM Supply inlets with coupling nuts for 3/8" or 1/2" flexible risers
- Mounting hardware included
- Handles indexed hot & cold



802-V317C

Part #	Mfg #	Description	Cartridge	Aerator	Finish	Price
CHF802V317	802-V317CP	4"cc, 317 ADA Wrist Blades	Quatum™	E12VP	CP	187.53
CHF802V336	802-V336CP	4"cc, 336 ADA Push-Tilt Handles	NAIAD™	E12VP	CP	305.51

Commercial Faucets

All Items May Not Be Stocked In All Branches

Commercial Faucets

Metering Lavatory Faucets

2-Hdl Deck-Mount Metering Lavatory Faucet with 4" Integral Spout

- Solid brass body construction
- 1/2" NPSM Supply inlets with coupling nuts for 3/8" or 1/2" flexible risers
- Mounting hardware included



Part #	Mfg #	Description	Cartridge	Aerator	Finish	Price
CHF802V665	802-V665CP	4"cc, 665 MVP™ ADA Push-Buttons	MVP™	E12VP	CP	278.14

Two-Handle Kitchen Faucets

2-Hdl Concealed Deck-Mount Kitchen Faucet with GN8A Rigid/Swing Gooseneck Spout

- Solid brass body construction
- 1/2" NPSM Supply inlets with coupling nuts for 3/8" or 1/2" flexible risers
- Mounting hardware included
- Handles indexed hot & cold



Part #	Mfg #	Description	Cartridge	Aerator	Finish	Price
CHF201AGN8AE3317	201-AGN8AE3-317CP	8"cc, 317 ADA Wrist Blades	Quatum™	E3	CP	281.81

2-Hdl Concealed Deck-Mount Kitchen Faucet with GN2A Rigid/Swing Gooseneck Spout

- Solid brass body construction
- 1/2" NPSM Coupling nut for 3/8" or 1/2" flexible riser
- Mounting hardware included
- Handles indexed hot & cold



Part #	Mfg #	Description	Cartridge	Aerator	Finish	Price
CHF786E3	786-E3CP	8"cc, 317 ADA Wrist Blades	Quatum™	E3	CP	282.84

2-Hdl Concealed Deck-Mount Kitchen Faucet with L8 Cast Swing Spout

- Solid brass body construction
- 1/2" NPSM Coupling nut for 3/8" or 1/2" flexible riser
- Mounting hardware included
- Handles indexed hot & cold



Part #	Mfg #	Description	Cartridge	Aerator	Finish	Price
CHF1100	1100-CP	8"cc, 1000 ADA Wing Canopies	Quatum™	E3	CP	268.84

Commercial Faucets

Prices & Specifications are Subject to Change.

Commercial Faucets

Two-Handle Sink Faucets

2-Hdl Deck-Mount Sink Faucet with Rigid/Swing Gooseneck Spout

- Solid brass body construction
- 1/2" NPSM Supply inlets with coupling nuts for 3/8" or 1/2" flexible risers
- Mounting hardware included
- Handles indexed hot & cold



Part #	Mfg #	Description	Cartridge	Aerator	Finish	Price
CHF895317	895-317CP	4"cc, 317 ADA Wrist Blades, GN1A Spout	Quatum™	E3	CP	217.21

Service Sink Faucets

2-Hdl Wall-Mount Exposed Service Sink Faucet

- Solid brass body construction
- "G" Adjustable 1/2" NPT female supply arms
- Loose wall flange
- Handles indexed hot & cold



Part #	Mfg #	Description	Cartridge	Aerator	Finish	Price
CHF540LD	540-LDLESSSPTCP	7-1/4" - 8-3/4"cc, 369 ADA Levers Less Spout	Quatum™	-	CP	202.13

2-Hdl Wall-Mount Exposed Service Sink Faucet

With Vacuum Breaker Spout with Pail Hook & Wall Brace

- Solid brass body construction
- Adjustable 1/2" FNPT supply arms
- 3/4" Male hose thread outlet
- Mounting hardware included
- Handles indexed hot & cold



Part #	Mfg #	Description	Cartridge	Aerator	Finish	Price
CHF897RCF	897-MPRCF	7-5/8" - 8-3/8"cc, 369 ADA Levers	Quatum™	-	RC	165.89

Inside Sill Fitting

Wall-Mount Inside Sill Fitting with Atmospheric Vacuum Breaker Spout

- Solid brass body construction
- Mounting hardware included



Part #	Mfg #	Description	Cartridge	Finish	Price
CHF952	952-CP	1-Hole, 293-6 Loose Key, 3/4" FNPT Thread Inlet	Slow Compression	CP	221.71

Commercial Faucets

Spouts

- Fits 1-1/16" - 18 UNEF Male body outlet



Part #	Mfg #	Description	Finish	Price
CHFL8	L8JKCP	Swing Spout, 4-3/8"H, 8" Reach, E3 Softflo® Aerator	CP	79.22
CHFL9	L9JKCP	Swing Spout, 6-1/2"H, 9-1/2" Reach, E3 Softflo® Aerator	CP	60.50
CHFL12	L12JKCP	Swing Spout, 4-5/8"H, 12" Reach, E3 Softflo® Aerator	CP	60.50
CHFL15	L15JKCP	Swing Spout, 4-5/8"H, 14" Reach, E3 Softflo® Aerator	CP	84.10

Vacuum Breakers

Atmospheric Vacuum Breakers

Part #	Mfg #	Description	Finish	Price
CHF892	892-CP	1/2" Female Inlet & Outlet	CP	56.20



Ultra-Sense Sensor Faucet

- Battery-powered, sensor-activated with infrared position sensitive direction (PSD) system
- Vandal resistant
- Temperature limit stop
- 1.5 gpm Low profile, vandal-resistant aerator
- 10 Second factory-set cycle time with automatic shut-off feature
- 6V Lithium battery power pack
- In-line check/strainers



Part #	Mfg #	Description	Handle(s)	Finish	Price
SYMS6080	S-6080	4"cc Deck-Plate	Sensor	Chrome	621.23

Scot® Metering Lavatory Faucets

Metering

- With temperature selection



Part #	Mfg #	Description	Price
SYMS60H	S-60-H	Faucet Only	265.25

Commercial Faucets

Prices & Specifications are Subject to Change.

Commercial Faucets

Single Handle Lavatory Faucets

Symmetric® 1-Hdl Lavatory Faucets

- Red & blue indicators
- Handle limit stops
- Standard aerator 2.2 gpm flow rate
- 1/4-Turn ceramic control components
- 6-3/8" Copper tubing
- Metal construction



Part #	Mfg #	Description	Handle(s)	Finish	Price
SYMS200IPS	S-20-0-IPS	4"cc, 1/2" IPS Adaptors	ADA Lever	Chrome	105.62
SYMS202IPS	S-20-2-IPS	4"cc Pop-Up Drain & Lift Rod 1/2" IPS Connections	ADA Lever	Chrome	121.23

Two Handle Lavatory Faucets

Symmetrix® 2-Hdl Lavatory Faucets

- 1/4-Turn ceramic control components
- Red & blue indicators
- 1/2" IPS Shanks
- Aerator with 2.2 gpm flow rate
- Metal construction



Part #	Mfg #	Description	Handle(s)	Finish	Price
SYMS2402	S-240-2	4"cc, Lift Rod, Metal Pop-Up Drain	Metal Insert Lever	Chrome	105.77
SYMS2402LCT	S-240-2-LCT	4"cc, Lift Rod, Metal Pop-Up Drain	Clear Acrylic	Chrome	105.77

Visionary Baths & More

Because your time is valuable...

Visit your local Visionary Baths & More Kitchen and Bath Design Centers to let one of our trained knowledgeable consultants help you with your project.

<http://www.visionarybaths.com>

Commercial Faucets

Tub & Shower Accessories

Tub & Shower Accessories

Showerheads

- Utilizes brass ball connector to attach shower head to water supply
- Energy efficient - meets all industry codes

Classic Full Spray Showerhead

- Rub clean nozzles for removal of mineral deposits
- Double-check valve
- Spray setting: full spray



Part #	Mfg #	Description	Price
DEL52675PK	52675-PK	Chrome, Retail Pkg	16.00

Designer 5-Spray/Massage Showerhead

- Trickle setting for shampoo/soap-up
- Easy-turn spray dial with lever
- Anti-clog, rub clean nozzles for easy cleaning
- Spray settings:
 - Full spray
 - Fast massage
 - Slow massage
 - Trickle



Part #	Mfg #	Description	Price
DEL52635PK	52635-PK	Chrome, Retail Pkg	45.00

Premium European-Style 5-Spray/Massage Showerhead

- Easy-turn spray dial with (5) spray settings:
 - Full spray
 - Fast massage
 - Slow massage
 - Full spray massage
 - Trickle (for shampoo/soap-up)
- Engineering grade plastics
- Dimensions: 4.2" H x 3.3" W
- Flow rate: 2.5 gpm @ 80 psi



Part #	Mfg #	Description	Price
DEL52625PK	52625-PK	Chrome, Retail Pkg	72.00

Handshowers

Premium In2ition® Two Showers in One - 4-Spray Handshower

- 72" Reinforced vinyl hose
- Double check valve
- Integral 3-way diverter
- Spray settings:
 - Full spray
 - Massage
 - Full spray with massage
 - Pause



Part #	Mfg #	Description	Price
DEL58464PK	58464-PK	Chrome, Retail Pkg	140.00

Premium European-Style 5-Spray/Massage Handshower

- Easy-turn spray dial with (5) spray settings:
 - Full spray
 - Fast massage
 - Slow massage
 - Full spray massage
 - Trickle (for shampoo/soap-up)
- Engineering grade plastics
- Dimensions: 8.9" L x 3.3" W x 3.7" D
- Flow rate: 2.5 gpm @ 80 psi



Part #	Mfg #	Description	Price
DEL59425PK	59425-PK	Chrome, Retail Pkg	83.00
DEL59425WHPK	59425-WH-PK	White, Retail Pkg	76.00

Designer 5-Spray/Massage Handshower

- Trickle setting for shampoo/soap-up
- Easy-turn spray dial with lever
- Anti-clog/rub clean nozzles for easy cleaning
- Spray settings:
 - Full spray
 - Fast massage
 - Slow massage
 - Full spray massage
 - Trickle



Part #	Mfg #	Description	Price
DEL59435PK	59435-PK	Chrome, Retail Pkg	55.00

Prices & Specifications are Subject to Change.

Tub & Shower Accessories

Tub & Shower Accessories

Classic Full Spray Handshower

- Rub clean nozzles for removal of deposits
- Double check valve
- Spray setting: full spray



Part #	Mfg #	Description	Price
DEL59462WHPK	59462-WH-PK	White, Retail Pkg	21.00

Classic Full Spray Handshower with Push-Button Pause Control

- Push button trickle/full spray control
- Push button reduces water to trickle
- Rub clean nozzles for removal of deposits
- Double check valve
- Spray settings
 - Full spray
 - Trickle



Part #	Mfg #	Description	Price
DEL59462BPK	59462-B-PK	Chrome, Retail Pkg	33.00
DEL59462WHBPK	59462-WHB-PK	Pol Brass, Retail Pkg	24.00

Wall-Mount Handshower Units

Premium European-Style 5-Spray/Massage Unit

- Single wall mount
- Trickle setting for shampoo/soap-up
- Easy-turn spray dial
- Consists of:
 - 425 Handshower
 - 3001 Wall mount
 - UltraFlex® 490 70" or 494 C 60" hose



Part #	Mfg #	Description	Price
DEL59710PK	59710-PK	Chrome, Retail Pkg	126.00
DEL59710WHPK	59710-WH-PK	White, Retail Pkg	115.00

Designer 5-Spray/Massage Unit with Pause Control

- Consists of:
 - 435 Handshower
 - 628 Shower head
 - 3001 Wall mount
 - UltraFlex® 490 60" or 494 C 60" hose



Part #	Mfg #	Description	Price
DEL55435PK	55435-PK	Chrome, Retail Pkg	84.00

Classic Full Spray Unit with Pause Control

- Single wall mount
- Push button/full-spray handshower
- Double check valve
- Consists of:
 - 462 PB Handshower
 - 3001 Wall mount
 - UltraFlex® 490 60" or 494 C 60" hose



Part #	Mfg #	Description	Price
DEL59410WHBPK	59410-WHB-PK	White & Chrome, Retail Pkg	65.00

Adjustable Height Wall-Mount Handshower Units

Classic Unit with Push-Button Pause Control

- Double check valve
- Classic 24" wall bar with adjustable pin-mount
- Metal swivel connector
- Consists of:
 - 462 PB Handshower
 - 5002 Swivel connector
 - 25011 Wall bar
 - 495 DS Matching 60" - 80" Extendible stainless steel hose



Part #	Mfg #	Description	Price
DEL51501WH	51501-WH	White & Chrome, Boxed	172.00

Tub & Shower Accessories

**Tub & Shower
Accessories**

Showerarm-Mount Units

Premium European 5-Spray/Massage Showerarm-Mount Unit

- Double-check valve
- UltraFlex® hose:
70" for Polished brass finish
72" for Satin nickel hose with vacuum breaker
- Consists of:
 - 425 Handshower
 - 3401 Showerarm mount
 - 490 60" or 70" UltraFlex® hose



Part #	Mfg #	Description	Price
DEL59345PK	59345-PK	Chrome, Retail Pkg	116.00

Wall Grab Bar Handshower Units

ADA Wall Grab Bar System



- Works with any Delta handshower (handshower sold separately)
- Easy grip adjustable slide mechanism
- Matching 60" to 82" extendible, stainless steel hose (495 DS) (RB double spiral)
- 1-1/4" Diameter decorative 24" wall grab bar
- Kit includes:
 - Wall grab bar (60026 series)
 - ADA wall bar shower mount (6300 series)
 - Stretchable stainless steel hose (495DS series)
 - Limited lifetime warranty



Part #	Mfg #	Description	Price
DEL56302	56302	Chrome ADA Kit	175.00

Volume Controls

476 Volume Control

- Brass with pause; plastic side lever



Part #	Mfg #	Description	Price
DELU4760PK	U4760-PK	Chrome, Retail Pkg	31.00

Shower Hoses

All Brass Double Spiral with Brass Nuts

- (1) Conical and
(1) hex all-brass nuts



Part #	Mfg #	Description	Price
DELU495D60PK	U495D-60-PK	60" to 82", Chrome, Retail Pkg	36.00
DELU495DPB60PK	U495D-PB60-PK	60" to 82", Pol Brass, Retail Pkg	105.00

All Brass Stainless Steel Hose with Brass Nuts



Part #	Mfg #	Description	Price
DELU495S60PK	U495S-W-PK	60", Bright SS, Retail Pkg	30.00
DELU495S69PK	U495569-PK	69", Bright SS, Retail Pkg	34.00

UltraFlex® Reinforced Black Vinyl with Brass Nuts

- Black hose with chrome ribbon



Part #	Mfg #	Description	Price
DELU490R70PK	U490R-70-PK	70", Black/Chrome, Retail Pkg	31.00

Swivel Connectors

Metal Pin Mount Swivel Connector

- All metal components
- For use with pin mount (sold separately)



Part #	Mfg #	Description	Price
DELU5002PBPK	U5002-PB-PK	Chrome, Retail Pkg	67.00

Plastic Pin Mount Swivel Connector

- Engineering grade plastics & metal
- Chrome-plated end
- For use with pin mount (sold separately)



Part #	Mfg #	Description	Price
DELU4002PK	U4002-PK	Chrome, Retail Pkg	15.00
DELU4002WHPK	U4002-WH-PK	White, Retail Pkg	13.00

Prices & Specifications are Subject to Change.

Tub & Shower Accessories

Tub & Shower
Accessories

Wall Bars

Deluxe 24" Adjustable Height Wall Bar

- Screws included
- Brilliance™ lifetime anti-tarnish finish

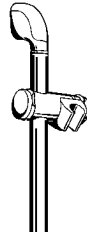

Part #	Mfg #	Description	Price
DEL55041PK	55041-PK	Chrome, Boxed	110.00

Classic 24" Wall Bars with Concealed Mount & Tile Offset

- Concealed single screw mounting & tile offset
- Pin-mount system
- Accommodates swivel connector



Part #	Mfg #	Description	Price
DEL55024	55024	Chrome, Boxed	108.00

24" Glide Rail Wall Bars with Pin-Mount

- Adhesive or concealed screw mounting
- Metal rail & acrylic self-tension slide
- ADA Compliant



Part #	Mfg #	Description	Price
DEL55511PK	55511-PK	Chrome, Retail Pkg	88.00

Wall Pin-Mounts

Clear Pin-Mount & Mounting Screws



Part #	Mfg #	Description	Price
DELU5001PK	U5001-PK	Chrome, Retail Pkg	14.00

Pin Wall Mount

- For use with swivel connector
- Self-adhesive



Part #	Mfg #	Description	Price
DELU5001APK	U5001-A-PK	Chrome, Retail Pkg	12.00

Hose Nut Wall Mounts

With Self-Adhesive or Mounting Screws

- Conical hose nut wall mount
- Engineering grade plastic components
- Stationary positioning for hands free showering



Part #	Mfg #	Description	Price
DELU3001PK	U3001-PK	Chrome, Retail Pkg	18.00

Showerarm Mounts

Showerarm Pin Mount

- All metal components
- Requires a swivel connector (sold separately)



Part #	Mfg #	Description	Price
DELU4301PK	U4301-PK	Chrome, Retail Pkg	21.00

Standard Showerarm Mount

- Fully adjustable at ball connector
- Attaches directly to showerarm
- Accommodates conical hose nuts
- Made of rubber & engineering grade plastics



Part #	Mfg #	Description	Price
DELU3401PK	U3401-PK	Chrome, Retail Pkg	14.00

Water Outlet Components

Supply Elbow for 1/2" Connections

- Alternative to standard shower arm



Part #	Mfg #	Description	Price
DELU4980PK	U4980-PK	Chrome, Retail Pkg	37.00

Vacuum Breaker - Atmospheric Type

- 1/2" connections



Part #	Mfg #	Description	Price
DELU4900PK	U4900-PK	Chrome w/Brass Shield, R Pkg	27.00

All Items May Not Be Stocked In All Branches

Tub & Shower Accessories

Water Diverters

Deluxe Push-Pull 3-Way Diverter

- All brass diverter for shower arm
- Allows use of handshower & showerhead together or each independently



Part #	Mfg #	Description	Price
DELU4923PK	U4923-PK	Chrome, Retail Pkg	48.00
DELU4923PBPk	U4923-PB-PK	Pol Brass, Retail Pkg	68.00
DELU4923SSPK	U4923-SS-PK	Satin Nickel, Boxed	68.00

2-Way Diverter with Lever Control

- All-brass diverter for shower arm
- Allows use of handshower & showerhead independently



Part #	Mfg #	Description	Price
DELU4922PK	U4922-PK	Chrome, Retail Pkg	25.00

Diverter Spouts (Add-A-Shower)

- Handshowers can be added to a bath without a shower by replacing existing spout with one listed below

Extra-Long 6-3/4" Diverter Tub Spout (IPS)

- 1/2" & 3/4" Connections



Part #	Mfg #	Description	Price
DELU1010PK	U1010-PK	Chrome, Retail Pkg	68.00

Diverter Tub Spout (IPS)

- 5-1/4" Spout with 1/2" & 3/4" connections



Part #	Mfg #	Description	Price
DELU1072PK	U1072-PK	Chrome, Retail Pkg	52.00

Bath Installation Aids

Metal Lavatory Drain Assembly

- Metal pop-up drain
- Metal lift-rod



Part #	Mfg #	Description	Price
DELRP5651	RP5651	Chrome	52.55
DELRP5651PB	RP5651PB	Pol Brass*	93.25

Pressure Balance Cartridge Assembly

- Single-function pressure balance temperature control only
- For use with MultiChoice Universal valve body and 13 Series or 14 Series trim

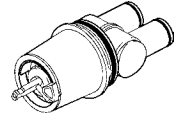

Part #	Mfg #	For	Price
DELRP46074	RP46074	MultiChoice, 13 & 14	59.75

Pressure Balance Cartridge Adapter

- Dual-function volume & pressure balance temperature control
- For use with MultiChoice Universal valve body & 17 Series or 18 Series trim



Part #	Mfg #	For	Price
DELRP46463	RP46463	MultiChoice, 17 & 18	83.05

Shower Renovation Cover Plate

- Covers up 8" center holes



Part #	Mfg #	Description	Price
DELRP29827	RP29827	Chrome	30.55

Handshowers

Wall Elbow for Handshower

- Hand shower wall supply
- 1/2" IPS Female inlet
- 1/2" IPS Male outlet



Part #	Mfg #	Description	Price
DEL50560SS	50560-SS	Stainless*	58.60

Showerheads

H2O Water-Efficient Showerhead

- H2Oknetic Technology™
- 3-1/4" Spray face diameter
- 4-3/4" Showerhead length
- 1.6 gpm



Part #	Mfg #	Description	Price
DELRP46384	RP46384	Chrome	61.80

Prices & Specifications are Subject to Change.

Tub & Shower Accessories

Tub & Shower Accessories

Tub Spouts

RP5834 Diverter Tub Spout

- Pull up to divert
- 5-1/2" Long
- Sweat onto 1/2" CWT - 1/4" to 1" from wall surface
- Thread onto 1/2" IPS nipple - 5/8" to 1-5/8" from wall surface
- Non-metallic
- RP12307 adapter assembly included



Part #	Mfg #	Description	Price
DELRP5834	RP5834	Chrome	30.65

RP17453 Diverter Tub Spout

- Pull down to divert
- 6" Long
- Sweat onto 1/2" CWT - 1/4" to 1" from wall surface
- Thread onto 1/2" IPS nipple - 5/8" to 1-5/8" from wall surface
- Non-metallic
- RP12307 Adapter assembly included



Part #	Mfg #	Description	Price
DELRP17453	RP17453	Chrome	32.45

RP5836 Diverter Tub Spout

- Pull down to divert
- 6" Long
- Slip onto 1/2" CWT - 2" to 4" from wall surface
- Non-metallic
- RP33794 Adapter assembly included

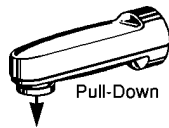

Part #	Mfg #	Description	Price
DELRP5836	RP5836	Chrome	31.35

Bath Waste Parts

Caps

- With adjusting ring



Part #	Mfg #	Description	Price
DELRP50	RP50	Chrome	15.75

Mini-Bulk Parts

Stem Unit & Seat

- For 1600 tub/shower series

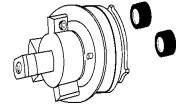

Part #	Mfg #	Description	Price
DELRP1991	RP1991	Stem Unit & Seats	30.15



Portofino Add-A-Showers & Components

Economy Add-A-Shower Enclosure

- Made to fit clawfoot tubs with 3-3/8" wall faucet drillings
- Solid brass diverter faucet coated with chrome plated plastic cover
- 62" Riser pipe 5/8"OD
- Chrome plated plastic shower head
- 24" x 42" Aluminum shower ring
- 12" Wall support and 30" ceiling support
- Plastic fittings
- 6-7 Gallon per minute flow rate
- 80 PSI or greater water pressure required

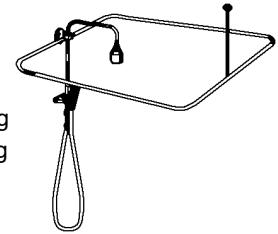

Part #	Mfg #	Description	Price
SPRR2200	R-2200	Encloser & Hardware	180.00

Bathcock

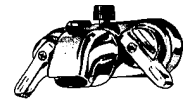

Part #	Mfg #	Description	Price
SPRR3100	R3100	With 3/8" Swivel Adapter (For CP Risers)	77.00

* Brilliance® Anti-Tarnish Lifetime Finishes

All Items May Not Be Stocked In All Branches

Faucet Parts & Accessories

Service Sink Valves

Cross Handle Self-Closing Valve

- Heavy brass construction
- 1/2" FIP Connection



Part #	Mfg #	Description	Price
PLSELFCLOSEVLV	S05-105	Chrome-Plated	47.01

THE BOLD LOOK
OF **KOHLER**

Tub & Shower Accessories

Flipside™ Tub & Shower Accessories

- Flipstream Technology™
- Four unique, experiential spray patterns:
 - Koverage™, Kotton™, Komotion™, Kurrent™
- Adjustable angle for various user heights
- 2.5 gpm
- 4-Function handshower: full, soft, drenching & massage



Part #	Mfg #	Finish	Price
KOHK17493CP	K-17493-CP	Pol Chrome	107.00

Forté® Tub & Shower Accessories

- Single function showerhead
- Master Clean™ spray face
- Single-Function Katalyst showerhead
- 1/2" NPT Connection



K-10282

Part #	Mfg #	Finish	Price
KOHK10282AKCP	K-10282-AK-CP	Pol Chrome	64.55



Handshowers

Monticello, Villeta, Castleby 4-Function Handshower

- Fits M-Pact system
- (4) Spray patterns - massage, full, vigorous, combination
- With wall bracket, 69" flexible hose assembly, vacuum breaker and wall bracket with attaching hardware
- With slide bar model includes 69" flexible hose assembly, vacuum breaker and 30" slide bar with attaching hardware



Part #	Mfg #	Description	Price
MOE3836	3836	Chrome	231.75

4-Function Massaging Handshower

- With slide bar & bracket
- 69" Double interlock metal spiral hose
- Vacuum breaker
- 30" Slide bar w/push-button height selection
- 2.5 gpm @ 60 psi
- Wall bracket (rotates)
- Drop ell required for installation, sold separately



Part #	Mfg #	Description	Price
MOE3867	3867	Chrome	234.85
MOE3867BN	3867BN	Brushed Nickel	478.15
MOE3867ORB	3867ORB	Oil Rubbed Bronze	526.00

Showerheads

Easy Clean Showerhead with Arm & Flange



Part #	Mfg #	Description	Price
MOE6304	6304	Chrome	32.05

Tub & Shower
Accessories

Tub & Shower Accessories

Tub & Shower Accessories

Moenflo XL Single-Function Showerhead

- 1/2" IPS Connection
- 1 Spray pattern



Part #	Mfg #	Description	Price
MOE6302	6302	Chrome	71.10

Shower Accessories

Drop Ell

- 1/2" IPS



Part #	Mfg #	Description	Price
MOEA725	A725	Chrome	43.05
MOEA725BN	A725BN	Brushed Nickel	60.90

Remodel Cover Plate for Tub & Shower



Part #	Mfg #	Description	Price
MOE1920	1920	Chrome	78.25

Shower Arm



Part #	Mfg #	Description	Price
MOE10154	10154	6" Shower Arm, Chrome	16.40

Shower Arm Diverter

- 1/2" IPS



Part #	Mfg #	Description	Price
MOEA720	A720	Chrome	58.45

Tub Spouts

Chateau Diverter Spout with Soap Tray

- 5-1/2" Length



Part #	Mfg #	Description	Conn	Price
MOE3960	3960	Chrome	1/2" Slip	43.80

Concentric Diverter Spout

- 5-1/2" Length



Part #	Mfg #	Description	Conn	Price
MOE3926	3926	Chrome	1/2" IPS	41.40
MOE3931	3931	Chrome	1/2" Slip	41.40

Zinc Diverter Spouts

- 5-1/2" Length



Part #	Mfg #	Description	Conn	Price
MOE3801	3801	Chrome	1/2" Slip	49.50
MOE3803P	3803P	Pol Brass	1/2" Slip	126.20

Handle Assemblies

Clear Acrylic Knob 1-Hdl Kit



Part #	Mfg #	Description	Price
MOE94514	94514	Posi-Temp T&S, Less Insert	9.10
MOE96797	96797	Chateau T&S (Tear Drop), White/Chrome Inserts	23.10
MOE13094	13094	Legend, Moentrol & Boutique T&S, White/Chrome Inserts	20.75

Moentrol Accent Kits

Moentrol Shower



Part #	Mfg #	Description	Price
MOEAT2199	AT2199	Chrome	6.65

All Items May Not Be Stocked In All Branches

Tub & Shower Accessories

Handle Extension Kits

Posi-Temp Handle Extension Kit to Correct Deep Rough-In

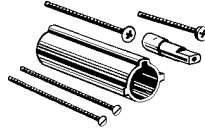

Part #	Mfg #	Description	Price
MOE96945	96945	1" Chrome	38.85

Handle Adapters



100429



97556

Part #	Mfg #	Description	Price
MOE100429	100429	Handle Adapter Kit	5.05
MOE97556	97556	Handle Adapter Kit, Monticello Centerset, Mini Widespread, Roman Tub, Hot	18.10



Padded Shower Seats

- Wall supported
- Fold down



Part #	Mfg #	Size	Description	Price
BARSEATLH26	61-PA2601	26" x 21"	LH Wht	425.00
BARSEATRH26	60-PA2601	26" x 21"	RH Wht	425.00

Grab Bars



SS Straight 1-1/2" Concealed Twist-Lock Flange Safety Bar

Part #	Mfg #	Size	Description	Price
BAR12	01-5212ST	12"	Smooth	32.36

Grab Bars (Continued)

SS Straight 1-1/2" Concealed Twist-Lock Flange Safety Bar

Part #	Mfg #	Size	Description	Price
BAR16	01-5216ST	12"	Smooth	32.68
BAR18	01-5218ST	18"	Smooth	33.74
BAR24	01-5224ST	24"	Smooth	36.95
BAR30	01-5230ST	30"	Smooth	40.12
BAR32	01-5232ST	32"	Smooth	41.18
BAR36	01-5236ST	36"	Smooth	43.33
BAR42	01-5242ST	42"	Smooth	46.50
BAR48	01-5248ST	48"	Smooth	49.71

Tub & Shower Accessories

Service Starts Here with Irr Supply!

Prices & Specifications are Subject to Change.

Bath Accessories

Kelston® Bath Accessories

Kelston® Double Towel Bar

- 4-5/16"H x 6-11/16"W x 26-7/16"L



Part #	Mfg #	Description	Price
KOHK13503CP	K13503CP	24", Pol Chrome	82.55

Kelston® Towel Ring



Part #	Mfg #	Finish	Price
KOHK13507CP	K-13507-CP	Pol Chrome	30.45

Kelston® Toilet Tissue Holder



Part #	Mfg #	Finish	Price
KOHK13504CP	K-13504-CP	Pol Chrome	45.15
KOHK13504BN	K-13504-BN	Vibrant Brushed Nickel	61.00

Margaux™ Bath Accessories

Margaux™ Single Sconce

- Premium metal construction
- Lights are UL listed up to 60W
- T-10 Bulb required (sold separately)



Part #	Mfg #	Finish	Price
KOHK16268BV	K-16268-BV	Vibrant Brushed Bronze	303.80



Bath Accessories

Adjustable Length Curved Shower Rod

- Adjusts to fit shower enclosures between 54" and 72"
- Pivoting flanges
- Stainless steel rod and covers
- Works with standard shower curtain



Part #	Mfg #	Description	Price
CSICSR2160BN	CSR2160BN	Brushed Nickel	58.80
CSICSR2160CH	CSR2160CH	Chrome	53.45

Kingsley® Bath Accessories

Kingsley® Towel Ring



Part #	Mfg #	Description	Price
CSIYB5486CH	YB5486CH	Chrome	38.80

Kingsley® Towel Bar



Part #	Mfg #	Description	Price
CSIYB5418ORB	YB5418ORB	18", Oil Rubbed Bronze	65.45

Preston Bath Accessories

Preston Towel Bar



Part #	Mfg #	Description	Price
CSIDN8424CH	DN8424CH	24" Chrome	21.55

All Items May Not Be Stocked In All Branches

Bath Accessories

Preston Paper Holder



Part #	Mfg #	Description	Price
CSIDN8408CH	DN8408CH	Chrome	15.40

Sage® Bath Accessories

Sage® Towel Ring



Part #	Mfg #	Finish	Price
CSIDN6886CH	DN6886CH	Chrome	21.10

Sage® Robe Hook



Part #	Mfg #	Description	Price
CSIDN6803CH	DN6803CH	Chrome	13.35

Home Care® by Moen Accessories

SecureMount™ Anchor



Part #	Mfg #	Description	Price
CSISMA1000CH	SMA1000CH	Pair of Anchors w/Chrome Mounting Plates	37.50

Vanity Tops

Cultured Marble Vanity Tops - 4"cc Plain Oval

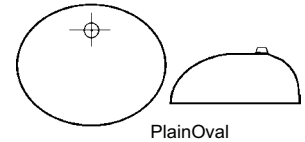

Part #	Mfg #	Size	Finish	Price
REM1917MO4 WH/WH	1917MO4WH /WH	19" x 17"	White/White	75.14

Cultured Marble Vanity Tops - 4"cc Recessed Oval

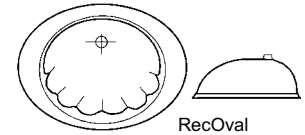

Part #	Mfg #	Size	Finish	Price
REM2519MRO 4WH/WH	2519MRO4W H/WH	25" x 19"	White/White	111.38
REM2522MRO 4WH/WH	2522MRO4W H/WH	25" x 22"	White/White	117.57
REM3119MRO 4WH/WH	3119MRO4W H/WH	31" x 19"	White/White	126.41
REM3122MRO 4WH/WH	3122MRO4W H/WH	31" x 22"	White/White	132.60
REM3722MRO 4WH/WH	3722MRO4W H/WH	37" x 22"	White/White	150.28
REM4322MRO 4WH/WH	4322MRO4W H/WH	43" x 22"	White/White	170.71
REM4922MRO 4WH/WH	4922MRO4W H/WH	49" x 22"	White/White	194.48

Faucet Parts & Accessories

Faucet Parts

Faucet Cartridges

Duralast™ Cartridge



Part #	Mfg #	Description	Price
MOE1255	1255	Duralast™ Cartridge	25.35

Posi-Temp 1-Hdl Faucet

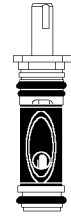

Part #	Mfg #	Description	Price
MOE1222	1222	Carded	67.25

Cartridge Tool



Part #	Mfg #	Description	Price
MOE104421	104421	Cartridge Puller, Comp 1200/1225/1222	48.25
MOE14272	14272	Cartridge Retainer Removal Tool, Roman Tub & Monticello Lav	5.00

Brass 1-Hdl Faucet



Part #	Mfg #	Description	Price
MOE1200B	1200B	Bulk	39.00

1-Hdl Faucet



Part #	Mfg #	Description	Price
MOE1225B	1225B	Bulk	25.35

2-Hdl Faucet

- Hot or cold



Part #	Mfg #	Description	Price
MOE1224B	1224B	Bulk	13.20

2-Hdl Roman Tub Faucet

- High-Flow for 4999 valve



Part #	Mfg #	Description	Price
MOE1248	1248	Carded	13.20

Spout O-Ring Kit



Part #	Mfg #	Description	Price
MOE117	117	Bulk	4.80

PureTouch® Replacement Filters & Parts

MicroTech Filters

- For PureTouch Professional and Euro faucets
- Reduces poor taste and odor, 93.3% of chlorine and 97.7% of lead



Part #	Mfg #	Description	Price
MOE5001	5001	1Pk for PureTouch Professional & Euro Faucets, Reduces 99.95% of Cysts	36.15
MOE9001	9001	1Pk for AquaSuite Faucets, Reduces 99.99% of Cysts	77.50

All Items May Not Be Stocked In All Branches

Faucet Parts

Aerators

Male Thread Aerator

- Carded
- 2.2 gpm



Part #	Mfg #	Description	Price
MOE3919	3919	Chrome	11.55

Female Thread Aerator

- 2.2 gpm



Part #	Mfg #	Description	Price
MOE3924	3924	Chrome	11.55

Waste Assemblies

Tub Drain with Brass Tubing

- With trip lever assembly
- 1-1/4" Threaded drain shoe
- 20g Brass tubing with brass nuts
- For 14" and 16" tubs
- Cast brass tee



Part #	Mfg #	Description	Price
MOE90410ORB	90410ORB	Oil Rubbed Bronze	158.15

Kitchen Faucet Accessories

Deck Extension Kit

Part #	Mfg #	Description	Price
MOE137114	137114	Kitchen Deck Extension Kit for 1-H Faucets	61.45

Soap/Lotion Dispenser

- Top lifts off for easy refill
- 16 oz Refillable bottle
- Mounts in 1-1/8" diameter hole



2-3/4" Reach

Part #	Mfg #	Description	Price
MOE3942CSL	3942CSL	Classic Stainless	98.30

Parts & Accessories

Hose & Spray Accessory

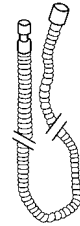

Part #	Mfg #	Description	Price
MOE114299	114299	Chrome Hose Kit for 7592 Series	26.90

Service Parts & Accessories



Part #	Mfg #	Description	Price
MOE104234	104234	Protege Hose & Spray, Female Conn, Chrome	40.25
MOE1198	1198	Diverter, Push Button, Legend & Moentrol Shower, Standard	38.50
MOE136103C	136103C	Protege Hose & Spray, Female Conn w/Black Spray, Chrome	30.50
MOE1394	1394	Diverter Extension, 1", Push Button, 2400 & 3250 Series, T&S	38.25
MOE1423	1423	Balancing Spool, Moentrol T&S	81.60
MOE143530	143530	Side Spray Plug	7.15
MOE14699	14699	Retainer Pivot Nut, Lever Handle, 1-H Kit	5.90
MOE16352	16352	Metering Cartridge	88.40
MOE1883	1883	Retainer Clip, Kitchen Lever Handle, 6/Bag	2.16
MOE883	883	Retainer Clip, Legend, Chateau, Boutique, Moentrol Lav & T&S, Knob Handle	3.05
MOE91192	91192	Diverter Service Kit, Model 7310, 7600 & 7800 Series, Kit Deck	22.80
MOE93980	93980	Handle Mechanism Kit f/7100/7600 Kitchen Faucet	23.45
MOE9601	9601	ChoiceFlo 9600 Replacement Filter, for F7400 & 77200 Faucet Series	43.85

Faucet Parts & Accessories

Faucet Parts

Faucet Handles

Faucet Handle - Lavatory



K-16012-3

Part #	Mfg #	Description	Price
KOHK160125CP	K-16012-5-CP	(2) Triton® Wristblade Handles for WS, CP	138.80

H-24 Small Lever Handle Bases

- Innovations® style includes screws
- For kitchen, bar, lavatory, 2- or 3-H tub/shower/bidet
- Sold in pairs



Part #	Mfg #	Description	Price
DELH24	H24	Chrome	36.25

BRIZO

Brizo® Finials

Crystal Finials

Part #	Mfg #	Description	Price
DELRP48142PC	RP48142PC	Accessories (Pair), Chrome	106.00



H-25 Small Lever Handles

- Neo Style® includes screws & finials
- For kitchen, bar, lavatory 2- or 3-H tub/shower/bidet
- Sold in pairs



Part #	Mfg #	Description	Price
DELH25	H25	Chrome	55.35

H-269 Orleans™ Small Lever Lavatory/Bidet

- Includes screws & finial
- Sold in pairs



Part #	Mfg #	Description	Price
DELH269SS	H269SS	Stainless*	58.85

Handle Accents

A-24 Small Lever Handle Inserts

- Innovations® style includes finial
- For 3-H tub/shower/bidet



Part #	Mfg #	Description	Price
DELA24	A24	Chrome	19.20

Soap/Lotion Dispensers

- 13 oz Bottle
- Replaced RP1000
- Refillable from above the deck



Part #	Mfg #	Description	Price
DELRP1001	RP1001	Chrome	41.10

Faucet Handles

H-21 Small Clear Knob Handles

- Includes buttons, screws & finial
- For kitchen, bar, lavatory, laundry, 2- or 3-H tub/shower/bidet
- Sold in pairs



Part #	Mfg #	Description	Price
DELH21	H21	F/CP/BS/NC/NN/WC/WH	13.20

H-22 Small Lever Handle Bases

- Includes screws
- For kitchen, bar, lavatory, 2- or 3-H tub/shower/bidet
- Sold in pairs

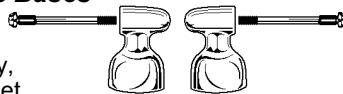

Part #	Mfg #	Description	Price
DELH22	H22	Chrome	34.90

Delta® Repair Kits/Parts

Ball Assemblies

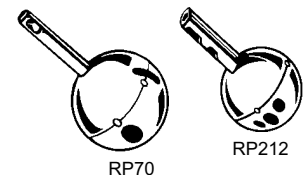

Part #	Mfg #	Description	Price
DELRP70	RP70	For 1-H Lever	13.45
DELRP212	RP212	For 1-H Knob	12.40

All Items May Not Be Stocked In All Branches

Faucet Parts

O-Rings



RP25

Part #	Mfg #	Description	Price
DELRP2055	RP2055	For 2-H Kitchen Spout	5.90

Mini-Bulk Parts

Stainless Steel Ball - Lever

- For single lever handle faucets except 1300, 1400, 1500, 1600, 1700 & 1800 T/S series and pull-out spray models

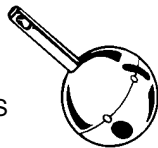

Part #	Mfg #	Description	Price
DELRP70MBS	RP70MBS	60 Each	34.50

Stem Unit with Stainless Steel Plate

- For 2-hdl and basin faucets



Part #	Mfg #	Description	Price
DELRP1740	RP1740	Stem Unit Assy	10.80
DELRP1740MBS	RP1740MBS	60 Each	31.20

Delta® Repair Parts



Part #	Mfg #	Description	Price
DELRP3614	RP3614	Internal Parts Kit	10.60
DELRP4993	RP4993	Deluxe Seats & Springs (2)	4.60
DELRP5649	RP5649	Diverter Assy, Chrome	24.35
DELRP8230	RP8230	Ceramic Stem, Seat, O-Ring, Spring	25.10
DELRP12491	RP12491	(2) HDF Wrist Blade Handles w/Set Screw	61.45
DELRP17451	RP17451	Clear Handle w/Button & Screw, Chrome for Tub & Shower	13.90
DELRP18627	RP18627	Extender w/o Screws	4.05
DELRP19804	RP19804	Cartridge Assembly	62.75
DELRP25513	RP25513	Stem Unit w/Brass Stem	21.15
DELRP32104	RP32104	1700 Cartridge	83.05
DELRP44647	RP44647	Pull-Out Hose Assembly	85.75
DEL060160A	060160A	Metering Cartridge K It	39.40

Commercial Electronic Accessories Mechanical Mixer

Part #	Mfg #	Description	Price
DELR2900MIX	R2900MIX	2 gpm w/Thermostatic Limit Stop	83.75



Spouts

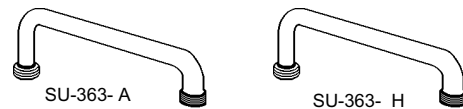

Part #	Mfg #	Description	Price
CEBSU363JA	SU-363-JA	10" Tube Spout w/Aerator	34.14
CEBSU363JH	SU-363-JH	10" Tube Spout w/Hose End	35.63
CEBSU363LA	SU-363-LA	12" Tube Spout w/Aerator	37.20
CEBSU363LH	SU-363-LH	12" Tube Spout w/Hose End	38.69
CEBSU363MA	SU-363-MA	14" Tube Spout w/Aerator	38.76
CEBSU363MH	SU-363-MH	14" Tube Spout w/Hose End	40.25

Handles

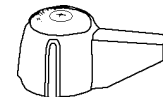

Part #	Mfg #	Description	Price
CEB523C	G-523-C	Cold Hdl	5.25
CEB523H	G-523-H	Hot Hdl	5.25

Replacement Part Kits

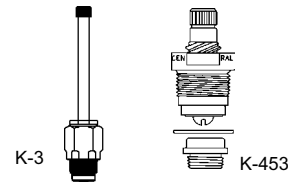

Part #	Mfg #	Description	Price
CEBK3CT	K-3-CT	Complete Corner Stem Assy	19.53
CEBK352C	K-352-C	Ceramic Cold Stem Assembly	28.37
CEBK352H	K-352-H	Ceramic Hot Stem Assembly	28.37
CEBK453C	K-453-C	O-Ring Stem Repair Kit with Stem Assy & Seat, Cold Side LH Thread	10.08
CEBK453H	K-453-H	O-Ring Stem Repair Kit with Stem Assy & Seat, Hot Side RH Thread	10.08

* Brilliance® Anti-Tarnish Lifetime Finishes

Prices & Specifications are Subject to Change.

Faucet Parts & Accessories

Faucet Parts

Faucet Repair Parts

Tub & Shower

Part #	Mfg #	For Faucet:	Price
BRPSK0054	SK0054	Central Brass Rebuild Kit	119.97
BRPSK0156	SK0156	Gerber Long/Shallow Broach, 1-Pc Escutcheon	129.23
BRPSK0157	SK0157	Gerber Short/Deep Broach, 1-Pc Escutcheon	112.46
BRPSK0273	SK0273	Price Pfister Verve Current, Chrome	98.38
BRPSK0305	SK0305	Sayco Space Age, Chrome	100.79

Faucet Stem



Part #	Mfg #	For Faucet:	Price
BRPST0037	ST0037	Sayco Hot Lav Stem	8.85
BRPST0038	ST0038	Sayco Cold Lav Stem	8.85
BRPST0041	ST0041	Gerber Hot Lav/Sink Stem	8.44
BRPST0042	ST0042	Gerber Cold Lav/Sink Stem	8.44
BRPST0332	ST0332	Am Std Hot/Cold Lav/Sink Stem	13.57
BRPST0565	ST0565	Am Std Hot Stem	17.34
BRPST0566	ST0566	Am Std Aquaseal Cold Lav/Sink/Tub Stem	17.34
BRPST1461	ST1461	Crane Diazeze Hot Lav Stem	12.99
BRPST1462	ST1462	Crane Diazeze Cold Lav Stem	12.99
BRPST2682	ST2682	Sayco Hot Tub & Shower Stem	13.05
BRPST2683	ST2683	Sayco Cold Tub & Shower Stem	13.05
BRPST2684	ST2684	Sayco Diverter Stem	15.99
BRPST3969	ST3969	Gerber Hot/Cold T&S Stem	18.25

Faucet Handle

Part #	Mfg #	For Faucet:	OEM #	Price
BRPSH2851	SH2851	Sayco		24.44
BRPSH4576	SH4576	Gerber		15.41
BRPSH4577	SH4577	Gerber	98-823	15.41
BRPSH5155	SH5155	Sayco		17.79

Faucet Bibb Seat

Part #	Mfg #	Description	Price
BRPSC0832	SC0832	5/8" x 24 Thd, for Central Brass 2/Pk	4.81
BRPSC0833	SC0833	1/2" x 24 Thd, for Central Brass 2/Pk	8.89
BRPSC1096	SC1096	5/8" x 20 Thd, for Gerber 2/Pk	3.43
BRPSC1515	SC1515	1/2" x 20 Thd, Brass for Sayco 2/Pk	3.92
BRPSC1516	SC1516	1/2" x 20 Thd, Brass for Sayco 2/Pk	3.92

Faucet Washer



Part #	Mfg #	Description	Price
BRPSF0152	SF0152	AquaSeal Washer (2/Pk)	2.54



Repair Parts

Scot® Slow-Closing Omni Temperature Lavatory Faucet 1984 To March 2000

Part #	Mfg #	Description	Price
SYMLL1A	LL1A	Control Cartridge	109.65

Cartridge

Part #	Mfg #	Description	Price
SYMKN4	KN-4	Symmetrix Cartridge	39.30

All Items May Not Be Stocked In All Branches

Faucet Parts & Accessories

Faucet Parts

Replacement Parts

Part #	Mfg #	Description	Finish	Price
CHF892-202K	892-202KJKNF	Vacuum Breaker Renewing Kit Bagged Individually, Pkg of 12	NF	17.61

Faucet Stems & Cartridges



Part #	Mfg #	Description	Finish	Price
CHF1099XT	1-099XTJKNF	New Style RH Quatum Short Stem Unit for Exposed Valve (Box of 12 Only)	NF	20.97
CHF1100XT	1-100XTJKNF	New Style LH Quatum Short Stem Unit for Exposed Valve (Box of 12 Only)	NF	20.97
CHF377XTRH	377-XTRHJKNF	RH Quatum™ Long Stem Cartridge for Concealed Valve		24.70
CHF377XTLH	377-XTLHJKNF	LH Quatum™ Long Stem Cartridge for Concealed Valve (Box of 12 Only)		24.70



Gerber Replacement Parts

Cartridge Assemblies

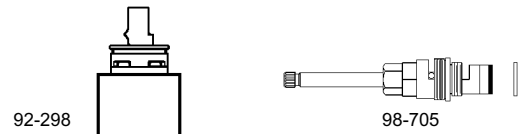

Part #	Mfg #	Description	Finish	Price
GER92298	92-298	Hardwater® Ceramic Cartridge with Limit Stop	Chrome	35.69
GER95154	95-154	Replacement Cartridge for GS103/GS105	-	20.86
GER97022	97-022	Safetemp™ Control Cartridge	Chrome	14.82
GER98027	98-027	Clamshell - Hardwater® Ceramic Cartridge (6)	Chrome	38.53
GER98705	98-705	Long Ceramic Cartridge (2 & 3 Valves), Hot	Chrome	24.34
GER98709	98-709	Long Ceramic Cartridge (2 & 3 Valves), Cold	Chrome	24.34

Faceplates

Part #	Mfg #	Description	Finish	Price
GER97171KT	97-171	Faceplate Assembly	Chrome	18.94

Handles

Part #	Mfg #	Description	Finish	Price
GER86986	86-986	New Ceramaflo™ Disc Cartridge, Handle, Cold	Chrome	18.81
GER86987	86-987	New Ceramaflo™ Disc Cartridge, Handle, Hot	Chrome	18.81

Parts

Part #	Mfg #	Description	Finish	Price
GER97014	97-014	Complete Safetemp Assembly, Less Control Cartridge	Chrome	80.35
GER99171KT	99171KT	Tank Lever & Actuator Rod Kit		14.80
GER99524	99-524	Time-Rated Flapper with Baffle	-	4.50

Prices & Specifications are Subject to Change.

Flushometers

Manual Flushometers

Royal® Diaphragm Type Exposed Parts Flushometers

- Dual filtered by-pass
- Diaphragm, handle packing, stop seat & vacuum breaker molded from PERMEX™ rubber compound for chloramine resistance
- ADA Compliant metal oscillating non-hold-open handle with triple seal handle packing
- Free spinning vandal resistant stop cap
- Adjustable tailpiece
- High back pressure vacuum breaker flush connection with 1-piece bottom hex coupling nut
- Sweat solder adapter with cover tube and case set screw wall flange
- Valve body, cover, tailpiece & control stop manufactured per ASTM alloy class for semi-red brass
- Valve in compliance with applicable sections of ASSE 1037, ANSI/ASME 112.19.6 & military specification V-29193

Royal® Models 110/111 Exposed Water Closet Flushometers

- Exposed water closet flushometer, for floor mounted or wall hung top spud bowls
- 1" IPS Screwdriver Bak-Chek™ angle stop
- Spud coupling & flange for 1-1/2" top spud



Part #	Mfg #	Model	Description	GPF	Spud	Price
SLO110	3010100	110	Water Saver	3.5	1-1/2"	175.50
SLO111	3010000	111-1.6	Low Consumption	1.6	1-1/2"	167.10

Royal® Model 186 Exposed Urinal Flushometers

- Exposed urinal flushometer, for 3/4" top spud urinals
- 3/4" IPS Screwdriver Bak-Chek™ angle stop
- Spud coupling & flange for 3/4" top spud



Part #	Mfg #	Model	Description	GPF	Spud	Price
SLO186	3012600	186	Water Saver	1.5	3/4"	167.10
SLO186-1	3012636	186-1	Low Consumption	1.0	3/4"	167.10

Faucet Parts & Accessories

Flushometers

Royal Flushometer Parts

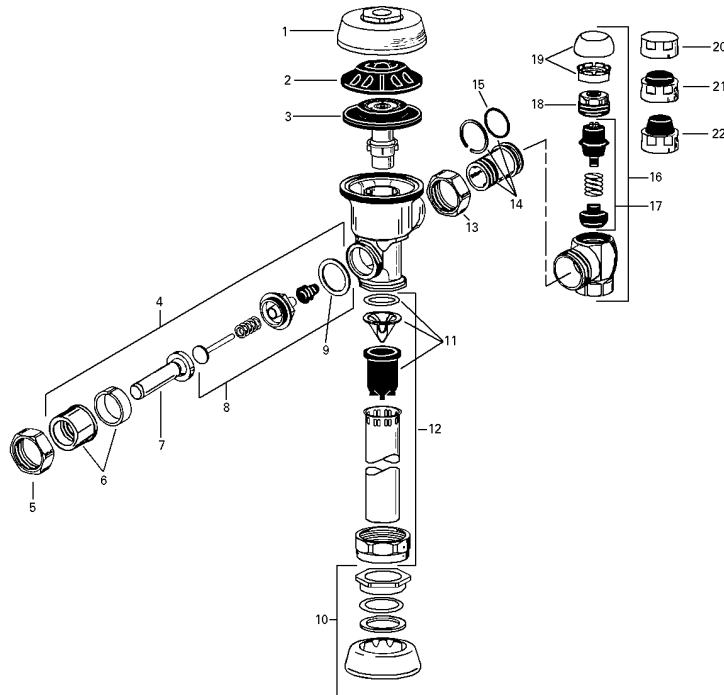

Faucet Parts & Accessories

Part #	Mfg #	Model	Ref	Description	Price
SLOA71	0301168	A-71	2	Inside Cover	7.60
SLOA1101A	3301070	A-1101-A	3-5	Rebuild Kit 1.6 gpf - Closet Exposed	50.70
SLOA1102A	3301071	A-1102-A	3-6	Rebuild Kit 3.5 gpf - Closet Exposed	50.70
SLOA1107A	3301074	A-1107-A	3-9	Rebuild Kit 1.0 gpf - Urinal Exposed	50.70
SLOA1108A	3301075	A-1108-A	3-10	Rebuild Kit 1.5 gpf - Urinal Exposed	50.70
SLOB73A	0302390	B-73-A	4-1	Handle Assembly	18.85
SLOB32A	5302279	B-32-A	4-2	Handle Assembly	14.20
SLOA156A	5301188	A-156-A	5	Diaphragm	5.95
SLOB51A	3302306	B-51-A	8	Handle Repair Kit	7.30
SLOF5A34-212	0306125	F-5-A	10-1	3/4" Spud Coupling, CP	14.85
SLOF5A	0306146	F-5-A	10-3	1-1/2" Spud Coupling, CP	14.85
SLOV651A	3323182	V-651-A	11	Vacuum Breaker Repair Kit	3.50
SLOV600AA34-9	3393004	V-600-AA	12-1	3/4" x 9" Vacuum Breaker, CP	24.10
SLOV600AA112-9	3393007	V-600-AA	12-3	1-1/2" x 9" Vacuum Breaker, CP	24.10
SLOH553	5308696	H-553	15	O-Ring	0.95
SLOH541AA	3308853	H-541-ASD	17-1	1" Screwdriver Stop Repair Kit	11.00
SLOH543AA	3308856	H-543-ASD	17-2	3/4" Screwdriver Stop Repair Kit	11.00

Prices & Specifications are Subject to Change.

Flushometers

Regal® Diaphragm Type Exposed Flushometers

- ADA Compliant metal oscillating non-hold-open handle
- Vandal resistant stop cap
- Adjustable tailpiece
- Vacuum breaker flush connection
- Low consumption flush accuracy controlled by Para-Flo™ inside parts kit
- Handle packing, stop seat & vacuum breaker molded from PERMEX™ rubber compound for chloramine resistance
- Valve body, cover, tailpiece & control stop manufactured per ASTM alloy class for semi-red brass
- Valve in compliance with applicable sections of ASSE 1037, ANSI/ASME 112.19.6 & military specification V-29193

Regal® 110/111 Exposed Water Closet Flushometer

- Exposed water closet flushometer, for floor mounted or wall hung top spud bowls
- 1" IPS Screwdriver Bak-Chek™ angle stop
- Spud coupling, wall & spud flanges for 1-1/2" top spud



Part #	Mfg #	Model	Description	GPF	Spud	Price
SLO111XL	3080053	111-XL	Low Consumption*	1.6	1-1/2"	149.90

* XL variation includes ADA compliant handle, vandal resistant stop cap with set screw & sweat-solder adapter with cover tube & cast set screw wall flange

Regal® 180/181 Exposed Urinal Flushometers

- Exposed urinal flushometers for 1-1/4" top spud
- 1" IPS Screwdriver Bak-Chek™ angle stop
- Spud coupling & flange for 1-1/4" top spud



Part #	Mfg #	Model	Description	GPF	Spud	Price
SLO1801XL	3082475	180-1-XL	Low Consumption *	1.0	1-1/4"	149.90

* XL variation includes ADA compliant handle, vandal resistant stop cap with set screw & sweat-solder adapter with cover tube & cast set screw wall flange

Regal® 186 Exposed Urinal Flushometers

- Exposed urinal flushometer, for 3/4" top spud urinals
- 3/4" IPS Screwdriver Bak-Chek™ angle stop
- Spud coupling, wall & spud flanges for 3/4" top spud



Part #	Mfg #	Model	Description	GPF	Spud	Price
SLO1861XL	3082675	186-1-XL	Water Saver*	1.5	3/4"	149.90

* XL variation includes ADA compliant handle, vandal resistant stop cap with set screw & sweat-solder adapter with cover tube & cast set screw wall flange

All Items May Not Be Stocked In All Branches

Flushometers

Regal Flushometer Parts

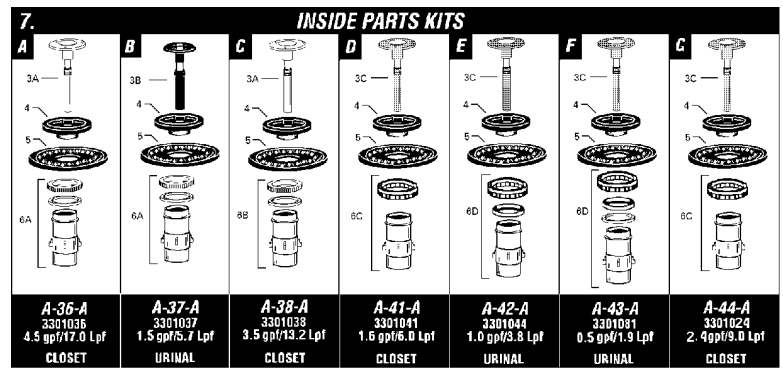
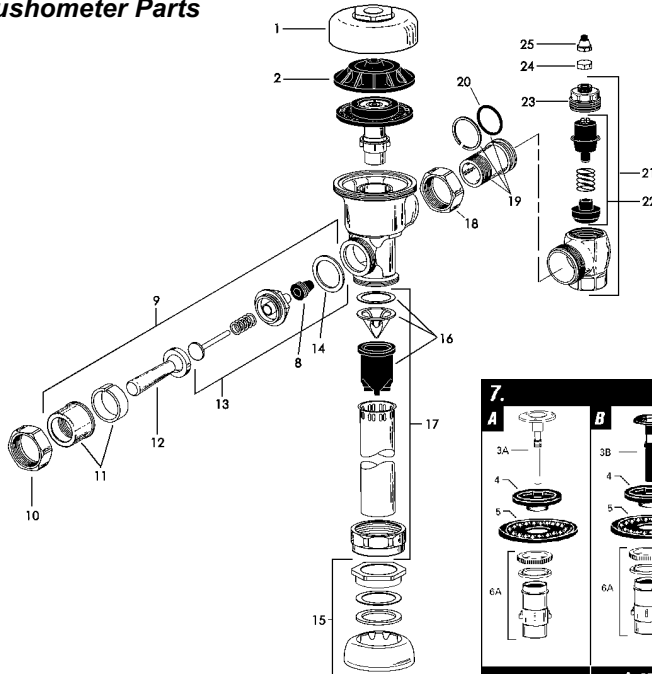

Faucet Parts & Accessories

Part #	Mfg #	Model	Ref	Description	Price
SLOA71	0301168	A-71	2	Inside Cover	7.60
SLOA19AC	5301058	A-19-AC	3A	Relief Valve Closet	5.95
SLOA19AU	5301059	A-19-AU	3B	Relief Valve Urinal	5.95
SLOA15A	5301111	A-15-A	4	Molded Disc	5.05
SLOA156A	5301188	A-156-A	5	Diaphragm	5.95
SLOA163A	5301236	A-163-A	6A	Guide Assembly for 4.5 gpf Closet & 1.5 gpf Urinal	4.85
SLOA36A	3301036	A-36-A	7A	4.5 gpf Closet Repair Kit	22.05
SLOA37A	3301037	A-37-A	7B	1.5 gpf Urinal Repair Kit	22.05
SLOA38A	3301038	A-38-A	7C	3.5 gpf Water Saver Repair Kit	22.05
SLOA41A	3301041	A-41-A	7D	1.6 gpf Closet Repair Kit LC	30.80
SLOA42A	3301044	A-42-A	7E	1.0 gpf Urinal Kit LC	30.80
SLOB73A	0302390	B-73-A	9-1	Handle Assembly (ADA Compliant), CP	18.85
SLOB32A	5302279	B-32-A	9-2	Handle Assembly	14.20
SLOB50A	5302305	B-50-A	13	Handle Repair Kit	3.75
SLOV500AA114-9	5323006	V-500-AA	17-2	1-1/4" x 9" Vacuum Breaker CP	24.10
SLOV500AA112-9	5323007	V-500-AA	17-3	1-1/2" x 9" Vacuum Breaker CP	24.10
SLOH553	5308696	H-553	20	O-Ring	0.95
SLOH541AA	3308853	H-541-ASD	22-1	1" Screwdriver Stop Repair Kit	11.00
SLOH543AA	3308856	H-543-ASD	22-2	3/4" Screwdriver Stop Repair Kit	11.00
SLOR1002A	3317002	R-1002-A	REG	Regal Rebuild Kit, 1.5 gpf Urinal	28.95
SLOR1003A	3317003	R-1003-A	REG	Regal Rebuild Kit, 3.5 gpf Closet	28.95

Prices & Specifications are Subject to Change.

Flushometers

Sensor Operated Flushometers

G2 OptimaPlus® Battery Powered Exposed Water Closet Flushometers

- PERMEX™ synthetic rubber diaphragm with dual filtered fixed bypass
- Flex tube diaphragm designed for improved life and reduced maintenance
- ADA Compliant OptimaPlus® battery powered infrared sensor for automatic “No Hands” operation
- Infrared Sensor with multiple-focused, lobular sensing fields for high and low target detection
- Isolated latching solenoid operator, isolates magnetic components from water contact
- Engineered metal cover with replaceable lens window
- 3-second Flush delay and Courtesy Flush™ override button
- Four (4) Size AA batteries factory installed
- “Low Battery” flashing LED
- Infrared sensor range adjustment screw
- Initial set-up range indicator light (first 10 minutes)
- Free spinning, vandal resistant stop cap and adjustable tailpiece
- High back pressure vacuum breaker flush connection with 2-piece bottom hex coupling nut
- Sweat solder adapter with cover tube and cast set screw wall flange
- High copper, low zinc brass castings for dezincification resistance
- Fixed metering bypass and no external volume adjustment for water conservation
- Flush accuracy controlled by CID™ Technology



G2 OptimaPlus® Models 8110/8111 Exposed Water Closet Flushometer

- Exposed, battery powered, sensor operated water closet flushometer for floor mounted or wall hung top spud bowls
- 1" IPS Screwdriver Bak-Chek™ angle stop
- Spud coupling and flange for 1-1/2" top spud

Faucet Parts & Accessories

Part #	Mfg #	Model	Description	GPF	Spud	Price
SLO8111	3250400	8111	Low Consumption	1.6	1-1/2"	528.70

G2 OptimaPlus® Model 8186 Exposed Urinal Flushometers

- Exposed, battery powered, sensor operated urinal flushometer
- 3/4" IPS Screwdriver Bak-Chek™ angle stop
- Spud coupling and flange for 3/4" top spud
- Supplied less handle opening and metal cap



Part #	Mfg #	Model	Description	GPF	Spud	Price
SLO8186	3250403	8186	Water Saver	1.5	3/4"	528.70
SLO81861	3250401	8186-1	Water Saver	1.0	3/4"	528.70

G2® OptimaPlus RESS Royal Retro Conversion Kit

- Battery powered, sensor operated G2® Model retrofit conversion kit for Sloan Royal®, Regal Pro® and Regal® flushometers
- 3-second Flush delay and Courtesy Flush™ override button
- ADA Compliant
- Installation tools provided
- Chrome plated metal handle cap



Part #	Mfg #	Model	Description	Price
SLORESSG2C	3325400	RESS-G2-C	1.6 Closet Retrofit Kit, with (2) Flush Regulators	404.50
SLORESSG2U	3325402	RESS-G2-U	1.0 Optima Urinal Retrofit Kit, with (2) Flush Regulators	404.50

All Items May Not Be Stocked In All Branches

Flushometers

OptimaPlus® Flushometer Parts

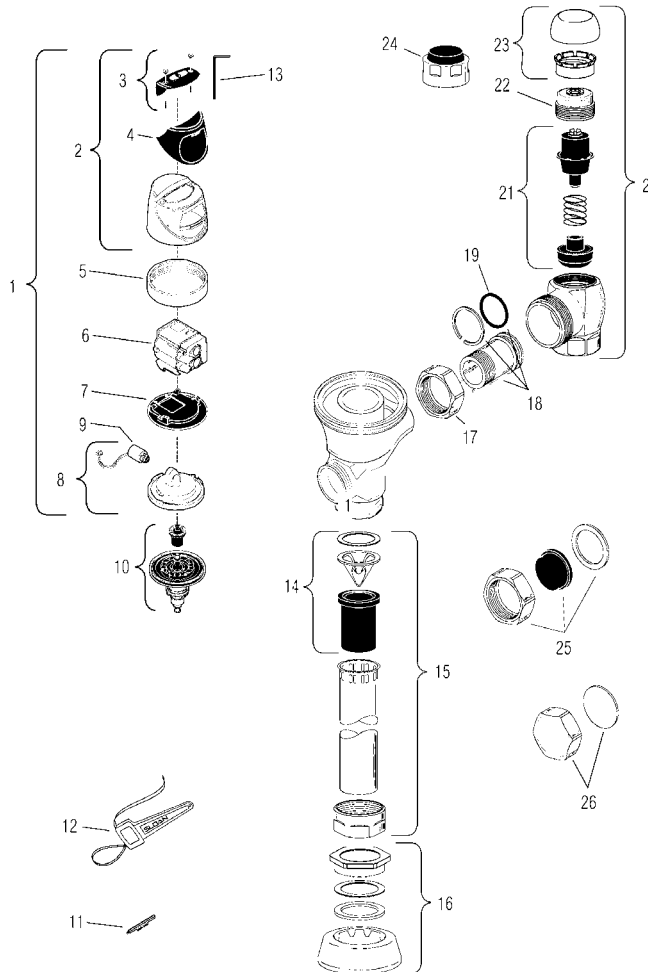

Faucet Parts & Accessories

Part #	Mfg #	Model	Ref	Description	Price
SLOEBV146AC	0325176	EBV-146-A-C	-	G2 Electronic Module Optima 1.6 - Closet	236.90
SLOEBV146AU	0325177	EBV-146-A-U	-	G2 Sensor Module Urinal	236.90
SLOV651A	3323182	V-651-A	14	Vacuum Breaker Repair Kit	3.50
SLOV600AA112-9	3393007	V-600-AA	15	1-1/2" x 9" Vacuum Breaker, CP	24.10
SLOV600AA34-9	3393004	V-600-AA	15	3/4" x 9" Vacuum Breaker, CP	24.10
SLOF5A34-212	0306125	F-5-AW	16	3/4" Spud Coupling, CP	14.85
SLOF5A	0306146	F-5-AT	16	1-1/2" Spud Coupling, CP	14.85
SLOH553	5308696	H-553	19	O-Ring	0.95
SLOH541AA	3308853	H-541-A	21	1" Screwdriver Stop Repair Kit	11.00
SLOH543AA	3308856	H-543-A	21	3/4" Screwdriver Stop Repair Kit	11.00

WES Waterfree Urinal Cartridge Kit

- Cartridge is made from recyclable ABS
- Includes: 100% Biodegradable sealant liquid, cartridge installation/removal tool, protective glove and disposal bag



Part #	Mfg #	Model	Description	Price
SLOWES150	1001500	WES-150	6,000 to 7,000 Use Urinal Cartridge Kit	58.94

Prices & Specifications are Subject to Change.

Flushometers

Replacement Parts & Accessories



H551A

Part #	Mfg #	Model	Description	Price
SLOA50	0301255	A-50	Super Wrench	46.95
SLOH551A3	0308803	H-551-A	3-1/16" Long Adjustable Tailpiece, CP	18.85
SLOH551A4	0308805	H-551-A	4-1/16" Long Adjustable Tailpiece, CP	22.80
SLOH700A34	3308384	H-700-A	3/4" Adjustable Screwdriver Stop w/Vandal Resistant Cap	63.25
SLOH1010A	3308772	H-1010-A	1" Vandal Resistant Stop Cap	10.75
SLOEBV1022A	3325000	EBV-1022-A	OptimaPlus Repair Kit	42.30
SLOEBV1020A	3325001	EBV-1020-A	1.6 Inside Part Kit	42.30
SLOEBV136A	3325453	EBV-136-A	Isolated Solenoid	26.65
SLOA56A	5301170	A-56-A	Segment Diaphragm w/A-29 Copper Gasket	6.35
SLOA156AA	5301189	A-156-AA	Diaphragm Repair	12.40

Vacuum Breaker



Part #	Mfg #	Model	Description	Price
SLOV500AA34-15	0323210	V-500-AA	3/4" x 15", CP	42.00
SLOV500A	5323010	V-500-A	1-1/2" x 11-1/2", RB (140 ES-S & 152 ES-S)	24.10
SLOV500AA112-21	0323015	V-500-AA	1-1/2" x 21-1/2", CP	43.35
SLOV651A	3323182	V-651-A	Vacuum Breaker Repair Kit	3.50

Flushmate Replacement Parts



10050

Part #	Mfg #	Description	Price
SLOFUPPER	BU100505-K	Upper Supply for American Standard 4098.100 Tank	16.66
SLOFLOWER3	BL100504-3-K	Lower Supply for American Standard 4098.100 Tank	55.58
SLOFLOWER	BL100504-K	Lower Supply For 501-A & 501-B	69.50
SLOFCARTRIDGE	C-100500-K	Flush Cartridge For All Flushmate Series	26.65
SLOFTANK-GERBER	M-101526-F31	Complete System for All OEM Except Kohler	210.02
SLOFTANK-KOHLER	M-101526-F	Complete System for Kohler	210.02
SLOFSUPPLY	RK100100	Complete Supply Group Retrofit Kit For All Series Except 503	87.34

All Items May Not Be Stocked In All Branches

Disposals & Hot Water Dispensers

Residential Grade Garbage Disposers

Badger Series Garbage Disposer

- Continuous feed, PVC grind chamber
- Galvanized steel rotating shredder with two stainless steel, 360° slotted swivel impellers
- Permanently lubricated upper & lower bearings
- Quick-Lock™ mounting
- Overload protector manual reset
- Dishwasher drain connection
- Exclusive self-service wrenchette
- We Come To You™ service warranty



Badger 1



Badger 5

Part #	Mfg #	Model	HP	Warranty	Notes	Price
ISE1	72338	Badger 1	1/3	1-Year	-	173.26
ISE5	72339	Badger 5	1/2	2-Year	-	201.28

Evolution Series Residential Grade Garbage Disposer

Evolution Excel™ Continuous Feed Disposer

- MultiGrind Plus™ Three grind stages let you quickly grind virtually any food waste
- SoundSeal Plus™ Makes the Evolution Excel™ at least 60% quieter than standard disposers
- Jam-Sensor Circuit™ automatically increases torque to break through jams
- 40 oz Stainless steel grind chamber and grind component handles more volume than standard disposers
- 1.0 Horsepower Dura-Drive® induction motor gives you the most horsepower of any food waste disposer
- We Come To You™ service warranty



Part #	Mfg #	Model	HP	Grind Stages	Warranty	Price
ISEPROXL	74175	Pro-XL	1	3	7-Year	805.12

Evolution™ Essential Continuous Feed Disposer

- MultiGrind™ Two grind stages let you quickly grind difficult food waste
- SoundSeal™ makes the Evolution Essential™ at least 40% quieter than standard disposers
- 40 oz Stainless steel grind chamber and grind component handles more volume than standard disposers
- 3/4 Horsepower Dura-Drive® induction motor gives you more horsepower than standard disposers
- Quiet-Collar™ sink baffle ensures quiet operation
- We Come To You™ service warranty



Part #	Mfg #	Model	HP	Grind Stages	Warranty	Price
ISEPROES	74174	Pro-ES	3/4	2	6-Year	517.62

Disposers & Hot Water Makers

Prices & Specifications are Subject to Change.

Disposals & Hot Water Dispensers

Evolution Compact™ Continuous Feed Disposer

- Perfect for households with restricted cabinet space
- MultiGrind™ Two grind stages let you quickly grind difficult food waste
- SoundSeal™ makes the Evolution Compact™ at least 40% quieter than standard disposers
- 34.6 oz Stainless steel grind chamber and grind component handles more volume than standard disposers
- 3/4 Horsepower Dura-Drive® induction motor gives you more horsepower than standard disposers
- Quiet Collar™ sink baffle ensures quiet operation
- We Come To You™ service warranty



Part #	Mfg #	Model	HP	Grind Stages	Warranty	Price
ISEPROCOM	74173	Pro-COM	3/4	2	4-Year	446.08

Evolution Cover Control™ Batch Feed Disposer

- MultiGrind™ Two grind stages let you quickly grind difficult food
- SoundSeal Plus™, at least 60% quieter than standard disposers
- Magnetic CoverStart™ Activation runs only when the cover is on
- 40 oz SS Grind chamber and grind component handles more volume than standard disposers
- 3/4 Horsepower Dura-Drive® induction motor
- Removable Sink Baffle
- We Come To You™ service warranty



Part #	Mfg #	Model	HP	Grind Stages	Warranty	Price
ISEPROCC	74172	Pro-CC	3/4	2	7-Year	583.16

Evolution Septic Assist™ Disposer

- MultiGrind™ Two grind stages let you quickly grind difficult food waste you wouldn't put in a standard disposer, like celery and potato peels
- SoundSeal™, at least 40% quieter than standard disposers
- 40 oz SS Grind chamber and grind component handles more volume than standard disposers
- 3/4 Horsepower Dura-Drive® induction motor
- We Come To You™ service warranty



Part #	Mfg #	Model	HP	Grind Stages	Warranty	Price
ISESEPTIC	74032	SEPTIC	3/4	2	4-Year	515.16

Contractor 333™ Food Waste Disposer

- Quiet Dura-Drive® induction motor
- Stainless steel grind elements
- Matching rough-in dimensions - easily replaces all Badger Series models
- Polished stainless steel flange with 1-piece steel stopper
- Quick Lock® sink mount
- 3-Year "We Come to You" in-home service warranty



Part #	Mfg #	Model	HP	Warranty	Price
ISE333	333	Contractor 333	3/4	3-Year	359.58

All Items May Not Be Stocked In All Branches

Disposals & Hot Water Dispensers

Food Waste Disposers for Septic Systems

Bio-Charge™ Replacement Cartridge



Part #	Mfg #	Description	Price
ISEBIOCHARGE	71760	BIO-CG 16 oz Biocharge Refill Cartridge for Septic Disposer	25.38

Hot/Cold Water Dispensers

GN1100 Contemporary ADA Lever Hot Water Dispenser

- Gooseneck spout
- F-201 Filtration System included
- Hot Only - dispenses 60 cups of water filtered near-boiling water per hour
- Adjustable thermostat control
- Durable all brass faucet construction
- 1/2 Gallon tank capacity
- 5-Year We Come To You™ warranty



Part #	Mfg #	Model	Faucet Finish/Color	Price
ISEFGN1100SN	F-GN1100SN	GN-1100SN Less Tank	Satin Nickel	512.30

H770 Twist Top Hot Water Dispenser

- Dispenses 60 cups of near-boiling water per hour
- Adjustable thermostat control
- Patented DuraTank™ hot water tank system
- 2/3 Gallon stainless steel tank
- 3-Year We Come to You™ warranty



Part #	Mfg #	Model	Faucet Finish/Color	Price
ISEH770SS	H770-SS	H770-SS	Chrome/Black	487.70

H990 European Easy-Grip Style Hot Water Dispenser

- Dispenses 60 cups of near-boiling water per hour
- Adjustable thermostat control
- Patented DuraTank® hot water tank system
- 2/3 Gallon stainless steel tank
- 3-Year We Come to You™ warranty



Part #	Mfg #	Model	Faucet Finish/Color	Price
ISEH990WSS	44002A	H990W-SS	White	618.20

Disposers & Hot Water Makers

Prices & Specifications are Subject to Change.

Disposals & Hot Water Dispensers

HOT-1 ADA Lever Hot Water Dispensers

- Dispenses 40 cups of near-boiling 190°F water per hour
- Durable all brass faucet construction
- 1/3 Gallon tank capacity
- 1-Year We Come to You™ warranty



Part #	Mfg #	Model	Faucet Finish/Color	Price
ISEHOT1	41746	HOT-1	Stainless Steel w/Black Handle	335.10

Stainless Steel Tank & Filtration System

- F-201 Filtration System included for fresher tasting water
- 35% More near-boiling water from larger 2/3 gallon stainless steel tank
- Easy to adjust temperature control
- Tool-free tank connections and dry start protection to ease installation
- Provides 60 cups/hour of near-boiling water
- 115V, 750 Watts, 6.25 amps
- NSF® And UL listed
- For use with all In-Sink-Erator instant hot water dispenser models except Hot1
- 1-Year filtration system warranty (excluding replaceable filter cartridge)
- 3-Year We Come To You™ service warranty



Part #	Mfg #	Model	Description	Price
ISESSTFLTR	44017	SST-FLTR	For Instant Hot Water Dispenser	577.94

In-Sink-Erator Parts & Accessories

Switch



Part #	Mfg #	Description	Price
ISESTS00	STS-00	Sinktop Switch Chrome/White Buttons Included	126.04

Disposers & Hot Water Makers

**Walk in or call ahead.
You'll find thousands of products ready for same-day pickup or delivery.**

E Granite/Stainless Steel Sinks

E-Granite Sinks

Harmony® E-Granite Undermount Single Bowl Sink

- Molded from E-Granite which is up to 85% natural quartz and acrylic resins
- Naturally sound deadened, heat resistant
- Color is solid throughout and is UV resistant
- 3/8" Rim height
- Available colors: Black, White, Mocha, Bisque



ELKELGUS3322BK

Part #	Mfg #	Overall Size	Bowl Sizes	Depth	Drain Opening	Min Sink Base	Color	Price
ELKELGUS3322RBQ0	ELGUS3322RBQ0	33" x 20"	30-5/16" x 17-7/8"	9-1/2"	3-1/2"	36"	Bisque	714.00

Dayton® Stainless Steel Sinks

- High quality
- Seamlessly drawn of heavy-gauge, nickel-plated stainless steel
- Raised faucet deck
- All exposed surfaces polished to satin finish with high-shine bowl radius
- Underside is fully sound deadened



D-11719-3

Dayton® Self-Rimming Hospitality Single Bowl SS Sinks

Part #	Mfg #	Overall Size	Depth	Holes	Price
ELKD117192	D-11719-2	17" x 19"	6-1/8"	2	131.00
ELKD117193	D-11719-3	17" x 19"	6-1/8"	3	131.00

Dayton® Undermount Double Bowl SS Sinks

- Fully undercoated to dampen sound and prevent condensation
- 3-1/2" Drain opening
- 36" Minimum cabinet size



DXUH3118



DXUH312010L



DXUH312010R

Part #	Mfg #	Overall Size	Left Bowl	Right Bowl	Depth	Material	Price
ELKDXUH3118	DXUH3118	31-3/4" x 18-1/4"	14" x 15-3/4"	14" x 15-3/4"	8"	18 ga SS	332.00
ELKDXUH312010L	DXUH312010L	31-3/4" x 20-1/2"	14" x 15-3/4"	13-1/2" x 18"	8"/10"	18 ga SS	359.00
ELKDXUH312010R	DXUH312010R	31-3/4" x 20-1/2"	13-1/2" x 18"	14" x 15-3/4"	10"/8"	18 ga SS	359.00

Single Bowl Stainless Steel Kitchen Sinks

Gourmet® Celebrity® SS Self-Rimming Single Bowl Sinks

- Type 304 18-8 nickel bearing stainless steel, 20 gauge
- Fully undercoated
- Ribbed area on the faucet deck
- Brushed satin finish



ECC2522-4

Part #	Mfg #	Overall Size	Holes	Depth	Drain Opening	Min Sink Base	Price
ELKECC2522	ECC2522-4	25" x 22"	4	7-1/2"	3-1/2"	30"	335.00

Kitchen Sinks

Prices & Specifications are Subject to Change.

Stainless Steel Sinks

Double Bowl Stainless Steel Kitchen Sinks

Gourmet® Celebrity® SS Self-Rimming Double Bowl Sinks

- Type 304 18-8 nickel bearing stainless steel, 20 gauge
- Fully undercoated
- Ribbed area on the faucet deck
- Brushed satin finish



ECC3322-4

Part #	Mfg #	Overall Size	Holes	Depth	Drain Opening	Min Sink Base	Price
ELKECC3322	ECC3322-4	33" x 22"	4	7-1/2"	3-1/2"	36"	473.00

Stainless Steel Hospitality Sinks

Gourmet® (Celebrity®) SS Self-Rimming Single Bowl Hospitality Sinks

- Type 304 18-8 nickel bearing stainless steel, 20 gauge
- Fully undercoated
- BCR150-C Package Includes:
 - BCR15 Bar Sink
 - KA-2475 Two-handle faucet with 5-1/2" high deck to aerator gooseneck swing spout
 - LK-58 Basket strainer



BCR15-2



BCR15C

Part #	Mfg #	Overall Size	Holes	Depth	Drain Opening	Min Sink Base	Price
ELKBCR152	BCR15-2	15" x 15"	2	6-1/8"	2"	18"	255.00
ELKBCRA150C	BCRA150-C	15" x 15", Package	2	6-1/8"	2"	18"	407.00

Elkay Sink Mounting Clips

Part #	Mfg #	Description	Price
ELKCLIP	LKU-CLIP	Replacement Set of Elkay SS Sink Clips Bag of 10	25.18



Stainless Steel Kitchen Sinks

Southhaven® Stainless Steel Self-Rimming Single Bowl Sink

- Ledge back
- Curved deck design
- Satin finish stainless steel
- Self-rimming; rolled rim
- SilentShield™ sound deadening
- Faucet sold separately



Part #	Mfg #	Overall Dimensions	Basin Depth	Holes	Gauge/Finish	Price
STS252265	11403-4-NA	25" x 22"	6-1/2"	4	22ga Satin	125.30
STS25227	11404-4-NA	25" x 22"	7"	4	21ga Satin	145.90

Kitchen Sinks

All Items May Not Be Stocked In All Branches

Stainless Steel Sinks

Southhaven® Stainless Steel Self-Rimming Double Bowl Sink

- Ledge back
- Curved deck design
- Satin finish stainless steel
- Self-rimming; rolled rim
- SilentShield™ sound deadening



11402-4 Shown

Part #	Mfg #	Overall Dimensions	Basin Depth	Holes	Gauge/Finish	Price
STS332265	11400-4-NA	33" x 22"	6-1/2"	4	22ga Satin	162.50
STS33227	11401-4-NA	33" x 22"	7"	4	21ga Satin	185.60
STS33228	11402-4-NA	33" x 22"	8"	4	20ga Satin	258.00

Specialty Stainless Steel ADA Self-Rimming Double Bowl Sink

- Ledge back
- Curved deck design
- Satin finish 23-gauge one-piece stainless steel
- Luster basin finish
- Self-rimming; rolled rim
- SilentShield™ sound-absorption technology



Part #	Mfg #	Overall Dimensions	Basin Depth	Holes	Gauge/Finish	Price
STS3319	14619-4-NA	33" x 19"	6"	4	23ga Satin	170.80

Stainless Steel Entertainment Sinks

Secondary Stainless Steel Self-Rimming Single Bowl Entertainment Sink

- Ledge back
- Stud mounting
- 22-Gauge type 302 series nickel-bearing stainless steel
- Rounded corners
- Self-rimming; rolled rim
- SilentShield™ sound-absorption technology



Part #	Mfg #	Overall Dimensions	Basin Depth	Holes	Gauge/Finish	Price
STSB1532	B153-2	15" x 15"	5-1/2"	2	22ga Satin	119.55

Parts

Part #	Mfg #	Description	Price
STS7256	1049958	Channel Installation Clips Pkg of 12	3.50

Kitchen Sinks

Prices & Specifications are Subject to Change.

Stainless Steel Sinks

Excalibur® Stainless Steel Sinks

- Standard finish
- 22 Gauge, type 301 nickel-bearing stainless steel
- Fully undercoated to deaden sound & inhibit condensation
- 5-Year limited warranty



Excalibur® Stainless Steel Double Equal Size Bowl Sinks

- U channel
- 33" x 22"
- Two 14" x 16" x 6-1/2" bowls



Order #	Mfg #	Model	Size	Bowl Depth	Holes	Price
MOE22827	22827	22827	33" x 22"	6-1/2"	4	97.10

Excalibur® Stainless Steel Rectangular Single Bowl Sinks

- U channel
- One 21-1/4" x 16" x 6-1/2" bowl



Order #	Mfg #	Model	Size	Bowl Depth	Holes	Price
MOE22831	22831	22831	25" x 22"	6-1/2"	3	88.60

THE BOLD LOOK
OF **KOHLER**®

Stainless Steel Kitchen Sinks

Staccato™ Stainless Steel Self-Rimming Sink

- 18 Gauge stainless steel
- SilentShield™ sound absorption
- Includes installation hardware
- Faucets sold separately



K-3361-4



K-3369-4

Part #	Mfg #	Overall Dimensions	Basin Depth	Holes	Bowls	Price
KOHK33614	K-3361-4-NA	33" x 22"	8"	4	Large/Medium	397.20
KOHK33694	K-3369-4-NA	33" x 22"	8"	4	Equal	367.90

Cast Iron Kitchen Sinks

Brookfield™ Cast Iron Self-Rimming Double Bowl Sink

- Equal double compartments
- Acid-resistant enamel finish
- Faucet sold separately



Part #	Mfg #	Overall Dimensions	Basin Depth	Holes	Color	Price
KOHK59424W	K-5942-4-0	33" x 22"	8"	4	White	433.35

Kitchen Sinks

All Items May Not Be Stocked In All Branches

Stainless Steel & Cast Iron Sinks

Hartland™ Cast Iron Self-Rimming Double Bowl Sink

- Equal double bowl compartments
- Acid-resistant enamel finish
- Includes installation hardware
- Faucet sold separately



K-5823-4

Part #	Mfg #	Overall Dimensions	Basin Depth	Holes	Color	Price
KOHK58234W	K-5823-4-0	33" x 22"	7-1/2"	4	White	255.15

Lakefield™ Cast Iron Self-Rimming Double Bowl Sink

- High/Low double bowl compartments
- Acid-resistant enamel finish
- Faucet sold separately



Part #	Mfg #	Overall Dimensions	Basin Depth	Holes	Color	Price
KOHK59244W	K-5924-4-0	33" x 22"	L 6", R 9-1/2"	4	White	679.80

Mayfield™ Cast Iron Self-Rimming Single Bowl Sink

- Acid-resistant enamel finish
- Includes installation hardware
- Faucet sold separately



Part #	Mfg #	Overall Dimensions	Basin Depth	Holes	Color	Price
KOHK59644W	K-5964-4-0	25" x 22"	8"	4	White	280.25

Visionary Baths & More Kitchen and Bath Design Centers

*Professionally staffed to assist you and your customers
with design and selection <http://www.visionarybaths.com>*

Kitchen Sinks

Lavatories

Lavatories

Fireclay Pedestal Lavatories

Memoirs® Fireclay Pedestal Lavatory

- Faucet sold separately

K-2238 Combination:

K-2239 Classic Lavatory
K-2267 Pedestal

K-2268 Combination:

K-2269 Stately Lavatory
K-2267 Pedestal



K-2238-8 Faucet Not Included



K-2268-8 Faucet Not Included

Part #	Mfg #	Description	Dimensions	Color	Price
KOHK22388W	K-2238-8-0	8"cc Classic Complete	24" x 19-3/4" x 34-3/8"	White	493.90
KOHK22398W	K-2239-8-0	8"cc Classic Basin	24" x 19-3/4"	White	271.55
KOHK22698W	K-2269-8-0	8"cc Stately Basin	30" x 21-3/4"	White	721.35
KOHK2267W	K-2267-0	Pedestal Leg	26-1/8"	White	222.35
KOHK2267BI	K-2267-96	Pedestal Leg	26-1/8"	Biscuit	289.05

Vitreous China Pedestal Lavatories

Bancroft™ Vitreous China Pedestal Lavatory

- With overflow
- Faucet sold separately

K-2338 Combination:

K-2340 Lavatory
K-2346 Pedestal



K-2338 Faucet Not Included

Part #	Mfg #	Description	Dimensions	Color	Price
KOHK23388W	K-2338-8-0	8"cc Complete (Lav and Pedestal)	24" x 21" x 35-1/4"	White	392.00
KOHK23408W	K-2340-8-0	8"cc Basin	24" x 21"	White	215.50
KOHK2346W	K-2346-0	Pedestal Leg	-	White	176.50

Devonshire® Vitreous China Pedestal Lavatory

- Faucet sold separately

K-2286 Combination:

K-2287 Lavatory
K-2288 Pedestal



2286-4 Faucet Not Included

Part #	Mfg #	Description	Dimensions	Color	Price
KOHK22864W	K-2286-4-0	4"cc Complete	24-1/8" x 19-3/4" x 33-1/2"	White	325.25
KOHK22874W	K-2287-4-0	4"cc Basin	24-1/8" x 19-3/4"	White	178.90
KOHK2288W	K-2288-0	Pedestal Leg	26-1/2"	White	146.35

All Items May Not Be Stocked In All Branches

Lavatories

Pinoir® Vitreous China Pedestal Lavatory

K-2015 Combination:

K-2028 Lavatory
K-2033 Pedestal



K-2015-1

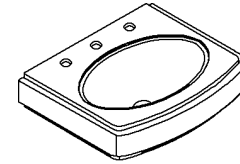

K-2028-8

Part #	Mfg #	Description	Dimensions	Color	Price
KOHK20288W	K-2028-8-0	8"cc ADA Basin	22" x 18" x 7-1/2"	White	215.50

Wellworth™ Vitreous China Pedestal Lavatory

- Faucet sold separately

K-2293 Combination:

K-2296 Lavatory
K-2019 Pedestal



K-2293-4 Faucet Not Included

Part #	Mfg #	Description	Dimensions	Color	Price
KOHK22934W	K-2293-4-0	4"cc Complete	22-1/4" x 18-1/4" x 34-7/8"	White	234.55
KOHK22964W	K-2296-4-0	4"cc Basin	22-1/4" x 18-1/4"	White	116.50
KOHK2019W	K-2019-0	Pedestal Leg	-	White	118.05

Vitreous China Countertop Lavatories

ADA - Compliant when installed according to the Accessibility Guidelines, Section 606 Lavatories and Mirrors, of the Act

Brookline™ Vitreous China Self-Rimming Countertop Lavatory

- Includes sealant
- Basin depth: 8-3/8"
- Faucet sold separately



K-2202-4 Faucet Not Included

Part #	Mfg #	Description	Dimensions	Color	Price
KOHK22024W	K-2202-4-0	4"cc ADA Basin	19" Diameter	White	122.65

Cimarron® Vitreous China Self-Rimming Countertop Lavatory

- Basin depth: 7-7/8"
- Faucet sold separately



K-2351-4 Faucet Not Included

Part #	Mfg #	Description	Dimensions	Color	Price
KOHK23514IG	K-2351-4-95	4"cc ADA Basin	23" x 18-3/16"	Ice Grey	212.75

Prices & Specifications are Subject to Change.

Lavatories

Lavatories

Memoirs® Classic Vitreous China Self-Rimming Countertop Lavatory

- Faucet sold separately



K-2241-8 Faucet Not Included

Part #	Mfg #	Description	Dimensions	Color	Price
KOHK22414W	K-2241-4-0	4"cc Classic Basin	22-3/4" x 18"	White	224.85
KOHK22418W	K-2241-8-0	8"cc Classic Basin	22-3/4" x 18"	White	224.85

Pennington™ Vitreous China Self-Rimming Countertop Lavatory

- Includes sealant
- Basin depth: 8-1/2"
- Faucet sold separately



K-2196-4 Faucet Not Included

Part #	Mfg #	Description	Dimensions	Color	Price
KOHK21964W	K-2196-4-0	4"cc ADA Basin	20-1/4" x 17-1/2"	White	123.65
KOHK21964AL	K-2196-4-47	4"cc ADA Basin	20-1/4" x 17-1/2"	Almond	160.55
KOHK21964BI	K-2196-4-96	4"cc ADA Basin	20-1/4" x 17-1/2"	Biscuit	160.55
KOHK21968W	K-2196-8-0	8"cc ADA Basin	20-1/4" x 17-1/2"	White	123.65

Portrait® Vitreous China Self-Rimming Countertop Lavatory

- Includes sealant
- Basin depth: 8-7/8"



K-2189-8 Faucet Not Included

Part #	Mfg #	Description	Dimensions	Color	Price
KOHK21898W	K-2189-8-0	8"cc ADA Basin	22-5/8" x 18-7/8"	White	286.75
KOHK21898BI	K-2189-8-96	8"cc ADA Basin	22-5/8" x 18-7/8"	Biscuit	372.50

For instructions as to proper installation, servicing, and troubleshooting, please refer to the Manufacturer's literature.

Lavatories

Vitreous China Under-Counter Lavatories

ADA - Compliant when installed according to the Accessibility Guidelines, Section 606 Lavatories and Mirrors, of the Act

Caxton™ Vitreous China Under-Counter Lavatory

- With 52047 clamp assembly
- Exterior dimensions: (2205) 19-1/4" x 16-1/8",
(2209, 2210) 17" x 14",
(2211) 21-1/4" x 17-1/4"



K2209 Shown Installed



K2210 Shown Installed



K2211 Shown Installed

Part #	Mfg #	Description	Dimensions	Color	Price
KOHK2209W	K-2209-0	ADA Basin, With Overflow	15" x 12" x 7-1/2"	White	102.85
KOHK2209BI	K-2209-96	ADA Basin, With Overflow	15" x 12" x 7-1/2"	Biscuit	133.60
KOHK2210W	K-2210-0	ADA Basin, With Overflow	17" x 14" x 8-1/4"	White	94.70
KOHK2210BI	K-2210-96	ADA Basin, With Overflow	17" x 14" x 8-1/4"	Biscuit	123.05
KOHK2210GHW	K-2210-G-HW1	ADA Basin, Less Overflow, Glazed Underside	17" x 14" x 8-1/4"	Honed White	174.05
KOHK2211W	K-2211-0	ADA Basin, With Overflow	19" x 15" x 7-1/2"	White	103.00

Vanity Top Lavatories

Persuade® Curv Vitreous China Vanity Top and Basin

- Countertop installation
- Works with Persuade furniture K-2526, K2537 and K-2529 or other 24"H x 22"W standard bath furniture or vanities
- With overflow
- Faucet sold separately
- Stand sold separately



Faucet Not Included

Part #	Mfg #	Description	Dimensions	Color	Price
KOHK29568W	K-2956-8-0	8"cc Top & Basin	25-1/4" x 22"	White	175.35

Cast Iron Countertop Lavatories

ADA - Compliant when installed according to the Accessibility Guidelines, Section 606 Lavatories and Mirrors, of the Act

Farmington™ Cast Iron Self-Rimming Countertop Lavatory

- With overflow
- Basin depth: 8-3/4"
- ADA-Compliant when installed in a 21" minimum depth countertop
- Faucet sold separately



K-2905-1-0 Faucet Not Included

Part #	Mfg #	Description	Dimensions	Color	Price
KOHK29054W	K-2905-4-0	4"cc ADA Basin	19-1/4" x 16-1/4"	White	157.25

Prices & Specifications are Subject to Change.

Lavatories

Lavatories

Tahoe™ Cast Iron Commercial Self-Rimming Countertop Lavatory

- Basin depth: 5"
- Faucet sold separately



K-2895-8-0 Faucet Not Included

Part #	Mfg #	Description	Dimensions	Color	Price
KOHK28954W	K-2895-4-0	4"cc ADA Basin	21" x 19"	White	338.75

Vitreous China Wall-Mount Lavatories

ADA - Compliant when installed according to the Accessibility Guidelines, Section 606 Lavatories and Mirrors, of the Act

Chesapeake™ Commercial Vitreous China Wall-Mount Lavatory

- Ledge-back with hanger
- Includes overflow
- Drilled for concealed arm carrier
- Basin depth: 10-1/2"
- Faucet sold separately



Faucet Not Included

Part #	Mfg #	Description	Dimensions	Color	Price
KOHK1729W	K-1729-0	4"cc ADA Basin	20" x 18-1/4"	White	116.05

Greenwich™ Vitreous China Wall-Mount Lavatory

- Ledge-back with hanger
- Drilled for concealed arm carrier
- With overflow
- Basin depth: 12-7/8"
- Faucet sold separately



K-2030 Faucet Not Included

K-2032-1 Faucet Not Included

Part #	Mfg #	Description	Dimensions	Color	Price
KOHK2032W	K-2032-0	4"cc ADA Basin	20-3/4" x 18-1/4"	White	130.05
KOHK2030W	K-2030-0	8"cc ADA Basin	20-3/4" x 18-1/4"	White	130.05

Kingston™ Vitreous China Wall-Mount Lavatory

- With back, wall hanger
- Drilled for concealed arm carrier
- Faucet sold separately



K-2005-8 Faucet Not Included

Part #	Mfg #	Description	Dimensions	Color	Price
KOHK2005W	K-2005-0	4"cc ADA Basin	21-1/4" x 18-1/8"	White	128.30

All Items May Not Be Stocked In All Branches

Lavatories

Soho™ Vitreous China Wall-Mount Lavatory

- Drilled for concealed arm carrier
- Basin depth: 7"
- Faucet sold separately



K-2054-1 Faucet Not Included

Part #	Mfg #	Description	Dimensions	Color	Price
KOHK2054W	K-2054-0	4"cc ADA Basin	20" x 18"	White	233.55

Lavatories



Pedestal Lavatories

Allerton™ Vitreous China Pedestal Lavatory

- Concealed front overflow
- Faucet sold separately



22-578 Combination:

12-579 8"cc Basin
29-843 Pedestal Base

Part #	Mfg #	Description	Dimensions	Centers	Color	Price
GER12579W	12-579	Lavatory Basin	25-1/2" x 21"	8"	White	338.00
GER29843W	29-843	Pedestal	28"	-	White	77.00

La Mer™ Petite Vitreous China Pedestal Lavatory

- Back overflow
- 1-Piece wall hanger
- Faucet sold separately



Part #	Mfg #	Description	Dimensions	Centers	Color	Price
GER22534W	22-534	Complete	31-3/4" x 20" x 17-1/4"	4"	White	185.00

Prices & Specifications are Subject to Change.



www.irrsupply.com

Lavatories

Lavatories

La Rive™ Petite Pedestal Lavatory

- Back overflow
- 1-Piece wall hanger
- Faucet sold separately



Part #	Mfg #	Description	Dimensions	Centers	Color	Price
GER22594W	22-594	Complete	32" x 25-1/2" x 21-1/2"	4"	White	176.00
GER12584W	12-584	Lavatory Basin	25-1/2" x 21-1/2"	4"	White	127.00

Standard Pedestal Base for La Mer™ & La Rive™ (Comb. Hgt. 32")



Part #	Mfg #	Description	Size	Color	Price
GER29840W	29-840	Standard Leg Pedestal	25"	White	49.00

Drop-In Lavatories

Luxoval Self-Rimming Lavatory

- Concealed front overflow
- Faucet sold separately



Part #	Mfg #	Description	Size	Centers	Color	Price
GER12844BI	12-844-09	Lavatory Basin	8-3/4" x 20" x 17"	4"	Biscuit	106.00

Luxoval Petite Undercounter Lavatory

- Concealed front overflow
- 16-5/8" x 13-1/2" Inside diameter



Part #	Mfg #	Description	Size	Centers	Color	Price
GER12770W	12-770	Lavatory Basin	7-5/8" x 18-3/8" x 15-3/8"	--	White	59.00

All Items May Not Be Stocked In All Branches



www.irrsupply.com

Lavatories

Maxwell Self-Rimming Lavatory

- 4" Centers
- Concealed front overflow
- CH - trapezoid packaging
- Faucet sold separately



Part #	Mfg #	Description	Size	Centers	Color	Price
GER12884W	12-884-CH-00	Lavatory Basin	19" Round	4"	White	44.00
GER12834W	12-834-CH-00	Lavatory Basin	20" x 17" Oval	4"	White	55.00

Vanity™ Tops

Marquis Vanity Top

- Front overflow
- Faucet sold separately



Part #	Mfg #	Cabinet Model	Splash Back	Integral Size	Centers	Color	Price
GER12224W	12-224	29-526	2-1/2"	10-3/4" x 19" x 17"	4"	White	98.00
GER12244W	12-244	29-726	2-3/4"	10-3/4" x 25" x 19"	4"	White	119.00

Lavanity™ Cabinets

- Elevated base
- Concealed hinges



Cabinet Only

Part #	Mfg #	Description	Size	Color	Price
GER29526	29-526	Single Door for 19" x 17" Vanity Top Lavatory	18" x 16"	Pure White	123.00
GER29726	29-726	Double Door for 25" x 19" Vanity Top Lavatory	24" x 18"	Pure White	162.00

Wall-Hung Lavatories

Monticello II Wall-Hung Lavatory

- Ledge type
- Back overflow
- 2-Self-draining soap dishes
- 1-Piece wall hanger
- Faucet sold separately



Part #	Mfg #	Model	Size	Centers	Color	Price
GER12654W	12-654	Monticello	20" x 18"	4"	White	101.00

Prices & Specifications are Subject to Change.



www.irrsupply.com

Lavatories

Lavatories

Plymouth Wall-Hung Lavatory

- Ledge type
- Back overflow
- 2-Self-draining soap dishes
- 1-Piece wall hanger
- Holes provided for legs and towel bars
- Faucet sold separately



Part #	Mfg #	Model	Size	Centers	Color	Price
GER12314W	12-314	Plymouth	12-3/4" x 19" x 17"	4"	White	79.00

West Point Wall-Hung Lavatory

- Ledge type
- Space saver
- Front overflow
- 2 Self-draining soap dishes
- 1-Piece wall hanger
- Faucet sold separately



Part #	Mfg #	Model	Size	Centers	Color	Price
GER12354W	12-354	West Point	8-1/8" x 14" x 12"	4"	White	61.00

Hayes Wall-Hung Lavatory

- Ledge type
- Front overflow
- 2-Self-draining soap dishes
- 1-Piece wall hanger
- Holes provided for legs and towel bars
- Faucet sold separately



Part #	Mfg #	Model	Size	Centers	Color	Price
GER12384W	12-384	Hayes	10-1/2" x 20" x 18"	4"	White	91.00

Eaton Wall-Hung Lavatory

- Wheelchair
- Concealed carrier arm support
- Back overflow
- Faucet sold separately



Part #	Mfg #	Model	Size	Centers	Color	Price
GER12464W	12-464	Eaton	7" x 20" x 27"	4"	White	309.00

All Items May Not Be Stocked In All Branches

Toilets & Urinals

One-Piece Residential Toilets

Archer® Class Five® 1-Piece Residential 1.28 Toilet

- Class Five™ flushing technology
- 29"L x 17-3/4"W x 26-1/4"H
- 2-1/8" Glazed trapway
- Includes Cachet® Quite-Close™ seat and cover



Part #	Mfg #	Description	Rough-In	Color	Price
KOHK3639W	K-3639-0	Elongated Complete, LH Trip, less Supply	12"	White	673.35

Devonshire® Comfort Height® 1-Piece Residential 1.6 Toilet

- Ingenium® flushing system
- 27-3/4"L x 17-1/8"W x 28-1/4"H
- 16-1/4" High bowl is ADA compliant
- Includes K-4733 Glenbury™ Quiet-Close™ seat and cover



Part #	Mfg #	Description	Rough-In	Color	Price
KOHK3488W	K-3488-0	ADA Elongated Complete, LH CP Trip, less Supply	12"	White	996.35

Memoirs® Comfort Height™ 1-Piece Residential 1.28 Toilet

- Dimensions: 28-1/8" x 17-3/4" x 28-5/8"



Part #	Mfg #	Description	Rough-In	Color	Price
KOHK3812W	K-3812-0	ADA Classic Elongated Complete, LH CP Trip, less Supply	12"	White	1176.65

Rialto™ 1-Piece Residential 1.6 Toilet

- Rim jet flushing system
- 25-1/4"L x 21-1/8"W x 22-3/4"H
- 14-7/8" High bowl
- Includes K-4663 French Curve™ seat and cover
- EPDM Flapper



Part #	Mfg #	Description	Rough-In	Color	Price
KOHK3386W	K-3386-0	Round Complete, CP Trip, less Supply	12"	White	594.45

Toilets & Urinals

Prices & Specifications are Subject to Change.

Toilets & Urinals

Two-Piece Residential Toilets

Archer™ Comfort Height® 2-Piece Residential 1.28 Toilet

- Class Five™ flushing system
- 29"L x 17-7/8"W x 30"H
- 16-1/2" High bowl is ADA compliant
- 2-1/8" Glazed trapway
- Less seat



K-3551 Seat not Included

K-3551 Combination:

K-4356 Elongated Front
K-4431 LH Trip Tank

Part #	Mfg #	Description	Rough-In	Color	Price
KOHK4356W	K-4356-0	Class 5 ADA Comfort Height Bowl,less Seat & Supply	12"	White	230.80
KOHK4431W	K-4431-0	Tank, LH Trip	-	White	147.35

Cimarron™ Comfort Height® 2-Piece Residential 1.6/1.4 Toilet

- Class Five™ flushing technology
- Elongated: 29-3/8"L x 19"W x 30-3/4"H
- Round: 28-1/8"L x 19"W x 30-3/4"H
- 16-1/2" High bowl is ADA compliant
- Less seat



K-3496 Seat not Included

K-3497 Seat not Included

K-3496 Combination:

K-4286 Elongated Front
K-4634 LH Trip Tank

K-3497 Combination:

K-4287 Round Front
K-4634 LH Trip Tank

Part #	Mfg #	Description	Rough-In	Color	Price
KOHK3496W	K-3496-0	ADA Elongated Complete, LH Trip, less Supply	12"	White	367.60
KOHK3497W	K-3497-0	ADA Round Complete, LH Trip, less Supply	12"	White	333.45
KOHK3497BI	K-3497-96	ADA Round Complete, LH Trip, less Supply	12"	Biscuit	433.25
KOHK4287W	K-4287-0	ADA Round Bowl, less Supply	12"	White	192.05
KOHK4634W	K-4634-0	Tank, LH Trip	-	White	141.40
KOHK4634BI	K-4634-96	Tank, LH Trip	-	Biscuit	183.70

Cimarron™ Comfort Height® 2-Piece Residential Toilet with Class Six™ Technology

- Class Six flushing technology
- 29-3/8" x 17-3/5" x 30-3/4"
- Less seat
- The K-3609 combination meets the EPA WaterSense program guidelines



K-3589
Seat Not Included

K-3589 Combination:

K-4309 Elongated Front
K-4418 LH Trip Tank

Part #	Mfg #	Description	Rough-In	Color	Price
KOHK3589W	K-3589-0	ADA Elongated Complete 1.6gpf, less Supply	12"	White	390.25
KOHK4309W	K-4309-0	Elongated Bowl, less Supply	12"	White	246.00
KOHK4418W	K-4418-0	Class 6 Tank, LH Trip	-	White	144.25

All Items May Not Be Stocked In All Branches

Toilets & Urinals

Devonshire® 2-Piece Residential 1.6 Toilet

- Ingenium™ flushing system
- 30-7/8"L x 18-1/4"W x 31-1/2"H
- 15" High bowl
- 2" Glazed trapway
- Less seat



K-3457 Seat Not Included

K-3457 Combination:

K-4269 Elongated Front

K-4619 LH Trip Tank

Part #	Mfg #	Description	Rough-In	Color	Price
KOHK3457W	K-3457-0	Elongated Complete, CP Trip, less Supply	12"	White	329.85

Devonshire® Comfort Height® 2-Piece 1.28 Toilet

- Class Five® flushing system
- 30-1/2"L x 17-1/4"W x 31"H
- 16-1/2" High bowl is ADA compliant
- Combination toilet
- 2-1/8" Glazed trapway
- Less seat and supply



K-3837 Seat not Included

K-3837 Combination:

K-4397 Elongated Front

K-4438 LH Trip Tank

Part #	Mfg #	Description	Rough-In	Color	Price
KOHK3837W	K-3837-0	Class 5 ADA Elongated Complete, CP Trip, less Seat & Supply	12"	White	398.55
KOHK4397W	K-4397-0	ADA Compact Elongated Bowl, less Supply	12"	White	207.20
KOHK4397BI	K-4397-96	ADA Compact Elongated Bowl, less Supply	12"	Biscuit	269.45
KOHK4438W	K-4438-0	Tank, LH PC Trip	-	White	191.35
KOHK4438BI	K-4438-96	Tank, LH PC Trip	-	Biscuit	248.45

Highline® Comfort Height® 2-Piece Residential 1.28 Toilet with Class Five Flushing Technology

- Class Five® flushing system
- 29-1/2"L x 19-5/8"W x 30-3/8"H
- 16-1/2" High bowl is ADA compliant
- 2-1/8" Glazed trapway
- Less seat

4199 ECC



Seat Not Included

K-3658 Combination:

K-4199 Elongated Front

K-4436 LH Trip Tank

Part #	Mfg #	Description	Rough-In	Color	Price
KOHK4199W	K-4199-0	ADA Elongated Bowl, less Supply	12"	White	205.30
KOHK4199AL	K-4199-47	ADA Elongated Bowl, less Supply	12"	Almond	266.65
KOHK4199BI	K-4199-96	ADA Elongated Bowl, less Supply	12"	Biscuit	228.85

Prices & Specifications are Subject to Change.

Toilets & Urinals

Memoirs® Comfort Height® 2-Piece 1.6 Toilet

- Class Five™ flushing system
- Classic: 30-3/8"L x 17-13/16"W x 31-1/2"H
- 16-1/2" ADA Bowl height
- Includes polished chrome trip lever
- Less seat and supply



K-3818 Seat not Included

K-3818 Combination:

**K-4380 Elongated Front
K-4641 LH Trip Classic Tank**

Part #	Mfg #	Description	Rough-In	Color	Price
KOHK3818W	K-3818-0	Class 5 Classic ADA Elongated Complete, less Supply	12"	White	444.85
KOHK3818BI	K-3818-96	Class 5 Classic ADA Elongated Complete, less Supply	12"	Biscuit	578.35
KOHK4380W	K-4380-0	Class 5 ADA Elongated Bowl	12"	White	215.55
KOHK4380BI	K-4380-96	Class 5 ADA Elongated Bowl	12"	Biscuit	280.25
KOHK4641W	K-4641-0	Class 5 Classic Tank, LH Trip	-	White	229.30
KOHK4641BI	K-4641-96	Class 5 Classic Tank, LH Trip	-	Biscuit	298.10
KOHK4642W	K-4642-0	Class 5 Stately Tank, LH Trip	-	White	240.20
KOHK4642BI	K-4642-96	Class 5 Stately Tank, LH Trip	-	Biscuit	312.20

Persuade™ 2-Piece Residential 1.6/0.8 Toilet

- Dual Flush flushing technology
- 27-5/8"L x 14-3/16"W x 31-1/2"H
- Skirted trapway
- Includes 2-button actuator that provides easy-to-use flushing options
- WaterSense toilet - use 20% less water than 1.6 toilets
- Less seat



Seat Not Included



K-3654 Combination

**K-4322 Elongated Front
K-4419 Tank**

Part #	Mfg #	Description	Rough-In	Color	Price
KOHK3654W	K-3654-0	Elongated Complete, with Supply, WaterSense	12"	White	412.60
KOHK4322W	K-4322-0	Elongated Bowl, less Supply	12"	White	260.10
KOHK4419W	K-4419-0	Dual Flush Tank	-	White	152.50

Portrait® 2-Piece Residential 1.6 Toilet

- Ingenium™ flushing system
- 30"L x 20-7/16"W x 32-5/8"H
- 14-3/4" High bowl
- 2" Glazed trapway
- Less seat



K-3591 Seat Not Included

K-3591 Combination

**K-4317 Elongated Front
K-4607 LH Trip Tank**

Part #	Mfg #	Description	Rough-In	Color	Price
KOHK3591W	K-3591-0	Elongated Complete, LH CP Trip, less Supply	12"	White	594.95

All Items May Not Be Stocked In All Branches

Toilets & Urinals

Wellworth® Comfort Height® 2-Piece Residential 1.6 Toilet

- Ingenium® flushing system
- 29"L x 19-5/8"W x 30"H
- 16-1/2" High bowl is ADA compliant
- Less seat



K-3481 Seat Not Included

K-3481 Combination:

- K-4278 Elongated Front
- K-4620 LH Trip Tank

Part #	Mfg #	Description	Rough-In	Color	Price
KOHK4278W	K-4278-0	Elongated Bowl, Concealed Trapway, less Supply	12"	White	357.15
KOHK4620W	K-4620-0	Tank, LH CP Trip	-	White	108.55

Wellworth™ 2-Piece Residential 1.28 Toilet with Class Five™ Flushing Technology

- 30"L x 19-5/8"W x 28-1/4"H
- 14-1/2" Bowl height
- 2-1/8" Glazed trapway
- Class Five® flushing technology
- Less seat



Seat Not Included

K-3575 Combination:

- K-4198 Elongated Front
- K-4436 LH Trip Tank

K-3577 Combination:

- K-4197 Round Front
- K-4436 LH Trip Tank

Part #	Mfg #	Description	Rough-In	Color	Price
KOHK4198W	K-4198-0	Class Five Elongated Bowl, less Supply	12"	White	175.90
KOHK4198BK	K-4198-7	Class Five Elongated Bowl, less Supply	12"	Black	262.75
KOHK4198BI	K-4198-96	Class Five Elongated Bowl, less Supply	12"	Biscuit	228.60
KOHK4197W	K-4197-0	Class Five Round Bowl, less Supply	12"	White	119.35
KOHK4197BI	K-4197-96	Class Five Round Bowl, less Supply	12"	Biscuit	154.95
KOHK4467UW	K-4467-U-0	Class Five Tank, LH CP Trip, w/Insuliner	-	White	161.05
KOHK4467UBI	K-4467-U-96	Class Five Tank, LH CP Trip, w/Insuliner	-	Biscuit	188.10

Wellworth™ 2-Piece Residential 1.6 Toilet with Class Five™ Flushing Technology

- 28-1/2"L x 18"W x 29-1/4"H
- 14-1/2" Bowl height
- 2-1/8" Glazed trapway
- Class Five® flushing technology
- Less seat



Seat Not Included

K-3977 Combination:

- K-4197 Round Front
- K-4468 LH Trip Tank

K-3978 Combination

- K-4198 Elongated Front
- K-4468 LH Trip Tank

Part #	Mfg #	Description	Rough-In	Color	Price
KOHK3977W	K-3977-0	Round Complete, LH CP Trip, less Supply	12"	White	227.90
KOHK3977AL	K-3977-47	Round Complete, LH CP Trip, less Supply	12"	Almond	290.55
KOHK3977BI	K-3977-96	Round Complete, LH CP Trip, less Supply	12"	Biscuit	290.55
KOHK3977IG	K-3977-95	Round Complete, LH CP Trip, less Supply	12"	Ice Grey	290.55
KOHK3978W	K-3978-0	Elongated Complete, LH CP Trip, less Supply	12"	White	284.45

Prices & Specifications are Subject to Change.

Toilets & Urinals

Two-Piece Residential Toilets (Continued)

Wellworth™ 2-Piece Residential 1.6 Toilet with Class Five™ Flushing Technology

Part #	Mfg #	Description	Rough-In	Color	Price
KOHK3978BK	K-3978-7	Elongated Complete, LH CP Trip, less Supply	12"	Black Black	418.55
KOHK3978AL	K-3978-47	Elongated Complete, LH CP Trip, less Supply	12"	Almond	364.20
KOHK3978IG	K-3978-95	Elongated Complete, LH CP Trip, less Supply	12"	Ice Grey	364.20
KOHK3978BI	K-3978-96	Elongated Complete, LH CP Trip, less Supply	12"	Biscuit	364.20
KOHK4197W	K-4197-0	Class Five Round Bowl, less Supply	12"	White	119.35
KOHK4197BI	K-4197-96	Class Five Round Bowl, less Supply	12"	Biscuit	154.95
KOHK4198W	K-4198-0	Class Five Elongated Bowl, less Supply	12"	White	175.90
KOHK4198BK	K-4198-7	Class Five Elongated Bowl, less Supply	12"	Black	262.75
KOHK4198BI	K-4198-96	Class Five Elongated Bowl, less Supply	12"	Biscuit	228.60
KOHK4468W	K-4468-0	Class Five Tank, LH CP Trip	-	White	108.55
KOHK4468BK	K-4468-7	Class Five Tank, LH CP Trip	-	Black	155.80
KOHK4468BI	K-4468-96	Class Five Tank, LH CP Trip	-	Biscuit	135.60

Toilets & Urinals

Over 140 years of doing business with integrity.

THANK YOU!
We appreciate
your business



www.irrsupply.com

Toilets & Urinals

Ultra Flush™ Pressure Assist Toilets

Ultra Flush™ 2-Piece 1.6 Toilet

- 1.6 gpf Pressure assist
- 2-Piece toilet
- Insulated non-sweating tank
- Toilet seat not included
- 10-Year limited warranty

21-300 Combination:

21-342 Round Front
28-385 Front Trip

21-302 Combination:

21-342 Round Front
28-380 Front Trip

21-304 Combination:

21-342 Round Front
28-384 Front Trip

21-317 Combination:

21-377 Elongated Front
28-385 Front Trip

21-318 Combination:

21-377 Elongated Front
28-380 Front Trip

21-324 Combination:

21-377 Elongated Front
28-384 Front Trip

21-311 Combination:

21-372 Elongated Front
28-385 Front Trip

21-312 Combination:

21-372 Elongated Front
28-380 Front Trip

21-314 Combination:

21-372 Elongated Front
28-384 Front Trip

21-310 Combination:

21-374 Elongated Front
28-380 Front Trip

21-325 Combination:

21-375 Elongated Front
28-380 Front Trip



Toilets & Urinals

Part #	Mfg #	Description	Rough-In	Color	Price
GER21302W	21-302	Round Complete, 28-1/4" x 20-1/4" x 27-1/2"	12"	White	366.00
GER21312W	21-312	Elongated Complete, 28-1/4" x 20-1/4" x 30"	12"	White	403.00
GER21317W	21-317	ADA Elongated Complete, 30-1/2" x 20-1/4" x 28-1/4"	10"	White	474.00
GER21318W	21-318	ADA Elongated Complete, 30-1/2" x 20-1/4" x 28-3/4"	12"	White	453.00
GER21310W	21-310	Elongated Complete, 28-1/2" x 20-1/4" x 30-1/2"	4-1/4" Vert RI	White	491.00
GER21342W	21-342	Round Bowl	10", 12", 14"	White	161.00
GER21372W	21-372	Elongated Bowl	10", 12", 14"	White	198.00
GER21377W	21-377	17" ADA Elongated Bowl	10", 12", 14"	White	248.00
GER21374W	21-374	Elongated Bowl, Back Outlet	4-1/4"V	White	286.00
GER21375W	21-375	17" ADA Elongated Bowl, Back Outlet	4-1/4"V	White	351.00
GER28380W	28-380	Tank, LH Trip	12"	White	205.00
GER28380AL	28-380-15	Tank, LH Trip	12"	Almond	226.00
GER2838097W	28-380-97	Tank, RH Trip	12"	White	205.00
GER28384W	28-384	Tank, LH Trip	14"	White	226.00
GER28385W	28-385	Tank, LH Trip	10"	White	226.00

Prices & Specifications are Subject to Change.



www.irrsupply.com

Toilets & Urinals

2-Piece Vitreous China Toilets

Allerton™ 2-Piece Gravity Fed 1.6 Toilet

- Gerber HP-2 technology
- Fluidmaster fill valve
- 2" Glazed trapway
- Reverse trap
- Dual-fed flush valve



20-007 Combination:

21-577 Round Front

28-580 LH Trip

Toilets & Urinals

Part #	Mfg #	Description	Rough-In	Color	Price
GER21577W	21-577	ADA Elongated Bowl, ErgoHeight™	12"	White	264.00
GER28580W	28-580	Tank, LH Trip	12"	White	90.00

Aqua Saver™ 2-Piece Gravity Fed 1.6 Toilet

- Anti-siphon ballcock
- Reverse trap
- Elite tank
- Less seat

21-700 Combination:

21-752 Round Front

28-795 Front Trip

21-702 Combination:

21-752 Round Front

28-790 Front Trip

21-704 Combination:

21-752 Elongated Front

28-794 Front Trip

21-710 Combination:

21-762 Elongated Front

28-795 Front Trip

21-712 Combination:

21-762 Elongated Front

28-790 Front Trip

21-714 Combination:

21-762 Elongated Front

28-794 Front Trip

21-717 Combination:

21-728 Elongated Front

28-795 Front Trip

21-724 Combination:

21-728 Elongated Front

28-794 Front Trip



21-700 Shown With Seat



21-710 Shown With Seat

Part #	Mfg #	Description	Rough-In	Color	Price
GER28792W	28-792	Tank, Insulated, For 21-700 Series	10"	White	82.00
GER28795W	28-795-95	Tank, RH Trip	10"	White	101.00

All Items May Not Be Stocked In All Branches



www.irrsupply.com

Toilets & Urinals

Maxwell™ 2-Piece Gravity Fed 1.6 Toilet

- 1.6 gpf Gravity
- Fully glazed trapway
- Non corrosive solid brass tank-to-bowl bolts
- Toilet seat not included
- Limited lifetime warranty

21-400 Combination:

21-752 Round Front
28-495 Front Trip

21-402 Combination:

21-752 Round Front
28-490 Front Trip

21-404 Combination:

21-752 Round Front
28-494 Front Trip

21-417 Combination:

21-728 Elongated Front
28-495 Front Trip

21-418 Combination:

21-728 Elongated Front
28-490 Front Trip



Part #	Mfg #	Description	Rough-In	Color	Price
GER21400W	21-400-95	Round Complete, 18-1/2" x 25-1/2" x 28-1/4", w/Fluidmaster	10"	White	186.00
GER21402W	21-402-95	Round Complete, 18-1/4" x 26-3/4" x 28-1/4", w/Fluidmaster	12"	White	151.00
GER21404W	21-404	Round Complete, 18-1/4" x 26-3/4" x 28-1/4"	14"	White	176.00
GER21417W	21-417-95	ADA Elongated Complete, ErgoHeight 17", w/Fluidmaster	10"	White	259.00
GER21418W	21-418	ADA Elongated Complete, 31-1/2" x 18-1/4" x 28-1/4"	12"	White	224.00
GER21752W	21-752	Round Bowl	10", 12", 14"	White	100.00
GER21728W	21-728	ADA Elongated Bowl	10", 12", 14"	White	173.00
GER28490W	28-490-95	Tank, LH Trip, Fluidmaster	12"	White	51.00
GER28494W	28-494-95	Tank, LH Trip, Fluidmaster	14"	White	86.00
GER28495W	28-495-95	Tank, LH Trip, Fluidmaster	10"	White	86.00

Toilets & Urinals

Visionary Baths & More

Because your time is valuable...

Visit your local Visionary Baths & More Kitchen and Bath Design Centers to let one of our trained knowledgeable consultants help you with your project.

<http://www.visionarybaths.com>

Prices & Specifications are Subject to Change.



www.irrsupply.com

Toilets & Urinals

Viper™ High Performance 2-Piece Gravity Fed 1.6 Toilet

- Fluidmaster 400A fill valve
- Glazed trapway
- Dual feed siphon-jet flushing action
- Reverse trap
- Slimline tank
- Less seat

21-500 Combination:

21-552 Round Front
28-595 Front Trip

21-502 Combination:

21-552 Round Front
28-590 Front Trip

21-504 Combination:

21-552 Round Front
28-594 Front Trip

21-517 Combination:

21-528 Elongated Front
28-595 Front Trip

21-510 Combination:

21-562 Elongated Front
28-595 Front Trip

21-512 Combination:

21-562 Elongated Front
28-590 Front Trip

21-514 Combination:

21-562 Elongated Front
28-594 Front Trip

21-518 Combination:

21-528 Elongated Front
28-590 Front Trip

21-524 Combination:

21-528 Elongated Front
28-594 Front Trip

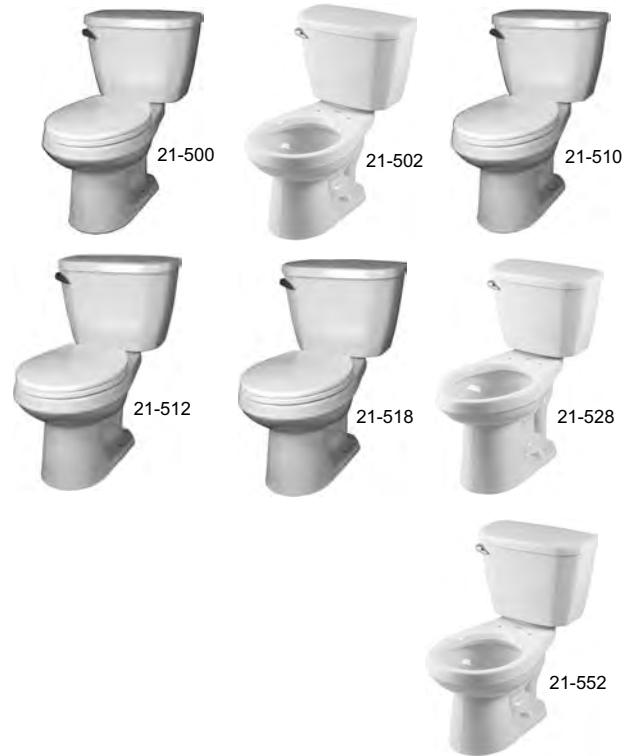

Toilets & Urinals

Part #	Mfg #	Description	Rough-In	Color	Price
GER21500W	21-500	Round Complete, 29-1/4" x 18" x 7"	10"	White	199.00
GER21502W	21-502	Round Complete, 29-1/4" x 18" x 27"	12"	White	167.00
GER21502BI	21-502-09	Round Complete, 29-1/4" x 18" x 27"	12"	Biscuit	198.00
GER21502BN	21-502-25	Round Complete, 29-1/4" x 18" x 27"	12"	Bone	198.00
GER21512W	21-512	Elongated Complete, 29-1/4" x 18" x 29-1/4"	12"	White	204.00
GER21512BI	21-512-09	Elongated Complete, 29-1/4" x 18" x 29-1/4"	12"	Biscuit	235.00
GER21518W	21-518	ADA Elongated Complete, 31-1/4" x 18" x 29-1/4"	12"	White	268.00
GER21518BI	21-518-09	ADA Elongated Complete, 31-1/4" x 18" x 29-1/4"	12"	Biscuit	319.00
GER21518BN	21-518-25	ADA Elongated Complete, 31-1/4" x 18" x 29-1/4"	12"	Bone	319.00
GER21504W	21-504	Round Complete, 29-1/4" x 18" x 27"	14"	White	197.00
GER21524W	21-524	ADA Elongated Complete, 31-1/4" x 18" x 29-1/4"	14"	White	298.00
GER21552W	21-552	Round Bowl	10", 12", 14"	White	100.00
GER21552BI	21-552-09	Round Bowl	10", 12", 14"	Biscuit	117.00
GER21552BN	21-552-25	Round Bowl	10", 12", 14"	Bone	117.00
GER21562W	21-562	Elongated Bowl	10", 12", 14"	White	137.00
GER21562BI	21-562-09	Elongated Bowl	10", 12", 14"	Biscuit	154.00
GER21528W	21-528	ADA Elongated Bowl	10", 12", 14"	White	201.00
GER21528BI	21-528-09	ADA Elongated Bowl	10", 12", 14"	Biscuit	238.00
GER21528BN	21-528-25	ADA Elongated Bowl	10", 12", 14"	Bone	238.00
GER28595W	28-595	Tank, LH Trip	10"	White	97.00
GER28590W	28-590	Tank, LH Trip	12"	White	67.00
GER28590BI	28-590-09	Tank, LH Trip	12"	Biscuit	81.00
GER28590BN	28-590-25	Tank, LH Trip	12"	Bone	81.00
GER2859097W	28-590-97	Tank, RH Trip	12"	White	67.00
GER28592W	28-592	Tank, LH Trip, Insulated	12"	White	85.00

All Items May Not Be Stocked In All Branches



www.irrsupply.com

Toilets & Urinals

2-Piece Vitreous China Toilets (Continued)

Viper™ High Performance 2-Piece Gravity Fed 1.6 Toilet

Part #	Mfg #	Description	Rough-In	Color	Price
GER28592BI	28-592-09	Tank, LH Trip, Insulated	12"	Biscuit	108.00
GER28592BN	28-592-25	Tank, LH Trip, Insulated	12"	Bone	108.00
GER28594W	28-594	Tank, LH Trip	14"	White	97.00

Avalanche 2-Piece Gravity Fed 1.6 Toilet

- 17" ErgoHeight bowl with 3" flush valve
- Fluidmaster 400A fill valve
- Glazed trapway
- Dual feed siphon-jet flushing action
- Reverse trap
- Slimline tank



21-818

21-818 Combination:
21-828 Elongated Front
28-890 Side Trip Tank

21-802 Combination
21-852 Round Bowl
28-890 Side Trip Tank

Part #	Mfg #	Description	Rough-In	Color	Price
GER21802W	21-802	Round Complete	12"	White	282.00
GER21818W	21-818	ADA Elongated Complete, 31-1/4" x 18" x 29-1/4"	12"	White	336.00
GER21852W	21-852	Round Bowl	10", 12", 14"	White	174.00
GER21828W	21-828	ADA Elongated Bowl Only	10", 12", 14"	White	228.00
GER28890W	28-890	Slimline Tank, Side Trip	12"	White	108.00

Avalanche High Efficiency 2-Piece Gravity Fed 1.28 Toilet

- 17" ErgoHeight with 3" flush valve
- Fluidmaster® Fill valve
- Glazed trapway
- Reverse trap
- Dual-feed jet
- Side tank lever
- (2) Bolt caps



HE-21-818 Combination:
HE-21-828 Elongated Bowl
HE-21-890 Tank

Part #	Mfg #	Description	Rough-In	Color	Price
GERHE21818W	HE-21-818	ADA Elongated Complete	12"	White	347.00
GERHE21828W	HE-21-828	ADA Elongated Bowl	12"	White	212.00
GERHE28890W	HE-28-890	Tank, Side Trip	12"	White	135.00

Flappers

Part #	Mfg #	Description	Price
GER99647	99647	1.6 gpf Flapper	3.20
GER99770	99770	1.6 gpf Flapper for 3" Flush Valves	5.50

Prices & Specifications are Subject to Change.

Toilets & Urinals

Commercial Toilets

Highcliff™ Commercial 1.6 Toilet - Bowl Only

- 26"L x 14-1/2" W
- 17-1/2" High bowl is ADA compliant
- 1-1/2" Spud
- Less seat



K-4368 Seat Not Included

Part #	Mfg #	Description	Rough-In	Color	Price
KOHK4368W	K-4368-0	ADA Elongated Bowl, 1-1/2" Top Spud	10" or 12"	White	240.75

Kingston™ Commercial 1.6 Toilet - Bowl Only

- 25-5/8"L x 16-3/4"W x 13-1/4"H
- 17" - 19" High installation, floor to top of seat or installed with K-4679-CA toilet seat for ADA compliance
- Less seat



K-4330 Seat Not Included

Part #	Mfg #	Description	Color	Price
KOHK4330W	K-4330-0	Elongated Bowl, Wall-Mount, 1-1/2" Top Spud	White	192.80

Primary™ Child-Size Commercial 1.6 Toilet - Bowl Only

- 30"L x 12-7/8"W x 10-3/4"H
- 10-3/4" High bowl is ADA compliant
- Included Primary™ seat available in white, primary yellow, primary red, or primary blue



Part #	Mfg #	Description	Rough-In	Color	Price
KOHK4321W	K-4321-0	Elongated Bowl, 1-1/2" Top Spud, White Seat	10"	White	265.70

Wellcomme™ Commercial 1.6 Toilet - Bowl Only

- 27-5/8"L x 14-1/2" W
- 14-3/4" High bowl
- Sweat extension nipple required for 12" rough-in
- Less seat



K4350 Seat Not Included

Part #	Mfg #	Description	Rough-In	Color	Price
KOHK4350W	K-4350-0	Elongated Bowl, 1-1/2" Top Spud	10" or 12"	White	196.65

Toilets & Urinals

All Items May Not Be Stocked In All Branches

Toilets & Urinals

Two-Piece Commercial Toilets

Highline® Pressure Lite® Comfort Height® 2-Piece Toilet

- Pressure assisted flushing system
- 30-1/8"L x 21-1/4"W x 31-1/4"H
- 17-1/8" High bowl is ADA compliant
- Less seat

K-3493 Combination:

K-4304 Elongated Bowl

K-4645 LH Trip Tank



K-3493 Seat Not Included

Part #	Mfg #	Description	Rough-In	Color	Price
KOHK3493W	K-3493-0	ADA 1.4gpf Elongated Complete, LH Trip, less Supply	12"	White	618.25
KOHK4304W	K-4304-0	ADA Elongated Bowl, less Supply	12"	White	210.70
KOHK4645W	K-4645-0	Tank, LH CP Trip, w/Flushmate	-	White	407.55

Wellworth™ Pressure-Lite™ 2-Piece Commercial 1.4 Toilet

- Equipped with Sloan Flushmate™
- 30-1/4"L x 21-1/4"W x 29-1/4"H
- 15" High bowl
- Includes polished chrome trip lever
- Less seat

K-3505 Combination:

K-4303 Elongated Front

K-4645 LH Trip Tank



Seat Not Included

Part #	Mfg #	Description	Rough-In	Color	Price
KOHK3505W	K-3505-0	Elongated Complete, LH Trip, less Supply	12"	White	539.15
KOHK4303W	K-4303-0	Bowl, Elongated Front	12"	White	131.60
KOHK4645W	K-4645-0	Tank, LH CP Trip, w/Sloan	-	White	407.55

Vitreous China Commercial Urinals

Bardon™ 0.5 - 1.0 Vitreous China Urinal

- Washout stall
- 14-1/8" Extended rim
- Includes:
 - Removable beehive strainer
 - Inlet and outlet spuds
 - Hangers
- 17" High rim from finished floor for ADA compliance



Part #	Mfg #	Description	Color	Price
KOHK4960ETW	K-4960-ET-0	ADA Urinal, 3/4" Top Spud	White	381.30

Toilets & Urinals

Darfield™ 0.5 to 1.0 Vitreous China Urinal

- Washout stall
- Includes
 - Strainer
 - Inlet and outlet spuds
 - Hanger
 - 1-1/2" Tailpiece
- 17" High mount from finished floor for ADA compliance
- Flush valve sold separately



Flush Valve Not Included

Part #	Mfg #	Description	Color	Price
KOHK5024TW	K-5024-T-0	ADA Urinal, 3/4" Top Spud	White	227.10

Dexter™ 1.0 Vitreous China Urinal

- Siphon jet
- 14-1/2" Extended rim
- Includes:
 - Inlet and outlet spuds
 - Hangers
 - Anti-backsplash wall
- 17" High mount from finished floor for ADA compliance



Part #	Mfg #	Description	Color	Price
KOHK5016ETW	K-5016-ET-0	ADA Elongated Urinal, 3/4" Top Spud	White	237.00

Freshman™ 1.0 Vitreous China Space-Saving Urinal

- Siphon jet
- Includes:
 - Inlet and outlet spuds
 - Hangers
- 17" High mount from finished floor for ADA compliance



Part #	Mfg #	Description	Color	Price
KOHK4989TW	K-4989-T-0	Urinal, 3/4" Top Spud	White	425.10

Stanwell™ Lite 1.0 Elongated Vitreous China Urinal

- Blow-out urinal
- Includes:
 - Inlet and outlet spuds
 - Hangers
- 17" High mount from finished floor for ADA compliance



Part #	Mfg #	Description	Color	Price
KOHK4972TW	K-4972-ET-0	ADA Urinal, 1-1/4" Top Spud	White	535.35

All Items May Not Be Stocked In All Branches



www.irrsupply.com

Toilets & Urinals

Commercial Wall Mount Spud Bowls

Top Spud Wall Hung

- Elongated bowl
- 1-1/2" Spud for flushometer valve
- Wall waste outlet
- Siphon-jet



Part #	Mfg #	Description	Rough-In	Color	Price
GER25030W	25-030	Elongated, 13" x 14-1/2" x 25-1/2"	5-1/4" or 7-1/4"(ADA)	White	180.00

Commercial Floor Mount Spud Bowls

Top Spud Floor Mount

- Large trapway
- 1-1/2" Spud for flushometer valve
- Siphon-jet



25-830

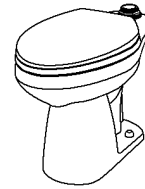

25-730

Part #	Mfg #	Description	Rough-In	Color	Price
GER25730W	25-730	ADA Elongated Bowl, 17" x 14-1/2" x 27"	10"	White	181.00
GER25830W	25-830	Elongated Bowl, 14-3/4" x 14-1/2" x 27-1/2"	10"	White	156.00

Toilets & Urinals

Urinals

Lafayette Washout 1.0 Urinal

- 18" x 13-1/2" x 13-3/4"
- Wall hung
- Minimum wall space
- Integral strainer
- 1-1/2" x 1-1/2" Outlet spud for flushometer



Part #	Mfg #	Description	Color	Price
GER27740W	27-740	Urinal, 3/4" Top Spud	White	115.00

Clinton 1.0 Urinal

- 21-3/4" x 14-1/4" x 14-3/8"
- Minimum wall space
- Dual hangers
- 2" SPS female outlet connection supplied
- Siphon-jet



Part #	Mfg #	Description	Color	Price
GER27750W	27-750	Urinal, 3/4" Top Spud	White	173.00

Prices & Specifications are Subject to Change.



www.irrsupply.com

Toilets & Urinals

Hamilton 1.0 Urinal

- 26" x 18" x 14-1/4"
- Half stall size
- Integral flush spreader
- Extended shields
- Dual hangers
- 2" SPS female outlet connection supplied
- Siphon-jet



Part #	Mfg #	Description	Color	Price
GER27770W	27-770	Urinal, 3/4" Top Spud	White	260.00

Monitor Washout 1.0 Urinal

- 27-1/4" x 18-1/2" x 12-1/2"
- Wall hung
- Commercial size
- Integral flush spreader
- Extended shields
- Dual hangers
- 2" SPS female outlet connection supplied



Part #	Mfg #	Description	Color	Price
GER27780W	27-780	Urinal, 3/4" Top Spud	White	266.00

Toilets & Urinals

For instructions as to proper installation, servicing, and troubleshooting, please refer to the Manufacturer's literature.

Toilet Systems

Saniplus® Macerating Toilet System

- Used to install a complete bathroom up to 12' below the sewer line or even up to 150' away from a soil stack

System Includes:

- Macerating pump
- Toilet tank
- Bowl



Saniplus® Components

Part #	Mfg #	Description	Price
SANPLUS	SANI-002	Macerating Pump Only	790.00
SANBOWLRFW	SANI-003	White Round Front Bowl Only	132.00
SANBOWLEFW	SANI-007	White ADA Elongated Front Bowl Only	166.00
SANTANKW	SANI-005	White Tank Only	111.00

Sanibest® Macerating Toilet System

- Designed for commercial use
- Used to install a complete bathroom up to 18' below the sewer line or up to 150' away from a soil stack

System Includes:

- Macerating pump
- Toilet tank
- Bowl



Sanibest® Components

Part #	Mfg #	Description	Price
SANBEST	SANI-013	Grinder Pump Only	999.00

Sanicompact® Self-Contained Macerator Toilet

- Build a half bathroom for residential applications
- Vertical pumping up to 9' and 100' horizontally
- Allows the connection of a sink
- 1.0 gpf
- Stylish toilet seat with chrome hinges included
- 15-3/4"H x 14-1/2"W x 18-1/4"D



Part #	Mfg #	Description	Price
SANCOMPACT48	SANI-023	Sanicompact 48 1-Piece Complete	899.00

Sanishower®

- Allows installation of a wash basin or shower anywhere in the house to a height of up to 16' and/or 100' away from a soil stack
- Small gray water pump that may be used to pump waste water away from a shower, hand basin, bar sink or other fixture



Part #	Mfg #	Description	Price
SANSHOWER	SANI-010	Water Pump Light Duty	309.00

Saniswift® Pump

- Grey water pump for remote fixtures such as sinks, showers, laundry sinks, washing machines and dishwashers
- (3) Inlets
- Vertical pumping up to 14' and 140' away for soil stack
- Dimensions: 8-3/4"H x 10-1/4"W x 9"D
- 0.3 hp, 115V - 60Hz, 5.9A



Part #	Mfg #	Description	Price
SANSWIFT	SANI-021	Discharge 18gpm@14'	258.00

SaniAlarm® Alarm

- Level pressure switch triggers an alarm fixed on top of the unit if the volume of water exceeds the maximum allowed level
- Continuous 80dB warning sound
- Battery operated



Part #	Mfg #	Description	Price
SANALARM	SANI-050	For All Saniflo Macerating Pumps	59.00

Parts & Accessories

Part #	Mfg #	Description	Price
SANEXTENSION	SANI-030	4" x 16" PVC Extension Pipe with Flexible Rubber Seal & Bell Housing	53.00

Toilets & Urinals

Whirlpools & Bathtubs

ProFlex® Whirlpools

- ProFlex® whirlpools operate with single-speed motors and air switches and include color-matched jet trim

Devonshire® Acrylic Whirlpool

- Reversible drain
- (8) Factory-installed color-matched adjustable ProFlex® jets
- Pump with air switch and grounding-type plug-in cord
- Textured bottom surface
- 120V GFCI



Part #	Mfg #	Description	Pump	Jets	Color	Price
KOHK1357LAW	K-1357-LA-0	60" x 32" x 20", Tile Flange, LH Drain, Apron	1-1/4 hp	8	White	1667.45
KOHK1357RAW	K-1357-RA-0	60" x 32" x 20", Tile Flange, RH Drain, Apron	1-1/4 hp	8	White	1667.45
KOHK1357RABI	K-1357-RA-96	60" x 32" x 20", Tile Flange, RH Drain, Apron	1-1/4 hp	8	Biscuit	1735.85

Select Kohler® Bathtubs

Mendota™ Cast Iron Recessed Bathtub

- Safeguard® finish
- ADA Compliant when installed with seat at head end



Part #	Mfg #	Description	Color	Price
KOHK505W	K-505-0	60" x 32" x 16-1/4", LH Drain	White	1195.80
KOHK506W	K-506-0	60" x 32" x 16-1/4", RH Drain	White	1195.80

Experience Bathtubs

Memoirs® Alcove Cast Iron Bathtub

- Safeguard® finish
- Integral apron
- ADA Compliant when installed with seat at head end



Part #	Mfg #	Description	Color	Price
KOHK721W	K-721-0	60" x 33-3/4" x 17-7/16", LH Drain, Apron	White	1683.20
KOHK722W	K-722-0	60" x 33-3/4" x 17-7/16", RH Drain, Apron	White	1683.20

All Items May Not Be Stocked In All Branches

Whirlpools & Bathtubs

Villager™ Cast Iron Recessed Bathtub

- Safeguard® finish
- ADA Compliant when installed with seat at head end



K-715



K-716

Part #	Mfg #	Description	Color	Price
KOHK715W	K-715-0	60" x 34-1/4" x 14", LH Drain	White	544.85
KOHK715BI	K-715-96	60" x 34-1/4" x 14", LH Drain	Biscuit	708.25
KOHK716W	K-716-0	60" x 34-1/4" x 14", RH Drain	White	544.85
KOHK716BI	K-716-96	60" x 34-1/4" x 14", RH Drain	Biscuit	708.25

ProFlex® Bathtubs

Archer™ Acrylic Bathtubs

- Comfort Depth™ design
- Integral armrests and lumbar support
- Slotted overflow for deeper bathing depth
- Textured bottom surface



Part #	Mfg #	Dimensions	Color	Price
KOHK1123LAW	K-1123-LA-0	60" x 32" x 19", Tile Flange, Integral Apron, LH Drain	White	796.85

Bancroft™ 5' Acrylic Bathtubs

- Molded lumbar support
- Three wall alcove installation
- Acrylic construction
- Textured bottom surface



K-1150-LA



K-1150-RA

Part #	Mfg #	Dimensions	Color	Price
KOHK1150LAW	K-1150-LA-0	60" x 32" x 20", Tile Flange, Integral Apron, LH Drain	White	865.50
KOHK1150RAW	K-1150-RA-0	60" x 32" x 20", Tile Flange, Integral Apron, RH Drain	White	865.50
KOHK1150RABI	K-1150-RA-96	60" x 32" x 20", Tile Flange, Integral Apron, RH Drain	Biscuit	908.75

Devonshire® 5' Acrylic Bathtubs

- Integral tile-in flange
- Arm rests & lumbar support



K-1184-LA



K-1184-RA

Part #	Mfg #	Dimensions	Color	Price
KOHK1184LAW	K-1184-LA-0	60" x 32" x 20", Tile Flange, Integral Apron, LH Drain	White	793.80
KOHK1184RAW	K-1184-RA-0	60" x 32" x 20", Tile Flange, Integral Apron, RH Drain	White	793.80

Prices & Specifications are Subject to Change.

Tub & Shower Modules

Vikrell™ Tub & Shower Modules

Acclaim™ Tub & Shower Modules

- Solid Vikrell™ material for strength & durability
- High-gloss, easy to clean finish
- 3-Piece wall set
- Tongue & groove interlocking joints
- Bath only installation not recommended
- Wall surround features molded-in back wall shelving and an arch-like design
- Large deck area
- AFD - Above floor drain



Part #	Mfg #	Description	Drain	Size	Color	Price
STEV460LW	71090110-0	Tub & Shower Complete	Left Hand	60" x 30" x 72"	White	550.40
STEV460RW	71090120-0	Tub & Shower Complete	Right Hand	60" x 30" x 72"	White	550.40
STEV460TUBLW	71091110-0	Tub Only, 15" Apron	Left-Hand	60" x 30" x 15"	White	228.90
STEV460WALLSETW	71094100-0	Complete Wall Set	-	60" x 30" x 54"	White	321.50

Accord® Tile Tub & Shower Modules

- Solid Vikrell™ material for strength & durability
- High-gloss, easy to clean finish
- 3-Piece wall set
- Realistic tile look
- No caulking required in the seams
- Bath only installation not recommended
- Molded in shelving on back wall



Part #	Mfg #	Description	Drain	Size	Color	Price
STEACCORDTLW	71140110-0	Tub & Shower Complete	Left-Hand	60" x 30" x 72"	White	590.05
STEACCORDTRW	71140120-0	Tub & Shower Complete	Right-Hand	60" x 30" x 72"	White	590.05
STEACCORDTUBLW	71141110-0	Tub Only, 15" Apron	Left-Hand	60" x 30" x 15"	White	272.05
STEACCORDTUBLBI	71141110-96	Tub Only, 15" Apron	Left-Hand	60" x 30" x 15"	Biscuit	299.25
STEACCORDTUBRW	71141120-0	Tub Only, 15" Apron	Right-Hand	60" x 30" x 15"	White	272.05
STEACCORDTUBRBI	71141120-96	Tub Only, 15" Apron	Right-Hand	60" x 30" x 15"	Biscuit	299.25
STEACCORDTWALLSETW	71144100-0	Complete Tile Wall Set	-	60" x 31-1/4" x 55"	White	318.00

Accord® Smooth Tub & Shower Modules

- Solid Vikrell™ material for strength & durability
- High-gloss, easy to clean finish
- 3-Piece wall set
- No caulking required in the seams
- Four integrated and recessed corner shelves



Part #	Mfg #	Description	Drain	Size	Color	Price
STEACCORDSLW	71240110-0	Tub & Shower Complete	Left-Hand	60" x 30" x 72"	White	568.55
STEACCORDSLBI	71240110-96	Tub & Shower Complete	Left-Hand	60" x 30" x 72"	Biscuit	625.35
STEACCORDSRW	71240120-0	Tub & Shower Complete	Right-Hand	60" x 30" x 72"	White	568.55
STEACCORDSRBI	71240120-96	Tub & Shower Complete	Right-Hand	60" x 30" x 72"	Biscuit	625.35
STEACCORDSWALLSETW	71244100-0	Complete ADA Smooth Wall Set	-	60" x 31-1/4" x 55"	White	296.50
STEACCORDSWALLSETBI	71244100-96	Complete ADA Smooth Wall Set	-	60" x 31-1/4" x 55"	Biscuit	326.10

All Items May Not Be Stocked In All Branches

Tub & Shower Modules

Advantage™ Tub & Shower Modules

- Solid Vikrell™ material for strength & durability
- Lightly textured swirl-gloss finish hides scratches from use
- 3-Piece wall set
- Tongue & groove interlocking joints
- Bath only installation not recommended
- (2) Shelves and 18" towel bar on back wall



Part #	Mfg #	Description	Drain	Size	Color	Price
STEOCAPTSLW	61030110-0	Tub & Shower Complete	Left-Hand	60" x 30" x 72"	White	518.60
STEOCAPTSRW	61030120-0	Tub & Shower Complete	Right-Hand	60" x 30" x 72"	White	518.60
STEOCAPTSTUBLW	61031110-0	Tub Only, 15" Apron	Left-Hand	60" x 30" x 15"	White	239.35
STEOCAPTSTUBRW	61031120-0	Tub Only, 15" Apron	Right-Hand	60" x 30" x 15"	White	239.35
STEOCAPTSWALLSETW	61034100-0	Complete Wall Set	-	60" x 31-1/4" x 56-1/4"	White	279.25

Ensemble™ Tile Tub & Shower Modules

- Solid Vikrell™ material for strength & durability
- High-gloss, easy to clean finish
- 2" Wainscot on tub allows tile installation above bath deck
- Order back wall and end walls separately
- Realistic tile look
- Tongue & groove interlocking joints
- Shelving on back wall

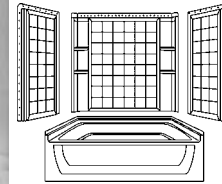

Part #	Mfg #	Description	Drain	Size	Color	Price
STETILE32LW	71120110-0	Tub & Shower Complete	Left-Hand	60" x 32" x 74"	White	637.55
STETILE32LBI	71120110-96	Tub & Shower Complete	Left-Hand	60" x 32" x 74"	Biscuit	701.00
STETILE32RW	71120120-0	Tub & Shower Complete	Right-Hand	60" x 32" x 74"	White	637.55
STEENSEMBLE32TUBLW	71121110-0	Tub Only, 18" Apron	Left-Hand	60" x 32" x 18"	White	297.75
STEENSEMBLE32TUBLAL	71121110-47	Tub Only, 18" Apron	Left-Hand	60" x 32" x 18"	Almond	327.35
STEENSEMBLE32TUBLBI	71121110-96	Tub Only, 18" Apron	Left-Hand	60" x 32" x 18"	Biscuit	327.35
STEENSEMBLE32TUBRW	71121120-0	Tub Only, 18" Apron	Right-Hand	60" x 32" x 18"	White	297.75
STEENSEMBLE32TUBRBI	71121120-96	Tub Only, 18" Apron	Right-Hand	60" x 32" x 18"	Biscuit	327.35
STETILE32WALLSETW	71124100-0	Tile Complete Wall Set	-	60" x 32" x 54"	White	339.80
STETILE32WALLSETBI	71124100-96	Tile Complete Wall Set	-	60" x 32" x 54"	Biscuit	373.65

Ensemble™ Curve Tub & Shower Modules

- Solid Vikrell™ material for strength & durability
- High-gloss, easy to clean finish
- 2" Wainscot on tub allows tile installation above bath deck
- Optional 3-piece wall set
- Curve wall with smooth contemporary look
- Tongue & groove interlocking joints
- Shelving on back wall



Part #	Mfg #	Description	Drain	Size	Color	Price
STECURVE32LW	71220110-0	Tub & Shower Complete	Left-Hand	60" x 32" x 74"	White	622.85
STECURVE32LBI	71220110-96	Tub & Shower Complete	Left-Hand	60" x 32" x 74"	Biscuit	685.05
STECURVE32RW	71220120-0	Tub & Shower Complete	Right-Hand	60" x 32" x 74"	White	622.85
STECURVE32RBI	71220120-96	Tub & Shower Complete	Right-Hand	60" x 32" x 74"	Biscuit	685.05

Prices & Specifications are Subject to Change.

Tub & Shower Modules

Vikrell™ Tub & Shower Modules (Continued)

Ensemble™ Curve Tub & Shower Modules

Part #	Mfg #	Description	Drain	Size	Color	Price
STECURVE32WALLSETW	71224100-0	Complete Wall Set	-	60" x 32" x 54"	White	325.10
STECURVE32WALLSETAL	71224100-47	Complete Wall Set	-	60" x 32" x 54"	Almond	357.70
STECURVE32WALLSETBI	71224100-96	Complete Wall Set	-	60" x 32" x 54"	Biscuit	357.70

Performa™ Tub & Shower Modules

- Solid Vikrell™ material for strength & durability
- High-gloss, easy to clean finish
- Lightly pebbled bottom surface for sure footing
- Caulk required in both vertical and horizontal wall seams to finish installation
- Convenient shelving & acrylic towel bar located on the back wall provide generous storage for toiletries, soap & accessories
- Sloping backrest provides better lumbar support
- Tub liner included to protect the tub during installation

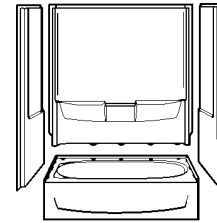

Part #	Mfg #	Description	Drain	Size	Color	Price
STEV260WALLSETW	71044100-0	Complete Wall Set	-	60" x 30" x 59-1/4"	White	359.85
STEV260LW	71041110-0	Performa™ Tub	Left-Hand	60" x 30" x 15"	White	214.90
STEV260RW	71041120-0	Performa™ Tub	Right-Hand	60" x 30" x 15"	White	214.90

Vikrell™ Whirlpool Tub & Shower Modules

Ensemble™ 8 Jet Whirlpool Curve Tub & Shower Module

- Solid Vikrell™ material for strength & durability
- High-gloss, easy to clean finish
- 1-1/4 hp Pump with air switch and grounding-type plug-in cord
- 3-Piece curve wall set
- 18" Integral apron with removable access panel
- Tongue & groove interlocking joints
- (8) Jets with independent variable control



Part #	Mfg #	Description	Drain	Size	Color	Price
STECURVE32WHPLW	76220110-0	WP & Shower Complete	Left-Hand	60" x 32" x 74"	White	1508.40

Vikrell™ Whirlpools

Ensemble™ 8 Jet Whirlpool Tub

- Solid Vikrell™ material for strength & durability
- High-gloss, easy to clean finish
- 1-1/4 hp Pump with air switch and grounding-type plug-in cord
- Lightly pebbled bottom surface
- (8) Jets with independent variable control



Part #	Mfg #	Description	Drain	Size	Color	Price
STEENSEMBLE32WHPLTUBLBI	76121110-96	Whirlpool Bath with 18" Apron	Left-Hand	60" x 32" x 18"	Biscuit	1301.90
STEENSEMBLE32WHPLTUBRW	76121120-0	Whirlpool Bath with 18" Apron	Right-Hand	60" x 32" x 18"	White	1183.30

All Items May Not Be Stocked In All Branches

Tub & Shower Modules

Vikrell™ Shower Modules

Accord® Alcove Shower Modules

- Solid Vikrell™, high-gloss finish
- Completely caulkless seams
- Interlocking wall clips click securely into place
- Large, deep shelves & semi-hidden storage design
- CUPC Certified



Complete

Part #	Mfg #	Description	Size	Color	Price
STEACCORDENDWALLSETBI	72245100-96	36" End Wall Set	36" x 77"	Biscuit	238.15
STEACCORDENDWALLSETW	72245100-0	36" End Wall Set	36" x 77"	White	216.50

Accord® Seated Shower Modules

- Solid Vikrell™, high-gloss finish
- Completely caulkless seams
- Interlocking wall clips click securely into place
- Large, deep shelves & semi-hidden storage design
- 12" Wide seat can be positioned on the left or right



Part #	Mfg #	Description	Size	Color	Price
STEACCORDST48BASEW	72281100-0	48" Base Only	48" x 36" x 20-1/2"	White	329.60

Advantage™ Shower Modules

- Solid Vikrell™ material for strength & durability
- Lightly textured swirl-gloss finish hides scratches from use
- Order back wall and end walls separately
- Lightly pebbled base
- Tongue & groove interlocking joints
- (2) Shelves & acrylic towel bar on back wall
- Other colors available

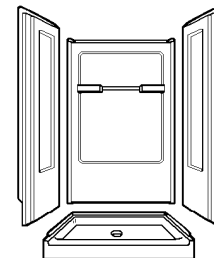

Part #	Mfg #	Description	Size	Color	Price
STES32W	62010100-0	Shower Complete	32" x 34" x 72"	White	550.80
STES32BASEW	62011100-0	Base Only	32" x 34"	White	170.75
STES36BASEW	62021100-0	Base Only	36" x 34"	White	170.75
STES32BACKWALLW	62012100-0	Back Wall	32" x 34" x 67"	White	180.95
STES36BACKWALLW	62022100-0	Back Wall	36" x 34" x 67"	White	180.95
STES32-36ENDWALLW	62015100-0	End Wall Set	32" x 35-1/4" x 66-1/4"	White	199.10

Advantage™ Seated Shower Modules

- Solid Vikrell™ material for strength & durability
- Lightly textured swirl-gloss finish hides scratches from use
- Base includes (2) molded-in seats, lightly pebbled bottom
- 3-Piece wall set
- Tongue & groove interlocking joints
- (2) Shelves & 18" towel bar on back wall

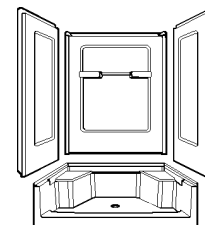

Part #	Mfg #	Description	Size	Color	Price
STESS48W	62030100-0	Tile Seated Shower Complete	48" x 34" x 72"	White	566.35
STESS60W	62040100-0	Tile Seated Shower Complete	60" x 34" x 76"	White	614.95

Prices & Specifications are Subject to Change.

Tub & Shower Modules

Vikrell™ Shower Modules (Continued)

Advantage™ Seated Shower Modules

Part #	Mfg #	Description	Size	Color	Price
STESS48BASEW	62031100-0	Seated Base Only	48" x 34"	White	196.25
STESS60BASEW	62041100-0	Seated Base Only	60" x 34"	White	248.85
STESS48WALLSETW	62034100-0	Complete Wall Set	48" x 35-1/4" x 56"	White	370.10
STESS60WALLSETW	62044100-0	Complete Wall Set	60" x 35-1/4" x 60"	White	366.10

Ensemble™ Tile Alcove Shower Modules

- Solid Vikrell™ material for strength & durability
- High-gloss, easy to clean finish
- Order back wall and end walls separately
- Lightly pebbled base
- Base can be installed using Ensemble™ Tile wall surround and Ensemble™ Curve wall surround, also perfect for tile down applications
- Realistic tile look
- Tongue & groove interlocking joints
- Shelving on back wall



Part #	Mfg #	Description	Size	Color	Price
STETILE36W	72100100-0	Tile Shower Complete	36" x 34" x 75-3/4"	White	564.70
STETILE42W	72110100-0	Tile Shower Complete	42" x 34" x 75-3/4"	White	619.05
STETILE48W	72120100-0	Tile Shower Complete	48" x 34" x 75-3/4"	White	619.05
STETILE60W	72130100-0	Tile Shower Complete	60" x 34" x 75-3/4"	White	711.40
STETILE60BI	72130100-96	Tile Shower Complete	60" x 34" x 75-3/4"	Biscuit	782.25
STEENSEMBLE36BASEW	72101100-0	Base Only	36" x 34"	White	164.70
STEENSEMBLE42BASEW	72111100-0	Base Only	42" x 34"	White	192.95
STEENSEMBLE48BASEW	72121100-0	Base Only	48" x 34"	White	192.95
STEENSEMBLE48BASEBI	72121100-96	Base Only	48" x 34"	Biscuit	212.00
STEENSEMBLE60BASEW	72131100-0	Base Only	60" x 34"	White	245.70
STEENSEMBLE60BASEBI	72131100-96	Base Only	60" x 34"	Biscuit	268.35
STETILE36BACKWALLW	72102100-0	Tile Back Wall	36" x 72-1/2"	White	148.85
STETILE42BACKWALLW	72112100-0	Tile Back Wall	42" x 72-1/2"	White	174.95
STETILE48BACKWALLW	72122100-0	Tile Back Wall	48" x 72-1/2"	White	174.95
STETILE60BACKWALLW	72132100-0	Tile Back Wall	60" x 72-1/2"	White	214.55
STETILE60BACKWALLBI	72132100-96	Tile Back Wall	60" x 72-1/2"	Biscuit	237.55
STETILEENDWALLSETW	72105100-0	Tile End Wall Set	36" x 72-1/2"	White	251.15
STETILEENDWALLSETBI	72105100-96	Tile End Wall Set	36" x 72-1/2"	Biscuit	276.35

Whirlpools, Tubs & Modules

All Items May Not Be Stocked In All Branches

Tub & Shower Modules

Ensemble™ Curve Alcove Shower Modules

- Solid Vikrell™ material for strength & durability
- High-gloss, easy to clean finish
- Order back wall and end walls separately
- Lightly pebbled base
- Base can be installed using Ensemble™ Tile wall surround and Ensemble™ Curve wall surround, also perfect for tile down applications
- Tongue & groove interlocking joints
- Shelving on back wall



Part #	Mfg #	Description	Size	Color	Price
STECURVE36W	72200100-0	Curve Shower Complete	36" x 34" x 75-3/4"	White	547.50
STECURVE42W	72210100-0	Curve Shower Complete	42" x 34" x 75-3/4"	White	598.45
STECURVE48W	72220100-0	Curve Shower Complete	48" x 34" x 75-3/4"	White	598.45
STECURVE48BI	72220100-96	Curve Shower Complete	48" x 34" x 75-3/4"	Biscuit	658.00
STECURVE60W	72230100-0	Curve Shower Complete	60" x 34" x 75-3/4"	White	690.65
STEENSEMBLE36BASEW	72101100-0	Base Only	36" x 34"	White	164.70
STEENSEMBLE42BASEW	72111100-0	Base Only	42" x 34"	White	192.95
STEENSEMBLE48BASEW	72121100-0	Base Only	48" x 34"	White	192.95
STEENSEMBLE48BASEBI	72121100-96	Base Only	48" x 34"	Biscuit	212.00
STEENSEMBLE60BASEW	72131100-0	Base Only	60" x 34"	White	245.70
STEENSEMBLE60BASEBI	72131100-96	Base Only	60" x 34"	Biscuit	268.35
STECURVE36BACKWALLW	72202100-0	Curve Back Wall	36" x 72-1/2"	White	139.20
STECURVE42BACKWALLW	72212100-0	Curve Back Wall	42" x 72-1/2"	White	161.90
STECURVE48BACKWALLW	72222100-0	Curve Back Wall	48" x 72-1/2"	White	161.90
STECURVE48BACKWALLBI	72222100-96	Curve Back Wall	48" x 72-1/2"	Biscuit	178.35
STECURVE60BACKWALLW	72232100-0	Curve Back Wall	60" x 72-1/2"	White	201.35
STECURVEENDWALLSETW	72205100-0	Curve End Wall Set	36" x 72-1/2"	White	243.60
STECURVEENDWALLSETBI	72205100-96	Curve End Wall Set	36" x 72-1/2"	Biscuit	267.65

Intrigue™ 39" Neo-Angle Shower Modules

- Solid Vikrell™ material for strength & durability
- High-gloss, easy to clean finish
- Lightly pebbled base
- 2-Piece back wall
- Tongue & groove interlocking joints
- (3) Shelves in corner column

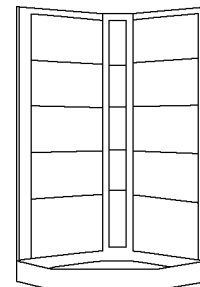

Part #	Mfg #	Description	Size	Color	Price
STENEOW	72040100-0	Shower Complete	39" x 39" x 74-1/2"	White	511.90
STENEOBASEW	72041100-0	Base Only	39" x 39"	White	193.20
STENEOWALLSETW	72044100-0	Complete Tile Wall Set		White	318.70
STENEOWALLSETBI	72044100-96	Complete Tile Wall Set		Biscuit	350.65

Whirlpools, Tubs & Modules

Prices & Specifications are Subject to Change.

Tub & Shower Modules

Finesse™ By-Pass Tub Doors

- Heavy-duty, anodized aluminum-framed sliding glass doors
- Top track roller system and continuous contact bottom track combine for a smooth, silent operation
- Ball-bearing rollers with brass inserts provide effortless panel glide
- (2) Designer tower bars, located both inside and outside
- Stainless steel hardware prevents rusting or corrosion



Part #	Mfg #	Height	Maximum Opening	Frame Finish	Glass Texture	Glass Color	Glass Pattern	Price
STE512659S	5126-59S	55-3/4"	59-5/8"	Silver	Rain	Natural	None	416.50

Shower Doors

Deluxe By-Pass Shower Doors

- Fits Ensemble and Accord
- Heavy-duty, anodized aluminum-framed sliding glass doors
- Top track roller system and continuous contact bottom track combine for a smooth, silent operation
- Ball-bearing rollers with brass inserts provide effortless panel glide
- Stainless steel hardware prevents rusting or corrosion



Part #	Mfg #	Height	Maximum Opening	Frame Finish	Glass Texture	Glass Color	Glass Pattern	Price
STE5966SP46S	5966SP-46S	65-15/16"	46-3/16"	Silver	Rain	Natural	None	334.95
STE5976SP59S	5976SP-59S	70"	59-3/8"	Silver	Rain	Natural	None	357.40

Intrigue™ Neo-Angle Shower Door

- Corner design
- Threshold direct water back into shower
- Watertight flexible door magnet and seal
- Tempered glass
- No track cutting required
- Aluminum components extruded from alloy 6063-T5
- Stainless steel hardware
- Made for Sterling Intrigue Series 7204



Part #	Mfg #	Height	Maximum Opening	Frame Finish	Glass Texture	Glass Color	Glass Pattern	Price
STESP2270A38S	SP2270A-38S	72"	15-3/16" x 27-9/16"	Silver	Pebbled	Natural	None	524.45

Whirlpools, Tubs & Modules

Tub & Shower Modules

Finesse™ Sliding/By-Pass Shower Doors

- Heavy-duty anodized aluminum framed sliding glass doors
- Top track roller system and continuous contact bottom track combine for a smooth, silent operation
- Ball-bearing rollers with brass inserts
- (2) Designer towel bars, located both inside and outside
- Stainless steel hardware avoids rusting or corrosion



Part #	Mfg #	Height	Maximum Opening	Frame Finish	Glass Texture	Glass Color	Glass Pattern	Price
STE517648S	5176-48S	47-5/8"	70-5/16"	Silver	Rain	Natural	None	388.25
STE517659S	5176-59S	59-5/8"	70-5/16"	Silver	Rain	Natural	None	402.35

Finesse™ Hinge Shower Doors

- Heavy-duty, aluminum-hinge shower door with stainless steel pin
- Continuous hinge runs full length of jamb for improved performance
- Attractive handle/towel bar
- Height 65-1/2" (no top track)
- Stainless steel hardware prevents rusting or corrosion



Part #	Mfg #	Height	Maximum Opening	Frame Finish	Glass Texture	Glass Color	Glass Pattern	Price
STE650630s	6506-30S	65-1/2"	30-1/2"	Silver	Rain	Natural	None	397.25
STE650633S	6506-33S	65-1/2"	33-1/2"	Silver	Rain	Natural	None	427.55
STE650639S	6506-39S	65-1/2"	39-1/2"	Silver	Rain	Natural	None	468.25

Whirlpools, Tubs & Modules

Check our website for special promotions!
www.irrsupply.com

Tub & Shower Modules

Durawall® Bathtub Walls

Durawall® Deluxe Thermoplastic Bathtub Walls

- Hi-impact panels adhesive-mounted to drywall & like surfaces
- Fits bathtub alcoves up to 30" deep and 60" wide
- Four molded-in, self-draining shelves
- Seamless corner panels
- Easily adjustable for out-of-square alcoves
- Smooth, glossy, colorfast finish

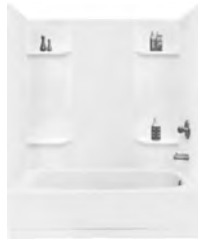

Part #	Mfg #	Pieces	Color	Price
MUS51W	53WHT	5	White	266.56

Durawall® Shower Walls

Durawall® Thermoplastic Deluxe Shower Walls

- 5-Piece construction
- Overlapping panels
- Adhesive mount
- Formed shelves

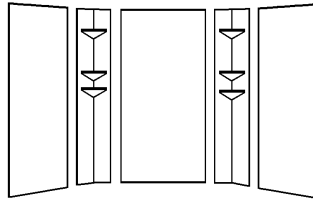

Part #	Mfg #	Description	Color	Price
MUS260W	260WHT	To 60"W & 34"D	White	553.74

Durawall® Thermoplastic Deluxe Neo-Angle/Corner Shower Walls

- 3-Piece construction
- Overlapping panels
- Adhesive mount
- Formed shelves

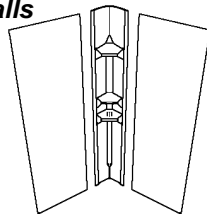

Part #	Mfg #	Description	Color	Price
MUS237W	237WHT	To 42" Corner	White	261.40

Durawall® Fiberglass Rectangular Shower Wall Set

- 5-Piece molded fiberglass
- Fits 3060 L/R ShowerTub™ and 360 L/R Barrier-Free Durabase® shower floors
- Embossed large tile pattern on back and side panels
- Mold and mildew resistant



Part #	Mfg #	Size	Color	Price
MUS760T30	760T-30WHT	30" x 60"	White	730.24

Durabase® Fiberglass Shower Floors

- Sturdy 1-piece molded construction
- Ribbed underbody for extra strength, slip-resistant surface
- Integrally molded drain with seal - removable stainless steel strainer
- Semi-gloss surface, resistant to mold & mildew, easy to clean

Fiberglass Square Shower Floors - Single Threshold



Part #	Mfg #	Size	Color	Price
MUS3232MW	3232M	32" x 32"	White	194.62
MUS3434MW	3434M	34" x 34"	White	229.20
MUS3636MW	3636M	36" x 36"	White	220.72

Fiberglass Rectangular Shower Floors - Single Threshold



Part #	Mfg #	Size	Color	Price
MUS3442MW	3442M	34" x 42"	White	260.66
MUS3448MW	3448M	34" x 48"	White	268.02
MUS3460MW	3460M	34" x 60"	White	333.24

Fiberglass Neo-Angle Shower Floors - Corner Threshold



Part #	Mfg #	Size	Color	Price
MUS3636CMW	3636CM	36" x 36"	White	154.40
MUS3838CMW	3838CM	38" x 38"	White	262.30

All Items May Not Be Stocked In All Branches

Tub & Shower Modules

Durastall® Shower Enclosures

- Ideal for bathrooms, basements, breezeways, garages, utility rooms and vacation homes
- Free-standing, KD assembly
- Hi-gloss thermoplastic wall panels - choice of decorative trim
- Leak/rust resistant construction and components
- Resistant to mold and mildew, easy to clean
- Floor drain assembly and brass shower valve included

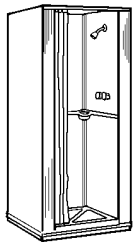

30

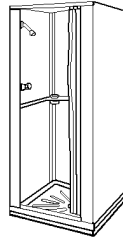

80, 82, 140, 142

Part #	Mfg #	Size	Base	Price
MUS30	30	30"x30"x75"	Std	434.22
MUS80	80	32"x32"x75-3/8"	Std	519.34
MUS82	82	32"x32"x77-7/8"	Extd	578.18
MUS140	140	36"x36"x75-3/8"	Std	609.68
MUS142	142	36"x36"x78-3/8"	Extd	703.50

Shower Doors for Durastall™ Shower Enclosures

- Install to open from either side

Standard Shower Doors for Durastall™ Shower Stalls

- Obscure, crystal styrene panel with aluminum frame
- 64" Height



Part #	Mfg #	Open	Fits Models	Price
MUS45700	45.700	28"	130,132,140,142	229.84

CareGiver™ Easy-Access Showers

Showertub™ - Single Threshold

- 1-Piece molded fiberglass
- Slip-resistant floor

Part #	Mfg #	Description	Color	Price
MUS3060LW	3060L	30" x 60", LH Drn	White	278.84
MUS3060RW	3060R	30" x 60", RH Drn	White	278.84

Barrier-Free Shower Floor with Entry Ramp

- Easy wheelchair access
- Strong molded fiberglass
- Resistance to mold, mildew and stains
- Choice of left or right hand drain, offset 8-1/2" x 15" to utilize existing plumbing when replacing standard 5' tub



Part #	Mfg #	Drain	Color	Price
MUS360LW	360L	LH	White	578.82
MUS360RW	360R	RH	White	578.82

Entry Ramp for Barrier-Free Shower Floor

- Molded fiberglass 30" x 60" shower floor & 12" x 60" entry ramp provides easy wheelchair movement/access, slip resistant

Part #	Mfg #	Size	Color	Price
MUS360100W	360.100	12" x 60"	White	275.84

Accessories for Barrier-Free Shower Floor

Part #	Mfg #	Description	Price
MUS360200	360.200	Drip Rail - 1" x 60" Flexible Vinyl Blade	61.78

Shower Drains

Part #	Mfg #	Description	Price
MUS42304A	42.304A	2" PVC Solvent Weld	27.40
MUS60300	60.300	Tub & Shower Drain Kit	65.78

Shower Stall Parts



80.400

Part #	Mfg #	Description	Price
MUS80400	80.400	3-3/8"cc White Shower Valve Unit Complete	64.60
MUS80454	80.454	Stem for 80-400 Shower Valve	8.00

Whirlpools, Tubs & Modules

Prices & Specifications are Subject to Change.

Tub & Shower Modules

Tub & Showers

- Supercore is an additional protective honeycombed layer that gives the unit more protection from the outside

2603CT-SC Everyday 1-Piece Supercore Tub & Shower

- Smooth tile finish
- Ergonomic backrest
- Molded toiletry shelves
- Slip-resistant textured bottom



Part #	Mfg #	Color	Size	Description	Price
LAS2603CTSLW	2603CTSLW	White	60" x 32" x 72"	LH Drain	840.00

2603SG-SC Everyday 1-Piece Supercore Tub & Shower

- Smooth wall finish
- Ergonomic backrest
- Installed acrylic grab bar
- Molded toiletry shelves
- Slip-resistant textured bottom



Part #	Mfg #	Color	Size	Description	Price
LAS2603SGSCLW	2603SG-L	White	60" x 32" x 72"	LH Drain	653.00
LAS2603SGSCRW	2603SG-R	White	60" x 32" x 72"	RH Drain	653.00
LAS2603SGSCLBI	2603SG-L	Biscuit	60" x 32" x 72"	LH Drain	653.00
LAS2603SGSCRBI	2603SG-R	Biscuit	60" x 32" x 72"	RH Drain	653.00

6030CTS A² Composite 4-Piece Tub & Shower

- Durable high gloss, smooth wall finish
- Pre-leveled base
- Molded toiletry shelves
- Leakproof right angle joint flanges
- Chaulkless installation
- Easy wedge & lock installation
- Slip resistant, textured bottom



Part #	Mfg #	Color	Size	Description	Price
LAS6030CTSLW	6030CTS-L	White	60" x 34" x 76"	LH Drain	265.00
LAS6030CTSRW	6030CTS-R	White	60" x 34" x 76"	RH Drain	265.00

All Items May Not Be Stocked In All Branches

Tub & Shower Modules

6036SG-SC Everyday 1-Piece Supercore Tub & Shower

- Smooth wall finish
- Ergonomic backrest
- Installed acrylic grab bar
- Molded toiletry shelf
- Slip-resistant textured bottom
- Whirlpool features:
 - 3/4 Hp Motor
 - (6) Adjusta-flow whirlpool jets
 - Pneumatic on/off control
 - Advanced safety suction system



Part #	Mfg #	Color	Size	Description	Price
LAS6036SGSCLW	6036SG-SC-L	White	60" x 34-1/2" x 76-1/2"	LH Drain	697.00

2543N-2P-SC Remodeline Sectional 2-Piece Supercore Tub & Shower

- Smooth wall
- Molded toiletry shelf
- Requires 59" turning space
- Gelcoat surface



Part #	Mfg #	Color	Size	Description	Price
LAS2543N2PSCLW	2543N-2P-SC-L	White	54" x 29" x 72"	LH Drain	701.00
LAS2543N2PSCRW	2543N-2P-SC-R	White	54" x 29" x 72"	RH Drain	701.00

2603TRIO-SC Remodeline Sectional 3-Piece Supercore Tub & Shower

- Smooth wall
- Molded toiletry shelves
- Installed acrylic grab bar
- Gelcoat surface



Part #	Mfg #	Color	Size	Description	Price
LAS2603TRIOSCLW	2603TRIO-SC-L	White	60" x 30" x 72"	LH Drain	704.00
LAS2603TRIOSCRW	2603TRIO-SC-R	White	60" x 30" x 72"	RH Drain	704.00
LAS2603TRIOSCRBI	2603TRIO-SC-R	Biscuit	60" x 30" x 72"	RH Drain	704.00

Whirlpools, Tubs & Modules

Prices & Specifications are Subject to Change.

Tub & Shower Modules

26030-4P-SC Remodeline Sectional 4-Piece Supercore Tub & Shower

- Smooth wall
- Molded toiletry shelves
- Installed acrylic grab bar
- Gelcoat surface



Part #	Mfg #	Color	Size	Description	Price
LAS260304PSCLW	26030-4P-SC-L	White	60" x 30" x 76"	LH Drain	959.00

60ACTS Domed Tub & Shower

- Decorative back wall
- Molded toiletry shelves
- Integral acrylic grab bar
- Slip-resistant floor
- Lucite cast acrylic surface



Part #	Mfg #	Color	Size	Description	Price
LAS60ACTSLW	60ACTS-L	White	60" x 34" x 84"	LH Drain	1153.00

Whirlpools, Tubs & Modules

Showers

- Supercore is an additional protective honeycombed layer that gives the unit more protection from the outside

1323C-SC Everyday 1-Piece Supercore Shower

- Smooth wall finish
- Molded toiletry shelves
- Slip-resistant textured bottom
- Not listed by IAPMO or FHA



Part #	Mfg #	Color	Size	Description	Price
LAS1323CSCW	1323C-SC	White	32" x 32" x 72"	Center Drain	653.00

Tub & Shower Modules

1363C-SC Everyday 1-Piece Supercore Shower

- Smooth wall finish
- Molded toiletry shelves
- Slip-resistant textured bottom
- Gelcoat surface



Part #	Mfg #	Color	Size	Description	Price
LAS1363CSCW	1363C-SC	White	36" x 36" x 72"	Center Drain	711.00
LAS1363CSCBI	1363C-SC	Biscuit	36" x 36" x 72"	Center Drain	711.00

1382NAC-SC Everyday 1-Piece Neo-Angle Corner Supercore Shower

- Smooth wall finish
- Two-wall, neo-angle corner design
- Decorative border at top and base
- Molded toiletry shelf
- Slip-resistant textured bottom
- Gelcoat surface



Part #	Mfg #	Color	Size	Description	Price
LAS1382NACSCW	1382NAC-SC	White	38" x 38" x 72"	Center Drain	711.00

1483CST-SC Everyday 1-Piece Supercore Shower

- Smooth wall finish
- Molded toiletry shelf
- Slip-resistant textured bottom
- Gelcoat surface



Part #	Mfg #	Color	Size	Description	Price
LAS1483CSTSCW	1483CST-SC	White	48" x 33-1/2" x 76"	No Seat, Center Drain	751.00

1483OS-SC Everyday 1-Piece Supercore Shower

- Smooth wall finish
- Molded seat
- Molded toiletry shelf
- Slip-resistant textured bottom
- Gelcoat surface



Part #	Mfg #	Color	Size	Description	Price
LAS1483OSSCLW	1483OS-SC	White	48" x 33-1/2" x 72"	(1) LH Seat, Center Drain	725.00

Prices & Specifications are Subject to Change.

Tub & Shower Modules

Showers (Continued)

1483OS-SC Everyday 1-Piece Supercore Shower

Part #	Mfg #	Color	Size	Description	Price
LAS1483OSSCRW	1483OS-SC	White	48" x 33-1/2" x 72"	(1) RH Seat, Center Drain	725.00

1483STS-SC Everyday 1-Piece Supercore Shower

- Smooth wall finish
- Integral toiletry shelves
- Slip resistant, textured bottom
- East zone only
- Gelcoat surface
- 3-Year limited warranty



Part #	Mfg #	Color	Size	Description	Price
LAS1483STSSCLW	1483STS-SC	White	48" x 36" x 76"	(1) LH Seat, Center Drain	831.00
LAS1483STSSCRW	1483STS-SC	White	48" x 36" x 76"	(1) RH Seat, Center Drain	831.00

1603DTS-SC Everyday 1-Piece Supercore Shower

- Smooth tile finish with diagonal tile trim
- Molded seat
- Installed acrylic grab bar
- Molded toiletry shelves
- Slip-resistant textured bottom
- Gelcoat surface



Part #	Mfg #	Color	Size	Description	Price
LAS1603DTSSCLW	1603DTS-SC	White	60" x 36" x 76"	(1) LH Seat, Center Drain	938.00

1603SG-SC Everyday 1-Piece Supercore Shower

- Smooth wall finish
- (2) Molded seat
- Molded toiletry shelves
- Slip-resistant textured bottom
- Gelcoat surface



Part #	Mfg #	Color	Size	Description	Price
LAS1603SGSCW	1603SG-SC	White	60" x 35" x 72"	(2) Seats, Center Drain	674.00

All Items May Not Be Stocked In All Branches

Tub & Shower Modules

1603STC Everyday 1-Piece Shower

- Smooth tile finish
- Molded seat
- Installed acrylic grab bar
- Molded toiletry shelves
- Slip-resistant textured bottom
- Gelcoat surface



Part #	Mfg #	Color	Size	Description	Price
LAS1603STCSCCLW	1603STC-SC	White	60" x 35" x 76"	(1) LH Seat, Center Drain	780.00
LAS1603STCSCRW	1603STC-SC	White	60" x 35" x 76"	(1) RH Seat, Center Drain	780.00

1323-2P-SC Everyday 2-Piece Supercore Shower

- Smooth wall finish
- Molded toiletry shelves
- Requires 47" turning space
- Slip-resistant textured bottom
- Gelcoat surface



Part #	Mfg #	Color	Size	Description	Price
LAS13232PSCW	1323-2PSC	White	32" x 32" x 72-3/4"	Center Drain	619.00

1363-2P-SC Remodeline Sectional 2-Piece Supercore Shower

- Smooth wall
- Molded toiletry shelf
- Requires 52" turning space
- Gelcoat surface



Part #	Mfg #	Color	Size	Description	Price
LAS13632PSCW	1363-2PSC	White	36" x 36" x 72"	Center Drain	670.00

1382NA-2P-SC Remodeline Sectional 2-Piece Neo-Angle Supercore Shower

- Smooth wall
- Two wall, neo-angle corner design
- Molded toiletry shelf
- Requires 56" turning space
- Gelcoat surface



Part #	Mfg #	Color	Size	Description	Price
LAS1382NA2PSCW	1382NA-2P-SC	White	38" x 38" x 72"	Center Drain	708.00

Prices & Specifications are Subject to Change.

Tub & Shower Modules

1483-2P-SC Remodeline Sectional 2-Piece Supercore Shower

- Smooth wall
- (2) Integral seats
- Molded toiletry shelf
- Requires 60" turning space
- Gelcoat surface



Part #	Mfg #	Color	Size	Description	Price
LAS14832PSCW	1483-2P-SC	White	48" x 34" x 72"	Center Drain	721.00

14834-4P Remodeline Sectional 4-Piece Shower

- Smooth wall
- Integral seat
- Installed acrylic grab bar
- Gelcoat surface



Part #	Mfg #	Color	Size	Description	Price
LAS148344PSCSCLW	148344P-SC	White	48" x 34" x 76"	Center Drain	967.00

1483N-TRI-SC Remodeline Sectional 3-Piece Supercore Shower

- Smooth wall
- Molded toiletry shelf
- Gelcoat surface



Part #	Mfg #	Color	Size	Description	Price
LAS1483NTRISCW	1483N-TRI-SC	White	48" x 34" x 72-3/4"	Center Drain	782.00

1603-3P-SC Everyday 3-Piece Supercore Shower

- Smooth wall
- Integral seats
- Molded toiletry shelf
- Gelcoat surface



Part #	Mfg #	Color	Size	Description	Price
LAS16033PSCW	1603-3P-SC	White	60" x 34" x 72"	Center Drain	748.00

All Items May Not Be Stocked In All Branches

Tub & Shower Modules

16034-4PS-SC Remodeline Sectional 4-Piece Supercore Shower

- Smooth wall
- Integral seat (opposite of drain)
- Molded toiletry shelves
- Installed acrylic grab bar
- Gelcoat surface



Part #	Mfg #	Color	Size	Description	Price
LAS160344PSSCLW	160344PS-SC-L	White	60" x 34" x 76"	(1) RH Seat, LH Drain	989.00
LAS160344PSSCRW	160344PS-SC-R	White	60" x 34" x 76"	(1) LH Seat, RH Drain	989.00

1363BF-SC Freedomline 1-Piece Barrier-Free Supercore Shower

- Smooth wall
- Pre-leveled base
- 3/4" Skirt
- No interior threshold
- Barrier free when properly installed
- Gelcoat surface



Part #	Mfg #	Color	Exterior Size	Description	Price
LAS1363BFSCCLW	1363BF-SC	White	38" x 38-1/4" x 77"	(1) LH Seat & Valve, Center Drain	2267.00
LAS1363BFSCRW	1363BF-SC	White	38" x 38-1/4" x 77"	(1) RH Seat & Valve, Center Drain	2267.00

1603BF-SD Freedomline 1-Piece Barrier-Free Shower

- Smooth wall
- Pre-leveled base
- 3/4" Skirt
- 1/2" Interior threshold
- Barrier free when properly installed
- Gelcoat surface



Part #	Mfg #	Color	Exterior Size	Description	Price
LAS1603BFSDLW	1603BFSD	White	62" x 36-1/4" x 76-7/8"	(1) LH Seat, No Valve, Center Drain	1737.00
LAS1603BFSDRW	1603BFSD	White	62" x 36-1/4" x 76-7/8"	(1) RH Seat, No Valve, Center Drain	1737.00

Whirlpools, Tubs & Modules

Prices & Specifications are Subject to Change.

Tub & Shower Modules

Bathtubs

254027 Everyday Bathtub

- Alcove bath
- Ergonomic backrest
- Integral tiling flange (3T)
- Integral skirt
- Molded toiletry shelf
- Slip-resistant textured bottom
- Gelcoat surface



Part #	Mfg #	Color	Size	Description	Price
LAS254027LW	254027-L	White	54" x 27-1/8" x 15"	LH Drain	373.00
LAS254027RW	254027-R	White	54" x 27-1/8" x 15"	RH Drain	373.00

260030 Everyday Bathtub

- Alcove bath
- Integral tiling flange (3T)
- Integral skirt
- Slip-resistant textured bottom
- Gelcoat surface



Part #	Mfg #	Color	Size	Description	Price
LAS260030LW	260030-L	White	60" x 30" x 15"	LH Drain	382.00
LAS260030RW	260030-R	White	60" x 30" x 15"	RH Drain	382.00

6030CT A² Composite Bathtub

- Pre-leveled base
- Slip-resistant textured bottom
- Durable high gloss finish



Part #	Mfg #	Color	Size	Description	Price
LAS6030CTLW	6030CT-L-WHT	White	60" x 30" x 15"	LH Drain	250.00
LAS6030CTRW	6030CT-R-WHT	White	60" x 30" x 15"	RH Drain	250.00

6030AIS Everyday Bathtub

- Alcove bath
- Ergonomic backrest
- Double tiling flange (3T)
- Integral skirt with removable access panels
- Slip-resistant textured bottom
- Standard skirt height
- Acrylic surface



Part #	Mfg #	Color	Size	Description	Price
LAS6030AISLW	6030AISLW	White	60" x 30" x 17"	LH Drain	563.00
LAS6030AISRW	6030AISRW	White	60" x 30" x 17"	RH Drain	563.00

All Items May Not Be Stocked In All Branches

Tub & Shower Modules

Victoria Q Builders' Choice Bathtub/Whirlpool

- Extended skirt (AFR)
- Ergonomic backrest
- Integral double tile flange
- Bowed skirt
- Slip-resistant bottom
- Lucite cast acrylic surface
- Whirlpool features:
 - (8) Hydrotherapy jets
 - 3/4 Hp Pump
 - Advanced safety suction system
 - Bath-side on/off button



Part #	Mfg #	Color	Size	Description	Price
LAS9760600QLW	9760600Q LH	White	60" x 31"-39-1/2" x 24-1/2"	Soaker, LH Drain	1235.00

Whirlpools

Belmont II Builders' Choice Whirlpool

- (8) Hydrotherapy jets
- 3/4 Hp Pump
- Advanced safety suction system
- Bath-side on/off button
- Sculpted armrests
- Slip-resistant bottom
- Lucite cast acrylic surface



Part #	Mfg #	Color	Size	Description	Price
LAS4072621W	4072621	White	72" x 42" x 24"	Oval, Universal Drain	1659.00

Montrose II Builders' Choice Whirlpool

- (8) Hydrotherapy jets
- 3/4 Hp Pump
- Advanced safety suction system
- Bath-side on/off button
- Sculpted armrests
- Slip-resistant bottom
- Lucite cast acrylic surface



Part #	Mfg #	Color	Size	Description	Price
LAS4272621W	4272621	White	72" x 36" x 22"	Rect, Universal Drain	1551.00

Whirlpools, Tubs & Modules

Prices & Specifications are Subject to Change.

Shower Doors & Wall Sets

Shower Doors

Builders' Choice Framed Bypass Shower Door

- Aluminum polished, anodized metal
- (2) Towel bars
- Bypass stop
- Easy-clean bottom track roller assembly
- T-lock feature



Part #	Mfg #	Fits	Size	Description	Price
LAS602041BS	602041BS	1483OS	40" - 42" x 64-1/2"	Shower Height	342.00

Bypass Shower Door

- Aluminum polished, anodized metal
- Easy-clean track assemblies
- (7) Different glass options

Part #	Mfg #	Fits	Description	Price
LAS602055BS	602055BS	1603SG, 1603-3P	CP Bypass, Obscure	404.00

Swing Shower Door

- Aluminum polished, anodized metal
- Easy-clean track assemblies
- (7) Different glass options

Part #	Mfg #	Fits	Description	Price
LAS606028S	606028S	1323-2P, 1323C	CP Swing	264.00
LAS606032S	606032S	1363C, 1363-2P	CP Swing	264.00

Neo Shower Door

- Aluminum polished, anodized metal
- Easy-clean track assemblies
- (7) Different glass options

Part #	Mfg #	Fits	Description	Price
LAS60K02517S	60K02517S	1382NA-2P	CP Neo	646.00

Walls

Tub & Shower Side Wall Set

- Includes (1) right and (1) left side wall

Part #	Mfg #	Size	Color	Price
LAS2462CSW	2462CSW-WH	24" x 62"	White	170.00

Tub & Shower Back Wall

Part #	Mfg #	Size	Color	Price
LAS6062CBW	6062CBW-WHT	60" x 62"	White	210.00

All Items May Not Be Stocked In All Branches

Tub & Shower Enclosures

Bathtub Wall Panels

RM-58 Swan High-Gloss 3-Panel Bathtub Wall System

- Designed to fit 29" - 30" x 60" or smaller bathtub
- Ultra-bright, glossy surface from durable, baked-on finish
- Includes:
 - (1) Back panel with molded-in soap dish
 - (2) End panels
 - (1) Roll of pressure sensitive tape
 - (3) Tubes of adhesive
 - (1) Tube of caulk
 - Complete installation instructions
- Will not mold or mildew, no grout to clean
- Limited lifetime warranty



Part #	Mfg #	Width	Depth	Height	Color	Price
SWARM58W	RM-58	60"	29"	58"	White	635.00

TW-32 Swan High-Gloss 5-Panel Bathtub Wall System

- Designed to fit 29" - 32" x 57" - 62" bathtub
- Ultra-bright, glossy surface from durable, baked-on finish
- Includes:
 - (1) Back panel with molded-in soap dish
 - (2) Right angle corner panels with molded-in shampoo shelves
 - (2) Flat side panels
 - (2) Apron strips
 - (1) Roll of pressure sensitive tape
 - (3) Tubes of adhesive
 - (1) Tube of caulk
 - Complete installation instructions
- Will not mold or mildew, no grout to clean
- Limited lifetime warranty



Part #	Mfg #	Width	Depth	Height	Color	Price
SWATW32W	TW-32	57" - 62"	29" - 32"	58"	White	712.00

Veritek™ Bath Alcove Wall

- Nails directly to studs for fast installation
- Sturdy interlocking system connects panels and BT-3060 bathtub for 1-piece appearance
- Made of Veritek™ with no surface coating to chip or crack
- Includes:
 - (1) Right side panel
 - (1) Left side panel
 - (1) Back panel with (6) factory installed wall mounting clips
 - Complete installation instructions
- Limited lifetime warranty



Part #	Mfg #	Width	Depth	Height	Color	Price
SWABA3060W	BA-3060	60"	60"	59-1/2"	White	481.00

Whirlpools, Tubs & Modules

Tub & Shower Enclosures

Shower Wall Panels

SW-7060 High Gloss 6-Panel Shower Wall System

- Ultra-bright, glossy surface from durable, baked-on finish
- Includes:
 - (1) Back panel with molded-in soap dish and shampoo shelf
 - (2) Right angle corner panels
 - (2) Flat side panels
 - (1) Flat extension panel
 - (1) Roll of pressure sensitive tape
 - (3) Tubes of adhesive
 - (1) Tube of caulk
 - Complete installation instructions
- Compression molded
- Limited lifetime warranty

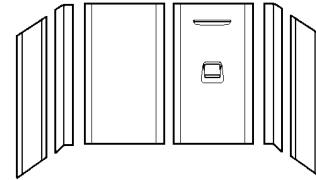

Part #	Mfg #	Width	Depth	Height	Color	Price
SWASW7060W	SW-7060	30" - 60"	30" - 60"	70"	White	1060.00

Veritek™ Bathtubs

- Natural gloss surface for easy cleaning
- Deeper than a standard tub

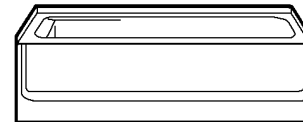

Part #	Mfg #	Description	Size	Color	Price
SWABT3060RW	BT-3060R	Right Hand Drain	60"W x 30"D x 16"H	White	341.00
SWABT3060RBI	BT-3060R	Right Hand Drain	60"W x 30"D x 16"H	Bisque	358.00
SWABT3060LW	BT-3060L	Left Hand Drain	60"W x 30"D x 16"H	White	341.00

Whirlpools, Tubs & Modules

Steam Systems

Residential Super Steambath Generator

- Must use eTempo/Plus control
- Chrome finish
- 17"L x 18-1/2"H x 7-7/8"D
- 50/60Hz, 240V/1-Phase
- Shipping weight: 40 lbs



Part #	Mfg #	Kw	Amps	Rm Vol	Price
MRSMSUPER1E	MS SUPER 1E	10	42	361-475	CALL

Butler Package 1 with Square Control

- All models shipped complete with eTempo/Plus® control
- With Aroma Steam™ steamhead
- AutoFlush® system
- Steam Genie™
- Drip pan



Part #	Mfg #	Description	Price
MRSMSBUTLER1SQPC	MS BUTLER 1SQPC	Butler Package 1 with Square Control	CALL

eTempo/Plus® Digital Temperature Display Controls

- Solid 100% brass decorative cover
- Programmable time and temperature
- Soft touch keypad with On/Off modes
- Microprocessor control
- Low voltage operation
- Real time clock display standard
- Aromasteam® steamhead standard
- For models MS90E thru MS400E only



Part #	Mfg #	Finish	Price
MRSMSETEMPOPLUSRDPC	MS ETPLUS RD PC	Pol Chrome	CALL
MRSMSETEMPOPLUSRDBN	MS ETPLUS RD BN	Brushed Nickel	CALL

AutoFlush® Automatic Drain System

- Automatically and electronically drains the system
- Quiet operation



Part #	Mfg #	Description	Price
MRSMS81500	MS 81500E	Auto Flush, Auto Drain System	CALL

Whirlpools, Tubs & Modules

Prices & Specifications are Subject to Change.



Towel Warmers

Towel Warmers

200 Series Towel Warmer

- Sleek curved lines for maximized surface heating area
- Energy-efficient temperature control
- All welded steel construction
- UL Listed



Part #	Mfg #	Description	Price
MRSW228PC	W228PC	Pol Chrome 28" x 20" x 4-1/4"	810.00

Whirlpools, Tubs & Modules

Visionary Baths & More Kitchen and Bath Design Centers

Professionally staffed to assist you and your customers with design and selection <http://www.visionarybaths.com>

Laundry Tubs & Accessories

Durastone® Countertop Specialty Sinks

- Extra-deep bowls, self-rimming, seamless corners, 1-piece construction

10 Durastone® Countertop Specialty Sink

- Made with Durastone® - "hi-impact" fiberglass and crushed stone blended with special resins for extra strength and durability
- 17 Gallon capacity, extra deep self-rimming bowl
- Includes 1-1/2" drain assembly with stopper
- Hooks up to standard 1-1/2" P- or S-trap
- Accommodates single or dual-handle faucet with 4" or 8" centers (sold separately)



Part #	Mfg #	Size	Color	Price
MUS10	10	22" x 25" x 13-3/4"	White	123.04

Durastone® Laundry Tubs

17F Utilatub® Durastone® Laundry Tub

- Sturdy, 1-piece, extra deep molded tub
- Made with Durastone® - combination of fiberglass and crushed stone blended with special resins for extra strength and durability, marblized white
- 19 Gallon capacity, 13" deep
- Built in scrub board
- Leakproof, integrally molded-in drain with stopper
- Hooks up to standard 1-1/2" P- or S-trap
- Accommodates dual-handle faucets with 4" centers (sold separately)
- Floor model includes adjustable leg levelers
- Wall model includes wall mounting bracket, side supports and hardware for securing tub to concrete or stud wall
- Smooth surface, rust resistant



Part #	Mfg #	Size	Mounting	Price
MUS17F	17F	23" x 23-1/2"	Floor	140.06

18F & 18W Utilatub® Durastone® Laundry Tub

- Sturdy, 1-piece, extra deep molded tub
- Made with Durastone® - combination of fiberglass and crushed stone blended with special resins for extra strength and durability, marblized white
- 18 Gallon capacity, 13" deep
- Leakproof, integrally molded-in drain with stopper
- Hooks up to standard 1-1/2" P- or S-trap
- Accommodates single or dual-handle faucets with 4" or 8" centers (sold separately)
- Floor model includes adjustable leg levelers
- Wall model includes wall mounting bracket, side supports and hardware for securing tub to concrete or stud wall
- Smooth surface, rust resistant



Part #	Mfg #	Size	Mounting	Price
MUS18F	18F	20" x 24"	Floor	128.10
MUS18W	18W	20" x 24"	Wall	128.10

26F & 26W Utilatwin® Durastone® Laundry Tubs

- Sturdy, 1-piece, extra deep molded tub
- Made with Durastone® - combination of fiberglass and crushed stone blended with special resins for extra strength and durability, marblized white
- Includes twin drain waste connector - joins drain assemblies, assures rapid and uniform discharge of waste water, washers, slip nuts and stoppers provided
- 19 Gallon capacity per tub, 13" deep
- Hooks up to standard 1-1/2" P- or S-trap
- Accommodates single or dual-handle faucet with 4" or 8" centers (sold separately)
- Floor model includes adjustable leg levelers
- Wall model includes wall mounting bracket, side supports and hardware for securing tub to concrete or stud wall
- Smooth surface, rust resistant



Part #	Mfg #	Size	Mounting	Price
MUS26F	26F	40" x 24"	Floor	282.88
MUS26W	26W	40" x 24"	Wall	303.24

Laundry Tubs & Accessories

Prices & Specifications are Subject to Change.

Laundry Tubs & Accessories

Structural Thermoplastic Laundry Tubs

19F & 19W Utilatub® Thermoplastic Laundry Tub

- Sturdy, 1-piece, extra deep molded tub
- Made with structural thermoplastic - innovative cellular molding process makes these white tubs "literally indestructible"
- 18 Gallon capacity, 13" deep
- Leakproof, integrally molded-in drain with stopper
- Hooks up to standard 1-1/2" P- or S-trap
- Accommodate dual-handle faucet with 4" center (sold separately)
- Floor model includes adjustable leg levelers
- Wall model includes wall mounting bracket, side supports and hardware for securing tub to concrete or stud wall
- Smooth surface, rust resistant



Part #	Mfg #	Size	Mounting	Price
MUS19F	19F	20" x 24"	Floor	115.54
MUS19W	19W	20" x 24"	Wall	115.54

Co-PolyPure® Laundry Tubs

Single Utilatwin® Co-PolyPure® Laundry Tubs

- Smooth, white satin-finish is a polypropylene-injected molded material
- Floor mounted
- Ribbed underbody
- Utilatub® has 1-1/2" integral molded drain
- Faucet sold separately



Part #	Mfg #	Description	Price
MUS14K	14K	23", 20 gal Laundry Tray	54.26

Laundry Tub Parts & Accessories

Part #	Mfg #	Description	Price
MUS26619	26.619	Twin Waste for 26F Laundry Tub	53.22

27F & 27W Utilatwin® Thermoplastic Laundry Tub

- Sturdy, 1-piece, extra deep molded tubs
- Made with structural thermoplastic - innovative cellular molding process makes these white tubs "literally indestructible"
- Include twin drain waste connector - joins drain assemblies, assures rapid and uniform discharge of waste water, washers, slip nuts and stoppers provided
- 19 Gallon capacity per tub, 13" deep
- Hooks up to standard 1-1/2" P or S trap
- Accommodate single or dual-handle faucet with 4" or 8" centers (sold separately)
- Floor model Includes adjustable leg levelers
- Wall model includes wall mounting bracket, side supports and hardware for securing tub to concrete or stud wall
- Smooth surface, rust resistant



Part #	Mfg #	Size	Mounting	Price
MUS27F	27F	40" x 24"	Floor	253.08
MUS27W	27W	40" x 24"	Wall	253.08

Laundry Tubs & Accessories



All Items May Not Be Stocked In All Branches

Toilet Seats

Residential Toilet Seats

Brevia™ Residential Seat and Cover with Q2 Advantage

- Quick-Attach™ hardware for a fast and secure installation
- Quick-Release™ hinges allow the seats to be easily removed for cleaning
- Fits one- and two-piece toilets
- Made of solid polypropylene and is resistant to staining, fading, chipping and peeling
- Closed-front
- Contoured seat for user comfort



Part #	Mfg #	Description	Color	Price
KOHK4774W	K-4774-0	Elongated Seat, Closed Front w/Q2 Advantage™	White	25.50
KOHK4774BI	K-4774-96	Elongated Seat, Closed Front w/Q2 Advantage™	Biscuit	25.50

Cachet™ Quiet-Close™ Residential Seat and Cover

- Solid polypropylene plastic resistant to staining, fading, chipping peeling
- Ergonomically contoured seat and cover
- Slow closing lid and ring with Quick-Release™ functionality
- Fits one- and two-piece toilets



Part #	Mfg #	Description	Color	Price
KOHK4639W	K-4639-0	Round Seat, Closed Front, Quiet-Close Hinge	White	48.30
KOHK4636W	K-4636-0	Elongated Seat, Closed Front, Quiet-Close Hinge	White	61.45
KOHK4636BI	K-4636-96	Elongated Seat, Closed Front, Quiet-Close Hinge	Biscuit	80.00

Visionary Baths & More

Because your time is valuable...

Visit your local Visionary Baths & More Kitchen and Bath Design Centers to let one of our trained knowledgeable consultants help you with your project.

<http://www.visionarybaths.com>

Toilet Seats

Fixture Parts & Accessories

Residential Molded Wood Toilet Seats

500EC/1500EC Easy-Clean & Change™ Closed Front Molded Wood Seat

- Lifts off for easy cleaning - twist hinge to unlock
- Color-matched Easy-Clean & Change™ bumpers & hinges
- Lift-Off™ top-tightening bolts, wing nuts, and no-slip washers



Part #	Mfg #	Style	Color	Price
BEM500W	500EC-000	Regular	White	18.04
BEM500IG	500EC-062	Regular	Ice Grey	20.96
BEM500AL	500EC-146	Regular	Almond	20.96
BEM500BI	500EC-346	Regular	Biscuit	18.04
BEM1500W	1500EC-000	Elongated	White	23.96
BEM1500IG	1500EC-062	Elongated	Ice Grey	27.14
BEM1500AL	1500EC-146	Elongated	Almond	27.14
BEM1500BI	1500EC-346	Elongated	Biscuit	23.96

Residential Plastic Toilet Seats

70/170 Residential Closed Front Plastic Seat with Cover

- Standard weight
- Molded-in bumpers
- Color-matched Top-Tite® hinges with non-corrosive top-tightening bolts and wing nuts
- Ring thickness is 3/8"
- Height of seat with cover is 1-1/2"

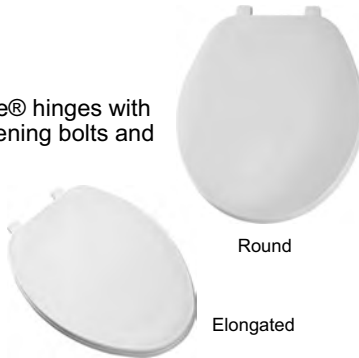

Part #	Mfg #	Style	Color	Price
BEM70W	70-000	Regular	White	17.80
BEM170W	170-000	Elongated	White	26.73

200/1200SLOW Whisper-Close™ Residential Closed Front Plastic Seat with Cover

- Easy-2-Clean & Change™ hinge
- Heavy-weight solid plastic

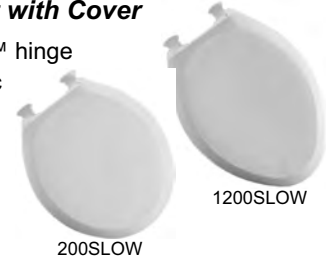

Part #	Mfg #	Style	Color	Price
BEM200SLOWW	200SLOW-000	Round	White	59.95
BEM200SLOWBI	200SLOW-346	Round	Biscuit	68.02
BEM1200SLOWW	1200SLOW-000	Elongated	White	64.40
BEM1200SLOWBI	1200SLOW-346	Elongated	Biscuit	74.97

800EC/1800EC Easy-Clean & Change™ Closed Front Plastic Seat

- Lifts off for easy cleaning - twist hinge to unlock
- Color-matched Easy-Clean & Change™ hinges with stainless steel pintles
- Lift-Off™ top-tightening bolts, wing nuts, and no-slip washers



Part #	Mfg #	Style	Color	Price
BEM800W	800EC-000	Round	White	26.30
BEM800BN	800EC-006	Round	Bone	31.58
BEM800BI	800EC-346	Round	Biscuit	26.30
BEM1800W	1800EC-000	Elongated	White	35.12
BEM1800BN	1800EC-006	Elongated	Bone	40.40
BEM1800BI	1800EC-346	Elongated	Biscuit	35.12

Call Us For Special Order Colors

Toilet Seats

200TC/1200TC Residential Closed Front Plastic Seat with Cover

- Heavy-weight & injection molded of solid plastic
- Features large molded-in bumpers
- Color-matched Top-Tite® hinges
- Closed front, includes cover

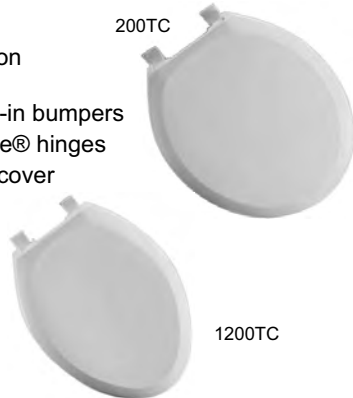

Part #	Mfg #	Style	Color	Price
BEM200W	200TC-000	Regular	White	48.94
BEM200BI	200TC-346	Regular	Biscuit	53.60
BEM1200W	1200TC-000	Elongated	White	62.06
BEM1200IG	1200TC-062	Elongated	Ice Grey	78.85
BEM1200BI	1200TC-346	Elongated	Biscuit	69.51

Commercial Plastic Toilet Seats

1655SSC Commercial Open Front Plastic Seat

- Extra heavy-weight
- Self-sustaining & external check hinge
- Cover sold separately



Part #	Mfg #	Style	Color	Price
BEM1655SSCW	1655SSC-000	Elongated	White	58.04

955C/1955C Commercial Open Front Plastic Seat

- Heavy-weight
- External check hinge with stainless steel post
- Cover sold separately

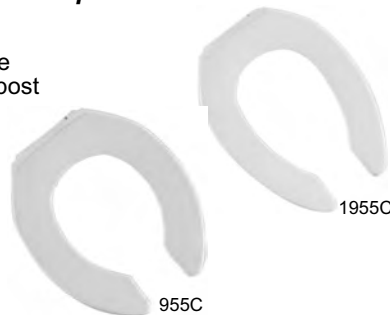

Part #	Mfg #	Style	Color	Price
BEM955CW	955C-000	Regular	White	31.64
BEM1955CW	1955C-000	Elongated	White	31.64
BEM1955CBK	1955C-047	Elongated	Black	31.64

1955SSC Commercial Open Front Plastic Seat

- Heavy-weight
- Self-sustaining & external check hinge
- Cover sold separately



Part #	Mfg #	Style	Color	Price
BEM1955SSCW	1955SSC-000	Elongated	White	35.87

1950 Commercial Open Front Plastic Seat with Cover

- Commercial weight
- Top-Tite® hinge



Part #	Mfg #	Style	Color	Price
BEM1950W	1950-000	Elongated	White	75.63

Color Direct Seats

- Choice of 94 colors

Part #	Mfg #	Description	Price
BEMCOLORPKG	CLRDRCT	Must Specify Color	89.57

**"Service Starts Here"
is not just a motto
it's how we do business.**



Fixture Parts & Accessories

Parts & Accessories

Fixture Parts & Accessories

Trip Levers

Wellworth™ Class Five™ Trip Lever

- Solid brass construction
- For Wellworth™ & Highline™ toilets



Part #	Mfg #	Description	Price
KOHK9386LBN	K-9386-L-BN	LH, Vibrant Brushed Nickel	49.35

Wellworth®/Highline™ Trip Lever

- Solid brass construction
- For Wellworth® & Highline™ toilets



Part #	Mfg #	Description	Price
KOHK9404LBN	K-9404-L-BN	LH, Vibrant Brushed Nickel	49.35

Wellworth® Water-Guard® Trip Lever & Nut

- For model K-3520



Part #	Mfg #	Description	Price
KOH30324	30324-CP	LH, Pol Chrome	13.62

Valve Repair & Accessories

Valve Repair Kit

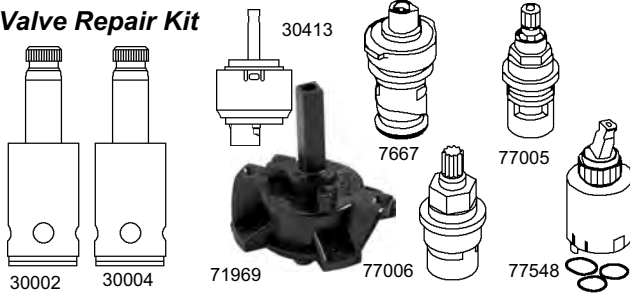

Part #	Mfg #	Description	Price
KOH30002	30002	2-1/2" Valve Unit, RH	18.90
KOH30004	30004	2-1/2" Valve Unit, LH	18.90
KOH30006	30006	Valve Seat & Washer, Plunger & O-Rings, RH	8.10
KOH30413	30413	Single Control for Older Coralais® Cart Vlv Rpr Kit	27.90
KOH71969	71969	Valve Mixer Kit for Coralais® Bath & Shower Faucets	33.10
KOH76671	76671	Coralais® Valve Kit, CCW Close	9.90
KOH77005	77005-RP	Valve Kit- CW	14.90
KOH77006	77006-RP	Valve Kit- CCW	14.90
KOH77548	77548	Single Control Valve Kit Coralais™	12.90

Niedecken Kit

Part #	Mfg #	Description	Price
KOH30090	30090	Repair Kit	31.98
KOH30092	30092	Yoke, Bath/Shower	61.40

Valve Stems

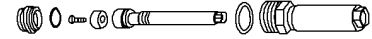

Part #	Mfg #	Description	Price
KOH30119	30119	Stem & Seat Assembly, RH for Trend Bath & Shower Faucets, Clockwise Close	19.20

Washer & Gasket

Part #	Mfg #	Description	Price
KOH51487	51487	Tank Gasket	12.90
KOH53410	53410	Flush Valve Washer	2.80

Parts



Part #	Mfg #	Description	Price
KOH76851	76851	Mixer Cap/Pressure Balance Unit Sp Kit	89.00
KOH500520	500520	Pressure Balance Unit	75.74
KOH1083980	1083980	Canister Valve Assembly Kit	18.90
KOH1085760	1085760	Canister Valve Assembly Kit	19.70
KOH1105656	1105656	1.549" x .103" #129 O-Ring	1.22
KOHGP1039444	GP1039444	Flapper Assembly	10.90
KOHGP1059291	GP1059291	Seal Kit for Cimarron Tank	6.90
KOHGP1074231	GP1074231	Spline Adapter Kit (includes Two 78125)	3.20
KOH1078440	GP1078440	Flapper Assembly	7.90
KOHGP1083167	GP1083167	Adjustable Fill Valve Kit	19.99
KOHGP1138930	GP1138930	Fill Valve Service Kit 400A Series	18.99
KOHGP30000	GP30000	Plug Button Kit	7.80
KOHGP41398CP	GP41398-CP	Pol Chrome Strainer Cup Assembly	19.90
KOH77759	GP77759	Mixer Cap Kit (Shower)	39.50

All Items May Not Be Stocked In All Branches

Parts & Accessories

Residential Drains

No-Calk® Shower Base Drain

- The original Caspers No-Calk® shower drain
- Designed for use with preformed shower bases; fiberglass, acrylic, nylon or metal
- Mechanically attaches over 2" Sch 40 DWV pipe
- The drain is fixed to the drain pipe from above the shower base
- Ideal for slab construction
- 4-1/4" Snap-in strainer
- Fiber & rubber gasket provides a tight seal to the base



Part #	Mfg #	Description	Price
DEADRAINCP	42150	2" NC Brass with SS Strainer	61.20

Drain Strainers

Universal 4-1/4" Snap Tight Strainers in Designer Finishes

- For use with 101PNC & 140 NC No-Caulk, snap-in shower drains and 101 PS solvent weld & 2-part shower drains
- PVD is UltraShine® finish



Part #	Mfg #	Description	Price
DEAGRIDSN	42014	4-1/4" Satin Nickel	4.75
DEAGRIDORB	42017	4-1/4" Rubbed Brz Carded	48.74
DEAGRIDBN	42018	4-1/4" Brass Nickel Carded	26.10
DEAGRIDPB	42137	4-1/4" PVD Pol Brass	57.04



Gerber Toilet Parts

Trip Lever

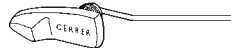

Part #	Mfg #	Description	Price
GER99656	99-656	Chrome LH Trip Lever for Viper Tank	18.10
GER99656WH	99-656WH	White LH Trip Lever for Viper Tank	18.10
GER99571	99-571KT	Chrome Tank Lever	17.30



Urinal Parts

Push Button Urinal Valve Cartridge

- Assembly complete with dash pot

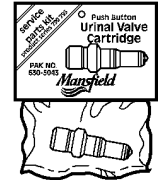

Part #	Mfg #	Description	Price
MAN5043	630-5043	Push Button Urinal Valve Cartridge Assembly w/Dashpot	61.35



High-Gloss Window Trim Kits

- For window sill application up to 36"W x 8"D
- Ultra-bright, glossy surface from durable, bake-on finish
- Will not mold or mildew, no grout to clean
- Limited lifetime warranty

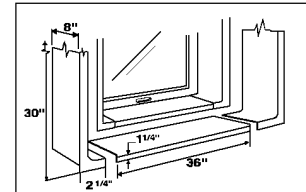

Part #	Mfg #	Color	Price
SWAWTK1W	WTK-1	White	193.00

Fixture Parts & Accessories

Water Coolers

No Lead Water Coolers

Barrier-Free Wall Mount Adult/Child Access No Lead Water Coolers

- Uses HFC-134A refrigerant
- Barrier-free ADA design
- GPH Capacity based on 80°F inlet water temperature, 90°F room temperature, 50°F drinking water temperature
- Extra deep basin
- Easy-touch controls on right and left sides



Part #	Mfg #	Capacity	Rated	Full Load	Ship Wt	Description	Price
ELKEZS8L	EZS-8L	8.0 gph	370W	4.0A	56 lbs	Light Gray Granite	CALL
ELKEZSTL8L	EZSTL-8LC	8.0 gph	370W	4.0A	89 lbs	Bi-level, Hi on L, Light Gray Granite	CALL

Water Coolers

We Value Your Opinion
Let us know what we are doing right, but more importantly let us know how we can serve you better.



Plumbing Chemicals

Cements

PVC 704™ Clear Medium Bodied Cements

- Fast setting, up to 6" Sch 40 and 4" Sch 80



Part #	Mfg #	Model #	Size	Price
CEM7044	12126	107040051	1/4 pt	6.95
CEM7048	12125	107040041	1/2 pt	9.95
CEM70416	12124	107040031	1 pt	16.75
CEM70432	12123	107040021	1 qt	27.75

CPVC 713™ Orange Regular Bodied Cements



Part #	Mfg #	Model #	Size	Price
CEM7134	10129	107130651	1/4 pt	8.15
CEM7138	10128	107130641	1/2 pt	13.05
CEM71316	10127	107130631	1 pt	21.00

PVC 747™ Pool 'R Spa™ Blue Medium Bodied Low Voc Cement

- Extremely fast setting, up to 6" Sch 40 and 4" Sch 80
- Fades to clear in sunlight



Part #	Mfg #	Model #	Size	Price
CEM74716	10853	107470931	1 pt	19.80



Plastic Pipe Cements

All Purpose Cement

- Medium-bodied milky clear cement for ABS, PVC & CPVC up to 6" diameter
- Recommended application temperature 40°F to 100°F
- Recommended for Sch 40 & Sch 80, potable water, pressure pipe, gas, conduit & DWV
- Meets performance requirements of ASTM D-2564, D-2235 & F-493



Part #	Mfg #	Size	Price
CEMOATAP4	30818	4 oz	7.06
CEMOATAP8	30821	8 oz	11.62
CEMOATAP16	30834	16 oz	23.72
CEMOATAP32	30847	32 oz	41.02

PVC Heavy Duty Clear Cement

- Heavy-bodied clear cement for PVC pipe & fittings up to 12" dia for Sch 40 & Sch 80
- Recommended for all grades & types of PVC pipe & fittings, potable water, pressure pipe, gas, conduit & DWV
- Helps fill gaps in large diameter pipe & loose fitting joints



Part #	Mfg #	Size	Price
CEMOATHD4	30850	4 oz	7.42
CEMOATHD8	30863	8 oz	11.78
CEMOATHD16	30876	16 oz	21.08
CEMOATHD32	31008	32 oz	32.66

PVC Medium Clear Cement

- Medium-bodied clear cement for use on PVC pipe & fittings up to 6" dia for Sch 40 & Sch 80
- Recommended application temperature 40°F to 100°F
- Recommended for all grades & types of PVC pipe & fittings, gas, conduit, drain, waste & vent pipe, pressure pipe & potable water
- Meets ASTM D-2564



Part #	Mfg #	Size	Price
CEMOATMD4	31017	4 oz	6.36
CEMOATMD8	31018	8 oz	10.06
CEMOATMD16	31019	16 oz	18.14
CEMOATMD32	31020	32 oz	25.78

Plumbing Chemicals

Prices & Specifications are Subject to Change.

Plumbing Chemicals

PVC Heavy-Duty Gray Cement

- Heavy-bodied gray colored cement for use on PVC pipe & fittings up to 12" dia for Sch 40 & Sch 80
- Recommended for all grades & types of PVC pipe & fittings, potable water, pressure pipe, gas, conduit & DWV
- Thick formula fills gaps in large diameter pipe & fittings
- Recommended application temperature 40°F to 100°F
- Meets ASTM D-2564



Part #	Mfg #	Size	Price
CEMOATSCH8016	31095	16 oz	12.15
CEMOATSCH8032	31105	32 oz	19.88

CPVC Medium Orange Cement

- Medium-bodied orange colored cement for use on CPVC pipe & fittings up to 6" diameter
- For C.T.S. (copper tube size) & Sch 80, potable water pressure pipe
- Recommended application temperature 40°F to 100°F
- Meets ASTM F-493



Part #	Mfg #	Size	Price
CEMOATCPVC4	31128	4 oz	7.96
CEMOATCPVC8	31129	8 oz	12.52
CEMOATCPVC16	31130	16 oz	24.32
CEMOATCPVC32	31131	32 oz	26.86

PVC Rain-R-Shine® Blue Cement

- Medium bodied blue colored cement for use on PVC pipe & fittings up to 6" dia
- Very fast setting cement formulated for wet conditions &/or quick pressurization & fast installation
- Use with Sch 40 & 80
- Pool/irrigation
- Recommended application temperature 40°F to 100°F
- No primer needed on non-pressure DWV, where local codes permit
- Meets ASTM D-2564



Part #	Mfg #	Size	Price
CEMOATRS8	30891	8 oz	12.34
CEMOATRS16	30893	16 oz	22.60

LO-V.O.C CPVC Flowguard® Gold™

1-Step Yellow

- Exceeds new environmental requirements & meets various California district rules
- May be used without primer - where local codes permit
- For cold water systems & hot water systems up to 180°F
- Faster cure time/reduced installation time
- For copper tube size (CTS) CPVC hot & cold potable water pipe & fittings up to 2" dia interference fit only
- Meets ASTM F-493



Part #	Mfg #	Size	Price
CEMOATFG8	31911	8 oz	14.00
CEMOATFG16	31912	16 oz	17.31
CEMOATFG32	31913	32 oz	30.22

PVC All Weather Clear Cement

- Medium bodied clear cement for use on PVC pipe & fittings up to 6" dia
- Formulated for fast initial set-up at temps down to -5° to 100°F Sch 40 & Sch 80
- Non-pressure, DWV, up thru 4" dia: no primer needed - where local codes permit
- Recommended for all grades & types of PVC pipe & fittings, potable water, pressure pipe, gas, conduit & DWV
- Meets ASTM D-2564



Part #	Mfg #	Size	Price
CEMOATAW16	31132	16 oz	22.56
CEMOATAW32	31133	32 oz	30.22



www.irrsupply.com

Plumbing Chemicals

Plastic Pipe Primers & Cleaners

PVC & CPVC UnPurple Primer (Green Label)

- Softens & prepares surfaces of PVC pipe and fittings before applying solvent cements
- Special purple dye appears clear - purple color revealed only under UV light



Part #	Mfg #	Size	Price
CLEOATUNPUR16	60445	1 pt	19.76
CLEOATUNPUR32	60447	1 qt	32.72

PVC & CPVC UnPurple Primer Flashlight



Part #	Mfg #	Description	Price
OAT50350	50350	High Intensity UV Flashlight	22.76



Primers & Cleaners

PVC/CPVC P-70™ Low Voc Purple Primer



Part #	Mfg #	Model #	Size	Price
CLEP7032	10223	107700421	1 qt	32.95

PVC/CPVC/ABS/Styrene C-65™ Low Voc Clear Cleaner



Part #	Mfg #	Model #	Size	Price
CLEC654	10204	107650051	1/4 pt	5.50
CLEC658	10203	107650041	1/2 pt	8.20
CLEC6516	10202	107650031	1 pt	14.25
CLEC6532	10201	107650021	1 qt	20.95



Plastic Pipe Primers/Cleaners

Clear Primer - NSF Listed

- A clear aggressive primer for use on PVC and CPVC pipe and fittings
- Removes all surface dirt & grease as well as softens pipe in preparation for solvent cement
- All schedules and all diameters
- Meets ASTM F-656



Part #	Mfg #	Size	Price
CLEOATCLR8	30751	8 oz	9.80
CLEOATCLR16	30752	16 oz	21.36
CLEOATCLR32	30753	32 oz	27.56

Purple Primer - NSF Listed

- Purple-tinted aggressive primer for use on PVC & CPVC pipe & fittings
- Removes surface dirt, grease & grime as well as softens pipe surface for fast, secure solvent weld
- For use when code calls for verification that a primer has been used
- Meets ASTM F-656



Part #	Mfg #	Size	Price
CLEOATPUR8	30756	8 oz	10.06
CLEOATPUR16	30757	16 oz	22.04
CLEOATPUR32	30758	32 oz	29.00

Cleaner

- Clear cleaner for ABS, PVC & CPVC pipe and fittings
- All schedules and all diameters
- Flows freely and evaporates quickly
- Fast removal of surface dirt, grease and grime



Part #	Mfg #	Size	Price
CLEOATAP4	30779	4 oz	5.86
CLEOATAP8	30782	8 oz	8.48
CLEOATAP16	30795	16 oz	14.56
CLEOATAP32	30805	32 oz	21.74

Plumbing Chemicals

Prices & Specifications are Subject to Change.



www.irrsupply.com

Plumbing Chemicals

Drain & Waste System Cleaners

Wham® Drain & Waste System Cleaner

- Environmentally safe and biodegradable, non-caustic and non-acid
- Dissolves and controls grease, slime, soap detergents and odors in waste systems
- Harmless to digestive bacteria
- Restores porosity and maximum drainage to grease-clogged soil



Part #	Mfg #	Size	Price
HER20110	20110	1 qt	48.02
HER20115	20115	1 gal	146.74

Clobber®

For Professional Use Only. Not for Retail Sale.

- Fastest method for clearing emergency waste line stoppages
- No mechanical equipment needed
- Rapidly disintegrates paper, rags, sanitary napkins, food scraps & all organic matter, melts ice & liquefies grease
- Special inhibitors prevent corrosion of cast iron, copper, & steel piping
- Jugs with child-resistant caps packed in plastic bags



Part #	Mfg #	Size	Price
HER20205	20205	1 qt	27.76
HER20211	20211	1/2 gal	48.52

Sizzle® Cleaner

For Professional Use Only. Not for Retail Sale.

- Removes lime, rust, scale, concrete, hard mineral deposits & insoluble salts from water systems, waste lines, humidifiers, heating, processing & air conditioning equipment
- Dissolves urinary salts
- Special inhibitors make it safe for iron, steel, copper, brass, bronze, lead & plastic
- Child-resistant caps



Part #	Mfg #	Size	Price
HER20305	20305	1 qt	22.26
HER20310	20310	1 gal SAF-T-POR Spout	56.70

R-D Root Destroyer

- Clears & prevents root-blocked sewer lines
- Non-caustic & non-acid
- Safe to use in lines leading to septic tanks
- Works only on live roots - will not harm trees or shrubs



Part #	Mfg #	Size	Price
HER20602	20602	2 lb	45.38

Septic Tank & Cesspool Cleaner

- Dissolves grease & organic matter
- Improves drainage conditions
- Ideal for emergency use to eliminate back-up & overflow



Part #	Mfg #	Size	Price
HER20705	20705	5 lb	65.32

Break-Thru™ Drain & Waste System Cleaners

GLUG™ Crystals

- Non-acid crystals clear sluggish drains & prevent clogging
- Harmless to metal & plastic pipe, valves & fittings
- Leaves no offensive after-odor



Part #	Mfg #	Size	Price
HER20410	20410	20 oz	9.71

Liquid GLUG™ for Bathrooms

- Maximum strength
- Attacks clogs caused by hair & soap deposits
- Flows through standing water



Part #	Mfg #	Size	Price
HER20455	20455	1/2 gal	12.31

Plumbing Chemicals

All Items May Not Be Stocked In All Branches



www.irrsupply.com

Plumbing Chemicals

Flux

All Hercules Fluxes Can be Used with Soft Solder Alloys on Commonly Soldered Metals, but NOT Recommended for Use on Aluminum or Some Grades of Stainless Steel

Climate Smooth™ Soldering Paste

- Self-cleaning lead-free formula
- Made to withstand extreme climate temperatures
- Smooth, easily applied paste flux for easy flow in hot or cold weather
- For sweat soldering on most common metals



Part #	Mfg #	Size	Price
HER10606	10606	1.8 oz	4.54
HER10619	10619	9 oz (Brush-In-Cap)	13.70
HER10616	10616	1/2 lb	12.50
HER10621	10621	1 lb	21.58

Thread Sealants

Pipe Joint Compound

- Lead-free, non-toxic, non-setting formula makes leak-proof joints
- Safe for drinking water lines
- Approved for natural gas



Part #	Mfg #	Size	Price
HER15308	15308	2 oz Tube	3.80

Pro Dope® Compound

- Lead-free, no-drip, no-spill, non-toxic pipe joint compound
- No mixing - will not harden - uniform throughout can
- Lubricates while forming tight pressure seal
- Inhibits rust & corrosion
- Wipes clean from hands



Part #	Mfg #	Size	Price
HER15420	15420	1/2 pt	8.60
HER15427	15427	1 pt	13.96

Megaloc™ Sealant

- Lead-free, blue, grit-free high performance thread sealant
- Leak-proof hydraulic resistance to 12,000 psi
- Withstands gas pressure to 2,600 psi
- Performs over temperatures of -50° to +400°F
- Odorless, non-separating & non-hazardous
- Never hardens, cracks or becomes brittle
- Wipes clean from hands with a dry rag



Part #	Mfg #	Size	Price
HER15806	15806	8 oz	23.52
HER15808	15808	16 oz	38.00
HER15811	15811	32 oz	70.48

Grrip™ Pipe Joint

- Lead-free, all-purpose, leak-proof, non-hardening pipe joint & gasket seal
- Brushable semi-liquid forms tough, pliable film on joints, valves, flanges & gaskets



Part #	Mfg #	Size	Price
HER15510	15510	1/4 pt	13.34
HER15515	15515	1/2 pt	19.24
HER15520	15520	1 pt	33.08

Grrip™ Lite Pipe Joint

- Same as above, except formulated not to leave dark stains on skin, tools, equipment or clothing



Part #	Mfg #	Size	Price
HER15555	15555	1/2 pt	20.16

Real-Tuff™ Sealant

- Lead-free, multi-purpose, heavy-duty PTFE paste thread sealant
- Non-toxic & non-separating
- Positive, leak-proof seal on all piping material & for all liquids and gases except oxygen



Part #	Mfg #	Size	Price
HER15615	15615	1/4 pt	13.74
HER15620	15620	1/2 pt	24.68
HER15625	15625	1 pt	44.20

Plumbing Chemicals

Prices & Specifications are Subject to Change.



www.irrsupply.com

Plumbing Chemicals

Block™ Pipe Dope

- Lead-free, brushable, blue, all-purpose, leak-proof non-hardening, pipe joint & gasket sealing compound
- Semi-liquid forms tough, pliable film on joints, valves, flanges & gaskets



Part #	Mfg #	Size	Price
HER15707	15707	1/2 pt	24.58

Epoxy

Pro Poxy® 20

- Electrically non-conductive
- Withstands temperatures to 300°F
- Fast acting, single stick, steel-reinforced epoxy putty
- Makes steel-hard repairs in 20 minutes



Part #	Mfg #	Size	Price
HER25515	25515	4 oz	8.96

Putty

Plastic Seal™

- Excellent lead substitute for caulking cast iron soil pipe joints
- Single component polyurethane sealant that cures rapidly to a durable, flexible, waterproof seal
- Does not contain any volatile organic compounds



Part #	Mfg #	Size	Price
HER25215	25215	10.3 oz	23.26

Sta Put®

- Flexible, stretchable, plastic putty that will not harden, crumble, crack or shrink
- Will not stick to hands



Part #	Mfg #	Size	Price
HER25101	25101	14 oz	3.84
HER25103	25103	3 lb	11.42
HER25105	25105	5 lb	18.46
HER25110	25110	7 lb	25.86

Sta Put® Ultra

- Non-staining
- Oil-free and can be used without pre-treatment for natural, porous surfaces such as stone, marble, granite, plastics, rubber, fiberglass, grout on manufactured sinks, shower bases, countertops, etc.
- Safe for most types of plumbing fixtures & surfaces
- Molds easily, remains permanently soft, malleable & flexible
- Will not melt, rot, crumble, dry out or shrink
- No greasy residue on hands or surfaces



Part #	Mfg #	Size	Price
HER25171	25171	14 oz	9.16

Roof & Flashing Sealant

- Special bituminous composition with superior adhesion under the most severe weather conditions
- Heavy, paste-like consistency, easily applied with trowel or putty knife
- Adheres to wet/moist surfaces - can be applied in rain
- Forms durable, flexible, weatherproof coating



Gallon

Part #	Mfg #	Size	Price
HER25405	25405	1 qt	23.82

Anti-Freeze

Cryo-Tek™ 100 Anti-Freeze

- Gives anti-freeze protection to -100°F when used undiluted
- Contains chemical ingredients to prevent corrosion
- Non-toxic



Part #	Mfg #	Size	Price
HER35281	35281	1 gal	55.87
HER35284	35284	5 gal	276.02
HER35287	35287	55 gal	2767.89

Plumbing Chemicals

All Items May Not Be Stocked In All Branches



www.irrsupply.com

Plumbing Chemicals

Cryo-Tek™ Test Kit

- Checks level of propylene glycol & level of corrosion protection



Part #	Mfg #	Description	Price
HER35271	35271	Contains (10) Color-Coded Disposable Test Strips	17.49

Cryo-Tek™ Triple Protection Inhibitor

- Liquid corrosion protection additive
- Used to adjust pH of hydronic systems charged with cryo-tek anti-freeze



Part #	Mfg #	Size	Price
HER35276	35276	8 oz	18.04

Lubricants

Cutting Oil - Clear

- Recommended for hand-threading applications
- High quality mineral oils with sulfur base
- Will not stain brass or copper
- Contains no nitrosamines



Part #	Mfg #	Size	Price
HER40115	40115	1 qt	23.84
HER40120	40120	1 gal	57.22

Cutting Oil - Dark

- For high speed machine-threading requirements
- High quality mineral oils with sulfur-lard base
- Contains no nitrosamines



Part #	Mfg #	Size	Price
HER40215	40215	1 qt	23.84
HER40220	40220	1 gal	55.46

Lube Oil with Extenda-Spout

- Non-gumming, non-toxic, non-foaming non-detergent, multi-purpose oil for wherever metal lubrication is required



Part #	Mfg #	Size	Price
HER40404	40404	4 oz	5.24

300° Plumbers Grease

- Valve & faucet stem grease
- For use on steam & hot water
- Non-melting, non-hazardous & waterproof



Part #	Mfg #	Size	Price
HER40601	40601	2 oz	7.04

Brushes

Pipe Dope Brush

- Round, extra-strong, natural bristle brush with wood handle



Part #	Mfg #	Size	Price
HER50310	50310	7"	1.71

Acid, Flux, & Swif® Solder Brush

- Metal shaft, natural bristle brush



Part #	Mfg #	Size	Price
HER50400	50400	5-3/4"	0.33

Gas Leak Detectors

- Detects gas leaks in pipe lines, tanks, etc.
- Used to detect leaks of air, natural gas, refrigerants, CO2 & almost all known gases



Part #	Mfg #	Description	Price
HER45801	45801	8 oz Dauber Bottle	8.09
HER45804	45804	16 oz Spray Bottle	16.98

Plumbing Chemicals

Prices & Specifications are Subject to Change.



www.irrsupply.com

Plumbing Chemicals

Hand Cleaners

Hercules For Hands™ Tub

- Ready-to-use, pre-saturated towels remove plastic pipe cement, grease & grime, tar & ink from users' hands
- Contains aloe, lanolin, & vitamin E
- Won't shred - leaves no residue



Part #	Mfg #	Size	Towel Qty	Price
HER45333	45333	Large	70/Tub	22.20



Teflon® Thread Sealants

Blue Monster™ Heavy-Duty Industrial Grade Thread Sealant Compound

- Slow-drying, soft-setting, non-hardening pipe thread compound
- Recommended for on-site or assembly line work
- Lead-free, non-toxic - will not harden or separate in the can



Part #	Mfg #	Size	Price
BLMST4	76009	1/4 pt	8.46
BLMST8	76011	1/2 pt	13.34
BLMST16	76015	1 pt	21.01
BLMST32	76019	1 qt	38.76

Blue Monster™ PTFE Pipe Thread Sealant Compound

- Seals threads on all metals, PVC, CPVC, ABS and nylon plastic pipe systems
- Does not require any set or cure time



Part #	Mfg #	Size	Price
BLMST4T	76001	4 oz	9.35
BLMST8T	76003	1/2 pt	14.58
BLMST16T	76005	1 pt	23.06



Pipe Compounds

Pipe/Gasket Lube

- Non-toxic, soft, paste like material for lubricating bell joint pipe gaskets
- Will not deteriorate natural or synthetic rubber
- Will not support bacteria
- Dissolves in hot water



Part #	Mfg #	Size	Price
OATLUBE	30600	1 qt	9.44



X-Pando Pipe Joint Compound

- For flanged or threaded joints, expands as it sets
- Comes as a powder, mix only what you need with water to create a tight, leak proof joint
- Tasteless, odorless and non-toxic
- Recommended for use on joints of most kinds of pipes
- Withstands deflections, vibrations, high pressures (up to 5000 psi) and extreme temperatures (-300° to 1000°F)

Part #	Mfg #	Description	Price
XPA1	12001	14 oz Can	20.72

Plumbing Chemicals

All Items May Not Be Stocked In All Branches

Tubular Brass

Brass P-Traps

P-Traps Less Cleanout

- DF - Deep flange
- -1 Polished chrome



Part #	Mfg #	Size	Gauge	Price
DEA700DF	700DF-1	1-1/4"	20	20.44
DEA702DF	702DF-1	1-1/2"	20	23.12
DEA701	701-1	1-1/4"	17	23.97
DEA704	704-1	1-1/2"	17	27.84

Brass Repair Traps

- -1 Polished chrome



Part #	Mfg #	Size	Gauge	Price
DEA700R	700R-1	1-1/4"	20	33.71
DEA702R	702R-1	1-1/2"	20	36.75

Brass Low Inlet Tube P-Traps

- A - 3" Longer
- -1 Polished chrome



Part #	Mfg #	Size	Gauge	Price
DEA711A	711A-1	1-1/4"	17	33.33
DEA714A	714A-1	1-1/2"	17	40.05

Brass Sink Traps

Washer Joint Sink Traps

- -1 Polished chrome



Part #	Mfg #	Size	Gauge	Price
DEA738W	738W-1	1-1/2"	20	25.06

Brass J-Bends

Brass J-Bends

- Without cleanout
- -1 Polished chrome



Part #	Mfg #	Size	Gauge	Price
DEA650	650-1	1-1/4"	20	36.60
DEA651	651-1	1-1/2"	20	40.00

Brass Sink J-Bends

- Ground joint unless noted
W - Washer joint
- -1 Polished chrome



Part #	Mfg #	Size	Gauge	Price
DEA654	654-1	1-1/2"	20	47.96
DEA654W	654W-1	1-1/2"	20	15.87

Brass S-Traps

- -1 Polished chrome



Part #	Mfg #	Size	Gauge	Price
DEA2718	2718-1	1-1/4"	22	28.93
DEA2720	2720-1	1-1/2"	22	83.92
DEA718	718-1	1-1/4"	20	35.16
DEA720	720-1	1-1/2"	20	38.93

Brass End Outlet Wastes

Slip-Joint End Outlet Wastes

- -1 Polished chrome



Part #	Mfg #	Size	Gauge	Price
DEA2108A	2108A-1	1-1/2" x 16"	22	33.61
DEA108A	108A-1	1-1/2" x 16"	20	42.64

Hi-Line End Outlet Wastes

- -1 Polished chrome



Part #	Mfg #	Size	Gauge	Price
DEA2121A	2121A-1	1-1/2" x 16"	Budget	33.84

Plumbing Specialties

Prices & Specifications are Subject to Change.

Tubular Brass

Brass Center Outlet Wastes

Slip-Joint Center Outlet Wastes

- 1 Polished chrome



Part #	Mfg #	Size	Gauge	Price
DEA2114A	2114A-1	1-1/2" x 16"	Budget	41.89
DEA114A	114A-1	1-1/2" x 16"	20	53.78

Hi-Line Center Outlet Wastes

- 1 Polished chrome



Part #	Mfg #	Size	Gauge	Price
DEA2123A	2123A-1	1-1/2" x 16"	22	35.29
DEA123A	123A-1	1-1/2" x 16"	20	126.34

Brass Waste Arms

Hi-Line Waste Arms

- 1 Polished chrome



Part #	Mfg #	Size	Gauge	For	Price
DEA138C	138C-1	1-1/2" x 15"	20	16" EO	49.18

Brass Extension Tubes

Slip-Joint Extension Tubes

- 1 Polished chrome



Part #	Mfg #	Size	Gauge	Price
DEA790	790-1	1-1/4" x 6"	Budget	7.60
DEA790A	790A-1	1-1/4" x 8"	Budget	8.86
DEA791A	791A-1	1-1/4" x 12"	Budget	10.68
DEA792A	792A-1	1-1/2" x 8"	Budget	9.62
DEA793A	793A-1	1-1/2" x 12"	Budget	11.15

Threaded Extension Tubes

- 1 Polished chrome



Part #	Mfg #	Size	Gauge	Price
DEA820A	820A-1	1-1/4" x 8"	20	8.68
DEA822	822-1	1-1/4" x 12"	20	10.48
DEA827	827-1	1-1/2" x 12"	20	13.07
DEA824	824-1	1-3/8" x 12"	17	33.22

Brass Flanged Strainer Tailpieces

Flanged Strainer Tailpieces

- D - Double flange
- 1 Polished chrome



Part #	Mfg #	Size	Gauge	Price
DEA800	800-1	1-1/2" x 6"	Budget	4.73
DEA801	801-1	1-1/2" x 8"	Budget	5.95
DEA803ED	803ED-1	1-1/2" x 16"	Budget	15.02
DEA798	798-1	1-1/2"x1-1/4"x12"	20	30.62

Brass Branch Tailpieces

1/2" Nom Swt Branch Tailpieces

- 1 Polished chrome



Part #	Mfg #	Size	Price
DEA812A	812A-1	1-1/2" x 6"	16.24
DEA812B	812B-1	1-1/2" x 8"	16.68

Plumbing Specialties

All Items May Not Be Stocked In All Branches

Tubular Brass

Hose & Clamp with Threaded Top

- 1 Polished chrome



Part #	Mfg #	Size	Price
DEA814TB	814TB-1	1-1/2" x 8"	46.50

Brass Trap Offsets

- Double slip
- -1 Polished chrome



Part #	Mfg #	Size	Gauge	Price
DEA1046	1046-1	1-1/4"	20	17.83
DEA1046A	1046A-1	1-1/2"	20	19.39

Brass Slip-Joint Connections

Brass Double Slip-Joint Connection

- -1 Polished chrome



Part #	Mfg #	Size	Gauge	Price
DEA793C	793C-1	1-1/4" x 2"	20	10.65
DEA793D	793D-1	1-1/2" x 16"	20	11.47

Brass 45° Slip-Joint Connector



Part #	Mfg #	Size	Gauge	Price
DEA8477	8477	1-1/4"	20	17.47
DEA8478	8478	1-1/2"	20	18.95

Brass 90° Slip-Joint Connector

Part #	Mfg #	Size	Gauge	Price
DEA8482	8482	1-1/4"	20	19.15
DEA8483	8483	1-1/2"	20	19.73

Brass Tee Slip-Joint Connector

Part #	Mfg #	Size	Gauge	Price
DEA8481	8481	1-1-2"	20	22.11

Wrot Plugs

Two-Piece Wrot Plugs with Chain & Stopper

- -1 Polished chrome
- K - Less overflow

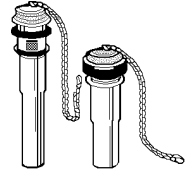

Part #	Mfg #	Size	Gauge	Price
DEA763	763-1	1-1/4" x 5"	20	35.06
DEA763K	763K-1	1-1/4" x 5"	20	16.37
DEA764A	764A-1	1-1/4" x 8"	Budget	17.09

Brass Closet Flush Elbows

- -1 Polished chrome

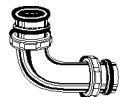

Part #	Mfg #	Size	Gauge	Price
DEA1032AD	1032AD-1	2" x 5" x 7"	20	87.20

Brass Bath Wastes

Chain & Stopper Brass Bath Wastes

- -1 Polished chrome

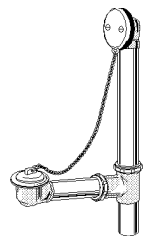

Part #	Mfg #	Description	Price
DEA202	202-1	20ga with Chrome Plated Ells & 1-3/8" Reducing Tailpiece for 16" Leg Tubs	55.87

Plumbing Specialties

Prices & Specifications are Subject to Change.

Plumbing Specialties

Brass P-Traps

Eco-Line Cast Brass Adjustable P-Traps

- Heavy cast brass J-bend with cleanout plug
- Includes brass slip nuts, & box flange
- Brass nut type
- Polished chrome
- 17 Gauge
- 5" Height

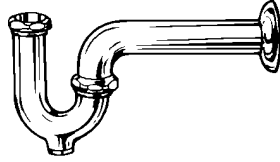

Part #	Mfg #	Size	Length	Price
MCG8872CBECO	8872CBECO	1-1/4" x 1-1/4"	11"	34.80
MCG8912CBECO	8912CBECO	1-1/2" x 1-1/2"	12"	36.91

Flanges

Brass Set Screw Flange

Part #	Mfg #	Size	Finish	Price
MCG127150	1271500	1-1/2" OD	CP	11.06

Sink Strainers

4-3/8" Stainless Steel Basket Strainer

- Heavy duty
- Cast brass lock & coupling nuts
- Will fit sink depth up to 1/2"



Part #	Mfg #	Description	Price
MCG151A	151A	1-1/2" x 4" 20ga Tailpiece, CP	33.22

Eco-Line 2-1/4" Cast Brass Open Grid P.O. Plug

- Cast brass locknut
- Will fit sink depth up to 2-1/4"
- Rubber washer
- Friction washer
- Brass locknut



Part #	Mfg #	Description	Price
MCG155AECO	155AECO	Chrome 1-1/4" x 6" 17ga Tailpiece	17.77

Lavatory Strainers

Eco-Line 5-1/8" ADA Offset Wheelchair Lavatory Strainer

- Seamless cast brass grid drain strainer, heavy cast brass elbow
- Will fit sink depth up to 2-1/4"
- Rubber washer
- Friction washer
- Cast brass P.O. plug

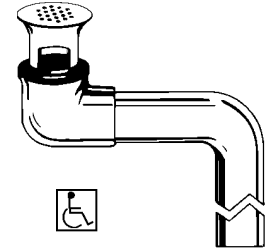

Part #	Mfg #	Description	Price
MCG155WCECO	155WCECO	1-1/4" 17ga Tailpiece, CP	33.00

Flexible Supply Kits

Standard Line Lavatory Supplies (IPS x Comp)

- 12" Flexible chrome plated riser with (2) chrome plated steel flanges
- Includes (2) chrome plated solid brass angle stops with round wheel handles, all brass stems & replaceable high tech purple washers
- LK Designates loose key

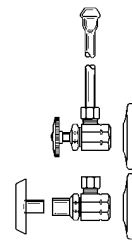

Part #	Mfg #	IPS x OD	Price
EBCLA10K	165LK	3/8" x 3/8"	22.40
MCG2165LK	2165LK	1/2" x 3/8"	29.70

Standard Line Lavatory Supplies with Extension Tube (Swt x Comp)

- 5" Flexible chrome plated copper extension tube
- 12" Chrome plated riser with (2) chrome plated steel flanges
- Includes (2) chrome plated solid brass angle stops with round wheel handles, all brass stems & replaceable high tech purple washers
- LK Designates loose key

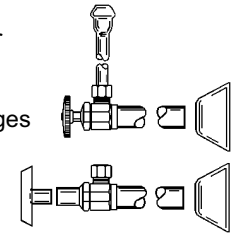

Part #	Mfg #	Swt x OD	Price
MCG170	170	1/2" x 3/8"	23.87
MCG170LK	170LK	1/2" x 3/8"	42.29

Plumbing Specialties

Standard Line Closet Supplies (Swt x Comp)

- 5" Chrome plated copper extension tube
- 12" Flexible chrome plated riser with (1) chrome plated steel flanges
- Includes (1) chrome plated solid brass angle stop with round wheel handle, all brass stems & replaceable high tech purple washers
- LK Designates loose key

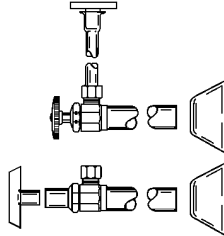

Part #	Mfg #	Swt x OD	Price
MCG172	172	1/2" x 3/8"	20.42
MCG172LK	172LK	1/2" x 3/8"	23.39

Wastes

End Outlet Continuous Waste

- Satin plated cast brass tee
- Chrome plated seamless brass waste arm
- Brass tailpiece
- Cast brass nuts

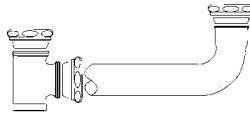

Part #	Mfg #	Size	Finish	Price
MCG111C16G17	111C16G17	17ga 1-1/2" x 16"	CP	64.17



Brass Drains

Pop-Up Brass Drain

- Pre-adjustable linkage
- Fits most tubs 14" to 16"
- Roman fits most tubs 24"

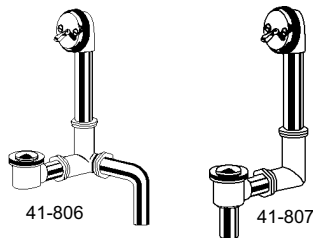

Part #	Mfg #	Description	Price
GER41807	41-807	Chrome Fit-All Side Outlet, 20 ga, Brass-Plated Zinc Nuts	114.73
GER41806	41-806	Chrome Fit-All Drain in Shoe, 20 ga, Brass-Plated Zinc Nuts	100.26

Trip Lever Brass Drain

- Pre-adjustable linkage
- Fits most tubs 14" to 16"
- Roman fits most tubs 24"



Part #	Mfg #	Description	Price
GER41818	41-818	Chrome All-Tub Drain in Tee, 20 ga, Brass-Plated Zinc Nuts	87.86
GER4181891	41-818-91	Chrome All-Tub Drain in Tee, 20 ga, Brass Nuts	92.17
GER41813	41-813	Chrome Roman, 18" O.F., 9" Shoe, 17 ga, Brass Nuts	112.59
GERN1812	N1-812	Brushed Nickel Roman, 18" O.F., 9" Shoe, 17 ga, Brass Nuts	133.45
GERN1813	N1-813	Brushed Nickel Roman, 18" O.F., 9" Shoe, 17 ga, Brass Nuts	148.70



Plastic P-Traps

PVC P-Traps

- BG - Bagged



Part #	Mfg #	Description	Price
DEA9701	P9701	1-1/4", Less Flange	4.55
DEA9701BG	P9701BG	1-1/4", Less Flange	4.38
DEA9704BG	P9704BG	1-1/2" with Threaded PVC Adapter	3.25

PVC Repair Traps

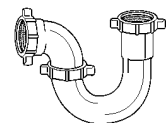

Part #	Mfg #	Description	Price
DEA9738	P9738	1-1/2" with 1-1/2" x 1-1/4" Washer & Sch40 PVC Elbow	11.70

Plumbing Specialties

Prices & Specifications are Subject to Change.

Tubular Plastic

Plastic S-Traps

Plastic S-Trap with PVC S-Bend & Solvent Weld Adapter

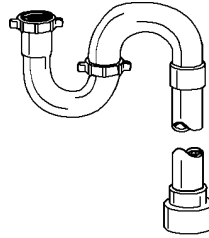

Part #	Mfg #	Size	Desc	Price
DEA9718	P9718	1-1/4"	PVC	11.70

Plastic S-Trap with ABS S-Bend & Threaded Adapter

Part #	Mfg #	Size	Desc	Price
DEA9722	P9722	1-1/2"	PVC	11.18

Plastic Wastes & Baffle Tees

Slip-Joint Plastic End Outlet Waste

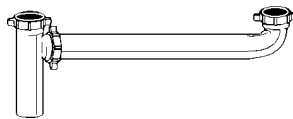

Part #	Mfg #	Size	Desc	Price
DEA9108A	P9108A	1-1/2" x 16"	PVC	7.12

Slip-Joint Plastic End Outlet Waste with Baffle Tee Hi-Line/Slip Joint Combo



Part #	Mfg #	Size	Desc	Price
DEA9121A	P9121A	1-1/2" x 16"	PVC	7.28

Slip-Joint Center Outlet Wastes with Baffle Tees



Part #	Mfg #	Size	Desc	Price
DEA9114A	P9114A	1-1/2" x 16"	PVC	9.40
DEA9123A	P9123A	1-1/2" x 16"	PVC Hi-Line	9.40

Plastic Extension Tubes

Solvent Weld Extension Tubes



Part #	Mfg #	Size	Desc	Price
DEA9787E	P9787E	1-1/2" x 16"	PVC	3.73

Slip-Joint Extension Tubes

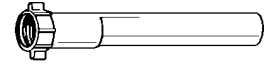

Part #	Mfg #	Size	Description	Price
DEA9791E	P9791E	1-1/4" x 6"	PVC Double Connect, Wht	7.35
DEA9793E	P9793A	1-1/2" x 12"	PVC	5.07

Strainer Tailpieces



Part #	Mfg #	Size	Desc	Price
DEA9801	P9801	1-1/2" x 8"	PVC	1.64
DEA9803	P9803	1-1/2" x 12"	PVC	2.22
DEA9803E	P9803E	1-1/2" x 16"	PVC Dbl Flg	2.90

Branch Tailpieces

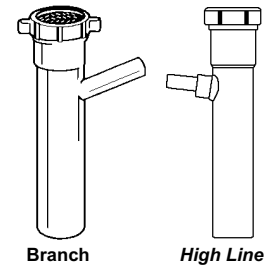

Part #	Mfg #	Size	Description	Price
DEA9816	PP9816	1-1/2" x 8"	PVC SJ 1/2" Branch	4.93
DEA9818	PP9818	1-1/2" x 8"	PVC Hi-Line 1/2" Branch	4.93

Plastic Disposer Kits

For In-Sink-Erator

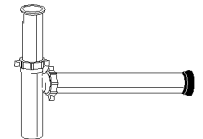

Part #	Mfg #	Size	Desc	Price
DEA9100	P9100	1-1/2" x 13"	EO PVC	9.14

Plastic Elbows & Connectors

Slip-Joint Nuts

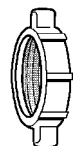

Part #	Mfg #	Size	Desc	Price
DEA9001	P9001	1-1/2"	PVC Nut	0.74

Plumbing Specialties

All Items May Not Be Stocked In All Branches

Tubular Plastic

Slip-Joint Washer



Part #	Mfg #	Size	Desc	Price
DEA9002	9002	1-1/2" x 1-1/2"	Poly	0.12
DEA9003	9003	1-1/2" x 1-1/4"	Poly Red	0.28

Touch-Toe Plastic Bath Wastes

Touch-Toe Sch 40 1/2 Kits

- Includes 1-1/2" waste shoe
- Less tubes & tee

Part #	Mfg #	Description	Price
DEA7224	P7224B	Chrome, PVC, 1-Hole FP	24.13

Decorator Parts

Decorator Plastic Strainer Assembly

- 3-1/2" Bowl

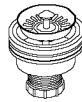

Part #	Mfg #	Color	Price
DEA9WH	9WH	White	31.27
DEA9BC	9BC	Biscuit	31.27
DEA9BNE	9BNE	Bone	31.27
DEA9BL	9BL	Black	31.27

Waste Repair Parts

Repair Part for Bath Waste

- -1 Polished chrome

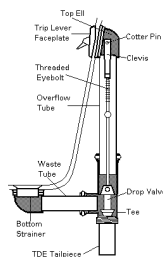

Trip Lever Bath Waste

Part #	Mfg #	Description	Price
DEA4503	4503-1	Faceplate, Trip Lever	5.27

Toilet Repair Parts

Slip Nuts - Die Cast

- LW - Less washer



Part #	Mfg #	Size	Price
DEA803	8031	1-1/2" x 1-1/4"	8.63

Floor & Ceiling Plates

Floor & Ceiling Plate with Spring



Part #	Mfg #	Description	Price
DEA5355P	5355P	1-1/2" IPS, Plastic	3.24



PVC & ABS Drains

Trip Lever PVC/ABS Drain

- Pre-adjustable linkage
- Fits most tubs 14" to 16"



Part #	Mfg #	Description	Price
GER41510	41-510	Chrome All-Tub Drain in Tee, PVC	36.09

Roman Trip Lever PVC/ABS Drain

- Fits most tubs 24"

Part #	Mfg #	Description	Price
GER41572	41-572	Chrome 1-1/2" PVC	40.28

Schedule 40 Drains

- Includes tubing & tee
- Auto Trip Sch 40 Drain**



Part #	Mfg #	Description	Price
GER41542	41-542	Chrome Kit, Less Tubing/Tee, PVC	25.94

Plumbing Specialties

Prices & Specifications are Subject to Change.



www.irrsupply.com

Plumbing Specialties

Drain Exposed Parts Trim Kits

Trip Lever Trim Kit

- Includes:
 - Lever/faceplate
 - (2) 2-1/4" Faceplate screws
 - Strainer with screw



Part #	Mfg #	Finish	Price
GERN6863	N6-863	Brushed Nickel	59.73

WATCO



Tubular Plastic Bath Waste Kits

500 Series Bath Waste

- Coarse thread
- For 14" to 16" high tubs
- Slip joint assembly
- Metal strainer body
- 1-1/2" Pipe
- Theft-resistant metal stopper
- Retainer plate

Quick Adjust® Complete Bath Waste Kits

Part #	Mfg #	Piping	Finish	Price
WAO500CP	500-TQ-PVC-CP	PVC	Chrome	26.45
WAO500BN	500-TQ-PVC-BN	PVC	Br Nickel	67.40
WAO500PB	500-TQ-PVC-PB	PVC	Pol Brass	55.30

550 Series Bath Waste

- Coarse thread
- For 24" high tubs
- Slip joint assembly
- Metal strainer body
- 1-1/2" Pipe
- Theft-resistant metal stopper
- Retainer plate

Trip Lever Complete Bath Waste Kits

Part #	Mfg #	Piping	Finish	Price
WAO550CP	550-TL-PVC-CP	PVC	Chrome	39.55

Innovator® 900 Series Schedule 40 Bath Wastes

- 1.5" PVC or ABS Solvent weld assembly
- Built-in testing and snap-on overflow plate
- Threads on strainer body & drain elbow are 1-1/2" to 11-1/2" NPSM (Coarse thread); 11.5 threads per inch

Complete Bath Waste with Foot Actuated Tub Closures

- Fits most tubs 14" to 16" high
- IAPMO, SBCCI, CSA
- Conforms to ANSI/ASTM F 409-88



Part #	Mfg #	Piping	Finish	Price
WAO901FAPVCCP	901-FA-PVC-CP	PVC	Chrome	21.05

Miscellaneous Parts

Part #	Mfg #	Description	Price
WAO146	146	PV-140 Unplated Fixture, Vent 1-1/2" Provent	2.01



Bath Drains

Pop-Up Drains



Part #	Mfg #	Description	Price
CEB1675S	1675-S	Adjustable for 14" - 16" Tubs	125.00

Plumbing Specialties

All Items May Not Be Stocked In All Branches

Plumbing Specialties

Bath Waste & Overflow

- With trim kit for acrylic, fiberglass, cast iron or steel tubs & whirlpools
- Teflon® coated stainless steel cable
- No internal linkage or moving parts in the pipe to adjust
- 1-1/2" Tubular

Euro TurnControl™ Cable-Operated Rough-In Body

- 1-1/2" Tubular polypropylene .08" wall
- Installation tools included



Part #	Mfg #	Color/Finish	Price
GEB150183211	150.183.21.1	Chrome, for Whirlpools	148.32

TurnControl™ Trim Kits - Molded Plastic



Part #	Mfg #	Color/Finish	Price
GEB240701211	151.550.21.1	Pol Chrome Trim Only	51.50

TurnControl™ Trim Kits - Metal Trim



Part #	Mfg #	Color/Finish	Price
GEB240722FW1	151.551.ID.1	Brushed Nickel, Metal Trim Kit Only	124.84



Pneumatic Pipe Plugs

Single-Size TEST-BALL®



Part #	Mfg #	Size	Price
CHETP114-112	270-016	1-1/4" - 1-1/2"	46.56
CHETP2	270-024	2"	49.66
CHETP3	270-032	3"	53.70
CHETP4	270-040	4"	60.60
CHETP6	270-067	6"	155.60

Clean Seal Plugs



Part #	Mfg #	Size	Price
CHECSP2	271-705	2"	54.80
CHECSP3	271-713	3"	59.56
CHECSP4	271-721	4"	68.92

Mechanical Pipe Plugs

End of Pipe Gripper® Plugs



Part #	Mfg #	Size	Price
CHEGP112	270-210	1-1/2"	3.75
CHEGP2	270-229	2"	4.30
CHEGP3	270-237	3"	5.80
CHEGP4	270-245	4"	7.10

Plumbing Specialties



www.irrsupply.com

Plumbing Specialties

Inside Gripper® Plugs



Part #	Mfg #	Size	Price
CHEGP6	270-253	6"	32.16
CHEGP8	270-288	8"	61.02

Accessories

Test Pump



Part #	Mfg #	Description	Price
CHEPUMP	273-958	Air-Max Test Deluxe w/Gauge	79.62

Extension Hose



Part #	Mfg #	Size	Price
CHEHOSE24	274-011	2'	18.74
CHEHOSE36	274-038	3'	21.34



Elkay Strainers



Part #	Mfg #	Description	Price
ELK35	LK-35	1-1/2" Duo Strainer with Brass Tailpiece	62.00
ELK36	LK-36	1-1/2" Bar Sink Strainer with Crumb Cup	70.00



Strainers

Domestic Strainer



Part #	Mfg #	Description	Price
DEA711	DB711	"Spin-N-Lock", SS Body	48.10
DEA1120	DB1120	Deep Locking Cup, SS	38.34

Metal Strainer for 3-1/2" to 4" Opening

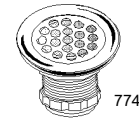
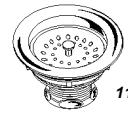

Part #	Mfg #	Description	Price
DEA11	11	SS Body & Basket with Chrome Plastic Slide Post	8.80
DEA18	18	SS Body & Basket, Deep Locking Cup, Neoprene Stopper, 3-3/4" Length	12.89
DEA3785A	3785A-1	Standard Bar Sink Brass Body SS Cup with Tailpiece	17.30
DEA774	774	Duplex Brass Body Flat SS Strainer	11.99

Strainers

Replacement Basket



4204-11-3



4204-20-3

Part #	Mfg #	Description	Price
BRIP221	4204-11-3	Replacement Basket for #711 Briggs	31.32
BRIR100	4204-20-3	Replacement Basket for 1120 Garvin-Briggs	14.32

Plumbing Specialties

All Items May Not Be Stocked In All Branches

Plumbing Specialties

Basket Strainers

Basket Strainer - Stainless Steel Flange & Basket

- Positive seal



Part #	Mfg #	Finish	Price
PLSSTRAINERBRSS	B02-401	Brushed Stainless	50.43
PLSSTRAINERORB	B02-406	Oil Rubbed Bronze	86.34
PLSSTRAINERBN	B02-408	Brushed Nickel	86.34

Garbage Disposer Flanges

Disposal Flange Assembly for ISE Evolution

- Contains flange and splash guard



Part #	Mfg #	Color	Price
PLSDISPSTRWH	B03-031	Polar White	45.07
PLSDISPSTRBI	B03-033	Biscuit	45.07
PLSDISPSTRAL	B03-034	Almond	45.07
PLSDISPSTRBK	B03-035	Black	45.07

Kitchen Sprays

Kitchen Hose & Spray (Fit-All)

- Reinforced hose with universal coupling adapter
- Individually bagged
- Automatic off

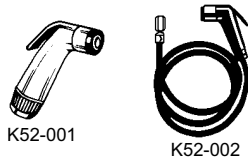

K52-001

K52-002

Part #	Mfg #	Description	Price
PLSSPRAY	K52-002	Chrome Plated Assembly	12.01
PLSSPRAYW	K52-010	Polar White Assembly	10.25
PLSSPRAYHEAD	K52-001	Spray Head Only	5.40
PLSSPRAYHEADW	K52-005	White Spray Head Only	4.59

Aerators

Non-Slotted Full Flow Aerator

- Made in the USA
- Individually bagged

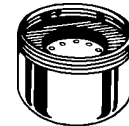

Part #	Mfg #	Description	Price
PLSAERDUAL	A01-010	Dual Thread	1.96

Aerator Tube

- Made in the USA
- (6) Aerators per tube
- Dual threads: 15/16"-27 male x 55/64"-27 female



Part #	Mfg #	Description	Price
PLSAERDUAL6	A01-022	Non-Slotted Full Flow Dual Thread	10.57

Faucet Hole Covers

Cock Hole Cover

- Stainless steel



Part #	Mfg #	Description	Price
PLSHOLECVRSS112SNAP	B10-200	1/2" Snap-In	0.84

Nuts and Washers

Basin Nut

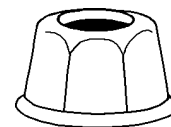

Part #	Mfg #	Description	Price
PLSNUTBASIN58	B10-104	1/2"-14 x 9/16" Brass	0.94

Metal Slip-Joint Nut



Part #	Mfg #	Description	Price
PLSSLIPNUT112	T78-012	1-1/2" x 1-1/2" CP Brass	2.45

Square Cut Rubber Slip-Joint Washer



Part #	Mfg #	Nut x Tube	Price
PLSWASHSJ114R	T79-125	1-1/4" x 1-1/4"	0.12

Plumbing Specialties

Prices & Specifications are Subject to Change.

Plumbing Specialties

Nuts and Washers (Continued)

Square Cut Rubber Slip-Joint Washer

Part #	Mfg #	Nut x Tube	Price
PLSWASHSJ112R	T79-150	1-1/2" x 1-1/2"	0.08
PLSWASHSJ112-114R	T79-151	1-1/2" x 1-1/4"	0.16

Poly Beveled Slip-Joint Washer

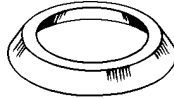

Part #	Mfg #	Nut x Tube	Price
PLSWASHSJ114BEVP	T80-125	1-1/4" x 1-1/4"	0.11
PLSWASHSJ112-114BEVP	T80-151	1-1/2" x 1-1/4"	0.37

Die Cast Slip-Joint Nut and Washer

- Chrome-plated nut packed with square cut rubber washer



Part #	Mfg #	Size	Price
PLSSLIPNUT114BR	T77-014	1-1/4" x 1-1/4"	0.69
PLSSLIPNUT112BR	T77-012	1-1/2" x 1-1/2"	0.93
PLSSLIPNUT112-114BR	T77-013	1-1/2" x 1-1/4"	1.25

Flanged Poly Tailpiece Washer

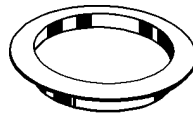

Part #	Mfg #	Size	Price
PLSWASHSJ112FLGP	T81-150	1-1/2" x 1-1/2"	0.11

Flexible Floor & Ceiling Plates

White Plastic



Part #	Mfg #	Size	Price
PLSESCR12COP	F07-375	3/8" IPS or 1/2" CTS	0.66

Brass Lift Wires



Part #	Mfg #	Size	Description	Price
PLSLIFTLOW5	C05-046	5"	Lower	1.26
PLSLIFTUP8	C05-048	8"	Upper	1.70

Tank Trip Levers

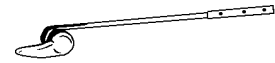

Part #	Mfg #	Description	Price
PLSFLUSHHANDLE	T01-002	Chrome Fit-All, 9" Brass Arm	2.82

Sponge Closet Gaskets



Part #	Mfg #	Size	Price
PLSGASKETSPNG634	G13-634	6-3/4" OD x 3-1/2" ID x 3/4" Thick*	5.27

* Has (2) Bolt Holes

Flappers

3-Way Flapper

- Fits plastic brass and old Crane 57 flush valves
- High grade vinyl construction

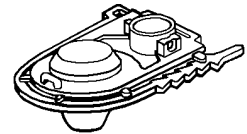

Part #	Mfg #	Description	Price
PLSFLAPPEREARS	C04-006	3-Way with SS Chain	3.19

Waste Connectors

- Brass body and ferrule with die cast nut



Part #	Mfg #	Size	Price
PLSTA114OD-114F	T75-125	1-1/4" FIP x 1-1/4" OD Slip	6.01
PLSTA112OD-112F	T75-150	1-1/2" FIP x 1-1/2" OD Slip	7.05

MIP x Slip

- MIP Units are combination female sweat

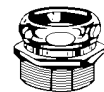

Part #	Mfg #	Size	Price
PLSTA114OD-114M	T76-125	1-1/4" MIP x 1-1/4" OD Slip	5.52
PLSTA112OD-112M-COP	T76-150	1-1/2" MIP x 1-1/2" OD Slip	6.26

Plumbing Specialties

All Items May Not Be Stocked In All Branches

Plumbing Specialties

Brass Sink Drains

Brass Pop-Up Assembly

- All metal construction
- Tool free locknut and ballrod nut
- 1-1/4" Tubular

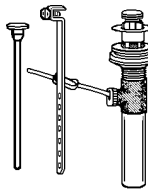

Part #	Mfg #	Finish	Price
PLSDRNASSY	P35-001	CP Brass	24.74

Diverter Spouts

Standard Chrome-Plated Diverter Spout

- 1/2" CTS Unit includes hex key
- Zamack material



Part #	Mfg #	Size	Conn	Price
PLSSPOUT12F	D01-001	1/2" FIP	Nose	19.02
PLSSPOUT34-12	D01-002	3/4"x1/2" FIP	Base	22.04

7" Chrome-Plated Diverter Spout

- Longer length for today's larger tubs
- CTS Unit comes with hex key



Part #	Mfg #	Size	Conn	Price
PLSSPOUT12-7	D01-025	1/2"CTS	Slide	30.35

Faceplate Gaskets



Part #	Mfg #	Description	Price
PLSWASHBEV3	T05-025	Beveled 2-1/8" ID x 3-3/16" OD - 9/16" - 3/16" Thick	0.81

Shower Arms

Chrome-Plated Brass Shower Arm

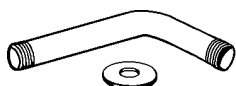

Part #	Mfg #	Description	Price
PLSSHWRARM6	S01-044	6" Arm & SS Flange	7.62

Shower Rods

Aluminum Shower Rod with Holder

- 1" OD - .025 Wall



Part #	Mfg #	Description	Price
PLSSHWRROD5CP	S02-071	5' Rod with Chrome Flange & Screws	5.29

Offset Bath Supplies

- Chrome-plated
- Includes all hardware needed for connection



Part #	Mfg #	Description	Price
PLSBATHSUPPLY	B49-021	Double Offset (Pair)	36.36

Tub Spouts

Chrome-Plated Tub Spout

- Includes hex key
- Zamack material



Part #	Mfg #	Size	Conn	Price
PLSTUBSPOUT	D01-020	1/2" FIP	Nose	14.12

Bath Cocks

- 3-3/8" Centers
- 3/4" Threaded inlets
- Chrome-plated brass body
- Replaceable stem and set

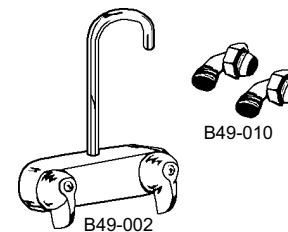

Part #	Mfg #	Description	Price
PLSLEGTUBFTG	B49-001	"O" Pattern with Slip-On Spout	43.04
PLSLEGTUBFTGGOOSE	B49-002	Code Pattern with Goose Neck Spout	68.05
PLSBATHCOCKCPLG	B49-010	Coupling Elbows (Pair) 3/4" Threads x 1/2" Male IPS	15.87

Plumbing Specialties

Prices & Specifications are Subject to Change.

Plumbing Specialties

Lavatory Legs

- Fit vitreous china, steel or cast iron lavatories

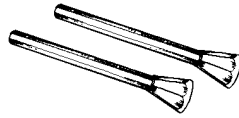

Part #	Mfg #	Description	Price
PLSLAVLEG	L65-001	(1) Pair of 27" Legs	25.02

Lavatory and Sink Hangers

- Wall-mount



Part #	Mfg #	Description	Price
PLSLAVHANGER2	L56-022	Steel (for Vitreous China)	0.68

Flush Valves

Eljer* Touch Flush Assembly

- Complete with tank lever, chain, ball and arm

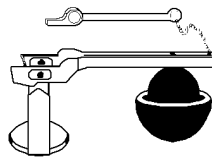

Part #	Mfg #	Description	Price
PLSELJERKIT	C04-019	Touch Flush Assembly	11.81

* Manufacturer's name used only to describe whose products item will fit

Douglas Flush Valve

- Includes locknut, beveled washer
- Brass unit includes split guide
- Plastic unit includes flapper tank ball



Part #	Mfg #	Description	Price
PLSFLUSHVALVE	C05-070	Plastic with SS Chain	4.74

Close Bolt Caps

Custom Packed

- (2) Each



Part #	Mfg #	Description	Price
PLSBOLTCAP	C02-103	Round White with Washer	0.75

Tank-to-Bowl Bolt Sets

Tank-to-Bowl with Wing Nut

- 5/16" x 3"
- Universal fit sponge rubber gasket

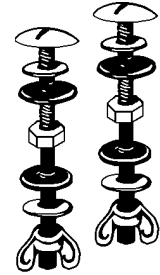

Part #	Mfg #	Description	Price
PLSTANKBOWLKITSS	C03-202	Less Gasket, Brass Bolt	5.70

Close Spuds

Brass Close Spuds

- Cast brass
- Includes spud washer and metal friction ring



Part #	Mfg #	Size	Price
PLSSPUDC114	C27-125	1-1/4"	13.86
PLSSPUDC112	C27-150	1-1/2"	9.20
PLSSPUDC2	C27-200	2"	11.90
PLSSPUDC2-112	C27-202	2" x 1-1/2"	18.94

Close Spud Washers

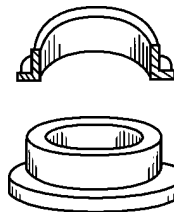

Part #	Mfg #	Size	Price
PLSWASHSPUD112	C27-302	1-1/2"	0.93

Urinal Spuds



Part #	Mfg #	Size	Price
PLSSPUDU1-34	C27-134	1" x 3/4"	9.90
PLSSPUDU114-34	C27-126	1-1/4" x 3/4"	6.34

Plumbing Specialties

Plumbing Specialties

Plastic Closet Flanges

Plastic Plumbfit Flush Closet Flange

- 3" x 4" Fits flush with floor
- 3" Fits inside 3" Sch 40 DWV pipe
- Extra-thick flange with short slots for extra strength
- (6) Screw holes
- Long shank
- Beveled 3" and 4" entrance

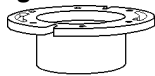

Part #	Mfg #	Description	Price
PLSCFIP3KO	C50-300	3", PVC with Knockout	6.28
PLSCFIP3	C51-300	3", PVC less Knockout	5.21
PLSCFIP4	C51-340	3" x 4", PVC less Knockout	4.85

Plastic Plumbfit with Adjustable Metal Ring

- Fits over 3" or inside 4" Sch 40 DWV pipe
- (2) Radial slots for closet bolts



Part #	Mfg #	Description	Price
PLSCFPRK04-4-3	C52-342	4" x 3", PVC with Knockout	8.18

Plastic 4-Way 2" Offset Closet Flange

- Fits over 3" or 4" Sch 40 DWV pipe

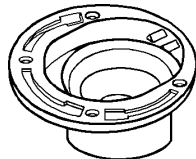

Part #	Mfg #	Size	Price
PLSCFOFFSET	C54-342	3" x 4" PVC	11.80

Closet Flange Ring

- Fit over 3" or PVC
- Converts 3" and 4" PVC pipe into a toilet ready application



Part #	Mfg #	Description	Price
PLSCFFLAT3	C51-302	3" PVC f/Concrete Installation	3.79
PLSCFFLAT4	C51-402	4" PVC f/Concrete Installation	3.95

Cast Iron Closet Flanges

Cast Iron Two Finger Flanges

- Pushes easily into cast iron or Sch 40 DWV pipe
- No tearout or caulking required
- ASTM C-564 Rubber gasket

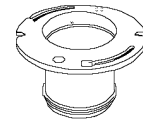

Part #	Mfg #	Size	Price
PLSCFCOMP	C47-420	4" x 2"	38.61

Closet Flange Spacers

Closet Flange Spacer Kit

- Reusable toilet seal gasket
- For repair or correction of problems resulting from installation errors or remodeling projects
- Includes:
 - (2) Gaskets
 - 1/2" Spacer
 - 1/4" x 3-1/2" Closet bolt kit
 - (2) Plastic shims



Part #	Mfg #	Description	Price
PLSCFSK	C88-600	1" Repair Ring	8.97

Urinal Flanges

Adjustable Kits

- Fits over 2" Sch 40 DWV pipe
- Include:
 - Bolts
 - Nuts
 - Washers
 - Gasket
- 3-1/2" - 7" Flange mounting centers

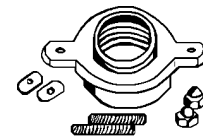

Part #	Mfg #	Description	Price
PLSUFK	F10-002	2" PVC Socket	21.64

Plastic Assembled Coverall Drains

3" x 4" Pipe Fit Base and 3-1/2" Plastic Spud with Round Strainer

- Fits over 3" or inside 4" Sch 40 DWV pipe

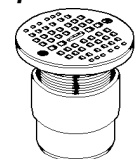

Part #	Mfg #	Description	Price
PLSFD5-4NB-TP	D53-431	5" NB Strainer, PVC	40.00

Prices & Specifications are Subject to Change.

Plumbing Specialties

**Plastic Assembled Coverall Drains
(Continued)**

3" x 4" Pipe Fit Base and 3-1/2" Plastic Spud with Round Strainer

Part #	Mfg #	Description	Price
PLSFD6-4SS	D53-020	6" SS Strainer, PVC	28.75

Plastic Assembled Coverall Cleanouts

3" x 4" Pipe Fit Base and 3-1/2" Plastic Spud with 5" Round Cover

- Fits over 3" or inside 4" Sch 40 DWV pipe
- Supplied with 3" IPS countersunk plug
- 3/16" Thick cover

Part #	Mfg #	Description	Price
PLSCO5-4NB	C59-218	5" NB Cover, PVC	44.27

Cleanouts

Internal Pipe Cleanout

- Solvent welds into Sch 40 DWV pipe
- Allows pipe to be cut flush with floor or wall
- Countersunk plug included



Part #	Mfg #	Description	Price
PLSCOIP3	C60-007	3" PVC 2-1/2" IPS	8.07
PLSCOIP4	C60-008	4" PVC 3-1/2" IPS	9.96

Cleanout Plugs

PVC Cleanout Plugs - Countersunk

- White plastic



Part #	Mfg #	Size	Price
PLSPLUG2	P49-002	2"	2.50
PLSPLUG3	P49-003	3"	3.68
PLSPLUG4	P49-004	4"	4.96

Lead Fit-All Plugs

- Cast iron cored
- Sizes are true measurement, not iron pipe size



Part #	Mfg #	Size	Price
PLSFITALL3	P56-300	3"	10.23
PLSFITALL312	P56-350	3-1/2"	11.57
PLSFITALL4	P56-400	4"	12.17

Drum Trap Covers

- Flanged, plated die cast
- Cover supplied with gasket

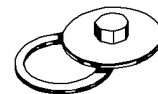

Part #	Mfg #	Description	Price
PLSTRAPCVR414	D02-001	Cover & Gasket	13.26

Floor Sink Drains

PVC Floor Sink Kit

- Includes sink, 3/4" top grate and bottom strainer



Part #	Mfg #	Description	Price
PLSFLRSINK14-14-3	S49-063	3", Full Top Grate, Dome Bottom Grate	79.10

General Purpose Drains

2" x 3" Fits Over 2" or Inside 3" Sch 40 DWV Pipe - Plastic

- Coverall top



Part #	Mfg #	Description	Price
PLSFD4-3SS	D54-001	PVC Drain with SS Strainer	7.29
PLSFD4-3NK	D54-013	PVC Drain with NB Strainer	24.69

Plumbing Specialties

Plumbing Specialties

3" x 4" Fits Over 3" or Inside 4" DWV Pipe - Plastic

- Coverall top
- Brass inserts
- NSF Approved



Part #	Mfg #	Description	Price
PLSFD5-4SS	D54-100	PVC Drain with SS Strainer	12.89
PLSFD5-4NK	D54-113	PVC Drain with NB Strainer	26.10

Snap-In Drains

Plastic Snap-In Drains with Stainless Steel Strainer

- Fits into Sch 40 DWV pipe

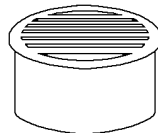

Part #	Mfg #	Description	Price
PLSFDIP3SS	D54-003	3" PVC	8.10
PLSFDIP4SS	D54-004	4" PVC	8.59

Shower/Floor Drains

Plastic Body Fits Over 2" or Inside 3" Sch 40 DWV Pipe

- Low profile
- Beveled edge
- Reversible clamping ring for additional 1/2" height adjustment
- Dual weep holes
- Recessed sump area for added drainage

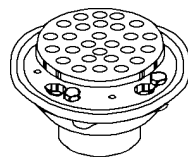

Part #	Mfg #	Description	Price
PLSSD2CLAMPING	D50-001	PVC, 4" SS Strainer	15.48

Shower Stall Drains

No-Caulk Shower Stall Drains - Coverall Tops

- Fits 2" Sch 40 DWV pipe
- Snap-in strainer
- Wrench included
- For 2" CTS order gasket separately

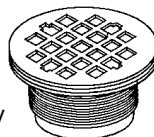

Part #	Mfg #	Description	Price
PLSSD2SS-NC	D40-101	Plastic Body, SS (101PNC) Strainer	8.85

Plastic Body Receptor Base Shower Stall Drains

- Fits over 2" Sch 40 DWV pipe
- Allows for secondary drainage



Part #	Mfg #	Description	Price
PLSSD2SS	D41-001	PVC, SS Strainer	8.66

Bell Trap Drains

Heavy-Duty PVC Bell Traps with Hinged Lids

- Molded bell in lid
- Use 2" coupling to convert 6" x 6" x 1-1/2" to 2" outlet



Part #	Mfg #	Size	Outlet	Price
PLSBELLTRAP6-6-2	D42-006H	6"x6"PVC 1-1/2"	2"	10.37
PLSBELLTRAP9-9-3	D42-009H	9"x9"PVC 3"x4"		22.50
PLSBELLTRAP9-9-4	D42-010H	9"x9"PVC 4"		23.15

Roof Drains

PVC Roof Drains

- Fits over Sch 40 DWV pipe
- Brass inserts in underside for under deck clamps
- Dome has 50 sq inches of free area

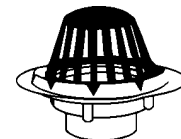

R18-006

Part #	Mfg #	Includes:	Price
PLSRD3	R18-005	3" Cast Iron Dome	76.84
PLSRD4	R18-006	4" Cast Iron Dome	80.56
PLSRDUDC	R18-011	2", 3" & 4" Underdeck Clamp	31.59

Plumbing Specialties

Prices & Specifications are Subject to Change.

Plumbing Specialties

Backwater Valves

Plastic Backwater Valves

- Reduces backflow in drainage system
- Flapper and cover have elastomeric gasket to ensure watertight seal
- Stepped construction encourages flow (minimum 1/4" per foot fall)
- Threaded access cover for easy inspection and cleaning of drain line
- Sockets are Sch 40 DWV
- BOCA, IAPMO, SBCCI and CSA Approvals

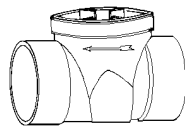

Part #	Mfg #	Size	Price
PLSBWT3	B04-300	3" PVC	34.79
PLSBWT4	B04-400	4" PVC	44.54

Clean Check® Backwater Valve

- Prevent sewage backup into a residence or building as a result of a plugged sewer system, excess volume in the system or groundwater flooding
- Extendable valves consist of a tee-shaped valve body, a top collar and a bottom collar with a replaceable PVC flapper attached
- Designed for easy installation outdoors



Part #	Mfg #	Size	Price
PLSCLEANCHECK4	96924	4" PVC	232.30
PLSCLEANCHECK6	96926	6" PVC	560.00

Vent Caps

Mushroom Vent Caps

- Gray PVC construction
- Includes (3) installation screws
- Fits 3" or 4" vent stacks

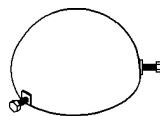

Part #	Mfg #	Size	Price
PLSMV34	M05-034	3" x 4"	7.69

Saddle Tee Kits

- Solvent branch
- Use bushing to reduce 2" unit to 1-1/2"
- Includes:
 - V-Bolts
 - Nuts
 - Washers

Saddle Tee Conversion Kit - with Gasket

- Conversion kit also contains gasket mat for use with cast iron pipe

Part #	Mfg #	Size	Price
PLSSADDLET3-2	S26-009	3" x 2"	18.18
PLSSADDLET4-2	S26-010	4" x 2"	18.89
PLSSADDLET4-3	S26-011	4" x 3"	21.82
PLSSADDLET4-4	S26-012	4" x 4"	22.13
PLSSADDLEGASKET	S26-008	6" x 7" x 1/4" Closed Cell Foam Gasket	3.15

Dishwasher Drain Connector

- Includes (2) worm gear clamps

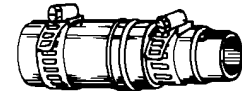

Part #	Mfg #	Description	Price
PLSDISHWASH	D10-001	Universal Connector	1.60

Washing Machine Hose

- High pressure hose
- For hot or cold use
- 3/4" FIP Ends
- Resists softening action of hot water
- Packaged with washers
- Female ends, non-grounded
- Individually bagged



Part #	Mfg #	Description	Price
PLSWASHMACHHOSE	J04-006	Straight Female, 6' Filler Hose	10.75

Plumbing Specialties

Plumbing Specialties

Brass Needle Valves

Self-Piercing Valve - Brass

- 1/4" OD Compression outlet
- Fits 3/8" - 1.315" OD tube

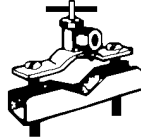

Part #	Mfg #	Tube Size	Price
PLSICEVALVE	S92-001	1/4"	9.48

Icemaker or Humidifier Kit

- Self-piercing valve
- Brass fittings
- Poly tubing

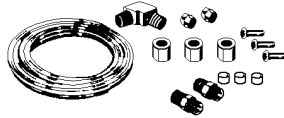

Part #	Mfg #	Size	Price
PLSICEKIT	S92-025	1/4" x 25'	12.97

Steel Hinged Pipe Repair Clamp

- (2) Each bolts and nuts
- Neoprene gasket



Part #	Mfg #	Size	Price
PLSREPAIRCLAMP12	R61-050	1/2" IPS	5.16
PLSREPAIRCLAMP34	R61-075	3/4" IPS	5.68
PLSREPAIRCLAMP1	R61-100	1" IPS	6.00
PLSREPAIRCLAMP114	R61-125	1-1/4" IPS	7.58
PLSREPAIRCLAMP112	R61-150	1-1/2" IPS	8.11
PLSREPAIRCLAMP2	R61-200	2" IPS	8.95

Brass Hose Fittings

Brass Adapters (MHT x MIP)



Part #	Mfg #	Size	Price
PLSHOSE34MH-12MIP	G20-002	3/4" MHT x 1/2" MIP	4.26
PLSHOSE34MH-34MIP-12FIP	G20-003	3/4" MHT x 3/4" MIP	4.14

Brass Adapters (MHT x MHT)



Part #	Mfg #	Size	Price
PLSHOSE34MH-34MH	G20-008	3/4" MHT x 3/4" MHT (1/2" FIP Tap)	4.08

Brass Adapters (MHT x FIP)



Part #	Mfg #	Size	Price
PLSHOSE34MH-12FIP	G20-010	3/4" MHT x 1/2" FIP	3.39
PLSHOSE34MH-34FIP	G20-011	3/4" MHT x 3/4" FIP	4.28

Brass Adapters (FHT x FIP)



Part #	Mfg #	Size	Price
PLSHOSE34FH-12FIP	G20-020	3/4" FHT x 1/2" FIP	4.71
PLSHOSE34FH-34FIP	G20-021	3/4" FHT x 3/4" FIP	4.98

Brass Garden Hose Fittings (Swivel FHT x FHT)



Part #	Mfg #	Size	Price
PLSHOSE34FH-34FH	G20-030	3/4" FHT x 3/4" FHT	6.05

Brass Garden Hose Fittings (Swivel FHT x FIP)



Part #	Mfg #	Size	Price
PLSHOSE34FH-12FIPSW	G20-031	3/4" FHT x 1/2" FIP	5.61
PLSHOSE34FH-34FIPSW	G20-032	3/4" FHT x 3/4" FIP	6.48

Plumbing Specialties

Prices & Specifications are Subject to Change.

Plumbing Specialties

Garden Hose Washers



Part #	Mfg #	Size	Price
PLSWASHHOSE	G20-057	3/4", Vinyl	0.08

Water Meter Accessories

Gaskets for Water Meter Couplings



Part #	Mfg #	Size	Price
PLSGASKETMV34	M20-751	3/4"	0.58
PLSGASKETMV1	M20-101	1"	0.58

Flange Connection Gaskets

Gasket and Washer Material

- Make your own gaskets and washers
- 6" x 6" Square in hanging display bag



Part #	Mfg #	Description	Price
PLSGASKETSHEET116	G55-001	1/16" Thick Red Rubber	1.70

Pressure Test Equipment

Pigtail Syphons

- For use with gauges on steam line
- 1/4" MPT x 1/4" MPT
- Steel construction



G60-000



G60-001

Part #	Mfg #	Description	Price
PLSSYPHON14	G60-000	1/4" Straight	7.82
PLSSYPHON12ANGLE	G60-001	1/4" 90° Angle	4.26

THE BOLD LOOK OF KOHLER®

Sink Accessories

Duostrainer® Sink Strainer

- For sinks with 3-1/2" or 4" outlets
- 1-1/2" x 4" Tailpiece



Part #	Mfg #	Description	Price
KOHK8801CP	K-8801-CP	Pol Chrome	60.15

Toilet Installation & Accessories

Ballcock Retro Fit Valve

- For Rialto/SanRaphael 3.5 toilets

Part #	Mfg #	Description	Price
KOH84499	K-84499	Plastic	134.90

Flush Ball

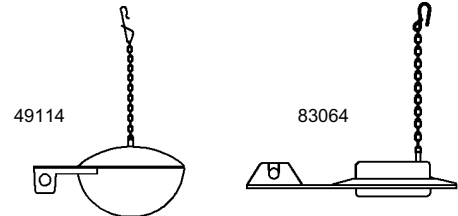

Part #	Mfg #	Description	Price
KOH49114	49114	15 Chain Links	7.90
KOH83064	83064	Flush Ball - Flapper Assy Kit	12.08

Flapper



Part #	Mfg #	Description	Price
KOH84995	84995	Flapper Assembly	7.90
KOH85160	GP85160	Flush Ball Flapper, Blue with Float	7.90

Plumbing Specialties

Float Valves

Palarre™/Rochelle™/Pompton™ Float Valve

- For Palarre (3383), Rochelle (3385), Pompton (3400) toilets

Part #	Mfg #	Description	Price
KOH30668	30668	Float/Fill Valve	349.00

Float Valve

Part #	Mfg #	Description	Price
KOH1068030	K-1068030	Fill Valve Assembly	36.90

Tub & Shower Wastes

Clearflo Adjustable Pop-Up Tub Drain - Above/Through-The-Floor Installation



Part #	Mfg #	Description	Price
KOHK7161AFCP	K-7161-AF-CP	1-1/2", 17" to 26" Baths, Pol Chrome for Above-the-Floor	205.50
KOHK7161AFBN	K-7161-AF-BN	1-1/2", 17" to 26" Baths, Vibrant Brushed Nickel for Above-the-Floor	369.90

Swiftflo™ Adjustable Pop-Up Tub Waste - 17 Gauge Brass

- Through-the-floor installation



K11660

Part #	Mfg #	Description	Price
KOHK11660CP	K-11660-CP	1-1/2", 14" to 16" Baths, CP	100.30



Bowl Setting Bolts

Johni-Bolt®

- Original, patented, solid brass closet bolt with time saving snap-off slot & captive washer
- 2-1/4" Long
- Includes a pair of each:
 - Bolts
 - Washers
 - Brass cap nuts



Part #	Mfg #	Size	Price
HER90124	90124	5/16"	6.14

Johni-Bolt® XL

- Extra long, patented, solid brass closet bolt with captive washer
- 3-1/2" Long
- Includes:
 - (2) Bolts
 - (2) Washers
 - (2) Brass cap nuts



Part #	Mfg #	Size	Price
HER90174	90174	5/16"	11.36

Johni Quick Bolt®

- Push-down & twist to tighten
- Includes a pair of each:
 - Solid brass bolts
 - Cap nuts
 - Stainless steel washers
 - Heavy-duty plastic washers



Part #	Mfg #	Size	Price
HER90905	90905	5/16" x 2-1/4"	5.18

Plumbing Specialties

Toilet Tank Fill Valves

- Fits most toilet tanks
- Saves water
- Easy to install
- Replaces old-fashioned units
- Corrosion-resistant materials

Pro Series™ Fill Valve

- Heavy-duty shank manages water flow, eliminating water hammer by 99% and delivering tank refill at half the noise level of other valves
- Adjustable height for a universal fit and a float screw for fine tuning
- Extremely durable



Part #	Mfg #	Description	Price
FLUPRO45	PRO45	Anti-Siphon Fill Valve	13.74
FLUPRO45B	PRO45B	Anti-Siphon Fill Vlv w/Brass Shank	19.98
FLUPRO45C	PRO45C	Anti-Siphon Fill Vlv w/Adj Flapper	15.96

Fill Valve Repair Part

Replacement Seal

- Easy repair, extends valve life



Part #	Mfg #	Description	Price
FLU242	242	For 200A, 400A Fill Valve	2.70

Flush Valves

507A Flush Valve

- Saves water, stops leaks at the drain
- Includes proven Bull's Eye® Super Flapper
- Fits most tanks, including 1.6 gallon models
- Easy to install
- Future repairs are easy
- See-through blister pack
- 5-Year warranty



Part #	Mfg #	Description	Price
FLU507A	507A	Flush Valve (Display Box)	11.72

Pro Series™ Ballcocks

- Solid brass arm
- 3-Year warranty



Part #	Mfg #	Description	Price
FLUPRO15	PRO15	12" Ballcock less Flapper	7.58

Flappers

PRO53 Flappers

- Professional grade material
- Kink-free heavy duty metal chain
- Replaces most worn flapper or tank ball units



Part #	Mfg #	Description	Price
FLUPRO53	PRO53	Heavy-Duty Flapper	3.53

Bull's Eye® Super Flapper

- Chlorine-resistant for harsh water regions
- Outlasts vinyl or rubber
- Ends leaks at the tank drain
- Rigid frame precisely aligns flapper on drain
- 5-Year warranty



Part #	Mfg #	Description	Price
FLU501X	501X	Bull's Eye Super Flapper Assembly	6.74

3" Universal™ Flapper

- Fits all 3" flapper-style flush valves
- Adjustable frame width and an adjustable flapper float
- Designed with a rigid frame and silicone seal



Part #	Mfg #	Description	Price
FLU5403	FL5403	3" Universal Flapper	16.98

Plumbing Specialties

Flusher Fixer® Kit

- Includes new drain seat for repairing older, corroded tank drains
- Fits most tanks
- Adjustable timing cup
- Chlorine-resistant flapper for harsh water
- 5-Year warranty



Part #	Mfg #	Description	Price
FLU555	555C	Fits Most Tanks	12.16

Tank-To-Bowl Connections

Bolt & Gasket

- Durable solid brass bolts & universal gasket
- Sponge rubber gasket fits most close-coupled toilets with both round & hex-shaped flush valve nuts
- Includes bolts with washers and wing nuts



Part #	Mfg #	Description	Price
FLU6106	6106	(3) Closet Bolts & Gasket	8.75

Wax-Free™ Bowl Gasket

- Adapts to all types of flooring & drain pipes
- Eliminates the need for stacking multiple wax rings on new, raised flooring
- 10-Year warranty



Part #	Mfg #	Description	Price
FLU7500	7500	Fits 3" or 4" Drain Pipes	17.86

Flush N' Sparkle™ Toilet Cleaning System

- Repels stains
- Leaves no residue
- 8100 Is surfactant-based cleaning agent
- Easily installed
- 5-Year warranty on dispenser



Part #	Mfg #	Description	Price
FLU8100	8100	Flush N Sparkle™ Toilet Bowl Cleaner	24.58
FLU8102	8102	Flush N Sparkle™ Refill Cartridge for 8100	12.38

No-Burst® Braided Stainless Steel Water Supply Connectors

- Nickel-plated brass water supply hex nut
- 250' Stainless steel wire per foot
- Extra long stainless ferrules
- 10-Year warranty



Fem Comp x Fem Ballcock

Part #	Mfg #	Length	Fittings	Price
FLU1T9	B1T09	9"	3/8" x 7/8"	3.50
FLU1T12	B1T12	12"	3/8" x 7/8"	3.71
FLU1T16	B1T16	16"	3/8" x 7/8"	4.26
FLU1T20	B1T20	20"	3/8" x 7/8"	4.62
FLU3T12	B3T12	12"	1/2" x 7/8"	4.00

No-Burst® Braided Stainless Steel Water Supply Connectors

- Non-toxic polymer inner core surrounded by braided stainless steel
- Captured cone washers for perfect seal
- For use with hot and cold water
- IAPMO Listed
- 10-Year warranty

Faucet (Fem Comp x FIP)



Part #	Mfg #	Length	Fittings	Price
FLU1F9	B1F09	9"	3/8" x 1/2"	3.63
FLU1F12	B1F12	12"	3/8" x 1/2"	3.89
FLU1F16	B1F16	16"	3/8" x 1/2"	4.26
FLU1F20	B1F20	20"	3/8" x 1/2"	4.62
FLU1F30	B1F30	30"	3/8" x 1/2"	5.51

Prices & Specifications are Subject to Change.



www.irrsupply.com

Plumbing Specialties

Faucet (FIP Comp x FIP)

Part #	Mfg #	Length	Fittings	Price
FLU3F12	B3F12	12"	1/2" x 1/2"	4.31

Faucet (FIP Straight x FIP)



Part #	Mfg #	Length	Fittings	Price
FLU4F20	B4F20	20"	1/2" x 1/2"	4.86

Faucet (Fem Comp x OD Copper Tubing Cplg)

Part #	Mfg #	Length	Fittings	Price
FLU8F12	B8F12	12"	3/8" x 3/8"	4.39
FLU8F20	B8F20	20"	3/8" x 3/8"	5.54

No-Burst® Braided Stainless Steel Appliance Water Supply Connectors

- Non-toxic polymer inner core surrounded by braided stainless steel
- Captured cone washers for perfect seal
- IAPMO Listed
- 10-Year warranty

Dishwasher Connector (Fem Comp x FIP)

- Includes elbow

Part #	Mfg #	Length	Fittings	Price
FLU1W48	B1W48	48"	3/8" x 1/2"	10.79

Dishwasher Connector (Fem Comp x Fem Comp)

- Includes elbow



Part #	Mfg #	Length	Fittings	Price
FLU6W48	B6W48	48"	3/8" x 3/8"	18.78
FLU6W60	B6W60	60"	3/8" x 3/8"	23.40

Washing Machine Water Supply (Hose Fitting x Hose Fitting)



Part #	Mfg #	Length	Fittings	Price
FLU9WM48	B9WM48	48"	3/4" x 3/4"	20.38
FLU9WM72	B9WM72	72"	3/4" x 3/4"	25.50

Dishwasher Adapters

Part #	Mfg #	Description	Price
FLU7150W	7150W	3/4" Hose x 3/8" Comp Elbow	7.78

Ice Maker Water Supply Connectors

Ice Maker Connectors (Comp x Comp)

- Sleeve packaged



Part #	Mfg #	Length	Fittings	Price
FLU12IM72	12IM72	72"	1/4" x 1/4"	15.49

Water Heater Water Supply Connectors

Water Heater Connectors (FIP x FIP)



Part #	Mfg #	Length	Fittings	Price
FLU1H18	B1H18	18"	3/4" x 3/4"	21.22

Water Heater Connectors (FIP x Comp Cplg)

Part #	Mfg #	Length	Fittings	Price
FLU4H18	B4H18	18"	3/4" x 3/4"	21.22

Plumbing Specialties

All Items May Not Be Stocked In All Branches



www.irrsupply.com

Plumbing Specialties

Access Panels

- For spa pumps and security systems
- Works on ceilings and walls
- No visible clamps or screws

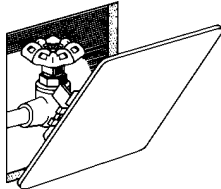

Part #	Mfg #	Size	Price
FLUAP0808	AP-0808	8" x 8"	14.37
FLUAP1414	AP-1414	14" x 14"	20.14



Accessories

Closet Bolt



Part #	Mfg #	Description	Price
SCH1006L	1006L	5/16" x 3-1/2" Brass w/Washer	0.88

Cleanout Cover Plate

- Stainless steel 22 gauge



Part #	Mfg #	Description	Price
SCH1033C	1033C	4" 22ga Stainless Steel	3.42
SCH1033D	1033D	5" 22ga Stainless Steel	4.13
SCH1033E	1033E	6" 22ga Stainless Steel	4.20
SCH1033F	1033F	8" 22ga Stainless Steel	34.76
SCH1033G	1033G	10" 22ga Stainless Steel	14.94

Hose Cap



Part #	Mfg #	Description	Price
SCH1195T	1195T	Brass Plated Die Cast	2.46

Repair Part

Part #	Mfg #	Description	Price
SCH1525	1525	1" Heavy Plain Brass Bar Sink Plug	63.06



Bowl Setting Gaskets

Johni-Ring® Plus

- 100% No-leak special blend golden wax gasket for installing closet bowls
- Contains 40% more wax than standard bowl rings
- Makes positive, permanent, sanitary closet bowl seal
- Bacteria-free & won't dry or deteriorate



Part #	Mfg #	Description	Price
WAXREG	90210	Wax Gasket (Plain)	1.42

Johni-Ring® Plus with Plastic Horn

- 100% No-leak special blend golden wax gasket for installing closet bowls
- Horn fits 3" & 4" waste lines
- Makes positive, permanent, sanitary closet bowl seal
- Bacteria-free & won't dry or deteriorate



Part #	Mfg #	Description	Price
WAXDEEP	90220	Wax Gasket with Horn	1.84

Johni-Ring® 4 Plus With Plastic Horn

- 100% No-leak special blend golden wax gasket for installing closet bowls
- Horn fits 4" waste lines
- Makes positive, permanent, sanitary closet bowl seal
- Bacteria-free & won't dry or deteriorate



Part #	Mfg #	Description	Price
WAX5	90230	Wax Gasket with Horn	4.66

Plumbing Specialties

Prices & Specifications are Subject to Change.



BrassCraft®

www.irrsupply.com

Plumbing Specialties

Jumbo Johni-Ring® Plus

- 100% No-leak special blend golden wax gasket for installing closet bowls
- Contains 40% more wax than standard bowl rings
- Makes positive, permanent, sanitary closet bowl seal
- Bacteria-free & won't dry or deteriorate



Part #	Mfg #	Description	Price
WAXJUMBO	90241	Jumbo Wax Gasket with Horn	5.52

Johni-Ring® Plus for Back Outlet Toilets

- No-leak high quality golden wax gasket with sturdy felt core
- Fits most 4" hung & wall mounted toilets
- Makes permanent gas & water tight sanitary closet bowl seal
- Won't dry or deteriorate



Part #	Mfg #	Description	Price
WAX4	90270	Wax Gasket/Toilet	8.66

Johni-Ring® Plus for Urinals

- High quality golden wax gasket with sturdy felt core provides a no-leak seal every time
- Makes positive, permanent, sanitary closet bowl seal
- Bacteria-free & won't dry or deteriorate

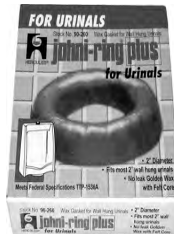

Part #	Mfg #	Description	Price
WAX6	90260	2" Wax Gasket/Urinal	7.72



Trip Levers

42 Model - Trip Lever

- Non-bendable



Part #	Mfg #	Description	Color	Price
MAN1238867	123-8867	Plastic LH	Chrome	6.44

Toilet Parts

Torpedo Timer Cartridge Assembly

- Model 1075 preset to 3/4 gallons
- Includes:
 - Timer cartridge assembly
 - Timer cartridge O-ring
 - Push button retainer
 - Push button screw

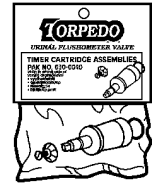

Part #	Mfg #	Description	Price
MAN630-0040KIT	630-0040	Torpedo™ FV Cartridge	48.07

Flush Valves

210 "Universal" Watersaver Flush Valve

- Fits virtually any tank-type toilet
- Only one moving part for trouble-free operation
- Accommodates all trip levers direct connect or chain connect
- "Tea-Cup handle" trip lever holder won't loosen, slip, or bind (eliminates handle jiggling)
- Won't rust or corrode



Part #	Mfg #	Description	Price
MAN210	210-1112	11-1/2" Length	10.84

210 Flush Valve Service Pack

- Includes valve seal



Part #	Mfg #	Description	Price
MAN630-0030	630-0030	Valve Seal for #210 Flush Valves	0.79



Multi-Turn Stop Valves

Straight Stop (Comp x Comp)



Part #	Mfg #	Nom x OD	Finish	Price
BRACR14CP	OCR14 C	1/2" x 3/8"	CP	13.94

Plumbing Specialties

All Items May Not Be Stocked In All Branches

Plumbing Specialties

Multi-Turn Stop Valves (Continued)

Straight Stop (Comp x Comp)

Part #	Mfg #	Nom x OD	Finish	Price
BRACR14PB	OCR14 P	1/2" x 3/8"	PB	67.90
BRACR34CP	OCR34 C	1/2" x 1/2"	CP	23.58

Straight Stop (FIP x Comp)



Part #	Mfg #	Nom x OD	Finish	Price
BRAR10CP	OR10 C	3/8" x 3/8"	CP	12.73
BRAR12CP	OR12 C	1/2" x 3/8"	CP	12.73

Straight Stop (Swt x Comp)



Part #	Mfg #	Nom x OD	Finish	Price
BRAR04CP	R04C	1/2" x 1/4"	CP	17.33
BRAR14CP	R14 C	1/2" x 3/8"	CP	13.18
BRAR14RB	R14 R	1/2" x 3/8"	RB	12.44

Straight Stop (5" Swt Extension x Comp)

- Includes bell escutcheon



Part #	Mfg #	Nom x OD	Finish	Price
BRACS41BCP	CS41B C	1/2" x 3/8"	CP	32.36

Angle Stop (Comp x Comp)



Part #	Mfg #	Nom x OD	Finish	Price
BRACR19CP	OCR19 C	1/2" x 3/8"	CP	13.18

Angle Stop (FIP x Comp)



Part #	Mfg #	Nom x OD	Finish	Price
BRAR15CP	OR15 C	3/8" x 3/8"	CP	12.11
BRAR17CP	OR17 C	1/2" x 3/8"	CP	12.11

Angle Stop (Swt x Comp)



Part #	Mfg #	Nom x OD	Finish	Price
BRAR09CP	R09 C	1/2" x 1/4"	CP	15.67
BRAR19CP	R19 C	1/2" x 3/8"	CP	12.18
BRAR19RB	R19 R	1/2" x 3/8"	RB	11.40

Angle Stop (5" Swt Extension x Comp)

- Includes bell escutcheon



Part #	Mfg #	Nom x OD	Finish	Price
BRACS40BCP	CS40B C	1/2" x 3/8"	CP	29.58

Water Ball Stops - 1/4-Turn On-Off

- PTFE Seats provide corrosion resistance and watertight seal
- Blow-out proof stem
- Plated stem
- 100% Leak tested



Straight Stop (Comp x Comp)

Part #	Mfg #	Nom x OD	Finish	Price
BRAKTCR11FC	KTCR11F C	3/8" Fe x 3/8"	CP	20.88

Plumbing Specialties

Plumbing Specialties

Dual Outlet Stops

Dual Outlet (Comp Inlet x Comp x Comp)

- CRxxxxLR Is neutral direction



Part #	Mfg #	Nom x OD x OD	Finish	Price
BRACR1901LRC	CR1901LR C	1/2" x 3/8" x 3/8"	CP	28.57

Supply Kit Components

Shallow Escutcheon



Part #	Mfg #	Size	Finish	Price
BRA646SS	646	3/8" IPS	SS	1.19
BRA647SS	647	1/2" IPS	SS	1.19
BRA649SS	649	1/2"Nom (5/8"OD)	SS	1.19

Bell Escutcheon



Part #	Mfg #	Size	Finish	Price
BRA650CP	650 C	3/8"IPS (11/16"OD)	CP	4.01
BRA651CP	651 C	1/2" IPS	CP	4.53
BRA654CP	654 C	1/2"Nom (5/8"OD)	CP	4.01

Brass Cover Tube

- For 1/2" nominal copper tube



Part #	Mfg #	Size	Finish	Price
BRA8489C	8489 C	3-1/2"	CP	7.30

Lavatory/Sink Risers

- Actual riser length is length to connect less 1/2"

Lav/Sink Riser - 1-Piece with Insert



Part #	Mfg #	OD x Length	Finish	Price
BRA112ACP	1-12A C	3/8" x 12"	CP	8.61

Lavatory/Sink Risers (Continued)

Lav/Sink Riser - 1-Piece with Insert

Part #	Mfg #	OD x Length	Finish	Price
BRA112ARB	1-12A R	3/8" x 12"	RB	6.40
BRA120ACP	1-20A C	3/8" x 20"	CP	12.43
BRA120ARB	1-20A R	3/8" x 20"	RB	10.07
BRA130ACP	1-30A C	3/8" x 30"	CP	19.44
BRA130ARB	1-30A R	3/8" x 30"	RB	14.75
BRA136ACP	1-36A C	3/8" x 36"	CP	22.92
BRA136ARB	1-36A R	3/8" x 36"	RB	18.02

Lav/Sink Riser (Comp)



Part #	Mfg #	OD x Length	Finish	Price
BRA112KCCP	1-12KC C	3/8" x 12"	CP	12.45
BRA112KCRB	1-12KC R	3/8" x 12"	RB	11.31
BRA120KCCP	1-20KC C	3/8" x 20"	CP	19.06
BRA120KCRB	1-20KC R	3/8" x 20"	RB	17.66

Lav/Sink Riser (PEX)



Part #	Mfg #	OD x Length	Price
BRAP112A	P1-12A	3/8" x 12"	2.46
BRAP120A	P1-20A	3/8" x 20"	3.33
BRAP130A	P1-30A	3/8" x 30"	4.52
BRAP136A	P1-36A	3/8" x 36"	5.32

Closet Risers

Closet Riser (Gasket Nosepiece)



Part #	Mfg #	OD x Length	Finish	Price
BRA112DLCP	1-12DL C	3/8" x 12"	CP	9.11
BRA112DLPB	1-12DL PP	3/8" x 12"	PB	11.02
BRA120DLCP	1-20DL C	3/8" x 20"	CP	12.95
BRA312DLCP	3-12DL C	1/2" x 12"	CP	15.47

Closet Riser (HD Rubber Nosepiece)

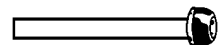

Part #	Mfg #	OD x Length	Finish	Price
BRA112DECP	1-12DE C	3/8" x 12"	CP	11.14
BRA120DECP	1-20DE C	3/8" x 20"	CP	14.64

Plumbing Specialties

All Items May Not Be Stocked In All Branches

Plumbing Specialties

PEX Closet Riser



Part #	Mfg #	OD x Length	Price
BRAP112DL	P1-12DL	3/8" x 12"	2.46
BRAP120DL	P1-20DL	3/8" x 20"	3.33

**Riser Tube Components
For Lavatory Riser Tube**



Part #	Mfg #	Description	Price
BRA1A	1A	3/8" Nose Piece	1.24



Gauge Glass Washer

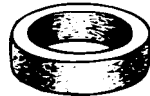

Part #	Mfg #	Size	Price
PLSGGWASHER	2715004	5/8"	0.13

Gauge Glass

- Sight glass tubing



Part #	Mfg #	Size	Price
PLSGG58	1724006	5/8" x 12"	1.13

Gauge Glass Brass Friction Rings

Part #	Mfg #	Description	Price
PLSGGRING	2712006	For 5/8" ga Glass	0.37



Residential Drainage

Shower Pan Drains with Stainless Steel Strainer

- Full metal top
- Screw-on 18 gauge strainer
- PVC Connection
- Threaded brass inserts in drain body for collar screws

Round Top

- 4-1/4" Strainer width x 3-5/8" to 5-5/8" height



Part #	Mfg #	Hub Size	Description	Price
SOC821280P	821-280P	2" Hub	PVC	10.10

Closet Flanges

TKO™ Total Knockout Closet Flange

- Knockout will not break apart and cannot fall down drain pipe
- Strong, corrosion-resistant SS ring eliminates cracked flanges
- Easier installation, no need to hold knockout while hammering

PVC TKO™ Total Knockout Closet Flange



Part #	Mfg #	Description	Price
SOC884PTM	884-PTM	3" x 4" SS Swivel Ring	6.60
SOC886PTS	886-PTS	3" Spigot	5.26

Ringer™ Stainless Steel Closet Ring

- Strong corrosion-proof stainless steel
- Perfect for repairs - cups the damaged flange
- Mount around 3" or 4" pipe on concrete floors



Part #	Mfg #	Description	Price
SOC886MR	886-MR	Stainless Steel Closet Ring	5.75

Plumbing Specialties

Plumbing Specialties

EZ Quick™ Water Line Installation Kits

- Patented "tool-less" quick-connect
- Will not corrode
- 1/4 Turn shut-off
- Leak resistant
- Kink resistant PEX

EZ Quick™ Ice Maker Kit

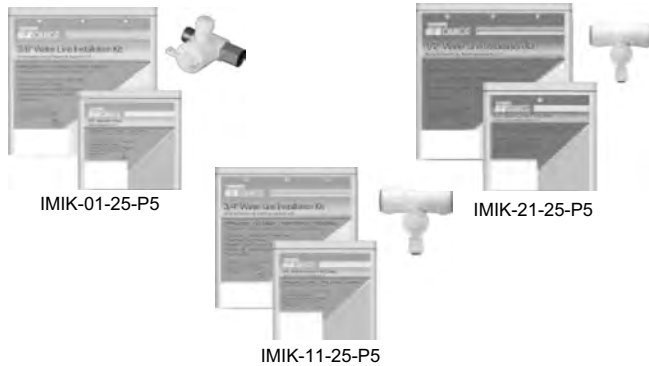

Part #	Mfg #	Description	Price
DORICEKIT12	IMIK-01-25-P5	1/2" Valve w/25' Tube	35.00
DORICEKIT34	IMIK-11-25-P5	3/4" Valve w/25' Tube	39.00
DORICEKIT38	IMIK-21-25-P5	3/8" Valve w/25' Tube	37.00

EZ Quick™ Ice Maker Tee



Part #	Mfg #	Description	Price
DORICETEE12	TEE-010-P5	1/2" Tee Quick Connect Valve for Ice Maker	12.75
DORICETEE34	TEE-013-P5	3/4" Tee Quick Connect Valve for Ice Maker	16.00
DORICETEE38	TEE-012-P5	3/8" Tee Quick Connect Valve for Ice Maker	14.75

JUMBO

Aluminum Vent Strainers

- Buffalo, NY style



Peterson Vent

Part #	Mfg #	Size	Price
PEVMV4	MV4	4" Mushroom Vent	27.38
PEVPV3	PV3	3" Perforated Vent	19.56
PEVPV4	990	4" Perforated Vent	10.02
PEVPV6	989	6" Perforated Vent	39.90

Radiator Specialty Company

Gunk® Faucet Parts

Stem Bonnet Packing



Part #	Mfg #	Description	Pkg Qty	Price
RASP3002V	P-3002V	1/8" Stem & Valve, 24"	10	4.58

O-Rings

O-Ring Assortment

R-291



Part #	Mfg #	Description	Pkg Qty	Price
RASR291	R-291	(14) Sizes	200	18.98
RASR1095R	R-1095R	All Purpose	200	81.52

Plumbing Specialties



Plumbing Specialties

Gunk® Faucet Washers



Golden State® Beveled Washer

Part #	Mfg #	Size	Pkg Qty	Price
RASW130	W-130	00	100	0.30

Golden State® Flat Washers

Part #	Mfg #	Size	Pkg Qty	Price
RASW146	W-146	1/4" S	100	0.32

Golden State® Washer Assortments



Part #	Mfg #	Description	Pkg Qty	Price
RASW144R	W-144R	(23) Sizes Flat/Bevel	375	120.50
RASW157	W-157	Assorted Flat	100	32.14
RASW159R	W-159R	(10) Sizes Flat/Bevel	300	96.40

Golden State® Washer "Handi-Boxes"



Part #	Mfg #	Description	Pkg Qty	Price
RASW243	W-243	Assorted Beveled	25	14.28
RASW257	W-257	Assorted Flat	25	14.28

Polyethylene Slip-Joint Washer

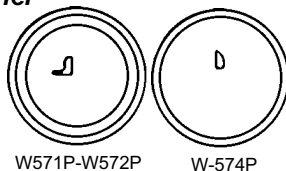

Part #	Mfg #	Size	Pkg Qty	Price
RASW571P	W-571P	1-1/4"	100	0.34

**Gunk® Faucet Washers (Continued)
Polyethylene Slip-Joint Washer**

Part #	Mfg #	Size	Pkg Qty	Price
RASW572P	W-572P	1-1/2"	100	0.34
RASW574P	W-574P	1-1/2" x 1-1/4"	100	0.36

Sink Strainer Coupling



Part #	Mfg #	Size	Pkg Qty	Price
RASW573P	W-573P	1-1/2"	100	0.34

Square-Cut Slip-Joint Washer

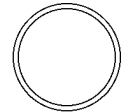

Part #	Mfg #	Size	Pkg Qty	Price
RASW522	W-522	1-1/2" M	100	0.34
RASW531	W-531	1-1/4" H	100	0.34
RASW533	W-533	1-1/2" H	100	0.36
RASW535	W-535	1-1/4" x 1-1/2"	100	0.19

Waste & Overflow Washer

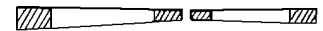

Part #	Mfg #	Description	Pkg Qty	Price
RASW752	W-752	1-7/8" Beveled	25	2.22
RASW754	W-754	2-3/8" Beveled	25	2.42

Sink Connection Washer

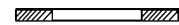

Part #	Mfg #	Size	Price
RASW831	W-831	1-3/4" x 1-5/16" x 1/8"	0.32

Hose Washer



Part #	Mfg #	Description	Pkg Qty	Price
RASW455	W-455	36 Bags of 12	432	2.86

**Toilet Parts
Bowl Ring**



Part #	Mfg #	Description	Price
RASG227	G-227	Rubber Bowl Ring	6.76

Prices & Specifications are Subject to Change.

Plumbing Specialties



Plumbing Specialties

Triple Seal® Tank Ball



B-252



B-251-12



B-274

Part #	Mfg #	Description	Price
RASB251	B-251-12	2-5/8" Standard, 12/Pk	1.84
RASB252	B-252	3" Standard	2.58
RASB274	B-274	Heavy-Duty	6.42

Sealmaster® Tank Ball



Part #	Mfg #	Description	Price
RASB25512	B-255-12	Sealmaster® - Standard 12/Pk	3.09

TITE-SEAL® Tank Ball

- Designed to fit the curvature of all flush valves



Part #	Mfg #	Description	Price
RASB25412	B-254-12	Standard, 12/Pk	2.69

Toilet Flapper



B-257V



B-262V

Part #	Mfg #	Description	Price
RASB257V	B-257V	Anchor - Standard	3.60
RASB262V	B-262V	Kohler Replacement, Carded	3.47
RASB295V	B-295V	Screw-on Seat Disc	2.24
RASB296V	B-296V	Snap-on Seat Disc	2.00

Sealmaster® Toilet Flapper



Part #	Mfg #	Description	Price
RASB264V	B-264V	Sealmaster® - Std	3.47

Seal-O-Matic® Toilet Flapper



Part #	Mfg #	Description	Price
RASB260V	B-260V	Seal-O-Matic®, 10/Pk	3.62

Spud Washer

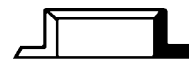

Flanged



Beveled

Part #	Mfg #	Description	Pkg Qty	Price
RASW300	W-300	For 3/4" Urinal	12	1.42
RASW302	W-302	1-1/2" Flanged	12	1.40

Close Couple Gasket

Tank-to-Bowl



G-604

Part #	Mfg #	Description	Pkg Qty	Price
RASG601	G601	Standard Size	12	2.64
RASG604	G604	For Gerber & Crane	12	1.80
RASG605	G605	For Am Std & Crane	12	1.49

Appliance Hose & Connectors

Dishwasher Drain Hose



Part #	Mfg #	Description	Price
RASRS58R	58R-50	5/8" ID Reinforced 50'	0.81

Plumbing Specialties

All Items May Not Be Stocked In All Branches

Plumbing Specialties

Washing Machine Hose (FIP Connectors)

- Rubber
- Non-grounded



Part #	Mfg #	Size	Price
RAS2154	215-4	4'	5.53
RAS2156	215-6	6'	6.84

Liquid Wrench® Lubricants & Penetrants

Liquid Wrench® Penetrating Oil

- Loosens rusted bolts, nuts & parts



Part #	Mfg #	Description	Price
RASL112	L112	11 oz Aerosol Can	7.05



Trap Seal Primers

M-500 Pressure Drop Activated Trap Seal Primers

- Brass trap seal primer
- Inlet opening of 1/2" male NPT
- Outlet opening of 1/2" female NPT
- Four view holes, removable filter screen



M1-500

Part #	Mfg #	Description	Price
MIFMR500	MR-500	Up to 6 Drains	73.30

Trap Seal Primer Distribution Units

MI-DU Distribution Units

- Four brass compression outlet connections (specify 1/2" or 5/8")



Part #	Mfg #	Description	Price
MIFMIDU	MI-DU-625	5/8"	40.51



Inline Trap Sealers

- Drain not included



Sure Seal Installed

Inline Floor Drain Trap Guard

- Fit all manufacturers standard floor drains
- Stops floor drain odors with waterless trap protection
- Resistant to lime scale and microbiological growth
- Protects against the spread of dangerous bacteria
- Commercial grade ABS plastic housing
- Proprietary neoprene rubber diaphragm
- (2) Soft rubber sealing gaskets



SS2009



SS4009

Part #	Mfg #	Description	Price
SUS2	SS2009	2" Floor Drain Outlet	71.90
SUS3	SS3000	3" Floor Drain Outlet	73.90
SUS4	SS4009	4" Floor Drain Outlet	87.90

Ask about our Service Guarantee

Plumbing Specialties

Prices & Specifications are Subject to Change.

Plumbing Specialties

Interceptors

Series WD PDI Certified Grease Interceptor

- Recessed or floor mounted epoxy coated steel
- Removable baffle assembly
- Deep seal trap with cleanout
- No hub connections
- External cast iron flow control fitting
- Includes:
 - Gasketed solid steel cover
 - Hex head center bolt(s)
 - Removable baffle assembly
 - Deep seal trap with cleanout
 - No-hub connections
 - External cast iron flow control fitting



Part #	Mfg #	Flow Rate	Grease Cap	Price
WADWD4	WD-4	4 gpm 16"Lx10"Wx11"H	8 lbs	288.64
WADWD7	WD-7	7 gpm 18"Lx13"Wx12"H	14 lbs	308.32
WADWD10	WD-10	10 gpm 21-3/4"Lx14"Wx12"H	20 lbs	364.08
WADWD15	WD-15	15 gpm 22"Lx15"Wx14"H	30 lbs	495.28
WADWD20	WD-20	20 gpm 24"Lx15-3/4"Wx15"H	40 lbs	613.36

SI-742 Hair, Plaster & Sediment Interceptor

- Epoxy-coated
- 10" Clearance required above cover to remove sediment basket
- Includes:
 - Removable stainless steel sediment basket
 - Gasketed cover
 - 2" IPS Threaded connections



Part #	Mfg #	Description	Price
WADSI742	SI-742	Cast Iron Hair, Lint, Plaster, Sediment Interceptor	394.72



Tub & Shower Parts

Tub Spout



Part #	Mfg #	Description	Price
PLSSPOUT34F	359A	Diverter, CP Brass, 3/4" IPS	37.63

Low Pattern Chrome Plated Flange



Part #	Mfg #	Size	Price
PLSESC12COP	1099	5/8" OD for 1/2" Nom	0.43
PLSESC34COP	1099A	7/8" OD for 3/4" Nom	0.43
PLSESC38IPS	1100	3/8" NPT	0.43
PLSESC12IPS	1101	1/2" NPT	0.43
PLSESC34IPS	1101A	3/4" NPT	0.56
PLSESC112IPS	1106	1-1/2" NPT	0.54

High Bell Pattern Chrome Plated Flange



Part #	Mfg #	Size	Price
PLSESCD38IPS	1109	3/8" IPS	1.34
PLSESCD12IPS	1110	1/2" IPS	1.32
PLSESCD114OD	1114	1-1/4" OD	1.48

Box Pattern Chrome Plated Flange



Part #	Mfg #	Size	Price
PLSESCB114OD	1116	1-1/4" OD	2.75
PLSESCB114IPS	1116A	1-1/4" IPS	2.94
PLSESCB112OD	1117	1-1/2" OD	2.75
PLSESCB112IPS	1117A	1-1/2" NPT	2.94

Plumbing Specialties

All Items May Not Be Stocked In All Branches

Plumbing Specialties

Sink Parts

Sink Hole Cover

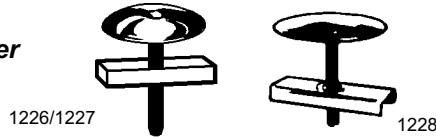

Part #	Mfg #	Description	Price
PLSHOLECVRSS2	1226	2" w/Two-Piece Head Stainless Steel	3.79
PLSHOLECVRSS134-2	1227	1-3/4" w/Two-Piece Head Stainless Steel	1.65
PLSHOLECVRSS134	1228	1-3/4" w/One Piece Head Chrome Plated Steel	1.91

Ground Joint Waste Connectors

(DeSanko Fitting)

- With brass ring & chrome plated die cast nut

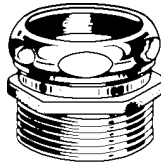

Part #	Mfg #	Description	Price
PLSTA114OD-112M-COP	R1006	1-1/4" x 1-1/2" M-Waste Connector	5.93

Drum Trap Covers

Adjustable Cover Style "B"

- With 5-1/4" stainless steel cover
- 3-1/4" - 4" Diameter, self-adjusting
- Includes rubber gasket

Part #	Mfg #	Description	Price
PLSTRAPCVRADJ	1024	Stainless Steel	14.52

Toilet Repair Parts

Rubber Slip Joint Washer



Part #	Mfg #	Size	Qty	Price
PLSWASHSJ2R	7204	2" Rubber SJ	100	0.28

Slip Nuts - Die Cast

- LW - Less washer



Part #	Mfg #	Size	Price
PLSSLIPNUT112-138	8032	1-1/2" x 1-3/8"	1.66

Flanged Closet Bowl Gasket



Part #	Mfg #	Size	Price
PLSGASKETSPNG538	7556	5-3/8"OD x 3-1/2"ID x 3/4" Thick	2.50

Tank-To-Bowl Gasket

- For close coupled connection
- Sponge rubber - for unit closet combinations



Part #	Mfg #	Size	Price
PLSGASKETSPNG314	7557	3-1/4"OD x 2-1/8"ID x 9/16" Thick	1.55

Econo Plugs

- Molded rubber gasket
- Plug features high grade molded rubber for positive seal in soil, plastic or copper pipe

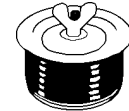

Part #	Mfg #	Description	Price
PLSTP112	3413	1-1/2" Econo Plug	3.31
PLSTP2	3410	2" Econo Plug	3.81
PLSTP3	3411	3" Econo Plug	4.97
PLSTP4	3412	4" Econo Plug	5.80

Floor & Ceiling Plates

Heavy Grade Floor & Ceiling Plate with Spring



Part #	Mfg #	Description	Price
PLSESCR12COP	5340H	1/2" CTS	5.49
PLSESCR34COP	5341H	3/4" CTS	5.63
PLSESCR1COP	5342H	1" CTS	5.69
PLSESCR114COP	5343H	1-1/4" CTS	6.15
PLSESCR112COP	5344H	1-1/2" CTS	6.28
PLSESCR2COP	5345H	2" CTS	9.29
PLSESCR38IPS	5350H	3/8" IPS	4.07
PLSESCR12IPS	5351H	1/2" IPS	4.11
PLSESCR34IPS	5352H	3/4" IPS	4.37
PLSESCR1IPS	5353H	1" IPS	5.11
PLSESCR114IPS	5354H	1-1/4" IPS	5.19
PLSESCR112IPS	5355H	1-1/2" IPS	5.83
PLSESCR2IPS	5356H	2" IPS	6.45

Regulators and Valves

Stop Valves

KwikStop Angle 1/4-Turn Ball Valve Water Supply Stop

- Ball valve style
- Large, conventional handle
- Chrome-plated brass construction with PTFE seats
- Nuts and ferrules assembled



Part #	Mfg #	Model	Size	Price
WATKS38AI	0144765	BV889003	3/8" IPS x 3/8" OD	5.20
WATKS12AI	0144716	BV890003	1/2" IPS x 3/8" OD	4.85
WATKS12A	0144717	BV892003	1/2" Swt x 3/8" OD	5.35
WATKS58A	0144718	BV894003	5/8" OD x 3/8" OD	5.55
WATKSP12A	0144719	BV891203	1/2" PEX x 3/8" OD	5.90

KwikStop Straight 1/4-Turn Water Supply Stop

- Ball valve style
- Large, conventional handle
- Chrome-plated brass construction with PTFE seats
- Nuts and ferrules assembled



Part #	Mfg #	Model	Size	Price
WATKS38SI	0144766	BV889013	3/8" IPS x 3/8" OD	5.35
WATKSP12SP	0144767	BV891313	1/2" PEX x 1/2" PEX	6.75
WATKS12SI	0144712	BV890013	1/2" IPS x 3/8" OD	5.35
WATKS12S	0144713	BV892013	1/2" Swt x 3/8" OD	5.55
WATKS58S	0144714	BV892013	5/8" OD x 3/8" OD	5.90
WATKSP12S	0144715	BV891213	1/2" PEX x 3/8" OD	6.00

KwikStop Angle 1/4-Turn Water Supply Stop

- Quick-connect technology
- For use on copper, CPVC or PEX
- NSF, UPC and CSA Approved



Part #	Mfg #	Model	Size	Price
WATKS12AQC	0145728	QC894A	1/2" x 3/8"	7.85

KwikStop Straight 1/4-Turn Water Supply Stop

- Quick-connect technology
- For use on copper, CPVC or PEX
- NSF, UPC and CSA Approved



Part #	Mfg #	Model	Size	Price
WATKS12SQC	0145729	QC894S	1/2" x 3/8"	7.85

Plumbing Specialties

All Items May Not Be Stocked In All Branches

Cast Iron Plumbing Specialties

Saddle Fittings

Repair Plates

- For repairing holes & cracks, etc. in soil pipe
- Supplied with U-bolts



Part #	Mfg #	Size	Price
JUM984	984	4"	6.51

Gasket for Saddle Fittings and Repair Plates

- Heat and oil resistant Neoprene sponge
- Good compressibility for tight joint

Part #	Mfg #	Size	Price
JUM845	845	8" x 8" x 1/2"	5.92

Plumbing Specialties

Standard Body Cleanout with Raised Hollow Head Plug

- With Southern Code brass plug



Part #	Mfg #	Pipe Size	Plug Size	Price
JUMCO2	182	2"	1-1/2"	7.82
JUMCO3	183	3"	2-1/2"	12.42
JUMCO4	185	4"	3-1/2"	18.57
JUMCO6	187	6"	5"	33.87

Standard Body Cleanout with Countersunk Plug

- With Southern Code brass plug

Part #	Mfg #	Pipe Size	Plug Size	Price
JUMCO4CS	185CS	4"	3-1/2"	18.57

Extra Heavy Body Cleanout with Raised Solid Hex Head Plug

- With Ohio and New York code brass plug
- 1" Raised solid hex brass plug



Part #	Mfg #	Pipe Size	Plug Size	Price
JUM194X	194X	4"	3-1/2"	24.54

Brass Raised Head Southern Code Cleanout Plug



Part #	Mfg #	Size	Price
JUM1100112	1100-1.5	1-1/2" IPS	2.48
JUM11002	1100-2	2" IPS	3.23
JUM1100212	1100-2.5	2-1/2" IPS	3.63
JUM11003	1100-3	3" IPS	5.68
JUM1100312	1100-3.5	3-1/2" IPS	9.00
JUM11004	1100-4	4" IPS	10.09
JUM11005	1100-5	5" IPS	15.10
JUM1100512	1100-5.5	5-1/2" IPS	25.53
JUM11006	1100-6	6" IPS	28.55

Brass Countersunk Southern Code Cleanout Plug



Part #	Mfg #	Size	Price
JUM11102	1110-2	2" IPS	4.66
JUM1110212	1110-2.5	2-1/2" IPS	5.59
JUM11103	1110-3	3" IPS	6.97
JUM1110312	1110-3.5	3-1/2" IPS	9.75
JUM11104	1110-4	4" IPS	13.41
JUM11105	1110-5	5" IPS	18.77
JUM1110512	1110-5.5	5-1/2" IPS	30.14
JUM11106	1110-6	6" IPS	36.73

Standard Cast Iron Closet Flange

- Slotted and notched
- Caulk connection



Part #	Mfg #	Size	Price
JUM949	949	4" x 1"	5.46
JUM950	950	4" x 1-1/2"	5.52
JUM951	951	4" x 2"	6.97
JUM952	952	4" x 2-1/2"	7.67
JUM953	953	4" x 3"	9.78
JUM954	954	4" x 4"	11.94

Cast Iron Specialties

Cast Iron Plumbing Specialties

Cast Iron Specialties

Easy to Set Cast Iron Closet Flange

- Eliminates need for lead and oakum



Part #	Mfg #	Size	Price
JUM967	967	4" x 2"	18.70

Cast Iron No-Hub Closet Flange

- Use with no-hub soil pipe or in conventional soil pipe hubs with neoprene slip-type gasket

Part #	Mfg #	Size	Price
JUM2383	2383	3" x 3"	9.82
JUM2393	2393	4" x 3"	10.05
JUM2394	2394	4" x 4"	11.34

Brass Closet Flange

- With lead connection



Part #	Mfg #	Size	Price
JUM1920	1920	4" x 3/8"	7.59
JUM1921	1921	4" x 1-1/8"	10.25

Inside Caulk Hinged Strainer Bell Trap Cesspool

Part #	Mfg #	Description	Price
JUM911	911	9" x 9" x 3" Outlet Floor Drain	30.83
JUM911B	911B	9" x 9" x 4" Outlet Floor Drain	34.24

Cast Iron Fresh Air Inlet

- To fit spigot end of soil pipe
- 4" Size provides center knockout so a pipe can be passed through the strainer



Part #	Mfg #	Description	Price
JUM6204	620-4	4-1/2" dia for 4" Pipe Spigot	4.84

Cast Iron Mushroom Vent Cap

- Furnished with three bolts
- Fits standard or extra heavy pipe



Part #	Mfg #	Size	Price
JUM2956	2956	6" Solid	36.03

Cast Iron Side Clamp Vent Cap

- Fits 3" or 4" standard or extra heavy pipe



Part #	Mfg #	Size	Price
JUM2950	2950	4"	9.30

Curb Boxes



Part #	Mfg #	Description	Price
WAB5	P337	3" Shaft w/45"-60" Extension	119.36

Curb Box Part

Part #	Mfg #	Description	Price
WAB5T	P337 TOP	3" x 24" Top Section f/P337	50.00
WABBOLT	SB25B	Brass Bolt for 93E/95E/5 Water Box Lid	5.23
WABWATER3	SB25L	3" Curb Box Lid (Water Only)	6.69
WAB156	SBE16	16" Curb Box Extension	29.78
WABWRENCH	WR01	Pentagon Operating Wrench f/Water Box	17.08

Water Meter Accessories

Water Meter Keys

- Rebar shaft
- Vinyl covered handle

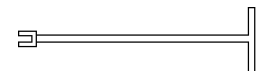

Part #	Mfg #	Size	Price
WABMETERKEY7	M25-784	3/4" x 84"	67.17

Cast Iron Plumbing Specialties

Trap Seal Primers

Trap Seal Primer with Integral Vacuum Breaker

- Flow activated



Part #	Mfg #	Description	Price
WADA200S	A-200	1/2" Sweat, Bronze	78.58

Floor Drains

Series FD-100 Floor Drain

- Epoxy coated, cast iron floor drain with anchor flange, reversible clamping, collar & heavy duty, round nickel bronze strainer



No Hub Type

Part #	Mfg #	Description	Price
WADFD103A51	FD-103-A5-1	For 3" Pipe w/5" Strainer & No-Hub Outlet	130.54
WADFD103PA51	FD-103P-A5-1	For 3" Pipe w/5" Strainer & Push-On Outlet	130.54
WADFD104A51	FD-104-A5-1	For 4" Pipe w/5" Strainer & No-Hub Outlet	130.54
WADFD104PA51	FD-104P-A5-1	For 4" Pipe w/5" Strainer & Push-On Outlet	130.54

Series FD-200 Floor Drain

- On-grade epoxy coated cast iron floor drain with anchor flange and weepholes
- Adjustable, round, 5" nickel bronze strainer



Part #	Mfg #	Description	Price
WADFD203A51	FD-203-A5-1	For 3" Pipe w/5" Strainer & No-Hub Outlet	99.46
WADFD203PA51	FD-203P-A5-1	For 3" Pipe w/5" Strainer & Push-On Outlet	99.46
WADFD204A51	FD-204-A5-1	For 4" Pipe w/5" Strainer & No-Hub Outlet	99.46
WADFD204PA51	FD-204P-A5-1	For 4" Pipe w/5" Strainer & Push-On Outlet	99.46

Deep Sanitary Floor Sink



Part #	Mfg #	Description	Price
WADFS743P	FS-743P	12" Square x 8" Deep, 3" Push-On Outlet, Porcelain Top	420.18
WADFS74322	FS-743-22	12" Square x 8" Deep, 3" No-Hub Floor Sink Body	258.00
WADFS743P22	FS-743P-22	12" Square x 8" Deep, 3" Push-On Floor Sink Body	258.00
WADFS744P22	FS-744P-22	12" Square x 8" Deep, 4" Push-On Floor Sink Body	258.00

Floor Drain/Sink Accessory

Part #	Mfg #	Description	Price
WADFG12	FG-12	Full Grate for 12" x 12" Floor Sink	99.00
WADFSDS	FS-DS	Dome Strainer	23.00

Roof Drains

Series RD-100 Large Area Roof Drain

- Epoxy coated cast iron
- Includes flashing clamp w/integral gravel stop



Part #	Mfg #	Description	Price
WARDRD103D	RD-103-D	No-Hub 3" Pipe w/Underdeck Clamp	254.86
WARDRD103PD	RD-103P-D	Push-On 3" Pipe w/Underdeck Clamp	254.86
WARDRD104D	RD-104-D	No-Hub 4" Pipe w/Underdeck Clamp	254.86
WARDRD104PD	RD-104P-D	Push-On 4" Pipe w/Underdeck Clamp	254.86
WARDRD106D	RD-106-D	No-Hub 6" Pipe w/Underdeck Clamp	337.44

Prices & Specifications are Subject to Change.

Cast Iron Plumbing Specialties

Cast Iron Specialties

Floor Cleanouts

Series CO-200-R Adjustable with Round Top

- Epoxy-coated
- 5" Round, adjustable, gasketed, nickel bronze top
- Removable gas tight, gasketed, brass cleanout put
- No hub (standard) outlet



Part #	Mfg #	Pipe Size	Price
WADCO203R1	CO-203-R-1	3"	172.06
WADCO204R1	CO-204-R-1	4"	172.06

Series CO-200-RX Adjustable Heavy-Duty Round Top

- Epoxy-coated cast iron floor cleanout
- 5" Round adjustable gasketed heavy-duty nickel bronze top
- Removable gas tight, gasketed, brass cleanout plug
- Push-on outlet type



Part #	Mfg #	Pipe Size	Price
WADCO203PR1	CO-203P-R-1	3"	183.16
WADCO204PR1	CO-204P-R-1	4"	183.16

Components for Floor Drains, Roof Drains & Cleanouts

Cast Iron Body for Floor Drain, Roof Drain & Cleanout

B2 Cast Iron Body



B2-3



B2-4

Part #	Mfg #	Connection	Price
WADB23	B2-3	3" No-Hub Outlet	68.00
WADB23P	B2-3P	3" Push-On	79.00
WADB24	B2-4	4" No-Hub Outlet	68.00
WADB24P	B2-4P	4" Push-On	79.00
WADB26	B2-6	6" No-Hub Outlet	72.00

B3 Cast Iron Body



B3-3P-7

Part #	Mfg #	Connection	Price
WADB32	B3-2	2" No-Hub Outlet	27.00
WADB32P	B3-2P	2" Push-On	36.00
WADB33	B3-3	3" No-Hub Outlet	27.00
WADB33P	B3-3P	3" Push-On	36.00
WADB34	B3-4	4" No-Hub Outlet	27.00
WADB34P	B3-4P	4" Push-On	36.00

B4-34 Cast Iron Body



Part #	Mfg #	Connection	Price
WADB42	B4-34-2	2" No-Hub Outlet	37.00
WADB43	B4-34-3	3" No-Hub Outlet	37.00
WADB44	B4-34-4	4" No-Hub Outlet	37.00
WADB43P	B4-34-3P	3" Push-On Outlet	47.00
WADB44P	B4-34-4P	4" Push-On Outlet	47.00

Strainer/Grate for Modular Drain

"A" Strainer with 1/4" Thick Grate

- Nickel bronze finish



A6-1

Part #	Mfg #	Description	Price
WADA5	A5-1	5" x 4" MPT Strainer	82.00
WADA6	A6-1	6" x 4" Straight MPT	122.00

"L" Nickel Bronze Strainer

- Load rating of 4500 lbs at a failure & a free area of 6.1 sq inches

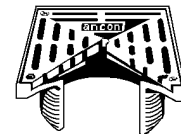

Part #	Mfg #	Description	Price
WADM5	L5-1	5" x 5" Sqr x 4" Straight MPT	189.00

All Items May Not Be Stocked In All Branches

Cast Iron Plumbing Specialties

Bolt-On Funnel Only for Use w/Strainers

Part #	Mfg #	Description	Price
WADF41	F4-1	4" Round Nickel Bronze	108.00

Top Assembly for Floor/Area Drains



FD-320



FD-460-AF

Part #	Mfg #	Description	Price
WADFD320	FD-320-50	8" Adj Top Assy w/Tractor Grate for FD-320, FD-320-14 Series Drains	114.00
WADFD4604	FD-460-AF-50	12" x 12" CI Square Adj Top Assy for FD-464	404.00

Body Collar & Clamp for Floor Drains

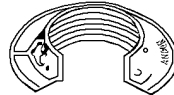

B3-XYC

Part #	Mfg #	Description	Price
WADB3XYC	B3-XYC	Std Reversible Clamp Collar for FD-100, FD-300; FC-1 Hardware Included	23.00
WADB3CB	B3-CB	Combo Body Collar & Membrane Clamp for FD-320, FD-300	55.00

Sediment Bucket for Floor Drain



B1B

Part #	Mfg #	Description	Price
WADB1B	B1B	For FD-100, FD-160, FD-200, FD-390-E	32.00
WADB2B	B2B	For FD-340, FD-450, FD-460	47.00
WADB3B	B3B	For FD-300, FD-320, FD-330, FD-390	32.00

Roof Drain Component

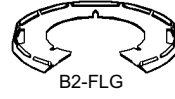

B2-FLG



B2-V



B2-DM

B2-S

Part #	Mfg #	Description	Price
WADB2FLG	B2-FLG	Flashing Ring & Gravel Stop for RD-100, RD-150 Series	88.00
WADB3FLG	B3-FLG	Flashing Ring & Gravel Stop for RD-200 Series	43.00
WADB2S	B2-S	24" x 24" Sump Receiver for RD-100	87.00
WADB2DC	B2-DC	Deck Clamp for RD-100 Roof Drain	88.00
WADB2DM	B2-DM	Poly Dome for B2 Body	49.00
WADB2KDM	B2KDM	Cast Ductile Iron Dome for B2 Body	103.00
WADB3DM	B3-DM	6" Self Locking f/Small Area Drain	38.00

Hardware Pack



FC-1

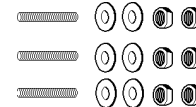

FC-2



FC-3

Part #	Mfg #	Description	Price
WADFC1	FC-1	Cap Screw w/Integral Washer	5.90
WADFC2	FC-2	Bolts, Washers & Nuts for Roof Drain	9.30
WADFC3	FC-3	Bolts, Washers & Nuts for Deck Clamps	14.20

Cleanout Cover for CO-100 & CO-200 Series



RX-1

Part #	Mfg #	Description	Price
WADRX1	RX-1	5" Round Heavy Duty Nickel Bronze Top Assembly	172.00
WADRX4	RX-4	5" Round Heavy Duty Ductile Iron Top Assembly	81.00

Cast Iron Specialties

Prices & Specifications are Subject to Change.

Cast Iron Plumbing Specialties

Cast Iron Specialties

Miscellaneous Parts

Part #	Mfg #	Description	Price
WADDDXY	DD-50	Adj Extension for A-5, A-6, A-7	61.00
WADR1	R-1	5" Adj Cleanout Top	118.00

Water Closet Carriers

Series CA-100 Water Closet Carriers

- Adjustable horizontal
- No hub connection

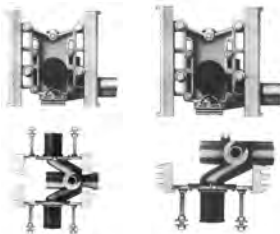

CA-101-D CA-101-L/R

Part #	Mfg #	Description	Price
WADCA101D	CA-101-D	Back-to-Back Carrier Only	758.80
WADCA101L	CA-101-L	Single - Left Hand Carrier Only	405.38
WADCA101R	CA-101-R	Single - Right Hand Carrier Only	405.38

Industry Standard Water Closet Carrier Parts

Part #	Mfg #	Description	Price
WADCA1	CA-1	Neoprene Wall Hung Closet Gasket	21.00

Series CA-121 Water Closet Carriers

- Adjustable vertical

Part #	Mfg #	Description	Price
WADCA121	CA-121	Single	461.76

Urinal Carriers

Series CA-300 Urinal Carriers

Floor Support

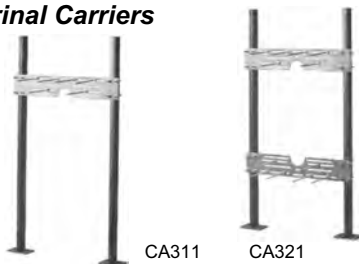

Part #	Mfg #	Description	Price
WADCA311	CA-311	Single Plate	191.80
WADCA321	CA-321	With Bearing Plate	214.00

Lavatory & Sink Carriers

Series CA-460 Lavatory Carrier

- Wall mount
- Concealed arm



Part #	Mfg #	Description	Price
WADCA462	CA-462	Single Plate Concealed Arm	150.08

Water Cooler Carriers

Series CA-411 Lavatory/Water Cooler Carrier

- Floor mount
- Epoxy coated
- Heavy gauge steel offset uprights with welded feet
- Steel cross plate with integral mounting brackets
- Sliding adjustable arm brackets
- Adjustable cast iron concealed arms with mounting clips, leveling screws and basin locking device



Part #	Mfg #	Description	Price
WADCA411	CA-411	Single	253.08
WADCA411D	CA-411-D	Double	360.08

Track Lavatory Carriers

Series TCA Proline Floor Mounted Concealed Arm Track Lavatory Carriers

- Epoxy coated
- Heavy gauge steel offset uprights with welded feet
- Steel cross plate with integral mounting brackets
- Sliding adjustable arm brackets
- Adjustable cast iron concealed arms
- Includes mounting clips, leveling screws, and basin locking device



TCA-411

Part #	Mfg #	Description	Price
WADCA411WC	TCA-411-WC	For 27" x 20" Lavatories	269.06

Lead -Solders

Packing

Lead Wool



Part #	Mfg #	Description	Price
OATLDWL5	L40-001	5 lb Box	91.62



No-Calk® Roof Flashing

Aluminum Base No-Calk®

- Slides over pipe - for pitch to 40°
- Rustproof .032 stamped aluminum standard base
- Non-fading, sealing collar
- Rated 180°F continuous heat
- Approved for Type B installations
- Not for hot-mopped or built-up roofs
- Soft aluminum base (18" x 18") allows for easy molding to tile roofing
- Do not use petroleum based products on collars



Standard Base Flashing

Part #	Mfg #	Size	Price
OATNC1	12920	1-1/4" - 1-1/2"	16.94
OATNC2	12933	2"	16.22
OATNC3	12946	3"	17.96
OATNC4	12959	4"	21.68

Thermoplastic Base No-Calk® Roof Flashing

- Slides over pipe - for pitch to 45°
- Non-fading and non-cracking, rigid black thermoplastic base
- Non-fading, sealing collar
- Do not use petroleum based products on plastic bases or rubber collars
- Rated 180°F continuous heat
- Approved for Type B installations
- Not for hot-mopped or built-up roofs

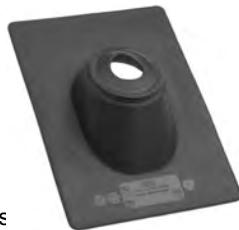

Standard Base Flashing

Part #	Mfg #	Size	Price
OATNC1P	11908	1-1/4" - 1-1/2"	9.16
OATNC2P	11909	2"	9.48
OATNC3P	11910	3"	8.54
OATNC4P	11911	4"	10.88

Adjustable Multi-Size All Flexible Roof Flashing

- For 1-1/4", 1-1/2", 2" or 3" vent pipes



3-In-1 Flashing

Part #	Mfg #	Model	Size	Price
OATNCF	81705	FB31	10" x 13-1/4"	6.62

All-Flash® No-Calk® Highrise® Roof Flashing

- Slides over pipe for pitch 10° to 60°
- Do not use petroleum based products on plastic bases or rubber collars
- Ring on collar tears off, allowing flashings to seal different pipe diameters
- Rated 180°F continuous heat
- Not for hot-mopped or built-up roofs
- Non-fading, non-cracking & non-rusting rigid black TPE base & sealing collars
- Approved for Type B installations



Part #	Mfg #	Size	Price
OATHRRF112	11930	1-1/2" - 3"	15.48
OATHRRF3	11931	3" - 4"	19.84

Master Flash® Roof & Wall Flashing

- Slides over pipe - for pitch to 45°
- Use silicone sealant between base & surface & secure with sheet metal screws
- Multi-size pipe sealing range
- Molds to metal, plastic, etc.
- Non-fading EPDM collar
- Rated 212°F continuous heat
- Approved for Type B installations



Part #	Mfg #	Size	Price
OATMF144	14052	1/4" - 4"	28.18

Rain Collar for No-Calk® Roof Flashings

- Use as a protective water shield (slides down over pipe)
- No caulking needed
- Do not use petroleum based products on rubber collars
- Non-fading EPDM collar
- Rated 212°F continuous heat
- Approved for Type B installations



Part #	Mfg #	Size	Price
OATRC2	14135	2"	8.90
OATRC3	14193	3"	11.02

Lead - Solders

Prices & Specifications are Subject to Change.

Lead - Solders

Lead Roof Flashing

Adjustable Lead Roof Flashing

Part #	Mfg #	Description	Price
OATLF2	17390	2" IPS, 12" x 12" x 12", 4#	27.08
OATLF3	17535	3" IPS, 12" x 12" x 12", 4#	73.20

Flux

No. 5 Paste Flux

- Cleans and fluxes at the same time
- Effective on all metals except aluminum, magnesium and stainless steel
- 100% Lead free
- Blended to clean surface oxidation



Part #	Mfg #	Size	Price
OATP4175	30011	1.7 oz	2.90
OAT58	30014	8 oz	7.92
OAT51	30041	16 oz	12.28

No. 95 Tinning Flux

- Formulated with the same high quality as No. 5 however, patented Oatey® silver solder powder is added to pre-tin the copper pipe
- Flux can never burn out
- 100% Lead free
- Excellent for large diameter copper
- Does not turn copper green



Part #	Mfg #	Size	Price
OAT958	30372	8 oz	13.70

Radiator Specialty Company

Gunk® Lubricating Products

Plumber's Heat-Pruf Grease

- Waterproof



Part #	Mfg #	Size	Price
RASGR1	GR-1	2.5 oz	3.00



Brazing Alloys

Dynaflow®

- Silver alloy
- Phos copper



Part #	Mfg #	Description	Price
HASDYNAFLOW	66000	1#, .050" x 1/8" x 28 Sticks	CALL
HASDYNAFLOW	66039	.050" x 1/8" x 8 Sticks MP	CALL

Safety-Silv® Brazing Alloys

- Cadmium-free silver
- General purpose non-toxic
- Used in government work
- Good ductility and capillary flow
- Color is silver to light yellow as in polished brass



Part #	Mfg #	Description	Price
HASSS1OZ	76310	45% 1 Troy oz, 1/16 x 1	CALL
HASSS3OZ	76313	45% 3 Troy oz, 1/16 x 3	CALL
HASSS5OZ	76315	45% 5 Troy oz, 1/16 x 5	CALL

Stay-Silv® 5

- Used to bridge gaps where close fit-up can't be maintained
- Medium-range alloys
- More ductile than Harris O



Part #	Mfg #	Description	Price
HASSS518	41035	1#, .050 x 1/8" x 28 Sticks	CALL
HASSS518MP	5620FMPOP	.050" x 1/8" x 8 Sticks	CALL

Stay-Silv® 15

- Used for air conditioning/refrigeration



Part #	Mfg #	Description	Price
HASSS1518SQ	60135	1/8" Square, 15%	CALL
HASSS1518	61035	1#, .050 x 1/8" x 28 Sticks	CALL
HASSS1518MP	61039	.050" x 1/8" x 8 Sticks	CALL

All Items May Not Be Stocked In All Branches

Lead - Solders



www.irrsupply.com

Lead - Solders

Solders

Bridgit® Lead-Free Solder

- Contains nickel for strong joints
- Excellent for large diameter fittings and ill-fitting or non-concentric pipes



Part #	Mfg #	Description	Price
HASBRIDGIT	16000	1/8" x 1 lb Spool	CALL

Stay-Brite® Silver Solder



Part #	Mfg #	Description	Price
HASSB18	10001	1/8" x 1 lb, 4%	CALL
HASSB818	10009	#8, 1/8" x 1 lb, 6%	CALL

Fluxes

Stay-Clean® Liquid Soldering Flux

- General purpose zinc chloride flux
- For soldering with all soft solders
- Use with tin/lead, tin/antimony, and Stay-Brite solders
- For virtually all metals except aluminum, magnesium, or titanium
- Not recommended for use in electrical or electronic applications



40003

Part #	Mfg #	Description	Price
HASSCLIQ4OZ	40002	4 oz Flip Top	8.28
HASSCLIQ16OZ	40003	16 oz Bottle	14.44
HASSCLIQ1QT	40004	32 oz Bottle	17.34

Stay-Silv® Brazing Flux

- White
- For use with silver brazing alloys on all metals except aluminum, magnesium or titanium
- Effective to 1600°F
- Meets AMS 3411, AWS 5.31, Class FB3C; Fed Spec. 0-F-499D, Type B



Part #	Mfg #	Description	Price
HASSSP4OZ	40020	1/4 lb	6.96
HASSSP8OZ	40021	1/2 lb	7.74
HASSSBRAZING	40022	6.5 oz	7.74

Stay-Clean® Paste Soldering Flux

- Active soldering flux for use with tin/lead, tin/antimony, and tin/silver solders
- For most metals, copper, brass, bronze, steel, stainless steel, galvanized, monel
- Not recommended for aluminum, magnesium, or titanium
- Not recommended for use in electrical or electronic applications



Part #	Mfg #	Description	Price
HASSCP4OZ	40027	4 oz Brush Cap	5.74



Solder

Premium Lead-Free Sterling Solder

- NSF 61 Certified for safe use in potable water applications
- Melting temperature 410°F
- Tensile strength 7130 psi



Part #	Mfg #	Description	Price
SOLTER1	WS15086	1 lb Spool	CALL

50/50 Leaded Solder

- 50% Tin, 50% lead solder
- For use in non-potable water applications



Part #	Mfg #	Description	Price
SOL501	WS10098	1 lb Spool	CALL

94/6 Lead-Free High Silver HVAC Solder

- Lead-free 94%, tin 6%
- Alternative to silver brazing rods
- Melting temperature: 430°F
- Tensile strength: 15,000 psi



Part #	Mfg #	Description	Price
SOL946	WS15098	1 lb Spool	CALL

95/5 Lead-Free Solder

- Melting temperature 455°F
- Tensile strength 5500 psi



Part #	Mfg #	Description	Price
SOL951	WS15018	1 lb Spool 95/5 Solder	CALL

Lead - Solders

Prices & Specifications are Subject to Change.

Gas & Tanks

Liquid Propane Gas & Tanks



Part #	Mfg #	Description	Price
GASLP14	LP-175	14.1 oz LP, Throwaway Cylinder	8.74
GASLP	LP-20-GAS	20# LP Gas Only	54.58

MAPP Gas & Tanks



Part #	Mfg #	Description	Price
GASMAPP	MT-1 MAPP	14.1 oz MAPP, Throwaway Gas Cylinder	11.46

Acetylene Tanks & Contents

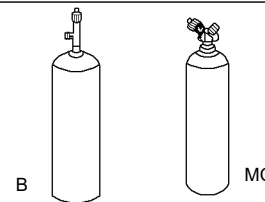

Part #	Mfg #	Description	Price
GASB	B GAS	B Acetylene Gas Only	CALL
GASBCOMP	B COMPLETE	B Acetylene Tank & Gas	CALL
GASMC	MC GAS	MC Acetylene Gas Only	CALL
GASMCCOMP	MC COMPLETE	MC Acetylene Tank & Gas	CALL

Nitrogen Tanks & Contents



Part #	Mfg #	Description	Price
GASNITROQCOMP	Q NITROGEN COMPLETE	Q Nitrogen Tank & Gas	CALL
GASR	R NITROGEN GAS	R Nitrogen Gas Only	CALL
GASRCOMP	R NITROGEN COMPLETE	R Nitrogen Tank & Gas	CALL
GASNITRO20	20-N-GAS	20 cu ft Nitrogen Gas Only	CALL
GASNITRO20COMP	20-N-COMPLETE	20 cu ft Nitrogen Tank & Gas	CALL
GASNITRO40	40-N-GAS	40 cu ft Nitrogen Gas Only	CALL
GASNITRO40COMP	40-N-COMPLETE	40 cu ft Nitrogen Tank & Gas	CALL
GASNITRO60	60-N-GAS	60 cu ft Nitrogen Gas Only	CALL
GASNITRO60COMP	60-N-COMPLETE	60 cu ft Nitrogen Tank & Gas	CALL

All Items May Not Be Stocked In All Branches

Power Tools

Power Threading Equipment

300 Model Power Drive Complete for Portable Threading

- Convert your 300 Power Drive into a portable threading machine
- Standard equipment:
 - Die heads and dies for use with 300 Power Drive with 311 carriage
 - (1) Model 360 cutter
 - (1) Model 341 reamer
 - (1) Model 311 carriage with lever
 - (1) Model 1206 stand
 - (1) Model 1452 clip-on tool tray
 - (1) Model 418 oiler with 1 gal Nu-Clear threading oil
 - (1) Model 32 transporter



Part #	Mfg #	Model	Spindle Speed	Pipe Capacity	Rod Capacity	Max Geared Threader Cap	Price
RID300	15682	300 Complete	38 rpm	1/8" - 2"	1/4" - 2"	6"	4420.00

600 Model Hand-held Power Threader

- Reversible 115V or 220V universal motor
- CSA, CSA & UL Approved (115V only)



Part #	Mfg #	Model	Description	Price
RID600	36912	600	115V 1/2 - 1-1/4" NPT with Case & Support Arm	1320.25

700 Model Heavy-Duty Hand-held Power Threader

- Reversible 115V or 230V universal motor
- CSA, CSA & UL Approved (115V only)



Part #	Mfg #	Model	Motor	Pipe Capacity	Rod Capacity	Max Geared Threader Cap	Price
RID700	41935	700	115V	1/8" - 2"	1/4" - 1"	6"	1537.50

Parts for 700 Power Drive

Part #	Mfg #	Description	Price
RID775	42625	Support Arm	195.80

Oil-Less Threading Machine Parts & Accessories

Part #	Mfg #	Model	Description	Price
RIDCOOLANT	30693	-	1 qt Thread Cutting Coolant f/1210	18.25
RID1210DIE	67807	-	1/2 - 3/4" NPT Oil-Less Gold Dies, RH	176.00
RID1210DIE1	67812	-	1" NPT Oil-Less Gold Dies, RH	176.00

Universal Die Head - Machine NPT

- Use with:
 - 535A Automatic Threading Machine
 - 300 Compact Threading Machine
 - 1822-I Threading Machine
 - 300 Power Drive



Part #	Mfg #	Model	Description	Price
RID97065	97065	811A	1/8 - 2" NPT, Quick-Opening, Automatic Release, RH Thread Direction	400.25

Prices & Specifications are Subject to Change.

Power Tools

Pipe Die for Machine Die Heads

Pipe Die for 504A, 711, 731, 811A, 815A & 842

Part #	Mfg #	Die Material or Type	(NPT) Nominal Pipe Size Threads Per Inch	Price
RID47750	47750	Alloy RH NPT	1"-2" - 11-1/2	119.05

Power Threader Parts & Accessories

Part #	Mfg #	Description	Price
RID44505	44505	HD Motor Switch for 300, 535	104.65
RID44715	44715	Jaw Insert, 3/Pk	79.65

Wet/Dry Vacuums

High Performance Wet/Dry Vac

- Power suction, large capacity, rugged construction
- 6 Peak HP motor
- 3-Layer fine dust filter captures dry wall dust
- Accessories stored on-board
- 360° Caster mobility
- Top handle with cord wrap
- Heavy duty 2-piece drum construction
- Large drain



Part #	Mfg #	Description	Price
RIDWD1450	WD-1450	14 Gallon High Performance w/Cart	175.90

Pro Pack™ Wet/Dry Vac

- Shaped and sized like a tool box
- 5.0 Peak hp motor
- Tug-A-Long® 7' locking hose, 20' power cord & accessory nozzles (utility nozzle, crevice tool, dusting brush) are contained inside the vac beneath hinged compartment covers
- (2) Extension wands store on clips on the back of the unit
- 3-Layer fine dust filter
- Scroll Noise Reduction® technology
- UL Listed



Part #	Mfg #	Description	Price
RIDWD4522	WD-4522	4.5 Gallon Portable, 130 mph Blowing Capacity, 15.5 lbs	118.30

Wet/Dry Vacuum Accessories

Part #	Mfg #	Description	Price
RIDWDFILTER2	26643	VF3500 3-Layer Filter, Short Pleated f/4522 ShopVac	26.15
RIDWDFILTER	72947	VF4000 Standard Pleated Paper Filter f/Shop Vacs	18.40

Power Tools

All Items May Not Be Stocked In All Branches

Power Tools

M12™ Lithium-Ion Cordless Tools

ProPEX® M12™ Cordless Expansion Tool Kit

- Powered by Milwaukee M12™ Lithium-Ion battery
- Speed: 60 SPM
- Head rotation: built-in auto-rotator
- Head compatibility: 3/8" - 1" M12™/Uponor®
- LED light
- Includes:
 - (2) Lithium-Ion batteries (M12™)
 - 1/2" Expansion head
 - 3/4" Expansion head
 - 1" Expansion head
 - Grease
 - Carrying case
- 5-Year Milwaukee warranty



Part #	Mfg #	Description	Price
MIL2432-22	2432-22	3/8" - 1" Capacity	672.00

M12™ Cordless 3/8" Drill Driver Kit

- Powered by Milwaukee M12™ Lithium-Ion battery
- All metal locking chuck
- 2-Speed all metal gear box
- No load speed: 0 - 400/0 - 1,500 rpm
- Clutch settings: 11+ drill
- Chuck type: 3/8" single sleeve
- Includes:
 - Drill driver (2410)
 - Lithium-Ion battery (M12™)
 - 30-Minute charger
 - Soft carrying case
- 5-Year Milwaukee warranty



Part #	Mfg #	Description	Price
MIL241022	2410-22	250 in/lbs Torque	275.00

Sawzall® Reciprocating Saws

12 Amp Sawzall®

- Quik-Lok® blade clamp
- Gear protecting clutch
- Counter weighted mechanism
- Includes:
 - (1) Sawzall® reciprocating blade
 - Carrying case



Part #	Mfg #	Length of Stroke	Strokes Per Minute	Price
MIL650931	6509-31	3/4"	0 - 3,000	240.00

Press System® Tools

PC-280 Pressing Tool

- Includes:
 - (2) 18V, 3.0 Ah Lithium-ion batteries
 - 110V Battery charger and case



Part #	Mfg #	Description	Price
RPPPC100	PC-280	Battery Operated Pressing Tool w/Case	3000.00
RPPPC16S	PC-16S	1/2" - 1-1/4" (4 Jaws) Std Press Jaw Kit w/Case	657.00
RPPPC17S	PC-17S	1-1/2" - 2" (2 Jaws) Std Press Jaw Kit w/Case	500.00
RPPPC2	PC-2	2-1/2" Pressing Chain w/Case	685.00
RPPPC3	PC-3	3" Pressing Chain w/Case	714.00
RPPPC5	PC-5	Chain Adapter	657.00
RPPPC9	PC-9L	AC Adapter	420.00

PC-200M Mini Pressing Tool

- Includes:
 - (2) 18V, 1.3 Ah Lithium-ion batteries
 - 110V Standard charger and case
 - (3) Jaws (1/2", 3/4" and 1")



Part #	Mfg #	Description	Price
RPPC100	PC-200M	Mini Pressing Tool & Jaws	3000.00

Power Tools

Power Tools

Pressing Tools

- Completes a reliable, watertight connection in seconds, cutting installation time in half versus soldering

Model RP210-B Battery-Operated Press Tools

- Smallest, lightest and most compact pressing tool developed by Ridgid
- Uses compact series pressing jaws
- 5400 lbs Hydraulic ram output
- 270° Swiveling barrel
- Features a portable, battery powered design utilizing a 18V 1.1Ah Ni-MH battery
- Capacity: 1/2" to 1-1/4" for copper and stainless; 3/8" to 1-1/2" for PEX
- Standard kit includes:
 - RP 210-B Press tool
 - (2) 1.1 Ah Ni-MH batteries
 - Li-Ion Charger
 - Carrying case



Part #	Mfg #	Model	Description	Price
RPP210B	31028	RP210-B	Kit with 1/2" to 1-1/4" Jaw Sets for ProPress (Copper & Stainless)	2237.10

RP 330-B Model Battery-Operated Press Tools

- 270° Barrel/jaw swivel
- 7,200 lbs Hydraulic ram output
- Operating temperature range 15° to 122°F
- 5 Second approximate cycle time
- Compatible with all Ridgid® standard jaws
- Standard kit includes:
 - RP 330-B Press tool
 - 18V Lithium-Ion Battery
 - Battery charger
 - Carrying case



Part #	Mfg #	Model	Description	Price
RPP330B	27923	RP 330-B	Kit with 1/2" - 2" Jaw Sets for ProPress (Copper & Stainless Steel)	3390.10

Individual Jaw Assemblies

Part #	Mfg #	Size	Series	Type	Price
RPPCR114	31228	1-1/4"	Compact (100-B/RP210-B)	ProPress (Copper & Stainless)	150.00



www.irrsupply.com

Hand Tools

Clog Buster™ Drain Flushers



Part #	Mfg #	Size	Price
CHE303135	303-135	1-1/2" - 3"	18.20
CHE303143	303-143	4" - 6"	41.38



Nitrogen Regulators

Radnor® Nitrogen Purge Regulator

- One-piece encapsulated seat design with internal filter and PTFE teflon seat
- Chrome-plated bonnet with brass adjusting screw
- Forged brass body
- 2" Dual scale gauges
- Cylinder regulator type



Part #	Mfg #	Description	Price
HAS25500C	25-500C-580	500 PSI Nitrogen Purging Regulator	194.30



Snips for Metal and Vinyl

Andy™ Classic Snip

- Suitable for mild curve cuts, straight shearing, or cutting multiple layers of sheet metal
- Lightweight aluminum handle
- 3" Cutting length



Part #	Mfg #	Description	Price
MALM14	M14A	14" Length	73.18

Punches

Snap Lock Punch for Siding

- Punch impression spaced 3/8" from edge of metal
- Heavy forged cutting jaw
- Nickel plate and black oxide finish
- Green grips



Part #	Mfg #	Length	Throat Depth	Price
MALSL1	SL1	8"	3/8"	99.02

Snap Lock Punch for Gutter

- Used to crimp end caps on gutter
- Formed metal cutting jaws
- Nickel plate and black oxide finish
- Green grips



Part #	Mfg #	Length	Throat Depth	Price
MALSL2	SL2	8"	1/4" - 5/8"	74.34

Seamers

Hand Seamer

- Bends and flattens metal easily
- Makes permanent, tight fitting seams
- Black vinyl cushion grips with handle stops
- All steel parts and hardware are nickel plated
- 1/4" - 1-1/4" Diameter



Part #	Mfg #	Jaw Capacity	Length	Price
MALS2	S2	3-1/4"W	8"	91.18

Offset Hand Seamer

- Bends and flattens metal overhead or in confined areas



Part #	Mfg #	Jaw Capacity	Length	Price
MALS3	S3	3-1/4"W	8"	103.16

Hand Tools

Prices & Specifications are Subject to Change.

Hand Tools

Hand Tools

6" Hand Seamer

- Use for all the Metal Trades
- Wider jaws minimizes buckling and bowing



Part #	Mfg #	Jaw Capacity	Length	Price
MALS6	S6	6"W	8"	137.54

Sheet Metal Fabricator

- Accommodates sheet metal up to 4' wide, any length
- Dual direction, cam-over style clamps keep anvil secure
- Makes bends to 135° in 22 gauge galvanized sheet metal
- Compact, 58 lb net weight nickel plated steel



Part #	Mfg #	Description	Price
MALMB48	MB48A	48" Mini-Brake	814.62

Folding Tools

- Folding seams are formed from two steel halves, permanently joined together



12F

Part #	Mfg #	Width	Folding Depths	Price
MAL12F	12F	12"	3/8" and 1"	29.56
MAL18F	18F	18"	3/8" and 1"	41.26

Duct Tools and Accessories

Duct Stretcher

- Wheels can be changed to other side of tool for applications where side of duct is close to wall or obstruction



Part #	Mfg #	Description	Price
MALDS2	DS2	16" Offset Handle	54.52

Pipe and Duct Holder

- Like an extra pair of hands
- (2) Clamps and 4' of 125 lb tensile strength linked chain
- Clamp handles are 8" long
- Both clamps and chain are nickel plated steel



Part #	Mfg #	Description	Price
MAL2DH	2DH	1 Pair of Clamps and Chain	62.52

TurboShear™ Drills

TurboShear HD™

- Inserts into chuck of 14.4V or larger A/C or cordless drill
- Navigates tight patterns and square cuts
- 18 Gauge capacity in galvanized steel
- Clamping devise standard



Part #	Mfg #	Description	Price
MALTSHD	TSHD	Heavy Duty TurboShear™ with Clamp	188.92

TurboShear™

- Attaches to the chuck of a 1200 RPM, 12V cordless or an A/C electric drill
- Makes fast cuts in sheet metal
- Capable of making precise 6" x 6" square hole cuts
- 20 Gauge capacity in spiral duct
- 18 Gauge capacity in galv steel
- Material must be pre-set or held by an assistant
- Shear cuts to the left
- Use TSDC drill clamp for 1-hand operation



Part #	Mfg #	Description	Price
MALTS1	TS1	TurboShear™ Sheet Metal Cutter	107.54

Hand Tools

Hole Cutters

"Gold Standard" Hole Cutter

- Cuts holes up to 12" diameter in 20 gauge sheet metal
- Use with any standard 1/4" electric drill
- Cast aluminum body
- All wearing parts made of special heat-treated steel



Part #	Mfg #	Hole Diameter	Price
MALHC1	HC1	2" - 12"	133.70

Hole Cutter Replacement Part

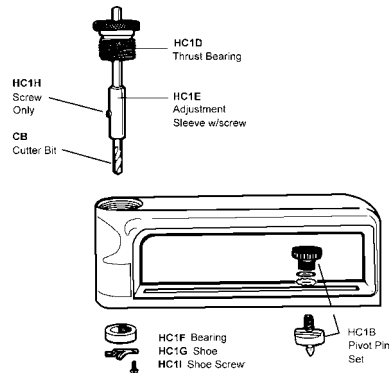

Part #	Mfg #	Description	Price
MALCB	CB	Malco Bit for HC1 and HC2	22.64

Crimpers

Offset Pipe Crimper

- Carbon steel blades
- Length: 9-5/8"



Part #	Mfg #	Throat Depth	Price
MALC6	C6	1-5/8"	66.46

Dampers

Pre-Assembled Damper

- Use for a properly balanced forced air system
- 1/4" Bearings allow installer to make bearing holes anywhere in pipe
- 28 Gauge

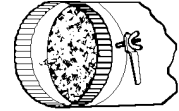

Part #	Mfg #	Pipe Dia	Bearing	Price
MALD6AS	D6AST	6"	Single	2.88
MALD7HTAS	D7HTAST	7"	Double	3.82
MALD8HTAS	D8HTAST	8"	Double	4.06

Fiberglass FasGroov™ Ductboard Tools

FasGroov™ Kit for 1" Fiberglass Ductboard



Part #	Mfg #	Description	Price
MALFGSLK	FGSLK	Shi lap Kit: Includes FGV1, FGV24, FGV3, FGV5, FGV6, FGS Sq, FGK, FGM, FG, FGC, Manual and Tool Case	974.02

Fiberglass Flex Duct Tools

Tensioning Tool

- Hardened steel stampings with weather resistant nickel chrome finish
- Vinyl grips with hand stops
- Tensioning adjustment knob and auto cut-off mechanism



Part #	Mfg #	Description	Price
MALTY6	TY6	High Leverage Tie Tool, Auto Cut-Off	106.02

Hand Tools

Hand Tools

Tie Tool

- Action tie tools feature long wearing, serviceable parts
- Comfortable handles reduce the pinch point area
- Works on all ties including thin designs



Part #	Mfg #	Description	Price
MALTY4	TY4	Manual Cut-Off	74.86

Flex Duct Cutter and Shear

- Double edged knife blade
- Thumb operated latch
- Easily resharpenable
- Handles feature non-slip vinyl grips



Part #	Mfg #	Description	Price
MALFDC2	FDC2	Flex Duct Shear	84.60

Tubing Tools

Sure Grip Tube Slicer

- Produces cuts in ABS, PVC, rubber and fabric reinforced hose to 1" ID
- Rigid, durable nylon handle
- Blade is resharpenable and replaceable



Part #	Mfg #	Description	Price
MALTC400	TC400	Plastic Tube Slicer	39.54

Bar Clamp Type Flaring Tool

- Flares 7 sizes of soft copper, aluminum and brass tubing



Part #	Mfg #	Description	Price
MALFT195	FT195	3/16", 1/4", 5/16", 3/8", 7/16", 1/2", 5/8" OD	109.34

Power Return Tapes

- Ultraviolet curing extends blade life
- Impact resistant cases

Magnetic Tip 1" Tape Measure

- Reinforced end hook
- Nylon coated blade
- Yellow blade



Part #	Mfg #	Size	Price
MALT416M	T416M	1" x 16'	29.02
MALT425M	T425M	1" x 25'	36.34

Non-Magnetic 1" Tape Measure



Part #	Mfg #	Size	Price
MALCT430	CT430	1" x 30'	26.34

Utility Knives and Knife Blades

Quick Open Utility Knife

- Retractable blade
- Integrated hinge



Part #	Mfg #	Description	Price
MAL9PK	9PK	3-Position	19.94

Hammers

Sheet Metal Hammer - Setting

- Polished finish



Part #	Mfg #	Size	Handle	Head Wt	Price
MALSH3	SH3	5-1/2"	Leather	18 oz	107.96

Hand Tools

Pliers

Multi-Track Pliers

- Tempered steel halves
- Long cushion grip
- Size: 10"



Part #	Mfg #	Sq Open	Tracks	Net Wt	Price
MALMT10	MT10	1-1/2"	5	12 oz	45.92

Electrical Cutter/Stripper Pliers

Cutter/Stripper/Crimper

- Up front scissors action strips copper wire clean and cuts easily sizes 10-20 and 22-14 (red and blue)



Part #	Mfg #	Crimping	Length	Price
MALWSC8	WSC8	22-10 Gauge	8-1/4"	46.50

Hex Keys

"T" Handle Hex Key Kit in Plastic Pouch

- Kits consist of sizes: 3/32", 7/64", 1/8", 9/64", 5/32", 3/16", 7/32" and 1/4"



Part #	Mfg #	Description	Price
MALWT6SG	WT6SG	(8) Keys, 6" Long, Grippd	56.96

Ball Tip L-Wrench Set

- Easy socket access at angles up to 25° off axis
- Wrench sets store in reusable case



Part #	Mfg #	Description	Price
MALWBL12S	WBL12S	12-Piece Set	78.32

Folding Hex Key Set

- Professional quality
- Produced from tough alloy steel



Part #	Mfg #	Description	Price
MALW29	W29	(9) Keys, Deluxe Pocket	20.54

Nut Drivers

CONNEXT™ Magnetic Hex Driver - Long Lengths

- CONNEXT™ Quick change handles
- Magnetic hex chuck driver shaft components
- Pre-assembled
- Use with Zip-In® and "A" hex head screws



Part #	Mfg #	Hex Dia	Shaft Length	Grips	Price
MALHHD1	HHD1	1/4"	6-7/8"	Red	24.22
MALHHD2	HHD2	5/16"	6-7/8"	Yellow	24.88

Power Bits

Magnetic Hex Driver Bit

- 1/4" Shank diameter



Part #	Mfg #	Hex Opening	Nose Diameter	Price
MALMSH14	MSH1/4	1/4"	7/16"	7.08
MALMSH516	MSH5/16	5/16"	1/2"	8.60

Long Style Hex Driver Bit

- 1/4" Shank diameter



Part #	Mfg #	Hex Opening	Nose Dia	Qty	Price
MALMSHL14	MSHL1/4	1/4"	7/16"	1	10.78
MALMSHL516	MSHL5/16	5/16"	1/2"	1	12.50

Extra Long Style Hex Driver Bit

- 1/4" Shank diameter



Part #	Mfg #	Hex Opening	O/A Length	Price
MALMSHXL14	MSHXL1/4	1/4"	6"	21.86
MALMSHXL516	MSHXL5/16	5/16"	6"	25.70

Power Bit Extension

- Ball bearing on holder provides a positive lock on 1/4" hex
- Tempered steel
- Black finish
- 9/16" Nose diameter



Part #	Mfg #	Hex Opening	O/A Length	Price
MALBHE10	BHE10	1/4"	10"	29.98

Prices & Specifications are Subject to Change.

Hand Tools

Hand Tools

Plumbing Specialty Tools

4-Way Key

- For valves, faucets and sillcocks
- Plated steel



Part #	Mfg #	Sizes	Price
PLSSILCOCK	J40-005	1/4", 9/32", 5/16" & 11/32"	4.10

Faucet Handle Pullers

- Removes faucet and valve handles
- Plated steel

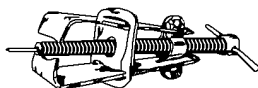

Part #	Mfg #	Description	Price
PLSHANDLEPULLER	J40-010	Standard Unit	6.84

Wrenches

Tub & Shower Valve Wrench Set

- Complete with handle

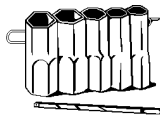

Part #	Mfg #	Description	Price
PLSWRENCHTUBVLV	J40-002	Plated Steel Socket Set	14.52

Radiator Spud Wrench

- For use as spud key and wrench



Part #	Mfg #	Description	Price
PLSWRENCHNIPPLE	J40-030	Plated Malleable Iron Wrench	14.97

4-Way Plug Wrench

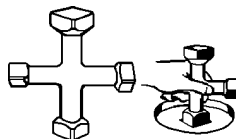

Part #	Mfg #	Description	Price
PLSWRENCHCSPLUG	J40-040	Countersunk Plug Wrench	24.53

4-Way P.O. Plug Wrenches

- For installing or removing basket strainers, tub drains and P.O. plugs

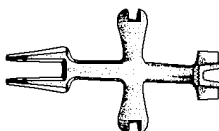

Part #	Mfg #	Description	Price
PLSWRENCHPOPLUG	J40-026	Wrench	6.43

Faucet Seat Wrenches

- Tapered for use on all sizes and types of seats

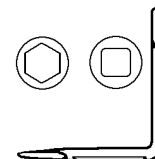

Part #	Mfg #	Description	Price
PLSWRENCHSEAT90TAP	S62-002	Angle Tapered	4.23

Strainer Wrench

- For use on basket strainers and tub drains with cross bars
- Long handle for leverage



Part #	Mfg #	Description	Price
PLSWRENCHSTRAINER	J40-028	Plated Steel Wrench	8.68

Solder Supplies

Pencil Flame Torch

- Includes valve, stem and burner
- For MAPP or propane



Part #	Mfg #	Description	Price
PLSTORCH	J40-229	Pencil Flame Torch	71.43



Gauge Glass Cutter



Part #	Mfg #	Description	Price
PLSGGCUTTER	1801006	Quarter-Turn Cutter	26.00

Hand Tools

Hand Tools

Wrenches

Heavy-Duty Straight Pipe Wrenches

- Sturdy, cast iron housing & I-beam hand with full floating forged hook jaw, nonstick adjustment nut & replaceable hook & heel jaws



Part #	Mfg #	Model	Nom Size	Pipe Capacity	Price
RIDWR6	31000	6	6"	3/4"	14.95
RIDWR8	31005	8	8"	1"	17.45
RIDWR10	31010	10	10"	1-1/2"	23.05
RIDWR12	31015	12	12"	2"	26.60
RIDWR14	31020	14	14"	2"	29.80
RIDWR18	31025	18	18"	2-1/2"	43.05
RIDWR24	31030	24	24"	3"	68.15

Aluminum Handle Straight Pipe Wrench

- Nearly 40% lighter than comparable cast iron models of the same size
- Jaws & all other parts identical to RIDGID heavy-duty wrenches



Part #	Mfg #	Model	Nom Size	Pipe Capacity	Price
RID810	31090	810	10"	1-1/2"	36.70
RID812	47057	812	12"	2"	43.95
RID814	31095	814	14"	2"	49.85
RID818	31100	818	18"	2-1/2"	62.15
RID824	31105	824	24"	3"	99.25
RID836	31110	836	36"	5"	170.75

Strap Wrench

- Best for any polished pipe
- Strong, woven nylon strap gives tight grip
- Polyurethane-coated strap prevents scratching
- Replacement straps available



Part #	Mfg #	Model	Handle Length	Strap Length	Strap Width	Pipe Capacity	OD Tube Capacity	Price
RID1	31335	1	11-3/4"	17"	1/2"	2"	3-1/2"	63.06

Hex Wrench

- Gives multi-sided, secure grip on all hex nuts, square nuts, unions, & valve packing nuts



Part #	Mfg #	Model	Description	Nom Size	Pipe Capacity	Price
RIDE110	31305	E110	Offset Hex	9-1/2"	1-1/8" - 2-5/8"	33.20

Spud Wrench

- Narrow jaws to fit into tight places
- Smooth, toothless jaws ideal for square or rectangular stock



Part #	Mfg #	Size	Pipe Capacity	Price
RIDSPUDWR12	31400	12"	3/8" - 2-5/8"	40.10

Prices & Specifications are Subject to Change.

Hand Tools

Hand Tools

Basin Wrench

- Spring-loaded jaws of forged alloy steel
- Tension plug holds head in any position up to 90° angle



Part #	Mfg #	Model	Nom Size	Pipe Capacity	Price
RID1017	31175	1017	Telescoping 10" - 17"	3/8" - 1-1/4"	35.45
RID1019	31180	1019	Telescoping 10" - 17"	1-1/4" - 2-1/2"	40.90

Faucet & Sink Installer (Plastic Nut Basin Wrench)

- Designed to reach & turn plastic mounting nuts on faucets, sprayers & ballcocks
- Used to fasten and remove plastic basin nuts, supply line nuts, along with 7/8" and 1" hex nuts
- Notched ends are designed to self-center on 2, 3, 4 & 6 tab nuts & to fit on metal hex nuts
- Strainer basket attachment holds drain unit in place while tightening strainer nut
- High strength plastic with aluminum inserts



Part #	Mfg #	Model	Length	Price
RID66807	66807	2006	10-1/4"	23.35

OneStop™ Wrench

- (2) Tools in one
- Provides all exact size surface wrenches needed for angle stop & compression coupling installation



Part #	Mfg #	Description	Price
RID2002	97452	OneStop™ Wrench	25.30

Torque Wrench

- Preset to eliminate guesswork in No Hub® cast-iron soil pipe installations
- Assures proper coupling tightness for strong, leak-free joints



Part #	Mfg #	Model	Capacity	Drive	Price
RID902	31410	902	60 in lbs	5/16"	39.65

Pipe Cutters

Heavy-Duty Pipe Cutter

- Fast, clean pipe cutting by hand or power
- Extra-long shank protects adjustment threads, while an extra-large handle is provided for quick, easy adjustment
- Can be converted to 3-wheel cutter by replacing rollers with cutter wheel



Part #	Mfg #	Model	Pipe Capacity	Description	Price
RID2A	32820	2-A	1/8" - 2"	Heavy-Duty	152.35

All Items May Not Be Stocked In All Branches

Hand Tools

Hand Tools

Soil Pipe Cutter

- Provides 1-stroke cutting of 1-1/2" to 6" service weight, No-Hub® soil pipe, clay, asbestos & cement pipe



Part #	Mfg #	Model	Pipe Capacity	Description	Price
RID226	69982	226	1-1/2" - 6"	In-Place, Cuts Hub and No-Hub Soil Pipe, 17" Long	546.70

Pipe Cutter Replacement Wheel



Part #	Mfg #	Model	Blade Exp	Application	For Models	Price
RIDF3	33105	F-3	.312	Steel & Ductile Iron	1A, 2A, 42A, 202, 360, 732, 820/364	11.40
RIDF514	33100	F-514	.312	Steel & Ductile Iron	1A, 2A, 42A, 202, 360, 732, 820/364	9.05

Tubing Cutters

Close Quarters Tubing Cutter

- Use in restricted spaces on small diameter, hard & soft copper, aluminum, brass & plastic tubing
- Large knurled feed screw knob



Part #	Mfg #	Model	Capacity	Description	Std Wheel	Price
RID101	40617	101	1/4" - 1-1/8"	Cutter with Spare Wheel	E-3469	21.95
RID103	32975	103	1/8" - 5/8"	Cutter	E-3469	13.25
RID104	32985	104	3/16" - 15/16"	Cutter	E-3469	15.45
RID117	97787	117	3/16" - 15/16"	Quick-Feed Cutter	E-3469	19.95
RID118	86127	118	1/4" - 1-1/8"	Quick-Feed Cutter	E-3469	27.40

Constant Swing Cutter with X-CEL

- Features an enclosed feed screw to eliminate clogging & jamming, grooved rolls for close-to-flare cuts, & a fold-away reamer
- Made from high-strength aluminum alloy



Part #	Mfg #	Model	Capacity	Description	Std Wheel	Price
RID150	31622	150	1/8" - 1-1/8"	Feed Cutter	E-3469	28.45

Enclosed Feed Cutter

- Cuts copper, brass & aluminum tubing & thin-wall conduit
- Quick-acting mechanism for faster size adjustments
- Spare cutter wheel



Part #	Mfg #	Model	Capacity	Description	Std Wheel	Price
RID205	33055	205	1/4" - 2-3/8"	Enclosed Feed Cutter	E-3469	76.45

Prices & Specifications are Subject to Change.

Hand Tools

Hand Tools

Tubing & Conduit Cutter with X-CEL

- Clean, square cuts on copper, brass, aluminum, & thin-wall conduit



Part #	Mfg #	Model	Capacity	Description	Std Wheel	Price
RID10	32910	10	1/8" - 1"	Screw Feed Cutter	F-158	27.95
RID15	32920	15	3/16" - 1-1/8"	Screw Feed Cutter, Fold-Away Reamer	F-158	32.55
RID15HD	32925	15	3/16" - 1-1/8"	Screw Feed Cutter, Fold-Away Reamer, HD Wheel	E-1240	33.85
RID20	32930	20	5/8" - 2-1/8"	Screw Feed Cutter, Fold-Away Reamer	F-158	62.65
RID30	32940	30	1" - 3-1/8"	Screw Feed Cutter f/Lg Dia Steel & SS Tube	F-158	96.95

Quick-Acting Tubing Cutter with X-CEL

- I-Beam construction, hardened wear surfaces & bearing side assemblies for smooth operation
- Plastic cutters include spare cutting wheel for cutting copper



Part #	Mfg #	Model	Capacity	Description	Std Wheel	Price
RID151	31632	151	1/4" - 1-5/8"	Quick-Acting, Fold-Away Reamer	E-3469	47.45
RID152	31642	152	1/4" - 2-5/8"	Quick-Acting, Fold-Away Reamer	E-3469	76.60
RID154	31652	154	1-7/8" - 4-1/2"	Quick-Acting Tubing Cutter	E-2558	117.25

P-TEC 2550 Tailpiece Extension Cutter

- For thin-wall plastic tube
- Undercounter specialty tool for polyethylene, polypropylene & thin-walled PVC disposer kits, tailpieces and wall tube
- Clean automatic deburring
- Automatic beveling



Part #	Mfg #	Model	Description	Price
RID2550	36263	P-TEC 2550	Tailpiece Extension Cutter	21.05

Tubing Cutter Wheels



Part #	Mfg #	Model	Blade Exp	Application	For Model	Price
RIDE1240	33165	E-1240	.162	Steel - SS	10, 15, 15-SI	7.35
RIDE2191	33175	E-2191	.292	HD Steel Tubing	30, 40, 122, 122XL, 133, 154, 156	10.15
RIDE2558	33170	E-2558	.220	Aluminum & Copper	30, 40, 108, 109P, 133, 154, 156	7.85
RIDE4546	33190	E-4546	.162	Steel - SS	151, 152, 153, 205	8.00
RIDE3469	33185	E-3469	.149	Copper, Aluminum, Brass & Plastic	101, 103, 104, 117, 118, 150, 151, 152, 153, 205	6.35
RIDF158	33160	F-158	.149	Aluminum & Copper	10, 15, 20	6.35

Tubing Cutter Parts

Part #	Mfg #	Description	For Model	Price
RID42327	42327	Retaining Ring	101, 103, 104, 117 & 118	0.69

All Items May Not Be Stocked In All Branches

Hand Tools

Hand Tools

Pipe Tools

Inner-Outer Reamer

- Plastic construction with long-wearing alloy steel blades



Part #	Mfg #	Model	Capacity	Construction	Price
RID127	34965	127	1/4" - 1-1/2" Nominal Water Tube	Plastic	21.85

Hardened Steel Inner-Outer Reamer

- Hardened Steel construction
- 46 Cutting edges on interior cone
- For fast, clean, inner reaming and outer deburring/beveling of 1/2"-2" copper and stainless steel tubing



Part #	Mfg #	Model	Capacity	Construction	Price
RID227	29993	227S	1/2" - 2" Copper & SS Tubing	Hardened Steel	73.95

Individual Pipe Extractors

- Easily removes broken threaded ends of pipe, pipe plugs & fittings
- Each is plainly marked showing drill size used when solid ends of plugs & fittings must be drilled to receive extractor
- E indicates extractors for schedule 80 pipe



Part #	Mfg #	Model	Pipe Size	Length Overall	Use Drill	Price
RID83	35610	83	1/2"	3"	5/8"	14.65
RID84	35615	84	3/4"	3-1/4"	1-3/16"	17.75

NPT Pipe Tap

- Hand use only
- Made from carbon steel in right hand configuration only
- Especially suited for restricted area work
- All taps have a taper of 3/4" per foot



Part #	Mfg #	Model	Drill Size	Nominal Pipe Size	Threads Per Inch	Weight	Price
RIDE5113	35820	E-5113	7/16	1/4"	18	1/8 lb	13.55
RIDE5114	35825	E-5114	9/16	3/8"	18	1/4 lb	19.05
RIDE5115	35830	E-5115	45/64	1/2"	14	1/4 lb	23.00
RIDE5116	35835	E-5116	29/32	3/4"	14	1/2 lb	33.10
RIDE5117	35840	E-5117	1-9/64	1"	11-1/2	1 lb	49.90
RIDE5119	35850	E-5119	1-47/64	1-1/2"	11-1/2	2 lbs	93.45
RIDE5120	35855	E-5120	2-15/64	2"	11-1/2	3-1/4 lbs	137.80

Prices & Specifications are Subject to Change.

Hand Tools

Hand Tools

Tubing Tools

Ratchet Flaring Tool

- Ratcheting feed screw handle
- Hardened steel flaring cone, eccentrically mounted in needle bearings



Part #	Mfg #	Model	Type	Sizes	Price
RID458R	83037	458R	45° SAE Flares	1/8", 3/16", 1/4", 5/16", 3/8", 1/2", 5/8", 3/4"	141.35

Hammer-Type Flaring Tool

- Made of high-grade hardened steel
- Long nose guide that centers tools for smooth, 45° uniform flares



Part #	Mfg #	Model	Water Tube Size	Price
RIDE45	41320	E-45	1/2"	12.40
RIDE47	41330	E-47	3/4"	15.60
RIDE52	41335	E-52	1"	19.70
RIDE61	41340	E-61	1-1/4"	32.55
RIDE63	41345	E-63	1-1/2"	43.00
RIDE64	41350	E-64	2"	68.40

Pipe Vises & Supports

Portable Tristand® Vise

- Foldable integral legs and tray



Part #	Mfg #	Model	Description	Pipe Capacity	Price
RID425	16703	425	Portable Tristand Chain Vise	1/8" - 2-1/2"	352.40

Manual Threaders

Ratchet & Handle Only

- Ratchet knob indicates forward and reverse
- Die heads snap in from both sides and lock in place



Part #	Mfg #	Model	Price
RID00R	38540	00-R	68.50
RID12R	38555	12-R	76.90

Hand Tools

Manual Threader Die Head

- North American standards



Part #	Mfg #	Model	Description	Nominal Pipe Capacity	Price
RIDOOR12	36890	00-R	Alloy RH	1/2"	70.85
RIDOOR34	36895	00-R	Alloy RH	3/4"	70.85
RIDOOR1	36900	00-R	Alloy RH	1"	76.30
RID12R12	37390	12-R	Alloy RH	1/2"	100.60
RID12R34	37395	12-R	Alloy RH	3/4"	100.60
RID12R1	37400	12-R	Alloy RH	1"	128.00
RID12R114	37405	12-R	Alloy RH	1-1/4"	128.00
RID12R112	37410	12-R	Alloy RH	1-1/2"	141.10
RID12R2	37415	12-R	Alloy RH	2"	141.10

Hand Tools

Pipe Die - National Pipe Taper NPT



Part #	Mfg #	Model	Description	Nominal Pipe Capacity	Price
RID12R38DIES	37820	12-R	Alloy RH	3/8" - 18	48.40
RID12R12DIES	37825	12-R	Alloy RH	1/2" - 14	48.40
RID12R34DIES	37830	12-R	Alloy RH	3/4" - 14	48.40
RID12R1DIES	37835	12-R	Alloy RH	1" - 11-1/2	57.45
RID12R114DIES	37840	12-R	Alloy RH	1-1/4" - 11-1/2	57.45
RID12R112DIES	37845	12-R	Alloy RH	1-1/2" - 11-1/2	63.85
RID12R2DIES	37850	12-R	Alloy RH	2" - 11-1/2	63.85

Receding Threaders Pipe Die

- For 65R-C & 65R-TC ratchet threaders

Part #	Mfg #	Model	Type	Description	Price
RID65R1-2DIES	38100	65-R	High Speed RH	(NPT) National Pipe Taper 1-2" - 11-1/2 TPI	86.95

Threader Oil

Oiler

- Hand-operated, easy pumping 2-finger trigger
- Completely portable, large pan catches oil run-off chips
- Oil is double-filtered & recirculated through reservoir
- Chip pan 14-1/2" diameter, 8-1/2" deep, hose length 54"



Part #	Mfg #	Model	Description	Price
RID418	10883	418	Hand-Operated Oiler Complete	291.10

Prices & Specifications are Subject to Change.

Hand Tools

Hand Tools

Hand Tools

K-5 Grappler Hook

- Retrieves rocks, tools, objects
- Extends your reach 6'



Part #	Mfg #	Model	Description	Price
RIDK5	59190	K-5	6' Grappler Hook Retriever	209.10



Hand Hacksaw Frames

High Tension Frame

- Ergonomic design
- Larger space fits gloved hands
- Handle holds up to five 12" hacksaw blades for quick changeouts
- Mount at 45° for flush cutting
- Insert standard reciprocating blade to use as jab saw
- 30,000 psi
- Frame includes (1) 12" 24 TPI blade



Part #	Mfg #	Description	Price
LEN4012	20918-4012	High Tension Metal Cutting	38.91

Hand Saws

Compact Hacksaw

- Heavy-duty aluminum handle
- Allows for flush cutting applications



Part #	Mfg #	Description	Price
LEN975	20975-975	Multi-Purpose	12.38

Close Quarter® Saw

- Reaches into tight spaces where standard won't fit



Part #	Mfg #	Description	Price
LEN908	20908-908	Close Quarter Saw	18.40
LEN906	20906-906	6"L x 1/4"W, 32 TPI Blade	1.61

Tri-Fold® Saw

- Complete with reciprocating blade
- Locks into three different positions for cutting anything from wood to drywall, to stainless steel at any angle
- Uses any reciprocating blade with 1/2" tang



Part #	Mfg #	Description	Price
LEN618636	20997-TFHS618636	(2) Blade, Plaster, Wood, & Metal Cutting (635R/636RP)	33.23

All Items May Not Be Stocked In All Branches

Hand Tools

PVC/ABS Plastic Pipe Hand Saw

- Wide rigid carbon steel blade with hardened teeth
- Cut any size diameter plastic pipe, wood & nail-embedded wood
- Heavy-duty lightweight aluminum handle



Part #	Mfg #	Description	Price
LENHSB12	20982-HSB12	12" Replacement Blade	12.03
LENHSB18	20981-HSB18	18" Replacement Blade	15.31
LENHSF120	20985-HSF12	12" Blade & Rubberized Handle	25.42
LENHSF180	20980-HSF18	18" Blade & Rubberized Handle	28.52

Hand Tools

Hole Saws

Bi-Metal Hole Saws

- TUFF TOOTH™ design is reinforced to cut stronger & last longer
- Patented VARI-TOOTH® design resists tooth strippage
- High speed steel teeth resist breaking & offer extended life

Use Arbor 1L, 1SL, 4L or 5L

- (1) Per clamshell



Part #	Mfg #	Dia	Pipe Tap	Pipe Entr	Price
LEN12L	30112-K12L	3/4"	1/2"	3/8"	11.67
LEN14L	30114-K14L	7/8"	3/4"	1/2"	11.67
LEN16L	30116-K16L	1"	-	-	12.64
LEN18L	30118-K18L	1-1/8"	1"	3/4"	12.64

Use Arbor 2L, 2SL, 3L or 6L

- (1) Per clamshell



Part #	Mfg #	Dia	Pipe Tap	Pipe Entr	Price
LEN20L	30120-K20L	1-1/4"	-	-	12.64
LEN22L	30122-K22L	1-3/8"	-	1"	13.31

Use Arbor 2L, 2SL, 3L, 6L or 7L

- (1) Per box

Part #	Mfg #	Dia	Pipe Tap	Pipe Entr	Price
LEN60L	30060-60L	3-3/4"	3-1/2"	-	31.63
LEN72L	30072-72L	4-1/2"	-	-	66.85
LEN80L	30080-80L	5"	-	-	82.47
LEN96L	30096-96L	6"	-	-	115.32

Prices & Specifications are Subject to Change.

Hand Tools

Hand Tools

Arbor 2L, 2SL, 3L, 6L or 7L

- (1) Per clamshell



Part #	Mfg #	Dia	Pipe Tap	Pipe Entr	Price
LEN24L	30124-K24L	1-1/2"	1-1/4"	-	13.31
LEN26L	12172-K26L	1-5/8"	-	-	13.31
LEN28L	30128-K28L	1-3/4"	1-1/2"	1-1/4"	16.73
LEN30L	30130-K30L	1-7/8"	-	-	16.73
LEN32L	30132-K32L	2"	-	1-1/2"	16.73
LEN34L	30134-K34L	2-1/8"	-	-	20.19
LEN36L	30136-K36L	2-1/4"	2"	-	20.19
LEN40L	30140-K40L	2-1/2"	-	2"	21.76
LEN42L	30142-K42L	2-5/8"	2-1/2"	-	21.76
LEN44L	30144-K44L	2-3/4"	-	-	21.76
LEN48L	30148-K48L	3"	-	-	22.53
LEN52L	30152-K52L	3-1/4"	3"	-	23.15
LEN56L	30156-K56L	3-1/2"	-	-	23.15
LEN58L	30158-K58L	3-5/8"	-	3"	26.78
LEN64L	30164-K64L	4"	-	-	34.06
LEN66L	30166-K66L	4-1/8"	-	3-1/2"	36.98
LEN76L	30176-K76L	4-3/4"	-	-	74.34

Diamond™ Hole Saw - 1-Piece

- For use on tile & stone
- Continuous brazed edge
- Over-sized slot in hole saw for easy plug removal
- No arbor required



Part #	Mfg #	Dia	Pipe Tap	Pipe Entr	Price
LEN12117	1211722DGDS	1-3/8"	-	-	78.21

Hole Saw Arbor

- 7L "Ejector Arbor" makes removal of material from inside of hole saw easier

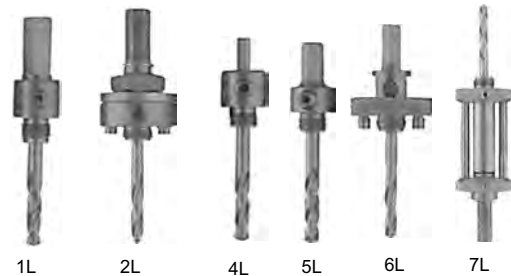

Part #	Mfg #	Fits Hole Saws	Size	Shank	Price
LEN1L	30001-1L	9L-19L	1/2"	Hex	16.50
LEN2L	30002-2L	20L-96L	1/2"	Hex	31.09
LEN4L	30004-4L	9L-19L	1/4"	3 Sided	12.23
LEN5L	30005-5L	9L-19L	3/8"	Hex	17.87
LEN6L	30006-6L	20L-96L	3/8"	Hex	28.65
LEN7L	30007-7L	26L-96L	3/8"	Hex	50.90

All Items May Not Be Stocked In All Branches

Hand Tools

Hand Tools

7-Piece One Tooth® Rough Wood Hole Cutter Kit

- Includes:
 - (3) ea: 2-1/8", 2-9/16" & 3-5/8" One Tooth® Hole Cutters
 - (1) Arbors: 2L
 - Diamond file
 - Pilot drill: (2) stubby spade bits
 - Plastic case



Part #	Mfg #	Description	Price
LEN301G	25476-301G	7-Piece Hole Saw Kit	201.87

One Tooth™ Wood Hole Cutter

- 3 Times faster than regular hole saws
- Safer/less torque than self feed bits
- Easy plug ejection
- Cuts wet, frozen, pressure treated & hard wood without binding
- Can be resharpened



Part #	Mfg #	Cutter Size	Price
LEN34HC	25434-34HC	2-1/8" for 1-1/2" Pipe, Lock Installation	34.86
LEN36HC	25436-36HC	2-1/4" for 1-1/2" Pipe & 45°/90° Bend Couplings	37.26
LEN41HC	25441-41HC	2-9/16" for 2" Pipe	38.62
LEN44HC	25444-44HC	2-3/4" for 2" Pipe & 45°/90° Bend Couplings	40.25
LEN56HC	25456-56HC	3-5/8" for 3" Pipe	55.53
LEN64HC	25464-64HC	4" for 3" Pipe & Coupling, Dryer Vent	70.92
LENSB38	25310-SB38	3/8" Stubby Spade Bit	5.18
LENDIAF1	25312-DIAF1	Diamond Sharpener File	31.42

4-Piece Diamond Drill/Hole Saw Kit

- Brazed edge
- Low torque
- Split point pilot
- Oversized slot for plug removal
- Includes:
 - (1) ea: 3/16", 1/4", 5/16", 3/8" Diamond coated hole saws

Part #	Mfg #	Description	Price
LEN12158	12158	3/16" to 3/8" Hole Saws	88.83

11-Piece One Tooth® Rough Wood Hole Cutter Kit

- Includes:
 - (1) ea: 2-1/8", 2-1/4", 2-9/16", 2-3/4", 3-5/8", 4" & 4-5/8" One Tooth® Hole Cutters
 - (1) Arbor: 2L
 - Diamond file
 - Pilot drill: (2) 3/8" stubby spade bits
 - Plastic case



Part #	Mfg #	Description	Price
LEN701G	25477-701G	11-pc Hole Saw Kit	438.08

Prices & Specifications are Subject to Change.

Hand Tools

Hand Tools

Bi-Metal Hole Saw Kit

- Designed for professional trades

Plumbers

- Includes:
 - (1) ea 3/4", 7/8", 1-1/8", 1-1/2", 1-3/4" & 2-1/4" Hole saws
 - (2) Arbors 2L & 5L
 - (1) 4321 Pilot drill
 - (1) Arbor adaptor
 - Plastic case



Part #	Mfg #	Description	Price
LEN600P	30808-600P	Hole Saw Kit	152.24

General Purpose - 26-Piece Kit

- Includes:
 - (1) ea 1-1/2", 1-3/4", 2", 2-1/8", 2-1/4", 2-1/2", 2-11/16", 3", 3-1/4", 3-3/8", 3-5/8", 3-3/4", 4-1/8", 4-1/2" & 4-3/4" Hole saws
 - (3) Arbors: 1L, 2L, 5L
 - (2) 4321 & (1) 56PD Pilot drills
 - Plastic case



Part #	Mfg #	Description	Price
LEN2000G	30804-2000G	Big Daddy™ Hole Saw Kit	582.89

Hole Saw Accessories



Part #	Mfg #	Description	Price
LEN4321	30850-4321	1/4" Pilot Drill fits 1L, 2L, 4L	5.65
LEN30851	30851-56PD	1/4" Pilot Drill fits 3L, 5L, 6L or 7L	5.02
LEN55X	30846-55X	5-1/2" Extension	19.31
LEN12X	30847-12X	12" Extension	19.90
LEN18X	30848-18X	18" Extension	27.56

Carbide Tipped Hole Saw Kits

- Designed for professional trades

17-Piece Plumbers

- Includes:
 - (1) ea 3/4", 7/8", 1-1/8", 1-1/2", 1-3/4", 2-1/4", 2-9/16", 3", 3-1/2", 4", 4-1/4" & 4-1/2" Hole saws
 - (2) Arbors: 2L & 5L,
 - (2) 4321 & (1) 56 PD Pilot drill
 - Plastic case



Part #	Mfg #	Description	Price
LEN1200P	30801-1200P	Bi-Metal Hole Saw Kit	372.32

Hand Tools

Hand Tools

Tubing Cutters

Ergonomic Tubing Cutter

- Ergonomically designed for professional performance
- Professional deburring
- Will not damage cutting wheel
- Easy to use - change out wheels with only a screwdriver



TC1-1/8



TC1-3/8

Part #	Mfg #	Tube Diameter Range	Price
LENTC118	21010-TC11/8	1/8" - 1-1/8"	38.58
LENTC138	21011-TC13/8	1/8" - 1-3/8"	55.60

TS Tight Space Tubing Cutter

- Shock-resistant steel
- Non-slip grooved cast body
- 1/2" Clearance to cut
- Stainless steel rollers



14830



14831



14832

Part #	Mfg #	Tube Dia Range	Price
LENTS1	14830-TS12	1/2"	28.00
LENTS12	14831-TS34	3/4"	21.00
LENTS34	14832-TS1	1"	23.33
LENTSB	14829-TSB	Replacement Copper Wheels f/TS Cutter 2/Pk	6.67

TSK Tight Space Tubing Cutter

- Shock-resistant steel
- Non-slip grooved cast body
- 1/2" Clearance to cut
- Stainless steel rollers



Part #	Mfg #	Description	Price
LENTSK	14833-TSK	3-Piece Tight Space Tube Cutter Kit	65.33

S1 Plastic Tubing Cutter

- Serrated stainless steel blade requires less force to make a cut
- Rubberized handles
- Easy open and close
- Conveniently positioned locking latch allows for one-handed operation of spring-loaded cutter



Part #	Mfg #	Tube Diameter Range	Price
LENS1	12121S1	1" Nom - 1-5/16" OD Max	28.89

Prices & Specifications are Subject to Change.

Hand Tools

Hand Tools

R1 PVC Tubing Cutter

- Specifically designed jaw holds pipe in place while cutting with stainless steel blade
- Rubberized handles
- Conveniently positioned release button allows for true one-handed operation for ratcheting cutter
- Locking tab secures blade in place



Part #	Mfg #	Tube Dia Range	Price
LENR1	12123R1	1-1/4" Nom - 1-5/8" OD Max	66.67

ProTool Lube®

- Extends tool life
- Synthetic blend for cutting, milling, reaming, tapping and drilling metal, wood and plastics
- Water-soluble
- Biodegradable and non-toxic
- Flip-top bottle



Part #	Mfg #	Description	Price
LENLUBE	68046LNX	6 oz ProTool Lube Spray	16.18

Vari-Bits®

Vari-Bit® Step Drill Bits

- High speed steel construction & steam oxide coating
- Two cutting flutes for clean burr-free holes



Part #	Mfg #	Nbr Hole Sizes	Hole Sizes	Elec Drill Size	Price
LENVB3	30883-VB3	9	1/4 - 3/4	3/8"	62.06

Bi-metal Utility Bits

- Extreme durability; long life even in nail-embedded wood
- Optimized for cordless drilling extending battery life
- (3) Cutting edges enhance chip removal for a fast, clean hole
- Resharpenable with Lenox® Diamond file no. 25312



5-Piece Bi-Metal Utility Bit Set

Part #	Mfg #	Description	Price
LEN10955	10955	Includes 3/4", 7/8", 1", 1-1/8" & 1-1/4"	127.55

Hand Tools

Snips

Aviation Snips

- Long blade life
- Ultimate spring durability
- Quick identification



Part #	Mfg #	Description	Price
LEN101	22101	Cuts Left	25.91
LEN102	22102	Cuts Right	25.91
LEN103	22103	Straight	25.91
LEN105	22105	Bulldog	31.90

Offset Snips

- Long blade life
- Ultimate spring durability
- Quick identification



Part #	Mfg #	Description	Price
LEN206	22206	Cuts Left	31.90
LEN207	22207	Cust Right	31.90

HVAC Hand Tools



Seamer

Part #	Mfg #	Description	Price
LENC5	22209-C5	5" Blade Crimper	39.88
LENS2	22210-S2	3" Seamer	50.51
LENN2	22211-N2	1" V Notcher	39.88
LENSL1	22212-SL1	Snap Lock Punch	39.88
LENPDC4R	22213-PDC4R	Pipe Duct Cutter	39.88

Utility Knives

Lenox® Gold™ Quick Change Knife



Part #	Mfg #	Description	Price
LENSRK1	20353-SSRK1	Retractable Blade Knife with (3) Blades	22.77
LENGOLD5C	20350-GOLD5C	Replacement Blades, 5/Pk	3.75
LENGOLD50D	20351-GOLD50D	Replacement Blades, 50/Pk	28.50

Prices & Specifications are Subject to Change.

Hand Tools

Hand Tools

Lenox® Gold™ Locking Tradesman Utility Knife

- Easy open & close secure locking mechanism
- Ergonomic, rubberized comfort grip
- Multi-use tool; bottle opener, screwdriver & pipe reamer
- Built-in wire stripper



Part #	Mfg #	Description	Price
LENFLK	10771	Locking Tradesman Utility Knife	19.94

Reciprocating Saw Blades

Lenox® Gold™ Reciprocating Blades

- Longest lasting blade ever™
- Reinforced tooth design and precision applied titanium coating dissipate heat
- Titanium coating makes teeth more wear resistant so they stay sharp for quicker cuts
- Bi-metal design stands up to the most demanding applications



Part #	Mfg #	TPI	L x W x Thick	Pkg Qty	Applications	Price
LEN656G	21060-656G	6	6" x 3/4" x .050"	5	Wood, Nail-Embedded Wood, Drywall & Plaster	5.45
LEN810G	21065-810G	10	8" x 3/4" x .050"	5	Wood & Thick Metal (1/8" - 1/2")	5.76
LEN614G	21067-614G	14	6" x 3/4" x .035"	5	Thick to Medium Metal (3/32" - 1/2")	4.37
LEN618G	21069-618G	18	6" x 3/4" x .035"	5	Medium Metal (3/32" - 5/16")	4.59
LEN818G	21070-818G	18	8" x 3/4" x .035"	5	Medium Metal (3/32" - 5/16")	5.76

Lenox Lazer Gold™ Reciprocating Saw Blade

- Titanium edge
- Bi-metal technology
- Designed for heavy metal cutting
- Shatter resistant

Part #	Mfg #	Grit	L x W x Thick	Pkg Qty	Applications	Price
LEN9114G	21098-9114G	14	9" x 1" x .042"	5	Heavy Metals	8.09

Demolition Blades

- Engineered to rip through a wide array of materials with ease including structural steel, lumber, pipe & nail embedded wood
- Wider & thicker to stand up to the brutal conditions in demolition applications
- Shatter resistant, bi-metal design provides the flexibility & durability single-metal blades can't



Part #	Mfg #	TPI	L x W x Thick	Pkg Qty	Applications	Price
LEN6066R	20512-6066R	6	6" x 7/8" x .062"	2	Demolition, Nail-Embedded Wood, Drywall & Plaster	4.82
LEN966R	20598-966R	6	9" x 7/8" x .062"	2	Demolition, Nail-Embedded Wood, Drywall & Plaster	6.39
LEN960R	20597-960R	10	9" x 7/8" x .062"	2	Demolition	6.39

All Items May Not Be Stocked In All Branches

Hand Tools

Lazer™ Reciprocating Saw Blades

- Best for Extreme metal cutting
- Reinforced tooth design ensures higher performance in the most demanding jobs
- A wider, thicker body than conventional blades delivers whip-free cuts that stay straight & smooth
- Lasts up to 45% longer than competitors blades
- Shatter resistant, bi-metal design provides the flexibility & durability single-metal blades can't



Part #	Mfg #	TPI	L x W x Thick	Pkg Qty	Applications	Price
LEN6114R	20172-6114R	14	6" x 1" x .042"	5	Structural Steels & All Metals (3/32" - 3/8")	5.41
LEN9114R	20178-9114R	14	9" x 1" x .042"	5	Structural Steels & All Metals (3/32" - 3/8")	6.75
LEN12114R	20184-12114R	14	12" x 1" x .042"	5	Structural Steels & All Metals (3/32" - 3/8")	8.13

Diamond™ Reciprocating Saw Blades

- Lasts three times longer than convention carbide grit
- Narrow kerf design enables thinner, faster cuts



Part #	Mfg #	Grit	L x W x Thick	Pkg Qty	Applications	Price
LEN800RDG	10833-800RDG	Diamond	8" x 3/4 x 0.40	1	Cast Iron, Tile, Brick & Architectural Stone	21.53

Master-Grit® Reciprocating Saw Blades

- Cuts through materials that resist chip-forming
- Uniformly applied, durable carbide grit particles on a flexible blade provide fast cuts without snagging or binding



Part #	Mfg #	Grit	L x W x Thick	Pkg Qty	Applications	Price
LEN800RG	20576-800RG	Medium	8" x 3/4" x .040"	2	Fiberglass, Ceramic Tile, Cultured Marble, Clays, Brick, Non-ferrous Metal, Cement Board & Cast Iron	10.72

Bi-Metal™ Reciprocating Saw Blades

- Patented TUFF TOOTH™ design provides long blade life
- Optimized for specific applications
- Shatter resistant, bi-metal design provides the flexibility & durability single-metal blades can't

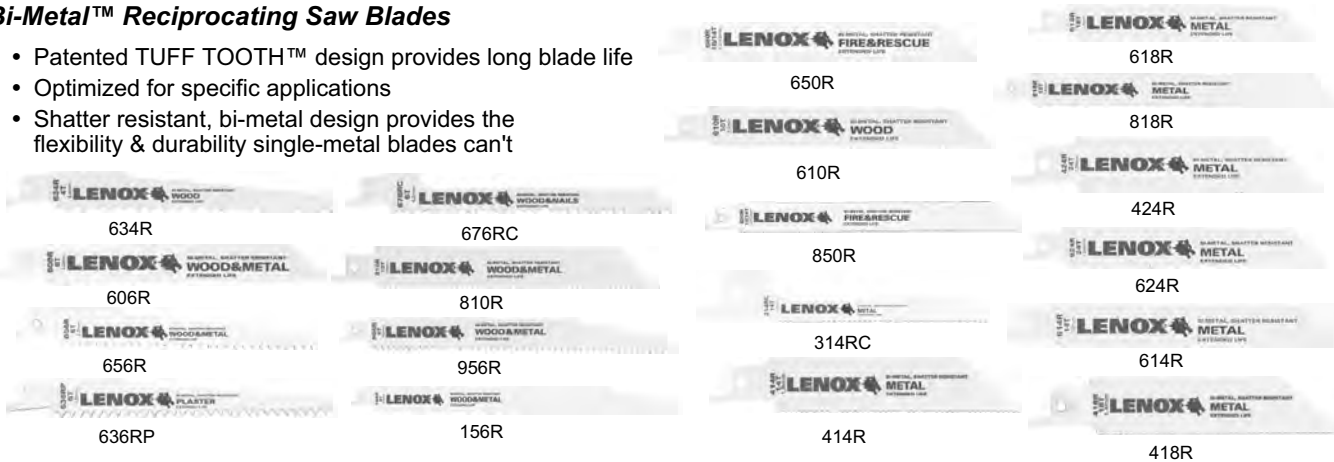

Part #	Mfg #	TPI	Lx W x Thick	Pkg Qty	Applications	Price
LEN634R	20575-634R	4	6" x 3/4" x .050"	5	Wood	4.19
LEN606R	20560-606R	6	6" x 3/4" x .035"	5	Wood, Non-ferrous Metal, Plastics & Composites	3.83
LEN656R	20572-656R	6	6" x 3/4" x .050"	5	Wood & Nail-Embedded Wood	4.56
LEN636RP	20570-636RP	6	6" x 3/4" x .050"	5	Drywall & Plaster	4.56

Prices & Specifications are Subject to Change.

Hand Tools

Hand Tools

Reciprocating Saw Blades (Continued)

Bi-Metal™ Reciprocating Saw Blades

Part #	Mfg #	TPI	Lx W x Thick	Pkg Qty	Applications	Price
LEN656BR	20530-B656R	6	6" x 3/4" x .050"	25	Wood & Nail-Embedded Wood	102.50
LEN676RC	20556-676RC	6	6" x 7/16" x .050"	5	Wood, Non-ferrous Metal, Plastics & Composites	4.84
LEN810R	20580-810R	10	8" x 3/4" x .050"	5	Nail-Embedded Wood, Non-ferrous Metal Thick Metal (1/8" - 1/2"), Plastics & Composites	4.84
LEN956R	20582-956R	6	9" x 3/4" x .050"	5	Wood & Nail-Embedded Wood	6.04
LEN156R	20585-156R	6	12" x 3/4" x .050"	5	Wood & Nail-Embedded Wood	7.38
LEN610R	20562-610R	10	6" x 3/4" x .035"	5	Wood, Non-ferrous Metal, Plastics & Composites	3.65
LEN614R	20564-614R	14	6" x 3/4" x .035"	5	Non-ferrous & Medium Metal (3/32" - 5/16")	3.83
LEN650R	20592-650R	10/14	6" x 3/4" x .050"	1	Demolition	4.77
LEN850R	20577-850R	10/14	8" x 3/4" x .050"	5	Medium Metal (3/32" - 5/16") & Nail-Embedded Wood	4.84
LEN110R	20583-110R	10/14	12" x 3/4" x .050"	5	Nail-Embedded Wood & Medium Metal (3/32" - 5/16")	7.38
LEN314RC	20520-314RC	14	3-5/8" x 5/16" x .035"	5	Wood & Medium Metal (3/32" - 5/16")	3.60
LEN414R	20550-414R	14	4" x 3/4" x .035"	5	Non-ferrous & Medium Metal (3/32" - 5/16")	2.96
LEN418R	20552-418R	18	4" x 3/4" x .035"	5	Non-ferrous & Thin Metal (1/8" & Less)	2.96
LEN618R	20566-618R	18	6" x 3/4" x .035"	5	Non-ferrous & Thin Metal (1/8" & Less)	3.83
LEN818R	20578-818R	18	8" x 3/4" x .035"	5	Non-ferrous & Thin Metal (1/8" & Less)	4.84
LEN424R	20554-424R	24	4" x 3/4" x .035"	5	Thin Metal (1/8" & Less)	2.96
LEN624R	20568-624R	24	6" x 3/4" x .035"	5	Thin Metal (1/8" & Less)	3.83

Bi-Metal Hacksaw Blades

- Bi-metal construction allows blades to bend and flex without breaking
- TUFF TOOTH™ Design eliminates tooth strippage

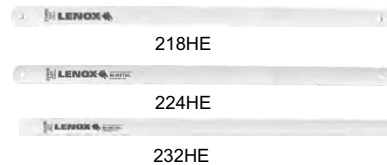

Part #	Item #	TPI	Length x Width	Pkg Qty	Application	Price
LEN018HE	20140-V018HE	18	10" x 1/2"	10	Heavy Metal	2.19
LEN218HE	20144-V218HE	18	12" x 1/2"	10	Heavy Metal	2.39
LEN024HE	20141-V024HE	24	10" x 1/2"	10	Medium Metal	2.19
LEN224HE	20145-V224HE	24	12" x 1/2"	10	Medium Metal	2.39
LEN032HE	20142-V032HE	32	10" x 1/2"	10	Non-ferrous Metals	2.19
LEN232HE	20146-V232HE	32	12" x 1/2"	10	Non-ferrous Metals	2.39

All Items May Not Be Stocked In All Branches

Hand Tools

Tools

Pipe Cutters

- With molybdenum vanadium stainless steel blade for PVC



Part #	Mfg #	Description	Price
HARM42	HM42	1-1/4" PVC Plastic Pipe Cutter	49.34
HARHL50	HL50	2" PVC Plastic Pipe Cutter	201.72
HARM42B	HM42B	Blade f/HM42 PVC Pipe Cutter	28.94

Hand Tools



Torches

Swivel Hand Torch

- Adjustable swirl flame



Part #	Mfg #	Description	Price
LENTLS10	21170-LS10	360° Swivel	100.94
LENTLS20R	21173-LS20R	Self Igniting 360° Swivel Torch Replacement Assembly	49.80

Self-Igniting Hand Torch



Part #	Mfg #	Description	Price
LENTLT92	21178-LT92	Self-Igniting Adj Ultra Swirl Flame	129.09

Mobile Torch System



Part #	Mfg #	Description	Price
LENTLX300FB	14812-LX300FB	Kit w/LX300 3/8" Tip Included	314.77

Prices & Specifications are Subject to Change.

Hand Tools

Hand Tools

Standard Air Acetylene Soldering Kit

- All brass piston regulator
- Metal strain relief
- Swirl flame tips
- Gaugeguard protects 2" easy read gauge



Part #	Mfg #	Description	Price
LENTLX311AB	10835	w/A-3 (3/16") & A-11 (7/16") Swirl Flame Tips	404.18
LENTLX4AB	10836	w/A-5 (1/4") & A-14 (1/2") Swirl Flame Tips	417.23

"B" Air Acetylene Kit

- Includes:
 - Air acetylene piston regulator with TANKTOTE handle, GAUGE GUARD & 2" gauge
 - AA Torch handle
 - AA Hose
 - TANKTOTE sleeve
 - "B" Tank key



Part #	Mfg #	Description	Price
LENTLX500B	21838LX500B	Kit w/AA500 1/4" Self-Igniting Swirl Flame Tip	413.48
LENTLX514B	21837LX514B	Kit w/A-5, A-14 Tips	468.52
LENTLX5B	21836LX5B	Kit w/A-5 Tip	412.43

"MC" Air Acetylene Kit

- Includes:
 - Air acetylene piston regulator with TANKTOTE handle, GAUGE GUARD & 2" gauge
 - AA Torch handle
 - AA Hose
 - TANKTOTE sleeve
 - "MC" Tank key



Part #	Mfg #	Description	Price
LENTLX500MC	21842LX500MC	LX500MC Kit with AA500 1/4" Self-Igniting Swirl Flame Tip	401.38

Self-Igniting Tip



Part #	Mfg #	Description	Price
LENTAA500	21850-AA500	1/4" Medium Duty Tip	126.34
LENTAA800	21851-AA800	3/8" Medium-Heavy Duty Tip	131.59
LENTAA900	21852-AA900	1/2" Extra-Heavy Duty Tip	137.80

All Items May Not Be Stocked In All Branches

Hand Tools

Swirl Flame Tip

- Quick connect, provides maximum output



Part #	Mfg #	Description	Price
LENTA2	10850A2	A2 1/8" Air Acetylene Light Duty HVAC Tip	83.17
LENTA3	21844A3	A3 3/16" Air Acetylene Light-Medium Duty Tip	84.70
LENTA5	21845A5	A5 1/4" Medium-Duty Tip	103.37
LENTA8	21846A8	A8 5/16" Air Acetylene Medium-Heavy Duty Tip	109.68
LENTA11	21847A11	A11 7/16" Heavy-Duty Tip	116.51
LENTA14	21848A14	A14 1/2" Air Acetylene Extra-Heavy Duty Tip	142.25

Air Acetylene Accessory



Handle

Part #	Mfg #	Description	Price
LENTTANKTOTE	10840	Tanktote Sleeve for "B" Tanks	93.80
LENTSTRIKER	10842	Torch Striker	3.62
LENTFLINTS	10843	Torch Flint 5 Pack	2.21
LENTTK	10844	"B" Torch Tank Key	1.37
LENTBREGULATOR	21854	"B" Air Acetylene Piston Regulator with Tank Tote Handle, Gauge Guard and 3" Easy Read Gauge	148.08
LENTMCREGULATOR	21855	Pressure Regulator f/MC Tank w/Gauge & Hdl	147.69
LENTAAHANDLE	21856	AA Torch Handle	97.90
LENTAHOSE-12	21857	12-1/2" AA Hose "A" Size Fittings 3/8"	56.93

Brazing Rods

- .125" x .050" x 20"
- Brazing rods for joining copper, brass & bronze

0% Silver Brazing Rod

- 0% Silver, 7.25% Phosphorus, balance Copper
- Melting temperature 1310°F
- Flow temperature 1460°F

Part #	Mfg #	Weight	Pkg Qty	Price
LENTWS78162	WS78162	1 lb	12	16.40

Sterling® Cold Coat® Patented Thermal Shield Gel

- Slows the transfer of heat in metal while soldering, brazing or welding
- Shields adjoining surfaces
- Rapidly cools hot materials
- Reduces the risk of hidden fires and heat damage
- Protects sensitive valves, gaskets, and previously soldered joints



Part #	Mfg #	Size	Price
LENWS80325	WS80325	32 oz	24.56

Prices & Specifications are Subject to Change.



www.irrsupply.com

Hand Tools

Hand Tools

System Tubing Tools

Tube Deburring Tool



Part #	Mfg #	Description	Price
RIT60163	60163	Tube Deburring Tool	62.64
RIT60164	60164	Replacement Blade for 60163	22.64

Tube Reamer/Burr Remover

- Heavy-duty shell with steel blades



Part #	Mfg #	Description	Price
RIT60161	60161	Tube Reamer - 1/6" Up To 1-3/8"	32.54

Ratchet Hand Bender Kit

- One-hand bending of soft copper, aluminum and light-wall hydraulic tubing from 3/8" - 7/8"
- Bending shoes change quickly
- Trouble-free ratchet mechanism
- Index marks ensure bending to length
- Includes:
 - #60332 3/8"OD Bending mandrel
 - #60333 1/2"OD Bending mandrel
 - #60334 5/8"OD Bending mandrel
 - #60335 3/4"OD Bending mandrel
 - #60336 7/8"OD Bending mandrel
 - #60337 Crossbar assembly
 - #60338 Steel case with inserts



Part #	Mfg #	Description	Price
RIT60331	60331	Complete Kit	320.36

Tube Benders - Full Range Heavy-Duty for 1/4" - 7/8" Radius

- Fast bends on AC&R copper, brass, aluminum, steel, and soft stainless steel tubing
- Special hardened wearing surfaces

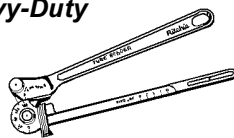

Part #	Mfg #	Tube Size	Bending Radius	Price
RIT60377	60377	1/2" OD	1-1/2"	243.86

3-In-1 Tube Benders - Full Range Heavy-Duty

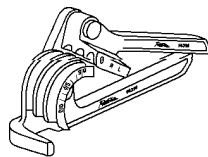

Part #	Mfg #	Tube Size	Radius	Price
RIT60390	60390	1/4" - 5/16" - 3/8" OD	15/16"	74.04

Spring Tube Bender for 1/4" - 7/8"

- Specially designed Yellow Jacket® spring benders slip over soft copper and aluminum tubing during bending to help prevent tube collapse
- Silver-plated finish
- Works for soft copper and aluminum tubing



Part #	Mfg #	Size	Price
RIT60359	60359	5/8" OD	10.56
RIT60360	60360	3/4" OD	12.74
RIT60351	60351	6-Pc Set 1/4", 5/16", 3/8", 7/16", 1/2" & 5/8" OD	38.24

45° Flaring Tools - Heavy-Duty

- Heavy-duty tool designed for tight places
- Hardened steel flaring bar to resist tube slippage
- Forged steel yoke slips over bar and locks with a turn
- Precision threaded feed screw and long handle



Part #	Mfg #	Capacity	Price
RIT60210	60210	3/16" OD to 5/8" OD	73.06

Flare/Burnish Tool

- Multi-faceted cone rolls a precise flare and polishes it on brass, copper and aluminum



Part #	Mfg #	Capacity	Price
RIT60270	60270	3/16" OD to 5/8" OD	156.50

Eccentric Cone Flaring Tool

- Black oxide-finished steel flaring bars
- Recommended by some mini-split manufacturers for R-410A flare



Part #	Mfg #	Description	Price
RIT60295	60295	3/16" to 3/4" OD	203.40

45° Flaring Kit - Full Range

- Includes:
 - Yoke
 - (2) Bars
 - Case
 - Instruction



Part #	Mfg #	Description	Price
RIT60240	60240	3/16" to 3/4" OD	198.26

All Items May Not Be Stocked In All Branches



www.irrsupply.com

Hand Tools

Swaging & 45° Flaring Tool Kits with Case

- Flare and swages copper and similar materials
- Hardened, chrome-plated adapters are interchangeable to convert sizes and functions
- Slip-on self-centering steel yoke with feed screw and extra long handle
- Deeply knurled adapters for sure grip



Part #	Mfg #	Description	Price
RIT60440	60440	3/16" - 3/4"OD	296.20

Swaging Tools - Punch-Type

- Durable, heat-treated tool
- Expands one end of copper tubing for connecting same size tubes



Part #	Mfg #	Description	Price
RIT60466	60466	3/8" OD Punch	18.68
RIT60469	60469	3/4" OD Punch	31.88
RIT60470	60470	7/8" OD Punch	38.90
RIT60460	60460	(6) Size Multi-Swage 3/16" - 5/8"	31.66
RIT60475	60475	4-Pc Set in Pouch: 1/4", 3/8", 1/2" & 5/8"	71.66

Pinch-Off Tools



Part #	Mfg #	Description	Price
RIT60661	60661	Plier-Type Pinch Off Tool	33.84
RIT60665	60665	Pinch Off & Reround Tool	44.84

6-In-1 Fin Straightener

- Straightener sizes are marked on head - 8, 9, 10, 12, 14 & 15 fins per inch



Part #	Mfg #	Description	Price
RIT61171	61171	Compact 4" Length	25.18

Service Wrench - Straight

- Square openings 1/4" & 3/16" at one end; 3/8" & 5/16" at other end



Part #	Mfg #	Description	Price
RIT60613	60613	Straight Service Wrench	20.16

Service Wrench - Offset

- Knuckle-Saver™ design for tight areas
- Square openings 1/4" & 3/16" at one end; 3/8" and 5/16" at other end



Part #	Mfg #	Description	Price
RIT60616	60616	Offset Service Wrench	25.56

Service Wrench - Large Service Valves

- Reversible for larger service valves
- 3/8" Square one end and 1/2" square the other end



Part #	Mfg #	Description	Price
RIT60615	60615	Refrigeration Wrench	43.30

Hex Key Adapter

- Fits Yellow Jacket® service wrenches
- Used on liquid and suction base valves on residential and commercial units up to 7-1/2 tons
- Works for 3/16" and 5/16" hex valves
- Heat-treated for toughness
- Black oxide plating



Part #	Mfg #	Description	Price
RIT60609	60609	Hex Key Adapter	19.12

Sporlan Valve Wrench

- Spanner end tightens packing nut around super heat adjustment stem
- Adjustable square end for solenoid valves w/manual lift stems (B6 and E6 thru MA 50)
- Also 3/16" square at same end for expansion valves

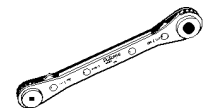

Part #	Mfg #	Description	Price
RIT60617	60617	1/8", 3/16" Square End	62.20

Prices & Specifications are Subject to Change.

Hand Tools

Hand Tools

Hand Saws

Wire Cable Saw

- Cuts PVC pipe in tight spaces
- Disposable - good for approximately 40 cuts

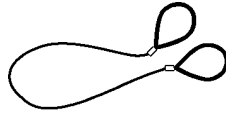

Part #	Mfg #	Description	Price
SOCPVCSAW	390-50105	36" Cable Saw for PVC	2.50



Accessory Products

Plews Grease Gun

Part #	Mfg #	Description	Price
MAR93355	93355	14 oz Professional Grease Gun	80.08

Plews Multi Purpose Lithium Grease



Part #	Mfg #	Description	Price
MAR93361	93361	14 oz Multi Purpose Cartridge	10.98

Specialty Tools



Part #	Mfg #	Description	Price
MAR79130	79130	Pilot Match Holder	11.16

Screwdrivers

Combination Screwdriver

- Multiple bits in one, #1 and #2 Phillips 3/16 and 5/16 slotted
- Lifetime guarantee



Part #	Mfg #	Description	Price
ACY6N1	5-61	6-in-1 Combo	19.76

SR6N1 - 6 in 1 Ratchet Screwdriver



- (3) Settings - forward, manual, reverse
- Bit Sizes:
 - Slotted: 3/16" & 1/4"
 - Phillips: #1 & #2
 - Nut Driver: 1/4" & 5/16"

Part #	Mfg #	Description	Price
ACY6N1R	SR6N1	6-in-1 Ratcheting	17.72

Power Bits

PlumBest E-Z Shear Inside Pipe Cutters



- Cuts PVC and ABS pipe
- High speed steel blade with zinc-plated shaft

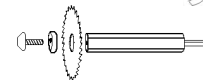

Part #	Mfg #	Description	Price
ACYIPCUTTER	J40-830	E-Z Shear Pipe Cutter	45.22
ACYIPBLADE	J40-831	(2) Replacement Blades	33.16



Sensible Products

Drill & Drive Anchoring Systems

- All-in-one
- To anchor into cement, brick and other masonry products
- Fits into any standard electric drill
- Includes:
 - (100) 1/4" x 1-1/4" Hex screws
 - (1) Drill & drive tool and bit
 - (1) Hex key



Part #	Mfg #	Description	Price
SEPDD1	DD-1	Drill & Drive Concrete Anchor Kit (w/Screws)	84.86

Flashlights

Extendable Magnetic Flashlight

- Magnet on grip and at light
- Telescopes from 6.5" to 21"
- Flexible shaft
- (3) Super-bright LEDs with On/Off button



Part #	Mfg #	Description	Price
SEPEMF1	EMF-1	LED Extendable	30.00
SEPF1	FB-1	(4) Batteries for EMF-1	7.90

All Items May Not Be Stocked In All Branches



www.irrsupply.com

Hand Tools

Fitting Brushes

#9400 Standard Stainless Steel

Good Quality A

- Stainless steel single-spiral construction
- 2-Wire galvanized stem
- Plastic contoured handle



Part #	Mfg #	Diameter	Price
MIRFTGB14	94000	1/4"	3.16
MIRFTGB38	94010	3/8"	3.08
MIRFTGB12	94020	1/2"	2.76
MIRFTGB58	94030	5/8"	2.76
MIRFTGB34	94040	3/4"	2.85
MIRFTGB78	94050	7/8"	2.92
MIRFTGB118	94070	1-1/8"	3.44
MIRFTGB138	94080	1-3/8"	3.77
MIRFTGB158	94090	1-5/8"	4.05
MIRFTGB218	94100	2-1/8"	4.93

#6600 Hex Shank Power Fitting Brushes

Superior Quality AA

- 1/4" Hex shank power fitting brush
- Carbon steel (plumbing) - 2/bag
- Point-of-purchase display



Part #	Mfg #	I.D.	O.D.	Price
MIR66431	66431	1/2"	5/8"	9.86
MIR66451	66451	3/4"	7/8"	9.97
MIR66471	66471	1"	1-1/8"	10.50

Quik-Change Chuck Adapter

- Change power brushes and other 1/4" hex-shank tools fast, inserts in 1/4" and 3/8" drill chucks



Part #	Mfg #	Description	Price
MIR70420	70420	Display Bag 5/Pk	14.33

Condenser Tube and Heat Exchanger Brushes

Fin Comb and Coil Whisk



Part #	Mfg #	Description	Price
MIRWHISK	73610	6-3/4" Fin & Coil Whisk	3.12

Condenser Tube Brushes

- 1/8 NPT Outside - 5/16-18 internal thread



Part #	Mfg #	Description	Price
MIRCONDB12	65145	1/2" Dia, 7-1/2" OAL, Stainless	8.48
MIRCONDB58	65155	4/8" Dia x 7-1/2" OAL, Stainless	8.48

Cleaning Brushes

#6200 Series Power Tube Cleaning Brush

- Use for solder or brazed fittings
- Carded 1/4" hex-shank tube cleaning brushes
- Point-of-purchase display

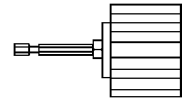

Part #	Mfg #	Description	Price
MIR62350	62350	1/2" Bagged	6.92
MIR62370	62370	3/4" Bagged	7.59
MIR62390	62390	1"	8.01

Power Brush Nutdriver and Screwdriver Kit

- Contains 1/4" hex shank power fitting, tube cleaning brushes in a range of sizes, magnetic power nut drivers and screwdriver bits



Part #	Mfg #	Description	Price
MIR72155	72155	Plumbing Kit	70.94

Power-Deuce Brushing Tool

- Fitting brush cleans the inside diameter and tube cleaning brush cleans the outside diameter
- Heavy-duty ABS housing is impact resistant and protects bristles so they retain their shape and prolong brush life



Part #	Mfg #	Description	Price
MIR62821	62821	1/2" ID Brush	16.90
MIR62831	62831	3/4" ID Brush	17.48

Prices & Specifications are Subject to Change.



www.irrsupply.com

Hand Tools

Hand Tools

Multi-Use Plumbing Brushes

Six-in-One Brush

- Hardened steel reamer/deburrer
- Poly-bagged



Part #	Mfg #	Description	Price
MIR6IN1	70266	1/2" x 3/4" ID (Plumbing)	16.58
MIR70269	70269	1/2" x 3/4" ID Replacement Kit, 6/pk	9.88

Fin Combs



Part #	Mfg #	Description	Price
MIRFINCOMB	73620	Adjustable Fin Comb	12.69

Maintenance Brushes

Scratch Brush



Shoe Handle

Part #	Mfg #	Block Size	Trim Size	Rows	Price
MIRSCRATCHB	70570	10"x1-1/8"	1-3/16"	4x16	4.73

Parts Cleaning Brush

70500



Part #	Mfg #	Description	Price
MIRSOFTPARTSB	70500	#8 Soft Nat Bristle Fill, 15/16" Dia, 10-1/8" OAL	9.37
MIRSTIFFPARTSB	70520	#10 Three-Color Gray Tampico, 1-1/16" Dia, 11-1/4" OAL	5.71

Flue and Boiler Tube Brushes

Specialty Boiler Brush

Columbia



Part #	Mfg #	Description	Price
MIRTBRLBFL12	84007	1/2" x 1", 48" OAL, Flat	11.63

Weil-McLain



Part #	Mfg #	Description	Price
MIRTBRLB112	84200	1-1/2" x 1-1/8", 30" OAL	7.48

Horsehair



Part #	Mfg #	Description	Price
MIRTBRLB178	84027	1-7/8" x 1-1/8", 42" OAL	7.48

Brushes and Accessories for Clothes Dryer Vents/Pellet Stove Flues

Pellet Stove Vent Cleaning Brushes and Extension Rods

- 5/16" - 18 Male/female thread

Part #	Mfg #	Description	Price
MIREXT	65015	3' Fiberglass Extension Rod	8.77

Applicator Brushes

Acid, Solder Paste and Flux, Adhesive

- Coated tin paste, bright-finished metal handle
- Pure medium stiff, black, graded natural horsehair bristles



Part #	Mfg #	Size	Wire	Price
MIRFLUXB1	70210	#1	1/4"	0.14
MIRFLUXB2	70220	#2	3/8"	0.19
MIRFLUXB3	70230	#3	1/2"	0.26

Hand Tools

Deburring Tool

- A fast and easy way to smooth edges of pipe and tubing



Part #	Mfg #	Description	Price
MIR70418	70418	Deburring Tool-Carded w/10 Blades	28.02

All Items May Not Be Stocked In All Branches



www.irrsupply.com

Hand Tools

Heat Shields

The Insurance Pad™

- Asbestos free heat resistance to 2500°F
- Ideal for use with propane, MAPP gas, acetylene/air and higher temperature torches
- Fibrous felt heat shield

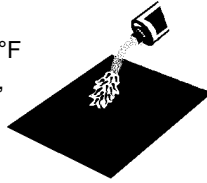

Part #	Mfg #	Description	Price
MIRHTSHD	71038	9" x 12" Display Pkg	43.68

Water-Gate Water Shut-Off Tools

- Solder without draining the entire water system
- Works with full port ball and gate valves to seal off water
- Replace valves, 90° elbows and tees, pinhole and mid-pipe leaks
- Ideal for refrigeration and boiler applications
- Works on copper, steel, PVC and CPVC lines

Water-Gate Tool Kit with Carrying Case



Part #	Mfg #	Description	Price
MIR77080	77080	1/2" - 2" Water-Gate Kit w/Carry Case	472.46

Lock'N Load Heavy-Duty Drybox

- Locks out moisture as well as dirt and grime
- (3) Compartments store and organize tools
- Easy access top compartment is ideal for small tools and parts



Part #	Mfg #	Description	Price
MIRDRYBOX	75605	Waterproof Box for Tools	32.59

Ringcrusher™ Decrimping Tool

- Cuts the crimp ring from 1/2", 3/4" and 1" PEX tube fittings
- Expands the crimped tubing for easy removal in seconds
- Will not damage PEX fittings when used properly



Part #	Mfg #	Description	Price
MIR73015	73015	For Crimp Rings 1/2", 3/4" & 1"	74.88

Easy-Cut Jaws™

- Cuts away steel, brass and plastic faucet mounting hardware
- Plated steel driver assembly fits 3/8" drill chucks
- Clear polymer chip guard collects cuttings



Part #	Mfg #	Length	Price
MIR73040	73040	10-1/2"	87.08

Razorback™ Wrench

- Remove shower and sink drains from top or bottom with just one hand
- T-Handle rotates 180°



Part #	Mfg #	Description	Price
MIR73055	73055	Razorback™ Wrench	42.99

Fitting Brushes

#9601 Soft Twist Fitting Brushes

Good Quality A

- Single stem, single spiral construction
- Rust proof crimped stainless steel fill wire
- Brightly colored non-slip plastisol comfort grip



Part #	Mfg #	I.D.	O.D.	Price
TUT14	96011	1/4"	3/8"	2.19
TUT38	96021	3/8"	1/2"	2.24
TUT12	96031	1/2"	5/8"	2.31
TUT34	96051	3/4"	7/8"	2.39
TUT1	96071	1"	1-1/8"	2.76
TUT114	96081	1-1/4"	1-3/8"	2.83
TUT112	96091	1-1/2"	1-5/8"	3.24
TUT2	96101	2"	2-1/8"	3.81

Prices & Specifications are Subject to Change.

Hand Tools

Hand Tools

Core Removal Tools

BV-CRT Service Tools - Original CRT's

- All accessory tools are compatible



Part #	Mfg #	Description	Price
CRTCD3900	CD3900	Core Removal Tool	60.20



Fiberglass Duct Fabrication Tools

Red Kerfing Tool

- All steel construction
- Replaceable blades
- 90° "V" or miter cut
- For cut #2, 3, 4

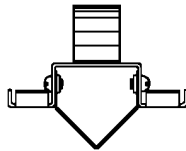

Part #	Mfg #	Size	Price
DBT1100	1100	1"	53.36

Radiator Specialty Company

Professional Plumbing Tools

Douglas® #60 No-Hub Torque Wrench

- Tightens to 60 inch pounds

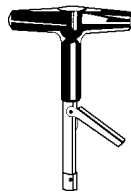

Part #	Mfg #	Description	Price
RAS60	60V	No-Hub Torque Wrench (6)	41.51

Douglas® "Yellow Handle" Angle Slip-Joint Plier

- Deep self-gripping, pipe-wrench style teeth
- Satin nickel-chrome plate finish
- Maximum jaw opening 2-1/8"



Part #	Mfg #	Description	Price
RASP813P	P-813P	10" Angle Nose Pliers, 5/Pk	21.00

Douglas® Teeny Weeny Hack Saw



Part #	Mfg #	Description	Price
RAS6	6	6" Frame	5.62
RAS632P	632P	Tiny Hacksaw Blade	0.49



Chamfering Tools



Part #	Mfg #	Size	Price
GAPCTOOL1	CHTOOL-8-16	1/2" CTS x 1" CTS	43.66
GAPCTOOL34	CHTOOL-12-16-IPS	3/4" IPS x 1" IPS	51.30
GAPCTOOL114	CHTOOL-12-20	3/4" IPS x 1-1/4" IPS	30.16



Tools

CinchClamp™ Tool



Part #	Mfg #	Order #	Desc	Price
PEXCINCHTOOL2	WPCCT-2	0651060	Tool w/Holster & Gauge	145.25
PEXRATCHTOOL	WPCCT-6	0651059	Ratcheting, 1/2" - 1"	193.51

Sewer Cleaning Tools

Pipe Inspecting & Locating

NaviTrack® Scout® Locator

- Multi-directional antenna technology sees the entire signal all of the time
- No nulls or false peaks
- Scout verifies the locate position using a micro-mapping display
- Depth is automatically calculated and displayed when over the target
- Approximately 24 hour battery life
- Standard equipment:
 - Hard plastic carrying case
 - Surface markers and clip
 - Instructional video
 - Operator's manual
 - (4) C-Cell batteries



Part #	Mfg #	Description	Price
RID19238	19238	Navitrack Scout Locator	1504.00

Accessories

Part #	Mfg #	Description	Price
RID30068	30068	9.5mm Imager Head	116.35
RID37098	37098	6.0mm Imager Head	116.35
RID37103	37103	17mm Replacement Imager	85.15

SeeSnake® Plus Camera

- 2" to 12" Lines up to 325'
- 2" 90s
- 3" P-Traps
- 100% Hardened stainless steel camera head spring assembly
- Rugged, high-intensity lights
- Flexible transmitters
- Can be used with any SeeSnake monitor or recorder
- Available in an upright, self-leveling camera design



Part #	Mfg #	Description	Price
RID13988	13988	115V 200' Self-Leveling Color Reel	7866.10
RID14053	14053	115V 200' Color Reel	7139.40

SeeSnake® microDrain™ Inspection Camera System

- Allows inspection of areas previously unreachable
- Small diameter and tight turn radius
- Multiple monitor capability
- Lightweight and compact
- Lifetime warranty



Part #	Mfg #	Description	Price
RID35153	35153	SeeSnake MicroReel L100' MicroExplorer Camera System	3784.35

Sewer Cleaning Tools

Prices & Specifications are Subject to Change.

Sewer Cleaning Tools

SeeSnake® micro™ Inspection Camera

- Allows you to easily perform visual inspections in hard to reach areas
- Light weight, hand-held design can be carried anywhere
- 3' Cable reach expandable to 30' with optional extensions
- Includes batteries, mirror, hook and magnet



Part #	Mfg #	Display	Diameter	Lighting	Power Source	Price
RID31118	31118	2.4" Color LCD	17mm	(1 or 2) Adj LEDs	(4) AA Batteries	260.60

micro CA-300 Inspection Camera

- Allows you to easily record still images and videos of problems in hard-to-reach areas
- JPG Image and AVI video capture
- External memory or SD card
- Features image rotation and digital zoom
- 3' Cable reach expandable to 30' with optional extension



Part #	Mfg #	Display	Diameter	Lighting	Power Source	Price
RID37888	37888	3.5" Color LCD	0.7"	(4) Adj LEDs	Rechargeable Lithium Ion Battery	434.95

SeeSnake® CS10 Digital Recording Monitor

- USB Thumbdrive recording lets you record digitally into a format that your customer can read on their computer
- 12.1" Daylight readable display
- Multi-mode recording: snapshots, record full frame video, and record in a lean video format
- Software integrations with SeeSnake HQ and RIDGIDConnect.com allow you to deliver your inspections in a wide array of formats from online to DVD
- Dimensions: 12.4"H x 11.9"W x 14.3"D



Part #	Mfg #	Description	Price
RID39338	39338	CS10 Monitor w/(2) Batteries & (1) Charger	4787.15

SeeSnake® Accessories

Part #	Mfg #	Description	Price
RID26658	26658	3' Cable Extension for SeeSnake micro™ Inspection Camera	54.95

SeekTech Line Locators

- Target line & guidance arrows quickly identify distortion
- Proximity signal and signal strength help work through difficult locates
- Uses (4) C-Cell batteries, approximately 16 hour battery life



Part #	Mfg #	Model	Description	Price
RID21893	21893	SR-20	SeekTech Line Locating Unit	2583.00
RID21898	21898	ST-305	SeekTech 5 Watt Transmitter	937.85

All Items May Not Be Stocked In All Branches

Sewer Cleaning Tools

Pipe Inspecting & Locating (Continued)

SeekTech Line Locators

Part #	Mfg #	Model	Description	Price
RID21903	21903	ST-510	SeekTech 10 Watt Transmitter	1875.75
RID26168	26168	ST-33Q	SeekTech Transmitter	2967.35

Drain Cleaners

Closet Auger

- Negotiate water-conserving closets
- Kink-resistant 1/2" compression-wrapped inner core cable



Part #	Mfg #	Model	Description	Weight	Replacement Cables	Price
RIDK3	59787	K-3	3' with Bulb Head	4.3 lbs	-	31.05

K-40 Sink Machine for 3/4 - 2-1/2" Drain Lines

- Compression wound inner core cable resists kinking & combines strength & flexibility
- Unique inner drum design virtually eliminates cable flip-over & drum leakage



Part #	Mfg #	Model	Includes	Price
RIDK40GPF	71722	K-40G PF	Machine with Autofeed, Guide Hose, Mounting Bracket & C13IC, 5/16" x 35' Cable w/Inner Drum	716.80

K-1500 Sectional Machine

- For 2" to 8" drain & sewer lines
- Cleans the heaviest blockages indoors or out
- Instant-acting cable clutch maximizes operator control:
 - Pull handle down, cable spins at constant 710 RPM
 - Release handle, frees cable instantly, no overrun to loop or break cable

B Frame Sectional Machine (Low Profile)

- Machine with A-1 mitt, A-12 pin key & A-34-12 rear guide hose - plus: (7) sections 1-1/4" (C-11) cable, total 105 feet, (2) A-8 cable carriers, 9-piece 1-1/4" tool set



Part #	Mfg #	Model	Voltage	Weight	Price
RIDK1500BSE	23717	K-1500B	115V-60 Hz	256 lbs	3043.75

K-50 Sectional Machine for 3/4 - 4" Drain Lines

- Capable of running three different size cables: 5/16", 3/8" & 5/8"
- Perfect for all-around sink, shower & floor drains



Part #	Mfg #	Model	Includes	Price
RIDK50	58920	K50	115V Machine Only	857.05
RIDK504	58960	K50-4	K-50 Machine w/A-30 Cable Kit	1148.25

Sewer Cleaning Tools

Prices & Specifications are Subject to Change.

Sewer Cleaning Tools

K-60SP Sectional Machine for 1-1/4 - 4" Drain Lines

- Compact machine for institutional, commercial or residential
- Ideal for septic tank vacuum truck operators
- Small enough to fit into cramped spaces, powerful enough to clear blockages
- Ideal for rooftop vent stacks
- Simple adjustment knob allows unit to spin both 7/8" & 5/8" diameter cable



Part #	Mfg #	Model	Includes	Price
RIDK60SPSE	66497	K-60SP-SE	115V Machine w/A-1 Operator's Mit, A-12 Pin Key, A-60-12 Rear Guide Hose, A-61 Tool Kit, A-62 Cable Kit	1940.75

Drain Cable



Bulb Auger



Drop Head



Metal Coupling

Part #	Mfg #	Model	Description	Price
RIDC7	62265	C-7	7-1/2' Tight-Wind Cable	38.55
RIDC8	62270	C-8	7-1/2' All-Purpose Wind Cable	28.55
RIDC10	62275	C-10	15' All-Purpose Wind Cable	58.40
RIDC11	62280	C-11	1-1/4" x 15' Standard All-Purpose Wind, 3/8" Pitch Good for 4" Traps, 3-8" Lines	95.70
RIDC12	62285	C-12	1-1/4" x 15' XHeavy-Duty Wind Sectional, 3/8" Pitch	119.30
RIDC11C	56782	C-11C	25' Cable with Bulb Auger	50.45
RIDC1	62225	C-1	25' Cable with Bulb Auger	48.35
RIDC2	62235	C-2	25' Cable with Drop Head Auger	60.55
RIDC4	62245	C-4	25' Cable with Male Coupling	59.85
RIDC5	62250	C-5	35' Cable with Bulb Auger	73.80
RIDC6	62260	C-6	35' Cable with Male Coupling	82.80
RIDC100	41697	C-100	100' Inner Core Cable	410.20

Replacement Cutters, Augers & Accessories

T Series Cutters & Tools



T-1 & T-5



HD Straight Auger



HD Funnel Auger

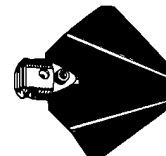

Grease Cutter

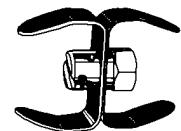

H-Cutter

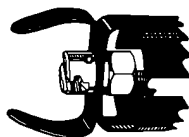

Sawtooth Cutter

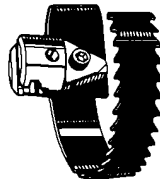

Spiral Sawtooth Cutter



4-Blade Cutter



Sharktooth Cutter

Part #	Mfg #	Model	Description	Replacement Blades	Price
RIDT1	62840	T-1	Straight Auger	-	27.50
RIDT2	61800	T-2	Heavy-Duty Straight Auger	-	29.40

All Items May Not Be Stocked In All Branches

Sewer Cleaning Tools

Replacement Cutters, Augers & Accessories (Continued)

T Series Cutters & Tools

Part #	Mfg #	Model	Description	Replacement Blades	Price
RIDT3	63105	T-3	Funnel Auger	-	27.50
RIDT4	61790	T-4	Heavy-Duty Funnel Auger	-	29.40
RIDT5	63190	T-5	Straight Retrieving Auger	-	28.10
RIDT6	63195	T-6	Funnel Retrieving Auger	-	28.10
RIDT8	63205	T-8	2-1/2" Grease Cutter	97920	28.10
RIDT9	63210	T-9	3-1/2" Grease Cutter	97925	29.40
RIDT11	59480	T-11	2-1/2" "H" Cutter	97800	38.65
RIDT13	61970	T-13	2-1/2" Sawtooth Cutter	98070	53.65
RIDT14	61975	T-14	3-1/2" Sawtooth Cutter	98075	61.30
RIDT15A	61770	T-15A	4"-6" Expanding Cutter	62970	113.65
RIDT21	59625	T-21	2-1/2" Spiral Sawtooth Cutter	97965	35.70
RIDT22	63075	T-22	3" Spiral Sawtooth Cutter	97970	38.65
RIDT23	63085	T-23	4" Spiral Sawtooth Cutter	97850	40.50
RIDT24	59765	T-24	4-Blade Cutter 2-1/2"	97940	43.40
RIDT25	59770	T-25	4-Blade Cutter 3-1/2"	97975	47.25
RIDT27	63090	T-27	2" Trap Leader f/1-1/4" Cable	-	53.65
RIDT501	98035	T-50-1	3" Sharktooth Cutter	98005	37.10
RIDT502	98040	T-50-2	4" Sharktooth Cutter	98010	38.65
RIDT503	98045	T-50-3	6" Sharktooth Cutter	98015	41.85

Sewer Cleaning Tools

T-100 Series Cutters & Tools

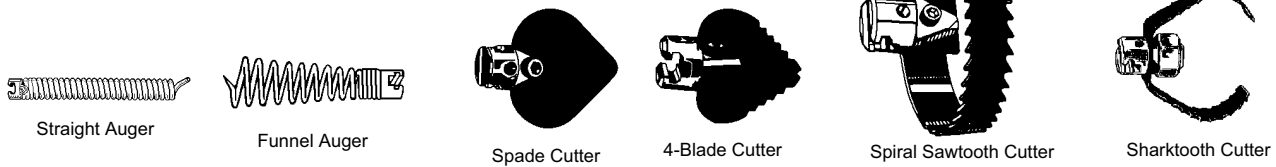

Part #	Mfg #	Model	Description	Replacement Blades	Price
RIDT101	62850	T-101	Straight Auger	-	22.70
RIDT102	62855	T-102	Funnel Auger	-	22.70
RIDT104	62865	T-104	2-1/2" "H" Cutter	97800	38.65
RIDT105	62870	T-105	2-1/2" Grease Cutter	97920	28.10
RIDT107	62880	T-107	1-3/4" Spade Cutter	92850	21.05
RIDT109	62915	T-109	1-3/4" Spiral Sawtooth Cutter	97930	22.70
RIDT110	62920	T-110	2-1/4" Spiral Sawtooth Cutter	97935	25.55
RIDT111	62925	T-111	3" Spiral Sawtooth Cutter	92890	37.10
RIDT112	62930	T-112	1-3/4" 4-Blade Cutter	97915	33.85
RIDT113	62935	T-113	3" 4-Blade Cutter	97940	38.65
RIDT1501	98055	T-150-1	3" Blade Sharktooth Cutter	98005	36.35

Prices & Specifications are Subject to Change.

Sewer Cleaning Tools

T-200 Series Cutters



Straight Auger



Bulb Auger



"C" Cutter



Funnel Auger



Spiral Cutter

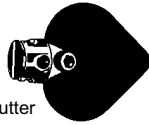

Spade Cutter



4-Blade Cutter



Drophead

Part #	Mfg #	Model	Description	Replacement Blades	Price
RIDT201	62990	T-201	Straight Auger 5" Long	-	15.30
RIDT202	62995	T-202	Bulb Auger 1-1/8" OD	-	14.70
RIDT203	63000	T-203	Bulb Auger 7/8" OD	-	14.70
RIDT204	54837	T-204	"C" Cutter 1"	54832	12.85
RIDT205	63005	T-205	"C" Cutter 1-3/8"	97835	14.70
RIDT206	63010	T-206	Funnel Auger 3" Long	-	15.30
RIDT207	63015	T-207	Spiral Cutter 1-1/4"	97840	17.60
RIDT209	63025	T-209	Spiral Cutter 2"	97900	21.05
RIDT210	63030	T-210	Spade Cutter 1"	97905	16.00
RIDT211	63035	T-211	Spade Cutter 1-3/8"	97825	16.00
RIDT213	63045	T-213	4-Blade Cutter 1"	97795	24.25
RIDT214	63050	T-214	4-Blade Cutter 1-3/8"	97910	26.55
RIDT215	63055	T-215	4-Blade Cutter 1-3/4"	97915	28.10
RIDT217	63065	T-217	Drop Head 4" Long	-	16.00

Sewer Cleaning Tools

T-400 Series Cutters & Tools



Retrieving Auger

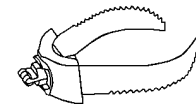

Double Cutter

Part #	Mfg #	Model	Description	Replacement Blades	Price
RIDT406	92495	T-406	Grease Spear Blade	92850	19.25
RIDT407	92500	T-407	Retrieving Auger 9-16"	-	28.70
RIDT411	92510	T-411	2" Double Cutter	92815	20.45

Replacement Cutter Blade

Part #	Mfg #	Model	Includes	Price
RIDB7010	98005	B-7010	3" Replacement Blade f/T50 -150	15.30
RIDC7011	98010	C-7011	4" Replacement Blade f/T50 -150	15.80

All Items May Not Be Stocked In All Branches

Sewer Cleaning Tools

Cable Kit

- Includes tools & accessories:
 - T-201 Straight Auger
 - T-202 Bulb Auger
 - T-205 "C" Cutter
 - T-211 Spade Cutter
 - A-13 Coupling Pin Key
 - A-10 Cable Carrier
 - A-14-6 Rear Guide Hose
 - A-1 Left-Handed Drain Cleaning Mitt



Part #	Mfg #	Model	Description	Price
RIDA30	59365	A-30	6 Sections: C-8, 5/8" x 7-1/2' (45')	312.70

Drain Cleaner Accessories

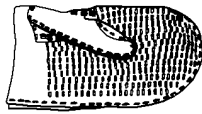

Drain Cleaning Mitt

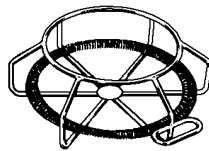

Cable Carrier



Pin Key

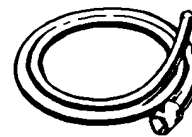

Rear Guide Hose

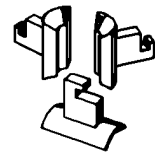

Replacement Jawset

Part #	Mfg #	Model	Description	Price
RIDA1	59205	A-1	Left-Hand Mitt	19.90
RIDA2	59295	A-2	Right-Hand Mitt	19.90
RIDA4	59440	A-4	30" Trap Spoon	70.70
RIDA8	59470	A-8	Cable Carrier (Holds 75' of 7/8" Cable)	59.00
RIDA12	59225	A-12	Pin Key for 1/2" Cable	3.05
RIDA13	59230	A-13	Pin Key for 3/8" Cable	3.10
RIDA146	59235	A-14-6	6' Rear Guide Hose	90.15
RIDA17A	59250	A-17A	Adapter with 25' x 5/16" Cable & Bulb Auger	201.15
RIDA17B	59255	A-17B	Adapter with 35' x 3/8" Cable & Bulb Auger	269.80
RIDA221	59945	A-221	Bearing for K-50 Sewer Machine	64.90
RIDA3179	59450	A-3179	5/8" Clutch Drive Jaws f/K-50 Machine	53.80
RIDA3412	59395	A-34-12	1-1/2" x 12' Rear Guide Hose	251.35
RIDA369X	59320	A-369-X	1-1/4" Replacement Jawset	50.45

Sewer Cleaning Tools

Prices & Specifications are Subject to Change.



www.irrsupply.com

Sewer Cleaning Tools

Closet Augers

Regular Head Closet Augers

- With Flexicore double layer wire rope center



3FL

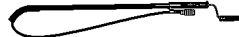

T6FL

Part #	Mfg #	Description	Price
GEW3FL	3FL	3' Flexicore (6/Ctn)	68.96
GEWT6FL	T-6FL	6' Teletube Flexicore	103.76

Down Head Closet Augers

- With Flexicore double layer wire rope center



3FL-DH

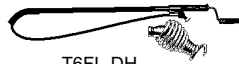

T6FL-DH

Part #	Mfg #	Description	Price
GEW3FLDH	3FL-DH	3' Flexicore (6/Ctn)	79.04
GEWT6FLDH	T6FL-DH	6' Teletube Flexicore	117.50

Urinal Augers



Part #	Mfg #	Description	Price
GEWTU4	TU4	Telescoping Teletube® - 48" Spring (6/Ctn)	55.56

Replacement Cable



Basin Plug Head



Male/Female Conn

Part #	Mfg #	Description	Price
GEW25HE1	25HE1	1/4" x 25' w/El Basin Plug Head	80.30
GEW35HE2	35HE2	3/8" x 35' w/Female Connector	175.00

D-25 Handy™

D-25 Handy™ Regular Head

- FLEXICORE cable units
- Can be attached to a drill

Part #	Mfg #	Description	Price
GEWD258	D-25-8	1/4" x 25'	175.74

Flood-Guard™



Part #	Mfg #	Description	Price
GEW2F	2F	2" Float Model	29.46
GEW3F	3F	3" Float Model	22.26
GEW4F	4F	4" Float Model	26.50

Sewer Cleaning Tools

Visionary Baths & More

Because your time is valuable...

Visit your local Visionary Baths & More Kitchen and Bath Design Centers to let one of our trained knowledgeable consultants help you with your project.
<http://www.visionarybaths.com>

All Items May Not Be Stocked In All Branches

Fasteners

Screws

Zip-In® Screw

Zip-in



Part #	Mfg #	Size	Pkg Qty	Price
MALHW7X12Z15000	HW7x1/2Z	7 x 1/2"	15,000	501.80
MALHW7X12Z1000	HW7x1/2ZT	7 x 1/2"	1,000	36.58
MALHW7X12Z100	HW7x1/2ZX	7 x 1/2"	100	5.06
MALHW8X12Z1000	HW8x1/2ZT	8 x 1/2"	1,000	39.34
MALHW8X12Z100	HW8x1/2ZX	8 x 1/2"	100	5.60
MALHW8X11Z250	HW8x1/2Z	8 x 1/2"	50	5.30
MALHW8X34Z1000	HW8x3/4ZT	8 x 3/4"	1,000	49.64
MALHW8X34Z100	HW8x3/4ZX	8 x 3/4"	100	6.96
MALHW8X1Z500	HW8x1ZT	8 x 1"	500	32.24
MALHW8X1Z100	HW8x1ZX	8 x 1"	100	8.08
MALHW8X112Z4500	HW8x11/2Z	8 x 1-1/2"	4,500	369.88
MALHW8X112Z250	HW8x11/2ZT	8 x 1-1/2"	250	22.22
MALHW8X2Z250	HW8x2ZT	8 x 2"	250	29.80
MALHW10X12Z1000	HW10x1/2ZT	10 x 1/2"	1,000	59.76
MALHW10X1Z100	HW10x1ZX	10 x 1"	100	10.08

Drill-In Screw



Part #	Mfg #	Size	Pkg Qty	Price
MALHW8X2Z250	HW8X2	8 x 2"	50	8.38

Bit-Tip® #3 Screws - Hex Washer Head

- Taps a matching thread
- Drills it's own hole
- Fastens in steel up to .200 thick
- Driver size: 5/16"

Bit-Tip



Part #	Mfg #	Screw Size	Pkg Qty	Price
MALBT143500	BT143T	10-16 x 3/4"	500	46.30
MALBT143100	BT143X	10-16 x 3/4"	100	10.58
MALBT156100	BT156	10-24 x 1-1/2"	100	19.96

Anchors

Red Lip Plastic Anchor Kit with Slotted Pan Head Screws

- Contains:
- (100) Screws and anchors;
- (50) in PA1416K
- (1) Matching carbide tip drill bit
- (1) Reusable hinged clear vinyl box



Part #	Mfg #	Anchor Size	Screw Size	Price
MALPA810K	PA810K	3/16" x 7/8"	SP8 x 1	20.84
MALPA1012K	PA1012K	1/4" x 1"	SP10 x 1-1/4	23.26
MALPA1416K	PA1416K	5/16" x 1-3/8"	SP14 x 1-1/2	27.20

Red Lip Plastic Anchor Kit with Hex Washer Head Screws

- Contains (100) screws and (100) anchors, (1) matching carbide tip drill bit and a reusable hinged clear vinyl box



Part #	Mfg #	Anchor Size	Screw Size	Price
MALPA1012KW	PA1012KW	1/4" x 1"	HW10x1Z	24.44



Miniature Nylon Cable Ties

18 lb

- AR - Custom packaging
- AL - ACT specification label



Part #	Mfg #	Color	Lgth	Per Bag	Price
TIE4	AL-04-18-0-C	UV Black	4.1"	100	2.50

Intermediate Nylon Cable Ties

40 lb

- AR - Custom packaging
- AL - ACT specification label



Part #	Mfg #	Color	Lgth	Per Bag	Price
TIE5	AL-05-40-0-C	UV Black	5.8"	100	5.06
TIE8	AL-08-40-0-C	UV Black	8.8"	100	6.70

Fasteners

Prices & Specifications are Subject to Change.

Fasteners

Standard Nylon Cable Ties

50 lb

- AR - Custom packaging
- AL - ACT specification label



Part #	Mfg #	Color	Lgth	Per Bag	Price
TIE11	AL-11-50-0-C	UV Black	11.5"	100	10.68
TIE14	AL-14-50-0-C	UV Black	14.5"	100	14.68

Extra Heavy Duty Nylon Cable Ties

175 lb



Part #	Mfg #	Color	Lgth	Per Bag	Price
TIE24	AL-24-175-9-L	Natural	25.2	50	0.52
TIE36	AL-36-175-9-L	Natural	36"	50	0.44
TIE48	AL-48-175-9-L	Natural	48.5"	50	0.72



Mechanical Anchors & Fasteners

Carbon Steel Smooth Wall Drop-In

- All-steel machine bolt anchor
- Used in solid concrete, hard stone, and solid block base materials
- Suitable for overhead applications



Part #	Mfg #	Size	Length	Price
RAW6306	6306	3/8"	1-9/16"	60.20
RAW6308	6308	1/2"	2"	113.10

Vertigo® Steel Vertical Hanger

- 1-Piece, all steel threaded for suspending steel threaded rod & other assemblies
- Install in steel bar joists & beams, wood frame columns & beams, concrete beams & columns



Part #	Mfg #	Rod Size	Screw Size/Lgn	Point Style	Price
RAW7157	7157	3/8"	1/4" x 2"	3	173.32

Vertigo® Wood Vertical Hanger

- 1-Piece, all steel threaded for suspending steel threaded rod & other assemblies
- Install in steel bar joists & beams, wood frame columns & beams, concrete beams & columns



Part #	Mfg #	Rod Size	Screw Size/Lgn	Point Style	Price
RAW7165	7165	3/8"	1/4" x 2"	17	173.32
RAW7164	7164	1/2"	5/16" x 2-1/2"	17	230.72

Vertigo® Wood Side Hanger

- 1-Piece, all steel threaded for suspending steel threaded rod & other assemblies
- Install in steel bar joists & beams, wood frame columns & beams, concrete beams & columns



Part #	Mfg #	Rod Size	Screw Size/Lgn	Point Style	Price
RAW7170	7170	3/8"	1/4" x 2"	17	199.64

Vertigo® Concrete Vertical Hanger

- 1-Piece, all steel threaded for suspending steel threaded rod & other assemblies
- Install in steel bar joists & beams, wood frame columns & beams, concrete beams & columns
- ANSI Wedge-bolt OT thread shank



Part #	Mfg #	Rod Size	Screw Size/Lgn	Point Style	Price
RAW7173	7173	3/8"	1/4" x 2"	17	195.22

Zamac Hammer-Screw®

- Zamac alloy with carbon steel & perma-seal drive screw
- Phillips type head
- Internal screw thread for use in concrete, block, brick or stone



Part #	Mfg #	Size	Price
RAW2842	2842	1/4" x 1-1/4"	61.64
RAW2844	2844	1/4" x 1-1/2"	76.64
RAW2846	2846	1/4" x 2"	103.04

Fasteners

Vertigo® Driver Socket



Part #	Mfg #	Description	Price
RAW7187	7187	Universal Red Steel & Wood Drive Socket	22.16
RAW7197	7197	3/8" Blue Concrete Drive Socket	22.16

Anchor Tools

Steel Dropin™ Setting Tools

- For carbon and stainless steel drop-ins



Part #	Mfg #	Anchor Size	Pin Length	Price
RAW6307	6307	3/8"	61/64"	7.90

Hammer Drives

Hammer Drive® Setting Tool



Part #	Mfg #	Description	Price
RAW1505	50310	Hammer Drive Tool	123.24

Hammer Drive® Pin

- No powder loads required
- For permanently fastening a fixture to concrete and some types of masonry
- 3/8" Diameter steel washer
- 1/4" Head diameter, .140" shank diameter



Part #	Mfg #	Description	Price
RAW1534	50294	1/4" x 3/4" 100/Box	74.20



Fasteners

PEX Stub-Out Brackets - Galvanized

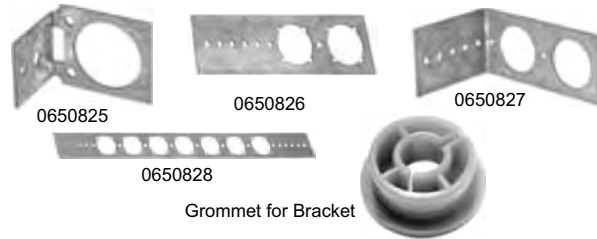

Part #	Mfg #	Order #	Desc	Price
PEXSO-1	WPSB-1S	0650825	1-Hole Elbw	3.20
PEXSO-2	WPSB-2S	0650826	2-Hole	2.83
PEXSO90-2	WPSB-2E	0650827	2-Hole Elbw	2.83
PEXSO-7	WPSB-7S	0650828	7-Hole	6.58
PEXGROMMET12	WPIG-08	0650829	1/2" Insert Grommet	1.00
PEXGROMMET34	WPIG-12	0650830	3/4" Insert Grommet	1.00

Stub-Out Elbows - Copper



Part #	Mfg #	Order #	Size	Price
PEXSO12-8	WPSB-B8	0650833	1/2" x 8"	13.52
PEXT6040	WPSB-D	0650837	1/2"CFxNom 8"Eared Strap	3.20

SnapClip™ for WaterPEX® Tubing

- Can be used with or without ClipRails™
- Can be interlocked for a very tight arrangement
- Anchor them with a single screw through base (screws not included)



Part #	Mfg #	Order #	Size	Price
PEXCLIP12	WPSC-08PB	0650904	1/2"	0.36
PEXCLIP34	WPSC-12PB	0650905	3/4"	0.41
PEXCLIP1	WPSC-16PB	0650906	1"	0.50

Fasteners

Plumbing Sundries

Leak Detectors

Smokeys

- Smoke emitter cartridge
- Low coast leak testing of heat exchangers, air ducts, tanks and boilers
- Visual air balancing of HVAC systems
- Clean, non-toxic, oil-free smoke



Part #	Mfg #	Description	Price
SMO45	14145	45 sec Burn Time, 150 cu ft, 10/Pk	2.75
SMO90	14175	75 sec Burn Time, 600 cu ft, 10/Pk	3.41

Flashlights by Mag-Lite™

Magna-Lite™ Pocket Flashlight/Magnifier

- Unbreakable, lightweight
- Replaceable penlight batteries



Part #	Mfg #	Description	Price
WAGML100	ML-100	Magna-Lite	17.82



Tube Brackets & Hangers

Copper-Plated Stub Out Brackets

- Extruded models provide four times the soldering surface for extra strength
- Heat the tube, not the bracket



521-118



521-810

Part #	Mfg #	Description	Price
HOL10118	521-118	1-1/4" x 20" Flat (8) Holes 1/2" CTS	2.94
HOL10718	521-810	1-3/4" x 20" Flat (7) Holes 1/2" CTS (4) Holes 3/4" CTS (4) Holes 1" CTS	3.85

Hangers & Fasteners

Suspensulor™ Clamp & Insulators

- Tube suspension clamp and insulator
- For use with any CTS pipe
- Split design for use after piping is run

Body Only



Part #	Mfg #	Size	Price
SOCSCCLAMP12	558-E2	1/2" CTS	0.26
SOCSCCLAMP34	558-E3	3/4" CTS	0.27
SOCSCCLAMP1	558-E4	1" CTS	0.37

Pick-Up Talon Isolating Drive Hook

- Protects tube from abrasive mounting surface
- No more ticking noise behind the wall
- Eliminates costly call backs



Part #	Mfg #	Description	Price
SOCTT38	556-1	3/8" CTS w/Nail	0.13
SOCTT12	556-2	1/2" CTS w/Nail	0.08
SOCTT34	556-3	3/4" CTS w/Nail	0.11
SOCTT1	556-4	1" CTS w/Nail	0.32

Padlock™ Tube Straps

- Fits and fastens to grid Iron bracket
- Will not damage tube if overdriven

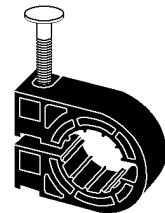

Part #	Mfg #	Description	Price
SOCTS12	551-P2	1/2" CTS w/Preloaded Nail	0.16
SOCTS34	551-P3	3/4" CTS w/Preloaded Nail	0.27

Plumbing Sundries

Tube Brackets & Hangers

Stud Shoe Bracket

- Barbs hold bracket in place prior to nailing
- Pipe opening 2" DWV or smaller pipe

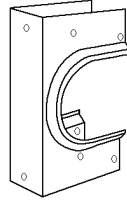

Part #	Mfg #	Description	Price
SOCSSBRKT	533-1	Single Stud Shoe	2.56
SOCDSBRKT	533-2	Double Stud Shoe	4.10

Edge Support System™ Steel Support Brackets

- Angle design provides a rigid cross brace between studs
- One clamp supports vertical and horizontal applications
- Perforated angle designed for undersized stud bays
- 20 Gauge steel



Part #	Mfg #	Description	Price
SOCES16C	520-E16C	Copper-Plated with Flat Tabs	1.79

Power Bar™ Universal Slider Bracket for 9" - 16"

Part #	Mfg #	Description	Price
SOCSLIDERBAR	523-162001	(50) Bracket, (100) Touchdown Clamps, (200) Drill-Tip Screws	4.22

ZipStrap™ with Power Bar™ Foot Adapter

- Install on Power Bar to support larger diameter pipes on topside of bracket
- Can link two or more



Part #	Mfg #	Description	Price
SOCZIPSTRAP	523-01	Ratchet-Locking Strap	2.03

FHA Shield Plates

- Extra long joist protection - great for mechanical runs



539-18

Part #	Mfg #	Size	Gauge	Price
SOCPLT18-112	536-18	1-1/2" x 18"	16ga	1.13
SOC5396	539-6	3-1/2" x 6"	16ga	0.79

Self-Nailing BOCA Shield Plate



Part #	Mfg #	Size	Gauge	Price
SOCPLT5-8	536-58	5" x 8"	16ga	1.68

Stud Guards

- Self-nailing

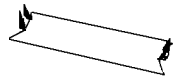

Part #	Mfg #	Description	Price
SOCPLT6-112	530-6	1-1/2" x 6" - 18ga	0.25
SOCSEG3-112	530-163	1-1/2" x 3" - 16ga	0.20
SOCSEG6-112	530-166	1-1/2" x 6" - 16ga	0.32

Copper-Plated Stub Out Brackets

- Extruded models provide four times the soldering surface for extra strength
- Heat the tube, not the bracket

Part #	Mfg #	Description	Price
SOC521820	521-820	1-3/4" x 20" Extruded (7) Holes 1/2" CTS (4) Holes 3/4" CTS (3) Holes 1" CTS	3.76

Universal Pipe Clamps

Touchdown Universal Pipe Clamps

- Clamps any pipe conduit or wire from 3/8" OD to 1-1/8" OD
- Releasable locking mechanism
- Hanger body is 100% corrosion proof virgin Nylon 66, UV protected and V2 flame rating
- Screw is 1" x #6 Phillips head



Part #	Mfg #	Description	Price
SOCCLAMP	550-11	(1) Bridge, (1) Base, (1) Screw	0.60

Plumbing Sundries

Prices & Specifications are Subject to Change.

Plumbing Sundries

Touchdown Channel Clamps with USB/Power Bar Foot

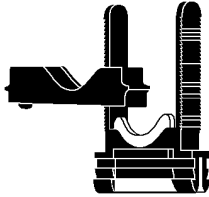

Part #	Mfg #	Description	Price
SOCSLIDER	522-5501	(1) Bridge, (1) Base, (1) Insert	0.87

Touchdown II™ Large Universal Pipe Clamps

- Clamps 1/2" to 2" CTS tube (copper or plastic) and 3/4" to 2" Sch 40 pipe (steel or plastic)
- Releasable locking mechanism
- Variable clamping tension allows for expansion and contraction
- Use with AC condenser line sets
- Provides 5/8" stand-off



Part #	Mfg #	Description	Price
SOCCLAMP2	550-20	(1) Bridge, (1) Base, (2) Screws	1.80

Universal Slider Bracket™

Power Bar™ Universal Slider Brackets



Part #	Mfg #	Description	Price
SOCPOWERBAR	523-242001	(50) Brackets, (100) Touchdown Clamps, Bases Loaded Into Bracket, Bridges	5.31

DWV Hangers

ZipStick™ Universal Pipe Hanger

- Perfect for hanging wrapped or insulated pipe, bundles of PEX, cable, wiring, or supporting vent pipe in attics
- Universal cradle hangs any pipe from 1" CTS to 6" IPS
- Releasable locking mechanism
- Graduated numerals at nail ways for easy measuring



Part #	Mfg #	Description	Price
SOCHANGER	553-014W	14", White Nylon	2.68

Preformed Copper for Sweat

Full Slip Repair Coupling

Sweat Connection Female Swt x Female Swt

- Full slip extra long repair coupling with no stop

Part #	Mfg #	Slips Over	Length	Price
SOCSLCPLG12	600-206	1/2" CTS	6"	3.40
SOCSLCPLG34	600-306	3/4" CTS	6"	4.82

PEX Fittings

Tube & Shower Pressure Connectors

- Perfect for sweat connection to standard tub & shower valves
- No torch at the tub & shower valve



Part #	Mfg #	Description	Price
SOCSC12PEX12M	632X263	1/2" PEX x 1/2" M Swt	3.64

Elbow Adapters

Swt x PEX

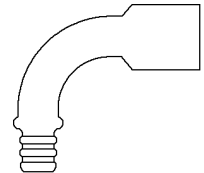

Part #	Mfg #	Description	Price
SOCSC12PEX12FTG	632X222	1/2" PEX x 1/2" M Swt	2.14

Ice Maker Valve - Tee

- For adding 1/4" OD supply lines for ice makers and humidifiers
- Lead-free solder joint



Part #	Mfg #	Description	Price
SOCPEXIMVALVE	637X9220	1/2" PEX x 1/4" OD Comp	14.68

Plumbing Sundries

Preformed Copper for CPVC

Tub & Shower Pressure Connectors

- Rough-In ready™
- Long radius bend for better flow and less noise
- 1-Piece type L copper
- Guaranteed leakproof



CPVC Socket x Male Swt Elbow

Part #	Mfg #	Description	Price
SOC632C263	632-C263	1/2" CPVC x COP, 6" Long	4.81

Transition Tailpiece

- Connects sillcocks, laundry boxes, water service connections, etc.



CPVC x Male Swt Adapter

Part #	Mfg #	Description	Price
SOC643C211	643-C211	1/2" CPVC x COP, 11" Long	6.91
SOC643C311	643-C311	3/4" CPVC x COP, 11" Long	13.19

Non-Swivel Adapters (CPVC x FIP)

- Lead-free solder joint guaranteed leakproof

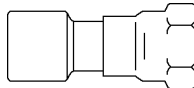

Part #	Mfg #	Description	Price
SOC647C2	647-C2	1/2" CPVC x 1/2" FIP	4.30
SOC647C3	647-C3	3/4" CPVC x 3/4" FIP	5.81

Water Hammer Arresters

Hydra-Rester® Engineered Water Hammer Arresters

- Keeps system surge pressure to 150 PSIG or below



MIP Connection

Part #	Mfg #	Conn Size	L x W	Price
SOHYDRA	653-B	3/4" IPS	8-3/4" x 1-3/8"	21.25

Test Plugs

Test Titan™ Mechanical Test Plug

- Back to front wedge design prevents blowouts at high and low temperatures
- Provides leak-free seal
- Non-slip shoulder



Part #	Mfg #	Size	Price
SOCTP112	882-1	1-1/2"	3.10
SOCTP2	882-2	2"	3.35
SOCTP3	882-3	3"	4.75
SOCTP312	882-35	3-1/2"	6.25
SOCTP4	882-4	4"	6.25

Grip Tip™ Test Cap & Test Plug

- Tip acts as a handle while applying glue & can be snipped to allow filling & bleeding with water or air for testing
- Deeper glue surface ensures a good seal especially on unevenly cut pipe
- Durable, virgin ABS may be glued to pipe with all-purpose glue
- Test nipple is 1/2" CTS (5/8" OD)



Part #	Mfg #	Description	Price
SOCGT112	881-10C	1-1/2" Test Plug, High-Visibility	0.32
SOCGT2	881-12C	2" Test Plug, High-Visibility	0.37
SOCGT3	881-13C	3" Test Plug, High-Visibility	0.49
SOCGT4	881-14C	4" Test Plug, High-Visibility	0.66

Lav/Sink/Tub

Trim Titer™ PVC Shallow Escutcheons

- 1" CTS & 1" IPS Through 2" IPS sizes have deluxe 3-1/2" OD, other have 2-1/2" OD
- White finish



Part #	Mfg #	Description	Price
SOCFLG12	920-2W	1/2" Nom CTS	0.18
SOCFLG112	921-6W	1-1/2" IPS	0.39

Plumbing Sundries

Prices & Specifications are Subject to Change.

Plumbing Sundries

Snap One™ Floor & Ceiling Plates

- Split for pre-piped jobs
- ABS 100% Rust-proof
- Non breakable



Part #	Mfg #	Description	Price
SOC9262	926-2	1/2" Nom CTS, CP	1.05

Toilet Parts

Wedge-It™ Multi-Purpose Stability Wedge

- Corrosion proof

Soft Rubber-Like PVC



Part #	Mfg #	Description	Price
SOC46020J	460-20J	Closet Wedge - White 10/Bag	0.36

Closet Flange Floor Support

- Repairs and replaces rotted-out flooring around closet flanges
- Heavy gauge, zinc plated steel die-cut plate
- Pre-slotted and furnished with mounting screws



Part #	Mfg #	Description	Price
SOCREPAIRFLNG	490-11322	Closet Flange Floor Support	17.22

Brass Valves

Brass Stop & Waste Valve w/CPVC Connections

- NSF/ANSI 14
- ASTM D2846 Socket joint
- Teflon seat
- EPDM O-rings
- Rated 100 PSI at 180°F



Part #	Mfg #	Description	Price
SOC648C2W	648-C2W	1/2" CPVC x 4-3/8"L	17.40
SOC648C3W	648-C3W	3/4" CPVC x 6-1/8"L	20.12

Vacuum Breaker

- Solid machined brass



Part #	Mfg #	Description	Price
SOC11703	117-03	3/4" Female Hose Thread x 3/4" Male Hose Thread	6.34

Ox Box™ Outlet Boxes

Gas Ox Box™

- 1/4-Turn ball valve
- High-impact ABS
- CSA Certified



Part #	Mfg #	Description	Price
SOCGASBOX	696-1021GF	1/2" NPT Valve & Adapter for Iron Pipe	29.89



Boss 889 Citrus Hand Cleaner with Pumice

- Removes oil, grease, grime and stains without damaging skin



Part #	Mfg #	Size	Price
HARFORG15	BOSS 88915	15 oz	9.24
HARFORG1	BOSS 88920	1 gal	45.58

Gate Valves

Valterra PVC Slice Gate Valve

- Designed for pool and spa, irrigation, plumbing, waste water and agricultural applications
- Stainless steel shaft
- Ozone and chemical resistant Santoprene™ materials
- Maximum working pressure is 50 PSI (through 2")
- Solvent cement traps
- Triple o-ring neck seal



Part #	Mfg #	Description	Price
VAL6101	VSGV150SL	1-1/2" Slip x Slip 3-Pc	19.00
VAL6201	VSGV200SL	2" Slip x Slip 3-Pc	23.48
VAL6301	VSGV300SL	3" Slip x Slip 3-Pc	37.42
VAL6401	VSGV400SL	4" Slip x Slip 3-Pc	162.35

Plumbing Sundries

Safety Supplies

Dust Mask

- Extremely lightweight, metal nose clips



Part #	Mfg #	Description	Price
ACYMASK	5-500	Disposable Dust Mask	0.54

KNEE N' BACK Pad by Bennette Design Group

- Lightweight kneepad
- Can be used as back support pad when working inside cabinetry
- Closed cell foam construction
- Ribbed anti-slip surfacing on bottom
- Made in U.S.A.



Part #	Mfg #	Description	Price
ACYKNEEPAD	KNEE N' BACK	18" x 13.5" x 2" Thick	55.08

Industrial Towels & Hand Cleaners

Workhorse™ Manufactured Rags

- Versatile, economical
- Made from Hydorknit™
- 9-3/4" x 16-3/4"



Part #	Mfg #	Description	Price
ACYRAG	5-41455	Workhorse™ Rags, White	26.92

Shop Towels

- Heavy-duty reusable towels
- 100% Cotton material, pre-shrunk and hemmed



Part #	Mfg #	Description	Price
ACYST	ST-10	13" x 16", 10/Bag	27.22

Brushes

Chip Brush



Part #	Mfg #	Size	Price
ACYCHIP3	B-505	3"	2.24

Caution Tape

- Black print on safety yellow
- 3 mil Thickness



JSC
Joseph Stimpert Corp.

Part #	Mfg #	Size	Price
ACYCATAPE	J43-310	3" x 1,000'	18.76



Silicone Sealants

385 RTV Tub 'N' Tile Plumber's Silicone Sealant with Mildew Resistance

- One-part, fungicidal, acetoxo, RTV silicone
- Seals around ceramic tile, showers, tubs, sinks and plumbing fixtures
- Resists mildew, stains, spotting and color changes
- Remains flexible in temperature extremes and high humidity



Part #	Mfg #	Description	Price
CAUS10C	38500	10.1 oz Clear	8.44
CAUS10W	38501	10.1 oz White	8.44

Caulk

362 Siliconized Acrylic Latex Caulk

- Mildew resistant
- Paintable
- Weatherproof
- Cures to a tough flexible, seal
- Interior and exterior



Part #	Mfg #	Description	Price
CAUW5A	36255	10.1 oz Almond	5.92

362t 100% Acrylic Tub 'N' Tile Caulk

- For use around showers, baths, tubs, tiles, backsplashes and sinks
- Also for use on baseboards, door frames, windows, crown molding - anywhere weathertight seal is needed



Part #	Mfg #	Description	Price
CAUW5C	36250	5.5 oz Clear	6.70
CAUW5W	36251	5.5 oz White	5.92

Plumbing Sundries

Prices & Specifications are Subject to Change.



www.irrsupply.com

Plumbing Sundries

368 Butyl Rubber Sealant

- One-part skinning material
- Adheres to metal, asphalt, wood & masonry
- Excellent for sealing standing seam roofs, side walls, gutters & downspouts
- Fills & caulks joint in HVAC ducts
- Excellent sealant for sheet metal joints
- Exceeds metal building requirements and Federal Spec TTS-001657



Part #	Mfg #	Description	Price
CAUB10W	36801	10.3 oz White	9.68

Caulk Guns

Part #	Mfg #	Description	Price
CAUGUN	M0017	9" Skeleton Type, Orange	19.56



Perma Wet Plug

- Hydraulic cement
- Stops water leaks
- For exterior or interior use



Part #	Mfg #	Description	Price
WEP3	300WE	3 lbs	14.14
WEP5	5WE	5 gal	103.18



Roofing Cements

19AF Flashing Cement

- Dries to a tough, flexible, waterproof and corrosion-proof coating
- Retains flexibility and ductility
- Resistant to flow (sag) at high temperatures



Part #	Mfg #	Size	Price
ROOFCEM	19-AF	1 gal	42.12



Joist Reinforcers

- For floor joist repair
- #### Hole Joist Reinforcer



Part #	Mfg #	Description	Price
MED210HR	210HR	2" x 10" w/6" Dia Hole	37.32

Notch Joist Reinforcer



Part #	Mfg #	Description	Price
MED210NR	210NR	2" x 10" w/3-1/2"H x 5"W Notch	37.32



Abrasive Products

Blue Monster™ Ultra-Flex® Abrasive Cloth

- Conforms to tight work areas
- Premium 150 grit
- 100% Waterproof



Part #	Mfg #	Size	Qty	Price
BLMSC10	70174	2" x 10 yd Roll	24/Pk	10.40
BLMSC25	70176	2" x 25 yd Roll	24/Pk	22.55

Plumbing Sundries

All Items May Not Be Stocked In All Branches



www.irrsupply.com

Plumbing Sundries

Blue Monster™ Aluminum Oxide Open Mesh

- 21 x 21 Mesh - resists clogging
- Premium blended 165 grit white aluminum oxide
- Waterproof
- Bright blue color



Part #	Mfg #	Size	Qty	Price
BLMSCOM5	70152	2" x 5 yd Roll	24/Pk	10.58
BLMSCOM10	70154	2" x 10 yd Roll	24/Pk	19.13

Cleaning Towels

Blue Monster Heavy-Duty Citrus Scrubbing Towel

- Pre-moistened, heavy-duty cleaning towel
- Flip-top container
- Free of harsh solvents and chemicals
- Lint free, quick drying



Part #	Mfg #	Description	Price
BLMTOWELS	77095	10" x 12" Towels (Floor Display - 75 Count)	27.43

Teflon® Thread Sealants

Blue Monster™ PTFE Thread Seal Tape

- Rugged, not flimsy
- Compatible with a broad range of gases and liquids, piping materials



Part #	Mfg #	Description	Price
TETBLUE	70885	1/2" x 1429" Roll	4.33
TETBLUE34	70886	3/4" x 1429" Roll	5.90

Plumber's Full-Density Thread Seal Tape

3-Wrap Water Line (Red) Teflon® Tape TF5-15

- For plumbers and pipe fitters
- May be used on most thread seal connections (metal or plastic) involving air, water, sewage, chemicals, hydraulic systems and overhead sprinkler systems



Part #	Mfg #	Description	Price
TETRED	70878	1/2" x 260"	3.40

Full-Density Gas Thread Seal Tape

Oxygen (Green) Teflon® Thread Seal Tape TF5-25

- 99.6% Virgin PTFE Teflon
- Green
- 3,000 psi



Part #	Mfg #	Description	Price
TETGREEN	70861	1/2" x 260" Roll	6.60

Gas (Yellow) Teflon® Thread Seal Tape TF5-20

- For ferrous and non-ferrous threaded fittings in gas pipelines, cylinders, containers and storage vessels
- -450°F to +550°F
- 0-5000 psi



Part #	Mfg #	Description	Price
TETYELLOW	70825	1/2" x 260"	4.65

Better Quality White Thread Sealant Tape

Standard Grade (White) Teflon® Sealant Tape TF20-1

- 100% Virgin PTFE Teflon
- -450°F to +550°F
- 3000 psi



Part #	Mfg #	Description	Price
TET12	70190	1/2" x 260" Roll	0.90
TET12-520	70200	1/2" x 520" Roll	0.53
TET34	70195	3/4" x 310" Roll	1.74

Plumbing Sundries

Prices & Specifications are Subject to Change.



Plumbing Sundries

Sakrete® Sand Mix

- Repair & resurface old concrete
- Bedding for slate, block & flagstone



Part #	Mfg #	Size	Price
SAK80S	12080	80# Bag	14.30

Sakrete® Fast Setting Concrete Mix



Part #	Mfg #	Size	Price
SAK80	10280	80# Bag	12.86



Heavy Stud Shoe Kits

4-Pack with Screws



Part #	Mfg #	Description	Price
SIMHSS2KT	HSS2KT	Heavy Stud Shoe	39.48

Tubing

Relief Valve Run-Off Tubing

- High temperature (230°F) polypropylene
- One size fits all, 60" long
- Include standard electroplated steel pipe nipple
- Side-mounted: 3/4" x 1-1/2" x 60" (for residential water heaters)
- Top-mounted: 3/4" x 8" x 60" (retaining clip included)



Part #	Mfg #	Description	Price
PERRVRT	RVRT	3/4" x 60"	2.73

Radiator Specialty Company

Gunk® Force Cups



C-104



C-106F



C-107

Part #	Mfg #	Description	Price
RASC101	C-101	Utility Force Cup 4-1/2"	3.80
RASC104	C-104	High Neck 4"	10.42
RASC106F	C-106F	Heavy Duty 6"	21.24
RASC107	C-107	Free Flo 6"	9.78

Hold-Zit Straps



- Hold down tarps and other equipment
- Reinforced ends to strengthen hooks



Part #	Mfg #	Description	Price
RASR79B	R7-9D	9" - Display	2.72
RASR715B	R7-15B	15" - Bulk Pack (50)	3.40
RASR722B	R7-22-D	22" - Display	4.18
RASR731B	R7-31D	31" - Display	4.92

Plumbing Sundries

Norlab Dyes
Tracing Dye



Part #	Mfg #	Description	Price
NOLDYE	YELLOWGREEN DYE	1# Yellow-Green	35.54



Flashlights & Lanterns
Industrial Grade Flashlight



Part #	Mfg #	Description	Price
RAYIN2	IN-2	2 Cell D Size	8.94

Professional-Grade Flashlight

- Battery run time: 150 hours on Rayovac alkaline, 55 hours on Rayovac heavy duty batteries
- Polypropylene body
- Impact resistant to 7 feet
- Water, grease and corrosion resistant
- Comfort grip, protected slide switch
- Hanging ring
- Two (D) zinc chloride batteries included
- Lifetime warranty



Part #	Mfg #	Description	Price
RAYI2DLED B	I2DLED-B	3 LED Yellow	16.78

Industrial Multi-Pack Batteries
UltraPRO Industrial Multi-Pack Battery



Part #	Mfg #	Description	Price
RAYALAA	AL-AA	AA Size 8 Pack	1.00
RAYALAAA	AL-AAA	AAA Size 8 Pack	1.02
RAYALC	AL-C	C Size 6 Pack	1.50
RAYALD	AL-D	D Size 6 Pack	1.68
RAYAL9V	AL-9V	9 Volt 6 Pack	2.94



Accessories
Gas Line Warning Tape



Part #	Mfg #	Size	Price
GAPPTAPE2	MAG-TAPE	2" x 1000'	101.86



Specialty Products

Quick Seal™ Pipe Repair

- Knitted fiberglass impregnated tape
- Can be used on both cold or hot water
- Safe for potable water
- UL listed, ANSI/NSF Standard 61



Part #	Mfg #	Description	Price
CAL429910	4299-10	2" x 3' Wrap	71.56
CAL429911	4299-11	4" x 12' Wrap	216.16

Plumbing Sundries

Plumbing

Durastone® Mop Basins

- 1-Piece white molded construction
- Integrally molded drain with seal
- 65M Has elevated shelf
- Meets or exceeds ANSI specifications Z124.2 & 124.6

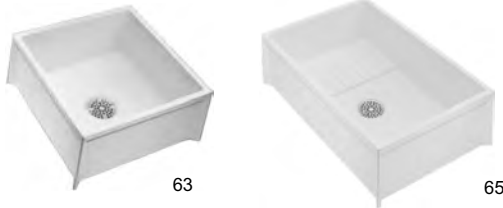

Part #	Mfg #	Size	IPS	Price
MUS63M	63M	24" x 24" x 10"	3"	160.84
MUS65M	65M	24" x 36" x 10"	3"	314.74

Mop Basin Accessories



Part #	Mfg #	Description	Price
MUSMTGBLK	20.600	Faucet Block	5.62
MUS42317A	42.317A	PVC Drain Assy w/Seal for 2" Pipe	27.40
MUS63401	63.401	Bumper Guard 20-3/4" Length Fits 63M	31.72
MUS65308	65.308	2" Drain Seal for 63M	15.78
MUS65403	65.403	Bumper Guard 32-3/4" Length Fits 65M	31.72
MUS65600	65.600	Mop Hanger	93.60
MUS65700	65.700	Hose & Hose Holder	55.72
MUS82400	82.400A	Drain Assembly Side Outlet 1-1/2" w/Leveling Screws Ext Bases	82.16

Plumbing Sundries



Knee Pads

- Lightweight and water-resistant
- Comfortable while kneeling, standing or walking
- Won't pinch or bind behind knee
- Velcro closures on straps
- Soft, breathable inner lining for coolness and comfort



Part #	Mfg #	Description	Price
PLSKNEEPAD	K01-2000	Heavy Duty Knee Cap	31.22

Lead Ingot

- Handle with (4) 5 lb plugs



Part #	Mfg #	Description	Price
LEACKL	L40-002	25 lbs	5.10

Packing

Oakum

- Original Oakum with benonite - expands over 10 times when wet
- Baled in coils or cut length
- No tar in brown oakum



Part #	Mfg #	Description	Price
OAK3	O15-006	Brown Random Cut - 1 lb Bags Pack	10.49

Nipple Caddies

Steel Nipple Caddy Tray

- Steel construction
- Push away handles
- Baked epoxy finish
- Nipple storage range (close - 6")

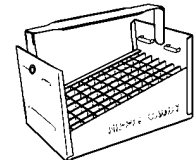

Part #	Mfg #	Description	Price
SCH1899A	N70-050	1/2" Nipple, 77-Pc	34.67
SCH1899B	N70-075	3/4" Nipple, 66-Pc	37.28
SCH1899C	N70-016	1" Nipple, 50-Pc	37.82

All Items May Not Be Stocked In All Branches

Plumbing Sundries

Water Heater Pans

Aluminum Water Heater Pans

- Manufactured from .032 prime aluminum & are expertly worked to exact specifications under strict quality control
- Meets requirements of Southern Building Code
- Exposed edges have been rolled to protect the installer from injury
- Recommended for gas or electric heaters



Part #	Mfg #	Size	Fitting	Price
OATWHPANAL	34152	22"	1" PVC	32.38
OATWHPANAL26	34084	26"	1-1/2" PVC	45.04

Plastic Polymer Water Heater Pans

- Manufactured from semi-flexible, tough and durable .0625" plastic polymer
- Will not rust or corrode
- Meets requirements of Southern Building Code
- Pans pre-drilled to accommodate fittings
- Recommended for electric water heaters



Part #	Mfg #	Size	Fitting	Price
OATWHPAN22	34062	22"	1" PVC	14.78
OATWHPAN24	34063	24"	1" PVC	16.66
OATWHPAN30	34065	30"	1" PVC	29.76

Water Heater Stands

- Allows the placement of water heater tanks 18" above the ground as required by the National Fuel Gas Code
- Constructed of 18 gauge spangled galvanized sheet metal, holds up to 50 gallon water heaters



Part #	Mfg #	Description	Price
OATWHSTAND	34057	21" Square x 18" High	120.42

Access Panels

- For plumbing, electrical security systems, telephone, TV, computer cables & sprinkler system applications
- Reversible outer frame allows for flush mounting
- Special designed drill guides for cable or wire
- UV Stabilized material is paint & wallpaper compatible
- No lumber framing required, ideal for new construction
- Eliminates costly repairs



Part #	Mfg #	Description	Price
OATAP1414	34056	14" x 14" Plastic	26.56

Washing Machine Pans

- Provides lasting protection from washing machine overflow or hose failure
- Made from high impact plastic
- Will not rust or corrode
- Pans have formed hole to punch out for the furnished, 1" PVC plastic fitting



Part #	Mfg #	Description	Price
OATWMPAN	34067	28" x 30" Plastic	36.40

Shower Pan Liners

CPE Shower Pan Liner

- Original flexible pan liner
- Liner marked in 6" increments for ease of measuring
- Meets ASTM Spec D4068



Part #	Mfg #	Size	mil	Color	Price
OATSPL4	41588	4" x 50'	40	Black	15.04
OATSPL5	41590	5" x 40'	40	Black	18.80

CPE Solvent

- CPE Solvent is specially formulated for extended working times
- CPE Solvent provides exceptional sheet to sheet bonding

Part #	Mfg #	Description	Price
OATSOL16	30810	16 oz with Dauber	21.70

Closet Flanges

Closet Flange Replacement

- Slides inside of 4" cast iron or Sch 40 DWV plastic pipe
- 3" Stainless steel bolts are tightened from the finished floor
- Compression joint allows up to 3" of adjustment to the riser
- No tearout or caulking required



Part #	Mfg #	Description	Price
OATCCF4	43539	4" PVC	39.42

Closet Flange Spacer

- 1/4" Spacer builds up an existing closet flange when new flooring is installed
- Can be stacked to desired height



Part #	Mfg #	Description	Price
OATCFSPACER	43519	1/4" Closet Spacer for PVC or ABS Closet	5.40

Plumbing Sundries

Prices & Specifications are Subject to Change.

Plumbing Sundries

Valves

Sure-Vent® Air Admittance Valve - 160DFU

- For use as a secondary vent



Part #	Mfg #	Description	Price
OATAAV-160	39220	2" x 3", PVC 40 Adapter	42.26

Sure Vent® II Air Admittance Valve



Part #	Mfg #	Description	Price
OATAAV	39016	1-1/2" with 1-1/2" to 2" PVC Adapter	24.50

Sure Vent® Wall Box

- Allows access to Sure Vent® air admittance valve



Part #	Mfg #	Description	Price
OATAAVBOX	39010	Wall Box With Faceplate	16.50

Ice Maker Outlet Boxes

- Valves comply with requirements of NSF 61, Section 9
- High impact polystyrene boxes

Center Drain With 1/4-Turn Brass Ball Valves

- (2) Support brackets
- Dimensions
 - Box: 6"W x 6"H x 3-3/8"D
 - Faceplate: 8-1/4"W x 8-1/4"H



Part #	Mfg #	Connection	Pack	Price
OATIMB	38681	Copper SWT	Standard	43.62
OATIMBPEX	38684	PEX	Standard	45.56

Quadro™ Washing Machine Outlet Boxes

- 2" Drain opening fits PVC or ABS Sch 40 DWV pipe
- Box made of high impact polystyrene
- (4) Support brackets
- Easy to remove knockout
- Snap-on faceplate frame accommodates up to 1" drywall
- 'Lock and Load' valve mounting system
- Dimensions:
 - Box: 8-3/4"W x 7-1/2"H x 3-5/8"D
 - Faceplate: 11-3/4"W x 10-1/8"H



QUADRO™ 1/4-Turn Brass Ball Valve

Part #	Mfg #	Connection	Pack	Price
OATOUTBOX3	38530	Copper SWT	Standard	57.00
OATOUTBOX6	38532	PEX	Standard	58.82

QUADRO™ 1/4-Turn Brass Hammer Ball Valve

Part #	Mfg #	Connection	Pack	Price
OATOUTBOX8	38542	PEX	Standard	186.24

QUADRO™ Single Lever Ball Valve

Part #	Mfg #	Connection	Pack	Price
OATOUTBOX1	38535	Copper SWT	Standard	99.14
OATOUTBOX5	38537	PEX	Standard	116.02

Toilet Repair Aids

LiquiLock™ Gel

- Solidifies water for easy toilet removal
- Prevents water spills
- Gel formed in 4 minutes
- Non-toxic, Lo-VOC



Part #	Mfg #	Size	Price
OATLIQUILOCK	31416	0.6 oz	2.50

Cement Carrier

- Designed to make it easier to keep cement and cleaner ready for use on the job
- Patented



Part #	Mfg #	Description	Price
OATCEMCAR	31250	Holds (2) 32 oz Cans	13.24

Plumbing Sundries

Plumbing Sundries

Johnny-Guard

- 15" x 24" Overall size
- Toilet Base

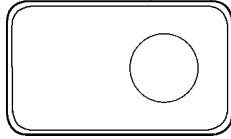

Part #	Mfg #	Description	Price
TOBREG	REG	White 5-5/8" Small Hole	70.05
TOBRETRO	RETRO	White 7-1/2" Large Hole	70.05



Bathroom & Kitchen Cleaning/Care

KRC-7® Ultra Foaming



Part #	Mfg #	Description	Price
KRC7	72416	32 oz Bottle	23.52



Under-Sink Protectors (Pipe Covers)

- The LAV-GUARD™ undersink protective pipe cover is the original high-quality ADA piping protection system, proven at thousands of facilities across the USA
- Made of antimicrobial molded closed cell vinyl with a smooth, high gloss finish
- ADA Conforming, rotatable, flexible design
- Patented Lock-Lid™ covers angle stop valves
- Patented Snap-Clip™ reusable fasteners simplifies installation and servicing
- Internal rib design maximizes safety

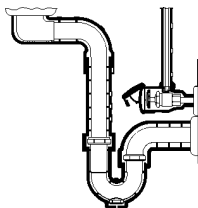

102

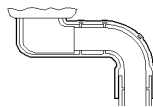

105



Part #	Mfg #	Includes:	Price
TRUTRAP	100	(1) P-Trap Cover	17.30

Under-Sink Protectors (Pipe Covers) (Continued)

Part #	Mfg #	Includes:	Price
TRULAVKIT	102	(1) P-Trap Cover (2) Angle Valve Covers (2) Supply Tube Covers	43.50
TRUOFFSET	105	(1) P-Trap Cover (2) Angle Valve Covers (2) Supply Tube Covers (1) 5" Offset Tailpiece Wheelchair Strainer Cover	10.80

E-Z LavGuard2™ Pipe Covers

- #100 Series designed to fit all tubular and cast brass P-trap assemblies
- #400 Series designed for schedule 40 plastic p-traps and is based on original E-Z LavGuard
- Built-in E-Z grip internal fasteners
- E-Z Tear-to-fit trimming



Part #	Mfg #	Includes:	Price
TRUSUPPLY	#99	(1) Angle Valve (1) Supply Cover	17.30

Lav Shield® Lavatory Protective Enclosure

- ADA Compliant
- Heavy-duty, vandal-resistant, durable, single-piece construction
- Impact/stain/chemical-resistant, rigid vinyl



Part #	Mfg #	Description	Price
TRU2018MAN	2018-MA-N	For Mansfield 2018 HB-N	177.46

Black Steel Pipe

Black Pipe & Fittings

Black Steel TBE Cut Pipe

- Threaded both ends



Part #	Size	Price
BLKP12-10	1/2" x 10'	40.69
BLKP34-10	3/4" x 10'	45.45
BLKP1-10	1" x 10'	58.19
BLKP114-10	1-1/4" x 10'	77.97
BLKP112-10	1-1/2" x 10'	93.42
BLKP2-10	2" x 10'	125.36

Standard Black Steel T&C Pipe

- Threaded and coupled



Part #	Size	Price
BLKP18-21	1/8" x 21'	256.80
BLKP14-21	1/4" x 21'	308.55
BLKP38-21	3/8" x 21'	352.51
BLKP12-21	1/2" x 21'	67.42
BLKP34-21	3/4" x 21'	87.28
BLKP1-21	1" x 21'	118.07
BLKP114-21	1-1/4" x 21'	155.31
BLKP112-21	1-1/2" x 21'	185.96
BLKP2-21	2" x 21'	243.36
BLKP212-21	2-1/2" x 21'	402.73
BLKP3-21	3" x 21'	527.29
BLKP4-21	4" x 21'	753.56

Black Steel Nipples



Standard Weight Black Steel Nipples

1/8" Std Wgt Black Steel Nipple

Part #	Size	Price
BLKN18-CL	1/8" x Close	1.62
BLKN18-112	1/8" x 1-1/2"	2.05
BLKN18-2	1/8" x 2"	2.05
BLKN18-212	1/8" x 2-1/2"	2.27

Standard Weight Black Steel Nipples (Continued)

1/8" Std Wgt Black Steel Nipple

Part #	Size	Price
BLKN18-3	1/8" x 3"	2.27
BLKN18-312	1/8" x 3-1/2"	2.86
BLKN18-4	1/8" x 4"	2.86
BLKN18-412	1/8" x 4-1/2"	5.39
BLKN18-5	1/8" x 5"	5.39
BLKN18-512	1/8" x 5-1/2"	5.82
BLKN18-6	1/8" x 6"	5.82

1/4" Std Wgt Black Steel Nipple

Part #	Size	Price
BLKN14-CL	1/4" x Close	1.94
BLKN14-112	1/4" x 1-1/2"	2.05
BLKN14-2	1/4" x 2"	2.05
BLKN14-212	1/4" x 2-1/2"	2.64
BLKN14-3	1/4" x 3"	2.64
BLKN14-312	1/4" x 3-1/2"	3.07
BLKN14-4	1/4" x 4"	3.07
BLKN14-412	1/4" x 4-1/2"	4.69
BLKN14-5	1/4" x 5"	4.69
BLKN14-512	1/4" x 5-1/2"	5.50
BLKN14-6	1/4" x 6"	5.50

3/8" Std Wgt Black Steel Nipple

Part #	Size	Price
BLKN38-CL	3/8" x Close	2.05
BLKN38-112	3/8" x 1-1/2"	2.27
BLKN38-2	3/8" x 2"	2.27
BLKN38-212	3/8" x 2-1/2"	2.97
BLKN38-3	3/8" x 3"	2.97
BLKN38-312	3/8" x 3-1/2"	3.40
BLKN38-4	3/8" x 4"	3.40
BLKN38-412	3/8" x 4-1/2"	4.90
BLKN38-5	3/8" x 5"	4.90
BLKN38-512	3/8" x 5-1/2"	5.50
BLKN38-6	3/8" x 6"	5.50

1/2" Std Wgt Black Steel Nipple

Part #	Size	Price
BLKN12-CL	1/2" x Close	1.58
BLKN12-112	1/2" x 1-1/2"	1.58
BLKN12-2	1/2" x 2"	1.58
BLKN12-212	1/2" x 2-1/2"	1.93
BLKN12-3	1/2" x 3"	1.93
BLKN12-312	1/2" x 3-1/2"	2.29

Standard Weight Black Steel Nipples (Continued)

1/2" Std Wgt Black Steel Nipple

Part #	Size	Price
BLKN12-4	1/2" x 4"	2.29
BLKN12-412	1/2" x 4-1/2"	2.70
BLKN12-5	1/2" x 5"	2.70
BLKN12-512	1/2" x 5-1/2"	3.00
BLKN12-6	1/2" x 6"	3.00
BLKN12-7	1/2" x 7"	5.30
BLKN12-8	1/2" x 8"	5.30
BLKN12-9	1/2" x 9"	6.42
BLKN12-10	1/2" x 10"	6.42
BLKN12-11	1/2" x 11"	7.59
BLKN12-12	1/2" x 12"	7.59
BLKN12-14	1/2" x 14"	9.81
BLKN12-16	1/2" x 16"	10.80
BLKN12-18	1/2" x 18"	11.86
BLKN12-24	1/2" x 24"	15.53
BLKN12-30	1/2" x 30"	18.23
BLKN12-36	1/2" x 36"	21.43
BLKN12-48	1/2" x 48"	27.03
BLKN12-60	1/2" x 60"	32.53

3/4" Std Wgt Black Steel Nipple

Part #	Size	Price
BLKN34-CL	3/4" x Close	1.83
BLKN34-112	3/4" x 1-1/2"	1.93
BLKN34-2	3/4" x 2"	1.93
BLKN34-212	3/4" x 2-1/2"	2.24
BLKN34-3	3/4" x 3"	2.24
BLKN34-312	3/4" x 3-1/2"	2.97
BLKN34-4	3/4" x 4"	2.80
BLKN34-412	3/4" x 4-1/2"	3.66
BLKN34-5	3/4" x 5"	3.46
BLKN34-512	3/4" x 5-1/2"	4.09
BLKN34-6	3/4" x 6"	3.87
BLKN34-7	3/4" x 7"	6.52
BLKN34-8	3/4" x 8"	6.52
BLKN34-9	3/4" x 9"	7.59
BLKN34-10	3/4" x 10"	8.03
BLKN34-12	3/4" x 12"	8.89
BLKN34-18	3/4" x 18"	14.66
BLKN34-24	3/4" x 24"	18.79
BLKN34-30	3/4" x 30"	21.95
BLKN34-36	3/4" x 36"	26.02
BLKN34-48	3/4" x 48"	34.62
BLKN34-60	3/4" x 60"	42.31

All Items May Not Be Stocked In All Branches

Black Steel Nipples

1" Std Wgt Black Steel Nipple

Part #	Size	Price
BLKN1-CL	1" x Close	2.70
BLKN1-2	1" x 2"	2.90
BLKN1-212	1" x 2-1/2"	3.23
BLKN1-3	1" x 3"	3.05
BLKN1-312	1" x 3-1/2"	4.04
BLKN1-4	1" x 4"	3.82
BLKN1-412	1" x 4-1/2"	4.80
BLKN1-5	1" x 5"	4.80
BLKN1-512	1" x 5-1/2"	5.66
BLKN1-6	1" x 6"	5.35
BLKN1-8	1" x 8"	9.21
BLKN1-10	1" x 10"	10.72
BLKN1-12	1" x 12"	12.34
BLKN1-18	1" x 18"	19.99
BLKN1-24	1" x 24"	26.13
BLKN1-30	1" x 30"	30.07
BLKN1-36	1" x 36"	36.32
BLKN1-48	1" x 48"	47.47
BLKN1-60	1" x 60"	59.75

1-1/4" Std Wgt Black Steel Nipple

Part #	Size	Price
BLKN114-CL	1-1/4" x Close	3.36
BLKN114-2	1-1/4" x 2"	3.77
BLKN114-212	1-1/4" x 2-1/2"	4.26
BLKN114-3	1-1/4" x 3"	4.02
BLKN114-312	1-1/4" x 3-1/2"	5.01
BLKN114-4	1-1/4" x 4"	4.73
BLKN114-412	1-1/4" x 4-1/2"	6.09
BLKN114-5	1-1/4" x 5"	6.09
BLKN114-512	1-1/4" x 5-1/2"	7.22
BLKN114-6	1-1/4" x 6"	6.83
BLKN114-8	1-1/4" x 8"	11.54
BLKN114-10	1-1/4" x 10"	13.13
BLKN114-12	1-1/4" x 12"	14.82

1-1/2" Std Wgt Black Steel Nipple

Part #	Size	Price
BLKN112-CL	1-1/2" x Close	4.37
BLKN112-2	1-1/2" x 2"	4.80
BLKN112-212	1-1/2" x 2-1/2"	5.39
BLKN112-3	1-1/2" x 3"	5.39
BLKN112-312	1-1/2" x 3-1/2"	5.98
BLKN112-4	1-1/2" x 4"	5.98
BLKN112-412	1-1/2" x 4-1/2"	7.28
BLKN112-5	1-1/2" x 5"	7.28

Standard Weight Black Steel Nipples (Continued)

1-1/2" Std Wgt Black Steel Nipple

Part #	Size	Price
BLKN112-512	1-1/2" x 5-1/2"	8.30
BLKN112-6	1-1/2" x 6"	8.30
BLKN112-8	1-1/2" x 8"	13.25
BLKN112-12	1-1/2" x 12"	17.89

2" Std Wgt Black Steel Nipple

Part #	Size	Price
BLKN2-CL	2" x Close	5.65
BLKN2-212	2" x 2-1/2"	6.90
BLKN2-3	2" x 3"	6.90
BLKN2-312	2" x 3-1/2"	8.30
BLKN2-4	2" x 4"	8.30
BLKN2-412	2" x 4-1/2"	9.64
BLKN2-5	2" x 5"	9.64
BLKN2-512	2" x 5-1/2"	11.26
BLKN2-6	2" x 6"	10.64
BLKN2-8	2" x 8"	18.86
BLKN2-10	2" x 10"	22.14
BLKN2-12	2" x 12"	25.60

2-1/2" Std Wgt Black Steel Nipple

Part #	Size	Price
BLKN212-CL	2-1/2" x Close	18.86
BLKN212-3	2-1/2" x 3"	19.34
BLKN212-312	2-1/2" x 3-1/2"	22.74
BLKN212-4	2-1/2" x 4"	22.74
BLKN212-412	2-1/2" x 4-1/2"	24.95
BLKN212-5	2-1/2" x 5"	24.95
BLKN212-512	2-1/2" x 5-1/2"	25.97
BLKN212-6	2-1/2" x 6"	25.97
BLKN212-8	2-1/2" x 8"	33.08
BLKN212-10	2-1/2" x 10"	37.23
BLKN212-12	2-1/2" x 12"	41.33

3" Std Wgt Black Steel Nipple

Part #	Size	Price
BLKN3-CL	3" x Close	22.36
BLKN3-3	3" x 3"	24.30
BLKN3-312	3" x 3-1/2"	28.83
BLKN3-4	3" x 4"	28.83
BLKN3-412	3" x 4-1/2"	31.68
BLKN3-5	3" x 5"	31.68
BLKN3-512	3" x 5-1/2"	34.48

Standard Weight Black Steel Nipples (Continued)

3" Std Wgt Black Steel Nipple

Part #	Size	Price
BLKN3-6	3" x 6"	34.48
BLKN3-10	3" x 10"	52.32
BLKN3-12	3" x 12"	58.03

4" Std Wgt Black Steel Nipple

Part #	Size	Price
BLKN4-CL	4" x Close	33.68
BLKN4-4	4" x 4"	39.01
BLKN4-412	4" x 4-1/2"	44.50
BLKN4-5	4" x 5"	44.50
BLKN4-512	4" x 5-1/2"	47.58
BLKN4-6	4" x 6"	47.58

Black Steel Nipple Sets

Slant Box Black Steel Nipple Assortment



Part #	Size	Pcs	Price
BLKN6612	1/2"	66 Pcs	122.36
BLKN6634	3/4"	66 Pcs	148.87
BLKN661	1"	60 Pcs	173.17

Black Steel Run Close - 6 Nipples

Part #	Size	Price
BLKNRUN38	Run 3/8 Cls - 6	39.92
BLKNRUN12	Run 1/2 Cls - 6	24.23
BLKNRUN34	Run 3/4 Cls - 6	30.30
BLKNRUN1	Run 1 Cls - 6	38.95
BLKNRUN114	Run 1-1/4 Cls - 6	52.69
BLKNRUN112	Run 1-1/2 Cls - 6	63.04
BLKNRUN2	Run 2 Cls - 6	78.29

Tank Nipples

Part #	Size	Price
BLKTL114-10	1-1/4" x 10" Oil Tank Leg	10.08
BLKTL114-12	1-1/4" x 12" Oil Tank Leg	11.87

Black Pipe & Fittings

Prices & Specifications are Subject to Change.

Black Malleable Iron Fittings

Black Pipe & Fittings

Black Malleable Iron Fittings Threaded 150#

Threaded 150# Hex Bushing - Black MI



Part #	Size	Price
BLKBU14-18	1/4" x 1/8"	1.87
BLKBU38-18	3/8" x 1/8"	2.21
BLKBU38-14	3/8" x 1/4"	2.21
BLKBU12-18	1/2" x 1/8"	3.27
BLKBU12-14	1/2" x 1/4"	3.09
BLKBU12-38	1/2" x 3/8"	3.09
BLKBU34-18	3/4" x 1/8"	3.49
BLKBU34-14	3/4" x 1/4"	3.37
BLKBU34-38	3/4" x 3/8"	3.49
BLKBU34-12	3/4" x 1/2"	2.97
BLKBU1-14	1" x 1/4"	7.27
BLKBU1-12	1" x 1/2"	5.25
BLKBU1-34	1" x 3/4"	5.10
BLKBU114-14	1-1/4" x 1/4"	10.33
BLKBU114-12	1-1/4" x 1/2"	8.10
BLKBU114-34	1-1/4" x 3/4"	6.62
BLKBU114-1	1-1/4" x 1"	6.62
BLKBU112-12	1-1/2" x 1/2"	8.25
BLKBU112-34	1-1/2" x 3/4"	8.25
BLKBU112-1	1-1/2" x 1"	7.27
BLKBU112-114	1-1/2" x 1-1/4"	8.53
BLKBU2-12	2" x 1/2"	8.17
BLKBU2-34	2" x 3/4"	6.79
BLKBU2-1	2" x 1"	6.45
BLKBU2-114	2" x 1-1/4"	6.45
BLKBU2-112	2" x 1-1/2"	10.52
BLKBU212-34	2-1/2" x 3/4"	11.71
BLKBU212-1	2-1/2" x 1"	11.71
BLKBU212-114	2-1/2" x 1-1/4"	11.71
BLKBU212-112	2-1/2" x 1-1/2"	10.85
BLKBU212-2	2-1/2" x 2"	10.85
BLKBU3-112	3" x 1-1/2"	15.88
BLKBU3-2	3" x 2"	15.51
BLKBU3-212	3" x 2-1/2"	15.02
BLKBU312-3	3-1/2" x 3"	28.21
BLKBU4-2	4" x 2"	41.22
BLKBU4-3	4" x 3"	41.22

Threaded 150# Cap - Black MI



Part #	Size	Price
BLKCAP14	1/4"	3.07
BLKCAP38	3/8"	3.56
BLKCAP12	1/2"	3.04
BLKCAP34	3/4"	4.07
BLKCAP1	1"	4.96
BLKCAP114	1-1/4"	6.57
BLKCAP112	1-1/2"	9.50
BLKCAP2	2"	13.81
BLKCAP212	2-1/2"	16.92
BLKCAP3	3"	25.18
BLKCAP4	4"	80.57

Threaded 150# Cross - Black MI



Part #	Size	Price
BLKCR12	1/2"	15.89
BLKCR34	3/4"	19.47
BLKCR1	1"	23.88

Threaded 150# RH Coupling - Black MI



Part #	Size	Price
BLKCPLGM38	3/8"	5.71
BLKCPLGM12	1/2"	4.07
BLKCPLGM34	3/4"	4.90
BLKCPLGM1	1"	7.21
BLKCPLGM114	1-1/4"	9.97
BLKCPLGM112	1-1/2"	13.45
BLKCPLGM2	2"	19.83
BLKCPLGM212	2-1/2"	55.09
BLKCPLGM3	3"	74.45
BLKCPLGM4	4"	149.83

Merchant Coupling - Black Steel



Part #	Size	Price
BLKCPLG14	1/4"	4.00
BLKCPLG38	3/8"	4.78

All Items May Not Be Stocked In All Branches

Black Malleable Iron Fittings

Black Malleable Iron Fittings Threaded 150# (Continued)

Merchant Coupling - Black Steel

Part #	Size	Price
BLKCPLG12	1/2"	5.08
BLKCPLG34	3/4"	6.55
BLKCPLG1	1"	9.09
BLKCPLG114	1-1/4"	17.15
BLKCPLG112	1-1/2"	14.74
BLKCPLG2	2"	21.11
BLKCPLG212	2-1/2"	60.01
BLKCPLG3	3"	78.75
BLKCPLG4	4"	149.32

Threaded 150# 45° Elbow - Black MI



Part #	Size	Price
BLK4514	1/4"	6.85
BLK4538	3/8"	6.85
BLK4512	1/2"	4.96
BLK4534	3/4"	6.49
BLK451	1"	8.20
BLK45114	1-1/4"	14.44
BLK45112	1-1/2"	17.86
BLK452	2"	27.05
BLK45212	2-1/2"	78.19
BLK453	3"	101.39

Threaded 150# 45° Street Elbow - Black MI



Part #	Size	Price
BLKST4538	3/8"	9.04
BLKST4512	1/2"	7.32
BLKST4534	3/4"	11.06
BLKST451	1"	12.82
BLKST45114	1-1/4"	22.33
BLKST45112	1-1/2"	28.71
BLKST452	2"	48.28

Threaded 150# 90° Elbow - Black MI



Part #	Size	Price
BLK9014	1/4"	4.57
BLK9038	3/8"	4.57
BLK9012	1/2"	2.99
BLK9034	3/4"	3.63
BLK901	1"	6.32
BLK90114	1-1/4"	10.35
BLK90112	1-1/2"	13.63
BLK902	2"	23.48
BLK90212	2-1/2"	55.40
BLK903	3"	81.04
BLK904	4"	174.18

Threaded 150# 90° Reducing Elbow - Black MI



Part #	Size	Price
BLK9012-14	1/2" x 1/4"	6.07
BLK9012-38	1/2" x 3/8"	6.02
BLK9034-12	3/4" x 1/2"	5.74
BLK901-12	1" x 1/2"	8.67
BLK901-34	1" x 3/4"	7.89
BLK90114-34	1-1/4" x 3/4"	15.00
BLK90114-1	1-1/4" x 1"	13.50
BLK90112-34	1-1/2" x 3/4"	21.70
BLK90112-1	1-1/2" x 1"	18.95
BLK90112-114	1-1/2" x 1-1/4"	18.95
BLK902-1	2" x 1"	31.25
BLK902-114	2" x 1-1/4"	31.25
BLK902-112	2" x 1-1/2"	26.16
BLK90212-112	2-1/2" x 1-1/2"	79.79

Threaded 150# 90° Street Elbow - Black MI



Part #	Size	Price
BLKST9014	1/4"	6.80
BLKST9038	3/8"	6.80
BLKST9012	1/2"	6.28

Black Pipe & Fittings

Prices & Specifications are Subject to Change.

Black Malleable Iron Fittings

Black Pipe & Fittings

Black Malleable Iron Fittings Threaded 150# (Continued)

Threaded 150# 90° Street Elbow - Black MI

Part #	Size	Price
BLKST9034	3/4"	6.28
BLKST901	1"	8.73
BLKST90114	1-1/4"	14.44
BLKST90112	1-1/2"	19.31
BLKST902	2"	31.41
BLKST903	3"	121.43

Threaded 150# Floor Flange - Black MI



Part #	Size	Price
BLKFF12	1/2"	11.99
BLKFF34	3/4"	12.67
BLKFF1	1"	16.35
BLKFF114	1-1/4"	16.82
BLKFF112	1-1/2"	18.53
BLKFF2	2"	24.35

Threaded 150# Square Headed Plug Cored - Black MI



Part #	Size	Price
BLKPLUG18	1/8"	0.78
BLKPLUG14	1/4"	0.98
BLKPLUG38	3/8"	1.40
BLKPLUG12	1/2"	2.38
BLKPLUG34	3/4"	2.38
BLKPLUG1	1"	2.59
BLKPLUG114	1-1/4"	4.24
BLKPLUG112	1-1/2"	6.45
BLKPLUG2	2"	5.30
BLKPLUG212	2-1/2"	10.10
BLKPLUG3	3"	13.91
BLKPLUG4	4"	38.86

Threaded 150# Reducer - Black MI



Part #	Size	Price
BLKCPLG14-18	1/4" x 1/8"	4.47
BLKCPLG38-14	3/8" x 1/4"	5.97
BLKCPLG12-18	1/2" x 1/8"	6.02

Black Malleable Iron Fittings Threaded 150# (Continued)

Threaded 150# Reducer - Black MI

Part #	Size	Price
BLKCPLG12-14	1/2" x 1/4"	5.40
BLKCPLG12-38	1/2" x 3/8"	4.90
BLKCPLG34-12	3/4" x 1/2"	5.39
BLKCPLG1-12	1" x 1/2"	8.63
BLKCPLG1-34	1" x 3/4"	8.48
BLKCPLG114-12	1-1/4" x 1/2"	13.50
BLKCPLG114-34	1-1/4" x 3/4"	11.52
BLKCPLG114-1	1-1/4" x 1"	10.88
BLKCPLG112-12	1-1/2" x 1/2"	17.24
BLKCPLG112-34	1-1/2" x 3/4"	19.47
BLKCPLG112-1	1-1/2" x 1"	16.82
BLKCPLG112-114	1-1/2" x 1-1/4"	14.53
BLKCPLG2-34	2" x 3/4"	24.24
BLKCPLG2-1	2" x 1"	22.84
BLKCPLG2-114	2" x 1-1/4"	24.24
BLKCPLG2-112	2" x 1-1/2"	21.18
blkcplg212-114	2-1/2" x 1-1/4"	57.00
BLKCPLG212-112	2-1/2" x 1-1/2"	57.62
BLKCPLG212-2	2-1/2" x 2"	48.49
BLKCPLG3-112	3" x 1-1/2"	75.90
BLKCPLG3-2	3" x 2"	62.87
BLKCPLG3-212	3" x 2-1/2"	73.36
BLKCPLG4-2	4" x 2"	152.17
BLKCPLG4-3	4" x 3"	152.17

Threaded 150# Tee - Black MI



Part #	Size	Price
BLKT14	1/4"	6.69
BLKT38	3/8"	6.69
BLKT12	1/2"	4.02
BLKT34	3/4"	5.69
BLKT1	1"	9.86
BLKT114	1-1/4"	15.88
BLKT112	1-1/2"	21.03
BLKT2	2"	33.78
BLKT212	2-1/2"	77.15
BLKT3	3"	113.70
BLKT4	4"	274.58

All Items May Not Be Stocked In All Branches

Black Malleable Iron Fittings

Threaded 150# Reducing Run/Outlet Tee - Black MI



Part #	Size	Price
BLKT34-12-12	3/4" x 1/2" x 1/2"	9.02
BLKT1-12-12	1" x 1/2" x 1/2"	13.60
BLKT1-34-12	1" x 3/4" x 1/2"	13.60
BLKT1-34-34	1" x 3/4" x 3/4"	12.62
BLKT114-34-34	1-1/4" x 3/4" x 3/4"	25.23
BLKT114-1-34	1-1/4" x 1" x 3/4"	22.17
BLKT114-1-1	1-1/4" x 1" x 1"	22.17
BLKT112-34-114	1-1/2" x 3/4" x 1-1/4"	29.59
BLKT112-1-1	1-1/2" x 1" x 1"	30.22
BLKT112-114-34	1-1/2" x 1-1/4" x 3/4"	30.22
BLKT112-114-114	1-1/2" x 1-1/4" x 1-1/4"	40.44
BLKT2-112-112	2" x 1-1/2" x 1-1/2"	46.21

Threaded 150# Reducing Run Tees - Black MI



Part #	Size	Price
BLKT34-12-34	3/4" x 1/2" x 3/4"	10.90
BLKT1-12-1	1" x 1/2" x 1"	13.60
BLKT1-34-1	1" x 3/4" x 1"	13.81
BLKT114-12-114	1-1/4" x 1/2" x 1-1/4"	25.23
BLKT114-34-114	1-1/4" x 3/4" x 1-1/4"	22.84
BLKT112-34-112	1-1/2" x 3/4" x 1-1/2"	30.22

Threaded 150# Reducing Outlet Tee - Black MI



Part #	Size	Price
BLKT34-34-12	3/4" x 3/4" x 1/2"	8.88
BLKT1-1-12	1" x 1" x 1/2"	11.23
BLKT1-1-34	1" x 1" x 3/4"	11.23
BLKT114-114-12	1-1/4" x 1-1/4" x 1/2"	21.70
BLKT114-114-34	1-1/4" x 1-1/4" x 3/4"	17.95
BLKT114-114-1	1-1/4" x 1-1/4" x 1"	20.61
BLKT112-112-12	1-1/2" x 1-1/2" x 1/2"	25.39
BLKT112-112-34	1-1/2" x 1-1/2" x 3/4"	23.93

Black Malleable Iron Fittings Threaded 150# (Continued)

Threaded 150# Reducing Outlet Tee - Black MI

Part #	Size	Price
BLKT112-112-1	1-1/2" x 1-1/2" x 1"	23.93
BLKT112-112-114	1-1/2" x 1-1/2" x 1-1/4"	29.65
BLKT2-2-12	2" x 2" x 1/2"	38.21
BLKT2-2-34	2" x 2" x 3/4"	37.53
BLKT2-2-1	2" x 2" x 1"	37.53
BLKT2-2-114	2" x 2" x 1-1/4"	40.44
BLKT2-2-112	2" x 2" x 1-1/2"	40.44
BLKT212-212-112	2-1/2" x 2-1/2" x 1-1/2"	106.79
BLKT212-212-2	2-1/2" x 2-1/2" x 2"	100.30
BLKT3-3-2	3" x 3" x 2"	134.10

Threaded 150# Bull Tee - Black MI

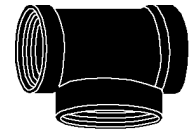

Part #	Size	Price
BLKT12-12-34	1/2" x 1/2" x 3/4"	10.90
BLKT34-34-1	3/4" x 3/4" x 1"	14.22

Threaded 150# Brass Seat Unions - Black MI



Part #	Size	Price
BLKUN14	1/4"	22.53
BLKUN38	3/8"	15.52
BLKUN12	1/2"	13.29
BLKUN34	3/4"	15.15
BLKUN1	1"	19.91
BLKUN114	1-1/4"	28.39
BLKUN112	1-1/2"	35.45
BLKUN2	2"	41.14
BLKUN212	2-1/2"	130.15
BLKUN3	3"	156.63

Black Cast Iron Flanges

125# Companion Flange - Black CI

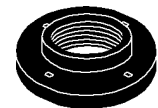

Part #	Size	Size x OD	Price
BLKCF2-2	2"	2" x 6"	39.66
BLKCF4-3	4" x 3"	3" x 9"	116.60

Prices & Specifications are Subject to Change.

Galvanized Steel Pipe

Galvanized Steel T&C Pipe

21' Lengths T&C Steel Pipe - Galv



Part #	Size	Price
GALP18-21	1/8" x 21'	305.20
GALP14-21	1/4" x 21'	461.67
GALP12-21	1/2" x 21'	133.12
GALP34-21	3/4" x 21'	160.32
GALP1-21	1" x 21'	215.61
GALP114-21	1-1/4" x 21'	281.22
GALP112-21	1-1/2" x 21'	335.89
GALP2-21	2" x 21'	451.05
GALP3-21	3" x 21'	952.48

Standard Galvanized Steel Nipples (Continued)

1/4" Std Wgt Galv Steel Nipples

Part #	Size	Price
GALN14-312	1/4" x 3-1/2"	4.99
GALN14-4	1/4" x 4"	4.99
GALN14-412	1/4" x 4-1/2"	6.80
GALN14-5	1/4" x 5"	6.80
GALN14-512	1/4" x 5-1/2"	7.58
GALN14-6	1/4" x 6"	7.58

Standard Galvanized Steel Nipples (Continued)

3/4" Std Wgt Galv Steel Nipples

Part #	Size	Price
GALN34-312	3/4" x 3-1/2"	4.53
GALN34-4	3/4" x 4"	4.53
GALN34-412	3/4" x 4-1/2"	5.39
GALN34-5	3/4" x 5"	5.39
GALN34-512	3/4" x 5-1/2"	6.47
GALN34-6	3/4" x 6"	6.47

3/8" Std Wgt Galv Steel Nipples

Part #	Size	Price
GALN38-CL	3/8" x Close	2.95
GALN38-112	3/8" x 1-1/2"	3.39
GALN38-2	3/8" x 2"	3.39
GALN38-212	3/8" x 2-1/2"	4.54
GALN38-3	3/8" x 3"	4.54
GALN38-312	3/8" x 3-1/2"	5.38
GALN38-4	3/8" x 4"	5.38
GALN38-412	3/8" x 4-1/2"	7.42
GALN38-5	3/8" x 5"	7.42
GALN38-512	3/8" x 5-1/2"	8.23
GALN38-6	3/8" x 6"	8.23

1" Std Wgt Galv Steel Nipples

Part #	Size	Price
GALN1-CL	1" x Close	3.99
GALN1-2	1" x 2"	4.71
GALN1-212	1" x 2-1/2"	5.08
GALN1-3	1" x 3"	5.08
GALN1-312	1" x 3-1/2"	6.11
GALN1-4	1" x 4"	6.11
GALN1-412	1" x 4-1/2"	7.50
GALN1-5	1" x 5"	7.50
GALN1-512	1" x 5-1/2"	8.52
GALN1-6	1" x 6"	8.52

1/2" Std Wgt Galv Steel Nipples

Part #	Size	Price
GALN12-CL	1/2" x Close	2.39
GALN12-112	1/2" x 1-1/2"	2.53
GALN12-2	1/2" x 2"	2.53
GALN12-212	1/2" x 2-1/2"	2.96
GALN12-3	1/2" x 3"	2.96
GALN12-312	1/2" x 3-1/2"	3.66
GALN12-4	1/2" x 4"	3.66
GALN12-412	1/2" x 4-1/2"	4.40
GALN12-5	1/2" x 5"	4.40
GALN12-512	1/2" x 5-1/2"	5.00
GALN12-6	1/2" x 6"	5.00

1-1/4" Std Wgt Galv Steel Nipples

Part #	Size	Price
GALN114-CL	1-1/4" x Close	5.36
GALN114-2	1-1/4" x 2"	5.81
GALN114-212	1-1/4" x 2-1/2"	6.31
GALN114-3	1-1/4" x 3"	6.31
GALN114-312	1-1/4" x 3-1/2"	7.50
GALN114-4	1-1/4" x 4"	7.50
GALN114-412	1-1/4" x 4-1/2"	9.29
GALN114-5	1-1/4" x 5"	9.29
GALN114-512	1-1/4" x 5-1/2"	10.79
GALN114-6	1-1/4" x 6"	10.79

Galvanized Steel Nipples



Standard Galvanized Steel Nipples



1/8" Std Wgt Galv Steel Nipples

Part #	Size	Price
GALN18-CL	1/8" x Close	2.53
GALN18-112	1/8" x 1-1/2"	3.50
GALN18-2	1/8" x 2"	3.50
GALN18-212	1/8" x 2-1/2"	4.62
GALN18-3	1/8" x 3"	4.62
GALN18-312	1/8" x 3-1/2"	3.48
GALN18-4	1/8" x 4"	5.49
GALN18-412	1/8" x 4-1/2"	8.56
GALN18-5	1/8" x 5"	9.25
GALN18-512	1/8" x 5-1/2"	10.37
GALN18-6	1/8" x 6"	9.60

1/4" Std Wgt Galv Steel Nipples

Part #	Size	Price
GALN14-CL	1/4" x Close	2.71
GALN14-112	1/4" x 1-1/2"	3.16
GALN14-2	1/4" x 2"	3.16
GALN14-212	1/4" x 2-1/2"	4.14
GALN14-3	1/4" x 3"	4.14

3/4" Std Wgt Galv Steel Nipples

Part #	Size	Price
GALN34-CL	3/4" x Close	2.92
GALN34-112	3/4" x 1-1/2"	3.15
GALN34-2	3/4" x 2"	3.15
GALN34-212	3/4" x 2-1/2"	3.49
GALN34-3	3/4" x 3"	3.49

All Items May Not Be Stocked In All Branches

Galvanized Steel Nipples

**1-1/2" Std Wgt Galv Steel
Nipples**

Part #	Size	Price
GALN112-CL	1-1/2" x Close	6.29
GALN112-2	1-1/2" x 2"	6.75
GALN112-212	1-1/2" x 2-1/2"	7.50
GALN112-3	1-1/2" x 3"	7.50
GALN112-312	1-1/2" x 3-1/2"	9.49
GALN112-4	1-1/2" x 4"	9.49
GALN112-412	1-1/2" x 4-1/2"	11.47
GALN112-5	1-1/2" x 5"	11.47
GALN112-512	1-1/2" x 5-1/2"	12.90
GALN112-6	1-1/2" x 6"	12.90

2" Std Wgt Galv Steel Nipples

Part #	Size	Price
GALN2-CL	2" x Close	8.83
GALN2-212	2" x 2-1/2"	9.95
GALN2-3	2" x 3"	9.95
GALN2-312	2" x 3-1/2"	12.09
GALN2-4	2" x 4"	12.09
GALN2-412	2" x 4-1/2"	15.43
GALN2-5	2" x 5"	15.43
GALN2-512	2" x 5-1/2"	17.92
GALN2-6	2" x 6"	17.92

**2-1/2" Std Wgt Galv Steel
Nipples**

Part #	Size	Price
GALN212-CL	2-1/2" x Close	26.33
GALN212-5	2-1/2" x 5"	35.39
GALN212-6	2-1/2" x 6"	38.87

3" Std Wgt Galv Steel Nipples

Part #	Size	Price
GALN3-CL	3" x Close	31.58
GALN3-4	3" x 4"	42.13

**Galv Steel Run Close - 6
Nipples**

Part #	Size	Price
GALNRUN12	Run 1/2" Cls-6	31.09
GALNRUN34	Run 3/4" Cls-6	38.52
GALNRUN1	Run 1" Cls-6	49.68
GALNRUN114	Run 1-1/4" Cls-6	62.06

**Galv Steel Run Close - 6
Nipples (Continued)**

Part #	Size	Price
GALNRUN112	Run 1-1/2" Cls-6	75.33
GALNRUN2	Run 2" Cls-6	94.05

**Irr Supply is your one stop shop
for all your Plumbing, HVAC,
Refrigeration, and Electrical needs.
Why go anywhere else!**



**Galvanized Pipe &
Fittings**

Galvanized Malleable Iron Fittings

Galvanized Malleable Iron Fittings

Threaded 150# Hex Bushing - Galv MI



Part #	Size	Price
GALBU14-18	1/4" x 1/8"	2.16
GALBU38-18	3/8" x 1/8"	2.36
GALBU38-14	3/8" x 1/4"	2.36
GALBU12-18	1/2" x 1/8"	3.80
GALBU12-14	1/2" x 1/4"	3.59
GALBU12-38	1/2" x 3/8"	3.59
GALBU34-18	3/4" x 1/8"	15.54
GALBU34-14	3/4" x 1/4"	4.51
GALBU34-38	3/4" x 3/8"	5.25
GALBU34-12	3/4" x 1/2"	4.02
GALBU1-14	1" x 1/4"	7.58
GALBU1-38	1" x 3/8"	11.88
GALBU1-12	1" x 1/2"	6.87
GALBU1-34	1" x 3/4"	6.50
GALBU114-34	1-1/4" x 3/4"	8.76
GALBU114-1	1-1/4" x 1"	8.76
GALBU112-34	1-1/2" x 3/4"	12.71
GALBU112-1	1-1/2" x 1"	11.45
GALBU112-114	1-1/2" x 1-1/4"	10.56
GALBU2-12	2" x 1/2"	34.66
GALBU2-34	2" x 3/4"	32.27
GALBU2-1	2" x 1"	10.33
GALBU2-114	2" x 1-1/4"	10.33
GALBU2-112	2" x 1-1/2"	8.63

Threaded 150# Cap - Galv MI



Part #	Size	Price
GALCAP18	1/8"	3.07
GALCAP14	1/4"	3.27
GALCAP38	3/8"	4.00
GALCAP12	1/2"	6.64
GALCAP34	3/4"	3.04
GALCAP1	1"	10.52
GALCAP114	1-1/4"	15.30
GALCAP112	1-1/2"	19.54
GALCAP2	2"	8.41

Threaded 150# Coupling - Galv MI



Part #	Size	Price
GALCPLG18	1/8"	4.16
GALCPLG14	1/4"	5.39
GALCPLG38	3/8"	6.92
GALCPLG12	1/2"	7.35
GALCPLG34	3/4"	9.22
GALCPLG1	1"	12.91
GALCPLG114	1-1/4"	16.48
GALCPLG112	1-1/2"	20.47
GALCPLG2	2"	30.58

Threaded 150# 45° Elbow - Galv MI



Part #	Size	Price
GAL4512	1/2"	9.90
GAL4534	3/4"	13.85
GAL451	1"	15.89
GAL45114	1-1/4"	29.00
GAL45112	1-1/2"	34.57
GAL452	2"	51.58

Threaded 150# 45° Street Elbow - Galv MI



Part #	Size	Price
GALST4512	1/2"	14.30

Threaded 150# 90° Elbow - Galv MI



Part #	Size	Price
GAL9018	1/8"	10.12
GAL9014	1/4"	9.62
GAL9038	3/8"	9.62
GAL9012	1/2"	6.36
GAL9034	3/4"	7.65
GAL901	1"	14.34
GAL90114	1-1/4"	22.11
GAL90112	1-1/2"	29.13
GAL902	2"	48.54

All Items May Not Be Stocked In All Branches

Galvanized Malleable Iron Fittings

Threaded 150# 90° Reducing Elbow - Galv MI



Part #	Size	Price
GAL901-34	1" x 3/4"	16.56
GAL90112-114	1-1/2" x 1-1/4"	42.66

Threaded 150# 90° Street Elbow - Galv MI



Part #	Size	Price
GALST9014	1/4"	13.22
GALST9038	3/8"	13.22
GALST9012	1/2"	13.65
GALST9034	3/4"	13.22
GALST901	1"	18.01
GALST90114	1-1/4"	30.28
GALST90112	1-1/2"	37.29
GALST902	2"	64.65

Threaded 150# Floor Flange - Galv MI



Part #	Size	Price
GALFF34	3/4"	45.28
GALFF1	1"	49.80
GALFF2	2"	93.19

Threaded 150# Square Headed Plug Cored - Galv MI



Part #	Size	Price
GALPLUG18	1/8"	0.87
GALPLUG14	1/4"	1.00
GALPLUG38	3/8"	1.49
GALPLUG12	1/2"	4.46
GALPLUG34	3/4"	2.99
GALPLUG1	1"	4.75
GALPLUG114	1-1/4"	15.60
GALPLUG112	1-1/2"	21.05
GALPLUG2	2"	26.73
GALPLUG212	2-1/2"	52.14

Threaded 150# Reducer - Galv MI



Part #	Size	Price
GALCPLG14-18	1/4" x 1/8"	10.52
GALCPLG38-14	3/8" x 1/4"	10.52
GALCPLG12-14	1/2" x 1/4"	9.59
GALCPLG12-38	1/2" x 3/8"	8.99
GALCPLG34-14	3/4" x 1/4"	11.87
GALCPLG34-12	3/4" x 1/2"	10.49
GALCPLG1-12	1" x 1/2"	17.50
GALCPLG1-34	1" x 3/4"	16.22
GALCPLG114-34	1-1/4" x 3/4"	22.25
GALCPLG114-1	1-1/4" x 1"	22.25
GALCPLG112-34	1-1/2" x 3/4"	28.67
GALCPLG112-1	1-1/2" x 1"	28.67
GALCPLG112-114	1-1/2" x 1-1/4"	27.10
GALCPLG2-34	2" x 3/4"	46.78
GALCPLG2-1	2" x 1"	39.10
GALCPLG2-114	2" x 1-1/4"	41.31
GALCPLG2-112	2" x 1-1/2"	39.10
GALCPLG212-2	2-1/2" x 2"	120.95

Threaded 150# Tee - Galv MI



Part #	Size	Price
GALT18	1/8"	14.47
GALT14	1/4"	12.55
GALT38	3/8"	12.55
GALT12	1/2"	7.72
GALT34	3/4"	12.97
GALT1	1"	21.23
GALT114	1-1/4"	33.55
GALT112	1-1/2"	41.88
GALT2	2"	69.89

Galvanized Pipe & Fittings

Galvanized Malleable Iron Fittings

Threaded 150# Reducing Run/Outlet Tee - Galv MI



Part #	Size	Price
GALT34-12-12	3/4" x 1/2" x 1/2"	20.48
GALT34-12-34	3/4" x 1/2" x 3/4"	20.48
GALT1-34-34	1" x 3/4" x 3/4"	30.28

Threaded 150# Reducing Outlet Tee - Galv MI



Part #	Size	Price
GALT34-34-12	3/4" x 3/4" x 1/2"	17.92
GALT1-1-12	1" x 1" x 1/2"	25.14
GALT1-1-34	1" x 1" x 3/4"	25.14
GALT114-114-34	1-1/4" x 1-1/4" x 3/4"	38.89
GALT114-114-1	1-1/4" x 1-1/4" x 1"	38.89
GALT112-112-1	1-1/2" x 1-1/2" x 1"	48.14

We have 32 convenient locations proudly serving Western NY, Central NY, and Northern Pennsylvania.

Over 140 years of doing business with integrity.

Galvanized Malleable Iron Unions

Threaded 150# Brass Seat Union - Galv MI



Part #	Size	Price
GALUN14	1/4"	43.31
GALUN38	3/8"	28.81
GALUN12	1/2"	29.12
GALUN34	3/4"	34.55
GALUN1	1"	42.98
GALUN114	1-1/4"	58.43
GALUN112	1-1/2"	74.82
GALUN2	2"	53.37



Red Brass Nipples

Red Brass Nipples



Brass Nipples - 1/4"

Part #	Mfg #	Size	Price
BRSN14-CL	N14-CL	1/4" x Close	3.35
BRSN14-112	N14-112	1/4" x 1-1/2"	3.87
BRSN14-2	N14-2	1/4" x 2"	4.39
BRSN14-212	N14-212	1/4" x 2-1/2"	4.75
BRSN14-3	N14-3	1/4" x 3"	5.58
BRSN14-312	N14-312	1/4" x 3-1/2"	6.07
BRSN14-4	N14-4	1/4" x 4"	7.14
BRSN14-412	N14-412	1/4" x 4-1/2"	7.75
BRSN14-5	N14-5	1/4" x 5"	8.45
BRSN14-512	N14-512	1/4" x 5-1/2"	9.15
BRSN14-6	N14-6	1/4" x 6"	10.29

Brass Nipples - 3/8"

Part #	Mfg #	Size	Price
BRSN38-CL	N38-CL	3/8" x Close	3.47
BRSN38-112	N38-112	3/8" x 1-1/2"	4.11
BRSN38-2	N38-2	3/8" x 2"	4.99
BRSN38-212	N38-212	3/8" x 2-1/2"	5.41
BRSN38-3	N38-3	3/8" x 3"	6.62
BRSN38-312	N38-312	3/8" x 3-1/2"	7.14
BRSN38-4	N38-4	3/8" x 4"	8.49
BRSN38-412	N38-412	3/8" x 4-1/2"	9.04
BRSN38-5	N38-5	3/8" x 5"	9.92
BRSN38-512	N38-512	3/8" x 5-1/2"	10.78
BRSN38-6	N38-6	3/8" x 6"	11.66

Brass Nipples - 1/2"

Part #	Mfg #	Size	Price
BRSN12-CL	N12-CL	1/2" x Close	4.63
BRSN12-112	N12-112	1/2" x 1-1/2"	5.36
BRSN12-2	N12-2	1/2" x 2"	6.29
BRSN12-212	N12-212	1/2" x 2-1/2"	7.49
BRSN12-3	N12-3	1/2" x 3"	8.79
BRSN12-312	N12-312	1/2" x 3-1/2"	10.03
BRSN12-4	N12-4	1/2" x 4"	11.49
BRSN12-412	N12-412	1/2" x 4-1/2"	12.47
BRSN12-5	N12-5	1/2" x 5"	13.74
BRSN12-512	N12-512	1/2" x 5-1/2"	15.09
BRSN12-6	N12-6	1/2" x 6"	16.73

Brass Nipples - 3/4"

Part #	Mfg #	Size	Price
BRSN34-CL	N34-CL	3/4" x Close	6.67
BRSN34-112	N34-112	3/4" x 1-1/2"	7.11
BRSN34-2	N34-2	3/4" x 2"	8.40
BRSN34-212	N34-212	3/4" x 2-1/2"	9.74
BRSN34-3	N34-3	3/4" x 3"	11.24
BRSN34-312	N34-312	3/4" x 3-1/2"	12.61
BRSN34-4	N34-4	3/4" x 4"	14.66
BRSN34-412	N34-412	3/4" x 4-1/2"	15.95
BRSN34-5	N34-5	3/4" x 5"	17.60
BRSN34-512	N34-512	3/4" x 5-1/2"	19.23
BRSN34-6	N34-6	3/4" x 6"	21.41

Brass Nipples - 1"

Part #	Mfg #	Size	Price
BRSN1-CL	N1-CL	1" x Close	9.84
BRSN1-2	N1-2	1" x 2"	12.14
BRSN1-212	N1-212	1" x 2-1/2"	14.16
BRSN1-3	N1-3	1" x 3"	16.31
BRSN1-312	N1-312	1" x 3-1/2"	18.88
BRSN1-4	N1-4	1" x 4"	21.23
BRSN1-412	N1-412	1" x 4-1/2"	23.68
BRSN1-5	N1-5	1" x 5"	26.18
BRSN1-512	N1-512	1" x 5-1/2"	28.68
BRSN1-6	N1-6	1" x 6"	31.27

Brass Nipples - 1-1/4"

Part #	Mfg #	Size	Price
BRSN114-CL	N114-CL	1-1/4" x Close	14.85
BRSN114-2	N114-2	1-1/4" x 2"	16.95
BRSN114-212	N114-212	1-1/4" x 2-1/2"	19.17
BRSN114-3	N114-3	1-1/4" x 3"	22.69
BRSN114-312	N114-312	1-1/4" x 3-1/2"	26.55
BRSN114-4	N114-4	1-1/4" x 4"	29.88
BRSN114-412	N114-412	1-1/4" x 4-1/2"	33.09
BRSN114-5	N114-5	1-1/4" x 5"	36.49
BRSN114-512	N114-512	1-1/4" x 5-1/2"	39.91
BRSN114-6	N114-6	1-1/4" x 6"	43.59

Brass Nipples - 1-1/2"

Part #	Mfg #	Size	Price
BRSN112-CL	N112-CL	1-1/2" x Close	19.30
BRSN112-2	N112-2	1-1/2" x 2"	20.77
BRSN112-212	N112-212	1-1/2" x 2-1/2"	24.88
BRSN112-3	N112-3	1-1/2" x 3"	28.59
BRSN112-312	N112-312	1-1/2" x 3-1/2"	32.83

Brass Pipe & Fittings

Prices & Specifications are Subject to Change.

Red Brass Nipples

Red Brass Nipples (Continued)

Brass Nipples - 1-1/2"

Part #	Mfg #	Size	Price
BRSN112-4	N112-4	1-1/2" x 4"	37.24
BRSN112-412	N112-412	1-1/2" x 4-1/2"	41.85
BRSN112-5	N112-5	1-1/2" x 5"	46.30
BRSN112-512	N112-512	1-1/2" x 5-1/2"	50.66
BRSN112-6	N112-6	1-1/2" x 6"	55.02

Brass Nipples - 2"

Part #	Mfg #	Size	Price
BRSN2-CL	N2-CL	2" x Close	29.39
BRSN2-212	N2-212	2" x 2-1/2"	31.74
BRSN2-3	N2-3	2" x 3"	36.62
BRSN2-312	N2-312	2" x 3-1/2"	42.16
BRSN2-4	N2-4	2" x 4"	47.92
BRSN2-412	N2-412	2" x 4-1/2"	53.42
BRSN2-5	N2-5	2" x 5"	59.23
BRSN2-512	N2-512	2" x 5-1/2"	64.97
BRSN2-6	N2-6	2" x 6"	70.74

Brass Nipple Sets - Close-6

Part #	Mfg #	Size	Set	Price
BRSNRUN14	NRUN14	1/4"	11 Pc	58.21
BRSNRUN38	NRUN38	3/8"	11 Pc	67.12
BRSNRUN12	NRUN12	1/2"	11 Pc	92.20
BRSNRUN34	NRUN34	3/4"	11 Pc	118.93
BRSNRUN1	NRUN1	1"	10 Pc	166.39
BRSNRUN2	NRUN2	2"	9 Pc	358.67

Threaded Brass Fittings

Barstock Threaded Brass Hex Bushings

Part #	Mfg #	Size	Price
BRSBU14-18	BS114-0402	1/4" x 1/8"	1.70
BRSBU38-14	BS114-0604	3/8" x 1/4"	3.01

Import Threaded Brass Fittings

Threaded Brass Hex Bushings - Import



Part #	Mfg #	Size	Price
BRSBU12-18	X114-0802	1/2" x 1/8"	4.78

Import Threaded Brass Fittings (Continued)

Threaded Brass Hex Bushings - Import

Part #	Mfg #	Size	Price
BRSBU12-14	X114-0804	1/2" x 1/4"	4.01
BRSBU12-38	X114-0806	1/2" x 3/8"	4.01
BRSBU34-18	X114-1202	3/4" x 1/8"	6.68
BRSBU34-14	X114-1204	3/4" x 1/4"	6.68
BRSBU34-38	X114-1206	3/4" x 3/8"	5.53
BRSBU34-12	X114-1208	3/4" x 1/2"	5.53
BRSBU1-18	X114-1602	1" x 1/8"	4.19
BRSBU1-14	X114-1604	1" x 1/4"	10.16
BRSBU1-38	X114-1606	1" x 3/8"	10.16
BRSBU1-12	X114-1608	1" x 1/2"	8.37
BRSBU1-34	X114-1612	1" x 3/4"	8.37
BRSBU114-12	X114-2008	1-1/4" x 1/2"	17.21
BRSBU114-34	X114-2012	1-1/4" x 3/4"	14.27
BRSBU114-1	X114-2016	1-1/4" x 1"	14.27
BRSBU112-34	X114-2412	1-1/2" x 3/4"	22.29
BRSBU112-1	X114-2416	1-1/2" x 1"	18.23
BRSBU112-114	X114-2420	1-1/2" x 1-1/4"	18.23
BRSBU2-34	X114-3212	2" x 3/4"	32.53
BRSBU2-1	X114-3216	2" x 1"	32.53
BRSBU2-114	X114-3220	2" x 1-1/4"	27.00
BRSBU2-112	X114-3224	2" x 1-1/2"	27.00
BRSBU3-2	X114-4832	3" x 2"	81.67

Threaded Brass Caps - Import



Part #	Mfg #	Size	Price
BRSCAP18	X116-02	1/8"	3.79
BRSCAP14	X116-04	1/4"	3.79
BRSCAP38	X116-06	3/8"	3.79
BRSCAP12	X116-08	1/2"	5.05
BRSCAP34	X116-12	3/4"	6.68
BRSCAP1	X116-16	1"	10.46
BRSCAP114	X116-20	1-1/4"	15.91
BRSCAP112	X116-24	1-1/2"	21.48
BRSCAP2	X116-32	2"	36.46

Threaded Brass Couplings - Import



Part #	Mfg #	Size	Price
BRSCPLG18	X111-02	1/8"	5.05
BRSCPLG14	X111-04	1/4"	5.05
BRSCPLG38	X111-06	3/8"	5.05
BRSCPLG12	X111-08	1/2"	6.34

All Items May Not Be Stocked In All Branches

Threaded Brass Fittings

**Import Threaded Brass Fittings
(Continued)**

Threaded Brass Couplings - Import

Part #	Mfg #	Size	Price
BRSCPLG34	X111-12	3/4"	8.37
BRSCPLG1	X111-16	1"	12.72
BRSCPLG114	X111-20	1-1/4"	19.87
BRSCPLG112	X111-24	1-1/2"	27.00
BRSCPLG2	X111-32	2"	44.45

Threaded Brass Coupling Reducers - Import



Part #	Mfg #	Size	Price
BRSCPLG12-14	X112-0804	1/2" x 1/4"	6.76
BRSCPLG12-38	X112-0806	1/2" x 3/8"	6.76
BRSCPLG34-14	X112-1204	3/4" x 1/4"	11.18
BRSCPLG34-38	X112-1206	3/4" x 3/8"	10.06
BRSCPLG34-12	X112-1208	3/4" x 1/2"	10.06
BRSCPLG1-12	X112-1608	1" x 1/2"	16.73
BRSCPLG1-34	X112-1612	1" x 3/4"	16.73
BRSCPLG114-34	X112-2012	1-1/4" x 3/4"	27.00
BRSCPLG114-1	X112-2016	1-1/4" x 1"	27.00
BRSCPLG112-34	X112-2412	1-1/2" x 3/4"	38.42
BRSCPLG112-1	X112-2416	1-1/2" x 1"	34.12
BRSCPLG112-114	X112-2420	1-1/2" x 1-1/4"	34.12
BRSCPLG2-34	X112-3212	2" x 3/4"	57.14
BRSCPLG2-1	X112-3216	2" x 1"	57.14
BRSCPLG2-114	X112-3220	2" x 1-1/4"	50.71
BRSCPLG2-112	X112-3224	2" x 1-1/2"	50.71

Threaded Brass 45° Elbows - Import



Part #	Mfg #	Size	Price
BRS4514	X102-04	1/4"	5.53
BRS4538	X102-06	3/8"	5.53
BRS4512	X102-08	1/2"	7.03
BRS4534	X102-12	3/4"	10.35
BRS451	X102-16	1"	17.46

Threaded Brass 90° Elbows - Import



Part #	Mfg #	Size	Price
BRS9018	X101-02	1/8"	5.05

**Import Threaded Brass Fittings
(Continued)**

Threaded Brass 90° Elbows - Import

Part #	Mfg #	Size	Price
BRS9014	X101-04	1/4"	5.05
BRS9038	X101-06	3/8"	5.05
BRS9012	X101-08	1/2"	7.68
BRS9034	X101-12	3/4"	10.35
BRS901	X101-16	1"	15.96
BRS90114	X101-20	1-1/4"	25.38
BRS90112	X101-24	1-1/2"	31.69
BRS902	X101-32	2"	51.58

Threaded Brass 90° Reducing Elbows - Import

Part #	Mfg #	Size	Price
BRS9034-12	X101-1208	3/4" x 1/2"	11.32
BRS901-34	X101-1612	1" x 3/4"	19.87

Threaded Brass 90° Street Elbows - Import



Part #	Mfg #	Size	Price
BRSS9018	X103-02	1/8"	7.68
BRSS9014	X103-04	1/4"	7.68
BRSS9038	X103-06	3/8"	7.68
BRSS9012	X103-08	1/2"	9.55
BRSS9034	X103-12	3/4"	13.47
BRSS901	X103-16	1"	22.29
BRSS90114	X103-20	1-1/4"	34.12
BRSS90112	X103-24	1-1/2"	44.45
BRSS902	X103-32	2"	75.37

Threaded Brass Plugs - Cored Square Head Import



Part #	Mfg #	Size	Price
BRSPUG18	X117-02	1/8"	2.15
BRSPUG14	X117-04	1/4"	2.85
BRSPUG38	X117-06	3/8"	4.40
BRSPUG12	X117-08	1/2"	5.29
BRSPUG34	X117-12	3/4"	6.05
BRSPUG1	X117-16	1"	7.98
BRSPUG114	X117-20	1-1/4"	11.88
BRSPUG112	X117-24	1-1/2"	15.14
BRSPUG2	X117-32	2"	23.88

Brass Pipe & Fittings

Prices & Specifications are Subject to Change.

Threaded Brass Fittings

Threaded Brass Tee - Import



Part #	Mfg #	Size	Price
BRST14	X106-04	1/4"	7.03
BRST38	X106-06	3/8"	7.03
BRST12	X106-08	1/2"	8.84
BRST34	X106-12	3/4"	12.72
BRST1	X106-16	1"	22.59
BRST114	X106-20	1-1/4"	31.69
BRST112	X106-24	1-1/2"	43.59
BRST2	X106-32	2"	71.43

Threaded Brass Reducing Tee - Import

Part #	Mfg #	Size	Price
BRST34-12-12	X106-120808	3/4" x 1/2" x 1/2"	16.74
BRST34-12	X106-121208	3/4" x 3/4" x 1/2"	15.24
BRST1-12	X106-161608	1" x 1" x 1/2"	27.83
BRST1-34	X106-161612	1" x 1" x 3/4"	27.83
BRST114-34	X106-202012	1-1/4" x 1-1/4" x 3/4"	39.20
BRST2-1	X106-323216	2" x 2" x 1"	88.23

Threaded Brass Union - Import



Part #	Mfg #	Size	Price
BRSUN18	X187-02	1/8"	17.92
BRSUN14	X187-04	1/4"	17.92
BRSUN38	X187-06	3/8"	17.92
BRSUN12	X187-08	1/2"	19.48
BRSUN34	X187-12	3/4"	27.00
BRSUN1	X187-16	1"	35.77
BRSUN114	X187-20	1-1/4"	52.38
BRSUN112	X187-24	1-1/2"	61.83
BRSUN2	X187-32	2"	95.17

Chrome Plated Pipe Nipples (Continued)

Part #	Mfg #	Size	Price
CHPN38-412	N38-412	3/8" x 4-1/2"	19.19
CHPN38-5	N38-5	3/8" x 5"	21.04
CHPN38-512	N38-512	3/8" x 5-1/2"	22.87
CHPN38-6	N38-6	3/8" x 6"	24.74
CHPN12-CL	N12-CL	1/2" x Close	9.82
CHPN12-112	N12-112	1/2" x 1-1/2"	27.34
CHPN12-2	N12-2	1/2" x 2"	13.35
CHPN12-212	N12-212	1/2" x 2-1/2"	15.88
CHPN12-3	N12-3	1/2" x 3"	18.64
CHPN12-312	N12-312	1/2" x 3-1/2"	21.28
CHPN12-4	N12-4	1/2" x 4"	24.38
CHPN12-412	N12-412	1/2" x 4-1/2"	26.46
CHPN12-5	N12-5	1/2" x 5"	29.16
CHPN12-512	N12-512	1/2" x 5-1/2"	32.02
CHPN12-6	N12-6	1/2" x 6"	35.50

Chrome Plated Pipe Fittings

90° Elbows - Chrome Plated



Part #	Size	Price
CHP9038	3/8"	72.07
CHP9012	1/2"	72.07

Couplings - Chrome Plated



Part #	Size	Price
CHPCPLG38	3/8"	60.26
CHPCPLG12	1/2"	60.26

Cap - Chrome Plated

Part #	Size	Price
CHPCAP12	1/2"	47.90

Chrome Plated Pipe Nipples



Part #	Mfg #	Size	Price
CHPN38-CL	N38-CL	3/8" x Close	7.36
CHPN38-112	N38-112	3/8" x 1-1/2"	8.72
CHPN38-2	N38-2	3/8" x 2"	10.59
CHPN38-212	N38-212	3/8" x 2-1/2"	11.48
CHPN38-3	N38-3	3/8" x 3"	14.03
CHPN38-312	N38-312	3/8" x 3-1/2"	15.14
CHPN38-4	N38-4	3/8" x 4"	18.02

Brass Pipe & Fittings

All Items May Not Be Stocked In All Branches

Brass Flare Fittings

Brass Flare Fittings

Brass Flare Plug



Part #	Mfg #	Size	Price
BRAFLPLUG38	39-6	3/8" OD	2.33

Brass Flare Cap



Part #	Mfg #	Size	Price
BRAFLCAP38	40-6	3/8" OD	1.90
BRAFLCAP12	40-8	1/2" OD	2.74

Brass Flare Nut - Short



Part #	Mfg #	Size	Price
BRAFLNUT14	41S-4	1/4" OD	1.36
BRAFLNUT38	41S-6	3/8" OD	2.00
BRAFLNUT12	41S-8	1/2" OD	2.99
BRAFLNUT58	41S-10	5/8" OD	4.34

Brass Forged Refrigeration Nut - Short



Part #	Mfg #	Size	Price
BRAFRNUT14	141S-4	1/4" OD	2.85
BRAFRNUT38	141S-6	3/8" OD	3.66
BRAFRNUT12	141S-8	1/2" OD	4.51
BRAFRNUT58	141S-10	5/8" OD	6.30

Brass Flare Union



Part #	Mfg #	Size	Price
BRAFLUN14	42-4	1/4" OD	1.11
BRAFLUN38	42-6	3/8" OD	3.11
BRAFLUN12	42-8	1/2" OD	4.62
BRAFLUN58	42-10	5/8" OD	4.45

Brass Flare Reducing Union



Part #	Mfg #	Size	Price
BRAFLUN12-38	42-8-6	1/2" OD x 3/8" OD	3.04

Brass Flare Female Adapter



Part #	Mfg #	Size	Price
BRAFLFEA38	46-6-6	3/8" OD Tube x 3/8" FIP	3.83
BRAFLFEA12	46-8-8	1/2" OD Tube x 1/2" FIP	5.35

Brass Flare Female Reducing Adapter



Part #	Mfg #	Size	Price
BRAFLFEA38-14	46-6-4	3/8" OD Tube x 1/4" FIP	1.74
BRAFLFEA38-12	46-6-8	3/8" OD Tube x 1/2" FIP	4.90
BRAFLFEA58-34	46-10-12	5/8" OD Tube x 3/4" FIP	4.76

Brass Flare Male Adapter



Part #	Mfg #	Size	Price
BRAFLMA14	48-4-4	1/4" OD Tube x 1/4" MIP	2.19
BRAFLMA38	48-6-6	3/8" OD Tube x 3/8" MIP	3.08
BRAFLMA12	48-8-8	1/2" OD Tube x 1/2" MIP	4.77

Brass Flare Male Reducing Adapter



Part #	Mfg #	Size	Price
BRAFLMA14-38	48-4-6	1/4" OD Tube x 3/8" MIP	2.25
BRAFLMA38-14	48-6-4	3/8" OD Tube x 1/4" MIP	2.70
BRAFLMA38-12	48-6-8	3/8" OD Tube x 1/2" MIP	4.75
BRAFLMA12-14	48-8-4	1/2" OD Tube x 1/4" MIP	2.77
BRAFLMA12-38	48-8-6	1/2" OD Tube x 3/8" MIP	4.36
BRAFLMA58-12	48-10-8	5/8" OD Tube x 1/2" MIP	5.78
BRAFLMA58-34	48-10-12	5/8" OD Tube x 3/4" MIP	9.02

Brass Pipe & Fittings

Prices & Specifications are Subject to Change.

Brass Flare Fittings

Brass Forged Flare Male Elbow Adapter

- Extruded flare elbows, tees and crosses are available

Part #	Mfg #	Size	Price
BRAFLM9014	149-4-4	1/4" OD x 1/4" MIP	4.23
BRAFLM9038	149-6-6	3/8" OD x 3/8" MIP	5.27
BRAFLM9012	149-8-8	1/2" OD x 1/2" MIP	7.24

Brass Forged Flare Male Reducing Elbow Adapter

- Extruded flare elbows, tees and crosses are available

Part #	Mfg #	Size	Price
BRAFLM9038-14	149-6-4	3/8" OD x 1/4" MIP	4.41
BRAFLM9012-14	149-8-4	1/2" OD x 1/4" MIP	7.03
BRAFLM9012-38	149-8-6	1/2" OD x 3/8" MIP	6.87

Brass Flare Elbow Union



Part #	Mfg #	Size	Price
BRAFL9038	55-6	3/8" OD	3.90
BRAFL9012	55-8	1/2" OD	5.01

Brass Flare Tee Union



Part #	Mfg #	Size	Price
BRAFLT38	44-6	3/8" OD	9.19
BRAFLT12	44-8	1/2" OD	12.40

Brass Forged Flare Tee Union

Part #	Mfg #	Size	Price
BRAFFLT38	144-6	3/8" OD	6.05
BRAFFLT12	144-8	1/2" OD	9.26

Plastic Compression Sleeves



Part #	Mfg #	Size	Price
BRAPFER38	60PT-6	3/8" OD	0.48

Brass Compression Fittings

Brass Plug (Comp)



Part #	Mfg #	Description	Price
BRAPLUG38	CSP-6	For 3/8" OD Tube	2.05

Brass Sleeve (Comp)



Part #	Mfg #	Size	Price
BRAFER14	60-4	1/4" OD	0.24
BRAFER38	60-6	3/8" OD	0.31
BRAFER12	60-8	1/2" OD	0.62
BRAFER58	60-10	5/8" OD	0.89

Brass Nut (Comp)



Part #	Mfg #	Size	Finish	Price
BRACNUTRB14	61-4	1/4" OD		0.75
BRACNUTRB38	61-6	3/8" OD		1.08
BRACNUTCP38	61-6-C	3/8" OD	CP	1.37
BRACNUTRB12	61-8	1/2" OD		2.06
BRACNUTRB58	61-10	5/8" OD		1.97

Brass Cap (Comp)

Part #	Mfg #	Size	Price
BRACCAP38	61CP-6	3/8" OD	1.29

Brass Union (Comp) - Drill Through



Part #	Mfg #	Size	Price
BRACUN14	62-4	1/4" OD	3.64
BRACUN38	62-6	3/8" OD	4.72
BRACUN12	62-8	1/2" OD	7.42
BRACUN58	62-10	5/8" OD	9.70
BRACUN78	62-14	7/8" OD	23.79

Brass Pipe & Fittings

Brass Flare Fittings

Brass Reducing Union (Comp)



Part #	Mfg #	Size	Price
BRACUN38-14	62-6-4	3/8" x 1/4" OD	5.13
BRACUN12-38	62-8-6	1/2" x 3/8" OD	7.46
BRACUN58-38	62-10-6	5/8" x 3/8" OD	8.90

Brass Union (FIP x Comp) - Drill Through



Part #	Mfg #	Size	Finish	Price
BRA10CP	10 C	3/8" x 3/8"	CP	4.81
BRA12CP	12 C	1/2" x 3/8"	CP	5.57

Brass Union (MIP x Comp) - Drill Through



Part #	Mfg #	Size	Finish	Price
BRA13CP	13C	1/2" x 3/8"	CP	6.11

Brass Union (Swt x Comp)



Part #	Mfg #	Size	Finish	Price
BRA14CP	14C	1/2" x 3/8"	CP	5.20
BRA14RB	14R	1/2" x 3/8"	RB	3.63

Brass Female Reducing Adapter (Comp)



Part #	Mfg #	Size	Price
BRACFEA38-12	66-6-8	3/8" OD x 1/2" FIP	5.29
BRACFEA58-12	66-10-8	5/8" OD x 1/2" FIP	8.70
BRACFEA58-34	66-10-12	5/8" OD x 3/4" FIP	7.35
BRACFEA78-34	66-14-12	7/8" OD x 3/4" FIP	11.77

Brass Male Adapter (Comp)



Part #	Mfg #	Size	Price
BRACMA14	68-4-4	1/4" OD x 1/4" MIP	3.13
BRACMA38	68-6-6	3/8" OD x 3/8" MIP	4.24
BRACMA12	68-8-8	1/2" OD x 1/2" MIP	6.24

Brass Male Reducing Adapter (Comp)



Part #	Mfg #	Size	Price
BRACMA14-18	68-4-2	1/4" OD x 1/8" MIP	2.52
BRACMA14-38	68-4-6	1/4" OD x 3/8" MIP	4.55
BRACMA14-12	68-4-8	1/4" OD x 1/2" MIP	7.43
BRACMA38-18	68-6-2	3/8" OD x 1/8" MIP	2.20
BRACMA38-14	68-6-4	3/8" OD x 1/4" MIP	3.48
BRACMA38-12	68-6-8	3/8" OD x 1/2" MIP	5.25
BRACMA12-38	68-8-6	1/2" OD x 3/8" MIP	5.58
BRACMA58-12	68-10-8	5/8" OD x 1/2" MIP	7.17
BRACMA78-34	68-14-12	7/8" OD x 3/4" MIP	14.63

Brass Elbow (Comp)



Part #	Mfg #	Size	Price
BRAC9014	65-4	1/4" OD	2.90
BRAC9038	65-6	3/8" OD	8.71

Brass Male Elbow (Comp x MIP)



Part #	Mfg #	Size	Price
BRACM9014	69-4-4	1/4" OD x 1/4" MIP	7.96
BRACM9038	69-6-6	3/8" OD x 3/8" MIP	7.89

Brass Male Reducing Elbow (Comp x MIP)

Part #	Mfg #	Size	Price
BRACM9038-12	69-6-8	3/8" OD x 1/2" MIP	10.48

Brass Pipe & Fittings

Prices & Specifications are Subject to Change.

Brass Flare Fittings

Brass Female Reducing Elbow (Comp x FIP)

Part #	Mfg #	Size	Finish	Price
BRACFE9038-12	70-6-8	3/8" OD x 1/2" FIP		7.25
BRA17CP	70-6-8C	3/8" OD x 1/2" FIP CP		8.57

Brass Elbow (Swt x Comp)

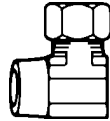

Part #	Mfg #	Size	Finish	Price
BRA19CP	19C	1/2" x 3/8"	CP	9.31

Brass Tee (Comp)



Part #	Mfg #	Size	Price
BRACT14	64-4	1/4" OD	8.43
BRACT38	64-6	3/8" OD	11.56
BRACT58	64-10	5/8" OD	25.09

Gas Appliance Connector Fittings

Brass - For 5/8" OD Tube (15/16"-16 Thread)

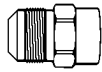

MAU1

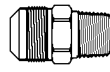

MAU2

Part #	Mfg #	Description	Price
BRAMAU1108	MAU1108	Fem Union 5/8" x 1/2"	3.72
BRAMAU11012	MAU11012	Fem Union 5/8" x 3/4"	4.82
BRAMAU2108	MAU2108	Male Union 5/8" x 1/2"	3.89



Better Service Thru Better People



Brass Pipe & Fittings

Copper Pipe

Type K Copper - Green



Coils

Type K Soft Green - 40' Coils

Part#	Size	Price
COPCK2-40	2" x 40'	CALL

Type K Soft Green - 45' Coils

Part#	Size	Price
COPCK34-45	3/4" x 45'	CALL

Type K Soft Green - 60' Coils

Part#	Size	Price
COPCK12-60	1/2" x 60'	CALL
COPCK34-60	3/4" x 60'	CALL
COPCK1-60	1" x 60'	CALL
COPCK114-60	1-1/4" x 60'	CALL
COPCK112-60	1-1/2" x 60'	CALL
COPCK2-60	2" x 60'	CALL

Type K Soft Green - 100' Coils

Part#	Size	Price
COPCK12-100	1/2" x 100'	CALL
COPCK34-100	3/4" x 100'	CALL
COPCK1-100	1" x 100'	CALL

Type L Copper - Blue



Coils

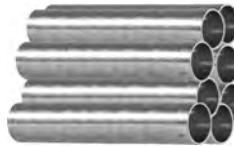

Lengths

Type L Soft Blue - 60' Coils

Part#	Size	Price
COPCL14-60	1/4" x 60'	CALL
COPCL38-60	3/8" x 60'	CALL
COPCL12-60	1/2" x 60'	CALL
COPCL34-60	3/4" x 60'	CALL
COPCL1-60	1" x 60'	CALL

Type L Soft Blue - 100' Coils

Part#	Size	Price
COPCL34-100	3/4" x 100'	CALL
COPCL1-100	1" x 100'	CALL

Type L Hard Blue - 20' Lengths

Part#	Size	Price
COPPL12-20	1/2" x 20'	CALL
COPPL34-20	3/4" x 20'	CALL
COPPL1-20	1" x 20'	CALL
COPPL114-20	1-1/4" x 20'	CALL
COPPL112-20	1-1/2" x 20'	CALL
COPPL2-20	2" x 20'	CALL
COPPL212-20	2-1/2" x 20'	CALL
COPPL3-20	3" x 20'	CALL
COPPL4-20	4" x 20'	CALL

Type L Hard Blue - 10' Lengths

Part#	Size	Price
COPPL12-10	1/2" x 10'	CALL
COPPL34-10	3/4" x 10'	CALL
COPPL1-10	1" x 10'	CALL

Type M Copper - Red

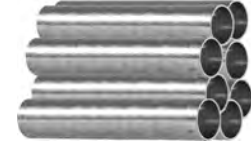

Type M Hard Red - 20' Lengths

Part#	Size	Price
COPPM12-20	1/2" x 20'	CALL
COPPM34-20	3/4" x 20'	CALL
COPPM1-20	1" x 20'	CALL
COPPM114-20	1-1/4" x 20'	CALL
COPPM112-20	1-1/2" x 20'	CALL
COPPM2-20	2" x 20'	CALL
COPPM212-20	2-1/2" x 20'	CALL
COPPM3-20	3" x 20'	CALL

Type M Hard Red - 10' Lengths

Part#	Size	Price
COPPM12-10	1/2" x 10'	CALL
COPPM34-10	3/4" x 10'	CALL
COPPM1-10	1" x 10'	CALL
COPPM114-10	1-1/4" x 10'	CALL
COPPM112-10	1-1/2" x 10'	CALL
COPPM2-10	2" x 10'	CALL

Coated Copper Tubing

Coated Copper Tubing

Gas-Tec® Coated Type L-G/Gas Copper Gas Tubing

- Flexible yellow polyethylene-coated tubing
- Continuously line-marked for clear identification
- Coating provides added corrosion protection
- Used above & below ground



Part #	Mfg #	Nom Size	OD	Length	Price
CCTG38-60	21460	1/4"	3/8"	60'	CALL
CCTG38-100	21410	1/4"	3/8"	100'	CALL
CCTG12-60	23860	3/8"	1/2"	60'	CALL
CCTG12-100	23810	3/8"	1/2"	100'	CALL
CCTG58-60	21260	1/2"	5/8"	60'	CALL
CCTG58-100	21210	1/2"	5/8"	100'	CALL

Oil Pro-Tec™ Coated Copper Oil Tubing

- Flexible orange polyethylene-coated tubing for fuel oil
- Grooves between coating and copper assist with leak detection should a line failure occur
- Continuously line-marked for clear identification
- Coating provides added corrosion protection



Part #	Mfg #	OD	Length	Price
CCTO38-50	30385	3/8"	50'	CALL
CCTO38-100	30381	3/8"	100'	CALL
CCTO38-250	30380	3/8"	250'	CALL
CCTO12-50	30125	1/2"	50'	CALL
CCTO12-100	30121	1/2"	100'	CALL

Copper Wrot Fittings

**Copper Wrot Pressure Fittings
Adapters (C x FIP)**



Part #	Nom Size	OD Size	Price
COPFEA38	3/8"	1/2" OD x 3/8"	CALL
COPFEA12	1/2"	5/8" OD x 1/2"	CALL
COPFEA12-14	1/2" x 1/4"	5/8" OD x 1/4"	CALL
COPFEA12-38	1/2" x 3/8"	5/8" OD x 3/8"	CALL
COPFEA12-34	1/2" x 3/4"	5/8" OD x 3/4"	CALL
COPFEA12-1	1/2" x 1"	5/8" OD x 1"	CALL
COPFEA34	3/4"	7/8" OD x 3/4"	CALL
COPFEA34-12	3/4" x 1/2"	7/8" OD x 1/2"	CALL
COPFEA34-1	3/4" x 1"	7/8" OD x 1"	CALL
COPFEA34-114	3/4" x 1-1/4"	7/8" OD x 1-1/4"	CALL
COPFEA1	1"	1-1/8" OD x 1"	CALL
COPFEA1-12	1" x 1/2"	1-1/8" OD x 1/2"	CALL
COPFEA1-34	1" x 3/4"	1-1/8" OD x 3/4"	CALL
COPFEA1-114	1" x 1-1/4"	1-1/8" OD x 1-1/4"	CALL
COPFEA1-112	1" x 1-1/2"	1-1/8" OD x 1-1/2"	CALL
COPFEA114	1-1/4"	1-3/8" OD x 1-1/4"	CALL
COPFEA114-34	1-1/4" x 3/4"	1-3/8" OD x 3/4"	CALL
COPFEA114-1	1-1/4" x 1"	1-3/8" OD x 1"	CALL
COPFEA114-112	1-1/4" x 1-1/2"	1-3/8" OD x 1-1/2"	CALL
COPFEA112	1-1/2"	1-5/8" OD x 1-1/2"	CALL
COPFEA112-114	1-1/2" x 1-1/4"	1-5/8" OD x 1-1/4"	CALL
COPFEA112-2	1-1/2" x 2"	1-5/8" OD x 2"	CALL
COPFEA2	2"	2-1/8" OD x 2"	CALL
COPFEA212	2-1/2"	2-5/8" OD x 2-1/2"	CALL
COPFEA3	3"	3-1/8" OD x 3"	CALL

Adapters (FTG x FIP)



Part #	Nom Size	OD Size	Price
COPFFEA12	1/2"	5/8" OD x 1/2"	CALL
COPFFEA34	3/4"	7/8" OD x 3/4"	CALL
COPFFEA1	1"	1-1/8" OD x 1"	CALL
COPFFEA114	1-1/4"	1-3/8" OD x 1-1/4"	CALL
COPFFEA112	1-1/2"	1-5/8" OD x 1-1/2"	CALL
COPFFEA2	2"	2-1/8" OD x 2"	CALL

Adapters (C x MIP)



Part #	Nom Size	OD Size	Price
COPMA38	3/8"	1/2" OD x 3/8"	CALL

**Copper Wrot Pressure Fittings
(Continued)**

Adapters (C x MIP)

Part #	Nom Size	OD Size	Price
COPMA38-12	3/8" x 1/2"	1/2" OD x 1/2"	CALL
COPMA12	1/2"	5/8" OD x 1/2"	CALL
COPMA12-14	1/2" x 1/4"	5/8" OD x 1/4"	CALL
COPMA12-38	1/2" x 3/8"	5/8" OD x 3/8"	CALL
COPMA12-34	1/2" x 3/4"	5/8" OD x 3/4"	CALL
COPMA34	3/4"	7/8" OD x 3/4"	CALL
COPMA34-12	3/4" x 1/2"	7/8" OD x 1/2"	CALL
COPMA34-1	3/4" x 1"	7/8" OD x 1"	CALL
COPMA34-114	3/4" x 1-1/4"	7/8" OD x 1-1/4"	CALL
COPMA1	1"	1-1/8" OD x 1"	CALL
COPMA1-12	1" x 1/2"	1-1/8" OD x 1/2"	CALL
COPMA1-34	1" x 3/4"	1-1/8" OD x 3/4"	CALL
COPMA1-114	1" x 1-1/4"	1-1/8" OD x 1-1/4"	CALL
COPMA1-112	1" x 1-1/2"	1-1/8" OD x 1-1/2"	CALL
COPMA114	1-1/4"	1-3/8" OD x 1-1/4"	CALL
COPMA114-34	1-1/4" x 3/4"	1-3/8" OD x 3/4"	CALL
COPMA114-1	1-1/4" x 1"	1-3/8" OD x 1"	CALL
COPMA114-112	1-1/4" x 1-1/2"	1-3/8" OD x 1-1/2"	CALL
COPMA112	1-1/2"	1-5/8" OD x 1-1/2"	CALL
COPMA112-1	1-1/2" x 1"	1-5/8" OD x 1"	CALL
COPMA112-114	1-1/2" x 1-1/4"	1-5/8" OD x 1-1/4"	CALL
COPMA112-2	1-1/2" x 2"	1-5/8" OD x 2"	CALL
COPMA2	2"	2-1/8" OD x 2"	CALL
COPMA2-112	2" x 1-1/2"	2-1/8" OD x 1-1/2"	CALL
COPMA212	2-1/2"	2-5/8" OD x 2-1/2"	CALL
COPMA3	3"	3-1/8" OD x 3"	CALL

Adapters (FTG x MIP)



Part #	Nom Size	OD Size	Price
COPFMA12	1/2"	5/8" OD x 1/2"	CALL
COPFMA34	3/4"	7/8" OD x 3/4"	CALL
COPFMA1	1"	1-1/8" OD x 1"	CALL
COPFMA114	1-1/4"	1-3/8" OD x 1-1/4"	CALL
COPFMA112	1-1/2"	1-3/8" OD x 1-1/2"	CALL
COPFMA2	2"	2-1/8" OD x 2"	CALL

Prices & Specifications are Subject to Change.

Copper Wrot Fittings

Flush Bushings (FTG x C)



Part #	Nom Size	OD Size	Price
COPBU34-12	3/4" x 1/2"	7/8" x 5/8"	CALL
COPBU1-34	1" x 3/4"	1-1/8" x 7/8"	CALL
COPBU114-1	1-1/4" x 1"	1-3/8" x 1-1/8"	CALL

Flush Bushing (FTG x FIP)



Part #	Nom Size	OD Size	Price
COPFEBU12-18	1/2" x 1/8"	5/8" OD x 1/8"	CALL
COPFEBU12-14	1/2" x 1/4"	5/8" OD x 1/4"	CALL

Tube Cap (C)



Part #	Nom Size	OD Size	Price
COPCAP38	3/8"	1/2" OD	CALL
COPCAP12	1/2"	5/8" OD	CALL
COPCAP34	3/4"	7/8" OD	CALL
COPCAP1	1"	1-1/8" OD	CALL
COPCAP114	1-1/4"	1-3/8" OD	CALL
COPCAP112	1-1/2"	1-5/8" OD	CALL
COPCAP2	2"	2-1/8" OD	CALL
COPCAP212	2-1/2"	2-5/8" OD	CALL
COPCAP3	3"	3-1/8" OD	CALL
COPCAP4	4"	4-1/8" OD	CALL

Couplings - Rolled Stops (C x C)



Part #	Nom Size	OD Size	Price
COPCPLG14	1/4"	3/8" OD	CALL
COPCPLG38	3/8"	1/2" OD	CALL
COPCPLG12	1/2"	5/8" OD	CALL
COPCPLG34	3/4"	7/8" OD	CALL
COPCPLG1	1"	1-1/8" OD	CALL
COPCPLG114	1-1/4"	1-3/8" OD	CALL
COPCPLG112	1-1/2"	1-5/8" OD	CALL
COPCPLG2	2"	2-1/8" OD	CALL
COPCPLG212	2-1/2"	2-5/8" OD	CALL
COPCPLG3	3"	3-1/8" OD	CALL
COPCPLG4	4"	4-1/8" OD	CALL

Coupling - Less Stops (C x C)



Part #	Nom Size	OD Size	Price
COPSLCPLG12	1/2"	5/8" OD	CALL
COPSLCPLG34	3/4"	7/8" OD	CALL
COPSLCPLG1	1"	1-1/8" OD	CALL
COPSLCPLG114	1-1/4"	1-3/8" OD	CALL
COPSLCPLG112	1-1/2"	1-5/8" OD	CALL
COPSLCPLG2	2"	2-1/8" OD	CALL
COPSLCPLG212	2-1/2"	2-5/8" OD	CALL
COPSLCPLG3	3"	3-1/8" OD	CALL

Reducing Coupling (C x C)



Part #	Nom Size	OD Size	Price
COPCPLG38-14	3/8" x 1/4"	1/2" x 3/8"	CALL
COPCPLG12-14	1/2" x 1/4"	5/8" x 3/8"	CALL
COPCPLG12-38	1/2" x 3/8"	5/8" x 1/2"	CALL
COPCPLG34-38	3/4" x 3/8"	7/8" x 1/2"	CALL
COPCPLG34-12	3/4" x 1/2"	7/8" x 5/8"	CALL
COPCPLG1-12	1" x 1/2"	1-1/8" x 5/8"	CALL
COPCPLG1-34	1" x 3/4"	1-1/8" x 7/8"	CALL
COPCPLG114-12	1-1/4" x 1/2"	1-3/8" x 5/8"	CALL
COPCPLG114-34	1-1/4" x 3/4"	1-3/8" x 7/8"	CALL
COPCPLG114-1	1-1/4" x 1"	1-3/8" x 1-1/8"	CALL
COPCPLG112-12	1-1/2" x 1/2"	1-5/8" x 5/8"	CALL
COPCPLG112-34	1-1/2" x 3/4"	1-5/8" x 7/8"	CALL
COPCPLG112-1	1-1/2" x 1"	1-5/8" x 1-1/8"	CALL
COPCPLG112-114	1-1/2" x 1-1/4"	1-5/8" x 1-3/8"	CALL
COPCPLG2-12	2" x 1/2"	2-1/8" x 5/8"	CALL
COPCPLG2-34	2" x 3/4"	2-1/8" x 7/8"	CALL
COPCPLG2-1	2" x 1"	2-1/8" x 1-1/8"	CALL
COPCPLG2-114	2" x 1-1/4"	2-1/8" x 1-3/8"	CALL
COPCPLG2-112	2" x 1-1/2"	2-1/8" x 1-5/8"	CALL
COPCPLG212-112	2-1/2" x 1-1/2"	2-5/8" x 1-5/8"	CALL
COPCPLG212-2	2-1/2" x 2"	2-5/8" x 2-1/8"	CALL
COPCPLG3-112	3" x 1-1/2"	3-1/8" x 1-5/8"	CALL
COPCPLG3-2	3" x 2"	3-1/8" x 2-1/8"	CALL
COPCPLG3-212	3" x 2-1/2"	3-1/8" x 2-5/8"	CALL
COPCPLG4-2	4" x 2"	4-1/8" x 2-1/8"	CALL

Copper Wrot Fittings

45° Elbows (C x C)



Part #	Nom Size	OD Size	Price
COP4512	1/2"	5/8" OD	CALL
COP4534	3/4"	7/8" OD	CALL
COP451	1"	1-1/8" OD	CALL
COP45114	1-1/4"	1-3/8" OD	CALL
COP45112	1-1/2"	1-5/8" OD	CALL
COP452	2"	2-1/8" OD	CALL
COP45212	2-1/2"	2-5/8" OD	CALL
COP453	3"	3-1/8" OD	CALL

45° Elbows (FTG x C)



Part #	Nom Size	OD Size	Price
COPST4512	1/2"	5/8" OD	CALL
COPST4534	3/4"	7/8" OD	CALL
COPST451	1"	1-1/8" OD	CALL
COPST45114	1-1/4"	1-3/8" OD	CALL
COPST45112	1-1/2"	1-5/8" OD	CALL
COPST452	2"	2-1/8" OD	CALL
COPST45212	2-1/2"	2-5/8" OD	CALL
COPST453	3"	3-1/8" OD	CALL

90° Close Rough Elbows (C x C)



Part #	Nom Size	OD Size	Price
COP9014	1/4"	3/8" OD	CALL
COP9038	3/8"	1/2" OD	CALL
COP9012	1/2"	5/8" OD	CALL
COP9034	3/4"	7/8" OD	CALL
COP9034-12	3/4" x 1/2"	7/8" OD x 5/8" OD	CALL
COP901	1"	1-1/8" OD	CALL
COP901-12	1" x 1/2"	1-1/8" OD x 5/8" OD	CALL
COP901-34	1" x 3/4"	1-1/8" OD x 7/8" OD	CALL
COP90114	1-1/4"	1-3/8" OD	CALL
COP90114-34	1-1/4" x 3/4"	1-3/8" OD x 7/8" OD	CALL
COP90114-1	1-1/4" x 1"	1-3/8" OD x 1-1/8" OD	CALL
COP90112	1-1/2"	1-5/8" OD	CALL
COP902	2"	2-1/8" OD	CALL
COP90212	2-1/2"	2-5/8" OD	CALL

**Copper Wrot Pressure Fittings
(Continued)**

90° Close Rough Elbows (C x C)

Part #	Nom Size	OD Size	Price
COP903	3"	3-1/8" OD	CALL

90° Close Rough Elbows (FTG x C)



Part #	Nom Size	OD Size	Price
COPST9038	3/8"	1/2" OD	CALL
COPST9012	1/2"	5/8" OD	CALL
COPST9034	3/4"	7/8" OD	CALL
COPST901	1"	1-1/8" OD	CALL
COPST90114	1-1/4"	1-3/8" OD	CALL
COPST90112	1-1/2"	1-5/8" OD	CALL
COPST902	2"	2-1/8" OD	CALL
COPST90212	2-1/2"	2-5/8" OD	CALL
COPST903	3"	3-1/8" OD	CALL

Fitting Reducers (FTG x C)



Part #	Nom Size	OD Size	Price
COPFRCLPG12-14	1/2" x 1/4"	5/8" x 3/8"	CALL
COPFRCLPG12-38	1/2" x 3/8"	5/8" x 1/2"	CALL
COPFRCLPG34-38	3/4" x 3/8"	7/8" x 1/2"	CALL
COPFRCLPG34-12	3/4" x 1/2"	7/8" x 5/8"	CALL
COPFRCLPG1-12	1" x 1/2"	1-1/8" x 5/8"	CALL
COPFRCLPG1-34	1" x 3/4"	1-1/8" x 7/8"	CALL
COPFRCLPG114-12	1-1/4" x 1/2"	1-3/8" x 5/8"	CALL
COPFRCLPG114-34	1-1/4" x 3/4"	1-3/8" x 7/8"	CALL
COPFRCLPG114-1	1-1/4" x 1"	1-3/8" x 1-1/8"	CALL
COPFRCLPG112-12	1-1/2" x 1/2"	1-5/8" x 5/8"	CALL
COPFRCLPG112-34	1-1/2" x 3/4"	1-5/8" x 7/8"	CALL
COPFRCLPG112-1	1-1/2" x 1"	1-5/8" x 1-1/8"	CALL
COPFRCLPG112-114	1-1/2" x 1-1/4"	1-5/8" x 1-3/8"	CALL
COPFRCLPG2-12	2" x 1/2"	2-1/8" x 5/8"	CALL
COPFRCLPG2-34	2" x 3/4"	2-1/8" x 7/8"	CALL
COPFRCLPG2-1	2" x 1"	2-1/8" x 1-1/8"	CALL
COPFRCLPG2-114	2" x 1-1/4"	2-1/8" x 1-3/8"	CALL
COPFRCLPG2-112	2" x 1-1/2"	2-1/8" x 1-5/8"	CALL
COPFRCLPG212-1	2-1/2" x 1"	2-5/8" x 1-1/8"	CALL

Prices & Specifications are Subject to Change.

Copper Wrot Fittings

**Copper Wrot Pressure Fittings
(Continued)**

Fitting Reducers (FTG x C)

Part #	Nom Size	OD Size	Price
COPFRCPGL212-112	2-1/2" x 1-1/2"	2-5/8" x 1-5/8"	CALL
COPFRCPGL212-2	2-1/2" x 2"	2-5/8" x 2-1/8"	CALL
COPFRCPGL3-112	3" x 1-1/2"	3-1/8" x 1-5/8"	CALL
COPFRCPGL3-2	3" x 2"	3-1/8" x 2-1/8"	CALL

Tee (C x C x C)



Part #	Nom Size	OD Size	Price
COPT14	1/4"	3/8" OD	CALL
COPT38	3/8"	1/2" OD	CALL
COPT12	1/2"	5/8" OD	CALL
COPT12-12-34	1/2" x 3/4"	5/8" x 7/8"	CALL
COPT34	3/4"	7/8" OD	CALL
COPT34-12-12	3/4"x1/2"x1/2"	7/8"x5/8"x5/8"	CALL
COPT34-12-34	3/4"x1/2"x3/4"	7/8"x5/8"x7/8"	CALL
COPT34-34-12	3/4" x 1/2"	7/8" x 5/8"	CALL
COPT34-34-1	3/4" x 1"	7/8" x 1-1/8"	CALL
COPT1	1"	1-1/8" OD	CALL
COPT1-12-12	1"x1/2"x1/2"	1-1/8"x5/8"x5/8"	CALL
COPT1-12-1	1" x 1/2"x1"	1-1/8"x5/8"x1-1/8"	CALL
COPT1-34-12	1"x3/4"x1/2"	1-1/8"x7/8"x5/8"	CALL
COPT1-34-34	1"x3/4"x3/4"	1-1/8"x7/8"x7/8"	CALL
COPT1-34-1	1"x3/4"x1"	1-1/8"x7/8"x1-1/8"	CALL
COPT1-1-12	1" x 1/2"	1-1/8" x 5/8"	CALL
COPT1-1-34	1" x 3/4"	1-1/8" x 7/8"	CALL
COPT1-1-114	1" x 1-1/4"	1-1/8" x 1-3/8"	CALL
COPT1-1-112	1" x 1-1/2"	1-1/8" x 1-5/8"	CALL
COPT114	1-1/4"	1-3/8" OD	CALL
COPT114-12-114	1-1/4"x1/2"x1-1/4"	1-3/8"x5/8"x1-3/8"	CALL
COPT114-34-34	1-1/4"x3/4"x3/4"	1-3/8"x7/8"x7/8"	CALL
COPT114-34-1	1-1/4"x3/4"x1"	1-3/8"x7/8"x1-1/8"	CALL
COPT114-34-114	1-1/4"x3/4"x1-1/4"	1-3/8"x7/8"x1-3/8"	CALL
COPT114-1-12	1-1/4"x1"x1/2"	1-3/8"x1-1/8"x5/8"	CALL
COPT114-1-34	1-1/4"x1"x3/4"	1-3/8"x1-1/8"x7/8"	CALL
COPT114-1-1	1-1/4"x1"x1"	1-3/8"x1-1/8"x1-1/8"	CALL
COPT114-1-114	1-1/4"x1"x1-1/4"	1-3/8"x1-1/8"x1-3/8"	CALL
COPT114-114-12	1-1/4" x 1/2"	1-3/8" x 5/8"	CALL
COPT114-114-34	1-1/4" x 3/4"	1-3/8" x 7/8"	CALL
COPT114-114-1	1-1/4" x 1"	1-3/8" x 1-1/8"	CALL
COPT112	1-1/2"	1-5/8" OD	CALL
COPT112-12-112	1-1/2" x 1/2" x 1-1/2"		CALL

**Copper Wrot Pressure Fittings
(Continued)**

Tee (C x C x C)

Part #	Nom Size	OD Size	Price
COPT112-34-34	1-1/2" x 3/4" x 1/2"		CALL
COPT112-34-1	1-1/2" x 3/4" x 1"		CALL
COPT112-34-112	1-1/2" x 3/4" x 1-1/2"		CALL
COPT112-1-34	1-1/2"x1"x3/4"	1-5/8"x1-1/8"x7/8"	CALL
COPT112-1-1	1-1/2"x1"x1"	1-5/8"x1-1/8"x1-1/8"	CALL
COPT112-1-112	1-1/2"x1"x1-1/2"	1-5/8"x1-1/8"x1-5/8"	CALL
COPT112-114-34	1-1/2"x1-1/4"x3/4"	1-5/8"x1-3/8"x7/8"	CALL
COPT112-114-1	1-1/2"x1-1/4"x1"	1-5/8"x1-3/8"x1-1/8"	CALL
COPT112-114-114	1-1/2x1-1/4x1-1/4	1-5/8x1-3/8x1-3/8	CALL
COPT112-112-12	1-1/2" x 1/2"	1-5/8" x 5/8"	CALL
COPT112-112-34	1-1/2" x 3/4"	1-5/8" x 7/8"	CALL
COPT112-112-1	1-1/2" x 1"	1-5/8" x 1-1/8"	CALL
COPT112-112-114	1-1/2" x 1-1/4"	1-5/8" x 1-3/8"	CALL
COPT112-112-2	1-1/2" x 2"	1-5/8" x 2-1/8"	CALL
COPT2	2"	2-1/8" OD	CALL
COPT2-34-2	2" x 3/4" x 2"		CALL
COPT2-1-2	2"x1"x2"	2-1/8"x1-1/8"x2-1/8"	CALL
COPT2-112-1	2" x 1-1/2" x 1"		CALL
COPT2-112-114	2"x1-1/2"x1-1/4"	2-1/8"x1-5/8"x1-3/8"	CALL
COPT2-112-112	2"x1-1/2"x1-1/2"	2-1/8"x1-5/8"x1-5/8"	CALL
COPT2-112-2	2"x1-1/2"x 2"	2-1/8"x1-5/8"x2-1/8"	CALL
COPT2-2-12	2" x 1/2"	2-1/8" x 5/8"	CALL
COPT2-2-34	2" x 3/4"	2-1/8" x 7/8"	CALL
COPT2-2-1	2" x 1"	2-1/8" x 1-1/8"	CALL
COPT2-2-114	2" x 1-1/4"	2-1/8" x 1-3/8"	CALL
COPT2-2-112	2" x 1-1/2"	2-1/8" x 1-5/8"	CALL
COPT212	2-1/2"	2-5/8" OD	CALL
COPT212-212-34	2-1/2" x 3/4"		CALL
COPT212-212-1	2-1/2" x 1"		CALL
COPT212-212-114	2-1/2" x 1-1/4"	2-5/8" x 1-3/8"	CALL
COPT212-212-112	2-1/2" x 1-1/2"	2-5/8" x 1-5/8"	CALL
COPT212-212-2	2-1/2" x 2"	2-5/8" x 2-1/8"	CALL
COPT3	3"	3-1/8" OD	CALL
COPT3-3-12	3" x 1/2"		CALL
COPT3-3-34	3" x 3/4"	3-1/8" x 7/8"	CALL
COPT3-3-1	3" x 1"		CALL
COPT3-3-114	3" x 1-1/4"		CALL
COPT3-3-112	3" x 1-1/2"		CALL
COPT3-3-2	3" x 2"	3-1/8" x 2-1/8"	CALL
COPT3-3-212	3" x 2-1/2"	3-1/8" x 2-5/8"	CALL

All Items May Not Be Stocked In All Branches

Copper Cast Fittings

Cast Copper Pressure Fittings

Copper Drain Coupling (C x C)

Part #	Size	Price
COPDRCLG12	1/2"	CALL
COPDRCLG34	3/4"	CALL
COPDRCLG1	1"	CALL

Copper 90° Drop Ear Elbows (C x C)



Part #	Size	Price
COPDE9012	1/2"	CALL
COPDE9034	3/4"	CALL

Copper 90° Drop Ear Elbows (C x FIP)



Part #	Size	Price
COPFEDE9012	1/2"	CALL
COPFEDE9012-38	1/2" x 3/8"	CALL
COPFEDE9034	3/4"	CALL

Copper 90° Elbows (C x FIP)



Part #	Size	Price
COPFE9012	1/2"	CALL
COPFE9012-38	1/2" x 3/8"	CALL
COPFE9034	3/4"	CALL
COPFE9034-12	3/4" x 1/2"	CALL
COPFE901	1"	CALL

Copper 90° Elbow (C x MIP)



Part #	Size	Price
COPM9012	1/2"	CALL
COPM9034	3/4"	CALL
COPM901	1"	CALL

Copper 90° Flanged Sink Elbow (C x FIP)



Part #	Size	Price
COPSINK9012	1/2"	CALL

125# Copper Companion Flange (C)



Part #	Size	Price
COPCF3	3"	CALL
COPCF4	4"	CALL

Copper Baseboard Tee (C x FIP x C)



Part #	Size	Price
COPBBT12-18-12	1/2" x 1/8" x 1/2"	CALL
COPBBT34-18-34	3/4" x 1/8" x 3/4"	CALL
COPBBT1-18-1	1" x 1/8" x 1"	CALL
COPBBT114-18-114	1-1/4" x 1/8" x 1-1/4"	CALL

Copper Vent Elbow Tee (C x C)

Part #	Size	Price
COPDR9012	1/2"	CALL
COPDR9034	3/4"	CALL

Copper Tee (C x C x FIP)



Part #	Size	Price
COPTCCF12	1/2"	CALL
COPTCCF12-12-34	1/2" x 1/2" x 3/4"	CALL
COPTCCF34	3/4"	CALL
COPTCCF34-34-12	3/4" x 3/4" x 1/2"	CALL
COPTCCF1	1"	CALL
COPTCCF1-1-12	1" x 1" x 1/2"	CALL
COPTCCF1-1-34	1" x 1" x 3/4"	CALL
COPTCCF114-114-12	1-1/4" x 1-1/4" x 1/2"	CALL
COPTCCF114-114-34	1-1/4" x 1-1/4" x 3/4"	CALL
COPTCCF114-114-1	1-1/4" x 1-1/4" x 1"	CALL
COPTCCF112-112-12	1-1/2" x 1-1/2" x 1/2"	CALL
COPTCCF2-2-34	2" x 2" x 3/4"	CALL

Copper Cast Fittings

Copper Tees (C x FIP x C)

Part #	Size	Price
COPTCFC34	3/4"	CALL
COPTCFC34-12-34	3/4" x 1/2" x 3/4"	CALL

Copper Drop Ear Tees (C x C x FIP)



Part #	Size	Price
COPDETCCF12	1/2"	CALL

Copper Union (C x C)



Part #	Size	Price
COPUN12	1/2"	CALL
COPUN34	3/4"	CALL
COPUN1	1"	CALL
COPUN114	1-1/4"	CALL
COPUN112	1-1/2"	CALL
COPUN2	2"	CALL
COPUN212	2-1/2"	CALL
COPUN3	3"	CALL

Copper Unions (C x FIP)



Part #	Size	Price
COPFEUN12	1/2"	CALL
COPFEUN34	3/4"	CALL

Copper Unions (C x MIP)

Part #	Size	Price
COPMUN12	1/2"	CALL
COPMUN34	3/4"	CALL

Copper Pipe & Fittings

Copper Tube



Type DWV Copper - Yellow



Type DWV Yellow - 20' Lengths

Part#	Size	Price
DWVP112-20	1-1/2" x 20'	CALL
DWVP2-20	2" x 20'	CALL
DWVP3-20	3" x 20'	CALL

Copper DWV Fittings



Copper Cast DWV Fittings

Copper Threaded Adapter (C x MIP)



Part #	Size	Price
DWVBU112	1-1/2"	CALL

Copper Threaded Adapters (C x MIP)



Part #	Size	Price
DWVMA112	1-1/2"	CALL
DWVMA2	2"	CALL
DWVMA3	3"	CALL

Copper Cleanout with Plug (FTG x Cleanout)

Part #	Size	Price
DWVCO112	1-1/2"	CALL
DWVCO2	2"	CALL

Cast & Wrot Copper DWV Fittings

Copper Flush Cleanout w/Plug (FTG x Cleanout)

Part #	Size	Price
DWVFLCO112	1-1/2"	CALL
DWVFLCO2	2"	CALL
DWVFLCO3	3"	CALL

Copper Closet Flange (C)

Part #	Size	Price
DWVSCF4	4"	CALL

Copper Reducing Couplings (C x C)



Part #	Size	Price
DWVCPLG3-112	3" x 1-1/2"	CALL
DWVCPLG3-2	3" x 2"	CALL

Copper 22-1/2° Elbow (C x C)

Part #	Size	Price
DWV22112	1-1/2"	CALL
DWV222	2"	CALL
DWV223	3"	CALL

Copper Tees (C x C x C)



Part #	Size	Price
DWVTY3	3"	CALL
DWVTY3-112	3" x 3" x 1-1/2"	CALL
DWVTY3-2	3" x 3" x 2"	CALL

Copper Double Tee Wye (C x C x C x C)

Part #	Size	Price
DWVDBLTY2	2"	CALL
DWVDBLTY2-112	2" x 1-1/2"	CALL

Copper 45° Wyes (C x C x C)



Part #	Size	Price
DWVY112	1-1/2"	CALL
DWVY2	2"	CALL
DWVY2-112	2" x 2" x 1-1/2"	CALL
DWVY3	3"	CALL
DWVY3-112	3" x 3" x 1-1/2"	CALL
DWVY3-2	3" x 3" x 2"	CALL

Copper 45° Double Wye (C x C x C x C)

Part #	Size	Price
DWVDBLY2	2"	CALL
DWVDBLY2-112	2" x 1-1/2"	CALL

Copper P-Trap with Plug (C x C x Cleanout)

Part #	Size	Price
DWVPTCO112	1-1/2"	CALL

Copper P-Traps (C x C)



Part #	Size	Price
DWVPT112	1-1/2"	CALL
DWVPT2	2"	CALL

Copper Wrot DWV Fittings

Copper Trap Adapters (FTG x SJ)



Part #	Size	Price
DWVFTA112	1-1/2" x 1-1/2" OD	CALL
DWVFTA112-114	1-1/2" x 1-1/4" OD	CALL

Cast & Wrot Copper DWV Fittings

Copper Trap Adapters (C x SJ)

Part #	Size	Price
DWVTA114	1-1/4" x 1-1/4" OD	CALL
DWVTA112-114	1-1/2" x 1-1/4" OD	CALL
DWVTA112	1-1/2" x 1-1/2" OD	CALL

Copper Threaded Adapters (C x FIP)



Part #	Size	Price
DWVFEA112	1-1/2"	CALL
DWVFEA2	2"	CALL
DWVFEA3	3"	CALL

Copper Bushing - External (FTG x C)



Part #	Size	Price
DWVFRCPG112-114	1-1/2" x 1-1/4"	CALL
DWVFRCPG2-112	2" x 1-1/2"	CALL
DWVFRCPG3-2	3" x 2"	CALL

Copper Closet Flange (C)



Part #	Size	Price
DWVCF4-3	3" x 4"	CALL

Copper Couplings (C x C)



Part #	Size	Price
DWVCPLG114	1-1/4"	CALL
DWVCPLG112	1-1/2"	CALL
DWVCPLG112-114	1-1/2" x 1-1/4"	CALL
DWVCPLG2	2"	CALL
DWVCPLG2-112	2" x 1-1/2"	CALL
DWVCPLG3	3"	CALL

Copper Repair Couplings (C x C)



Part #	Size	Price
DWVSLCPLG112	1-1/2"	CALL
DWVSLCPLG2	2"	CALL
DWVSLCPLG3	3"	CALL

Copper 45° Elbows (C x C)



Part #	Size	Price
DWV45112	1-1/2"	CALL
DWV452	2"	CALL
DWV453	3"	CALL

Copper 45° Elbows (FTG x C)



Part #	Size	Price
DWVST45114	1-1/4"	CALL
DWVST45112	1-1/2"	CALL
DWVST452	2"	CALL
DWVST453	3"	CALL

Copper 90° Elbows (C x C)



Part #	Size	Price
DWV90114	1-1/4"	CALL
DWV90112	1-1/2"	CALL
DWV902	2"	CALL
DWV903	3"	CALL

Copper 90° Elbows (FTG x C)



Part #	Size	Price
DWVST90112	1-1/2"	CALL
DWVST902	2"	CALL
DWVST903	3"	CALL

All Items May Not Be Stocked In All Branches

Cast & Wrot Copper DWV Fittings

Copper Tee (C x C x C)



Part #	Size	Price
DWVTY112	1-1/2"	CALL
DWVTY2	2"	CALL
DWVTY2-112-112	2" x 1-1/2" x 1-1/2"	CALL
DWVTY2-112	2" x 2" x 1-1/2"	CALL

Copper Test Caps (C)



Part #	Size	Price
DWVCAP112	1-1/2"	CALL
DWVCAP3	3"	CALL

Copper Tube



Copper A/C Refrigeration Tubing - Red



Refrigeration ASTM B280 Red - 50' Coils

Part#	Size	Price
ACRC18-50	1/8" OD x 50'	CALL
ACRC316-50	3/16" OD x 50'	CALL
ACRC516-50	5/16" OD x 50'	CALL
ACRC118-50	1-1/8" OD x 50'	CALL

Copper A/C Refrigeration Tubing - Blue



Type ACR-I Cleaned & Capped - Per Foot

Part#	Size	Price
ACRLP14	1/4" OD	CALL

Copper A/C Refrigeration Tubing - Blue (Continued)

Type ACR-I Cleaned & Capped - Per Foot

Part#	Size	Price
ACRLP38	3/8" OD	CALL
ACRLP12	1/2" OD	CALL
ACRLP58	5/8" OD	CALL
ACRLP34	3/4" OD	CALL
ACRLP78	7/8" OD	CALL
ACRLP118	1-1/8" OD	CALL
ACRLP138	1-3/8" OD	CALL
ACRLP158	1-5/8" OD	CALL
ACRLP218	2-1/8" OD	CALL
ACRLP258	2-5/8" OD	CALL
ACRLP318	3-1/8" OD	CALL
ACRLP418	4-1/8" OD	CALL

Type ACR ASTM B280 Blue - 50' Lengths

Part#	Size	Price
ACRC14-50	1/4" OD x 50'	CALL
ACRC38-50	3/8" OD x 50'	CALL
ACRC12-50	1/2" OD x 50'	CALL
ACRC58-50	5/8" OD x 50'	CALL
ACRC34-50	3/4" OD x 50'	CALL
ACRC78-50	7/8" OD x 50'	CALL

Type ACR ASTM B280 Blue - 100' Lengths

Part#	Size	Price
ACRC38-100	3/8" OD x 100'	CALL
ACRC12-100	1/2" OD x 100'	CALL
ACRC58-100	5/8" OD x 100'	CALL

Wrot Copper Fittings



Copper Wrot ACR Pressure Fittings Female Adapter (C x FIP)



Part #	OD Size	Price
ACRFEA38-18	3/8" x 1/8"	CALL
ACRFEA12-14	1/2" x 1/4"	CALL

Copper Pipe & Fittings

Prices & Specifications are Subject to Change.

ACR Copper Fittings

**Copper Wrot ACR Pressure Fittings
(Continued)**

Female Adapter (C x FIP)

Part #	OD Size	Price
ACRFEA58-38	5/8" x 3/8"	CALL
ACRFEA58-12	5/8" x 1/2"	CALL
ACRFEA58-34	5/8" x 3/4"	CALL
ACRFEA78-12	7/8" x 1/2"	CALL
ACRFEA78-34	7/8" x 3/4"	CALL
ACRFEA78-1	7/8" x 1"	CALL
ACRFEA118-12	1-1/8" x 1/2"	CALL
ACRFEA118-34	1-1/8" x 3/4"	CALL
ACRFEA118-1	1-1/8" x 1"	CALL
ACRFEA138-1	1-3/8" x 1"	CALL
ACRFEA138-114	1-3/8" x 1-1/4"	CALL

Female Fitting Adapter (FTG x FIP)



Part #	OD Size	Price
ACRFESTA58-12	5/8" x 1/2"	CALL
ACRFESTA78-34	7/8" x 3/4"	CALL

Male Adapter (C x MIP)



Part #	Size	Price
ACRMA12-38	1/2" x 3/8"	CALL
ACRMA12-12	1/2" x 1/2"	CALL
ACRMA58-38	5/8" x 3/8"	CALL
ACRMA58-12	5/8" x 1/2"	CALL
ACRMA58-34	5/8" x 3/4"	CALL
ACRMA78-34	7/8" x 3/4"	CALL
ACRMA78-1	7/8" x 1"	CALL
ACRMA118-1	1-1/8" x 1"	CALL
ACRMA118-114	1-1/8" x 1-1/4"	CALL
ACRMA138-1	1-3/8" x 1"	CALL
ACRMA138-114	1-3/8" x 1-1/4"	CALL
ACRMA158-112	1-5/8" x 1-1/2"	CALL
ACRMA218-2	2-1/8" x 2"	CALL

Tube Cap (C)



Part #	Size	Price
ACRCAP14	1/4"	CALL

**Copper Wrot ACR Pressure Fittings
(Continued)**

Tube Cap (C)

Part #	Size	Price
ACRCAP38	3/8"	CALL
ACRCAP12	1/2"	CALL
ACRCAP58	5/8"	CALL
ACRCAP34	3/4"	CALL
ACRCAP78	7/8"	CALL
ACRCAP118	1-1/8"	CALL
ACRCAP138	1-3/8"	CALL
ACRCAP158	1-5/8"	CALL
ACRCAP218	2-1/8"	CALL

Coupling - with Dimpled Stops (C x C)



Part #	OD Size	Price
ACRCPLG316	3/16"	CALL
ACRCPLG14	1/4"	CALL
ACRCPLG38	3/8"	CALL
ACRCPLG516	5/16"	CALL
ACRCPLG12	1/2"	CALL
ACRCPLG58	5/8"	CALL
ACRCPLG34	3/4"	CALL
ACRCPLG78	7/8"	CALL
ACRCPLG118	1-1/8"	CALL
ACRCPLG138	1-3/8"	CALL
ACRCPLG158	1-5/8"	CALL
ACRCPLG218	2-1/8"	CALL
ACRCPLG258	2-5/8"	CALL
ACRCPLG318	3-1/8"	CALL

Reducing Coupling (C x C)



Part #	OD Size	Price
ACRCPLG14-18	1/4" x 1/8"	CALL
ACRCPLG38-14	3/8" x 1/4"	CALL
ACRCPLG38-516	3/8" x 5/16"	CALL
ACRCPLG12-14	1/2" x 1/4"	CALL
ACRCPLG12-38	1/2" x 3/8"	CALL
ACRCPLG58-14	5/8" x 1/4"	CALL
ACRCPLG58-38	5/8" x 3/8"	CALL
ACRCPLG58-12	5/8" x 1/2"	CALL
ACRCPLG34-38	3/4" x 3/8"	CALL

All Items May Not Be Stocked In All Branches

ACR Copper Fittings

**Copper Wrot ACR Pressure Fittings
(Continued)**

Reducing Coupling (C x C)

Part #	OD Size	Price
ACRCPLG34-12	3/4" x 1/2"	CALL
ACRCPLG34-58	3/4" x 5/8"	CALL
ACRCPLG78-38	7/8" x 3/8"	CALL
ACRCPLG78-12	7/8" x 1/2"	CALL
ACRCPLG78-58	7/8" x 5/8"	CALL
ACRCPLG78-34	7/8" x 3/4"	CALL
ACRCPLG118-12	1-1/8" x 1/2"	CALL
ACRCPLG118-58	1-1/8" x 5/8"	CALL
ACRCPLG118-34	1-1/8" x 3/4"	CALL
ACRCPLG118-78	1-1/8" x 7/8"	CALL
ACRCPLG138-78	1-3/8" x 7/8"	CALL
ACRCPLG138-118	1-3/8" x 1-1/8"	CALL
ACRCPLG158-78	1-5/8" x 7/8"	CALL
ACRCPLG158-118	1-5/8" x 1-1/8"	CALL
ACRCPLG158-138	1-5/8" x 1-3/8"	CALL
ACRCPLG218-118	2-1/8" x 1-1/8"	CALL
ACRCPLG218-138	2-1/8" x 1-3/8"	CALL
ACRCPLG218-158	2-1/8" x 1-5/8"	CALL
ACRCPLG258-158	2-5/8" x 1-5/8"	CALL
ACRCPLG258-218	2-5/8" x 2-1/8"	CALL
ACRCPLG318-158	3-1/8" x 1-5/8"	CALL

Fitting Reducer (FTG x C)



Part #	OD Size	Price
ACRBU14-18	1/4" x 1/8"	CALL
ACRBU38-14	3/8" x 1/4"	CALL
ACRBU12-14	1/2" x 1/4"	CALL
ACRBU12-38	1/2" x 3/8"	CALL
ACRBU58-38	5/8" x 3/8"	CALL
ACRBU58-12	5/8" x 1/2"	CALL
ACRBU34-12	3/4" x 1/2"	CALL
ACRBU34-58	3/4" x 5/8"	CALL
ACRBU78-12	7/8" x 1/2"	CALL
ACRBU78-58	7/8" x 5/8"	CALL
ACRBU78-34	7/8" x 3/4"	CALL
ACRBU118-58	1-1/8" x 5/8"	CALL
ACRBU118-34	1-1/8" x 3/4"	CALL
ACRBU118-78	1-1/8" x 7/8"	CALL
ACRBU138-58	1-3/8" x 5/8"	CALL
ACRBU138-78	1-3/8" x 7/8"	CALL
ACRBU138-118	1-3/8" x 1-1/8"	CALL

**Copper Wrot ACR Pressure Fittings
(Continued)**

Fitting Reducer (FTG x C)

Part #	OD Size	Price
ACRBU158-78	1-5/8" x 7/8"	CALL
ACRBU158-118	1-5/8" x 1-1/8"	CALL
ACRBU158-138	1-5/8" x 1-3/8"	CALL
ACRBU218-78	2-1/8" x 7/8"	CALL
ACRBU218-118	2-1/8" x 1-1/8"	CALL
ACRBU218-138	2-1/8" x 1-3/8"	CALL
ACRBU218-158	2-1/8" x 1-5/8"	CALL
ACRBU258-218	2-5/8" x 2-1/8"	CALL
ACRBU318-138	3-1/8" x 1-3/8"	CALL

45° Elbow (C x C)



Part #	OD Size	Price
ACR4514	1/4"	CALL
ACR4538	3/8"	CALL
ACR4512	1/2"	CALL
ACR4558	5/8"	CALL
ACR4534	3/4"	CALL
ACR4578	7/8"	CALL
ACR45118	1-1/8"	CALL
ACR45138	1-3/8"	CALL
ACR45158	1-5/8"	CALL
ACR45218	2-1/8"	CALL

45° Elbows (FTG x C)



Part #	OD Size	Price
ACRST4538	3/8"	CALL
ACRST4512	1/2"	CALL
ACRST4558	5/8"	CALL
ACRST4534	3/4"	CALL
ACRST4578	7/8"	CALL
ACRST45118	1-1/8"	CALL
ACRST45138	1-3/8"	CALL
ACRST45158	1-5/8"	CALL
ACRST45218	2-1/8"	CALL

Prices & Specifications are Subject to Change.

ACR Copper Fittings

90° Close Rough Elbows (C x C)



Part #	OD Size	Price
ACR9014	1/4"	CALL
ACR9038	3/8"	CALL
ACR9012	1/2"	CALL
ACR9058	5/8"	CALL
ACR9058-12	5/8" x 1/2"	CALL
ACR9034	3/4"	CALL
ACR9078	7/8"	CALL
ACR9078-58	7/8" x 5/8"	CALL
ACR9078-34	7/8" x 3/4"	CALL
ACR90118	1-1/8"	CALL
ACR90138	1-3/8"	CALL
ACR90138-118	1-3/8" x 1-1/8"	CALL
ACR90158	1-5/8"	CALL
ACR90218	2-1/8"	CALL

90° Long Radius Elbow (C x C)



Part #	Size	Price
ACRLT9014	1/4"	CALL
ACRLT90516	5/16"	CALL
ACRLT9038	3/8"	CALL
ACRLT9012	1/2"	CALL
ACRLT9058	5/8"	CALL
ACRLT9034	3/4"	CALL
ACRLT9078	7/8"	CALL
ACRLT90118	1-1/8"	CALL
ACRLT90138	1-3/8"	CALL
ACRLT90158	1-5/8"	CALL
ACRLT90218	2-1/8"	CALL
ACRLT90258	2-5/8"	CALL
ACRLTST90418	4-1/8"	CALL

90° Close Rough Street Elbow (FTG x C)



Part #	OD Size	Price
ACRST9038	3/8"	CALL
ACRST9012	1/2"	CALL

**Copper Wrot ACR Pressure Fittings
(Continued)**

90° Close Rough Street Elbow (FTG x C)

Part #	OD Size	Price
ACRST9058	5/8"	CALL
ACRST9034	3/4"	CALL
ACRST9078	7/8"	CALL
ACRST90118	1-1/8"	CALL
ACRST90138	1-3/8"	CALL
ACRST90158	1-5/8"	CALL
ACRST90218	2-1/8"	CALL
ACRST90318	3-1/8"	CALL

90° Long Radius Street Elbow (FTG x C)



Part #	OD Size	Price
ACRST9014	1/4"	CALL
ACRLTST9038	3/8"	CALL
ACRLTST9012	1/2"	CALL
ACRLTST9058	5/8"	CALL
ACRLTST9034	3/4"	CALL
ACRLTST9078	7/8"	CALL
ACRLTST90118	1-1/8"	CALL
ACRLTST90138	1-3/8"	CALL
ACRLTST90158	1-5/8"	CALL
ACRLTST90218	2-1/8"	CALL
ACRLTST90258	2-5/8"	CALL
ACRST90418	4-1/8"	CALL

Tee (C x C x C)



Part #	OD Size	Price
ACRT14	1/4"	CALL
ACRT516	5/16"	CALL
ACRT38	3/8"	CALL
ACRT38-14	3/8" x 1/4"	CALL
ACRT38-12	3/8" x 1/2"	CALL
ACRT12	1/2"	CALL
ACRT12-38	1/2" x 3/8"	CALL
ACRT58	5/8"	CALL
ACRT58-12	5/8" x 1/2"	CALL
ACRT34	3/4"	CALL

All Items May Not Be Stocked In All Branches

ACR Copper Fittings

Copper Wrot ACR Pressure Fittings (Continued)

Tee (C x C x C)

Part #	OD Size	Price
ACRT34-58	3/4" x 5/8"	CALL
ACRT78	7/8"	CALL
ACRT78-58-58	7/8" x 5/8" x 5/8"	CALL
ACRT78-58-78	7/8" x 5/8" x 7/8"	CALL
ACRT78-38	7/8" x 3/8"	CALL
ACRT78-12	7/8" x 1/2"	CALL
ACRT78-58	7/8" x 5/8"	CALL
ACRT78-118	7/8" x 1-1/8"	CALL
ACRT118	1-1/8"	CALL
ACRT118-78-78	1-1/8" x 7/8" x 7/8"	CALL
ACRT118-78-118	1-1/8" x 7/8" x 1-1/8"	CALL
ACRT118-58	1-1/8" x 5/8"	CALL
ACRT118-78	1-1/8" x 7/8"	CALL
ACRT118-138	1-1/8" x 1-3/8"	CALL
ACRT138	1-3/8"	CALL
ACRT138-78-78	1-3/8" x 7/8" x 7/8"	CALL
ACRT138-78-138	1-3/8" x 7/8" x 1-3/8"	CALL
ACRT138-118-78	1-3/8" x 1-1/8" x 7/8"	CALL
ACRT138-118-118	1-3/8" x 1-1/8" x 1-1/8"	CALL
ACRT138-58	1-3/8" x 5/8"	CALL
ACRT138-78	1-3/8" x 7/8"	CALL
ACRT138-118	1-3/8" x 1-1/8"	CALL
ACRT158	1-5/8"	CALL
ACRT158-58	1-5/8" x 5/8"	CALL
ACRT158-78	1-5/8" x 7/8"	CALL
ACRT158-118	1-5/8" x 1-1/8"	CALL
ACRT218	2-1/8"	CALL
ACRT218-138	2-1/8" x 1-3/8"	CALL
ACRT218-158	2-1/8" x 1-5/8"	CALL

Tube Strap - Two Hole



Part #	OD Size	Price
ACRCTS14	1/4"	CALL
ACRCTS38	3/8"	CALL
ACRCTS12	1/2"	CALL
ACRCTS58	5/8"	CALL
ACRCTS34	3/4"	CALL
ACRCTS78	7/8"	CALL
ACRCTS118	1-1/8"	CALL
ACRCTS138	1-3/8"	CALL
ACRCTS158	1-5/8"	CALL
ACRCTS218	2-1/8"	CALL

Unions (C x C)



Part #	OD Size	Price
ACR3PCUN12	1/2"	CALL
ACR3PCUN58	5/8"	CALL
ACR3PCUN78	7/8"	CALL

Suction Line P-Traps (C x C)



Part #	Size	Price
ACRPT58	5/8"	CALL
ACRPT34	3/4"	CALL
ACRPT78	7/8"	CALL
ACRPT118	1-1/8"	CALL
ACRPT138	1-3/8"	CALL
ACRPT158	1-5/8"	CALL
ACRPT218	2-1/8"	CALL



www.irrsupply.com

Copper Push-On Fittings

TecTite™ Fittings

200 TecTite™ Couplings with Stop (C x C)



Part #	Mfg #	Size	Price
TTECPLG12	88005	1/2"	9.62
TTECPLG34	88010	3/4"	11.00
TTECPLG1	88014	1"	23.66

TecTite™ Repair Couplings without Stop (C x C)

Part #	Mfg #	Size	Price
TTESLCPG12	88084	1/2"	18.07
TTESLCPG34	88086	3/4"	22.16

201-R TecTite™ Reducer Couplings (C x C)



Part #	Mfg #	Size	Price
TTECPLG34-12	88075	3/4" x 1/2"	11.26
TTECPLG1-34	88078	1" x 3/4"	28.72

203 TecTite™ Female Adapters (C x F)



Part #	Mfg #	Size	Price
TTEFEA12	88035	1/2"	8.02
TTEFEA34	88040	3/4"	9.14
TTEFEA1	88044	1"	18.48

204 TecTite™ Male Adapters (C x M)



Part #	Mfg #	Size	Price
TTEMA12	88025	1/2"	7.75
TTEMA34	88030	3/4"	8.74
TTEMA1	88034	1"	19.20

207 TecTite™ 90° Elbows (C x C)



Part #	Mfg #	Size	Price
TTE9012	88015	1/2"	9.96
TTE9034	88020	3/4"	12.43
TTE901	88024	1"	25.43

208 Water Heater Hose

- C x 20" Hose x FMPT



Part #	Mfg #	Nom Size	Price
TTEHWH34	10088104	3/4"	22.13

210 TecTite™ Ball Valves



Part #	Mfg #	Size	Price
PSHBV12	820-04	1/2"	14.00
PSHBV34	820-06	3/4"	21.00
PSHBV1	820-07	1"	40.00

211 TecTite™ Tees



Part #	Mfg #	Size	Price
TTET12	88060	1/2"	13.75
TTET34-34-12	88070	3/4" x 3/4" x 1/2"	17.45
TTET34	88065	3/4"	17.28
TTET1	88068	1"	30.79

217 TecTite™ Tube Caps



Part #	Mfg #	Size	Price
TTECAP12	88045	1/2"	10.04
TTECAP34	88050	3/4"	10.30
TTECAP1	88054	1"	23.60

Demounting Clip - Removal Key



Part #	Mfg #	Size	Price
TTETOOL12	65630	1/2"	2.49
TTETOOL34	65625	3/4"	2.49
TTETOOL1	65627	1"	2.80

Copper Pipe & Fittings

All Items May Not Be Stocked In All Branches



www.irrsupply.com

Poly Water Service Pipe

Prime Poly Pipe IPS Well Service Tube



Plastic Pipe & Fittings

Part #	Mfg #	Description	Price
PLAC1-200-100	P3408EA 1X200X100 PSI	1"IPS x 200' x 100# PSI Black/Dark Blue	161.18
PLAC114-200-100	P3408EA 1-1/4X200X100PSI	1-1/4"IPS x 200' x 100# PSI Black/Dark Blue	275.76
PLAC12-100-125	P3408EA 1/2X100X125 PSI	1/2"IPS x 100' x 125# PSI Black/Green	42.18
PLAC12-400-125	P3408EA 1/2X400X125 PSI	1/2"IPS x 400' x 125# PSI Black/Green	168.76
PLAC12-100-160	P3408EA 1/2X100X160 PSI	1/2"IPS x 100' x 160# PSI Black/Red	42.18
PLAC1-150-160	P3408EA 1X150X160 PSI	1"IPS x 150' x 160# PSI Black/Red	157.36
PLAC1-200-160	P3408EA 1X200X160 PSI	1"IPS x 200' x 160# PSI Black/Red	209.80
PLAC1-500-160	P3408EA 1X500X160 PSI	1"IPS x 500' x 160# PSI Black/Red	524.50
PLAC114-200-160	P3408EA 1-1/4X200X160PSI	1-1/4"IPS x 200' x 160# PSI Black/Red	377.82
PLAC34-100-100	PE3408EA 3/4 X 100 X 100	3/4"IPS x 100' x 100# SIDR 15 Black/Dark Blue	55.40
PLAC34-400-100	PE3408EA 3/4 X 400 X 100	3/4"IPS x 400' x 100# SIDR 15 Black/Dark Blue	221.62
PLAC34-500-100	PE3408EA 3/4 X 500 X 100	3/4"IPS x 500' x 100# SIDR 15 Black/Dark Blue	277.04
PLAC1-100-100	PE3408EA 1 X 100 X 100	1"IPS x 100' x 100# SIDR 15 Black/Dark Blue	80.60
PLAC1-300-100	PE3408EA 1 X 300 X 100	1"IPS x 300' x 100# SIDR 15 Black/Dark Blue	241.78
PLAC114-100-100	PE3408EA 1 1/4X100X100	1-1/4"IPS x 100' x 100# SIDR 15 Black/Dark Blue	137.88
PLAC114-300-100	PE3408EA 1 1/4X300X100	1-1/4"IPS x 300' x 100# SIDR 15 Black/Dark Blue	413.64
PLAC112-100-100	PE3408EA 1 1/2X100X100	1-1/2"IPS x 100' x 100# SIDR 15 Black/Dark Blue	188.90
PLAC112-250-100	PE3408EA 1 1/2X250X100	1-1/2"IPS x 250' x 100# SIDR 15 Black/Dark Blue	472.20
PLAC112-300-100	PE3408EA 1 1/2X300X100	1-1/2"IPS x 300' x 100# SIDR 15 Black/Dark Blue	566.68
PLAC2-100-100	PE3408EA 2 X 100 X 100	2"IPS x 100' x 100# SIDR 15 Black/Dark Blue	319.88
PLAC34-100-160	PE3408EA 3/4 X 100 X 160	3/4"IPS x 100' x 160# SIDR 9 Black/Red	66.48
PLAC34-400-160	PE3408EA 3/4 X 400 X 160	3/4"IPS x 400' x 160# SIDR 9 Black/Red	265.96
PLAC1-100-160	PE3408EA 1 X 100 X 160	1"IPS x 100' x 160# SIDR 9 Black/Red	104.90
PLAC1-300-160	PE3408EA 1 X 300 X 160	1"IPS x 300' x 160# SIDR 9 Black/Red	314.70
PLAC114-100-160	PE3408EA 1 1/4X100X160	1-1/4"IPS x 100' x 160# SIDR 9 Black/Red	188.90
PLAC114-300-160	PE3408EA 1 1/4X300X160	1-1/4"IPS x 300' x 160# SIDR 9 Black/Red	566.72
PLAC112-100-160	PE3408EA 1 1/2X100X160	1-1/2"IPS x 100' x 160# SIDR 9 Black/Red	259.42
PLAC112-250-160	PE3408EA 1 1/2X250X160	1-1/2"IPS x 250' x 160# SIDR 9 Black/Red	648.60
PLAC2-100-160	PE3408EA 2 X 100 X 160	2"IPS x 100' x 160# SIDR 9 Black/Red	428.14

Blue Endo Pure Prime

Part #	Mfg #	Description	Price
PLAC1-100-160EP	1X100X160 ENDO PURE-BLUE	1"IPS x 100' x 160#	129.22
PLAC1-300-160EP	1X300X160 ENDO PURE-BLUE	1"IPS x 300' x 160#	387.64
PLACCTS1-100-200EP	CTS ENDOPURE 1X100X200	1"CTS x 100' x 200#	129.60
PLACCTS1-300-200EP	CTS ENDOPURE 1-300-200	1"CTS x 300' x 200#	388.50
PLACCTS1-500-200EP	CTS ENDOPURE 1X500X200	1"CTS x 500' x 200#	648.02

CTS Water Service Tube

Part #	Mfg #	Description	Price
PLACCTS34-100-200	CTSEA 3/4 X 100 X 200	3/4"CTS x 100' x 200# SODR 9 Black/Light Blue	73.94
PLACCTS34-500-200	CTSEA 3/4 X 500 X 200	3/4"CTS x 500' x 200# SODR 9 Black/Light Blue	369.58
PLACCTS1-100-200	CTSEA X 100 X 200	1"CTS x 100' x 200# SODR 9 Black/Light Blue	121.90
PLACCTS1-300-200	CTSEA 1 X 300 X 200	1"CTS x 300' x 200# SODR 9 Black/Light Blue	365.68
PLACCTS114-300-200	CTSEA 1-1/4X300X200	1-1/4"CTS x 300' x 200# SODR 9 Black/Light Blue	549.64
PLACCTS112-300-200	CTSEA 1-1/2X300X200	1-1/2"CTS x 300' x 200# SODR 9 Black/Light Blue	775.26
PLACCTS2-100-200	CTSEA 2-100-200	2"CTS x 100' x 200# SODR 9 Black/Light Blue	433.62

Prices & Specifications are Subject to Change.

PVC Schedule 40 Pipe & Fittings

Plastic Pipe & Fittings

PVC Type 1120 Pressure Pipe

PVC1120 Sch 40 Pressure Pipe (NSF-pw)

- ASTM D1785
- Potable water



PVC Sch 40 Plain End

Part #	Nom Pipe Size	Price
P40P12-10	1/2" x 10'	6.16
P40P34-10	3/4" x 10'	6.81
P40P1-10	1" x 10'	11.25
P40P12-20	1/2" x 20'	12.31
P40P34-20	3/4" x 20'	13.62
P40P1-20	1" x 20'	22.50

PVC Sch 40 Fittings

PVC Tee (SOC)



Part #	Size	Price
P40T12	1/2"	0.76
P40T34	3/4"	0.87
P40T1	1"	1.63
P40T114	1-1/4"	2.55
P40T112	1-1/2"	3.10
P40T2	2"	4.51

PVC Tee (SOC x FIP)



Part #	Size	Price
P40COT34	3/4"	2.52

PVC Reducing Tee (SOC)



Part #	Size	Price
P40T34-12	3/4" x 1/2"	1.02
P40T1-34	1" x 3/4"	1.88

PVC Sch 40 Fittings (Continued)

PVC Reducing Tee (SOC)

Part #	Size	Price
P40T112-34	1-1/2" x 3/4"	4.91
P40T112-1	1-1/2" x 1"	4.91

PVC Reducing Tee (SOC x FIP)



Part #	Size	Price
P40TSSF12	1-1/2" x 1"	1.01

PVC 90° Elbow (SOC)



Part #	Size	Price
P409012	1/2"	0.61
P409034	3/4"	0.68
P40901	1"	1.23
P4090114	1-1/4"	2.17
P4090112	1-1/2"	2.34
P40902	2"	3.66

PVC 90° Street Elbow (Spg x SOC)



Part #	Size	Price
P40ST9012	1/2"	1.72
P40ST9034	3/4"	2.12
P40ST901	1"	3.66
P40ST90114	1-1/4"	3.87
P40ST90112	1-1/2"	4.83
P40ST902	2"	9.32

PVC 45° Elbow (SOC)



Part #	Size	Price
P404512	1/2"	1.01
P404534	3/4"	1.56
P40451	1"	1.88
P4045114	1-1/4"	2.62

All Items May Not Be Stocked In All Branches

PVC Schedule 40 Pipe & Fittings

PVC Sch 40 Fittings (Continued)

PVC 45° Elbow (SOC)

Part #	Size	Price
P4045112	1-1/2"	3.29
P40452	2"	4.28

PVC Coupling (SOC)



Part #	Size	Price
P40CPLG12	1/2"	0.40
P40CPLG34	3/4"	0.55
P40CPLG1	1"	0.97
P40CPLG114	1-1/4"	1.34
P40CPLG112	1-1/2"	1.43
P40CPLG2	2"	2.18

PVC Adapter (SOC x FIP)



Part #	Size	Price
P40FEA12	1/2"	0.68
P40FEA34	3/4"	0.87
P40FEA1	1"	1.01
P40FEA114	1-1/4"	1.56
P40FEA112	1-1/2"	1.79
P40FEA2	2"	2.40

PVC Adapter (MIP x SOC)



Part #	Size	Price
P40MA12	1/2"	0.55
P40MA34	3/4"	0.61
P40MA1	1"	1.10
P40MA114	1-1/4"	1.34
P40MA112	1-1/2"	1.79
P40MA2	2"	2.35

PVC Reducing Adapter (MIP x SOC)



Part #	Size	Price
P40MA34-12	3/4" x 1/2"	1.10
P40MA1-34	1" x 3/4"	1.56
P40MA112-114	1-1/2" x 1-1/4"	4.12

PVC Flush Style Reducer Bushing (Spg x SOC)



Part #	Size	Price
P40BU34-12	3/4" x 1/2"	0.64
P40BU1-12	1" x 1/2"	1.16
P40BU1-34	1" x 3/4"	1.16
P40BU114-12	1-1/4" x 1/2"	1.47
P40BU114-34	1-1/4" x 3/4"	1.47
P40BU114-1	1-1/4" x 1"	1.56
P40BU112-12	1-1/2" x 1/2"	1.65
P40BU112-34	1-1/2" x 3/4"	1.65
P40BU112-1	1-1/2" x 1"	1.65
P40BU112-114	1-1/2" x 1-1/4"	1.65
P40BU2-12	2" x 1/2"	2.57
P40BU2-34	2" x 3/4"	2.73
P40BU2-1	2" x 1"	2.73
P40BU2-114	2" x 1-1/4"	2.73
P40BU2-112	2" x 1-1/2"	2.73

PVC Flush Style Reducer Bushing (Spg x FIP)



Part #	Size	Price
P40FBU34-12	3/4" x 1/2"	1.01
P40FBU1-12	1" x 1/2"	1.63
P40FBU1-34	1" x 3/4"	1.63
P40FBU114-34	1-1/4" x 3/4"	2.51
P40FBU114-1	1-1/4" x 1"	2.51
P40FBU112-12	1-1/2" x 1/2"	2.89
P40FBU112-34	1-1/2" x 3/4"	2.89
P40FBU112-1	1-1/2" x 1"	2.89

Plastic Pipe & Fittings

Prices & Specifications are Subject to Change.

PVC Schedule 40 Pipe & Fittings

Plastic Pipe & Fittings

PVC Sch 40 Fittings (Continued)

PVC Flush Style Reducer Bushing (Spg x FIP)

Part #	Size	Price
P40FBU112-114	1-1/2" x 1-1/4"	2.89
P40FBU2-34	2" x 3/4"	3.88
P40FBU2-1	2" x 1"	3.88
P40FBU2-112	2" x 1-1/2"	3.88

PVC Cap (SOC)



Part #	Size	Price
P40CAP12	1/2"	0.55
P40CAP34	3/4"	0.64
P40CAP1	1"	1.01
P40CAP114	1-1/4"	1.43
P40CAP112	1-1/2"	1.56
P40CAP2	2"	1.88

PVC Plug (Spg)



Part #	Size	Price
P40PLUG1	1"	1.88

PVC U-Trap



Part #	Size	Price
P40UTRAP34	3/4"	2.68

PVC Schedule 40 Unions

PVC Unions with Buna-N O-Ring Seal (SOC)

- 150 psi @ 73°F



Part #	Size	Price
P40UN34	3/4"	6.40

PVC Drain Waste & Vent Pipe

PVC DWV Sch 40 Pipe (NSF-dwv)

- ASTM D2665, NSF-dwv
- ASTM D1785, NSF-pw



Part #	Nom Pipe Size	Ends	Price
PVCP114-20	1-1/4" x 20'	PE	23.98
PVCP112-10	1-1/2" x 10'	PE	12.73
PVCP112-20	1-1/2" x 20'	PE	25.46
PVCP2-10	2" x 10'	PE	17.76
PVCP2-20	2" x 20'	PE	35.52
PVCP3-10	3" x 10'	PE	34.63
PVCP3-20	3" x 20'	PE	69.26
PVCP4-10	4" x 10'	PE	48.54
PVCP4-20	4" x 20'	PE	97.09
PVCP6-10	6" x 10'	PE	109.52
PVCP6-20	6" x 20'	PE	219.04
PVCP8-10	8" x 10'	PE	123.73
PVCP8-20	8" x 20'	PE	247.46
PVCP10-20	10" x 20'	PE	401.97

PVC DWV Fittings

PVC Sewer & Drain Pipe Adapters (S&D Spg x DWV Spg)

- Adapts S&D spigot to DWV spigot

Part #	Size	Price
PVCACPLG4-3	4" x 3"	25.54
PVCACPLG4	4" x 4"	28.97

PVC Fem Trap Adapters with Chrome Nut (H x SJ)

Part #	Size	Price
PVCTA112-114	1-1/2" x 1-1/4"	9.50
PVCTA112	1-1/2"	9.73

PVC Couplings (Hub)



Part #	Size	Price
PVCCPLG114	1-1/4"	8.32

All Items May Not Be Stocked In All Branches

PVC DWV Pipe & Fittings

PVC DWV Fittings (Continued)

PVC Couplings (Hub)

Part #	Size	Price
PVCCPLG112	1-1/2"	1.88
PVCCPLG2	2"	2.45
PVCCPLG2-112	2" x 1-1/2"	5.45
PVCCPLG3	3"	8.43
PVCCPLG3-112	3" x 1-1/2"	16.57
PVCCPLG3-2	3" x 2"	12.73
PVCCPLG4	4"	14.94
PVCCPLG4-2	4" x 2"	25.26
PVCCPLG4-3	4" x 3"	26.86
PVCCPLG6	6"	48.67
PVCCPLG8	8"	107.19
PVCCPLG10	10"	116.78
PVCCPLG12	12"	198.90

PVC Repair Couplings (Hub)



Part #	Size	Price
PVCSLCPG112	1-1/2"	10.20
PVCSLCPG2	2"	7.13
PVCSLCPG3	3"	18.00
PVCSLCPG4	4"	34.66
PVCSLCPG6	6"	149.78

PVC Bushing (MIP x FIP)

Part #	Size	Price
PVCBU112M114F	1-1/2" x 1-1/4"	3.59

PVC Fitting Flush Bushings (Spg x H)



Part #	Size	Price
PVCBU112-114	1-1/2" x 1-1/4"	7.33
PVCBU2-112	2" x 1-1/2"	3.23
PVCBU3-112	3" x 1-1/2"	15.51
PVCBU3-2	3" x 2"	8.10
PVCBU4-2	4" x 2"	26.97
PVCBU4-3	4" x 3"	13.76
PVCBU6-4	6" x 4"	71.60

PVC DWV Fittings (Continued)

PVC Fitting Flush Bushings (Spg x H)

Part #	Size	Price
PVCBU8-6	8" x 6"	155.93
PVCBU10-6	10" x 6"	184.07
PVCBU10-8	10" x 8"	189.68

PVC Ftg Slip Joint Trap Adapters w/Plastic Nut (Spg x SJ)



Part #	Size	Price
PVCTAFP112-114	1-1/2" x 1-1/4"	7.64

PVC Ftg Slip Joint Trap Adapters w/Chr Nut (Spg x SJ)

Part #	Size	Price
PVCTAF112	1-1/2"	9.73
PVCTAF112-114	1-1/2" x 1-1/4"	9.77

PVC Slip Joint Trap Adapters w/Plastic Nut (H x SJ)

Part #	Size	Price
PVCTAP112-114	1-1/2" x 1-1/4"	6.93

PVC Female Adapters (H x FIP)



Part #	Size	Price
PVCFEA112	1-1/2"	3.50
PVCFEA2	2"	5.96
PVCFEA3	3"	16.03
PVCFEA4	4"	20.55
PVCFEA6	6"	69.02
PVCFEA8	8"	129.91

PVC Female Fitting Adapters (Spg x FIP)



Part #	Size	Price
PVCFFEA112	1-1/2"	4.43

Plastic Pipe & Fittings

Prices & Specifications are Subject to Change.

PVC DWV Pipe & Fittings

Plastic Pipe & Fittings

PVC DWV Fittings (Continued)

PVC Female Fitting Adapters (Spg x FIP)

Part #	Size	Price
PVCFFEA2	2"	5.72
PVCFFEA3	3"	16.12
PVCFFEA4	4"	26.47

PVC Male Adapters (H x MIP)



Part #	Size	Price
PVCMA114	1-1/4"	8.90
PVCMA112	1-1/2"	3.65
PVCMA112-114	1-1/2" x 1-1/4"	4.79
PVCMA2	2"	4.73
PVCMA3	3"	13.56
PVCMA4	4"	30.05

PVC Male Fitting Adapters (Spg x MIP)



Part #	Size	Price
PVCFMA112	1-1/2"	14.27
PVCFMA2	2"	15.94

PVC Soil Pipe (Caulk) Adapters (H x Spg)

Part #	Size	Price
PVCABU3	3"	23.89
PVCABU4	4"	11.53

PVC Flush Cleanout Plugs (MIP)



Part #	Size	Price
PVCFLPLUG3	3"	14.06
PVCFLPLUG4	4"	14.21

PVC Caps (Hub/Socket)

Part #	Size	Price
PVCCAP112	1-1/2"	7.48
PVCCAP2	2"	12.49

PVC DWV Fittings (Continued)

PVC Caps (Hub/Socket)

Part #	Size	Price
PVCCAP3	3"	21.60
PVCCAP4	4"	30.85
PVCCAP6	6"	77.90
PVCCAP8	8"	267.24

PVC Cast Iron Hub Adapters (H x SJ)

Part #	Size	Price
PVCSHA2-2	2"	18.33
PVCSHA3-3	3"	32.86
PVCSHA4-4	4"	52.85

PVC Cast Iron Hub Adapter (H x Spg)

Part #	Size	Price
PVCSHA4-3	4" x 3"	37.48

PVC Test Caps



Part #	Size	Price
PVCTCAP112	1-1/2"	4.13
PVCTCAP2	2"	3.72
PVCTCAP3	3"	4.53
PVCTCAP4	4"	5.67

PVC 90° Elbows (Hub)



Part #	Size	Price
PVC90114	1-1/4"	13.76
PVC90112	1-1/2"	3.77
PVC902	2"	5.96
PVC903	3"	17.55
PVC904	4"	34.59
PVC906	6"	121.40
PVC908	8"	221.30
PVC9010	10"	546.23

All Items May Not Be Stocked In All Branches

PVC DWV Pipe & Fittings

Plastic Pipe & Fittings

PVC 90° Vent Elbows (Hub)



Part #	Size	Price
PVCV90112	1-1/2"	8.03
PVCV902	2"	10.55
PVCV903	3"	27.37

PVC 90° Long Turn Elbows (Hub)



Part #	Size	Price
PVCLT90112	1-1/2"	9.06
PVCLT902	2"	9.80
PVCLT903	3"	23.09
PVCLT904	4"	44.10

PVC 90° Street Vent Elbows (Spg x H)



Part #	Size	Price
PVCVST90112	1-1/2"	8.13
PVCVST902	2"	12.62
PVCVST903	3"	32.39

PVC 90° Street Elbows (Spg x H)



Part #	Size	Price
PVCST90114	1-1/4"	19.49
PVCST90112	1-1/2"	5.05
PVCST902	2"	7.69
PVCST903	3"	19.45
PVCST904	4"	36.56
PVCST906	6"	169.12

PVC 90° Side Inlet Elbows (Hub)



Part #	Size	Price
PVCSO903-112	3" x 3" x 1-1/2"	48.44
PVCSO903-2	3" x 3" x 2"	35.80

PVC 45° Elbows (Hub)



Part #	Size	Price
PVC45114	1-1/4"	8.99
PVC45112	1-1/2"	3.70
PVC452	2"	5.33
PVC453	3"	15.70
PVC454	4"	27.55
PVC456	6"	111.12
PVC458	8"	198.77
PVC4510	10"	265.50

PVC 45° Street Elbows (Spg x H)



Part #	Size	Price
PVCST45114	1-1/4"	12.32
PVCST45112	1-1/2"	3.68
PVCST452	2"	5.66
PVCST453	3"	15.39
PVCST454	4"	26.31
PVCST456	6"	136.10
PVCST458	8"	215.73

PVC 22-1/2° Elbows (Hub)



Part #	Size	Price
PVC22112	1-1/2"	5.19
PVC222	2"	6.46
PVC223	3"	16.52
PVC224	4"	25.26
PVC226	6"	151.69

PVC 22-1/2° Street Elbows (Spg x H)



Part #	Size	Price
PVCST22112	1-1/2"	14.70
PVCST222	2"	15.73
PVCST223	3"	24.76
PVCST224	4"	36.12

Prices & Specifications are Subject to Change.

PVC DWV Pipe & Fittings

Plastic Pipe & Fittings

PVC DWV Fittings (Continued)

PVC 22-1/2° Street Elbows (Spg x H)

Part #	Size	Price
PVCST226	6"	146.96

PVC 60° Elbows (Hub)



Part #	Size	Price
PVC60112	1-1/2"	8.24
PVC602	2"	10.59
PVC603	3"	33.70
PVC604	4"	52.16

PVC 60° Street Elbows (Spg x H)

Part #	Size	Price
PVCST60112	1-1/2"	16.51
PVCST602	2"	21.54
PVCST603	3"	46.41
PVCST604	4"	67.51

PVC 45° Wyes (Hub)



Part #	Size	Price
PVCY114	1-1/4"	17.61
PVCY112	1-1/2"	12.90
PVCY2	2"	12.26
PVCY2-112-112	2" x 1-1/2" x 1-1/2"	17.29
PVCY2-112-2	2" x 1-1/2" x 2"	26.47
PVCY2-112	2" x 2" x 1-1/2"	15.05
PVCY3	3"	33.10
PVCY3-112	3" x 3" x 1-1/2"	21.65
PVCY3-2	3" x 3" x 2"	24.47
PVCY4	4"	60.02
PVCY4-112	4" x 4" x 1-1/2"	72.38
PVCY4-2	4" x 4" x 2"	36.13
PVCY4-3	4" x 4" x 3"	48.70
PVCY6	6"	181.19
PVCY6-3	6" x 6" x 3"	176.06
PVCY6-4	6" x 6" x 4"	133.15
PVCY8	8"	422.11
PVCY8-6	8" x 8" x 6"	318.69
PVCY10-8	10" x 10" x 8"	418.60

PVC 45° Street Wyes (Spg x H x H)

Part #	Size	Price
PVCSTY112	1-1/2"	21.79
PVCSTY2	2"	22.09
PVCSTY3	3"	46.95
PVCSTY3-112	3" x 3" x 1-1/2"	49.32
PVCSTY3-2	3" x 3" x 2"	38.21
PVCSTY4	4"	93.05
PVCSTY4-2	4" x 4" x 2"	106.22
PVCSTY4-3	4" x 4" x 3"	98.98

PVC Sanitary Tees (Hub)



Part #	Size	Price
PVCTY114	1-1/4"	13.81
PVCTY112	1-1/2"	6.84
PVCTY2	2"	10.06
PVCTY3	3"	26.44
PVCTY4	4"	46.97
PVCTY6	6"	195.96
PVCTY8	8"	586.46

PVC Reducing Sanitary Tees (Hub)



Part #	Size	Price
PVCTY2-112-112	2" x 1-1/2" x 1-1/2"	8.85
PVCTY2-112-2	2" x 1-1/2" x 2"	10.73
PVCTY2-112	2" x 2" x 1-1/2"	8.88
PVCTY3-112	3" x 3" x 1-1/2"	18.69
PVCTY3-2	3" x 3" x 2"	19.77
PVCTY4-112	4" x 4" x 1-1/2"	50.57
PVCTY4-2	4" x 4" x 2"	41.99
PVCTY4-3	4" x 4" x 3"	57.05
PVCTY6-4	6" x 6" x 4"	189.50

PVC Cleanout Tees with Plug (Hub)

Part #	Size	Price
PVCTT112	1-1/2"	17.29
PVCTT2	2"	19.96
PVCTT3	3"	38.15
PVCTT4	4"	66.35
PVCTT6	6"	329.37

All Items May Not Be Stocked In All Branches

PVC DWV Pipe & Fittings

PVC Street Tees (Spig x H x H)

Part #	Size	Price
PVCSTTY112	1-1/2"	20.65
PVCSTTY2	2"	20.05
PVCSTTY2-112	2" x 2" x 1-1/2"	17.48
PVCSTTY3	3"	33.43
PVCSTTY3-112	3" x 3" x 1-1/2"	38.04
PVCSTTY3-2	3" x 3" x 2"	33.02
PVCSTTY4	4"	87.28
PVCSTTY4-2	4" x 4" x 2"	58.67
PVCSTTY6	6"	131.27

PVC Cleanouts w/Plug (Spig x CO)



Part #	Size	Price
PVCCO112	1-1/2"	7.74
PVCCO2	2"	9.40
PVCCO3	3"	22.72
PVCCO4	4"	36.18
PVCCO6	6"	109.50

PVC Plugs (MIP)



Part #	Size	Price
PVCPLUG34	3/4"	1.80
PVCPLUG112	1-1/2"	3.32
PVCPLUG2	2"	3.69
PVCPLUG3	3"	6.61
PVCPLUG4	4"	9.73
PVCPLUG6	6"	32.41
PVCPLUG8	8"	164.34

PVC 45° Double Wyes (Hub)



Part #	Size	Price
PVCDBLY112	1-1/2"	27.94
PVCDBLY2	2"	32.27
PVCDBLY2-112	2" x 2" x 1-1/2" x 1-1/2"	28.48
PVCDBLY3	3"	65.62
PVCDBLY3-112	3" x 3" x 1-1/2" x 1-1/2"	51.95
PVCDBLY3-2	3" x 3" x 2" x 2"	48.89
PVCDBLY4	4"	133.11

PVC DWV Fittings (Continued)

PVC 45° Double Wyes (Hub)

Part #	Size	Price
PVCDBLY4-2	4" x 4" x 2" x 2"	79.80
PVCDBLY4-3	4" x 4" x 3" x 3"	105.40
PVCDBLY6-4	6" x 6" x 4" x 4"	353.57

PVC Double Sanitary Tees (Hub)



Part #	Size	Price
PVCDBLTY112	1-1/2"	15.20
PVCDBLTY2	2"	20.53
PVCDBLTY2-112	2" x 2" x 1-1/2" x 1-1/2"	15.51
PVCDBLTY3	3"	57.39
PVCDBLTY3-112	3" x 3" x 1-1/2" x 1-1/2"	32.95
PVCDBLTY3-2	3" x 3" x 2" x 2"	34.66
PVCDBLTY4	4"	92.30
PVCDBLTY4-2	4" x 4" x 2" x 2"	76.34
PVCDBLTY4-3	4" x 4" x 3" x 3"	78.33

PVC Double 90° Elbows (Hub)



Part #	Size	Price
PVCDBL90112	1-1/2"	15.41
PVCDBL902	2"	21.01
PVCDBL903	3"	55.50

PVC 90° Low Heel Inlet Elbows (Hub)



Part #	Size	Price
PVCHO903-112	3" x 3" x 1-1/2"	36.66
PVCHO903-2	3" x 3" x 2"	31.57
PVCHO904-2	4" x 4" x 2"	62.35

Plastic Pipe & Fittings

Prices & Specifications are Subject to Change.

PVC DWV Pipe & Fittings

Plastic Pipe & Fittings

PVC Sanitary Tees with 90° Left Inlet (Hub)



Part #	Size	Price
PVCLHSOTY3-2	3" x 3" x 3" x 2"	48.06
PVCLHSOTY4-2	4" x 4" x 4" x 2"	108.40

PVC Sanitary Tees with 90° Right Inlet (Hub)



Part #	Size	Price
PVCRHSOTY3-2	3" x 3" x 3" x 2"	48.06
PVCRHSOTY4-2	4" x 4" x 4" x 2"	108.40

PVC Return Bend (Hub)



Part #	Size	Price
PVCUB112	1-1/2"	11.67
PVCUB2	2"	20.05
PVCUB3	3"	60.77
PVCUB4	4"	110.37
PVCUB6	6"	89.87

PVC P-Trap (Hub)



Part #	Size	Price
PVCPT112	1-1/2"	13.11
PVCPT2	2"	17.68
PVCPT3	3"	59.96
PVCPT4	4"	136.72

PVC P-Traps w/Plug (H x H x CO)



Part #	Size	Price
PVCPTCO112	1-1/2"	21.65
PVCPTCO2	2"	36.71

PVC P-Traps w/Union Joint (H x SJ)



Part #	Size	Price
PVCLAPT112	1-1/2"	28.60

PVC P-Traps w/Union Joint (Hub)

Part #	Size	Price
PVCPTUNPL112	1-1/2"	16.78
PVCPTUNCP112	1-1/2" w/Chr Nut	25.09
PVCPTUN2	2"	36.41

PVC Drum Traps w/Cleanout (Hub)

Part #	Size	Price
PVCDT3-6-112	3" x 6" x 1-1/2"	53.09

PVC Closet Flanges (Hub)



Part #	Size	Price
PVCCF4	4"	19.03
PVCCF3	4" x 3"	15.39

PVC Fitting Closet Flanges (Spg)

Part #	Size	Price
PVCCFM3	4" x 3"	18.81

PVC Closet Flanges with KO Test Plug (Hub)

Part #	Size	Price
PVCCFKO4	4"	31.73
PVCCFKO3	4" x 3"	17.91

All Items May Not Be Stocked In All Branches

PVC DWV Pipe & Fittings

PVC Adj Closet Flanges with PVC Ring (Hub)

Part #	Size	Price
PVCCFPR3	4" x 3" w/KO	73.50

PVC Adj Closet Flanges with Metal Ring (Hub)



Part #	Size	Price
PVCCFMR4	4"	46.41
PVCCFMR3	4" x 3"	41.03

PVC Adj Ftg Closet Flanges with Metal Ring (Spg)

Part #	Size	Price
PVCCFMMR4	4"	47.84
PVCCFMMR3	4" x 3"	40.34

PVC Flush Closet Flanges (Hub)

- Fits over 3" pipe or inside 4" Pipe



Part #	Size	Price
PVCCFFLKO	4" x 4"/4" x 3" w/KO	28.65

PVC Offset Adj Closet Flanges (Hub)

With Metal Ring



Part #	Size	Price
PVCCFOMR3	4" x 3" w/Metal Ring	53.24
PVCCFO453	4" x 3"	10.50

PVC Type 1120 Pressure Pipe

PVC1120 Sch 80 Pressure Pipe (NSF-pw)

- ASTM D1785
- Potable water

PVC Sch 80 Plain End

Part #	Nom Pipe Size	Price
P80P12-20	1/2" x 20'	22.46
P80P34-20	3/4" x 20'	29.96
P80P1-20	1" x 20'	44.30
P80P114-20	1-1/4" x 20'	62.40
P80P112-20	1-1/2" x 20'	68.64
P80P2-20	2" x 20'	96.72
P80P212-20	2-1/2" x 20'	159.12

PVC Type 1120 Pressure Pipe (Continued)

PVC1120 Sch 80 Pressure Pipe (NSF-pw)

PVC Sch 80 Plain End

Part #	Nom Pipe Size	Price
P80P3-20	3" x 20'	177.84
P80P4-20	4" x 20'	281.42

PVC Sch 80 Fittings

PVC Tees (SOC)



Part #	Size	Price
P80T12	1/2"	8.85
P80T34	3/4"	9.28
P80T1	1"	11.61
P80T114	1-1/4"	31.89
P80T112	1-1/2"	31.89
P80T2	2"	39.87
P80T3	3"	54.19

PVC 90° Elbows (SOC)



Part #	Size	Price
P809012	1/2"	3.14
P809034	3/4"	4.01
P80901	1"	6.46
P8090114	1-1/4"	8.65
P8090112	1-1/2"	9.27
P80902	2"	11.20
P80903	3"	29.46
P80904	4"	44.80

PVC 45° Elbows (SOC)



Part #	Size	Price
P804512	1/2"	5.91
P804534	3/4"	9.03

Plastic Pipe & Fittings

Prices & Specifications are Subject to Change.

PVC Sch 80 Pipe & Fittings

Plastic Pipe & Fittings

PVC Sch 80 Fittings (Continued)
PVC 45° Elbows (SOC)

Part #	Size	Price
P80451	1"	13.54
P8045114	1-1/4"	17.24
P8045112	1-1/2"	20.39
P80452	2"	26.44
P80453	3"	67.55

PVC Couplings (SOC)



Part #	Size	Price
P80CPLG12	1/2"	5.68
P80CPLG34	3/4"	7.69
P80CPLG1	1"	7.90
P80CPLG114	1-1/4"	12.04
P80CPLG112	1-1/2"	12.98
P80CPLG2	2"	13.94
P80CPLG3	3"	39.39
P80CPLG4	4"	49.33

PVC Female Adapters (SOC x FIP)



Part #	Size	Price
P80FEA12	1/2"	5.32
P80FEA34	3/4"	7.90
P80FEA1	1"	11.65
P80FEA114	1-1/4"	18.87
P80FEA112	1-1/2"	23.13
P80FEA2	2"	40.36

PVC Male Adapters (SOC x MIP)



Part #	Size	Price
P80MA12	1/2"	6.64
P80MA34	3/4"	7.32
P80MA1	1"	12.67
P80MA114	1-1/4"	14.82
P80MA112	1-1/2"	21.29
P80MA2	2"	30.79

PVC Flush Style Reducer Bushings (Spg x SOC)



Part #	Size	Price
P80BU34-12	3/4" x 1/2"	1.83
P80BU1-12	1" x 1/2"	5.24
P80BU1-34	1" x 3/4"	5.24
P80BU114-34	1-1/4" x 3/4"	8.22
P80BU114-1	1-1/4" x 1"	8.22
P80BU112-34	1-1/2" x 3/4"	11.20
P80BU112-1	1-1/2" x 1"	11.20
P80BU112-114	1-1/2" x 1-1/4"	11.20
P80BU2-12	2" x 1/2"	15.97
P80BU2-34	2" x 3/4"	15.97
P80BU2-1	2" x 1"	15.97
P80BU2-114	2" x 1-1/4"	15.97
P80BU2-112	2" x 1-1/2"	15.97
P80BU3-2	3" x 2"	43.99

PVC Flush Style Reducer Bushings (Spg x FIP)



Part #	Size	Price
P80BUS34-12	3/4" x 1/2"	3.32
P80BUS1-12	1" x 1/2"	5.24
P80BUS114-12	1-1/4" x 1/2"	9.41
P80BUS114-1	1-1/4" x 1"	10.65
P80BUS112-34	1-1/2" x 3/4"	13.34
P80BUS112-1	1-1/2" x 1"	13.34
P80BUS2-34	2" x 3/4"	16.32
P80BUS2-1	2" x 1"	16.32
P80BUS2-114	2" x 1-1/4"	16.32
P80BUS2-112	2" x 1-1/2"	16.32

PVC Cap (SOC)



Part #	Size	Price
P80CAP12	1/2"	5.56
P80CAP34	3/4"	5.86
P80CAP1	1"	10.41
P80CAP114	1-1/4"	12.56
P80CAP112	1-1/2"	12.56

All Items May Not Be Stocked In All Branches

PVC Sch 80 Pipe & Fittings

PVC Sch 80 Fittings (Continued)

PVC Cap (SOC)

Part #	Size	Price
P80CAP2	2"	24.80

PVC Schedule 80 Unions

**PVC 2000 Unions (SOC)
with Viton® O-Ring Seal**

- 235 psi Max internal pressure rating @ 73°F



Part #	Size	Price
P80UNG12	1/2"	11.48
P80UNG34	3/4"	14.61
P80UNG1	1"	16.72
P80UNG114	1-1/4"	33.15
P80UNG112	1-1/2"	37.51
P80UNG2	2"	50.89

White PVC Union (SOC)

Part #	Size	Price
P80UN12	1/2"	2.66
P80UN34	3/4"	3.50
P80UN1	1"	4.50
P80UN114	1-1/4"	8.02
P80UN112	1-1/2"	10.13
P80UN2	2"	14.09

PVC DWV Foam Core Pipe



Part #	Nom Pipe Size	Price
PVFP112-10	1-1/2" x 10'	10.24
PVFP112-20	1-1/2" x 20'	20.48
PVFP2-10	2" x 10'	13.38
PVFP2-20	2" x 20'	26.76
PVFP3-10	3" x 10'	24.86
PVFP3-20	3" x 20'	49.73
PVFP4-10	4" x 10'	35.52
PVFP4-20	4" x 20'	71.04
PVFP6-20	6" x 20'	153.33

CPVC Pipe



CPVC CTS Pipe

Part #	Size	Price
CPVP12-10	1/2" x 10'	7.09
CPVP34-10	3/4" x 10'	12.79
CPVP34-20	3/4" x 20'	25.56
CPVP1-20	1" x 20'	55.52
CPVP114-10	1-1/4" x 10'	50.02
CPVP112-20	1-1/2" x 20'	130.72
CPVP2-20	2" x 20'	209.02

CPVC/CTS Fittings

CPVC Male Adapters (Slip x MIP)



Part #	Size	Price
CPVMA12	1/2"	1.36
CPVMA34	3/4"	2.32
CPVMA1	1"	10.38
CPVMA114	1-1/4"	16.99

CPVC Female Adapters (Slip x FIP)

- With washer



Part #	Size	Price
CPVFEA12	1/2"	4.58
CPVFEA34	3/4"	6.46

CPVC Couplings (Slip x Slip)



Part #	Size	Price
CPVCPLG12	1/2"	1.08
CPVCPLG34	3/4"	1.35
CPVCPLG34-12	3/4" x 1/2"	2.51
CPVCPLG1	1"	6.06
CPVCPLG1-34	1" x 3/4"	7.58
CPVCPLG114	1-1/4"	8.28
CPVCPLG112	1-1/2"	CALL
CPVCPLG2	2"	21.09

Plastic Pipe & Fittings

Prices & Specifications are Subject to Change.

CPVC Pipe & Fittings

Plastic Pipe & Fittings

CPVC 90° Elbow (Slip x Slip)



Part #	Size	Price
CPV9012	1/2"	1.24
CPV9034	3/4"	2.04
CPV9034-12	3/4" x 1/2"	4.71
CPV901	1"	5.97
CPV90112	1-1/2"	CALL
CPV902	2"	41.12

CPVC 90° Street Elbow (Spg x Slip)



Part #	Size	Price
CPVST9012	1/2"	1.55
CPVST9034	3/4"	2.42
CPVST901	1"	CALL

CPVC 90° Drop Ear Elbow (Slip x Slip)



Part #	Size	Price
CPVDE9012	1/2"	3.90

CPVC 90° Drop Ear Elbow (Slip x FIP)

- Includes washer



Part #	Size	Price
CPVFEDE9012	1/2"	5.43

CPVC/Brass 90° Drop Ear Elbow (Brs FIP x CPVC Hub)



Part #	Size	Price
CPVBFEDE9012	1/2"	23.21
CPVBFEDE9034	3/4"	23.00

CPVC 45° Elbow (Slip x Slip)



Part #	Size	Price
CPV4512	1/2"	1.66
CPV4534	3/4"	2.88
CPV451	1"	6.91

CPVC 45° Street Elbow (Spg x Slip)

Part #	Size	Price
CPVST4512	1/2"	3.33
CPVST4534	3/4"	4.72
CPVST451	1"	13.56

CPVC Tee (Slip x Slip x Slip)



Part #	Size	Price
CPVT12	1/2"	1.68
CPVT34	3/4"	2.96
CPVT34-12-12	3/4" x 1/2" x 1/2"	3.08
CPVT34-12-34	3/4" x 1/2" x 3/4"	4.22
CPVT34-12	3/4" x 3/4" x 1/2"	3.25
CPVT1	1"	15.63
CPVT1-12	1" x 1/2"	17.76
CPVT1-34	1" x 3/4"	16.95
CPVT114	1-1/4"	23.99
CPVT112	1-1/2"	31.25
CPVT112-112-12	1-1/2" x 1/2"	46.64
CPVT112-112-34	1-1/2" x 3/4"	38.90
CPVT112-112-1	1-1/2" x 1"	35.60
CPVT2	2"	50.52
CPVT2-2-34	2" x 3/4"	53.49
CPVT2-2-1	2" x 1"	50.69
CPVT2-2-112	2" x 1-1/2"	57.16

CPVC Cap (Slip)



Part #	Size	Price
CPVCAP12	1/2"	1.12
CPVCAP34	3/4"	1.50
CPVCAP1	1"	5.48
CPVCAP112	1-1/2"	11.98
CPVCAP2	2"	24.18

All Items May Not Be Stocked In All Branches

CPVC Pipe & Fittings

Plastic Pipe & Fittings

CPVC Reducer Bushing (Spig x Slip)



Part #	Size	Price
CPVBU34-12	3/4" x 1/2"	1.63
CPVBU1-12	1" x 1/2"	5.34
CPVBU1-34	1" x 3/4"	5.34
CPVBU114-1	1-1/4" x 1"	6.06
CPVBU112-34	1-1/2" x 3/4"	9.02
CPVBU112-1	1-1/2" x 1"	8.55
CPVBU112-114	1-1/2" x 1-1/4"	8.55
CPVBU2-12	2" x 1/2"	21.41
CPVBU2-34	2" x 3/4"	19.99
CPVBU2-1	2" x 1"	19.31
CPVBU2-114	2" x 1-1/4"	22.75
CPVBU2-112	2" x 1-1/2"	19.31

Plastic Strap for CPVC



Part #	Size	Price
CPVSTRAP12	1/2"	0.60
CPVSTRAP34	3/4"	0.83

CPVC Brass Threaded Male Adapter (Brass MPT x Hub)



Part #	Size	Price
CPVBMA12	1/2"	15.86
CPVBMA34	3/4"	21.57
CPVBMA1	1"	40.96
CPVBMA112	1-1/2"	159.73
CPVBMA2	2"	239.59

CPVC Brass Threaded Female Adapter (Brass FPT x Hub)



Part #	Size	Price
CPVFEAB12	1/2"	38.67
CPVFEAB34	3/4"	45.35
CPVBFEA1	1"	40.96

Copper Transition Female Adapter (CPVC Slip x Brs FIP)

Part #	Size	Price
CPVBFEA12	1/2"	20.55
CPVBFEA34	3/4"	25.60

Brass Transition Union (CPVC Slip x Brs SWT)



Part #	Size	Price
CPVUN12	1/2"	23.84
CPVUN34	3/4"	46.09

Brass Transition Union (CPVC Slip x Brs FIP)



Part #	Size	Price
CPVFEUN12	1/2"	39.52
CPVFEUN34	3/4"	67.61

**CPVC Schedule 80 Industrial Fittings
CPVC Sch 80 90° Elbows (SOC)**



Part #	Size	Price
CPV80902	2"	33.87
CPV80903	3"	88.30

CPVC Sch 80 Coupling (SOC)



Part #	Size	Price
CPV80CPLG2	2"	24.99
CPV80CPLG3	3"	60.47

Prices & Specifications are Subject to Change.

CPVC Pipe & Fittings

Plastic Pipe & Fittings

CPVC Sch 80 Flush Style Reducer Bushings (Spg x SOC)



Part #	Size	Price
CPV80BU3-2	3" x 2"	72.18

CPVC Schedule 80 Unions

CPVC Sch 80 Unions (SOC) with Viton® O-Ring Seal



Part #	Size	Price
CPVCUN12	1/2"	5.29
CPVCUN34	3/4"	6.33



Dual Wall Pipe

Dual Wall SDR38 Solid Pipe

- Solid polyethylene sewer drain pipe



Part #	Mfg #	Size	Price
SEDPS4-10POLY	04560010	4" x 10'	15.76
SEDPS6-10POLY	06560010	6" x 10'	39.70

Dual Wall SDR38 Perforated Pipe

- Perforated polyethylene sewer drain pipe
- 2-Hole, 120°

Part #	Mfg #	Size	Price
SEDPP4-10POLY	04570010	4" x 10'	15.76
SEDPP6-10POLY	06570010	6" x 10'	39.70

PVC Sewer and Drain Pipe

PVC ASTM D-2729 Sewer & Drain Pipe

Part #	Mfg #	Nom Pipe Size	Type	Price
SEDPS3-10		3" x 10'	Solid	13.52
SEDPS4-10		4" x 10'	Solid	14.92
SEDPP4-10		4" x 10'	Perforated	14.92
SEDPS6-10		6" x 10'	Solid	29.00
SEDPP6-10		6" x 10'	Perforated	29.00



PVC Sewer and Drain Pipe

PVC SDR 35 Solvent Weld Pipe

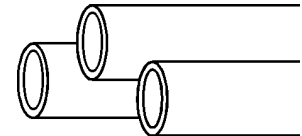

Part #	Mfg #	Nom Pipe Size	Price
SMSP4-10	P4-10	4" x 10' Solid	25.16
SMSP4-10	PP4-10	4" x 10' Perf	24.56
SMSP6-10	P6-10	6" x 10' Solid	53.87



PVC Solvent Weld SDR 35 (ASTM D-3034)

PVC SDR 35 Straight Tee SW (H x H x H)



Part #	Mfg #	Size	Type	Price
SMST4	P104	4"	Molded Fitting	8.54
SMST6-4	P116	6" x 4"	Molded Fitting	33.99
SMST6	P106	6"	Molded Fitting	33.32

PVC SDR 35 Pipe & Fittings

PVC SDR 35 Sanitary Tee (TY) SW (H x H x H)



Part #	Mfg #	Size	Type	Price
SMSTY4	P156	4"	Molded Fitting	13.13
SMSTY6-4	P157-4	6" x 4"	Molded Fitting	68.17
SMSTY6	P157	6"	Molded Fitting	90.08

PVC SDR 35 1/4 Bend (90°) SW (H x H)



Part #	Mfg #	Size	Type	Price
SMSSW904	P204	4"	Molded Fitting	7.23
SMSSW906	P206	6"	Molded Fitting	22.75

PVC SDR 35 Vent 1/4 Bend (90°) SW (H x H)

Part #	Mfg #	Size	Price
SMSV904	V204	4"	7.23

PVC SDR 35 1/4 Bend (90°) SW (H x S)



Part #	Mfg #	Size	Type	Price
SMSSWST906	P226	6"	Molded Fitting	46.45

PVC SDR 35 Long Turn 1/4 (90°) Bend SW (H x H)



Part #	Mfg #	Size	Type	Price
SMS904	P256	4"	Molded Fitting	8.54

PVC SDR 35 Long Turn 1/4 (90°) Bend SW (H x S)



Part #	Mfg #	Size	Type	Price
SMSST904	P274	4"	Molded Fitting	10.02

PVC SDR 35 45° Wye SW (H x H x H)



Part #	Mfg #	Size	Type	Price
SMSY4	P304	4"	Molded Fitting	11.35
SMSY6-4	P316	6" x 4"	Molded Fitting	41.95
SMSY6	P306	6"	Molded Fitting	48.14

PVC SDR 35 1/8 Bend (45°) SW (H x H)



Part #	Mfg #	Size	Type	Price
SMS454	P504	4"	Molded Fitting	6.22
SMS456	P506	6"	Molded Fitting	24.45

PVC SDR 35 1/8 Bend (45°) SW (H x S)



Part #	Mfg #	Size	Type	Price
SMSST454	P404	4"	Molded Fitting	8.41
SMSST456	P406	6"	Molded Fitting	31.31

PVC SDR 35 1/16 Bend (22-1/2°) SW (H x H)



Part #	Mfg #	Size	Type	Price
SMS224	P1704	4"	Molded Fitting	6.82
SMS226	P1706	6"	Molded Fitting	29.88

Plastic Pipe & Fittings

Prices & Specifications are Subject to Change.

PVC SDR 35 Pipe & Fittings

Plastic Pipe & Fittings

PVC SDR 35 1/16 Bend (22-1/2°) SW (H x S)



Part #	Mfg #	Size	Type	Price
SMSST224	P1714	4"	Molded Fitting	8.41
SMSST226	P1716	6"	Molded Fitting	34.86

PVC SDR 35 Coupling SW (H x H)



Part #	Mfg #	Size	Type	Price
SMSCPLG4	P604	4"	Molded Fitting	4.11
SMSCPLG6	P606	6"	Molded Fitting	15.01

PVC SDR 35 Reducer Coupling SW (H x H)



Part #	Mfg #	Size	Type	Price
SMSCPLG4-3	P654	4" x 3"	Molded Fitting	7.76
SMSCPLG6-4	P661	6" x 4"	Molded Fitting	19.98

PVC SDR 35 Drain Grate SW



Part #	Mfg #	Size	Type	Price
SMSDG4	P911	4"	Molded Fitting	6.77
SMSDG6	P916	6"	Molded Fitting	27.32

PVC SDR 35 Threaded Plug SW



Part #	Mfg #	Size	Type	Price
SMSPLUG4	P1154	4"	Molded Fitting	4.96
SMSPLUG6	P1156	6"	Molded Fitting	24.96

PVC SDR 35 DWV Bushing SW (Sewer Spgt x DWV H)



Part #	Mfg #	Size	Type	Price
SMSBU4-112	P1204	4" x 1-1/2"	Molded Fitting	14.05
SMSBU4-2	P1205	4" x 2"	Molded Fitting	14.04

PVC SDR 35 Reducer Bushing SW (S x H)



Part #	Mfg #	Size	Type	Price
SMSBU6-4	P1216	6" x 4"	Molded Fitting	19.55

PVC SDR 35 Adapter SW (DWV Spgt x Sewer H)



Part #	Mfg #	Size	Type	Price
SMSACPLG4	P1208	4"	Molded Fitting	7.83

PVC SDR 35 Female Adapter SW (H x FIP)



Part #	Mfg #	Size	Type	Price
SMSFEA4	P1404	4"	Molded Fitting	8.18
SMSFEA6	P1406	6"	Molded Fitting	38.63

PVC SDR 35 Fitting Cleanout SW (Spgt x FIP)



Part #	Mfg #	Size	Type	Price
SMSCOA4	P1504	4"	Molded Fitting	6.41
SMSCOA6	P1506	6"	Molded Fitting	40.03

PVC SDR 35 Cap SW



Part #	Mfg #	Size	Type	Price
SMSCAP4	P1604	4"	Molded Fitting	3.60
SMSCAP6	P1606	6"	Molded Fitting	13.16

PVC SDR 35 Downspout Adapter



Part #	Mfg #	Size	Type	Price
SMSDSA2-3-4	P1904	2" x 3" x 4"	Molded Fitting	8.41
SMSDSA3-4-4	P1906	3" x 4" x 4"	Molded Fitting	13.33

* Last dimension is the pipe dimension

All Items May Not Be Stocked In All Branches

PVC SDR 35 Pipe & Fittings

**PVC SDR 35 Downspout Adapter
(Flush Mount Downspout x Sewer H)**



Part #	Mfg #	Size	Price
SMSDSAO2-3-4	P1924	2" x 3" x 4"	6.38
SMSDSAO4-6-6	P1928	4" x 6" x 6"	36.71

* Last dimension is the pipe dimension

**PVC Sewer and Drain Pipe
PVC SDR 35 Gasketed Sewer & Drain Pipe**

Part #	Mfg #	Nom Pipe Size	Price
SMGP4-14	P4-14	4" x 14'	33.70
SMGP6-14	P6-14	6" x 14'	77.95
SMGP8-14	P8-14	8" x 14'	145.45
SMGP10-14	P10-14	10" x 14'	211.34



**STI™ PVC Gasketed SDR 35
(ASTM D-3034)**

**STI™ PVC SDR 35 Straight Tee Gasketed
(G x G x G)**



Part #	Mfg #	Size	Price
SMGT4	G104	4"	27.60
SMGT6-4	G106-4	6" x 4"	57.87
SMGT6	G106	6"	59.16

**STI™ PVC SDR 35 Sanitary Tee (TY) Gasketed
(G x G x G)**



Part #	Mfg #	Size	Price
SMGTY4	G156	4"	32.80
SMGTY6-4	G157-4	6" x 4"	70.99
SMGTY6	G157	6"	82.78
SMGTY8-4	G158-4	8" x 4"	89.93
SMGTY8-6	G158-6	8" x 6"	103.41
SMGTY8	G158	8"	254.52

**STI™ PVC SDR 35 1/4 Bend (90°) Gasketed
(G x G)**



Part #	Mfg #	Size	Price
SMGSW146	G206	6"	39.45
SMGSW148	G208	8"	109.11

**STI™ PVC SDR 35 1/4 Bend (90°) Gasketed
(G x S)**



Part #	Mfg #	Size	Price
SMGSWST146	G226	6"	41.70
SMGSWST148	G228	8"	112.60

**STI™ PVC SDR 35 Long Turn 1/4 Bend (90°)
Gasketed (G x G)**



Part #	Mfg #	Size	Price
SMG144	G256	4"	31.13
SMG146	G257	6"	92.35

Plastic Pipe & Fittings

PVC Gasketed SDR 35 Pipe & Fittings

Plastic Pipe & Fittings

STI™ PVC SDR 35 Long Turn 1/4 Bend (90°) Gasketed (G x S)



Part #	Mfg #	Size	Price
SMGST144	G274	4"	28.01
SMGST146	G277	6"	102.89

STI™ PVC SDR 35 1/8 (45°) Bend Gasketed (S x G)



Part #	Mfg #	Size	Price
SMGST184	G404	4"	15.33
SMGST186	G406	6"	30.65
SMGST188	G408	8"	92.49

STI™ PVC SDR 35 45° Wye Gasketed (G x G x G)



Part #	Mfg #	Size	Price
SMGY4	G304	4"	29.38
SMGY6-4	G306-4	6" x 4"	59.59
SMGY6	G306	6"	67.47
SMGY8-4	G308-4	8" x 4"	88.91
SMGY8-6	G308-6	8" x 6"	106.03
SMGY8	G308	8"	184.86

STI™ PVC SDR 35 1/16 Bend (22-1/2°) Gasketed (G x G)



Part #	Mfg #	Size	Price
SMG1164	G1704	4"	17.02
SMG1166	G1706	6"	33.53
SMG1168	G1708	8"	97.67

STI™ PVC SDR 35 45° Wye Gasketed (G x S x G)



Part #	Mfg #	Size	Price
SMGYS4	G324	4"	43.32

STI™ PVC SDR 35 1/16 Bend (22-1/2°) Gasketed (G x S)



Part #	Mfg #	Size	Price
SMGST1164	G1714	4"	16.19
SMGST1166	G1716	6"	31.83
SMGST1168	G1718	8"	102.07

STI™ PVC SDR 35 1/8 (45°) Bend Gasketed (G x G)



Part #	Mfg #	Size	Price
SMG184	G504	4"	17.04
SMG186	G506	6"	34.59
SMG188	G508	8"	96.82

STI™ PVC SDR 35 Stop Coupling Gasketed (G x G)



Part #	Mfg #	Size	Price
SMGCPLG4	G604	4"	21.06
SMGCPLG6	G606	6"	42.09

STI™ PVC SDR 35 Concentric Increaser Coupling Gasketed (G x G)



Part #	Mfg #	Size	Price
SMGCPLG6-4	G606-4	6" x 4"	60.44

All Items May Not Be Stocked In All Branches

PVC Gasketed SDR 35 Pipe & Fittings

**STI™ SDR 35 Adapter Gasketed
(Sewer Spgt x S/W DWV H)**



Part #	Mfg #	Size	Price
SMGADCPLG4	G944	4"	19.98
SMGADCPLG6	G946	6"	57.44

STI™ PVC SDR 35 Spigot Plug Gasketed



Part #	Mfg #	Size	Price
SMGPLUG4	G1164	4"	8.30
SMGPLUG6	G1166	6"	12.73

**STI™ PVC SDR 35 Adapter Gasketed
(DWV Spgt x Sewer Gasket H)**



Part #	Mfg #	Size	Price
SMGACPLG4	G1208	4"	38.12

**STI™ PVC SDR 35 Short Pattern Increaser Bushing
Gasketed (S x G)**



Part #	Mfg #	Size	Price
SMGINC6-4	G1216	6" x 4"	30.65
SMGINC8-6	G1220	8" x 6"	93.78

**STI™ PVC SDR 35 Eccentric Increaser Bushing
Gasketed (S x G)**



Part #	Mfg #	Size	Price
SMGEINC6-4	G1306-4	6" x 4"	32.17

STI™ PVC SDR 35 Cap Gasketed



Part #	Mfg #	Size	Price
SMGCAP4	G1604	4"	11.01
SMGCAP6	G1606	6"	20.62
SMGCAP8	G1608	8"	55.66

CHARLOTTE
PIPE AND FOUNDRY COMPANY

**PVC Water Main Pipe
PVC SDR-21 Gasket End**



Part #	Nom Pipe Size	Price
PWMP2-20	2" x 20'	18.58
PWMP4-20	4" x 20'	69.10

Plastic Pipe & Fittings

THANK YOU!
**We appreciate
your business**

Prices & Specifications are Subject to Change.

Cast Iron Soil Pipe & Fittings

Cast Iron Service-Weight Soil Pipe

Cast Iron Service Weight Single-Hub Soil Pipe - 10' Lengths

Part #	Mfg #	Size	Price
SEWPSH2-10	00869	2" x 10'	109.00
SEWPSH3-10	00870	3" x 10'	150.40
SEWPSH4-10	00871	4" x 10'	195.50
SEWPSH6-10	00873	6" x 10'	335.90

Cast Iron Service Weight Single-Hub Soil Pipe - 5' Lengths

Part #	Mfg #	Size	Price
SEWPSH2-5	00851	2" x 5'	107.70
SEWPSH3-5	00852	3" x 5'	113.70
SEWPSH4-5	00853	4" x 5'	132.00
SEWPSH6-5	00855	6" x 5'	249.60

Cast Iron Service Weight Single-Hub Soil Pipe - 42" Lengths

Part #	Mfg #	Size	Price
SEWPSH4-42		4" x 42"	47.06

Cast Iron Service Weight Double-Hub Soil Pipe - 5' Lengths

Part #	Mfg #	Size	Price
SEWPDH2-5	00864	2" x 5'	113.90
SEWPDH3-5	00865	3" x 5'	127.00
SEWPDH4-5	00866	4" x 5'	144.60
SEWPDH6-5	00868	6" x 5'	263.70

Cast Iron Service-Weight Soil Fittings

Cast Iron Single-Hub Service-Weight Soil 1/4 Bend

Part #	Mfg #	Size	Price
SEW142	00881	2"	26.00
SEW143	00882	3"	34.70
SEW144	00883	4"	54.30
SEW146	00885	6"	94.50

Cast Iron Single-Hub Service-Weight Soil 1/8 Bend

Part #	Mfg #	Size	Price
SEW182	00901	2"	18.50
SEW183	00902	3"	29.00
SEW184	00903	4"	42.50

Cast Iron Service-Weight Soil Fittings (Continued)

Cast Iron Single-Hub Service-Weight Soil 1/8 Bend

Part #	Mfg #	Size	Price
SEW186	00905	6"	71.80

Cast Iron Single-Hub Service-Weight Soil 1/16 Bend

Part #	Mfg #	Size	Price
SEW1164	00912	4"	37.10

Cast Iron Service-Weight Single-Hub Soil Wye

Part #	Mfg #	Size	Price
SEWY2	01134	2"	33.10
SEWY3	01136	3"	61.40
SEWY4-2	01137	4" x 2"	61.40
SEWY4-3	01138	4" x 3"	70.40
SEWY4	01139	4"	82.20
SEWY4	01108	4"	71.80
SEWY6-4	01146	6" x 4"	127.40
SEWY6	01148	6"	162.20

Cast Iron Service-Weight Soil Combination Wye & 45° Elbow (Long Turn Pattern)

Part #	Mfg #	Size	Price
SEWCY184	01002	4"	95.20

Cast Iron Service-Weight Soil P-Trap

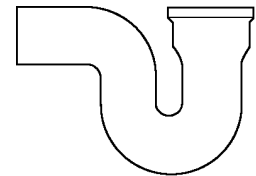

Part #	Mfg #	Size	Price
SEWPT3	01605	3"	61.80
SEWPT4	01606	4"	89.10

Cast Iron Service-Weight Running Trap with Single-Hub Vent

Part #	Mfg #	Size	Price
SEWSHVT4	01617	4" x 4"	188.20
SEWSHVT6-4	01619	6" x 4"	807.30
SEWSHVT6		6" x 6"	451.14

All Items May Not Be Stocked In All Branches

Cast Iron Pipe & Fittings

Cast Iron Soil Pipe & Fittings

Cast Iron Service-Weight Reducer

Part #	Mfg #	Size	Price
SEWRED3-2	01478	3" x 2"	25.50
SEWRED4-3	01480	4" x 3"	33.10

Cast Iron Service-Weight Pipe Plug

Part #	Mfg #	Size	Price
SEWPLUG4	01554	4"	22.70

Lubricants



Adhesive



Regular

Part #	Mfg #	Description	Price
SEWLUBEFAST	LUB910AQ	Quart Adhesive Lube	37.40
SEWLUBE	LUB910Q	Quart Regular Lube	7.89

Quik-Tite Gaskets

- For service weight soil pipe



Part #	Mfg #	Size	Price
SEWGSKT2	01868	2"	8.60
SEWGSKT3	01869	3"	11.30
SEWGSKT4	01870	4"	14.30
SEWGSKT6	01871	6"	22.90
SEWGSKT8	01872	8"	50.50

Cast Iron No-Hub Soil Pipe

Cast Iron No-Hub Soil Pipe - 10' Lengths

Part #	Size	Price
NOHP112-10	1-1/2" x 10'	98.40
NOHP2-10	2" x 10'	98.80
NOHP3-10	3" x 10'	136.30
NOHP4-10	4" x 10'	177.00
NOHP6-10	6" x 10'	304.30
NOHP8-10	8" x 10'	474.00

Cast Iron No-Hub Soil Fittings

Cast Iron No-Hub Soil 1/4 Bends

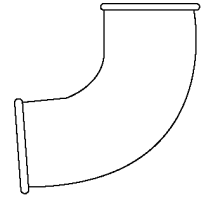

Part #	Mfg #	Size	Price
NOH14112	00136	1-1/2"	13.40
NOH142	00137	2"	14.50
NOH143	00141	3"	20.30
NOH144	00146	4"	30.10
NOH146	00149	6"	72.70

Cast Iron No-Hub Soil 1/8 Bends

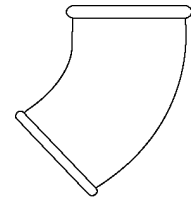

Part #	Mfg #	Size	Price
NOH18112	00169	1-1/2"	11.30
NOH182	00170	2"	12.50
NOH183	00173	3"	16.80
NOH184	00176	4"	22.00
NOH186	00179	6"	48.80

Cast Iron No-Hub Soil 1/16 Bends

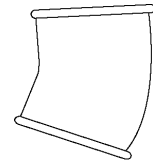

Part #	Mfg #	Size	Price
NOH1162	00183	2"	12.80
NOH1163	00184	3"	14.90
NOH1164	00185	4"	19.70

Cast Iron No-Hub Soil Sanitary Tees

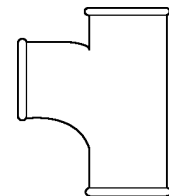

Part #	Mfg #	Size	Price
NOHTY112	00301	1-1/2"	18.80
NOHTY2-112	00308	2" x 1-1/2"	17.86
NOHTY2	00302	2"	20.00
NOHTY3-112	00309	3" x 1-1/2"	15.04
NOHTY3-2	00310	3" x 2"	21.90

Cast Iron Pipe & Fittings

Prices & Specifications are Subject to Change.

Cast Iron No-Hub Soil Pipe & Fittings

**Cast Iron No-Hub Soil Fittings
(Continued)**

Cast Iron No-Hub Soil Sanitary Tees

Part #	Mfg #	Size	Price
NOHTY3	00303	3"	24.80
NOHTY4-2	00312	4" x 2"	31.50
NOHTY4-3	00313	4" x 3"	36.10
NOHTY4	00304	4"	46.80
NOHTY6	00306	6"	111.80

Cast Iron No-Hub Soil Wyes

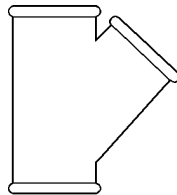

Part #	Mfg #	Size	Price
NOHY112	00207	1-1/2"	19.00
NOHY2	00208	2"	18.60
NOHY3-2	00216	3" x 2"	20.00
NOHY3	00209	3"	27.10
NOHY4-2	00217	4" x 2"	28.90
NOHY4-3	00218	4" x 3"	37.60
NOHY4	00210	4"	43.20
NOHY6-3	00224	6" x 3"	89.40
NOHY6-4	00223	6" x 4"	92.00
NOHY6	00212	6"	115.20

Cast Iron No-Hub Soil Double Wyes

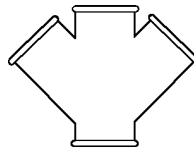

Part #	Mfg #	Size	Price
NOHDBLY3	00235	3"	54.30
NOHDBLY4-2	00242	4" x 2"	61.20
NOHDBLY4-3	00243	4" x 3"	69.20
NOHDBLY4	00236	4"	110.60

Cast Iron No-Hub Tapped Wye

Part #	Mfg #	Size	Price
NOHTPTY2-112	00295	2" x 1-1/2"	21.90
NOHTPTY2-2	04421	2" x 2"	25.20

Cast Iron No-Hub Soil Sanitary Crosses

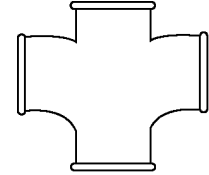

Part #	Mfg #	Size	Price
NOHDBLTY3-2	00332	3" x 2"	47.10
NOHDBLTY3	00328	3"	52.80
NOHDBLTY4-2	00334	4" x 2"	67.20
NOHDBLTY4-3	00335	4" x 3"	81.20
NOHDBLTY4	00329	4"	99.90

Cast Iron No-Hub Soil Test Tees with Type A Brass Plug

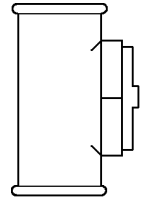

Part #	Mfg #	Size	Price
NOHTT2	00473	2" - 2"	12.37
NOHTT3	00474	3" - 3"	20.36
NOHTT4	00475	4" - 4"	33.18

Cast Iron No-Hub Soil Short Reducers

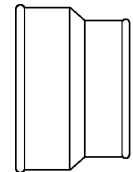

Part #	Mfg #	Size	Price
NOHRED2-112	00494	2" x 1-1/2"	10.50
NOHRED3-2	00496	3" x 2"	10.30
NOHRED4-2	00497	4" x 2"	15.90
NOHRED4-3	00498	4" x 3"	15.90
NOHRED6-4	00504	6" x 4"	42.70

Cast Iron No-Hub Soil Blind Plugs

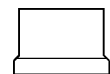

Part #	Mfg #	Size	Price
NOHPLUG2	00562	2"	4.35
NOHPLUG3	00563	3"	6.53
NOHPLUG4	00564	4"	10.06
NOHPLUG6	00566	6"	31.90

All Items May Not Be Stocked In All Branches

Cast Iron No-Hub Soil Pipe & Fittings

Cast Iron No-Hub Soil P-Traps

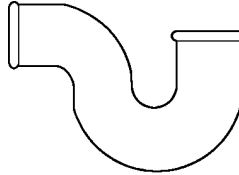

Part #	Mfg #	Size	Price
NOHPT2	00515	2"	21.20
NOHPT3	00516	3"	46.50
NOHPT4	00517	4"	82.40

Cast Iron No-Hub Running Trap with Vent

Part #	Mfg #	Size	Price
NOHSHVT4	00545	4"	139.50

NH 1 Stainless Steel No-Hub Coupling

Part #	Mfg #	Size	Price
NOHCPLG112	00097	1-1/2"	7.89
NOHCPLG2-112	00099	2" x 1-1/2"	9.21
NOHCPLG2	00098	2"	7.89
NOHCPLG3	00100	3"	9.43
NOHCPLG4-3	00103	4" x 3"	17.01
NOHCPLG4	00102	4"	11.15
NOHCPLG6	00105	6"	28.25
NOHCPLG8	00106	8"	53.33

Heavy Duty 4000 Stainless Steel No-Hub Coupling

Part #	Mfg #	Size	Price
NOHCPLGHW112	11512	1-1/2"	14.90
NOHCPLGHW2	11513	2"	14.95
NOHCPLGHW3	11514	3"	18.40
NOHCPLGHW4	11515	4"	21.35
NOHCPLGHW6	11517	6"	50.50

**Refer to the Branch listings
in the front of this book
to find the Irr Supply Center
location nearest you!**

Cast Iron Pipe & Fittings



Gas Connectors

Supr-Safe® 10 Series Stainless Steel Gas Connectors

- For water heater, gas log and space heaters

Gas Heater Connector - 3/8" MIP x 1/2" FIP



Part #	Mfg #	Size	Price
FGC12-38M-24	10-2132-24	3/8" OD x 24"	28.16

Supr-Safe® 30 Series Stainless Steel Gas Range Connectors

- For ranges, furnaces and manufactured homes

Gas Range Connector - 1/2" FIP x 1/2" FIP



Part #	Mfg #	Size	Price
FGC12-12	30-3232-12	5/8" OD x 12"	25.54
FGC12-18	30-3232-18	5/8" OD x 18"	31.04
FGC12-24	30-3232-24	5/8" OD x 24"	35.62
FGC12-30	30-3232-30	5/8" OD x 30"	37.28
FGC12-36	30-3232-36	5/8" OD x 36"	40.65
FGC12-48	30-3232-48	5/8" OD x 48"	51.79
FGC12-60	30-3232-60	5/8" OD x 60"	61.90

Gas Range Connector - 3/4" FIP x 3/4" FIP



Part #	Mfg #	Size	Price
FGC34-12	30-4242-12	5/8" OD x 12"	25.54
FGC34-18	30-4242-18	5/8" OD x 18"	31.04
FGC34-24	30-4242-24	5/8" OD x 24"	35.62
FGC34-36	30-4242-36	5/8" OD x 36"	40.65
FGC34-48	30-4242-48	5/8" OD x 48"	51.79
FGC34-60	30-4242-60	5/8" OD x 60"	61.96

Ultraflow™ High BTU Stainless Steel Gas Connectors

- PVC Coating with antimicrobial agent
- Coating will not hold a flame
- Unmatched corrosion and UV protection
- Ideal for outdoor installations

41 Series - 1" OD (3/4" ID) with 3/4" (MIP x FIP) Fitting



Part #	Mfg #	Size	Price
FGC34-24MH	41-4142-24	24"	80.54

Stainless Steel Gas Hearth Connectors with High-Temperature Black Epoxy Coating

- LV® Low-visibility coating technology
- Designed to reduce glare and hide the connector from view to enhance the beauty of the hearth
- Coating hides the connector while withstanding up to 350°F
- Black adapters and flare nuts are plated with zinc di-chromate to further reduce the visibility of the gas connection

Black Epoxy LV® Coated Connector (3/8"OD)

Part #	Mfg #	Size	Price
FGCB38-24	10A-2121-24	3/8"MIPx3/8"MIPx24"	31.92
FGCB12-24	10A-3131-24	1/2"MIPx1/2"MIPx24"	31.92

Supr-Safe® Quick Disconnect Gas Appliance Connector Assemblies

- Stainless steel corrugated hose, encased in stainless steel braid, covered by thick Supr-Flex™ coating
- Fitted with an A type "push-to-connect" quick disconnect coupling



Part #	Mfg #	Size	Price
FGC34-48CM	1675BPQ48BX	3/4" x 48"	286.97

Stationery Connectors

- Stainless steel connectors coated with thick, Supr-Flex™ coating for food service installations
- NSF Certified



Part #	Mfg #	Size	Price
FGC34-48CS	1675NPFS48	3/4" ID x 48"	92.20

Flexible Tubing & Fittings

Gas Tubing & Fittings

Corrugated Stainless Steel Tubing (CSST) With Polyethylene Jacketing

- Supplies natural gas or liquefied petroleum to appliances
- Flexible & durable
- Allows for simple routing through complex building structures & designs
- Pre-marked by the foot for easy measuring & installation
- Lightweight (250' of 1/2" CSST weighs under 50 lbs)
- 100% Factory pressure tested
- Annealed 304 stainless steel makes tubing more flexible than brands not heat treated



Part #	Mfg #	Size	Length	Price
FGPP38-250	S93-6A4-250	3/8"	250'	4.80
FGPP12-50	S93-8A4-050	1/2"	50'	283.52
FGPP12-125	S93-8A4-125	1/2"	125'	5.36
FGPP12-250	S93-8A4-250	1/2"	250'	5.36
FGPP34-50	S93-11B4-050	3/4"	50'	368.46
FGPP34-125	S93-11B4-125	3/4"	125'	7.00
FGPP34-250	S93-11B4-250	3/4"	250'	7.00
FGPP1-150	S93-16A4-150	1"	150'	9.94
FGPP114-75	S93-20A4-75	1-1/4"	75'	12.46
FGPP114-150	S93-20A4-150	1-1/4"	150'	12.46
FGPP112-75	S93-24A4-75	1-1/2"	75'	21.88

"XR" Series Fittings

- Tool-free flare design/no special tools required
- Metal to metal seal with no split rings, o-rings or gaskets
- Self-guiding assembly ensures perfectly even flare
- Exclusive, patent-pending Jacket-Lock™ features to eliminate exposed stainless steel beyond the nut
- All components fully re-useable

Straight Fittings

- Connects flexible gas piping to gas supply, distribution manifolds or gas appliances



Part #	Mfg #	Size	NPT	Price
FGPMA38	XRFTG-6-24	3/8"	1/2"	19.46
FGPMA12	XRFTG-8-24	1/2"	1/2"	22.18
FGPMA34	XRFTG-11-24	3/4"	3/4"	30.50
FGPMA1	XRFTG-16-12	1"	1"	47.18
FGPMA114	XRFTG-20-6	1-1/4"	1-1/4"	89.10
FGPMA112	XRFTG-24-4	1-1/2"	1-1/2"	183.30

Tee Fitting

- Creates a branch line on tubing runs



Part #	Mfg #	Run	Run Branch	Price
FGPT12	XRT-8-12	1/2"	1/2"	63.20
FGPT34-12-12	XRT-11-8-8-6	3/4"	1/2"	82.34
FGPT34-34-12	XRT-11-11-8-6	3/4"	3/4"	91.50
FGPT34	XRT-11-12	3/4"	3/4"	86.88

Coupling

- Allows for additions to & the splicing of flexible gas piping



Part #	Mfg #	Size	Price
FGPCPLG12	XRCPL-8-12	1/2"	42.12
FGPCPLG34	XRCPL-11-12	3/4"	57.96
FGPCPLG1	XRCPL-16-6	1"	89.64

Termination Fittings

- Creates a fixed point "stub-out" on a wall or floor surface appliance attachment

Cast Iron



Part #	Mfg #	Size	NPT	Price
FGPTO12	XRTRM-8-12	1/2"	1/2"	30.36
FGPTO34	XRTRM-11-12	3/4"	3/4"	33.54
FGPTO1	XRTRM-16-6	1"	1"	54.16

Termination Bracket Fittings



Part #	Mfg #	Size	Price
FGPTBF12	XRTRMBKT-8-12	1/2"	30.36
FGPTBF34	XRTRMBKT-11-12	3/4"	33.54

Flexible Tubing & Fittings

Prices & Specifications are Subject to Change.

Gas Tubing & Fittings

Modular Stub System

XR-Series Appliance Stub-Out



Part #	Mfg #	Description	Price
FGPSO12A	XR-L-APSTUB-8-10	1/2"M x 1/2"M x 2-1/4" Stub Length w/1/2" Brass Female Fitting	48.36

Valves

Quick Connect Valves

- Provides a safe & easy "quick connect" for barbecue grills, space heaters & decorative lighting

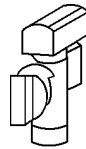

Part #	Mfg #	NPT Size	Price
FGPQCVALVE	T103029	1/2"	121.32

Quick Connect Accessories

- Provides a safe & easy "quick connect" for barbecue grills, space heaters and decorative lighting



OUTFLEX

Part #	Mfg #	Description	Price
FGPQCHOSE	OUTFLEX-3/8	Outdoor Flex Conn 3/8"NPT x 12'	80.88
FGPQCBOXPW	QCE-BOX	White Plastic Box & Grommets	227.06

Tubing Cutters

- Fitted with cutting wheel designed to cut stainless steel
- Creates clean cuts for optimal flaring of tubing

Aluminum Cutter - Flat Rollers



Part #	Mfg #	Tubing Size	Price
FGPGTC	GTCUTTER-SM	3/8" - 1"	114.96

Transition Fittings

Copper Pipe Size (CPS) Trans-X Fitting

- For Poly gas pipe



Part #	Mfg #	Size	Price
GAPPTRANS1	TRANS-16	1" CTS x 1" MIP	100.82

Iron Pipe Size (IPS) Trans-X Fitting

- For Poly gas pipe

Part #	Mfg #	Size	Price
GAPPTRANS34	TRANS-12	3/4" IPS x 3/4" MIP	102.62
GAPPTRANS114	TRANS-20	1-1/4" IPS x 1-1/4" MIP	250.52

PE Couplings - Underground



Part #	Mfg #	Size	Price
GAPPCPLG34	PECPL-12	3/4" IPS	46.06
GAPPCPLG1	PECPL-16	1" CTS	48.36
GAPPCPLG114	PECPL-20	1-1/4" IPS	186.98

Riser Brackets - Underground



Part #	Mfg #	Description	Price
GAPPRBRACE	RBRACE-1	All Sizes	62.88

Line Riser - Underground



Part #	Mfg #	Size	Price
GAPPRISER34	RISER-12-30	3/4"IPS x 30" Vert x 3/4"NPT w/Cplg	150.00
GAPPFRISER34	F-RISER-12-36	3/4"IPS x 36" x 3/4"NPT	98.06
GAPPRISER1	RISER-16-30	1"CTS x 30" Vert	149.70
GAPPRISER114	RISER-20-30	1-1/4"IPS x 30" Vert x 1-1/4"NPT w/Cplg	253.46



www.irrsupply.com

Yellow Gas Pipe

Yellow Gas Pipe

- PE-2406 Yellow polyethylene gas pressure pipe and tubing
- Meets or exceeds national standards for gas pressure pipe and pipelines published by The American Society for Testing & Materials and the Federal Government

PE2406 Gas Pressure Pipe (IPS)

Part #	Mfg #	Nominal Size	SDR	Coil Length	Price
GAPC34-150	PGA0.7541010020-150	3/4"	11	150'	119.64
GAPC114-150	PGA1.2541010027-150	1-1/4"	10	150'	319.96
GAPC112-150	PGA1.5041010020-150	1-1/2"	11	150'	382.22

PE2406 Gas Pressure Pipe (CTS)

Part #	Mfg #	Nominal Size	SDR	Coil Length	Price
GAPC1-150CTS	PGA1.0041010033-150	1"	11.5	150'	133.40

Product descriptions and specifications in this catalog are condensed from manufacturer's literature. For exact information, consult manufacturer's literature prior to installation and service. Contact us if you are not sure about specifications.

Flexible Tubing & Fittings

PEX Tubing & Fittings

PEX Tubing

PEX-A Tubing

- Oxygen barrier tubing is cross-linked polyethylene
- Thin coating of PE on top of the barrier for noise reduction



Part #	Mfg #	Size	Price
MRPEX38-600	1210060	3/8" x 600'	636.82
MRPEX12-300	1220030	1/2" x 300'	359.52
MRPEX12-1200	1220120	1/2" x 1200'	1438.00
MRPEX58-300	1230030	5/8" x 300'	467.36
MRPEX58-1000	1230100	5/8" x 1000'	1561.24
MRPEX34-300	1240030	3/4" x 300'	621.42
MRPEX1-300	1250030	1" x 300'	1073.34

Manifolds

Stainless Steel Manifold with Flowmeter

- Bright annealed high-grade stainless steel with high nickel content
- Adjustable flowmeter and balancing valves allow a positive shut-off
- Manual plastic cap on return valve can be removed to accommodate a valve actuator
- Supply and return manifold bodies have a multi-function swivel end cap allowing for fill/drain or vent
- Each inlet has a G1" thread (BSP straight metric thread)
- Branches have Eurokonus (EK20) connections
- Mr PEX EK20 compression fitting assemblies (PEX to EK20 or PEX-AL-PEX to EK20) can be used to connect tubing to manifold

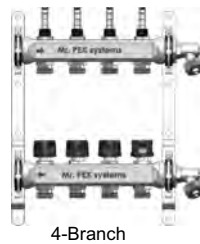

Part #	Mfg #	Description	Price
MRP402	3210200	2-Branch	336.80
MRP403	3210300	3-Branch	436.60
MRP404	3210400	4-Branch	536.38
MRP405	3210500	5-Branch	639.74
MRP406	3210600	6-Branch	750.22

Manifold Accessories

End Cap



Part #	Mfg #	Description	Price
MRP120	3610001	End Cap w/Swivel Fill/Drain Vlv for 1-1/4" Brass Manifold	28.52
MRP121	3610002	Basic End Cap for 1-1/4" Brass Manifold	14.26
MRP124	3610003	Loop End Cap EK20	8.04

Pressure Test Kit

- Includes:
 - 100 PSI Gauge
 - Air valve
 - Basic end cap



Part #	Mfg #	Description	Price
MRP182	3610005	For 1-1/4" Brs & SS Manifolds	80.20

Manifold Transition



Part #	Mfg #	Description	Price
MRP131	3620001	1" BSP to 1" & 1-1/4" Cpr for 1-1/4" Brs & SS Manifolds	17.82
MRP133	3620005	1" BSP Double Nipple for 1-1/4" Brs & SS Manifolds	17.92
MRP135B	3620008	1" BSP Isolation Union Ball Valve for 1-1/4" Brs & SS Manifolds	121.18

PEX Tubing & Fittings

All Items May Not Be Stocked In All Branches

PEX Tubing & Fittings

Compression Fittings

PEX and Erokonus (EK) Fitting

- For the connection of Mr PEX barrier PEX tubing to Mr PEX manifolds or transition fittings with EK connection
- Fitting consists of nut, insert and compression ring made of brass
- Insert features o-ring and EK seat



4352020-4353232



4310375 - 4331000

4310750

Part #	Mfg #	Description	Price
MRP143	4342050	EK20 PEX to 1/2" & 3/4" Copper Adapter Swt Transition	9.98
MRP145	4343210	EK32 PEX to 1" & 1-1/4" Copper Adapter Swt Transition	37.42
MRP151	4310375	3/8" PEX to EK20 Adapter Assembly	7.84
MRP152	4310500	1/2" PEX to EK20 Adapter Assembly	7.84
MRP153	4310625	5/8" PEX to EK20 Adapter Assembly	8.56
MRP154	4310750	3/4" PEX to EK20 Adapter Assembly	9.90
MRP155	4331000	1" PEX to EK20 Adapter Assembly	22.46
MRP163	4352020	EK20 To EK20 Coupling Nipple for PEX to PEX	9.46
MRP165	4353232	EK32 To EK32 Coupling Nipple for PEX to PEX	21.56

Mr PEX® Accessories



Part #	Mfg #	Description	Price
MRP702	6110702	18" x 5" Omega Alum Heat Transfer Plate f/1/2" Tubing 100/Bx	4.50

uponor

Uponor AQUAPEX® Non-Barrier Tubing

- Can be used in hot & cold potable water distribution systems & hydronic heating applications where the system contains no ferrous corrodible components or where ferrous components are isolated from the tubing
- Colored coded tubing for installation purposes



AQUAPEX® White Tubing

Part #	Mfg #	Size	Length	Price
WIRF1060500	F1060500	1/2"	300'	205.65
WIRF1120500	F1120500	1/2"	1000'	685.55
WIRF1060750	F1060750	3/4"	300'	352.55
WIRF1100750	F1100750	3/4"	500'	587.60
WIRF1061000	F1061000	1"	300'	617.00
WIRF1101000	F1101000	1"	500'	1028.35

AQUAPEX® White Straight Lengths



Part #	Mfg #	Size	Length	Price
WIRF1930750	F1930750	3/4"	20'	23.50
WIRF1921000	F1921000	1"	20'	41.14

AQUAPEX® Plus Red Tubing

Part #	Mfg #	Size	Length	Price
WIRF2060500	F2060500	1/2"	300'	205.65
WIRF2060750	F2060750	3/4"	300'	352.55

AQUAPEX® Plus Red Straight Lengths



Part #	Mfg #	Size	Length	Price
WIRF2930500	F2930500	1/2"	20'	17.14
WIRF2930750	F2930750	3/4"	20'	17.63

AQUAPEX® Plus Blue Tubing

Part #	Mfg #	Size	Length	Price
WIRF3060500	F3060500	1/2"	300'	205.65
WIRF3060750	F3060750	3/4"	300'	352.55

PEX Tubing & Fittings

Prices & Specifications are Subject to Change.

PEX Tubing & Fittings

AQUAPEX® Plus Blue Straight Lengths



Part #	Mfg #	Size	Length	Price
WIRF3930500	F3930500	1/2"	20'	13.71
WIRF3930750	F3930750	3/4"	20'	23.50

ProPEX® Engineered Plastic Fittings

ProPEX® Engineered Plastic Couplings

- Engineer plastic coupling makes PEX to PEX connections for hePEX plus & AQUAPEX tubing
- ProPEX® tool is required
- ProPEX® rings required, sold separately



Part #	Mfg #	Size	Price
WIRQ4775050	Q4775050	1/2" PEX x 1/2" PEX	1.50
WIRQ4775075	Q4775075	3/4" PEX x 1/2" PEX	3.15
WIRQ4777575	Q4777575	3/4" PEX x 3/4" PEX	1.90
WIRQ4771010	Q4771010	1" PEX x 1" PEX	2.90

ProPEX® Engineered Plastic Elbows (PEX x PEX)

- ProPEX® tool required
- ProPEX® rings required, sold separately



Part #	Mfg #	Size	Price
WIRQ4760500	Q4760500	1/2" PEX x 1/2" PEX	1.85
WIRQ4760750	Q4760750	3/4" PEX x 3/4" PEX	2.35
WIRQ4761000	Q4761000	1" PEX x 1" PEX	4.65

ProPEX® Engineered Plastic Tees (PEX x PEX x PEX)

- ProPEX® tool required
- ProPEX® rings required, sold separately



Part #	Mfg #	Size	Price
WIRQ4755050	Q4755050	1/2" PEX x 1/2" PEX x 1/2" PEX	1.85
WIRQ4757575	Q4757575	3/4" PEX x 3/4" PEX x 3/4" PEX	2.95
WIRQ4751010	Q4751010	1" PEX x 1" PEX x 1" PEX	5.30

ProPEX® Engineered Plastic Reducing Tee (PEX x PEX x PEX)

- ProPEX® tool required
- ProPEX® rings required, sold separately



Part #	Mfg #	Size	Price
WIRQ4757555	Q4757555	3/4" PEX x 1/2" PEX x 1/2" PEX	2.85
WIRQ4757557	Q4757557	3/4" PEX x 1/2" PEX x 3/4" PEX	2.85
WIRQ4757550	Q4757550	3/4" PEX x 3/4" PEX x 1/2" PEX	2.45
WIRQ4751775	Q4751775	1" PEX x 3/4" PEX x 3/4" PEX	4.60
WIRQ4751751	Q4751751	1" PEX x 3/4" PEX x 1" PEX	5.55
WIRQ4751150	Q4751150	1" PEX x 1" PEX x 1/2" PEX	4.85
WIRQ4751175	Q4751175	1" PEX x 1" PEX x 3/4" PEX	5.35

ProPEX® Engineered Plastic PEX Plugs

- For pressure testing & permanent plug installations
- ProPEX® tool required
- ProPEX® rings required, sold separately



Part #	Mfg #	Size	Price
WIRQ4350500	Q4350500	1/2" PEX	1.15
WIRQ4350750	Q4350750	3/4" PEX	1.80

ProPEX® Engineered Plastic Stop Valve

Part #	Mfg #	Description	Price
WIRQ4905038	Q4905038	Angle Stop Valve for 1/2" Pex	9.60
WIRQ4935038	Q4935038	Straight Stop Valve for 1/2" Pex	9.15

ProPEX® Fittings

ProPEX® Lead Free Brass Couplings (PEX x PEX)

- Use to make PEX to PEX connections
- Suitable w/AQUAPEX® & hePEX™ plus tubing
- ProPEX® tool required
- ProPEX® rings required, sold separately



Part #	Mfg #	Size	Price
WIRLF4543838	LF4543838	3/8" PEX x 3/8" PEX	3.05
WIRLF4545050	LF4545050	1/2" PEX x 1/2" PEX	5.80
WIRQ4546363	LF4546363	5/8" PEX x 5/8" PEX	5.95
WIRQ4547575	LF4547575	3/4" PEX x 3/4" PEX	8.85

All Items May Not Be Stocked In All Branches

PEX Tubing & Fittings

ProPEX Lead Free Brass Female Threaded Adapter

- Use to connect Uponor™ AQUAPEX® & hePEX™plus tubing to female NPT threads
- ProPEX® tool required
- ProPEX® rings required, sold separately



Part #	Mfg #	Size	Price
WIRQ4575075	LF4575075	1/2" PEX x 3/4" FIP, Lead Free	17.10

ProPEX® Lead Free Brass Sweat Adapters (PEX x CU)

- Use to transition AQUAPEX® & hePEX™plus tubing to copper pipe
- ProPEX® tool is required
- ProPEX® rings required, sold separately



Part #	Mfg #	Size	Price
WIRQ4513850	LF4513850	3/8" PEX x 1/2" Copper	8.55
WIRLF4515050	LF4515050	1/2" PEX x 1/2" Copper	3.65
WIRQ4516375	LF4516375	5/8" PEX x 3/4" Copper	5.75
WIRLF4517575	LF4517575	3/4" PEX x 3/4" Copper	8.45
WIRLF4511010	LF4511010	1" PEX x 1" Copper	14.05

ProPEX® Lead Free Brass Fitting Adapters (PEX x CU)

- Use to transition AQUAPEX® tubing to copper fittings
- ProPEX® tool is required
- ProPEX® rings required, sold separately



Part #	Mfg #	Size	Price
WIRLF4505050	LF4505050	1/2" PEX x 1/2" Copper	3.60
WIRQ4506375	LF4506375	5/8" PEX x 3/4" Copper	5.00
WIRLF4507575	LF4507575	3/4" PEX x 3/4" Copper	8.00
WIRQ4501010	LF4501010	1" PEX x 1" Copper	14.85

ProPEX® Lead Free 90° Brass Elbows (PEX x PEX)

- (Brass) Use to make 90° connections
- ProPEX® tool required
- ProPEX® rings required, sold separately



Part #	Mfg #	Size	Price
WIRQ4710500	LF4710500	1/2" PEX x 1/2" PEX	4.85
WIRQ4710625	LF4710625	5/8" PEX x 5/8" PEX	8.95
WIRLF4710750	LF4710750	3/4" PEX x 3/4" PEX	11.30

ProPEX® Fittings (Continued)

ProPEX® Lead Free 90° Brass Elbows (PEX x PEX)

Part #	Mfg #	Size	Price
WIRQ4711000	LF4711000	1" PEX x 1" PEX	18.20

ProPEX® Lead Free Drop Ear Elbows (PEX x FIP)

- Provides rigid 90° & the ability to secure AQUAPEX® tubing where it exits a stud wall or penetrates a floor
- ProPEX® tool required
- ProPEX® rings required, sold separately



Part #	Mfg #	Size	Price
WIRQ4235038	LF4235038	1/2" PEX x 3/8" FIP	17.40
WIRLF4235050	LF4235050	1/2" PEX x 1/2" FIP	14.15

ProPEX® Lead Free Brass Elbows (PEX x MIP)

- Makes 90° connections for 1/2" AQUAPEX to 1/2" MIP
- ProPEX® tool required
- ProPEX® rings required, sold separately

Part #	Mfg #	Size	Price
WIRQ4125050	LF4125050	1/2" PEX x 1/2" MIP	11.90

ProPEX® Lead Free Brass Tees (PEX x PEX x PEX)

- ProPEX® tool required
- ProPEX® rings required, sold separately



Part #	Mfg #	Size	Price
WIRLF4705050	LF4705050	1/2" PEX x 1/2" PEX x 1/2" PEX	9.75
WIRQ4707575	LF4707575	3/4" PEX x 3/4" PEX x 3/4" PEX	15.85
WIRQ4701010	LF4701010	1" PEX x 1" PEX x 1" PEX	29.30

ProPEX® Lead Free Brass Reducing Tees (PEX x PEX x PEX)

- ProPEX® tool required
- ProPEX® rings required, sold separately



Part #	Mfg #	Size	Price
WIRLF4707550	LF4707550	3/4" PEX x 3/4" PEX x 1/2" PEX	15.85
WIRQ4707557	LF4707557	3/4" PEX x 1/2" PEX x 3/4" PEX	8.95

PEX Tubing & Fittings

Prices & Specifications are Subject to Change.

PEX Tubing & Fittings

ProPEX® Fittings (Continued)

ProPEX® Lead Free Brass Reducing Tees (PEX x PEX x PEX)

Part #	Mfg #	Size	Price
WIRQ4701775	LF4701775	1" PEX x 3/4" PEX x 3/4" PEX	29.30

ProPEX® Lead Free Brass Male Threaded Adapter

- Use to connect Uponor™ AQUAPEX® & hePEX™plus tubing to male NPT threads
- ProPEX® tool required
- ProPEX® rings required, sold separately



Part #	Mfg #	Size	Price
WIRLF4525050	LF4525050	1/2" PEX x 1/2" MIP	5.30
WIRLF4527575	LF4527575	3/4" PEX x 3/4" MIP	9.55
WIRQ4527510	LF4527510	3/4" PEX x 1" MIP	20.15
WIRLF4521010	LF4521010	1" PEX x 1" MIP	19.75

ProPEX® Lead Free Brass Female Threaded Adapter

- Use to connect Uponor™ AQUAPEX® & hePEX™plus tubing to female NPT threads
- ProPEX® tool required
- ProPEX® rings required, sold separately



Part #	Mfg #	Size	Price
WIRLF4575050	LF4575050	1/2" PEX x 1/2" FIP	10.55
WIRLF4577575	LF4577575	3/4" PEX x 3/4" FIP	11.80

ProPEX® Copper Tube Elbows (1/2" PEX x 1/2" CU)

- Provides a 90° transition from tub & shower valve to AQUAPEX®
- ProPEX® tool required
- ProPEX® rings required, sold separately



Part #	Mfg #	Size	Price
WIRQ2875050	Q2875050	3" x 6"	15.35

ProPEX® Copper Stub Elbows (PEX x CU)

- Provides a 90° transition from AQUAPEX® to copper
- ProPEX® tool required
- ProPEX® rings required, sold separately



Part #	Mfg #	Size	Price
WIRQ2865050	Q2865050	3-1/2" x 8", 1/2" PEX x 1/2" CU	13.35

ProPEX® Baseboard Fittings

ProPEX® Baseboard Elbow

- Use to connect 1/2" & 5/8" hePEX plus and AQUAPEX tubing products to 3/4" copper baseboard
- ProPEX® tool is required
- ProPEX® rings required, sold separately



Part #	Mfg #	Size	Price
WIRQ4386375	Q4386375	5/8" PEX x 3/4" Copper Adapter	12.40
WIRQ4387575	Q4387575	3/4" PEX x 3/4" Copper Adapter	15.55
WIRQ4376375	Q4376375	5/8" PEX x 3/4" Copper Ftg Adapter	14.95
WIRQ4377575	Q4377575	3/4" PEX x 3/4" Copper Ftg Adapter	16.05

ProPEX® Baseboard Tee

- Use to connect 1/2", & 5/8" hePEX plus & AQUAPEX to 3/4" copper baseboard
- 1/8" Threads for air vent/air vent not included
- ProPEX® tool required
- ProPEX® rings required, sold separately

Part #	Mfg #	Size	Price
WIRQ4396375	Q4396375	5/8" PEX x 3/4" Copper	16.05

PEX Tubing & Fittings

All Items May Not Be Stocked In All Branches

PEX Tubing & Fittings

ProPEX® Brass Plugs

- Terminates the end of PEX tubing
- Installed for temporary or permanent usage
- ProPEX® tool is required
- ProPEX® rings required, sold separately



Part #	Mfg #	Size	Price
WIRQ4537575	Q4537575	3/4" PEX	1.40

ProPEX® Rings

- A ProPEX® ring is required to make a proper ProPEX® connection
- Red and blue print on the rings distinguishes hot and cold lines



Part #	Mfg #	Size	Color	Price
WIRQ4690302	Q4690302	3/8"	Blue	0.20
WIRQ4690512	Q4690512	1/2"	Blue w/Stop	0.20
WIRQ4680625	Q4680625	5/8"	Black	0.40
WIRQ4690756	Q4690756	3/4"	Blue w/Stop	0.40
WIRQ4691000	Q4691000	1"	Blue	0.75

Fitting Assemblies

ProPEX® Fitting Assemblies

- PEX tubing to the brass manifolds
- Sold as a two-piece assembly, it includes a ProPEX® insert and R20 swivel nut
- ProPEX® tool is required
- ProPEX® rings required, sold separately



This fitting is not compatible with the TruFLOW Sr.

Part #	Mfg #	Description	Price
WIRQ4020375	Q4020375	3/8" ProPEX®, R20 Thread	10.80
WIRQ4020500	Q4020500	1/2" ProPEX®, R20 Thread	9.05
WIRQ4020625	Q4020625	5/8" ProPEX®, R20 Thread	10.90

ProPEX® Valves

Compression Inserts

- AQUAPEX® stainless steel inserts
- Must be used w/compression straight & angle stops
- Do not substitute similar inserts



Part #	Mfg #	Size	Price
WIRF5400500	F5400500	1/2"	1.60

ProPEX® Ball Valves (PEX x PEX)

- Brass in-line shut-off valve for 3/8", 1/2" & 3/4" PEX
- Quarter-turn shut-off valve for 1/2" PEX
- ProPEX® tool required
- ProPEX® rings required, sold separately



Part #	Mfg #	Size	Price
WIRLF4815050	Q4815050	1/2" PEX x 1/2" PEX Large Bore	27.30
WIRLF4817575	Q4817575	3/4" PEX x 3/4" PEX Large Bore	36.20

Quick & Easy Valves

Quick & Easy Copper Ball Valves (PEX x Copper)

- Brass shut-off valve for 1/2" & 3/4" AQUAPEX® to 1/2" or 3/4" copper pipe
- Quick & Easy tool required
- Quick & Easy rings sold separately



Part #	Mfg #	Description	Price
WIRQ4805050	Q4805050	1/2" PEX x 1/2" Cpr, 0.44" Bore	11.30
WIRQ4807575	Q4807575	3/4" PEX x 3/4" Cpr, 0.44" Bore	43.35

PEX Tubing & Fittings

Prices & Specifications are Subject to Change.



www.irrsupply.com

PEX Tubing & Fittings

WaterPEX® Potable PEX Plumbing

Red Coil

Part #	Mfg #	Order #	Size	Price
PEXCR12-100	WPTC08-100R	0650377	1/2" x 100'	54.74
PEXCR12-500	WPTC08-500R	0650378	1/2" x 500'	273.72
PEXCR34-100	WPTC12-100R	0650380	3/4" x 100'	88.96

Red 20' Sticks

Part #	Mfg #	Order #	Size	Price
PEXPR12-20	WPTS08-50R	0650404	1/2" x 20'	10.70
PEXPR34-20	WPTS12-25R	0650405	3/4" x 20'	18.62

Blue Coil

Part #	Mfg #	Order #	Size	Price
PEXCB12-100	WPTC08-100B	0650385	1/2" x 100'	54.74
PEXCB12-500	WPTC08-500B	0650386	1/2" x 500'	273.72
PEXCB34-100	WPTC12-100B	0650388	3/4" x 100'	88.96

Blue 20' Sticks

Part #	Mfg #	Order #	Size	Price
PEXPB12-20	WPTS08-50B	0650406	1/2" x 20'	10.70
PEXPB34-20	WPTS12-25B	0650407	3/4" x 20'	18.62

White Coil

Part #	Mfg #	Order #	Size	Price
PEXCW1-100	WPTC16-100W	0650400	1" x 100'	164.80

White 20' Sticks

Part #	Mfg #	Order #	Size	Price
PEXPW1-20	WPTS16-5W	0650410	1" x 20'	36.26



Brass PEX Fittings

CrimpRing™ x Threaded Adapter



Part #	Mfg #	Order #	Size	Price
PEXMA12	WP12B-0808PB	0650516	1/2" CF x 1/2" MIP	2.18
PEXMA34-12	WP12B-0812PB	0650517	1/2" CF x 3/4" MIP	2.24
PEXMA12-34	WP12B-1208PB	0650518	3/4" CF x 1/2" MIP	2.41
PEXMA34	WP12B-1212PB	0650519	3/4" CF x 3/4" MIP	2.34
PEXMA1-34	WP12B-1216PB	0650520	3/4" CF x 1" MIP	7.25

All Items May Not Be Stocked In All Branches

PEX Fittings

Brass PEX Fittings (Continued)

CrimpRing™ x Threaded Adapter

Part #	Mfg #	Order #	Size	Price
PEXMA1	WP12B-1616PB	0650522	1" CF x 1" MIP	4.08

CrimpRing™ Sweat Adapters - Male (Ftg) Sweat



Part #	Mfg #	Order #	Size	Price
PEXFA38-12	WP10B-0806PB	0650497	1/2"M Swt x 3/8"CF	2.16
PEXFTG12	WP10B-0808	0650507	1/2"M Swt x 1/2"CF	0.67
PEXFTG34	WP10B-1212	0650508	3/4"M Swt x 3/4"CF	1.25
PEXFTG1	WP10B-1616	0650509	1"M Swt x 1"CF	4.86

CrimpRing™ Sweat Adapters - Female Sweat

Part #	Mfg #	Order #	Size	Price
PEXFEA12	WP11B-0808	0650511	1/2"F Swt x 1/2"CF	1.53
PEXFEA34	WP11B-1212	0650512	3/4"F Swt x 3/4"CF	2.54
PEXFEA1	WP11B-1616	0650513	1"F Swt x 1"CF	5.89

CrimpRing™ Sweat Adapters - Female Copper Sweat

Part #	Mfg #	Order #	Size	Price
PEXCOP12	WP11B-0808	0650511	1/2"F Swt x 1/2"CF	1.48
PEXCOP34	WP11B-1212	0650512	3/4"F Swt x 3/4"CF	2.70
PEXCOP1	WP11B-1616	0650513	1"F Swt x 1"CF	7.20

Stainless Steel CinchClamps™

- Perfect for connecting PEX to crimp-style fittings in hard-to-reach spaces
- Pinch tab closed with CinchTool™
- Do not use with wrot copper PEX fittings



Part #	Mfg #	Order #	Size	Price
PEXCINCH12	WP9S-08	0650542	1/2"	0.56
PEXCINCH34	WP9S-12	0650543	3/4"	0.77
PEXCINCH1	WP9S-16PB	0650540	1"	0.91

Copper PEX CrimpRing™



Part #	Mfg #	Order #	Size	Price
PEXRING12	WP14C-08PB		1/2"	0.21
PEXRING34	WP14C-12PB		3/4"	0.26
PEXRING1	WP14C-16PB	0650548	1"	0.57

PEX Tubing & Fittings

Prices & Specifications are Subject to Change.

PEX Fittings

CrimpRing™ Couplings



Part #	Mfg #	Order #	Size	Price
PEXCPLG12	WP15B-0808PB	0650557	1/2" CF x 1/2" CF	0.67
PEXCPLG34-12	WP15B-1208PB	0650558	3/4" CF x 1/2" CF	1.32
PEXCPLG34	WP15B-1212PB	0650559	3/4" CF x 3/4" CF	0.95
PEXCPLG1-34	WP15B-1612PB	0650560	1" CF x 3/4" CF	3.90
PEXCPLG1	WP15B-1616PB	0650561	1" CF x 1" CF	2.04

CrimpRing™ Tees



Part #	Mfg #	Order #	Size 1 x 2 x 3	Price
PEXT12	WP18B-08	0650602	1/2" x 1/2" x 1/2"	1.14
PEXT12-12-34	WP18B-080812PB	0650587	1/2" x 1/2" x 3/4"	1.56
PEXT34	WP18B-12	0650592	3/4" x 3/4" x 3/4"	1.56
PEXT34-12-12	WP18B-120808	0650604	3/4" x 1/2" x 1/2"	1.56
PEXT34-12-34	WP18B-120812PB	0650589	3/4" x 1/2" x 3/4"	3.34
PEXT34-34-12	WP18B-121208	0650607	3/4" x 3/4" x 1/2"	1.56
PEXT1-34-34	WP18B-161212PB	0650594	1" x 3/4" x 3/4"	9.40
PEXT1-1-12	WP18B-161608PB	0650595	1" x 1" x 1/2"	5.36
PEXT1-1-34	WP18B-161612PB	0650596	1" x 1" x 3/4"	5.52
PEXT1	WP18B-16PB	0650597	1" x 1" x 1"	5.60

CrimpRing™ Drip Tees w/Cap

- For draining water in potable systems



Part #	Mfg #	Order #	Size 1 x 2 x 3	Price
PEXDRIPT12	WPDT-08		1/2" x 1/2" x 3/8"	4.50
PEXDRIPT34	WPDT-12	0651039	3/4" x 3/4" x 3/8"	6.75

CrimpRing™ Elbows - Crimp x Crimp



Part #	Mfg #	Order #	Size	Price
PEX9012	WP19B-08	0650620	1/2" x 1/2"	1.07
PEX9034-12	WP19B-1208PB	0650616	3/4" x 1/2"	2.79
PEX9034	WP19B-1212	0650620	3/4" x 3/4"	1.30
PEX901	WP19B-16PB	0650618	1" x 1"	4.65

PEX Tubing & Fittings

All Items May Not Be Stocked In All Branches

PEX Fittings

CrimpRing™ Elbow - Copper Sweat x Crimp

Part #	Mfg #	Order #	Size	Price
PEX90COP34			3/4" x 3/4"	8.90

Drop Ear Elbow



Part #	Mfg #	Order #	Size	Price
PEXFEDE9012	WP22B-08PB	0650637	1/2" CF x 1/2" FIP	4.37

CrimpRing™ Test Plug



Part #	Mfg #	Order #	Size	Price
PEXPLUG12	WP24B-08	0650651	1/2" CF	0.57
PEXPLUG34	WP24B12	0650652	3/4" CF	0.82
PEXPLUG1	WP24B 16PB	0650649	1" CF	1.30

Poly-Alloy Fittings

Poly-Alloy CrimpRing™ x MIP Adapters



Part #	Mfg #	Order #	Size	Price
PEXPMA12	WP12P-08PB	0650673	1/2" CF x 1/2" MIP	2.56
PEXPMA34	WP12P-12PB	0650675	3/4" CF x 3/4" MIP	3.28

Poly-Alloy CrimpRing™ Couplings



Part #	Mfg #	Order #	Size	Price
PEXPCPLG12	WP15P-08PB	0650660	1/2" CF x 1/2" CF	0.60
PEXPCPLG34	WP15P-12PB	0650662	3/4" CF x 3/4" CF	1.92
PEXPCPLG1	WP15P-16PB	81004319	1" CF x 1" CF	3.25

Poly-Alloy CrimpRing™ Elbows



Part #	Mfg #	Order #	Size	Price
PEXP9012	WP19P-08	0650669	1/2" CF x 1/2" CF	1.74
PEXP9034	WP19P-1212	0650671	3/4" CF x 3/4" CF	3.07
PEXP901	WP19P-16	0650672	1" CF x 1" CF	5.58

PEX Tubing & Fittings

Prices & Specifications are Subject to Change.

PEX Fittings

Poly-Alloy CrimpRing™ Tees



Part #	Mfg #	Order #	Size	Price
PEXPT12	WP18P-08PB	0650685	1/2" x 1/2" x 1/2"	1.22
PEXPT34	WP18P-12PB	0650687	3/4" x 3/4" x 3/4"	4.60
PEXPT34-12-12	WP18P-120808PB	0650690	3/4" x 1/2" x 1/2"	3.30
PEXPT34-12-34	WP18P-120812PB	0650689	3/4" x 1/2" x 3/4"	3.87
PEXPT1-1-12	WP18P-161608PB	0650692	1" x 1" x 1/2"	5.99

Poly Alloy Test Plugs



Part #	Mfg #	Order #	Size	Price
PEXPPLUG12	WP27P-08PB	0650818	1/2" CF	0.52
PEXPPLUG34	WP27P-12PB	0650819	3/4" CF	1.47
PEXPPLUG1	WP27P-16PB	0650820	1" CF	2.37



RadiantPEX® Tubing

- For radiant heating and snow melting applications
- Durable, flexible, cross-linked polyethylene
- Meets ASTM standards, ICC listed, & NSF listed
- 25-Year limited warranty for hydronic heating, floor heating, and snow melting applications

RadiantPEX® Barrier Coils

- Barrier PEX tubing for radiant heating and snow melting
- 4-Layer PEX



Part #	Mfg #	Order #	Size	Price
HEYP38-600	PB032061-600	81000850	3/8" x 600'	450.00
HEYP12-300	PB032081-300	81003406	1/2" x 300'	276.00
HEYP12-1000	PB032081-1000	81001681	1/2" x 1000'	920.00
HEYP58-600	PB032101-600	81001684	5/8" x 600'	690.00
HEYP58-1200	PB032101-1200	81001683	5/8" x 1200'	1380.00
HEYP34-100	PB032121-100	81001685	3/4" x 100'	133.00
HEYP34-300	PB032121-300	81005303	3/4" x 300'	399.00

PEX Tubing & Fittings

All Items May Not Be Stocked In All Branches

Hydronic Accessories

CustomCut Manifolds

16 Branch BaseBranch CustomCut Manifolds

- 1/2" Brass basebranch, 48" long
- 1/2" Fittings, to accept 1/2" C x Fitting MBV's and/or 3/8-5/8" Onix, Crimp, or T20 fittings



Part #	Mfg #	Order #	Trunk	Price
HEYMAN1-12	205250	81001947	1" Brass	7.68
HEYMAN114-12	205350	81002884	1-1/4" Cpr	8.83

Manifold Accessories

Mini Ball Valve

Part #	Mfg #	Description	Price
HEYMBV12	445332	1/2" Mini Ball Valve	17.95

Onix™ Radiant Tubing

- Energy transfer hose w/AlumaShield oxygen barrier
- Rated to 180°F at 100 PSI



Standard Onix™ Tubing

- Coil

Part #	Mfg #	Order #	Size	Price
HEYONIX38	086061-200	81001560	3/8" x 200'	436.00
HEYONIX58-50	086101-50	81001612	5/8" x 50'	133.00
HEYONIX34-50	086121-50	81001635	3/4" x 50'	223.00
HEYONIX34	086121-200	81001629	3/4" x 200'	940.00

Onix™ Fittings & Accessories

Onix™ SelfTite™ Clamps

- For ease of use, use SqueezeTite™ pliers



Part #	Mfg #	Order #	Size	Qty	Price
HEYCLP38-10	663019-10	81000523	3/8"	10	12.90
HEYOCLIP58	663025-10	81000529	5/8"	10	1.93
HEYOCLIP34	663029-10	81000532	3/4"	10	2.46

Hydronic Accessories

Onix™ Barb x Sweat Fittings

- For transitioning Onix to sweat fittings



Part #	Mfg #	Order #	Onix x Barb	Qty	Price
HEYOADP38	684001-50	81000660	3/8" x 1/2"	50	3.34
HEYOADP34	687001-10	81000671	3/4" x 3/4"	10	8.14

SelfTite™ Onix™ Field Repair Kits

- Contains two double-ended barbs, four clamps, and instructions to help insure that the repair is done properly
- Be sure to pressure test the repair after work is performed



Part #	Mfg #	Order #	Size	Price
HEYONIXRK38	660075	81000507	3/8"	17.90
HEYONIXRK34	660125	81000513	3/4"	27.00

PEX Crimp Fittings

Copper Crimp x Male Sweat Adapters

- For connecting PEX to sweat fittings or baseboard manifolds



Part #	Mfg #	Order #	CF x SWT	Qty	Price
HEYPADP38	PC637X-10	81001027	3/8" x 1/2"	10	1.78
HEYPADP12	PC650X-10	81001030	1/2" x 1/2"	10	1.39
HEYPADP58	PC660X-10	81003685	1/2" x 5/8"	10	2.08
HEYPADP58-34	PC670X-10	81003427	5/8" x 3/4"	10	3.86

Copper CrimpRings™



Part #	Mfg #	Order #	Size	Qty	Price
HEYPCR12	PCCR3X-100	81001075	1/2"	100	0.31
HEYPCR58	PCCR6X-100	81004508	5/8"	100	1.18
HEYPCR34	PCCR4X-100	81001080	3/4"	100	0.39

Brass CrimpRing™ Couplings

- For field repairs or extending PEX lines



Part #	Mfg #	Order #	Size	Qty	Price
HEYPCPLG12	PCC33X-10	81005375	1/2" x 1/2"	10	1.12
HEYPCPLG58	PCC66X-10	81005376	5/8" x 5/8"	10	1.60

All Items May Not Be Stocked In All Branches

Hydronic Accessories

Fasteners

Mid-Run Bend Supports

- Helps PEX make 90° turns in walls and joist cavities
- Can also be used as terminal bend supports



Part #	Mfg #	Order #	Size	Price
HEYPBS12	PSBM33X-10	81005399	1/2" Mid-Run	2.60

Terminal Bend Supports

- Plastic elbows used near the completion of PEX circuits to help tubing make smooth transitions out of the slab up to the manifold



Part #	Mfg #	Order #	Size	Price
HEYPTBS12	PSB23X-10	81005401	3/8", 1/2"	2.06
HEYPTBS58	PSB45X-10	81005402	5/8", 3/4"	3.04

NailTites™

- For securing Onix or PEX to subfloors
- Holds Onix and PEX wherever a staple gun cannot get into a tight area
- For 3/8" Onix, and 3/8", 1/2" PEX, or 1/2" RadiantPEX-AL



Part #	Mfg #	Order #	Qty	Price
HEYNT	691060-100	81000690	100	11.60

Cable Ties

- Orange
- For tying all sizes of radiant tubing to rewire or rebar



Part #	Mfg #	Order #	Qty	Price
HEYTIE	667161-1000	81000580	1000	64.90

Tools

CinchClamp™

- Stainless steel
- Ratcheting tool provides easy one-tool assembly
- Connections can be dry-fit and made with wet tubing
- PEX pipe must be above 32°F to ensure a perfect seal



Part #	Mfg #	Order #	Size	Qty	Price
HEYCINCH38	PCCC2X-10	81004993	3/8"	10	1.06

Hydronic Accessories

CrimpAll™ Tool Kit

- Interchangeable crimping jaws crimp 3/8", 1/2", 5/8" and 3/4" CrimpRings
- Plastic case
- Includes: CrimpAll tool, 3/8, 1/2, 5/8, & 3/4" crimping jaws, Go/No-Go crimp gauge, and adjustment tools



Part #	Mfg #	Order #	Size	Price
HEYCTOOL	PCCRT-2346	81003038	15" Kit	280.20

Onix™ Staple Gun

- For Staple-Up™ & thin slab installations
- With guide plate & package of 1000 staples



Part #	Mfg #	Order #	Size	Price
HEYOGUN38	668510	81000588	3/8"	1076.00

Staple

- Highly recommended for straight shooting and trouble-free usage
- Works with 3/8" and 1/2" Onix, 3/8" and 1/2" RadiantPEX, or 1/2" RadiantPEX-AL(PAP) tubing

Part #	Mfg #	Order #	Size	Price
HEYOSTAPLES	668018-1660	81004290	1,660 Staples	37.60

PEX Tubing & Fittings

Ask about our Service Guarantee

All Items May Not Be Stocked In All Branches

Hydronics

Aquacenter™ Manifolds

AQUACENTER™ Valved Manifold Kits

- Made of durable EP
- Suitable for hot and cold-water distribution systems
- Includes manifold, red and blue valve clips, labels, valve-turning tool and installation instructions
- Valved manifold inlets, couplings, caps, swivel adapters and assembly/mounting brackets sold separately



Part #	Mfg #	Description	Price
WIRQ2110300	Q2110300	3 Outlet With 1/2" ProPEX®	88.25
WIRQ2110400	Q2110400	4 Outlet With 1/2" ProPEX®	105.85

Aquacenter™ Manifold Accessories

Valved End Cap

- Assembly/mounting brackets are required & sold separately



Part #	Mfg #	Description	Price
WIRQ2121250	Q2121250	For Aquacenter Valved Manifolds	12.50

Stop Coupling

- For use with Aquacenter valved manifolds
- Assembly/mounting brackets are required & sold separately



Part #	Mfg #	Description	Price
WIRQ2121251	Q2121251	For Aquacenter Valved Manifolds	17.15

Flo-Through Coupling

- For use with Aquacenter valved manifolds
- Assembly/mounting brackets are required & sold separately



Part #	Mfg #	Size	Price
WIRQ2121313	Q2121313	1-1/2"	14.70

ProPEX® Inlet

- For use with Aquacenter valved manifolds



Part #	Mfg #	Size	Price
WIRQ2120750	Q2120750	3/4"	12.50

Aquacenter® Manifold Mounting Brackets



Part #	Mfg #	Description	Price
WIRQ2120020	Q2120020	Aquacenter® Mounting Bracket	7.80

EP Manifolds

EP Branch Manifolds

- The EP Branch Manifold features 3/4" inlet with 1/2" ProPEX® branch outlets
- The Branch Manifold is made of EP, which is proven in demanding hot-water applications



Part #	Mfg #	Size	# Outlets	Price
WIRQ2247550	Q2247550	3/4"	4	14.50

EP Flow-Through Manifolds

- Made of EP, suitable for hot-water applications
- 1/2" ProPEX® branch outlets
- ProPEX® Tool is required
- ProPEX® rings required, sold separately



Part #	Mfg #	Inlet x Outlet	# Outlets	Price
WIRQ2227557	Q2227557	3/4" x 3/4"	2	8.55
WIRQ2237557	Q2237557	3/4" x 3/4"	3	11.60
WIRQ2247557	Q2247557	3/4" x 3/4"	4	14.50

1" Copper Manifolds

1" Copper ProPEX® Branch Manifold with 1/2" ProPEX® Outlets

- Type "L" copper manifold w/1/2" ProPEX® brass fittings brazed to manifold trunk
- Sweat together to create desired # of outlets
- ProPEX® tool required
- ProPEX® rings required, sold separately



Part #	Mfg #	Description	Price
WIRQ2801050	Q2801050	4 Outlets	69.15
WIRQ2811050	Q2811050	6 Outlets	94.35
WIRQ2821050	Q2821050	8 Outlets	118.80

PEX Tubing & Fittings

Prices & Specifications are Subject to Change.

Hydronics

1" Copper ProPEX® Branch Manifold with 3/4" ProPEX® Inlet

- 1" Type "L" copper manifold w/1/2" ProPEX® brass fittings brazed to manifold trunk & one 3/4" ProPEX® fitting brazed to manifold end
- ProPEX® tool required
- ProPEX® rings required, sold separately



Part #	Mfg #	Description	Price
WIRQ2807550	Q2807550	4 Outlets	84.50
WIRQ2817550	Q2817550	6 Outlets	130.70
WIRQ2827550	Q2827550	8 Outlets	164.45

1" Copper ProPEX® Valved Manifold with ProPEX® Ball Valves

- Type "L" copper features 1/2" ProPEX® outlets
- A soldered valve connection allows for simple and easy isolation of individual loops
- Sections can sweat together to extend the number of outlets using a standard 1" copper coupling
- Do not exceed accepted flow rates for 1" nominal copper
- Both 1" ends are copper pipe size and require a copper end cap, coupling or transition fitting to make the proper system connection
- ProPEX® tool is required
- ProPEX® rings required, sold separately



Part #	Mfg #	Description	Price
WIRQ2500400	Q2500400	4 Outlets	204.25
WIRQ2500800	Q2500800	8 Outlets	381.25

1" Copper Lead Free ProPEX® Valved Manifold with ProPEX® Ball Valves

Part #	Mfg #	Description	Price
WIRLF2500600	LF2500600	6 Outlets, Lead Free	288.35

Manifold Accessories for TruFLOW™ & 1-1/4" Brass Manifolds

ProPEX® Manifold Adapters

- Use to transition from the R32 manifold union nut to 3/4" & 1" AQUAPEX® & hePEX™plus



Use with 1-1/4" Brass & TruFLOW Manifolds
Not compatible with TruFLOW Sr.

Part #	Mfg #	Description	Price
WIRQ4143275	Q4143210	R32 x 1" Straight	33.70

PEX Tubing & Fittings

ProPEX® Outlet Boxes & Accessories

Washing Machine Outlet Box

- Plastic w/1/2" ProPEX® hot and cold color coded valves
- Valves may be mounted on top or bottom
- Knock-outs allow drain to be repositioned
- ProPEX® tool required
- ProPEX® rings must be purchased separately



Part #	Mfg #	Description	Price
WIRLF5930500	Q5830500	2 Valve w/Offset Drain	74.90

ProPEX® Water Heater Adapter (PEX x FIP)



Part #	Mfg #	Size	Price
WIRQ2957575	Q2957575	3/4" PEX x 3/4" FIP x 18"	52.40

ProPEX® Ice Maker Box with Support Brackets

- 1/2" ProPEX® valve
- 1/4" OD Compression connection
- (2) Support brackets



Part #	Mfg #	Description	Price
WIRLF5955025	Q5955025	ProPEX Ice Maker Box	44.25

ProPEX® In-Line Ice Maker Tee (PEX x PEX)

- In-line tee w/valve, 1/8" NPT x 1/4" OD compression
- ProPEX® tool required
- ProPEX® rings must be purchased separately



Part #	Mfg #	Size	Price
WIRQ4455050	Q4455050	1/2" x 1/2"	61.45

All Items May Not Be Stocked In All Branches

Hydronics

Installation Aids

Finish Sleeves

- Slides over 3/8" & 1/2" AQUAPEX® connected to point-of-use valve
- Provides protection & improves appearance



Part #	Mfg #	Description	Price
WIRF5600500	F5600500	1/2" PEX, Chrome	5.05

Plastic Drop Ear Bend Supports

- Glass reinforced nylon
- Provides rigid 90° bend & connection free stub-out from a stud wall or floor



Part #	Mfg #	Size	Price
WIRF5200500	F5200500	1/2"	3.00

Metal Drop Ear Bend Supports

- Zinc plated
- Provides rigid 90° bend & connection free stub-out for 3/8" or 1/2" PEX tubing products



Part #	Mfg #	Size	Price
WIRF5120500	F5120500	1/2"	8.00

PEX Clips - Plastic

- Enhanced Uponor PEX clips provide better holding power and can be attached together laterally for tight installations
- PEX Clips are attached under the wood subfloor for joist-heating applications
- Clips prevent tubing from coming in direct contact with subfloor
- Drywall screws are commonly used to secure the clips to the wood subfloor



Part #	Mfg #	Size	Price
WIRF7051258	F7051258	1/2" & 5/8"	0.91



Better Service Thru Better People



PEX Tubing & Fittings

Hydronics

CustomCut™ 1" Copper Manifolds

1 Trunk x 16 Branch - 3" OC Brass Fittings

- CustomCuts™ are designed to be cut up in the field
- Cut off the amount of branches you need
- All CustomCuts™ are 4' long with 16 fittings spaced 3" apart, so a pipe cutter can fit between the branches
- Comes with or without Mini Ball Valves (MBV)



Part #	Mfg #	Order #	Size	Price
PEXM16-12	WPCM5-M16-08	0650464	1/2" PEX Outlets	146.15

Copper Manifolds

Closed End x 3/4" CrimpRing™ End Manifolds

- 1" Diameter manifold trunks are closed at one end and have a 3/4" brass CrimpRing™ fitting at the supply end
- Available with 1/2" brass CrimpRing™ fittings, with or without 1/4-turn brass mini ball valves (MBV)
- Branches are 2" O.C.
- Manifolds are sold individually
- Order one for hot and one for cold

Part #	Mfg #	Order #	Size	Price
PEXM3PL154303	WPCM2-M3-08	0650436	3 Port - 3/4" CF	48.05

3/4" CrimpRing™ x 3/4" CrimpRing™ End Manifolds

- "Flow-through" manifold
- 3/4" Brass CrimpRing™ fitting at each end
- Available with 1/2" brass CrimpRing™ fittings, with or without 1/4-turn brass mini ball valves (MBV)
- Branches are 2"
- O.C. Manifolds are sold individually
- Order one for hot and one for cold

Part #	Mfg #	Order #	Size	Price
PEXM3PL153303	WPCM3-M3-08	0650448	3 Port 3/4" C x 1/2" CF	57.05

Press System Fittings

Press System® Fittings
Couplings (P x P)



Part #	Mfg #	Size	Price
RPPCPLG12	PC600-DS	1/2"	2.54
RPPCPLG34	PC600-DS	3/4"	3.85
RPPCPLG1	PC600-DS	1"	7.77
RPPCPLG114	PC600-DS	1-1/4"	9.63
RPPCPLG112	PC600-DS	1-1/2"	17.95
RPPCPLG2	PC600-DS	2"	22.90
RPPCPLG212	PC600-DS	2-1/2"	73.82
RPPCPLG3	PC600-DS	3"	94.06
RPPCPLG4	PC600-DS	4"	130.62

Reducer Couplings (P x P)



Part #	Mfg #	Size	Price
RPPCPLG34-12	PC600-R	3/4" x 1/2"	11.51
RPPCPLG1-12	PC600-R	1" x 1/2"	20.09
RPPCPLG1-34	PC600-R	1" x 3/4"	13.20
RPPCPLG114-34	PC600-R	1-1/4" x 3/4"	29.70
RPPCPLG114-1	PC600-R	1-1/4" x 1"	19.17
RPPCPLG112-34	PC600-R	1-1/2" x 3/4"	35.49
RPPCPLG112-1	PC600-R	1-1/2" x 1"	31.86
RPPCPLG112-114	PC600-R	1-1/2" x 1-1/4"	28.21
RPPCPLG2-1	PC600-R	2" x 1"	48.28
RPPCPLG2-114	PC600-R	2" x 1-1/4"	40.17
RPPCPLG2-112	PC600-R	2" x 1-1/2"	31.76

Fitting Reducers (P x SWT FTG)



Part #	Mfg #	Size	Price
RPPFRCPLG34-12	PC600-2	3/4" x 1/2"	2.83
RPPFRCPLG1-12	PC600-2	1" x 1/2"	7.23
RPPFRCPLG1-34	PC600-2	1" x 3/4"	7.50
RPPFRCPLG114-34	PC600-2	1-1/4" x 3/4"	8.88
RPPFRCPLG114-1	PC600-2	1-1/4" x 1"	10.00
RPPFRCPLG112-12	PC600-2	1-1/2" x 1/2"	26.14
RPPFRCPLG112-34	PC600-2	1-1/2" x 3/4"	14.85
RPPFRCPLG112-1	PC600-2	1-1/2" x 1"	14.68
RPPFRCPLG112-114	PC600-2	1-1/2" x 1-1/4"	14.78
RPPFRCPLG2-34	PC600-2	2" x 3/4"	33.63
RPPFRCPLG2-1	PC600-2	2" x 1"	16.65
RPPFRCPLG2-114	PC600-2	2" x 1-1/4"	20.38
RPPFRCPLG2-112	PC600-2	2" x 1-1/2"	19.81
RPPFRCPLG212-2	PC600-2	2-1/2" x 2"	86.51
RPPFRCPLG3-2	PC600-2	3" x 2"	107.10
RPPFRCPLG3-212	PC600-2	3" x 2-1/2"	110.33

Press System® Fittings (Continued)
Fitting Reducers (P x SWT FTG)

Part #	Mfg #	Size	Price
RPPFRCPLG4-3	PC600-2	4" x 3"	142.34

Repair Couplings (P x P)



Part #	Mfg #	Size	Price
RPPSLCPLG12	PC601	1/2"	6.09
RPPSLCPLG34	PC601	3/4"	8.33
RPPSLCPLG1	PC601	1"	10.20
RPPSLCPLG114	PC601	1-1/4"	15.53
RPPSLCPLG112	PC601	1-1/2"	23.93
RPPSLCPLG2	PC601	2"	27.85
RPPSLCPLG212	PC601	2-1/2"	72.83
RPPSLCPLG3	PC601	3"	94.05
RPPSLCPLG4	PC601	4"	129.29

Adapters (P x FIP)



Part #	Mfg #	Size	Price
RPPFEA12	PC603	1/2"	4.08
RPPFEA12-34	PC603	1/2" x 3/4"	8.37
RPPFEA34	PC603	3/4"	6.63
RPPFEA34-12	PC603	3/4" x 1/2"	6.12
RPPFEA1	PC603	1"	12.23
RPPFEA114	PC603	1-1/4"	27.58
RPPFEA112	PC603	1-1/2"	40.10
RPPFEA2	PC603	2"	68.07

Adapters (P x MIP)



Part #	Mfg #	Size	Price
RPPMA12	PC604	1/2"	3.38
RPPMA12-34	PC604	1/2" x 3/4"	6.24
RPPMA34	PC604	3/4"	6.12
RPPMA34-12	PC604	3/4" x 1/2"	6.95
RPPMA1	PC604	1"	11.21
RPPMA1-34	PC604	1" x 3/4"	16.77
RPPMA1-114	PC604	1" x 1-1/4"	20.88
RPPMA114	PC604	1-1/4"	24.53
RPPMA112	PC604	1-1/2"	34.39
RPPMA2	PC604	2"	66.22
RPPMA212	PC604	2-1/2"	147.01
RPPMA3	PC604	3"	184.95

Press System Fittings

Prices & Specifications are Subject to Change.

Press System Fittings

Press System Fittings

45° Elbows (P x P)



Part #	Mfg #	Size	Price
RPP4512	PC606	1/2"	3.28
RPP4534	PC606	3/4"	4.03
RPP451	PC606	1"	12.91
RPP45114	PC606	1-1/4"	18.50
RPP45112	PC606	1-1/2"	29.98
RPP452	PC606	2"	41.95
RPP45212	PC606	2-1/2"	97.12
RPP453	PC606	3"	138.74
RPP454	PC606	4"	192.68

45° Elbows (P x SWT FTG)



Part #	Mfg #	Size	Price
RPPST4512	PC606-2	1/2"	2.54
RPPST4534	PC606-2	3/4"	3.76
RPPST451	PC606-2	1"	12.35
RPPST45114	PC606-2	1-1/4"	17.84
RPPST45112	PC606-2	1-1/2"	27.28
RPPST452	PC606-2	2"	40.44
RPPST453	PC606-2	3"	162.20

90° Elbows (P x P)



Part #	Mfg #	Size	Price
RPP9012	PC607	1/2"	2.83
RPP9034	PC607	3/4"	4.77
RPP901	PC607	1"	9.55
RPP90114	PC607	1-1/4"	19.25
RPP90112	PC607	1-1/2"	36.43
RPP902	PC607	2"	50.63
RPP90212	PC607	2-1/2"	147.01
RPP903	PC607	3"	184.95
RPP904	PC607	4"	228.82

90° Elbows (P x SWT FTG)



Part #	Mfg #	Size	Price
RPPST9012	PC607-2	1/2"	2.83
RPPST9034	PC607-2	3/4"	4.77
RPPST901	PC607-2	1"	10.95
RPPST90114	PC607-2	1-1/4"	19.44
RPPST90112	PC607-2	1-1/2"	37.09
RPPST902	PC607-2	2"	50.99
RPPST90212	PC607-2	2-1/2"	152.87
RPPST903	PC607-2	3"	177.76

90° Drop Elbows (P x FIP)



Part #	Mfg #	Size	Price
RPPDE9012	PC707-3-5	1/2"	14.07

Tees (P x P x P)



Part #	Mfg #	Size	Price
RPPT12	PC611	1/2"	4.32
RPPT12-12-34	PC611	1/2" x 1/2" x 3/4"	14.40
RPPT34	PC611	3/4"	7.58
RPPT34-12-12	PC611	3/4" x 1/2" x 1/2"	11.68
RPPT34-12-34	PC611	3/4" x 1/2" x 3/4"	12.15
RPPT34-34-12	PC611	3/4" x 3/4" x 1/2"	6.38
RPPT1	PC611	1"	13.65
RPPT1-34-34	PC611	1" x 3/4" x 3/4"	20.75
RPPT1-34-1	PC611	1" x 3/4" x 1"	23.45
RPPT1-1-12	PC611	1" x 1" x 1/2"	15.62
RPPT1-1-34	PC611	1" x 1" x 3/4"	15.53
RPPT114	PC611	1-1/4"	23.08
RPPT114-114-12	PC611	1-1/4" x 1-1/4" x 1/2"	19.35
RPPT114-114-34	PC611	1-1/4" x 1-1/4" x 3/4"	21.12
RPPT114-114-1	PC611	1-1/4" x 1-1/4" x 1"	21.95
RPPT112	PC611	1-1/2"	44.83
RPPT112-112-34	PC611	1-1/2" x 1-1/2" x 3/4"	39.80
RPPT112-112-1	PC611	1-1/2" x 1-1/2" x 1"	40.53
RPPT112-112-114	PC611	1-1/2"x1-1/2"x1-1/4"	41.95
RPPT2	PC611	2"	55.38
RPPT2-2-34	PC611	2" x 2" x 3/4"	64.81
RPPT2-2-1	PC611	2" x 2" x 1"	66.98
RPPT2-2-114	PC611	2" x 2" x 1-1/4"	66.98

All Items May Not Be Stocked In All Branches

Press System Fittings

Press System® Fittings (Continued)

Tees (P x P x P)

Part #	Mfg #	Size	Price
RPPT2-2-112	PC611	2" x 2" x 1-1/2"	50.34
RPPT212	PC611	2-1/2"	181.63
RPPT212-212-112	PC611	2-1/2"x2-1/2"x1-1/2"	242.04
RPPT212-212-2	PC611	2-1/2" x 2-1/2" x 2"	213.36
RPPT3	PC611	3"	227.02
RPPT3-3-2	PC611	3" x 3" x 2"	261.18
RPPT3-3-212	PC611	3" x 3" x 2-1/2"	272.43
RPPT4	PC611	4"	318.54
RPPT4-4-2	PC611	4" x 4" x 2"	288.33
RPPT4-4-3	PC611	4" x 4" x 3"	325.73

Tees (P x P x FIP)



Part #	Mfg #	Size	Price
RPPTCCF34-34-12	PC712	3/4" x 3/4" x 1/2"	18.13
RPPTCCF1-1-12	PC712	1" x 1" x 1/2"	25.15
RPPTCCF114-114-12	PC712	1-1/4" x 1-1/4" x 1/2"	32.58
RPPTCCF114-114-34	PC712	1-1/4" x 1-1/4" x 3/4"	33.78
RPPTCCF112-112-12	PC712	1-1/2" x 1-1/2" x 1/2"	39.38
RPPTCCF2-2-12	PC712	2" x 2" x 1/2"	48.91

Tube Caps (P)



Part #	Mfg #	Size	Price
RPPCAP12	PC617	1/2"	5.43
RPPCAP34	PC617	3/4"	9.15
RPPCAP1	PC617	1"	14.11
RPPCAP114	PC617	1-1/4"	15.98
RPPCAP112	PC617	1-1/2"	24.76
RPPCAP2	PC617	2"	30.08

Unions (P x P)



Part #	Mfg #	Size	Price
RPPUN12	PC733	1/2"	20.31
RPPUN34	PC733	3/4"	28.28
RPPUN1	PC733	1"	45.18
RPPUN114	PC733	1-1/4"	60.68
RPPUN112	PC733	1-1/2"	87.59
RPPUN2	PC733	2"	143.02

Press System® Tools

PC-280 Pressing Tool

- Includes:
 - (2) 18V, 3.0 Ah Lithium-ion batteries
 - 110V Battery charger and case



Part #	Mfg #	Description	Price
RPPPC100	PC-280	Battery Operated Pressing Tool w/Case	3000.00
RPPPC16S	PC-16S	1/2" - 1-1/4" (4 Jaws) Std Press Jaw Kit w/Case	657.00
RPPPC17S	PC-17S	1-1/2" - 2" (2 Jaws) Std Press Jaw Kit w/Case	500.00
RPPPC2	PC-2	2-1/2" Pressing Chain w/Case	685.00
RPPPC3	PC-3	3" Pressing Chain w/Case	714.00
RPPPC5	PC-5	Chain Adapter	657.00
RPPPC9	PC-9L	AC Adapter	420.00

PC-200M Mini Pressing Tool

- Includes:
 - (2) 18V, 1.3 Ah Lithium-ion batteries
 - 110V Standard charger and case
 - (3) Jaws (1/2", 3/4" and 1")



Part #	Mfg #	Description	Price
RPPC100	PC-200M	Mini Pressing Tool & Jaws	3000.00

Prices & Specifications are Subject to Change.

HDPE Pipe

Single Wall Pipe

Heavy-Duty Single Wall AASHTO Plain HDPE Pipe

- Annular corrugated single wall
- Internal, external snap or split band coupler connection

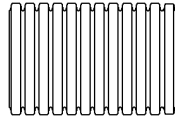

Part #	Mfg #	Size	Price
CORCS4-100	HY-PL1-04-0100	4" x 100'	113.96
CORCS4-250	HY-PL5-04-0250	4" x 250'	284.90
CORCS6-100	HY-PL1-06-0100	6" x 100'	304.92

Single Wall AASHTO Perforated HDPE Pipe

- Annular corrugated & perforated single wall
- Internal, external snap or split band coupler connection

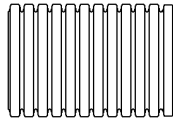

Part #	Mfg #	Size	Price
CORCP4-100	HY-PF1-04-0100	4" x 100'	113.96
CORCP4-250	HY-PF5-04-0250	4" x 250'	284.90
CORCP6-100	HY-PF1-06-0100	6" x 100'	304.92

Single Wall AASHTO Perforated HDPE Pipe with Wrap

- Annular corrugated & perforated single wall wrapped
- Internal, external snap or split band coupler connection

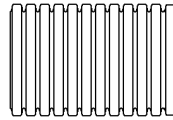

Part #	Mfg #	Size	Price
CORCP4-100 WRAP	HY-PWK-04-0100	4" x 100'	157.08
CORCP4-250 WRAP	HY-PWK-04-0250	4" x 250'	392.70

Dual Wall Pipe

Dual Wall Hi-Q® HDPE Plain Pipe

- Annular corrugation w/smooth interior
- External snap or split band coupler connection depending on diameter

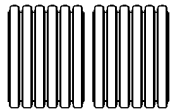

Part #	Mfg #	Size	Price
CORP8-20	DW-PL1-08	8" x 20'	197.12
CORP10-20	DW-PL1-10	10" x 20'	277.82
CORP12-20	DW-PL1-12	12" x 20'	347.42
CORP15-20	DW-PL1-15	15" x 20'	432.44

Single Wall Fittings

Single Wall Internal Snap Couplers

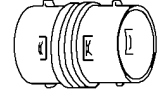

Part #	Mfg #	Size	Price
CORCPLG4	FC-CZB-04	4"	5.28
CORCPLG6	FC-CZB-06	6"	7.02

Single Wall External Hi-Q® End Caps

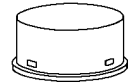

Part #	Mfg #	Size	Price
CORCAP4	FC-E0B-04	4"	6.92

Single Wall 90° Elbows

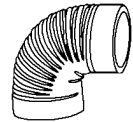

Part #	Mfg #	Size	Price
COR904	FC-LOB-04	4"	9.06

Single Wall Standard Tees

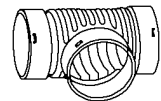

Part #	Mfg #	Size	Price
CORT4	FC-T0B-04	4"	11.06

Single Wall Wyes

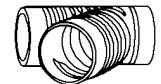

Part #	Mfg #	Size	Price
CORY4	FC-Y0B-04	4"	12.36

Dual Wall Fittings

Dual Wall Hi-Q® Coupler



Part #	Mfg #	Size	Type	Price
CORCPLG8	FC-CPS-08	8"	Split Band	11.94
CORCPLG10	FC-CPB-10	10"	Split Band	17.64
CORCPLG12	FC-CPB-12	12"	Split Band	19.94
CORCPLG15	FC-CPB-15	15"	Split Band	31.16

All Items May Not Be Stocked In All Branches

Corrugated Pipe & Fittings



www.irrsupply.com

Geothermal Pipe

Geothermal Pipe by ENDOT

SDR 11 Geothermal Tubing

Part #	Mfg #	Size x Length	Price
GEOC34-100	3/4 X 100' SDR-11 GEO	3/4" x 100' Coil	31.00
GEOC34-600	3/4 X 600' SDR-11 GEO	3/4" x 600' Coil	186.00
GEOC34-800	3/4 X 800' SDR-11 GEO	3/4" x 800' Coil	248.00
GEOC114-200	1 1/4 X 200' SDR-11 GEO	1-1/4" x 200' Coil	148.00

SDR 11 Geothermal Pipe Length

Part #	Mfg #	Size x Length	Price
GEOP34-20	3/4 X 20' SDR-11 GEO	3/4" x 20'	10.24
GEOP114-20	1 1/4 X 20' SDR-11 GEO	1-1/4" x 20'	24.42

Visionary Baths & More

Because your time is valuable...

Visit your local Visionary Baths & More Kitchen and Bath Design Centers to let one of our trained knowledgeable consultants help you with your project.

<http://www.visionarybaths.com>

Geothermal Pipe & Fittings

Geothermal Pipe Fittings

Geothermal Pipe Fittings

SDR 11 Geothermal Socket Fusion 90° Elbow

- PE 3408 IPS

Part #	Mfg #	Size x Length	Price
GEO9034	3/4 90 PE 3408IPS BLK	3/4" Black	6.94
GEO90114-34	114-34 90ELL PE 3408IPS	1-1/4" x 3/4" Black	4.92
GEO90114	PE 3408IPS 1 1/4 90ELL	1-1/4" Black	9.34

SDR 11 Geothermal Socket Fusion Cap

- PE 3408 IPS

Part #	Mfg #	Size x Length	Price
GEOCAP34	3/4 CAP PE 3408IPS	3/4" Black	5.22
GEOCAP114	1 1/4 CAP PE 3408IPS	1-1/4" Black	7.06

SDR 11 Geothermal Socket Fusion Coupling

- PE 3408 IPS

Part #	Mfg #	Size x Length	Price
GEOCLPG34	3/4 CPLG PE 3408IPS	3/4" Black	3.46
GEOCLPG114	1 1/4 CPLG PE 3408IPS	1-1/4" Black	4.42

SDR 11 Geothermal Socket Fusion Male Adapter

- PE 3408 IPS

Part #	Mfg #	Size x Length	Price
GEOMA114	1-1/4 MALE TRANS PE 3408	1-1/4" Socket to Male	36.26
GEOMA114-1	1-1/4 X 1 MALE TRANS PE 3408	1-1/4" Socket x 1" Male	23.56

SDR 11 Geothermal Socket Fusion Tee

- PE 3408 IPS

Part #	Mfg #	Size x Length	Price
GEOT34	3/4 TEE PE 3408IPS	3/4" Black	5.90
GEOT114-34	114-114-34 TEE PE 3408IPS	1-1/4" x 3/4" Black	9.28
GEOT114-34-34	114-34-34 TEE PE 3408IPS	1-1/4" x 3/4" x 3/4" Black	9.28

Geothermal Pipe & Fittings

Geothermal Accessories

Part #	Mfg #	Description	Price
GEOHOSE1	7602-103	1" MPT Neoprene Hose Kit Supply/Return	187.20

All Items May Not Be Stocked In All Branches

Pipe Accessories

Copper Tube Bell Hangers

Van Hanger - Copper Clad

- Wood screws included
- 20 per carton

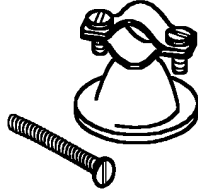

Part #	Mfg #	Pipe Size	Price
AMT60612	606-2	1/2"	1.47
AMT60634	606-3	3/4"	1.57
AMT6061	606-4	1"	1.72



Dresser Compression Couplings

- Galvanized
- 5" Length



Part #	Mfg #	Size	Price
DRE12L	440L03	1/2" x 5"	12.90
DRE34L	440L04	3/4" x 5"	14.32
DRE1L	440L05	1" x 5"	18.68
DRE114L	440L06	1-1/4" x 5"	24.44
DRE112L	440L07	1-1/2" x 5"	31.86
DRE2L	440L08	2" x 5"	38.40



Flange Connection Gaskets

Asbestos-Free Full Face Gasket Kits

- 1/6" Thick
- Meets ASTM A307 hex bolts and heavy hex nuts
- Constructed of Garlock 2910
- Meets ASTM F152, F36A and F146

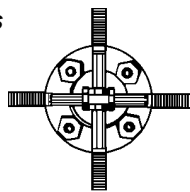

Part #	Mfg #	Pipe Size	Bolt Size	Bolts/Kit	Price
GRIFPAK212	G54-125	2-1/2"	5/8" x 3"	4	12.33
GRIFPAK3	G54-103	3"	5/8" x 3"	4	12.81
GRIFPAK4	G54-104	4"	5/8" x 3"	8	21.35



Pipe Clamps

Suspension Pipe Clamps

- Eliminates contact between the pipe & framing surface thereby reducing transmission of water line noise
- No corrosion - made of durable polypropylene (gray color)
- Ribbed design allows faster cooling and pipe expansion and contraction
- Can be used on hydronic systems



Part #	Mfg #	Size	Pkg Qty	Price
OATSCCLAMP12	33935	1/2"	100	0.28
OATSCCLAMP34	33936	3/4"	100	0.32

Insulating Pipe Clamps

- Designed to eliminate notching & wrapping of pipe when running water lines through framing
- Reduces water line noise & vibration
- No corrosion - made of durable, low density polyethylene (gray color)



Part #	Mfg #	Size	Pkg Qty	Price
OATCL12	33950	1/2"	50	0.82
OATCL34	33951	3/4"	50	0.88
OATCL1	33952	1"	25	0.92

Standard Pipe Clamps

- Clamp design allows pipe to be flush mounted to walls & joists
- Minimizes the transmission of water line noise
- No corrosion - made of durable, polypropylene (gray color)
- Ribbed design allows pipe to cool faster & expand/contract freely



Part #	Mfg #	Size	Pkg Qty	Price
OATPCLAMP12	33940	1/2"	100	0.28
OATPCLAMP34	33941	3/4"	100	0.30
OATPCLAMP1	33942	1"	50	0.76

Pipe Accessories

Pipe Hooks

DWV Multi-Hook Pipe Holders

- Hooks swivel to any angle
- Has 3/4" saddle required for VA & FHA approved loans
- Made of high impact ABS

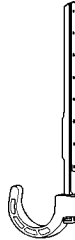

Part #	Mfg #	Size	Price
OATJH112	33831	1-1/2" x 9"	1.82
OATJH2	33832	2" x 9"	1.82
OATJH3	33833	3" x 9"	1.92
OATJH4	33834	4" x 9"	2.08

CTS Multi-Hook Water Pipe Holders

- Hooks swivel to any angle
- Made of high impact ABS



Part #	Mfg #	Description	Price
OATBJH34	33836	3/4" with 6" Stem	1.62
OATBJH12	33835	1/2" with 6" Stem	1.56
OATBJH1	33837	1" with 6" Stem	1.70

Hanger Strap

Plastic Hanger Strap

- Nail holes are 2-1/2" apart
- Non-corrosive, non-conductive, with nail holes
- Quick & inexpensive way to hang pipe from joists and rafters
- 1/8" Nominal hole size
- Polyethylene



Part #	Mfg #	Size	Price
OATPSTRAP50	33926	3/4" x 50'	11.22
OATPSTRAP100	33927	3/4" x 100'	21.06

H-Struts

1-5/8" x 1-5/8" Channel with Slots

- 1-5/8" x 1-5/8" x 12 gauge
- 9/16" x 1-1/8" Slots on 2" centers
- For heavy applications
- For individual fastening or for efficiently constructing pipe or tube routes
- Painted green finish



Part #	Mfg #	Lgth	Hole/Slot	Price
STR158-10	H-132-OS X 10' GRN	10'	Half Slot	47.10
STR158-20	H-132-OS X 20' GRN	20'	Half Slot	94.19

3/16" x 1-5/8" Channel with Slots

- 3/16" x 1-5/8" x 14 gauge
- 9/16" x 1-1/8" Slots on 2" centers
- For individual fastening or for efficiently constructing pipe or tube routes
- Painted green finish



Part #	Mfg #	Lgth	Hole/Slot	Price
STR1316-10	H-164-OS X 10' GRN	10'	Half Slot	39.28

Top Spring Channel Nut

- Electro-zinc plated
- For all H-strut

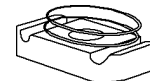

Part #	Mfg #	Description	Price
STRNUT38	TSN-801 3/8	3/8"-16 Top Twirl Nut for all Channel	3.11
STRNUT12	TSN-802 1/2	1/2"-13 Top Twirl Nut for all Channel	3.12

Strut Clamps

C-1000 Cushion Clamp for Tube

- Eliminates metal to metal contact
- Fits standard 1-5/8" strut channel
- Thermoplastic elastomer cushion
- Unique shoulder stud securely fastened to one half of clamp - eliminated over-tightening and rotation
- Permits various fluid conductors to be mixed



Part #	Mfg #	Tube OD	Steel Gauge	Price
STRVC14	C-100025 1/4 OD	1/4"	14	6.67

Pipe Accessories

All Items May Not Be Stocked In All Branches

Pipe Accessories

Strut Clamps (Continued)

C-1000 Cushion Clamp for Tube

Part #	Mfg #	Tube OD	Steel Gauge	Price	
STRVC38	C-100037	3/8" OD	3/8"	14	6.67
STRVC12	C-100050	1/2" OD	1/2"	14	6.67
STRVC58	C-100062	5/8" OD	5/8"	14	6.82
STRVC34	C-100075	3/4" OD	3/4"	14	7.69
STRVC78	C-100087	7/8" OD	7/8"	14	8.75
STRVC118	C-100112	1-1/8" OD	1-1/8"	12	10.11
STRVC138	C-100137	1-3/8" OD	1-3/8"	11	11.96
STRVC158	C-100162	1-5/8" OD	1-5/8"	11	15.76
STRVC218	C-100212	2-1/8" OD	2-1/8"	11	29.15
STRVC258	C-100262	2-5/8" OD	2-5/8"	12	33.28
STRVC318	C-100312	3-1/8" OD	3-1/8"	12	45.69

Tube Clamp

- Electro-galvanized



Part #	Mfg #	OD Size	Price
STRCTC12	C-1101 X 1/2 CT	1/2"	3.05
STRCTC34	C-1101 X 3/4 CT	3/4"	3.40
STRCTC1	C-1101 X 1 CT	1"	3.76
STRCTC114	C-1101 X 1-1/4 CT	1-1/4"	4.33
STRCTC112	C-1101 X 1-1/2 CT	1-1/2"	4.52
STRCTC2	C-1101 X 2 CT	2"	6.12
STRCTC212	C-1101 X 2-1/2 CT	2-1/2"	6.82
STRCTC3	C-1101 X 3 CT	3"	7.47

Rigid Conduit Clamp

- Electro-zinc plated finish



Part #	Mfg #	Pipe Size	Steel Gauge	Price
STRGPC12	C-1102 X 1/2	1/2"	16	2.36
STRGPC34	C-1102 X 3/4	3/4"	14	2.41
STRGPC1	C-1102 X 1	1"	14	2.77
STRGPC114	C-1102 X 1-1/4	1-1/4"	14	3.00
STRGPC112	C-1102 X 1-1/2	1-1/2"	12	3.91
STRGPC2	C-1102 X 2	2"	12	4.22
STRGPC212	C-1102 X 2-1/2	2-1/2"	12	4.44
STRGPC3	C-1102 X 3	3"	12	4.78

Strut Clamps (Continued)

Rigid Conduit Clamp

Part #	Mfg #	Pipe Size	Steel Gauge	Price
STRGPC4	C-1102 X 4	4"	11	6.26
STRGPC6	C-1102 X 6	6"	10	11.84

Rooftop Support Systems

C Series Channel Support

- Designed for support of gas and refrigeration piping systems, cable tray, electrical conduit, multiple lines, HVAC equipment and many other applications
- With galvanized H-164 steel channel
- Suitable for installation on most types of roofing material or other flat surfaces
- 100% Recycled rubber, UV resistant
- 750 lbs/ft Maximum load



RT-C10-H-164



RT-C10-H-132

Part #	Mfg #	Pipe Size	Steel Gauge	Price
STRPIER4	RT-C10-H-164 PG	4-7/8"H x 6"W x 9.6"L Single Base, 13/16" Channel		39.12
STRPIER6	RT-C10-H-132 PG	5-5/8"H x 6"W x 9.6"L Single Base, 1-5/8" Channel		47.82

Peter Mangone, Inc.

Clip Guns

Pneumatic Clip Gun

- Utilizes stand-off or flush mount clips
- Hammer head of tool repeatedly strikes clips until the two nails are 5/8" deep



Part #	Mfg #	Description	Price
PEMRB6	RB-6	Pneumatic Clip Gun	727.20

Prices & Specifications are Subject to Change.

Pipe Accessories

Manual Clip Gun

- Utilizes stand-off or flush mount clips

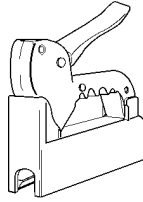

Part #	Mfg #	Description	Price
PEMGUN	RB-5	Manual Clip Gun	69.48

Clips

RB Stand Off Clips

- For use on radiant heating systems, PEX and CPVC water pipe

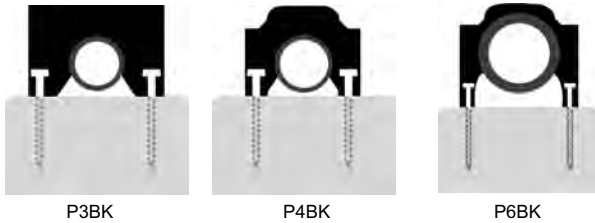

Part #	Mfg #	Description	Price
PEMCLIP38	P3BK	For 3/8" ID (1/2" OD)	22.60
PEMCLIP12	P4BK	For 1/2" ID (5/8" OD)	13.58
PEMCLIP34	P6BK	For 3/4" ID (7/8" OD)	22.60

Reddi-Strip® Fastening System

Reddi-Strip® Stand-Up Stapler

- Utilizes flexible strips of PEX staples
- Easy to load, easy to use
- For use on foamboard or insulating tarp
- 5 lbs



Part #	Mfg #	Description	Price
PEMRSST	RSST	Reddi-Strip® Stand-Up Stapler	581.76

Reddi-Strip® Staples

- For use with Reddi-Strip® Stapler
- High-density polyethylene
- 0.75" Interior width, 1.9" interior height
- Packaged in strips of 50 staples, 4 strips/box
- For securing PEX tubing up to 5/8" ID

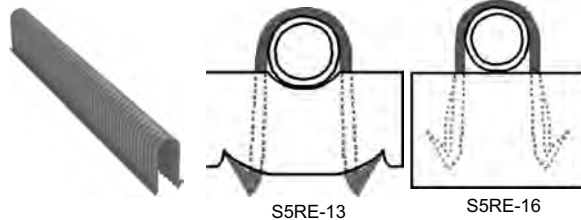

Part #	Mfg #	Description	Price
PEMS5RE13	S5RE-13	For Fastening to Insulating Tarp	51.72
PEMS5RE	S5RE-16	For Fastening to Foamboard	42.02



Hangers

CLIC-X Thermoplastic Support & Hanger System

- Made from Xenoy 5730 and Nylon PA 12
- Supports all types of weights of conduit, pipe, tubing, and cable
- Allows expansion and contraction of piping systems
- Excellent dielectric
- Corrosion-resistant
- UL, IAPMO, ROHS listed
- Green product, no halogens and/or phosphates



Part #	Mfg #	Description	Price
CLI15	CLIC15	1/2" x 5/8"OD	1.18
CLI20	CLIC20	3/4" x 7/8"OD	1.56
CLI22	CLIC22	3/4" x 59/64"OD	1.74
CLI28	CLIC28	1" x 1-1/8"OD	2.46
CLI32	CLIC32	1-1/8" x 1-3/8"OD	3.20
CLI40	CLIC40	1-1/2" x 1-5/8"OD	4.30
CLI47	CLIC47	1-1/2" x 1-57/64"OD	5.50
CLI51	CLIC51	2" x 2-1/8"OD	5.94
CLI59	CLIC59	2" x 2-1/4"OD	7.34
CLI80	CLIC80	3" x 3-1/2"OD	7.50

Pipe Accessories

Imcolock Pluseal® Pipe Insulation

- Engineered polymer foam insulation (EPFI)
- Pre-slit/pre-glued on both sides
- Upper working temperature +210°F
- Lower working temperature -330°F
- Retains flexibility to -165°F
- 25/50 Flame & smoke rating
- Environmentally safe Fuse-Seal™ joining system
- 6' Lengths



Imcolock Pluseal® Pipe Insulation - 1/2" Nominal Wall Thickness

Part #	Mfg #	Copper Tubing ID	Copper Tubing OD	Pipe Size	Price
INSSS2-12-6	6IL048200	-	-	1-1/2"	8.00
INSSS218-12-6	6IL048218	2"	2-1/8"	-	14.70
INSSS238-12-6	6IL048238	-	-	2"	15.82
INSSS258-12-6	6IL048258	2-1/2"	2-5/8"	-	18.02
INSSS318-12-6	6IL048318	3"	3-1/8"	-	23.58
INSSS358-12-6	6IL048358	3-1/2"	3-5/8"	-	31.02
INSSS412-12-6	6IL048448	-	-	4"	67.33

Imcolock™ Pipe Insulation

- Self-sealing, flexible, polyolefin, thermal insulation
- Used to retard heat gain and prevent condensation or frost formation on cold water plumbing, chilled water and air conditioning lines
- Also retards heat loss on hot water plumbing
- Service temperature range: -330° to 210°F
- Pre-slit with factory applied pressure sensitive adhesive with built-in release tabs for easy installation
- Black color



Imcolock™ Pipe Insulation - 1/2" Nominal Wall Thickness

Part #	Mfg #	Copper Tubing ID	Copper Tubing OD	Pipe IPS	Price
INSSS58-12-6	58CT	1/2"	5/8"	3/8"	6.59
INSSS78-12-6	78CT	3/4"	7/8"	-	7.43
INSSS118-12-6	118CT	1"	1-1/8"	-	8.51
INSSS138-12-6	138CT	1-1/4"	1-3/8"	-	9.55
INSSS158-12-6	158CT	1-1/2"	1-5/8"	1-1/4"	11.23

Imcolock™ Fiber Self-Seal Pipe Insulation - 1/2" Nominal Wall Thickness

Part #	Mfg #	Pipe OD/Nom Insul ID	Lgth	Price
INSFIB38-12-3	050058SSL	3/8" IPS (5/8" CTS)	3'	4.86
INSFIB12-12-3	050050SSL	1/2" IPS (7/8" CTS)	3'	4.86
INSFIB34-12-3	050075SSL	3/4" IPS (1-1/8" CTS)	3'	5.61
INSFIB1-12-3	050001SSL	1" IPS (1-3/8" CTS)	3'	5.97
INSFIB114-12-3	050125SSL	1-1/4" IPS (1-5/8" CTS)	3'	6.30
INSFIB112-12-3	050150SSL	1-1/2" IPS (1-7/8" CTS)	3'	6.99
INSFIB2-12-3	050002SSL	2" IPS (2-3/8" CTS)	3'	8.94
INSFIB218-12-3	050218SSL	2-1/8" IPS (2-1/2" CTS)	3'	9.66
INSFIB258-12-3	050258SSL	2-5/8" IPS (3" CTS)	3'	10.09

Prices & Specifications are Subject to Change.

Pipe Accessories

Imcolock™ Fiber Self-Seal Pipe Insulation - 1" Nominal Wall Thickness

Part #	Mfg #	Pipe OD/Nom Insul ID	Lgth	Price
INSFIB38-1-3	100058SSL	3/8" IPS (5/8" CTS)	3'	5.97
INSFIB12-1-3	100050SSL	1/2" IPS (7/8" CTS)	3'	5.97
INSFIB34-1-3	100075SSL	3/4" IPS (1-1/8" CTS)	3'	6.69
INSFIB1-1-3	100001SSL	1" IPS (1-3/8" CTS)	3'	6.63
INSFIB112-1-3	100150SSL	1-1/2" IPS (1-7/8" CTS)	3'	8.43
INSFIB2-1-3	100002SSL	2" IPS (2-3/8" CTS)	3'	9.24
INSFIB318-1-3	100318SSL	2-3/4" IPS (3-1/8" CTS)	3'	13.75
INSFIB3-1-3	100003SSL	3" IPS (3-3/8" CTS)	3'	13.75
INSFIB4-1-3	100004SSL	4" IPS (4-3/8" CTS)	3'	16.35
INSFIB6-1-3	100006SSL	6" IPS (6-3/8" CTS)	3'	21.78

FLEXTHERM Insulation (Unslit)

- Flexible closed cell insulation
- Environmentally friendly, CFC-free
- Flexible elastomeric thermal insulation
- Non-porous, non-fibrous and resists mold



3/8" Wall (BUF)

- 6' Length

Part #	Mfg #	Insul Nom Size	Copper Tubing ID	Copper Tubing OD	IPS Nom	Price
INSRUB58-38-6	6RU038058	5/8"	1/2"	5/8"	3/8"	5.60
INSRUB34-38-6	6RU038068	3/4"	5/8"	3/4"	1/2"	5.96
INSRUB78-38-6	6RU038078	7/8"	3/4"	7/8"	-	6.23
INSRUB118-38-6	6RU038118	1-1/8"	1"	1-1/8"	3/4"	7.10

1/2" Wall (CUF)

- 6' Length

Part #	Mfg #	Insul Nom Size	Copper Tubing ID	Copper Tubing OD	IPS Nom	Price
INSRUB38-12-6	6RU048038	3/8"	1/4"	3/8"	1/8"	6.98
INSRUB12-12-6	6RU048048	1/2"	3/8"	1/2"	1/4"	7.46
INSRUB58-12-6	6RU048058	5/8"	1/2"	5/8"	3/8"	8.23
INSRUB34-12-6	6RU048068	3/4"	5/8"	3/4"	1/2"	8.48
INSRUB78-12-6	6RU048078	7/8"	3/4"	7/8"	-	9.18
INSRUB118-12-6	6RU048118	1-1/8"	1"	1-1/8"	-	10.28
INSRUB138-12-6	6RU048138	1-3/8"	1-1/4"	1-3/8"	1"	11.29
INSRUB158-12-6	6RU048158	1-5/8"	1-1/2"	1-5/8"	1-1/4"	13.13
INSRUB218-12-6	6RU048218	2-1/8"	2"	2-1/8"	-	17.09
INSRUB258-12-6	6RU048258	2-5/8"	2-1/2"	2-5/8"	-	23.79
INSRUB318-12-6	6RU048318	3-1/8"	3"	3-1/8"	-	28.14
INSRUB358-12-6	6RU048358	3-5/8"	3-1/2"	3-5/8"	-	37.59
INSRUB418-12-6	6RU048418	4-1/8"	4"	4-1/8"	-	41.61

Pipe Accessories

3/4" Wall (CUF)

- 6' Length

Part #	Mfg #	Insul Nom Size	Copper Tubing ID	Copper Tubing OD	IPS Nom	Price
INSRUB12-34-6	6RU068048	1/2"	3/8"	1/2"	1/4"	11.59
INSRUB58-34-6	6RU068058	5/8"	1/2"	5/8"	3/8"	12.65
INSRUB78-34-6	6RU068078	7/8"	3/4"	7/8"	-	15.12
INSRUB118-34-6	6RU068118	1-1/8"	1"	1-1/8"	-	18.54
INSRUB138-34-6	6RU068138	1-3/8"	1-1/4"	1-3/8"	1"	21.15
INSRUB158-34-6	6RU068158	1-5/8"	1-1/2"	1-5/8"	1-1/4"	28.46
INSRUB218-34-6	6RU068218	2-1/8"	2"	2-1/8"	-	35.28
INSRUB258-34-6	6RU068258	2-5/8"	2-1/2"	2-5/8"	-	44.38

1" Wall (CUF)

- 6' Length

Part #	Mfg #	Insul Nom Size	Copper Tubing ID	Copper Tubing OD	IPS Nom	Price
INSRUB58-1-6	6RU100058	5/8"	1/2"	5/8"	3/8"	23.77
INSRUB34-1-6	6RU100068	3/4"	5/8"	3/4"	1/2"	26.35
INSRUB78-1-6	6RU100078	7/8"	3/4"	7/8"	-	29.50
INSRUB118-1-6	6RU100118	1-1/8"	1"	1-1/8"	-	35.83
INSRUB138-1-6	6RU100138	1-3/8"	1-1/4"	1-3/8"	1"	41.71
INSRUB158-1-6	6RU100158	1-5/8"	1-1/2"	1-5/8"	1-1/4"	47.09
INSRUB218-1-6	6RU100218	2-1/8"	2"	2-1/8"	-	58.00

FLEXTHERM Insulation (Seam Seal)

- Flexible closed cell insulation
- Environmentally friendly, CFC-free
- Flexible elastomeric thermal insulation
- Non-porous, non-fibrous and resists mold

Part #	Mfg #	Size	Price
INSRUBSS34-12-6	6RUL048068	3/4" IPS x 1/2" x 6'	15.64
INSRUBSS78-12-6	6RUL048078	7/8" IPS x 1/2" x 6'	17.03
INSRUBSS118-12-6	6RUL048118	1-1/8" IPS x 1/2" x 6'	19.10
INSRUBSS138-12-6	6RUL048138	1-3/8" IPS x 1/2" x 6'	21.74

Sheet Insulation

- Used primarily for ambient service to retard heat gain and control condensation drip
- Used for reducing heat flow for hot water plumbing and liquid heating, dual temp piping and air conditioning and refrigeration systems



Part #	Mfg #	Size	Price
INSSHEET38	6RSX3X4038	36" x 48" x 3/8" Thickness	32.97
INSSHEET12	6RSX3X4048	36" x 48" x 1/2" Thickness	34.93
INSSHEET34	6RSX3X4068	36" x 48" x 3/4" Thickness	52.61
INSSHEET1	6RSX3X4100	36" x 48" x 1" Thickness	64.04

Pipe Accessories

Prices & Specifications are Subject to Change.



www.irrsupply.com

Flexible Connectors

Flexible Couplings

Flex-Seal® Adjustable Repair Couplings

- Flexible rubber couplings connect any two pipes without use of bushings
- Sleeve manufactured of molded natural and synthetic rubber
- Sealing o-rings under each sealing clamp band
- Two surgical grade 316 stainless steel nut and bolt clamping bands



MR06 Series - Concrete to CI/PL

- Concrete to cast iron or plastic

Part #	Mfg #	Pipe Size	Price
FER100644	MR06-44	4" Concrete to 4" CI/PL	18.42

MR51 Series - AC/DI to CI/PL

- Asbestos cement or ductile iron to cast iron or plastic

Part #	Mfg #	Pipe Size	Price
FER105154	MR51-54	5" AC/DI to 4" CI/PL	108.92

Flexible Couplings

For Sewer, Drain, Waste & Vent Piping

- Elastomeric polyvinyl chloride (PVC)
- Unaffected by soil conditions
- Resistant to chemical, ultraviolet rays, fungus growth and normal sewer gases
- Stainless steel clamps

CI, Plastic, Cpr, Stl or Lead to CI, Plastic, Stl or Lead Flex Cplgs

- Designed for CI or plastic to CI or plastic



Part #	Mfg #	Pipe Size	Price
FER1056075	1056-075	3/4" Condensate	15.34

Compression Joint Sealers

- Joins bell and spigot pipe

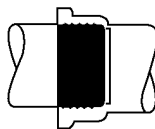

CI Service Wt to Sch 40 Steel or CI XH

Part #	Mfg #	Size	Price
FER22U205	MR22U-205	2" x 2"	13.36
FER33U205	MR33U-205	3" x 2"	20.54

Compression Joint Sealers (Continued)

CI Service Wt to Sch 40 Steel or CI XH

Part #	Mfg #	Size	Price
FER33U305	MR33U-305	3" x 3"	15.50
FER44U405	MR44U-405	4" x 4"	17.88
FER66U405	MR66U-405	6" x 4"	35.24

SV Weight to Sch 40 or Steel

Part #	Mfg #	Size	Price
FER22U139	MR22U-139	2" x 1-1/2"	15.10
FER33U139	MR33U-139	3" x 1-1/2"	19.94

CI Extra Heavy to Plastic Hub Donut



Part #	Mfg #	Size	Price
FER44UX301	44UX-301	4" x 3" S&D	24.12
FER44UX305	44UX-305	4" x 3"	10.64
FER44UX401	44UX-401	4" x 4"	19.98

Flex Fittings

- The flexible way to repair, change or replace drain waste and vent fittings
- 300 Series stainless steel worm drive clamps for corrosion and rust resistance
- Fittings connect plastic, cast iron, copper or steel pipe

Tee Fittings

Part #	Mfg #	Size	Price
FERQT150	MTY150	1-1/2" x 1-1/2" x 1-1/2"	33.08
FERQT200	MTY200	2" x 2" x 2"	36.64
FERQT300	MTY300	3" x 3" x 3"	56.04
FERQT400	MTY400	4" x 4" x 4"	76.96

90° Ell Fittings

Part #	Mfg #	Size	Price
FERQL150	M90L-150	1-1/2" x 1-1/2"	27.12
FERQL200	M90L-200	2" x 2"	28.78
FERQL300	M90L-300	3" x 3"	42.76
FERQL400	M90L-400	4" x 4"	63.80

All Items May Not Be Stocked In All Branches



www.irrsupply.com

Flexible Connectors

T-Flex® Sewer Saddles Saddles



Part #	Mfg #	Pipe Size	Price
FEREZTAP4	1404 629	4"	104.44
FEREZTAP6	1406 634	6"	138.22

Flex Wye Saddles

Part #	Mfg #	Description	Price
FERTSW4	1404 649	4" Cast Iron or Plastic Inlet	115.46

Connectors

DTC Series

- Drain piping to tubular trap



Part #	Mfg #	Pipe Size	Price
FERDTC150	MRDTC150DS*	1-1/2" x 1-1/2" / 1-1/4"	7.05
FERDTC215	MRDTC215DS*	2" x 1-1/2" / 1-1/4"	9.32

* DS Indicates part made of soft flexible grey vinyl

TC Series

- Drain piping to tubular trap

Part #	Mfg #	Description	Price
FERTC150	MRTC150DS*	1-1/2" / 1-1/4" Connector	5.77

* DS Indicates part made of soft flexible grey vinyl

Hose Grip Clothes Washer Connector

- Eliminates washing machine hose leaks and spills
- Flexible rubber securely holds washer drain hose to any 1-1/2" or 2" standard laundry standpie
- Fits most washing machine hoses sizes 1" to 1-7/16" diameter

Part #	Mfg #	Description	Price
FERHG1	MRHG1	Hose Grip Connector	17.88

Shower Drain Connector



Part #	Mfg #	Size	Price
FERSD210	MSD210	2"	8.70

Stainless Steel Clamps

Part #	Mfg #	Pipe Size	Price
FERHAS64	300-60	3-9/16" to 4-1/2"	3.50
FERHAS80	300-78	4-5/8" to 5-1/2"	4.54
FERHAS96	300-96	4-1/2" to 6-1/2"	6.24
FERHAS116	300-100	5-3/4" to 7-3/4"	6.80
FERHAS128	300-128	6-1/2" to 8-1/2"	6.76
FERHAS152	300-148	8" to 10"	7.18

Closet Spanner Flange

Part #	Mfg #	Description	Price
FERSF100	MRTRF	Closet Spanner Flange	13.14

Band-Seal® Specialty Couplings

- Shielded transition couplings to join, adapt, reduce and repair w/over 600 connections
- Resists shear forces while maintaining alignment
- Corrosion-resistant 300 Series SS components
- Internal rubber sleeve reduces noise & vibration
- Neoprene rubber sleeve conforms to ASTM C 564



For Joining Cast Iron Pipe



1-1/2" Cast Iron To --

Part #	Mfg #	Pipe Size	Price
FER3001150	CK-115	1-1/2" CI to 1-1/4" PL, 1-1/4" Stl, 1-1/2" Cpr	22.46
FER3000150	CP-150	1-1/2" CI to 1-1/2" PL, Stl	16.06
FER3000215	CP-215	1-1/2" CI to 2" PL, Stl	21.38

2" Cast Iron To --

Part #	Mfg #	Pipe Size	Price
FER3001215	CK-215	2" CI to 1-1/4" PL, Stl 1-1/2" Copper	23.00

Prices & Specifications are Subject to Change.



www.irrsupply.com

Flexible Connectors

Flexible Couplings

Band-Seal® Specialty Couplings (Continued)

For Joining Cast Iron Pipe

2" Cast Iron To --

Part #	Mfg #	Pipe Size	Price
FER3000215	CP-215	2" CI to 1-1/2" PL, Stl	21.38
FER300122	CK-22	2" CI to 2" Copper	29.52
FER300022	CP-200	2" CI to 2" PL, Stl	16.06

3" Cast Iron To --

Part #	Mfg #	Pipe Size	Price
FER300132	CK-32	3" CI to 2" Copper	34.18
FER300133	CK-33	3" CI to 3" Copper	31.68
FER300033	CP-33	3" CI to 3" PL, Stl, XH CI	24.48

4" Cast Iron To --

Part #	Mfg #	Pipe Size	Price
FER300143	CK-43	4" CI to 3" Copper	34.72
FER300043	CP-43	4" CI to 3" PL, Stl, XH CI	36.62
FER300144	CK-44	4" CI to 4" Copper	33.40
FER300044	CP-44	4" CI to 4" PL, Stl, XH CI	26.76

For Joining Extra Heavy CI Pipe

3" Extra Heavy Cast Iron To --



Part #	Mfg #	Pipe Size	Price
FER300033	CP-33	3" XH CI to 3" CI	24.48
FER300043	CP-43	3" XH CI to 4" CI	36.62

4" Extra Heavy Cast Iron To --

Part #	Mfg #	Pipe Size	Price
FER300044	CP-44	4" XH CI to 4" CI	26.76

For Joining Copper

1-1/4" Copper To --



Part #	Mfg #	Pipe Size	Price
FER3001215	CK-215	1-1/4" to 2" PL, Stl, CI	23.00

1-1/2" Copper To --

Part #	Mfg #	Pipe Size	Price
FER3001150	CK-115	1-1/2" Cpr to 1-1/2" PL, Stl, CI	22.46
FER3001215	CK-215	1-1/2" Cpr to 2" PL, Stl	23.00

2" Copper To --

Part #	Mfg #	Pipe Size	Price
FER300122	CK-22	2" Cpr to 2" PL, Stl, CI	29.52
FER300132	CK-32	2" Cpr to 3" CI	34.18

3" Copper To --

Part #	Mfg #	Pipe Size	Price
FER300133	CK-33	3" Cpr to 3" CI	31.68
FER300143	CK-43	3" Cpr to 4" CI	34.72

4" Copper To --

Part #	Mfg #	Pipe Size	Price
FER300144	CK-44	4" Cpr to 4" CI	33.40

For Joining Sch40 Plastic (ABS-PVC)

1-1/4" Plastic To --



Part #	Mfg #	Pipe Size	Price
FER3001150	CK-115	1-1/4" PL to 1-1/2" PL, Stl, CI	22.46

1-1/2" Plastic To --

Part #	Mfg #	Pipe Size	Price
FER3001150	CK-115	1-1/2" PL to 1-1/4" PL, Stl, 1-1/2" Copper	22.46
FER3000150	CP-150	1-1/2" PL to 1-1/2" PL, Stl, CI	16.06
FER3000215	CP-215	1-1/2" PL to 2" PL, Stl	21.38

2" Plastic To --

Part #	Mfg #	Pipe Size	Price
FER3001215	CK-215	2" PL to 1-1/4" PL, Stl, 1-1/2" Copper, CI	23.00
FER3000215	CP-215	2" PL to 1-1/2" PL, Stl	21.38
FER300122	CK-22	2" PL to 2" Copper	29.52
FER300022	CP-200	2" PL to 2" PL, Stl, CI	16.06

All Items May Not Be Stocked In All Branches



www.irrsupply.com

Flexible Connectors

3" Plastic To --

Part #	Mfg #	Pipe Size	Price
FER300033	CP-33	3" PL to 3" CI	24.48
FER300043	CP-43	3" PL to 4" CI	36.62

For Joining Steel Pipe

1-1/4" Steel To --



Part #	Mfg #	Pipe Size	Price
FER3001150	CK-115	1-1/4" Stl to 1-1/2" PL, Stl, CI	22.46
FER3001215	CK-215	1-1/4" Stl to 2" PL, Stl, CI	23.00

1-1/2" Steel To --

Part #	Mfg #	Pipe Size	Price
FER3001150	CK-115	1-1/2" Plastic, 1-1/2" Steel, 1-1/2" Copper	22.46
FER3000150	CP-150	1-1/2" Stl to 1-1/2" PL, Stl, CI	16.06
FER3000215	CP-215	1-1/2" Stl to 2" PL, Stl, CI	21.38

2" Steel To --

Part #	Mfg #	Pipe Size	Price
FER3001215	CK-215	1-1/4" Plastic, Steel, 1-1/2" Copper, CI	23.00
FER3000215	CP-215	2" Stl to 1-1/2" PL, Stl, CI	21.38
FER300022	CP-200	2" Stl to 2" PL, Stl, CI	16.06

3" Steel To --

Part #	Mfg #	Pipe Size	Price
FER300033	CP-33	3" Stl to 3" CI	24.48
FER300043	CP-43	3" PL to 4" CI	36.62

4" Steel To --

Part #	Mfg #	Pipe Size	Price
FER300044	CP-44	4" Stl to 4" CI	26.76

Flex-Seal® Couplings

- Flexible rubber couplings connect any two pipes without use of bushings
- Sleeve manufactured of molded natural and synthetic rubber
- Leakproof seal
- Two 300 series SS worm drive clamping bands
- Manufactured w/natural & synthetic rubbers conforming to ASTM C 425, ASTM C 1173, and ISO 9002 quality standards

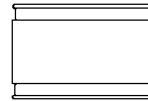

Size-on-Size

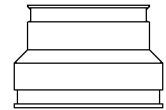

Transition

MR56 Series - CI/PL to CI/PL

- Cast iron or plastic to cast iron or plastic

Part #	Mfg #	Pipe Size	Price
FER1056125	MR56-125	1-1/4" PL to 1-1/2" PL	8.77
FER1056150	MR56-15	1-1/2" CI/PL to 1-1/2" CI/PL	9.38
FER1056150125	MR56-15/125	1-1/2" CI/PL to 1-1/4" PL	9.72
FER1056215	MR56-215	2" CI/PL to 1-1/2" CI/PL	10.65
FER105622	MR56-22	2" CI/PL to 2" CI/PL	10.08
FER105632	MR56-32	3" CI/PL to 2" CI/PL	12.60
FER105633	MR56-33	3" CI/PL to 3" CI/PL	13.63
FER105642	MR56-42	4" CI/PL to 2" CI/PL	23.78
FER105643	MR56-43	4" CI/PL to 3" CI/PL	18.37
FER105644	MR56-44	4" CI/PL to 4" CI/PL	17.06
FER105664	MR56-64	6" CI/PL to 4" CI/PL	42.83
FER105666	MR56-66	6" CI/PL to 6" CI/PL	36.48
FER105686	MR56-86	8" CI/PL to 6" CI/PL	67.76
FER105688	MR56-88	8" CI/PL to 8" CI/PL	56.12
FER10561010	MR56-1010	10" CI/PL to 10" CI/PL	84.25
FER10561212	MR56-1212	12" CI/PL to 12" CI/PL	98.32

MR01 Series - Clay to Clay

Part #	Mfg #	Pipe Size	Price
FER100144	MR01-44	4" CL to 4" CL	18.42
FER100166	MR01-66	6" CL to 6" CL	39.40

Flexible Couplings

Prices & Specifications are Subject to Change.



www.irrsupply.com

Flexible Connectors

Flexible Couplings

MR02 Series - Clay to CI/PL

- Clay to cast iron or plastic

Part #	Mfg #	Pipe Size	Price
FER100243	MR02-43	4" CL to 3" CI/PL	18.83
FER100244	MR02-44	4" CL to 4" CI/PL	17.06
FER100264	MR02-64	6" CL to 4" CI/PL	42.83
FER100266	MR02-66	6" CL to 6" CI/PL	36.48
FER100286	MR02-868	8" CL to 6" CI/PL	67.76
FER100288	MR02-88	8" CL to 8" CI/PL	56.12
FER10021010	MR02-1010	10" CL to 10" CI/PL	84.25
FER10021212	MR02-1212	12" CL to 12" CI/PL	98.32

MR51 Series - AC/DI to CI/PL

- Asbestos cement or ductile iron to cast iron or plastic

Part #	Mfg #	Pipe Size	Price
FER105144	MR51-44	4" AC/DI to 4" CI/PL	18.42

Flex-Seal®

Compression Joint Sealers

- Joins bell and spigot pipe

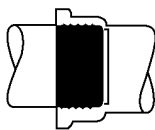

Part #	Mfg #	Description	Price
FER22UX139	MR22UX 139	2" CI XH Hub to 1-1/2" Sch 40 PL, Stl	15.44
FER44U305	MR44U 305	4" CI SV Hub to 3" Sch 40 PL, Stl, CI XH	22.64
FER44UX405	MR44UX 405	4" CI XH Hub to 4" Sch 40 PL, Stl, CI XH	19.74

Flex Fittings

Compression O-Ring

- Used in joining 6" inside diameter pipe to 4" outside diameter CI/Sch40 PL/Stl pipe

Part #	Mfg #	Description	Price
FERFR64	MR64	Compression O Ring	20.02

Shower Drain Connectors

- For AB&A, Casper, Armstrong, Kohler, Intercon & Shaul



Part #	Mfg #	Description	Price
FERSD200	MSD200	2" Shower Drain Conn	8.70

Band-Seal® End Caps

End Caps

- Reusable
- Strong - molded "x" braces against head pressures & axially tapered design distributes & dissipates internal stress
- Needs no plastic liner
- Made of high quality rubber
- Resists water & ozone
- Tight fitting, molded internal cone is integral part of end cap
- For use with cast iron, steel, PVC, & ABS piping materials



Part #	Mfg #	Pipe Size	Price
FERQC101	0701-011	1-1/2"	4.39
FERQC102	0702-019	2"	5.14
FERQC103	0703-017	3"	6.51
FERQC104	0704-015	4"	8.33
FERQC105	0705-020	5"	11.15
FERQC106	0706-028	6"	11.44
FERQC108	0708-016	8"	23.11

Flex-Seal® Adjustable Repair Couplings

- Flexible rubber couplings connect any two pipes without use of bushings
- Sleeve manufactured of molded natural and synthetic rubber
- Sealing o-rings under each sealing clamp band
- Two surgical grade 316 stainless steel nut and bolt clamping bands

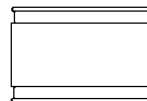

Size-on-Size

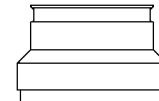

Transition

Adjustable Repair Coupling

Part #	Mfg #	Pipe Size	Price
MISMR0166ARC	MR01 66 ARC	6" CL to 6" CL	103.44
MISMR0244ARC	MR02 44 ARC	4" CL to 4" CI/PL	79.62
MISMR0264ARC	MR02 64 ARC	6" CL to 4" CI/PL	198.18
MISMR0266ARC	MR02 66 ARC	6" CL to 6" CI/PL	132.02
MISMR0288ARC	MR02 88 ARC	8" CL to 8" CI/PL	153.58
MISMR5633ARC	MR56 33 ARC	3" CI/PL to 3" CI/PL	41.72
MISMR5644ARC	MR56 44 ARC	4" CI/PL to 4" CI/PL	53.10
MISMR5655ARC	MR56 55 ARC	5" CI/PL to 5" CI/PL	77.38
MISMR5664ARC	MR56 64 ARC	6" CI/PL to 4" CI/PL	130.84
MISMR5666ARC	MR56 66 ARC	6" CI/PL to 6" CI/PL	101.16
MISMR5688ARC	MR56 88 ARC	8" CI/PL to 8" CI/PL	153.58

All Items May Not Be Stocked In All Branches



www.irrsupply.com

Water Service Fittings

Water Service Products

Corporation Stops

Plugs Valves (AWWA x Cpr Flr)



Part #	Mfg #	Size	Price
AYMCORPFL34	4701	3/4"	36.48

Regular Pattern - Curb Stop Ball Valves

- 300 psig water Flathead (Flr x Flr)

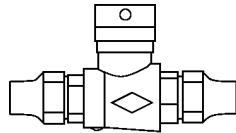

Part #	Mfg #	Inlet x Ball Size x Outlet	Price
AYMCSFL34BV	6100	3/4" x 5/8" x 3/4"	47.42

Regular Pattern - Curb Stop Inverted Plug

Stop with Check (FIP x FIP)

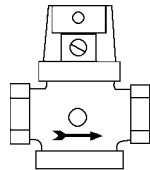

Part #	Mfg #	Size	Price
AYMCSFE34	3061	3/4"	47.51
AYMCSFE1	3061	1"	82.96

Stop with Check (Flr x FIP)

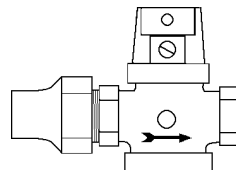

Part #	Mfg #	Size	Price
AYMCSFLFE34	4711	3/4"	54.41

Stop with Check (Flr x Flr)

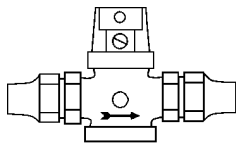

Part #	Mfg #	Size	Price
AYMCSFL34	4713	3/4"	62.54
AYMCSFL1	4713	1"	104.12

Stop with Check (CTS Comp x CTS Comp)



Part #	Mfg #	Size	Price
AYMCSC34	4713T	3/4"	68.81
AYMCSC1	4713T	1"	106.27

Curb Stop & Drain Ball Valve (FIP x FIP)



Part #	Mfg #	Size	Price
AYMCSFF34BV	6001	3/4"	80.08

Curb Boxes

Arch Style Curb Box - 1" Upper with Rod



Part #	Mfg #	Size	Rod	Price
AYMBOX4	5601	4'	24"	60.00
AYMBOX5	5601	5'	42"	63.80

Coupling - Female Flr x Comp

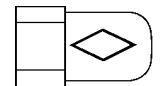

Part #	Mfg #	Size	Price
AYMCADP34	6130CC	3/4"	19.67
AYMCADP1	6130CC	1"	27.85

Curb Box Key & Lid Wrench



Part #	Mfg #	Size	Price
AYM304B3	304B	3'	46.13
AYM304B4	304B	4'	46.64

Water Service Fittings

Prices & Specifications are Subject to Change.



www.irrsupply.com

Water Service Fittings

Service Fittings

Couplings for 3121 Corporation Valves & Corporation Valves with MIP Outlets

Straight Coupling (CPR Flr x FNPT)

- With 4700 tube nut, no gasket



Part #	Mfg #	Size	Price
AYMFLFEA34	4754	3/4"	15.42
AYMFLFEA1	4754	1"	23.61

Straight Coupling (T CTS Comp x FNPT)

- With 4700T compression nut



Part #	Mfg #	Size	Price
AYMCFEA34	4754T	3/4"	18.46
AYMCFEA1	4754T	1"	25.05
AYMCFEA112	4754T	1-1/2"	66.63
AYMCFEA2	4754T	2"	79.32

Straight Couplings (Flr x MIP)



Part #	Mfg #	Size	Price
AYMFLMA34	4753	3/4"	15.61
AYMFLMA1	4753	1"	22.30
AYMFLMA112	4753	1-1/2"	62.88
AYMFLMA2	4753	2"	115.40

Straight Couplings (Q CTS Comp x MNPT)



Part #	Mfg #	Size	Price
AYMCMA34	4753Q	3/4"	17.56
AYMCMA1	4753Q	1"	20.80
AYMCMA114	4753Q	1-1/4"	36.36
AYMCMA112	4753Q	1-1/2"	52.09
AYMCMA2	4753Q	2"	75.89

Straight Couplings (CTS Comp x MIP)



Part #	Mfg #	Size	Price
AYMCMAMAC34	4753-22	3/4"	17.56

Three-Part Unions (Flr x Flr)



Part #	Mfg #	Size	Price
AYMFLUN34	4758	3/4"	19.71
AYMFLUN1	4758	1"	34.54
AYMFLUN114	4758	1-1/4"	64.79
AYMFLUN112	4758	1-1/2"	94.79
AYMFLUN2	4758	2"	154.68

Three-Part Unions (T CTS Comp x T CTS Comp)



Part #	Mfg #	Size	Price
AYMCUN34	4758T	3/4"	21.38
AYMCUN1	4758T	1"	24.46
AYMCUN114	4758T	1-1/4"	38.61
AYMCUN112	4758T	1-1/2"	74.82
AYMCUN2	4758T	2"	101.04
AYMCUN1-34	4758T	3/4" x 1"	24.84

Three-Part Unions (Copper Flr x Strong Lead Comp)



Part #	Mfg #	Size	Price
AYMFLLCPLG34	4758C-66	3/4"	32.87
AYMFLLCPLG34-58	4758C-66	3/4" x 5/8"	33.66

Three-Part Unions (Copper Flr x Extra Strong Lead Comp)



Part #	Mfg #	Size	Price
AYMFLXCPLG34	4758C-67	3/4"	38.84
AYMFLXCPLG34-12	4758C-67	3/4" x 1/2"	29.43
AYMFLXCPLG34-58	4758C-67	3/4" x 5/8"	30.77

All Items May Not Be Stocked In All Branches

Water Service Fittings



www.irrsupply.com

Water Service Fittings

Three-Part Unions (Copper Flr x XX Strong Lead Comp)



Part #	Mfg #	Size	Price
AYMFLXXCPLG34	4758C-68	3/4"	45.79

Three-Part Unions (Tube Comp x Tube Comp)



Part #	Mfg #	Size	Price
AYMCUN34GI	4758-22	3/4"	21.38

Tees (T CTS Comp x T CTS Comp x T CTS Comp)



Part #	Mfg #	Size	Price
AYMCT34	4760T	3/4"	51.77
AYMCT1	4760T	1"	55.35

**Irr Supply is your one stop shop
for all your Plumbing, HVAC,
Refrigeration, and Electrical needs.
Why go anywhere else!**

**Water Service
Fittings**

Insert Stiffeners

Stainless Steel Insert Stiffener for Polyethylene Tubing



Part #	Mfg #	Size	Price
AYMINSS34	6133T	3/4"	2.13
AYMINSS1	6133T	1"	2.26
AYMINSS114	6133T	1-1/4"	2.78
AYMINSS112	6133T	1-1/2"	3.11
AYMINSS112CTS	6133T	1-1/2" CTS	3.29
AYMINSS2	6133T	2"	3.11



Prices & Specifications are Subject to Change.

Residential Cooling

Efficient 13 SEER Single Phase 1.5 Thru 5 Ton Split System Air Conditioner - R-22

- Copeland® Scroll™ compressor
- Copper tube/aluminum fin coil
- Easy Access service valves
- External high and low refrigerant service ports
- (2) Screw access control panel
- Pre-painted cabinet finish over galvanized steel
- Coated inlet grille with 3/8" spacing
- 208/230V, 1-Phase, 60Hz
- 5-Year limited compressor warranty
- 5-Year limited coil and parts warranty



Part #	Mfg #	Size Tons	Nominal BTUH	Min Circuit Ampacity	Max Fuse or Breaker	Dimensions H x W x D	Ship Wt	Price
R22R2A318	R2A318GKR	1.5	18,000	10.9	15	24-13/16" x 23-1/8" x 23-1/8"	120 lbs	CALL
R22R2A324	R2A324GKR	2.0	24,000	14.0	20	28-7/16" x 23-1/8" x 23-1/8"	124 lbs	CALL
R22R2A330	R2A330GKR	2.5	30,000	17.7	30	28-7/16" x 23-1/8" x 23-1/8"	127 lbs	CALL
R22R2A336	R2A336GKA	3.0	36,000	20.4	30	24-13/16" x 31-3/16" x 31-3/16"	158 lbs	CALL
R22R2A348	R2A348GKR	4.0	48,000	26.7	40	42" x 31-3/16" x 31-3/16"	210 lbs	CALL
R22R2A360	R2A360GKR	5.0	60,000	33.0	50	35-3/16" x 31-3/16" x 31-3/16"	230 lbs	CALL

Cooling

Visionary Baths & More

Because your time is valuable...

Visit your local Visionary Baths & More Kitchen and Bath Design Centers to let one of our trained knowledgeable consultants help you with your project.

<http://www.visionarybaths.com>

Residential Cooling

Efficient 13 SEER Single Phase Split System Air Conditioner - R-410A - Maratherm

- Copeland® Scroll™ compressor
- Copper tube/aluminum fin coil
- Easy access service valves
- External high and low refrigerant service ports
- (2) Screw access control panel
- Pre-painted cabinet finish over galvanized steel
- Factory charged with R-410A refrigerant
- Coated inlet grille with 2" spacing
- 208/230V, 1-Phase, 60Hz
- 5-Year limited compressor warranty
- 10-Year limited coil and parts warranty with timely registration (applies to original purchaser/homeowner)



Part #	Mfg #	Size Tons	Nominal BTUH	Min Circuit Ampacity	Max Fuse or Breaker	Dimensions H x W x D	Ship Wt	Price
MAMR4A318	R4A318AKA	1.5	18,000	11.7	20	24-13/16" x 23-1/8" x 23-1/8"	120 lbs	CALL
MAMR4A324	R4A324AKA	2.0	24,000	17.6	30	24-13/16" x 23-1/8" x 23-1/8"	123 lbs	CALL
MAMR4A330	R4A330AKA	2.5	30,000	16.8	25	28-7/16" x 23-1/8" x 23-1/8"	126 lbs	CALL
MAMR4A336	R4A336AKB	3.0	36,000	23.0	30	35-3/16" x 23-1/8" x 23-1/8"	139 lbs	CALL
MAMR4A342	R4A342AKB	3.5	42,000	28.4	40	31-13/16" x 31-3/16" x 31-3/16"	187 lbs	CALL
MAMR4A348	R4A348AKB	4.0	48,000	27.0	40	38-3/16" x 31-3/16" x 31-3/16"	197 lbs	CALL
MAMR4A360	R4A360AKB	5.0	60,000	35.9	50	28-7/16" x 31-3/16" x 31-3/16"	216 lbs	CALL

Cooling

Special orders - If you need it we can get it promptly!

Residential Cooling

High-Efficiency Single-Stage Air Conditioners - R-410A

- Copeland Scroll UltraTech™ compressor
- Filter-drier supplied with every unit for field installation
- External high and low refrigerant service ports
- Copper tube/aluminum fin coil
- Easy access service valve
- Factory charged with R-410A
- Baked-on powder coat finish over galvanized steel
- Post-painted (black) coil fins
- Coated inlet grille with 2" spacing standard
- 208/230-1-60
- 5-Year limited compressor, coil & parts warranties



13 SEER - R-410A - 1-Phase - N4A3 Air Conditioner with Standard Grille

Part #	Mfg #	Size Tons	Nominal BTUH	Min Circuit Ampacity	Max Fuse or Breaker	Dimensions H x W x D	Ship Wt	Price
HEAN4A318	N4A318AKA	1.5	18,000	11.7	15	25-1/2" x 25-3/4" x 25-3/4"	138 lbs	CALL
HEAN4A324	N4A324AKA	2.0	24,000	17.6	25	25-1/2" x 25-3/4" x 25-3/4"	143 lbs	CALL
HEAN4A330	N4A330AKC	2.5	30,000	16.8	25	28-11/16" x 23-1/8" x 23-1/8"	136 lbs	CALL
HEAN4A336	N4A336AKB	3.0	36,000	21.5	30	31-13/16" x 25-3/4" x 25-3/4"	170 lbs	CALL
HEAN4A342	N4A342AKA	3.5	42,000	23.5	40	32-5/16" x 31-3/16" x 31-3/16"	208 lbs	CALL
HEAN4A348	N4A348AKB	4.0	48,000	26.2	40	35-3/4" x 31-3/16" x 31-3/16"	215 lbs	CALL
HEAN4A360	N4A360AKC	5.0	60,000	34.2	50	25-1/2" x 31-3/16" x 31-3/16"	218 lbs	CALL

High Efficiency 16 SEER 1-Phase Split System Air Conditioner - R-410A

- 208/230V, 1-Phase, 60Hz
- Copeland® compressor
- Filter-drier for field installation
- Copper tube/aluminum fin coil
- Easy Access service valves
- External high and low refrigerant service ports
- (2) Screw access control panel
- Baked-on powder coat finish over galvanized steel
- Post-painted, black coil fins
- Coated, weather-resistant cabinet screws
- Coated inlet grille with 3/8" grille spacing
- 5-Year limited compressor warranty
- 5-Year limited coil and parts warranty



Part #	Mfg #	Size Tons	Nominal BTUH	Min Circuit Ampacity	Max Fuse or Breaker	Dimensions H x W x D	Ship Wt	Price
HEANXA618GK	NXA618GKA	1.5	18,000	11.8	20	28-11/16" x 25-3/4" x 25-3/4"	154 lbs	CALL
HEANXA624GK	NXA624GKA	2.0	24,000	17.7	25	28-5/16" x 31-3/16" x 31-3/16"	147 lbs	CALL
HEANXA630GK	NXA630GKA	2.5	30,000	16.8	25	32-5/16" x 31-3/16" x 31-3/16"	188 lbs	CALL
HEANXA636GK	NXA636GKA	3.0	36,000	18.1	30	28-5/16" x 35" x 35"	204 lbs	CALL
HEANXA648GK	NXA648GKA	4.0	48,000	26.1	40	39-1/8" x 35" x 35"	317 lbs	CALL
HEANXA660GK	NXA660GKA	5.0	60,000	28.0	40	45-15/16" x 35" x 35"	310 lbs	CALL

All Items May Not Be Stocked In All Branches

Residential Cooling

QuietComfort™ 13 SEER 1.5 Thru 5 Ton Split Air Conditioner - R-410A

- 5-Year No hassle replacement warranty
- 10-Year limited warranty on scroll compressor
- 5-Year limited coil and parts warranty
- HELP® (Homeowner's Extended Labor Program) available
- 208/230V, 1-Phase, 60Hz
- Copeland® scroll compressor
- Filter-drier for field installation
- Copper tube/aluminum fin coil
- 5 Ton model has 2-row coil
- 2-Speed fan motors factory wired
- Compressor sound jacket
- Comfort Alert™ diagnostics
- Easy access service valves
- Compressor access panel
- New, innovative control box design
- High and low pressure switches
- External high and low refrigerant service ports
- Fan motor in-line disconnect plug
- Only two screws to access control panel
- High gloss, baked-on powder coat finish over galvanized steel cabinet
- Post-painted coil fins
- SermaGard® coated cabinet screws
- Coated inlet grille with 3/8" spacing
- Corner posts



Part #	Mfg #	Size Tons	Nom BTUH	Dimensions H x W x D	Approx Ship Wt	Price
HEAH4A318	H4A318GKD	1.5	18,000	25-3/16" x 23-1/8" x 23-1/8"	143 lbs	CALL
HEAH4A324	H4A324GKD	2.0	24,000	25-3/16" x 23-1/8" x 23-1/8"	142 lbs	CALL
HEAH4A330	H4A330GKD	2.5	30,000	28-9/16" x 23-1/8" x 23-1/8"	151 lbs	CALL
HEAH4A336	H4A336GKD	3.0	36,000	25-3/16" x 31-3/16" x 32-5/16"	196 lbs	CALL
HEAH4A348	H4A348GKD	4.0	48,000	35-3/8" x 31-3/16" x 31-3/16"	243 lbs	CALL
HEAH4A360	H4A360GKD	5.0	60,000	28-9/16" x 31-3/16" x 31-3/16"	250 lbs	CALL

Cooling

We have 32 convenient locations proudly serving Western NY, Central NY, and Northern Pennsylvania.

Residential Cooling

High Efficiency 16 SEER 1.5 Thru 5 Ton Split System Air Conditioner - R-410A

- 208/230V, 1-Phase, 60Hz
- Copeland® compressor
- Filter-drier for field installation
- Copper tube/aluminum fin coil
- 2-Speed fan motor factory wired on all models
- Comfort Alert™ Diagnostics device on all models
- Easy Access service valves
- External high and low refrigerant service ports
- Fan motor in-line disconnect plug
- (2) Screw access control panel
- Baked-on powder coat finish over galvanized steel
- Post-painted, black coil fins
- Coated, weather-resistant cabinet screws
- Coated inlet grille with 3/8" grille spacing
- 5-Year No Hassle Replacement™ limited warranty
- 5-Year limited compressor warranty
- 5-Year limited coil and parts warranty



Part #	Mfg #	Size Tons	Nom BTUH	SEER	Dimensions H x W x D	Approx Ship Wt	Price
HEAHXA618GK	HXA618GK	1.5	18,000	11.8	28-5/16" x 31-3/16" x 31-3/16"	183 lbs	CALL
HEAHXA624GK	HXA624GK	2.0	24,000	17.7	28-5/16" x 31-3/16" x 31-3/16"	183 lbs	CALL
HEAHXA630GK	HXA630GK	2.5	30,000	16.8	32-5/16" x 31-3/16" x 31-3/16"	188 lbs	CALL
HEAHXA636GK	HXA636GK	3.0	36,000	18.1	28-5/16" x 35" x 35"	204 lbs	CALL
HEAHXA648GK	HXA648GK	4.0	48,000	26.1	39-1/8" x 35" x 35"	317 lbs	CALL
HEAHXA660GK	HXA660GK	5.0	60,000	28.0	45-15/16" x 35" x 35"	310 lbs	CALL

Cooling

Let us know how we may best serve you. Suggestions help us improve.

Residential Cooling

QuietComfort™ 1.5 Thru 5 Ton Split Air Conditioner - R-410A

- 208/230V, 1-Phase, 60Hz
- Copeland® scroll compressor
- Filter-drier for field installation
- Copper tube/aluminum fin coil
- 5 Ton model has 2-row coil
- 2-Speed fan motors factory wired
- Compressor sound jacket
- Comfort Alert™ diagnostics
- Easy access service valves
- Compressor access panel
- New, innovative control box design
- High and low pressure switches
- External high and low refrigerant service ports
- Fan motor in-line disconnect plug
- Only two screws to access control panel
- High gloss, baked-on powder coat finish over galvanized steel cabinet
- Post-painted coil fins
- SermaGard® coated cabinet screws
- Coated inlet grille with 3/8" spacing
- Corner posts
- 5-Year No hassle replacement warranty
- 10-Year limited warranty on scroll compressor
- 5-Year limited coil and parts warranty
- HELP® (Homeowner's Extended Labor Program) available



16 & 18 SEER - R-410A - Air Conditioner

Part #	Mfg #	Size Tons	Nom BTUH	SEER	Dimensions H x W x D	Approx Ship Wt	Price
HEAH4A624	H4A624GKD	2.0	24,000	16	36-11/16" x 35" x 35"	293 lbs	CALL
HEAH4A836	H4A836GKD	3.0	36,000	18	40-1/8" x 35" x 35"	309 lbs	CALL
HEAH4A648	H4A648GKD	4.0	48,000	16	40-1/8" x 35" x 35"	310 lbs	CALL
HEAH4A660	H4A660GKD	5.0	60,000	16	40-1/8" x 35" x 35"	336 lbs	CALL

Cooling

If you need a product not listed in this catalog, please check with us. We have not listed every product we can get for you.

Residential Cooling

QuietComfort™ DXC 1600 16 SEER Split System Air Conditioner - R-410A

- With Observer™ Communicating Control System
- Text based diagnostics and communicating, self-configuring operation with Observer Communicating Wall Control
- Copeland® scroll compressor
- Filter-drier included for field installation
- External high and low refrigerant service ports
- Factory installed outdoor temperature sensor
- Copper tubing with aluminum fin coils
- Compressor sound blanket
- Isolation compressor grommets
- High and low pressure switches
- Factory charged with R-410A refrigerant
- High gloss baked-on powder coat over galvanized steel cabinet
- Post-painted black coil fins
- Coated inlet grille with 3/8" spacing
- 5-Year No Hassle Replacement™ limited warranty
- 5-Year parts limited warranty (including compressor and coil)
 - With timely registration, an additional 5-year parts limited warranty (including compressor and coil)



Part #	Mfg #	Tons	SEER	Nominal BTUH	Electrical	Dimensions H x W x D	Approx Ship Wt	Price
HEAHS624	HSA624GKA	2.0	16	24,000	208/230-1-60	28-9/16" x 31-3/16" x 31-3/16"	212 lbs	CALL
HEAHS630	HSA630GKA	2.5	16	30,000	208/230-1-60	32" x 31-3/16" x 31-3/16"	223 lbs	CALL
HEAHS636	HSA636GKA	3.0	16	36,000	208/230-1-60	29-7/8" x 35" x 35"	243 lbs	CALL
HEAHS642	HSA642GKA	3.5	16	42,000	208/230-1-60	40-1/8" x 35" x 35"	297 lbs	CALL
HEAHS648	HSA648GKA	4.0	16	48,000	208/230-1-60	40-1/8" x 35" x 35"	340 lbs	CALL
HEAHS660	HSA660GKA	5.0	16	60,000	208/230-1-60	46-7/8" x 35" x 35"	374 lbs	CALL

Cooling

Thank you for doing business with us. We appreciate your order.

Residential Cooling

High Efficiency 2-Stage Heat Pumps

- Copeland Scroll UltraTech™ compressor
- Crankcase heater factory installed
- Suction line accumulator factory installed
- Bi-flow filter-drier included for field installation
- External high and low refrigerant service ports
- Integrated solid state control with Time-Temperature Defrost
- High, low and compressor unloader pressure switches
- Discharge gas thermostat
- Copper tube/aluminum fin coil
- High performance compressor sound shield standard
- Comfort Alert™ UltraTech™ diagnostics device
- Easy access service valve
- Compressor access panel
- Fan motor in-line disconnect plug
- Factory charged with R-410A
- High gloss, baked-on powder coat finish over galvanized steel
- Post-painted (black) coil fins
- 208/230-1-60
- 10-Year No-Hassle replacement limited warranty
- 10-Year limited compressor warranty
- 10-Year limited coil warranty
- 7-Year limited parts warranty



17 SEER - R-410A - 2-Stage - H4H7 Heat Pump

Part #	Mfg #	Size Tons	Nominal BTUH	Min Circuit Ampacity	Max Fuse or Breaker	Dimensions H x W x D	Ship Wt	Price
HEAH4H736	H4H736GKD	3.0	36,000	22.1	35	40-1/4" x 35" x 35"	326 lbs	CALL

Cooling

**Walk in or call ahead.
You'll find thousands of products ready for same-day pickup or delivery.**

Prices & Specifications are Subject to Change.

Residential Cooling

QuietComfort™ DXC 1500 15 SEER Split System Heat Pump - R-410A

- With Observer™ Communicating Control System
- Text based diagnostics and communicating, self-configuring operation with Observer Communicating Wall Control
- Copeland® scroll compressor
- Bi-flow filter-drier included for field installation
- Integrated solid state control with time-temperature defrost
- External high and low refrigerant service ports
- Copper tubing with aluminum fin coils
- Compressor sound blanket
- Isolation compressor grommets
- High and low pressure switches
- Factory charged with R-410A refrigerant
- High gloss baked-on powder coat over galvanized steel cabinet
- Post-painted black coil fins
- Coated inlet grille with 3/8" spacing
- Factory installed suction line accumulator and outdoor temperature sensor
- 5-Year No Hassle Replacement™ limited warranty
- 5-Year parts limited warranty (including compressor and coil)
 - With timely registration, an additional 5-year parts limited warranty (including compressor and coil)



Part #	Mfg #	Tons	SEER	Nominal BTUH	Electrical	Dimensions H x W x D	Approx Ship Wt	Price
HEAHS524	HSH524GKA	2.0	15	24,000	208/230-1-60	33-5/16" x 35" x 35"	257 lbs	CALL
HEAHS530	HSH530GKA	2.5	15	30,000	208/230-1-60	33-5/16" x 35" x 35"	259 lbs	CALL
HEAHS536	HSH536GKA	3.0	15	36,000	208/230-1-60	36-11/16" x 35" x 35"	273 lbs	CALL
HEAHS542	HSH542GKA	3.5	15	42,000	208/230-1-60	29-7/8" x 35" x 35"	305 lbs	CALL
HEAHS548	HSH548GKA	4.0	15	48,000	208/230-1-60	33-5/16" x 35" x 35"	323 lbs	CALL
HEAHS560	HSH560GKA	5.0	15	60,000	208/230-1-60	40-1/8" x 35" x 35"	357 lbs	CALL

Cooling

**Can't find what you are looking for?
We have access to hundreds of vendors and thousands of items not listed in this catalog**

Residential Cooling

High Efficiency Split System Heat Pumps

15 SEER - High Efficiency Environmentally Sound Heat Pump - R-410A

- 208/230V, 1-Phase, 60Hz
- Copeland Scroll™ compressor
- Suction line accumulator factory installed
- Bi-flow filter-drier for field installation
- Integrated solid state control with Time-Temperature Defrost
- High and low pressure switches
- Copper tube/aluminum fin coil
- Easy access service valves
- External high and low refrigerant service ports
- Only two screws to access control panel
- Factory charged with R-410A refrigerant
- Baked-on powder coat finish over galvanized steel
- Post-painted (black) coil fins
- Coated, weather-resistant cabinet screws
- Coated inlet grill with 3/8" grille spacing for extra protection
- 5-Year compressor limited warranty; extra 5-years with timely registration
- 5-Year parts limited warranty (including compressor and coil)



Part #	Mfg #	Tons	Nominal BTUH	Min Circuit Ampacity	Max Fuse or Breaker	Dimensions H x W x D	Ship Wt	Price
HEANXH524	NXH524GKA	2.0	24,000	16.5	25	32-5/16" x 35" x 35"	233 lbs	CALL
HEANXH548	NXH548GKA	4.0	48,000	28.5	40	28-15/16" x 35" x 35"	303 lbs	CALL



Copper Line Sets

- All line sets are plain end and 90° bend end



1/2" Insulation Line Set

Part #	Mfg #	Liq Line	Suct Line	Length	Price
ACL61030	61020300	3/8"	5/8"	30'	CALL
ACL61050	61020500	3/8"	5/8"	50'	CALL
ACL61220	61280200	3/8"	3/4"	20'	CALL
ACL61230	61280300	3/8"	3/4"	30'	CALL
ACL61250	61280500	3/8"	3/4"	50'	CALL
ACL61420	61480200	3/8"	7/8"	20'	CALL
ACL61430	61480300	3/8"	7/8"	30'	CALL
ACL61450	61480500	3/8"	7/8"	50'	CALL
ACL61850	61880500	3/8"	1-1/8"	50'	CALL

Residential Cooling

NEW MODEL NUMBER IDENTIFICATION GUIDE - A COILS							
EVAPORATOR	E	P	A	36	B15	A	Revision Code
E = Entral Level Orifice Pin							Cabinet / Drain Pan Width
P = Orifice Pin							B15 = 15-1/2" Cabinet/14-3/4" Drain Pan
X = TXV							F19 = 19-1/8" Cabinet/18-1/8" Drain Pan
A = Loose Coil, No Cabinet							J22 = 22-3/4" Cabinet/21-7/8" Drain Pan
D = Dual Purpose, Upflow/Downflow							L24 = 24-1/2" Cabinet/14-1/2" Drain Pan
M = Multi Purpose, Upflow/Downflow/Horizontal							N26 = 26-3/8" Cabinet/25-1/2" Drain Pan
							Nominal Capacity
							18 = 1-1/2 Ton, 24 = 2 Ton, 3 = 3-1/2 Ton
							36 = 3 Ton, 42 = 3-1/2 Ton, 48 = 4 Ton, 60 = 5 Ton

NEW MODEL NUMBER IDENTIFICATION GUIDE - SLAB COILS								
MODEL NUMBER	E	A	H	55	36	S	A	REVISION CODE
PRODUCT FAMILY								CONNECTIONS
E = Evaporator Coil								S = Sweat
PRODUCT TYPE								CAPACITY - BTU
A = A Slab Coil								036 = 36,000
COIL TYPE								Series 55 = 5500
H = Horizontal								

Evaporator Coils

END4X - Cased N-Coil - R-410A

- Upflow or downflow installation
- TXV Metering device
- Compact design - shorter than comparable A-coils
- Cabinet widths match flush with ICP 80% gas furnaces (2010 F, G & N models)
- Removable front access panel
- Hemmed flanges for safer handling
- Plain copper hairpin
- Foil faced insulation
- Non-sweat cabinets - meet or exceed 2% air leakage codes
- Pre-painted steel cabinet
- 5-Year parts limited warranty



Cooling

Part #	Mfg #	Tons	Connections Liq, Suc	Dimensions H x D x W	Price
ICAEND4X24T14	END4X24T14A*	2.0	3/8", 5/8"	14-5/8" x 14-3/16" x 21"	CALL
ICAEND4X24T17	END4X24T17A*	2.0	3/8", 5/8"	14-5/8" x 17-1/2" x 21"	CALL
ICAEND4X30T14	END4X30T14A*	2.5	3/8", 3/4"	17" x 14-3/16" x 21"	CALL
ICAEND4X30T17	END4X30T17A*	2.5	3/8", 3/4"	17" x 17-1/2" x 21"	CALL
ICAEND4X36T17	END4X36T17A*	3.0	3/8", 3/4"	17" x 17-1/2" x 21"	CALL
ICAEND4X36T21	END4X36T21A*	3.0	3/8", 3/4"	17" x 21" x 21"	CALL
ICAEND4X42T21	END4X42T21A*	3.5	3/8", 7/8"	19" x 21" x 21"	CALL
ICAEND4X48T21	END4X48T21A*	4.0	3/8", 7/8"	22-1/6" x 21" x 21"	CALL
ICAEND4X48T24	END4X48T24A*	4.0	3/8", 7/8"	22-1/6" x 24-1/2" x 21"	CALL
ICAEND4X60T24	END4X60T24A*	5.0	3/8", 7/8"	26-7/8" x 24-1/2" x 21"	CALL

* Tin coated copper hairpin

All Items May Not Be Stocked In All Branches

Residential Cooling

FVM Multi-position Variable-Speed Fan Coil Air Handlers

- 10-Year No-Hassle replacement limited warranty
- 10-Year limited evaporator coil
- 7-Year limited parts warranties
- Supports 2-stage outdoor units
- High efficiency variable speed electronically commutated motor (ECM)
- Bolt-on, hard shut-off TXV metering device factory installed
- Copper tube/aluminum fin coil
- Sweat connections
- Primary and secondary drain fittings with brass inserts
- Time delay relay (TDR)
- HUD Approved for manufactured housing
- Filter factory supply
- Heat staging option
- Humidifier/Humidistat terminals
- 2% or Less leakage rate at 1" water column
- 1" Insulation with R value of 4.2
- 208/230-1-60



R-410A - Upflow or Horizontal Left - TXV Metering - FVM4 Fan Coil

- Horizontal right with minor modification and seal kit sold separately

Part #	Mfg #	Size Tons	CFM Range High, Low	Dimensions H x D x W	Filter Size	Ship Wt	Price
ICAFVM4X2400A	FVM4X2400A	2.0	1200, 350	42-11/16" x 17-5/8" x 22-1/16"	16-3/8" x 21-1/2"	135 lbs	CALL
ICAFVM4X3600A	FVM4X3600A	3.0	1400, 415	53-7/16" x 21-1/8" x 22-1/16"	19-7/8" x 21-1/2"	150 lbs	CALL
ICAFVM4X4800A	FVM4X4800A	4.0	1600, 425	53-7/16" x 21-1/8" x 22-1/16"	19-7/8" x 21-1/2"	172 lbs	CALL
ICAFVM4X6000A	FVM4X6000A	5.0	2000, 540	59-3/16" x 24-11/16" x 22-1/16"	23-5/16" x 21-1/2"	207 lbs	CALL

Cooling

Residential Cooling

FSM Multi-position Fan Coil Air Handlers

- 5-Year limited coil and parts warranties
- Additional 5-year limited parts warranty with timely registration
- Copper tube/aluminum fin coil
- Sweat connections
- Primary and secondary drain fittings with brass inserts
- Multiple electrical entry locations
- Time delay relay (TDR)
- 2% or Less leakage rate at 1" water column
- 1" Insulation with R value of 4.2
- Washable filter available as accessory
- HUD Approved for manufactured housing
- 208/230V, 1-Phase, 60Hz



R-410A - Upflow or Horizontal Left - TXV Metering - FSM4X Fan Coil

- 5-Year No-Hassle replacement limited warranty
- Horizontal right with minor modification and seal kit sold separately
- PSC 3-Speed motor
- TXV Metering device factory installed
- 5A Automotive type fuse on control board

Part #	Mfg #	Tons	Nom CFM	Dimensions H x W x D	Filter Size	Ship Wt	Price
ICAFSM4X6000A	FSM4X6000A	5.0	2000	59-3/16" x 24-11/16" x 22-1/8"	23-5/16" x 21-1/2"	201 lbs	CALL

R-410A - Upflow or Horizontal Left - Piston Metering - FSM4P Fan Coil

- 1-Year No-Hassle replacement limited warranty
- Horizontal right with minor modification and seal kit sold separately
- Factory installed piston with Teflon ring metering device



Part #	Mfg #	Tons	Nom CFM	Dimensions H x W x D	Filter Size	Ship Wt	Price
ICAFSM4P2400A	FSM4P2400A	2.0	800	49-5/8" x 17-5/8" x 22-1/16"	16-3/8" x 21-1/2"	120 lbs	CALL
ICAFSM4P3600A	FSM4P3600A	3.0	1200	53-7/16" x 21-1/8" x 22-1/16"	19-7/8" x 21-1/2"	146 lbs	CALL
ICAFSM4P4800A	FSM4P4800A	4.0	1600	53-7/16" x 24-11/16" x 22-1/16"	19-7/8" x 21-1/2"	175 lbs	CALL

Cooling

All Items May Not Be Stocked In All Branches

Residential Cooling

Blower Cabinets

Modular Blower Cabinet - 115V

- Air Conditioning ready
- 115 Volt operation, less coil
- Prepainted galvanized steel cabinet
- Internally lined with 1/2" Tuf-Skin II insulation
- Electronic control board
- Direct drive slide-out blower assembly
- Variable speed blower motor
- Efficient and quiet fan only setting 60% airflow
- Dehumidification speed 80% airflow
- Adjustable blower time delay
- Accepts accessory slip-in electric heaters and two-stage outdoor thermostats
- Flush matches full line of cased coils
- Heat pump ready (no electric heat)
- Upflow, downflow and horizontal right or left applications
- 5-Year parts limited warranty



Part #	Mfg #	Dimensions H x W x D	Tons	Price
ICAMB08B	MB08B1500A	24" x 15-1/2" x 20"	1.5 to 2.0	CALL
ICAMB12F	MB12F1900A	24" x 19-1/8" x 20"	2.5 to 3.0	CALL
ICAMB16J	MB16J2200A	24" x 22-3/4" x 20"	3.5 to 4.0	CALL
ICAMB20L	MB20L	24" x 26-3/8" x 20"	5.0	CALL

Upflow/Horizontal Right or Left - MV Modular Variable-Speed Blower Cabinet

- Supports 2-stage outdoor units
- Dehumidification speed: 80% airflow
- Efficient low continuous fan selection: 50% airflow
- Downflow requires sub-base accessory
- Electronic fan control board
- Adjustable blower time delay
- Accepts accessory 2-stage outdoor thermostats
- Matches with AC & HP cased coils
- 208/230-1-60 Supply voltage
- Direct drive slide-out blower assembly
- Requires a "NO HEAT KIT" if installed without electric heat
- Internally lined with 1/2" Tuf-Skin II insulation
- Prepainted galvanized steel cabinet
- 5-Year limited parts warranty



Cooling

Part #	Mfg #	Size Tons	CFM Range Low High	Motor HP	Dimensions H x D x W	Ship Wt	Price
ICAMV08B	MV08B1500B	2.0	350 1200	1/2	24" x 15-1/2" x 20-1/2"	56 lbs	CALL
ICAMV12F	MV12F1900B	3.0	415 1400	1/2	24" x 19-1/8" x 20-1/2"	58 lbs	CALL
ICAMV16J	MV16J2200B	4.0	425 1600	3/4	24" x 22-3/4" x 20-1/2"	69 lbs	CALL
ICAMV20L	MV20L2400B	5.0	540 2000	3/4	24" x 24-1/2" x 20-1/2"	72 lbs	CALL

Electric Heater for MV & MF Series

Part #	Mfg #	Description	Used with	Price
ICAEHIA00KN10	EHIA00KN10	No Heat Kit	08, 12, 16, 20	CALL

Prices & Specifications are Subject to Change.

Residential Cooling

Performance Series Residential Air Conditioners

- Copeland compressors on all models
- Filter-drier supplied with every unit for field installation
- Copper tube, aluminum fin coil
- Easy access service valves on all models
- External high and low refrigerant service ports
- Only (2) screws to access control panel
- Factory charged with R-410A refrigerant
- Baked-on powder coat finish over galvanized steel
- Post-painted (black) coil fins
- Coated, weather-resistant cabinet screws
- Coated inlet grille with 2" spacing standard, alternate models available with 3/8" grille spacing for extra protection



Warranty for Residential Original Purchaser

- 5-Year compressor limited warranty
- 10-Year parts limited warranty (including compressor and coil) with timely registration, otherwise 5-year limited warranty



16 SEER - R-410A High Efficiency Air Conditioner with Protective Grille - NXA6

- Coated inlet grille with 3/8" grille spacing for extra protection



Part #	Mfg #	Capacity	Electrical	Unit Dimensions H x W x D	Linesets Liq, Suction	Ship Wt	Price
TEANXA618GK	NXA618GKA	1.5 Ton	208/230-1-60	28-11/16" x 25-3/4" x 25-3/4"	3/8", 3/4"	154 lbs	CALL
TEANXA624GK	NXA624GKA	2.0 Ton	208/230-1-60	28-5/16" x 31-3/16" x 31-3/16"	3/8", 3/4"	147 lbs	CALL
TEANXA630GK	NXA630GKA	2.5 Ton	208/230-1-60	32-5/16" x 31-3/16" x 31-3/16"	3/8", 3/4"	188 lbs	CALL
TEANXA636GK	NXA636GKA	3.0 Ton	208/230-1-60	28-5/16" x 35" x 35"	3/8", 7/8"	204 lbs	CALL
TEANXA648GK	NXA648GKA	4.0 Ton	208/230-1-60	39-1/8" x 35" x 35"	3/8", 7/8"	317 lbs	CALL
TEANXA660GK	NXA660GKA	5.0 Ton	208/230-1-60	45-15/16" x 35" x 35"	3/8", 1-1/8"	310 lbs	CALL

Cooling

13 SEER - R-410A - 1-Phase - N4A3 Air Conditioner with Standard Grille

Part #	Mfg #	Capacity	Electrical	Unit Dimensions H x W x D	Linesets Liq, Suction	Ship Wt	Price
TEAN4A318	N4A318AKA	1.5 Ton	208/230-1-60	25-5/16" x 23-1/8" x 23-1/8"	3/8", 3/4"	130 lbs	CALL
TEAN4A324	N4A324AKA	2.0 Ton	208/230-1-60	25-1/2" x 25-3/4" x 25-3/4"	3/8", 3/4"	143 lbs	CALL
TEAN4A330	N4A330AKC	2.5 Ton	208/230-1-60	28-11/16" x 23-1/2" x 23-1/2"	3/8", 3/4"	136 lbs	CALL
TEAN4A336	N4A336AKB	3.0 Ton	208/230-1-60	31-13/16" x 25-3/4" x 25-3/4"	3/8", 7/8"	170 lbs	CALL
TEAN4A342	N4A342AKA	3.5 Ton	208/230-1-60	32-5/16" x 31-3/16" x 31-3/16"	3/8", 7/8"	208 lbs	CALL
TEAN4A348	N4A348AKB	4.0 Ton	208/230-1-60	35-3/4" x 31-3/16" x 31-3/16"	3/8", 7/8"	216 lbs	CALL
TEAN4A360	N4A360AKC	5.0 Ton	208/230-1-60	25-1/2" x 31-3/16" x 31-3/6"	3/8", 1-1/8"	218 lbs	CALL

All Items May Not Be Stocked In All Branches

Residential Cooling

Efficient 13 SEER Single Phase 1.5 Thru 5 Ton Split System Air Conditioner - R-22

- Copeland® Scroll™ compressor
- Copper tube/aluminum fin coil
- Easy Access service valves
- External high and low refrigerant service ports
- (2) Screw access control panel
- Pre-painted cabinet finish over galvanized steel
- Coated inlet grille with 3/8" spacing
- 208/230V, 1-Phase, 60Hz
- 5-Year limited compressor warranty
- 5-Year limited coil and parts warranty



Part #	Mfg #	Size Tons	Nominal BTUH	Min Circuit Ampacity	Max Fuse or Breaker	Dimensions H x W x D	Ship Wt	Price
R22R2A318	R2A318GKR	1.5	18,000	10.9	15	24-13/16" x 23-1/8" x 23-1/8"	120 lbs	CALL
R22R2A324	R2A324GKR	2.0	24,000	14.0	20	28-7/16" x 23-1/8" x 23-1/8"	124 lbs	CALL
R22R2A330	R2A330GKR	2.5	30,000	17.7	30	28-7/16" x 23-1/8" x 23-1/8"	127 lbs	CALL
R22R2A336	R2A336GKA	3.0	36,000	20.4	30	24-13/16" x 31-3/16" x 31-3/16"	158 lbs	CALL
R22R2A348	R2A348GKR	4.0	48,000	26.7	40	42" x 31-3/16" x 31-3/16"	210 lbs	CALL
R22R2A360	R2A360GKR	5.0	60,000	33.0	50	35-3/16" x 31-3/16" x 31-3/16"	230 lbs	CALL

Efficient 13 SEER Single Phase Split System Air Conditioner - R-410A - Maratherm

- Copeland® Scroll™ compressor
- Copper tube/aluminum fin coil
- Easy access service valves
- External high and low refrigerant service ports
- (2) Screw access control panel
- Pre-painted cabinet finish over galvanized steel
- Factory charged with R-410A refrigerant
- Coated inlet grille with 2" spacing
- 208/230V, 1-Phase, 60Hz
- 5-Year limited compressor warranty
- 10-Year limited coil and parts warranty with timely registration (applies to original purchaser/homeowner)



Part #	Mfg #	Size Tons	Nominal BTUH	Min Circuit Ampacity	Max Fuse or Breaker	Dimensions H x W x D	Ship Wt	Price
MAMR4A318	R4A318AKA	1.5	18,000	11.7	20	24-13/16" x 23-1/8" x 23-1/8"	120 lbs	CALL
MAMR4A324	R4A324AKA	2.0	24,000	17.6	30	24-13/16" x 23-1/8" x 23-1/8"	123 lbs	CALL
MAMR4A330	R4A330AKA	2.5	30,000	16.8	25	28-7/16" x 23-1/8" x 23-1/8"	126 lbs	CALL
MAMR4A336	R4A336AKB	3.0	36,000	23.0	30	35-3/16" x 23-1/8" x 23-1/8"	139 lbs	CALL
MAMR4A342	R4A342AKB	3.5	42,000	28.4	40	31-13/16" x 31-3/16" x 31-3/16"	187 lbs	CALL
MAMR4A348	R4A348AKB	4.0	48,000	27.0	40	38-3/16" x 31-3/16" x 31-3/16"	197 lbs	CALL
MAMR4A360	R4A360AKB	5.0	60,000	35.9	50	28-7/16" x 31-3/16" x 31-3/16"	216 lbs	CALL



Prices & Specifications are Subject to Change.

Residential Cooling

SmartComfort™ Residential Air Conditioners

- Copeland Scroll™ compressors on all models
- Filter-drier supplied with every unit for field installation
- External high and low refrigerant service ports
- Copper tube, aluminum fin coil
- 2-Speed fan motors factory wired on all models
- Compressor sound jacket standard
- Comfort Alert™ diagnostics device on all models
- Easy access service valves on all models
- Innovative control box design
- High and low pressure switches
- Fan motor in-line disconnect plug
- Only (2) screws to access control panel
- Factory charged with R-410A refrigerant
- High gloss, baked-on powder coat finish over galvanized steel
- Post-painted (black) coil fins
- Coated, weather-resistant cabinet screws
- Coated inlet grille with 3/8" spacing for extra protection
- Corner Posts for extra strength and style



16 SEER TX 5600 High Efficiency Split System Air Conditioner - R-410A

Warranty for Residential Original Purchaser

- 5-Year No Hassle Replacement™ limited warranty
- 10-Year compressor limited warranty with timely registration
- 10-Year parts limited warranty (including compressor and coil) with timely registration, otherwise 5-year limited warranty



Cooling

Part #	Mfg #	Capacity	Electrical	Unit Dimensions		Linesets		Ship Wt	Price
				H x W x D		Liq, Suction			
TEATXA618	TXA618GKA	1.5 Ton	208/230-1-60	28-1/2" x 31-3/16" x 31-3/16"		3/8", 3/4"		183 lbs	CALL
TEATXA624	TXA624GKA	2.0 Ton	208/230-1-60	28-1/2" x 31-3/16" x 31-3/16"		3/8", 3/4"		183 lbs	CALL
TEATXA630	TXA630GKA	2.5 Ton	208/230-1-60	32-1/2" x 31-3/16" x 31-3/16"		3/8", 3/4"		188 lbs	CALL
TEATXA636	TXA636GKA	3.0 Ton	208/230-1-60	28-1/2" x 35" x 35"		3/8", 7/8"		204 lbs	CALL
TEATXA648	TXA648GKA	4.0 Ton	208/230-1-60	39-1/4" x 35" x 35"		3/8", 7/8"		317 lbs	CALL
TEATXA660	TXA660GKA	5.0 Ton	208/230-1-60	45-15/16" x 35" x 35"		3/8", 7/8"		310 lbs	CALL

13 SEER Deluxe R-410 Air Conditioner - SmartComfort T4A3

Warranty for Residential Original Purchaser

- 1-Year No Hassle Replacement™ limited warranty
- 10-Year compressor limited warranty
- 10-Year parts limited warranty (including compressor and coil) with timely registration, otherwise 5-year limited warranty



Part #	Mfg #	Capacity	Electrical	Unit Dimensions		Linesets		Ship Wt	Price
				H x W x D		Liq, Suction			
TEAT4A324	T4A324GKD	2.0 Ton	208/230-1-60	25-5/16" x 23-1/8" x 23-1/8"		3/8", 3/4"		142 lbs	CALL
TEAT4A330	T4A330GKD	2.5 Ton	208/230-1-60	28-11/16" x 23-1/8" x 23-1/8"		3/8", 3/4"		151 lbs	CALL
TEAT4A336	T4A336GKD	3.0 Ton	208/230-1-60	25-5/16" x 31-3/16" x 31-3/16"		3/8", 7/8"		196 lbs	CALL
TEAT4A342	T4A342GKD	3.5 Ton	208/230-1-60	32-1/8" x 31-3/16" x 31-3/16"		3/8", 7/8"		230 lbs	CALL
TEAT4A348	T4A348GKD	4.0 Ton	208/230-1-60	35-1/2" x 31-3/16" x 31-3/16"		3/8", 7/8"		243 lbs	CALL
TEAT4A360	T4A360GKD	5.0 Ton	208/230-1-60	28-11/16" x 31-3/16" x 31-3/16"		3/8", 1-1/8"		250 lbs	CALL

All Items May Not Be Stocked In All Branches

Residential Cooling

SmartComfort™ TXC 5600 16 SEER Communicating Split System Air Conditioner - R-410A

- With Observer™ Communicating Control System
- Text based diagnostics and communicating, self-configuring operation with Observer Communicating Wall Control
- Single stage
- Copeland® scroll compressor
- Filter-drier included for field installation
- External high and low refrigerant service ports
- Factory installed outdoor temperature sensor
- Copper tubing with aluminum fin coils
- Compressor sound blanket
- Isolation compressor grommets
- High and low pressure switches
- Factory charged with R-410A refrigerant
- High gloss baked-on powder coat over galvanized steel cabinet
- Post-painted black coil fins
- Coated inlet grille with 3/8" spacing
- 5-Year No Hassle Replacement™ limited warranty
- 5-Year parts limited warranty (including compressor and coil)
 - With timely registration, an additional 5-year parts limited warranty (including compressor and coil)



Part #	Mfg #	Tons	SEER	Nominal BTUH	Electrical	Dimensions H x W x D	Approx Ship Wt	Price
TEATSA624	TSA624GKA	2.0	16	24,000	208/230-1-60	28-11/16" x 31-3/16" x 31-3/16"	212 lbs	CALL
TEATSA630	TSA630GKA	2.5	16	30,000	208/230-1-60	32-1/8" x 31-3/16" x 31-3/16"	223 lbs	CALL
TEATSA636	TSA636GKA	3.0	16	36,000	208/230-1-60	30-1/16" x 35" x 35"	243 lbs	CALL
TEATSA642	TSA642GKA	3.5	16	42,000	208/230-1-60	40-1/4" x 35" x 35"	297 lbs	CALL
TEATSA648	TSA648GKA	4.0	16	48,000	208/230-1-60	40-1/4" x 35" x 35"	340 lbs	CALL
TEATSA660	TSA660GKA	5.0	16	60,000	208/230-1-60	47-1/16" x 35" x 35"	374 lbs	CALL

Cooling

We Value Your Opinion
Let us know what we are doing right, but more importantly let us know how we can serve you better.

Prices & Specifications are Subject to Change.

Residential Cooling

SmartComfort™ Residential Heat Pumps

- Copeland Scroll™ compressors on all models
- Suction line accumulator factory installed
- Bi-flow filter-drier included for field installation
- Integrated solid state control with time-temperature defrost
- High and low pressure switches
- External high and low refrigerant service ports
- Copper tube, aluminum fin coil
- 2-Speed fan motors factory wired on all models
- Compressor sound jacket standard
- Comfort Alert™ diagnostics device on all models
- Easy access service valves on all models
- Innovative control box design
- Fan motor in-line disconnect plug
- Only (2) screws to access control panel
- Factory charged with R-410A refrigerant
- High gloss, baked-on powder coat finish over galvanized steel
- Post-painted (black) coil fins
- Coated, weather-resistant cabinet screws
- Coated inlet grille with 3/8" spacing for extra protection
- Corner Posts for extra strength and style



17 SEER High Efficiency R-410 2-Stage Heat Pump - SmartComfort T4H+

- Crankcase heater factory installed
- High, low & compressor unloader pressure switches
- High performance compressor sound shield standard
- Comfort Alerter™ UltraTech™ diagnostics device on all models

Warranty for Residential Original Purchaser

- 10-Year No Hassle Replacement™ limited warranty
- 10-Year compressor limited warranty
- 10-Year parts limited warranty (including compressor and coil) with timely registration, otherwise 5-year limited warranty



Cooling

Part #	Mfg #	Capacity	Electrical	Unit Dimensions H x W x D	Linesets Liq, Suction	Ship Wt	Price
TEAT4H736	T4H736GKD	3.0 Ton	208/230-1-60	40-1/4" x 35" x 35"	3/8", 7/8"	326 lbs	CALL

All Items May Not Be Stocked In All Branches

Residential Cooling

SmartComfort™ TXC 5500 Communicating 15 SEER Split System Heat Pump - R-410A

- With Observer™ Communicating Control System
- Text based diagnostics and communicating, self-configuring operation with Observer Communicating Wall Control
- Single stage
- Copeland® scroll compressor
- Factory installed suction line accumulator and outdoor temperature sensor
- Bi-flow filter-drier included for field installation
- Integrated solid state control with time-temperature defrost
- External high and low refrigerant service ports
- Copper tubing with aluminum fin coils
- Compressor sound blanket
- Isolation compressor grommets
- High and low pressure switches
- Factory charged with R-410A refrigerant
- High gloss baked-on powder coat over galvanized steel cabinet
- Post-painted black coil fins
- Coated inlet grille with 3/8" spacing
- 5-Year No Hassle Replacement™ limited warranty
- 5-Year parts limited warranty (including compressor and coil)
 - With timely registration, an additional 5-year parts limited warranty (including compressor and coil)



Part #	Mfg #	Capacity	Nominal BTUH	Electrical	Unit Dimensions H x W x D	Ship Wt	Price
TEATSH524	TSH524GKA	2.0	24,000	208/230-1-60	33-1/2" x 35" x 35"	257 lbs	CALL
TEATSH530	TSH530GKA	2.5	30,000	208/230-1-60	33-1/2" x 35" x 35"	259 lbs	CALL
TEATSH536	TSH536GKA	3.0	36,000	208/230-1-60	36-7/8" x 35" x 35"	273 lbs	CALL
TEATSH542	TSH542GKA	3.5	42,000	208/230-1-60	30-1/16" x 35" x 35"	305 lbs	CALL
TEATSH548	TSH548GKA	4.0	48,000	208/230-1-60	33-1/2" x 35" x 35"	323 lbs	CALL
TEATSH560	TSH560GKA	5.0	60,000	208/230-1-60	40-1/4" x 35" x 35"	357 lbs	CALL

Cooling

Irr Supply is your one stop shop for all your Plumbing, HVAC, Refrigeration, and Electrical needs. Why go anywhere else!

Prices & Specifications are Subject to Change.

Residential Cooling

15 SEER- High Efficiency Environmentally Sound Heat Pump - R-410A

- 1-1/2 Thru 5 tons
- 208/230V, 1-Phase, 60Hz
- Copeland Scroll™ compressor
- Bi-flow filter-drier for field installation
- Integrated solid state control with Time-Temperature Defrost
- High and low pressure switches
- Copper tube/aluminum fin coil
- Easy access service valves
- External high and low refrigerant service ports
- Only two screws to access control panel
- Factory charged with R-410A refrigerant
- Baked-on powder coat finish over galvanized steel
- Post-painted coil fins
- Coated, weather-resistant cabinet screws
- Coated inlet grill with 3/8" grille spacing for extra protection
- 5-Year compressor limited warranty
- 5-Year parts limited warranty (including compressor and coil)



Part #	Mfg #	Capacity	Electrical	Unit Dimensions H x W x D	Ship Wt	Price
TEANXH524	NXH524GKA	2.0	208/230-1-60	32-5/16" x 35" x 35"	233 lbs	CALL
TEANXH548	NXH548GKA	4.0	208/230-1-60	28-15/16" x 35" x 35"	303 lbs	CALL



Copper Line Sets

- All line sets are plain end and 90° bend end



1/2" Insulation Line Set

Part #	Mfg #	Liq Line	Suct Line	Length	Price
ACL61030	61020300	3/8"	5/8"	30'	CALL
ACL61050	61020500	3/8"	5/8"	50'	CALL
ACL61220	61280200	3/8"	3/4"	20'	CALL
ACL61230	61280300	3/8"	3/4"	30'	CALL
ACL61250	61280500	3/8"	3/4"	50'	CALL
ACL61420	61480200	3/8"	7/8"	20'	CALL
ACL61430	61480300	3/8"	7/8"	30'	CALL
ACL61450	61480500	3/8"	7/8"	50'	CALL
ACL61850	61880500	3/8"	1-1/8"	50'	CALL

All Items May Not Be Stocked In All Branches

Residential Cooling

Blower Cabinets

Modular Blower Cabinet - 115V

- Air Conditioning ready
- 115 Volt operation, less coil
- Prepainted galvanized steel cabinet
- Internally lined with 1/2" Tuf-Skin II insulation
- Electronic control board
- Direct drive slide-out blower assembly
- Variable speed blower motor
- Efficient and quiet fan only setting 60% airflow
- Dehumidification speed 80% airflow
- Adjustable blower time delay
- Accepts accessory slip-in electric heaters and two-stage outdoor thermostats
- Flush matches full line of cased coils
- Heat pump ready (no electric heat)
- Upflow, downflow and horizontal right or left applications
- 5-Year parts limited warranty



Part #	Mfg #	Dimensions H x W x D	Tons	Price
ICAMB08B	MB08B1500A	24" x 15-1/2" x 20"	1.5 to 2.0	CALL
ICAMB12F	MB12F1900A	24" x 19-1/8" x 20"	2.5 to 3.0	CALL
ICAMB16J	MB16J2200A	24" x 22-3/4" x 20"	3.5 to 4.0	CALL
ICAMB20L	MB20L	24" x 26-3/8" x 20"	5.0	CALL

Upflow/Horizontal Right or Left - MV Modular Variable-Speed Blower Cabinet

- Supports 2-stage outdoor units
- Dehumidification speed: 80% airflow
- Efficient low continuous fan selection: 50% airflow
- Downflow requires sub-base accessory
- Electronic fan control board
- Adjustable blower time delay
- Accepts accessory 2-stage outdoor thermostats
- Matches with AC & HP cased coils
- 208/230-1-60 Supply voltage
- Direct drive slide-out blower assembly
- Requires a "NO HEAT KIT" if installed without electric heat
- Internally lined with 1/2" Tuf-Skin II insulation
- Prepainted galvanized steel cabinet
- 5-Year limited parts warranty



Cooling

Part #	Mfg #	Size Tons	CFM Range Low High	Motor HP	Dimensions H x D x W	Ship Wt	Price
ICAMV08B	MV08B1500B	2.0	350 1200	1/2	24" x 15-1/2" x 20-1/2"	56 lbs	CALL
ICAMV12F	MV12F1900B	3.0	415 1400	1/2	24" x 19-1/8" x 20-1/2"	58 lbs	CALL
ICAMV16J	MV16J2200B	4.0	425 1600	3/4	24" x 22-3/4" x 20-1/2"	69 lbs	CALL
ICAMV20L	MV20L2400B	5.0	540 2000	3/4	24" x 24-1/2" x 20-1/2"	72 lbs	CALL

Electric Heater for MV & MF Series

Part #	Mfg #	Description	Used with	Price
ICAEHIA00KN10	EHIA00KN10	No Heat Kit	08, 12, 16, 20	CALL

Prices & Specifications are Subject to Change.

Residential Cooling

Performance Series Residential Air Conditioners

- Copeland compressors on all models
- Filter-drier supplied with every unit for field installation
- Copper tube, aluminum fin coil
- Easy access service valves on all models
- External high and low refrigerant service ports
- Only (2) screws to access control panel
- Factory charged with R-410A refrigerant
- Baked-on powder coat finish over galvanized steel
- Post-painted (black) coil fins
- Coated, weather-resistant cabinet screws
- Coated inlet grille with 2" spacing standard, alternate models available with 3/8" grille spacing for extra protection



Warranty for Residential Original Purchaser

- 5-Year compressor limited warranty
- 10-Year parts limited warranty (including compressor and coil) with timely registration, otherwise 5-year limited warranty



16 SEER - R-410A High Efficiency Air Conditioner with Protective Grille - NXA6

- Coated inlet grille with 3/8" grille spacing for extra protection



Part #	Mfg #	Capacity	Electrical	Unit Dimensions H x W x D	Linesets Liq, Suction	Ship Wt	Price
AQANXA618GK	NXA618GKA	1.5 Ton	208/230-1-60	28-11/16" x 25-3/4" x 25-3/4"	3/8", 3/4"	154 lbs	CALL
AQANXA624GK	NXA624GKA	2.0 Ton	208/230-1-60	28-5/16" x 31-3/16" x 31-3/16"	3/8", 3/4"	147 lbs	CALL
AQANXA630GK	NXA630GKA	2.5 Ton	208/230-1-60	32-5/16" x 31-3/16" x 31-3/16"	3/8", 3/4"	188 lbs	CALL
AQANXA636GK	NXA636GKA	3.0 Ton	208/230-1-60	28-5/16" x 35" x 35"	3/8", 7/8"	204 lbs	CALL
AQANXA648GK	NXA648GKA	4.0 Ton	208/230-1-60	39-1/8" x 35" x 35"	3/8", 7/8"	317 lbs	CALL
AQANXA660GK	NXA660GKA	5.0 Ton	208/230-1-60	45-15/16" x 35" x 35"	3/8", 1-1/8"	310 lbs	CALL

Cooling

13 SEER - R-410A - 1-Phase - N4A3 Air Conditioner with Standard Grille

Part #	Mfg #	Capacity	Electrical	Unit Dimensions H x W x D	Linesets Liq, Suction	Ship Wt	Price
AQAN4A318	N4A318AKA	1.5 Ton	208/230-1-60	25-5/16" x 23-1/8" x 23-1/8"	3/8", 3/4"	130 lbs	CALL
AQAN4A324	N4A324AKA	2.0 Ton	208/230-1-60	25-1/2" x 25-3/4" x 25-3/4"	3/8", 3/4"	143 lbs	CALL
AQAN4A330	N4A330AKC	2.5 Ton	208/230-1-60	28-11/16" x 23-1/2" x 23-1/2"	3/8", 3/4"	136 lbs	CALL
AQAN4A336	N4A336AKB	3.0 Ton	208/230-1-60	31-13/16" x 25-3/4" x 25-3/4"	3/8", 7/8"	170 lbs	CALL
AQAN4A342	N4A342AKA	3.5 Ton	208/230-1-60	32-5/16" x 31-3/16" x 31-3/16"	3/8", 7/8"	208 lbs	CALL
AQAN4A348	N4A348AKB	4.0 Ton	208/230-1-60	35-3/4" x 31-3/16" x 31-3/16"	3/8", 7/8"	216 lbs	CALL
AQAN4A360	N4A360AKC	5.0 Ton	208/230-1-60	25-1/2" x 31-3/16" x 31-3/6"	3/8", 1-1/8"	218 lbs	CALL

All Items May Not Be Stocked In All Branches

Residential Cooling

Efficient 13 SEER Single Phase 1.5 Thru 5 Ton Split System Air Conditioner - R-22

- Copeland® Scroll™ compressor
- Copper tube/aluminum fin coil
- Easy Access service valves
- External high and low refrigerant service ports
- (2) Screw access control panel
- Pre-painted cabinet finish over galvanized steel
- Coated inlet grille with 3/8" spacing
- 208/230V, 1-Phase, 60Hz
- 5-Year limited compressor warranty
- 5-Year limited coil and parts warranty



Part #	Mfg #	Size Tons	Nominal BTUH	Min Circuit Ampacity	Max Fuse or Breaker	Dimensions H x W x D	Ship Wt	Price
R22R2A318	R2A318GKR	1.5	18,000	10.9	15	24-13/16" x 23-1/8" x 23-1/8"	120 lbs	CALL
R22R2A324	R2A324GKR	2.0	24,000	14.0	20	28-7/16" x 23-1/8" x 23-1/8"	124 lbs	CALL
R22R2A330	R2A330GKR	2.5	30,000	17.7	30	28-7/16" x 23-1/8" x 23-1/8"	127 lbs	CALL
R22R2A336	R2A336GKA	3.0	36,000	20.4	30	24-13/16" x 31-3/16" x 31-3/16"	158 lbs	CALL
R22R2A348	R2A348GKR	4.0	48,000	26.7	40	42" x 31-3/16" x 31-3/16"	210 lbs	CALL
R22R2A360	R2A360GKR	5.0	60,000	33.0	50	35-3/16" x 31-3/16" x 31-3/16"	230 lbs	CALL

Cooling

Visionary Baths & More

Because your time is valuable...

Visit your local Visionary Baths & More Kitchen and Bath Design Centers to let one of our trained knowledgeable consultants help you with your project.

<http://www.visionarybaths.com>

Residential Cooling

Efficient 13 SEER Single Phase Split System Air Conditioner - R-410A - Maratherm

- Copeland® Scroll™ compressor
- Copper tube/aluminum fin coil
- Easy access service valves
- External high and low refrigerant service ports
- (2) Screw access control panel
- Pre-painted cabinet finish over galvanized steel
- Factory charged with R-410A refrigerant
- Coated inlet grille with 2" spacing
- 208/230V, 1-Phase, 60Hz
- 5-Year limited compressor warranty
- 10-Year limited coil and parts warranty with timely registration (applies to original purchaser/homeowner)



10-Year with timely registration



Part #	Mfg #	Size Tons	Nominal BTUH	Min Circuit Ampacity	Max Fuse or Breaker	Dimensions H x W x D	Ship Wt	Price
MAMR4A318	R4A318AKA	1.5	18,000	11.7	20	24-13/16" x 23-1/8" x 23-1/8"	120 lbs	CALL
MAMR4A324	R4A324AKA	2.0	24,000	17.6	30	24-13/16" x 23-1/8" x 23-1/8"	123 lbs	CALL
MAMR4A330	R4A330AKA	2.5	30,000	16.8	25	28-7/16" x 23-1/8" x 23-1/8"	126 lbs	CALL
MAMR4A336	R4A336AKB	3.0	36,000	23.0	30	35-3/16" x 23-1/8" x 23-1/8"	139 lbs	CALL
MAMR4A342	R4A342AKB	3.5	42,000	28.4	40	31-13/16" x 31-3/16" x 31-3/16"	187 lbs	CALL
MAMR4A348	R4A348AKB	4.0	48,000	27.0	40	38-3/16" x 31-3/16" x 31-3/16"	197 lbs	CALL
MAMR4A360	R4A360AKB	5.0	60,000	35.9	50	28-7/16" x 31-3/16" x 31-3/16"	216 lbs	CALL

Cooling

Special orders - If you need it we can get it promptly!

Residential Cooling

High Efficiency 16 SEER 1-Phase Split System Air Conditioner - R-410A

- 208/230V, 1-Phase, 60Hz
- Copeland® compressor
- Filter-drier for field installation
- Copper tube/aluminum fin coil
- Easy Access service valves
- External high and low refrigerant service ports
- (2) Screw access control panel
- Baked-on powder coat finish over galvanized steel
- Post-painted, black coil fins
- Coated, weather-resistant cabinet screws
- Coated inlet grille with 3/8" grille spacing
- 5-Year limited compressor warranty
- 5-Year limited coil and parts warranty



Part #	Mfg #	Size Tons	Nominal BTUH	Min Circuit Ampacity	Max Fuse or Breaker	Dimensions H x W x D	Ship Wt	Price
AQANXA624GK	NXA624GKA	2.0	24,000	17.7	25	28-5/16" x 31-3/16" x 31-3/16"	147 lbs	CALL
AQANXA630GK	NXA630GKA	2.5	30,000	16.8	25	32-5/16" x 31-3/16" x 31-3/16"	188 lbs	CALL
AQANXA636GK	NXA636GKA	3.0	36,000	18.1	30	28-5/16" x 35" x 35"	204 lbs	CALL
AQANXA648GK	NXA648GKA	4.0	48,000	26.1	40	39-1/8" x 35" x 35"	317 lbs	CALL
AQANXA660GK	NXA660GKA	5.0	60,000	28.0	40	45-15/16" x 35" x 35"	310 lbs	CALL
AQANXA618GK	NXA618GKA	1.5	18,000	11.8	20	28-11/16" x 25-3/4" x 25-3/4"	154 lbs	CALL

High-Efficiency Single-Stage Air Conditioners - R-410A

- Copeland Scroll UltraTech™ compressor
- Filter-drier supplied with every unit for field installation
- External high and low refrigerant service ports
- Copper tube/aluminum fin coil
- Easy access service valve
- Factory charged with R-410A
- Baked-on powder coat finish over galvanized steel
- Post-painted (black) coil fins
- Coated inlet grille with 2" spacing standard
- 208/230-1-60
- 5-Year limited compressor, coil & parts warranties



Cooling

13 SEER - R-410A - 1-Phase - N4A3 Air Conditioner with Standard Grille

Part #	Mfg #	Size Tons	Nominal BTUH	Min Circuit Ampacity	Max Fuse or Breaker	Dimensions H x W x D	Ship Wt	Price
AQAN4A318	N4A318AKA	1.5	18,000	11.7	15	25-1/2" x 25-3/4" x 25-3/4"	138 lbs	CALL
AQAN4A324	N4A324AKA	2.0	24,000	17.6	25	25-1/2" x 25-3/4" x 25-3/4"	143 lbs	CALL
AQAN4A330	N4A330AKC	2.5	30,000	16.8	25	28-11/16" x 23-1/8" x 23-1/8"	136 lbs	CALL
AQAN4A336	N4A336AKB	3.0	36,000	21.5	30	31-13/16" x 25-3/4" x 25-3/4"	170 lbs	CALL
AQAN4A342	N4A342AKA	3.5	42,000	23.5	40	32-5/16" x 31-3/16" x 31-3/16"	208 lbs	CALL
AQAN4A348	N4A348AKB	4.0	48,000	26.2	40	35-3/4" x 31-3/16" x 31-3/16"	215 lbs	CALL
AQAN4A360	N4A360AKC	5.0	60,000	34.2	50	25-1/2" x 31-3/16" x 31-3/16"	218 lbs	CALL

Prices & Specifications are Subject to Change.

Residential Cooling

Condensing Units

QuietComfort™ 1.5 Thru 5 Ton Split Air Conditioner - R-410A

- 208/230V, 1-Phase, 60Hz
- Copeland® scroll compressor
- Filter-drier for field installation
- Copper tube/aluminum fin coil
- 2-Speed fan motors factory wired
- Compressor sound jacket
- Comfort Alert™ diagnostics
- Easy access service valves
- Innovative control box design
- High and low pressure switches
- External high and low refrigerant service ports
- Fan motor in-line disconnect plug
- Only two screws to access control panel
- High gloss, baked-on powder coat finish over galvanized steel cabinet
- Post-painted (black) coil fins
- Coated, weather-resistant cabinet screws
- Coated inlet grille with 3/8" spacing
- Corner posts
- 5-Year limited warranty on scroll compressor
- 1-Year No hassle replacement warranty
- 5-Year limited coil and parts warranty (additional 5-year warranty with timely registration - including compressor)



13 SEER - R-410A - Air Conditioner

Part #	Mfg #	Size Tons	Nominal BTUH	Min Circuit Ampacity	Max Fuse or Breaker	Dimensions H x W x D	Ship Wt	Price
AQAH4A318	H4A318GKD	1.5	18,000	11.8	20	25-3/16" x 23-1/8" x 23-1/8"	143 lbs	CALL
AQAH4A324	H4A324GKD	2.0	24,000	17.6	30	25-3/16" x 23-1/8" x 23-1/8"	142 lbs	CALL
AQAH4A330	H4A330GKD	2.5	30,000	16.8	25	28-9/16" x 23-1/8" x 23-1/8"	151 lbs	CALL
AQAH4A336	H4A336GKD	3.0	36,000	21.9	30	25-3/16" x 31-3/16" x 32-5/16"	196 lbs	CALL
AQAH4A342	H4A342GKD	3.5	42,000	23.5	40	32" x 31-3/16" x 31-3/16"	230 lbs	CALL
AQAH4A348	H4A348GKD	4.0	48,000	26	40	35-3/8" x 31-3/16" x 31-3/16"	243 lbs	CALL
AQAH4A360	H4A360GKD	5.0	60,000	34.2	50	28-9/16" x 31-3/16" x 31-3/16"	250 lbs	CALL

Cooling

Product descriptions and specifications in this catalog are condensed from manufacturer's literature. For exact information, consult manufacturer's literature prior to installation and service. Contact us if you are not sure about specifications.

Residential Cooling

High Efficiency 16 SEER 1-Phase Split System Air Conditioner - R-410A

- 208/230V, 1-Phase, 60Hz
- Copeland® compressor
- Filter-drier for field installation
- Copper tube/aluminum fin coil
- External high and low refrigerant service ports
- Easy Access service valves, (2) screw access control panel
- Baked-on powder coat finish over galvanized steel
- Post-painted, black coil fins
- Coated, weather-resistant cabinet screws
- Coated inlet grille with 3/8" grille spacing
- 5-Year limited compressor warranty
- 5-Year limited coil and parts warranty (including compressor and coil), additional 5-year parts limited warrant with timely registration to original purchaser



Part #	Mfg #	Size Tons	Nominal BTUH	Min Circuit Ampacity	Max Fuse or Breaker	Dimensions H x W x D	Ship Wt	Price
AQANXA618GK	NXA618GK	1.5	18,000	11.8	20	28-11/16" x 25-3/4" x 25-3/4"	154 lbs	CALL
AQANXA624GK	NXA624GKA	2.0	24,000	17.7	25	28-5/16" x 31-3/16" x 31-3/16"	147 lbs	CALL
AQANXA630GK	NXA630GKA	2.5	30,000	16.8	25	32-5/16" x 31-3/16" x 31-3/16"	188 lbs	CALL
AQANXA636GK	NXA636GKA	3.0	36,000	18.1	30	28-5/16" x 35" x 35"	204 lbs	CALL
AQANXA648GK	NXA648GKA	4.0	48,000	26.1	40	39-1/8" x 35" x 35"	317 lbs	CALL
AQANXA660GK	NXA660GK	5.0	60,000	28.0	40	45-15/16" x 35" x 35"	310 lbs	CALL

High Efficiency 16 SEER 1.5 Thru 5 Ton Split System Air Conditioner - R-410A

- 208/230V, 1-Phase, 60Hz, 2-speed fan motor factory wired on all models
- Copeland® compressor, filter-drier for field installation
- Copper tube/aluminum fin coil
- Comfort Alert™ Diagnostics device on all models
- Easy Access service valves, (2) screw access control panel
- External high and low refrigerant service ports
- Fan motor in-line disconnect plug
- Baked-on powder coat finish over galvanized steel
- Post-painted, black coil fins
- Coated, weather-resistant cabinet screws
- Coated inlet grille with 3/8" grille spacing
- 5-Year limited warranty on scroll compressor
- 1-Year No hassle replacement warranty
- 5-Year limited coil and parts warranty (additional 5-year warranty with timely registration - including compressor)



Part #	Mfg #	Size Tons	Nom BTUH	SEER	Dimensions H x W x D	Approx Ship Wt	Price
AQAHXA618GK	HXA618GK	1.5	18,000	11.8	28-5/16" x 31-3/16" x 31-3/16"	183 lbs	CALL
AQAHXA624GK	HXA624GK	2.0	24,000	17.7	28-5/16" x 31-3/16" x 31-3/16"	183 lbs	CALL
AQAHXA630GK	HXA630GK	2.5	30,000	16.8	32-5/16" x 31-3/16" x 31-3/16"	188 lbs	CALL
AQAHXA636GK	HXA636GK	3.0	36,000	18.1	28-5/16" x 35" x 35"	204 lbs	CALL
AQAHXA648GK	HXA648GK	4.0	48,000	26.1	39-1/8" x 35" x 35"	317 lbs	CALL
AQAHXA660GK	HXA660GK	5.0	60,000	28.0	45-15/16" x 35" x 35"	310 lbs	CALL

Cooling

Prices & Specifications are Subject to Change.

Residential Cooling

Communicating High Efficiency 16 SEER Split System Air Conditioner - R-410A

- With Observer™ Communicating Control System
- Text based diagnostics and communicating, self-configuring operation with Observer Communicating Wall Control
- Copeland® scroll compressor
- Filter-drier included for field installation
- External high and low refrigerant service ports
- Factory installed outdoor temperature sensor
- Copper tubing with aluminum fin coils
- Compressor sound blanket
- Isolation compressor grommets
- High and low pressure switches
- Factory charged with R-410A refrigerant
- High gloss baked-on powder coat over galvanized steel cabinet
- Post-painted black coil fins
- Coated inlet grille with 3/8" spacing
- 5-Year No Hassle Replacement™ limited warranty
- 5-Year parts limited warranty (including compressor and coil)
 - With timely registration, an additional 5-year parts limited warranty (including compressor and coil)



Part #	Mfg #	Tons	SEER	Nominal BTUH	Electrical	Dimensions H x W x D	Approx Ship Wt	Price
AQAHSA624	HSA624GKA	2.0	16	24,000	208/230-1-60	28-9/16" x 31-3/16" x 31-3/16"	212 lbs	CALL
AQAHSA630	HSA630GKA	2.5	16	30,000	208/230-1-60	32" x 31-3/16" x 31-3/16"	223 lbs	CALL
AQAHSA636	HSA636GKA	3.0	16	36,000	208/230-1-60	29-7/8" x 35" x 35"	243 lbs	CALL
AQAHSA642	HSA642GKA	3.5	16	42,000	208/230-1-60	40-1/8" x 35" x 35"	297 lbs	CALL
AQAHSA648	HSA648GKA	4.0	16	48,000	208/230-1-60	40-1/8" x 35" x 35"	340 lbs	CALL
AQAHSA660	HSA660GKA	5.0	16	60,000	208/230-1-60	46-7/8" x 35" x 35"	374 lbs	CALL

Cooling

Check our website for special promotions!
www.irrsupply.com

Residential Cooling

Heat Pumps

Communicating High Efficiency 15 SEER Split System Heat Pump - R-410A

- With Observer™ Communicating Control System
- Text based diagnostics and communicating, self-configuring operation with Observer Communicating Wall Control
- Copeland® scroll compressor
- Factory installed suction line accumulator and outdoor temperature sensor
- Bi-flow filter-drier included for field installation
- Integrated solid state control with time-temperature defrost
- External high and low refrigerant service ports
- Copper tubing with aluminum fin coils
- Compressor sound blanket
- Isolation compressor grommets
- High and low pressure switches
- Factory charged with R-410A refrigerant
- High gloss baked-on powder coat over galvanized steel cabinet
- Post-painted black coil fins
- Coated inlet grille with 3/8" spacing
- 5-Year No Hassle Replacement™ limited warranty
- 5-Year parts limited warranty (including compressor and coil)
 - With timely registration, an additional 5-year parts limited warranty (including compressor and coil)



Part #	Mfg #	Tons	SEER	Nominal BTUH	Electrical	Dimensions H x W x D	Approx Ship Wt	Price
AQAHS524	HSH524GKA	2.0	15	24,000	208/230-1-60	33-5/16" x 35" x 35"	257 lbs	CALL
AQAHS530	HSH530GKA	2.5	15	30,000	208/230-1-60	33-5/16" x 35" x 35"	259 lbs	CALL
AQAHS536	HSH536GKA	3.0	15	36,000	208/230-1-60	36-11/16" x 35" x 35"	273 lbs	CALL
AQAHS542	HSH542GKA	3.5	15	42,000	208/230-1-60	29-7/8" x 35" x 35"	305 lbs	CALL
AQAHS548	HSH548GKA	4.0	15	48,000	208/230-1-60	33-5/16" x 35" x 35"	323 lbs	CALL
AQAHS560	HSH560GKA	5.0	15	60,000	208/230-1-60	40-1/8" x 35" x 35"	357 lbs	CALL

Cooling

"Service Starts Here" is not just a motto it's how we do business.

Prices & Specifications are Subject to Change.

Residential Cooling

15 SEER - High Efficiency Environmentally Sound Heat Pump - R-410A

- 1-1/2 Thru 5 tons
- 208/230V, 1-Phase, 60Hz
- Copeland Scroll™ compressor
- Bi-flow filter-drier for field installation
- Integrated solid state control with Time-Temperature Defrost
- High and low pressure switches
- Copper tube/aluminum fin coil
- Easy access service valves
- External high and low refrigerant service ports
- Only two screws to access control panel
- Factory charged with R-410A refrigerant
- Baked-on powder coat finish over galvanized steel
- Post-painted coil fins
- Coated, weather-resistant cabinet screws
- Coated inlet grill with 3/8" grille spacing for extra protection
- 5-Year compressor limited warranty
- 5-Year parts limited warranty (including compressor and coil)



Part #	Mfg #	Tons	Nominal BTUH	Min Circuit Ampacity	Max Fuse or Breaker	Dimensions H x W x D	Ship Wt	Price
AQANXH524	NXH524GKA	2.0	24,000	16.5	25	32-5/16" x 35" x 35"	233 lbs	CALL
AQANXH548	NXH548GKA	4.0	48,000	28.5	40	28-15/16" x 35" x 35"	303 lbs	CALL



Copper Line Sets

- All line sets are plain end and 90° bend end



1/2" Insulation Line Set

Part #	Mfg #	Liq Line	Suct Line	Length	Price
ACL61030	61020300	3/8"	5/8"	30'	CALL
ACL61050	61020500	3/8"	5/8"	50'	CALL
ACL61220	61280200	3/8"	3/4"	20'	CALL
ACL61230	61280300	3/8"	3/4"	30'	CALL
ACL61250	61280500	3/8"	3/4"	50'	CALL
ACL61420	61480200	3/8"	7/8"	20'	CALL
ACL61430	61480300	3/8"	7/8"	30'	CALL
ACL61450	61480500	3/8"	7/8"	50'	CALL
ACL61850	61880500	3/8"	1-1/8"	50'	CALL

Cooling

All Items May Not Be Stocked In All Branches

Residential Cooling

Blower Cabinets

Modular Blower Cabinet - 115V

- Air Conditioning ready
- 115 Volt operation, less coil
- Prepainted galvanized steel cabinet
- Internally lined with 1/2" Tuf-Skin II insulation
- Electronic control board
- Direct drive slide-out blower assembly
- Variable speed blower motor
- Efficient and quiet fan only setting 60% airflow
- Dehumidification speed 80% airflow
- Adjustable blower time delay
- Accepts accessory slip-in electric heaters and two-stage outdoor thermostats
- Flush matches full line of cased coils
- Heat pump ready (no electric heat)
- Upflow, downflow and horizontal right or left applications
- 5-Year parts limited warranty



Part #	Mfg #	Dimensions H x W x D	Tons	Price
ICAMB08B	MB08B1500A	24" x 15-1/2" x 20"	1.5 to 2.0	CALL
ICAMB12F	MB12F1900A	24" x 19-1/8" x 20"	2.5 to 3.0	CALL
ICAMB16J	MB16J2200A	24" x 22-3/4" x 20"	3.5 to 4.0	CALL
ICAMB20L	MB20L	24" x 26-3/8" x 20"	5.0	CALL

Upflow/Horizontal Right or Left - MV Modular Variable-Speed Blower Cabinet

- Supports 2-stage outdoor units
- Dehumidification speed: 80% airflow
- Efficient low continuous fan selection: 50% airflow
- Downflow requires sub-base accessory
- Electronic fan control board
- Adjustable blower time delay
- Accepts accessory 2-stage outdoor thermostats
- Matches with AC & HP cased coils
- 208/230-1-60 Supply voltage
- Direct drive slide-out blower assembly
- Requires a "NO HEAT KIT" if installed without electric heat
- Internally lined with 1/2" Tuf-Skin II insulation
- Prepainted galvanized steel cabinet
- 5-Year limited parts warranty



Cooling

Part #	Mfg #	Size Tons	CFM Range Low	CFM Range High	Motor HP	Dimensions H x D x W	Ship Wt	Price
ICAMV08B	MV08B1500B	2.0	350	1200	1/2	24" x 15-1/2" x 20-1/2"	56 lbs	CALL
ICAMV12F	MV12F1900B	3.0	415	1400	1/2	24" x 19-1/8" x 20-1/2"	58 lbs	CALL
ICAMV16J	MV16J2200B	4.0	425	1600	3/4	24" x 22-3/4" x 20-1/2"	69 lbs	CALL
ICAMV20L	MV20L2400B	5.0	540	2000	3/4	24" x 24-1/2" x 20-1/2"	72 lbs	CALL

Electric Heater for MV & MF Series

Part #	Mfg #	Description	Used with	Price
ICAEHIA00KN10	EHIA00KN10	No Heat Kit	08, 12, 16, 20	CALL

Prices & Specifications are Subject to Change.

Commercial Cooling

Residential Package Air Conditioning Units

PAJ 13 SEER Single-Phase Package Air Conditioners - R-410A

- 5-Year parts limited warranty including compressor & coils
- 208/230V, 1-Phase, 60Hz
- Compact, fully self-contained, electric cooling unit with horizontal supply & return ducts
- Light weight - suitable for manufactured housing & residential applications
- Compressors have internal over current protection
- Liquid refrigerant filter driers
- Can be serviced from both the side & front
- Accessory electric heaters with single port connections
- Pre-painted steel cabinet
- No-rust base pan with integrated drain pan
- Direct-drive ECM multi-speed blower motor
- Vibration isolation & aerodynamic fan blade for quiet operation



Part #	Mfg #	Tons	Capacity BTUH	Dimensions H x W x D	Approx Ship Wt	Price
ICAPAJ324	PAJ324000K000A	2.0	22,800	30" x 51" x 32"	237 lbs	CALL
ICAPAJ330	PAJ330000K000A	2.5	28,400	30" x 51" x 32"	249 lbs	CALL
ICAPAJ336	PAJ336000K000A	3.0	34,800	30" x 51" x 32"	279 lbs	CALL

Efficient Three-Phase Commercial Air Conditioners - R-410A

- Copeland Scroll compressor
- Filter-drier supplied with every unit for field installation
- External high and low refrigerant service ports
- Copper tube/aluminum fin coil
- Easy access service valve
- Factory charged with R-410A refrigerant
- Baked-on powder coat finish over galvanized steel
- Post-painted (black) coil fins
- Coated, weather-resistant cabinet screws
- Coated inlet grille with 3/8" spacing (hail guard)
- 5-Year compressor limited warranty
- 1-Year coil and parts limited warranty



13 SEER - R-410A - 3-Phase - N4A3 Entry Level Air Conditioner with 3/8" Spacing Inlet Grille

- Coil guard grille

Part #	Mfg #	Size Tons	Nominal BTUH	Min Circuit Ampacity	Max Fuse or Breaker	Voltage	Dimensions H x W x D	Ship Wt	Price
ICCN4A336GH	N4A336GHB	3.0	36,000	14.5	20	208/230	31-13/16" x 25-3/4" x 25-3/4"	170 lbs	CALL
ICCN4A348GH	N4A348GHB	4.0	48,000	17.8	30	208/230	35-3/4" x 31-3/16" x 31-3/16"	215 lbs	CALL
ICCN4A360GH	N4A360GHC	5.0	60,000	21.4	30	208/230	28-15/16" x 31-3/16" x 31-3/16"	224 lbs	CALL

Commercial Cooling

Commercial Package Gas/Electric Units

PGD3 Series 13 SEER Commercial Gas/Electric Package Unit - R-410A

- Scroll compressor
- Copper tube/aluminum fin condenser and evaporator coils
- Installs easily on a rooftop or at ground level
- Easy 3-panel accessibility for maintenance and installation
- Easily converts to down discharge applications
- Combination gas heating and electric cooling
- Wire grille
- Induced-draft combustion and venting
- Direct spark ignition
- Pre-painted steel cabinet
- X-13 ECM Indoor blower motor
- Aluminized steel tubular heat exchanger
- Vertical condenser fan discharge
- Full perimeter steel base rails
- High and low pressure switches provide added reliability for the compressor
- 10-Year heat exchanger limited warranty
- 5-Year compressor limited warranty
- 1-Year parts limited warranty



PGD3 Series 13 SEER Commercial Gas/Electric Package Unit - R-410A Standard Model

Part #	Mfg #	Tons	Cooling BTUH	Heating BTUH	Electrical	Dimensions H x W x D	Operating Wt	Price
ICCPGD324060K	PGD324060K000C	2.0	23,000	60,000	208/230-1-60			CALL
ICCPGD330060K	PGD330060K000C	2.5	28,600	60,000	208/230-1-60	42" x 48-3/16" x 32-5/8"	309 lbs	CALL
ICCPGD336090H	PGD336090H000C	3.0	34,400	90,000	208/230-3-60	46" x 48-3/16" x 32-5/8"	319 lbs	CALL
ICCPGD336090K	PGD336090K000C	3.0	34,200	90,000	208/230-1-60	46" x 48-3/16" x 32-5/8"	319 lbs	CALL
ICCPGD348115K	PGD348115K000C	4.0	46,500	115,000	208/230-1-60	42" x 48-3/16" x 44-1/8"	419 lbs	CALL
ICCPGD348115L	PGD348115L000C	4.0	46,500	115,000	460-3-60	42" x 48-3/16" x 44-1/8"	419 lbs	CALL
ICCPGD348130H	PGD348130H000C	4.0	46,500	130,000	208/230-3-60	42" x 48-3/16" x 44-1/8"	419 lbs	CALL
ICCPGD360130K	PGD360130K000C	5.0	57,000	130,000	208/230-1-60	42" x 48-3/16" x 44-1/8"	441 lbs	CALL
ICCPGD360130H	PGD360130H000C	5.0	57,000	130,000	208/230-3-60	42" x 48-3/16" x 44-1/8"	441 lbs	CALL
ICCPGD360130L	PGD360130L000C	5.0	57,000	130,000	460-3-60	42" x 48-3/16" x 44-1/8"	441 lbs	CALL

Cooling

Ask about our Service Guarantee

Prices & Specifications are Subject to Change.

Commercial Cooling

RGS Series 13 SEER Package Gas Heating/Electric Cooling Rooftop Unit - R-410A

- 15-Year limited warranty on optional stainless steel heat exchanger
- 10-Year limited warranty on aluminized heat exchanger
- 5-Year compressor limited warranty
- 1-Year parts limited warranty
- Standard ASHRAE 90.1-2010 efficiency
- One-piece, high efficiency gas heating and electric cooling with a low profile
- Prewired, tested, and charged at the factory
- Field convertible from vertical to horizontal air flow
- Full perimeter base rail with built-in rigging adapters and fork truck slots
- Pre-painted exterior panels and primer-coated interior panels tested to 500 hours salt spray protection
- Fully insulated cabinet
- Tubular-section type aluminized heat exchanger standard
- Single-stage or two stage cooling capacity control
- Redundant gas valve, up to two stages of heating
- Exclusive IGC solid-state control for on-board diagnostics
- High efficiency, gas heat with induced draft flue exhaust design
- Scroll compressor with internal line-break overload protection
- High and low pressure switches
- 2" Disposable fiberglass type return air filters in dedicated rack
- Refrigerant circuits contain a liquid line filter drier
- Indoor and outdoor coils constructed of aluminum fins mechanically bonded to seamless copper tubes
- Newly-designed indoor refrigerant header for easier maintenance and replacement
- Exclusive non-corrosive composite condensate pan in accordance with ASHRAE 62 Standard, sloping design; side or center drain
- Belt drive evaporator-fan motor and pulley combinations
- Access panels with easy grip handles, "no-strip" screw system
- Outdoor temperature cooling operation range up to 115°F and down to 25°F using winter start kit
- Fixed orifice metering devices
- Single point gas and electrical connections



3 Ton - 6 Ton



7.5 Ton - 10 Ton



12.5 Ton - 15 Ton



RGS Series 13 SEER Package Gas Heating/Electric Cooling Rooftop Unit - R-410A 1-Stage

Part #	Mfg #	Tons	Cooling BTUH	Heating BTUH	Volts-Phase @60Hz	Dimensions H x W x D	Ship Wt	Price
ICCRGS072HFAA	RGS072HFAA0AAA	6.0	70,000	150,000	208/230-3	41-3/8" x 74-3/8" x 46-3/4"	652 lbs	CALL
ICCRGS072LFAA0AAA	RGS072LFAA0AAA	6.0	70,000	150,000	460-3	41-3/8" x 74-3/8" x 46-3/4"	652 lbs	CALL
ICCRGS091HFAA	RGS091HFAA0AAA	7.5	88,000	224,000	208/230-3	41-1/4" x 88-1/8" x 59-1/2"	780 lbs	CALL
ICCRGS101HFAA	RGS101HFAA0AAA	8.5	97,000	224,000	208/230-3	49-3/8" x 88-1/8" x 59-1/2"	920 lbs	CALL
ICCRGS121HFAA	RGS121HFAA0AAA	10.0	117,000	250,000	208/230-3	49-3/8" x 88-1/8" x 59-1/2"	930 lbs	CALL



www.irrsupply.com

Commercial Cooling

RGS Series Package 10.8-11.0 EER Gas Heating/Electric Cooling Rooftop Unit - R-410A 2-Stage

Part #	Mfg #	Tons	Cooling BTUH	Heating BTUH	Volts-Phase @60Hz	Dimensions H x W x D	Ship Wt	Price
ICCRGS090HFAA	RGS090HFAA0AAA	7.5	83,000	224,000	208/230-3	41-1/4" x 88-1/8" x 59-1/2"	835 lbs	CALL
ICCRGS120HFAA	RGS120HFAA0AAA	10.0	114,000	250,000	208/230-3	49-3/8" x 88-1/8" x 59-1/2"	940 lbs	CALL
ICCRGS180HFAA	RGS180HFAA0AAA	15.0	174,000	350,000	208/230-3	57-3/8" x 115-7/8" x 63-3/8"		CALL

RGS Series 13 SEER Package Gas Heating/Electric Cooling Rooftop Unit with Microchannel Coil - R-410A

- Aluminum/aluminum condenser; aluminum/copper evaporator coil
- 208/230V

Part #	Mfg #	Tons	Cooling BTUH	Heating Capacity	Dedicated Airflow	Dimensions H x W x D	Unit Wt	Price
ICCRGS150HFAA	RGS150HFAA0AGA	12.5	140,000	High(250,000)	--	49-3/8" x 88-1/8" x 59-1/2"	1167 lbs	CALL
ICCRGS181HFAA	RGS181HFAA0AGA	15.0	181,000	High	Vertical	49-3/8" x 127-7/8" x 86-5/8"	2160 lbs	CALL

Commercial Air Conditioning Package Units

RAS Series 13 SEER Electric Cooling Single Package Rooftop Units - R-410A

- One-piece, high efficiency electric cooling with a low profile, prewired, tested, and charged at the factory
- All units are convertible from downflow to horizontal air flow; no special adapter curbs are necessary
- Full perimeter base rail with built-in rigging adapters and fork truck slots; fully insulated cabinet
- Pre-painted exterior panels and primer-coated interior panels tested to 500 hours salt spray protection
- Single-stage or two stage cooling capacity control; all units have high and low pressure switches
- Single scroll or dual scroll compressor with internal line-break overload protection
- Two inch disposable fiberglass type return air filters in dedicated rack with tool-less filter access door
- Refrigerant circuits contain a liquid line filter drier to trap dirt and moisture
- Indoor and outdoor coils constructed of aluminum fins mechanically bonded to seamless copper tubes
- Newly-designed indoor refrigerant header for easier maintenance and replacement
- Exclusive non-corrosive composite condensate pan in accordance with ASHRAE 62 Standard, sloping design; side or center drain
- Belt drive evaporator-fan motor and pulley combinations available to meet any application
- Access panels with easy grip handles provide quick and easy access to the blower and blower motor, control box, and compressor
- "No-strip" screw system has superior holding power and guides screws into position while preventing the screw from stripping the unit's metal
- Newly designed terminal board facilitates simple safety circuit troubleshooting and simplified control box arrangement
- Outdoor temperature cooling operation range up to 115°F (46°C) and down to 25°F (-4°C) using winter start kit
- Fixed orifice metering devices on all models to precisely control refrigerant flow
- Large, laminated control wiring and power wiring drawings are affixed to unit to make troubleshooting easy
- Standard, medium and high static fan motor options available
- Provisions for thru-the-bottom power entry capability
- Single point electrical connections
- 5-Year compressor limited warranty
- 1-Year parts limited warranty



Cooling

Part #	Mfg #	Nom Tons	Capacity BTUH	Electrical	Dimensions H x W x D	Operating Wt	Price
ICCRAS048H0AA	RAS048H0AA0AAA	4.0	45,000	208/230-3-60	33-3/8" x 46-3/4" x 74-3/8"	494 lbs	CALL
ICCRAS060H0AA	RAS060H0AA0AAA	5.0	59,000	208/230-3-60	33-3/8" x 46-3/4" x 74-3/8"	524 lbs	CALL

Prices & Specifications are Subject to Change.

Commercial Cooling

RAS Series Electric Cooling Dual Stage Package Rooftop Unit - R-410A

- One-piece, high-efficiency electric cooling with a low profile, prewired, tested, and charged at the factory
- Dedicated vertical or horizontal air flow duct configuration
- Full perimeter base rail with built-in rigging adapters and fork truck slots
- Pre-painted exterior panels and primer-coated interior panels
- Fully insulated cabinet
- 2-Stage cooling with independent circuit and control
- Scroll compressors
- High and low pressure switches
- 2" Disposable fiberglass type return air filters in dedicated rack with tool-less filter access door
- Refrigerant circuits contain a liquid line filter drier to trap dirt and moisture
- Outdoor coils constructed of aluminum fin and tube microchannel design
- Newly-designed indoor refrigerant header for easier maintenance and replacement
- Exclusive non-corrosive composite condensate pan in accordance with ASHRAE 62 Standard, sloping design, end drain
- Belt drive evaporator-fan motor and pulley combinations available to meet most applications
- Access panels with easy grip handles
- No-strip screw system
- Newly-designed terminal board facilitates simple safe circuit troubleshooting and simplified control box arrangement
- Outdoor temperature cooling operation range: 30° to 115°F
- Fixed orifice metering device to control refrigerant flow
- Large, laminated control wiring and power wiring drawings affixed to unit to make troubleshooting easy
- Single point electrical connections
- ASHRAE 90.1 Compliant
- 5-Year compressor limited warranty
- 1-Year parts limited warranty



Cooling

Part #	Mfg #	Nom Tons	Capacity BTUH	Electrical	Dimensions H x W x D	Operating Wt	Price
ICCRAS090H0AA	RAS090H0AA0AAA	7.5	83,000	208/230-3-60	41-3/8" x 59-1/2" x 88-1/8"	760 lbs	CALL
ICCRAS120H0AA	RAS120H0AA0AAA	10.0	114,000	208/230-3-60	49-3/8" x 59-1/2" x 88-1/8"	865 lbs	CALL

We Value Your Opinion
Let us know what we are doing right, but more importantly let us know how we can serve you better.

Commercial Cooling

Commercial Packaged Air Handlers

FAS Series Direct Expansion Commercial Packaged Air Handlers

- Multiposition design for horizontal or vertical installation without modification
- (2) Sloped condensate pans on each unit for horizontal or vertical applications
- Cleanable insulation treated with EPA registered antimicrobial agent improved indoor air quality
- 2" Filters
- High static design meets a wide range of applications
- Powerful belt-driven forward curved fans
- Single refrigerant circuit on 072 & 091 sized, dual refrigerant circuit on 120 - 300 sizes
- Single blower on 072 - 120 sizes, dual blower on 150 - 300 sizes
- Cooling coils with mechanically bonded fins provide peak heat transfer
- Standard factory-installed thermo-static expansion valve (TXV) with removable power element
- Easy maintenance - removal of single panel allows access to virtually all components
- Die-formed galvanized steel casings provide durability and structural integrity, optional paint is available
- 24V Terminal block for control wiring connection
- Economizer accessory provides ventilation air and free cooling
- 1-Year parts limited warranty



Part #	Mfg #	Tons	No of Circuits	Dimensions H x W x D	Operating Wt	Price
ICCFAS091MA	FAS091MAAA0A0A	7.5	1	56-1/16" x 49" x 28-3/16"	404 lbs	CALL
ICCFAS120MA	FAS120MAAA0A0A	10.0	2	56-1/16" x 49" x 28-3/16"	425 lbs	CALL

Cooling

For instructions as to proper installation, servicing, and troubleshooting, please refer to the Manufacturer's literature.



www.irrsupply.com

ICP Commercial Accessories

Packaged Unit Accessories

Gas & Electric Packs Accessory

Part #	Mfg #	Description	Price
ICCAXB260CTA	AXB260CTA	Concentric Duct Transition Kit PGE 20 Ton	CALL
ICCCPECOMZR007	CPECOMZR007A00	Vertical Economizer, Use with PGD/PGS/PAD 24-36 & PHD 24/30	CALL
ICCCRRFCURB001	CRRFCURB001A01	14" Roof Curb, Use with 3 - 6 Ton Units	CALL
ICCCRRFCURB003	CRRFCURB003A01	14" High Roof Curb for RGS090 - 150	CALL
ICCCPRFCURB011	CPRFCURB011A00	14" High Roof Curb for PGD 24 - 60	CALL
ICCCPRFCURB013	CPRFCURB013A00	14" High Roof Curb for PGD 42 - 60	CALL
ICCCRRFCURB045	CRRFCURB045A00	14" High Roof Curb for RGS181-210	CALL
ICCCRRFCURB47A00	CRRFCURB047A00	14" Roof Curb for 20 Ton Units	CALL
ICCCRRFCURB074	CRRFCURB074	14" High Roof Curb for RGS180	CALL

Dedicated Vertical Economizer

- Internal with solid state controller
- Gear driven
- Fully modulating damper
- Spring return actuator
- Up to 50% barometric relief
- Supply and dry bulb outdoor air sensors
- Includes filter rack with 1" filters

Part #	Mfg #	Description	Price
ICCCPECOMZR008	CPECOMZR008A00	Dedicated Vertical Economizer for PGD 42 - 48	CALL
ICCCPECOMZR009	CPECOMZR009A00	Dedicated Vertical Economizer for PGD 60	CALL
ICCAXB078ENT	AXB078ENT	Outdoor Enthalpy Control for CPECOMZR & DNFECOMZR	CALL

EconoMi\$er IV Economizer

- Solid state controller
- Gear driven
- 3-Position modulating damper
- Spring return actuator
- Up to 100% barometric relief
- Supply and outdoor air sensors
- CO2 Sensor compatible

Part #	Mfg #	Description	Price
ICCDNECOMZR020	DNCOMZR020A02	Vertical EconoMi\$er IV with W7212 for RGS072	CALL
ICCDNECOMZR021	DNCOMZR021A03	Vertical EconoMi\$er IV with W7212 for RGS 090 - 150	CALL
ICCDNECOMZR025	DNCOMZR025A02	Horizontal EconoMi\$er IV with W7212 for RGS072	CALL
ICCDNECOMZR052	DNCOMZR052A00	Vertical EconoMi\$er IV with W7212 for RGS180 - 240	CALL
ICCDNECOMZR062	DNCOMZR062	Vertical EconoMi\$er IV 3 Position for RGS180	CALL

Cooling

All Items May Not Be Stocked In All Branches



www.irrsupply.com

Cooling Parts & Accessories

ICP Replacement Compressors

Part #	Mfg #	Description	Price
ICPZP16K5EPFV830	ZP16K5EPFV830	1-1/2 Ton R-410A Scroll Compressor for N4A318	CALL
ICPZP20K5EPFV830	ZP20K5EPFV830	Compressor for N4A324	CALL
ICPZR21K5PFV830	ZR21K5PFV-830	Copeland Scroll 21,000 BTU 208/230V Compressor	CALL
ICPZP24K5EPFV830	ZP24K5EPFV830	Compressor for N4A330	CALL
ICPZP29K5EPFV830	ZP29K5EPFV830	Compressor for N4A336	CALL
ICPZP36K5EPFV830	ZP36K5EPFV830	Compressor for N4A342	CALL
ICPZP39K5EPFV830	ZP39K5EPFV830	Compressor for N4A348	CALL
ICPZP51K5EPFV830	ZP51K5EPFV830	Compressor for N4A360	CALL
ICPZR16KAPFV830	ZR16KAPFV830	Scroll Compressor	CALL
ICPZR21KAPFV830	ZR21KAPFV830	Scroll Compressor	CALL
ICPZR22K4PFV830	ZR22K4PFV830	2 Ton 208/230V Scroll Compressor	CALL
ICPZR26KAPFV830	ZR26KAPFV830	Scroll Compressor	CALL
ICPZR28KAPFV830	ZR28KAPFV830	Scroll Compressor	CALL
ICPZR61K3PFV830	ZR61K3PFV830	Scroll Compressor	CALL
ICPZR61K3TF5830	1160984	5 Ton 3-Phase 230V Scroll Compressor ZR61K3-TF5-830	CALL

Visionary Baths & More Kitchen and Bath Design Centers

Professionally staffed to assist you and your customers with design and selection <http://www.visionarybaths.com>

Cooling

Prices & Specifications are Subject to Change.



www.irrsupply.com

Manufactured Housing Equipment

Condenser-AC QC 13 SEER MicroChannel[mc] Split-System Air Conditioners

- R-410A Environmentally friendly
- Compressor is internally protected against high pressure and temperature
- 10-Year limited warranty on the parts (with timely registration), otherwise 5-year/1-year labor



Part #	Mfg #	Cooling Tons	Refrigerant Sizes Liquid, Vapor	Dimensions H x W x D	Operating Wt	Price
COL14C41324	14C41324	2.0	3/8", 3/4"	28" x 24" x 24"	97	CALL
COL14C41330	14C41330	2.5	3/8", 3/4"	28" x 24" x 24"	129	CALL

Vexar® R-410A 13 SEER+ Uncased Evaporator A-Coil

- Compatible with 10/12 SEER A/C and H/P installations
- Designed to be "THE" high efficiency A-Coil choice to be installed on new and existing downflow MH furnaces
- Special drain pans available for up flow gas/oil applications
- Factory installed TXV valve suitable for A/C or H/P applications
- TXV For R22, but compatible with R410A with a simple TXV change
- Coil has built-in strainer for coil protection
- Leak tested to 500 p.s.i. Code approved 2-opening drain pan
- Dry-type pan does not maintain standing water
- Kit contains drain hose, fittings, and furnace cover plates for gas/oil furnaces
- Furnace compatibility:
Coleman, Evcon, Vexar, Red T, Mortex, Nordyne, Intertherm, and Miller brands
- UL Listed



Cooling

Part #	Mfg #	Nominal A/C Size	Nominal H/P Size	Dimensions	Connections	Price
COL1638Q4A	1830Q4A	1.5 to 2 Tons	1.5 Ton	14" x 18" x 19-5/8"	Quick Connect	CALL

All Items May Not Be Stocked In All Branches

Residential Cooling

Room Air Conditioner

Compact-Aire™ Room Air Conditioners

- Electronic controls with remote, auto restart
- One degree temperature adjustment
- Easy to access, slide-out, washable filter
- Four-way adjustable air direction



* Energy Star compliant



Part #	Mfg #	Cooling Capacity BTUH	Approx Sq Ft Cooling	EER	Ship Weight Lbs	Additional Features	Price
COMRADS51	RADS-51H *	5,200	100-150	10.7	44	24-hr On/Off Timer, Dehumidification Mode, with Remote	204.00
COMRADS61	RADS-61H *	6,000	150-250	10.7	46	24-hr On/Off Timer, Dehumidification Mode, with Remote	404.04
COMRADS81	RADS-81H *	8,000	350	9.8	54		265.00
COMRADS101	RADS-101H *	10,000	400-450	10.8	65	24-hr On/Off Timer, Dehumidification Mode, with Remote	715.26
COMRADS121	RADS-121H *	12,000	450-550	10.8	74	24-hr On/Off Timer, Dehumidification Mode, with Remote	757.12
COMRADS151	RADS-151H *	15,000	600-700	10.7	131	24-hr On/Off Timer, Dehumidification Mode, with Remote	991.90
COMRADS183	RADS-183H *	18,200/18,500	700-1000	10.7	131	24-hr On/Off Timer, Dehumidification Mode, with Remote	1093.82
COMRAD283	RAD-283H	28,000/28,500	1500-1600	8.5/8.5	151	24-hr On/Off Timer, Dehumidification Mode, with Remote	1841.84

Power-Aire™ Room Air Conditioners

- Electronic controls with full feature remote
- One degree temperature adjustment
- Energy saver mode, 12-hour on/off timer
- Easy to access, slide-out, washable filter
- Four-way adjustable air direction



* Energy Star compliant



Part #	Mfg #	Cooling Capacity BTUH	Approx Sq Ft Cooling	EER	Ship Weight Lbs	Additional Features	Price
COMRAD123	RAD-123A	11,500/12,000	650	9.8	87	230V	1048.32
COMRADS253	RADS-253A *	24,000/24,500	1400-1500	9.4	162	208/230V	1310.40

Power-Aire™ Builder Series Room Air Conditioners

- Protective rear grille; fits existing wall sleeves
- Electronic controls with full feature remote
- Energy saver mode, 12-hour on/off timer, auto restart
- Four-way adjustable air direction



* Energy Star compliant



Part #	Mfg #	Cooling Capacity BTU/Hr	Approx Sq ft Cooling	EER	Ship Weight Lbs	Electric Volts	Price
COMBG81	BG-81G *	8,000	350	9.6	79	115V	873.60
COMBG101	BG-101G *	9,800	490	8.8	84	115V	957.32
COMBG123	BG-123G *	11,200/11,500	650	9.4	87	230V	999.18

Air Conditioner Accessories

Part #	Mfg #	Description	Price
COMEA448	EA-448F	Wall Sleeve Kit Builders Series Thru-the-Wall	174.72

Prices & Specifications are Subject to Change.

Cooling

Residential Cooling

Comfort-Aire® Casement Series Room Air Conditioners

- For horizontal sliding or casement windows
- Fits openings 21" to 42" high, starting at 15-1/2" wide
- Electronic controls with remote
- Energy saver mode, 12-hour on/off timer, auto restart
- Six-way adjustable air direction



* Energy Star compliant



Part #	Mfg #	Cooling Capacity BTU/Hr	Approx Sq ft Cooling	EER	Ship Weight Lbs	Electric Volts	Price
COMCD101	CD-101G *	10,000	400-450	9.5	97	115V	813.54
COMCD121	CD-121G *	12,000	450-550	9.5	99	115V	831.74

Portable Cooling

Portable-Aire™ Series Portable Cooling w/Dehumidification

- Cools without the need for ductwork, special wiring or other installation
- Ideal for situations where a window isn't available or can't handle a room A/C unit, or where temporary cooling is needed
- Unit has auto, cool, dehumidify and air circulation modes
- Programmable wireless remote control shows the same display as the unit's LCD
- Dual 71" long flexible hoses for A/C mode included
- Dimensions: 33-7/8"H x 19-11/16"W x 18-1/2"D



Part #	Mfg #	Cooling Capacity BTUH	Approx Sq ft Cooling	Refrigerant Type	EER	Ship Weight	Price
COMPD121	PD-121B	12,000	550	R-410A	8.7	92.5 lbs	984.62
COMPS91	PS-91B	9,000	400	R-410A	8.9	75.0 lbs	879.06

Cooling

Dehumidifiers

Comfort-Aire® Dehumidifier

- Condensed water can be drained into removable container or drained directly using included adapter
- When the drain container is full, unit shuts off, beeps three times and displays "full" light
- Auto restart after a power outage
- Slide out filter
- R-410A
- BHD-501 & BHD-651 Are Energy Star compliant



BHD-301



BHD-501/651

Part #	Mfg #	Capacity (pts. / day)	Electric Volts	Low Temp Operation	Ship Wt Lbs	Controls	Price
COMBHD301	BHD-301-G	30	115V	Yes	52.2	Electro-Mechanical	360.36
COMBHD501	BHD-501-G	50	115V	Yes	49	Electronic Touchpad	453.18
COMBHD651	BHD-651-G	65	115V	Yes	46.5	Electronic Touchpad	516.88

All Items May Not Be Stocked In All Branches

Residential Cooling

Air Handlers

- Modular indoor air handler & duct system for mini-duct high-velocity systems

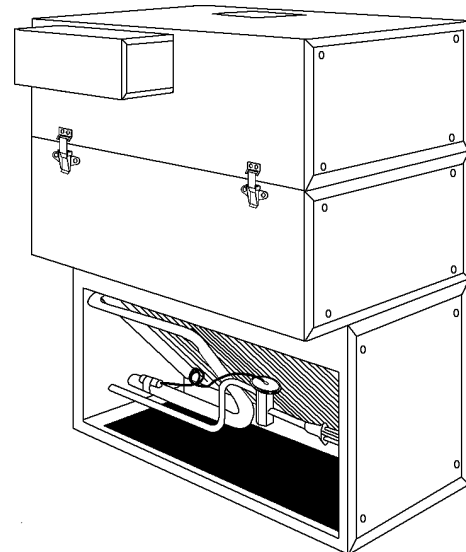
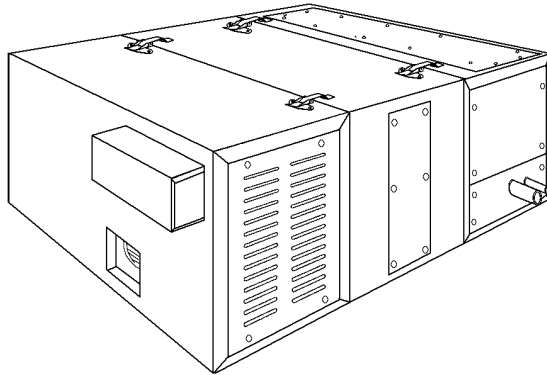

Air Handler Fan Coil Module

- 1 - 1-1/2 Ton fan coil unit

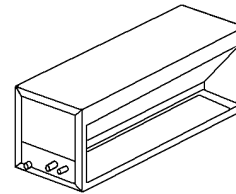

Part #	Mfg #	Description	Price
UNIM1218ACX	M1218+ACX	With A/C Coil R-410A	CALL
UNI1218L1EC2BX	U1218L-1EC2BX	220V FCU EC Mtr w/R410A A/C Coil	CALL

Air Handler Blower Module

- 208/230-1-60

Includes:

- Control box
- Plenum adapter



MB2430L

Part #	Mfg #	Motor @ 1.5"		Ton	Description	Price
		HP	RPM			
UNIMB2430L	MB2430L	1/2	1700	2 - 2.5 Ton		CALL
UNIMB2430LCB	MB2430L+CB	1/2	1700	2 - 2.5 Ton	w/ACB Control	CALL
UNIM2430BL1EC2	M2430BL1-EC2	1/2	1700	2 - 2.5 Ton	w/220V EC Motor & Smart Control	CALL
UNIMB3642L	MB3642L	1	1700	3 - 3.5 Ton		CALL
UNIMB3642LCB	MB3642L+CB	1	1700	3 - 3.5 Ton	w/ACB Control	CALL
UNIM3642BL1EC2	M3642BL1-EC2	1	1700	3 - 3.5 Ton	w/220V EC Motor & Smart Control	CALL
UNIMB4860L	MB4860L	1	1700	4 - 5 Ton		CALL
UNIMB4860LCB	MB4860L+CB	1	1700	4 - 5 Ton	w/ACB Control	CALL
UNIM4860BL1EC2	M4860BL1-EC2	1	1700	4 - 5 Ton	w/220V EC Motor & Smart Control	CALL

Prices & Specifications are Subject to Change.

Cooling

Residential Cooling

Air Handler Heating or Cooling Module

- Without coil



MH3660

Part #	Mfg #	Description	Price
UNIMH2430	MH2430	Heating Module	CALL
UNIMH3660	MH3660	Heating Module	CALL

Hot Water Coil



Part #	Mfg #	Description	Price
UNIHW2430	HW2430	2 to 2-1/2 Ton	CALL
UNIHW3660	HW3660	3 to 5 Ton	CALL

Plenum Module

Part #	Mfg #	Description	Price
UNIMV2430	MV2430	2 - 2.5 Ton Vertical	CALL
UNIMV3642	MV3642	3 - 3.5 Ton Vertical	CALL
UNIMV4860	MV4860	4 - 5 Ton Vertical	CALL

Refrigerant Cooling Module

Includes:

- R-22 Refrigerant coil
- Expansion valve

Cooling Only



Part #	Mfg #	Tons	--Conn--		Description	Price
			Inlet OD	Outlet OD		
UNIMC2430CX	MC2430CX	2 - 2-1/2	3/8"	7/8"	w/R-410A Coil	CALL
UNIMC3642CX	MC3642CX	3 - 3-1/2	3/8"	7/8"	w/R-410A Coil	CALL
UNIMC4860CX	MC4860CX	4 - 5	3/8"	7/8"	w/R-410A Coil	CALL

All Items May Not Be Stocked In All Branches

Residential Cooling

Return Air Parts

Return Air Box

Part #	Mfg #	Used on	Diameter	Price
UNIUPC011218	UPC011218	1218	12"	258.12

Return Air Grille

Part #	Mfg #	Size	Price
UNIUPC012430	UPC-01-2430	14" x 25"	278.30
UNIUPC013642	UPC-01-3642	14" x 30"	321.56
UNIUPC014860	UPC-01-4860	24" x 30"	455.68

Return Air Duct

- Tough aluminized outer mylar wrap
- Spun-bonded nylon and helical wire core
- 10' Lengths
- 1' Fiberglass insulation, R-4

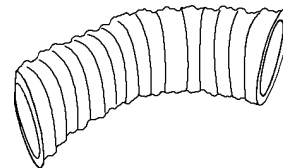

Part #	Mfg #	Used on	Duct Dia	Price
UNIUPC041218	UPC-04-1218	1218	12"	167.28
UNIUPC042430	UPC-04-2430	2430	14"	219.18
UNIUPC043642	UPC-04-3642	3642	18"	324.46
UNIUPC044860	UPC-04-4860	4860	20"	337.42

Return Air Transition

Includes:

- Outer insulation blanket

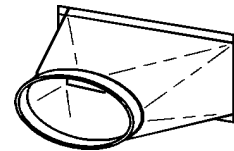

Part #	Mfg #	Used on	Duct Dia	Price
UNIUPC592430	UPC-59-2430	2430	14"	129.78
UNIUPC593642	UPC-59-3642	3642	18"	149.96
UNIUPC594860	UPC-59-4860	4860	20"	167.28

Return Air Adapter

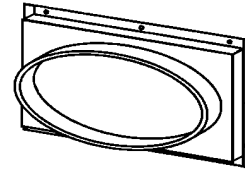

Part #	Mfg #	Used on	Duct Dia	Price
UNIUPC1042430	UPC-104-2430	2430	18"	222.06
UNIUPC1043642	UPC-104-3642	3642	18"	272.54
UNIUPC1044860	UPC-104-4860	4860	20"	272.54

Metal Tee w/Turning Vane

- Galvanized

Part #	Mfg #	Size	Price
UNIUPC19V9-7-7	UPC-19V-9X7X7	9" x 7" x 7"	86.52
UNIUPC19V10-9-9	UPC-19V-10X9X9	10" x 9" x 9"	103.82

Cooling

Residential Cooling

Supply Air Parts
Outlet Kit (1 Outlet)

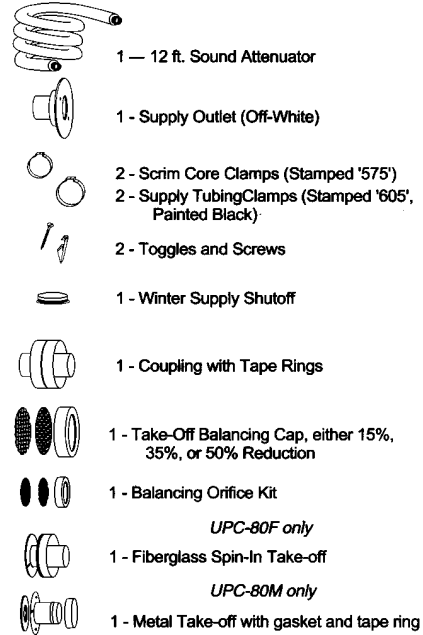

Part #	Mfg #	Description	Price
UNIUPC80F	UPC-80F-1	Fiberglass Plenum	148.52
UNIUPC80M	UPC-80M-1	Metal Plenum	148.52
UNIUPC80MR6	UPC-80MR6-1	Complete Metal Kit R-6 Insulation	197.56

Installation Kit (6 Outlets)

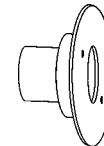

Part #	Mfg #	Description	Price
UNIUPC89F6	UPC-89F-6	Fiberglass Plenum	343.20
UNIUPC89M6	UPC-89M-6	Metal Plenum	343.20

Round Plenum Adapter

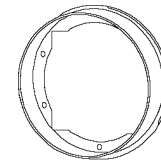

Part #	Mfg #	Description	Price
UNIUPC612430	UPC-61-2430	7" ID Round	54.80
UNIUPC611218	UPC-61-1218	9" ID Round	46.14
UNIUPC613642	UPC-61-3642	9" ID Round	59.12
UNIUPC614860	UPC-61-4860	10" ID Round	64.90

Cooling

Residential Cooling

Sound Attenuator

- Tough aluminized mylar outer wrap
- Spun-bonded nylon & helical wire core
- Fully insulated
- 12' Lengths, 2" ID

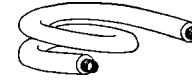

Part #	Mfg #	Description	Price
UNIUPC26C	UPC-26C-5	R-4	71.86
UNIUPC26CR6	UPC-26CR6-6	2.0" ID x 12' R6.0	118.24

Supply Tubing

- Tough aluminized mylar outer wrap
- Two-ply aluminum core
- 25' Lengths, 2" ID

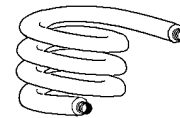

Part #	Mfg #	Description	Price
UNIUPC25	UPC-25-R4	R4.2, 4.0" OD x 25'	143.14
UNIUPC25R6	UPC-25-R6-4	R6.0, 2" ID x 25'	245.14

Heating Adapter

Part #	Mfg #	Description	Price
UNIUPC1041218	UPC-104-1218	Heating Adapter, 1218	129.78

For Square Plenum Installations

Fiberglass Straight Duct

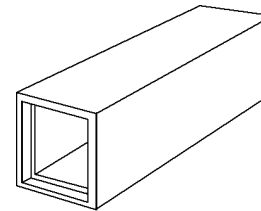

Part #	Mfg #	Size	Price
UNIUPC12065S6	UPC-12-065S6-4	6.5"	117.52

90° Square Elbow

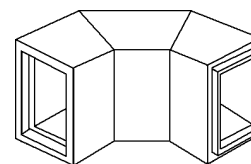

Part #	Mfg #	Description	Price
UNIUPC18065S	UPC-18B-4	6.5" x 6.5" x 1" Thick Fiberglass Ductwork	70.66

Cooling

Residential Cooling

Plenum Adapter

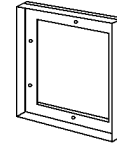

Part #	Mfg #	Description	Price
UNIUPC62	UPC-62	8.25" x 8.25" Square	36.06

Unico Accessories

Secondary Drain Pan

- 3/4" Female PVC socket connection

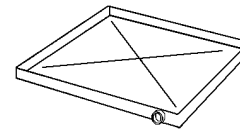

Part #	Mfg #	Used On	No. Of Modules	Price
UNIUPC94	UPC-94	1218	N/A	144.20
UNIUPC20B	UPC-20B	2436	2	144.20
UNIUPC20C	UPC-20C	2436	3	155.74
UNIUPC24B	UPC-24B	4260	2	165.84
UNIUPC24C	UPC-24C	4260	3	175.92
UNIUPC24D	UPC-24D	4860	3	194.68

Metal Takeoff Package

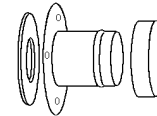

Part #	Mfg #	Description	Price
UNIUPC28	UPC-28	Includes Tape Ring & Gasket	30.28

Takeoff Balancing Orifice Package



Part #	Mfg #	Description	Price
UNIUPC35	UPC-35-15	Package Includes 15-15% Reduction Caps, 5-35% Red Perf Disks, and 5-50% Red Perf Disks	76.42

Supply Duct Coupling

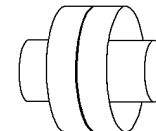

Part #	Mfg #	Description	Price
UNIUPC38C	UPC-38C-10	Includes Supply Tubing Clamps & Tape Rings	13.26

All Items May Not Be Stocked In All Branches

Residential Cooling

Winter Shutoff Cap



Part #	Mfg #	Description	Price
UNIUPC42	UPC-42-20	2" Winter Shutoff Cap	2.10

Outlet Deflector

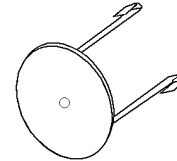

Part #	Mfg #	Description	Price
UNIUPC45	UPC-45-5	Outlet Deflector	16.72

Outlet Hardware Package

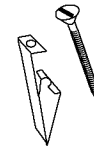

Part #	Mfg #	Description	Price
UNIUPC51	UPC-51	Hardware Pkg	23.08

Supply Tubing Clamp

- For aluminum core
- 50 Pack

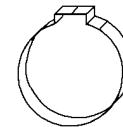

Part #	Mfg #	Description	Price
UNIUPC52	UPC-52-50	Black, Stamped 605	1.48

Scrim Core Clamp

- For sound attenuator core

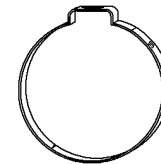

Part #	Mfg #	Description	Price
UNIUPC53	UPC-53-50	Stamped 575 (50)	1.48

Clamp Plier



Part #	Mfg #	Description	Price
UNIUPC54	UPC-54	Clamp Pliers	86.52

Cooling

Residential Cooling

Supply Outlet Terminator

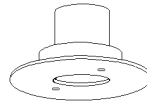

UPC-56B

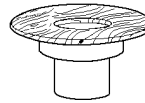

UPC-57

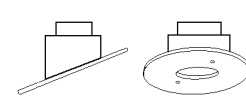

UPC-58-1-15

Part #	Mfg #	Description	Price
UNIUPC56B	UPC-56B	Off-White w/Toggles & Screws	21.64
UNIUPC57	UPC-57	Unfinished Oak w/Screen	57.68
UNIUPC58125	UPC-58-1-25	25° White Angled with Toggles & Screws	34.60

Slotted Outlet

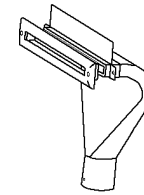

Part #	Mfg #	Description	Price
UNIUPC66	UPC-66	90° Slotted Outlet	164.38
UNIUPC67A	UPC-67A	90° Slotted Outlet	98.06

Plaster Frame Kit

- For new construction
- Includes:
 - (2) Left hanger bars
 - (2) Right hanger bars
 - (1) Plaster frame

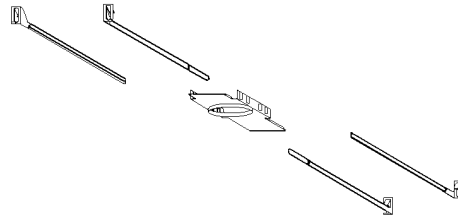

Part #	Mfg #	Description	Price
UNIUPC86	UPC-86-5	For Locating Outlet Prior to Sheet Rock	33.74

Cooling

Refer to the Branch listings in the front of this book to find the Irr Supply Center location nearest you!

Residential Heating

97% QuietComfort® VC97 Modulating, Variable-Speed Gas Furnaces

- Direct vent (2 pipe), single-pipe venting or ventilated combustion air
- Factory shipped for natural gas with propane gas conversion kits available
- Four position - upflow/downflow/horizontal (left/right) installation
- Twelve or more venting configurations
- Xtra SEER variable speed ECM blower motor
- Variable-speed induced draft combustion blower
- Modulating heating operation (40% - 100%)
- Supports two-stage cooling units
- Slide out heat exchanger assembly and blower assembly
- Flame roll-out sensors standard
- Adjustable timed blower heating off delay
- Insulated, 1-piece steel cabinet for noise reduction
- 24VAC Humidifier terminal
- Electronic air cleaner terminal
- Dehumidification feature in cooling
- RPJ Stainless steel primary heat exchanger
- Stainless steel secondary heat exchanger
- High temperature limit control
- Direct ignition with silicon nitride ignition
- Factory set blower on delay
- Simple troubleshooting of gas valve
- Self-configuring and communicating control
- California NOx approved
- Limited lifetime warranty on heat exchanger with timely registration
- 10-Year No-Hassle replacement limited warranty
- 5-Year limited parts warranty (additional 5-years with timely registration)



97% - Upflow/Downflow/Horizontal Multi-Position - Modulating - G9MAC Furnace

Part #	Mfg #	Cooling Capacity @ 1/2" in WC	Input BTUH	Efficiency AFUE	Dimensions H x W x D	Operating Wt	Price
HEHG9MAC0601714	G9MAC0601714	510-1335 CFM	60,000	97.0%	35" x 17-1/2" x 29-1/2"	154 lbs	CALL
HEHG9MAC0801714	G9MAC0801714	490-1375 CFM	80,000	97.0%	35" x 17-1/2" x 29-1/2"	164 lbs	CALL
HEHG9MAC1002120	G9MAC1002120	710-2030 CFM	100,000	97.0%	35" x 21" x 29-1/2"	179 lbs	CALL
HEHG9MAC1202422	G9MAC1202422	680-2185 CFM	120,000	97.0%	35" x 24-1/2" x 29-1/2"	203 lbs	CALL

Heating

Prices & Specifications are Subject to Change.

Residential Heating

96% QuietComfort® VT96 Two-Stage Variable-Speed Gas Furnaces

- Direct vent (2 pipe), single-pipe venting or ventilated combustion air
- Factory shipped for natural gas with propane gas conversion kits available
- Four position - upflow/downflow/horizontal (left/right) installation
- Twelve or more venting configurations
- Xtra SEER variable speed ECM blower motor
- Two-speed induced draft combustion blower
- Two-stage heating operation
- Supports two-stage cooling units
- Slide out heat exchanger assembly and blower assembly
- Flame roll-out sensors standard
- Adjustable timed blower heating off delay
- Fully insulated, 1-piece steel cabinet for noise reduction
- 24VAC Humidifier terminal
- Electronic air cleaner terminal
- Dehumidification feature in cooling
- RPJ Stainless steel primary heat exchanger
- Stainless steel secondary heat exchanger
- High temperature limit control
- Direct ignition with silicon nitride ignition
- Factory set blower on delay
- California NOx approved
- Limited lifetime warranty on heat exchanger with timely registration
- 10-Year No-Hassle replacement limited warranty
- 5-Year limited parts warranty (additional 5-years with timely registration)



96% - Upflow/Downflow/Horizontal Multi-Position - 2-Stage - G9MVT Furnace

Part #	Mfg #	Cooling Capacity @ 1/2" in WC	Input BTUH	Efficiency AFUE	Dimensions H x W x D	Operating Wt	Price
HEHG9MVT0401410	G9MVT0401410	440-905 CFM	40,000	96.0%	35" x 14-3/16" x 29-1/2"	121 lbs	CALL
HEHG9MVT0601714	G9MVT0601714	435-1475 CFM	60,000	96.0%	35" x 17-1/2" x 29-1/2"	141 lbs	CALL
HEHG9MVT0801716	G9MVT0801716	555-1610 CFM	80,000	96.0%	35" x 17-1/2" x 29-1/2"	152 lbs	CALL
HEHG9MVT1002116	G9MVT1002116	480-1805 CFM	100,000	96.0%	35" x 21" x 29-1/2"	166 lbs	CALL
HEHG9MVT1202422	G9MVT1202422	480-2115 CFM	120,000	96.0%	35" x 24-1/2" x 29-1/2"	190 lbs	CALL

Residential Heating

96% QuietComfort® IIX96 Two-Stage ECM Gas Furnaces

- Direct vent (2 pipe), single-pipe venting or ventilated combustion air
- Factory shipped for natural gas with propane gas conversion kits available
- Four position - upflow/downflow/horizontal (left/right) installation
- Twelve or more venting configurations
- Xtra SEER ECM blower motor
- Two-speed induced draft combustion blower
- Two-stage heating operation
- Supports two-stage cooling units
- Slide out heat exchanger assembly and blower assembly
- Flame roll-out sensors standard
- Adjustable timed blower heating off delay
- Fully insulated, 1-piece steel cabinet for noise reduction
- 24VAC Humidifier terminal
- Dehumidification feature in cooling
- Stainless steel secondary heat exchanger
- High temperature limit control
- Direct ignition with silicon nitride ignition
- Factory set blower on delay
- Self diagnostics with LED
- California NOx approved
- Limited lifetime warranty on heat exchanger with timely registration
- 5-Year No-Hassle replacement limited warranty
- 5-Year limited parts warranty (additional 5-years with timely registration)



96% - Upflow/Downflow/Horizontal Multi-Position - 2-Stage - G9MXT Furnace

Part #	Mfg #	Cooling Capacity @ 1/2" in WC	Input BTUH	Efficiency AFUE	Dimensions H x W x D	Operating Wt	Price
HEHG9MXT0401410	G9MXT0401410	385-925 CFM	40,000	96.0%	35" x 14-3/16" x 29-1/2"	125 lbs	CALL
HEHG9MXT0601714	G9MXT0601714	530-1505 CFM	60,000	96.0%	35" x 17-1/2" x 29-1/2"	146 lbs	CALL
HEHG9MXT0801716	G9MXT0801716	920-1610 CFM	80,000	96.0%	35" x 17-1/2" x 29-1/2"	156 lbs	CALL
HEHG9MXT1002116	G9MXT1002116	1155-1720 CFM	100,000	96.0%	35" x 21" x 29-1/2"	170 lbs	CALL
HEHG9MXT1202422	G9MXT1202422	1215-2055 CFM	120,000	96.0%	35" x 24-1/2" x 29-1/2"	195 lbs	CALL

Heating

Residential Heating

96% QuietComfort® DLX96 Single-Stage ECM Gas Furnaces

- Direct vent (2 pipe), single-pipe venting or ventilated combustion air
- Factory shipped for natural gas with propane gas conversion kits available
- Four position - upflow/downflow/horizontal (left/right) installation
- Twelve or more venting configurations
- Xtra SEER ECM blower motor
- Supports two-stage cooling units
- Slide out heat exchanger assembly and blower assembly
- Flame roll-out sensors standard
- Adjustable timed blower heating off delay
- Fully insulated, 1-piece steel cabinet for noise reduction
- 24VAC Humidifier terminal
- Electronic air cleaner terminal
- Dehumidification feature in cooling
- Stainless steel secondary heat exchanger
- High temperature limit control
- Direct ignition with silicon nitride ignition
- Factory set blower on delay
- Self diagnostics with LED
- California NOx approved
- Limited lifetime warranty on heat exchanger with timely registration
- 1-Year No-Hassle replacement limited warranty
- 5-Year limited parts warranty (additional 5-years with timely registration)



96% - Upflow/Downflow/Horizontal Multi-Position - Single-Stage - G9MXE Furnace

Part #	Mfg #	Cooling Capacity @ 1/2" in WC	Input BTUH	Efficiency AFUE	Dimensions H x W x D	Operating Wt	Price
HEHG9MXE0401410	G9MXE0401410	385-925 CFM	40,000	96.0%	35" x 14-3/16" x 29-1/2"	120 lbs	CALL
HEHG9MXE0601714	G9MXE0601714	530-1505 CFM	60,000	96.0%	35" x 17-1/2" x 29-1/2"	141 lbs	CALL
HEHG9MXE0801716	G9MXE0801716	920-1610 CFM	80,000	96.0%	35" x 17-1/2" x 29-1/2"	151 lbs	CALL
HEHG9MXE1002116	G9MXE1002116	1155-1720 CFM	100,000	96.0%	35" x 21" x 29-1/2"	166 lbs	CALL
HEHG9MXE1202422	G9MXE1202422	1215-2055 CFM	120,000	96.0%	35" x 24-1/2" x 29-1/2"	190 lbs	CALL

Product descriptions and specifications in this catalog are condensed from manufacturer's literature. For exact information, consult manufacturer's literature prior to installation and service. Contact us if you are not sure about specifications.

Residential Heating

95.5% AFUE Multi-Position Single-Stage PSC Gas Furnace

- Flame roll-out sensors standard
- Adjustable heating blower off delay
- Factory set blower on delay
- RPJ Aluminized steel primary heat exchanger
- Stainless steel secondary heat exchanger
- High temperature limit control prevents overheating
- Direct ignition with silicon nitride ignitor
- High quality, corrosion-resistant, prepainted steel cabinet
- Direct vent (2-pipe), single-pipe venting or ventilated combustion air
- 24 VAC Humidifier terminal and electronic air cleaner terminal
- 35" High
- Simplified, factory installed internal condensate drain system
- Innovative knobs for easy door removal and secure attachment
- Factory shipped for natural gas, with propane gas conversion kits available
- Four position - upflow/downflow/horizontal (left/right) installation
- At least twelve different venting configurations
- Through the casing flue pipe for counterflow or horizontal applications with accessory
- Concentric vent available
- Self diagnostics with super bright LED
- Slide out heat exchanger and blower assembly
- 20-Year heat exchanger limited warranty
- 5-Year parts limited warranty with an additional 5-year parts limited warranty with timely registration



Part #	Mfg #	Cooling Capacity @ 1/2" in WC	Input BTUH	Efficiency AFUE	Dimensions H x W x D	Operating Wt	Price
HEHN9MSE0401410	N9MSE0401410A	625-905 CFM	40,000	95.5%	35" x 14-3/16" x 29-1/2"	123 lbs	CALL
HEHN9MSE0601410	N9MSE0601410A	675-1,130 CFM	60,000	95.5%	35" x 14-3/16" x 29-1/2"	127 lbs	CALL
HEHN9MSE0801716	N9MSE0801716A	810-1,600 CFM	80,000	95.5%	35" x 17-1/2" x 29-1/2"	154 lbs	CALL
HEHN9MSE1002114	N9MSE1002114A	695-1,565 CFM	100,000	95.5%	35" x 21" x 29-1/2"	169 lbs	CALL
HEHN9MSE1002120	N9MSE1002120A	1,225-2,145 CFM	100,000	95.5%	35" x 21" x 29-1/2"	169 lbs	CALL
HEHN9MSE1202420	N9MSE1202420A	1,254-2,065 CFM	120,000	95.5%	35" x 24-1/2" x 29-1/2"	186 lbs	CALL
HEHN9MSE1402420	N9MSE1402420A	1,230-2,100 CFM	140,000	95.5%	35" x 24-1/2" x 29-1/2"	190 lbs	CALL

Heating

Prices & Specifications are Subject to Change.

Residential Heating

92.1% AFUE Multi-Position Single-Stage PSC Gas Furnace

- Flame roll-out sensors standard
- Adjustable heating blower off delay
- Factory set blower on delay
- RPJ Aluminized steel primary heat exchanger
- Stainless steel secondary heat exchanger
- High temperature limit control prevents overheating
- Direct ignition with silicon nitride ignitor
- High quality, corrosion-resistant, prepainted steel cabinet
- Direct vent (2-pipe), single-pipe venting or ventilated combustion air
- 24 VAC Humidifier terminal and electronic air cleaner terminal
- 35" High
- Simplified, factory installed internal condensate drain system
- Innovative knobs for easy door removal and secure attachment
- Factory shipped for natural gas, with propane gas conversion kits available
- Four position - upflow/downflow/horizontal (left/right) installation
- At least twelve different venting configurations
- Through the casing flue pipe for counterflow or horizontal applications with accessory
- Concentric vent available
- Self diagnostics with super bright LED
- Slide out heat exchanger and blower assembly
- 20-Year heat exchanger limited warranty
- 5-Year parts limited warranty with an additional 5-year parts limited warranty with timely registration



Part #	Mfg #	Cooling Capacity @ 1/2" in WC	Input BTUH	Efficiency AFUE	Dimensions H x W x D	Operating Wt	Price
HEHN9MSB0401410	N9MSB0401410A	625-905 CFM	40,000	92.1	35" x 14-3/16" x 29-1/2"	123 lbs	CALL
HEHN9MSB0601410	N9MSB0601410A	675-1,130 CFM	60,000	92.1	35" x 14-3/16" x 29-1/2"	127 lbs	CALL
HEHN9MSB0801716	N9MSB0801716A	810-1,600 CFM	80,000	92.1	35" x 17-1/2" x 29-1/2"	154 lbs	CALL
HEHN9MSB1002114	N9MSB1002114A	695-1,565 CFM	100,000	92.1	35" x 21" x 29-1/2"	169 lbs	CALL
HEHN9MSB1002120	N9MSB1002120A	1,225-2,145 CFM	100,000	92.1	35" x 21" x 29-1/2"	169 lbs	CALL

Heating

For instructions as to proper installation, servicing, and troubleshooting, please refer to the Manufacturer's literature.

Residential Heating

80% AFUE Two-Stage Heating Gas Furnaces

- Supports two-stage cooling units
- Flame roll-out sensors
- Category I venting & blocked vent switch
- Electronic air cleaner terminal & 24 VAC Humidifier terminal
- Twinning furnaces of same heating and cooling sizes
- PSC Blower motor
- Factory set blower ON delay and adjustable heating blower OFF delay
- RPJ Aluminized steel heat exchanger
- High temperature limit control prevents overheating
- Direct ignition with silicone nitride ignitor
- One-piece prepainted steel cabinet
- Two-stage operation
- Two-stage induced draft blower
- In-shot burners
- 4-Position - upflow/downflow/horizontal (left/right) installation
- 3-Position inducer elbow capacity
- Through the casing flue pipe for counterflow applications
- Common venting with other Category I appliances
- Self-diagnostics
- Slide out blower assembly
- 115-1-60
- 5-Year No Hassle Replacement™ limited warranty
- 20-Year heat exchanger limited warranty with timely registration
- 5-Year parts limited warranty (additional 5-year warranty with timely registration)



Part #	Mfg #	Gas Type	Heating Input	CFM @.5" wc	Dimensions H x W x D	Approx Ship Wt	Price
HEHG8MTL0451412	G8MTL0451412	NG	44,000	1,200	33-1/3" x 14-3/16" x 29"	107 lbs	CALL
HEHG8MTL0701412	G8MTL0701412	NG	66,000	1,200	33-1/3" x 14-3/16" x 29"	115 lbs	CALL
HEHG8MTL0901714	G8MTL0901714	NG	88,000	1,400	33-1/3" x 17-1/2" x 29"	127 lbs	CALL
HEHG8MTL1102122	G8MTL1102122	NG	110,000	2,200	33-1/3" x 21" x 29"	152 lbs	CALL
HEHG8MTL1352422	G8MTL1352422	NG	132,000	2,200	33-1/3" x 24-1/2" x 29"	163 lbs	CALL

Irr Supply is your one stop shop for all your Plumbing, HVAC, Refrigeration, and Electrical needs. Why go anywhere else!

Heating

Residential Heating

80% AFUE Single-Stage Heating Gas Furnaces

- Flame roll-out sensors
- Category I venting & blocked vent switch
- 24 VAC and 115 VAC Humidifier terminal
- Electronic air cleaner terminal
- Twinning furnaces of same heating and cooling sizes
- PSC Blower motor
- Factory set blower on delay and adjustable heating blower off delay
- RPJ Aluminized steel heat exchanger
- High temperature limit control prevents overheating
- Direct ignition with silicone nitride ignitor
- One-piece prepainted steel cabinet
- In-shot burners
- 4-Position - upflow/downflow/horizontal (left/right) installation
- 3-Position inducer elbow capacity
- Through the casing flue pipe for counterflow applications
- Common venting with other Category I appliances
- Self-diagnostics
- Slide out blower assembly
- 115-1-60
- 20-Year heat exchanger limited warranty
- 5-Year parts limited warranty (additional 5-year warranty with timely registration)



Part #	Mfg #	Gas Type	Heating Input	CFM @.5" wc	Dimensions H x W x D	Approx Ship Wt	Price
HEHN8MSN0451412	N8MSN0451412A	NG	44,000	1040 - 1145	33-1/3" x 14-3/16" x 29"	107 lbs	CALL
HEHN8MSN0701412	N8MSN0701412A	NG	66,000	1050 - 1200	33-1/3" x 14-3/16" x 29"	115 lbs	CALL
HEHN8MSN0901714	N8MSN0901714A	NG	88,000	1065 - 1385	33-1/3" x 17-1/2" x 29"	127 lbs	CALL
HEHN8MSN1102122	N8MSN1102122A	NG	110,000	1720 - 2265	33-1/3" x 21" x 29"	152 lbs	CALL
HEHN8MSN1352422	N8MSN1352422A	NG	132,000	1715 - 2195	33-1/3" x 24-1/2" x 29"	163 lbs	CALL

Residential Heating

Oil Furnaces

OLF Front Flue Lo-Boy Oil Furnace

- Fan control switch
- Accessory terminals
- Large external front cleanout
- Clean out sealed from blower compartment
- Easy access control panel
- Sight glass/view port
- Easy access heat exchanger
- Multit-speed direct drive motor
- Heavy-duty insulated cabinet
- Approved for 1" clearance to combustibles for tight installations
- Ceramic combustion chamber
- Precision balanced blower
- Raised cabinet base
- Less burner
- Limited lifetime heat exchanger warranty
- 5-Year parts limited warranty (additional 5-year warranty with timely registration)



Part #	Mfg #	Input BTUH	Efficiency AFUE	Cooling Capacity @.5" wc	Dimensions H x W x D	Operating Wt	Price
HEHOLF105A12A	OLF105A12	70,000 - 105,000	80.3 - 85.1	1.5 - 3 Ton	32" x 21" x 43.4"	207 lbs	CALL

OLR Rear Flue Lo-Boy Oil Furnace

- Fan control switch
- Accessory terminals
- Large external front cleanout
- Clean out sealed from blower compartment
- Easy access control panel
- Sight glass/view port
- Easy access heat exchanger
- Multit-speed direct drive motor
- Heavy-duty insulated cabinet
- Approved for 1" clearance to combustibles for tight installations
- Ceramic combustion chamber
- Precision balanced blower
- Raised cabinet base
- Less burner
- Limited lifetime heat exchanger warranty
- 5-Year parts limited warranty (additional 5-year warranty with timely registration)



Part #	Mfg #	Input BTUH	Efficiency AFUE	Cooling Capacity @.5" wc	Dimensions H x W x D	Operating Wt	Price
HEHOLR105A12A	OLR105A12	70,000 - 105,000	80.3 - 85.1	1.5 - 3 Ton	32" x 21" x 43.4"	200 lbs	CALL

Heating

Prices & Specifications are Subject to Change.

Residential Heating

OUF Hi-Boy Direct Vent - 82.2% AFUE

- Approved for direct vent application
- 81% AFUE
- Approved for chimney installation ONLY
- Shipped complete with vestibule, burners & nozzles installed
- Fan control switch for continuous speed
- Prewired accessory terminals for add-on electronic air cleaner, power humidifier & A/C
- Large external front cleanout sealed from blower compartment
- Easy access control panel
- Factory installed test ports
- "Easy Access" heat exchanger manufactured from heavy gauge steel
- Multi-speed direct drive motors
- Heavy duty insulated cabinet
- Approved for 1" clearance to combustibles
- Ceramic combustion chamber withstands temps of 2600°F with unique "self-aligning" design
- Precision balanced blower
- Raised cabinet base
- Less burner
- Lifetime limited warranty on heat exchanger
- 3-Year warranty on burner
- 1-Year warranty on parts only



Part #	Mfg #	Size	Price
HEHOUF105A12A	OUF105A12A	48" x 21" x 18.9"	CALL

Burners

Part #	Mfg #	Description	Price
ICHNO1J040	N01J040	Beckett AFG-F0 Oil Burner for 5" Breech Models NOUF105, OUF105, OLF105, OLF105 & OCF105	CALL

Residential Heating

97% SmartComfort® VC97 Modulating, Variable-Speed Gas Furnaces

- Direct vent (2 pipe), single-pipe venting or ventilated combustion air
- Factory shipped for natural gas with propane gas conversion kits available
- Four position - upflow/downflow/horizontal (left/right) installation
- Twelve or more venting configurations
- Xtra SEER variable speed ECM blower motor
- Variable-speed induced draft combustion blower
- Modulating heating operation (40% - 100%)
- Supports two-stage cooling units
- Slide out heat exchanger assembly and blower assembly
- Flame roll-out sensors standard
- Adjustable timed blower heating off delay
- Insulated, 1-piece steel cabinet for noise reduction
- 24VAC Humidifier terminal
- Electronic air cleaner terminal
- Dehumidification feature in cooling
- RPJ Stainless steel primary heat exchanger
- Stainless steel secondary heat exchanger
- High temperature limit control
- Direct ignition with silicon nitride ignition
- Factory set blower on delay
- Simple troubleshooting of gas valve
- Self-configuring and communicating control
- California NOx approved
- Limited lifetime warranty on heat exchanger with timely registration
- 10-Year No-Hassle replacement limited warranty
- 5-Year limited parts warranty (additional 5-years with timely registration)



Part #	Mfg #	Cooling Cap @.5" wc	Input BTUH	AFUE	Dimensions H x W x D	Operating Wt	Price
TEHF9MAC0601714	F9MAC0601714	510-1335 CFM	60,000	97.0%	35" x 17-1/2" x 29-1/2"	154 lbs	CALL
TEHF9MAC0801714	F9MAC0801714	490-1375 CFM	80,000	97.0%	35" x 17-1/2" x 29-1/2"	164 lbs	CALL
TEHF9MAC1002120	F9MAC1002120	710-2030 CFM	100,000	97.0%	35" x 21" x 29-1/2"	179 lbs	CALL
TEHF9MAC1202422	F9MAC1202422	680-2185 CFM	120,000	97.0%	35" x 24-1/2" x 29-1/2"	203 lbs	CALL

Heating

Prices & Specifications are Subject to Change.

Residential Heating

96% SmartComfort® VT96 Two-Stage Variable-Speed Gas Furnaces

- Direct vent (2 pipe), single-pipe venting or ventilated combustion air
- Factory shipped for natural gas with propane gas conversion kits available
- Four position - upflow/downflow/horizontal (left/right) installation
- Twelve or more venting configurations
- Xtra SEER variable speed ECM blower motor
- Two-speed induced draft combustion blower
- Two-stage heating operation
- Supports two-stage cooling units
- Slide out heat exchanger assembly and blower assembly
- Flame roll-out sensors standard
- Adjustable timed blower heating off delay
- Fully insulated, 1-piece steel cabinet for noise reduction
- 24VAC Humidifier terminal
- Electronic air cleaner terminal
- Dehumidification feature in cooling
- RPJ Stainless steel primary heat exchanger
- Stainless steel secondary heat exchanger
- High temperature limit control
- Direct ignition with silicon nitride ignition
- Factory set blower on delay
- California NOx approved
- Limited lifetime warranty on heat exchanger with timely registration
- 10-Year No-Hassle replacement limited warranty
- 5-Year limited parts warranty (additional 5-years with timely registration)



Part #	Mfg #	Cooling Cap @.5" wc	Input BTUH	AFUE	Dimensions H x W x D	Operating Wt	Price
TEHF9MVT0401410	F9MVT0401410	440-905 CFM	40,000	96.0%	35" x 14-3/16" x 29-1/2"	121 lbs	CALL
TEHF9MVT0601714	F9MVT0601714	435-1475 CFM	60,000	96.0%	35" x 17-1/2" x 29-1/2"	141 lbs	CALL
TEHF9MVT0801716	F9MVT0801716	555-1610 CFM	80,000	96.0%	35" x 17-1/2" x 29-1/2"	152 lbs	CALL
TEHF9MVT1002116	F9MVT1002116	480-1805 CFM	100,000	96.0%	35" x 21" x 29-1/2"	166 lbs	CALL
TEHF9MVT1202422	F9MVT1202422	480-2115 CFM	120,000	96.0%	35" x 24-1/2" x 29-1/2"	190 lbs	CALL

Residential Heating

96% SmartComfort® IIX96 Two-Stage ECM Gas Furnaces

- Direct vent (2 pipe), single-pipe venting or ventilated combustion air
- Factory shipped for natural gas with propane gas conversion kits available
- Four position - upflow/downflow/horizontal (left/right) installation
- Twelve or more venting configurations
- Xtra SEER ECM blower motor
- Two-speed induced draft combustion blower
- Two-stage heating operation
- Supports two-stage cooling units
- Slide out heat exchanger assembly and blower assembly
- Flame roll-out sensors standard
- Adjustable timed blower heating off delay
- Fully insulated, 1-piece steel cabinet for noise reduction
- 24VAC Humidifier terminal
- Dehumidification feature in cooling
- Stainless steel secondary heat exchanger
- High temperature limit control
- Direct ignition with silicon nitride ignition
- Factory set blower on delay
- Self diagnostics with LED
- California NOx approved
- Limited lifetime warranty on heat exchanger with timely registration
- 5-Year No-Hassle replacement limited warranty
- 5-Year limited parts warranty (additional 5-years with timely registration)



Part #	Mfg #	Cooling Cap @.5" wc	Input BTUH	AFUE	Dimensions H x W x D	Operating Wt	Price
TEHF9MXT0401410	F9MXT0401410	385-925 CFM	40,000	96.0%	35" x 14-3/16" x 29-1/2"	125 lbs	CALL
TEHF9MXT0601714	F9MXT0601714	530-1505 CFM	60,000	96.0%	35" x 17-1/2" x 29-1/2"	146 lbs	CALL
TEHF9MXT0801716	F9MXT0801716	920-1610 CFM	80,000	96.0%	35" x 17-1/2" x 29-1/2"	156 lbs	CALL
TEHF9MXT1002116	F9MXT1002116	1155-1720 CFM	100,000	96.0%	35" x 21" x 29-1/2"	170 lbs	CALL
TEHF9MXT1202422	F9MXT1202422	1215-2055 CFM	120,000	96.0%	35" x 24-1/2" x 29-1/2"	195 lbs	CALL

**Not all products are available at all branches.
Contact your local branch for availability.**

Heating

Residential Heating

96% SmartComfort® DLX96 Single-Stage ECM Gas Furnaces

- Direct vent (2 pipe), single-pipe venting or ventilated combustion air
- Factory shipped for natural gas with propane gas conversion kits available
- Four position - upflow/downflow/horizontal (left/right) installation
- Twelve or more venting configurations
- Xtra SEER ECM blower motor
- Supports two-stage cooling units
- Slide out heat exchanger assembly and blower assembly
- Flame roll-out sensors standard
- Adjustable timed blower heating off delay
- Fully insulated, 1-piece steel cabinet for noise reduction
- 24VAC Humidifier terminal
- Electronic air cleaner terminal
- Dehumidification feature in cooling
- Stainless steel secondary heat exchanger
- High temperature limit control
- Direct ignition with silicon nitride ignition
- Factory set blower on delay
- Self diagnostics with LED
- California NOx approved
- Limited lifetime warranty on heat exchanger with timely registration
- 1-Year No-Hassle replacement limited warranty
- 5-Year limited parts warranty (additional 5-years with timely registration)



Part #	Mfg #	Cooling Cap @.5" wc	Input BTUH	AFUE	Dimensions H x W x D	Operating Wt	Price
TEHF9MXE0401410	F9MXE0401410	385-925 CFM	40,000	96.0%	35" x 14-3/16" x 29-1/2"	120 lbs	CALL
TEHF9MXE0601714	F9MXE0601714	530-1505 CFM	60,000	96.0%	35" x 17-1/2" x 29-1/2"	141 lbs	CALL
TEHF9MXE0801716	F9MXE0801716	920-1610 CFM	80,000	96.0%	35" x 17-1/2" x 29-1/2"	151 lbs	CALL
TEHF9MXE1002116	F9MXE1002116	1155-1720 CFM	100,000	96.0%	35" x 21" x 29-1/2"	166 lbs	CALL
TEHF9MXE1202422	F9MXE1202422	1215-2055 CFM	120,000	96.0%	35" x 24-1/2" x 29-1/2"	190 lbs	CALL

Heating

We are continually adding new products. Please call us with your inquires.

Residential Heating

95.5% AFUE Multi-Position Single-Stage PSC Gas Furnace

- Flame roll-out sensors standard
- Adjustable heating blower off delay
- Factory set blower on delay
- RPJ Aluminized steel primary heat exchanger
- Stainless steel secondary heat exchanger
- High temperature limit control prevents overheating
- Direct ignition with silicon nitride ignitor
- High quality, corrosion-resistant, prepainted steel cabinet
- Direct vent (2-pipe), single-pipe venting or ventilated combustion air
- 24 VAC Humidifier terminal and electronic air cleaner terminal
- 35" High
- Simplified, factory installed internal condensate drain system
- Innovative knobs for easy door removal and secure attachment
- Factory shipped for natural gas, with propane gas conversion kits available
- Four position - upflow/downflow/horizontal (left/right) installation
- At least twelve different venting configurations
- Through the casing flue pipe for counterflow or horizontal applications with accessory
- Concentric vent available
- Self diagnostics with super bright LED
- Slide out heat exchanger and blower assembly
- 20-Year heat exchanger limited warranty
- 5-Year parts limited warranty with an additional 5-year parts limited warranty with timely registration



Part #	Mfg #	Cooling Capacity @ 0.5" in WC	Input BTUH	Efficiency AFUE	Dimensions H x W x D	Shipping Wt	Price
TEHN9MSE0401410	N9MSE0401410A	625-905 CFM	40,000	95.5%	35" x 14-3/16" x 29-1/2"	123 lbs	CALL
TEHN9MSE0601410	N9MSE0601410A	675-1,130 CFM	60,000	95.5%	35" x 14-3/16" x 29-1/2"	127 lbs	CALL
TEHN9MSE0801716	N9MSE0801716A	810-1,600 CFM	80,000	95.5%	35" x 17-1/2" x 29-1/2"	154 lbs	CALL
TEHN9MSE1002114	N9MSE1002114A	695-1,565 CFM	100,000	95.5%	35" x 21" x 29-1/2"	169 lbs	CALL
TEHN9MSE1002120	N9MSE1002120A	1,225-2,145 CFM	100,000	95.5%	35" x 21" x 29-1/2"	169 lbs	CALL
TEHN9MSE1202420	N9MSE1202420A	1,254-2,065 CFM	120,000	95.5%	35" x 24-1/2" x 29-1/2"	186 lbs	CALL
TEHN9MSE1402420	N9MSE1402420A	1,230-2,100 CFM	140,000	95.5%	35" x 24-1/2" x 29-1/2"	190 lbs	CALL

Heating

Prices & Specifications are Subject to Change.

Residential Heating

92.1% AFUE Multi-Position Single-Stage PSC Gas Furnace

- Flame roll-out sensors standard
- Adjustable heating blower off delay
- Factory set blower on delay
- RPJ Aluminized steel primary heat exchanger
- Stainless steel secondary heat exchanger
- High temperature limit control prevents overheating
- Direct ignition with silicon nitride ignitor
- High quality, corrosion-resistant, prepainted steel cabinet
- Direct vent (2-pipe), single-pipe venting or ventilated combustion air
- 24 VAC Humidifier terminal and electronic air cleaner terminal
- 35" High
- Simplified, factory installed internal condensate drain system
- Innovative knobs for easy door removal and secure attachment
- Factory shipped for natural gas, with propane gas conversion kits available
- Four position - upflow/downflow/horizontal (left/right) installation
- At least twelve different venting configurations
- Through the casing flue pipe for counterflow or horizontal applications with accessory
- Concentric vent available
- Self diagnostics with super bright LED
- Slide out heat exchanger and blower assembly
- 20-Year heat exchanger limited warranty
- 5-Year parts limited warranty with an additional 5-year parts limited warranty with timely registration



Part #	Mfg #	Cooling Capacity @ 1/2" in WC	Input BTUH	Efficiency AFUE	Dimensions H x W x D	Operating Wt	Price
TEHN9MSB0401410	N9MSB0401410A	625-905 CFM	40,000	92.1	35" x 14-3/16" x 29-1/2"	123 lbs	CALL
TEHN9MSB0601410	N9MSB0601410A	675-1,130 CFM	60,000	92.1	35" x 14-3/16" x 29-1/2"	127 lbs	CALL
TEHN9MSB0801716	N9MSB0801716A	810-1,600 CFM	80,000	92.1	35" x 17-1/2" x 29-1/2"	154 lbs	CALL
TEHN9MSB1002114	N9MSB1002114A	695-1,565 CFM	100,000	92.1	35" x 21" x 29-1/2"	169 lbs	CALL
TEHN9MSB1002120	N9MSB1002120A	1,225-2,145 CFM	100,000	92.1	35" x 21" x 29-1/2"	169 lbs	CALL

Residential Heating

80% SmartComfort™ 80 2-Stage Multiposition Gas Furnaces

- Category I venting
- Multi-position furnace - upflow/downflow/horizontal installation
- Factory shipped for natural gas, LP gas conversion kits available
- 3-Position vent elbow capability
- Through the casing flue pipe for counterflow applications
- Masonry chimney adapter available
- Supports 2-stage cooling units
- 2-Stage gas valve operation; 2-stage induced draft
- 24VAC & 115VAC Humidifier terminal
- Direct ignition with Silicon Nitride igniter
- Common venting with other Category I appliances
- Self diagnostics
- Slide-out blower assembly
- Innovative knobs for easy door removal & secure attachment
- RPJ Aluminized steel heat exchanger
- Insulated blower compartment
- High temperature limit control prevents overheating
- Flame roll-out sensors standard
- Blocked vent switch
- One piece prepainted steel cabinet
- Factory set blower ON delay
- Adjustable heating blower OFF delay
- Electronic air cleaner terminal
- Dehumidification feature in cooling
- Inshot burners
- 5-Year No Hassle Replacement™ limited warranty
- 20-Year heat exchanger warranty with timely registration
- 10-Year parts limited warranty with timely registration, otherwise 5-year limited part warranty



Part #	Mfg #	Heating Input	Cooling Capacity @.5" wc	Unit Dimensions (H x W x D)	Ship Wt	Price
TEHF8MTL0451412	F8MTL0451412A	44,000	745-1,175 CFM	33-1/3" x 14-3/16" x 29"	107 lbs	CALL
TEHF8MTL0701412	F8MTL0701412A	66,000	370-1,240 CFM	33-1/3" x 14-3/16" x 29"	115 lbs	CALL
TEHF8MTL0901714	F8MTL0901714A	88,000	1,065-1,385 CFM	33-1/3" x 17-1/2" x 29"	127 lbs	CALL
TEHF8MTL1102122	F8MTL1102122A	110,000	1,180-2,235 CFM	33-1/3" x 21" x 29"	152 lbs	CALL
TEHF8MTL1352422	F8MTL1352422A	132,000	1,485-2,195 CFM	33-1/3" x 24-1/2" x 29"	163 lbs	CALL

Heating

Prices & Specifications are Subject to Change.

Residential Heating

80% AFUE Single-Stage Heating Gas Furnaces

Standard Features

- Category I venting
- Multi-position furnace - upflow/downflow/horizontal (left/right) installation
- Factory shipped for natural gas, LP gas conversion kits available
- 3-Position inducer elbow capability
- Through the casing flue pipe for counterflow applications
- Masonry chimney adapter available
- Direct ignition with Silicon Nitride igniter
- Common venting with other Category I appliances
- Self diagnostics
- Slide-out blower assembly
- Innovative knobs for easy door removal & secure attachment
- RPJ Aluminized steel heat exchanger
- High temperature limit control prevents overheating
- Flame roll-out sensors standard
- Blocked vent switch
- One piece prepainted steel cabinet
- Louvered doors
- Factory set blower ON delay
- Adjustable heating blower OFF delay
- 24VAC & 115VAC humidifier terminal
- Electronic air cleaner terminal
- Twinning furnaces of same heating & cooling sizes w/approved kit
- Inshot burners
- 33-1/3" High and 29" deep
- 20-Year limited warranty on heat exchanger with timely registration
- 10-Year parts limited warranty with timely registration, otherwise 5-year limited part warranty



Part #	Mfg #	Heating Input	Cooling Capacity @.5" wc	Unit Dimensions (H x W x D)	Ship Wt	Price
TEHN8MSN0451412	N8MSN0451412A	44,000	1,040 - 1,145	33-1/3" x 14-3/16" x 29"	107 lbs	CALL
TEHN8MSN0701412	N8MSN0701412A	66,000	1,050 - 1,200	33-1/3" x 14-3/16" x 29"	115 lbs	CALL
TEHN8MSN0901714	N8MSN0901714A	88,000	1,195 - 1,385	33-1/3" x 17-1/2" x 29"	127 lbs	CALL
TEHN8MSN1102122	N8MSN1102122A	110,000	1,720 - 2,265	33-1/3" x 21" x 29"	152 lbs	CALL
TEHN8MSN1352422	N8MSN1352422A	132,000	1,715 - 2,195	33-1/3" x 24-1/2" x 29"	163 lbs	CALL

Residential Heating

Oil Furnaces

OLR Rear Flue Lo-Boy Oil Furnace

- Fan control switch
- Accessory terminals
- Large external front cleanout
- Clean out sealed from blower compartment
- Easy access control panel
- Sight glass/view port
- Easy access heat exchanger
- Multi-speed direct drive motor
- Heavy-duty insulated cabinet
- Approved for 1" clearance to combustibles for tight installations
- Ceramic combustion chamber
- Precision balanced blower
- Raised cabinet base
- Less burner
- Limited lifetime heat exchanger warranty with timely registration
- 5-Year parts limited warranty (additional 5-year warranty with timely registration)



Part #	Mfg #	Input BTUH	Efficiency AFUE	Cooling Capacity @.5" wc	Dimensions H x W x D	Operating Wt	Price
TEHOLR105A12A	OLR105A12	70,000 - 105,000	80.3 - 85.1	1.5 - 3 Ton	32" x 21" x 43.4"	200 lbs	CALL

OUF Hi-Boy Direct Vent - 82.2% AFUE

- Approved for direct vent application
- Fan control switch for continuous speed
- Pre-wired acc'y terminals for add-on electronic air cleaner, power humidifier & A/C
- Large external front cleanout sealed from blower compartment
- "Easy Access" control panel & heat exchanger
- Sight glass/view port
- Multi-speed direct drive motors
- HD insulated cabinet
- Approved for 1" clearance to combustibles, raised cabinet base
- Ceramic combustion chamber withstands temps of 2600°F with unique "self-aligning" design
- Precision balanced blower
- Less burner



Part #	Mfg #	Size	Price
TEHOUF105A12A	OUF105A12A	48" x 21" x 18.9"	CALL

Burners

Part #	Mfg #	Description	Price
ICHNO1J040	N01J040	Beckett AFG-F0 Oil Burner for 5" Breech Models NOUF105, OUF105, OLF105, OLF105 & OCF105	CALL

Heating

Prices & Specifications are Subject to Change.

Residential Heating

96% Two-Stage Variable-Speed Gas Furnaces

- Direct vent (2 pipe), single-pipe venting or ventilated combustion air
- Factory shipped for natural gas with propane gas conversion kits available
- Four position - upflow/downflow/horizontal (left/right) installation
- Twelve or more venting configurations
- Xtra SEER variable speed ECM blower motor
- Two-speed induced draft combustion blower
- Two-stage heating operation
- Supports two-stage cooling units
- Slide out heat exchanger assembly and blower assembly
- Flame roll-out sensors standard
- Adjustable timed blower heating off delay
- Fully insulated, 1-piece steel cabinet for noise reduction
- 24VAC Humidifier terminal
- Electronic air cleaner terminal
- Dehumidification feature in cooling
- RPJ Stainless steel primary heat exchanger
- Stainless steel secondary heat exchanger
- High temperature limit control
- Direct ignition with silicon nitride ignition
- Factory set blower on delay
- California NOx approved
- Limited lifetime warranty on heat exchanger with timely registration
- 10-Year No-Hassle replacement limited warranty
- 5-Year limited parts warranty (additional 5-years with timely registration)



96% - Upflow/Downflow/Horizontal Multi-Position - 2-Stage - G9MVT Furnace

Part #	Mfg #	Cooling Capacity @ 0.5" in WC	Input BTUH	Efficiency AFUE	Dimensions H x W x D	Shipping Wt	Price
AQHG9MVT0401410	G9MVT0401410	440-905 CFM	40,000	96.0%	35" x 14-3/16" x 29-1/2"	121 lbs	CALL
AQHG9MVT0601714	G9MVT0601714	435-1475 CFM	60,000	96.0%	35" x 17-1/2" x 29-1/2"	141 lbs	CALL
AQHG9MVT0801716	G9MVT0801716	555-1610 CFM	80,000	96.0%	35" x 17-1/2" x 29-1/2"	152 lbs	CALL
AQHG9MVT1002116	G9MVT1002116	480-1805 CFM	100,000	96.0%	35" x 21" x 29-1/2"	166 lbs	CALL
AQHG9MVT1202422	G9MVT1202422	480-2115 CFM	120,000	96.0%	35" x 24-1/2" x 29-1/2"	190 lbs	CALL

Residential Heating

96% QuietComfort® IIX96 Two-Stage ECM Gas Furnaces

- Direct vent (2 pipe), single-pipe venting or ventilated combustion air
- Factory shipped for natural gas with propane gas conversion kits available
- Four position - upflow/downflow/horizontal (left/right) installation
- Twelve or more venting configurations
- Xtra SEER ECM blower motor
- Two-speed induced draft combustion blower
- Two-stage heating operation
- Supports two-stage cooling units
- Slide out heat exchanger assembly and blower assembly
- Flame roll-out sensors standard
- Adjustable timed blower heating off delay
- Fully insulated, 1-piece steel cabinet for noise reduction
- 24VAC Humidifier terminal
- Dehumidification feature in cooling
- Stainless steel secondary heat exchanger
- High temperature limit control
- Direct ignition with silicon nitride ignition
- Factory set blower on delay
- Self diagnostics with LED
- California NOx approved
- Limited lifetime warranty on heat exchanger with timely registration
- 5-Year No-Hassle replacement limited warranty
- 5-Year limited parts warranty (additional 5-years with timely registration)



96% - Upflow/Downflow/Horizontal Multi-Position - 2-Stage - G9MXT Furnace

Part #	Mfg #	Cooling Capacity @ 0.5" in WC	Input BTUH	Efficiency AFUE	Dimensions H x W x D	Shipping Wt	Price
AQHG9MXT0401410	G9MXT0401410	385-925 CFM	40,000	96.0%	35" x 14-3/16" x 29-1/2"	125 lbs	CALL
AQHG9MXT0601714	G9MXT0601714	530-1505 CFM	60,000	96.0%	35" x 17-1/2" x 29-1/2"	146 lbs	CALL
AQHG9MXT0801716	G9MXT0801716	920-1610 CFM	80,000	96.0%	35" x 17-1/2" x 29-1/2"	156 lbs	CALL
AQHG9MXT1002116	G9MXT1002116	1155-1720 CFM	100,000	96.0%	35" x 21" x 29-1/2"	170 lbs	CALL
AQHG9MXT1202422	G9MXT1202422	1215-2055 CFM	120,000	96.0%	35" x 24-1/2" x 29-1/2"	195 lbs	CALL

Residential Heating

96% QuietComfort® DLX96 Single-Stage ECM Gas Furnaces

- Direct vent (2 pipe), single-pipe venting or ventilated combustion air
- Factory shipped for natural gas with propane gas conversion kits available
- Four position - upflow/downflow/horizontal (left/right) installation
- Twelve or more venting configurations
- Xtra SEER ECM blower motor
- Supports two-stage cooling units
- Slide out heat exchanger assembly and blower assembly
- Flame roll-out sensors standard
- Adjustable timed blower heating off delay
- Fully insulated, 1-piece steel cabinet for noise reduction
- 24VAC Humidifier terminal
- Electronic air cleaner terminal
- Dehumidification feature in cooling
- Stainless steel secondary heat exchanger
- High temperature limit control
- Direct ignition with silicon nitride ignition
- Factory set blower on delay
- Self diagnostics with LED
- California NOx approved
- Limited lifetime warranty on heat exchanger with timely registration
- 1-Year No-Hassle replacement limited warranty
- 5-Year limited parts warranty (additional 5-years with timely registration)



96% - Upflow/Downflow/Horizontal Multi-Position - Single-Stage - G9MXE Furnace

Part #	Mfg #	Cooling Capacity @ 0.5" in WC	Input BTUH	Efficiency AFUE	Dimensions H x W x D	Shipping Wt	Price
AQHG9MXE0401410	G9MXE0401410	385-925 CFM	40,000	96.0%	35" x 14-3/16" x 29-1/2"	120 lbs	CALL
AQHG9MXE0601714	G9MXE0601714	530-1505 CFM	60,000	96.0%	35" x 17-1/2" x 29-1/2"	141 lbs	CALL
AQHG9MXE0801716	G9MXE0801716	920-1610 CFM	80,000	96.0%	35" x 17-1/2" x 29-1/2"	151 lbs	CALL
AQHG9MXE1002116	G9MXE1002116	1155-1720 CFM	100,000	96.0%	35" x 21" x 29-1/2"	166 lbs	CALL
AQHG9MXE1202422	G9MXE1202422	1215-2055 CFM	120,000	96.0%	35" x 24-1/2" x 29-1/2"	190 lbs	CALL

Residential Heating

95.5% AFUE Multi-Position Single-Stage PSC Gas Furnace

- Flame roll-out sensors standard
- Adjustable heating blower off delay
- Factory set blower on delay
- RPJ Aluminized steel primary heat exchanger
- Stainless steel secondary heat exchanger
- High temperature limit control prevents overheating
- Direct ignition with silicon nitride ignitor
- High quality, corrosion-resistant, prepainted steel cabinet
- Direct vent (2-pipe), single-pipe venting or ventilated combustion air
- 24 VAC Humidifier terminal and electronic air cleaner terminal
- 35" High
- Simplified, factory installed internal condensate drain system
- Innovative knobs for easy door removal and secure attachment
- Factory shipped for natural gas, with propane gas conversion kits available
- Four position - upflow/downflow/horizontal (left/right) installation
- At least twelve different venting configurations
- Through the casing flue pipe for counterflow or horizontal applications with accessory
- Concentric vent available
- Self diagnostics with super bright LED
- Slide out heat exchanger and blower assembly
- 20-Year heat exchanger limited warranty
- 5-Year parts limited warranty with an additional 5-year parts limited warranty with timely registration



Part #	Mfg #	Cooling Capacity @ 0.5" in WC	Input BTUH	Efficiency AFUE	Dimensions H x W x D	Shipping Wt	Price
AQHN9MSE0401410	N9MSE0401410A	625-905 CFM	40,000	95.5%	35" x 14-3/16" x 29-1/2"	123 lbs	CALL
AQHN9MSE0601410	N9MSE0601410A	675-1,130 CFM	60,000	95.5%	35" x 14-3/16" x 29-1/2"	127 lbs	CALL
AQHN9MSE0801716	N9MSE0801716A	810-1,600 CFM	80,000	95.5%	35" x 17-1/2" x 29-1/2"	154 lbs	CALL
AQHN9MSE1002114	N9MSE1002114A	695-1,565 CFM	100,000	95.5%	35" x 21" x 29-1/2"	169 lbs	CALL
AQHN9MSE1002120	N9MSE1002120A	1,225-2,145 CFM	100,000	95.5%	35" x 21" x 29-1/2"	169 lbs	CALL
AQHN9MSE1202420	N9MSE1202420A	1,254-2,065 CFM	120,000	95.5%	35" x 24-1/2" x 29-1/2"	186 lbs	CALL
AQHN9MSE1402420	N9MSE1402420A	1,230-2,100 CFM	140,000	95.5%	35" x 24-1/2" x 29-1/2"	190 lbs	CALL

Heating

Prices & Specifications are Subject to Change.

Residential Heating

92.1% AFUE Multi-Position Single-Stage PSC Gas Furnace

- Flame roll-out sensors standard
- Adjustable heating blower off delay
- Factory set blower on delay
- RPJ Aluminized steel primary heat exchanger
- Stainless steel secondary heat exchanger
- High temperature limit control prevents overheating
- Direct ignition with silicon nitride ignitor
- High quality, corrosion-resistant, prepainted steel cabinet
- Direct vent (2-pipe), single-pipe venting or ventilated combustion air
- 24 VAC Humidifier terminal and electronic air cleaner terminal
- 35" High
- Simplified, factory installed internal condensate drain system
- Innovative knobs for easy door removal and secure attachment
- Factory shipped for natural gas, with propane gas conversion kits available
- Four position - upflow/downflow/horizontal (left/right) installation
- At least twelve different venting configurations
- Through the casing flue pipe for counterflow or horizontal applications with accessory
- Concentric vent available
- Self diagnostics with super bright LED
- Slide out heat exchanger and blower assembly
- 20-Year heat exchanger limited warranty
- 5-Year parts limited warranty with an additional 5-year parts limited warranty with timely registration



Part #	Mfg #	Cooling Capacity @ 1/2" in WC	Input BTUH	Efficiency AFUE	Dimensions H x W x D	Operating Wt	Price
AQHN9MSB0401410	N9MSB0401410A	625-905 CFM	40,000	92.1	35" x 14-3/16" x 29-1/2"	123 lbs	CALL
AQHN9MSB0601410	N9MSB0601410A	675-1,130 CFM	60,000	92.1	35" x 14-3/16" x 29-1/2"	127 lbs	CALL
AQHN9MSB0801716	N9MSB0801716A	810-1,600 CFM	80,000	92.1	35" x 17-1/2" x 29-1/2"	154 lbs	CALL
AQHN9MSB1002114	N9MSB1002114A	695-1,565 CFM	100,000	92.1	35" x 21" x 29-1/2"	169 lbs	CALL
AQHN9MSB1002120	N9MSB1002120A	1,225-2,145 CFM	100,000	92.1	35" x 21" x 29-1/2"	169 lbs	CALL

Residential Heating

80% AFUE Two-Stage Heating Gas Furnaces

- Supports two-stage cooling units
- Two-stage operation
- Two-stage induced draft blower
- 115-1-60
- 5-Year No Hassle Replacement™ limited warranty
- 20-Year heat exchanger limited warranty with timely registration
- 5-Year parts limited warranty (additional 5-year warranty with timely registration)



Part #	Mfg #	Gas Type	Heating Input	CFM @.5" wc	Dimensions H x W x D	Approx Ship Wt	Price
AQHG8MTL0451412	G8MTL0451412A	NG	44,000	1,200	33-1/3" x 14-3/16" x 29"	107 lbs	CALL
AQHG8MTL0701412	G8MTL0701412A	NG	66,000	1,200	33-1/3" x 14-3/16" x 29"	115 lbs	CALL
AQHG8MTL0901714	G8MTL0901714A	NG	88,000	1,400	33-1/3" x 17-1/2" x 29"	127 lbs	CALL
AQHG8MTL1102122	G8MTL1102122A	NG	110,000	2,200	33-1/3" x 21" x 29"	152 lbs	CALL
AQHG8MTL1352422	G8MTL1352422A	NG	132,000	2,200	33-1/3" x 24-1/2" x 29"	163 lbs	CALL

80% AFUE Single-Stage Heating Gas Furnaces

- Flame roll-out sensors
- Category I venting & blocked vent switch
- 24 VAC and 115 VAC Humidifier terminal
- Electronic air cleaner terminal
- Twinning furnaces of same heating and cooling sizes
- PSC Blower motor
- Factory set blower on delay and adjustable heating blower off delay
- RPJ Aluminized steel heat exchanger
- High temperature limit control prevents overheating
- Direct ignition with silicone nitride ignitor
- One-piece prepainted steel cabinet
- In-shot burners
- 4-Position - upflow/downflow/horizontal (left/right) installation
- 3-Position inducer elbow capacity
- Through the casing flue pipe for counterflow applications
- Common venting with other Category I appliances
- Self-diagnostics
- Slide out blower assembly
- 115-1-60
- 20-Year heat exchanger limited warranty
- 5-Year parts limited warranty (additional 5-year warranty with timely registration)



Part #	Mfg #	Gas Type	Heating Input	CFM @.5" wc	Dimensions H x W x D	Approx Ship Wt	Price
AQHN8MSN0451412	N8MSN0451412A	NG	44,000	1040 - 1145	33-1/3" x 14-3/16" x 29"	107 lbs	CALL
AQHN8MSN0701412	N8MSN0701412A	NG	66,000	1050 - 1200	33-1/3" x 14-3/16" x 29"	115 lbs	CALL
AQHN8MSN0901714	N8MSN0901714A	NG	88,000	1065 - 1385	33-1/3" x 17-1/2" x 29"	127 lbs	CALL
AQHN8MSN1102122	N8MSN1102122A	NG	110,000	1720 - 2265	33-1/3" x 21" x 29"	152 lbs	CALL
AQHN8MSN1352422	N8MSN1352422A	NG	132,000	1715 - 2195	33-1/3" x 24-1/2" x 29"	163 lbs	CALL

Heating

Prices & Specifications are Subject to Change.

Residential Heating

Oil Furnaces

OLF Front Flue Lo-Boy Oil Furnace

- Limited lifetime heat exchanger warranty
- 5-Year parts limited warranty (additional 5-year warranty with timely registration)
- Fan control switch
- Accessory terminals
- Large external front cleanout
- Clean out sealed from blower compartment
- Easy access control panel
- Sight glass/view port
- Easy access heat exchanger
- Multi-speed direct drive motor
- Heavy-duty insulated cabinet
- Approved for 1" clearance to combustibles for tight installations
- Ceramic combustion chamber
- Precision balanced blower
- Raised cabinet base
- Less burner



Part #	Mfg #	Input BTUH	Efficiency AFUE	Cooling Capacity @.5" wc	Dimensions H x W x D	Operating Wt	Price
AQHOLR105A12A	OLF105A12	70,000 - 105,000	80.3 - 85.1	1.5 - 3 Ton	32" x 21" x 43.4"	207 lbs	CALL

OUF Hi-Boy Direct Vent - 82.2% AFUE

- Approved for direct vent application
- Fan control switch for continuous speed
- Pre-wired acc'y terminals for add-on electronic air cleaner, power humidifier & A/C
- Large external front cleanout sealed from blower compartment
- "Easy Access" control panel & heat exchanger
- Sight glass/view port
- Multi-speed direct drive motors
- HD insulated cabinet
- Approved for 1" clearance to combustibles, raised cabinet base
- Ceramic combustion chamber withstands temps of 2600°F with unique "self-aligning" design
- Precision balanced blower
- Less burner



Part #	Mfg #	Size	Price
AQHOUF105A12A	OUF105A12A	48" x 21" x 18.9"	CALL

Burners

Part #	Mfg #	Description	Price
ICHNO1J040	N01J040	Beckett AFG-F0 Oil Burner for 5" Breech Models NOUF105, OUF105, OLF105, OLF105 & OCF105	CALL

Heating

All Items May Not Be Stocked In All Branches

Manufactured Home Heating

95+ Modular Housing Direct Vent Condensing Downflow Gas Furnaces

- High efficiency, induced draft
- MR7L design allows direct substitution in place of the M1 and M3 series furnaces - will fit in the same footprint & uses the same duct connector
- Clean & quiet operation
- Fixed 30 second blower delay at start-up adjustable off settings at 60, 90, 120 & 180 seconds
- Fixed 30 second post purge
- Dependable, hot surface igniter
- Multi-speed direct drive blower
- Fixed 90 second cooling cycle blower-off relay (TDR)
- LP Convertible
- Tubular primary aluminized steel heat exchanger
- Stainless steel secondary heat exchanger
- Diagnostic lights for troubleshooting without counting flashes
- Easy open pawl latch
- Appliance quality door - baked enamel finish
- Fully insulated cabinet
- 3 Amp fuse protection against low voltage shorts
- Low voltage terminal board
- Sealed combustion approved for direct vent furnace, flexible Category IV venting system - May be vertically or horizontally vented using a two-pipe system
- 3 Amp fuse protection against low voltage shorts
- Low voltage terminal board
- Color-coded wire harness
- 19-3/4" Wide, 23-3/4" Depth; AW - 56", BW - 76" with Coil Cavity



95+ AFUE Condensing Downflow - 115-1-60 - Multi Speed - M7RL Gas Furnace

Part #	Mfg #	Order #	Input BTUH	Heating Capacity BTUH	Motor HP - Speed Type	Height	Approx Ship Weight	Price
MLRM7RL060A	M7RL060A-BW		60,000	57,000	1/2 - 4 - PSC	76" with Coil Cavity	170 lbs	CALL
MLRM7RL072A	M7RL072A-BW		72,000	68,400	1/2 - 4 - PSC	76" with Coil Cavity	175 lbs	CALL

Furnace Vent Transition Kit for M3RL Series Furnaces

Part #	Mfg #	Description	Price
MLR237963	904106	Furnace Vent Transition Kit for M3RL Series Furnaces	82.02

Heating

Manufactured Home Heating

80+ M1 Series Gas Furnaces

- Designed for all sizes of manufactured & mobile homes
- May be installed free standing in a utility room or enclosed in an alcove or closet
- Available in A/C adaptable or A/C ready, with or without coil cavity box, multiple blower combinations for cooling requirements, and many burner options
- Sealed combustion systems vents exhaust gas directly outdoors & draws in 100% outside air for the burner
- Easy open pawl latch which secures door
- Large permanent washable filter
- High efficiency drum heat exchanger, low air resistance
- Appliance quality door - baked enamel finish
- Fully insulated cabinet
- Reliable burner
- 76" Height w/Coil Box, 56" Height w/o Coil Box; 19-3/4" Wide, 23-3/4" Depth
- 5-Year limited parts warranty



80+ AFUE Direct Vent - Forced Draft - HSI - A/C Ready - 120-1-60 - M1MB Gas Furnace

Part #	Mfg #	Order #	A/C Ready Tons	Heating Input/Output BTUH	Motor HP	Height	Approx Ship Weight	Price
MLRM1MB056AAW	M1MB-056AAW	903228	3.0	56,000/46,000	1/4	56" less Coil Cavity	152 lbs	CALL
MLRM1MB070AAW	M1MB-070AAW	903229	3.0	70,000/57,000	1/4	56" less Coil Cavity	153 lbs	CALL
MLRM1MB077AAW	M1MB-077AAW	903230	3.0	77,000/62,000	1/4	56" less Coil Cavity	149 lbs	CALL
MLRM1MB090AAW	M1MB-090AAW	903231	3.0	90,000/72,000	1/4	56" less Coil Cavity	151 lbs	CALL

Manufactured Home Gas Furnaces

Manufactured Home Gas Furnace - CMF Series

- Beckett oil burner standard
- Three speed custom fit and painted blower
- Titanium killed steel heat exchanger
- Multi-speed blower and multi-fired burner
- Designed for all sizes of manufactured and modular homes
- 240V-1-60, 29"H x 20"W x 24-1/2"D



Part #	Mfg #	Order #	Factory Set Firing Rate MBTUH	Heating Capacity MBTUH	AFUE	Motor HP-Spd-Type	Price
MLRCMF80PG	CMF80PG	238000/903097	75	56	75+	1/4-3-PSC	CALL

Heating

All Items May Not Be Stocked In All Branches

Manufactured Home Heating

Oil Furnaces

Manufactured Home Oil Furnace - CMF Series

- Beckett oil burner standard
- Three speed custom fit and painted blower
- Titanium killed steel heat exchanger
- Multi-speed blower and multi-fired burner
- Designed for all sizes of manufactured and modular homes
- 240V-1-60, 29"H x 20"W x 24-1/2"D



Part #	Mfg #	Order #	Factory Set Firing Rate MBTUH	Heating Capacity MBTUH	AFUE	Motor HP-Spd-Type	Price
MLRCMF80PO	CMF80PO	238001/903098	75	60	80+	1/4-3-PSC	CALL

Accessories

Furnace Base

Part #	Mfg #	Description	Price
MLRCB200A	CB-200A	Cottage Base	372.24
MLRMA100	238361	MA-100 Universal Base Package w/13" Feeder Duct	276.00
MLRMA200	238355	MA-200 Base Package w/13" Feeder Duct	147.00

M Series Furnaces Accessory

Part #	Mfg #	Description	Price
MLR237941	911969A	White Coil Cabinet to Make M1 Furnaces 76" High	215.02
MLR237966	901935	5" x 10" Interior Vent Extension	99.12

Roof Jack

Part #	Mfg #	Description	Price
MLRSRJ1	SRJ-1	12" Roof Jack Assembly (Needs Vent Pipe)	199.28
MLRSRJ2	SRJ-2	24" Roof Jack Assembly (Needs Vent Pipe)	225.40
MLRSRJ3	SRJ-3	36" Roof Jack Assembly (Needs Vent Pipe)	325.06
MLRSRJ5	SRJ-5	60" Roof Jack Assembly (Needs Vent Pipe)	476.96
MLR237951	903660	27" - 47" Max Flat Roof Jack for M1 #237951	265.52
MLR237956	903663	27" - 47" Max Pitched Roof Jack for M1 #237956	265.52
MLR237954	901920	35" - 63" Max Pitched Roof Jack for M1 #237954	340.32
MLR237955	901921	51" - 95" Max Pitched Roof Jack for M1 #237955	501.14

Roof Jack Adapter

Part #	Mfg #	Description	Price
MLRRAS25	RA-S2.5	For 2.5/12 Slope Roof Installations	74.78
MLRRAS30	RA-S3.0	For 3/12 Slope Roof Installations	74.78
MLRRAS40	RA-S4.0	For 4/12 Slope Roof Installations	74.78

Prices & Specifications are Subject to Change.



www.irrsupply.com

Manufactured Home Heating

Manufactured Housing Equipment - Style Crest

MG9S Series 95.5% Manufactured Home Natural Gas Furnaces

- 4-Speed direct drive PSC blower fan motor
- Electronic hot surface ignition
- Built-in high level self diagnostics
- Blower door safety switch
- 1/4 Turn knobs
- 10-Year parts limited warranty on heat exchanger
- 5-Year parts limited warranty on all other components



Part #	Mfg #	Input BTUH	Output BTUH	AFUE %	Dimensions H x W x D	CFM	Wgt lbs	Price
COLMG95060B12MP	MG9S060B12MP	60,000	57,000	95.5%	33" x 17-1/2" x 29-1/2"	1200	122	CALL

DGA 90% Downflow Manufactured Home Natural Gas Furnaces

- Sealed combustion downflow gas or propane
- 2-Speed blower fan operation
- Automatic hot surface ignition with remote flame sensor
- 10-Year parts limited warranty on heat exchanger
- 5-Year parts limited warranty on all other components



Part #	Mfg #	Input BTUH	Output BTUH	AFUE %	Dimensions H x D x W	CFM	Price
COLDGAD060	DGAD060CDJ	60,000	55,000	91%	45" x 28-1/2" x 17-1/2"	1200	CALL

We have 32 convenient locations proudly serving Western NY, Central NY, and Northern Pennsylvania.

Heating

All Items May Not Be Stocked In All Branches



www.irrsupply.com

Manufactured Home Heating

Conquest Series DGAA/DGAT 80%+ Downflow Mobile Home Natural Gas Furnaces

- Sealed combustion
- Air conditioning ready to 4 tons, built-in coil cabinet
- Fail-safe automatic hot surface ignition system
- Full louver high impact plastic return air door
- Built-in coil cabinet
- Zero clearance
- Easy conversion to propane
- Standard replaceable filters (included)
- 2-Year limited parts & labor warranty



Part #	Mfg #	Input BTUH	Output BTUH	Dimensions H x W x D	Weight (lb)	Price
COLDGAA056	DGAA056BDTA	56,000	45,000	76" x 19-1/2" x 24-1/2"	145	CALL
COLDGAA070	DGAT070BDF	70,000	56,000	76" x 19-1/2" x 24-1/2"	145	CALL
COLDGAA077	DGAA077BDTA	77,000	62,000	76" x 19-1/2" x 24-1/2"	146	CALL
COLDGAA090	DGAT090BDF	90,000	72,000	76" x 19-1/2" x 24-1/2"	159	CALL

Compact™ Series DGAH/DLAS 80%+ Downflow Mobile Home Propane Gas Furnaces

- Low profile
- Sealed combustion
- Heating only
- Fail-safe automatic hot surface ignition system
- Full louver high impact plastic return air door
- Standard replaceable filters (included)
- Approved for mobile/modular homes
- 2-Year limited parts & labor warranty



Part #	Mfg #	Input BTUH	Output BTUH	Dimensions H x W x D	Weight (lb)	Price
COLDGAH056	DGAH056BBSA	56,000	47,000	60" x 19-1/2" x 24-1/2"	131	CALL
COLDGAH077	DLAS075BDF	75,000		60" x 19-1/2" x 24-1/2"	131	CALL

Vexar® VMA Series 95% Gas Furnace

- 4-Speed direct drive PSC blower fan motor
- 18 Gauge aluminum coated heat exchanger
- Sealed combustion design; LED diagnostic feature
- Easy conversion from natural gas to propane, have convertible gas valves
- 22 Gauge powder coated cabinet
- Fits standard MH furnace footprint
- ETL and Energy Star listed
- Lifetime limited warranty on heat exchanger
- 5-Year parts limited warranty



Part #	Mfg #	Model Number	Tons	Input MBH	Output MBH	Dimensions H x W x D	Ship Wgt	Price
COLVMA50	VMA50	0854001	3.5	50,000	48,000	57" x 18" x 25-3/4"	175 lbs	CALL
COLVMA75	VMA75	0854002	4.0	75,000	72,000	57" x 18" x 25-3/4"	175 lbs	CALL

Heating

Prices & Specifications are Subject to Change.



www.irrsupply.com

Manufactured Home Heating

Coil Cabinet

Part #	Mfg #	Description	Price
COL9155835	9115-835	Coil Cabinet for 95% Furnace	CALL

Conquest Series DFAA 80%+ Downflow Mobile Home Oil Furnaces

- Sealed combustion
- Air conditioning ready to 3 tons, built-in coil cabinet
- Fail-safe automatic hot surface ignition system
- Full louver high impact plastic return air door
- Standard replaceable filters (included)
- Approved for mobile/modular homes
- 1-Year limited parts & labor warranty



Part #	Mfg #	Output BTU	Input BTU	AFUE	Dimensions (in)	Weight (lb)	Price
COLDFAA084	DFAA084BBTA	69,000	84,000	80.0	76" x 20" x 24"	173	CALL

Compact™ Series DFAH 80%+ Downflow Mobile Home Oil Furnaces

- Sealed combustion
- Air conditioning ready to 3 tons, built-in coil cabinet
- Fail-safe automatic hot surface ignition system
- Full louver high impact plastic return air door
- Standard replaceable filters (included)
- Approved for mobile/modular homes
- 1-Year limited parts & labor warranty

Part #	Mfg #	Output BTU	Input BTU	AFUE	Dimensions (in)	Weight (lb)	Price
COLDFAH084	DFAH084BBSA	69,000	84,000	75.3	60" x 19-1/2" x 24-1/2"	175	CALL

Heating

Thank you for doing business with us. We appreciate your order.

All Items May Not Be Stocked In All Branches

Unit Heaters

Hot Dawg® Gas-Fired Low Profile Commercial Heaters

Power Exhausted, Gas-Fired Low Profile Heater

- 80% Thermal efficiency
- Horizontal or vertical venting
- Field convertible to propane
- Low profile casing
- 115-1-60, Hot surface ignition, single-stage, direct spark
- 100% Shut-off with continuous retry
- Installs 1" from ceiling with only two angle brackets (included)
- 10-Year warranty on heat exchanger



Part #	Mfg #	Type Gas	BTUH Input	BTUH Output	Air Vent Dia	Entering Air CFM	Air Temp Rise	Max Mount Height	Heat Throw	Ship Wt	Price
MODHD30	HD30-AS-01-11	NG	30,000	24,000	3"	505	44°F	10'	25'	55 lbs	CALL
MODHD45	HD45-AS-01-11	NG	45,000	36,000	3" or 5"	720	46°F	10'	27'	60 lbs	CALL
MODHD60	HD60-AS-01-11	NG	60,000	48,000	3" or 5"	990	45°F	12'	36'	80 lbs	CALL
MODHD75	HD75-AS-01-11	NG	75,000	60,000	3" or 5"	1,160	48°F	14'	38'	85 lbs	CALL
MODHD100	HD100-AS-01-11	NG	100,000	80,000	4"	1,490	50°F	12'	42'	125 lbs	CALL
MODHD125	HD125-AS-01-11	NG	125,000	100,000	4"	1,980	47°F	16'	56'	125 lbs	CALL

Hot Dawg® Parts

Part #	Mfg #	Description	Price
MODHDLP	3H34933A1	Natural Gas to LP Gas Conversion Kit	57.94
MODHDLP100	53080	100,000 BTU LP Gas Conversion Kit	64.02
MODHDLP125	53081	125,000 BTU LP Gas Conversion Kit	64.02
MOD27865	27865	3" Breidert Vent Cap for Modine Separated Combustion Unit Heaters	117.72
MOD27867	27867	5" Breidert Type L Cap for Separated Combustion Unit Heater	157.52

Gas-Fired Power Exhausted High-Efficiency II™ Propeller Unit Heaters

- CSA Certification for use in the US and Canada
- 80% Thermal efficiency
- Power exhauster motor
- Differential pressure switch for proof of venting
- Aluminized steel heat exchanger
- Aluminized steel burner with stainless steel separator strip
- Certified to 0.5"wc external static pressure
- High limit safety control
- Control terminal board
- Adjustable motor sheaves on blower motors
- 115-1-60, Totally enclosed fan/blower motors



Single-Stage, Intermittent Pilot Ignition, Natural Gas Propeller Unit Heater

Part #	Mfg #	BTUH Input	BTUH Output	Vent Transition Outlet	Air CFM @70°F	Max Temp Rise	Heat Mounting Ht	Motor Throw	Motor HP	Price
MODPDP150	PDP150AE0130	150,000	120,000	4"	2,180	51°F	16'	55'	1/8PSC	CALL
MODPDP175	PDP175AE0130	175,000	140,000	5"	2,550	51°F	17'	59'	1/6PSC	CALL
MODPDP200	PDP200AE0130	200,000	160,000	5"	2,870	52°F	15'	51'	1/6PSC	CALL
MODPDP300	PDP300AE0130	300,000	240,000	6"	4,460	50°F	21'	74'	1/2PSC	CALL
MODPDP400	PDP400AE0130	400,000	320,000	6"	5,440	54°F	19'	69'	3/4PSC	CALL

Heating

Prices & Specifications are Subject to Change.

Unit Heaters

Effinity93 High Efficiency Separated Combustion Gas Fired Unit Heater

- Exclusive Conservicore™ technology relieves fear of failure thanks to its ability to withstand acidic condensate
- Designed for faster installation and lower installation costs
- The Contractor Convenience Package is standard on all units, allowing for easier connectivity and troubleshooting
- Power exhauster with round vent pipe and combustion air inlet pipe connections
- Automatic reset vent pressure switch
- 115V to 24V Control step-down transformer
- Integrated direct spark control board
- Remote flame sensor
- Single stage gas valve
- Direct spark igniter
- High limit switches
- Condensate drain overflow switch
- Gas pipe, condensate drain, combustion air and vent pipe (Fernco® rubber boot) connections
- Fan guard
- External junction box
- Horizontal air deflector blades (hidden)

Effinity⁹³
with Conservicore™ Technology



Part #	Mfg #	BTUH Input	BTUH Output	Vent Dia	Air CFM @70°F	Air Temp Rise	Max Mount Height	Max Throw	Motor Type, HP,RPM	Approx Ship Wt	Price
MODPTC135	PTC135	135,000	125,550	3"	2160	54°F	14'	51'	PSC, 1/3, 1075	165 lbs	CALL
MODPTC155	PTC155	155,000	144,150	4"	2510	53°F	17'	59'	PSC, 1/3, 1075	165 lbs	CALL
MODPTC215	PTC215	215,000	199,950	4"	3865	48°F	17'	60'	PSC, 1/2, 1075	265 lbs	CALL

Effinity93 High Efficiency Single-Stage, 115V-60Hz Separated Combustion Gas Fired Unit Heater

Part #	Mfg #	BTUH Input	BTUH Output	Vent Dia	Air CFM @70°F	Air Temp Rise	Max Mount Height	Max Throw	Motor Type, HP,RPM	Approx Ship Wt	Price
MODPTC260	PTC260AS0111	260,000	241,800	4"	4585	49°F	20'	70'	PSC, 3/4, 1125	265 lbs	CALL
MODPTC310	PTC310AS0111	310,000	288,300	6"	5400	49°F	19'	67'	PSC, 3/4, 1125	310 lbs	CALL

Steam/Hot Water, Horizontal Delivery Unit Heaters

- Ideal for heating buildings with large open areas and low ceilings
- Top and bottom supply and return connections which permits unit to be rotated 360° without piping changes
- Two-piece casing for easy coil access
- Adjustable horizontal deflector blades
- Built-in fan safety guard
- 115V-1-60Hz, Single-phase, totally-enclosed motor with built-in thermal overload protection



Heating

Part #	Mfg #	Input BTUH	Final Air Temp @60°F* Entering Air	Max Mount Height	Entering CFM	Fan Dia	Motor HP, RPM	Connections Female	Approx Ship Wt	Price
MODHS18	HSB18	18,000	107°F	8'	340	9"	1/60, 1550	3/4" NPT	16 lbs	CALL
MODHS24	HSB24	24,000	119°F	9'	370	9"	1/25, 1550	3/4" NPT	20 lbs	CALL
MODHS33	HSB33	33,000	108°F	10'	630	12"	1/25, 1550	1-1/4" NPT	34 lbs	CALL
MODHS47	HSB47	47,000	119°F	12'	730	12"	1/12, 1550	1-1/4" NPT	36 lbs	CALL
MODHS63	HSB63	63,000	111°F	14'	1120	14"	1/12, 1550	1-1/4" NPT	48 lbs	CALL
MODHS86	HSB86	86,000	118°F	15'	1340	14"	1/8, 1625	1-1/4" NPT	52 lbs	CALL

*Data is under standard conditions and at high motor speed

All Items May Not Be Stocked In All Branches

Oil Furnaces

Oil Furnaces

CHB Centennial High Boy Oil-Fired Water Furnace

- Heaviest heat exchanger
- Interior baffling
- Dual spring-loaded clean-out ports
- Spring-loaded observation port with test port
- Heavy gauge burner mounting plate with studs and nuts
- Multi-speed direct drive blower motor
- Heavy gauge with "Seal-Tite" construction cabinet with appliance finish powder coat paint
- Foil faced insulation
- Preformed slide-out combustion chamber
- Factory wired burner and controls
- Lifetime limited warranty on heat exchanger
- 5-Year limited warranty on parts



Part #	Mfg #	Max Cooling Tons	Input BTUH	Output BTUH	Type	Burner	AFUE w/o Elec Damper	Shipping Weight	Price
WILCHB105	CHB105-DDS2BW	3-1/2	105,000	89,400	Direct-Drive	Beckett	82.8	265	CALL
WILCHB140	CHB140-DDS2BW	5	140,000	119,900	Direct-Drive	Beckett	82.4	315	CALL

CLB Centennial Low Boy Oil-Fired Water Furnace

- Heaviest heat exchanger
- Interior baffling
- Dual spring-loaded clean-out ports
- Spring-loaded observation port with test port
- Heavy gauge burner mounting plate with studs and nuts
- Multi-speed direct drive blower motor
- Heavy gauge with "Seal-Tite" construction cabinet with appliance finish powder coat paint
- Foil faced insulation
- Preformed slide-out combustion chamber
- Factory wired burner and controls
- Lifetime limited warranty on heat exchanger
- 5-Year limited warranty on parts



Part #	Mfg #	Max Cooling Tons	Input BTUH	Output BTUH	Type	Burner	AFUE w/o Elec Damper	Shipping Weight	Price
WILCLB105F	CLB105-DDFS2BW	3-1/2	105,000	90,200	Direct-Drive Front	Beckett	82.8	250	CALL
WILCLB105R	CLB105-DDRS2BW	3-1/2	105,000	90,200	Direct-Drive Rear	Beckett	82.8	250	CALL
WILCLB140F	CLB140-DDFS2BW	5	140,000	119,900	Direct-Drive Front	Beckett	85.7	345	CALL
WILCLB140R	CLB140-DDRS2BW	5	140,000	119,900	Direct-Drive Rear	Beckett	85.7	345	CALL

Heating

Prices & Specifications are Subject to Change.

Oil Furnaces

PLB Low Boy Oil-Fired Water Furnace

- Rear flue heavy gauge stainless steel primary heat exchanger
- Heavy gauge with "Seal-Tite" construction cabinet with appliance finish powder coat paint
- Foil faced insulation
- PSC motor
- Factory wired burner and controls
- Solid state ignitor
- PLB-210: 34-3/4"H x 21-1/4"W x 50-3/4"D
- Residential Use:
 - Limited lifetime warranty on heat exchanger
 - 5-Year limited warranty on parts
- Commercial or industrial use:
 - 5-Year limited warranty on heat exchanger
 - 3-Year limited warranty on other components



Part #	Mfg #	Max Cooling Tons	Input BTUH	Output BTUH	Type	Burner	AFUE w/o Elec Damper	Shipping Weight	Price
WILPLB210	PLB210-DDRS2BW	5	210,000	171,000	Direct-Drive Rear	Beckett	85.7	250	CALL

TLB Temp-O-Matic Multi-Position Series 2 Oil-Fired Furnace

- Heavy gauge wrap-around heat exchanger
- Interior baffling
- Spring-loaded observation port with test port
- Heavy gauge burner mounting plate with studs and nuts
- Multi-speed direct drive blower motor
- Heavy gauge with "Seal-Tite" construction cabinet with appliance finish powder coat paint
- Foil faced insulation
- Preformed slide-out combustion chamber
- Factory wired burner and controls
- Lifetime limited warranty on heat exchanger
- 5-Year limited warranty on parts



Part #	Mfg #	Max Cooling Tons	Input BTUH	Output BTUH	Type	Burner	AFUE	Shipping Weight	Price
WILTMP105	TMP105-DDS2BW	2-1/2	105,000	85,200	Direct-Drive	Beckett	80.2	205	CALL

Burners

Part #	Mfg #	Description	Price
WILWL4205C	BBCHB/LB105S2	Beckett Burner WI 4205C f/CHB/CLB 105 Furnace	CALL
WILC8512447	RBCHB/LB105S2	Riello Burner C8512447 f/CHB/CLB 105 Furnace	762.00

Heating

Wood & Combination Furnaces

Caddy Wood and Combination Furnaces

Caddy E.P.A. Combination Furnace

- Wood only, wood-electric, wood-oil or wood add-on
- Wood only furnace requires the addition of a blower box PA08568 and a fan limit kit PA00500
- Wood-electric furnace requires the addition of a blower box PA08568 and an electric element PA01000, PA01050 or PA01100
- Wood-oil requires the addition of a blower box PA08568 and an oil unit PA03050 or PA03100
- Wood add-on furnace requires the addition of a fan limit kit PA08522
- Furnace exterior dimensions: 47-7/8"H x 26"W x 29-7/8"D
- Firebox dimensions: 16"H x 17"W x 22.5"D



Part #	Mfg #	Max Input Cap	Wgt	Price
SBICADDY	PF01010	140,000	510 lbs	CALL

Max Caddy E.P.A. Combination Furnace

- Wood, wood-electric or wood-oil
- Requires the addition of a blower box and electronic fan limit kit PA08565
- G-10 1/2HP 1780 CFM blower
- Recommended chimney diameter:
 - Wood or wood-electric: 6"
 - Wood-oil: 7"
- Furnace exterior dimensions: 50"H x 30"W x 62"D
- Firebox dimensions: 14-1/2"H x 20-3/8"W x 26-1/4"D



Part #	Mfg #	Max Input Cap	Wgt	Price
SBIMAXCADDY	PF01101	180,000	650 lbs	CALL

Pellet Furnaces

Caddy Alterna Pellet Furnace

- Warm-air pellet furnace, 81.2% efficiency
- Wood and biomass pellets
- Bottom-feed burner; tested with standard wood pellets, 100% bark pellets, sawdust/hay mix pellets and switch grass pellets
- Regulated feed rate
- 240 lb Hopper
- LCD Control panel
- Can accept optional electric element
- Furnace exterior: 47"H x 26-1/4"W x 56-1/4"D
- Ash drawer: 7-3/4"H x 19-15/16"W x 14"D
- Glass door with cast iron frame
- Limited lifetime warranty



Part #	Mfg #	Max Input Cap	Max Output Cap	Wgt	Price
SBIALTERNA	PF09000	120,000	108,000	500 lbs	CALL

Heating

Prices & Specifications are Subject to Change.

Wood-Burning Furnace

Wood-Burning Furnaces

Icon High Efficiency Wood Furnace

- Wood-burning furnace
- Smoke free combustion with air curtain
- Smokeless loading
- Dual lock system
- Clean burning gasification technology
- Refires automatically from stand-by, self-regulating combustion controls
- Maintains constant water temperatures
- Refractory fire brick lining retains heat
- 10-12 Hour burn times
- Up to 90% efficiency
- Dual combustion downdraft system
- Insulated exterior - safe to touch
- No extra water storage tank necessary, built-in reservoir
- Ash door and tray
- Large firebox for wood up to 24" long, 6" diameter
- 16" x 14" Loading door opening
- Burn 24" or 36" wood up to 10" diameter
- Water level indicator
- Primary and secondary burn chambers
- 21"H x 19"W x 28"D Firebox
- 60 Gallon water capacity
- 48"H x 28"W x 52"L Furnace
- Includes flue cleaning brush and ash rake
- Minimum clearance to combustibles:
 - 12" Flue pipe/side and back wall
 - 48" Front
 - 24" Ceiling



Part #	Mfg #	Description	Price
PRFICON100	ICON 100	60 gal 125,000 BTU Peak Wood-Burning, 945#	CALL

Add-On Boilers

Add-On Boilers

The Logwood™ Add-On Boiler

- Wood-burning boiler
- For operation with existing oil or gas fired central hot water heating systems
- Provides dual fuel heating
- Closed pressure vessels
- Burn 24" or 36" wood up to 10" diameter
- 15" x 11" Firedoor
- Heavy cast iron grates
- Non-electric, automatic draft regulator
- ASME pressure relief valve
- Fusible (melt out) plug
- Heavy, 1/4" steel plate design
- 5-Year limited warranty



Part #	Mfg #	Description	Price
LOGAOB24W	AOB24W	25 gal 70,000 BTU Wood-Burning, 625#	CALL
LOGAOB24C	AOB24C	25 gal 100,000 BTU Coal-Burning, 625#	CALL

Quality people, quality products, excellent service.

Heating



www.irrsupply.com

Residential Heaters

QMark® Residential Heaters

CRA Series Fan-Forced Zonal Wall Heater

- Fast-response coil element assures quick heat and low maintenance
- 3-Piece construction for ease of installation
- European styling: sleek rounded corners
- Dual protection: thermal cutout with indicator light and one time thermal fuse
- Northern white finish
- 500-1000W Units are approved for ceiling mount



Part #	Mfg #	Description	Price
BBEMCRA2024T2	CRA2024-T2	2000/1500/1000/500W, 240V, 8.3/6.3/4.2/2.1A, 11 lbs	223.70

QPH4A Portable Unit Heater

- Easy to carry with built-in handles
- (2) Heat settings: 9100 BTUs (2667 Watts), 13650 BTUs (4000 Watts)
- Permanently lubricated, unit-bearing fan motor
- Adjustable thermostat to maintain heating comfort levels
- Operates on 240V
- 3-Way bracket lets you stand unit on floor or other flat surface, or mount on ceiling or wall
- Comes with 6' cord
- 5-Year-limited warranty on heating elements



Part #	Mfg #	Description	Price
BBEMQPH4A	QPH4A	2667/2000W Low 4000/3000W High, 240/208V, 20A , 25 lbs	427.09



Residential Gas Heaters

Infrared Vent-Free Heater - Manual 1-Heat Setting

- Standing pilot/Piezo ignition systems



Part #	Mfg #	Input BTUH	Gas Type	Ship Weight	Price
EMPSR6LP	SR-6 LP	6,000	LP	18 lbs	298.00
EMPSR10	SR-10 NG	10,000	NG	18 lbs	298.00

Heating

All Items May Not Be Stocked In All Branches



www.irrsupply.com

Residential Heating

Infrared Vent-Free Heater - Manual 3-Heat Setting

- Standing pilot/Piezo ignition systems



SR-18

SR-30

Part #	Mfg #	Input BTUH	Gas Type	Ship Weight	Price
EMPSR18	SR-18 NG	18,000	NG	27 lbs	362.00
EMPSR18LP	SR-18 LP	18,000	LP	27 lbs	362.00
EMPSR30	SR-30 NG	30,000	NG	35 lbs	493.00
EMPSR30LP	SR-30 LP	30,000	LP	35 lbs	493.00

Infrared Vent-Free Heater - Hydraulic Thermostats

- Standing pilot/Piezo ignition systems



SR-6/10

SR-18

SR-30

Part #	Mfg #	Input BTUH	Gas Type	Ship Weight	Price
EMPSR10T	SR-10T NG	10,000	NG	18 lbs	379.00
EMPSR10TLP	SR-10T LP	10,000	LP	18 lbs	379.00
EMPSR18T	SR-18T NG	18,000	NG	27 lbs	477.00
EMPSR18TLP	SR-18T LP	18,000	LP	27 lbs	477.00
EMPSR30T	SR-30T NG	30,000	NG	35 lbs	615.00
EMPSR30TLP	SR-30T LP	30,000	LP	35 lbs	615.00

Heater Accessories

Part #	Mfg #	Description	Price
EMPSRB18T	SRB-18T	Automatic Blower for SR-18T	115.00
EMPSRB30T	SRB-30T	Automatic Blower for SR-30T	115.00
EMPSRS18	SRS-18	Stand for Floor Installation of SR-18 & SR-18T	56.00
EMPSRS30	SRS-30	Stand for Floor Installation of SR-30 & SR-30T	56.00

Heating

Prices & Specifications are Subject to Change.



www.irrsupply.com

Residential Heating

Blue Flame Vent-Free Room Heater

- Visual warmth of an alluring blue flame
- Modulating hydraulic thermostat



BF-10, BF-20



BF-30

Part #	Mfg #	Input BTUH	Dimensions	Price
EMPBF10	BF-10 NG	10,000	18" x 6-1/2" x 22"	393.00
EMPBF10LP	BF-10 LP	10,000	18" x 6-1/2" x 22"	393.00
EMPBF20	BF-20 NG	18,000	18" x 6-1/2" x 22"	418.00
EMPBF20LP	BF-20 LP	20,000	18" x 6-1/2" x 22"	418.00
EMPBF30	BF-30 NG	30,000	24-1/8" x 6-1/2" x 22"	496.00
EMPBF30LP	BF-30 LP	30,000	24-1/8" x 6-1/2" x 22"	496.00

Console Vented Room Heater

- Ideal for medium to large rooms
- Hydraulic thermostat control
- Standing pilot/Piezo ignition system
- Beige powder coated cabinet
- Add optional blower for added circulation
- 37"W x 11-1/2"D x 26"H
- 10-Year limited warranty on combustion chamber
- 1-Year limited warranty on other parts



Part #	Mfg #	Input BTUH	Gas Type	Ship Weight	Price
EMPRH25	RH-25 NG	25,000	NG	84 lbs	918.00
EMPRH25LP	RH-25 LP	25,000	LP	84 lbs	918.00
EMPRH35	RH-35 NG	35,000	NG	88 lbs	1007.00
EMPRH35LP	RH-35 LP	35,000	LP	88 lbs	1007.00

Visual Flame Vented Room Heater

- Hydraulic thermostat control
- Standing pilot/Piezo ignition system
- Beige powder coated cabinet
- Includes automatic blower
- 34"W x 16"D x 29-9/16"H
- 10-Year limited warranty on combustion chamber
- 1-Year limited warranty on other parts



Part #	Mfg #	Input BTUH	Gas Type	Ship Weight	Price
EMPRH50B	RH-50B NG	50,000	NG	124 lbs	1502.00
EMPRH50BLP	RH-50B LP	50,000	LP	124 lbs	1502.00
EMPRH65B	RH-65B NG	65,000	NG	142 lbs	1639.00
EMPRH65BLP	RH-65B LP	65,000	LP	142 lbs	1639.00

Heating

All Items May Not Be Stocked In All Branches



www.irrsupply.com

Residential Heating

Closed Front Vented Room Heater

- Hydraulic thermostat control
- Standing pilot/Piezo ignition system
- Beige powder coated cabinet
- RH-50CB 29-9/16"H x 34"W x 16"
RH-65CB 29-9/16"H x 34"W x 20"
- C Models: add optional blower for added circulation (included with CB models)
- 10-Year limited warranty on combustion chamber
- 1-Year limited warranty on other parts



Part #	Mfg #	Input BTUH	Gas Type	Ship Weight	Price
EMPRH50CB	RH-50CB-NG	50,000	NG	124 lbs	1222.00
EMPRH50CBLP	RH-50CB-LP	50,000	LP	124 lbs	1222.00
EMPRH65C	RH-65C-NG	65,000	NG	142 lbs	1187.00
EMPRH65CB	RH-65CB-NG	65,000	NG	142 lbs	1382.00
EMPRH65CBLP	RH-65CB-LP	65,000	LP	142 lbs	1382.00

RH Room Heater Accessories

Part #	Mfg #	Description	Price
EMPRAD8	RAD-8	Radiants & Supports	173.00
EMPRHL2	RHL-2	Log Kit f/RH-50B & RH-65B	72.00
EMPRH425	RH425	Floor Pad	82.00

Residential Wall Furnaces

Direct Vent Wall Furnace - DV-210/DV-215

- Millivolt wall thermostat control
- Matchless Piezo ignition system
- Beige cabinet and front panel
- Optional blower available
- Includes standard vent kit through outside wall
- DV-210 16-1/4"W x 9-3/8"D x 21-3/8"H
- DV-215 20-1/4"W x 9-3/8"D x 24-7/8"H
- 10-Year limited warranty on combustion chamber
- 1-Year limited warranty on other parts



Part #	Mfg #	Input BTUH	Gas Type	Ship Weight	Price
EMPDV210	DV-210-SG NG	10,000	NG	42 lbs	806.00
EMPDV210LP	DV-210-SG LP	10,000	LP	42 lbs	806.00
EMPDV215	DV-215-SG NG	15,000	NG	60 lbs	903.00
EMPDV215LP	DV-215-SG LP	15,000	LP	60 lbs	903.00

Heating

Prices & Specifications are Subject to Change.



www.irrsupply.com

Residential Heating

Direct Vent Wall Furnace - DV-25/DV-35

- Beige cabinet and front panel
- Millivolt wall thermostat control
- Standing pilot/Piezo ignition system
- 37"W x 11-1/2"D x 27-1/4"H
- 10-Year limited warranty on combustion chamber
- 1-Year limited warranty on other parts



Part #	Mfg #	Input BTUH	Gas Type	Ship Weight	Price
EMPDV25	DV-25-SG-NG	25,000	NG	98 lbs	1118.00
EMPDV25LP	DV-25-SG-LP	25,000	LP	98 lbs	1118.00
EMPDV35	DV-35-SG-NG	35,000	NG	101 lbs	1178.00
EMPDV35LP	DV-35-SG-LP	35,000	LP	101 lbs	1178.00

High Efficiency Direct Vent Wall Furnace

- Beige cabinet and front panel
- Electronic thermistor thermostat
- Hot surface/electronic ignition system
- Filtered air system
- Mobile home certified
- 26"H x 37"W x 15-3/4"D
- 10-Year limited warranty on combustion chamber
- 5-Year limited warranty on other parts with 2-year limited labor warranty



Part #	Mfg #	Input BTUH	Gas Type	Ship Weight	Price
EMPDV20E	DV-20E-NG	20,000	NG	128 lbs	2039.00
EMPDV40E	DV-40E-NG	40,000	NG	135 lbs	2583.00
EMPDV55E	DV-55E-NG	55,000	NG	146 lbs	2983.00

Direct Vent Wall Furnace Accessories

Part #	Mfg #	Description	Price
EMPDVB1	DVB-1	Automatic Blower DV-210 & 215	200.00
EMPDV822	DV-822	Vinyl Siding Vent Kit	69.00
EMPDV844	DV-844	Extension Tube	25.00
EMPDV845	DV-845	6" Outer Extension Pipe f/DV-25/35	31.00



www.irrsupply.com

Residential Heating

76% AFUE Direct Vent Counterflow Wall Furnace - DVC-35/DV-55

- 24V Wall thermostat
- DVC-35 May be recessed between standard wall studs
- DV-55 and DVC-35 Install on outside walls
- Front panels remove easily for cleaning and servicing
- Beige cabinet and front panels
- Dimensions:
DVC-35 14-1/8"W x 10-3/8"D x 72-1/2"H
DV-55 16"W x 11-5/16"D x 82-3/8"H
- 1-Year limited warranty on other parts
- 10-Year limited warranty on combustion chamber



Standing Pilot/Piezo Ignition Furnace

Part #	Mfg #	Input BTUH	Gas Type	Ship Weight	Price
EMPDVC35SPP	DVC-35-SPP-NG	35,000	NG	115 lbs	1568.00
EMPDVC35SPPLP	DVC-35-SPP-LP	35,000	LP	115 lbs	1568.00
EMPDV55SPP	DV-55-SPP-NG	55,000	NG	140 lbs	1808.00
EMPDV55SPPLP	DV-55-SPP-LP	55,000	LP	140 lbs	1808.00

Electronic Ignition Furnace

Part #	Mfg #	Input BTUH	Gas Type	Ship Weight	Price
EMPDVC35IP	DVC-35-IP-NG	35,000	NG	115 lbs	1925.00
EMPDV55IP	DV-55-IP-NG	55,000	NG	140 lbs	2166.00
EMPDV55IPLP	DV-55-IP LP	55,000	LP	140 lbs	2166.00

76% AFUE Up-Vented Counterflow Wall Furnace - FAW-40/FAW-55

- 24V Wall thermostat control
- FAW-40 May be recessed between standard wall studs
- FAW-55 and FAW-40 Installs on inside or outside walls
- 4" Oval venting
- Front panels remove easily for cleaning and servicing
- Beige cabinet and front panels
- Dimensions:
FAW-40 14-1/8"W x 10-3/8"D x 72-1/2"H
FAW-55 16"W x 11-5/16"D x 82-3/8"H
- 1-Year limited warranty on other parts
- 10-Year limited warranty on combustion chamber



Standing Pilot/Piezo Ignition Furnace

Part #	Mfg #	Input BTUH	Gas Type	Ship Weight	Price
EMPFAW40SPP	FAW-40-SPP-NG	40,000	NG	110 lbs	1363.00
EMPFAW40SPPLP	FAW-40-SPP-LP	40,000	LP	110 lbs	1363.00
EMPFAW55SPP	FAW-55-SPP-NG	55,000	NG	135 lbs	1601.00
EMPFAW55SPPLP	FAW-55-SPP-LP	55,000	LP	135 lbs	1601.00

Electronic Ignition Furnace

Part #	Mfg #	Input BTUH	Gas Type	Ship Weight	Price
EMPFAW55IP	FAW-55-IP-NG	55,000	NG	135 lbs	1959.00

Heating

Prices & Specifications are Subject to Change.



www.irrsupply.com

Residential Heating

Gravity Vented Wall Furnace

- Millivolt wall thermostat control
- GWT-25/35 Recesses into the wall
- Dual wall unit GWT-50 heats two rooms
- Standing pilot, piezo ignition
- 66-1/8"H x 16"W x 6"D
- 4" Oval venting
- Beige cabinet and front panels
- 1-Year limited warranty on other parts
- 10-Year limited warranty on combustion chamber



Part #	Mfg #	Input BTUH	Gas Type	Ship Weight	Price
EMPGWT25	GWT-25-NG	25,000	NG	86 lbs	749.00
EMPGWT35	GWT-35-NG	35,000	NG	86 lbs	806.00
EMPGWT50	GWT-50-NG	50,000 (a)	NG	133 lbs	1126.00

(a) 25,000 each room

Gravity Wall Furnace Accessories

Part #	Mfg #	Description	Price
EMPGWTB2	GWTB-2	Automatic Blower Kit	290.00
EMPGWTR1	GWTR-1	Rear Register Kit	136.00
EMPGWTW2	GWTW-2	Beige Out-of-the-Wall Kit	302.00

Floor Furnace

- Millivolt wall thermostat control
- Standing pilot/Piezo ignition system



Part #	Mfg #	Input BTUH	Gas Type	Ship Weight	Price
EMP3588	3588-NG	32,500	NG	108 lbs	1508.00
EMP5088	5088-NG	45,000	NG	128 lbs	1601.00
EMP7088	7088-NG	65,000	NG	152 lbs	1873.00

Heating

All Items May Not Be Stocked In All Branches

Ductless Split Systems

Single Zone Systems

M-Series (R-410A) Wall-Mount Ductless Air Conditioners

- Residential & light commercial applications
- Efficient, quiet operation
- No ductwork, easy to install
- Wireless remote controller
- R-410A Inverter Technology
 - High-speed cooling and heating (high rotation)
 - Low rotation speed maintains temperature, keeps starting current low leaving other appliances unaffected
 - Precise rotation speed for comfortable, consistent room temperature
 - A-Control System - Indoor unit is powered through the outdoor unit through three polarity sensitive wires and a ground conductor providing power and communication
- Washable long-life anti-allergen filters
- Advanced microprocessor controls

MS Non-Inverter Wall-Mount Ductless Cooling Only - R-410A

- Wireless remote
- Electrical 115-1-60
- 7-Year compressor warranty; 5-year parts warranty



Part #	Mfg #	Unit	Cooling BTUH	System SEER	Power Supply	Dimensions (H" x W" x D")	Unit Weight	Price
MITMSA09WA	MSA-09WA	Indoor	9,500	13.0	115-1-60	11-3/4 x 30-11/16 x 8-1/4	23 lbs	CALL
MITMUA09WA	MUA-09WA	Outdoor	9,500	13.0	115-1-60	21-5/8 x 31-1/2 x 11-1/4	78 lbs	CALL
MITMSA12WA	MSA-12WA	Indoor	12,000	13.0	115-1-60	11-3/4 x 30-11/16 x 8-1/4	23 lbs	CALL
MITMUA12WA	MUA-12WA	Outdoor	12,000	13.0	115-1-60	23-13/16 x 33-7/16 x 11-7/16	96 lbs	CALL

MSY Inverter-Driven Wall-Mount Ductless Cooling Only - R-410A

- MSY (GE24,D30,D36) Models have a WIDE VANE button to evenly distribute airflow to a wider angle (150°) from right to left
- Wireless remote
- Electrical 208/230-1-60
- Energy Star Systems: MSY-GE09, MSY-GE12, MSY-GE15, MSY-GE24
- Tax Credit Systems: MSY-GE09, MSY-GE15
- 7-Year compressor warranty; 5-year parts warranty

INVERTER



Part #	Mfg #	Unit	Cooling BTUH	System SEER	Power Supply	Dimensions (H" x W" x D")	Unit Weight	Price
MITMSYGE09	MSY-GE09NA	Indoor	9,000	21.0	208/230-1/60	11-5/8 x 31-7/16 x 9-1/8	22 lbs	CALL
MITMUYGE09	MUY-GE09NA	Outdoor	9,000	21.0	208/230-1-60	21-5/8 x 31-1/2 x 11-1/4	66 lbs	CALL
MITMSYGE12	MSY-GE12NA	Indoor	12,000	20.5	208/230-1-60	11-5/8 x 31-7/16 x 9-1/8	22 lbs	CALL
MITMUYGE12	MUY-GE12NA	Outdoor	12,000	20.5	208/230-1-60	21-5/8 x 31-1/2 x 11-1/4	77 lbs	CALL
MITMSYGE15NA	MSY-GE15NA	Indoor	14,000	21.0	208/230-1-60	11-5/8 x 31-7/16 x 9-1/8	22 lbs	CALL
MITMUYGE15NA	MUY-GE15NA	Outdoor	14,000	21.0	208/230-1-60	21-5/8 x 31-1/2 x 11-1/4	80 lbs	CALL
MITMSYGE18NA	MSY-GE18NA	Indoor	17,200	19.2	208/230-1-60	11-5/8 x 31-7/16 x 9-1/8	22 lbs	CALL
MITMUYGE18NA	MUY-GE18NA	Outdoor	17,200	19.2	208/230-1-60	33-7/16 x 33-1/16 x 13	118 lbs	CALL
MITMSYGE24NA	MSY-GE24NA	Indoor	22,500	19.0	208/230-1-60	12-13/16" x 43-5/16" x 9-3/8"	37 lbs	CALL
MITMUYGE24NA	MUY-GE24NA	Outdoor	22,500	19.0	208/230-1-60	34-5/8" x 33-1/16" x 13"	117 lbs	CALL
MITMSYD30NA	MSY-D30NA	Indoor	30,700	16.0	208/230-1-60	14-3/8 x 46-1/16 x 11-5/8	40 lbs	CALL
MITMUYD30NA	MUY-D30NA	Outdoor	30,700	16.0	208/230-1-60	33-7/16 x 33-1/16 x 13	126 lbs	CALL
MITMSYD36NA	MSY-D36NA	Indoor	34,600	15.1	208/230-1-60	14-3/8 x 46-1/16 x 11-5/8	40 lbs	CALL
MITMUYD36NA	MUY-D36NA	Outdoor	34,600	15.1	208/230-1-60	33-7/16 x 33-1/16 x 13	126 lbs	CALL

Prices & Specifications are Subject to Change.

Mini-Splits

Ductless Split Systems

Single Zone Systems

MSZ Inverter-Driven Wall-Mount Ductless Heat Pump - R-410A

- MSZ (FE18,GE24,D30,D36) Models have a WIDE VANE button to evenly distribute airflow to a wider angle (150°) from right to left
- Hot start technology
- Enhanced filtration
- Auto changeover on heat pump MUZ outdoor units
- Wireless remote
- Energy Star Systems: MSZ-GE09, MSZ-GE12, MSZ-GE15, MSZ-FE09, MSZ-FE12, MSZ-FE18, MSZ-GE24
- Tax Credit Systems: MSZ-GE09, MSZ-GE12, MSZ-GE15, MSZ-FE09, MSZ-FE12, MSZ-FE18, MSZ-GE24
- MSZ-FE09 & MSZ-FE12 feature i-see™ Sensor technology for superior cooling/heating
- H2i® for exceptional heating MSZ-FE09, MSZ-FE12 & MSZ-FE18
- 7-Year compressor warranty; 5-year parts warranty

Wireless Remote



MSZ-A09 thru 18



MSZ-A24 thru 30

Part #	Mfg #	Unit	Cool/Heat BTUH	System SEER/HSPF	Power Supply	Dimensions (H" x W" x D")	Unit Weight	Price
MITMSZGE09NA	MSZ-GE09NA	Indoor	9,000/10,900	21.0/10.0	208/230-1-60	11-5/8 x 31-7/16 x 9-1/8	22 lbs	CALL
MITMUZGE09NA	MUZ-GE09NA	Outdoor	9,000/10,900	21.0/10.0	208/230-1-60	21-5/8 x 31-1/2 x 11-1/4	66 lbs	CALL
MITMSZFE09NA	MSZ-FE09NA	Indoor	9,000/10,900	26.0/10.0	208/230-1-60	11-5/8 x 31-3/8 x 10-1/8	27 lbs	CALL
MITMUZFE09NA	MUZ-FE09NA	Outdoor	9,000/10,900	26.0/10.0	208/230-1-60	21-5/8 x 31-1/2 x 11-1/4	80 lbs	CALL
MITMSZGE12NA	MSZ-GE12NA	Indoor	12,000/14,400	20.5/10.0	208/230-1-60	11-5/8 x 31-7/16 x 9-1/8	22 lbs	CALL
MITMUZGE12NA	MUZ-GE12NA	Outdoor	12,000/14,400	20.5/10.0	208/230-1-60	21-5/8 x 31-1/2 x 11-1/4	77 lbs	CALL
MITMSZFE12NA	MSZ-FE12NA	Indoor	12,000/13,600	23.0/10.5	208/230-1-60	11-5/8 x 31-3/8 x 10-1/8	27 lbs	CALL
MITMUZFE12NA	MUZ-FE12NA	Outdoor	12,000/13,600	23.0/10.0	208/230-1-60	21-5/8 x 31-1/2 x 11-1/4	80 lbs	CALL
MITMSZGE15NA	MSZ-GE15NA	Indoor	14,000/18,000	21.0/10.0	208/230-1-60	11-5/8 x 31-7/16 x 9-1/8	22 lbs	CALL
MITMUZGE15NA	MUZ-GE15NA	Outdoor	14,000/18,000	21.0/10.0	208/230-1-60	21-5/8 x 31-1/2 x 11-1/4	80 lbs	CALL
MITMSZGE18NA	MSZ-GE18NA	Indoor	17,200/21,600	19.2/10.0	208/230-1-60	11-5/8 x 31-7/16 x 9-1/8	22 lbs	CALL
MITMUZGE18NA	MUZ-GE18NA	Outdoor	17,200/21,600	19.2/10.0	208/230-1-60	33-7/16 x 33-1/16 x 13	119 lbs	CALL
MITMSZFE18NA	MSZ-FE18NA	Indoor	17,000/21,600	20.2/10.3	208/230-1-60	12-13/16 x 43-5/16 x 9-3/8	37 lbs	CALL
MITMUZFE18NA	MUZ-FE18NA	Outdoor	17,000/21,600	20.2/10.3	208/230-1-60	34-5/8 x 33-1/16 x 13	156 lbs	CALL
MITMSZGE24NA	MSZ-GE24NA	Indoor	22,500/27,600	19.0/10.0	208/230-1-60	12-13/16" x 43-5/16" x 9-3/8"	37 lbs	CALL
MITMUZGE24NA	MUZ-GE24NA	Outdoor	22,500/27,600	19.0/10.0	208/230-1-60	34-5/8" x 33-1/16" x 81"	119 lbs	CALL
MITMSZD30NA	MSZ-D30NA	Indoor	30,700/32,600	14.5/8.2	208/230-1-60	14-3/8 x 46-1/16 x 11-5/8	40 lbs	CALL
MITMUZD30NA	MUZ-D30NA	Outdoor	30,700/32,600	14.5/8.2	208/230-1-60	33-7/16 x 33-1/16 x 13	141 lbs	CALL
MITMSZD36NA	MSZ-D36NA	Indoor	33,200/35,200	14.5/8.2	208/230-1-60	14-3/8 x 46-1/16 x 11-5/8	40 lbs	CALL
MITMUZD36NA	MUZ-D36NA	Outdoor	33,200/35,200	14.5/8.2	208/230-1-60	33-7/16 x 33-1/16 x 13	141 lbs	CALL

All Items May Not Be Stocked In All Branches

Ductless Split Systems

SEZ/SUZ Heat Pumps

SEZ Indoor Ceiling-concealed Ducted Heat Pump - R-410A

- Also compatible with MXZ-2B20/3B24/3B30/4B36NA/8B48 / SUZ outdoor units
- Built-in drain mechanism for condensate removal
- Air filter is included with indoor unit
- Quiet operation - as low as 23 dBA
- Automatic fan speed control
- Auto restart
- 208/230-1-60 Indoor/outdoor units
- Energy Star Systems: All 1 to 1 systems
- Tax Credit Systems: SEZKD12/SEZKD18NA/SUZKA12/SUZKA18NA
- 7-Year compressor warranty; 5-year parts warranty



Mini-Splits

Part #	Mfg #	Unit	Cool/Heat BTUH	System SEER	Power Supply	Dimensions (H" x W" x D")	Unit Weight	Price
MITSEZKD12NA4	SEZ-KD12NA	Indoor	11,500/13,600	16	208/230-1-60	7-7/8 x 39 x 27-9/16	50 lbs	CALL
MITSUZKA12NA	SUZ-KA12NA	Outdoor	11,500/13,600	16	208/230-1-60	21-5/8 x 31-1/2 x 11-1/4	77 lbs	CALL

SLZ Indoor 4-Way Ceiling Cassette Inverter Heat Pump - R-410A

- Four-way 2' x 2' indoor unit
- Built-in drain mechanism for condensate removal
- Long life air filter is included with indoor unit
- Quiet operation at 28 dBA
- Automatic fan speed control
- Auto restart
- Energy Star Systems: SLZ/SUZ09&12
- 208/230-1-60 Indoor/outdoor units
- 7-Year compressor warranty; 5-year parts warranty



Part #	Mfg #	Unit	Cool/Heat BTUH	System SEER	Power Supply	Dimensions (H" x W" x D")	Unit Weight	Price
MITSZKA09NA	SLZ-KA09NA	Indoor	8,400/10,900	15	208/230-1-60	9-1/4 x 22-7/16 x 22-7/16	36 lbs	CALL
MITSUZKA09NA	SUZ-KA09NA	Outdoor	8,400/10,900	15	208/230-1-60	21-5/8 x 31-1/2 x 11-1/4	66 lbs	CALL
MITSZKA12NA	SLZ-KA12NA	Indoor	11,100/13,600	15.4	208/230-1-60	9-1/4 x 22-7/16 x 22-7/16	36 lbs	CALL
MITSUZKA12NA	SUZ-KA12NA	Outdoor	11,100/13,600	15.4	208/230-1-60	21-5/8 x 31-1/2 x 11-1/4	77 lbs	CALL
MITSZKA15NA	SLZ-KA15NA	Indoor	15,000/18,000	16	208/230-1-60	9-1/4 x 22-7/16 x 22-7/16	36 lbs	CALL
MITSUZKA15NA	SUZ-KA15NA	Outdoor	15,000/18,000	16	208/230-1-60	21-5/8 x 31-1/2 x 11-1/4	80 lbs	CALL

Prices & Specifications are Subject to Change.

Ductless Split Systems

Multi-Zone Systems

MXZ Outdoor Inverter Heat Pumps for Combination Options

- Hot start technology
- Enhanced filtration

MXZ Outdoor Units Using MSZ-GE, MSZ-FE Ductless Wall-mount, Ductless MFZ Floor-mount and/or SEZ Series Ducted Ceiling Concealed Indoor Units - R-410A, SLZ Cassette

- Energy Star Systems: MXZ-2B20NA with (2) MSZ-GE09, MXZ-3B24NA with (2) MSZ-GE06NA & (1) MSZ-GE09NA
MXZ-3B24NA with (2) MSZGE06 & (1) MSZGE12
- Tax Credit Systems: MXZ-2B20NA with (2) MSZ-GE09, MXZ-3B24NA with (2) MSZ-GE06NA & (1) MSZ-GE12NA
MXZ-3B24NA with (2) MSZGE06 & (1) MSZGE12
- 208/230-1-60
- 7-Year compressor warranty; 5-year parts warranty

INVERTER



Part #	Mfg #	Unit	Indoor Non-ducted SEER/HSPF	Indoor Ducted & Non-ducted SEER/HSPF	Indoor Ducted SEER/HSPF	Price
MITMXZ2B20NA	MXZ-2B20NA	1.5 Ton Outdoor	16.0/8.5	15.5/8.5	15.5/8.5	CALL
MITMXZ3B24NA	MXZ-3B24NA	2.0 Ton Outdoor	17.5/9.3	16.25/8.9	15.0/8.5	CALL
MITMXZ3B30NA	MXZ-3B30NA	2.5 Ton Outdoor	17.5/10.5	16.0/10.0	14.5/9.5	CALL
MITMXZ4B36NA	MXZ-4B36NA	3.0 Ton Outdoor	16.5/9.2	15.0/9.0	15.0/8.7	CALL
MITMXZ8B48NA	MXZ-8B48NA	4.0 Ton Outdoor	15.0/8.7	14.9/8.8	14.7/8.9	CALL

MXZ-8B48NA Branch Box Unit

Part #	Mfg #	Description	Price
MITPACAKA51BC	PAC-AKA51BC	5-Port Branch Box	CALL
MITPACAKA31BC	PAC-AKA31BC	3-Port Branch Box	CALL

Compatible Indoor Units for use with MXZ Outdoor Units

Refer to application manual for proper combinations

MSZ-GE06NA	MSZ-GE18NA	MFZ-KA09NA
MSZ-GE09NA	SLZ-KA09NA	MFZ-KA12NA
MSZ-FE09NA	SLZ-KA12NA	MFZ-KA18NA
MSZ-GE12NA	SLZ-KA15NA	
MSZ-FE12NA	SEZ-KD09NA	
MSZ-GE15NA	SEZ-KD12NA	
MSZ-FE15NA	SEZ-KD15NA	
MSZ-GE18NA	SEZ-KD18NA	
MSZ-FE18NA		

All Items May Not Be Stocked In All Branches

Ductless Split Systems

P-Series with PKA Hi-Wall Units

- Large residential, varied commercial and institutional
- A-Control System - indoor unit is powered through the outdoor unit through (3) polarity sensitive wires & ground conductor providing power & communication
- Precharged with enough refrigerant to be installed 70' (PUY/Z 12-36) and up to 100' (PUY/Z 42) from the indoor units, R-410A refrigerant
- Dehumidification
- Advanced microprocessor controls
- Auto fan speed feature (excludes PEA model)
- Outdoor units employ advanced Pulse Amplitude Modulation (PAM)
- Inverter-driven compressor technology
- Low ambient cooling down to 0° outdoors (requires wind baffle)
- 208/230-1-60 Indoor/outdoor units
- 7-Year compressor warranty; 5-Year parts warranty

INVERTER



PKA-A12/18



PKA-A24/30



PKA-A36

PKA/PUY Wall-Mount Ductless Air Conditioner - R-410A - 1.0 to 3.0 Ton

Same indoor model for "Cooling Only PUY" and "Heat Pump PUZ" Models

- Auto vane control
- Controller must be ordered separately

Part #	Mfg #	Unit	Cooling BTUH	System SEER	Power Supply	Dimensions (H" x W" x D")	Unit Weight	Price
MITPKAA12HA4	PKA-A12HA4	Indoor	12,000	15.2	208/230-1-60	11-5/8 x 35-3/8 x 9-13/16	29 lbs	CALL
MITPUYA12NHA4	PUY-A12NHA4	Outdoor	12,000	15.2	208/230-1-60	23-5/8 x 31-1/2 x 13+7/8	90 lbs	CALL
MITPKAA18HA4	PKA-A18HA4	Indoor	18,000	15.3	208/230-1-60	11-5/8 x 35-3/8 x 9-3/16	29 lbs	CALL
MITPUYA18NHA4	PUY-A18NHA4	Outdoor	18,000	15.3	208/230-1-60	23-5/8 x 31-1/2 x 13+7/8	97 lbs	CALL
MITPKAA24KA4	PKA-A24KA4	Indoor	24,000	17.0	208/230-1-60	14-3/8 x 46-1/16 x 11-5/8	46 lbs	CALL
MITPUYA24NHA4	PUY-A24NHA4	Outdoor	24,000	17.0	208/230-1-60	37-1/8 x 37-3/8 x 13+1-3/16	163 lbs	CALL
MITPKAA30KA4	PKA-A30KA4	Indoor	30,000	15.5	208/230-1-60	14-3/8 x 46-1/16 x 11-5/8	46 lbs	CALL
MITPUYA30NHA4	PUY-A30NHA4	Outdoor	30,000	15.5	208/230-1-60	37-1/8 x 37-3/8 x 13+1-3/16	163 lbs	CALL
MITPKAA36KA4	PKA-A36KA4	Indoor	34,200	14.0	208/230-1-60	14-3/8 x 46-1/16 x 11-5/8	46 lbs	CALL
MITPUYA36NHA4	PUY-A36NHA4	Outdoor	34,200	14.0	208/230-1-60	37-1/8 x 37-3/8 x 13+1-3/16	163 lbs	CALL

Prices & Specifications are Subject to Change.

Mini-Splits

Ductless Split Systems

PKA/PUZ Wall-Mount Ductless Heat Pump - R-410A - 1.5 to 3.0 Ton

Same indoor model for "Cooling Only PUY" and "Heat Pump PUZ" Models

- Auto vane control
- Controller must be ordered separately

Mini-Splits

Part #	Mfg #	Unit	Cool/Heat BTUH	System SEER/HSPF	Power Supply	Dimensions (H" x W" x D")	Unit Weight	Price
MITPKAA18HA4	PKA-A18HA4	Indoor	18,000/19,000	15.3/9.5	208/230-1-60	11-5/8 x 35-3/8 x 9-3/16	29 lbs	CALL
MITPUZA18NHA4	PUZ-A18NHA4	Outdoor	18,000/19,000	15.3/9.5	208/230-1-60	23-5/8 x 31-1/2 x 13+7/8	91 lbs	CALL
MITPKAA24KA4	PKA-A24KA4	Indoor	24,000/26,000	17.0/10.8	208/230-1-60	14-3/8 x 46-1/16 x 11-5/8	46 lbs	CALL
MITPUZA24NHA4	PUZ-A24NHA4	Outdoor	24,000/26,000	17.0/10.8	208/230-1-60	37-1/8 x 37-3/8 x 13+1-3/16	165 lbs	CALL
MITPKAA30KA4	PKA-A30KA4	Indoor	30,000/32,000	15.5/8.9	208/230-1-60	14-3/8 x 46-1/16 x 11-5/8	46 lbs	CALL
MITPUZA30NHA4	PUZ-A30NHA4	Outdoor	30,000/32,000	15.5/8.9	208/230-1-60	37-1/8 x 37-3/8 x 13+1-3/16	165 lbs	CALL
MITPKAA36KA4	PKA-A36KA4	Indoor	34,200/37,000	14.0/9.3	208/230-1-60	14-3/8 x 46-1/16 x 11-5/8	46 lbs	CALL
MITPUZA36NHA4	PUZ-A36NHA4	Outdoor	34,200/37,000	14.0/9.3	208/230-1-60	37-1/8 x 37-3/8 x 13+1-3/16	165 lbs	CALL

PKA/PUZ-H Wall-Mount Ductless Heat Pump with Hyper-Heating H2i® - R-410A - 2.5 - 3.0 Ton

- Energy Star rated



Part #	Mfg #	Unit	Cool/Heat BTUH	System SEER/HSPF	Power Supply	Dimensions (H" x W" x D")	Unit Weight	Price
MITPKAA30KA4	PKA-A30KA	Indoor	30,000/32,000	16.5/9.5	208/230-1-60	14-3/8 x 46-1/16 x 11-5/8	46 lbs	CALL
MITPKAA36KA4	PKA-A36KA	Indoor	33,500/38,000	16.2/10.0	208/230-1-60	14-3/8 x 46-1/16 x 11-5/8	46 lbs	CALL
MITPUZHA30NHA2	PUZ-HA30NHA2	Outdoor	30,000/32,000	16.5/9.5	208/230-1-60	53-1/8 x 37-3/8 x 13+1-3/16	265 lbs	CALL
MITPUZHA36NHA2	PUZ-HA36NHA2	Outdoor	33,500/38,000	16.2/10.0	208/230-1-60	53-1/8 x 37-3/8 x 13+1-3/16	265 lbs	CALL

Check our website for special promotions!
www.irrsupply.com

Ductless Split Systems

P-Series with PCA Ceiling-Suspended Units

- Large residential, varied commercial and institutional
- A-Control System - indoor unit is powered through the outdoor unit through (3) polarity sensitive wires & ground conductor providing power & communication
- Precharged with enough refrigerant to be installed 70' (PUY/Z 12-36) and up to 100' (PUY/Z 42) from the indoor units, R-410A refrigerant
- Dehumidification
- Advanced microprocessor controls
- Auto fan speed feature (excludes PEA model)
- Outdoor units employ advanced Pulse Amplitude Modulation (PAM)
- Inverter-driven compressor technology
- Low ambient cooling down to 0° outdoors (requires wind baffle)
- 208/230-1-60 Indoor/outdoor units
- 7-Year compressor warranty; 5-Year parts warranty



Mini-Splits

PCA/PUY Ceiling-Suspended Ductless Air Conditioner - R-410A - 2.0 to 3.5 Ton

Same indoor model for "Cooling-Only PUY" and "Heat Pump PUZ" Models

- Control must be ordered separately
- Auto fan speed control
- i-see™ Sensor optional accessory

Part #	Mfg #	Unit	Cooling BTUH	System SEER	Power Supply	Dimensions (H" x W" x D")	Unit Weight	Price
MITPCAA24KA4	PCA-A24KA4	Indoor	24,000	16.8	208/230-1-60	9-1/16 x 50-3/8 x 26-3/4	71 lbs	CALL
MITPUYA24NHA4	PUY-A24NHA4	Outdoor	24,000	16.8	208/230-1-60	37-1/8 x 37-3/8 x 13+1-3/16	163 lbs	CALL
MITPCC30KA4	PCC-30KA4	Indoor	30,000	14.5	208/230-1-60	9-1/16 x 50-3/8 x 26-3/4	71 lbs	CALL
MITPUYA30NHA4	PUY-A30NHA4	Outdoor	30,000	14.5	208/230-1-60	37-1/8 x 37-3/8 x 13+1-3/16	163 lbs	CALL
MITPCAA36KA4	PCA-A36KA4	Indoor	35,000	14.4	208/230-1-60	9-1/16 x 63 x 26-3/4	79 lbs	CALL
MITPUYA36NHA4	PUY-A36NHA4	Outdoor	35,000	14.4	208/230-1-60	37-1/8 x 37-3/8 x 13+1-3/16	163 lbs	CALL
MITPCAA42KA4	PCA-A42KA4	Indoor	42,000	15.8	208/230-1-60	9-1/16 x 63 x 26-3/4	84 lbs	CALL
MITPUYA42NHA4	PUY-A42NHA4	Outdoor	42,000	15.8	208/230-1-60	53-1/8 x 37-3/8 x 13+1-3/16	258 lbs	CALL

PCA/PUZ Ceiling-Suspended Ductless Heat Pump - R-410A - 2.0 - 3.5 Ton

Same indoor model for "Cooling-Only PUY" and "Heat Pump PUZ" Models

- Control must be ordered separately
- Auto fan speed control
- i-see™ Sensor optional accessory

Part #	Mfg #	Unit	Cool/Heat BTUH	System SEER/HSPF	Power Supply	Dimensions (H" x W" x D")	Unit Weight	Price
MITPCAA24KA4	PCA-A24KA4	Indoor	24,000/26,000	16.8/10.9	208/230-1-60	9-1/16 x 50-3/8 x 26-3/4	71 lbs	CALL
MITPUZA24NHA4	PUZ-A24NHA4	Outdoor	24,000/26,000	16.8/10.9	208/230-1-60	37-1/8 x 37-3/8 x 13+1-3/16	165 lbs	CALL
MITPCC30KA4	PCC-30KA4	Indoor	30,000/32,000	14.5/9.2	208/230-1-60	9-1/16 x 50-3/8 x 26-3/4	71 lbs	CALL
MITPUZA30NHA4	PUZ-A30NHA4	Outdoor	30,000/32,000	14.5/9.2	208/230-1-60	37-1/8 x 37-3/8 x 13+1-3/16	165 lbs	CALL
MITPCAA36KA4	PCA-A36KA4	Indoor	35,000/37,000	14.4/10.2	208/230-1-60	9-1/16 x 63 x 26-3/4	79 lbs	CALL
MITPUZA36NHA4	PUZ-A36NHA4	Outdoor	35,000/37,000	14.4/10.2	208/230-1-60	37-1/8 x 37-3/8 x 13+1-3/16	165 lbs	CALL
MITPCAA42KA4	PCA-A42KA4	Indoor	42,000/45,000	15.8/10.2	208/230-1-60	9-1/16 x 63 x 26-3/4	84 lbs	CALL
MITPUZA42NHA4	PUZ-A42NHA4	Outdoor	42,000/45,000	15.8/10.2	208/230-1-60	53-1/8 x 37-3/8 x 13+1-3/16	260 lbs	CALL

Prices & Specifications are Subject to Change.

Ductless Split Systems

Mini-Splits

PCA/PUZ-H Ductless Ceiling-Suspended Ductless Heat Pump with Hyper-Heating H2i® - R-410A - 2.5 - 3.0 Ton

- Energy Star rated
- Tax credit



Part #	Mfg #	Unit	Cool/Heat BTUH	System SEER/HSPF	Power Supply	Dimensions (H" x W" x D")	Unit Weight	Price
MITPCAA36KA4	PCA-A36KA	Indoor	34,000/38,000	16.6/10.3	208/230-1-60	9-1/16 x 63 x 26-3/4	79 lbs	CALL
MITPUZHA36NHA2	PUZ-HA36NHA2	Outdoor	34,000/38,000	16.6/10.3	208/230-1-60	53-1/8 x 37-3/8 x 13+1-3/16	265 lbs	CALL

P-Series with PLA Ceiling-Recessed Units

- Large residential, varied commercial and institutional
- A-Control System - indoor unit is powered through the outdoor unit through (3) polarity sensitive wires & ground conductor providing power & communication
- Precharged with enough refrigerant to be installed 70' (PUY/Z 12-36) and up to 100' (PUY/Z 42) from the indoor units, R-410A refrigerant
- Dehumidification
- Advanced microprocessor controls
- Auto fan speed feature (excludes PEA model)
- Outdoor units employ advanced Pulse Amplitude Modulation (PAM)
- Inverter-driven compressor technology
- Low ambient cooling down to 0° outdoors (requires wind baffle)
- Built-in condensate lift mechanism
- Knockout for ventilation air
- Auto wave feature in heating mode
- 7-Year compressor warranty; 5-Year parts warranty

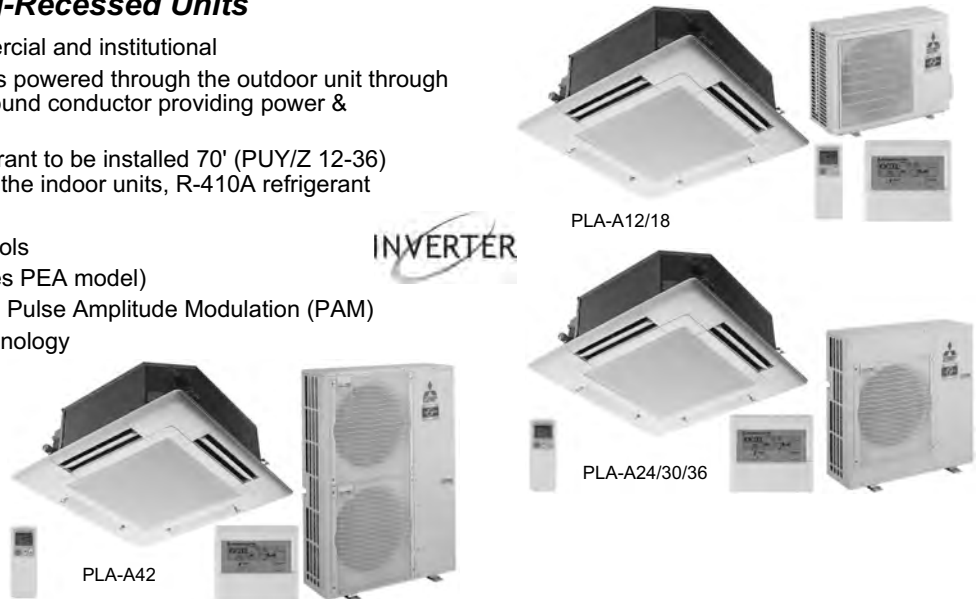

PLA/PUY Ceiling-Recessed Cassette Ductless Air Conditioner - R-410A - 1.0 to 3.5 Ton

Same indoor model for "Cooling-Only PUY" and "Heat Pump PUZ" Models

- Control must be ordered separately
- i-see™ Sensor optional accessory

Part #	Mfg #	Unit	Cooling BTUH	System SEER	Power Supply	Dimensions (H" x W" x D")	Unit Weight	Price
MITPLAA12BA4	PLA-A12BA4	Indoor	12,000	13.5	208/230-1-60	10-3/16 x 33-1/16 x 33-1/16	49 lbs	CALL
MITPUYA12NHA4	PUY-A12NHA4	Outdoor	12,000	13.5	208/230-1-60	23-5/8 x 31-1/2 x 13+7/8	90 lbs	CALL
MITPLAA18BA4	PLA-A18BA4	Indoor	18,000	14.2	208/230-1-60	10-3/16 x 33-1/16 x 33-1/16	49 lbs	CALL
MITPUYA18NHA4	PUY-A18NHA4	Outdoor	18,000	14.2	208/230-1-60	23-5/8 x 31-1/2 x 13+7/8	97 lbs	CALL
MITPLAA24BA4	PLA-A24BA4	Indoor	24,000	13.6	208/230-1-60	10-3/16 x 33-1/16 x 33-1/16	51 lbs	CALL
MITPUYA24NHA4	PUY-A24NHA4	Outdoor	24,000	13.6	208/230-1-60	37-1/8 x 37-3/8 x 13+1-3/16	163 lbs	CALL
MITPLAA30BA4	PLA-A30BA4	Indoor	30,000	13.6	208/230-1-60	10-3/16 x 33-1/16 x 33-1/16	51 lbs	CALL
MITPUYA30NHA4	PUY-A30NHA4	Outdoor	30,000	13.6	208/230-1-60	37-1/8 x 37-3/8 x 13+1-3/16	163 lbs	CALL
MITPLAA36BA4	PLA-A36BA4	Indoor	35,000	14.2	208/230-1-60	11-3/4 x 33-1/16 x 33-1/16	55 lbs	CALL
MITPUYA36NHA4	PUY-A36NHA4	Outdoor	35,000	14.2	208/230-1-60	37-1/8 x 37-3/8 x 13+1-3/16	163 lbs	CALL
MITPLAA42BA4	PLA-A42BA4	Indoor	42,000	14.4	208/230-1-60	11-3/4 x 33-1/16 x 33-1/16	55 lbs	CALL
MITPUYA42NHA4	PUY-A42NHA4	Outdoor	42,000	14.4	208/230-1-60	53-1/8 x 37-3/8 x 13+1-3/16	260 lbs	CALL

All Items May Not Be Stocked In All Branches

Ductless Split Systems

PLA/PUZ Ceiling-Recessed Cassette Ductless Heat Pump R-410A - 1.5 - 3.0 Ton

Same indoor model for "Cooling-Only PUY" and "Heat Pump PUZ" Models

- Control must be ordered separately
- i-see™ Sensor optional accessory

Part #	Mfg #	Unit	Cool/Heat BTUH	System SEER/HSPF	Power Supply	Dimensions (H" x W" x D")	Unit Weight	Price
MITPLAA18BA4	PLA-A18BA4	Indoor	18,000/19,000	14.2/9.8	208/230-1-60	10-3/16 x 33-1/16 x 33-1/16	49 lbs	CALL
MITPUZA18NHA4	PUZ-A18NHA4	Outdoor	18,000/19,000	14.2/9.8	208/230-1-60	23-5/8 x 31-1/2 x 13+7/8	99 lbs	CALL
MITPLAA24BA4	PLA-A24BA4	Indoor	24,000/26,000	13.6/8.5	208/230-1-60	10-3/16 x 33-1/16 x 33-1/16	51 lbs	CALL
MITPUZA24NHA4	PUZ-A24NHA4	Outdoor	24,000/26,000	13.6/8.5	208/230-1-60	37-1/8 x 37-3/8 x 13+1-3/16	165 lbs	CALL
MITPLAA30BA4	PLA-A30BA4	Indoor	30,000/32,000	13.6/8.7	208/230-1-60	10-3/16 x 33-1/16 x 33-1/16	51 lbs	CALL
MITPUZA30NHA4	PUZ-A30NHA4	Outdoor	30,000/32,000	13.6/8.7	208/230-1-60	37-1/8 x 37-3/8 x 13+1-3/16	165 lbs	CALL
MITPLAA36BA4	PLA-A36BA4	Indoor*	35,000/37,000	14.2/9.3	208/230-1-60	11-3/4 x 33-1/16 x 33-1/16	55 lbs	CALL
MITPUZA36NHA4	PUZ-A36NHA4	Outdoor	35,000/37,000	14.2/9.3	208/230-1-60	37-1/8 x 37-3/8 x 13+1-3/16	165 lbs	CALL
MITPLAA42BA4	PLA-A42BA4	Indoor	42,000/45,000	14.4/9.3	208/230-1-60	11-3/4 x 33-1/16 x 33-1/16	55 lbs	CALL
MITPUZA42NHA4	PUZ-A42NHA4	Outdoor	42,000/45,000	14.4/9.3	208/230-1-60	53-1/8 x 37-3/8 x 13+1-3/16	260 lbs	CALL

Mini-Splits

PLA/PUZ-H Ceiling-Recessed Cassette Ductless Heat Pump with Hyper-Heating H2i® - R-410A - 2.5 - 3.0 Ton

- Energy Star rated
- Tax Credit: PLA-A36BA/PUZ-H
- Control must be ordered separately



INVERTER

Part #	Mfg #	Unit	Cool/Heat BTUH	System SEER/HSPF	Power Supply	Dimensions (H" x W" x D")	Unit Weight	Price
MITPLAA30BA4	PLA-A30BA4	Indoor	30,000/32,000	15.6/9.4	208/230-1-60	10-3/16 x 33-1/16 x 33-1/16	51 lbs	CALL
MITPLAA36BA4	PLA-A36BA4	Indoor	36,000/38,000	16.0/9.4	208/230-1-60	11-3/4 x 33-1/16 x 33-1/16	55 lbs	CALL
MITPUZHA36NHA2	PUZ-HA36NHA2	Outdoor	36,000/38,000	16.0/9.4	208/230-1-60	53-1/8 x 37-3/8 x 13+1-3/16	265 lbs	CALL

Ductless Split System Parts & Accessories

Control Options

Part #	Mfg #	Description	Use With:	Price
MITPAR21MAAG	PAR-21MAA	Deluxe MA Remote Controller (Requires MAC-3971F-E on M-Series)	Wired M-Series & P-Series Controller	CALL

Remote Controller Kit

- For use with P-Series NHA4 systems, SEZ-4/SUZ one-to-one systems and SLZ/SUZ one-to-one systems
- Backlit
- Supports Fahrenheit and Celsius
- User can set On/Off, Cool/Heat/Drying/Fan operation modes, temperature, fan speed and airflow direction
- Day/Time display with 12-hour clock
- Kit includes:
 - MIFH1 Wireless receiver
 - Remote controller
 - MRC1 Cable



Part #	Mfg #	Description	Use With:	Price
MITMHK1	MHK1	Back Lit Wall Mount Controller Kit	P-Series NHA4, SEZ-4/SUZ, SLZ/SUZ	285.00

Prices & Specifications are Subject to Change.

Ductless Split Systems

Low Ambient Accessories

Part #	Mfg #	Description	Use With:	Price
MITWBPA1	WB-PA1	Wind Baffle	P-Series (1 Piece) PUY-/Z-A12/A18	130.00
MITWBPA2	WB-PA2	Wind Baffle	P-Series (1-Piece) PUY-/Z-A24/A30/A36/A42 (42 Installation Requires 2 Pieces) PUZ--HA36NA (Requires 2 Pieces)	165.00

Mini Condensate Pumps

Part #	Mfg #	Description	Use With:	Price
MITPACSH84DME	PAC-SH84DME	230V Mini Condensate Pump	PCAA Series	280.00
MITS1730230	SI-1730230	230V Mini Condensate Pump	P-Series - 24,000 BTUH or Greater MSY/Z - 24,000 BTUH or Greater PKFY-P30	230.00
MITS3100115	SI-3100115	115V Mini Condensate Pump	MS-Series	175.00
MITS3100230	SI-3100230	230V Mini Condensate Pump	P-Series - Less than 24,000 BTUH MSY/Z - Less than 24,000 BTUH	175.00

Refrigerant Tubing Sets

Tubing Sets for use with MS-A09WA, MSY-GE09/12NA, MSZ-GE09/12NA, MSZ-FE09/12NA, SEZ-KD09/12NA, SL2-KA09/12NA

Part #	Mfg #	Tube Size	Length	Insulation	Price
MITLS143815	MLS-143812T15	1/4" x 3/8"	15'	1/2"	CALL
MITLS143830	MLS-143812T30	1/4" x 3/8"	30'	1/2"	CALL
MITLS143850	MLS-143812T50	1/4" x 3/8"	50'	1/2"	CALL

Tubing Sets for use with MS-A12WA, MSY-A15NA, MSY-GE15/18NA, MSZ-A15NA, MSZ-GE15/18NA, SEZ-KD15/18NA, PKA-A12/18HA, PLA-A12/18BA, PEA-A12/18AA, SLZ-KA15

Part #	Mfg #	Tube Size	Length	Insulation	Price
MITLS141215	MLS-141212T15	1/4" x 1/2"	15'	1/2"	CALL
MITLS141230	MLS-141212T30	1/4" x 1/2"	30'	1/2"	CALL
MITLS141250	MLS-141212T50	1/4" x 1/2"	50'	1/2"	CALL

Tubing Sets for use with MSY-D30/36NA, MSZ-D30/36NA, PKA-A24/30/36KA, PLA-A24/30/36/42BA, PCA-A24/30/36/42KA, PEAD-A24/30/36/42AA, MSY-GE24NA, MSZ-GE24NA, MSZ-FE18NA

Part #	Mfg #	Tube Size	Length	Insulation	Price
MITLS385815	MPLS-385812T15	3/8" x 5/8"	15'	1/2"	CALL
MITLS385830	MPLS-385812T30	3/8" x 5/8"	30'	1/2"	CALL
MITLS385850	MPLS-385812T50	3/8" x 5/8"	50'	1/2"	CALL

All Items May Not Be Stocked In All Branches

Hydronic Heating

PFG Atmospheric Gas Packaged Boiler - Water Only

- Factory fire tested
- Insulated extended jacket
- Built-in air separator
- Vertical draft hood
- Combination gas valve & regulator
- Non-limiting pilot burner
- Aluminized steel burners
- Combination relay receptacle & 40VA transformer
- Circulator relay
- High limit temperature control for PIN & PIDN
- 30 PSI ASME Relief valve
- Combination pressure-temperature gauge
- Drain valve



Intermittent Ignition - Natural Gas - Combustion Efficiency 81.0%

Part #	Mfg #	Boiler Model	AGA Input MBH	DOE Heating Capacity MBH	Net I=B=R Rating MBH	Approx Ship Wt	I=B=R Chimney Size	Price
WMCDFG6PIN	128-061-308	PFG-6-PIN	305	247	215	605	8" ID x 20'	CALL
WMCDFG7PIN	128-071-308	PFG-7-PIN	366	296	257	690	9" ID x 20'	CALL
WMCDFG8PIN	128-081-308	PFG-8-PIN	427	346	301	760	9" ID x 20'	CALL

CG Series Gas Boilers



- Designed for forced hot water heating systems
- 20' Chimney recommended; chimney height may be reduced to 10' in special cases where surrounding conditions permit
- Cast iron sections with elastomer sealing rings
- Combination pressure-temperature gauge
- Temperature & pressure gauge installed
- Jacket is 23-1/4" front-to-back
- 30 psi ASME Relief valve (boiler sections tested for 50 psi working pressure)
- Limited lifetime warranty on cast iron sections



CGa Series - Natural Draft - Standing Pilot - Natural Gas - Water Only

- Automatic vent damper
- Stainless steel burners
- Constant burning, thermally-supervised pilot system
- Thermocouple
- Combination relay receptacle and 40VA transformer
- Plug-in circulator relay

Part #	Mfg #	Boiler Model	AGA Input BTUH	% DOE Seasonal Efficiency (AFUE)	DOE Heating Capacity BTUH	Net I=B=R Rating BTUH	Approx Ship Wt	Chimney Size	Price
WMRCGA25SPDN	381-357-335	CGa-25-SPDN	52,000	81.5	44,000	38,000	200 lbs	4" ID x 20'	CALL
WMRCGA3SPDN	381-357-336	CGa-3-SPDN	70,000	81.6	59,000	51,000	200 lbs	4" ID x 20'	CALL
WMRCGA4SPDN	381-357-337	CGa-4-SPDN	105,000	81.7	88,000	77,000	240 lbs	5" ID x 20'	CALL
WMRCGA5SPDN	381-357-338	CGa-5-SPDN	140,000	81.8	117,000	102,000	280 lbs	6" ID x 20'	CALL
WMRCGA6SPDN	381-357-339	CGa-6-SPDN	175,000	81.9	146,000	127,000	325 lbs	6" ID x 20'	CALL
WMRCGA7SPDN	113-071-369	CGa-7-SPDN	210,000	82.0	175,000	152,000	370 lbs	7" ID x 20'	CALL
WMRCGA8SPDN	113-081-365	CGa-8-SPDN	245,000	82.1	204,000	177,000	425 lbs	7" ID x 20'	CALL

Prices & Specifications are Subject to Change.

Residential Boilers

Hydronic Heating

CGa Series - Natural Draft - Spark Ignition - Natural Gas Only - Water Only

- Automatic vent damper
- Electronic pilot control system
- Weil-McLain control module and ignition control with indicator/diagnostic lights
- Plug-in connector and wiring

Part #	Mfg #	Boiler Model	AGA Input BTUH	% DOE Seasonal Efficiency (AFUE)	DOE Heating Capacity BTUH	Net I=B=R Rating BTUH	Approx Ship Wt	Chimney Size	Price
WMRCGA3PIDN	381-357-308	CGa-3-PIDN	70,000	84.0	59,000	51,000	200 lbs	4" ID x 20'	CALL
WMRCGA4PIDN	381-357-309	CGa-4-PIDN	105,000	84.0	88,000	77,000	240 lbs	5" ID x 20'	CALL
WMRCGA5PIDN	381-357-310	CGa-5-PIDN	140,000	83.5	117,000	102,000	280 lbs	6" ID x 20'	CALL
WMRCGA6PIDN	381-357-311	CGa-6-PIDN	175,000	83.2	146,000	127,000	325 lbs	6" ID x 20'	CALL
WMRCGA7PIDN	113-071-365	CGa-7-PIDN	210,000	83.0	175,000	152,000	370 lbs	7" ID x 20'	CALL
WMRCGA8PIDN	113-081-365	CGa-8-SPDN	245,000	82.1	204,000	177,000	425 lbs	7" ID x 20'	CALL

CGi - Series 2 - Direct Exhaust (Induced Combustion) - Natural Draft - Spark Ignition

- Electronic pilot control system
- Weil-McLain control module and ignition control with indicator/diagnostic lights
- High-Grade stainless steel burners



Natural Gas Only - Water Only

Part #	Mfg #	Boiler Model	AGA Input BTUH	% DOE Seasonal Efficiency (AFUE)	DOE Heating Capacity BTUH	Net I=B=R Rating BTUH	Approx Ship Wt	Minimum Vent Size	Price
WMRCGI25	381-355-044	CGi-25-PIN	50,000	84.0	42,000	37,000	200 lbs	4" ID	CALL
WMRCGI3	381-355-045	CGi-3-PIN	60,000	85.1	51,000	45,000	200 lbs	4" ID	CALL
WMRCGI4E	381-355-056	CGi-4E-PIN	90,000	85.0	76,000	66,000	240 lbs	5" ID	CALL
WMRCGI5	381-355-047	CGi-5-PIN	120,000	83.3	100,000	87,000	280 lbs	5" ID	CALL
WMRCGI6	381-355-048	CGi-6-PIN	167,000	83.3	140,000	122,000	325 lbs	5" ID	CALL
WMRCGI7	381-355-049	CGi-7-PIN	200,000	83.0	167,000	145,000	370 lbs	5" ID	CALL

All Items May Not Be Stocked In All Branches

Hydronic Heating

CGs Series - Direct Exhaust (Sealed Combustion) - Spark Ignition

- Electronic pilot control system
- Flexible venting; direct or non-direct
- Weil-McLain control module and ignition control with indicator/diagnostic lights
- High-Grade stainless steel burners



Natural Gas

Part #	Mfg #	Boiler Model	AGA Input BTUH	% DOE Seasonal Efficiency (AFUE)	DOE Heating Capacity BTUH	Net I=B=R Rating BTUH	Approx Ship Wt	Minimum Vent Size	Price
WMRCGS3	381-356-214	CGs-3	67,000	85.3	57,000	50,000	200 lbs	3"	CALL
WMRCGS4E	381-356-218	CGs-4E*	90,000	84.6	77,000	67,000	240 lbs	3"	CALL
WMRCGS5	381-356-216	CGs-5	133,000	84.0	112,000	97,000	280 lbs	3"	CALL
WMRCGS6	381-356-217	CGs-6	167,000	83.4	140,000	122,000	325 lbs	3"	CALL

* Direct Vent Only

GV90+ Series High Efficiency Cast Iron Gas Boilers

- Insulated extended jacket
- Hot surface ignition system
- Cast iron primary heat exchanger
- Condensing stainless steel secondary heat exchanger
- Unique 7 pass heat exchanger design
- Vents with PVC
- Multiple vent options (direct vent, direct exhaust, concentric)
- Natural gas, easy conversion to propane (kit included)
- 3" Minimum vent size
- Water, sealed combustion or direct exhaust
- Down-fired, counterflow boiler design
- Built-in dual circulator
- 30-3/4"H x 24-5/8"W



Part #	Mfg #	Boiler Model	AGA Input MBH	DOE Heating Capacity MBH	Net I=B=R Water Rating MBH	Approx Ship Wt	DOE Seasonal AFUE	Lgth	Price
WMRGV903	GV90+3	GV90+3	70	65	56	313 lbs	91.9%	30-3/4"	CALL
WMRGV904	GV90+4	GV90+4	105	97	84	353 lbs	91.2%	30-3/4"	CALL
WMRGV905	GV90+5	GV90+5	140	130	113	423 lbs	91.4%	37-3/4"	CALL
WMRGV906	GV90+6	GV90+6	175	161	140	464 lbs	91.0%	37-3/4"	CALL

Residential Boilers

Prices & Specifications are Subject to Change.

Hydronic Heating

Ultra Series 3 - Condensing High-Efficiency Gas Boiler with 20 - 100% Modulation

- Factory tested
- Cast aluminum block
- 30 psi ASME Relief valve
- Drain valve
- Stainless steel burner with woven steel fiber mesh
- Direct spark ignition
- Variable speed blower assembly
- Gas/air ratio venturi with air silencer
- Negative pressure regulation gas valve
- 50VA Transformer
- Combination T&P gauge
- Outlet and return water temperature sensor
- Flue gas and outdoor temperature sensors
- 5-Year warranty on parts and labor



Ultra 3 Series - Packaged Natural Gas

Part #	Mfg #	Boiler Model	CSA Input MBH	DOE Heating Capacity MBH	Net I=B=R Rating MBH	Approx Ship Wt	Min Pipe Size	Price
WMRULTRA803	383-500-500	UP-80	80	71	62	199 lbs	1"	CALL

Ultra 3 Series - Propane Gas

Part #	Mfg #	Boiler Model	CSA Input MBH	DOE Heating Capacity MBH	Net I=B=R Rating MBH	Approx Ship Wt	Min Pipe Size	Price
WMRULTRA803LP	383-500-501	UP-80	80	71	62	199 lbs	1"	CALL

Ultra 3 Series - Natural Gas & Field Convertible to Propane Gas

Part #	Mfg #	Boiler Model	CSA Input MBH	DOE Heating Capacity MBH	Net I=B=R Rating MBH	Approx Ship Wt	Min Pipe Size	Price
WMRULTRA1053	383-500-502	UP-105	105	94	81	207 lbs	1"	CALL
WMRULTRA1553	383-500-503	UP-155	155	139	123	234 lbs	1-1/4"	CALL
WMRULTRA2303	383-500-504	UP-230	230	207	183	246 lbs	1-1/4"	CALL
WMRULTRA299	383-500-705	Ultra 310	299	270	234	297 lbs	1-1/2"	CALL

Residential Boilers

Hydronic Heating

Oil Boilers

Ultra Oil-Fired Water Boiler

- 86+ AFUE
- Reversible swing away burner door
- 3-Pass cast iron heat exchanger with captured elastomer seals
- Chimney vent (CV) or direct vent (DV) with no external draft inducer needed
- EnviraCOM™ ready Honeywell L7248 electronic oil aquastat
- Beckett NX burner with Weil-McLain designed burner cover
- Standard equipment Includes:
 - Service switch
 - Temperature/pressure gauge
 - Boiler drain
 - Barometric damper
 - 30 psi Relief valve
- Limited lifetime warranty on boiler sections



Ultra Oil Boiler Less Burner - Chimney Vent

Part #	Mfg #	Boiler Model	I=B=R Burner Capacity	CSA Input BTUH	DOE Heating Capacity BTUH	Net I=B=R Rating BTUH	Approx Shp Wt	Price
WMRUO3	386-901-000	UO-3-CV	1.00 gph	140,000	122,000	106,000	636 lbs	CALL
WMRUO3CV	169-031-202	UO-3-CV *	1.00 gph	140,000	122,000	106,000	636 lbs	CALL
WMRUO4	386-901-001	UO-4-CV	1.20 gph	168,000	146,000	127,000	737 lbs	CALL
WMRUO5CV	169-031-206	UO-5-CV *	1.40 gph	196,000	172,000	150,000	852 lbs	CALL

* With Burner

Ultra Oil Boiler with Burner - Direct Vent

Part #	Mfg #	Boiler Model	I=B=R Burner Capacity	CSA Input BTUH	DOE Heating Capacity BTUH	Net I=B=R Rating BTUH	Approx Shp Wt	Price
WMRUO3DV	169-031-203	UO-3-DV	1.00 gph	140,000	122,000	106,000	636 lbs	CALL
WMRUO4DV	169-031-205	UO-4-DV	1.20 gph	168,000	146,000	127,000	737 lbs	CALL
WMRUO5DV	169-031-207	UO-5-DV	1.40 gph	196,000	172,000	150,000	852 lbs	CALL

Residential Boilers

For instructions as to proper installation, servicing, and troubleshooting, please refer to the Manufacturer's literature.

Hydronic Heating

WGO Gold Series 3 - Oil-Fired Water Boiler

- Factory water tested
- Jacketed block assembly
- Cast iron sections with Weil-McLain captured seals
- Refractory combustion chamber with high temperature target wall
- Convertible flue (rear or top)
- Full swing-away burner door
- Insulated jacket with quick inspection opening cover
- Drain valve
- Combination pressure-temperature gauge
- 30 psi ASME Relief valve
- Electrical junction box with wiring harnesses
- Service switch mounted on junction box cover plate
- High limit temperature control with circulator relay
- Balanced draft damper
- I=B=R Chimney size: 8" x 8" x 15'
- Limited lifetime warranty on boiler sections



WGO Packaged Boiler Less Burner and Burner Controls

- Factory assembled and wired with jacket, circulator and controls.
- Circulator included and shipped loose for mounting on supply or return

Residential Boilers

Part #	Mfg #	Boiler Model	I=B=R Burner Capacity	DOE Heating Capacity BTUH	Net I=B=R Ratings BTUH	DOE Seasonal Efficiency % AFUE	Approx Ship Wt	Price
WMRPWGO2	386-700-827	P-WGO-2	0.70 gph	86,000	75,000	85.4	472 lbs	CALL
WMRPWGO3	386-700-828	P-WGO-3	0.95 gph	115,000	100,000	85.3	525 lbs	CALL
WMRPWGO4	386-700-829	P-WGO-4	1.20 gph	145,000	126,000	85.0	645 lbs	CALL
WMRPWGO5	386-700-830	P-WGO-5	1.45 gph	175,000	152,000	85.0	760 lbs	CALL
WMRPWGO6	386-700-831	P-WGO-6	2.30 gph	266,000	231,000	--	1030 lbs	CALL

Non-Packaged Boiler with Beckett AFG Burner & Controls

Part #	Mfg #	Boiler Model	I=B=R Burner Capacity	DOE Heating Capacity BTUH	Net I=B=R Ratings BTUH	I=B=R Chimney Size	Price
WMRBWGO7	167-071-230	B-WGO-7	2.00	242,000	210,000	8" x 8" x 15'	CALL
WMRBWGO8	167-081-230	B-WGO-8	2.30	266,000	231,000	8" x 12" x 20'	CALL
WMRBWGO9	167-091-230	B-WGO-9	2.55	295,000	257,000	8" x 12" x 20'	CALL

Hydronic Heating

WTGO Gold Series 3 - Oil-Fired Water Boiler with Tankless Heater Opening

- Jacketed block assembly
- Refractory combustion chamber with high temperature target wall
- Convertible flue (rear or top)
- Full swing-away burner door
- Insulated jacket with quick inspection opening cover
- Cast iron sections with Weil-McLain captured seals
- Drain valve
- 30 psi ASME Relief valve
- Pressure/temperature gauge
- Electrical junction box with wiring harnesses
- Service switch mounted on junction box cover plate
- Applicable temperature control with circulator relay
- I=B=R Chimney size: 8" x 8" x 15'
- Balanced draft damper
- Limited lifetime warranty on boiler sections



Packaged Boiler with Tankless Heater - Less Burner & Burner Controls

- Circulator included and shipped loose for mounting on supply or return
- High-low limit control with circulator relay
- Factory assembled and wired with jacket, circulator and controls

Part #	Mfg #	Boiler Model	I=B=R Burner Capacity	DOE Heating Capacity BTUH	Net I=B=R Ratings BTUH	DOE Seasonal Efficiency % AFUE	Approx Ship Wt	Price
WMRPWTGO3	386-700-832	P-WTGO-3	0.95 gph	115,000	100,000	85.3	542 lbs	CALL
WMRPWTGO4	386-700-833	P-WTGO-4	1.20 gph	145,000	126,000	85.0	583 lbs	CALL
WMRPWTGO5	386-700-834	P-WTGO-5	1.45 gph	175,000	152,000	85.0	683 lbs	CALL

Residential Boilers

Visionary Baths & More

Because your time is valuable...

Visit your local Visionary Baths & More Kitchen and Bath Design Centers to let one of our trained knowledgeable consultants help you with your project.

<http://www.visionarybaths.com>

Hydronic Heating

SGO Gold Series 3 - Oil-Fired Steam Boiler with Tankless Heater Opening

- Cast iron sections with Weil-McLain capture seals
- Jacketed block assembly
- Refractory combustion chamber with high temperature target wall
- Convertible flue (top or rear)
- Heater opening cover plate
- Full swing- away burner door
- Insulated jacket with quick inspection opening cover
- Steam pressure gauge
- Siphon
- Gauge glass, cocks and guard
- Drain valve
- Electrical junction box with wiring harness
- Service switch mounted on junction box cover plate
- Balanced draft damper
- I=B=R Chimney size: 8" x 8" x 15'
- 15 psig ASME Safety valve (boiler sections tested for 15 psig steam working pressure)
- 10-Year limited warranty on boiler sections



Packaged Boiler Less Burner - Probe Type Low Water Cut-Off

- Factory assembled and wired with jacket and controls

Residential Boilers

Part #	Mfg #	Boiler Model	I=B=R Burner Capacity	DOE Heating Capacity BTUH	Net I=B=R Rating - Steam Sq Ft/ BTUH	DOE Seasonal Efficiency % AFUe	Approx Ship Wt	Price
WMRPSGO3	386-700-819	P-SGO-3-S	0.95 gph	114,000	354/85,000	84.1	535 lbs	CALL
WMRPSGO4	386-700-820	P-SGO-4-S	1.25 gph	144,000	450/108,000	84.0	640 lbs	CALL
WMRPSGO5	386-700-821	P-SGO-5-S	1.50 gph	174,000	546/131,000	83.9	735 lbs	CALL
WMRPSGO6	386-700-822	P-SGO-6-S	1.80 gph	210,000	658/158,000	83.7	830 lbs	CALL

Walk in or call ahead.

You'll find thousands of products ready for same-day pickup or delivery.

Hydronic Heating

ECR™ 97gb Condensing Hot Water Boiler

- 97% AFUE
- Space-saving wall or conventional floor-mount installation
- Mounting floor/wall leveling legs and wall bracket both included
- Top and bottom connections for easy match up to existing piping
- Automatic low voltage/intermittent power reset boiler control module controls up to 16 boilers for multiple boiler applications
- User Display Interface: Easy programming with text display
- Remote mount option utilizes standard thermostat conductor wiring
- High grade 316L/444 Stainless Steel fin coil heat exchanger with flame sight glass
- Built-in primary/secondary manifold piping and pump
- Gas valve with premix Venturi and blower
- Durable stainless steel mesh burner
- Direct spark igniter
- Flame sensor and LP conversion kit included
- Electrical: Detachable low voltage terminal strip, high voltage junction box, transformer, lighted power switch and auxiliary service power outlet
- Low Water Cutoff with test feature
- Venting with Sch 40 PVC pipe
- Boiler drain valve
- Condensate drain with built-in trap
- 30 PSI Safety relief valve



Residential Boilers

Part #	Mfg #	Input BTUH Min / Max	Heating Capacity BTUH	I=B=R Net Rating BTUH	Dimensions H x W x D	Approx Ship Wt	Price
DUNECR075	ECR075	15,000 / 75,000	69,000	60,000	35-5/8" x 22-1/16" x 16-3/16"	140 lbs	CALL
DUNECR100	ECR100	20,000 / 100,000	91,000	79,000	35-5/8" x 22-1/16" x 16-3/16"	140 lbs	CALL

Visionary Baths & More Kitchen and Bath Design Centers

Professionally staffed to assist you and your customers with design and selection <http://www.visionarybaths.com>

Hydronic Heating

Quantum Q95M-200 - Modulating Condensing Boilers

- 95% AFUE
- Natural or LP Gas; LP conversion kit standard
- May be installed on combustibile flooring (No carpets)
- 8' Clearance to rear, 1" clearance to top, front, left side, right side and base to combustibile construction
- Option of left, right, or rear exit for return plumbing and gas piping
- 8" Clearance to side where exits for air intake, gas water & electrical installation
- 8" Clearance to top, 24" clearance to front and left side, 12' clearance to rear for service
- 0' Clearance for vent and air intake pipes to combustibile clearances
- Water content in heat exchanger is 2.6 gallons
- Aluminum monoblock boiler w/painted metal and plastic jacket
- High limit Aquastat
- Circulator (Taco 007 or Grundfos) with isolation ball valves
- Manual reset LWCO
- Pressure gauge
- Temperature display
- 30 lb psi ASME Relief valve
- Air purge vent
- Service switch
- Service receptacle outlet
- Microprocessor-based modulating control
- Ceramic coated modulating burner
- Modulating automatic gas valve & blower
- Direct spark igniter
- Manual reset casting temperature switch
- Air proving/blocked vent safety assembly
- Integral condensate trap
- Outdoor temperature sensor with cover
- Dimensions: 39-3/8" High x 18" Wide x 30-7/8" Deep
- 15-Year limited manufacturer's warranty



Residential Boilers

Part #	Mfg #	Heating Input BTUH Min / Max	Heating Capacity BTUH Min / Max	I=B=R Net Rating BTUH Min / Max	AFUE	Flue Diameter	Approx Ship Wt	Price
DUNQ95M200	Q95M-200	80,000 / 200,000	76,000 / 190,000	66,000 / 165,000	95.0%	3"	284 lbs	CALL

Hydronic Heating

Helix VLT - Gas Modulating Hot-Water Condensing Boilers

- 96% AFUE
- VLT: Vertical laser tube
- Natural or LP Gas; LP conversion kit standard
- Water content in heat exchanger is 1.1 gallons (050/075/100) or 1.8 gallons (150/200)
- Wall mounting bracket included
- Vertically mounted 316L/444 stainless steel helical fin tube heat exchanger
- Sealed housing
- Factory installed probe-type LWCO with test feature
- Corrosion resistant CPVC flue collector
- 30 lb psi Safety relief valve
- Integral condensate trap
- Removable terminal block
- Built in primary/secondary piping with pump
- Modulating control included
- 15-Year limited manufacturer's heat exchanger warranty



Residential Boilers

Part #	Mfg #	Input MBTUH	Heating Capacity BTUH	Net I=B=R Rating BTUH	AFUE	Flue Diameter*	Dimensions H x W x D	Approx Ship Wt	Price
DUNDKVL050	DKVLT-050	10 - 50	46,000	40,000	96.0%	2"	31" x 20" x 14"	111 lbs	CALL
DUNDKVL075	DKVLT-075	15 - 75	69,000	60,000	96.0%	2" or 3"	31" x 20" x 14"	111 lbs	CALL
DUNDKVL100	DKVLT-100	20 - 100	91,000	79,000	96.0%	2" or 3"	31" x 20" x 14"	111 lbs	CALL
DUNDKVL150	DKVLT-150	30 - 150	139,000	121,000	96.0%	3"	42" x 23" x 16"	182 lbs	CALL
DUNDKVL200	DKVLT-200	40 - 200	185,000	161,000	96.0%	3"	42" x 23" x 16"	182 lbs	CALL

* Must vent with Schedule 40 PVC

**Can't find what you are looking for?
We have access to hundreds of vendors and thousands
of items not listed in this catalog**

Hydronic Heating

Quantum Q90 - Gas-Fired Hot-Water Boilers

- 90% AFUE
- May be installed on combustible flooring (no carpets)
- 1" Clearance pm all sides and top to combustible construction
- 8" Clearance right side for vent/air intake pipe installation
- 24" Clearance front and left side, 8" top clearance for servicing
- 0" Clearance for vent and air intake pipes to combustible construction
- Assembled boiler with baked enamel finish jacket
- High limit aquastat
- Transformer
- 1-1/4" Circulator with isolation (ball) valves
- 30 psi ASME Relief valve
- Air vent
- Service switch
- Completely installed and wired safety control system with burner consisting of:
 - Microprocessor-based integrated boiler control
 - Stainless steel premix burner
 - Automatic gas valve
 - Hot surface igniter
 - Casting and vent temperature safety switches
 - Air flow proving switch
 - Temperature/pressure gauges
- 15-Year limited heat exchanger warranty



Q90-100



Residential Boilers

Part #	Mfg #	Input BTUH	Heating Capacity BTUH	Net I=B=R Rating BTUH	AFUE	Flue Diameter*	Dimensions H x W x D	Approx Ship Wt	Price
DUNQ9050	Q90-50	50,000	45,000	39,000	90.0%	2" or 3"	39.5" x 28" x 19.75"	256 lbs	CALL
DUNQ9075	Q90-75	75,000	68,000	59,000	90.0%	2" or 3"	39.5" x 28" x 19.75"	256 lbs	CALL
DUNQ90100	Q90-100	100,000	90,000	78,000	90.0%	2" or 3"	39.5" x 28" x 19.75"	256 lbs	CALL

* Must vent with Schedule 40 PVC

Q90 Burner

Part #	Mfg #	Description	Price
DUN550001811	550001811	Q90 Burner Replacement Kit	203.00

Hydronic Heating

XEB Series - Gas-Fired Water Boilers

- Assembled boiler with insulated jacket
- Combination high limit control and circulator relay
- 24 volt Transformer to power gas control system
- Flame rollout safety shut-off fuse link (rollout switch) with spare fuse link included
- Pressure switch
- Combination pressure/temperature gauge
- 1-1/4" Circulator pump with isolation (ball) valves
- 3/4" Boiler drain valve
- 30 lb ASME Relief valve
- Completely installed and wired gas control system with burners & manifold, consisting of:
 - Titanium composite burners
 - Automatic redundant combination gas valve, 24V, with pilot filter
 - Pressure regulator
 - Intermittent pilot control, continuous re-try, 100% shut-off for natural & propane gas
 - Combination pilot/burner/electrode/ flame sensor
- Dimensions: 29" High x 23-1/4" Deep
- 20-Year limited heat exchanger warranty



Natural Gas

Part #	Mfg #	Sections	AGA Input BTUH	DOE Heating Capacity BTUH	Net I=B=R Rating BTUH	Flue Diameter	Width	AFUE	Approx Ship Wt	Price
DUNXEB2T	XEB-2	2	42,500	36,000	31,000	4"	11"	84.4%	215 lbs	CALL
DUNXEB3T	XEB-3	3	75,000	63,000	55,000	4"	14-1/4"	83.4%	265 lbs	CALL
DUNXEB4T	XEB-4	4	112,500	94,000	82,000	4"	17-1/2"	83.0%	322 lbs	CALL
DUNXEB5T	XEB-5	5	150,000	125,000	109,000	4"	20-3/4"	82.7%	370 lbs	CALL
DUNXEB6T	XEB-6	6	187,500	155,000	135,000	4"	24"	82.3%	431 lbs	CALL
DUNXEB7T	XEB-7	7	225,000	186,000	162,000	4"	27-1/4"	82.0%	480 lbs	CALL

*Conventional venting through a lined chimney use 4" flue adapter included
 Through the wall venting - sizes 2, 3, 4, 5 use 3" stainless steel vent pipe (sold separately)
 - sizes 6, 7 use 4" stainless steel vent pipe (sold separately)

Propane

Part #	Mfg #	Sections	AGA Input BTUH	DOE Heating Capacity BTUH	Net I=B=R Rating BTUH	Flue Diameter	Width	AFUE	Approx Ship Wt	Price
DUNXEB3LP	XEB-3-LP	3	75,000	63,000	55,000	4"	14-1/4"	83.4%	265 lbs	CALL
DUNXEB4LP	XEB-4-LP	4	112,500	94,000	82,000	4"	17-1/2"	83.0%	322 lbs	CALL
DUNXEB5LP	XEB-5-LP	5	150,000	125,000	109,000	4"	20-3/4"	82.7%	370 lbs	CALL

*Conventional venting through a lined chimney use 4" flue adapter included
 Through the wall venting - sizes 2, 3, 4, 5 use 3" stainless steel vent pipe (sold separately)
 - sizes 6, 7 use 4" stainless steel vent pipe (sold separately)

XEB Temperature/Pressure Gauge

Part #	Mfg #	Description	Price
DUN240005245	240-00-5245	Temperature/Pressure Gauge for XEB	55.00

Prices & Specifications are Subject to Change.

Residential Boilers

Hydronic Heating

Plymouth Steam II - Gas-Fired Boilers

- Assembled boiler with insulated jacket
- (2) 2-1/2" Supply tappings and (2) 2-1/2" return tappings
- Integral draft diverter - built into jacket
- 24 volt, 40VA Transformer
- Pressure limit control
- Electronic probe-type low water cut-off
- Flame rollout safety shut-off fuse link and blocked vent safety shut-off switch with spare fuse link included
- Sight glass water level gauge
- Steam pressure gauge
- 3/4" Boiler drain valve
- (2) 2-1/2" Square head pipe plugs
- Vent damper
- Completely installed and wired gas control systems with burners and manifold consisting of:
 - Titanium composite burners
 - Automatic redundant combination gas valve, 24V
 - 15 lb ASME Pop safety valve
- Dimensions: 37-3/8" High x 26-1/2" Deep
- 12-Year limited heat exchanger warranty



Residential Boilers

Standing Pilot with Damper

- Pilot burner and thermocouple

Natural Gas

Part #	Mfg #	Sections	AGA Input BTUH	Heating Capacity BTUH	Net I=B=R Rating BTUH	Flue Diameter	Width	AFUE	Approx Ship Wt	Price
DUNPVSB4D	PVSB-4D	4	112,500	91,000	68,000	6"	14-1/2"	78.8%	368 lbs	CALL
DUNPVSB5D	PVSB-5D	5	150,000	122,000	92,000	6"	17-3/4"	79.2%	440 lbs	CALL
DUNPVSB6D	PVSB-6D	6	187,500	153,000	115,000	7"	21"	79.6%	512 lbs	CALL
DUNPVSB7D	PVSB-7D	7	225,000	183,000	137,000	7"	24-1/4"	80.1%	584 lbs	CALL
DUNPVSB8D	PVSB-8D	8	262,500	214,000	161,000	7"	27-1/2"	80.5%	659 lbs	CALL
DUNPVSB9D	PVSB-9D	9	299,000	245,000	184,000	7"	30-3/4"	80.9%	736 lbs	CALL

Hydronic Heating

Plymouth Xtreme XL Series - Gas-Fired Hot Water Boilers

- Assembled boiler with insulated jacket, factory crated
- Integral draft diverter built into jacket
- Cast iron heat exchanger and push nipples
- Combination aquastat and LWCO
- Flame rollout safety shutoff (fuse link) and manual, reset blocked vent safety shutoff, with spare fuse link included
- Combination pressure/temperature gauge
- 1-1/4" Circulator pump
- 3/4" Boiler drain valve
- 24 volt Transformer
- Service switch (power on/off)
- Vent damper
- Completely installed and wired gas control system with burners and manifold consisting of:
 - Titanium composite burners
 - Automatic redundant combination gas valve, 24V
 - 30 lb ASME Relief valve
- Dimensions: 31-3/8" High x 26-1/2" Deep; add 5-1/2" to height for vent damper
- 20-Year limited heat exchanger warranty



Residential Boilers

Standing Pilot with Vent Damper

- Pilot burner and thermocouple

Part #	Mfg #	Sections	AGA Input BTUH	Heating Capacity BTUH	Net I=B=R Rating BTUH	Flue Diameter	Width	AFUE	Approx Ship Wt	Price
DUNPWXL3V	PWXL-3VNT2000	3	70,000	57,000	50,000	5"	11-1/4"	80.4%	268 lbs	CALL
DUNPWXL4V	PWXL-4VNT2000	4	105,000	85,000	74,000	6"	14-1/2"	80.4%	320 lbs	CALL
DUNPWXL5V	PWXL-5VNT2000	5	140,000	113,000	98,000	6"	17-3/4"	80.3%	376 lbs	CALL
DUNPWXL6V	PWXL-6VNT2000	6	175,000	142,000	123,000	7"	21"	80.2%	436 lbs	CALL
DUNPWXL7V	PWXL-7VNT2000	7	210,000	170,000	148,000	7"	24-1/4"	80.1%	498 lbs	CALL
DUNPWXL8V	PWXL-8VNT2000	8	245,000	198,000	172,000	7"	27-1/2"	80.0%	551 lbs	CALL
DUNPWXL9V	PWXL-9VNT2000	9	280,000	226,000	197,000	7"	30-3/4"	80.0%	616 lbs	CALL

Intermittent Ignition with Vent Damper

- Combination pilot burner/electrode/flame sensor

Part #	Mfg #	Sections	AGA Input BTUH	Heating Capacity BTUH	Net I=B=R Rating BTUH	Flue Diameter	Width	AFUE	Approx Ship Wt	Price
DUNPWXL3E	PWXL-3ENT2000	3	70,000	57,000	50,000	5"	11-1/4"	81.6%	290 lbs	CALL
DUNPWXL4E	PWXL-4ENT2000	4	105,000	85,000	74,000	6"	14-1/2"	81.5%	355 lbs	CALL
DUNPWXL5E	PWXL-5ENT2000	5	140,000	113,000	98,000	6"	17-3/4"	81.3%	426 lbs	CALL
DUNPWXL6E	PWXL-6ENT2000	6	175,000	142,000	123,000	7"	21"	81.1%	493 lbs	CALL
DUNPWXL8E	PWXL-8ENT2000	8	245,000	198,000	172,000	7"	27-1/2"	80.8%	631 lbs	CALL
DUNPWXL9E	PWXL-9ENT2000	9	280,000	226,000	197,000	7"	30-3/4"	80.7%	694 lbs	CALL

Prices & Specifications are Subject to Change.

Hydronic Heating

Plymouth Water Ultra Gas-Fired Hot-Water Boilers

- Ultra high efficiency model
- Assembled boiler with insulated jacket, factory crated
- Integral draft inverter - built into jacket
- Combination high limit control and circulator relay
- Flame rollout safety shutoff (fuse link) and manual, reset blocked vent safety shutoff, with spare fuse link included
- Combination pressure/temperature gauge
- 1-1/4" Grundfos circulator pump with isolation (ball) valves
- 3/4" Boiler drain valve
- 30 lb ASME Relief valve
- Vent damper
- Completely installed and wired gas control system with burners and manifold consisting of:
 - Titanium composite burners
 - Automatic redundant combination gas valve, 24V



Intermittent Ignition w/Vent Damper - Natural Gas

- Intermittent pilot control, 100% shut-off continuous re-try
- Combination pilot burner/electrode/flame sensor

Residential Boilers

Part #	Mfg #	Sections	AGA Input BTUH	Heating Capacity BTUH	Net I=B=R Rating BTUH	Flue Diameter	AFUE	Price
DUNWPSB3D	WPSB-3D	3	75,000	63,000	55,000	5"	84.0%	CALL
DUNWPSB4D	WPSB-4D	4	112,500	94,000	82,000	6"	84.0%	CALL
DUNWPSB5D	WPSB-5D	5	150,000	126,000	110,000	6"	84.1%	CALL
DUNWPSB6D	WPSB-6D	6	187,500	157,000	137,000	7"	84.1%	CALL

Product descriptions and specifications in this catalog are condensed from manufacturer's literature. For exact information, consult manufacturer's literature prior to installation and service. Contact us if you are not sure about specifications.

Hydronic Heating

Excelsior Oil-Fired Hot-Water Boilers

- Cast-Iron 3-pass heat exchanger
- Flexible oil line
- Dual hinge swing door with right or left mount option
- Wide flue-ways
- Site glass for flame observation
- Removable 1/4" sampling port for combustion readings
- Combination powder-coated steel/plastic jacket
- Lighted on/off switch with protective cover
- Target wall
- 3/4" ASME Relief valve
- Piping tree
- 1-1/4" Supply and return tapings
- Temperature/Pressure gauge
- Aquastat/boiler control
- Circulator control
- Terminal block for power wiring
- Wiring harnesses with Molex connectors
- Burner electrical disconnect
- Drain valve
- Limited lifetime warranty



Residential Boilers

Part #	Mfg #	Sections	Firing Rate GPH	Input BTUH	D.O.E. Heating Cap BTUH	I=B=R Net Ratings BTUH	AFUE	Approx Ship Wt	Price
DUNDK4EXA075	DK4EXA075	4	0.75	105,000	90,000	79,000	86.0%	436 lbs	CALL
DUNDK5EXA100	DK5EXA100	5	1.00	140,000	120,000	105,000	86.5%	496 lbs	CALL
DUNDK6EXA130	DK6EXA130	6	1.30	182,000	157,000	136,000	86.5%	560 lbs	CALL

For instructions as to proper installation, servicing, and troubleshooting, please refer to the Manufacturer's literature.

Hydronic Heating

Empire II - Oil-Fired Hot-Water Boilers

- Efficiencies up to 86.5% AFUE
- Cast-Iron heat exchanger and swing door
- Cast-Iron sections and push nipples
- Tankless heater option
- Cast-iron boiler
- Circulating pump included
- Baked enamel steel jacket
- Clean cut AFG Beckett burner
- Combustion chamber insulation system:
 - Target wall (vacuum formed refractory ceramic fiber)
 - Ceramic fiber blanket
 - Swing fire door insulation (vacuum formed ceramic fiber)
- ASME Relief valve
- Combination temperature/pressure gauge
- 6" Barometric draft control
- 1-1/4" Taco circulator pump with isolation ball valves
- 3/4" Boiler drain valve
- 30 PSI ASME Relief valve
- Completely installed and wired Beckett AFG series oil burner
- 20-Year limited heat exchanger warranty



Residential Boilers

Boiler Package less Tankless Coil with Beckett Taco Package

Part #	Mfg #	# of Sections	I=B=R Oil Burner GPH	I=B=R Oil Burner MBH	D.O.E. Heating Cap MBH	I=B=R Net Ratings Steam MBH	AFUE Rating	Price
DUN3EW	3EW.75ZBTP	3	0.75	105	92	80	85.2	CALL
DUN4EW	4EW1.25ZBTP	4	1.25	175	150	130	83.9	CALL
DUN5EW	5EW1.75ZBTP	5	1.75	245	209	182	83.6	CALL

Boiler Package with Tankless Coil with Beckett Taco Package

Part #	Mfg #	# of Sections	I=B=R Oil Burner GPH	I=B=R Oil Burner MBH	D.O.E. Heating Cap MBH	I=B=R Net Ratings Steam MBH	AFUE Rating	Price
DUN3EWT	3EW.75TBTP	3	0.75	105	92	80	85.2	CALL
DUN4EWT	4EW1.25TBTP	4	1.25	175	150	130	83.9	CALL

Hydronic Heating

Baxi Luna 3 Comfort 310Fi Near-Condensing Wallhung Boilers

- 85.5% AFUE efficiency
- Luna 3 Comfort 310Fi consists of combination central heating and domestic hot water boiler
- Direct vent, sealed combustion
- Whisper-quiet operation, closet-installation approved
- Includes:
 - Controller (sets up in °F or °C)
 - Termination kit
 - Valve kit
 - Built-in components
- Nickel-chrome stainless steel AISI 316L premix burner and heat exchanger
- Power venting using outdoor air for combustion
- ASME H-Stamp certified heat exchanger
- 10-Year heat exchanger warranty

LUNA BAXI



Part #	Mfg #	Gas Type	Heating Cap BTU/hr	Temp Setting Range	Dimensions H x W x D	Price
BAXLUNA3COMFORT310KIT	LUNA 3 COMFORT 310	NG	35,486 to 105,776	86° - 180°	30" x 17-3/4" x 13-1/2"	CALL

Residential Boilers

Baxi Luna 3 Comfort 1.31Fi Near-Condensing Wallhung Boilers

- 85.5% AFUE efficiency
- Direct vent, sealed combustion
- Whisper-quiet operation, closet-installation approved
- Includes:
 - Controller (sets up in °F or °C)
 - Termination kit
 - Valve kit
 - Built-in components
- Nickel-chrome stainless steel AISI 316L premix burner and heat exchanger
- Power venting using outdoor air for combustion
- ASME H-Stamp certified heat exchanger
- 10-Year heat exchanger warranty

LUNA BAXI



Part #	Mfg #	Gas Type	Heating Cap BTU/hr	Temp Setting Range	Dimensions H x W x D	Price
BAXLUNA3COMFORT131KIT	LUNA 3 COMFORT 1.31	NG	35,486 to 105,776	86° - 180°	30" x 17-3/4" x 13-1/2"	CALL

Prices & Specifications are Subject to Change.

Hydronic Heating

Baxi Luna HT Wallhung Condensing Boiler

- 99% Efficiency
- HT 380: Combination heating and domestic hot water
- HT 1.33: Central heating-only boiler
- Fully modulating fan and calibrated venturi
- Fully modulating gas valve has 1:1 gas/air mechanical control
- Nickel-chrome stainless steel (AISI 316L) primary heat exchanger
- Double cylinder stainless steel burner (AISI 316L)
- Sealed combustion
- Fully electronic 3 way motorized valve
- Double CPU microprocessor for highest efficiency optimization
- Fully automatic self diagnostics
- Anti-freeze protection
- 3-Way valve protection

LUNA BAXI



Residential Boilers

Part #	Mfg #	Gas Type	Heating Cap BTU/hr	Temp Setting Range	Dimensions H x W x D	Price
BAXLUNAHT380KIT	LUNA HT 380	NG	32,804 to 112,601	86° - 180°	30.04" x 17.71" x 13.58"	CALL
BAXLUNAHT133KIT	LUNA HT 1.33	NG	32,804 to 112,601	86° - 180°	17-3/4" x 13-1/2" x 30"	CALL

Venting Parts

Part #	Mfg #	Description	Price
BAX714059712	714059712	Coaxial 90° Bend for HT 33, 1.33	107.38
BAX714059812	714059812	Coaxial 45° Bend for HT 33, 1.33	139.72
BAX714059513	714059511/2/3/4	Coaxial Pipe Extension for HT	183.48
BAX714059611	714059611	Coaxial Horizontal Termination for HT 33, 1.33	183.48
BAX714093510	714093510	Coaxial Vertical Termination	872.60
BAX714093910	714093910	Condensing Flue Adapter for Vertical Vent for HT 33, 1.33	104.40
BAX714016810	714016810	Coaxial Flue 90° Elbow	71.84
BAX714016910	714016910	39" Coaxial Termination Pipe	112.26
BAX714017610	714017610	Coaxial Pipe Extension	98.60
BAX714036410	714036410	Vertical Coaxial Flue Termination	747.96
BAX714036610	714036610	Pitched Roof Flashing	210.74
BAX714059110	714059110	Dual Flue Kit for HT 33, 1.33	104.72
BAX714059410	714059410	Dual Flue 1 Meter Vent Tube for HT	91.34
BAX714059910	714059910	Dual Flue .5 Meter Vent Tube for HT	59.30
BAX714059210	714059210	90° Bend for HT	92.14
BAX714061510	714061510	Dual Flue System Kit for LUNA 2000	177.22
BAX714096510	714096510	ABS-PVC Vent Adapter	209.72
BAX714101410	714101410	Luna 3 Comfort Starting Coaxial 90° Vent Elbow	71.86
BAX714101710	714101710	Luna 3 Comfort 1 Meter Coaxial Vent Pipe	98.60
BAX714101810	714101810	Luna 3 Comfort Coaxial Horizontal Termination	114.20

All Items May Not Be Stocked In All Branches

Hydronic Heating

Boiler Accessories

Part #	Mfg #	Description	Price
BAX714062110	714062110	Outdoor Sensor	41.22
BAX714072511	714072511	Interface Kit for Remote Controller	144.24
BAX714072611	714072611	QAA73 Remote Controller & Climatic Regulator	620.64
BAX714072811	714072811	Outdoor Air Temperature Sensor QAC34	131.16



GWA Gas-Fired Water Boiler

- One piece access door
- All controls in easy reach
- Cast iron sections with built-in air separator
- Insulated heavy-gauge steel jacket
- Lifetime limited warranty on heat exchanger
- 1-Year limited warranty on parts



Residential Boilers

GWA Gas-Fired Water Boiler with Standing Pilot and Taco Pump

Part #	Mfg #	Gas	AGA Input MBH	Net I=B=R Ratings MBH	Height Over Vent Damper	Width	Flue Dia	AFUE	Ship Wt	Price
WILGWA052	GWA-052-N-S-T	NG	52	37	45-3/8"	10"	4"	80.2	200 lbs	CALL
WILGWA070	GWA-070-N-S-T	NG	70	50	52-3/8"	10"	4"	80.1	200 lbs	CALL
WILGWA105	GWA-105-N-S-T	NG	105	77	54-3/8"	13"	5"	80.4	240 lbs	CALL
WILGWA140	GWA-140-N-S-T	NG	140	102	57-7/8"	16"	6"	80.4	280 lbs	CALL
WILGWA175	GWA-175-N-S-T	NG	175	126	60-7/8"	19"	6"	80.5	325 lbs	CALL
WILGWA210	GWA-210-N-S-T	NG	210	151	62-1/8"	22"	7"	80.5	370 lbs	CALL

Hydronic Heating

GSA Gas-Fired Steam Atmospheric Boiler

- One piece access door
- All controls in easy reach
- Stainless steel burners
- Cast iron sections
- Insulated heavy-gauge steel jacket
- 10-Year limited warranty on boiler sections



GSA Gas-Fired Steam Atmospheric Boiler with Standing Pilot

- P Suffix: Probe low water cutoff

Part #	Mfg #	Gas	AGA Input MBH	Net I=B=R Ratings MBH	Height Over Vent Damper	Width	Flue Dia	AFUE	Ship Wt	Price
WILGSA100	GSA-100-N-S-P	NG	100	62	38-3/8"	17"	5"	81.3	400 lbs	CALL
WILGSA125	GSA-125-N-S-P	NG	125	78	38-7/8"	21-1/4"	6"	81.5	500 lbs	CALL
WILGSA150	GSA-150-N-S-P	NG	150	94	38-7/8"	21-1/4"	6"	81.6	500 lbs	CALL
WILGSA250	GSA-250-N-S-P	NG	250	157	41-7/8"	29-3/4"	8"	82.0	680 lbs	CALL

GWI Gas-Fired Water Induced-Draft Boiler

- Induced-draft allows sidewall or chimney venting
- High efficiency
- Spark-ignited pilot with electronic control
- One piece access door
- All controls in easy reach
- Color-coded wiring
- Cast iron sections with built-in separator
- Insulated heavy-gauge steel jacket
- Lifetime limited warranty on heat exchanger
- 1-Year limited warranty on parts



GWI Gas-Fired Water Draft-Induced Boiler with Intermittent Pilot and Taco Pump

Part #	Mfg #	Gas	AGA Input MBH	Net I=B=R Ratings MBH	Height	Width	Flue Dia	AFUE	Ship Wt	Price
WILGWI047	GWI-047-N-I-T	NG	47	35	28-3/8"	10"	3"/4"	83.0	190 lbs	CALL
WILGWI063	GWI-063-N-I-T	NG	63	46	28-3/8"	10"	3"/4"	83.3	190 lbs	CALL
WILGWI095	GWI-095-N-I-T	NG	95	69	28-3/8"	13"	3"/5"	83.0	230 lbs	CALL
WILGWI127	GWI-127-N-I-T	NG	127	92	28-3/8"	16"	3"/5"	82.7	270 lbs	CALL
WILGWI190	GWI-190-N-I-T-W	NG	190	137	28-3/8"	22"	3"/5"	82.1	370 lbs	CALL

All Items May Not Be Stocked In All Branches

Hydronic Heating

GWS Gas-Fired Water Sealed Combustion Boiler

- Sealed combustion allows use of outside combustion air
- High efficiency
- Spark-ignited pilot with electronic control
- One piece access door
- Easy service
- Plug-in wiring
- Control module with diagnostic lights
- Cast iron sections with built-in separator
- Insulated heavy-gauge steel jacket
- Lifetime limited warranty on heat exchanger
- 1-Year limited warranty on parts



Part #	Mfg #	Gas	AGA Input MBH	Net I=B=R Ratings MBH	Height	Width	Flue Dia	AFUE	Ship Wt	Price
WILGWS063	GWS-063-N-I-T-W *	NG	63	47	28-3/8"	13"	3"	85.3	240 lbs	CALL
WILGWS095	GWS-095-N-I-T-W	NG	95	70	28-3/8"	16"	3"	84.6	280 lbs	CALL
WILGWS127	GWS-127-N-I-T-W	NG	127	93	28-3/8"	19"	3"	84.0	325 lbs	CALL
WILGWS158	GWS-158-N-I-T-W	NG	158	115	28-3/8"	22"	3"	83.4	370 lbs	CALL

* Energy Star

OWB/OWT Oil-Fired Water Boiler

- OWB: No tankless heater
- OWT: With tankless heater
- Swing-away burner door
- Low draft loss
- Top access cleanout cover
- Plug-in wiring harness
- High efficiency
- Flame retention head design
- Solenoid valve
- PSC motor
- Solid state igniter
- Rear flue outlet
- Cast iron sections with built-in air separator
- Insulated heavy-gauge steel jacket
- Lifetime limited warranty on heat exchanger
- 3-Year limited warranty on parts



Oil-Fired Water Boiler with Beckett Burner

- 35-5/8"H x 20-1/4"W

Part #	Mfg #	DOE Htg Cap(MBH)	Net I=B=R Ratings MBH	Width	Flue Conn Size	Min Chimney Size	AFUE	Ship Wt	Price
WILOWB3100	OWB-3-100-B-T-W	115	100	13-3/4"	7" Rnd	8" x 8"/6"	85.0	540 lbs	CALL
WILOWT3100	OWT-3-100-B-T-W	115	100	13-3/4"	7" Rnd	8" x 8"/6"	85.0	560 lbs	CALL
WILOWB4125	OWB-4-125-B-T-W	122	106	16-7/8"	7" Rnd	8" x 8"/6"	86.2	645 lbs	CALL
WILOWB5150	OWB-5-150-B-T-W	174	152	20"	7" Rnd	8" x 8"/7"	85.0	760 lbs	CALL

Residential Boilers

Prices & Specifications are Subject to Change.

Hydronic Heating

OSB Oil-Fired Steam Boilers Series 2

- Swing-away burner door
- Low draft loss
- Top access cleanout cover
- Plug-in wiring harness
- High efficiency oil burner
- Flame retention head design
- Solenoid valve
- PSC motor
- Solid state igniter
- Rear flue outlet
- Cast iron sections with built-in air separator
- Insulated heavy-gauge steel jacket
- 10-Year limited warranty on cast iron sections
- 3-Year limited warranty on parts



Oil-Fired Steam Boiler with Beckett Burner

- 35-5/8"H x 20-1/4"W

Residential Boilers

Part #	Mfg #	DOE Htg Cap(MBH)	Net I=B=R Ratings MBH	Width	Flue Conn Size	Min Chimney Size	AFUE	Ship Wt	Price
WILOSB4125	OSB-4-125-B-P	144	108	20"	7" Rnd	8" x 8"/6"	84.0	705 lbs	CALL
WILOSB5150	OSB-5-150-B-P	174	131	22-1/2"	7" Rnd	8" x 8"/6"	83.9	820 lbs	CALL

Burners

Part #	Mfg #	Description	Price
WILWL4205C	BB-CHB/LB-105-S2	Beckett Burner WI 4205C f/CHB/CLB 105 Furnace	CALL
WILC8512447	RB-CHB/LB-105-S2	Riello Burner C8512447 f/CHB/CLB 105 Furnace	CALL

If you need a product not listed in this catalog, please check with us. We have not listed every product we can get for you.

Hydronic Heating

Vitodens Wall-Mounted Gas-Fired Condensing Boilers

Vitodens 200-W Compact Lambda Pro Wall-Mount Gas-Fired Boiler

- Lambda Pro is an intelligent combustion management system
- Modulating stainless steel MatriX-compact cylinder burner
- 316 Ti Stainless steel Inox-Radial heat exchanger
- Low-emission combustion
- Built-in programmable indoor/outdoor control system
- Venting flexibility
- Quiet operation



Part #	Mfg #	Type Gas	CSA Output/DOE Htg MBTU (Gas)	AFUE % Gas	Dimensions (HxWxD)	Ship Wt	Price
VIEWB2B857	WB2B857	NG	28-61	96.1%	33-1/2" x 17-3/4" x 14"	102 lbs	CALL
VIEWB2B858	WB2B858	NG	28-85	96.1%	33-1/2" x 17-3/4" x 14"	102 lbs	CALL
VIEWB2B859	WB2B859	NG	28-114	96.1%	33-1/2" x 17-3/4" x 14"	102 lbs	CALL
VIEWB2B860	WB2B860	NG	55-146	96.1%	33-1/2" x 19" x 15"	155 lbs	CALL
VIEWB2B861	WB2B861	NG	55-194	96.1%	33-1/2" x 19" x 15"	155 lbs	CALL
VIEWB2B912	WB2B912	NG	95-260	96.1%	33-1/2" x 19" x 21"	225 lbs	CALL
VIEWB2B913	WB2B913	NG	98-350	94.5%	33-1/2" x 19" x 21"	225 lbs	CALL

Vitodens 100-W Wall-Mount Gas-Fired Boiler

- Modulating stainless steel cylinder burner
- Inox-Radial heat exchanger surface
- Low-emission combustion
- Built-in automatic frost protection
- Limited lifetime warranty in residential applications



Part #	Mfg #	Type Gas	CSA Input MBTU (Gas)	CSA Output MBTU (Gas)	AFUE % Gas	Dimensions (HxWxD)	Ship Wt	Price
VIE7459301	7459-301	NG	37- 91	34- 83	95.2%	28-1/2" x 15-3/4" x 14-1/8"	95 lbs	CALL
VIE7459302	7459-302	NG	37- 118	34-108	95.2%	28-1/2" x 15-3/4" x 14-1/8"	95 lbs	CALL

Residential Boilers

Hydronic Heating

Vitodens 100-W Wall-Mount Gas-Fired Boiler with CombiPlus Kit

- On-demand domestic hot water (DHW) - up to 3.6 gpm
- Modulating stainless steel cylinder burner
- Inox-Radial heat exchanger surface
- Low-emission combustion
- Built-in automatic frost protection
- Virtually silent DHW production
- Built-in DHW temperature and flow sensors
- CombiPlus Kit:
 - 8-3/4"H x 17"W x 9-7/8"D
 - 11-1/2" - 36" Distance between boiler and Combi Plus kit
 - Kit weighs 25 lbs
- Limited lifetime warranty in residential applications



Residential Boilers

Part #	Mfg #	Type Gas	CSA Input MBTU (Gas)	CSA Output MBTU (Gas)	AFUE % Gas	Dimensions (HxWxD)	Boiler Ship Wt	Price
VIEWB1B486	WB1B486	NG	37- 91	34- 83	95.2%	28-1/2" * x 15-3/4" x 14-1/8"	95 lbs	CALL
VIEWB1B487	WB1B487	NG	37- 118	34-108	95.2%	28-1/2" * x 15-3/4" x 14-1/8"	95 lbs	CALL

* Height is increased by 8-3/4" for the kit and 11-1/2" to 36" for space between the boiler and the kit

CombiPlus Kits

- For on-demand DHW

Part #	Mfg #	Description	Price
VIE7459305	7459-305	DHW Hot Water Kit	CALL

Boiler Accessories

Boiler Service Tool Kit

Part #	Mfg #	Description	Price
VIE9537070	9537-070	Vitodens 200 Boiler Service Tool Set	CALL

Coding Plug

Part #	Mfg #	Description	Price
VIE7425953	7425-953	Coding Plug for WB2B857 Vitodens, 5,000'-10,000'	CALL
VIE7425954	7425-954	Coding Plug for WB2B858 Vitodens, 5,000'-10,000'	CALL
VIE7425956	7425-956	Coding Plug for WB2B860 Vitodens, 5,000'-10,000'	CALL
VIE7425957	7425-957	Coding Plug for WB2B861 Vitodens, 5,000'-10,000'	CALL

Hydronic Heating

Boiler Parts

Part #	Mfg #	Description	Price
VIE7424088	7424-088	4" 60/100 Coax 1.6' Straight Vent Pipe	CALL
VIE7424091	7424-091	4" 60/100 Coax 3.3' Straight Vent Pipe	CALL
VIE7424094	7424-094	4" 60/100 Coaxial 90° Elbow	CALL
VIE7424097	7424-097	4" 60/100 Coaxial 45° Elbows Pack of 2	CALL
VIE7424100	7424-100	4" 60/100 Coax 2.6' Horiz Vent Term	CALL
VIE7424106	7424-106	4" 60/100 Coax 1.25' Sliding Coupling	CALL
VIE7424109	7424-109	4" 60/100 Coax Mounting Clip	CALL
VIE7424119	7424-119	4" 60/100 Basic Horizontal Vent Kit for Vitodens	CALL

Low-Loss Header

- To decouple high flow rate systems from the boiler loop

Part #	Mfg #	Description	Price
VIE7424646	7424-646	17.5 GPM Low Loss Header	CALL
VIE7424647	7424-647	35 GPM Low Loss Header	CALL
VIE7498529	7498-529	Low Loss Header w/Insulation	CALL



Indirect Water Heaters

Aqua Plus Indirect Fired Water Heaters

- 316L Stainless steel tank welded with "TIG and Plasma" technology coil tank
- Temperature and pressure relief valve standard equipment
- Thermostat connections already installed for quick and easy wiring
- All connections include boiler supply and return, domestic water and domestic recirculation on side of tank
- Magnesium Anode installed in all tanks
- Inspection port located near bottom of all tanks
- Exceptional "R Value" with 2" dense foam insulation
- Adjustable feet for uneven floors
- Available in gold and pewter colors



Part #	Mfg #	Model	Domestic Water Gallons	Domestic Water Inlet/Outlet	Boiler Water Supply/Return	H x Dia	Approx Ship Wt(lbs)	Price
WMIAP35P	633-500-000	Aqua Plus 35	29.6	3/4"	1"	36-3/8" x 21-7/8"	94	CALL
WMIAP45P	633-500-001	Aqua Plus 45	39.9	3/4"	1"	46-1/4" x 21-7/8"	111	CALL
WMIAP55P	633-500-002	Aqua Plus 55	53.1	3/4"	1"	60" x 21-7/8"	122	CALL
WMIAP85P	633-500-003	Aqua Plus 85	80.6	1"	1"	59-1/2" x 26"	223	CALL
WMIAP105P	633-500-004	Aqua Plus 105	109.4	1"	1"	59-3/4" x 30"	238	CALL

Prices & Specifications are Subject to Change.

Residential Boilers



www.irrsupply.com

Hydronics

Indirect Water Heaters

WH-41 Series BoilerMate® Classic Water Heater Less Circulator

- 41 Gallon capacity residential heater
- 22" Diameter, 48" height
- Optional Smart Control™ operates on 24V or 120V with up/down arrows to change settings and built-in diagnostics
- T&P Valve included
- 5-Year transferable warranty



Part #	Mfg #	Description	Price
AMTWH41L	WH-41L	Smart Control™ Pkgd	1429.00
AMTWH41Z	WH-41Z	Electromechanical Thermostat, Std Dial Aquastat	1317.00
AMTWH41ZDW	WH-41Z-DW	Double Wall Electromechanical Thermostat, Std Dial Aquastat	1651.00

WHS-60 Series BoilerMate® Premier Water Heater Less Circulator

- 60 Gallon capacity residential heater
- Great for households with high water use
- Stainless steel tank surrounded by insulation and plastic outer jacket
- 26" Diameter, 54" height
- T&P Valve
- 10-Year limited warranty



Part #	Mfg #	Features	Price
AMTWHS60	WHS-60	Smart Control™	3251.00

WHS-80 Series BoilerMate® Premier Water Heater Less Circulator

- 80 Gallon capacity residential heater
- High volume for large whirlpools, perfect for hot tubs, multi-head showers and other high demand applications
- Stainless steel tank surrounded by insulation and plastic outer jacket
- 26" Diameter, 66" height
- T&P Valve
- 10-Year limited warranty



Part #	Mfg #	Features	Price
AMTWHS80	WHS-80	Smart Control™	3826.00

Residential Boilers

We have 32 convenient locations proudly serving Western NY, Central NY, and Northern Pennsylvania.

All Items May Not Be Stocked In All Branches

Commercial Hydronic Heating

LGB Series - Commercial Atmospheric Gas Boiler

For Hot Water or Steam

- Short draw rods permit faster, easier assembly of boiler sections
- Includes factory-assembled base and burners, and simplified piping for quick and easy installation
- Compact design allows for more piping and venting headroom
- The highest efficiency commercial cast iron atmospheric gas boiler available by Weil-McLain
- Built-in air separator diverts air to the expansion tank
- Gas natural draft water and steam boiler with cast iron sections



LGB Commercial Atmospheric Gas Boiler for Water

Part #	Mfg.#	A.G.A. Input MBH	A.G.A. Gross Output MBH	Net I-B-R Rating MBH	Boiler HP	Approximate Shipping Weight (lbs)	I-B-R Chimney Size	Price
WMCLGB4W	LGB-4W	400	324.0	282	9.7	1185	10"	CALL
WMCLGB5W	LGB-5W	520	421.2	366	12.6	1455	12"	CALL
WMCLGB6W	LGB-6W	650	526.5	458	15.7	1725	12"	CALL
WMCLGB7W	LGB-7W	780	631.8	549	18.9	2005	12"	CALL
WMCLGB8W	LGB-8W	910	737.1	641	22.0	2290	14"	CALL
WMCLGB9W	LGB-9W	1040	842.4	733	25.2	2560	14"	CALL
WMCLGB10W	LGB-10W	1170	947.7	824	28.3	2800	16"	CALL
WMCLGB11W	LGB-11W	1300	1053.0	916	31.5	3105	16"	CALL
WMCLGB12W	LGB-12W	1430	1158.3	1007	34.6	3365	16"	CALL
WMCLGB13W	LGB-13W	1560	1263.6	1099	37.8	3785	16"	CALL
WMCLGB14W	LGB-14W	1690	1368.9	1190	40.9	4085	16"	CALL
WMCLGB15W	LGB-15W	1820	1474.2	1282	44.0	4355	16"	CALL
WMCLGB16W	LGB-16W	1950	1579.5	1373	47.2	4725	17"	CALL
WMCLGB17W	LGB-17W	2080	1684.8	1465	50.3	4975	17"	CALL
WMCLGB18W	LGB-18W	2210	1790.1	1557	53.5	5270	18"	CALL
WMCLGB19W	LGB-19W	2340	1895.4	1648	56.6	5540	18"	CALL
WMCLGB20W	LGB-20W	2470	2000.7	1740	59.8	5820	19"	CALL
WMCLGB21W	LGB-21W	2600	2106.0	1831	62.9	6080	19"	CALL
WMCLGB22W	LGB-22W	2730	2211.3	1923	66.1	6365	19"	CALL
WMCLGB23W	LGB-23W	2860	2316.6	2014	69.2	6625	20"	CALL

Commercial Boilers

Prices & Specifications are Subject to Change.

Commercial Hydronic Heating

LGB Commercial Atmospheric Gas Boiler for Steam

Part #	Mfg.#	A.G.A. Input MBH	A.G.A. Gross Output MBH	Net I-B-R Rating MBH	Boiler HP	Approximate Shipping Weight (lbs)	I-B-R Chimney Size	Price
WMCLGB4S	LGB-4S	400	324.0	243	9.7	1185	10"	CALL
WMCLGB5S	LGB-5S	520	421.2	316	12.6	1455	12"	CALL
WMCLGB6S	LGB-6S	650	526.5	395	15.7	1725	12"	CALL
WMCLGB7S	LGB-7S	780	631.8	474	18.9	2005	12"	CALL
WMCLGB8S	LGB-8S	910	737.1	533	22.0	2290	14"	CALL
WMCLGB9S	LGB-9S	1040	842.4	632	25.2	2560	14"	CALL
WMCLGB10S	LGB-10S	1170	947.7	711	28.3	2800	16"	CALL
WMCLGB11S	LGB-11S	1300	1053.0	790	31.5	3105	16"	CALL
WMCLGB12S	LGB-12S	1430	1158.3	869	34.6	3365	16"	CALL
WMCLGB13S	LGB-13S	1560	1263.6	949	37.8	3785	16"	CALL
WMCLGB14S	LGB-14S	1690	1368.9	1035	40.9	4085	16"	CALL
WMCLGB15S	LGB-15S	1820	1474.2	1123	44.0	4355	16"	CALL
WMCLGB16S	LGB-16S	1950	1579.5	1211	47.2	4725	17"	CALL
WMCLGB17S	LGB-17S	2080	1684.8	1298	50.3	4975	17"	CALL
WMCLGB18S	LGB-18S	2210	1790.1	1386	53.5	5270	18"	CALL
WMCLGB19S	LGB-19S	2340	1895.4	1470	56.6	5540	18"	CALL
WMCLGB20S	LGB-20S	2470	2000.7	1553	59.8	5820	19"	CALL
WMCLGB21S	LGB-21S	2600	2106.0	1635	62.9	6080	19"	CALL
WMCLGB22S	LGB-22S	2730	2211.3	1717	66.1	6365	19"	CALL
WMCLGB23S	LGB-23S	2860	2316.6	1799	69.2	6625	20"	CALL

Commercial Boilers

Ultra Commercial Condensing High-Efficiency Gas Boiler with 20 - 100% Modulation

- Factory test report shipped with boiler
- Cast aluminum block
- CSD-1 Comes standard
- Manual reset low water cut-off
- Adjustable manual reset high limit
- Stainless steel burner with woven steel fiber mesh
- Venting with PVC or CPVC up to 100 feet
- Direct vent or direct exhaust capable
- Venturi mixing system with air silencer
- Variable speed motor
- Negative pressure regulation gas valve
- 50VA Transformer
- Integrated drain in vent adapters
- Outlet and inlet water temperature sensors
- Flue gas and outdoor temperature sensors



Part #	Mfg #	Boiler Model	CSA Input MBH	CSA Gross Output MBH	Net I=B=R Rating MBH	IBR Thermal Efficiency	Approx Ship Wt	Price
WMCULTRA399	383-500-706	Ultra 399	399,000	365,000	317,000	91.7	297 lbs	CALL
WMCULTRA550	383-600-010	550	550,000	517,000	445,000	93.9	505 lbs	CALL
WMCULTRA750	383-600-011	750	750,000	702,000	605,000	93.6	550 lbs	CALL

All Items May Not Be Stocked In All Branches

Commercial Hydronic Heating

Oil Boilers

80 Series for use with Gas, Light Oil, & Gas/Light Oil - Fired Burners

- Cast iron sections
- Insulated steel jacket
- Aluminized steel flue collector assembly
- Steel flue collar & breeching damper
- Observation ports on front & rear sections
- Refractory blanket & target wall in combustion area
- Side cleanout plates
- Flue brush
- Less burner; not assembled
- Forced draft



Water Boilers - Top Outlet Flexibility

- 30 PSIG ASME Safety relief valve
- Combination high limit/low limit control
- Combination pressure/temperature gauge
- Built-in air eliminator

Part #	Mfg #	Boiler Model Number	Gas Input GPH	Gas Input MBH	Boiler HP	I=B=R Water Rating MBH	Vent Size	Operating Weight lbs	Price
WMCH380WF	H380WF	380	2.4	346	8.3	242	8"	1,170	CALL
WMCH480WF	H480WF	480	3.4	491	11.8	344	8"	1,411	CALL
WMCH580WF	H580WF	580	4.45	639	15.4	448	8"	1,752	CALL
WMCH680WF	H680WF	680	5.5	787	18.9	551	8"	2,093	CALL
WMCH780WF	H780WF	780	6.5	935	22.5	655	10"	2,434	CALL
WMCH880WF	H880WF	880	7.5	1082	26	758	10"	2,774	CALL
WMCH980WF	H980WF	980	8.5	1230	29.6	862	10"	3,115	CALL
WMCH1080WF	H1080WF	1080	9.6	1378	33.2	965	10"	3,456	CALL
WMCH1180WF	H1180WF	1180	10.6	1526	36.7	1069	10"	3,697	CALL

Steam Boilers - Top Outlet Flexibility

- 15 PSIG ASME Safety relief valve
- Low limit & high limit pressure controls control
- Steam pressure gauge
- Gauge glass, gauge cocks & gauge guards

Part #	Mfg #	Boiler Model Number	Gas Input GPH	Gas Input MBH	Boiler HP	I=B=R Water Rating MBH	Steam Vent Size	Ship Weight	Price
WMCH380SF	H380SF	380	2.4	346	8.3	208	8"	1,170	CALL
WMCH480SF	H480SF	480	3.4	491	11.8	297	8"	1,411	CALL
WMCH580SF	H580SF	580	4.45	639	15.4	386	8"	1,752	CALL
WMCH680SF	H680SF	680	5.5	787	18.9	476	8"	2,093	CALL
WMCH780SF	H780SF	780	6.5	935	22.5	565	10"	2,434	CALL
WMCH880SF	H880SF	880	7.5	1082	26	654	10"	2,774	CALL
WMCH980SF	H980SF	980	8.5	1230	29.6	743	10"	3,115	CALL
WMCH1080SF	H1080SF	1080	9.6	1378	33.2	833	10"	3,456	CALL
WMCH1180SF	H1180SF	1180	10.6	1526	36.7	922	10"	3,697	CALL

Commercial Boilers

Prices & Specifications are Subject to Change.

Commercial Hydronic Heating

88 Series Gas-Oil Boiler Components

Standard Jacket Carton includes:

- Front panel, rear panel, right side panel, upper left side panel, lower left side panel, top panel, bottom support bracket, outlet cover plate, top support channel

Extension Jacket Carton includes:

- Right side extension panel, upper left side extension panel, lower left side extension panel, top extension panel, bottom support bracket, outlet cover plate top support channel

A Box Major Components include:

- Flue collar assembly, observation port assembly, elastomer seals, rope, draw rods, silicone sealant, cleanout plates

B Box Major Components include:

- Cleanout plates, elastomer seals, draw rods

Water Trim Carton Major Components includes:

- Relief valve, dual limit control, pressure/temperature gauge

Cast Iron Water Boiler

- 30 PSIG ASME Relief valve
- Combination high limit and low limit with manual reset control
- Combination pressure/temperature gauge
- Nipple and 5" x 6" reducing coupling (1288 - 1888 boilers only)
- Built-in air eliminator



Commercial Boilers

Part #	Mfg #	Boiler Model Number	Oil Input GPH	Gas Input MBH	Boiler HP	I=B=R Water Rating MBH	Vent Size	Price
WMCH488WF	H488WF	488	7.0	1,010	25.1	730	10"	CALL
WMCH588WF	H588WF	588	9.4	1,356	33.6	979	10"	CALL
WMCH688WF	H688WF	688	11.8	1,701	42.2	1,229	10"	CALL
WMCH788WF	H788WF	788	14.2	2,046	50.8	1,478	12"	CALL
WMCH888WF	H888WF	888	16.6	2,382	59.4	1,728	12"	CALL
WMCH988WF	H988WF	988	18.8	2,737	67.9	1,977	14"	CALL
WMCH1088WF	H1088WF	1088	21.5	3,082	76.5	2,227	14"	CALL
WMCH1188WF	H1188WF	1188	23.5	3,428	85.1	2,477	14"	CALL
WMCH1288WF	H1288WF	1288	26.0	3,773	93.7	2,726	14"	CALL
WMCH1388WF	H1388WF	1388	28.5	4,119	102.2	2,976	14"	CALL
WMCH1488WF	H1488WF	1488	31.0	4,464	110.8	3,225	16"	CALL
WMCH1588WF	H1588WF	1588	33.0	4,809	119.4	3,475	16"	CALL
WMCH1688WF	H1688WF	1688	35.5	5,155	127.9	3,724	16"	CALL
WMCH1788WF	H1788WF	1788	38.0	5,494	136.5	3,974	18"	CALL
WMCH1888WF	H1888WF	1888	40.5	5,845	145.1	4,123	18"	CALL

All Items May Not Be Stocked In All Branches

Commercial Hydronic Heating

Cast Iron Steam Boiler

- 15 PSIG ASME Safety valve side outlet
- Low limit & high limit pressure controls control
- Steam pressure gauge siphon
- Gauge glass, gauge cocks & gauge guards

Part #	Mfg #	Boiler Model Number	Oil Input GPH	Gas Input MBH	Boiler HP	I=B=R Steam Rating MBH	Vent Size	Price
WMCH488SF	H488SF	488	7.0	1,010	25.1	629	10"	CALL
WMCH588SF	H588SF	588	9.4	1,356	33.6	845	10"	CALL
WMCH688SF	H688SF	688	11.8	1,701	42.2	1,072	10"	CALL
WMCH788SF	H788SF	788	14.2	2,046	50.8	1,311	12"	CALL
WMCH888SF	H888SF	888	16.6	2,382	59.4	1,543	12"	CALL
WMCH988SF	H988SF	988	18.8	2,737	67.9	1,766	14"	CALL
WMCH1088SF	H1088SF	1088	21.5	3,082	76.5	1,988	14"	CALL
WMCH1188SF	H1188SF	1188	23.5	3,428	85.1	2,211	14"	CALL
WMCH1288SF	H1288SF	1288	26.0	3,773	93.7	2,434	14"	CALL
WMCH1388SF	H1388SF	1388	28.5	4,119	102.2	2,657	14"	CALL
WMCH1488SF	H1488SF	1488	31.0	4,464	110.8	2,880	16"	CALL
WMCH1588SF	H1588SF	1588	33.0	4,809	119.4	3,102	16"	CALL
WMCH1688SF	H1688SF	1688	35.5	5,155	127.9	3,325	16"	CALL
WMCH1788SF	H1788SF	1788	38.0	5,494	136.5	3,548	18"	CALL
WMCH1888SF	H1888SF	1888	40.5	5,845	145.1	3,771	18"	CALL

Commercial Boilers

Over 140 years of doing business with integrity.

Commercial Hydronic Heating

EG Series Atmospheric Gas Boilers

- Factory assembled section block
- Insulated extended jacket
- Horizontal to vertical draft hood
- Aluminized steel burners
- Combination gas control valve & regulator
- Non-linting pilot burner
- Spill switch (EG-30 thru 65)
- Thermal rollout fuse element (EG-30 thru 65)
- Automatic Vent damper (EG-30 thru 65)
- W Suffix - for water; S suffix - for steam



Intermittent Ignition with Damper - Natural Gas

Part #	Mfg #	Boiler Model	AGA Input MBH	DOE Heating Capacity MBH	Net I=B=R Rating MBH	Approx Ship Wt	I=B=R Chimney Size	Price
WMREG40PIDNW	118-401-335	EG-40-PIDN-W	125	102	88	500 lbs	6" ID x 20'	CALL
WMREG45PIDNW	118-451-335	EG-45-PIDN-W	150	122	106	500 lbs	6" ID x 20'	CALL
WMREG65PIDNW	118-651-335	EG-65-PIDN-W	250	203	177	680 lbs	8" ID x 20'	CALL
WMREG75PINW	118-751-335	EG-75-PIN-W	300	240	209	755 lbs	8" ID x 20'	CALL
WMREG40PIDNS	118-404-340	EG-40-PIDN-S	125	102	76	500 lbs	6" ID x 20'	CALL
WMREG45PIDNS	118-454-340	EG-45-PIDN-S	150	122	92	500 lbs	6" ID x 20'	CALL
WMREG50PIDNS	118-504-340	EG-50-PIDN-S	175	142	107	590 lbs	7" ID x 20'	CALL
WMREG65PIDNS	118-654-340	EG-65-PIDN-S	250	203	152	680 lbs	8" ID x 20'	CALL
WMREG75PINS	118-754-340	EG-75-PIN-S	300	240	180	755 lbs	8" ID x 20'	CALL

Standing Pilot with Damper - Natural Gas

Part #	Mfg #	Boiler Model	AGA Input MBH	DOE Heating Capacity MBH	Net I=B=R Rating MBH	Approx Ship Wt	I=B=R Chimney Size	Price
WMREG30SPDNW	118-301-325	EG-30-SPDN-W	75	61	53	410 lbs	5" ID x 20'	CALL
WMREG35SPDNW	118-351-325	EG-35-SPDN-W	100	081	70	410 lbs	5" ID x 20'	CALL
WMREG40SPDNW	118-401-325	EG-40-SPDN-W	125	102	88	500 lbs	6" ID x 20'	CALL
WMREG45SPDNW	118-451-325	EG-45-SPDN-W	150	122	106	500 lbs	6" ID x 20'	CALL
WMREG50SPDNW	118-501-325	EG-50-SPDN-W	175	142	123	590 lbs	7" ID x 20'	CALL
WMREG55SPDNW	118-551-325	EG-55-SPDN-W	200	163	142	590 lbs	7" ID x 20'	CALL
WMREG65SPDNW	118-651-325	EG-65-SPDN-W	250	203	177	680 lbs	8" ID x 20'	CALL
WMREG75SPNW	118-751-325	EG-75-SPN-W	300	240	209	755 lbs	8" ID x 20'	CALL
WMREG30SPDNS	118-304-330	EG-30-SPDN-S	75	61	46	410 lbs	5" ID x 20'	CALL
WMREG35SPDNS	118-354-330	EG-35-SPDN-S	100	081	61	410 lbs	5" ID x 20'	CALL
WMREG40SPDNS	118-404-330	EG-40-SPDN-S	125	102	76	500 lbs	6" ID x 20'	CALL
WMREG45SPDNS	118-454-330	EG-45-SPDN-S	150	122	92	500 lbs	6" ID x 20'	CALL
WMREG50SPDNS	118-504-330	EG-50-SPDN-S	175	142	107	590 lbs	7" ID x 20'	CALL
WMREG55SPDNS	118-554-330	EG-55-SPDN-S	200	163	122	590 lbs	7" ID x 20'	CALL
WMREG65SPDNS	118-654-330	EG-65-SPDN-S	250	203	152	680 lbs	8" ID x 20'	CALL
WMREG75SPNS	118-754-330	EG-75-SPN-S	300	240	180	755 lbs	8" ID x 20'	CALL

Commercial Boilers

All Items May Not Be Stocked In All Branches

Commercial Hydronic Heating

EGH Atmospheric Gas Boiler

- Factory assembled section block
- Insulated extended jacket
- Horizontal to vertical draft hood
- Non-linting pilot burner
- Combination gas valve & regulator
- Aluminized steel burners
- 40 VA Transformer



24 Volt Intermittent Electronic Ignition Model - Natural Gas (Water)

- Built-in Air separator
- 30 PSI ASME Relief valve
- High limit temperature control for PI with damper & PI models
- Combination pressure-temperature gauge

Part #	Mfg #	Boiler Model Number	A.G.A Input MBH	A.G.A Gross Input MBH	Net I=B=R Rating MBH	Approx Ship Wt	I=B=R Chimney Size	Price
WMREGH85WPI	117-081-302	EGH-85-W-PI	349	280	243	845 lbs	9" ID x 20'	CALL
WMREGH95WPI	117-091-302	EGH-95-W-PI	400	320	278	880 lbs	10" ID x 20'	CALL
WMREGH105WPI	117-101-302	EGH-105-W-PI	450	360	313	975 lbs	10" ID x 20'	CALL
WMREGH125WPI	117-121-302	EGH-125-W-PI	550	440	383	1,145 lbs	12" ID x 20'	CALL

24 Volt Intermittent Electronic Ignition Model - Natural Gas (Steam)

- 15 PSI ASME Relief valve
- High limit pressure control for PI with damper & PI models
- Low water cut-off (electrode type)
- Steam pressure gauge
- Gauge cocks
- Gauge glass

Part #	Mfg #	Boiler Model Number	A.G.A Input MBH	A.G.A Gross Input MBH	Net I=B=R Rating MBH	Approx Ship Wt	I=B=R Chimney Size	Price
WMREGH85SPI	117-084-314	EGH-85-S-PI	349	280	210	845 lbs	9" ID x 20'	CALL
WMREGH95SPI	117-094-314	EGH-95-S-PI	400	320	240	880 lbs	10" ID x 20'	CALL
WMREGH105SPI	117-104-314	EGH-105-S-PI	450	360	270	975 lbs	10" ID x 20'	CALL
WMREGH125SPI	117-124-314	EGH-125-S-PI	550	440	383	1,145 lbs	12" ID x 20'	CALL

Commercial Boilers

Prices & Specifications are Subject to Change.

Indoor Air Quality

Residential Humidifiers

- 5-Year limited warranty

Models 350/360 Self-Contained Humidifier

- For homes with radiators or baseboard heat, also works equally well with central heating and cooling systems
- Evaporative capacity 0.50 gph
- Designed for application in up to 4,500 sq ft tight homes

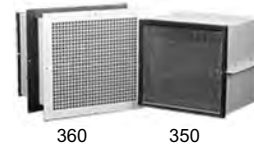

Part #	Mfg #	Size	Description	Price
APR350	350	13-3/4"W x 12-3/4"H x 15-1/2"D	120V, 60Hz, 0.5A, Can Be Hung From the Floor Joists & Connected to the Ductwork	716.74
APR360	360	13-3/4"W x 12-3/4"H x 12-1/2"D	120V, 60Hz, 0.7A Through-the-Wall Unit	678.76

Model 400 Bypass Humidifier

- Perfect choice for homes with septic systems or where a floor drain is not available
- Built-in bypass damper utilizing new evaporative technology
- 24V, 60Hz, 0.5A
- 6" Diameter round opening



Part #	Mfg #	Description	Evap Cap	Cu Ft Cap	Unit Size	Plenum Opening	Price
APR400A	400A	Auto	17 gpd	Up to 4000	15-3/4"H x 15-3/8"W x 10-1/4"D	12-3/4"H x 10"W	420.18

Model 500 Duct Mounted Bypass Humidifier

- Built-in bypass damper
- Equipped with drain to flush minerals from the system
- 24V, 60Hz, 0.5A
- 6" Diameter round opening



Part #	Mfg #	Description	Evap Cap	Cu Ft Cap	Unit Size	Plenum Opening	Price
APR500A	500A	Auto	12 gpd	Up to 3000	15-5/8"W x 13"H x 10-1/4"D	9-1/2"W x 9-1/2"H	311.98
APR500M	500M	Manual	12 gpd	Up to 3000	15-5/8"W x 13"H x 10-1/4"D	9-1/2"W x 9-1/2"H	266.26

Model 600 Bypass Humidifier

- Built-in bypass damper
- Converts from automatic to manual where outdoor sensor is impossible
- Simple wiring with 24V power source
- 24V, 60Hz, 0.5A
- 6" Diameter round opening



Part #	Mfg #	Description	Evap Cap	Cu Ft Cap	Unit Size	Plenum Opening	Price
APR600	600	Auto	17 gpd	1000 - 4000	15-3/8"W x 15-3/4"H x 10-1/4"D	10"W x 12-3/4"H	369.86
APR600M	600M	Manual	17 gpd	1000 - 4000	15-3/8"W x 15-3/4"H x 10-1/4"D	10"W x 12-3/4"H	292.54

Indoor Air Quality

All Items May Not Be Stocked In All Branches

Indoor Air Quality

Model 700 Plenum Mounted Power Humidifier

- Outdoor temperature sensor monitors slightest changes
- High capacity
- Built-in fan pulls heated air directly from furnace
- 120V, 60Hz, 0.8A



Part #	Mfg #	Description	Evap Cap	Cu Ft Cap	Unit Size	Plenum Opening	Price
APR700A	700A	Auto	18 gpd	4,200	15-29/32"W x 18"H x 10-11/32"D	14-3/4"W x 14-5/16"H	544.72

Model 800 Steam Humidifier

- Proven design using electrode technology
- Remote or duct mount with no additional accessories
- No cleaning or scrubbing, remove canister and replace
- Steam dispersion technology, ensures proper dispersion into the air
- No water filtration needed
- Automatic control, can be installed in manual mode
- Complements non-forced air heating sources and other specialty heating systems
- Includes control, dispersion tube, steam hose and drain tube



Part #	Mfg #	Evap Cap (gpd)	Sq Ft Cap	Unit Size	Price
APR800	800	11.5 @ 120V, 20.5 @ 208V, 23.3 @ 240V	6,200	10-1/8"W x 20-7/8"H x 7-1/8"D	1521.30

Fan Pack

- Use with Aprilaire Model 800 steam humidifier to provide comfortable humidity levels to homes without duct work
- Recessed into a wall, connects directly to the Aprilaire Model 800 steam humidifier



Part #	Mfg #	Description	Price
APR850	850	24VAC, 60Hz, 0.75 Amps	534.90

Humidifier Parts & Accessories

Replacement Water Panel

- Provide like-new performance to all Aprilaire® humidifiers when replaced regularly
- Individually packaged with complete instructions



Part #	Mfg #	Fits Models:	Price
APR10	10	110, 220, 500, 550, 550A	11.78
APR12	12	112, 224, 440, 440A, 445, 445A, 448	22.08
APR35	35	350, 360, 560 Series, 600 Series, 700 Series	16.46

Indoor Air Quality

Prices & Specifications are Subject to Change.

Indoor Air Quality

Automatic Humidifier Control

- Fits plenum mounted humidifier



Part #	Mfg #	Description	Size	Price
APR60	60	Digital Electronic Auto	6"W x 4"H	160.90

Current Sensing Relay

- For interfacing Aprilaire® humidifiers or EAC's with multi-speed blower motors
- No need for line voltage wiring

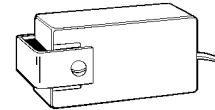

Part #	Mfg #	Power	Price
APR50	50	24V	41.20

Residential Whole-House Dehumidifiers

Model 1730A/1750A Whole-House Dehumidifier

- No tanks to empty
- Automatically manages moisture based on changing conditions
- Switches automatically between whole-house with A/C and localized dehumidification when A/C is off
- Can be operated manually
- MERV 8 Filter
- 115VAC, 60Hz, 9A
- 5-Year warranty



Part #	Mfg #	Capacity	Size	Weight	Price
APR1730A	1730A	65 Pints per Day	12.5"W x 14.5"H x 22"L	65 lbs	2106.40
APR1750A	1750A	90 Pints per Day	20.5"W x 19.58"H x 24"L	93 lbs	2384.34

Air Cleaners

Whole-House High Efficiency Media Air Cleaner

- Silent operation
- No wiring or service necessary
- For forced air systems up to 1600 CFM high efficiency, non-electric operation
- Maintenance free
- 5-Year limited warranty



Part #	Mfg #	Description	Price
APR2250	2250	22-3/4"H x 27-3/4"D x 9-1/4"L, Grille-Mount; Can Be Attached to Roof or Slab-Mount, Attic or Closet Air Conditioning Units	635.30

Indoor Air Quality

All Items May Not Be Stocked In All Branches

Indoor Air Quality

Whole-House Central Media Air Cleaner

- Captures dust, pollen, fungi, mold and pet dander
- Traps pollen and spores 3 - 10 microns with 85% efficiency
- Traps dust 1 - 3 microns with 50% efficiency
- Disposable filter media lasts 1 to 2 years
- 57% MERV 13 Removal efficiency
- Maintenance free
- 5-Year limited warranty



Part #	Mfg #	Description	Price
APR2210	2210	Adaptable to Upflow or Horizontal Duct Configurations	CALL
APR2410	2410	Compact, Suitable for Use with Shorter Furnaces in Platform or Closet Installations	CALL

Whole-House Central Electronic Air Cleaner with One-Touch Control™

- Unit equipped with 5' grounded plug with cord
- 94% Efficient at removing bacteria as small as 0.35 micron
- Traps viruses with an 80% efficiency
- Over 99% efficient on pollen and spores
- 2-Year limited warranty



Part #	Mfg #	Size	Power	Current	Weight	Price
APR5000	5000	17-3/4"H x 28-1/8"D x 11-1/2"W	120VAC, 60Hz	0.3A	35 lbs	1125.92

Air Cleaner Replacement Media

- Renewed performance when replaced regularly
- Individually packaged with complete instructions



213

Part #	Mfg #	Fits Models:	Price
APR501	501	2600	68.16
APR213	213	4200, 2200 with Upgrade Kit	75.12
APR413	413	4400, 2400 with Upgrade Kit	68.64

Air Cleaner Upgrade Kit

- Upgrade existing air cleaner to MERV 13
- No tools required to upgrade
- Replaces inner housing and eliminates need for pleat spacers to hold media together
- One time upgrade
- Use Aprilaire® 413 or 213 air filter media after kit is installed



Part #	Mfg #	Fits Models:	Price
APR1213	1213	2200, 2120 & 4200	103.60
APR1413	1413	2400, 2140 & 4400	103.60

Indoor Air Quality

Prices & Specifications are Subject to Change.

Indoor Air Quality

Zone Control Panels

- 2-Year limited warranty

Aprilaire
ZONE CONTROL SYSTEM
Custom Comfort Throughout Your Home®



6202, 6203



6404



Part #	Mfg #	Description	Price
APR6202	6202	2-Zone Single-Stage Heat/Cool	190.16
APR6203	6203	3-Zone Single-Stage Heat/Cool	203.36
APR6404	6404	4-Zone to 12-Zone Panel for Heat/Cool or Heat Pump	404.48

Dampers

Normally Open, Power Close Round Zone Damper



Part #	Mfg #	Diameter	Price
APR6606	6606	6"	163.54

Side Mount Zone Damper



Part #	Mfg #	Size (W x H)	Price
APR6721	06721	8" x 8"	240.30
APR6722	06722	10" x 8"	242.80
APR6723	06723	12" x 8"	247.84
APR6724	06724	14" x 8"	251.60
APR6725	06725	16" x 8"	256.64
APR6726	06726	18" x 8"	260.42
APR6727	06727	20" x 8"	264.18
APR6729	06729	24" x 8"	275.52

Bottom Mount Zone Damper

Part #	Mfg #	Size (W x H)	Price
APR6812	06812	8" x 10"	242.80
APR6813	06813	8" x 12"	247.84
APR6814	06814	8" x 14"	251.60
APR6815	06815	8" x 16"	256.64
APR6816	06816	8" x 18"	260.42
APR6817	06817	8" x 20"	264.18

Round Barometric Bypass Damper

Part #	Mfg #	Size	Price
APR6910	6910	10"	148.44

Damper Motor

Part #	Mfg #	Description	Price
APR6993	6993	Motor (Shaft w/Two Flat Sides) for all Flexible Link Style Aprilaire Round Dampers, Plastic Actuator Cover	90.02

Indoor Air Quality

All Items May Not Be Stocked In All Branches

Indoor Air Quality

Oxidation Air Cleaners

PHI™ Cell Air Cleaners

- The PHI Cell uses an advanced oxidation process to reduce airborne contaminants
- Also effective on gases, vapors, VOC's & odors
- PHI Cells are easily mounted into existing A/C & heating systems
- Installed in air duct & distributed through air handler
- UL, ETL, TUV, EU, & EPA Listed
- 110 - 240VAC Auto switching power supply 50/60Hz
- 3-Year parts warranty



5"

Part #	Mfg #	Probe / Plate Size	HVAC Air Blower Size	Replacement Cell#	Price
RGFPHI118GAVSF	HVAC-PHI-118-GA-VSF	5" / 5-1/2" Dia	300 - 1,200 scfm	PHIC-5GA-VSF	646.00
RGFPHI212GA	HVAC-PHI-212-GA	9" / 5-1/2" Dia	1,000 - 6,500 scfm	PHIC-9GA	646.00

Plug In Plus PHI™ Air Cleaners

- Ideal for homes, hotel rooms, suites, restrooms, offices, locker rooms, etc.
- The PHI Cell uses an advanced oxidation process to reduce airborne contaminants
- No wiring required, plugs into existing outlets
- 25,000 Hour cell life
- Built-in night light
- Built-in electrical outlet two sides (4 total)
- Theft proof - hidden mounting screws
- 3-Year parts warranty



Part #	Mfg #	Dimensions	Electrical	Fan Controls	Replacement Cell#	Price
RGFPIP16	PIP-16	6-1/2"W x 3-3/4"D x 10"H	110VAC, 50W	Off/Low/High	(1) PHIC-5A-PIP	499.00

Guardian Air REME® Generator Advanced Oxidation System

- Reflective Electro-Magnetic Energy Cell Air Cleaner
- Reduces micro-organisms by over 99%, .3 micron particulates up to 93%, gases & odors up to 85%
- Installed in HVAC duct or plenum
- Silent plasma propulsion propels purifying plasma @ 2 cfm for a continuous purification process & quick kill of newly introduced odors & microbials
- 110-220 VAC 50/60Hz
- 2-Year parts warranty



Part #	Mfg #	Description	cfm	Price
RGFREMEHVAC305	REME-HVAC 305	14 Watts	1,000 - 6,500	765.00

Replacement Cells

Part #	Mfg #	Description	Price
RGFPHIC9GA	PHIC-9GA	Replacement Cell for PHI-212-GA	272.00
RGFPHIC5A	PHI-5A	Replacement Cell f/PIP-16 Plug-In	266.00
RGFPHIC5GA	PHIC-5GA	5" Replacement Cell f/HVAC Mini-GA Unit	272.00
RGFPHIC5GAVSF	PHIC-5GA-VSF	5" Std Cell f/PHI-118-GA-VSF Unit	272.00
RGFPHIC9	PHIC-9	9" Std Cell f/IMS-B-GA Ice Machine Unt	272.00
RGFPHIC9R	PHIC-9R-GA	9" Std REME Cell f/REME-HVAC-305	272.00

For more information, please visit RGFAirPurification.com

Indoor Air Quality

Prices & Specifications are Subject to Change.

Indoor Air Quality

Media Air Cleaners

Air Bear® Supreme Media Air Cleaners

- Accepts 5" thick pleated Air Bear Media
- Mounts direct to heating & cooling systems
- Suitable for use with all types of central forced-air configurations
- Eliminates standard return filters
- 10-Year limited warranty on cabinet



Air Bear® Supreme 2000

- Accepts media size: 20"H x 24-1/4"W x 5"D

Part #	Mfg #	Outside Dim Sz " (H x W x D)	MERV	Price
TRNAB2000	455602-025	20 1/4 x 24-7/8 x 7-1/8	8	165.00

Air Bear® Supreme 1400

- Accepts media size: 16"H x 25"W x 5"D

Part #	Mfg #	Outside Dim Sz " (H x W x D)	MERV	Price
TRNAB1400	455602-125	16-1/4 x 24-7/8 x 7-1/8	8	165.00

Air Bear® Right Angle Media Air Cleaners

- Universal right/left-hand installation
- For areas where a 90° duct adapter is required
- Typically saves 6-8" of space
- Ideal for basement applications
- Eliminates standard return filters
- Accepts media size: 20"H x 25"W x 5"D
- 10-Year limited warranty on cabinet



Part #	Mfg #	Outside Dim Sz " (H x W x D)	CFM	Price
TRNABRA	447380-010	24-3/8 x 15 1/2 x 25-5/8	2000	270.00

Air Bear® Media Filters



Part #	Mfg #	Use For:	Price
TRN255649101	255649-101	16 x 25 x 3 Air Bear Cub	23.34
TRN255649102	255649-102	20 x 25 x 5 Air Bear	34.67
TRN255649103	255649-103	20 x 20 x 5 Air Bear	37.50
TRN255649105	255649-105	16 x 25 x 5 Air Bear	34.67

THANK YOU!
We appreciate your business



Indoor Air Quality

UV-AIRE™ Air Purification Systems

Duct Mounted UV Air Cleaner

- Installed directly inside forced-air ductwork
- Hinged cover for easy accessibility
- 5-Year warranty



Part #	Mfg #	Min Duct Width	Voltage	Amps	Hz	Watts	Recommended Max Sq Ft	Price
FIEUV18	UV-18	14"	120	0.5	60	30	2000	338.48

UV-AIRE™ Replacement Lamp



Part #	Mfg #	Description	Price
FIEUV18BULB	46365402	UV18 Replacement Lamps	89.76

UV-1500C Portable Model

- Purifies air in areas up to 1500 square feet
- 23-3/4"H x 18"W x 6-5/16"D
- 12" Germicidal UV lamp
- 12" x 12" High-efficiency/carbon filter
- Audible and visual lamp and filter condition alert
- Built-in fan with adjustable speed control



Part #	Mfg #	Min Duct Width	Voltage	Amps	Hz	Watts	Recommended Max Sq Ft	Price
FIEUV1500C	UV-1500C	N/A	120	0.5	60	30	1500	1211.42

UV-Aire® Replacement Kit



Part #	Mfg #	Description	Price
FIEUV1500RK	UV-1500RK	Replacement Kit for UV-1500C: 4 High Efficiency/Carbon Filters, 1 Carbon Filter, 1 UV Lamp	194.52

Indoor Air Quality

Prices & Specifications are Subject to Change.

Indoor Air Quality

Air Cleaners

AirCleen 1500 Electrostatic Air Filters

- HEPA Class™ performance
- Attracts particles below one micron
- Uses patented Electro-Fibre™ technology based on Electronic Polarization Technology (EPT)
- Fights home air pollution
- Increases equipment efficiency
- Permanently replaces throwaway filter
- 5-Year limited warranty



Part #	Mfg #	Size	Price
CIM1500-1620	AS1500 16x20x1	16" x 20" x 1"	199.00
CIM1500-1625	AS1500 16x25x1	16" x 25" x 1"	199.00
CIM1500-2020	AS1500 20x20x1	20" x 20" x 1"	199.00
CIM1500-2025	AS1500 20x25x1	20" x 25" x 1"	199.00

Replacement Media



Part #	Mfg #	Size	Qty	Price
CIM1620MK	AS100R 16x20x1	16"x20"x1"	(4) Sets	29.95
CIM1625MK	AS100R 16x25x1	16"x25"x1"	(4) Sets	29.95
CIM2020MK	AS100R 20x20x1	20"x20"x1"	(4) Sets	29.95
CIM2025MK	AS100R 20x25x1	20"x25"x1"	(4) Sets	29.95
CIM1500-1625MK	AS15001625M	16"x25"x1"	(8) Pcs	59.90
CIM1500-1620MK	AS15001620M	16"x20"x1"	(8) Pcs	59.90
CIM1500-2020MK	AS15002020M	20"x20"x1"	(8) Pcs	59.90
CIM1500-2025MK	AS15002025M	20"x25"x1"	(8) Pcs	59.90

Heating Sundries

Draft Inducers

- Inline Auto-Draft® inducers
- Quick and easy to install
- Trouble free
- Vari-Draft control permits adjustments to the individual job requirement
- 115V 60Hz



Part #	Mfg #	Smokepipe Size	RPM	Watts	Amps	HP Open	Price
TJEDJ3	DJ-3	3" - 6"	1550	35	4.3	1/70	230.00
TJED3	D-3	5" - 8"	1550	74	.96	1/20	294.00

Fan Proving Switches

- Monitors pressure within the fan housing only
- SPST
- Maximum pressure: 1/2 psi

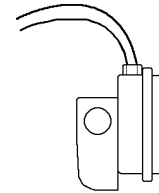

Part #	Mfg #	Description	Price
TJEPS1505	PS1505	Pressure Switch	132.00

Commercial Sidewall Gas Power Venters

HS Series Sidewall Gas Power Venter

- Used for side wall venting residential/light commercial natural gas, LP or oil fired equipment
- Reliable and consistent mechanical draft
- Factory calibrated fan proving switch
- Straight forward installation
- Does not come with vent hood
- Includes UC1 universal control
- UL Approved

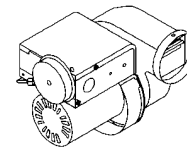

Part #	Mfg #	BTUH Input Ranges	Size (H x W x D)	Inlet/Outlet	Price
TJEHSJ	HS-J	50,000 - 125,000	7-7/8" x 10-1/4" x 7"	4"	540.00
TJEHS1	HS-1	150,000 - 300,000	7-7/8" x 11" x 7"	4"	546.00
TJEHS2	HS-2	350,000 - 600,000	9-1/4" x 11-1/2" x 8-1/2"	6"	778.00
TJEHS3	HS-3	450,000 - 700,000	12-1/2" x 13-1/4" x 11"	8"	1460.00

Indoor Air Quality

Heating Sundries

Power Venters

SideShot® Side Wall Vent System

- For oil and gas heating equipment
- No chimney required
- Zero clearance
- Fast, easy installation
- Energy saving
- Safety protection by pressure switch and high limit control



Part #	Mfg #	Description	Price
TJESS1	SS1	Gas and Oil Heating Equipment - Up to 160,000 BTUH, ETL Listed	1540.00
TJESS2	SS2	Oil Vent System - Up to 168,000 BTUH	1224.00

Packaged Side Wall Vent System

- Complete vent system
 - Power Venter
 - 4" Vent Hood (VH1-4)
 - 4" Draft Control (DC4)
- Non-adjustable 45-second, post-purge relay/timer to purge vent system of residual flue gases after burner cycle
- For gas furnaces, boilers, pool heaters, and commercial water heaters
- AGA Certified
- Built-in fan proving switch interlocks with gas valve
- Durable, heavy-duty aluminum vent hood
- Includes everything for installations except vent pipe
- 4" Vent pipe
- 115V, 60 Hz, 3000 RPM, 95 Watts, 1.26 Amps
- 24/115V Switching relay therm protection



Part #	Mfg #	Description	Price
TJEGPAKJT	GPAK-JT	Up To 120,000 BTUH, Includes DC-4 4" Draft Control, 45 Second Fixed Delay	712.00
TJEGPAK1T	GPAK-1T	Up To 250,000 BTUH, Includes DC-4 4" Draft Control, 45 Second Fixed Delay	712.00

Side Wall Vent Hoods

- Heavy duty, corrosive resistant aluminum construction and built-in clearances from combustibles
- All mounting hardware included



Part #	Mfg #	Description	Price
TJEVH13	VH1-3	3" Diameter, 6-3/4" sq Rough-In	154.00
TJEVH14	VH1-4	4" Diameter, 8" sq Rough-In	195.00
TJEVH16	VH1-6	6" Diameter, 9" sq Rough-In	211.00

Indoor Air Quality

All Items May Not Be Stocked In All Branches

Heating Sundries

Gas Water Heater Vent Kits

- Vents any brand or type of gas water heater
- Quiet operation
- Safety controls shut heater off if vent system fails
- AGA Design certified, used for side wall venting residential or light commercial gas water heaters
- Kit includes everything for complete installation except vent pipe
- 115V, 60 Hz, 3000 RPM
- 75 Equivalent feet maximum venting
- Post purge times



Part #	Mfg #	Burner Cap BTUH	Watts	Amps	Size (H x W x D)	Inlet/Outlet	Price
TJEVP2	VP-2	Up to 60,000	50	1	10-1/2" x 7-1/2" x 10"	3"	840.00
TJEVP3	VP-3	60,000 - 120,000	95	1.26	7-7/8" x 10-1/4" x 7"	4"	860.00

Accessory Controls

UC1 Universal Control

- Standard interlock for Tjernlund's full line of fixed speed power venters, draft inducers and combustion air in-forcers
- Can be interlocked with virtually any 24 - 120 VAC burner control circuit
- 10 Second prover switch delay to avoid burner start up and wind induced short cycling
- Adjustable pre- and post-purge times
- LED Status / diagnostic indicators



Part #	Mfg #	Description	Price
TJEUC1	UC1	UC1 Universal Control	220.00

Multiple Appliance Controller

- Used with UC1 Universal Controller to easily interlock additional 24 VAC, 115 VAC or millivolt controlled appliances with fixed speed auto-draft inducer, power venters, draft inducers or in-forcers
- Activates venter through its connections to the UC1 and relies on the UC1 fan prover safety circuit to allow its interlocked appliances to operate
- Circuit board housed in oversized 18 gauge electrical box with multiple knock-outs for easy wiring connections



Part #	Mfg #	Description	Price
TJEMAC1E	MAC-1E	Connect One Additional Device	240.00

Water Heater Interlock Kit

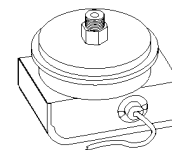

Part #	Mfg #	Description	Price
TJEWHKE	WHKE	Actuates Inducer/Venter and Disables Heater During Malfunction, for use with UC1, MAC-1E or MAC-4E	240.00
TJEWHKI	WHK-I	Instantaneous Water Heater Control	250.00

Indoor Air Quality

Prices & Specifications are Subject to Change.

Heating Sundries

Duct Boosters®

- Fits round or flat forced air heating/cooling ductwork
- Boosts air flow up to 275 CFM



Part #	Mfg #	Description	Price
TJEDB2	DB-2	Original 120V, 1/20 HP, .51A - 6" and 8" Duct	180.00

Dryer Duct Booster

- For residential capacity clothes dryers where duct runs exceed 25'
- Impeller: Reverse inclined, particulate handling
- Components:
 - (1) LB1 Wired fan assembly
 - (1) 16 Gauge galvanized steel mounting bracket
 - (1) Mounting hardware packet



Part #	Mfg #	Description	Price
TJELB1	LB1	160 cfm, 120VAC, 50W, 0.5A	575.00

Replacement Parts

Part #	Mfg #	Description	For:	Price
TJE9501030	950-1030	Fan Prover Kit	GPAK, Power Venters	122.14

Indoor Air Quality

Thank you for doing business with us. We appreciate your order.

Ventilation

Heat Recovery Ventilators**MAX Series Residential**

- 5-Speed electronics
- Compact electrically powered
- Aluminum heat exchange core
- Built-in dehumidistat
- Easy installation
- Increases air exchange rate when humidity rises
- Easy clean filters
- Quiet & reliable five speed motor
- 5-Year warranty on parts, lifetime on heat exchange core



155/200 MAX

Part #	Mfg #	Dimensions H x W x D	Defrost Type	Electrical	CFM @.1" ESP	Ship Wt	Price
LIF95MAX	95MAX	24-1/2" x 18-1/2" x 16"	Recirculate	120-1-60	76	56 lbs	1961.02
LIF155MAX	155MAX	19" x 33-5/8" x 14-3/4"	Damper	120-1-60	144	73 lbs	2084.94
LIF200MAX	200MAX	19" x 33-5/8" x 14-3/4"	Recirculate	120-1-60	207	73 lbs	2593.42

RNC Series Horizontal Residential

- With door port balancing
- 2-Speed electronics
- Each air stream has one centrifugal blower driven by a common PSC motor
- Compact electrically powered
- Patented aluminum core
- Built-in dehumidistat
- Built-in relay for interfacing to furnace
- Damper defrost system
- Cross-flow heat recovery core transfers heat between two air streams, removable for cleaning
- Washable air filters
- 5-Year warranty on parts, lifetime on heat exchange core



Part #	Mfg #	Dimensions H x W x D	Defrost Type	Electrical	CFM @.1" ESP	Price
LIFRNC155	RNC155	19" x 33-5/8" x 14-3/4"	Recirculating	120-1-60	144	1607.46
LIFRNC200	RNC200	19" x 33-5/8" x 14-3/4"	Recirculating	120-1-60	207	1787.88

Ventilation

Energy Recovery Ventilators

ERV Series Residential

- Membrane technology to transfer moisture and energy
- Counterflow design
- Proprietary non-cellulose material
- Water-washable ERV core
- Maintenance-free, energy efficient motor
- 5-Speed



Part #	Mfg #	Dimensions H x W x D	Defrost Type	Electrical	CFM @.1" ESP	Description	Price
LIF200ERV	200 ERV	19" x 33-1/2" x 14-3/4"	Damper	120-1-60	180	w/DXPL01 Wall Control	2258.08

Weather Hoods

- Meshed 1/4" exterior HRV duct terminations are used to resist entry of small animals, rain & snow
- Available in white 5", 6", & 7" diameter with special insulated flex terminations



Part #	Mfg #	Description	Price
LIF99186	99-186	Two 6" Diameter White Weatherhoods	86.20

Irr Supply is your one stop shop for all your Plumbing, HVAC, Refrigeration, and Electrical needs. Why go anywhere else!

Indoor Air Quality

Flexible Ducting

"Rip Stop" Silver Jacket Flex Duct

- Features metallized polyester vapor barrier with a special "rip stop" scrim reinforcement



R4.2 "Rip Stop" Silver Jacket Flex Duct

Part #	Mfg #	Size	Series	Price
FLDM4	G430	4" x 25'	30 (Box)	43.88

UV-Inhibited Black Jacket

- UV-Inhibited polyethylene vapor barrier



R-8.0 UV-Inhibited Black Jacket Flex Duct

Part #	Mfg #	Size	Series	Price
FLD4R8	G465	4" x 25'	65 (Bag)	58.68
FLD5R8	G565	5" x 25'	65 (Bag)	63.76
FLD7R8	G765	7" x 25'	65 (Bag)	75.04
FLD10R8	G1065	10" x 25'	65 (Bag)	101.48
FLD12R8	G1265	12" x 25'	65 (Bag)	124.60

Uninsulated Air Connectors



06 Series Metallic Uninsulated Air Connector

Part #	Mfg #	Size	Series	Price
FLDU3	G306	3" x 25'	06	16.76
FLDU4	G406	4" x 25'	06	20.42
FLDU6	G606	6" x 25'	06	24.44
FLDU8	G806	8" x 25'	06	32.32
FLDU12	G1206	12" x 25'	06	51.12

Flexible Insulated Ducting

- Ideal for use in general ventilation applications including heating, air conditioning, intake and exhaust
- Polyester core, black polyethylene jacket
- R6.0 or R8.0 Insulation



Part #	Mfg #	Size	Insulation	Price
FLD4	BPC425R6	4" x 25'	R6.0	40.66
FLD5	BPC525R6	5" x 25'	R6.0	48.68
FLD6	BPC625R6	6" x 25'	R6.0	55.28
FLD7	BPC725R6	7" x 25'	R6.0	60.96
FLD8	BPC825R6	8" x 25'	R6.0	65.28
FLD10	BPC1025R6	10" x 25'	R6.0	81.90
FLD12	BPC1225R6	12" x 25'	R6.0	97.08
FLD14	BPC1425R6	14" x 25'	R6.0	118.90
FLD16	BPC1625R6	16" x 25'	R6.0	138.86
FLD18	BPC1825R6	18" x 25'	R6.0	158.60
FLD20	BPC2025R6	20" x 25'	R6.0	188.34
FLD6R8	BPC625R8	6" x 25'	R8.0	68.12
FLD8R8	BPC825R8	8" x 25'	R8.0	83.56

Duct Insulation Sleeves

- Ideal for insulating existing rigid or flexible round pipes
- Black polyethylene jacket



Part #	Mfg #	Size	Insulation	Price
FLDDS4	BIS45	4" x 5'	R4.2	10.42
FLDDS5	BIS55	5" x 5'	R4.2	12.16
FLDDS6	BIS65	6" x 5'	R4.2	12.90
FLDDS7	BIS75	7" x 5'	R4.2	13.28
FLDDS8	BIS85	8" x 5'	R4.2	14.78
FLDDS9	BIS95	9" x 5'	R4.2	16.78
FLDDS10	BIS105	10" x 5'	R4.2	18.48
FLDDS12	BIS125	12" x 5'	R4.2	23.46

Flexible Duct

Baseboard Heating

Heat Base 750 Baseboard



Complete Baseboard

- 720 BTUs per foot
- 3/4" Copper element



Part #	Mfg #	Description	Price
HAYBB2C	750	2' White, Complete Assy	23.07
HAYBB3C	750	3' White, Complete Assy	34.60
HAYBB4C	750	4' White, Complete Assy	46.14
HAYBB5C	750	5' White, Complete Assy	57.67
HAYBB6C	750	6' White, Complete Assy	69.21
HAYBB7C	750	7' White, Complete Assy	80.74
HAYBB8C	750	8' White, Complete Assy	92.28
HAYBB10C	750	10' White, Complete Assy	115.34
HAY758P3	758-P	3' 758P Protector Series w/End Caps	87.30

Baseboard Panel/Cover

Part #	Mfg #	Description	Price
HAYBB2P	750	2' Cover Only, White	13.76
HAYBB3P	750	3' Cover Only, White	20.64
HAYBB4P	750	4' Cover Only, White	27.52
HAYBB5P	750	5' Cover Only, White	34.40
HAYBB6P	750	6' Cover Only, White	41.28
HAYBB7P	750	7' Cover Only, White	48.16
HAYBB8P	750	8' Cover Only, White	55.04

3/4" Elements

Part #	Mfg #	Description	Price
HAYBB2E	750	2' Element Only w/Aluminum Fins	11.40
HAYBB3E	750	3' Element Only w/Aluminum Fins	17.11
HAYBB4E	750	4' Element Only w/Aluminum Fins	22.81
HAYBB5E	750	5' Element Only w/Aluminum Fins	28.51
HAYBB6E	750	6' Element Only w/Aluminum Fins	34.21

Heat Base 750 Baseboard (Continued) 3/4" Elements

Part #	Mfg #	Description	Price
HAYBB7E	750	7' Element Only w/Aluminum Fins	39.92
HAYBB8E	750	8' Element Only w/Aluminum Fins	45.62

Snap-On Accessories

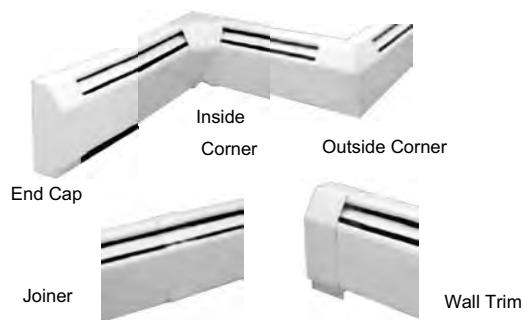

Part #	Mfg #	Description	Price
HAYBBECL	750	3" End Cap - Left, White	7.02
HAYBBECR	750	3" End Cap - Right, White	7.02
HAYBBIC	750	90° Inside Corner, White	9.58
HAYBBIC135	750	135° Inside Corner, White	9.58
HAYBBSPLICE	750	Joiner Set 2, White	3.79
HAYBBOC	750	90° Outside Corner, White	14.02
HAYBBOC135	750	135° Outside Corner, White	14.02
HAYBBWE	750	3" Wall Trim, White	4.96
HAYBBRTH	750	Return Line Hangers	0.73
HAYBBEB	750	Element Bracket w/Pivot	3.80

All Items May Not Be Stocked In All Branches

Baseboard Heating

Hi-Output 958

- Residential or light commercial for hot water or steam
- 18 Gauge front cover
- Quiet operation



Hi-Output Complete Baseboard



Part #	Mfg #	Description	Price
HAYBBHO2C	958	2' White, Complete Assy	41.84
HAYBBHO3C	958	3' White, Complete Assy	62.76
HAYBBHO4C	958	4' White, Complete Assy	83.68
HAYBBHO5C	958	5' White, Complete Assy	104.60
HAYBBHO6C	958	6' White, Complete Assy	125.52
HAYBBHO7C	958	7' White, Complete Assy	146.44
HAYBBHO8C	958	8' White, Complete Assy	167.36

Hi-Output Baseboard Enclosure

- Without element

Part #	Mfg #	Description	Price
HAYBBHO2P	958	2' Enclosure Only, White	24.62
HAYBBHO3P	958	3' Enclosure Only, White	36.94
HAYBBHO4P	958	4' Enclosure Only, White	49.25
HAYBBHO5P	958	5' Enclosure Only, White	61.56
HAYBBHO6P	958	6' Enclosure Only, White	73.87
HAYBBHO7P	958	7' Enclosure Only, White	86.18
HAYBBHO8P	958	8' Enclosure Only, White	98.50

Hi-Output Baseboard Element

Part #	Mfg #	Description	Price
HAYBBHO2E	958	2' Element Only, 3/4" Copper	23.80
HAYBBHO3E	958	3' Element Only, 3/4" Copper	35.70
HAYBBHO4E	958	4' Element Only, 3/4" Copper	47.61
HAYBBHO5E	958	5' Element Only, 3/4" Copper	59.51
HAYBBHO6E	958	6' Element Only, 3/4" Copper	71.41
HAYBBHO7E	958	7' Element Only, 3/4" Copper	83.31
HAYBBHO8E	958	8' Element Only, 3/4" Copper	95.21

Hi-Output Snap-On Accessory

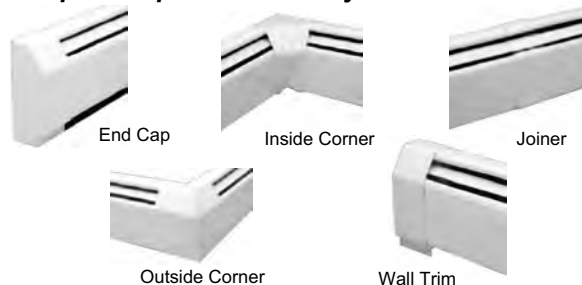

Part #	Mfg #	Description	Price
HAYBBHOECL	958	3" End Cap - Left, White	12.75
HAYBBHOECR	958	3" End Cap - Right, White	12.75
HAYBBHOVCL	958	4" Hinged End Cap - Left, White	14.67
HAYBBHOVCR	958	4" Hinged End Cap - Right, White	14.67
HAYBBHOIC135	958	135° Inside Corner, White	11.85
HAYBBHOIC	958	90° Inside Corner, White	11.85
HAYBBHOSPLICE	958	3" Joiner Set, White	4.74
HAYBBHOOC135	958	135° Outside Corner, White	15.67
HAYBBHOOC	958	90° Outside Corner, White	15.67
HAYBBHOWE	958	3" Wall Trim, White	5.92
HAYBBHOEB	958	Element Bracket w/Pivot	6.53

Residential Baseboard

Touch-Up Paint

Part #	Mfg #	Description	Price
HAYBBTP	2315	White Touch-Up Paint	14.87

Special orders - If you need it we can get it promptly!



www.irrsupply.com

Baseboard Heating

"The Heating Edge" Baseboard Heating

- Perimeter heating product
- Unique "coil block" and mounting system
- No brackets or hangers
- May use for geothermal and solar
- High BTU's per foot



Complete High Efficiency Baseboard

Part #	Mfg #	Description	Price
HEEHE22075W	HE2-2075W	2' Complete 3/4"cc	88.71
HEEHE23075W	HE2-3075W	3' Complete 3/4"cc	130.42
HEEHE24075W	HE2-4075W	4' Complete 3/4"cc	173.94
HEEHE25075W	HE2-5075W	5' Complete 3/4"cc	217.35
HEEHE26075W	HE2-6075W	6' Complete 3/4"cc	260.82
HEEHE27075W	HE2-7075W	7' Complete 3/4"cc	304.34
HEEHE28075W	HE2-8075W	8' Complete 3/4"cc	347.89

Baseboard Components

Part #	Mfg #	Description	Price
HEEHE4SW	HE-4SW	4" White Splicer	5.77
HEEHEEC12WL	HE-EC12WL	12" White Left Hand End Cap	24.70
HEEHEEC12WR	HE-EC12WR	12" White Right Hand End Cap	24.70
HEEHEEC6WL	HE-EC6WL	6" White Left Hand End Cap	24.39
HEEHEEC6WR	HE-EC6WR	6" White Right Hand End Cap	24.39
HEEHEIC90W	HE-IC90W	90° White Inside Corner	15.51
HEEHEOC90W	HE-OC90W	90° White Outside Corner	15.51
HEEHEIC135W	HE-IC135W	135° White Inside Bay Corner	15.51
HEEHEOC135W	HEOC135W	135° White Outside Bay Corner	15.51

We Value Your Opinion

Let us know what we are doing right, but more importantly let us know how we can serve you better.



All Items May Not Be Stocked In All Branches

Residential
Baseboard

Hydronic Heaters

Quiet-One 2000

Kickspace Heater

- One piece chassis with removable grille manufactured from high grade zinc coated steel
- Headered coil made of copper tubes, tested at 300 PSI and sealed for quality
- Integral two speed, max.-off-min. fan switches
- 120/60/1 Power supply is required
- Quiet efficient operation; installer friendly
- Easily fits in tight spaces or hard-to-heat areas



Part #	Mfg #	MBTUH	D x W x H	Price
SMIKS2004	KS-2004	4.3	10-7/8" x 13-7/8" x 3-1/2"	319.34
SMIKS2008	KS-2008	8.9	10-7/8" x 20" x 3-13/16"	442.64
SMIKS2010	KS-2010	10.9	14-13/32" x 23-3/8" x 4"	569.28

"Vector" Recessed Floor Unit

- Complete fan convector
- Designed for hard to heat areas
- Whisper quiet efficient operation
- Easily mounted between 16" O.C. joists in parallel or perpendicular position
- Attractive heel proof grille design
- Completely accessible through grill opening
- Two position speed switch (Max.-Off-Min.) hidden behind grille

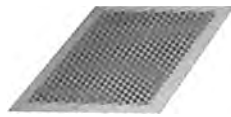

Part #	Mfg #	Description	Price
SMIFL100	FL 100	10,600 Btu/Hr	759.24

KSWK Recessed Wall Unit

- Whisper quiet efficient operation
- Easily mounted between 16" O.C. studs
- Attractive grille design
- Two position switch (Max.-Off-Min.) hidden behind access door
- Water vent easily accessible for venting air



Part #	Mfg #	Accepts:	Price
SMIKSWK	KS WK	KS2004, KS2006, KS2008	218.44
SMIKSWK2010	KS WK 2010	KS2010	256.32

Quick Fit Hose Kit

Includes:

- 8' Watts Radiant synthetic hose with DIN standard oxygen barrier
- 3/8" Radiant underfloor tubing
- Four 3/8" barb x 1/2" sweat tees
- Four 3/8" self tite clamps
- Tube of barb tite glue

Part #	Mfg #	Description	Price
SMIQFHK8	QFHK-8	For Quiet-One Kickspace Heaters	121.14

Profile

Wall Mount Fan Convector Series

- Quiet efficient operation
- Delivers a range from 3,000 to 23,000 BTUH in three different sizes
- Two position fan switch for maximum control
- Features the E-Z hanger mounting bracket
- Attractive dove grey baked enamel finish
- Ideal for dormitories, motels, hospitals or any space where high BTU output is required with only limited wall space



Part #	Mfg #	Width	Max/Min Cu Ft	Price
SMIPSU10	PSU 10	18-1/4"	75/50	784.50
SMIPSU15	PSU 15	30-1/2"	140/100	873.72
SMIPSU23	PSU 23	41-9/16"	210/150	1123.26

Residential Baseboard

**"Service Starts Here"
is not just a motto
it's how we do business.**

Prices & Specifications are Subject to Change.

Cast Iron Radiators

Cast Iron Radiant Radiators

Cast Iron Slenderized Radiators

- 4 Tube x 19" high covers 2.3 sq ft per section
- 4 Tube x 25" high covers 2.0 sq ft per section
- 6 Tube x 25" high covers 3.0 sq ft per section
- 1-3/4" Centers
- Water - 50 psi WP
- Steam - 15 psi WP
- Assembled to fit your job requirements

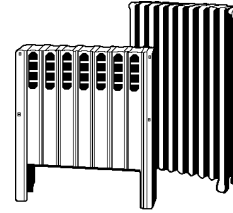

Part #	Mfg #	Section	Size	Option	Price
BUR4T19	4X191IG	Intermediate	4 Tube x 19"	-	108.52
BUR4T19E	4X191RG	End Section	4 Tube x 19"	With Legs	108.52
BURBBINT24	4X24Interm	Intermediate	4 Tube x 24"	-	288.98
BUR4T25E	4X25ENDSEC	End Section	4 Tube x 25"	With Legs	116.72
BUR6T25L	6X25Interm	Intermediate	6 Tube x 25"	With Legs	148.64
BUR6T25E	6X251RG	End Section	6 Tube x 25"	With Legs	148.64
BUR4T25	4T25	Intermediate	4 Tube x 25"	-	116.72
BUR6T25	6T25	Intermediate	6 Tube x 25"	-	148.64

**Residential
Baseboard**

Visionary Baths & More Kitchen and Bath Design Centers

*Professionally staffed to assist you and your customers
with design and selection <http://www.visionarybaths.com>*

Baseboard Heating

Baseray® Assemblies

- Cast Iron radiant baseboard
- Low profile and quiet

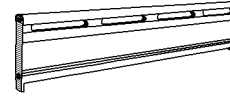

Part #	Mfg #	Description	Price
BURBB112	9A1.5C	1.5' Complete Baseray® Assembly	206.52
BURBB2	9A2C	2' Complete Baseray® Assembly	275.32
BURBB3	9A3C	3' Complete Baseray® Assembly	412.98
BURBB312	9A3.5C	3.5' Complete Baseray® Assembly	481.80
BURBB4	9A4C	4' Complete Baseray® Assembly	550.64
BURBB5	9A5C	5' Complete Baseray® Assembly	688.30
BURBB6	9A6C	6' Complete Baseray® Assembly	825.96
BURBBRE12	9A1R	1' RH Baseray® Assembly	144.48
BURBBRE24	9A2R	2' RH Baseray® Assembly	288.98
BURBBLE18	9A1.5L	1.5' LH Baseray® Assembly	216.72
BURBBLE24	9A2L	2' LH Baseray® Assembly	288.98

Baseray® Accessories & Fittings

Part #	Mfg #	Description	Price
BURBBLHENC	6074119	LH Valve Enclosure	69.12
BURBBRHENC	6074120	RH Valve Enclosure	69.12
BURBB90S	80741619	90-S 4-5/8" Corner Plate	100.62
BURIC458	80741603	4-5/8" Inverted Corner Plate	75.56

**Residential
Baseboard**

We Value Your Opinion
Let us know what we are doing right, but more
importantly let us know how we can serve you better.

Baseboard Heating

Electric Baseboard Heaters

High performance, compact heater. Trim lines enhance the appearance and rounded corners and edges make it safe for toddlers.

- Color:
 - Standard is white or almond
 - Custom colors available upon request
- Finish:
 - Epoxy/polyester powder paint
- Construction:
 - 20 Gauge steel connection box
 - 22 Gauge steel body
 - 20 Gauge front panel
 - Rounded upper corners
 - Linear high-limit temperature control with automatic reset
- Heating element:
 - Steel tubular heating element with aluminum fins
 - Floating heating element on high-temperature nylon bushings, eliminating expansion noises
- Watt density
 - Standard watt density of 275W/ft (900W/m)
 - Low watt density of 200W/ft (650W/m)
- Controls:
 - A wide selection of built-in thermostats available
 - Built-in thermostat kit can be installed at either end
 - Built-in relay kit fits in the right end box only
 - A low/high voltage separator plate (included with low voltage relay kit) must be added when installing low voltage relay in electric baseboard
- Installation:
 - Connection box at both ends of the heater
 - Installation directly on the floor
 - Single-screw built-in wire holder
 - Raceway for easier installation
 - (2) Rows of mounting holes spaced on 1 in. (25.4 mm) intervals for ease of installation
 - Variety of accessories available for wall-to-wall installation
- Voltage:
 - 120V, 208V, 240V/208V, 277V, 347V or 600V, 1-Phase
- Warranty:
 - Lifetime warranty on the electric heating element applies to the initial end user
 - 1-Year on the other components



Residential Baseboard

Part #	Mfg #	Electrical	Length	Color *	Price
BBE0FM0300BL	OFM0300BL	300W, 240/208V	22-5/16"	White	42.70
BBE0FM0500BL	OFM0500BL	500W, 240/208V	27-3/16"	White	44.60
BBE0FM0750BL	OFM0750BL	750W, 240/208V	37-3/16"	White	52.70
BBE0FM1000BL	OFM1000BL	1000W, 240/208V	47-1/2"	White	61.31
BBE0FM1250BL	OFM1250BL	1250W, 240/208V	57"	White	75.30
BBE0FM1500BL	OFM1500BL	1500W, 240/208V	65-11/16"	White	85.50
BBE0FM2000BL	OFM2000BL	2000W, 240/208V	83-13/16"	White	105.20
BBE0FM2500BL	OFM2500BL	2500W, 240/208V	101-13/16"	White	116.90

* Add "BL" for white, "AM" for almond

All Items May Not Be Stocked In All Branches

Baseboard Heating

Super-Compact Kickspace Heater

Toe-kick heater for use in kitchens, bathrooms, and recessed in stair risers

- Color:
 - Standard: black, white or almond
 - Optional and custom colors available upon request
- Finish:
 - Standard epoxy/polyester powder paint
- Construction:
 - 20 Gauge steel
 - 1000W Standard. Possibility of 500W in field (instructions)
 - High-limit temperature control with automatic reset (first level)
 - High-limit temperature control with manual reset (second level)
- Fan:
 - 80 cfm
 - 44.5 dB(a)
 - Factory-lubricated motor
- Heating element:
 - (2) 500W (1000W in parallel) durable tubular heating element with fins
- Control:
 - Built-in thermostat kit available
- Installation:
 - Garnishing frame included
- Voltage
 - 120V, 240/208V, 1-Phase
 - 1-Year warranty against defects



Residential Baseboard

Part #	Mfg #	Electrical	Weight	Color*	Price
BBEOCPU	OCPU1000	120V, 500W/1000W	13 lbs	Black	234.00

* Standard color is black. Add "BL" for white, "AM" for almond

Thermostats



Part #	Mfg #	Description	Price
BBEWALLSTAT2P	OTL102F	Line Voltage Thermostat; 40°F to 75°F, Double-Pole, Single-Throw, White	22.00
BBEUNITSTAT1P	OFMTB1	Single-Pole, Bi-Metal Electric Baseboard Heater Unitstat Kit, White	25.00
BBEUNITSTAT2P	OFMTB2	Double-Pole, Bi-Metal Electric Baseboard Heater Unitstat Kit, White	30.10

Line Voltage Relays



Part #	Mfg #	Description	Price
BBEORC840T	RC840T-240	208/240V, 22A Resistive Charge, On / Off Relay with Transformer	97.00

Prices & Specifications are Subject to Change.

Thermostats

T87K, T87N Non-Programmable Thermostats - The Round®

- Mercury free
- Provides electronic control of 24VAC heating and cooling systems
- Separate temperature setting and thermometer
- Classic twist dial
- Manual changeover
- Battery assisted power stealing
- Setting temperature range: 40° to 90°F
- Premier White®



T87K1007



T87N1000



T87N1026

Part #	Mfg #	Application	Terminal Designations	Dimensions	Price
HONT87K1007	T87K1007	Heat Only	R, W, Y	3-11/16" Dia x 1-3/4"D	64.58
HONT87N1000	T87N1000	1 Heat/1 Cool Conv & Heat Pump	R,Rc,W,Y,G,O,B	3-11/16" Dia x 1-3/4"D	94.52
HONT87N1026	T87N1026	1 Heat/1 Cool Conv & Heat Pump *	R,Rc,W,Y,G,O	4" Dia x 1-3/4"D	114.83

* EASY-TO-SEE Model with large raised markings & click at each 2° set point change, includes 6" cover ring & switch position labels

T812 Low Voltage Control Thermostats

- Snap-acting, bi-metal switch less mercury & requires no leveling
- For low voltage control of single-stage heating, cooling or heating/cooling systems
- Includes dealer logo pocket
- Switch type: snap-acting
- Electrical ratings: 18 to 30VAC
- Setting temperature change: 50° to 90°F
- Dimensions: 3-1/8"H x 3-1/8"W x 7/8"D
- Mounting: square



Part #	Mfg #	Application	Switching Action	System Switching	Fan Switching	Terminal Designations	Color	Comments	Price
HONT812C1000	T812C1000	1 Heat/1 Cool	SPDT	Off-Heat-Cool	Auto-On	R, W, Y, G	White	-	25.69

Thermostats

For instructions as to proper installation, servicing, and troubleshooting, please refer to the Manufacturer's literature.

Thermostats

VisionPRO® 8000 Universal Touch-Screen 7-Day Programmable Thermostats

- Electronic control of 24VAC, heating & cooling systems or 750mV heating systems
- Universal system compatibility, heating only or heating & cooling; conventional or heat pump systems
- Large backlight on-screen menu
- Ability to select multiple days
- Real-time clock
- Armchair programming - allows you to remove thermostat from wall to set the schedule
- Multiple HOLD, lockout options
- Adaptive Intelligent Recovery™
- Programmable fan
- Auto or manual changeover
- Dual-powered, battery or hardwired
- Change reminders - reminds you to service or replace the air filter, humidifier pad, ultraviolet lamp or thermostat batteries
- Temperature range:
 - Heat: 40° to 90°F
 - Cool: 50° to 99°F
- Horizontal mounting, dimensions: 4-9/16"H x 6"W x 1-1/4"D
- Premier White®
- 5-Year warranty



Part #	Mfg #	Application	Terminal Designations	Description	Price
HONTH8110U1003	TH8110U1003	1H/1C or HP w/o Aux Heat	R,RC,C,W,(O/B),Y,G,S1,S2		329.97
HONTH8321U1006	TH8321U1006	3H/2C Heat Pump, 2H/2C Conv	R,RC,W,(O/B),W2(AUX),Y,Y2,L*,E,G,S1/2	Dehumidity Control	399.96
HONTH8320U1008	TH8320U1008	3H/2C Heat Pump, 2H/2C Conv	R,RC,W,(O/B),W2(AUX),Y,Y2,L*,E,G,C,S1/2		366.63

* The L terminal is an input or output

FocusPRO® 6000 5+2 or 5-1-1 Day Programmable Digital Thermostats

- Electronic control of 24VAC, heating & cooling systems or 750mV heating systems
- 5-1-1 (Weekdays, Saturday, Sunday) or 5+2 (weekdays, weekend) programmable thermostat
- Available with large (5.09 sq in) or standard (3.75 sq in) backlight screens
- Temperature control range stops
- Soft-key, simplified controls
- Simultaneously displays both room temperature and temperature setting
- Easy change battery holder
- Auto or manual changeover
- Dual-powered, battery or hardwired
- Adaptive Intelligent Recovery™ - ensures programmed temperature is reached by programmed time
- Temperature range:
 - Heat: 40° to 90°F
 - Cool: 50° to 99°F
- Dimensions: 3-9/16"H x 5-13/16"W x 1-1/2"D
- Premier White®
- 5-Year warranty



Large Display

Part #	Mfg #	Application	Terminal Designations	Screen	Price
HONTH6110D1005	TH6110D1005	1 Heat/1 Cool	Rc,R,W(O/B),C,Y,G	Standard	137.22
HONTH6220D1002	TH6220D1002	2H/2C Conv, 2H/1C Heat Pump	Rc,R,W(O/B),W2(AUX),Y,Y2(E),G,L,C	Standard	173.54
HONTH6320U1000	TH6320U1000	2H/2C Conv, 3H/2C Heat Pump	Rc,R,W(O/B),W2(AUX/E),Y,Y2,G,L,C	Large	204.78

Thermostats

Prices & Specifications are Subject to Change.

Thermostats

FocusPRO® 5000 Non-Programmable Digital Thermostats

- Electronic control of 24VAC, heating & cooling systems or 750mV heating systems
- Clear backlight display available with large (2.98 sq in) or standard (1.95 sq in) screen
- Precise comfort control +/- 1°F of your set temperature
- Temperature control range stops
- Soft-key, simplified controls
- Easy change battery door - flips out with disassembling thermostat
- Automatic/manual selectable changeover
- Dual-powered, battery or hardwired
- Built-in Compressor Protection: Minimum-off timer protects compressor from restarting too early after a shutdown
- Temperature range:
 - Heat: 40° to 90°F
 - Cool: 50° to 99°F
- Dimensions: 3-7/16"H x 4-1/2"W x 1-5/16"D
- Premier White®



Standard Display



Large Display

Part #	Mfg #	Application	Terminal Designations	Screen	Price
HONTH5110D1006	TH5110D1006	1 Heat/1 Cool	R,Rc,C,W(O/B),Y,G	Standard	92.20
HONTH5110D1022	TH5110D1022	1 Heat/1 Cool	R,Rc,C,W(O/B),Y,G	Large	108.09
HONTH5320U1001	TH5320U1001	2H/2C Conv, 3H/2C Heat Pump	R,Rc,W(O/B),W2(AUX/E),Y,Y2,G,L,C	Large	169.32

PRO® 4000 5+2 Day Programmable Digital Thermostats

- Electronic control of 24VAC, heating & cooling systems or 750mV heating systems
- Weekday/Weekend programming to fit your lifestyle
- Large, clear, backlight display
- Precise comfort control +/- 1°F of your set temperature
- Easy slide switches allow selection of heat or cool mode, and fan operation
- Dual-powered, battery or hardwired
- Manual changeover
- Built-in instructions - simple, pull out instruction manual
- Adaptive Intelligent Recovery™ - ensures programmed temperature is reached by programmed time
- Temperature range:
 - Heat: 40° to 90°F
 - Cool: 50° to 99°F
- Dimensions: 3-13/16"H x 5-3/8"W x 1-1/4"D
- Premier White®



Part #	Mfg #	Application	Terminal Designations	Price
HONTH4110D1007	TH4110D1007	1 Heat/1 Cool Conv & Heat Pump	Rc,R,W,Y,G,O,B,C	84.57

Thermostats

Thermostats

Thermostat Accessories

Universal Thermostat Guard

- Tamper-resistant lock; key cannot be removed unless in locked position
- Vents in guard base allow airflow
- Includes clear acrylic cover, clear base and opaque wall plate



TG510A



TG511A / TG512A

Part #	Mfg #	Description	Price
HONTG510A1001	TG510A1001	Small Cover, Fits T87 & Similar 5-7/8"H x 5-7/8"W x 2-1/2"D	45.25
HONTG511A1000	TG511A1000	Medium Cover, Fits Series TH3000,TH4000,TH5000,TH6000,TH8000 & Similar 6-1/2"H x 7-1/2"W x 2-15/16"D	44.79
HONTG512A1009	TG512A1009	Large Cover, Fits Series TH5000,TH6000,TH8000 & Most Electronic Thermostats 7-1/4"Hx9-3/4"Wx3-3/8"D	46.44

Wireless Thermostat Systems

Prestige™ HD Comfort System Touchscreen Thermostat

- 3 Heat/2 Cool heat pump or up to 2 Heat/2 Cool conventional
- Powered by RedLINK™ reliability
- Wireless outdoor sensor
- High definition (HD) color touchscreen thermostat
- Large back-lit high-definition color display shows current indoor temperature, humidity, temperature setting, date & time on the home screen (also displays outdoor temperature & humidity on home screen (if wireless outdoor sensor is installed)
- Automatic daylight savings update
- Auto or manual changeover
- Change reminders for air filter, humidifier pad, ultraviolet bulb or batteries in connected devices
- 7-Day multiple day programming or non-programmable
- Humidity & dehumidity control
- 24VAC Hardwired only
- Arctic White



Part #	Mfg #	Description	Price
HONYTHX9321R5003	YTHX9321R5003	Comfort System Kit w/Personal Comfort Station Includes High Definition Color Touchscreen Thermostat, REM500R1001 Portable Comfort Control and C7089R1013 Wireless Outdoor Sensor	966.63

FocusPro® Wireless System Kit

- Powered by RedLINK™ reliability
- Can display outdoor temperature and humidity
- 1-Year battery life 2-year low battery warning



YTH5320R1000

Part #	Mfg #	Description	Price
HONYTH5320R1000	YTH5320R1000	Includes TH5320R1002 Wireless Non-Programmable FocusPRO® Thermostat, THM5320R1000 Equipment Interface Module, C7735A1000 Return Air Sensor	453.63
HONYTH6320R1001	YTH6320R1001	Includes TH6320R1004 Wireless FocusPRO® 5-1-1 Programmable Thermostat, THM5320R1000 Equipment Interface Module, C7735A1000 Return Air Sensor	488.38
HONYTH6320R1015	YTH6320R1015	Includes TH6320R1004 Wireless FocusPRO® 5-1-1 Programmable Thermostat, THM5320R1000 Equipment Interface Module, C7735A1000 Return Air Sensor, REM5000R1001 Personal Comfort Station, C7089R1013 Wireless Outdoor Sensor	716.63

Thermostats

Prices & Specifications are Subject to Change.

Thermostats

Wireless Outdoor Temperature Sensor

- Powered by RedLINK™ reliability
- No interference with other wireless devices in the home
- Reliable performance in all climates
- Installs in minutes
- 2-Year battery life, 2-month low battery warning
- Battery warning displayed on RedLINK™ enabled thermostats
- Includes (2) AA Lithium batteries and mounting hardware



Part #	Mfg #	Description	Price
HONC7089R1013	C7089R1013	Wireless Outdoor Sensor, Senses Outdoor Temperature and Humidity, RedLINK™	116.63

VisionPRO® IAQ Total Home Comfort System

- Provides control of temperature, humidification, dehumidification and ventilation
- Up to 2 Heat/2 Cool stages convention, up to 4 Heat/2 Cool in Heat Pump mode
- Selectable auto or manual changeover
- Large, clear display with backlit shows the current and set temperature and time
- Touchscreen interaction
- Common wire powering
- Manual or auto changeover selectable
- Real-time clock keeps time during power failures and automatically updates to daylight savings
- Change/check reminders for servicing/replacing filters
- Controls dehumidification using air conditioner with high or low speed fan or a whole house dehumidifier
- Controls ventilation with other HRV, ERV or fresh air damper
- Advanced heat pump control features balance point plus 2°F drop



Part #	Mfg #	Description	Price
HONYTH9421C1002	YTH9421C1002	TH9421C1004 VisionPRO IAQ Thermostat, THM5421C1008 Equipment Interface Module	516.58

Temperature Sensors

C7089 Remote Outdoor Temperature Sensor

- Senses outdoor temperature for display; can manage dual-fuel & lock-out auxiliary heat in heat pump applications
- Maximum wire run of 200'
- Includes 60" leadwire, mounting clips & screws
- Dimensions: 2-1/4" x 3/8" with 60" leadwire
- Factory calibrated



Part #	Mfg #	Description	Price
HONC7089U1006	C7089U1006	For VisionPRO® & VisionPRO® IAQ Thermostats	50.88

Thermostats

C7189 Remote Indoor Sensor

- Mounts in living space up to 200' away from W8900 remote module



Part #	Mfg #	Description	Price
HONC7189U1005	C7189U1005	For VisionPRO and VisionPRO IAQ Thermostats	59.37

Honeywell Accessories

Thermostat Accessory

Part #	Mfg #	Description	Price
HON50010944001	50010944-001	Range Stop To Limit Thermostat Settings on T87N and T87K Thermostats	7.88

Thermostat Cover Plate for FocusPRO® & PRO® Series

- Small Cover Plate: 4-5/16"H x 5-1/2"W
- Medium Cover Plate: 5"H x 6-7/8"W
- Large Cover Plate: 6"H x 8-5/16"W
- Premier White®



Part #	Mfg #	Description	Price
HON50002883001	50002883-001	(1) Medium & (1) Large Cover Plate, Bracket f/J-Boxes & Hardware f/FocusPRO®6000/5000, PRO®4000/3000	21.47

Thermostats

Irr Supply is your one stop shop for all your Plumbing, HVAC, Refrigeration, and Electrical needs. Why go anywhere else!

Thermostats

90 Series® Blue Touchscreen Thermostats

- Universal staging provides single-stage, multi-stage 2 heat/2 cool, heat pump 3 heat/2 cool
- Universal programming provides choice of 7-day, 5+1+1 or 0 program, installer selectable
- Large 12 sq in touch-screen
- Audible feedback
- Universal dual powered, choice of battery-powered or hardwired with battery back-up
- Meets ENERGY STAR® specifications
- Energy management recovery
- Total or partial key pad lockout selectable
- Permanent memory backup
- Gas, oil, electric, millivolt
- Dimensions: 4-9/16"H x 5-13/16"W x 1-3/16"D
- Classic white color
- 5-Year warranty



1F95-1277 Additional features:

- Remote sensing indoor/outdoor
- Programmable fan
- Circulator fan cycling
- Auto daylight savings options
- Dual-fuel heat pump control (1F95-1277)
- Patented cool savings
- Enhanced security settings
- 3-Wire zone valve

Part #	Mfg #	System	Program Options	Additional Applications	Power Source	Terminal Designations	Price
WHR1F951277	1F95-1277	1H/1C	Universal	3w Zn(O*)	Battery/Hardwire	RC,RH,C,W,Y,G,O,B,L,6,+ ,S,-	345.08
WHR1F951291	1F95-1291	Sgl Stg,HP	Universal	3w Zn, H/D	Battery/Hardwire	RC,RH,C,W/E,W2,Y,Y2,G,O/B,6,L,+ ,S,-,DHM,HM	382.60

* Dual fuel heat pump control (L)-Logic / (O)-Outdoor Sensor; system requires fossil fuel kit on dual fuel application if outdoor remote is not used

90 Series® Blue 6" Easy Reader

- Universal staging provides single-stage, multi-stage, heat pump
- Large, easy to read character size
- Large one-button/one-function keys
- Meets ENERGY STAR® specifications
- Energy management recovery
- Dimensions: 4.2"H x 6.4"W x 1.7"D
- Classic white



Part #	Mfg #	System	Program Options	Additional Applications	Power Source	Terminal Designations	Price
WHR1F95EZ0671	1F95EZ-0671	Universal	Universal	3w Zn, mV	Battery/Hardwire	RC,RH,C,G,Y,Y2,W/E,W2,A1,6,O/B,L,+ ,S,-	213.88

All Items May Not Be Stocked In All Branches

Thermostats

80 Series® Blue Universal Staging Thermostats

- Universal staging provides single-stage, multi-stage 2 heat/2 cool, heat pump 3 heat/2 cool
- Auto changeover
- Universal dual powered, choice of battery-powered or hardwired with permanent memory retention
- 4 sq in. LCD Lighted screen
- Cool Savings™
- Power monitor
- Dimensions: 5.1"W x 3.9"H x 1.2"D
- Includes F61-2634 wall plate
- Classic white color
- 5-Year warranty



Part #	Mfg #	System	Program Options	Additional Applications	Power Source	Terminal Designations	Price
WHR1F830422	1F83-0422	Univ 2/2 HP	Non Prog	3w Zn, mV	Battery/Hardwire	RC,RH,C,G,W/E, W2,Y,Y2,O/B,6,L	121.33

80 Series® Blue 4" Single-Stage Thermostats

- Fossil fuel or electric heat compatible
- Universal dual powered, choice of battery-powered or hardwired with permanent memory retention
- 4 sq in. LCD Lighted screen
- Configuration menu allows keypad selection of options
- Gas, oil, electric
- Selectable energy management recovery (1F80-0471)
- Auto changeover
- Dimensions: 4.4"W x 3.4"H x 1.2"D
- Includes F61-2634 wall plate
- Classic white color
- 5-Year warranty



Part #	Mfg #	System	Program Options	Additional Applications	Power Source	Terminal Designations	Price
WHR1F850422	1F85-0422	Single Stg	5+1+1,5+2,0	3w Zn, mV	Battery/Hardwire	RC,RH,C,G,W/E, W2,Y,Y2,O/B,6,L	160.86
WHR1F800471	1F80-0471	Single Stg	5+1+1,5+2,0	3w Zn, mV	Battery/Hardwire	RC,RH,C,W,Y,G,O/B	135.90

80 Series® Blue 2" Single-Stage Thermostats

- Fossil fuel or electric heat compatible
- Dual powered, choice of battery or hardwired for all applications
- Easy push-connect color coded terminals
- 2 Sq in. LCD Lighted screen
- Cool Savings™
- Dimensions: 4.8"W x 3.8"H x 1.5"D
- Classic white color
- 5-Year warranty



1F86-0244

1F80-0261

Part #	Mfg #	System	Program Options	Additional Applications	Power Source	Terminal Designations	Price
WHR1F860244	1F86-0244	Single Stg	Non-Prog	mV	Battery/Hardwire	R,C,W,Y,G,O/B	82.94
WHR1F800261	1F80-0261	Single Stg	5+1+1	mV	Battery/Hardwire	R,C,W,Y,G,O/B	117.67

Prices & Specifications are Subject to Change.

Thermostats

Thermostats

80 Series® Single-Stage Thermostats

- Fossil fuel or electric heat compatible
- 2.2 Sq in. digital lighted display
- 3-3/4"H x 6"W x 1-1/4"D
- Permanent memory back-up



Part #	Mfg #	System	Program Options	Additional Applications	Power Source	Terminal Designations	Price
WHR1F80361	1F80-361	Single Stg	5+1+1	mV	Battery/Hardwire	RC,RH,C,W,Y,G,O,B	117.19
WHR1F86344	1F86-344	Single Stg	Non-Prog	mV	Battery/Hardwire	RC,RH,C,W,Y,G,O,B	81.21

70 Series® Single-Stage Thermostats

- 24VAC Fossil fuel or electric heat or heat pump compatible
- 1.2" Square LCD backlit screen
- Selectable Celsius or Fahrenheit temperature display
- Includes B/O terminals
- Electronic accuracy
- Cool-off-heat system switches
- Auto-On fan switches
- Horizontal dimensions: 5.1"W x 3.75"H x 1.1"D
- Vertical dimensions: 3.25"W x 5.3"H x 1.1"D
- Classic white color



Part #	Mfg #	System	Program Options	Additional Applications	Power Source	Terminal Designations	Price
WHR1F78151	1F78-151	Sgl Stg, HP Horiz	5+2	mV	Battery	RC,RH,W,Y,G,O,B	72.73

Single-Stage Low Voltage Thermostats

Universal Single-Stage Mechanical Replacement Thermostat

- Mercury free
- 24V Replacement for hundreds of White-Rodgers and competitive models installed during the past 50-years
- Same footprint as older models with updated styling
- Enclosed contacts for increased reliability and accuracy
- Heat/cool with heating or cooling 3-wire zone mounting plate included
- Packaging is bilingual (English/Spanish)
- 5-Year warranty



Part #	Mfg #	System	Applications	Style	Color	Terminals	Price
WHR1F56N444	1F56N-444	Sgl Stg Heat/Cool	24V, mV, 3-W	Horizontal	White	RC,RH,W,Y,G,O,B,A	55.81

Thermostats

Thermostats

Programmable Thermostats

Touchscreen 7-Day Programmable Thermostat

- Large, dot-matrix true touchscreen with adjustable contrast
- 7-Day programmable with 4 events per day, copy option for each day
- Auto changeover
- Installer message
- Dual fuel capable when used with optional sensor kit (WTR064)
- Outdoor temperature display capable with optional sensor kit (WTR064)
- Filter and energy usage monitors
- Screen lockout



Part #	Mfg #	Description	Price
LUXPSPU721T	PSPU721T	2 Heat/1 Cool: Gas, Oil, Electric and Heat Pump	219.00
LUXPSPU732T	PSPU732T	2 Heat/2 Cool: Gas, Oil, Electric; 3 Heat/2 Cool Heat Pump	300.00

7-Day Programmable Thermostat



- 7-Day programmable with 4 events per day
- EL (Electroluminescent) backlight
- Filter and energy usage monitors
- System or battery powered
- Auto changeover
- Optional early recovery
- Energy Star rated



PSP722E

Part #	Mfg #	Description	Price
LUXPSP722E	PSP722E	2 Heat/2 Cool Universal, Emergency Heat Mode	200.00
LUXPSPA711	PSPA711	1 Heat/1 Cool Non Heat Pump, IAQ Clean Cycle® Fan	112.00
LUXPSPA722	PSPA722	2 Heat/2 Cool Non Heat Pump, IAQ Clean Cycle® Fan	118.40

5-2 Programmable Thermostat



- Separate weekday and weekend programming
- Energy Star approved



Part #	Mfg #	Description	Price
LUXPSP511L	PSP511L	1 Heat/1 Cool, Lighted, Horiz, Sys/Bat Powered	80.00

Digital Thermostats

- Non-programmable
- Battery powered



Part #	Mfg #	Description	Price
LUXPSD111	PSD111	1 Heat/1 Cool, Lighted, Horiz/Vert, Sys/Bat Powered	74.50

Wireless Outdoor Temperature Transmitter and Receiver Kit

- Accurately displays current outdoor temperature
- Enables dual fuel capability on PSPU721T/PSPU732T thermostats



Part #	Mfg #	Description	Price
LUXWTR064	WTR064	Outdoor Wireless Temperature Transmitter and Receiver Kit	90.00



Thermostat Multiplexers

Model 3000

- Often used to add air conditioning to a heating system
- Can also convert a 4-wire cable into a 6-wire cable for 2-stage heating,
- Converts a 2-wire cable into a 4-wire cable
- 2-Stage cooling or heat pump conversions
- Lifetime free replacement warranty



Part #	Mfg #	Description	Price
FASTSTAT	3000	Fast-Stat Wiring Extenders	179.90

Thermostats

Universal Controls

Line Voltage Commercial Thermostats

T651A Light-Duty Line Voltage Commercial Thermostat

- Control line voltage on valves, motors, contactors, electric heat elements, duct furnaces & fan coil units
- SPDT Switching action, breaks heating & makes cooling on temperature rise
- Heating & cooling application
- Mount on standard vertical or horizontal outlet box
- Automatic cooling & heating anticipation
- Includes vertical scaleplate with thermometer, horizontal scaleplate without thermometer, & high accuracy dual diaphragm sensor
- Dimensions: 4-1/2"H x 2-15/16"W x 1-1/2"D (switches & wiring terminals protrude into outlet box 3/4")
- Champagne gold faceplate with beige cover



Part #	Mfg #	Temp Setting	Description	Price
HONT651A3018	T651A3018	44° - 86°F	Range Stops & Locking Cover Screws, Wall Plate	127.91

Winter Watchman

- Used as freeze warning device
- Completes circuit to household lamp on temperature fall, indicating inoperative heating equipment



Part #	Mfg #	Description	Price
HONS483B1002	S483B1002	Winter Watchman Freeze Warning Device, 30° - 60°F, Adjustable	61.75

Contactors

Auxiliary Interlock for 3-Pole Economy DP-Series Contactor



Part #	Mfg #	Description	Price
HONDP3AUX1NO1NC	DP3AUX-1NO-1NC	1 NO & 1 NC Snap-On Side Mounted	43.33

Relays

General Purpose Relay

- Provides general purpose switching for refrigeration & air conditioning equipment, appliances, vending machines, etc
- 50/60Hz



Part #	Mfg #	Description	Price
HONR4222D1013	R4222D1013	DPDT 120V General Purpose Relay, 1 - 6 Power Poles	35.74
HONR8222B1067	R8222B1067	SPDT 24V General Purpose, Double Quick Connect, 1 - 3 Power Poles	31.14
HONR8222D1014	R8222D1014	DPDT 24V General Purpose, Double Quick Connect, 1 - 6 Power Poles	33.03

Universal Controls

All Items May Not Be Stocked In All Branches

Universal Controls

Enclosed Switching Relay

- With internal transformer



Part #	Mfg #	Description	Price
HONRA889A1001	RA889A1001	SPDT Line Voltage Enclosed Switching Relay Plus SPST Low Voltage Relay w/Powerpile Rating	119.23

Fan Centers

R8239 Control Center

- Provides low voltage control of line voltage fan motors & auxiliary circuits in heating, cooling or heat-cooling circuits
- Includes NEMA D Transformer, relay enclosures
- Convenient connections for thermostat and heating-cooling equipment wiring
- Mounts on standard 4" x 4" junction box in any indoor location without additional enclosures
- Relay is easily replaced without disturbing wiring



Part #	Mfg #	Description	Price
HONR8239A1052	R8239A1052	120V, SPDT Switching, 40VA Transformer, Includes R8222B for 1 or 2 Speed Fans	88.60

R8285 Control Center

- Low voltage control of line voltage fan motors & auxiliary circuits in heating, cooling or A/C systems
- Transformer powers low voltage control systems and provides overload protection
- Mounts on standard 4" x 4" junction box
- Low voltage terminal board provides convenient connections for thermostat & heating/cooling equipment wiring
- Relay is easily replaced without disturbing wiring
- Includes R8222B plug-in relay for 1- or 2-speed fans



Part #	Mfg #	Description	Price
HONR8285A1048	R8285A1048	120V, SPDT Switching, 40VA Transformer, 24V Secondary	62.48

Universal Controls

Universal Controls

Transformers

AT72 NEMA Standard Transformer

- 24V Control circuit step-down transformer designed to power any 24V control system, including thermostats, gas valves & relays
- NEMA Type D, meets 'NEC Class 2 Not Wet, Class 3 Wet' & UL 1585 requirements
- Color-coded leadwire for primary connections
- 9" Leadwire (primary)
- Combination mount can be foot-mounted, plate-mounted on 4" x 4", 4" octagon or 2" x 4" electrical boxes (transformer all above or 3/4 above plate) or clamp-mounted via a junction box knockout



Part #	Mfg #	Output (100 % Factor)	Primary Voltage @ 50/60 Hz	Secondary Voltage (Open Circuit)	Mounting	Electrical Connections Secondary	Price
HONAT72D1683	AT72D1683	40VA	120V	26.5	Combination	(2) Screw Terminals	50.11

AT87 NEMA Standard Transformer

- Used primarily for powering 24V air conditioning circuits
- NEMA Type E, meets NEC Class 2 Not Wet, Class 3 Wet & UL 1585 requirements
- Overload protection provided
- Color-coded leadwire for primary connections
- 1106: 13" Leadwire, built-in protection, primary winding burnout
- 1155/1189: 12" Leads, energy limiting overload protection



Part #	Mfg #	Output (100 % Factor)	Primary Voltage @ 50/60 Hz	Secondary Voltage (Open Circuit)	Mounting	Electrical Connections Secondary	Price
HONAT87A1106	AT87A1106	50VA	120/208/240V	26.5	Foot or 4" x 4" Plate	(2) Screw Terminals	65.86

AT140A/AT150A/AT175A Class 2 General Purpose Transformer

- Color-coded leadwire for primary connections
- 9" Leads (primary)
- Screw terminal secondary
- UL Listed, CSA certified



AT140A



AT150B



AT175A

Part #	Mfg #	Output (100 % Factor)	Primary Voltage @ 60 Hz	Mounting	Price
HONAT140A1000	AT140A1000	40VA	120V	Univ Mnt (Plate, Foot & K/O)	27.28
HONAT140A1018	AT140A1018	40VA	120/208/240V	Univ Mnt (Plate, Foot & K/O)	29.98
HONAT150A1007	AT150A1007	50VA	120/208/240V	Univ Mnt (Plate, Foot & K/O)	34.05
HONAT175A1008	AT175A1008	75VA	120/208/240V	Univ Mnt (Plate, Foot & K/O)	75.11

Universal Controls

All Items May Not Be Stocked In All Branches

Universal Controls

VR Series Combination Gas Controls

- Standard features for combination gas valves include:
 - (2) Automatic valves
 - Solenoid-operated first automatic valve opens on thermostat call for heat; closes when call for heat ends
 - Diaphragm-operated second automatic valve opens under control of regulator; closes if gas or power supply is interrupted
 - Meets codes requiring dual safety shutoff
 - Mounting: 0° to 90°, any direction from upright position of gas control knob, including vertically

VR8200 Continuous Pilot Dual Automatic Valve Combo Gas Control

- For 24VAC gas-fired, standing pilot appliances w/capacities from 20-200 cfh
- Includes all standard features plus:
 - Controls include manual valve, (2) automatic operators, Servco pressure regulator & pilot adjustment
 - Standard & slow opening natural gas models include natural to LP gas conversion kits; LP to natural gas conversion kits are also available
 - All adjustments, wiring connections & pilot outlets are accessible from the top of control
 - LITE-RITE (Off-Pilot-On) lighting sequence
 - Compatible with ECO connector
 - Capacities based on 1" p.d. 20,000 BTUH minimum, 130,000 BTUH maximum



Part #	Mfg #	Inlet/Outlet Size	Capacity cfh	Capacity m3/hr	Pressure Regulator Setting	Type of Gas	Type of Pressure Regulator	Price
HONVR8200A2132	VR8200A2132	1/2" x 1/2"	130	3.7	3.5"wc/0.87kPa	NG	Std (1)	160.52

(1) Includes 393691 Nat'l to LP gas conversion kit, one 1/2" x 3/8" reducer bushing 393690-14 bag assembly - 3/4" straight flange with o-ring, screws & wrench Q340 (36") thermocouple w/adapters

VR8300A Continuous Pilot Dual Automatic Valve Combo Gas Control

- For 24VAC gas-fired, standing pilot appliances with capacities from 30-300 cfh
- Includes all standard features plus:
 - Controls include 100% safety shutoff, manual valve, magnetic operators, pressure regulator & pilot adjustment
 - Standard & slow opening natural gas models include natural to LP gas conversion kits; LP to natural gas conversion kits are also available
 - All adjustments, wiring connections & pilot outlets are accessible from the top of control
 - LITE-RITE (Off-Pilot-On) lighting sequence
 - Compatible with ECO connector
 - Temperature ratings: 0° - 175°F ambient
 - Capacities based on 1" p.d. 30,000 BTUH minimum, 190,000 BTUH maximum



Part #	Mfg #	Inlet/Outlet Size	Capacity cfh	Capacity m3/hr	Pressure Regulator Setting	Type of Gas	Type of Pressure Regulator	Price
HONVR8300A4508	VR8300A4508	3/4" x 3/4"	200	5.7	3.5"wc/0.87kPa	NG	Std (3)	203.70
HONVR8300C4506	VR8300C4506	3/4" x 3/4"	200	5.7	0.9"wc/0.22kPa	NG	Step Opening	319.07

(3) Includes two 3/4" x 1/2" reducer bushings 393691 Nat'l to LP gas conversion kit

Universal Controls

Prices & Specifications are Subject to Change.

Universal Controls

VR8304 Intermittent Pilot Dual Automatic Valve Combo Gas Control

- For use in 24VAC gas-fired, intermittent pilot with capacities from 30-415 cfh
- Includes all standard features plus:
 - Controls include 100% safety shutoff, manual valve, two automatic operators, pressure regulator & pilot adjustment
 - Standard & slow opening natural gas models include natural to LP gas conversion kits; LP to natural gas conversion kits are also available
 - All adjustments, wiring connections & pilot outlets are accessible from the top of control
 - Adjustable servo regulator
 - Compatible with ECO connector
 - On-Off lighting sequence
 - Use with S86F,H; S860D; S8600F,H; S8610 & S90A,B Control Modules
 - Single stage unless otherwise noted
 - Capacities based on 1" p.d. 30,000 BTUH minimum, 300,000 BTUH maximum



Part #	Mfg #	Inlet/Outlet Size	Opening Characteristics	Capacity m3/hr	Pressure Regulator Setting	Type of Gas	Temp Rating	Price
HONVR8304M3509	VR8304M3509	1/2" x 3/4"	Standard (2)	3.5	0.87	NG	-40° - 175°F	239.81

(2) Includes one 3/4" x 1/2" reducer bushing 393691 Nat'l to LP gas conversion kit

VR8345 Universal Electronic Ignition Combination Gas Control

- For use with direct spark ignition, hot surface ignition or intermittent pilot ignition in 24VAC, gas-fired appliances, with capacities from 30 to 415 cfh
- Includes all standard features plus:
 - Manual valve, two automatic operators, pressure regulator, pilot adjustment, pilot plug & ignition adapter
 - Replaces virtually any IP, HSI or DSI gas control
 - For use with natural or manufactured gas or LP gas
 - Includes converter kit to adapt from natural gas to LP gas
 - 4" Swing radius allows easy rotation into position inside the tightest furnace vestibules
 - Clearly marked, keyed terminal block allows quick attachment wires & IP/DSI/HSI jumper
 - Internal inlet screen blocks contaminants in gas line from entering valve
 - Capacities based on 1" p.d. 30,000 BTUH minimum, 300,000 BTUH maximum



Part #	Mfg #	Inlet/Outlet Size	Capacity cfh	Capacity m3/hr	Prs Regulator Setting In wc	Prs Regulator Setting kPa	Type of Gas	Type of Pressure Regulator	Price
HONVR8345M4302	VR8345M4302	3/4" x 3/4"	300	8.5	3.5	0.87	NG	Std (1)	232.07

(1) Includes two 3/4" x 1/2" NPT reducer bushings and one 1/2"x 1/2" NPT bushing

Universal Controls

Universal Controls

Combination Gas Controls

V800 Low Voltage Standing Pilot Gas Control

- Auto 24V control for use with 30mV thermocouple, includes integral A & B gas cock, magnetic operator, pressure regulator, auto pilot, 100% shut-off, pressure tap & filter, one 36" thermocouple & LP kit
- Color coded blue to identify 24V operation



Part #	Mfg #	Inlet/Outlet Size	Capacity cfh	Capacity m3/hr	Pressure Regulator Setting	Type of Gas	Type of Pressure Regulator	Price
HONV800A1476	V800A1476	1/2" x 3/4"	250	7.1	3.5"wc/0.87kPa	NG	Std (6)	270.62
HONV800A1591	V800A1591	3/4" x 3/4"	335	9.5	3.5"wc/0.87kPa	NG	Std (2,6)	325.21

(2) Includes two 3/4" x 1/2" reducer bushing/adaptor

(6) Natural to LP Conversion Kit

VS820 Millivoltage Combo

- Provides complete control of continuous pilot gas-fired central furnaces & boilers
- Self-Powered automatic control for use with 750mV thermocouple
- Includes pilot flow adjustment screw
- All adjustments & connections are accessible from top of control
- Add separate energy cutoff (ECO) where codes call for dual safety shutoff
- Complete safety shutoff on pilot flame failure
- LITE-RITE (Off-Pilot-On) lighting sequence
- Adjustable pressure regulator
- Temperature range: 32° to 175°F
- Mounting 0° to 90° in any direction from the upright position of the gas control knob, including vertically



Part #	Mfg #	Inlet/Outlet Size	Capacity cfh	Capacity m3/hr	Pressure Regulator Setting	Type of Gas	Type of Pressure Regulator	Price
HONVS820A1047	VS820A1047	1/2" x 3/4" 1/2" Side Outlets	250	7.1	3.5"wc/0.87kPa	NG	Std (1)	370.79
HONVS820A1054	VS820A1054	3/4" x 3/4" 1/2" Side Outlets	335	9.5	3.5"wc/.087kPa	NG	Std (1)	396.22

(1) Includes one 3/4" x 1/2" and one 1/2" x 3/8" reducer bushing/adaptor

Universal Controls

Universal Controls

ST9120U1011 Universal Integrated Gas Combustion Blower Control

- Controls combustion blower & circulating fan operations in gas warm air appliance
- Central appliance wiring point simplifies appliance assembly and service
- Replaces all existing Honeywell fan timer boards
- Diagnostic LED
- Continuous EAC and HUM terminal connections
- Delays are field adjustable



Part #	Mfg #	Heat Fan On Delay	Heat Fan Off Delay	Cool Fan On Delay	Cool Fan Off Delay	Price
HONST9120U1011	ST9120U1011	30 or 60 Sec	60, 120, 150 or 180 Sec	4 or 30 Sec	30 or 60 Sec	230.68

Ignition Pilot Modules

Y8610U Universal Retrofit Intermittent Pilot Gas Burner Ignition System

- Complete kit for converting conventional standing pilot systems to intermittent pilot systems for use with 24VAC gas-fired atmospheric furnaces, boiler & heating appliances
- Includes: Intermittent Pilot Module; Intermittent Pilot Dual Valve Combo Gas Control (VR8304 with ON-OFF manual valve), pressure regulator & two automatic main gas valve operators & reducer bushings
- Includes 392431 Igniter-Sensor Assembly including ceramic-insulated Kanthal rod that attaches to existing pilot burner in place of the thermocouple; 394800-30 Ignition Cable - 30" cable with connectors, 30" wiring harness with 1/4" quick-connect terminals, reducer bushings for gas control, adhesive mounting tape for S8610 & misc installation hardware
- Y8610U Kits are for use with Natural or LP gas; 100% pilot gas shutoff & include 393691 LP gas conversion kit, 393690-14 flange assembly



Part #	Mfg #	Description	Price
HONY8610U6006	Y8610U6006	Y-pack Containing S8610U3009 & VR8304M with 1/2" x 3/4" Inlet/Outlet, Flange Kit, LP Conversion Kit	548.16

S8610U Universal Intermittent Pilot Module

- Field service replacement for most Honeywell, Robert Shaw, Johnson & UTEC (HSC) intermittent pilot ignition modules. Provides electronic control of most intermittent pilot ignition systems used on gas-fired furnaces, boilers & other heating appliances
- For use in systems w/combination igniter-sensor (single rod or dual rod sense)
- 100% Pilot gas shutoff & lockout on loss of pilot flame
- Includes relay contacts for use with any intermittent pilot gas control string w/max 1.0A pilot or 2.0A main valve rating
- Honeywell VR8204, VR8304 or VR8345M combination gas control recommended
- Functional equivalent of S86, S8600, S8610 & S90 modules
- Includes spark cable adapters to allow field replacement of both Honeywell & competitive controls without replacing existing spark cable
- Includes damper connection & automatic vent damper plug



Part #	Mfg #	Description	Price
HONS8610U3009	S8610U3009	NG or LP Gas, 90 Second Trial for Ignition, 5 Minute Wait, Continuous Retry (Replaces S8610U1003)	256.52

Universal Controls

All Items May Not Be Stocked In All Branches

Universal Controls

S8910U Universal Hot Surface Ignition Module

- Provides operating control of a direct ignition system using 120VAC hot surface igniter
- Replaces most hot surface ignition modules manufactured by Honeywell, Robert Shaw & White-Rodgers
- For local (single rod) or remote (dual rod) rectification type flame sensing
- For use only in 60Hz systems
- Provides one or three ignition trials (four-second or seven-second trials) per call for heat; prepurge of 32 seconds or less; up to 96 seconds between purge trial times
- Number of trials for ignition and trial time is determined by the selection tab. If a selection tab is not installed, the module will operate at four seconds trial time & one ignition trial
- Temperature range is -40°F to +175°F

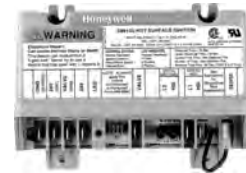

Part #	Mfg #	Description	Price
HONS8910U1000	S8910U1000	1.5 Second Flame Failure Response Time	260.22

S9200U Hot Surface Ignition Control

- Universal hot surface ignition integrated furnace control
- Controls a standard induction-type circulating fan motor
- Can be used with conventional thermostats as well as the EnviraCOM™ enable VisionPRO IAQ and FocusPRO
- Main burner ignition using a 120V hot surface igniter
- Flame rectification circuit to monitor flame presence
- Monitors system pressure switch, high temperature limit, and rollout functions



Part #	Mfg #	Description	Price
HONS9200U1000	S9200U1000	Universal Integrated Furnace Control	232.57

SmartValve® Hot Surface Pilot Ignition Controls

SV9501 SmartValve® System Controls

- Provides easy field replacement of a wide range of SV9500, SV9501, SV9502 & SV9602 SmartValve® System models
- Gas appliance manufacturers use these models in many types of gas fired heating appliances including central furnaces, residential boilers, rooftop furnaces, commercial cooking appliances, and unit heaters
- Provides intermittent pilot gas ignition sequencing, pilot flame sensing, and both pilot and main gas control functions in a single control
- Ignition sequence includes timed trial for ignition
- Compatible with Q3450 or Q3480 intermittent pilot burners used with the original controls on the appliance



Part #	Mfg #	Description	Price
HONSV9501M8129	SV9501M8129	Intermittent HSI Pilot , 1/2" x 1/2" In/Out, 3.4"wc Standard Opening, Natural Gas	388.23

Universal Controls

Universal Controls

SV9641 SmartValve® System Controls

- Combines gas flow control & electronic intermittent pilot sequencing functions
- Q3450 or Q3480 Pilot hardware supplies the low voltage igniter, flame sensor and pilot burner
- Communicates directly with an electronic fan timer (ST9160 Electronic Fan Timer for single stage applications; ST9162 Electronic Fan Timer for two-stage applications) in typical forced warm air furnace applications
- Provides prepurge, postpurge, timed trial for pilot ignition, with 100% shutoff and continuous retry
- Suitable for wide range of fan assisted combustion gas-fired appliances including: furnaces, rooftop furnaces, boilers, unit heaters, infrared heaters, water heaters, and commercial cooking appliances
- Ambient temperature range (F): -40°F to +175°F
- Diagnostic LED



Part #	Mfg #	Description	Price
HONSV9641M4510	SV9641M4510	2-Rod Flame Sense, 1/2" x 1/2" In/Out, 1/2" x 3/4" In/Out, Or 3/4" x 3/4" In/Out, Intermittent Hot Surface Pilot Ignition, Standard Opening, 3.5"wc	465.34

Power Generators

Q313 Replacement Thermopile Generators

- Provides power for a milli-voltage, self-powered control system
- Includes spade terminals
- Use with Q314, Q324, Q327, Q377, Q379 & Q382 pilot burners



Part #	Mfg #	Description	Price
HONQ313A1139	Q313A1139	600-750mV Replacement Thermopile Generator, 35" Lead, Push-in Clip	87.71
HONQ313A1170	Q313A1170	600-750mV Replacement Thermopile Generator, 35" Lead, PG9 Adapter	96.74
HONQ313A1188	Q313A1188	600-750mV Replacement Thermopile Generator, 35" Lead, Push-in Clip, 1/2" Thermopile Attaching Nut	84.90

Thermocouples

Q340 Universal 30 mV Thermocouples

- Includes push-in clip, split nut & adapter assembly for easy pilot burner installation
- Male nut connector for Pilotstat™ safety control power units



Part #	Mfg #	Description	Connection	Price
HONQ340A1066	Q340A1066	18" Lead	11/32" 32 Male Connector Nut	15.80
HONQ340A1074	Q340A1074	24" Lead	11/32" 32 Male Connector Nut	16.73
HONQ340A1082	Q340A1082	30" Lead	11/32" 32 Male Connector Nut	17.38
HONQ340A1090	Q340A1090	36" Lead	11/32" 32 Male Connector Nut	17.90
HONQ340A1108	Q340A1108	48" Lead	11/32" 32 Male Connector Nut	19.90

Universal Controls

All Items May Not Be Stocked In All Branches

Universal Controls

Igniters

Glowfly™ Universal Hot Surface Igniter

- Uses a 120V silicon nitride igniter design with long life and high resistance to damage or burn out in the appliance
- Kit includes specially designed silicon nitride igniter and six different bracket configurations
- Clear instructions and application templates are provided
- Replaces over 110 different models
- 3-Year warranty



Part #	Mfg #	Description	Price
HONQ3200U1004	Q3200U1004	Glowfly Universal Hot Surface Igniter Kit	66.47
HONQ3200U2002	Q3200U2002	Glowfly Universal Hot Surface Igniter Kit, Service Pack of (6) Kits	382.63

Pilot Burners

Q314 Pilot Burner

- Non-primary aerated, insert orifice-type, for main burner ignition w/Q340 or Q390 thermocouple for Pilotstat safety control operation
- Use with Q313 Thermopile generator for 750mV powerpile applications
- Natural Gas orifice, LP gas orifice
- Compression fitting size: 1/4"
- Special mounting bracket with screws for converting "B" bracket to "A"



Part #	Mfg #	Description	Price
HONQ314A4586	Q314A4586	B Bracket, BCR-18 Orifice, Single (F) Front Tip	49.56
HONQ314A6094	Q314A6094	B Bracket, BCR-18 Orifice, Single (L) Left Front Tip	49.56

Q327 Pilot Burner

- Primary-aerated, spud orifice-type pilot burner for main burner ignition with Q340 or Q390 thermocouple for Pilotstat safety control operation
- Use with Q313 Thermopile generator for 750mV powerpile applications



Part #	Mfg #	Description	Price
HONQ327A1626	Q327A1626	B Bracket, .026 Orifice, 1/4" Ftg, 1" Wing Span with (1) .014 Orifice Unassembled, 1" Target Span	60.97

Q345A Pilot Burner

- Non-primary aerated combination pilot burner & igniter
- Used with S86, S860 S8610 or S8670 in intermittent pilot systems
- Includes pilot burner with bracket, ceramic insulated Kanthal flame rod/spark igniter & ground strap
- Compression fitting size: 1/4"



Part #	Mfg #	Description	Price
HONQ345A1305	Q345A1305	B Bracket, BCR-18 Orifice, Single (F) Front Tip	52.14

Universal Controls

Prices & Specifications are Subject to Change.

Universal Controls

Aquastats®

L6006A Immersion High or Low Limit Aquastat Controls, SPDT

- Remote bulb model may be used to sense air temperature in ducts and outside air sensing applications
- Totally enclosed micro switch snap-acting switch
- Visible control point scale and external adjustment screw permit easy setting
- Horizontal or vertical insertion of the sensing element
- Direct or well immersion of the sensing element
- Select models have wells



Part #	Mfg #	Temperature Operating Range	Includes:	Price
HONL6006A1145	L6006A1145	100°-240°F	Stop Factory-Set @ 240° F, Heat-Conductive Compound	205.08

L6006C Strap-On Mount High or Low Circulator Control, SPDT

- Remote bulb model may be used to sense air temperature in ducts and outside air sensing applications
- Totally enclosed micro switch snap-acting switch
- Visible control point scale and external adjustment screw permit easy setting
- Horizontal or vertical insertion of the sensing element
- Select models have wells



Part #	Mfg #	Temperature Operating Range	Includes:	Price
HONL6006C1018	L6006C1018	65°-200°F	Stop Factory-Set @ 200° F	190.18

Aquastat® Relays

L8124 Triple Aquastat® Relay

- Immersion-type controllers that combine high limit protection with low limit & circulator control in forced hydronic heating systems, including domestic hot water systems
- Includes diaphragm powerhead & Micro Switch® assembly that responds to temperature changes in boiler water
- Mounts directly to boiler
- Requires 24VAC thermostat w/heat anticipator set @ 0.2 amps

L8124L Triple Aquastat™ Relay

- Includes ZC-ZR terminals for multi-zone control using separate circulator R845 relay for each zone with large transformer & extra terminals for supplying power to low voltage zone valves



Part #	Mfg #	Description	Price
HONL8124L1011	L8124L1011	120V, 3" Insulation Depth, Universal Element & Mounting	444.18

Universal Controls

All Items May Not Be Stocked In All Branches

Universal Controls

L8148 Aquastat® Relays

- Immersion-type controllers that combine high limit protection with switching relay control of burner & circulator motors
- High limit opens burner circuit only
- Includes transformer & accessory terminals for adding a remote low limit controller
- Requires 24VAC thermostat w/heat anticipator set @0.2 amps
- Includes well adapter & heat-conductive compound
- Mounts horizontally or vertically
- Max Bulb: 40° over selected setpoint up to 265°F
- Max Ambient: 150° including zone valves w/low voltage loads up to 1.2 amps



Part #	Mfg #	Description	Price
HONL8148A1017	L8148A1017	Line Voltage, 140°-240°F High Limit, 4-1/2" Capillary, Horizontal Mount	329.99
HONL8148J1009	L8148J1009	Millivolt or Low Voltage, 140°-240°F High Limit, 4-1/2" Capillary, Vertical/Horizontal Mount	369.84

Fan & Limit Controls

L4064B Combination Fan & Limit Furnace Control

- For control of high limit and fan motor in forced air heating systems
- Three wiring terminal options:
 - Female receptacles for 1/4" male flange connectors
 - Push-in receptacles for stripped wire
 - Field add-on screw terminals
- Helical bimetal sensing element, high limit set @ 200°F
- Manual fan switch
- Includes jumper



Part #	Mfg #	Description	Price
HONL4064B2210	L4064B2210	11-1/2" Insertion, Surface Mount	169.56
HONL4064B2228	L4064B2228	5" Insertion, Surface Mount	169.56
HONL4064B2236	L4064B2236	8" Insertion, Surface Mount	169.56

Pressuretrol® Pressure Controllers

PA404 Pressuretrol® Controllers

- Provides control for steam pressure
- Sensitive pressure-actuated diaphragm expands or contracts w/pressure variations moving lever mechanism operating snap-switch
- SPST snap-acting switch
- 1 to 5 psi differential

PA404A Pressuretrol® Controller

- Safety control for steam heating boilers, breaks an electrical circuit to shut down burner if steam pressure rises above safe level
- Makes at setpoint on pressure fall, breaks at setpoint plus differential on pressure rise



Part #	Mfg #	Description	Price
HONPA404A1033	PA404A1033	Pressuretrol Controller, SPST, 0.5 to 9.0 psi, 1 to 5 psi Differential	254.70

Universal Controls

Prices & Specifications are Subject to Change.

Universal Controls

Hydronic Switching Relays

R8845 Universal Hydronic Switching Relays

- Enclosed switching relay with internal 24V transformer
- (2) SPST, plus PowerPile® rated low voltage SPST relay (If normally closed contacts are needed, use RA889A)
- Replaces Honeywell models: R182A,B,C,J; R482A,B,C,J; R845; R882A,B,C,J & RA832



Part #	Mfg #	Description	Price
HONR8845U1003	R8845U1003	Intermediate Switching of Line and Low Voltage Devices from a Line or Low Voltage Controller	129.18

Hydronic Switching Relays

- Provides intermediate switching of line voltage device from low voltage controller
- Integral transformer provides low voltage power f/control circuit
- Provides DPST switching for hot water zone control systems, or SPST control of two separate loads
- Color-coded leadwire for easier wiring
- 120V, 50/60Hz



RA89



R845



RA832

Part #	Mfg #	Description	Price
HONRA89A1074	RA89A1074	SPST Enclosed 2-Wire for One-Line Voltage Load	138.79
HONRA832A1066	RA832A1066	DPST Enclosed 2-Wire for Two-Line Voltage Loads	175.23
HONR845A1030	R845A1030	DPST f/Hot Water Zone Control Systems, or SPST Control of Separate Loads, 2-Wire f/Two-Line Voltage Loads	171.07

Honeywell Accessories

Motor

Part #	Mfg #	Description	Price
HON802360JA	802360JA	24V Sealed Replacement Motor for V8043/V8044	60.70

Replacement Head for V Series Zone Valves

Part #	Mfg #	Description	Price
HON40003916048	40003916-048	24 VAC, 50/60 Hz Replacement Head with End Switch for V8043F	138.44

Well Assembly



Part #	Mfg #	Description	Price
HON121371A	121371A	3/8" x 3" Bulb Size, Copper 1/2" NPT, 1-1/2" Insulation, 3" Insertion Well with Mounting Clamp	47.99
HON121371B	121371B	3/8" x 3" Bulb Size, Copper 3/4" NPT, 1-1/2" Insulation, 3" Insertion Well with Mounting Clamp	54.65
HON121371M	121371M	3/8" x 3" Bulb Size, Copper 3/4" NPT, 3" Insulation, 3" Insertion Well with Mounting Clamp	70.95

Universal Controls

All Items May Not Be Stocked In All Branches

Universal Controls

Honeywell Parts

Part #	Mfg #	Description	Price
HON3864491	386449-1	1-1/4" Comp Fitting f/1/4"OD Pilot Tubing, 0.78" OAL	3.70
HON3921251	392125-1	25" Standard Ignition Cable f/S86/S87	47.48
HON3924511	392451-1	1/4" x 1/4" ECO Adapter for V800, Use instead of Q356A1005	45.94

Contactors

Deluxe PowerPro™ DP-Series Contactor

- Definite purpose one pole & two pole contactors provide switching for across-the-line starting of induction motors
- 1/4" Quick connects
- Multiple mounting holes and slots for convenient, interchangeable mounting with most competitive devices
- Low profile design allows for more wiring room
- Meets ARI-780 standard at started ratings (500,000 cycle mechanical life, 200,000 cycle electrical life and 10,000 cycle recycle life) - the most demanding requirements



Part #	Mfg #	Coil Ratings Voltage	Poles	Electrical Contacts Full Load	Electrical Contacts Resistive	Price
CNT40224	DP2040A5003	(a) 24V	2-Pole	40A @ 240/277VAC	55A @ 240/277VAC	49.28
CNT402240	DP2040C5001	208/240V	2-Pole	40A @ 277VAC	55A @ 277VAC	56.26

(a) #10-32 Combination head screws

PowerPro DP-Series Contactors - 3 Pole

- Definite purpose three pole contactors provide switching for across-the-line starting of induction motors
- 1/4" Quick connects & #6 screws



DP3030



DP3040



DP3050/3060

Part #	Mfg #	Coil Ratings Voltage	Poles	Electrical Contacts Full Load @ 277,480,600 VAC	Electrical Contacts Resistive @ 277,480,600 VAC	Price
CNT30324	DP3030A5003	(a) 24V	3-Pole	30A	40A	48.74
CNT303120	DP3030B5002	(a) 120V	3-Pole	30A	40A	48.74
CNT303240	DP3030C5001	(a) 208/240V	3-Pole	30A	40A	48.74
CNT40324	DP3040A5002	(d) 24V	3-Pole	40A	50A	47.90
CNT403120	DP3040B5001	(d) 120V	3-Pole	40A	50A	61.82
CNT403240	DP3040C5000	(d) 208/240V	3-Pole	40A	50A	47.90
CNT50324	DP3050A5001	(d) 24V	3-Pole	50A	63A	168.68
CNT503120	DP3050B5000	(d) 120V	3-Pole	50A	63A	168.68
CNT503240	DP3050C5009	(d) 208/240V	3-Pole	50A	63A	168.68
CNT60324	DP3060A5000	(d) 24V	3-Pole	60A	75A	188.26
CNT603120	DP3060B5009	120V	3-Pole	60A	75A	188.26
CNT603240	DP3060C5008	(d) 208/240V	3-Pole	60A	75A	188.26

(a) #10-32 Combination head screws

(d) Lug connectors

Prices & Specifications are Subject to Change.

Universal Controls

Ignition Pilot Modules

Universal Direct Spark Ignition Control for All Gases

- Designed for all gases
- Microcomputer-based
- Diagnostic indicator
- 1/4" & 3/16" Quick connect terminals
- CGA Approved
- Damper interface



Part #	Mfg #	Description	Price
WHR50D50842	50D50-842	Universal Direct Spark Control	232.06

Universal Proven Pilot Spark Control

- Gas ignition control
- Designed for all gases
- F92-0737 W/R LP Kit
- Microcomputer-based
- Field replacement for most Honeywell, Robertshaw, Johnson Controls, and Utec intermittent pilot ignition controls
- Works with single rod or dual rod remote sensor
- LED Diagnostic indicator



Part #	Mfg #	Description	Price
WHR50D50843	50D50-843	Universal Pilot Spark Control	232.06

Universal Non-Integrated Hot Surface Ignition Module

- Silicon carbide igniter
- Replaces all White-Rodgers 50E47-XXX modules
- Direct and indirect flame sense
- Six program keys, color-coded timing label, double-sided foam back tape, and mounting hardware included
- Extensive cross-reference guide



Part #	Mfg #	Description	Price
WHR50E47843	50E47-843	Universal Ignition Module	234.23

Igniters

Universal Nitride Hot Surface Upgrade Kit

- No need to replace existing module
- Replaces most silicon carbide igniters
- Super tough nitride igniter construction
- Power on LED indicator
- 12V Kits include Nitride Upgrade Furnace Label
- 3-Year warranty



Part #	Mfg #	Description	Price
WHR21D642	21D64-2	Includes Nitride Igniter w/15.5" Leads, Universal Mounting Bracket, Screw & (2) Ceramic Wire Nuts	60.96

Universal Controls

All Items May Not Be Stocked In All Branches

Universal Controls

Integrated Furnace Controls

21V51U-843 Universal Two-Stage HSI Integrated Furnace Control Kit

- Variable speed (ECM) circulator
- Replaces all 50V51-XXX and 50V61-XXX controls
- Heat/Fan/Off Delay
- Fan ON delay for cooling
- Pressure switch inputs & monitoring
- YLO, Y, W, W2, R, G, C, O, BK/DS/Dehum terminals
- Fuse protection - 3A
- Kit includes:
 - Ignition control module
 - Wiring harnesses for Amana/Goodman
 - Universal 120V nitride ignitor kit (21D64-2)



Part #	Mfg #	L/O Time	Igniter Warm-Up Time	Prepurge Time	Retries	Price
WHR21V51U843	21V51U-843	300 Sec	17 Sec	15 Sec	2	385.20

21M51U-843 Universal Two-Stage HSI Integrated Furnace Control Kit

- 3-Speed (PSC) circulator
- Replaces all 50M51-XXX and 50M61-XXX controls
- Heat/Fan/Off delay
- Fan ON delay for cooling
- Pressure switch inputs & monitoring
- YLO, Y, W1, W2, R, G, C, TWIN terminals
- Fuse protection - 3A
- Kit includes:
 - Ignition control module
 - Universal 120V nitride ignitor kit (21D64-2)
 - Installation instructions and OEM cross-reference



Part #	Mfg #	L/O Time	Igniter Warm-Up Time	Prepurge Time	Retries	Price
WHR21M51U843	21M51U-843	300 Sec	17 Sec	15 Sec	2	385.20

50A55 Universal Silicon Carbide Integrated Furnace Control

- Includes flash code diagnostics
- Replaces 50A50-XXX and 50A55-XXX controls
- Fused to protect low voltage system transformers
- Includes mounting hole template
- Adjustable blower relay



Part #	Mfg #	Prepurge	Delay Heat ON	Delay Heat OFF	Delay Cool ON	Delay Cool OFF	Price
WHR50A55843	50A55-843	30 Sec	30/45	60/90/120/180	5	45/90	223.24

Universal Controls

Prices & Specifications are Subject to Change.

Universal Controls

50M56-843 Universal Single-Stage HSI Integrated Furnace Control Kit

- Replaces virtually all single-stage carbide and nitride HSI systems
- Includes (9) quick-select/quick connect wiring harnesses, 21D64-2 Universal Nitride Igniter Kit
- 3-Fan speeds
- System diagnosis, with fault recall
- Cover label displays diagnostic table
- Red LED light-used for diagnostic flash codes
- Low voltage-fuse protection - 3A replaceable automotive type
- 7"H x 5.25"W x 1.25"D



Part #	Mfg #	Input Voltage	Operating Temp Range	Relay Load Rating	Mounting	Price
WHR50M56U843	50M56U-843	25VAC	-40° - 176°F	1.5A @ 25VAC 50/60Hz	Surface Mount Multi-Poise	257.91

50T35-743 Silicon Carbide Integrated Furnace Control

- Controls gas valve, ignitor, two-speed blower motor, inducer (both 120V & 24V input), and air cleaner
- Replaces OEM Goodman, UTEC, and TI models
- Includes flash code diagnostics
- Twinning
- Includes mounting hole template
- Fused to protect low voltage system transformers
- Adjustable blower relay



Part #	Mfg #	Prepurge	ON	Delay Heat OFF	ON	Delay Cool OFF	Price
WHR50T35743	50T35-743	15 Sec	30	90/120/150	5	60	198.81

Gas Burner Controls

36C Fast Opening Gas Valve

- Valve may be mounted in any position except upside down
- Gas cock knob, pilot adjust screw & regulator adjustment are on top of control
- Easy-grip pipe boss simplifies installation
- Use with thermocouples
- Natural gas, includes LP conversion kit & reducer bushing kit
- -333 Does not include inlet pressure tap, -433 does



Part #	Mfg #	Typical Appl	Coil Voltage	Inlet/Outlet Size	Capacity AGA Standard Gas	Side Taps	Price
WHR36C03300	36C03-300	Standing Pilot	24VAC, 60Hz	1/2" x 3/4"	230,000	No	150.74
WHR36C03333	36C03-333	Standing Pilot	24VAC, 60Hz	1/2" x 3/4"	230,000	Yes	160.11
WHR36C03433	36C03-433	Standing Pilot	24VAC, 60Hz	3/4" x 3/4"	280,000	Yes	202.73

Universal Controls

All Items May Not Be Stocked In All Branches

Universal Controls

36C Cycle Pilot Gas Valve

- Equipped with redundant pilot solenoid main gas regulator
- Integral gas pressure switch & electrical connection on the gas valve for mercury flame sensor connection
- 24VAC, 60Hz
- 1/2 Psi (14.0"wc) maximum pressure rating
- Natural gas with LP conversion kit included



Part #	Mfg #	Coil Voltage	Open	Inlet/Outlet Size	Capacity AGA Standard Gas	Side Taps	Price
WHR36C84912	36C84-412	24VAC		3/4" x 3/4"	280,000	No	450.11

36C Slow-Opening Valve

- (4) 1/4" Spade terminals, (1) 3/16" terminal adapter

Part #	Mfg #	Coil Voltage	Inlet/Outlet Size	Capacity AGA Standard Gas	Regulator Setting	Price
WHR36C94303	36C94-303	24VAC, 60Hz	1/2" x 3/4"	110,000	3.5"wc	238.17

36H Combination Gas Control Valve

- For use with intermittent ignition systems
- Electrical shut-off
- Quick-connect terminals (1/4")
- Adjustable regulator
- Natural gas, includes LP conversion kit



36H32-423

Part #	Mfg #	Coil Voltage	Inlet/Outlet Size	Capacity AGA Standard Gas	Opening Characteristic	Price
WHR36H32423	36H32-423	24VAC, 50/60Hz	3/4" x 3/4"	300,000	Fast Open	219.82
WHR36H33412	36H33-412	24VAC, 50/60Hz	3/4" x 3/4"	300,000	Slow Open	223.25
WHR36H64463	36H64-463	24VAC, 50/60Hz	3/4" x 3/4"	300,000	2-Stage Fast Open	299.98

Combination Gas Manifold Valve 3600 Series Accessory

Part #	Mfg #	Description	Price
WHRF670918	F67-0918	Use with 36 Cycle Pilot Gas Valves with Pressure Switch (Natural Gas Applications Only) Plug-In Types Only, 3098 Type Mercury Flame Sensors	28.38

Mercury Flame Sensors

Mercury Flame Sensor

- Prevents gas flow to main burner if pilot flame is not burning or is insufficient to properly ignite main burner
- Rugged snap-action switch & mercury actuated thermal element
- 125VA At 120VAC & 240VAC, 90VA at 30VAC



Part #	Mfg #	Size	Element Length	Price
WHR30465	3046-5	2-3/4"H x 2-1/16"W x 1-7/8"D	48"	261.30

Prices & Specifications are Subject to Change.

Universal Controls

Mercury Flame Sensor in Cycle Pilot Applications with Spade Terminals

- For proving pilot flame & controlling main valve in cycle pilot applications
- Bulb styles are designed to fit with various OEM applications
- Adapter fittings to allow use of these mercury flame sensors with competitive burners are packed with controls identified with an*
- Maximum temperature 1450°F at bulb tip

Part #	Mfg #	Element Length	Bulb Style	Description	Price
WHR3049115	3049-115*	48"	#20	Replaces Style #17 or #18, Adapter Ftgs Incl	252.01

Plug-In Mercury Flame Sensor in Cycle Pilot Applications

- For proving pilot flame & controlling main valve in cycle pilot applications
- Bulb styles are designed to fit with various OEM applications
- Maximum temperature 1450°F at bulb tip

Part #	Mfg #	Element Length	Bulb Style	Description	Price
WHR3098134	3098-134	48"	#19	Replaces Style #9 or #13, Adapter Ftgs Included	252.04
WHR3098156	3098-156	48"	#20	Replaces Style #17 or #18, Adapter Ftgs Included	252.04

Pilot Relite

Pilot Relite Control

- Ignition control generates spark pulses to ignite pilot gas
- AGA Design certified & CGA certified



Part #	Mfg #	Input Volts	Electric Rating	Description	Price
WHR505923	5059-23	24VAC	0.03A	Spark Plug & 1/4" Spade Connection	156.70

Refrigeration or Hydronic Temperature Control

Electronic Temperature Control for Refrigeration or Hydronic Heating



Part #	Mfg #	Temp Range	Differential	Switching	Capillary Length	Price
WHR16E09101	16E09-101	-40° - 220°F	Adj 1° - 30°F	SPDT	7-1/2'	153.88

Universal Controls

Hydronic Controls

Immersion Well

- Used where it is desired that the control operating from temperature of a liquid in a closed system
- Packing nuts permit closer control than wells because the bulb is directly immersed in the liquid

Universally Interchangeable Well

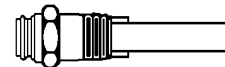

Part #	Mfg #	Type Well Used With	Bulb Size Of Control Used	Pipe Size NPT	Shank	Length	Price
WHRF890211	F89-0211	All	3-1/2" x 3/8"	1/2"	Standard	1-13/16"	47.36
WHRF890212	F89-0212	All	3-1/2" x 3/8"	1/2"	Standard Extended	3-5/16"	59.56
WHRF890213	F89-0213	All	3-1/2" x 3/8"	3/4"	Standard	1-13/16"	49.58

All Items May Not Be Stocked In All Branches

Universal Controls

Hydronic Controls (Continued)

Immersion Well

Universally Interchangeable Well

Part #	Mfg #	Type Well Used With	Bulb Size Of Control Used	Pipe Size NPT	Shank	Length	Price
WHRF890214	F89-0214	All	3-1/2" x 3/8"	3/4"	Standard Extended	3-5/16"	57.52

Zone Valves

Hydronic Zone Control

- Self aligning barrel-type valve stem uses line pressure to seal off binding on opening & closing
- Valve stem made of stainless steel
- Built-in auxiliary contacts to control burner or circulator relay



3-Wire, 24V Valve with Screw Terminal Wiring Panel & Auxiliary Switch

Part #	Mfg #	Tubing Size (ID)	24V AC Thermostat Circuit Rating	Time Cycle Open/Close	Price
WHR1311102	1311-102	3/4"	0.2A	45 Sec/45 Sec	244.94
WHR1311103	1311-103	1"	0.2A	45 Sec/45 Sec	269.48
WHR1311104	1311-104	1-1/4"	0.4A	45 Sec/45 Sec	303.39

2-Wire, 24V Valve with Screw Terminal Wiring Panel & Auxiliary Switch

Part #	Mfg #	Tubing Size (ID)	24V AC Thermostat Circuit Rating	Time Cycle Open/Close	Price
WHR1361102	1361-102	3/4"	0.2A	45 Sec/60 Sec	287.20
WHR1361103	1361-103	1"	0.2A	45 Sec/60 Sec	301.13
WHR1361104	1361-104	1-1/4"	0.2A	45 Sec/60 Sec	330.17

Zone Valve Assembly

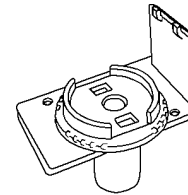

Part #	Mfg #	Description	Price
WHRF840433	F84-0433	3/4" Valve Assembly for 1311-103 & 1361-103	60.94
WHRF840434	F84-0434	1" Valve Assembly for 1311-103 & 1361-103	85.41
WHRF840435	F84-0435	1-1/4" Valve Assembly for 1311-104 & 1361-104	100.43

Universal Controls

Prices & Specifications are Subject to Change.

Contactors

Series 910 Definite Purpose Contactors

Definite Purpose Contactor

- Use on refrigeration, air conditioning & electric resistance heating systems
- Straight-through wiring to speed installation
- Small, compact design
- Universal mounting base
- UL & CSA Recognized
- ARI 780 Rated; 1,000,000 cycle mechanical life



Part #	Mfg #	Full Load Amps	Resistive Amps	Locked Rotor Amps@240	Coil Voltage	No of Poles	Dimensions H x W x D (in)	Price
CNT302120	91322	30	40	150	110/120	2	2.44" x 2.13" x 3.25"	18.80
CNT302240	91323	30	40	150	208/240	2	2.44" x 2.13" x 3.25"	15.50

Series 600 ACC Contactors

Series 600 ACC 20-40A Type C Power Contactor

- 1-Pole & 1-pole with shunt used in air conditioning industry for single phase applications
- 2-Pole contactors used where breaking both sides of the line & added safety are important
- Line & load terminations: 10-32 Phillips/slotted hex, washer head, box lug
- Quad .250 standard quick connects
- 40A Models have dual quick connects
- 25 in/lb Tightening torque
- Silver cadmium oxide contact material
- Approximate 1,000,000 mechanical life cycles
- 40A Model is standard with cover
- Permissible ambient temperature: operate +60°C/-40°C, storage +90°C/-50°C



Part #	Mfg #	AH Model	Coil Volts 50/60 Hz	Full Load Amps	No of Poles	Price
CNT25124	60005	C251U10	24	25	1	24.64

Series 600 ACC Model 93 25-40A Power Contactor

- Compact, easy to mount and wire
- Molded encapsulated coil
- Industry standard baseplate
- Specifications:
 - Quick connects: double .250 standard
 - Coil termination: 6-32 screw and single QC
 - Permissible ambient temperature: operate +60°C/-40°C, storage +90°C/-50°C
 - Contact material: silver cadmium oxide
 - Approximate mechanical life cycles: 1,000,000
 - 25, 30 and 40A Models are standard with arc covers
 - 40A Models are standard with lugs



Part #	Mfg #	AH Model 86 Molded Coil	Coil Volts	FLA 600V	No. of Poles	Price
CNT30224	60150	ACC323UMM10	24	30	2	18.22

Universal Controls

All Items May Not Be Stocked In All Branches

Contactors

75A Power Contactor

- Heavy-duty, ideal for high amperage applications in HVAC & other industries
- Uses 75 base
- Molded encapsulated coils



Part #	Mfg #	AH Model	Coil Volts 50/60Hz (1)	No. of Poles	FLA 600V	Locked Rotor Amps 240/480/600V	Price
CNT753120	60236	ACC730U20	110/120	3	75	450/375/300	409.42
CNT753240	60237	ACC730U30	208/240	3	75	450/375/300	374.88



Draft Controls

GVD Series Vent Dampers Less Harness

- Operates with all 24 VAC, 60Hz intermittent ignition and standing pilot ignition systems
- Stainless steel construction provides superior corrosion resistance
- Damper operation: power opens in 15 seconds, power closes in 15 seconds
- Keyed wiring harness connector plug installs only one way, preventing incorrect wiring connection



Part #	Mfg #	Pipe Size	Length	Height	Clearance	Exposed Pipe	Price
EFFRVGP4BK	GVD-4PL	4"	6-1/16"	8-7/8"	15/16"	4-13/16"	216.04
EFFRVGP5BK	GVD-5PL	5"	6-1/16"	9-7/8"	15/16"	4-13/16"	224.60
EFFRVGP6BK	GVD-6PL	6"	6-1/2"	10-7/8"	1-3/16"	5-1/4"	229.06
EFFRVGP7BK	GVD-7PL	7"	7-1/16"	11-7/8"	1-7/16"	5-13/16"	238.04
EFFRVGP8BK	GVD-8PL	8"	8-1/16"	12-7/8"	1-15/16"	6-13/16"	279.80

GVD Damper Motor Repair Kit

Part #	Mfg #	Description	Price
EFFCONT	GVD-RMA	Damper Motor Repair Kit	154.46

Wiring Harnesses

Part #	Mfg #	Description	Price
EFFGVDUWK	GVD-UWK	Universal Wiring Harness	91.42

Universal Controls

Prices & Specifications are Subject to Change.

Relays

Series 903 General Purpose Switching Relays

Series 903 SPST & SPDT Fan Relay

- Replaces WR/Essex/RBM Type 84 (90-290 through 90-295) quick-connect & screw terminal versions*
- Packaged with instructions & cross reference
- 2.38" x 1.63" x 1.5"
- Universal mounting bracket
- 3A Minimum contact duty recommended for best results
- 24 - 240VAC @ 50/60Hz; 5VA Maximum inrush; 3.0VA maximum sealed
- Made in USA
- 1/4" Quick-connect terminals
- UL & CSA Listed



Part #	Mfg #	WR/RBM No.*	Contacts Type	Coil Voltage	Full Load Voltage	Resistive Amps	Locked Rotor Amps	Price
MAR90290	90290	90-290/90-290Q	SPST	24				8.68
MAR90293	90293	90-293/90-293Q	SPDT	24				16.08
MAR90294	90294	90-294/90-294Q	SPDT	110/120	12	18	60	19.10
MAR90295	90295	90-295/90-295Q	SPDT	208/240	8	18	48	21.04

* For screw terminal versions, use 93029 push-on to screw-on adapters

Series 903 2-Pole Air Conditioning Relay

- Replaces Honeywell & White Rodgers/RBM - cross reference on package
- 2.13" x 1.88" x 2.25"
- Base designed for easy replacement of competitive relays
- Molded terminal numbers & circuit diagram on top of relay
- 24 - 240 VAC @ 50/60Hz; 21.5VA Maximum inrush; 9.5VA maximum sealed
- Made in USA
- Double quick-connect terminals on coil
- UL & CSA Listed



	POWER		PILOT	
	120V	208/240V	120V	208/240V
Full Load Amps	12	6	-	-
Resistive Amps*	15	15	3	3
Locked Rotor Amps	60	35	-	-
Horsepower	3/4	3/4	1/10	1/10

Part #	Mfg #	WR/RBM Model	Honeywell Model	Coil Voltage	Terminals 1-2-3	Terminals 1-2-3	Price
MAR90340	90340	90-340	R8222D1014	24	Power	Power	16.32
MAR90341	90341	90-341	R4222D1013	110/120	Power	Power	16.72
MAR90342	90342	90-342	R4222D1021	208/240	Power	Power	16.72

Universal Controls

All Items May Not Be Stocked In All Branches

Relays

Series 190 GE Potential Relays

one-on-one™ Direct Replacement Potential Relay

- Exact replacements for Bristol & Copeland applications



Part #	Mfg #	Description	Price
MAR16085	16085	3ARR3KC24E5, Copeland 040-0001-04	54.10
MAR16086	16086	Copeland 040-0001-60, 040-0001-61	58.78
MAR16088	16088	3ARR3KC4D5, Copeland 040-0001-08	68.72
MAR16093	16093	Copeland G3ARR3 Relay# CT7M5	54.54

Series 190 Potential Relays

Series 190 Universal Replacement Relay

- Wide calibration ranges & a universal break-off bracket
- Non-positional
- QC-6 Kit included to convert screw-on to push-on
- Instructions & wiring diagram include in each relay
- 19001 (6) Pack includes: 6 most popular relays & cross reference guide
- UL & CSA Listed



Part #	Mfg #	Model	Continuous Coil Voltage	Pick-Up Range Min - Max	Drop-Out Max	Price
MAR19002	19002	MARS 63	170	139 - 153	55	68.64
MAR19003	19003	MARS 64	395	260 - 275	120	78.68
MAR19004	19004	MARS 65	332	168 - 182	90	72.14
MAR19005	19005	MARS 66	395	215 - 225	120	80.20
MAR19006	19006	MARS 67	420	295 - 315	125	81.66
MAR19007	19007	MARS 68	502	325 - 345	135	83.70
MAR19008	19008	MARS 69	336	180 - 195	105	75.76

Series 503 Transformers

Series 503 Heavy Duty Control Transformer NEMA Class II

- 50/60Hz
- Low heat rise
- Made in USA
- UL 1585 Recognized



Part #	Mfg #	VA Rating	Primary Voltage	Secondary Voltage	Secondary Connections	Mount	Price
MAR50320	50320	75	120/208/240/480	24	Color Coded Leads	End Bell	115.94

Universal Controls

Prices & Specifications are Subject to Change.

Relays

Series 503 Manual Reset Control Transformer NEMA Class II

- Provides power source for control circuit for air conditioning, heating, or refrigeration systems
- Low heat rise
- Made in USA
- UL 1585 Recognized



Part #	Mfg #	VA Rating	Primary Voltage	Secondary Voltage	Primary Hz	Secondary Connections	Mount	Price
MAR50321	50321	75	120/208/240/480	24	50/60	Color Coded Leads	Foot-Mount End Bell	91.82

Pilot Ignition

41 Series Hot Surface Ignitors

- Delivers dependable ignition in heating systems of every description
- Engineered for easy handling, simple installation & trouble free operation

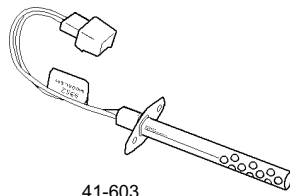

41-603

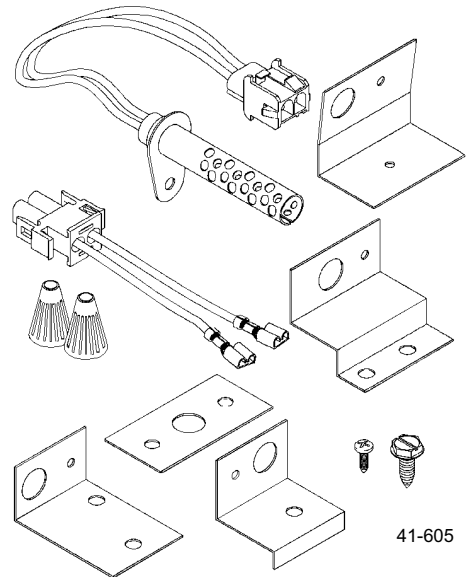

41-605

Series 41-600

Part #	Mfg #	Factory Model	Housing Length	Comments	Price
ROW41603	41-603	601XBM	2.5"	York #025-33421-000	50.86
ROW41605	41-605	601XBM +Harness & Brackets	2.5"	York Replacement Conversion Kit #473-20937-001	55.42

Universal Controls

Ignition Controls

Starlite® Hot Surface Igniters

- Manufactured of high purity, self-bonded silicon carbide
- With wire nuts



Part #	Mfg #	Description	Price
ISI1121	11120-100-1121	5-1/2" Leads HSI, Fit Goodman/Modine	35.00
ISI1401	11120-100-1401	4-1/2" Leads, Block Style A, Repl f/41-401	35.00
ISI1402	11120-100-1402	19" Leads, Block Style B, Repl f/41-402	35.00
ISI1403	11120-100-1403	5-1/2" Leads, Block Style C, Repl f/41-403	35.00
ISI1405	11120-100-1405	5-1/2" Leads, Block Style D, Repl f/41-405	35.00
ISI1406	11120-100-1406	10-1/2" Leads, Block Style E, Repl f/41-406	35.00
ISI1407	11120-100-1407	4-1/2" Leads, Block Style C, B Term Type	35.00
ISI1408	11120-100-1408	4-1/2" Leads, Block Style C, Repl f/41-408	35.00
ISI1409	11120-100-1409	4-1/2" Leads, Block Style C, D Term Type	35.00
ISI1410	11120-100-1410	4-1/2" Leads, Block Style B, B Term Type	35.00
ISI1411	11120-100-1411	4-1/2" Leads, Block Style B, C Term Type	37.00
ISI1412	11120-100-1412	5-1/2" Leads, Block Style F, D Term Type	34.00
ISI1061	11120-400-1061	19" Leads, Repl Igniter Assembly f/Coleman	39.00
ISI1090	11120-400-1090	Repl Igniter f/Flat & Spiral Igniters	36.00



Relays

RCO Series 3 N' 1 Start Relays

- Replaces relay, overload & provides a boost for hard start and unbalanced systems
- Prevents low voltage starting problems
- Select the right match to replace refrigerator compressor relay and overload units from 1/12 through 1/3 hp
- 115-230VAC
- For all capillary systems



Part #	Mfg #	Description	Price
SUORCO810	RCO-810	1/12 through 1/5 hp, 115V	18.06
SUORCO410	RCO-410	1/4 & 1/3 hp, 115V	18.06
SUORCO210	RCO-210	1/2 hp, 115/230VAC	28.10

URSC10 Ultimate Relay Start Capacitor

- Replaces current-type relays
- Provides a boost for hard start and unbalanced systems
- No additional wires required



Part #	Mfg #	Description	Price
SUORSC10	URSC10	1/20 hp to 1/2 hp, 120V	24.72

Universal Controls

Prices & Specifications are Subject to Change.



www.irrsupply.com



Universal Controls

SUPR Universal Potential Relays

- Replaces all OEM potential relays
- Use on any single phase motor or air conditioning and refrigeration compressor up to 5 hp
- Replaces both 5-terminal & 3-terminal potential relays
- Can recycle immediately
- Time function relay, 1.0-0.5 second start time



Part #	Mfg #	Description	Price
SUOSUPR	SUPR	Universal Potential Relay	35.96

APR5 Adjustable Potential Relays

- Replaces both 5-terminal & 3-terminal potential relays
- Can recycle immediately



Part #	Mfg #	Description	Price
SUOAPR5	APR5	Up to 5 hp 110/270V	43.80

Freeze Protection Control

- Includes clip to fit 7/8"OD tubing



Part #	Mfg #	Description	Price
SUOSFPC	SFPC	Opens 35°F/Closes 50°F	39.84



Run Capacitors

Turbo™ 200 Run Capacitors

- Multi-MFD Universal
- Permanent universal replacement capacitor
- Voltage rating 370 or 440 VAC



Turbo 200



Turbo 200 Mini

Part #	Mfg #	Description	Price
CAPTURBO200	TURBO200	Single or Dual Value Range 2.5 mfd to 67.5 mfd	96.00
CAPTURBO200MINI	TURBO200MINI	Single Value Range 2.5 mfd to 12.5 mfd	29.40
CAPTURBO200X	TURBO200X	Single or Dual Value Range 70 mfd to 97.5 mfd	135.00

Universal Controls

All Items May Not Be Stocked In All Branches



www.irrsupply.com

Universal Controls

Relays

Enclosed Power Relay

- Packaged to save installer time, trouble and expense of buying separate components (relay, LED indicator, socket, mounting rail, transient protection, and housing)
- UL Listed, C-UL Canada



RIB2401SB



RIB24P

Part #	Mfg #	Volts	Switch	Amps	HP	Price
RIB2401SB	RIB2401SB	24VAC/VDC	SPST	20A	2	49.18
RIB24P	RIB24P	24VAC/VDC	DPDT	20A	3	66.60

10 Amp Enclosed Pilot Relay

- Packaged to save installer time, trouble & expense of buying separate components (relay, LED indicator, socket, mounting rail, transient protection, and housing)
- 10A Resistive
- UL Listed, C-UL Canada



Part #	Mfg #	AC/DC	AC	Relays	Contacts	Motor	Price
RIBU1C	RIBU1C	10 - 30 AC/DC	120 AC	1	SPDT	1/3 hp	29.30



Motor Protection Controls

Programmable Three-Phase Line Voltage Monitor

- Fully programmable with LCD diagnostic display
- 25-Fault memory storage, non-volatile
- 190-630VAC Universal voltage operation
- Identifies front and back side faults
- Protects against voltage unbalance, high/low voltage, phase loss, phase reversal, faulty power, incorrect sequencing and rapid short cycling
- 18-240VAC Control, 50/60Hz
- SPDT, NO - 10A, NC - 6A
- 1 - 5 Minute delay on break timer



Part #	Mfg #	Description	Price
ICM450C	ICM450C	190-600VAC, Clamshell Pkg	277.70

Gas Appliance Pressure Regulators

Natural Gas Pressure Regulator

- High strength aluminum castings
- May be installed in any position



Part #	Mfg #	Pipe Size	Capacity BTUs	Price
MAXRV43A12	R48N32-0306-3.5	1/2"	230,000	39.94
MAXRV43A34	R48N42-0306-3.5	3/4"	250,000	30.94

Prices & Specifications are Subject to Change.

Universal Controls

Central Processing Unit Reset Controls

CPU-0500 Stand-Alone Indoor/Outdoor Reset Control

- Use with boilers, solar applications and geothermal installations
- Can run up to two on/off boilers or a single modulating boiler, as well as incorporating onboard DHW
- Mixing types include modulating mixing, PMLp and floating action
- Setpoint mode allow for dual or differential setpoints
- In geothermal installations, manages applications using heat pumps and compressors
- For solar, has simple differential control with dump feature
- Single dial, multi-color backlit display
- 120 VAC Power inputs
- Low temperature and high temperature demands
- Two programmable reset curves
- Runs reversing valve and a hot or cold tank



Part #	Mfg #	Description	Price
HBXCPU0500	CPU-0500	Multi Function Boiler/HP/Pump Control	652.32

CPU-1000 Fully Integrated Reset Control

- Based on indoor/outdoor reset control technology
- Onboard applications include staging, mixing, DHW, dual system or dual mixing control
- Supports 1-14 boiler stages (with addition of expansion modules)
- Built in pump sequencer
- Color coded and keyed terminals
- Warm weather shutdown (WWSD)
- Built-in setpoints, arc suppression & DHW capabilities
- Onboard graphing



Part #	Mfg #	Description	Price
HBXCPU1000	CPU1000	Modular Control System	1730.60

Microprocessor Based Thermostats

THM-0100 Non-Programmable Thermostat

- Serves as a single setpoint control
- User friendly temperature adjustments
- Room, floor, or dual sensing modes



Part #	Mfg #	Description	Price
HBXTHM0100	THM-0100	Single-Stage Setpoint Control	232.64

THM-0200 Programmable Thermostat

- Serves as a single boiler control
- 5-Weekday and 2-weekend programmable
- User friendly temperature adjustments
- Heating mode, cooling mode, as well as 2-stage heating or cooling modes
- Continuous fan option



Part #	Mfg #	Description	Price
HBXTHM0200	THM-0200	Boiler Reset Control or 2-Stage Temp Control	343.96

OUT-0100 Indoor/Outdoor Sensor

- Serves as a single boiler control
- 10K Ohm thermistor
- Bottom and rear 20mm knockouts



Part #	Mfg #	Description	Price
HBXOUT0100	OUT-0100	For THM-0200	48.80

Universal Controls

Adjustable Angle Industrial Thermometers

- Universally adjustable, liquid-in-glass
- Cast aluminum with dark blue epoxy powder coating
- Clear acrylic window through 300°F & double strength glass above 300°F
- White background with black figures & markings
- Accuracy +/- one scale division



Part #	Mfg #	Scale Size	Stem Material	Stem Length	Range	Price
TREBX90-100	BX9140302	9"	Aluminum	3-1/2"	0° to 100°F	52.80
TREBX930-240	BX9140307	9"	Aluminum	3-1/2"	30° to 240°F	52.80
TREBX930-300	BX9140308	9"	Aluminum	3-1/2"	30° to 300°F	52.80

Thermowells

Industrial Thermowell

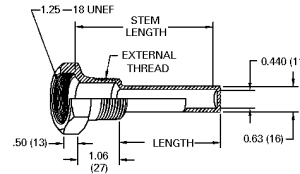

Part #	Mfg #	Description	Price
TREBX9WELL	3-4F2	3-1/2" Stem x 3/4" NPT OD Brass Well for BX & Others	8.20

Hydro-Therm Industrial Thermometers

- For both hot and chilled water hydronic applications
- Blue organic "spirit" fill
- Valox case
- 5-1/2" Case
- 1/2" NPT Brass thermowell included



Part #	Mfg #	Type	Stem Material	Stem Length	Range	Price
TREHT30	HT3047	Straight	Brass	2"	30° to 240°F	25.63
TREHT31	HT3147	90° Angle	Brass	2"	30° to 240°F	25.63

Econo-Met Commercial & Residential Thermometers

- For measuring hot water in hydronic systems
- 2-1/2" Diameter dial, 2" brass stem
- Bimetallic coil
- Glass, hermetically sealed window
- Drawn steel, black finished, stem-mounted flangeless case



Part #	Mfg #	Description	Range	Price
TREPEB13027	PEB13027	Economy Bimetal with 1/2" NPT Brass Thermowell	0° to 250°F	16.78

Flame Sensor



Part #	Mfg #	Description	Price
ROW10760	10-760	Flame Sensor	33.94

Universal Controls

Prices & Specifications are Subject to Change.

Gauges

Pressure Gauges

Contractor Gauge 620B

- 4-1/2" Dial, 1/4" NPT lower male connection
- 304 Stainless steel, stem-mounted flangeless case
- Acrylic window, white dial with black figures & graduations
- Brass movement, tube & socket; recalibrator screw



Part #	Mfg #	Dial Size	Connection Size & Location	Unit of Measure	Range	Price
TRE620B30-0	620B4502LA010	4-1/2"	1/4" NPT Lower	PSI	30"Hg - 0	22.05
TRE620B0-15	620B4502LA080	4-1/2"	1/4" NPT Lower	PSI	0 - 15	22.05
TRE620B0-30	620B4502LA090	4-1/2"	1/4" NPT Lower	PSI	0 - 30	22.05
TRE620B0-60	620B4502LA100	4-1/2"	1/4" NPT Lower	PSI	0 - 60	22.05
TRE620B0-100	620B4502LA110	4-1/2"	1/4" NPT Lower	PSI	0 - 100	22.05
TRE620B0-160	620B4502LA120	4-1/2"	1/4" NPT Lower	PSI	0 - 160	22.05
TRE620B0-200	620B4502LA130	4-1/2"	1/4" NPT Lower	PSI	0 - 200	22.05

Utility Dry Gauge 800B

- Drawn steel, black finish, stem mounted flangeless
- Acrylic window, aluminum dial with white background & black markings
- Brass socket and movement
- Bronze tube



Part #	Mfg #	Dial Size	Connection Size & Location	Unit of Measure	Range	Price
TRE620B30-30	800B4002BA030	4"	1/4" NPT Center Back	PSI	30"Hg - 30	22.05

Low Pressure Gauge 760B

- Drawn black-finished steel, stem-mounted flangeless case
- Polycarbonate, snap-in window; white dial with black figures & graduations
- Brass movement and socket; 316L stainless steel diaphragm capsule



Part #	Mfg #	Dial Size	Connection Size & Location	Unit of Measure	Range	Price
TRE760B0-30	760B2502LT660	2-1/2"	1/4" NPT Lower	Pressure	0/30" H2O	47.68
TRE760B0-100	760B2502LT680	2-1/2"	1/4" NPT Lower	Pressure	0/100" H2O	47.68

Plumbing Pressure Gauge

- Measures pressure in heating, air conditioning, pneumatic, plumbing or processes where general pressure indication is required
- Steel case and ring
- Bronze tube and brass socket



Part #	Mfg #	Dial Size	Connection Size & Location	Unit of Measure	Range	Price
TREPPG0-30	PPG10211	2-1/2"	1/4" NPT Lower	PSI	0 - 30	6.00
TREPPG0-60	PPG10212	2-1/2"	1/4" NPT Lower	PSI	0 - 60	6.00
TREPPG0-100	PPG10213	2-1/2"	1/4" NPT Lower	PSI	0 - 100	6.00
TREPPG0-200	PPG10216	2-1/2"	1/4" NPT Lower	PSI	0 - 200	6.00
TREPPG4-0-100	PPG10413	4"	1/4" NPT Lower	PSI	0 - 100	12.60

OEM Controls

OEM Controls

Overload Kit

Part #	Mfg #	Description	Price
TECK9010	K90-10	Overload Kit	21.46
TECK9011	K90-11	Overload Kit	23.60
TECK9012	K90-12	Overload Kit	21.46
TECK9016	K90-16	Overload Kit	21.46
TECK9019	K90-19	Overload Kit	22.08
TECK9020	K90-20	Overload Kit	21.46
TECK9021	K90-21	Overload Kit	23.60
TECK9022	K90-22	Overload Kit	23.60
TECK9027	K90-27	Overload Kit	21.46
TECK9034	K90-34	Overload Kit	47.42
TECK9035	K90-35	Overload Kit	47.42

OEM Controls

ESP Compressor Relay

Part #	Mfg #	Description	Price
TEC14946608	14946608	Compressor Relay	21.06

ESP Relay Kit

Part #	Mfg #	Description	Price
TECK7101	K71-01	Start Relay Kit	25.78
TECK7102	K71-02	Start Relay Kit	25.78
TECK7109	K71-09	Start Relay Kit	25.78
TECK7110	K71-10	Start Relay Kit	25.78
TECK7116	K71-16	Start Relay Kit	56.84
TECK7117	K71-17	Start Relay Kit	56.84
TECK7119	K71-19	Start Relay Kit	56.84
TECK7120	K71-20	Start Relay Kit	56.84
TECK7121	K71-21	Start Relay Kit	56.84

Check our website for special promotions!
www.irrsupply.com

Oil Controls

Ignition Transformers

- Designed with high temperature wire
- Runs cooler, quieter and safer on all types of burners
- Designed to burner manufacturers' specifications
- Meets American and European noise emission standards offering superior EMI and RFI protection
- Single porcelain designs
- Dependable power

Small Can Production Ignition Transformer

- 120V Primary 60Hz, 10,000V secondary 23mA
- Mid point grounded



2721-457



2721-605

Part #	Mfg #	Replaces	Price
ALL2721411	2721-411	ABC Sunray	93.70
ALL2721457	2721-457	Acme Weatherall	93.70
ALL2721631A	2721-631A	ABC Sunray	93.70
ALL2721605	2721-605	Beckett	93.70
ALL2721628G	2721-628G	Beckett A, AF, AFG	93.70
ALL2721630	2721-630	Carlin 99, 100, 101 CRD Miser	93.70
ALL2721619	2721-619	Wayne Hi Speed Model M/MH	93.70
ALL2721620	2721-620	Wayne E	93.70
ALL2721647	2721-647	Wayne Blue Angel Eagle One	93.70

Service Transformer

- UL Listed
- 120V Primary 10,000V secondary MPG
- Mid point grounded
- Adaptable to 97% of burners serviced
- Contains 3 sets of fixed terminals
- Hardware fittings and universal plate included



Part #	Mfg #	Description	Price
ALL421BT636	421-BT636	Universal 6-Way	131.40

Industrial Gas Replacement Igniter Transformer

- 120V, 50/60Hz, 15.6 kVpk volt secondary, 28mA
- 1-End ground
- Easy conversion
- No clumsy connections
- Constant duty
- Energy efficient draws only 1/2 an amp
- Meets or exceeds requirements for EMI/RFI conditions
- Quick and easy to install



Part #	Mfg #	Replaces	Price
ALL2260P	2260P	Center 2-Way Mounting, Primary Wire Plug Set w/Pigtails	110.38

Oil Controls & Accessories



Better Service Thru Better People



Oil Controls

Oil Burner Controls

120VAC Electronic Igniter with Base Plate

- Includes:
 - Terminals
 - Gaskets
 - Mounting hardware



Part #	Mfg #	Description	Price
BEC51771U	51771U	Igniter with Beckett "A"/NX Base	63.87
BEC51805U	51805U	AFII Igniter with Base Plate	76.67
BEC51824U	51824U	Igniter with Beckett "S" Based	71.87
BEC51825U	51825U	Igniter with Wayne "M" Based	76.67
BEC51826U	51826U	Igniter with Carlin 100 Base	71.87
BEC51836U	51836U	Igniter for Wayne HS Less Base	71.87
BEC51838U	51838U	Igniter for Beckett Less Base	61.87

GeniSys™ Advanced Burner Control

- Thermostat and boiler control compatible
- Programmable valve-on delay and motor-off delay
- (3) Indicator lights for system monitoring and diagnostics
- (2) Communication ports for adding alarm contacts, programming display and/or future wireless communications
- Welded relay protection with redundant motor relays
- Limit reset and limited recycle
- Cad cell resistance indicator
- 15 Second lockout time
- 5-Year warranty



Part #	Mfg #	Description	Price
BEC7505D152MU	7505D152MU	w/Programmable Display	185.00

GeniSys™ Programming & Diagnostics Tool

- Snap-on tool that indicates cad cell resistance and operational status
- Sealed pushbutton keypad
- Backlit alphanumeric display
- Customize pre-time and post-time settings
- Real-time cycle monitoring
- 5-Year warranty



Part #	Mfg #	Description	Price
BEC52082U	52082U	GeniSys™ Tool	121.22

Oil Controls & Accessories

Oil Controls

Flame Sensors

C554 Cadmium Sulfide Flame Detector

- Photoconductive flame sensing device f/sequencing oil burner systems



Part #	Mfg #	Description	Price
HONC554A1463	C554A1463	60" Lead, A/B/E/J/P Type & Oil Line Mounting Bracket Included	35.16

Replacement Cad Cell

Part #	Mfg #	Description	Price
HON120320	120320	Replacement Cad Cell for C554	33.85
HON130367	130367	Plug-In Cad Cell	33.87

Oil Primary Controls

R7184 Interrupted Electronic Oil Burner Control

- Interrupted electronic oil primary with status indicator light manual reset, 10 sec ignition carryover
- 10" Lead length
- R7184U Models have selectable valve and blower delays



Part #	Mfg #	Description	Price
HONR7184U1004	R7184U1004	15 Second Safety Switch Timing, Main Burner Junction Box Mounting	156.06

R8184G Protectorelay® Oil Burner Control

- Provides automatic, non-recycling control of an intermittent ignition oil burner system
- Low volt terminals, line volt leadwire connections & screw
- Intermittent ignition, safety switch
- 120V 60 Cycle or 110V 50 cycle
- Mount on 4" x 4" junction box or direct mount on burner housing
- With LED for lockout indication & manual trip lever on safety switch to assure burner shutdown during servicing
- C554 Cadmium Sulfide Flame Detector and 24VAC thermostat required



Part #	Mfg #	Description	Price
HONR8184G4009	R8184G4009	45 Second Safety Switch	159.77

RA117 Protectorelay® Controls

- One-piece, stack-mounted oil burner primary controls cycle burner on & shut down burner on flame loss or system malfunction
- 2- or 3-Wire, includes manual trip safety switch lever
- Use with line voltage or 24VAC control circuit
- RA116 - Safety switch heater energizes on flame or power failure lockout occurs if flame is not re-established by end of safety switch timing
- RA117 - Flame or power failure is followed by a 1 min scavenging period, then one attempt to re-establish flame, lockout occurs if not re-established



Part #	Mfg #	Description	Price
HONRA117A1047	RA117A1047	550VA, Interrupted Ignition Protectorelay	361.84

All Items May Not Be Stocked In All Branches

Oil Controls

Beckett Burners

Part #	Mfg #	Description	Price
BRWCF32BURNER	228-44392-01	w/Dual Aquastat for CF-32-6	1008.52
BRWRF30BURNER	228-44392-07	w/Dual Aquastat for RF-30-6 and RF-30SX-6	1257.08
BRWCF50-70BURNER	288-44392-03	for CF50/CF70	1008.52

Delavan

Oil Burner Nozzles - Type A Red Vial

- Hollow cone
- Creates stable flame at low flows



60° Angle Oil Burner Nozzles - Type A

Part #	Mfg #	GPH	Price
OINA4060	0004060A	.40	6.75
OINA5060	0005060A	.50	5.95
OINA6060	0006060A	.60	5.95
OINA6560	0006560A	.65	5.95
OINA7560	0007560A	.75	5.95
OINA8560	0008560A	.85	5.95
OINA10060	0010060A	1.00	5.95
OINA12060	0012060A	1.20	5.95
OINA12560	0012560A	1.25	5.95
OINA15060	0015060A	1.50	5.95
OINA20060	0020060A	2.00	5.95

70° Angle Oil Burner Nozzles - Type A

Part #	Mfg #	GPH	Price
OINA5070	0005070A	.50	5.95
OINA6070	0006070A	.60	5.95
OINA6570	0006570A	.65	5.95
OINA7570	0007570A	.75	5.95
OINA8570	0008570A	.85	5.95
OINA10070	0010070A	1.00	5.95
OINA11070	0011070A	1.10	5.95
OINA12570	0012570A	1.25	5.95
OINA13570	0013570A	1.35	5.95
OINA15070	0015070A	1.50	5.95
OINA20070	0020070A	2.00	5.95

80° Angle Oil Burner Nozzles - Type A

Part #	Mfg #	GPH	Price
OINA5080	0005080A	.50	5.95

Oil Burner Nozzles - Type A Red Vial (Continued)

80° Angle Oil Burner Nozzles - Type A

Part #	Mfg #	GPH	Price
OINA6080	0006080A	.60	5.95
OINA6580	0006580A	.65	5.95
OINA7580	0007580A	.75	5.95
OINA8580	0008580A	.85	5.95
OINA10080	0010080A	1.00	5.95
OINA11080	0011080A	1.10	5.95
OINA12080	0012080A	1.20	5.95
OINA12580	0012580A	1.25	5.95
OINA13580	0013580A	1.35	5.95
OINA15080	0015080A	1.50	5.95
OINA17580	0017580A	1.75	5.95

90° Angle Oil Burner Nozzles - Type A

Part #	Mfg #	GPH	Price
OINA5090	0005090A	.50	5.95
OINA6090	0006090A	.60	5.95
OINA7590	0007590A	.75	5.95

Oil Burner Nozzles - Type B Blue Vial

- Solid cone
- For larger burners & where air pattern is heavy in the center or for long fires



45° Angle Oil Burner Nozzles - Type B

Part #	Mfg #	GPH	Price
OINB7545	0007545B	.75	5.95
OINB8545	0008545B	.85	5.95
OINB22545	0022545B	2.25	5.95

60° Angle Oil Burner Nozzles - Type B

Part #	Mfg #	GPH	Price
OINB6060	0006060B	.60	5.95
OINB6560	0006560B	.65	5.95
OINB7560	0007560B	.75	5.95
OINB8560	0008560B	.85	5.95
OINB10060	0010060B	1.00	5.90
OINB11060	0011060B	1.10	5.95
OINB12560	0012560B	1.25	5.95
OINB15060	0015060B	1.50	5.95
OINB17560	0017560B	1.75	5.95
OINB20060	0020060B	2.00	5.95

Oil Controls & Accessories

Prices & Specifications are Subject to Change.

Oil Accessories

**Oil Burner Nozzles - Type B Blue Vial
(Continued)**

60° Angle Oil Burner Nozzles - Type B

Part #	Mfg #	GPH	Price
OINB22560	0022560B	2.25	5.95
OINB25060	0025060B	2.50	5.95

70° Angle Oil Burner Nozzles - Type B

Part #	Mfg #	GPH	Price
OINB5070	0005070B	.50	5.95
OINB6070	0006070B	.60	5.95
OINB6570	0006570B	.65	5.95
OINB7570	0007570B	.75	5.95
OINB8570	0008570B	.85	5.95
OINB10070	0010070B	1.00	8.28
OINB11070	0011070B	1.10	5.95
OINB12570	0012570B	1.25	5.95
OINB13570	0013570B	1.35	5.95
OINB15070	0015070B	1.50	5.95
OINB17570	0017570B	1.75	5.95
OINB20070	0020070B	2.00	5.95

80° Angle Oil Burner Nozzles - Type B

Part #	Mfg #	GPH	Price
OINB5080	0005080B	.50	5.95
OINB6080	0006080B	.60	5.95
OINB6580	0006580B	.65	5.95
OINB7580	0007580B	.75	5.95
OINB8580	0008580B	.85	5.95
OINB10080	0010080B	1.00	5.95
OINB11080	0011080B	1.10	5.95
OINB12080	0012080B	1.20	5.95
OINB12580	0012580B	1.25	5.95
OINB13580	0013580B	1.35	5.95
OINB15080	0015080B	1.50	5.95
OINB17580	0017580B	1.75	5.95
OINB20080	0020080B	2.00	5.95
OINB27580	0027580B	2.75	5.95

90° Angle Oil Burner Nozzles - Type B

Part #	Mfg #	GPH	Price
OINB6090	0006090B	.60	5.96

Oil Burner Nozzles - Type W Green Vial

- Neither truly hollow nor solid
- Can be used in place of Type A or B Types in reducing specific problems



60° Angle Oil Burner Nozzles - Type W

Part #	Mfg #	GPH	Price
OINW4060	0004060W	.40	6.95
OINW5060	0005060W	.50	6.05
OINW6060	0006060W	.60	6.05
OINW6560	0006560W	.65	6.05
OINW7560	0007560W	.75	6.05

70° Angle Oil Burner Nozzles - Type W

Part #	Mfg #	GPH	Price
OINW6070	0006070W	.60	6.05
OINW6570	0006570W	.65	6.05
OINW7570	0007570W	.75	6.05
OINW8570	0008570W	.85	6.05
OINW10070	0010070W	1.00	6.05

80° Angle Oil Burner Nozzles - Type W

Part #	Mfg #	GPH	Price
OINW6580	0006580W	.65	6.05
OINW7580	0007580W	.75	6.05
OINW8580	0008580W	.85	6.05
OINW10080	0010080W	1.00	6.05
OINW12580	0012580W	1.25	6.05
OINW13580	0013580W	1.35	6.05

90° Angle Oil Burner Nozzles - Type W

Part #	Mfg #	GPH	Price
OINW5590	0005590W	.55	6.05

Oil Nozzle Accessories

Nozzle Boxes



Part #	Mfg #	Description	Price
OINBOX110	268464	110 Nozzles, 5" x 3-5/8" x 11-15/16"	116.52

All Items May Not Be Stocked In All Branches

Oil Accessories

Oil Burners**AFG Series Oil Burner**

- Air turbo injector and high efficiency blower wheel for high static pressure firing under most draft conditions
- Capacities from 0.40 to 3.00 gph
- Chassis: 11-1/2"H x 12-7/8"W x 6-9/16"D



Part #	Mfg #	Description	Price
BECAFG	AFG	56,000 - 420,000 BTUH	693.20

Air Tubes**Air Tube for AF Models**

Part #	Mfg #	Firing Rate Min - Max GPH	Usable Air Tube Length	Burner Head	Price
BECAF30	AF30	Air Tube Combination			59.87
BECAF44	AF44	Less Head	4-1/2"	Less	59.87
BECAF53	AF53	Less Head	5-3/8"	Less	59.87
BECAF65	AF65	Less Head	6-5/8"	Less	59.87
BECAF72	AF72	Less Head	7-1/4"	Less	59.87
BECAF90	AF90	Less Head	9"	Less	59.87
BECAF104	AF104	Less Head	10-1/2"	Less	71.87

Oil Controls & Accessories
Oil Burner Accessories**AFII Parts**

Part #	Mfg #	Description	Price
BEC21444U	21444U	Motor 1/7 hp, 3,450 rpm, 115V/60Hz PSC	140.38

Base Plate

Part #	Mfg #	Description	Price
BEC51829U	51829U	Wayne M	21.20
BEC51830U	51830U	Beckett A	13.87
BEC51832U	51832U	Carlin 100	21.20
BEC51833U	51833U	Wayne E	21.20

Prices & Specifications are Subject to Change.

Oil Accessories

Burner Motor



Part #	Mfg #	Description	Price
BEC21805U	21805U	1/7 hp 3,450 rpm 120V PSC for Beckett AF/G, NX, All "M" Flange	100.64

Electrode Insulator Assembly Kit for F Head Type

- Universal glazed
- Kit includes:
 - Basic electrode insulator assemblies
 - Extension rods
 - Hex head nuts
 - Connectors
 - Convenient T-gauge for precise adjustment



Part #	Mfg #	Use with:	Price
BECELEASS	5780	AF, AFG, AR, SF, SR; Up to 9" Air Tube Length	16.67

Flame Retention Head

- For all models except AF II

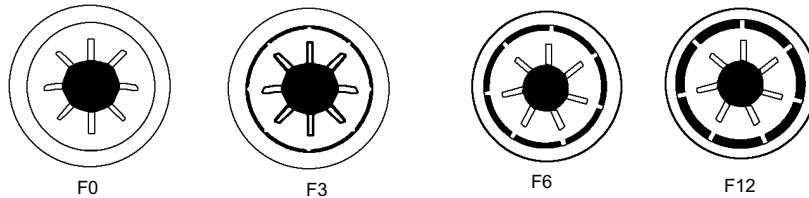

Part #	Mfg #	Description	Price
BECF0	F0	0.40 - 0.75 gph	9.84
BECF3	F3	0.75 - 1.25 gph	9.84
BECF4	F4	0.85 - 1.35 gph	9.84
BECF6	F6	0.85 - 1.65 gph	9.84
BECF12	F12	1.10 - 2.00 gph	9.84

Mounting Flange - Adjustable

- Kit includes a flange mounting gasket



Part #	Mfg #	Description	Price
BECADJFLG	5432	Adjustable Mounting Flange	9.90
BECFLGGKT	3616	Universal Gasket	3.00

Primary Control

Part #	Mfg #	Description	Price
BEC7456U	7456U	Primary Control, Valve-On Delay	114.53

All Items May Not Be Stocked In All Branches

Oil Accessories

Solenoid Valve Kit

- Kit includes:
 - Valve
 - Necessary hardware
 - Instructions for upgrading to valve operation

Part #	Mfg #	Description	Price
BEC2182602U	2182602U	Becket EV8FFNFB 120VAC 355 psi Delay	80.06

CleanCut Pumps

- Integrated solenoid valve for cleaner, more reliable cut-offs and cut-ons
- Includes Beckett Precision Delay Timer cordset for use on burners without a pre-purge type control
- For use with #2 and lighter fuel oils
- Rated speed: 3,600 rpm
- Nozzle pressure: 100 to 200 psi
- Inlet/return pressure: 10 psi maximum
- Delivers up to 4 gph at 100 psi (note applications above 3 gph will require an additional valve due to UL requirements)
- UL & CUL Certified



Part #	Mfg #	Description	Price
BEC2184404U	2184404U	120VAC 1-Stage	106.53

Replacement Parts

Part #	Mfg #	Description	Price
BEC21755U	21755U	115V Valve Coil Kit	13.87

**We are continually adding new products.
Please call us with your inquires.**



www.irrsupply.com

Oil Accessories

Vent Caps

- Available in threaded and slip-on designs
- Rust-resistant zinc-plated cast iron, as-well-as rust-proof aluminum and zinc castings
- Available sizes from 3/4" to 4"
- Includes a screen

Slip-On Vent Cap

- Zinc-plated steel with screen
- Lightweight and economical



Part #	Mfg #	Size	Price
OILVC114SO	4037	1-1/4"	3.72

Oil Vent Cap

- Designed to be installed on a threaded/unthreaded iron pipe
- Securely held in place with one simple screw
- Plated to prevent corrosion



Part #	Mfg #	Description	Price
OILV25S	V-25-S	1-1/2" with Screen	7.00

Water-Finding Paste

- Daub on measuring stick turns vivid red in contact with water



Part #	Mfg #	Description	Price
OILWFP	4000	2-1/2 oz Jar	10.54



SpeedFILL™ Fill Pipe Nozzle Connectors

- Zinc castings
- 100% Interchangeable with industry standard oil fill-pipe nozzle adapters
- Part number on each casting



SpeedFILL™ 45° Connector



Part #	Mfg #	Description	Price
SCU04328	3420	2" Female	11.63

SpeedFILL™ Straight Connector



Part #	Mfg #	Description	Price
SCU04340	3220	2" Female	8.53
SCU04314	3320	2" Male	8.53

SpeedFILL™ Cap



Part #	Mfg #	Description	Price
SCU04316	3100	Fits all connectors	5.25

Alarms & Gauges

King® Combination Fill Alarm & Tank Gauge

- Molded float - impervious to petroleum products
- Tangle-Free "solid link" hinge
- Cast iron with corrosion resistant powder coating
- Large, easy-to-read, plastic vial
- Flanged vial, double seal with exterior o-ring
- Vertical fits tanks with 42"-44" diameter
- Horizontal fits tanks with 26"-27" diameter



Part #	Mfg #	Description	Price
SCU01413	4523	Red Vertical, 2"MNPT Btm, 1-1/4"FNPT Top	41.60
SCU01456	4526	Blue Vertical, 2"MNPT Btm, 2"FNPT Top	48.97
SCU01409	4530	Red Horizontal, 2"MNPT Btm, 1-1/4"FNPT Top	41.60
SCU01455	4533	Blue Horizontal, 2"MNPT Btm, 2"FNPT Top	48.97

King® Leakproof Tank Gauge

- Molded float - impervious to petroleum products
- Tangle-Free "solid link" hinge
- Large, easy-to-read, plastic vial
- Flanged vial, double seal with exterior o-ring
- Rustproof zinc bushing
- Vertical fits tanks with 42"-44" diameter
- Horizontal fits tanks with 26"-27" diameter



Part #	Mfg #	Thread Size	Tank	Price
SCU01421	4503	1-1/2" & 2"	Horizontal	26.92
SCU01422	4504	1-1/2" & 2"	Vertical	26.92

All Items May Not Be Stocked In All Branches

Oil Accessories

King® Standard Fill Alarms

- Cast iron with corrosion resistant powder coating
- Whistles while tank is being filled
- Stops whistling when oil reaches safe capacity level



Part #	Mfg #	Description	Price
SCU00215	4514	Red, 5-1/4" Stem, 2" MNPT Btm, 1-1/4" FNPT Top	23.81
SCU00275	4517	Blue, 5-1/4" Stem, 2" MNPT Btm, 2" FNPT Top	43.20

King® Parts



Part #	Mfg #	Description	Price
SCU10159	6495	Vial & Gasket for Scully Gauges	8.59



Residential Oil Tanks

- Steel ASTM A-569
- Female threaded openings
- Pressure tested at 5 to 7 PSIG
- UL 80 label
- Operation at atmospheric pressure only
- UL 142 label also available on 275 & 330 US gal (including a 3" diameter emergency vent opening)
- External surface: washed and phosphated
- External finish: black or grey electrostatic powder paint



UL-80 Horizontal Tanks

- G - Grey

Part #	Mfg #	Capacity		Dimensions	Price
		(Gal)	Ga		
OIL275H12	204701	275	12	44" x 27" x 60"	1066.16

UL-80 Vertical Tanks

- G - Grey

Part #	Mfg #	Capacity		Dimensions	Price
		(Gal)	Ga		
OIL275V12	204201	275	12	44" x 27" x 60"	1013.44
OIL330V12	205201	330	12	47" x 27" x 72"	1139.38

Underground Protected Tanks

UL 58

- Tank built for environmental protection
- Female threaded openings with dielectric nylon reducers and shipping plugs
- Magnesium anodes
- Pressure tested at 5 to 7 PSIG
- External finish: commercial sandblast (SSPC-SP6) and polyurethane paint
- Atmospheric pressure operation only
- 30-Year limited warranty



Part #	Mfg #	Capacity		Dimensions	Price
		(Gal)	Ga		
OIL500UGC	3020334	500	10	50" x 60"	4185.54
OIL1000UGC	3039332A	1000	10	50" x 120"	5963.44



Better Service Thru Better People

Oil Controls & Accessories



www.irrsupply.com

Oil Accessories

Electrode Kits

Beckett Electrode Kits

Electrode Field Replacement Kits with "T" Gauge & Extension Rods

- Prepackaged in poly bags with complete setting gauge & instructions
- Includes:
 - (2) Electrode insulator assemblies
 - (2) Extension rods
 - (2) 10-32 Hex nuts,
 - (2) Connectors
 - (1) "T" Setting gauge
 - (1) Installation instruction sheet
 - (1) Setting firing rate instruction sheet



Part #	Mfg #	Burner Model	Size	Price
CRO5780K	5780	AF, SR, SF	to 9"	34.68
CRO5782K	5782K	AF, AR, SF, SR	Over 9"	38.06

31156K Wayne Electrode Tune-Up Kit

- For use on burner models: M, MSR, MH, ERA, EH, EHA, EHASR, OE and OEA
- Includes:
 - (2) Electrode assemblies
 - (2) Electrode stems
 - (2) Buss bars 8"
 - (2) Insulator bushings
 - (1) Oil line 3/16" x 8"
 - (1) Coupler w/ end caps
 - (1) Setting gauge
 - (1) Elbow
 - (1) Buss bar support
 - Instructions



Part #	Mfg #	Description	Price
CRO31156	31156K	Wayne Electrode Tune-Up	41.22

31157K Wayne Electrode Tune-Up Kit

- For use on Blue Angel burner model HS
- Includes:
 - (2) Electrode assembly w/buss bar
 - (1) Oil line 3/16" x 8"
 - (1) Coupler w/end caps
 - (1) Setting gauge
 - (1) Elbow
 - (1) Buss bar support
 - Instructions



Part #	Mfg #	Description	Price
CRO31157	31157K	Wayne Electrode Tune-Up	41.22

40286K Carlin Electrode Tune-Up Kit

- For use on burner models 98-102, elite, 201 CRD & 301 Crd
- Includes:
 - (2) Electrode assemblies,
 - (1) Yellow electrode setting gauge
 - (1) Red electrode setting gauge
 - (1) Instruction sheet
 - (1) KK100 Coupler w/end caps
 - (1) 12"L x 3/16" Diameter copper oil line



Part #	Mfg #	Description	Price
CRO40286K	40286K	Carlin Electrode Tune-Up	41.22

Couplers

Replacement Oil Burner Couplers

- Includes: 5" coupler assembled, 1/2" motor end cap, 7/16" & 5/16" pump end caps



Part #	Mfg #	Description	Price
CROKK120	KK120	Koupling King II - Carded w/Hanger Knockout	10.70

Oil Handling/Filtration Parts

Clean Flow Rayon Filters

- Solid one piece construction - no felt fibers or strings to hamper the oil flow
- Includes gaskets



Part #	Mfg #	Description	Price
CRO41411	41411-48	2-3/4" OD x 3/4" ID x 3" Long, Rayon Filter w/Gaskets	2.40

Quick Spin II Replacement Element

- Individually wrapped with "O" ring post gasket

Part #	Mfg #	Description	Price
CRO41436	41436	Replacement Element Only	16.62

All Items May Not Be Stocked In All Branches



www.irrsupply.com

Oil Accessories

Quick Spin II Head Mount

- Filter head mount with plugged gauge port
- Made of casted aluminum



Part #	Mfg #	Description	Price
CRO41437	41437	Filter Head Mount	18.10

Oil Pump Strainers

- Individually boxed with gasket



45676



45678

Part #	Mfg #	Description	Price
CRO45676	45676	F/Pump Models J, H, S	5.44
CRO45678	45678	F/Pump Model A	4.20

Steel (Flexible) Braided Hose Oil Line

- 1/4" NPT fittings on both ends for Tigerloop installation
- Made from Nitrate rubber (inside) & steel braided outer casing
- 143 psi Pressure rating
- 20 gph Max flow rate



Part #	Mfg #	Description	Price
CRO43005	43005	24" L x 1/2" Dia	30.50
CRO43006	43006	36" L x 1/2" Dia	33.86

Miller Gasket Kit

- Includes: 1-75000, 1-75001, 1-75002, 1-75018



Part #	Mfg #	Description	Price
CRO75019	75019	Used In Models CMF, MOC, MGC	27.14

Soot Cutter

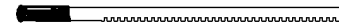
- For clearing of soot build-up in most narrow passage boilers
- Breaks up hardened carbon deposits in between sectional studs in narrow passage boilers
- Made of tempered steel
- Sold 12/case 

Part #	Mfg #	Description	Price
OILSAW	40417	Soot Cutter	27.52



Riello Parts & Accessories

Part #	Mfg #	Description	Price
RIE3000443	3000443	Pump Drive Key	5.72
RIE3002279	3002279	Coil f/All Burners	16.94
RIE3002280	3002280	Photo Cell	17.96
RIE3005719	3005719	Pump Screen	4.64
RIE3005843	3005843	Motor	235.80
RIE3005869	3005869	Electrode, Porcelain	14.92
RIE3006911	3006911	Hydraulic Jack	57.32
RIE3007568	3007568	Bleeder	12.80
RIETUBE36	3948873	6" Air Tube f/F3 Burner	153.40
RIETUBE310	3948874	10" Air Tube f/F3 Burner	221.40
RIETUBE56	3948973	6" Air Tube f/F5 Burner	153.40
RIE7001001	7001001	Emergency Service Kit	550.14
RIE7010002	7010002	Pump O-Ring	0.82
RIE7020004	7020004	24V Switching Relay f/40 Series Burner	93.68
RIE7001010	7111010	Pump	191.30
RIEC7001029	C7001029	Primary Control 530SE	231.94
RIEF3	F3CHASSIS	F-3 Oil Burner Chassis Only	770.70
RIEF5	F5 CHASSIS	F-5 Oil Burner Chassis Only	705.68
RIEF10	F10 CHASSIS	F-10 Oil Burner Chassis Only	1024.88
RIEF306	F-306	F-3 Burner w/6" Air Tube	912.74
RIEF506	F-506	F-5 Burner w/6" Air Tube	915.96

Oil Controls & Accessories

Prices & Specifications are Subject to Change.

Oil Accessories

Nylo-Flex™ Burner Couplings

- 3-Piece coupling
- No set screws

Pre-Cut Couplings

Part #	Mfg #	Description	Price
OILS85200	S85-200	For Beckett AF Burner	4.99

Nylo-Flex® Coupling Kits

Part #	Mfg #	Description	Price
OILS85500	S85-500	1/2", 7/16", & 5/16" End Pieces, 1" - 6" Nyloshaft	4.99

Pure-Oil Filter Elements

- Fiber-welded for shed free performance

Part #	Mfg #	Case	Price
OILF1048	F10-48	Fits General 1A-25A; Unifilter 77; Westwood F10, F12, F15, F20, F25; Sid Harvey 264, 264F	2.50
OILF3024	F30-24	Fits General 2A-700A; Unifilter 99; Westwood F30, F32, F35, F65, F70; Sid Harvey 265, 265F	4.25
OILF8048	F80-48	Fits Fulflo FB4	1.98

Pure-Oil™ Exact Replacement Fuel Oil Filters

- Replacement for popular cast iron top filters
- Heavy gauge canister with epoxy coating inside

F65



Part #	Mfg #	GPH	Replaces	Price
OILF20	F20	17	General 1A-25A	26.60
OILF65	F65	32	General 2A-700A	46.60

Copper Oil Nozzle Lines

Part #	Mfg #	Description	Price
OILLINE316-8	S213-8	3/16" OD x 8" Long	3.48
OILLINE316-12	S213-12	3/16" OD x 12" Long	3.80
OILLINE316-16	S213-16	3/16" OD x 16" Long	4.38
OILLINE14-16	S214-16	1/4" OD x 16" Long	5.54
OILLINEM	S214-25	Oil Line Parts Kit For Miller Furnaces	29.99

Flo-Thru Bleed Wrenches

- Quickly and neatly bleed oil burner pumps
- Handle slides side-to-side for easy bleeding

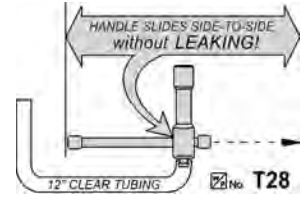

Part #	Mfg #	Description	Price
OILBLEEDER	T-28	Bleed Wrench w/12" Hose	40.28

Oil Burner Pump Gaskets

Part #	Mfg #	Description	Price
OILS1907	S190-7	Bag of Cover Gaskets f/New Style 70 Series	6.50

Safety & Spill Cleanup Supplies

Contractor Disposal Bag

Part #	Mfg #	Description	Price
OILDBAGS	S500-22 BOX	7 Bu Plastic Pkg of 20	37.92

Oil Absorbent Pad

Part #	Mfg #	Description	Price
OILPAD	S500-30 PADS	16-1/2" x 19-1/2" x 3/16" Thick	1.19

Magic*Patch™

Part #	Mfg #	Description	Price
OILPATCH	S216	Temporary Oil Tank Leak Patch	31.99

TN - Tigerloop® Oil De-Aerator

- Dual chamber design
- Protective vent shield
- Patented anti-foam system
- Reversible mounting bracket
- Maximum inlet pressure: 8 psi
- Maximum temperature: 105°F
- UL Listed



Part #	Mfg #	Description	Price
OILTIGERLOOP	S220	1/4" FNPT, for #1 or #2 Heating Oil	247.78

All Items May Not Be Stocked In All Branches



Oil Accessories

Boiler And Furnace Cleaning Items

Vacuum Cleaner Bags

Part #	Mfg #	Description	Price
OILVBAG3	S450-14	3-1/2 Gal Package of 5	14.88
OILVBAG5	S450-15	5 Gal Package of 5	23.14

Flue Gas Smoke Testers

- Virtually unbreakable polycarbonate barrel
- Hardware all brass and stainless steel
- Sampling tube hooks into smokepipe
- Lifetime lubrication



Part #	Mfg #	Description	Price
OILSTP	T40	Complete Kit w/Case, Smoke Test Paper, Smoke Scale	169.99
OILSTPAPER	T40-1	50 Precut Smoke Test Paper Strips	19.99

CO₂ Blow Out Guns & Kits

CO₂ Blow Out Gun

- For clearing clogged oil lines and instrument transmission lines
- Built-in check valve allows spent cartridge to be removed without loss of pressure
- T32-10 Limits pressure at outlet of gun to 150 PSI

Part #	Mfg #	Description	Price
OILCO2GUN	T32	CO ₂ Blow Out Gun	39.95

Quick-Connect Fittings Kit

- Contains quick-connect coupling, compression connectors and flare connectors

Part #	Mfg #	Description	Price
OILCO2	T32-20	Blow Gun Not Included	9.95

Rajah™ Terminals

Buss Bar

Part #	Mfg #	Description	Price
OILBUSS	E9-TYPE F	12" Flat Brass w/1/8" Hole	4.00

Odor Neutralizers

Part #	Mfg #	Description	Price
OILCB	60-621	8oz Heavy Duty Cherry Bomb Deodorant Gel Cup	9.90

JUMBO

Storage Tank Fittings

Slip-Through Tank Bushing

- Allows suction and return lines to be installed in the same tank opening
- Supplied with two brass compression tube fittings



Part #	Mfg #	Size	Price
OILDTB38	5311	2" x 3/8" x 3/8"	12.60
OILDTB12	5313	2" x 1/2" x 1/2"	12.86

Cast Iron Slip-Through Tank Bushing

- Cast iron, galvanized, threaded cap with stainless steel screen



Part #	Mfg #	Size	Price
OILVC1	5302	1"	7.88
OILVC114	5303	1-1/4"	9.60
OILVC112	5304	1-1/2"	12.04
OILVC2	5305	2"	17.10

Fill Box

- Grey iron, vented



Part #	Mfg #	Size	Price
OILHC2F	5317	2" Fem Thd Hinge Type	9.21
OILHC2M	5322	2" Male Thd Hinge Type	10.97

Tank Whistle Alarm

Part #	Mfg #	Size	Price
OILTW2-114	5665	2"M x 1-1/4"F	18.56

Oil Controls & Accessories

Prices & Specifications are Subject to Change.

Oil Accessories

Draft Controls

Type RC Draft Controls

For Oil or Coal Systems - Residential & Commercial

- Standard equipment on many leading brands of oil or coal heating equipment
- Calibrated to allow for easy adjustment to the furnace or boiler
- Designed for settings from .02" - .08" this control is so sensitive that instrumentation should be used when adjusting the unit during installation



Part #	Mfg #	Control Size	Nom Capacity Sq In	Recommended Pipe Dia	Recommended Pipe Circum	Dimensions	Price
FIE4RC	4RC	4"	12.6"	3" - 5"	9-1/2" - 15-3/4"	4" x 2-1/2" x 2"	55.08
FIE5RC	5RC	5"	19.6"	4" - 6"	12-1/2" - 19"	5" x 2-1/2" x 2"	55.44
FIE6RC	6RC	6"	28.3"	5" - 7"	15-3/4" - 22"	6" x 1-7/8" x 3"	59.26
FIE7RC	7RC	7"	38.5"	6" - 8"	19" - 25-1/4"	7" x 2-5/8" x 3-1/2"	72.90
FIE8RC	8RC	8"	50.3"	7" - 9"	22" - 28-1/8"	8" x 4-3/8" x 4"	100.90
FIE9RC	9RC	9"	63.6"	8" - 10"	25-1/4" - 31-1/2"	9" x 5-1/8" x 4-1/2"	120.64

Oil Controls & Accessories

Air Boosters

AB Air Boosters

- 120V



AB-1

Part #	Mfg #	Application	Increases CFM	Price
FIEAB1	AB-1	Heavy-Duty for Round & Square Metal Duct	305 CFM	174.78
FIEAB2	AB-2	Round or Square Metal Duct 6" or larger	220 CFM	54.96
FIEAB6	AB-6	6" Round Metal and Flex Duct	225 CFM	60.34
FIEAB8	AB-8	8" Round Metal and Flex Duct	425 CFM	70.40

Combustion Air Systems

Oil Heating Appliances - Direct Connect

- Connects directly to oil burners
- Up to 2 gph input



CAS-2

Part #	Mfg #	Burner	Components:	Price
FIECAS2B	CAS-2B	Beckett AFG or AF Burners	4" Intake Air Hood	202.62

All Items May Not Be Stocked In All Branches

Oil Accessories

Combustion Air Systems - Non-Direct

- Designed for use when direct connection is not possible or for multiple appliances
- Designed for optimum safety & includes a proving device that won't allow the burner to engage without incoming air flow
- Multiple units or additional controls are required for multiple appliance installations



Part #	Mfg #	Fuel	Application:	Components:	Price
FIECAS4	CAS-4	Gas	24V Gas Appliance	4" Intake Air Hood, Fan-In-a-Can Assy, 6" - 4" Reducer, Restrictor Plate	605.96

Draft Inducers

Type DI Draft Inducers

- For improving drafting & venting of oil & gas-fired equipment
- Designed for easy installation in a wide variety of applications



Part #	Mfg #	Pipe Diameter	BTUH	Price
FIEDI1	DI-1	3" - 6"	69,000 - 120,000	284.16

Thermal Safety Switches



Part #	Mfg #	Description	Price
FIEGSK3	GSK-3	Gas Spillage Safety Switch	47.72



Model A-7000 Single-Stage Fuel Units

- Suitable for kerosene, No 1 or No 2 fuel
- Strainer & nozzles:
 - V = 3 GPH
 - Y = 7 GPH
 - T = 16 GPH
- Pressure spring choices:
 - A = 20 -40 psi
 - B = 75 - 200 psi
 - C = 150 - 300 psi

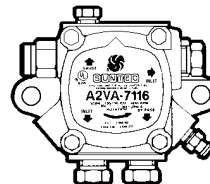

A2VA-7116

Part #	Mfg #	Speed	RPM	Rot	Nozzle Port Location	Price
SUNA1YA7912	A1YA-7912	1	1725	RH	RH	127.44
SUNA2VA7116	A2VA-7116	2	3450	RH	RH	133.08

Prices & Specifications are Subject to Change.

Oil Controls & Accessories

Oil Accessories

Model B-8000 Two-Stage Fuel Unit

- Suitable for kerosene, No 1 or No 2 fuel
- Strainer & nozzles:
 - V = 3 GPH
 - Y = 7 GPH
 - T = 16 GPH
- Pressure spring choices:
 - A = 20 -40 psi
 - B = 75 - 200 psi
 - C = 150 - 300 psi

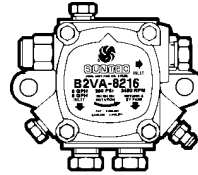

Part #	Mfg #	Speed	RPM	Rot	Nozzle Port Location	Price
SUNB2VA8216	B2VA-8216	2	3450	RH	RH	172.38

Oil Controls & Accessories



Fuel Filters

Oil Filter for All Types of Heating Applications

- Leakproof construction with machined gasket seat & UL listed gasket compounds
- High quality wool felt filter elements that remove all solid contaminants
- Can be used in one or two-pipe systems
- (6) Each



Part #	Mfg #	Description	Max Nozzle Capacity	Price
GEF1A25A	1A-25A	For Small to Average Size Homes & Commercial Buildings	10 gph	33.07
GEF2A700A	2A-700A	For Average to Large Size Homes	25 gph	49.96

Replacement Filter Cartridge

- 10 Micron wool felt
- Center core bonded to prevent media migration



Part #	Mfg #	Description	Price
GEF1A30	1A-30	Wool Felt - for Filter 1A-25A	2.92
GEF2A710	2A-710	Wool Felt - for Filter 2A-700A	5.08

All Items May Not Be Stocked In All Branches

Oil Accessories

Valves

Machined Brass Inline Fusible Valves



Part #	Mfg #	Size	Price
FIR100F	B100-F	3/8" FNPT x 3/8" FNPT	27.22
FIR105F	B105-F	3/8" Flr x 3/8" Flr	36.78
FIR205F	B205-F	1/2" Flr x 1/2" Flr	42.08

Forged Brass/Cast Bronze Burner Fusible Valves



Part #	Mfg #	Size	Price
FIR104CF	104-CF	3/8" Flr x 1/4" MNPT, 1-5/8" Shank	33.70

Cast Bronze Fusible Tank Valves

- Designed for use on oil tanks or drums that are fitted with 3/8" or 1/2" NPT outlet connections
- Allows direct hook-up from tank to oil filter
- Valve bodies are made of cast bronze
- TF Indicates fusible valve



Part #	Mfg #	Size	Price
FIR141TF	141-TF	1/2" MNPT x 3/8" MNPT	54.02

Machined Brass - Ball Type - CV Check Valves

- Used for general service to check flow
- Not designed to use where an absolutely tight shutoff is required



Part #	Mfg #	Size	Price
FIR100CV	B100-CV	3/8" FNPT x 3/8" FNPT	26.60
FIR200CV	B200-CV	1/2" FNPT x 1/2" FNPT	67.88

Hand Pump Parts

Part #	Mfg #	Description	Price
FIRHANDLES	9130-2165	Handles	4.16

Oil Controls & Accessories



www.irrsupply.com



Motors

Condenser Fan Motor - Permanent Split Capacitor

5.6" Diameter PSC High Ambient Condenser Fan, TEAO, All Angle Mount, without Capacitor

- TEAO - Totally enclosed air over
- 60C° Ambient design
- Stud mount/all angle mount
- Sleeve bearings have all angle thrust system
- Class B insulation
- Extended studs
- Designed for 370V capacitors
- Automatic thermal overload protector
- 30" Leads - hubless lead end
- Drain holes both ends
- Auto reset thermal overload protector
- Reversible



Part #	Mfg #	HP	Voltage	RPM	Frame	Full Load Amps	Options	Price
MOTCM14	1860	1/4	208-230	1075	48Y	1.7	61	105.00
MOTCM14R	1876	1/4	208-230	1075	48Y	1.7	-	108.00
MOTCM13	1861	1/3	208/230	1075	48Y	2.0		112.00
MOTCM13R	1877	1/3	208-230	1075	48Y	2.1	-	115.00
MOTCM12	1862	1/2	208-230	1075	48Y	3.0	61	124.00
MOTCM12R	1878	1/2	208-230	1075	48Y	3.0	-	127.00
MOTCM34R	1879	3/4	208-230	1075	48Y	4.7	-	156.00

Note 61 Sleeve bearings

Note LA Limited availability

Direct Drive Fan Motor - Single-Shaft Shaded Pole

5.0" Diameter OAO Shaded Pole

- OAO - Open air over
- For use on direct drive fan & blowers
- For use with 370V capacitors
- Non-Reversible rotation
- Continuous duty, air over
- 24" Line leads
- Automatic reset thermal overload protector



Part #	Mfg #	HP	Voltage	RPM	Frame	Full Load Amps	Notes	Price
MOTDD15	1340	1/5	115	1050	42	7.1	H3, H16	172.00

Note H3 20" Leads

Note H16 Rotation is CCW L.E.

Motors

All Items May Not Be Stocked In All Branches



www.irrsupply.com



Motors

Direct Drive Fan & Blower Motor - Permanent Split Capacitor

5.6" Diameter PSC DD Fan & Blower, OAO, Hub Ring Mount

- OAO - Open air over
- DD - Direct drive
- For use with direct drive fan & blowers
- For use with 370V capacitors
- 2.5" Diameter hub rings included
- Continuous duty, air over
- Reversible rotation
- 24" Leads
- Automatic reset thermal overload protector
- 2-1/2" Diameter hub rings included



8904

Part #	Mfg #	HP	Voltage	RPM/Speed	Frame	Full Load Amps	Notes	Price
MOTDD14	1863	1/4	115	1075/3	48Y	3.9	62,78	112.00
MOTDD13	1864	1/3	115	1075/3	48Y	5.0	62,78	115.00
MOTDD12	5840	1/2	115	1075/4	48	7.1	H1	139.00
MOTDD34	8904	3/4	115	1075/3	48	9.1	3	159.00
MOTDD1	8906	1	115	1075/3	48	12.1	2	298.00

Note 2 Class B Insulation, Studs Shaft Side Only, Ball Bearings

Note 3 No Stud Extension

Note 62 Not Economizer®

Note 78 Class B insulation

Note H1 2.25" Dia Hub Rings with Kit for 2.5" Included

RESCUE™ Condenser Fan Motor - Permanent Split Capacitor

5.6" Diameter PSC Rescue Condenser Fan, 60° C Rated, TEAO

- TEAO - Totally enclosed air over
- High efficiency for commercial & residential condensing units
- Designed for use with 370V capacitors
- Continuous duty, air over
- Special treated rotor for corrosion protection
- Includes lead end mounting holes for Rheem or Trane units
- Can replace a range of horsepower applications and a variety of mounting styles
- 60°C Ambient
- Extended mounting studs
- Automatic thermal overload protector
- 48" Leads
- Ball bearings
- Reversible rotation



Part #	Mfg #	HP	Voltage	RPM/Speed	Frame	Full Load Amps	Notes	Price
MOTCM16	1859	1/6	208-230	1075	48Y	1.1	61, LA	101.00
MOTMHCM13	5462	1/6, 1/5, 1/4, 1/3	208-230	1075		1.8, 2.0, 2.5, 2.6		140.00

Prices & Specifications are Subject to Change.

Motors



www.irrsupply.com



Motors

5.6" Diameter PSC Rescue DD Fan & Blower Motor, OPAO

- OAO - Open air over
- High efficiency for commercial & residential air handlers & furnaces
- Can replace a range of horsepower applications & a variety of mounting styles
- Designed for use with 370V capacitors
- Class B insulation
- Extended mounting studs
- Includes side shell holes for Rheem units
- Continuous duty, Air over
- Multi-HP
- Automatic thermal overload protector
- 36" Leads
- Ball bearing (unless noted)
- Reversible rotation
- 2.5" Diameter hub rings included

RESCUE



Part #	Mfg #	HP	Voltage	RPM	Amps	Price
MOTMHDD12	5460	1/6, 1/5, 1/4, 1/3, 1/2	208-230	1075	2.8, 3.6, 5.5, 6.9, 7.3	140.00
MOTMHDD34	5470	1/5, 1/4, 1/3, 1/2, 3/4	208-230	1075	3.1, 3.8, 4.6, 6.6, 8.1	177.00

Belted Fan & Blower Motors

Split-Phase Belted Fan & Blower, ODP - Resilient Base

- ODP - Open Dripproof
- For use with belted fans & blowers
- Class A insulation
- With threaded conduit hole
- Reversible rotation by easy reconnection
- Automatic thermal overload protector
- Single speed
- Ball Bearings (unless noted)
- Average shaft 0.5 x 1.5 except where noted



Part #	Mfg #	HP	Voltage	RPM	Frame	Full Load Amps	Notes	Price
MOT14B	8000	1/4	115	1800	48	5.9	61,77,78,79	127.00
MOT13B	8100	1/3	115	1800	48	6.4	61,77,78,79	132.00
MOT12B	8200	1/2	115	1800	48	8.7	61,77,78,79	158.00

Note 61 Sleeve bearings

Note 77 With shaft adapter for 5/8" shaft

Note 78 Class B insulation

Note 79 Combination mounting holes for NEMA 48 & 58 frame dimensions

All Items May Not Be Stocked In All Branches



www.irrsupply.com

Motors

Economy Model Belted Fan & Blower Motor

- All angle sleeve or ball bearings
- Resilient base mounted
- Slotted holes in base match 48 or 56 frame bolt patterns
- 1/2" Shaft diameter - 5/8" adapter with key included
- Single-phase, 60Hz
- Overload protection
- Open construction
- Continuous duty, 40°C ambient



Part #	Mfg #	HP	Voltage	RPM	Price
MOT34B	4338	3/4	115	1,725	459.48

Oil Burner Motor - Flange Mount

- For use with oil burners
- 40°C Ambient
- Manual overload protector
- 1.0 Service factor
- Class "A" insulation
- Reversible rotation except as noted
- Manual reset thermal overload protector
- Sleeve bearing where noted



Part #	Mfg #	HP	Voltage	RPM	Motor Type	Enclosure	Frame	Full Load Amps	Notes	Price
MOTOB18	3196	1/8	115	1725	SP	TENV	48N	2.4	61,85	133.00
MOTOB14	2302	1/4	115	3450	SP	ODP	48N	3.7	61	162.00

Replacement Motors

Split-Phase and Capacitor Start Oil Burner

- For use on oil burners
- Totally enclosed when mounted
- 40°C Ambient
- 20" Leads
- 1.0 Service factor
- Reversible rotation except as noted
- Manual reset thermal overload protector
- Class B insulation except as noted
- 48M & 48N Flange are ventilated
- Sleeve bearings have all angle thrust system
- Ball bearings (unless noted)



OEM Direct Replacements: Beckett®, Carlin®, Ducane®, Wayne Home®

Part #	Mfg #	HP	Voltage	RPM	Motor Type	Enclosure	Frame	Full Load Amps	Notes	Price
MOTOB17	5866	1/7	115	3600	SP	Enclosed	48M	2.0	0,1	112.00

Note 0 Sleeve bearings

Note 1 Non-Reversible

Prices & Specifications are Subject to Change.

Motors

3.3" Shaded Pole Motors

- Class B insulation
- 60/50Hz
- Automatic thermal overload protection
- 12" Motor leads

1550 RPM - Mechanically Reversible - MARS Super-Fit™ Commercial Evaporator Fan & Blower Motor

Part #	Mfg #	HP	Volts	Amps	Rot OLE	Shaft Length	Body Size	Price
MAR9914	09914	1/70	115	.7	CW	2.50"	2.34"	119.42
MAR9915	09915	1/50	115	.8	CW	2.50"	2.59"	130.70
MAR9916	09916	1/30	115	1.2	CW	2.50"	2.96"	126.74
MAR9917	09917	1/20	115	1.9	CW	2.50"	2.96"	112.10
MAR9927	09927	1/20	208/230	1.0	CW	2.50"	2.96"	123.36

3-7/8" Single-Phase Shaded Pole Motors

- 60Hz
- Overload protection
- Continuous, air over
- Adapter 08217 converts 1/4" threaded shaft to 5/16" smooth shaft

1500 RPM - Smooth Shaft - EM&S High Efficiency Shaded Pole Motor



Part #	Mfg #	EMS No. ESP-	Watts Output	Volts	Amps	ROT OSE	Shaft Length	Body Size	Price
MAR501	00501	OL50EM1	50	115	1.70	CW	1.50"	4.50"	195.54
MAR503	00503	OL50EM2	50	230	0.85	CW	1.50"	4.50"	174.40

1500 RPM - EM&S ESP-L Shaded Pole Motor for Tecumseh



Part #	Mfg #	EMS No. ESP-	Watts Output	Volts	Amps	ROT OSE	Shaft Length	Body Size	Price
MAR507	00507	ESP-0L50EMJR21	50W	230	0.85	CCW	2.00"	4.25"	213.60

Motors

Motors

4" Single-Phase Shaded Pole Motors

- 60Hz
- Overload protection
- Fan duty, continuous, air over
- Shaft end has (4) 8-32 tapped holes

1550 RPM - 4-Pole Unit Bearing Shaded Pole Motor



Part #	Mfg #	GE No. 5KSM92	HP	Volts	Amps	ROT OSe	Encl	Shaft Length	Body Size	Base No.	Price
MAR1332	01332*	KFL2007S	1/20	208/230	1.1	CW	Open	2.00"	4.82"/4.70"	08042	395.16

* 34" Leads, + 30" Leads, ! 60/50Hz

One-on-one™ Direct Replacement Motors

5-1/2" Diameter - Shell Only Enclosed - 3" Resilient Base - Direct Replacement Motor for Hill Refrigeration



Part #	Mfg #	Mfg No	HP	Volts	RPM/ Speeds	Rot	Amps	Shaft Length	Body Size	Cap Req	Price
MAR3001	03001	5KCP39KG1369S	1/3	208/230	1625/1	CW	2.9	3.5"	5.7"	Included	429.38

MARS2 Unit Bearing Motors

- Cast iron construction
- Universal mount
- Mounting screws included
- Individually boxed
- UL Recognized



Part #	Mfg #	Watts	Volts	Rotation	Price
MAR15211	15211	4	115	CW	33.92
MAR15212	15212	4	115	CCW	40.38
MAR15311	15311	6	115	CW	44.88
MAR15411	15411	9	115	CW	39.20
MAR15412	15412	9	115	CCW	34.94
MAR15421	15421	9	230	CW	34.94
MAR15422	15422	9	230	CCW	34.94
MAR15811	15811	16	115	CW	50.86
MAR15812	15812	16	115	CCW	58.34
MAR15821	15821	16	230	CW	67.34
MAR15822	15822	16	230	CCW	67.34

Motors

Prices & Specifications are Subject to Change.

Motors

3-3/8" Diameter Stock Motors

Shaded Pole Open Ventilated Fan & Blower Duty - 3-3/8" Dia

- Continuous duty, air over



Part #	Mfg #	HP	Volts	RPM/Speed	Amps	Rotation	Price
MAG575	575	1/20	208/230	1550/1	0.90	CWLE	187.24

Shaded Pole GE 11 Frame Replacements - 3-3/8" Dia

- All angle sleeve bearing
- Insulation Class B
- Open fan cooled (9439 is air over)
- Thermally protected
- 1-3/4" Resilient rings



Part #	Mfg #	HP	Volts	RPM/Speed	Amps	Rotation	Price
MAG671	671B	1/15	115/208/230	1550/1	2.1, 1.1	CCWSE	238.58

4-5/16" Diameter Stock Motors

Shaded Pole Heating, Ventilating & Welding Units - 4-5/16" Dia

- Auto protector
- Continuous duty, air over
- 3/8" Diameter shaft
- 60Hz
- For roof & wall ventilators, condenser fans, direct drive blowers & unit heaters



Part #	Mfg #	HP	Volts	RPM/Speed	Amps	Rotation	Price
MAG48	48	1/20	115	1050/1	2.1	CWSE	323.14

5" Diameter Stock Motors

Shaded Pole Furnace Blower, Attic Ventilator, Air Handler, Fan Coil - 5" Dia

- Auto protector
- Continuous duty air over
- 40°C Ambient
- 1/2" Dia flatted shaft
- Sleeve bearing
- 60Hz



Part #	Mfg #	HP	Volts	RPM/Speed	Amps	Rotation	Price
MAG98	98	1/8, 1/10, 1/12	115	1050/3	5.1, 3.5, 3.0	CCWLE	274.82
MAG90	90	1/8, 1/10	115	1050/2	5.2, 3.5	CCWLE	292.94
MAG469	469	1/12	115/230	1050/1	2.7, 1.3	CCWLE	513.40

All Items May Not Be Stocked In All Branches

Motors

Shaded Pole Refrigeration, Unit Heater, Space Heater - 5" Dia

- Replaces most GE 21/29 frame motors
- Continuous duty, air over
- Mechanically reversible
- Sleeve bearing
- Thermally protected
- 2-1/4" Mounting rings included
- (4) Tapped 10-32 holes for shaft end
- 60Hz



Part #	Mfg #	HP	Volts	RPM/Speed	Amps	Rotation	Shaft	Price
MAG614	614	1/10	115/230	1550/1	4.4, 2.2	CWSE	3/8" x 3-1/4"	317.10
MAG615	615	1/10	115/230	1550/1	4.4/2.2	CCWSE	3/8" x 3-1/4"	317.10

Shaded Pole Fan Coil - Dual Wheel Blower - 5" Dia less Resilient Base

- Auto protector
- Open construction
- Sleeve bearing
- 1/2" Diameter - flatted shafts
- 60Hz
- 40°C Ambient
- 42 Frame



Part #	Mfg #	HP	Volts	RPM/Speed	Amps	Rotation	Price
MAG389	389	1/15, 1/20, 1/30, 1/50	115	1050/4	2.4, 1.6, 1.1, 0.8	CWLE	241.60

PSC High Efficiency Direct Drive Fan & Blower Motor - 5-5/8" Dia

- Permanent split capacitor indoor blower motor
- Auto protector
- Continuous air over
- Open construction
- Multiple mount
- 1/2" Diameter - flatted shaft
- 22" Leads (minimum)
- 48 Frame
- 40°, 50°, and 60°C Ambient
- Reversible
- 60Hz



Part #	Mfg #	HP	Volts	RPM/Speed	Amps	Bearings	Capacitor	Price
MAG150	150A	3/4, 1/2, 1/3	208/230	1075/3	4.7	Ball	10MFD/370V	561.72

Motors

Prices & Specifications are Subject to Change.

Motors

Motors

Acme 4670 General Replacement Motor Kit

- Includes:
 - Fan blades 4" CW #2403 and 5-1/2" CCW #255
 - Single speed reversible motor 5/8" stack impedance protected
 - Patented H-bracket mounting system
 - Permanently lubricated bronze bearings
 - All necessary screws, nuts and wire nuts

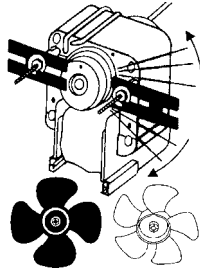

Part #	Mfg #	Description	Price
ACIAM4670	4670	1/100 hp 115V .35A 3000 rpm	31.74

Reversible Ball Bearing Fan Motor Kit

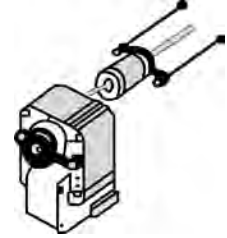

Part #	Mfg #	Description	Price
ACIBB700	BB700	1/100 hp 115V 3000 rpm	59.62
ACIBB750	BB750	1/50 hp 115V	69.24
ACIBB7502	BB7502	1/45 hp 115/230V	72.12

Acme 600 Reversible Evaporator Fan Motor Kit

- Impedance protected
- Includes:
 - Acme reversible motor CW or CCW
 - (1) 3-1/2" CW and (1) CW fan blade
 - H-Bracket hardware
 - Mounting hardware

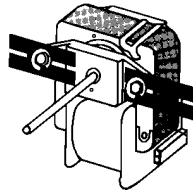

Part #	Mfg #	Description	Price
ACI600	600	1/100 hp 115V .35A 3000 rpm	35.66

Acme 700 Reversible Fan Motor Kit for Commercial Evaporators

- Bohn/Heatcraft mounting hardware and OEM duplicate fan blade included
- Includes (1) 4" and (2) 5-1/2" fan blades

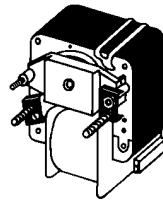

Part #	Mfg #	Description	Price
ACI700	700	1/100 hp 115V 3000 rpm .35A	40.94

Acme 750 Reversible Fan Motor Kit for Commercial Evaporators

- Kit contains:
 - 1-1/8" Stack Reversible fan motor with auto therm reset
 - Patented hardware & shaft adapter to fit 3/16", 1/4", 5/16" bores
 - (2) "H" Brackets
 - Special refrigeration mounting hardware for Bohn/Heatcraft or Peerless & Others

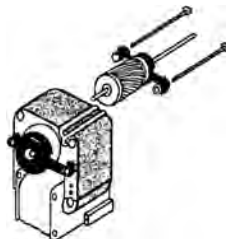

Part #	Mfg #	Description	Price
ACI750	750	1/45 hp 115V 3000 rpm 1.1A	53.52
ACI7502	7502	1/45 hp 115/230V 3000 rpm 110V @ 1.1A, 220V @ .55A	58.52

Special orders - If you need it we can get it promptly!

Motors

Motors

Motors

ESP Tecumseh Fan Motor

- CW Rotation viewing from end opposite shaft

Part #	Mfg #	Rating	Electrical	RPM	RLA	Min Lead Length	Shaft Size	Frame Dia	Over-all Lgth	Price
TECTFM61	810M006A76	6W	115-1-60	1500	0.50	30"	1/4"TD x 7/16"	3-1/2"	3-1/2"	96.38
TECTFM351	810M035C03	35W	115-1-60	1500	1.40	18"	1/4"TD x 7/16"	3-7/8"	4-1/4"	207.80
TECTFM372	810E037A84	1/20 HP	230-1-60	1500	1.10	29"	5/16" x 2-1/2"	5"	6-7/8"	267.98
TECTFM502	810E050A85	1/15 HP	230-1-60	1500	1.40	35"	5/16" x 2-1/2"	5"	7-1/8"	302.74
TECTFM1862	810E186A82	1/4 HP	230-1-60	1625	1.90	40"	1/2" x 2-3/16"	5-5/8"	7-1/2"	454.40

Special Fan Motor

Part #	Mfg #	Manufacturer No	Use ESP TFM Motor	Price
TEC810S186B40	810S186B40	F42A49A12	TFM1862	276.38

Universal Fan Motor

- Reversible

Part #	Mfg #	Description	Alternate for:	Price
TEC4W115	4W115	4W, 115V, 50/60 Hz	TFM41	88.76
TEC6W115	6W115	6W, 115V, 50/60 Hz	TFM61	102.46
TEC9W115	9W115	9W, 115V, 50/60 Hz	TFM91	115.10

Production Fan Motor

Part #	Mfg #	Rating	Electrical	RPM	RLA	Type	Type Motor Protection	Price
TECTFM352	810M035C02	35W	230-1-60	1500	0.70	SP	Thermal	198.38
TEC810F050C20	810F050C20	50W	230-1-50/60	-	0.70	PSC	Thermal	220.02
TEC810S124B38	810S124B38	1/6HP	230-1-50/60	1350/1550	1.35	PSC	Thermal	265.08

Motors

Motors & Accessories

Motors & Accessories

Universal Utility Motor Kits

- Replaces most 'C' frame style motors
- Length: 3/16" x 1-1/4"



Part #	Mfg #	Description	Price
GEEEM670	SM670(a)	120 VAC, 3000 rpm, .55 Amp, CW/CCW	20.32

(a) Includes hardware kit: (2) fan blades, mounting bracket, hub adapter, 1/4" shaft adapter, & 5/16" shaft adapter



Motor Brackets

- Brackets for 5-1/2" diameter motors



Part #	Mfg #	Description	Price
MOTDMB1	DMB-1	Fixed Lug Assembly	28.08
MOTDMB2	DMB-2	Adjustable Lug Assembly	19.40

Motors

Irr Supply is your one stop shop for all your Plumbing, HVAC, Refrigeration, and Electrical needs. Why go anywhere else!

Testing/Installation

Digital Multimeters

DM383B Multimeter

- 750 volts AC & 1000 volts DC
- 10 amps AC & DC
- Resistance to 40 Megohms
- Diode check function
- Continuity
- 3-3/4 Digit 4000 count display
- Max capture mode, data hold
- On-screen range and function indicators
- CD listed Cat III
- Includes test leads, rubber boot, 9V battery and fuses
- 5-Year limited warranty



Part #	Mfg #	Description	Price
UEIDM383B	DM383B	High Value Multimeter	114.98

UTL33 Digital Multimeter

- AC & DC Voltage, DC current
- Resistance to 200 ohms
- Audible continuity
- Data hold
- Compact pocket-design
- Impact resistant boot with a tilt stand
- 1-Year limited warranty



Part #	Mfg #	Description	Price
UEIU33	UTL33	Digital Multimeter	37.04

Clamp-On Digital Multimeters

DL49 Autoranging Clamp-On Multimeter

- 600V AC & DC, 400 Amps AC & DC
- Resistance to 40 megohms
- Continuity, autoranging
- AC Amp peak hold
- Data hold
- 1mV DC Resolution allows use of DMM adapters
- 7-11/16" x 3-1/16"
- UL & CE Listed CAT III
- Includes:
 - Test leads
 - 9V Battery
 - Soft holster
- 3-Year limited warranty



Part #	Mfg #	Description	Price
UEIDL49	DL49	1-1/4" Jaw Capacity	214.80

DL379 G2 Phoenix Pro Clamp-On Multimeter

- Dual display & low battery display lock
- Test lead storage & holder on clamp head
- Auto off
- Input jack lock
- Detachable clamp head
- Worklight
- Magnetic mount
- User temperature calibration
- EasyView high contrast backlight display
- Compatible with common industry accessories heads
- Safety compliance CAT III 600V, CAT II 1000V
- Includes:
 - Test leads
 - K-Type probe (no adapter required)
 - Zippered case
 - (2) AAA Batteries
- 3-Year limited warranty



Part #	Mfg #	Description	Price
UEIDL379	DL379	11 Functions Including -40° to 752°F Temperature (K-Type)	235.54

DL389 G2 Phoenix Pro+ Clamp-On Multimeter

- Dual display & low battery display lock
- Test lead storage & holder on clamp head
- Auto off
- Input jack lock
- Detachable clamp head
- Worklight
- Magnetic mount
- User temperature calibration
- EasyView high contrast backlight display
- Compatible with common industry accessories heads
- Safety compliance CAT III 600V, CAT II 1000V
- Includes:
 - Test leads
 - K-Type probe (no adapter required)
 - Zippered case
 - (2) AAA Batteries
- 3-Year limited warranty



Part #	Mfg #	Description	Price
UEIDL389	DL389	12 Functions Including TRUE-RMS (AC Volts & Amps)	310.80

Testing / Installation

Prices & Specifications are Subject to Change.

Testing/Installation

Thermometers - Infrared

INF155 Scout I Infrared Thermometer

- 10:1 Distance to spot ratio
- Maximum only, max value capture
- 60 Second hold
- Auto off
- 0.95 Fixed emissivity
- Auto shut-off at 15 seconds idle
- Backlit display
- Over-molded handle with comfort grip
- Low battery indicator
- Holster & carrying case
- 3-Year warranty



Part #	Mfg #	Description	Price
UEIINF155	INF155	-58° to 750°F Range	150.72

INF185 Scout II Infrared Thermometer

- 12:1 Distance to spot ratio
- White worklight
- Contact probe input (K-type)
- MIN/MAX, differential, average
- Hi/low Alarm (user adjustable)
- 60 Second hold
- Auto shut-off at 15 seconds idle
- Adjustable emissivity levels
- Backlit display
- Over-molded handle with comfort grip
- Low battery indicator
- Holster & carrying case
- 3-Year warranty



Part #	Mfg #	Description	Price
UEIINF185	INF185	-76° to 932°F Range	207.26

Digital Thermometers

PDT550 Digital Pen Type Thermometer

- Waterproof
- Built-in magnetic mount
- Records MIN/MAX temperatures
- Data hold
- Auto power off
- Easy access battery compartment
- Enhanced accuracy of digital circuitry
- Includes battery & multipurpose probe
- 3-Year limited warranty



Part #	Mfg #	Description	Price
UEIPDT550	PDT550	-58° to 572°F Range	37.62

550B Digital Pocket Thermometer

- Water resistant
- Records MIN/MAX temperatures
- Protective boot
- Magnetic mount
- HOLD freezes the current temp reading
- Auto power off
- Ergonomic designed head
- 3-Year limited warranty



Part #	Mfg #	Description	Price
UEI550	550B	-58° to 572°F Range	37.04

DT20A Dual Input Digital Thermometer

- Dual display
- Includes (2) replaceable and submersible metal probes
- Temperature range: -58° to 571°F (-50° to 300°C)
- High visibility backlit display
- 3-Year limited warranty



Part #	Mfg #	Description	Price
UEIDT20A	DT20A	-58° to 571°F Range	178.98

DT302 Apollo II Dual Input Digital Thermometer

- Dual thermocouple input
- Differential T1-T2
- -346° to 2192°F with J-type Thermocouples
- -328° to 2498°F with K-type Thermocouples
- Data logging
- 9999 Memory positions
- USB interface (software included)
- Thermocouple temperature offset
- Accepts J, K T and E type probes
- Includes:
 - (2) K-Type probes with lead wraps
 - (2) AAA Batteries
 - Quick start guide
 - Owners manual
- Safety compliance: CE certified, CAT 1 overvoltage & IP67 water submersion & high pressure dust resistance
- 5-Year limited warranty



Part #	Mfg #	Description	Price
UEIDT302	DT302	Dual Input Digital Logging	282.66

Testing/Installation

Temperature & Humidity Testers

DTH30 Pocket-Size Temperature & Humidity Tester

- Wet bulb temperature
- Dry bulb (ambient) temperature, dew point
- Relative Humidity (RH) from 00 to 99.9%
- Temperature in °F or °C 14 to 122°F (-10 to 50°C)
- Dual display (RH & temperature)
- MIN/MAX record f/all functions
- Data hold
- Sensor cover with pocket clip
- Includes 2 AAA batteries
- 1-Year limited warranty



Part #	Mfg #	Description	Price
UEIDTH30	DTH30	Pocket Size Dual	209.14

CO Detectors

CO91 Carbon Monoxide Analyzer

- Used to check ambient CO levels, find leaks or measure flue gas concentrations
- Simple to operate DMM style selector
- Temperature measurement
- Auto-zero at power up
- CO Max function recalls highest reading
- Infrared printer port



Part #	Mfg #	Description	Price
UEICO91	CO91	Carbon Monoxide Detector	923.56

CO71 "The CO Detective" Carbon Monoxide Monitor

- Tri-color LED indicates concentrations at 3 levels complying with residential and work place standards
- Audible alert triggers at 35 ppm indicating the threshold of dangerous concentration
- Backlight display
- Operating temperature: 32° to 104°F
- MAX Continually updates to provide recall of highest CO reading
- Auto zero activates upon turn on
- 9V Battery operated
- 3-Year limited warranty



Part #	Mfg #	Description	Price
UEICO71	CO71	Displays 0 to 999 ppm CO Level in Ambient Air	414.62

Leak Detectors

CD200 Combustion Leak Detector

- Visual leak detection by color coded LED's
- 50ppm Minimum detection
- Long 18" gooseneck
- Separate user adjustable alarm f/predetermined level detection
- Precision sensor detects smallest leaks
- Adjustable tick rate to locate leaks
- Fast response time of less than two seconds to 40% LEL
- Headphone jack
- 3-Year limited warranty



Part #	Mfg #	Description	Price
UEICD200	CD200	Gas Leak Detector	444.78

CD100A Combustible Gas Leak Detector

- Long 18" gooseneck for hard to reach areas
- Tip light in sensor cap illuminates search area
- Probe cage protects sensor
- Audio and visual tic rate fully adjustable
- Headphone jack
- Includes:
 - Sensor and cap
 - 9V Battery
- 1-Year limited warranty



Part #	Mfg #	Description	Price
UEICD100A	CD100A	50 ppm Minimum Detection	337.32

RLD15 Agent 1 Refrigerant Leak Detector

- Detects industry standard refrigerants
 - HFC - R-134a & R-410a (=> 0.05 oz/yr), R-404a, R407C, & R507
 - HCFC - R22 (=> 0.025 oz/yr)
 - CFC - R-12
 - Hydrocarbon blends
- Long life heated sensor technology
- Digital numeric leak size indicator
- Three sensitivity levels
- Visual LED leak alarms
- Splash resistant
- Automatic calibration and ambient level reset
- Includes:
 - (4) AA Batteries
 - Leak test vial
 - Hard carrying case, manual
- 3-Year limited warranty (includes sensor)



Part #	Mfg #	Description	Price
UEIRLD15	RLD15	Refrigerant Leak Detector	603.12

Testing / Installation

Prices & Specifications are Subject to Change.

Testing/Installation

EM151 Digital Electronic Manometer

- Single input measurement to $\pm 20"$ wg
- Integral protective boot w/magnet
- Simple two-button operation
- Measures in inches water gauge and Mbar
- Automatic after 5 minutes of inactivity & manual power-off
- Includes:
 - (1) Pressure tubes with brass fitting connector
 - (1) Std 9V battery
 - Manual
- 1-Year limited warranty



Part #	Mfg #	Description	Price
UEIEM151	EM151	Single Input Electronic Manometer	199.72

EM201 Dual Input Digital Electronic Manometer

- Dual input differential measurement to $\pm 40"$ wg
- MIN/MAX Value capture
- Data hold
- Backlit display
- Integral protective boot w/magnet
- Automatic & manual power-off
- Includes:
 - (2) Pressure tubes with brass fitting connector
 - (1) Std 9V battery
 - Manual
- 1-Year limited warranty



Part #	Mfg #	Description	Price
UEIEM201	EM201	Dual Input Electronic Manometer	348.64

SSM1 Super Heat/Sub Cool Meter

- Measures:
 - Pressure from 0 - 500 psia
 - Temperature from -40° to 400° F
- Calculates:
 - Superheat for low side
 - Subcool for high side (TXV systems)
- Refrigerants included for calculations: R-22, R-134a, R-404A, and R-410A



Part #	Mfg #	Description	Price
UEISSM1	SSM1	Super Heat/Sub Cool Meter	461.74

Airflow Meters

DAFM3 Digital Air Flow Meter

- Measures:
 - Temperature from -4 to 140° F
 - Air velocity from 1 to 114 ft/s
 - Relative humidity
- Calculates:
 - Dew point from -50 to 158° F
 - Wet bulb from -7.6 to 158° F
 - Volume from 0 to 99,999 CFM
- Protective twist cap
- Large LCD digital display
- Professional remote vane
- Powered by (4) AAA batteries
- Includes 9V battery, carrying case, manual
- 1-Year limited warranty



Part #	Mfg #	Description	Price
UEIDAFM3	DAFM3	Temperature & Air-Flow Meter w/Case	365.60

Accessories

Test Leads



Part #	Mfg #	Description	Price
UEIATL55	ATL55	Test Leads with Clips	20.64

ATL301KIT Test Lead Kit

- Includes
 - (1) Universal straight/right angle test lead extensions
 - (2) Insulated fine point tip leads
 - (Pr) Large jaw screw-on alligator clips
 - Remote grabber clips
 - Convenient carrying pouch
 - One year limited warranty



Part #	Mfg #	Description	Price
UEIATL301KIT	ATL301KIT	Test Lead Kit	58.34

K-Type Temperature Probes



Part #	Mfg #	Description	Price
UEIATT29A	ATT29A	4' Standard FDA Approved for DT200, DTO150, DL189, DL279, DL259, DL250 & TA2K	37.62



www.irrsupply.com

Testing/Installation

Combustion Analyzers

Smart Bell Combustion Analyzer

- Measures CO2 and flue temperature
- Real time analysis
- Direct CO2 measurements
- No sensor replacements
- Pre-programmed fuels include: light oil, propane, natural gas, heavy oil and wood
- Includes: probe, storage case, owner's manual and quick start guide



Part #	Mfg #	Description	Price
UEISMARTBELL	SMARTBELL	Combustion Analyzer	927.92

C75 Combustion Analyzer

- Measures: flue temperature, oxygen, and CO
- Calculates: CO, gross/net efficiency, excess air, CO air free
- Unique DMM style rotary selector
- Protective boot w/integral magnet
- Real-time clock
- Large 2-line backlit display
- Infrared printer port



Part #	Mfg #	Description	Price
UEIC75KIT	C75KIT	Analyzer w/ KMIRP2 Infrared Thermal Printer, Flue Probe, AC Adapter, Case & Filter	1658.72

Eagle 2X Xtended Life Combustion & System Analyzer Kit

- Includes:
 - C155 Combustion analyzer
 - Infrared thermal printer
 - Flue probe
 - (2) K-Type temperature probes
 - (2) Static pressure hoses
 - True draft probe
 - Gas pressure probe
 - AC Adapter
 - Hard carrying case
 - Thermal printer paper roll
 - Particle filter
- 5-Year limited warranty



Part #	Mfg #	Description	Price
UEIC155KIT	C155KIT	Combustion Analyzer Kit	2989.52

Testing / Installation

Prices & Specifications are Subject to Change.



www.irrsupply.com

Testing/Installation

Pipe Clamp Adapters

ATTPC Pipe Clamp & Surface Probe Adapter

- Works with any meter using K-type thermocouple inputs
- Velcro strap wraps around 1/4" to 3" pipe



Part #	Mfg #	Description	Price
UEIATTPC	ATT PC	Pipe Clamp Probe Assembly	94.16

ATTPC2 Pipe Clamp Adapter

- Works with any meter using K-type thermocouple inputs
- Measures 1/4" to 1-1/2" pipe
- Probe is thermally isolated from ambient temperatures for accuracy
- One year limited warranty



Part #	Mfg #	Description	Price
UEIATTPC2	ATTPC2	Quick Clamp Adapter	92.72

Replacement Parts & Supplies

Part #	Mfg #	Description	Price
UEI16646	16646	Replacement Printer Paper f/Combustion Analyzer Printer	21.60
UEI17631	17631	Replacement Filter f/C125 Combustion Analyzer Kit	15.00

Testing / Installation

Quality people, quality products, excellent service.

All Items May Not Be Stocked In All Branches



www.irrsupply.com

Testing/Installation

Refrigerant Analyzers

Refrigerant System Analyzer

- Comes with the TITAN™ 4-valve manifold
- External, replaceable vacuum sensor
- Blow-molded instrument case
- 84 NIST Refrigerant profiles included (upgradeable via USB for new refrigerants)
- Built-in pressure/temperature chart reference screen for all refrigerants
- Built-in full scale vacuum sensor reads deep vacuum down to 10 microns
- Dual "K-Type" temperature-compensated sensor ports allow for simultaneous section and liquid readings
- Provides real-time pressure data in selectable time increments: 0.1, 0.2, 0.5, 1 and 2 seconds
- Data logging for onscreen review or USB export to PC to generate performance/Excel™ work reports
- Highly weather resistant
- Fully gasketed for water and dust resistance
- Pressure sensing resolution (low and high sides):
 - 0.1 psi, 0.01 bar, 1 kPa, 0.1 MPA, 0.01 kg/cm²
- Pressure sensing accuracy:
 - 0.5% of Full scale at 25°C
 - 1% of Full scale at 55° to 130°F
 - 2% of Full scale -40° to 120°C
- Working pressure (maximum measurable pressure):
 - Low side: 0-350 psia
 - High side: 0-700 psia
- 2-Year warranty



Part #	Mfg #	Description	Price
RIT40815	40815	Operational Temperature -4° to 122°F (-20° to 50°C)	1806.56

SuperEvac™ Refrigerant Evacuation

SuperEvac™ Vacuum Pump

- 115V/60 Cycle voltage
- 2-Stage rotary vane evacuates quickly
- 15 Micron field blankoff
- 1/4" & 1/2" Male flare connections
- 1/2 hp, 1725 rpm Motor



Part #	Mfg #	CFM	Oil Cap	Dimensions	Price
RIT93560	93560	6.0	36	16.25"L x 6.75" x 12"H	862.88

SuperEvac™ Evacuation Manifold

- Flutterless™ gauge
- Non-restricting, full flow valves for fast vacuum
- Convenient 1/4-turn full flow
- Extra port for electronic gauge
- Includes step-down adapter to connect to 3/8" pump intake



Part #	Mfg #	Description	Price
RIT93860	93860	Two-Valve w/Low Side Gauge Mount w/1/2" Female Flare	278.70

Vacuum Gauges

SuperEvac™ LCD Vacuum Gauge

- Thermocouple sensor technology combined with advanced IC electronics not found with thermistor sensors or analog meters
- Accurate readings from atmosphere to 1 micron
- Compact design with case for sensor, cable and brass connector
- "D" Cell battery for approximate 70 hour battery life



Part #	Mfg #	Description	Price
RIT69075	69075	Atmosphere to 1 Micron Full Range, Case Included	644.96
RIT69073	69073	Replacement Sensor for 69070 Only	208.42

Digital Vacuum Gauge

- Displays 7 different units of vacuum (microns, milliTorr, Torr, millimeters of mercury, millibar, kiloPascal and Pascal)
- Cleanable, replaceable plug-in sensor automatically compensates for temperature with no calibration
- 12" Coiled sensor cord with 24" stretch
- 9V Alkaline battery



Part #	Mfg #	Description	Price
RIT69086	69086	Hand-Held Vacuum Gauge, Fabric Carry Pouch Included	441.18

Testing / Installation

Prices & Specifications are Subject to Change.



www.irrsupply.com

Testing/Installation

Digital LCD Economy Vacuum Gauge

- Gauge tracks 14 increments from atmosphere to 25 microns
- 9V Alkaline battery



Part #	Mfg #	Description	Price
RIT69080	69080	Vacuum Gauge with Battery, Hook & Pouch	314.16

Brute II™ 4-Valve Test & Charging Manifolds (°F & °C)

- Full 3/8" bore, forged aluminum alloy body
- Lighter than the original Brute™
- Fourth hose enables connection to hi/lo sides, refrigerant tank, and recovery unit or vacuum pump for diagnostics, evacuation and charging without switching hoses
- Double O-ring piston
- Exclusive 100-mesh filter in-line on all flare fittings
- Easy-grip color-coded handles
- Heavy-duty hook
- 3/8" Vacuum port



Brute II™ PSI Scale R-22, R-404A, R-410A - Red/Blue Gauges

Part #	Mfg #	Description	Price
RIT46010	46010	Manifold Only	331.68

TITAN™ 2-Valve Test & Charging Manifolds with Sight Glass (°F & °C)

- Forged aluminum alloy body makes this unit light weight
- Fourth hose to enable connection to hi-/lo-sides, refrigerant tank & recovery unit or vacuum pump for diagnostics, evacuation & charging without switching hoses
- 3/8" Vacuum port
- Front access for easy field recalibration



3-1/8" TITAN™ PSI Scales R-22, R-404A, R-410A - Red/Blue Gauges

Part #	Mfg #	Description	Price
RIT49863	49863	Manifold Only	217.70

Series 41 Manifolds

- Red and blue gauge cases
- Removable Lexan® crystals resist breakage
- Forged solid brass body for durability
- Full size metal valve handles for easy operation
- Hose anchors forged into back of body at 45°
- Heavy-duty swivel hook
- Flutterless™ technology for easier, more accurate readings
- Sliding double O-ring pistons
- Long-life nylon seat
- Yellow Jacket® charging hoses
- Basic unit includes manifold, gauges, hook and anchors



2-1/2" PSI Scales R-12, R-22 & R-502 less Hose

Part #	Mfg #	Description	Price
RIT42000	42000	Manifold Only, Clamshell	104.00

2-1/2" PSI Scales R-12, R-22 & R-502 - Original HA R/Y/B Hose

Part #	Mfg #	Description	Price
RIT41213	41213	Manifold with 36" Hoses	168.96

2-1/2" PSI Scales R-134a, R-404A & R-507 less Hose

Part #	Mfg #	Description	Price
RIT41312	41312	Manifold Only	108.20

Series 41 Manifolds with 3-1/8" Gauges

- Color-coded scales
- Sliding double O-ring pistons reduce wear
- Long life nylon seats
- Forged brass body for durability
- Full porting maximizes capacity and flow
- Some models include color-coded, 60" Plus II™ hoses with standard 1/4" flare fittings
- Hoses assemblies UL recognized for 4000 psi burst and 800 psi working pressure



3-1/8" PSI Scales R-22, R-404A & R-410A less Hose

Part #	Mfg #	Description	Price
RIT42001	42001	Manifold Only	121.60

Testing / Installation

All Items May Not Be Stocked In All Branches



www.irrsupply.com

Testing/Installation

Gauges

2-1/2" Class B Red & Blue Manifold Gauge

- Bold, high-visibility dials
- Colored temperature scales
- Flutterless™ technology
- 1/8" MPT Connection
- 3-2-3% Accuracy



2-1/2" Gauge (°F) for Gauge Scales R-12, R-22 & R-502

Part #	Mfg #	Description	Pressure Scale	Price
RIT49001	49001	Red Pressure	0-500 psi	30.58
RIT49002	49002*	Blue Compound	30"-0-120 psi	30.58

* Features retard protection to 350 psi

2-1/2" Gauge (°F) for Gauge Scales R-134a, R-507 & R-404A

Part #	Mfg #	Description	Pressure Scale	Price
RIT49051	49051	Red Pressure	0-500 psi	30.58
RIT49052	49052	Blue Compound	30"-0-120 psi	30.58

3-1/8" Dry Manifold Gauges - Large Red & Blue

- Flutterless™ technology with brass surge protector to minimize needle pulsation
- Brass gauge movement
- Copper gauge movement
- Copper alloy bourdon tube
- 1/8" MNPT Connection
- Calibrated to 1% accuracy
- Color-coded refrigerant types



3-1/8" Dry Manifold Gauge (°F) for Gauge Scales R-22, R-404A, R-410A

Part #	Mfg #	Description	Pressure Scale	Price
RIT49137	49137	Red Pressure	0-800 psi	42.48
RIT49138	49138**	Blue Compound	30"-0-300 psi	42.48

** Features retard protection to 500 psi

3-1/8" Dry Manifold Gauge (°F & °C) for Gauge Scales R-410A

Part #	Mfg #	Description	Pressure Scale	Price
RIT49135	49135	Red Pressure	0-800 psi	42.48
RIT49136	49136**	Blue Compound	30"-0-300 psi	42.48

** Features retard protection to 500 psi, psi/bar scale

3-1/2" Liquid-Filled Manifold Gauge (°F & °C) - Red & Blue

- Offset stem fits all major manifold brands
- No zero adjustment required
- 1/8" MNPT Connection
- Temperature rating of 0° to 122°F
- Calibrated to 1% Accuracy

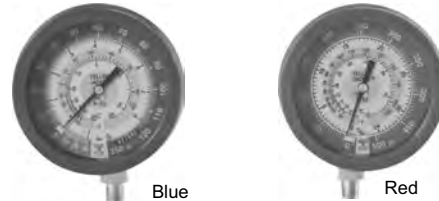

3-1/2" Liquid-Filled Gauge (°F) for Gauge Scales R-22 & R-410A

Part #	Mfg #	Description	Scale	Price
RIT49515	49515	Red Pressure	0-800 psi	99.28
RIT49516	49516	Blue Compound	30"-0-300 psi	99.28

Protective Gauge Boots

- Rubber
- Slip easily around gauges without covering recalibration screw
- Color-coded red or blue to match gauge



Part #	Mfg #	Description	Price
RIT49090	49090	Set of 2-1/2" Gauge Covers	20.74

1/4" Plus II™ Charging Hoses

1/4" Plus II™ Hose with Compact Ball Valve End

- Metal handle at end of hose fits tight areas and traps all gas
- Full flow valve
- Uses standard gasket and valve opener
- Burst pressure: 4000 psi
- Working pressure: 800 psi



Part #	Mfg #	Color	Length	Price
RIT29983	29983	R/Y/B	36"	190.70
RIT29985	29985	R/Y/B	60"	203.58

Prices & Specifications are Subject to Change.



www.irrsupply.com

Testing/Installation

Original 1/4" Charging Hoses

- Specially formulated rubber tube resists most refrigerants and assures long work life
- Blow-off groove channels refrigerant out of the front of the nut to help prevent spray back
- Hose cover pin-pricked to resist bubbling and bursting
- Minimum burst: 2500 psi
- Maximum working pressure: 500 psi



1/4" Original Hose with 1/4" Straight x 1/4" 45° Angle Brass Fittings 3/Packs

- Color-code:
 - Y = Yellow
 - B = Blue
 - W = White
 - R = Red



Part #	Mfg #	Model	Color	Length	Price
RIT11983	11983	HA36RYB	R/Y/B	36"	87.88
RIT11984	11984	HA48RYB	R/Y/B	48"	98.48
RIT11985	11985	HA60RYB	R/Y/B	60"	111.18
RIT11986	11986	HA72RYB	R/Y/B	72"	125.10

Vacuum/Charging Valves

1/4" 4-In-1 Vacuum/Charge Ball Valve & Core Tool

- Core replacement
- Extra 1/4" side port to attach electronic micron vacuum gauge right at system for greater accuracy
- Core removal access to evacuate and charge through an unrestricted line for increased speed and higher vacuum
- Core removal allows recovery unit to work at maximum efficiency, speeding the recovery process



Part #	Mfg #	Description	Price
RIT18975	18975	Vacuum/Charge Valve w/Side Port	108.14

Vacuum/Charging Ball Valve for Full Flow

- Straight flow-through valves connect hoses and provide full-flow capacity
- No angles for restriction or pressure drops
- Handle position shows when valve is open, securely closed, or anywhere in between



Part #	Mfg #	Connections	Price
RIT93844	93844	1/4" Male Flare x 1/4" Fe Flare	36.52

Access Fittings

Automotive R-134a A/C Economy Coupler Basic, Instant Flow Coupler



Part #	Mfg #	Description	Price
RIT41317	41317	Low-Side	60.10
RIT41318	41318	High-Side	60.10

Oil Pumps & Injectors

O-Ring Lubricant

- Lubricate O-rings in manifolds when pistons or O-rings are being replaced



Part #	Mfg #	Description	Price
RIT41118	41118	0.75 oz	19.02

Test Equipment

Superheat Calculation Kit

- Read from -58°F - 302°F
- Remove and replace broken Schraeder cores without opening system
- Chase damaged threads



Part #	Mfg #	Description	Price
RIT69104	69104	Superheat Kit & Accessories	245.70

Gas Pressure Test Kit

- Helps set manifold pressure for natural or LP gas
- Easier to use than a manometer
- Sensitive diaphragm gauge calibrated in inches of water column
- Tube nipple for easy connection to system manifold



Part #	Mfg #	Description	Price
RIT78055	78055	Complete Kit, 0 - 10"wc Range	114.10
RIT78060	78060	Complete Kit, 0 - 35"wc Range	112.70

Testing / Installation

All Items May Not Be Stocked In All Branches



www.irrsupply.com

Testing/Installation

Water-Type Manometer

- Helps set manifold pressure for natural or LP gas
- Economical plastic tube manometer
- Strong magnet on manometer holds it in convenient upright position
- Includes tubing with fitting



Part #	Mfg #	Description	Price
RIT78070	78070	-2" - 0 - 7-1/2" Scale	51.22
RIT78075	78075	-2" - 0 - 15" Scale	55.38

Horizontal Glass Tube Thermometer

- Hangs, stands, or permanently mount
- Magnifying lens
- Aluminum casing
- Dimensions: 1.3" x 5"
- NSF Certified



Part #	Mfg #	Temperature Range	Price
COI335	335	-40° to 80°F	10.34

Leak Detectors

AccuProbe™ Leak Detector

- Positively identifies lead source for all refrigerants
- Position probe for close-up or extended 18" detection
- Replaceable filters
- Sensor failure mode
- Automatic calibration
- Includes lead standard bottle of non-ozone depleting chemical
- 2-Year limited warranty (1-year on sensor)
- Sensor not poisoned by large amount of refrigerant



Part #	Mfg #	Description	Price
RIT69365	69365	AccuProbe Electronic Hand-Held with Heated Sensor Tip	840.42

Remote Vapor Tension Refrigerator/Freezer Thermometers

Front Flange, Back Connect Panel Thermometer

- 2" Dial, flush-mount
- (3) 0.156" Diameter mounting holes equally spaced on 2.645" diameter bolt circle
- 48" Capillary length except where noted
- NSF Certified



Part #	Mfg #	Temperature Range	Price
COI614220	6142-20	-40° to 60°F	48.96

Strap Hang, Bottom Connect Panel Thermometer

- 2" Dial
- 48" Capillary length



Part #	Mfg #	Temperature Range	Price
COI664206	6642-06	-40° to 60°F	48.00



Refrigerator/Freezer Thermometers

Professional Refrigerator/Freezer/Dry Storage Thermometer

- 2" Dial, hangs or stands
- HACCP Reference dial
- Includes dry storage range
- Stainless steel construction
- NSF Certified



Part #	Mfg #	Temperature Range	Price
COI25HP	25HP	-20° to 80°F	11.48

Thermistor Series Thermometers

Electronic Panel Thermometer

- Bright easy to read LED display
- Dual set point, high/low internal audio/visual alarm
- AA Battery operated
- 1-Year warranty



Part #	Mfg #	Temperature Range	Price
COIPM120	PM120	-40° to 122°F	48.80

Testing / Installation

Prices & Specifications are Subject to Change.

Testing/Installation

Industrial Multi-Zone Temperature Tester

- Minimum/maximum records highest and lowest temperatures
- Scan feature stores data from all 3 probes
- Auto shut-off with override option
- Backlit for dark environments
- Includes:
 - 1075 General purpose probe
 - 2010 Air probe
 - 4011 Surface probe
 - Battery eliminator jack
 - Sealed membrane touchpad
 - Polyethylene storage case
 - 9V Alkaline battery



Part #	Mfg #	Temperature Range	Price
COISH66A	SH66A	-40° to 300°F	479.80

Thermistor Probes

- 1-Year warranty

2010 Air Probe

- Maximum cable temperature: 200°F
- 6' Cable



Part #	Mfg #	Temperature Range	Price
COI2010	2010	-40° to 200°F	62.86

4011 Fast Surface Contact Probe

- Maximum cable temperature: 200°F
- 12' Polyurethane straight cable
- Pipe Strap with Velcro for SRH77A, SH88A & SH66A



Part #	Mfg #	Temperature Range	Price
COI4011	4011	-25° to 212°F	96.96

Easy Access Pressure Tester

Part #	Mfg #	Description	Price
ACYT90	T90	0-200 psi	77.56

Digital Capacitor Tester

- Includes 9V battery & test leads
- Low batter indicator



Part #	Mfg #	Description	Price
CAPTEST	65746	Digital Capacitor Tester	154.32



D-Tek™ Select Refrigerant Leak Detector

- Sensitive to all refrigerants
- 0.10 oz/year Minimum sensitivity
- 800-Hour infrared cell life
- Rechargeable NiMH power stick
- Charging status indicator
- Sensor failure indication
- 2-Year replacement warranty
- Base unit includes:
 - Infrared cell
 - NiMH batteries
 - Spare filters
 - 120V Adapter w/6' cord
 - 12V Adapter w/cigarette lighter plug
 - Hard plastic carrying case



Part #	Mfg #	Description	Price
LEIDTEKS	712-202-G1	120V Base Unit	739.00

D-Tek™ Accessories

Part #	Mfg #	Description	Price
LEISENSOR	703-020-G1	Replacement Sensor	87.16
LEIBATTERY	703-057-G1	Replacement NiCd Power Cells (3/Set)	102.90
LEI712700G1	712-700-G1	Replacement NiMH Power Stick	88.74
LEICELL	712-701-G1	Infrared Cell	170.10

Tek-Mate® Refrigerant Leak Detector

- 0.4oz/Year sensitivity to CFCs, HCFCs & HFCs
- Variable-intensity audible signal & single flashing LED to help pinpoint leaks
- Automatically compensates for changing background contamination
- 2-Year warranty
- Base unit includes:
 - Sensor
 - 2 D-size alkaline batteries
 - Spare filters
 - Hard plastic carrying case



Part #	Mfg #	Description	Price
LEITEKMATE	705-202-G1	Base Unit	336.20

Tek-Mate® Accessories

Part #	Mfg #	Description	Price
LEIFILTER	705-600-G1	Filter Kit	30.46

Testing / Installation

All Items May Not Be Stocked In All Branches

Sheet Metal

Flat Sheet Steel



Part #	Gauge	Size	Price
ACMSHEETMETAL28	28	3' x 8'	52.46
ACMSHEETMETAL26	26	3' x 8'	56.82

Galvanized Sheet Metal Pipes

Buttonlock Pipe



Part #	Size and Gauge	Price
ACMP3-2430	3" x 24" 30 Ga	4.90
ACMP3-2426	3" x 24" 26 Ga	5.50
ACMP3-6030	3" x 60" 30 Ga	15.32
ACMP4-2430	4" x 24" 30 Ga	5.52
ACMP4-2426	4" x 24" 26 Ga	6.62
ACMP4-6030	4" x 60" 30 Ga	12.24
ACMP4-6026	4" x 60" 26 Ga	19.50
ACMP5-2430	5" x 24" 30 Ga	5.80
ACMP5-2426	5" x 24" 26 Ga	8.26
ACMP5-6030	5" x 60" 30 Ga	12.62
ACMP5-6026	5" x 60" 26 Ga	21.56
ACMP6-2430	6" x 24" 30 Ga	5.06
ACMP6-2426	6" x 24" 26 Ga	7.80
ACMP6-2424	6" x 24" 24 Ga	12.74
ACMP6-6030	6" x 60" 30 Ga	10.62
ACMP6-6026	6" x 60" 26 Ga	22.12
ACMP6-12030	6" x 120" 30 Ga	23.72
ACMP7-2430	7" x 24" 30 Ga	8.08
ACMP7-2426	7" x 24" 26 Ga	10.36
ACMP7-2424	7" x 24" 24 Ga	13.80
ACMP7-6030	7" x 60" 30 Ga	17.26
ACMP7-6026	7" x 60" 26 Ga	25.72
ACMP8-2430	8" x 24" 30 Ga	8.48
ACMP8-2426	8" x 24" 26 Ga	11.44
ACMP8-2424	8" x 24" 24 Ga	15.64
ACMP8-6030	8" x 60" 30 Ga	16.72
ACMP8-6026	8" x 60" 26 Ga	28.48
ACMP9-2430	9" x 24" 30 Ga	11.18
ACMP9-2426	9" x 24" 26 Ga	14.66
ACMP9-6030	9" x 60" 30 Ga	23.72
ACMP9-6026	9" x 60" 26 Ga	33.58
ACMP10-2430	10" x 24" 30 Ga	11.82

Galvanized Sheet Metal Pipes (Continued)
Buttonlock Pipe

Part #	Size and Gauge	Price
ACMP10-2426	10" x 24" 26 Ga	15.76
ACMP10-6030	10" x 60" 30 Ga	24.40
ACMP10-6026	10" x 60" 26 Ga	35.52
ACMP12-2430	12" x 24" 30 Ga	14.88
ACMP12-2426	12" x 24" 26 Ga	18.22
ACMP12-6030	12" x 60" 30 Ga	36.60
ACMP12-6026	12" x 60" 26 Ga	44.32
ACMP14-2426	14" x 24" 26 Ga	23.16
ACMP16-2426	16" x 24" 26 Ga	27.74
ACMP18-2426	18" x 24" 26 Ga	33.26
ACMP20-2426	20" x 24" 26 Ga	39.98

Sheet Metal Fittings

Galvanized Round Fittings

Galvanized Adjustable 90° Elbow 30 Gauge



Part #	Size	Price
ACM90330	3"	3.88
ACM90430	4"	3.88
ACM90530	5"	4.00
ACM90630	6"	3.42
ACM90730	7"	4.84
ACM90830	8"	5.34
ACM90930	9"	12.26
ACM901030	10"	13.32
ACM901230	12"	16.82

Galvanized Adjustable 90° Elbow 26 Gauge



Part #	Size	Price
ACM90326	3"	5.16

Prices & Specifications are Subject to Change.

Sheet Metal

Sheet Metal Fittings

Galvanized Round Fittings (Continued)
Galvanized Adjustable 90° Elbow 26 Gauge

Part #	Size	Price
ACM90426	4"	5.42
ACM90526	5"	6.28
ACM90626	6"	6.38
ACM90726	7"	8.40
ACM90826	8"	10.08
ACM90926	9"	14.20
ACM901026	10"	16.20
ACM901226	12"	19.94
ACM901426	14"	28.30
ACM901626	16"	46.90
ACM901826	18"	55.30

Galvanized Adjustable 90° Elbow 24 Gauge



Part #	Size	Price
ACM90624	6"	11.32
ACM90724	7"	13.32
ACM90824	8"	15.08

Galvanized Perimeter Tee - No Crimp

Part #	Size	Price
ACMPT6	6"	24.84
ACMPT7	7"	26.52
ACMPT8	8"	30.68

Airflow Tees - No Crimp



Part #	Size and Gauge	Price
ACMT3	3" 26 Ga	25.16

Galvanized Round Fittings (Continued)
Airflow Tees - No Crimp

Part #	Size and Gauge	Price
ACMT4	4" 26 Ga	25.16
ACMT5	5" 26 Ga	26.22
ACMT6	6" 26 Ga	29.00
ACMT7	7" 26 Ga	31.40
ACMT8	8" 26 Ga	36.92
ACMT9	9" 26 Ga	45.84
ACMT10	10" 26 Ga	52.12
ACMT12	12" 26 Ga	67.50

Reducing Tees 90° - No Crimp

Part #	Size and Gauge	Price
ACMT4-3	4" x 4" x 3" 90° 26ga	26.64
ACMT5-3	5" x 5" x 3" 90° 26ga	27.74
ACMT5-4	5" x 5" x 4" 90° 26ga	27.74
ACMT6-3	6" x 6" x 3" 90° 26ga	31.68
ACMT6-4	6" x 6" x 4" 90° 26ga	31.68
ACMT6-5	6" x 6" x 5" 90° 26ga	31.68
ACMT7-5	7" x 7" x 5" 90° 26ga	33.14
ACMT7-6	7" x 7" x 6" 90° 26ga	42.16
ACMT8-6	8" x 8" x 6" 90° 26ga	39.10

Tee Cap - No Crimp



Part #	Size	Price
ACMCAP3	3"	7.80
ACMCAP4	4"	7.80
ACMCAP5	5"	7.80
ACMCAP6	6"	7.80
ACMCAP7	7"	9.20
ACMCAP8	8"	10.24
ACMCAP9	9"	11.24
ACMCAP10	10"	11.94
ACMCAP12	12"	12.92
ACMCAP14	14"	16.98
ACMCAP16	16"	19.04
ACMCAP18	18"	50.34

All Items May Not Be Stocked In All Branches

Sheet Metal

Tee Cap - Crimped



Part #	Size	Price
ACMCAPC6	6"	8.02
ACMCAPC8	8"	10.24

Increaser/Reducer - No Crimp



Part #	Size	Price
ACMIR4-3	3" x 4"	8.48
ACMIR5-3	3" x 5"	10.08
ACMIR6-3	3" x 6"	10.26
ACMIR7-3	3" x 7"	11.76
ACMIR8-3	3" x 8"	12.76
ACMIR5-4	4" x 5"	9.78
ACMIR6-4	4" x 6"	10.26
ACMIR7-4	4" x 7"	11.76
ACMIR8-4	4" x 8"	12.76
ACMIR6-5	5" x 6"	10.26
ACMIR7-5	5" x 7"	11.76
ACMIR8-5	5" x 8"	12.76
ACMIR9-5	5" x 9"	14.60
ACMIR7-6	6" x 7"	11.40
ACMIR8-6	6" x 8"	12.40
ACMIR9-6	6" x 9"	14.60
ACMIR10-6	6" x 10"	15.08
ACMIR12-6	6" x 12"	16.82
ACMIR8-7	7" x 8"	12.76
ACMIR9-7	7" x 9"	14.60
ACMIR10-7	7" x 10"	15.08
ACMIR9-8	8" x 9"	14.60
ACMIR10-8	8" x 10"	15.08
ACMIR12-8	8" x 12"	16.82
ACMIR10-9	9" x 10"	15.08
ACMIR12-9	9" x 12"	16.82
ACMIR12-10	10" x 12"	16.82
ACMIR14-10	10" x 14"	18.54
ACMIR14-12	12" x 14"	18.54

Tee Wye Joint - Crimp Inlet



Part #	Size	Price
ACMY4-3	4" x 3" x 3"	31.12
ACMY5-4-3	5" x 4" x 3"	30.18
ACMY5-4-4	5" x 4" x 4"	38.44
ACMY5-3	5" x 5" x 3"	31.12
ACMY5-4	5" x 5" x 4"	31.12
ACMY5	5" x 5" x 5"	31.12
ACMY6-4-3	6" x 4" x 3"	31.12
ACMY6-5-3	6" x 5" x 3"	31.12
ACMY6-5-4	6" x 5" x 4"	32.18
ACMY6-3	6" x 6" x 3"	32.18
ACMY6-4	6" x 6" x 4"	40.00
ACMY6	6" x 6" x 6"	32.18
ACMY8-6-6	8" x 6" x 6"	44.10

Sheet Metal Fittings

Plenums & Return Air Drops

Slip & Drive Cold Air Drop

Part #	Size	Price
BUBACMSD20-8	16" x 20" - 20" x 8"	110.60
BUBACMSD24-8	16" x 24" - 24" x 8"	123.16

Cold Air Drop Complete Package



Part #	Size	Price
BUBACM20-8	16" x 20" - 20" x 8"	228.44
BUBACM24-8	16" x 24" - 24" x 8"	269.04
BUBACM25-10	16" x 25" - 25" x 10"	260.16

Prices & Specifications are Subject to Change.

Sheet Metal

Sheet Metal Fittings

Cold Air Drop Shoe



Part #	Size	Price
ACMSHOE14-16-16-8	14" x 16" - 16" x 8"	126.56
ACMSHOE14-20-20-8	14" x 20" - 20" x 8"	133.82
ACMSHOE14-24-24-8	14" x 24" - 24" x 8"	141.62
ACMSHOE16-20-20-8	16" x 20" - 20" x 8"	138.16
ACMSHOE16-24-24-8	16" x 24" - 24" x 8"	141.62
ACMSHOE16-25-24-8	16" x 25" - 24" x 8"	148.08

Cold Air Boot



Part #	Size	Price
BUB18-8	18" x 8"	81.48
BUB20-8	20" x 8"	90.96
BUB24-8	24" x 8"	94.44
BUB24-10	24" x 10"	110.18

Cold Air Adapter Boot

Part #	Description	Price
BUB240024-8	24" x 8" f/2400 Spaceguard	94.44
BUB240024-10	24" x 10" f/2400 Spaceguard	106.62
BUB240024-12	24" x 12" f/2400 Spaceguard	117.60
BUB500024-8	24" x 8" f/Aprilaire 5000	94.44
BUB500024-10	24" x 10" f/Aprilaire 5000	106.62
BUB220020-8	20" x 8" f/New 2200 Spaceguard	90.96
BUB220024-8	24" x 8" f/New 2200 Spaceguard	94.44
BUB220024-10	24" x 10" f/New 2200 Spaceguard	110.18

Buffalo Boot

Part #	Description	Price
BUBOS20-8	20" x 8" Old Style Short Neck	83.70
BUBOS20-10	20" x 10" Old Style Short Neck	82.62
BUBOS24-8	24" x 8" Old Style Short Neck	94.16
BUBOS24-10	24" x 10" Old Style Short Neck	90.90
BUBOS24-12	24" x 12" Old Style Short Neck	101.20

Return Air Support Boxes



Part #	Size	Price
ACMRETBOXH30-28-10	30" x 28" x 10" Horizontal	132.48
ACMRETBOXH38-28-10	38" x 28" x 10" Horizontal	121.18

Takeoffs

Top Takeoffs



Part #	Size	Price
ACMTONADJ6	6"	8.98

Double Top Takeoffs



Part #	Size	Price
ACMTOD6	7" x 9" - 6"	37.70

Adjustable Takeoff with 2" Rise



Part #	Size	Price
ACMTOADJ4	4" x 6" - 4"	13.24
ACMTOADJ5	5" x 7" - 5"	12.76
ACMTOADJ6	6" x 8" - 6"	10.62
ACMTOADJ7	7" x 8" - 7"	15.98
ACMTOADJ8	8" x 9" - 8"	16.86
ACMTOADJ10	8" x 14" -10"	39.50

All Items May Not Be Stocked In All Branches

Sheet Metal

**Adjustable Takeoff
Round To Round Full Tab**



Part #	Size	Price
ACMTOR6	6"	11.18
ACMTOR7	7"	16.82

**Self Adhesive Top Takeoff
with Damper**



Part #	Size	Price
ACMTOTADHD	6"	17.38

**Square to Round Self-Adhesive
Takeoffs**



Part #	Size	Price
ACMTOADH6	6"	11.92

**Square to Round Self Adhesive
Takeoffs with Damper**



Part #	Size	Price
ACMTOADHD6	6"	15.66

**Round Self-Adhesive
Pipe Takeoffs with Damper**



Part #	Size	Price
ACMTORADHD6	6"	16.92
ACMTORADHD8	8"	20.60

**Self Adhesive Adjustable
Top Takeoff**



Part #	Size	Price
ACMTOADHADJ6	6"	19.16

**Collars & Spin Fittings
Start Collar No Crimp**



Part #	Size	Price
ACMSC3	3"	3.06
ACMSC4	4"	3.06
ACMSC5	5"	3.06
ACMSC6	6"	2.96
ACMSC7	7"	3.52
ACMSC8	8"	3.72
ACMSC9	9"	4.24

Top Collar - Crimped



Part #	Size	Price
ACMSCC3	3" Crimped	3.06
ACMSCC4	4" Crimped	2.90
ACMSCC5	5" Crimped	2.90
ACMSCC6	6" Crimped	3.06
ACMSCC7	7" Crimped	3.22
ACMSCC8	8" Crimped	3.84
ACMSCC9	9" Crimped	4.24
ACMSCC10	10" Crimped	4.56
ACMSCC12	12" Crimped	5.34
ACMSCC14	14" Crimped	6.80
ACMSCC16	16" Crimped	9.20

Sheet Metal Fittings

Prices & Specifications are Subject to Change.

Sheet Metal

Sheet Metal Fittings

Starting Collar with Damper



Part #	Size	Price
ACMSCD6	6"	12.66
ACMSCD7	7"	13.98
ACMSCD8	8"	17.04

Long Tab Collars with Damper



Part #	Size	Price
ACMSCL6	6" with Damper	3.34
ACMSCL7	7" with Damper	4.12
ACMSCL8	8" with Damper	4.62
ACMSCL10	10" with Damper	6.68
ACMSCL12	12" with Damper	7.68
ACMSCL14	14" with Damper	10.26
ACMSCL16	16" with Damper	14.20
ACMSCL18	18" with Damper	18.10

Duct Board Collars less Damper



Part #	Size	Price
ACMDBTAB6	6"	5.84
ACMDBTAB8	8"	7.76
ACMDBTAB10	10"	11.20
ACMDBTAB12	12"	13.08

Duct Board Collars with Damper



Part #	Size	Price
ACMDBTABD6	6"	12.76

Collars & Spin Fittings (Continued)

Duct Board Collars with Damper

Part #	Size	Price
ACMDBTABD8	8"	16.04

1.5" Duct Board Takeoff Collar with Damper

Part #	Size	Price
ACMDBTABD6112	6"	15.98
ACMDBTABD8112	8"	20.04

Duct Board Spin-In Collars less Damper



Part #	Size	Price
ACMDBSPIN6	6"	11.80

Duct Board Spin-In Collars with Damper



Part #	Size	Price
ACMDBSPIND6	6"	17.82

Duct & Fittings

S and D Duct 3 Ft



Part #	Size	Price
ACMSDD20-8-36	20" x 8"	44.10

All Items May Not Be Stocked In All Branches

Sheet Metal

S and D Duct 4 Ft



Part #	Size	Price
ACMSDD10-8-48	10" x 8"	31.40
ACMSDD12-8-48	12" x 8"	34.92
ACMSDD14-8-48	14" x 8"	38.16
ACMSDD16-8-48	16" x 8"	43.04
ACMSDD18-8-48	18" x 8"	46.34
ACMSDD20-8-48	20" x 8"	49.28
ACMSDD22-8-48	22" x 8"	56.92
ACMSDD24-8-48	24" x 8"	56.94

S and D Duct 5 Ft



Part #	Size	Price
ACMSDD8-8-60	8" x 8"	34.18
ACMSDD10-8-60	10" x 8"	38.98
ACMSDD12-8-60	12" x 8"	41.20
ACMSDD14-8-60	14" x 8"	47.56
ACMSDD16-8-60	16" x 8"	53.72
ACMSDD18-8-60	18" x 8"	57.86
ACMSDD20-8-60	20" x 8"	61.54
ACMSDD20-10-60	20" x 10"	84.88
ACMSDD24-8-60	24" x 8"	73.44
ACMSDD24-10-60	24" x 10"	100.70

Duct



Part #	Size	Price
ACMD8-8-36	8" x 8" - 36"	24.68
ACMD8-8-60	8" x 8" - 60"	34.18
ACMD10-8-36	10" x 8" - 36"	28.34
ACMD10-8-60	10" x 8" - 60"	37.82
ACMD12-8-36	12" x 8" - 36"	30.76
ACMD12-8-60	12" x 8" - 60"	36.76

Duct & Fittings (Continued)

Duct

Part #	Size	Price
ACMD14-8-36	14" x 8" - 36"	34.14
ACMD14-8-60	14" x 8" - 60"	41.18
ACMD16-8-36	16" x 8" - 36"	36.18
ACMD16-8-60	16" x 8" - 60"	46.50
ACMD18-8-36	18" x 8" - 36"	40.12
ACMD18-8-60	18" x 8" - 60"	56.14
ACMD20-8-36	20" x 8" - 36"	38.16
ACMD20-8-60	20" x 8" - 60"	54.90
ACMD22-8-36	22" x 8" - 36"	46.06
ACMD22-8-60	22" x 8" - 60"	71.18
ACMD24-8-36	24" x 8" - 36"	42.38
ACMD24-8-60	24" x 8" - 60"	63.54
ACMD24-10-36	24" x 10" - 36"	51.08
ACMD24-10-60	24" x 10" - 60"	100.70
ACMD24-12-36	24" x 12" - 36"	71.44
ACMD30-8-36	30" x 8" - 36"	68.56

S and D Straight Starting Collar



Part #	Size	Price
ACMSDSC10-8	10" x 8"	12.48
ACMSDSC12-8	12" x 8"	13.32
ACMSDSC14-8	14" x 8"	13.68
ACMSDSC16-8	16" x 8"	14.46
ACMSDSC18-8	18" x 8"	15.66
ACMSDSC20-10	20" x 10"	16.86

Straight Starting Collar - Knockdown



Part #	Size	Price
ACMSC8-8	8" x 8"	11.98
ACMSC20-8	20" x 8"	16.20
ACMSC22-8	22" x 8"	16.86
ACMSC24-8	24" x 8"	17.90
ACMSC24-10	24" x 10"	23.66
ACMSC24-12	24" x 12"	31.86

Sheet Metal Fittings

Prices & Specifications are Subject to Change.

Sheet Metal

Sheet Metal Fittings

S and D Offset Takeoff Collar



Part #	Size	Price
ACMSDSCO8-8	8" x 8"	30.20
ACMSDSCO16-8	16" x 8"	35.08
ACMSDSCO18-8	18" x 8"	36.54
ACMSDSCO20-8	20" x 8"	36.92
ACMSDSCO24-8	24" x 8"	40.20

Transition Take Off Collar Center



Part #	Plenum Size - Duct Size	Price
ACMSCTR14-8	14" x 8" - 12" x 10"	39.20
ACMSCTR16-8	16" x 8" - 10" x 13"	43.22
ACMSCTR18-8	18" x 8" - 12" x 12"	45.06
ACMSCTR20-8	20" x 8" - 18" x 10"	46.60
ACMSCTR22-8	22" x 8" - 18" x 10"	50.86
ACMSCTR24-8	24" x 8" - 20" x 10"	59.82

Offset Takeoff Collar



Part #	Size	Price
ACMSCO8-8	8" x 8"	27.28
ACMSCO10-8	10" x 8"	30.64
ACMSCO12-8	12" x 8"	31.26
ACMSCO14-8	14" x 8"	33.24
ACMSCO16-8	16" x 8"	35.08
ACMSCO18-8	18" x 8"	36.54
ACMSCO20-8	20" x 8"	36.92
ACMSCO22-8	22" x 8"	39.38
ACMSCO24-8	24" x 8"	40.20

S and D 45° Vertical Shortway Angle



Part #	Size	Price
ACMSDS458-8	8" x 8"	24.26
ACMSDS4510-8	10" x 8"	24.40
ACMSDS4512-8	12" x 8"	26.72
ACMSDS4514-8	14" x 8"	27.28
ACMSDS4516-8	16" x 8"	28.12
ACMSDS4518-8	18" x 8"	30.34
ACMSDS4520-8	20" x 8"	32.32
ACMSDS4524-8	24" x 8"	36.32
ACMSDS4524-10	24" x 10"	71.08

S and D Transition Take Off Collar Center



Part #	Plenum Size - Duct Size	Price
ACMSDSTR14-8	10" x 12" - 14" x 8" Center	48.66
ACMSDSTR16-8	10" x 13" - 16" x 8" Center	50.34
ACMSDSTR18-8	10" x 15" - 18" x 8" Center	56.92
ACMSDSTR20-8	10" x 16" - 20" x 8" Center	59.86
ACMSDSTR24-8	10" x 20" - 24" x 8" Center	71.24

45° Vertical Shortway Angle



Part #	Size	Price
ACMS458-8	8" x 8"	24.26
ACMS4510-8	10" x 8"	24.40
ACMS4512-8	12" x 8"	26.40
ACMS4514-8	14" x 8"	27.28
ACMS4516-8	16" x 8"	28.12
ACMS4518-8	18" x 8"	30.34
ACMS4520-8	20" x 8"	32.32

All Items May Not Be Stocked In All Branches

Sheet Metal

Sheet Metal Fittings

Duct & Fittings (Continued)

45° Vertical Shortway Angle

Part #	Size	Price
ACMS4522-8	22" x 8"	33.98
ACMS4524-8	24" x 8"	36.32

S and D 45° Horizontal Longway Angle



Part #	Size	Price
ACMSDL4510-8	10" x 8"	28.30
ACMSDL4512-8	12" x 8"	29.14
ACMSDL4514-8	14" x 8"	33.14
ACMSDL4516-8	16" x 8"	36.32
ACMSDL4520-8	20" x 8"	44.16
ACMSDL4524-8	24" x 8"	53.36

45° Horizontal Longway Angle



Part #	Size	Price
ACML4510-8	10" x 8"	26.80
ACML4512-8	12" x 8"	29.14
ACML4514-8	14" x 8"	33.14
ACML4516-8	16" x 8"	36.32
ACML4518-8	18" x 8"	39.92
ACML4520-8	20" x 8"	44.16
ACML4522-8	22" x 8"	47.62
ACML4524-8	24" x 8"	53.36

S and D 90° Vertical Shortway Elbow



Part #	Size	Price
ACMSDS9010-8	10" x 8"	30.64

Duct & Fittings (Continued)

S and D 90° Vertical Shortway Elbow

Part #	Size	Price
ACMSDS9012-8	12" x 8"	32.20
ACMSDS9014-8	14" x 8"	34.40
ACMSDS9016-8	16" x 8"	37.46
ACMSDS9020-8	20" x 8"	43.28
ACMSDS9024-8	24" x 8"	49.10
ACMSDS9024-10	24" x 10"	76.18

90° Vertical Shortway Elbow



Part #	Size	Price
ACMS908-8	8" x 8"	29.46
ACMS9010-8	10" x 8"	30.64
ACMS9012-8	12" x 8"	32.20
ACMS9014-8	14" x 8"	34.40
ACMS9016-8	16" x 8"	37.46
ACMS9018-8	18" x 8"	40.66
ACMS9020-8	20" x 8"	43.28
ACMS9022-8	22" x 8"	47.50
ACMS9024-8	24" x 8"	49.10
ACMS9024-10	24" x 10"	60.92

S and D 90° Horizontal Longway Elbow



Part #	Size	Price
ACMSDL908-8	8" x 8"	33.02
ACMSDL9010-8	10" x 8"	35.02
ACMSDL9012-8	12" x 8"	40.04
ACMSDL9014-8	14" x 8"	44.76
ACMSDL9016-8	16" x 8"	48.50
ACMSDL9018-8	18" x 8"	55.86
ACMSDL9020-8	20" x 8"	60.26
ACMSDL9024-8	24" x 8"	77.86

Prices & Specifications are Subject to Change.

Sheet Metal

Sheet Metal Fittings

90° Horizontal Longway Elbow

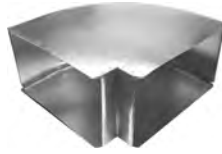

Part #	Size	Price
ACML908-8	8" x 8"	31.80
ACML9010-8	10" x 8"	34.64
ACML9012-8	12" x 8"	39.98
ACML9014-8	14" x 8"	44.76
ACML9016-8	16" x 8"	48.50
ACML9018-8	18" x 8"	55.56
ACML9020-8	20" x 8"	60.26
ACML9022-8	22" x 8"	70.26
ACML9024-8	24" x 8"	77.86

Slide & Drive Duct Outside End Cap



Part #	Size	Price
ACMSDCAPO8-8	8" x 8" Outside	7.14
ACMSDCAPO10-8	10" x 8" Outside	7.36
ACMSDCAPO12-8	12" x 8" Outside	7.48
ACMSDCAPO14-8	14" x 8" Outside	7.64
ACMSDCAPO16-8	16" x 8" Outside	8.08
ACMSDCAPO18-8	18" x 8" Outside	8.64
ACMSDCAPO20-8	20" x 8" Outside	8.74
ACMSDCAPO24-8	24" x 8" Outside	10.54

Duct End Cap



Part #	Size	Price
ACMCAPI8-8	8" x 8" Inside	7.20
ACMCAPI10-8	10" x 8" Inside	7.40
ACMCAPI12-8	12" x 8" Inside	7.64
ACMCAPI14-8	14" x 8" Inside	8.24
ACMCAPI16-8	16" x 8" Inside	8.70
ACMCAPI18-8	18" x 8" Inside	9.02
ACMCAPI20-8	20" x 8" Inside	9.50
ACMCAPI22-8	22" x 8" Inside	10.64
ACMCAPI24-8	24" x 8" Inside	11.04
ACMCAPI24-10	24" x 10" Inside	16.88
ACMCAPI30-8	30" x 8" Inside	17.16
ACMCAPO8-8	8" x 8" Outside	7.14
ACMCAPO10-8	10" x 8" Outside	7.36
ACMCAPO12-8	12" x 8" Outside	7.26
ACMCAPO14-8	14" x 8" Outside	7.64
ACMCAPO16-8	16" x 8" Outside	7.82
ACMCAPO18-8	18" x 8" Outside	8.64
ACMCAPO20-8	20" x 8" Outside	8.48
ACMCAPO22-8	22" x 8" Outside	10.38
ACMCAPO24-8	24" x 8" Outside	10.54
ACMCAPO24-10	24" x 10" Outside	11.36
ACMCAPO30-8	30" x 8" Outside	22.50

Duct Adapter/Side Reducer



Part #	Size	Price
ACMSDRED2	2" x 8"	8.18
ACMSDRED4	4" x 8"	9.20
ACMSDRED6	6" x 8"	9.14
ACMSDRED8	8" x 8"	9.84

Duct Adapter/Side Reducer



Part #	Size	Price
ACMRED2	2"	8.18
ACMRED4	4"	9.20
ACMRED6	6"	9.14
ACMRED8	8"	9.84
ACMRED10	10"	18.84

All Items May Not Be Stocked In All Branches

Sheet Metal

Galvanized Panning

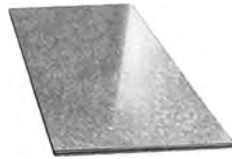

Part #	Size	Price
ACMPAN1	16-1/2" x 30" 30 Ga	8.02
ACMPAN2	33" x 30" 30 Ga	16.04

Drive Cleat



Part #	Size	Price
ACMDCLEAT120	120"	10.30

S Cleat - Flat



Part #	Size	Price
ACMSCLEAT36	1" x 36"	3.38
ACMSCLEAT48	1" x 48"	4.30
ACMSCLEAT60	1" x 60"	4.28
ACMSCLEAT120	1" x 120"	12.02

Wall Stack Boots & Fittings

24" Wall Stack



Part #	Size	Price
ACMWS2-10-24	2-1/4" x 10"	14.82
ACMWS2-12-24	2-1/4" x 12"	16.20
ACMWS2-14-24	2-1/4" x 14"	18.06
ACMWS3-10-24	3-1/4" x 10"	14.38
ACMWS3-12-24	3-1/4" x 12"	16.20
ACMWS3-14-24	3-1/4" x 14"	18.06

48" Wall Stack



Part #	Size	Price
ACMWS2-10-48	2-1/4" x 10"	27.24
ACMWS2-12-48	2-1/4" x 12"	30.64
ACMWS3-10-48	3-1/4" x 10"	28.82
ACMWS3-12-48	3-1/4" x 12"	32.06
ACMWS3-14-48	3-1/4" x 14"	36.76

100" Wall Stack



Part #	Size	Price
ACMWS2-10-100	2-1/4" x 10"	58.74
ACMWS2-12-100	2-1/4" x 12"	63.48
ACMWS3-10-100	3-1/4" x 10"	61.28
ACMWS3-12-100	3-1/4" x 12"	66.06

Stack Inside End Cap



Part #	Size	Price
ACMCAPI2-10	2-1/4" x 10"	7.86
ACMCAPI2-12	2-1/4" x 12"	8.34
ACMCAPI3-10	3-1/4" x 10"	7.08
ACMCAPI3-12	3-1/4" x 12"	8.34
ACMCAPI3-14	3-1/4" x 14"	9.24

Sheet Metal Fittings

Sheet Metal

Sheet Metal Fittings

Stack Outside End Cap



Part #	Size	Price
ACMCAPO2-10	2-1/4" x 10"	8.64
ACMCAPO2-12	2-1/4" x 12"	9.80
ACMCAPO3-10	3-1/4" x 10"	8.98
ACMCAPO3-12	3-1/4" x 12"	9.80

Stack Horizontal 45° Longway Angle



Part #	Size	Price
ACML452-10	2-1/4" x 10"	18.10
ACML452-12	2-1/4" x 12"	19.50
ACML453-10	3-1/4" x 10"	20.18
ACML453-12	3-1/4" x 12"	21.78
ACML453-14	3-1/4" x 14"	25.62

Stack Horizontal 90° Longway Elbow



Part #	Size	Price
ACML902-10	2-1/4" x 10"	22.72
ACML902-12	2-1/4" x 12"	26.46
ACML903-10	3-1/4" x 10"	21.22
ACML903-12	3-1/4" x 12"	24.88
ACML903-14	3-1/4" x 14"	36.60

Stack Vertical 45° Shortway Angle



Part #	Size	Price
ACMS452-10	2-1/4" x 10"	12.62
ACMS452-12	2-1/4" x 12"	11.92
ACMS452-14	2-1/4" x 14"	15.28
ACMS453-10	3-1/4" x 10"	12.62

Wall Stack Boots & Fittings (Continued)

Stack Vertical 45° Shortway Angle

Part #	Size	Price
ACMS453-12	3-1/4" x 12"	14.20
ACMS453-14	3-1/4" x 14"	19.50

Stack Vertical 90° Shortway Elbow



Part #	Size	Price
ACMS902-10	2-1/4" x 10"	15.08
ACMS902-12	2-1/4" x 12"	16.60
ACMS902-14	2-1/4" x 14"	18.98
ACMS903-10	3-1/4" x 10"	14.62
ACMS903-12	3-1/4" x 12"	16.60
ACMS903-14	3-1/4" x 14"	18.98

Straight Stack Boot



Part #	Size	Price
ACMSBS2-10-5	2-1/4" x 10" - 5"	11.18
ACMSBS2-10-6	2-1/4" x 10" - 6"	10.14
ACMSBS2-12-6	2-1/4" x 12" - 6"	9.84
ACMSBS2-12-7	2-1/4" x 12" - 7"	13.98
ACMSBS2-14-6	2-1/4" x 14" - 6"	13.98
ACMSBS3-10-4	3-1/4" x 10" - 4"	13.98
ACMSBS3-10-6	3-1/4" x 10" - 6"	8.94
ACMSBS3-10-7	3-1/4" x 10" - 7"	13.98
ACMSBS3-10-8	3-1/4" x 10" - 8"	16.82
ACMSBS3-12-6	3-1/4" x 12" - 6"	10.58
ACMSBS3-12-7	3-1/4" x 12" - 7"	13.98
ACMSBS3-12-8	3-1/4" x 12" - 8"	19.50
ACMSBS3-14-6	3-1/4" x 14" - 6"	19.50
ACMSBS3-14-7	3-1/4" x 14" - 7"	19.50
ACMSBS3-14-8	3-1/4" x 14" - 8"	19.50

All Items May Not Be Stocked In All Branches

Sheet Metal

Stack Boot 90° Elbow



Part #	Size	Price
ACMSB902-10-5	2-1/4" x 10" - 5"	11.18
ACMSB902-10-6	2-1/4" x 10" - 6"	10.14
ACMSB902-12-6	2-1/4" x 12" - 6"	8.78
ACMSB902-12-7	2-1/4" x 12" - 7"	13.98
ACMSB902-14-6	2-1/4" x 14" - 6"	19.50
ACMSB903-10-6	3-1/4" x 10" - 6"	8.74
ACMSB903-10-7	3-1/4" x 10" - 7"	13.98
ACMSB903-10-8	3-1/4" x 10" - 8"	19.50
ACMSB903-12-6	3-1/4" x 12" - 6"	10.38
ACMSB903-12-7	3-1/4" x 12" - 7"	13.98
ACMSB903-12-8	3-1/4" x 12" - 8"	19.50
ACMSB903-14-6	3-1/4" x 14" - 6"	19.50
ACMSB903-14-8	3-1/4" x 14" - 8"	19.50

Stack Boot Center End



Part #	Size	Price
ACMSBE2-10-6	2-1/4" x 10" - 6"	10.14
ACMSBE2-12-6	2-1/4" x 12" - 6"	8.78
ACMSBE2-12-7	2-1/4" x 12" - 7"	13.98
ACMSBE3-10-5	3-1/4" x 10" - 5"	11.18
ACMSBE3-10-6	3-1/4" x 10" - 6"	9.16
ACMSBE3-10-7	3-1/4" x 10" - 7"	13.98
ACMSBE3-12-6	3-1/4" x 12" - 6"	10.58
ACMSBE3-12-7	3-1/4" x 12" - 7"	13.98
ACMSBE3-12-8	3-1/4" x 12" - 8"	19.50
ACMSBE3-14-7	3-1/4" x 14" - 7"	19.50
ACMSBE3-14-8	3-1/4" x 14" - 8"	19.50

Stack Straight Starting Collar



Part #	Size	Price
ACMSC2-10	2-1/4" x 10"	9.48
ACMSC2-12	2-1/4" x 12"	10.08
ACMSC3-10	3-1/4" x 10"	11.24
ACMSC3-12	3-1/4" x 12"	12.30
ACMSC3-14	3-1/4" x 14"	16.82

Long Throat Stackhead



Part #	Size	Price
ACMSHL2-10-10-6	2-1/4" x 10" to 6" x 10"	24.06
ACMSHL3-10-10-6	3-1/4" x 10" to 6" x 10"	11.60
ACMSHL3-12-12-6	3-1/4" x 12" to 6" x 12"	17.98

Short Throat Stackhead



Part #	Size	Price
ACMSH2-10-10-6	2-1/4" x 10" to 6" x 10"	15.60
ACMSH2-12-12-6	2-1/4" x 12" to 6" x 12"	16.70
ACMSH3-10-10-4	3-1/4" x 10" to 4" x 10"	18.82
ACMSH3-10-10-6	3-1/4" x 10" to 6" x 10"	15.60
ACMSH3-12-12-6	3-1/4" x 12" to 6" x 12"	16.70
ACMSH3-14-14-6	3-1/4" x 14" to 6" x 14"	18.98

Sheet Metal Fittings

Sheet Metal

Sheet Metal Fittings

Straight Register Boots



Part #	Size	Price
ACMRBS2-10-6	2-1/4" x 10" - 6"	8.98
ACMRBS2-12-6	2-1/4" x 12" - 6"	7.50
ACMRBS2-12-7	2-1/4" x 12" - 7"	10.64
ACMRBS2-14-6	2-1/4" x 14" - 6"	9.80
ACMRBS4-10-6	4" x 10" - 6"	7.26
ACMRBS4-10-7	4" x 10" - 7"	10.58
ACMRBS4-10-8	4" x 10" - 8"	11.18
ACMRBS4-12-6	4" x 12" - 6"	8.64
ACMRBS4-12-7	4" x 12" - 7"	10.58
ACMRBS4-12-8	4" x 12" - 8"	10.86
ACMRBS4-14-6	4" x 14" - 6"	9.96
ACMRBS4-14-7	4" x 14" - 7"	11.18
ACMRBS4-14-8	4" x 14" - 8"	10.86
ACMRBS6-10-6	6" x 10" - 6"	13.98
ACMRBS6-10-7	6" x 10" - 7"	13.98
ACMRBS6-12-6	6" x 12" - 6"	13.98
ACMRBS6-12-7	6" x 12" - 7"	16.82
ACMRBS6-12-8	6" x 12" - 8"	16.82
ACMRBS6-14-8	6" x 14" - 8"	16.82

90° Register Boot



Part #	Size	Price
ACMRB902-10-4	2-1/2" x 10" - 4"	11.18
ACMRB902-10-5	2-1/4" x 10" - 5"	8.64
ACMRB902-10-6	2-1/4" x 10" - 6"	8.64
ACMRB902-12-6	2-1/4" x 12" - 6"	7.26
ACMRB902-12-7	2-1/4" x 12" - 7"	9.80
ACMRB902-14-6	2-1/4" x 14" - 6"	9.80
ACMRB904-10-6	4" x 10" - 6"	7.52
ACMRB904-10-7	4" x 10" - 7"	10.08
ACMRB904-12-6	4" x 12" - 6"	8.40
ACMRB904-12-7	4" x 12" - 7"	10.08
ACMRB904-12-8	4" x 12" - 8"	10.86
ACMRB904-14-6	4" x 14" - 6"	9.96
ACMRB904-14-7	4" x 14" - 7"	10.86

Wall Stack Boots & Fittings (Continued)

90° Register Boot

Part #	Size	Price
ACMRB904-14-8	4" x 14" - 8"	12.62
ACMRB906-10-6	6" x 10" - 6"	13.98
ACMRB906-10-7	6" x 10" - 7"	13.98
ACMRB906-10-8	6" x 10" - 8"	13.98
ACMRB906-12-6	6" x 12" - 6"	13.98
ACMRB906-12-7	6" x 12" - 7"	16.82
ACMRB906-12-8	6" x 12" - 8"	16.82
ACMRB906-14-6	6" x 14" - 6"	16.82
ACMRB906-14-8	6" x 14" - 8"	16.82

Center End Register Boot



Part #	Size	Price
ACMRBE2-10-6	2-1/4" x 10" - 6"	8.40
ACMRBE2-12-6	2-1/4" x 12" - 6"	7.50
ACMRBE2-12-7	2-1/2" x 12" - 7"	10.08
ACMRBE2-14-6	2-1/2" x 14" - 6"	9.96
ACMRBE4-10-6	4" x 10" - 6"	7.26
ACMRBE4-10-7	4" x 10" - 7"	10.08
ACMRBE4-12-6	4" x 12" - 6"	8.74
ACMRBE4-12-7	4" x 12" - 7"	10.58
ACMRBE4-12-8	4" x 12" - 8"	9.78
ACMRBE4-14-6	4" x 14" - 6"	13.98
ACMRBE6-10-6	6" x 10" - 6"	13.98
ACMRBE6-12-6	6" x 12" - 6"	13.98

Left End Register Boot



Part #	Size	Price
ACMRBEL2-12-6	2-1/4" x 12" - 6"	11.20

All Items May Not Be Stocked In All Branches

Sheet Metal

Right End Register Boot



Part #	Size	Price
ACMRBER2-12-6	2-1/4" x 12" - 6"	10.88

Register Box - 12" Deep



Part #	Size	Price
ACMBOX4-10-12	4" x 10"	29.50
ACMBOX4-12-12	4" x 12"	29.50
ACMBOX6-10-12	6" x 10"	27.56
ACMBOX6-12-12	6" x 12"	29.02
ACMBOX6-14-12	6" x 14"	30.68
ACMBOX8-10-12	8" x 10"	25.74
ACMBOX8-12-12	8" x 12"	26.80
ACMBOX10-12-12	10" x 12"	27.90
ACMBOX12-14-12	12" x 14"	32.02

Blind Floor Register Box - 6" Deep



Part #	Size	Price
ACMBOX4-10-6	4" x 10"	24.26
ACMBOX4-12-6	4" x 12"	24.26
ACMBOX6-10-6	6" x 10"	23.72
ACMBOX6-12-6	6" x 12"	26.24
ACMBOX8-10-6	8" x 10"	20.26
ACMBOX8-12-6	8" x 12"	21.56
ACMBOX10-12-6	10" x 12"	22.56
ACMBOX12-14-6	12" x 14"	33.58

Funnel Floor Register Box



Part #	Size	Price
ACMFB4-10-6	4" x 10" - 6"	25.62
ACMFB4-12-6	4" x 12" - 6"	25.62
ACMFB6-10-6	6" x 10" - 6"	27.96
ACMFB6-10-7	6" x 10" - 7"	27.96
ACMFB6-12-6	6" x 12" - 6"	27.96
ACMFB6-12-7	6" x 12" - 7"	27.96
ACMFB6-12-8	6" x 12" - 8"	27.96
ACMFB6-14-8	6" x 14" - 8"	27.96
ACMFB8-10-6	8" x 10" - 6"	31.52
ACMFB8-10-8	8" x 10" - 8"	22.56
ACMFB8-12-8	8" x 12" - 8"	25.16
ACMFB8-14-8	8" x 14" - 8"	31.52
ACMFB10-12-10	10" x 12" - 10"	34.32

Register Frame



Part #	Size	Price
ACMCAF14-6	6" x 14"	5.26
ACMCAF24-6	6" x 24"	11.32
ACMCAF30-6	6" x 30"	12.26

Dampers

Round Damper

- Round 2 pin



Part #	Size	Price
ACMDAMP6	6"	3.96
ACMDAMP7	7"	6.28
ACMDAMP8	8"	8.14
ACMDAMP10	10"	9.96
ACMDAMP12	12"	12.76

Black Cast Iron Damper

Part #	Description	Price
ACMBKDAMP6	6" Black Cast Iron Damper	12.54

Sheet Metal

Sheet Metal Fittings

Fresh Air Intake

- With screen



Part #	Size	Price
ACMFAV4	4"	21.22
ACMFAV6	6"	20.60

Diverters (Continued)

Galvanized Rain Cap

Part #	Size	Price
ACMTOP7	7"	12.30
ACMTOP8	8"	14.04

Note: Add 20% for birdproof.

Diverters

Vertical Draft Diverter



Part #	Size	Price
ACMDHV3	3"	22.54
ACMDHV4	4"	32.68
ACMDHV5	5"	42.48
ACMDHV6	6"	54.12
ACMDHV7	7"	73.74

Galvanized Oval Pipe & Fittings

Button Lock Pipe



Part #	Size	Price
ACMOP5-112	5" x 112"	31.46
ACMOP6-60	6" x 60"	18.98
ACMOP6-100	6" x 100"	21.22
ACMOP6-112	6" x 112"	25.16
ACMOP7-100	7" x 100"	28.48
ACMOP7-112	7" x 112"	33.58
ACMOP8-60	8" x 60"	25.16
ACMOP8-100	8" x 100"	38.48

Draft Diverter / Horizontal



Part #	Size	Price
ACMDHH3	3"	45.50

4-Piece Flat 90° Elbow



Part #	Size	Price
ACMOL906	6"	10.08
ACMOL907	7"	15.32
ACMOL908	8"	26.56

Galvanized Rain Cap



Part #	Size	Price
ACMTOP3	3"	8.30
ACMTOP4	4"	8.30
ACMTOP5	5"	8.58
ACMTOP6	6"	10.36

3 Piece Flat 45° Angle



Part #	Size	Price
ACMOL456	6"	6.80
ACMOL457	7"	14.46
ACMOL458	8"	21.78

All Items May Not Be Stocked In All Branches

Sheet Metal

Sheet Metal Fittings

One Piece Vertical 90° Elbow



Part #	Size	Price
ACMOS905	5"	7.02
ACMOS906	6"	6.24
ACMOS907	7"	9.68
ACMOS908	8"	11.04

90° Oval Register Boot



Part #	Size	Price
ACMOBOOT4-10-6	4" x 10" - 6"	22.94
ACMORB904-12-6	4" x 12" - 6"	30.60

One Piece Vertical 45° Angle



Part #	Size	Price
ACMOS456	6"	6.08
ACMOS457	7"	8.46
ACMOS458	8"	9.20

Angle Oval Register Box



Part #	Size	Price
ACMORB452-12-6	2-1/4" x 12" - 6"	18.24
ACMORB456	4" x 10"-x 6"	18.58
ACMORB7	4" x 12" - 7"	27.24

Oval Stackhead



Part #	Size	Price
ACMOSH10-6-6	10" x 6" - 6"	10.36
ACMOSH12-6-6	12" x 6" - 6"	12.62
ACMOSH12-6-7	12" x 6" - 7"	17.52
ACMOSH12-6-8	12" x 6" - 8"	24.26

90° Round To Oval Boot



Part #	Size	Price
ACMO-R905	5"	13.68
ACMO-R906	6"	13.68
ACMO-R906NC	6" No Crimp	13.68
ACMO-R907	7"	17.32
ACMO-R908	8"	19.56

90° Oval Register Box



Part #	Size	Price
ACMORB2-12-6	2-1/4" x 12" - 6"	17.04
ACMORB4-10-6	4" x 10" - 6"	16.60
ACMORB904-12-7	4" x 12" - 7"	20.42
ACMORB904-12-7	4" x 12" - 8"	23.72

Round To Oval Straight Boot



Part #	Size	Price
ACMOS5	5" to 5"	16.82
ACMOS6	6" to 6"	16.82
ACMOS7	7" to 7"	24.22
ACMOS8	8" to 8"	27.96

Prices & Specifications are Subject to Change.

Sheet Metal

Sheet Metal Fittings

Oval to Oval Reverse Boot



Part #	Size	Price
ACMO-O906	6" to 6"	27.24

Round To Oval End Boot



Part #	Size	Price
ACMO-RE5	5"	19.72
ACMO-RE6	6"	22.18
ACMO-RE7	6" to 7"	24.88
ACMO-RE6NC	6" No Crimp	22.18
ACMO-RE8	8"	40.00

Aluminum Products

8' Flex Aluminum Duct



Part #	Size	Price
ACMDVAT4-8	4"	12.92

Aluminum Pipe



Part #	Size	Price
ACMDVP4-24	4" x 24"	6.34

Aluminum Roof Caps

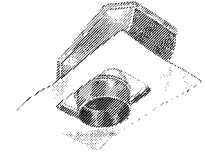

Part #	Size	Price
ACMALRC4	4" Damper/Screen	41.14
ACMALRC7	7" Damper/Screen	55.08

Aluminum Wall Cap



Part #	Size	Price
ACMHOOD3-10	3-1/4 x 10"	37.32

Aluminum Versa-Cap



Part #	Size	Price
ACMVCAP3-4	3-4"	76.46
ACMVCAP5-6	5-6"	100.68
ACMVCAP7-8	7-8"	139.66
ACMVCAP9-10	9-10"	205.88

Black Pipe & Fittings

Black Pipe



Part #	Size	Price
ACMBKP6-24	6" x 24"	14.26
ACMBKP7-24	7" x 24"	17.78
ACMBKP8-24	8" x 24"	20.08

Sheet Metal

Black Elbows



Part #	Size	Price
ACMBK906	6" - 90°	14.26
ACMBK907	7" - 90°	20.20
ACMBK908	8" - 90°	19.42

Black Tees



Part #	Size	Price
ACMBKT6	6"	34.64
ACMBKT8	8"	42.64

Reducers/Increases Non-Crimp



Part #	Size	Price
ACMBKIR6-7	7" x 6"	31.86
ACMBKIR6-8	8" x 6"	34.36
ACMBKIR7-8	8" x 7"	34.36

Black Tee Caps Non-Crimped

Part #	Size	Price
ACMBKCAP6	6"	12.40
ACMBKCAP8	8"	15.44

Air Distribution Products

Plenums

Part #	Description	Price
PLEIWAF3	17-5/8" x 18-1/2" x 3' F 50 & 75M 90% Plenum	101.98
PLEGWAA	12-7/8" x 19-1/4" x 4' Warm Air Plenum	107.26
PLEIWAB	14-13/16" x 18-11/16" x 4' B 50 & 75M 80% Plenum	113.92
PLEIRAF	14-15/16" x 23-5/16" x 3' F Horz Return Plenum	101.98
PLEICCB	14-3/16" x 16-11/16" x 3' B Cooling Plenum	101.98
PLEICCF	17-13/16" x 16-11/16" x 3' F Cooling Plenum	101.98
PLEICCJ	21-7/16" x 16-11/16" x 3' J Cooling Plenum	101.98
PLEICCL	23-3/16" x 16-11/16" x 3' L Cooling Plenum	101.98
PLEGWAB	16-1/8" x 19-1/4" x 4' Warm Air Plenum	107.26
PLEWWA5	16-7/16" x 16-7/16" x 3' THZ105 w/A & C/A Plenum	101.98
PLEIWAF	17-13/16" x 18-11/16" x 4' F 75 & 100M 80% Plenum	113.92
PLEIWAJ	21-7/16" x 18-11/16" x 4' J 100 to 150M 80% Plenum	113.92
PLEI WAL	23-3/16" x 18-11/16" x 4' L Plenum	113.92
PLEIWAN	24-7/8" x 18-1/2" x 4' N 125M 90% Plenum	113.92
PLEWRA1-2	18-11/16" x 15-11/16" x 3' CLB105 Cold Air Return	101.98
PLEWWA1-2	18-11/16" x 17-11/16" x 3' CLB105 Warm Air Plenum	101.98
PLEWRA1	18-7/16" x 15-11/16" x 3' CLB105 Cold Air Return	101.98
PLEWWA1	18-7/16" x 17-11/16" x 3' CLB105 Warm Air Plenum	101.98
PLEIOS105	18" x 20-1/4" x 3' 105M Oil Supply Plenum	101.98
PLEIOWA1	19-15/16" x 19-15/16" x 3' Warm Air Plenum f/New Oil Furnace	101.98
PLEGWAC	19-5/8" x 19-1/4" x 4' Warm Air Plenum	113.92
PLEGCC	19-7/8" x 18" x 3' Cooling Plenum	95.32
PLEWRA3	20-11/16" x 20-11/16" x 3' CCF105 Cold Air Return	101.98
PLEWWA3	21-3/16" x 19-13/16" x 3' CHB105 Warm Air Plenum	101.98
PLEWWA3-2	21-3/16" x 20-13/16" x 3' CHB105-2 Warm Air Plenum	101.98
PLEWRA2	22-15/16" x 13-11/16" x 3' CLB140 Cold Air Return	101.98
PLEWWA2	22-15/16" x 21-7/16" x 3' CLB140 Warm Air Plenum	101.98
PLEIRAB	12-13/16" x 23-5/16" x 3' B Horz Return Plenum	101.98
PLEIRAJ	18-15/16" x 23-5/16" x 3' J Horz Return Plenum	101.98

Sheet Metal Fittings

Prices & Specifications are Subject to Change.

Sheet Metal

Sheet Metal Fittings

Air Distribution Products (Continued)

Plenums

Part #	Description	Price
PLEIRAL	23-5/16" x 23-11/16" x 3' I Horz Return Plenum	101.98
PLEGWAD	23-1/8" x 19-1/4" x 4' Warm Air Plenum	107.26
PLEGCCD	23-3/8" x 18" x 3' Cooling Plenum	95.32
PLEWWA4	24-3/16" x 23-7/16" x 3' CHB140 Warm Air Plenum	101.98

GRAY METAL PRODUCTS, INC.
PRE-FABRICATED AIR DUCT & FITTINGS

Flat Sheet Steel



Part #	Gauge	Size	Price
GRASHEET36-96	30	3' x 8'	48.02

Galvanized Button Lock Pipe



24" Galv Button Lock Pipe 30ga

Part #	Size	Price
GRAP3-2430	3"	4.24
GRAP4-2430	4"	5.06
GRAP5-2430	5"	5.86
GRAP6-2430	6"	5.52
GRAP7-2430	7"	8.56
GRAP8-2430	8"	9.64
GRAP9-2430	9"	10.16
GRAP10-2430	10"	11.04
GRAP12-2430	12"	19.14

24" Galv Button Lock Pipe 26ga

Part #	Size	Price
GRAP3-2426	3"	5.34
GRAP4-2426	4"	5.68
GRAP5-2426	5"	7.56
GRAP6-2426	6"	8.34
GRAP7-2426	7"	10.46
GRAP8-2426	8"	11.82
GRAP10-2426	10"	15.06

Galvanized Button Lock Pipe (Continued)

24" Galv Button Lock Pipe 26ga

Part #	Size	Price
GRAP12-2426	12"	18.22
GRAP14-2426	14"	20.26
GRAP16-2426	16"	25.88
GRAP18-2426	18"	27.26
GRAP20-2426	20"	49.40

60" Galv Button Lock Pipe 30ga

Part #	Size	Price
GRAP3-6030	3"	10.86
GRAP4-6030	4"	10.40
GRAP5-6030	5"	10.58
GRAP6-6030	6"	10.92
GRAP7-6030	7"	16.28
GRAP8-6030	8"	21.90
GRAP9-6030	9"	28.32
GRAP10-6030	10"	31.28
GRAP12-6030	12"	40.28

60" Galv Button Lock Pipe 26ga

Part #	Size	Price
GRAP4-6026	4"	18.58
GRAP5-6026	5"	20.08
GRAP6-6026	6"	21.68
GRAP7-6026	7"	28.84
GRAP8-6026	8"	31.84
GRAP10-6026	10"	44.94
GRAP12-6026	12"	47.40
GRAP14-6026	14"	56.06

Round Elbows



Galvanized Adjustable 90° Elbow 30ga

Part #	Size	Price
GRA90330	3"	3.62
GRA90430	4"	3.78
GRA90530	5"	3.82
GRA90630	6"	3.28
GRA90730	7"	4.84
GRA90830	8"	5.18

All Items May Not Be Stocked In All Branches

Sheet Metal

Round Elbows (Continued)

Galvanized Adjustable 90° Elbow 30ga

Part #	Size	Price
GRA90930	9"	11.48
GRA901030	10"	12.32
GRA901230	12"	18.06

Galvanized Adjustable 90° Elbow 26ga

Part #	Size	Price
GRA90326	3"	5.18
GRA90426	4"	5.20
GRA90526	5"	7.42
GRA90626	6"	7.42
GRA90726	7"	8.98
GRA90826	8"	10.98
GRA90926	9"	16.08
GRA901026	10"	14.26
GRA901226	12"	19.22
GRA901426	14"	34.74
GRA901626	16"	38.82
GRA901826	18"	46.70

Tees



Galvanized Tee Joint - 26ga No Crimp

Part #	Size	Price
GRAT3	3"	19.96
GRAT4	4"	20.54
GRAT5	5"	22.80
GRAT6	6"	25.86
GRAT7	7"	27.96
GRAT8	8"	31.94
GRAT10	10"	38.90
GRAT12	12"	49.16
GRAT14	14"	68.10
GRAT4-3	4" x 4" x 3"	31.60
GRAT5-3	5" x 5" x 3"	27.20
GRAT5-4	5" x 5" x 4"	27.20
GRAT6-3	6" x 6" x 3"	37.30
GRAT6-4	6" x 6" x 4"	37.30
GRAT6-5	6" x 6" x 5"	37.30

End Caps



Galvanized Round End Cap - No Crimp

Part #	Size	Price
GRACAP3	3"	6.76
GRACAP4	4"	6.84
GRACAP5	5"	7.00
GRACAP6	6"	7.66
GRACAP7	7"	8.32
GRACAP8	8"	9.50
GRACAP9	9"	9.86
GRACAP10	10"	11.48
GRACAP12	12"	12.28
GRACAP14	14"	14.30
GRACAP16	16"	16.74

Galvanized Round Inside Crimped End Cap

Part #	Size	Price
GRACAPC4	4"	8.02
GRACAPC7	7"	8.92

Takeoffs

Adjustable Top Takeoffs Duct Board

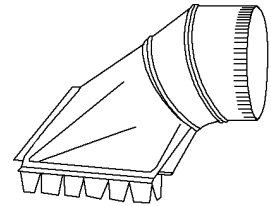

Part #	Size	Price
GRATOADJ4	4"	16.74
GRATOADJ5	5"	11.68
GRATOADJ6	6"	12.38
GRATOADJ7	7"	17.30
GRATOADJ8	8"	21.02
GRATOADJ10	10"	28.26
GRATOADJ12	12"	43.34

Top Takeoffs



Part #	Size	Price
GRATONADJ5	5"	9.56
GRATONADJ6	6"	9.56

Sheet Metal Fittings

Prices & Specifications are Subject to Change.

Sheet Metal

Sheet Metal Fittings

Takeoffs (Continued)

Top Takeoffs

Part #	Size	Price
GRATONADJ7	7"	13.48
GRATONADJ8	8"	16.50

**Adjustable Takeoffs
Round To Round Full Tab**



Part #	Size	Price
GRATOR5	5"	9.64
GRATOR6	6"	6.54
GRATOR7	7"	15.22

Round to Round Self-Adhesive Duct Takeoff



Part #	Size	Price
GRAADTO6	6"	10.68

Collars

Top Collar - Plain

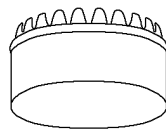

Part #	Size	Price
GRASC6	6"	2.96
GRASC7	7"	3.20
GRASC8	8"	3.42
GRASC10	10"	4.34
GRASC12	12"	4.64
GRASC14	14"	6.90
GRASC16	16"	9.16

Top Collar - Crimped



Part #	Size	Price
GRASCC6	6"	2.78
GRASCC7	7"	3.20
GRASCC8	8"	3.34

Duct & Fittings

Duct 17.5" Length

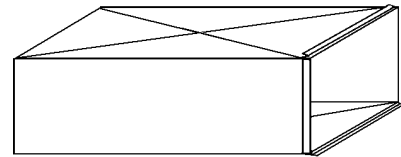

Part #	Size	Price
GRAD8-8-17	8" x 8"	20.36
GRAD10-8-17	10" x 8"	22.38
GRAD12-8-17	12" x 8"	24.06
GRAD14-8-17	14" x 8"	26.38
GRAD16-8-17	16" x 8"	29.24
GRAD18-8-17	18" x 8"	31.64
GRAD20-8-17	20" x 8"	34.08
GRAD24-8-17	24" x 8"	38.52

Duct 33.5" Length

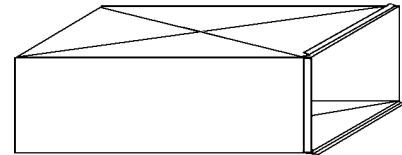

Part #	Size	Price
GRAD8-8-33	8" x 8"	25.30
GRAD10-8-33	10" x 8"	27.44
GRAD12-8-33	12" x 8"	29.88
GRAD14-8-33	14" x 8"	33.84
GRAD16-8-33	16" x 8"	36.22
GRAD18-8-33	18" x 8"	39.24
GRAD20-8-33	20" x 8"	42.82
GRAD20-10-33	20" x 10"	55.60
GRAD22-8-33	22" x 8"	45.56
GRAD24-8-33	24" x 8"	47.36
GRAD24-10-33	24" x 10"	57.82
GRAD24-12-33	24" x 12"	63.12
GRAD26-8-33	26" x 8"	50.24
GRAD28-8-33	28" x 8"	53.94
GRAD30-8-33	30" x 8"	55.56

Sheet Metal

Duct 49.5" Length

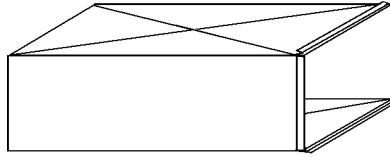

Part #	Size	Price
GRAD8-8-49	8" x 8"	36.76
GRAD10-8-49	10" x 8"	39.06
GRAD12-8-49	12" x 8"	42.42
GRAD14-8-49	14" x 8"	44.78
GRAD16-8-49	16" x 8"	48.24
GRAD18-8-49	18" x 8"	55.94
GRAD20-8-49	20" x 8"	56.78
GRAD20-10-49	20" x 10"	80.90
GRAD22-8-49	22" x 8"	66.44
GRAD24-8-49	24" x 8"	64.36

Duct 3' - Slide and Drive

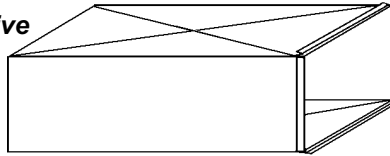

Part #	Size	Price
GRASDD8-8-36	8" x 8"	32.62
GRASDD10-8-36	10" x 8"	35.10
GRASDD12-8-36	12" x 8"	38.02
GRASDD14-8-36	14" x 8"	40.92
GRASDD16-8-36	16" x 8"	43.76
GRASDD20-8-36	20" x 8"	51.54
GRASDD24-8-36	24" x 8"	58.62

Duct 5'

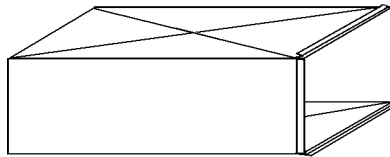

Part #	Size	Price
GRAD8-8-60	8" x 8"	48.74
GRAD10-8-60	10" x 8"	53.02
GRAD12-8-60	12" x 8"	63.18
GRAD14-8-60	14" x 8"	65.10
GRAD16-8-60	16" x 8"	69.82
GRAD18-8-60	18" x 8"	78.86
GRAD20-8-60	20" x 8"	82.44
GRAD22-8-60	22" x 8"	87.96
GRAD24-8-60	24" x 8"	93.52
GRAD24-10-60	24" x 10"	121.50

Duct 8' - Slide and Drive

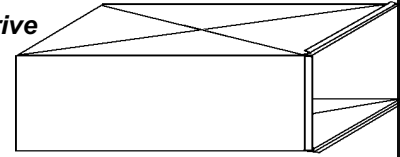

Part #	Size	Price
GRASDD12-8-96	12" x 8"	69.82
GRASDD16-8-96	16" x 8"	84.46
GRASDD18-8-96	18" x 8"	88.26
GRASDD24-8-96	24" x 8"	118.40

Duct - Slide & Drive

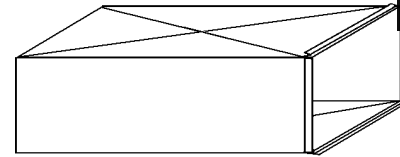

Part #	Size	Price
GRASDD8-8-60	8" x 8" x 5'	32.84
GRASDD10-8-60	10" x 8" x 5'	36.86
GRASDD12-8-60	12" x 8" x 5'	42.38
GRASDD14-8-60	14" x 8" x 5'	47.02
GRASDD16-8-60	16" x 8" x 5'	51.50
GRASDD18-8-60	18" x 8" x 5'	53.80
GRASDD20-8-60	20" x 8" x 5'	58.38
GRASDD24-8-60	24" x 8" x 5'	72.32

Straight Starting Collar

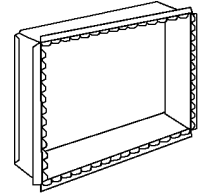

Part #	Size	Price
GRASC10-8	10" x 8"	14.36
GRASC12-8	12" x 8"	14.98
GRASC14-8	14" x 8"	15.78
GRASC16-8	16" x 8"	16.70
GRASC18-8	18" x 8"	17.94
GRASC20-8	20" x 8"	18.46
GRASC24-8	24" x 8"	19.68

Sheet Metal

Sheet Metal Fittings

Offset Takeoff Collar

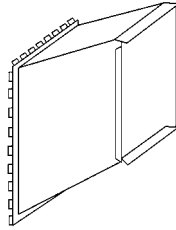

Part #	Size	Price
GRASCO8-8	8" x 8"	26.32
GRASCO10-8	10" x 8"	29.50
GRASCO12-8	12" x 8"	30.52
GRASCO14-8	14" x 8"	32.14
GRASCO16-8	16" x 8"	33.90
GRASCO18-8	18" x 8"	35.14
GRASCO20-8	20" x 8"	35.68
GRASCO24-8	24" x 8"	39.84

Transition Take Off Collar Center

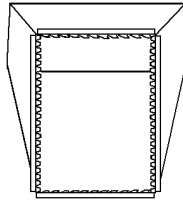

Part #	Size	Price
GRASCTR12-8	12" x 8"	37.76
GRASCTR14-8	14" x 8"	37.76
GRASCTR16-8	16" x 8"	41.70
GRASCTR18-8	18" x 8"	43.36
GRASCTR20-8	20" x 8"	44.96
GRASCTR20-10	20" x 10"	69.48
GRASCTR22-8	22" x 8"	49.00
GRASCTR24-8	24" x 8"	57.66
GRASCTR24-10	24" x 10"	69.26

45° Vertical Shortway Angle

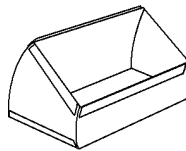

Part #	Size	Price
GRAS458-8	8" x 8"	23.46
GRAS4510-8	10" x 8"	24.58
GRAS4512-8	12" x 8"	25.54
GRAS4514-8	14" x 8"	26.32
GRAS4516-8	16" x 8"	27.14
GRAS4518-8	18" x 8"	29.24
GRAS4520-8	20" x 8"	31.24
GRAS4524-8	24" x 8"	35.06

Duct & Fittings (Continued)

45° Vertical Shortway Angle

Part #	Size	Price
GRAS4524-10	24" x 10"	45.56

45° Vertical Shortway Angle - Slip & Drive

Part #	Size	Price
GRASDS4520-8	20" x 8"	30.64
GRASDS4524-8	24" x 8"	40.66

90° Vertical Shortway Elbow

Part #	Size	Price
GRAS908-8	8" x 8"	30.70
GRAS9010-8	10" x 8"	33.86
GRAS9012-8	12" x 8"	35.06
GRAS9014-8	14" x 8"	36.48
GRAS9016-8	16" x 8"	38.14
GRAS9018-8	18" x 8"	40.54
GRAS9020-8	20" x 8"	42.82
GRAS9020-10	20" x 10"	64.26
GRAS9024-8	24" x 8"	49.00
GRAS9024-10	24" x 10"	86.90

90° Vertical Shortway Elbow - Slip & Drive

Part #	Size	Price
GRASDS908-8	8" x 8"	27.56
GRASDS9010-8	10" x 8"	29.10
GRASDS9012-8	12" x 8"	31.48
GRASDS9014-8	14" x 8"	32.32
GRASDS9016-8	16" x 8"	33.78
GRASDS9018-8	18" x 8"	37.84
GRASDS9020-8	20" x 8"	44.64
GRASDS9024-8	24" x 8"	58.74

90° Horizontal Longway Elbow

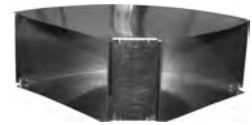

Part #	Size	Price
GRAL9010-8	10" x 8"	33.44
GRAL9012-8	12" x 8"	38.64
GRAL9014-8	14" x 8"	43.94
GRAL9016-8	16" x 8"	47.98
GRAL9018-8	18" x 8"	53.54
GRAL9020-8	20" x 8"	60.14
GRAL9024-8	24" x 8"	77.02

All Items May Not Be Stocked In All Branches

Sheet Metal

90° Vertical Longway Elbow - Slip & Drive

Part #	Size	Price
GRASDL9010-8	10" x 8"	33.90
GRASDL9012-8	12" x 8"	35.70
GRASDL9014-8	14" x 8"	39.96
GRASDL9016-8	16" x 8"	40.98
GRASDL9018-8	18" x 8"	44.00
GRASDL9020-8	20" x 8"	55.56

Duct End Cap



Part #	Size	Price
GRACAPO8-8	8" x 8"	7.30
GRACAPO10-8	10" x 8"	7.32
GRACAPO12-8	12" x 8"	7.36
GRACAPO14-8	14" x 8"	8.14
GRACAPO16-8	16" x 8"	8.62
GRACAPO18-8	18" x 8"	9.14
GRACAPO20-8	20" x 8"	9.52
GRACAPO20-10	20" x 10"	13.32
GRACAPO22-8	22" x 8"	10.52
GRACAPO24-8	24" x 8"	11.06
GRACAPO24-10	24" x 10"	11.06
GRACAPO24-12	24" x 12"	12.42
GRACAPO26-8	26" x 8"	12.24

Duct Set In Cap

Part #	Size	Price
GRACAPI8-8	8" x 8"	7.30
GRACAPI10-8	10" x 8"	7.32
GRACAPI20-10	10" x 10"	13.32
GRACAPI12-8	12" x 8"	7.54
GRACAPI14-8	14" x 8"	8.14
GRACAPI16-8	16" x 8"	8.62
GRACAPI18-8	18" x 8"	9.14
GRACAPI20-8	20" x 8"	9.52
GRACAPI24-8	24" x 8"	11.06
GRACAPI24-10	24" x 10"	11.06
GRACAPI24-12	24" x 12"	12.42
GRACAPI26-8	26" x 8"	12.24

Duct Set In Cap - Slip & Drive

Part #	Size	Price
GRASDCAPI8-8	8" x 8"	7.78
GRASDCAPI10-8	10" x 8"	7.92
GRASDCAPI12-8	12" x 8"	8.30

Duct & Fittings (Continued)

Duct Set In Cap - Slip & Drive

Part #	Size	Price
GRASDCAPI14-8	14" x 8"	8.60
GRASDCAPI16-8	16" x 8"	10.36
GRASDCAPI18-8	18" x 8"	9.50
GRASDCAPI20-8	20" x 8"	10.16
GRASDCAPI24-8	24" x 8"	10.68

Duct Reducer



Part #	Size	Price
GRARED2	2"	8.38
GRARED4	4"	9.00
GRARED6	6"	9.20
GRARED8	8"	10.02
GRARED10	10"	18.84

Duct Reducer - Slip & Drive

Part #	Size	Price
GRASDRED2	2"	8.42
GRASDRED4	4"	11.18
GRASDRED6	6"	9.80

Wall Stack & Fittings

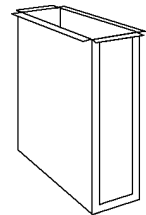

6" Wall Stack

Part #	Size	Price
GRAWS2-10-6	2-1/4" x 10"	5.86
GRAWS2-12-6	2-1/4" x 12"	6.76
GRAWS3-10-6	3-1/4" x 10"	5.88
GRAWS3-12-6	3-1/4" x 12"	6.70

12" Wall Stack

Part #	Size	Price
GRAWS2-10-12	2-1/4" x 10"	8.86
GRAWS2-12-12	2-1/4" x 12"	8.72
GRAWS3-10-12	3-1/4" x 10"	7.96
GRAWS3-12-12	3-1/4" x 12"	8.72

Prices & Specifications are Subject to Change.

Sheet Metal

Sheet Metal Fittings

24" Wall Stack

Part #	Size	Price
GRAWS2-10-24	2-1/4" x 10"	13.18
GRAWS2-12-24	2-1/4" x 12"	14.24
GRAWS3-10-24	3-1/4" x 10"	13.70
GRAWS3-12-24	3-1/4" x 12"	14.24

36" Wall Stack

Part #	Size	Price
GRAWS3-10-36	3-1/4" x 10"	27.42

48" Wall Stack

Part #	Size	Price
GRAWS2-10-48	2-1/4" x 10"	30.56
GRAWS2-12-48	2-1/4" x 12"	31.48
GRAWS3-10-48	3-1/4" x 10"	26.88
GRAWS3-12-48	3-1/4" x 12"	33.44

60" Wall Stack

Part #	Size	Price
GRAWS2-10-60	2-1/4" x 10"	31.70
GRAWS2-12-60	2-1/4" x 12"	35.32
GRAWS3-10-60	3 1/4" x 10"	26.88
GRAWS3-12-60	3 1/4" x 12"	35.86

96" Wall Stack

Part #	Size	Price
GRAWS2-10-96	2-1/4" x 10"	53.20
GRAWS2-12-96	2-1/4" x 12"	55.70
GRAWS3-10-96	3-1/4" x 10"	54.28
GRAWS3-12-96	3-1/4" x 12"	67.50

100" Wall Stack

Part #	Size	Price
GRAWS2-10-100	2-1/4" x 10"	51.86
GRAWS2-12-100	2-1/4" x 12"	55.70
GRAWS3-10-100	3-1/4" x 10"	54.28
GRAWS3-12-100	3-1/4" x 12"	60.28

Stack End Cap

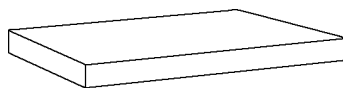

Part #	Size	Price
GRACAPO3-10	3-1/4" x 10"	6.90

Stack Set In End Cap

Part #	Size	Price
GRACAPI2-10	2-1/4" x 10"	6.70
GRACAPI2-12	2-1/4" x 12"	7.72
GRACAPI3-10	3-1/4" x 10"	5.94
GRACAPI3-12	3-1/4" x 12"	7.72

Horizontal 45° Longway Angle

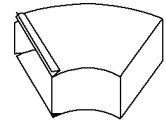

Part #	Size	Price
GRAL453-12	3-1/4" x 12"	20.98

Horizontal 90° Longway Elbow

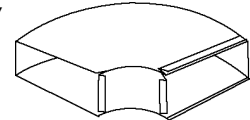

Part #	Size	Price
GRAL902-10	2-1/4" x 10"	20.06
GRAL902-12	2-1/4" x 12"	23.34
GRAL903-10	3-1/4" x 10"	18.82
GRAL903-12	3-1/4" x 12"	21.80

Vertical 45° Shortway Angle

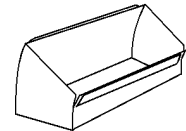

Part #	Size	Price
GRAS452-10	2-1/4" x 10"	10.28
GRAS452-12	2-1/4" x 12"	11.10
GRAS453-10	3-1/4" x 10"	10.02
GRAS453-12	3-1/4" x 12"	11.68

Vertical 90° Shortway Elbow

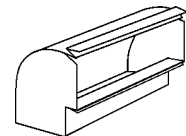

Part #	Size	Price
GRAS902-10	2-1/4" x 10"	13.36
GRAS902-12	2-1/4" x 12"	14.30
GRAS903-10	3-1/4" x 10"	13.36
GRAS903-12	3-1/4" x 12"	14.30

All Items May Not Be Stocked In All Branches

Sheet Metal

Long Throat Stackhead

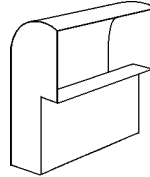

Part #	Size	Price
GRASHX2-10-10-6	2-1/4" x 10"	19.56
GRASHX2-12-12-6	2-1/4" x 12"	16.38

Sidewall Deep Throat Stackhead

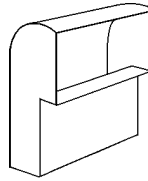

Part #	Size	Price
GRASHL2-10-10-6	2-1/4" x 10" - 10" x 6"	12.58
GRASHL2-12-12-6	2-1/4" x 12" - 12" x 6"	16.38
GRASHL3-10-10-6	3-1/4" x 10" - 10" x 6"	21.10
GRASHL3-12-12-6	3-1/4" x 12" - 12" x 6"	21.90

Stack Boots

Straight Stack Boot



Part #	Size	Price
GRASBS2-10-5	2-1/4" x 10" - 5"	10.56
GRASBS2-10-6	2-1/4" x 10" - 6"	8.78
GRASBS2-12-5	2-1/4" x 12" - 5"	10.58
GRASBS2-12-6	2-1/4" x 12" - 6"	9.38
GRASBS2-12-7	2-1/4" x 12" - 7"	22.98
GRASBS3-10-5	3-1/4" x 10" - 5"	11.10
GRASBS3-10-6	3-1/4" x 10" - 6"	10.56
GRASBS3-10-7	3-1/4" x 10" - 7"	17.30
GRASBS3-10-8	3-1/4" x 10" - 8"	18.40
GRASBS3-12-6	3-1/4" x 12" - 6"	11.34
GRASBS3-12-7	3-1/4" x 12" - 7"	16.68

Stack Boot 90° Elbow



Part #	Size	Price
GRASB902-10-5	2-1/4" x 10" - 5"	8.72

Stack Boots (Continued)

Stack Boot 90° Elbow

Part #	Size	Price
GRASB902-10-6	2-1/4" x 10" - 6"	8.56
GRASB902-12-6	2-1/4" x 12" - 6"	8.56
GRASB902-12-7	2-1/4" x 12" - 7"	16.68
GRASB903-10-4	3-1/4" x 10" - 4"	15.66
GRASB903-10-5	3-1/4" x 10" - 5"	11.16
GRASB903-10-6	3-1/4" x 10" - 6"	10.40
GRASB903-10-7	3-1/4" x 10" - 7"	17.98
GRASB903-12-6	3-1/4" x 12" - 6"	11.34
GRASB903-12-7	3-1/4" x 12" - 7"	16.68
GRASB903-12-8	3-1/4" x 12" - 8"	18.40

Stack Boot Center End



Part #	Size	Price
GRASBE2-10-5	2-1/4" x 10" - 5"	10.56
GRASBE2-10-6	2-1/4" x 10" - 6"	8.78
GRASBE2-12-6	2-1/4" x 12" - 6"	8.78
GRASBE2-12-7	2-1/4" x 12" - 7"	22.40
GRASBE3-10-5	3-1/4" x 10" - 5"	11.10
GRASBE3-10-6	3-1/4" x 10" - 6"	10.56
GRASBE3-10-7	3-1/4" x 10" - 7"	16.68
GRASBE3-12-6	3-1/4" x 12" - 6"	10.56
GRASBE3-12-7	3-1/4" x 12" - 7"	16.68
GRASBE3-12-8	3-1/4" x 12" - 8"	18.40

Stack Boot Adapter

Part #	Size	Price
GRABA	3-1/4" x 10" to 4" x 10"	5.70

Register Boots

Straight Back Register Boot



Part #	Size	Price
GRARBS4-12-8	4" x 12" - 8"	19.18
GRARBS6-10-6	6" x 10" - 6"	18.40
GRARBS6-12-6	6" x 12" - 6"	17.94
GRARBS6-12-7	6" x 12" - 7"	14.86
GRARBS6-12-8	6" x 12" - 8"	14.86

Sheet Metal Fittings

Prices & Specifications are Subject to Change.

Sheet Metal

Sheet Metal Fittings

Register Boot 90° Angle



Part #	Size	Price
GRARB902-10-5	2-1/4" x 10" - 5"	10.56
GRARB902-10-6	2-1/4" x 10" - 6"	8.78
GRARB902-12-6	2-1/4" x 12" - 6"	8.12
GRARB902-12-7	2-1/4" x 12" - 7"	14.50
GRARB904-10-5	4" x 10" - 5"	8.30
GRARB904-10-6	4" x 10" - 6"	7.42
GRARB904-10-7	4" x 10" - 7"	13.94
GRARB904-12-6	4" x 12" - 6"	8.10
GRARB904-12-7	4" x 12" - 7"	14.54
GRARB904-12-8	4" x 12" - 8"	18.40
GRARB906-10-6	6" x 10" - 6"	18.40
GRARB906-12-6	6" x 12" - 6"	18.40
GRARB906-12-8	6" x 12" - 8"	14.06

Register Boxes

Register Box - Floor

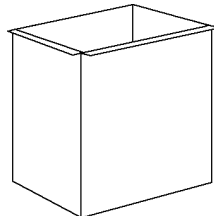

Part #	Size	Price
GRABOX6-10-6	6" x 10" x 6"	23.10

Funnel Floor Register Box

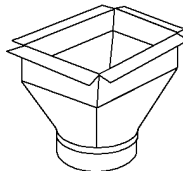

Part #	Size	Price
GRAFB6-10-6	6" x 10" - 6"	18.76
GRAFB6-12-6	6" x 12" - 6"	25.66
GRAFB6-12-7	6" x 12" - 7"	25.66
GRAFB6-12-8	6" x 12" - 8"	25.66
GRAFB8-10-8	8" x 10" - 8"	19.52
GRAFB8-12-8	8" x 12" - 8"	21.80

Return Air Products

Cold Air Boot

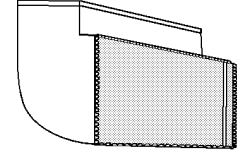

Part #	Size	Price
GRARETBOXH24-8	24" x 8" - 24" x 16"	159.32

Register Frame

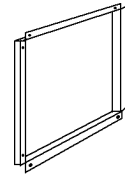

Part #	Size	Price
GRACAF12-6	6" x 12"	9.80
GRACAF14-6	6" x 14"	7.36
GRACAF24-6	6" x 24"	11.00
GRACAF30-6	6" x 30"	8.78

Cold Air Drop Panel

Part #	Size	Price
GRAPAN1	17" x 30"	8.56
GRAPAN2	32" x 30"	16.90

Dampers

Round Damper One Quad



Part #	Size	Price
GRADAMP6	6"	2.64
GRADAMP7	7"	3.34
GRADAMP8	8"	3.98
GRADAMP10	10"	9.54

Cast Iron Damper

Part #	Size	Price
GRBLKDAMP6	6"	7.48

All Items May Not Be Stocked In All Branches

Sheet Metal

Reducers

Taper Reducer / No Crimp



Part #	Size	Price
GRAIR4-3	4" x 3"	8.42
GRAIR5-3	5" x 3"	8.56
GRAIR5-4	5" x 4"	7.82
GRAIR6-3	6" x 3"	9.32
GRAIR6-4	6" x 4"	9.08
GRAIR6-5	6" x 5"	9.08
GRAIR7-3	7" x 3"	10.82
GRAIR7-4	7" x 4"	10.28
GRAIR7-5	7" x 5"	10.82
GRAIR7-6	7" x 6"	10.02
GRAIR8-4	8" x 4"	11.30
GRAIR8-5	8" x 5"	11.30
GRAIR8-6	8" x 6"	11.02
GRAIR8-7	8" x 7"	11.30
GRAIR9-6	9" x 6"	12.40
GRAIR9-7	9" x 7"	12.40
GRAIR10-6	10" x 6"	13.66
GRAIR10-7	10" x 7"	15.02
GRAIR10-8	10" x 8"	13.66
GRAIR10-9	10" x 9"	15.02
GRAIR12-6	12" x 6"	16.04
GRAIR12-8	12" x 8"	13.48
GRAIR12-10	12" x 10"	13.48
GRAIR14-12	14" x 12"	21.80
GRAIR16-14	16" x 14"	18.92

Tees

Tee Wye Joint - Crimp Inlet

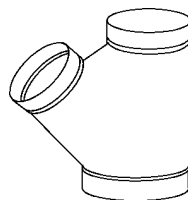

Part #	Size	Price
GRAY4-3-3	4" x 3" x 3"	37.30
GRAY4-4-3	4" x 4" x 3"	20.26
GRAY4-4-4	4" x 4" x 4"	39.12
GRAY5-4-3	5" x 4" x 3"	23.16
GRAY5-4-4	5" x 4" x 4"	20.98
GRAY5-5-3	5" x 5" x 3"	20.80

Tees (Continued)

Tee Wye Joint - Crimp Inlet

Part #	Size	Price
GRAY5-5-4	5" x 5" x 4"	37.46
GRAY5-5-5	5" x 5" x 5"	39.72
GRAY6-4-4	6" x 4" x 4"	37.10
GRAY6-5-4	6" x 5" x 4"	25.12
GRAY6-6-4	6" x 6" x 4"	34.54

Wyes

Wye Branch



Part #	Size	Price
GRAYBR8-6-6	8" x 6" x 6"	23.82
GRAYBR10-8-8	10" x 8" x 8"	28.16

Galvanized Oval Pipe & Fittings

Oval Button Lock Pipe



Part #	Size	Price
GRAOP5-60	5" x 60"	18.52
GRAOP5-100	5" x 100"	26.58
GRAOP6-60	6" x 60"	18.22
GRAOP6-100	6" x 100"	24.64
GRAOP7-60	7" x 60"	25.88
GRAOP7-100	7" x 100"	38.42

Oval 4-Piece Flat 90° Elbow

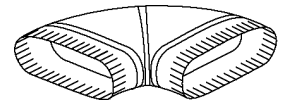

Part #	Size	Price
GRAOL905	5"	9.08
GRAOL906	6"	11.64
GRAOL907	7"	15.68
GRAOL908	8"	19.12

Prices & Specifications are Subject to Change.

Sheet Metal

Sheet Metal Fittings

Oval 3-Piece Flat 45° Angle

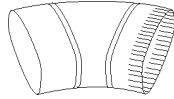

Part #	Size	Price
GRAOL456	6"	9.26

Oval 1-Piece Vertical 90° Elbow

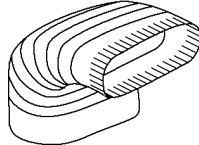

Part #	Size	Price
GRAOS456	6"	6.28
GRAOS458	8"	9.96

Oval 1-Piece Vertical 45° Angle

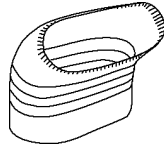

Part #	Size	Price
GRAOL455	5"	17.76

Oval Stackhead

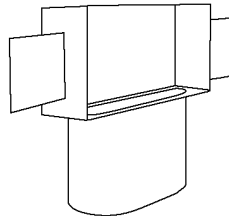

Part #	Size	Price
GRAOSH10-6-6	10" x 6" - 6"	9.92
GRAOSH12-6-6	12" x 6" - 6"	12.72
GRAOSH12-6-7	12" x 6" - 7"	14.08

90° Oval Register Box

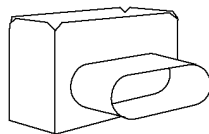

Part #	Size	Price
GRAOBOX4-10-6	4" x 10" - 6"	18.24

90° Round To Oval Boot

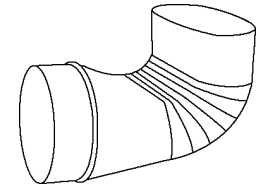

Part #	Size	Price
GRAO-R905	5"	14.30
GRAO-R906	6" Oval Crimp	11.68
GRAO-R906RC	6" Round Crimp	11.98
GRAO-R906NC	6" No Crimp	10.92
GRAO-R907	7"	26.36

Round To Oval Straight Boot

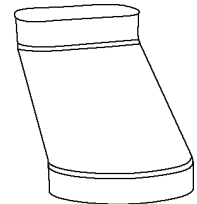

Part #	Size	Price
GRAOS6	6" to 6"	12.54
GRAOS7	7" to 7"	30.98
GRAOS8	8" to 8"	21.36

Round To Oval End Boot

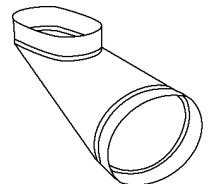

Part #	Size	Price
GRAO-RE5	5"	17.76
GRAO-RE6	6"	19.12
GRAO-RE8	8"	40.58

Black Pipe & Fittings

Black Pipe

Part #	Size	Price
GRABLK6-24	6" x 24"	17.68
GRABLK8-24	8" x 24"	22.70

Black Elbows

Part #	Size	Price
GRABLK906	6" - 90°	16.68
GRABLK908	8" - 90°	21.74

All Items May Not Be Stocked In All Branches

Sheet Metal

Black Tees

Part #	Size	Price
GRABLKT6	6"	37.66



Basset Brackets - Galvanized
Self-Nailing Galvanized Brackets

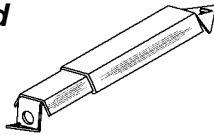

Part #	Mfg #	Description	Ctn Qty	Price
BASA1	A-150	12" - 19" Regular	50	1.74

"Tab" Galvanized Brackets

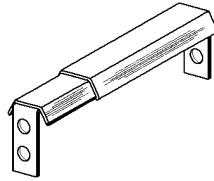

Part #	Mfg #	Description	Ctn Qty	Price
BASAT1	AT-125	12" to 19" Regular	25	1.86
BASET1	ET-125G	19" to 26" X Long	25	2.28

"PEX" Galvanized Brackets

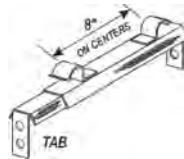

Part #	Mfg #	Description	Ctn Qty	Price
BASAT125P12	AT-125-P	12"-19" Regular Tab	25	2.82

Square Duct Hangers - Galvanized

- 18 Gauge

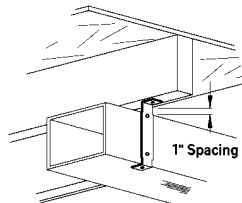
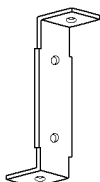

Part #	Mfg #	Size	Price
BASBH8	BH-8	8"	0.82
BASBH9	BH-9	9"	0.92

Basset Strap

Duct Strap



- For all square ducts running below the joists
- 18 Gauge galvanized steel

Part #	Mfg #	Qty	Price
BASDS3	DS-3	100/Cartron	0.46



Water Based Duct Sealant

Part #	Mfg #	Description	Price
DUB765C	613320	10.5 oz Cartridge UL-181 #765	4.52
DUB765G	613317	1 gal Pail UL-181 #765	29.86

Foam Sealants

333 Expanding Foam Sealant

- Easy-to-use, multi-purpose urethane foam
- Triple expanding
- Adheres to all building materials except Teflon, silicone and polyethylene
- Seals by expanding into gaps, cracks and crevices
- Uses include insulating, sealing and filling gaps around pipes, plumbing fixtures, ductwork and foundations
- UL Classified



Part #	Mfg #	Description	Price
INSFOAM	33316	12 oz	8.34

THANK YOU!
We appreciate your business

Prices & Specifications are Subject to Change.

Gas Vent Pipe & Fittings

Venting



Round Pipe

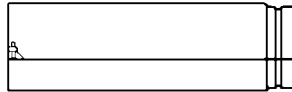

Adj Length Pipe

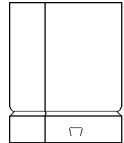

Univ Female Adapter

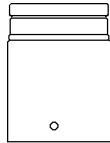

Univ Male Adapter



Top (Bird Proof)

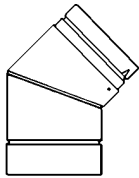

45° Adj Elbow

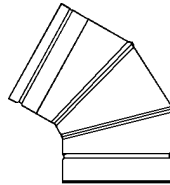

60° Adj Elbow

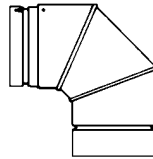

90° Adj Elbow

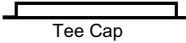

Tee Cap

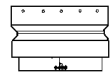

Draft Hood Connector

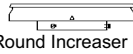

Round Increaser

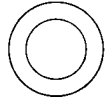

Galv Pipe Collar



Support Assembly

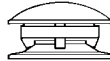

Vent Top

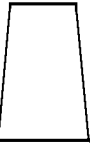

Tall Cone Flat Roof Flashing

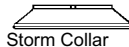

Storm Collar



Adj Roof Flashing

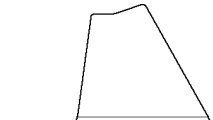

Tall Cone Adj Roof Flashing

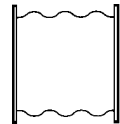

Adj Wall Thimble

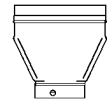

Rd to Oval Adapter

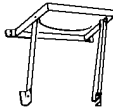

Wall Support

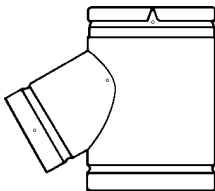

Fixed Wye

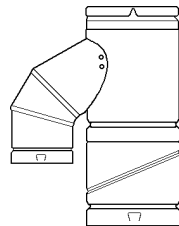

Adj Wye

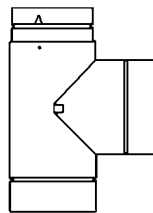

Round Tee

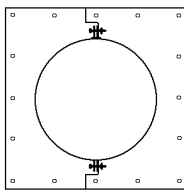

Support Plate

Type "B" Gas Vent Pipe & Fittings
3" Gas Vent Round

Part #	Mfg #	Description	Price
METP3-2	3RV-2	24" Round Pipe	21.48
METP3-3	3RV-3	36" Round Pipe	26.04
METP3-4	3RV-4	48" Round Pipe	33.96
METP3-5	3RV-5	60" Round Pipe	41.88
METP3-6	3RV-6	6" Round Pipe	13.02
METP3-12	3RV-12	12" Round Pipe	13.48
METP3-18	3RV-18	18" Round Pipe	16.16
MET453	3RV-60	45°/60° Adjustable Elbow	21.02
MET903	3RV-90	90° Adjustable Elbow	35.14
METRF3	3RV-AF	Adj Roof Flashing Flat to 6/12	12.64
METRF3-12	3RV-AF12	Adj Roof Flashing 6/12 to 12/12	38.86
METPADJ3-12	3RV-AJ	12" Adj Length Pipe	17.18
METDH3	3RV-DH	Draft Hood Connector	14.56
METPC3	3RV-GC	Pipe Collar - Galvanized	6.72
METSA3	3RV-GVS	Support Assembly	23.24
METHWTOP3	3RV-HWT	High Wind Top	26.54
METINC3-4	3RV-I4	4" Increaser	29.80
METINC3-5	3RV-I5	5" Increaser	33.22
METTOP3	3RV-RT	Vent Top	19.46
METSC3	3RV-SC	Storm Collar	3.48
METCAP3	3RV-TC	Tee Cap	3.72
METTCRF3	3RV-TF	Tall Cone Flat Roof Flashing	26.04
METT3	3RV-TS	Tee	51.88
METUAF3	3RV-UAF	Univ Female Adapter	31.74
METWSB3	3RV-WS/B	Wall Support/Band Assembly	37.50
METWT3	3RV-WT	Adj Wall Thimble	22.24

4" Gas Vent Round

Part #	Mfg #	Description	Price
METP4-6	4RV-6	6" Round Pipe	15.50
METP4-12	4RV-12	12" Round Pipe	15.88
METP4-18	4RV-18	18" Round Pipe	19.20
METP4-2	4RV-2	24" Round Pipe	23.90
METP4-3	4RV-3	36" Round Pipe	32.58
METP4-4	4RV-4	48" Round Pipe	42.44
METP4-5	4RV-5	60" Round Pipe	50.66
MET454	4RV-60	45°/60° Adjustable Elbow	24.90
MET904	4RV-90	90° Adjustable Elbow	42.60
METY4F	4RV-4FY	4" x 4" Fixed Wye	58.90
METRF4	4RV-AF	Adj Roof Flashing Flat to 6/12	14.30

All Items May Not Be Stocked In All Branches

Gas Vent Pipe & Fittings

Type "B" Gas Vent Pipe & Fittings (Continued)

4" Gas Vent Round

Part #	Mfg #	Description	Price
METRF4-12	4RV-AF12	Adj Roof Flashing 6/12 to 12/12	37.16
METPADJ4-12	4RV-AJ	12" Adj Length Pipe	20.42
METPADJ4-18	4RV-AJ18	18" Adj Length Pipe	31.58
METDH4	4RV-DH	Draft Hood Connector	15.30
METPC4	4RV-GC	Pipe Collar - Galvanized	6.76
METSA4	4RV-GVS	Support Assembly	24.10
METHWTOP4	4RV-HWT	Hi-Wind Cap	28.04
METINC4-5	4RV-I5	4" x 5" Increaser	28.42
METINC4-6	4RV-I6	4" x 6" Increaser	29.88
METTOP4	4RV-RT	Top Vent (Bird Proof)	20.48
METSC4	4RV-SC	Storm Collar	4.16
METCAP4	4RV-TC	Tee Cap	4.16
METTCRF4	4RV-TF	Tall Cone Flat Roof Flashing	30.14
METT4	4RV-TS	Tee	53.86
METUAF4	4RV-UAF	Univ Female Adapter	33.56
METUAM4	4RV-UAM	Univ Male Adapter	33.56
METWSB4	4RV-WS/B	Wall Support/Band Assembly	38.04
METWT4	4RV-WT	Adj Wall Thimble	24.80
METRVOVA4	4RV-WV4	Round to Oval Adapter	32.20

5" Gas Vent Round

Part #	Mfg #	Description	Price
METP5-6	5RV-6	6" Round Pipe	16.22
METP5-12	5RV-12	12" Round Pipe	18.78
METP5-18	5RV-18	18" Round Pipe	22.14
METP5-2	5RV-2	24" Round Pipe	29.24
METP5-3	5RV-3	36" Round Pipe	38.44
METP5-4	5RV-4	48" Round Pipe	49.44
METP5-5	5RV-5	60" Round Pipe	58.78
MET455	5RV-60	45°/60° Adjustable Elbow	29.24
MET905	5RV-90	90° Adjustable Elbow	49.92
METRF5	5RV-AF	Adj Roof Flashing Flat to 6/12	22.24
METRF5-12	5RV-AF12	Adj Roof Flashing 6/12 to 12/12	48.44
METPADJ5-12	5RV-AJ	12" Adj Length Pipe	23.16
METDH5	5RV-DH	Draft Hood Connector	17.32
METUAF5	5RV-FA	Univ Female Adapter	35.16
METY5-5-3F	5RV3-FY	3" Fixed Wye w/3" Snout	60.42
METY5-5-4F	5RV4-FY	4" Fixed Wye w/4" Snout	64.26
METY5-4-4F	5RV44-FY	5" x 4" x 4" Fixed Wye	82.60

Type "B" Gas Vent Pipe & Fittings (Continued)

5" Gas Vent Round

Part #	Mfg #	Description	Price
METTCRF5	5RV-TF	Tall Cone Flat Roof Flashing	33.56
METPC5	5RV-GC	Pipe Collar - Galvanized	7.00
METSA5	5RV-GVS	Support Assembly	24.74
METINC5-6	5RV-I6	6" Increaser	29.60
METINC5-7	5RV-I7	7" Increaser	37.56
METUAM5	5RV-MA	Univ Male Adapter	35.16
METTOP5	5RV-RT	Vent Top	28.12
METSC5	5RV-SC	Storm Collar	8.38
METCAP5	5RV-TC	Tee Cap	5.48
METT5	5RV-TS	Tee	58.68
METWSB5	5RV-WS/B	Wall Support	39.84
METHWTOP5	5RV-HWT	Hi-Wind Top	37.34
METWT5	5RV-WT	Adj Wall Thimble	27.84
METROA5-56	5RV-5/6WV	Round to Oval Adapter	48.84

6" Gas Vent Round

Part #	Mfg #	Description	Price
METP6-6	6RV-6	6" Round Pipe	19.90
METP6-12	6RV-12	12" Round Pipe	20.76
METP6-18	6RV-18	18" Round Pipe	25.24
METP6-2	6RV-2	24" Round Pipe	34.94
METP6-3	6RV-3	36" Round Pipe	44.90
METP6-4	6RV-4	48" Round Pipe	57.64
METP6-5	6RV-5	60" Round Pipe	69.02
METPADJ6-12	6RV-AJ	12" Adj Length Pipe	26.30
METRF6	6RV-AF	Adj Roof Flashing Flat to 6/12	31.10
METRF6-12	6RV-AF12	Adj Roof Flashing 6/12 to 12/12	59.54
METTCRF6	6RV-TF	Tall Cone Flat Roof Flashing	42.28
METDH6	6RV-DH	Draft Hood Connector	19.92
MET456	6RV-60	45°/60° Adjustable Elbow	35.08
MET906	6RV-90	90° Adjustable Elbow	59.72
METY6-6-4F	6RV-4FY	4" Fixed Wye	68.32
METY6-6-5F	6RV-5FY	5" Fixed Wye	72.76
METPC6	6RV-GC	Pipe Collar - Galvanized	7.26
METSA6	6RV-GVS	Support Assembly	25.08
METHWTOP6	6RV-HWT	Hi-Wind Cap	48.82
METINC6-7	6RV-I7	7" Increaser	40.64
METINC6-8	6RV-I8	8" Increaser	46.42
METTOP6	6RV-RT	Vent Top	35.62
METSC6	6RV-SC	Storm Collar	8.68
METCAP6	6RV-TC	Tee Cap	6.44

Venting

Prices & Specifications are Subject to Change.

Gas Vent Pipe & Fittings

Type "B" Gas Vent Pipe & Fittings (Continued)

6" Gas Vent Round

Part #	Mfg #	Description	Price
METT6	6RV-TS	Tee	63.16
METUAF6	6RV-UAF	Univ Female Adapter	39.26
METUAM6	6RV-UAM	Univ Male Adapter	39.26
METWSB6	6RV-WS/B	Wall Support	38.02
METWT6	6RV-WT	Adj Wall Thimble	34.04
METROA6	6RV-WV6	Round to Oval Adapter	57.28

7" Gas Vent Round

Part #	Mfg #	Description	Price
METP7-12	7RV-12	12" Round Pipe	35.22
METP7-18	7RV-18	18" Round Pipe	45.36
METP7-2	7RV-2	24" Round Pipe	62.24
METP7-3	7RV-3	36" Round Pipe	79.84
METP7-4	7RV-4	48" Round Pipe	97.62
METP7-5	7RV-5	60" Round Pipe	115.22
METPADJ7-12	7RV-AJ	12" Adj Length Pipe	37.70
METRF7	7RV-AF	Adj Roof Flashing Flat to 6/12	45.36
METTCRF7	7RV-TF	Tall Cone Flat Roof Flashing	58.56
MET457	7RV-45	45° Adjustable Elbow	58.42
MET907	7RV-90	90° Adjustable Elbow	108.82
METSA7	7RV-GVS	Support Assembly	34.82
METTOP7	7RV-RT	Vent Top	61.60
METSC7	7RV-SC	Storm Collar	11.90
METCAP7	7RV-TC	Tee Cap	12.00
METT7	7RV-TS	Tee	80.30
METWSB7	7RV-WS/B	Wall Support	49.78
METWT7	7RV-WT	Adj Wall Thimble	45.92

8" Gas Vent Round

Part #	Mfg #	Description	Price
METP8-12	8RV-12	12" Round Pipe	40.70
METP8-18	8RV-18	18" Round Pipe	54.60
METP8-2	8RV-2	24" Round Pipe	69.76
METP8-3	8RV-3	36" Round Pipe	89.42
METP8-4	8RV-4	48" Round Pipe	108.72
METP8-5	8RV-5	60" Round Pipe	121.00
METPADJ8-12	8RV-AJ	12" Adj Length Pipe	44.66
METRF8	8RV-AF	Adj Roof Flashing Flat to 6/12	49.14
METTCRF8	8RV-TF	Tall Cone Flat Roof Flashing	65.60
MET908	8RV-90	90° Adjustable Elbow	115.78

Type "B" Gas Vent Pipe & Fittings (Continued)

8" Gas Vent Round

Part #	Mfg #	Description	Price
METSA8	8RV-GVS	Support Assembly	34.72
METTOP8	8RV-RT	Vent Top	79.20
METSC8	8RV-SC	Storm Collar	12.28
METCAP8	8RV-TC	Tee Cap	14.14
METT8	8RV-TS	Tee	110.42
METWSB8	8RV-WS/B	Wall Support	49.88
METWT8	8RV-WT	Adj Wall Thimble	47.46

Gas Vent Oval Pipe & Fittings

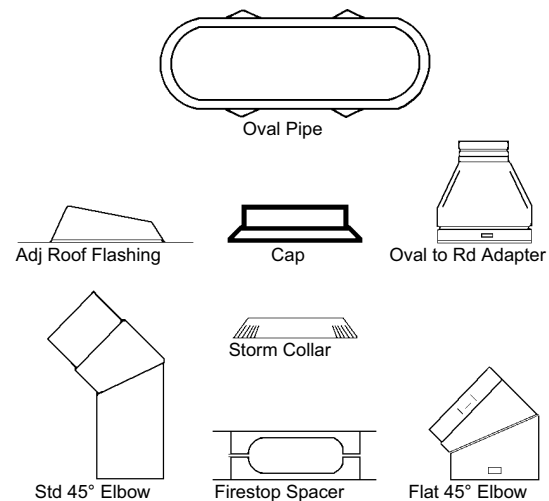

4" Gas Vent Oval Pipe

Part #	Mfg #	Description	Price
METPOV4-12	4OV-12	12" Oval Pipe	32.84
METPOV4-18	4OV-18	18" Oval Pipe	32.80
METPOV4-2	4OV-2	24" Oval Pipe	39.88
METPOV4-3	4OV-3	36" Oval Pipe	53.70
METPOV4-4	4OV-4	48" Oval Pipe	68.06
METPOV4-5	4OV-5	60" Oval Pipe	79.52
METOVF454	4OV-45F	Flat 45° Elbow	56.92
METOVS454	4OV-45S	Standard 45° Elbow	56.92
METOVRA4	4OV-RV4	Oval to 4" Round Adapter	39.04

Venting

All Items May Not Be Stocked In All Branches

Gas Vent Pipe & Fittings

Type B-W Installation Kit

- For vented wall furnace installations
- Adapts 4" WV oval for use with wall furnaces (vented recessed wall heaters)
- Kit contains:
 - Ceiling plate-spacers
 - Base plate
 - Screws for attachment
 - Complete directions for installation

Part #	Mfg #	Description	Price
METOVBW	4OV-BW	Type B-W Installation Kit	34.14

6" Gas Vent Oval

Part #	Mfg #	Description	Price
METORA6	6OV-6RV	Oval to 6" Round Adapter	57.28

5"/6" Gas Vent Oval

Part #	Mfg #	Description	Price
METPOV56-3	5/6OV-3	36" Oval Pipe	89.22
METPOV56-4	5/6OV-4	48" Oval Pipe	96.28
METPOV56-5	5/6OV-5	60" Oval Pipe	113.70
METORA56-5	5/6OV-RV5	Oval to 5" Round Adapter	63.20



Flexible Double Wall Gas Vent Connectors

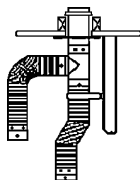

We Value Your Opinion
Let us know what we are doing right,
but more importantly let us know
how we can serve you better.

3" Flexible Gas Vent

Part #	Mfg #	Description	Price
METPFLEX3-4	3DWC-4'	4' Connector	61.54

4" Flexible Gas Vent

Part #	Mfg #	Description	Price
METPFLEX4-4	4DWC-4'	4' Connector	70.50

5" Flexible Gas Vent

Part #	Mfg #	Description	Price
METPFLEX5-4	5DWC-4'	4' Connector	81.42

Gas Vent Pipe & Fittings

Chimney Systems - All Fuel

- Rugged all fuel chimney
- Meets all UL® requirements
- Model SSII-Type HT tested to 2100°F
- Model SSII tested UL®-103 max temp of 1700°F
- Gravity venting only

Chimney Systems - All Fuel (Continued)

SSII-Type HT 6" Insulated Pipe & Fittings

Part #	Mfg #	Description	Price
MET6TAF6D	6T-AF6D	Dead Soft Flashing	148.48
MET6TAF12	6T-AF12	6/12 - 12/12 Adj Flashing	123.62
MET6TAIS	6T-AIS	Attic Insulation Shield	93.82
MET6TAP	6T-AP	Anchor Plate	76.08
MET6TCT	6T-CT	Round Top	104.08
MET6TDSA	6T-DSA	Dripless Smoke Pipe Adapter	72.36
MET6TDSAC	6T-DSAC	Dripless Smoke Pipe Adapter w/Coupler	90.76
MET6TEL15KIT	6T-EL15	15° Elbow	325.50
MET6TEL30KIT	6T-EL30	30° Elbow	474.46
MET6TFC	6T-FC	Finishing Collar	23.02
MET6TFCK	6T-FCK	6" Flat Ceiling Supp Kit	538.28
MET6TFSP	6T-FSP	Ceiling Support, Sqr Plate	121.68
MET6TFSPR	6T-FSPR	Ceiling Support, Rnd Plate	140.76
MET6TIT	6T-IT	Tee	306.98
MET6TIWT	6T-IWT	Insulated Wall Thimble	92.98
MET6TJS	6T-JS	Joist Shield	37.12
MET6TLB	6T-LB	Locking Band	15.22
MET6TPCPAJ	6T-PCPAJ	6" Adj Pitched Ceiling Plate	46.94
MET6TRBK	6T-RBK	Roof Brace Kit	126.94
MET6TRSP	6T-RSP	Roof Support Package	203.40
MET6TRTK	6T-RTK	Roof Top Kit	223.62
MET6TSA	6T-SA	Spark Arrestor	25.74
MET6TSB	6T-SB	Support Box	182.54
MET6TSC	6T-SC	Storm Collar	16.82
MET6TTF	6T-TF	0 - 2/12 Tall Cone Roof Flashing	126.40
MET6TTPS	6T-TPS	Fire Stop/Trim Collar w/Spacer	50.88
MET6TTWK	6T-TWK	6" Thru-the-Wall Kit	866.18
MET6TWB	6T-WB	Wall Band	40.70
MET6TWSK	6T-WSK	Wall Support Kit	116.10
MET6TIR	6T-IR	Interior Resupport	79.28

SSII-Type HT 7" Insulated Pipe & Fittings

Part #	Mfg #	Description	Price
MET7TCT	7T-CT	Round Top	142.02

SSII-Type HT 8" Insulated Pipe & Fittings

Part #	Mfg #	Description	Price
MET8T6	8T-6	6" Pipe	127.00
MET8T9	8T-9	9" Pipe	143.16
MET8T12	8T-12	12" Pipe	152.02

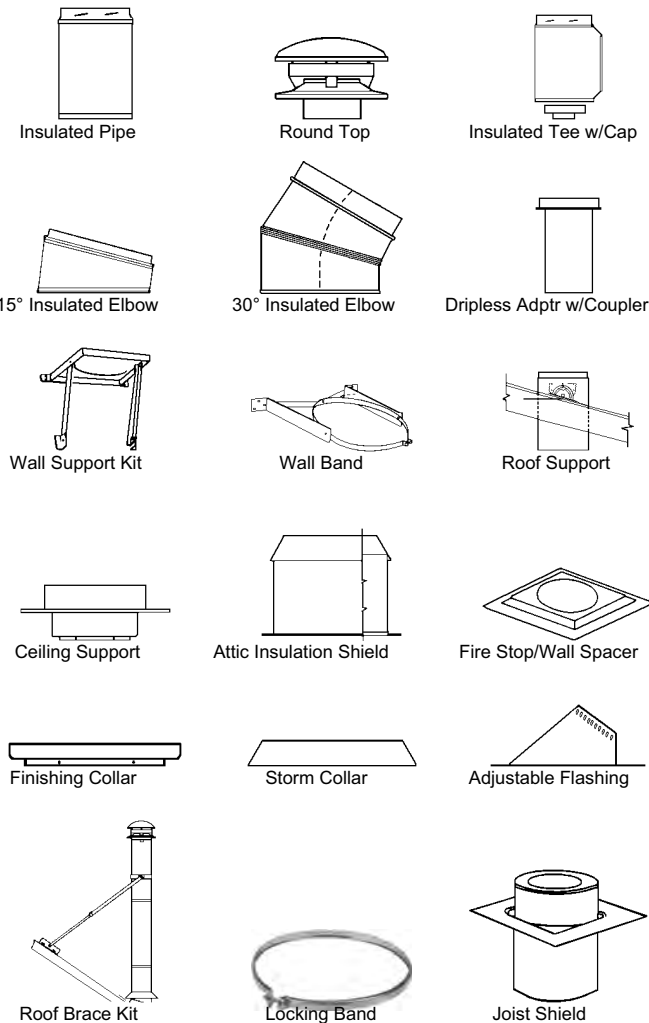

SSII-Type HT 6" Insulated Pipe & Fittings

Part #	Mfg #	Description	Price
MET6T6	6T-6	6" Pipe	89.50
MET6T9	6T-9	9" Pipe	96.54
MET6T12	6T-12	12" Pipe	101.42
MET6T18	6T-18	18" Pipe	122.16
MET6T24	6T-24	24" Pipe	157.26
MET6T36	6T-36	36" Pipe	217.20
MET6T48	6T-48	48" Pipe	273.76
MET6TAF6	6T-AF6	0/12 - 6/12 Adj Flashing	94.42

All Items May Not Be Stocked In All Branches

Venting

Gas Vent Pipe & Fittings

Chimney Systems - All Fuel (Continued)

SSII-Type HT 8" Insulated Pipe & Fittings

Part #	Mfg #	Description	Price
MET8T18	8T-18	18" Pipe	194.30
MET8T24	8T-24	24" Pipe	239.90
MET8T36	8T-36	36" Pipe	328.36
MET8T48	8T-48	48" Pipe	361.58
MET8TAF6	8T-AF6	Adj Flashing	118.56
MET8TAF6D	6T-AF6D	Dead Soft Flashing	167.16
MET8TAF12	8T-AF12	Adj Flashing	153.66
MET8TAIS	8T-AIS	Attic Insulation Shield	125.08
MET8TAP	8T-AP	Anchor Plate	103.48
MET8TCT	8T-CT	Round Top	190.72
MET8TDSA	8T-DSA	Dripless Smoke Pipe Adapter	82.06
MET8TDSAC	8T-DSAC	Dripless Smoke Pipe Adapter w/Coupler	101.68
MET8TEL15KIT	8T-EL15KIT	15° Elbow Kit	417.18
MET8TEL30KIT	8T-EL30KIT	30° Elbow Kit	562.82
MET8TFC	8T-FC	Finishing Collar	31.78
MET8TFCK	8T-FCK	8" Flat Ceiling Supp Kit	725.96
MET8TFSP	8T-FSP	Ceiling Support, Sqr Plate	150.02
MET8TIR	8T-IR	Interior Resupport Kit	87.98
MET8TIT	8T-IT	Tee	454.44
MET8TIWT	8T-IWT	Insulated Wall Thimble	109.86
MET8TJS	8T-JS	Joist Shield	65.78
MET8TLB	8T-LB	Locking Band	17.78
MET8TPCPAJ	8T-PCPAJ	8" Adj Pitched Ceiling Plate	59.38
MET8TRBK	8T-RBK	Roof Brace Kit	135.04
MET8TRSP	8T-RSP	Roof Support Pkg	256.28
MET8TRTK	8T-RTK	Roof Top Kit	339.08
MET8TSB	8T-SB	Support Box	199.46
MET8TSC	8T-SC	Storm Collar	19.06
MET8TTF	8T-TF	0 - 2/12 Tall Cone Roof Flashing	155.08
MET8TTPS	8T-TPS	Fire Stop/Trim Collar w/Spacer	73.20
MET8TTWK	8T-TWK	8" Thru-the-Wall Kit	1261.70
MET8TWB	8T-WB	Wall Band	52.22
MET8TWSK	8T-WSK	Wall Support Kit	169.34

SSII-Type HT Insulated Universal Roof Support Assembly

- Secures 5", 6", 7" or 8" diameter chimney with heavy duty band
- Can adjust installed length vertically
- Up to 30' pipe, up to 20' below

Part #	Mfg #	Description	Price
METURSA	U-RSA	Universal Roof Support Assembly	92.98



Check our website for special promotions!
www.irrsupply.com

Chimney Liners

Metalbest Flexible Aluminum Chimney Liner Kits

- Solution for gas-fired heat venting
- Eliminates chimney flue deterioration
- Aluminum Liner Kit includes:
 - 2-Ply Aluminum Flexi-liner
 - Round top (RV)
 - Flashing with 3" collar
 - Motor guard



Part #	Mfg #	Size	Length	Price
CHLA2503	AF25-03	3"	25'	144.82
CHLA3503	AF35-03	3"	35'	180.18
CHLA2504	AF25-04	4"	25'	152.80
CHLA3504	AF35-04	4"	35'	187.96
CHLA2505	AF25-05	5"	25'	183.12
CHLA3505	AF35-05	5"	35'	221.88
CHLA2555	AF25-05.5	5.5"	25'	218.34
CHLA3555	AF35-05.5	5.5"	35'	263.10
CHLA2506	AF25-06	6"	25'	218.34
CHLA3506	AF35-06	6"	35'	263.10
CHLA3507	AF35-07	7"	35'	387.86
CHLA3508	AF35-08	8"	35'	497.12

5.5" Flexi-Liner

Part #	Mfg #	Description	Price
CHLE1055	AFE10-05.5	5.5" x 10' Extension Kit	74.62
CHLLBF55	AF5.5-BVA	5.5" B-Vent Adapter	20.88
CHLLCJ55	AF5.5-FC	5.5" Flex Coupler	11.00

6" Flexi-Liner

Part #	Mfg #	Description	Price
CHLE1006	AFE10-06	6" x 10' Extension Kit	78.36
CHLLBF06	AF6-BVA	6" B-Vent Adapter	29.14
CHLLCJ6	AF6-FC	6" Flex Coupler	11.00
CHLN1006	AF6-FS	5.5" - 6" Flexi-Sleeve	56.52

7" Flexi-Liner

Part #	Mfg #	Description	Price
CHLE1007	AFE10-07	7" x 10' Extension Kit	107.50

8" Flexi-Liner

Part #	Mfg #	Description	Price
CHLE1008	AFE10-08	8" x 10' Extension Kit	134.64

Metalbest SS Versa-Liner Chimney Liner Kits

Part #	Mfg #	Size	Length	Price
CHLSL2505T	5RF-25KT	5"	25'	977.34
CHLS3505	5RF-35KT	5"	35'	1258.12
CHLSL2506T	6RF-25KT	6"	25'	1112.64
CHLS3506	6RF-35KT	6"	35'	1434.90
CHLS3507	7RF-35KT	7"	35'	1757.26

Metalbest Aluminum Flexi-Liner

3" Flexi-Liner

Part #	Mfg #	Description	Price
CHLE1003	AFE10-03	3" x 10' Extension Kit	50.98
CHLLCJ3	AF3-FC	3" Flex Coupler	9.08
CHLN1004	AF4-FS	3" - 4" Flexi-Sleeve	43.68

4" Flexi-Liner

Part #	Mfg #	Description	Price
CHLE1004	AFE10-04	4" x 10' Extension Kit	56.52
CHLLBF04	AF4-BVA	4" B-Vent Adapter	23.70
CHLLCJ4	AF4-FC	4" Flex Coupler	9.08

5" Flexi-Liner

Part #	Mfg #	Description	Price
CHLE1005	AFE10-05	5" x 10' Extension Kit	69.28
CHLLBF05	AF5-BVA	5" B-Vent Adapter	25.62
CHLLCJ5	AF5-FC	5" Flex Coupler	9.08
CHLN1005	AF5-FS	5" Flexi-Sleeve	49.16

All Items May Not Be Stocked In All Branches

Special Gas Vent & Fittings

Saf-T Vent®

**Saf-T Vent EZ Seal Single Wall AL29-4C®
Special Gas Vent
3" Diameter**

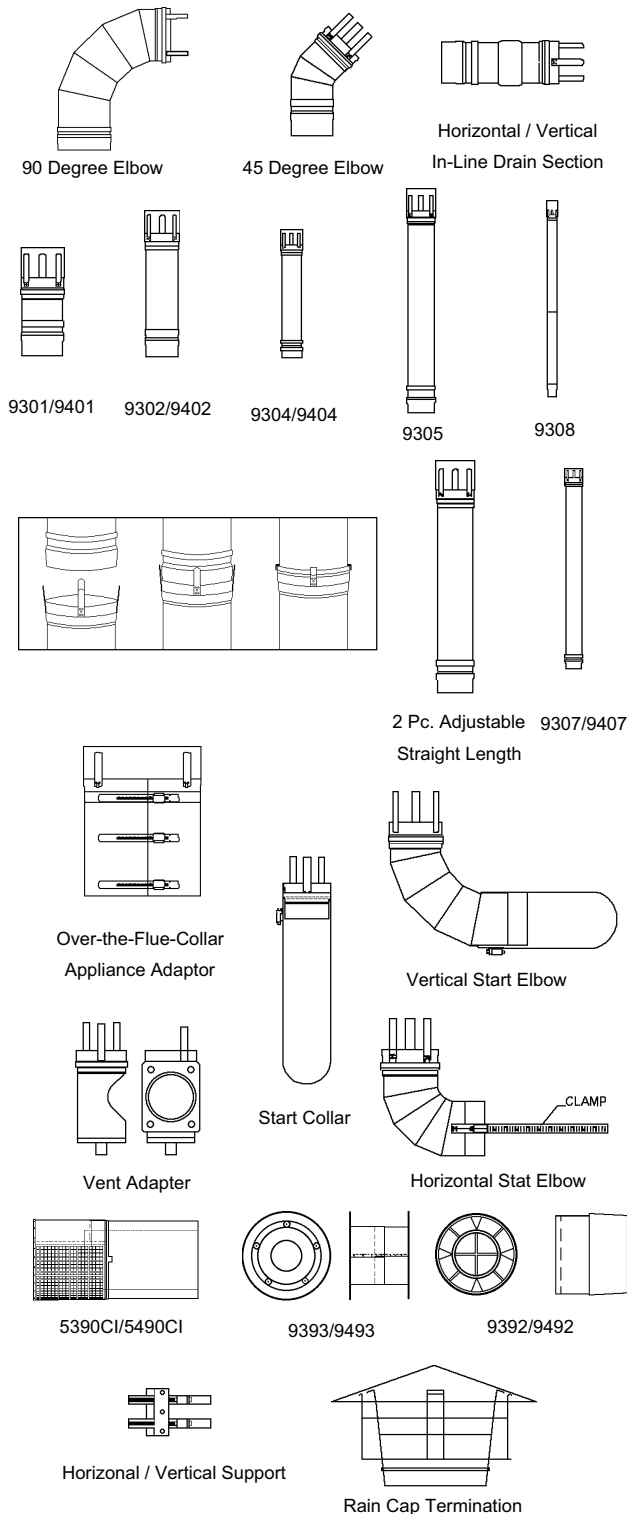

Part #	Mfg #	Description	Price
SSVP3-6EZ	9301	6" SS Pipe	29.48
SSVP3-12EZ	9302	12" SS Pipe	35.50
SSVP3-18EZ	9304	18" SS Pipe	49.88
SSVP3-24EZ	9305	24" SS Pipe	61.14
SSVP3-37EZ	9307	36" SS Pipe	80.10
SSVP3-60EZ	9360	60" SS Pipe	141.30
SSV453EZ	9311	SS 45° Elbow	76.38
SSV903EZ	9314	SS 90° Elbow	91.48
SSV90TERM3	9314TERM	90° Screen Elbow Termination	94.50
SSVT3EZ	9316B	SS Boot Tee	160.24
SSVDRN3EZ	9317D	Condensate Tee Cap w/3/8" Drain Ftg	52.86
SSVPDRN3EZ	9321	Horiz/Vert In-Line Drain	67.24
SSVPSC3-19EZ	9324	2 Pc, 6" to 19" Adjustable Pipe	62.35
SSVINC3-4EZ	9374	3" to 4" Increaser	78.56
SSVTERM3	9390	Mitre Cut Screen Termination	49.16
SSVWT3	9393	SS Horz Round Wall Thimble	49.88
SSV9301DEL	9301DEL	Adapter for Noritz 0531S	45.60
SSVTERMT3	9390TEE	SS Screened Termination Tee	91.48
SSVCGISTREZ	93WMCGIS	Starter Collar f/CGI	40.80
SSVGVSTRTEZ	93WMSTXL	GV Series Flanged Vent Adapter	93.32

4" Diameter

Part #	Mfg #	Description	Price
SSVP4-6EZ	9401	6" SS Pipe	33.24
SSVP4-12EZ	9402	12" SS Pipe	41.60
SSVP4-18EZ	9404	18" SS Pipe	61.14
SSVP4-24EZ	9405	24" SS Pipe	67.24
SSVP4-37EZ	9407	36" SS Pipe	96.76
SSVP4-60EZ	9460	60" SS Pipe	163.30
SSVT4EZ	9416B	SS Boot Tee	160.24
SSV454EZ	9411	SS 45° Elbow	99.04
SSV904EZ	9414	SS 90° Elbow	119.36
SSVDRN4EZ	9417D	Condensate Tee Cover	60.50
SSVPDRN4EZ	9421	Horiz/Vert In-Line Drain	86.92
SSVPSC4-19EZ	9424	2 Pc, 6" to 19" Adjustable Pipe	70.45
SSVWT4	9493	SS Horz Round Wall Thimble	52.22

Venting

Prices & Specifications are Subject to Change.

Special Gas Vent & Fittings

**Saf-T Vent EZ Seal Single Wall AL29-4C®
Special Gas Vent (Continued)**

4" Diameter

Part #	Mfg #	Description	Price
SSVTERM4	9490	Mitre Cut Screen Termination	49.88
SSVTERMT4	9490TEE	SS Screened Termination Tee	103.48
SSV9401RYPK	9401RYPK	Raypak Hi-Delta Adapter, Also for Noritz Series N063 N069 & N084	48.36

5" Diameter

Part #	Mfg #	Description	Price
SSVP5-18EZ	9504	18" SS Pipe	67.24
SSVP5-37EZ	9507	36" SS Pipe	102.80
SSV905EZ	9514	SS 90° Elbow	128.50
SSV9501NOR	9501NOR	Noritz Adapter, For Noritz N132 Series	117.18
SSVTERMT5	9590TEE	SS Screened Termination Tee	128.50

5" Diameter

Part #	Mfg #	Description	Price
SSVRF5EZ	5581CI	2/12 - 8/12 Pitched Cone Roof Flashing	336.36
SSVRFF5EZ	5582CI	Tall Flat Cone Roof Flashing	297.90
SSVWHT5	5590CI	SS Rnd Horiz Termination	382.28

Venting

EZ Seal Quick Kit

- Designed for sidewall venting of tankless heaters and wall-hung boilers
- (5) Easy to install components
- Compatible with other standard Saf-T Vent products

Part #	Mfg #	Description	Price
SSV94QK2H	94QK2H	4" EZ Seal Quick Kit	410.34

CI Single Wall AL29-4C® Special Gas Vent

Saf-T Vent

3" Diameter

Part #	Mfg #	Description	Price
SSVTOPSC3	5300CI	SS Rain Cap & Storm Collar	164.44
SSVWHT3	5390CI	SS Horizontal Termination	283.02

4" Diameter

Part #	Mfg #	Description	Price
SSVRF4EZ	5481CI	2/12 - 8/12 Pitched Cone Roof Flashing	290.44
SSVTOPSC4	5400CI	SS Rain Cap Termination	167.44
SSVWHT4	5490CI	SS Rnd Horiz Termination	312.72

Special orders - If you need it we can get it promptly!

All Items May Not Be Stocked In All Branches

Ventilation

SWG For Sidewall Venting

Outdoor Mounted for Oil & Gas

- Easy to install unit that significantly reduces motor noise
- Designed for walls up to 8" thick
- PEK Extension kit allows the SWG to be installed in walls up to 16" thick
- 115V, 60Hz, Thermal protection



How the SWG works:

1. Thermostat calls for heat.
2. The Control Kit (A) is activated. This energizes the SWG venter (B) which creates negative pressure in the vent system and starts the burner (C).
3. Outside air is drawn into the vent system between the inner and outer pipe (D), reducing heat buildup. The gases then exit the venter (E).
4. After the thermostat is satisfied and the burner shuts off, a post purge control operates the venter to vent any remaining combustion gases and then deactivates the venter.

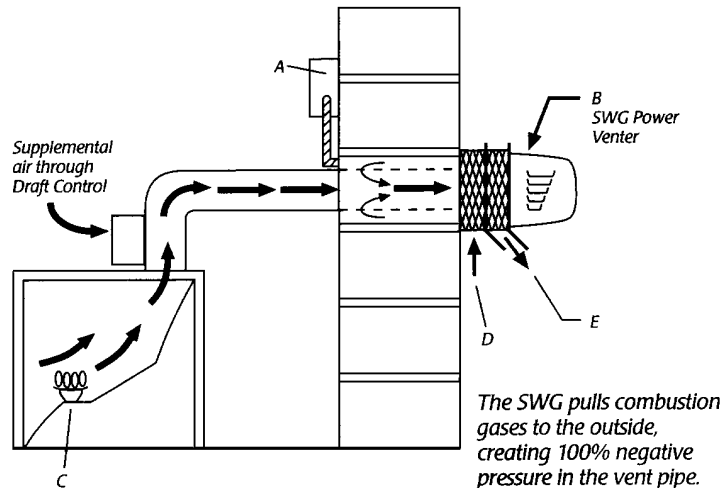

Venting

Part #	Mfg #	Description	Price
FIESWG3	SWG-3	115V Gas & Oil Venter, 3" Inlet	621.92
FIESWG4HD	SWGII-4HD	115V Gas & Oil Venter, 4" Inlet for 3", 4" & 5" Vent Sizes	625.92
FIESWG5	SWGII-5	115V Gas & Oil Venter, 5" Inlet	780.70

Control Kit for SWG Series Power Venter

- Required to operate SWG Power Venter
- Controls the operation of SWG power venters, field draft inducers & combustion air systems



Part #	Mfg #	Description	Price
FIECK20F	CK-20F	30 or 750mV Gas Fired Water Heaters & Gas Fired Pool or Spa Heaters w/Manual or Internally Mounted Thermostat & Fixed Post Purge; Includes Gas Pressure Switch & Secondary Safety Switch	305.82
FIECK41F	CK-41F	24V Furnaces, Boilers, Unit Heaters & Water Heaters Operating with a 24VAC Gas Valve less Factory Mounted Spillage Switches & Sec Safety Switch; Includes Draft Proving Switch & Fixed Post Purge	299.06
FIECK61	CK-61	All Oil Fired Systems, Has Adjustable Electronic Post Purge; Includes Draft Proving Switch & Secondary Safety Switch	600.04
FIECK62	CK-62	All Oil Fired Systems; Includes Thermally Activated Post Purge	652.50
FIECK91F	CK-91F	Gas Fired Draft Induced 24VAC Gas Valve System & a 30 mV Operated Water Heater; Includes: Fixed Post Purge, 4" MG-1 Draft Control & Post Purge	551.92

Prices & Specifications are Subject to Change.

Insulation

Duct Board

- Quiet system
- Lower operating costs
- Reduces condensation
- Durable and easy to clean
- Resists microbial growth



ToughGard® Rigid Liner Board with Enhanced Surface

- Fiberglass insulation for lining interior of sheet metal ducts and plenums



EI 475 R-4.3 ToughGard® Shiplap

Part #	Mfg #	Size	Price
DUBBOARD	706106	1" x 48" x 120"	82.12

Ultra*Duct™ Gold Fiberglass Duct Board

- Significantly less dust
- Innovative matt facing
- Smoother air stream surface

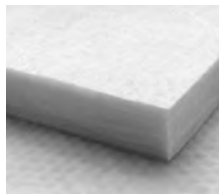

EI 475 R-4.3 Ultra*Duct™ Gold Butt Edge

Part #	Mfg #	Size	Price
DUBCOATED1	709106	1" x 48" x 100'	98.28

EI 800 R-6.5 Ultra*Duct™ Gold Shiplap

Part #	Mfg #	Size	Price
DUBCOATED112	707622	1-1/2" x 48" x 120"	152.70

Duct Wrap

- Used to insulate rectangular and round heating ventilating and air conditioning ductwork
- Glass fibers bonded together with thermosetting resin

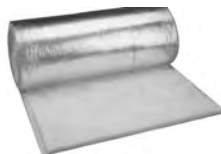

SoftTouch™ Standard FSK Faced Type 075

Part #	Mfg #	Size	Price
DUBWRAP	703261	1-1/2" x 48" x 100'	219.68
DUBWRAPR8	703265	3" x 48" x 50'	226.52

Duct Liner

ToughGard®2 Textile Type Duct Liner



1-1/2# Density - Type 150

Part #	Mfg #	Size	Price
DUBLINER1	709102	1" x 47" x 100'	546.58

2# Density - Type 200

Part #	Mfg #	Size	Price
DUBLINER12	709123	1/2" x 47" x 100'	402.42

**"Service Starts Here"
is not just a motto
it's how we do business.**

Insulation

IMCOA LeakTite Adhesive

Part #	Mfg #	Description	Price
INSADH8	1A-1	1/2 pt with Brush Top	15.43
INSADH16	1A-2	1 pt w/Brush Top - 24/Box	23.35
INSADH32	1A-3	1 qt	31.27

Insulation Tape

ASJ Fiberglass Insulation Tape

Part #	Mfg #	Size	Price
INSASJTAPE3	ASJTAPE300	3" x 150'	23.60

Foam Tape

- Used to retard heat gain and prevent condensation or frost formation on cold water plumbing
- Reduces heat flow for hot water plumbing
- Manufactured with pressure sensitive adhesive for applying to hot or cold pipes and fittings
- Adhesive adheres firmly and forms a long-lasting bond
- The closed cell structure provides good thermal and low moisture permeability properties



Part #	Mfg #	Description	Price
INSTAPE	800-EL-018	1/8" x 2" x 30' Foam Tape	14.65

Venting

Let us know how we may best serve you. Suggestions help us improve.

Registers, Grilles & Diffusers

Residential Registers & Grilles

11 Duct Ring

- Steel
- Round



Part #	Mfg #	Size	Finish	Price
HAC116	013200	6"	GS	12.30
HAC118	013201	8"	GS	14.08
HAC1110	013202	10"	GS	18.44
HAC1112	013203	12"	GS	22.18

12 Butterfly Damper

- Steel
- Round



Part #	Mfg #	Size	Finish	Price
HAC126	013220	6"	GS	19.04
HAC128	013221	8"	GS	30.66
HAC1210	013222	10"	GS	38.08
HAC1212	013223	12"	GS	51.70

16 Ceiling Diffuser

- Steel
- Round
- Step down



Part #	Mfg #	Size	Finish	Price
HAC166	012900	6"	W	15.00
HAC168	012901	8"	W	21.86
HAC1610	012902	10"	W	27.44
HAC1612	012903	12"	W	37.66

210 Floor Register

- Steel
- MS Valve



Part #	Mfg #	Size	Finish	Price
HAC2106-10	010636	6" x 10"	GS	55.36
HAC2106-12	010637	6" x 12"	GS	63.86
HAC2106-14	010638	6" x 14"	GS	69.80
HAC2108-10	010640	8" x 10"	GS	60.62

W = Bright White GS = Golden Sand SA = Satin Anodized

Residential Registers & Grilles (Continued)

210 Floor Register

Part #	Mfg #	Size	Finish	Price
HAC2108-12	010641	8" x 12"	GS	70.32
HAC2108-14	010642	8" x 14"	GS	84.30
HAC21010-12	010647	10" x 12"	GS	78.74
HAC21010-14	010648	10" x 14"	GS	104.18
HAC21012-14	010651	12" x 14"	GS	94.02

265 Floor Grille

- Steel

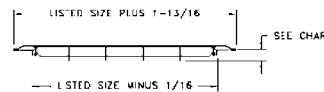

HEIGHT	WIDTH	MAXIMUM DEPTH
4 THRU 14	6 THRU 30	2 ¹ / ₃₂
14 THRU 14	32 THRU 36	2 ⁵ / ₃₂
16 THRU 18	16 THRU 36	1 ¹³ / ₃₂
20 THRU 24	20 THRU 36	1 ¹³ / ₃₂

Part #	Mfg #	Size	Finish	Price
HAC2654-10	011851	4" x 10"	GS	33.72
HAC2654-12	011852	4" x 12"	GS	20.32
HAC2656-10	011860	6" x 10"	GS	34.20
HAC2656-12	011861	6" x 12"	GS	20.92
HAC2656-14	011862	6" x 14"	GS	23.84
HAC2656-24	011866	6" x 24"	GS	41.86
HAC2656-30	011867	6" x 30"	GS	86.98
HAC2658-10	011870	8" x 10"	GS	37.30
HAC2658-12	011871	8" x 12"	GS	39.64
HAC2658-14	011872	8" x 14"	GS	25.64
HAC2658-16	011873	8" x 16"	GS	32.00
HAC2658-20	011875	8" x 20"	GS	71.24
HAC2658-24	011876	8" x 24"	GS	75.38
HAC2658-30	011877	8" x 30"	GS	87.96
HAC26510-12	011881	10" x 12"	GS	49.66
HAC26510-14	011882	10" x 14"	GS	57.76
HAC26510-24	011887	10" x 24"	GS	90.00
HAC26510-30	011888	10" x 30"	GS	94.48
HAC26512-12	011890	12" x 12"	GS	57.46
HAC26512-14	011891	12" x 14"	GS	61.24
HAC26512-20	011894	12" x 20"	GS	43.76
HAC26512-24	011895	12" x 24"	GS	48.28
HAC26514-24	011903	14" x 24"	GS	100.74
HAC26514-30	011906	14" x 30"	GS	120.64
HAC26516-30	011912	16" x 30"	GS	153.20

All Items May Not Be Stocked In All Branches

Register, Grilles, Diffusers

Registers, Grilles & Diffusers

406 Baseboard Diffusers

- Steel
- Plate damper



Part #	Mfg #	Size	Finish	Price
HAC406W	010680	18"	W	22.72
HAC406	010681	18"	GS	23.52

407 Baseboard Return

- Steel

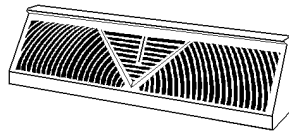

Part #	Mfg #	Size	Finish	Price
HAC407W	011960	18"	W	22.64
HAC407	011961	18"	GS	22.64

411 Deluxe Floor Diffuser

- Steel

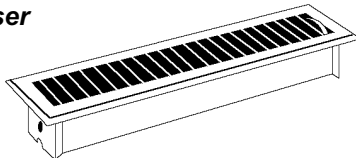

Part #	Mfg #	Size	Finish	Price
HAC4112-10	010686	2" x 10"	GS	33.94
HAC4112-12	010688	2" x 12"	GS	36.04
HAC4114-10	010692	4" x 10"	GS	37.98
HAC4114-12	010694	4" x 12"	GS	41.96
HAC4114-14	010696	4" x 14"	GS	49.04
HAC4116-10	010698	6" x 10"	GS	59.32
HAC4116-12	010700	6" x 12"	GS	59.74
HAC4116-14	010702	6" x 14"	GS	64.48

420 Toe-Space Grille

- Steel



Part #	Mfg #	Size	Finish	Price
HAC420W2-10	011300	10" x 2"	W	8.44
HAC4202-10	011301	10" x 2"	GS	8.20
HAC420W4-10	011306	10" x 4"	W	11.52
HAC4204-10	011307	10" x 4"	GS	11.12
HAC420W2-12	011302	12" x 2"	W	9.02
HAC4202-12	011303	12" x 2"	GS	8.60
HAC420W4-12	011308	12" x 4"	W	13.52
HAC4204-12	011309	12" x 4"	GS	13.06
HAC4202-14	011305	14" x 2"	GS	11.96
HAC4204-14	011311	14" x 4"	GS	15.32

421 Stamped Floor Diffuser

- Steel



Part #	Mfg #	Size	Finish	Price
HAC4212-10	010710	2" x 10"	GS	10.64
HAC421W2-10	010711	2" x 10"	W	11.02
HAC4212-12	010712	2" x 12"	GS	10.44
HAC421W2-12	010713	2" x 12"	W	10.44
HAC4212-14	010714	2" x 14"	GS	16.12
HAC421W2-14	010715	2" x 14"	W	15.58
HAC4214-8	010705	4" x 8"	GS	10.72
HAC4214-10	010717	4" x 10"	GS	9.50
HAC421W4-10	010718	4" x 10"	W	9.50
HAC4214-12	010719	4" x 12"	GS	12.88
HAC421W4-12	010720	4" x 12"	W	13.34
HAC4214-14	010721	4" x 14"	GS	19.54

462 Baseboard Diffuser

- Steel
- Plate damper



Part #	Mfg #	Size	Finish	Price
HAC462W	010726	24"	W	47.66

464 Baseboard Diffuser

- Steel



Part #	Mfg #	Size	Finish	Price
HAC464W	010728	48"	W	90.36

472 Baseboard Return

- Steel



Part #	Mfg #	Size	Finish	Price
HAC472W	011975	24"	W	46.42

474 Baseboard Return

- Steel

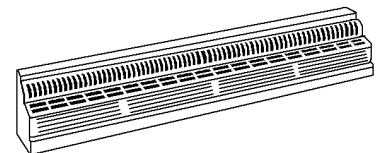

Part #	Mfg #	Size	Finish	Price
HAC474W	011977	48"	W	84.62

W = Bright White GS = Golden Sand SA = Satin Anodized

Prices & Specifications are Subject to Change.

Registers, Grilles & Diffusers

631 Supply Register

- Steel
- 3-Way deflection
- MS Valve



Part #	Mfg #	Size	Finish	Price
HAC63110-6	010753	10" x 6"	W	20.94
HAC63112-6	010756	12" x 6"	W	23.26

650 Sidewall Return Air Grille

- Steel
- 1/3" Fin spacing



Part #	Mfg #	Size	Finish	Price
HAC6508-6	043105	8" x 6"	W	9.64
HAC65010-4	043108	10" x 4"	W	9.32
HAC65010-6	043109	10" x 6"	W	8.12
HAC65010-8	043110	10" x 8"	W	11.52
HAC65010-10	043111	10" x 10"	W	16.52
HAC65012-4	043116	12" x 4"	W	10.00
HAC65012-6	043117	12" x 6"	W	7.82
HAC65012-8	043118	12" x 8"	W	12.14
HAC65012-10	043119	12" x 10"	W	17.72
HAC65012-12	043120	12" x 12"	W	15.48
HAC65012-14	043121	12" x 14"	W	21.48
HAC65014-4	043126	14" x 4"	W	10.38
HAC65014-6	043127	14" x 6"	W	9.18
HAC65014-8	043128	14" x 8"	W	10.64
HAC65014-12	043130	14" x 12"	W	21.48
HAC65014-14	043131	14" x 14"	W	19.42
HAC65014-16	043132	14" x 16"	W	30.02
HAC65016-6	043138	16" x 6"	W	14.08
HAC65016-12	043141	16" x 12"	W	25.60
HAC65016-20	043144	16" x 20"	W	39.70
HAC65016-24	043145	16" x 24"	W	47.60
HAC65020-6	043154	20" x 6"	W	15.52
HAC65020-8	043155	20" x 8"	W	15.88
HAC65020-10	043156	20" x 10"	W	20.80
HAC65020-16	043159	20" x 16"	W	38.36
HAC65020-20	043161	20" x 20"	W	38.52
HAC65024-6	043166	24" x 6"	W	13.22
HAC65024-8	043167	24" x 8"	W	14.00
HAC65024-12	043169	24" x 12"	W	33.60
HAC65024-20	043173	24" x 20"	W	61.74
HAC65024-24	043174	24" x 24"	W	78.88
HAC65030-6	043177	30" x 6"	W	15.26
HAC65030-8	043178	30" x 8"	W	18.36
HAC65030-10	043179	30" x 10"	W	35.56

**Register, Grilles,
Diffusers**

651 Sidewall Register

- Steel
- 1/3" Fin spacing
- Plate damper
- 3/16" Turnback

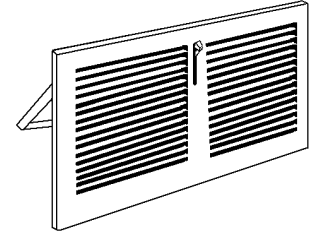

Part #	Mfg #	Size	Finish	Price
HAC65110-6	043603	10" x 6"	W	25.26
HAC65114-6	043606	14" x 6"	W	36.96

654 Baseboard Register

- Steel
- 1/3" Fin spacing
- Plate damper
- 7/8" Turnback

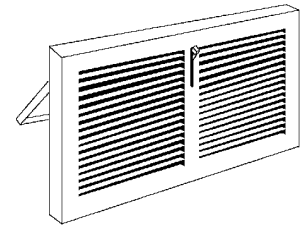

Part #	Mfg #	Size	Finish	Price
HAC65410-6	043620	10" x 6"	W	31.46
HAC65412-6	043621	12" x 6"	W	35.90
HAC65414-6	043622	14" x 6"	W	38.14

655 Baseboard Register

- Steel
- 1/3" Fin spacing
- Plate damper
- 3-3/4" Base projection

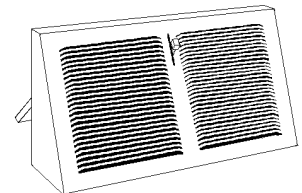

Part #	Mfg #	Size	Finish	Price
HAC65510-6	043631	10" x 6"	W	45.98
HAC65512-6	043632	12" x 6"	W	45.86
HAC65514-6	043633	14" x 6"	W	48.28

657 Baseboard Return

- Steel
- 1/3" Fin spacing
- 7/8" Turnback



Part #	Mfg #	Size	Finish	Price
HAC65710-6	043641	10" x 6"	W	17.60
HAC65712-6	043644	12" x 6"	W	17.34
HAC65712-8	043645	12" x 8"	W	18.98
HAC657GS14-6	043648	14" x 6"	GS	14.52
HAC65714-6	043649	14" x 6"	W	12.20
HAC65714-8	043650	14" x 8"	W	19.22
HAC65724-6	043663	24" x 6"	W	23.64
HAC65724-8	043664	24" x 8"	W	31.92

W = Bright White GS = Golden Sand SA = Satin Anodized

All Items May Not Be Stocked In All Branches

Registers, Grilles & Diffusers

Residential Registers & Grilles (Continued)

657 Baseboard Return

Part #	Mfg #	Size	Finish	Price
HAC65730-6	043670	30" x 6"	W	25.50
HAC65730-8	043671	30" x 8"	W	35.60

658 Baseboard Return

- Steel
- 1/3" Fin spacing
- 3-3/4" Base projection



Part #	Mfg #	Size	Finish	Price
HAC65812-6	043701	12" x 6"	W	26.66
HAC65814-6	043702	14" x 6"	W	28.66
HAC65830-6	043706	30" x 6"	W	43.02

659 Return Air Filter Grille

- Steel
- 1/3" Fin spacing
- Uses standard 1" filters (not included)
- Removable face



Part #	Mfg #	Size	Finish	Price
HAC65914-14	043404	14" x 14"	W	45.86
HAC65914-20	043405	14" x 20"	W	49.36
HAC65916-20	043410	16" x 20"	W	53.78
HAC65916-25	043411	16" x 25"	W	66.68
HAC65920-16	043418	20" x 16"	W	50.12
HAC65920-20	043419	20" x 20"	W	43.48
HAC65924-24	043428	24" x 24"	W	86.94
HAC65925-20	043432	25" x 20"	W	64.44

661 Supply Register

- Steel
- 2-Way deflection
- MS Valve



Part #	Mfg #	Size	Finish	Price
HAC6618-4	010812	8" x 4"	W	17.50
HAC6618-6	010814	8" x 6"	W	19.54
HAC66110-4	010816	10" x 4"	W	14.08
HAC66110-6	010819	10" x 6"	W	16.36
HAC66110-8	010820	10" x 8"	W	27.06
HAC66112-4	010821	12" x 4"	W	15.60

Residential Registers & Grilles (Continued)

661 Supply Register

Part #	Mfg #	Size	Finish	Price
HAC66112-6	010823	12" x 6"	W	9.70
HAC66112-8	010825	12" x 8"	W	28.56
HAC66114-4	010827	14" x 4"	W	22.80
HAC66114-6	010830	14" x 6"	W	11.12
HAC66114-8	010832	14" x 8"	W	15.02
HAC66116-8	010834	16" x 8"	W	41.78

664 Baseboard Register

- Steel



Part #	Mfg #	Size	Finish	Price
HAC66410-6	010881	10" x 6"	W	29.14
HAC66412-6	010883	12" x 6"	W	31.66
HAC66414-6	010885	14" x 6"	W	34.30

673 Return Air Filter Grille

- Steel
- 1/2" Fin spacing
- Uses standard 1" filters (not included)



Part #	Mfg #	Size	Finish	Price
HAC67314-20	043505	14" x 20"	W	66.30
HAC67314-25	043507	14" x 25"	W	78.10

Sundry

Laundry Chute Doors

Part #	Mfg #	Description	Price
HACDOOR	LCD12	12" Laundry Chute Door	49.90

**Register, Grilles,
Diffusers**

W = Bright White GS = Golden Sand SA = Satin Anodized

Prices & Specifications are Subject to Change.

Registers, Grilles & Diffusers

Commercial T-Bar

659T/PFT T-Bar Filter Grille

- Steel



659T/PFT Lanced Face with Filter-Frame Back

Part #	Mfg #	Size	Finish	Price
HAC659T	012745	20" x 20"	W	116.26

659T/PFT Lanced Face w/Insulated Back

Part #	Mfg #	Size	Finish	Price
HAC659TI	050560	20" x 20"	W	132.42

HVS T-Bar Ceiling Diffuser

- High volume
- Accepts 2"H snap-in collar
- Pre-scored fiberglass insulation blanket with foil vapor barrier
- Utilizes 3800 series butterfly damper insulated collar
- Bright white



Part #	Mfg #	Description	Price
HACHVS	050350	4-Way for 6-12" Collar	152.80

Surfaire® T-Bar Ceiling Diffuser

- Aluminum face

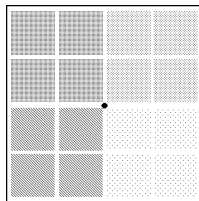

For 6"-12" Collar

Part #	Mfg #	Description	Price
HAC444W	50300	4-Way	118.38

5400 Collar

- Includes (4) small plastic push pins to snap into prepunched holes in metal plenum



Part #	Mfg #	Size	Price
HAC5406	050310	6"	11.70

Commercial T-Bar (Continued)

5400 Collar

Part #	Mfg #	Size	Price
HAC5408	050312	8"	11.70
HAC5410	050314	10"	11.70
HAC5412	050316	12"	11.90

3800 Damper

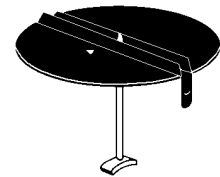

Part #	Mfg #	Size	Finish	Price
HAC3806	050290	6"	GS	22.34
HAC3808	050292	8"	GS	22.34



Ceiling Diffusers

Classic Diffuser, Outlet Assembly and Damper in One

- Quick tear off bands allow for easy size changes
- Swinging clips fasten assembly into ceiling in seconds



Part #	Mfg #	Description	Price
AICMV3	MV3	3-Way Square with Damper with Quick Install Clips for 6", 7", & 8" Duct	39.72
AICMV4	MV4	4-Way Square with Damper with Quick Install Clips for 6", 7", & 8" Duct	39.72
AICMV360	MV360	Round with Damper for 6", 7", & 8" Duct	39.72

W = Bright White GS = Golden Sand SA = Satin Anodized

All Items May Not Be Stocked In All Branches

Registers, Grilles & Diffusers

Ceiling Square Diffusers - 3 Cone

Non Removable Core

- Fixed air pattern
- Stamped heavy gauge steel
- White powder paint coating
- Fixed horizontal 360° diffusion air pattern
- Mounting - surface or Lay-in T-bar ceiling



Part #	Mfg #	Duct Size	Face Dia	Price
AIRDF3N6	DF3N-2406	6"	23-3/4" x 23-3/4"	48.82
AIRDF3N8	DF3N-2408	8"	23-3/4" x 23-3/4"	48.82
AIRDF3N10	DF3N-2410	10"	23-3/4" x 23-3/4"	48.82
AIRDF3N12	DF3N-2412	12"	23-3/4" x 23-3/4"	48.82

Metal Back

- Fixed face - directional louvers deflectors
- Stamped heavy gauge steel back panel
- Powder paint coating - white
- Air pattern - fixed horizontal 360° diffusion
- Mounting - Lay-in T-bar ceiling



Part #	Mfg #	Duct Size	Face Dia	Price
AIRPSML6	PSM-L-2406	6"	23-3/4" x 23-3/4"	97.16
AIRPSML8	PSM-L-2408	8"	23-3/4" x 23-3/4"	87.26
AIRPSML10	PSM-L-2410	10"	23-3/4" x 23-3/4"	44.16
AIRPSML12	PSM-L-2412	12"	23-3/4" x 23-3/4"	44.16

Round Opposed Blade Damper

- All galvanized steel
- Mill finish standard



Part #	Mfg #	Nom Clr Sz	Blade Dia	Price
AIRN406	N406	6"	5-3/4"	16.36
AIRN408	N408	8"	7-3/4"	18.10
AIRN410	N410	10"	9-3/4"	21.48
AIRN412	N412	12"	11-3/4"	21.48

Plastic Egg Crate Filter Return

- Molded fiberglass back with aluminum foil vapor barrier
- Hinged face
- Metal coated with white powder paint
- Mounting - T-bar Lay-in ceiling



Part #	Mfg #	Description	Price
AIRERIFP	ERIF-P	23-3/4" w/Access to 20" x 20" Filter	70.02

Perforated Face Supply Diffusers

Fiberglass Back

- Fixed face - directional louvers deflector
- Face painted with white powder paint
- Air pattern - fixed horizontal 360° diffusion
- Mounting - lay-in T-bar ceiling



Part #	Mfg #	Description	Price
AIRPSIL	PSI-L	24" x 24"	32.86

A/C Accessory Packages

Part #	Mfg #	Description	Price
AIR1	A/C PACKAGE 1	1.5 To 2 Ton	286.00
AIR2	A/C PACKAGE 2	2.5 To 3 Ton	320.00
AIR3	A/C PACKAGE 3	3.5 To 4 Ton	388.00

Pumps & Accessories

Utility Transfer Pumps

Potent® Water Transfer Pump Set

- Includes PP-1 Pump, (2) 10' hoses with vacuum/screen attachment for inlet hose
- 275 gph @ 1' Head
- 1/10 hp



Part #	Mfg #	Model	Desc	Price
LIGPPS1	555150	PPS-1	115V, Manual, 6' Cord	200.60

VC Series Automatic Condensate Pumps

- Thermal overload protection
- Includes check valve

VCC Low Profile Series

- Suitable for high-efficiency, gas-furnace condensate
- 3/10 Gallon tank
- Discharge is 3/8" OD barbed tubing adapter/check valve
- Pump engages in 1" of water and disengages in .45" of water
- 3-Prong plug
- Snap-action switch
- Stainless steel shaft
- Polypropylene impeller
- ABS Motor, tank cover and volute
- Thermal overload protection
- Safety switch
- UL/CSA Listed
- 6' Cord



Part #	Mfg #	Model	Desc	Price
LIGVCC20ULS	554200	VCC-20ULS	115V, 20' Shutoff	118.88

VCL Series

- 1 Gallon leak proof, rustproof, high impact ABS tank
- 3-Prong plug
- Safety switch on "S" suffix models
- 6' Cord



Part #	Mfg #	Model	Desc	Price
LIGVCL24ULS115	553201	VCL-24ULS	115V, 24' Shutoff	197.84
LIGVCL24ULS230	553211	VCL-24ULS	230V, 24' Shutoff	210.70
LIGVCL45ULS	553240	VCL-45ULS	115V, 45' Shutoff	455.50

VCMA Automatic Condensate Pumps

- Suitable for high-efficiency, gas furnace condensate
- Fully automatic
- 1/2 Gallon leak proof, rustproof, high impact ABS tank
- (3) Drain holes
- Removable 3/8" barbed check valve
- 3-Prong plug
- Snap-action switch
- Stainless steel shaft
- Polypropylene impeller
- ABS Plastic motor, tank cover and volute
- Includes check valve
- Optional safety switch
- Thermal overload protection



VCMA Series Condensate Pump - without Tubing

- Safety switch on "S" Suffix models
- 6' Cord

Part #	Mfg #	Model	Desc	Price
LIGVCM15UL	554401	VCMA-15UL	115V, 15' Shutoff	78.92
LIGVCM15ULS	554405	VCMA-15ULS	115V, 15' Shutoff	83.90
LIGVCM20UL	554421	VCMA-20UL	115V, 20' Shutoff	88.90

VCMX NEXTGen™ Automatic Condensate Pumps

- Slimmer footprint 4.8" x 10.2" x 6.5"
- Oil resistant tank & check valve to eliminate problem of cracked tanks
- 1/4-Turn check valve allows servicing without removal of tubing
- Patent-pending cooling design
- Rubber feet absorbs vibration
- Thermal overhead protection
- External overflow safety switch
- External test/run lever
- External tank anti-sweat sleeve
- Multiple brackets: steel mounting bracket for use on either side of tank
- 2-Year warranty



VCMX Series Condensate Pump - without Tubing

- 20' Shutoff
- 6' Cord

Part #	Mfg #	Model	Desc	Price
LIGVCMX20UL	554520	VCMX-20UL	115V	93.90
LIGVCMX20ULS	554530	VCMX-20ULS	115V, Safety Switch	99.90

Condensate Pumps

All Items May Not Be Stocked In All Branches

Pumps & Accessories

Electronic Condensate Pump

- Maximum flow is 4 gph
- Compact 2-piece design allows flexible installation for mini-split A/C units
- Self-priming pump can be located up to 3' above reservoir
- Suction tubing: 3" x 5/32" ID
Vent tubing: 8" x 5/32" ID
Drain tubing: 3" x 1/2" ID



Part #	Mfg #	Model	Desc	Price
LIGEC400	553455	EC-400	115V 60Hz	199.78

Ice Machine Replacement Pump

- Removable parts for easy cleaning
- 3' Cord
- 1/25 hp Motor with upper and lower sealed ball bearings



Part #	Mfg #	Description	Price
LIGRIMU	RIM-U	115/230V Universal Replacement	134.96



Condensate Pumps

CP-22 Condensate Pump - 22' Lift

- Vertical type pumping unit
- Overflow safety switch
- High impact ABS tank, ABS motor and tank covers, volute and impeller
- Includes vibration dampening feet and motor mounts, metal hang tabs, (4) versatile inlet holes, easy to understand indicator display, a simple float switch, check valve, pan pill dispenser
- Thermally protected motor, stainless steel shaft
- Engages in 2.5" of water, disengages in 1.125"
- UL & CSA Approved



Part #	Mfg #	Description	Price
DIVCP22	CP-22	115V Condensate Pump	76.26

ClearVue™ Pump - No Float, No Problem

- iQ Technology™ to think and adapt to changing conditions
- Variable lift
- Self-cleaning
- Floatless Sensor™



Part #	Mfg #	Description	Price
DIVIQP120	IQP-120	Clearvue™ Pump 120V	141.32

Flow-Plus™ Pump Treatment Tablets

- Unique polymer pan treatment in tablet form
- Table dispensing drawer in pump holds (3) tablets
- Dosage lasts up to 3 months



Part #	Mfg #	Description	Price
DIVSCM186	SCM-186-6	(6) Flow-Plus™ Condensate Tablets	13.32

THANK YOU!
We appreciate your business

Condensate Pumps



www.irrsupply.com

Pumps & Accessories

Hydronics

Circulator Pumps for Heating & Potable Water Systems

Oil-Lubricated Circulator - Three-Piece

- Replaceable resilient motor mounts
- Noise dampening coupler
- Built-in overload protection
- Long bronze sleeve bearings maintain exact shaft alignment
- Precision ground pump shaft is oversized to provide large bearing surfaces
- Mechanical seal is designed to withstand wide range of water temperatures, pressures, additives and dissolved solids
- Centrifugal impeller prevents accumulation of air at seal faces to assure long life
- Maximum working pressure: 125 psi
- Maximum operating temperature (standard seal): 225°F continuous



Series HV

Part #	Mfg #	Model	Flange Size NPT	HP	Voltage	Construction	Price
BEG100	106189	100 NFI	3/4", 1", 1-1/4", 1-1/2"	1/12	115	Cast Iron	539.28
BEG100B	106197	100BNFI	3/4", 1", 1-1/4", 1-1/2"	1/12	115	Bronze	1149.10
BEGHV	102210	HV-NFI	1", 1-1/4", 1-1/2"	1/6	115	Cast Iron	1224.70
BEGHVB	102213	HV-BNFI	1", 1-1/4", 1-1/2"	1/6	115	Bronze	1980.68

Red Fox® Cast Iron Wet Rotor Circulator - NRF

- 115V
- Maintenance free
- DuraGlide™ bearing system eliminates seasonal freeze-up
- Quick-connect wiring nut leads
- Face plate and rotor sleeve features corrosion resistant stainless steel construction
- Self-cleaning particle shield protects shaft and bearings from system start-up debris
- Stabilized, heat resistant, polypropylene impeller with closed design to improve efficiency
- Maximum working pressure: 150 psi
- Maximum operating temperature: 240°F for NRF-22 & NRF-9F/LW
225°F for NRF-25/33/36/45



Part #	Mfg #	Model	Flange Size NPT	Watts	RPM	Price
BEGNRF9	103267	NRF-9F/LW	3/4", 1", 1-1/4", 1-1/2"	41	2800	208.64
BEGNRF22	103251	NRF-22	3/4", 1", 1-1/4", 1-1/2"	92	2940	150.70
BEGNRF25	103417	NRF-25	3/4", 1", 1-1/4", 1-1/2"	125	2950	163.44
BEGNRF33	103350	NRF-33	3/4", 1", 1-1/4", 1-1/2"	125	2950	378.00
BEGNRF36	103400	NRF-36*	3/4", 1", 1-1/4", 1-1/2"	270	3300	546.18

* 3-Speed circulators

Bronze Fox® Wet Rotor Circulator - NBF

- 115V
- Maintenance free - 100% lead-free
- Designed specifically for quiet operation in open (potable) water systems
- Maximum working pressure: 150 psi
- Maximum operating temperature: 230°F for all except NBF-33
225°F for NBF-33



Flange Connections

Part #	Mfg #	Model	Connection	Watts	RPM	Price
BEGNBF22	103252	NBF-22	Flange 3/4", 1", 1-1/4", 1-1/2"	92	2940	567.00
BEGNBF25	103418	NBF-25	Flange 3/4", 1", 1-1/4", 1-1/2"	125	2950	523.96

All Items May Not Be Stocked In All Branches



www.irrsupply.com

Pumps & Accessories

PL Series - Close Coupled Dry Rotor Circulator

- 115V
- Maintenance free
- An alternative to large wet rotor pumps
- Precision-machined and balanced alloy steel rotor
- Quick-connect wire nut leads and dual knockouts
- Solid "stiff-shaft" design of high-strength alloy
- XL-11™ Precision-crafted bearing system
- Double-sided I-Seal™ design
- Models PL-75 & PL-130 have 4 bolt hole flange connection, all others have 2 bolt hole flange connectors
- Maximum working pressure: 150 psi
- Maximum operating temperature: 225°F



Hydronics

Part #	Mfg #	Model	Flange Size NPT	HP	Construction	Price
BEGPL30	1BL012	PL-30	3/4", 1", 1-1/4", 1-1/2"	1/12	Cast Iron	551.88
BEGPL36	1BL001	PL-36	3/4", 1", 1-1/4", 1-1/2"	1/6	Cast Iron	567.00
BEGPL45	1BL002	PL-45	1", 1-1/4", 1-1/2"	1/6	Cast Iron	642.60
BEGPL55	1BL032	PL-55	3/4", 1", 1-1/4", 1-1/2"	2/5	Cast Iron	1058.38
BEGPL75	1BL034	PL-75	2"	1/6	Cast Iron	1572.44
BEGPL130	1BL063	PL-130/2	2"	2/5	Cast Iron	1648.04

Companion Flanges for Cast Iron Circulators

- Includes fasteners



Flange for Series 100, PR, NRF-22, NRF-9F/LW, NRF-33, NRF-36, PL-30, PL-36, PL-55

Part #	Mfg #	Flange #	Size NPT	Quantity	Price
BEGFLGI34	101001	P00740	3/4"	12	13.48
BEGFLGI1	101002	P01510	1"	12	13.48
BEGFLGI114	101003	P03250	1-1/4"	12	13.48
BEGFLGI112	101004	P03430	1-1/2"	12	13.48

Flange for Series HV, PL-45, PL-50, NRF-45

Part #	Mfg #	Flange #	Size NPT	Quantity	Price
BEGFLGHV1	101005	P00802	1"	12	14.24
BEGFLGHV114	101006	P03300	1-1/4"	12	14.24
BEGFLGHV112	101007	P03410	1-1/2"	12	14.24

Companion Flanges for Bronze Circulators

- Includes fastener kit

Flange for Series 100B, PRAB, NBF-22, NBF-12F/LW, NBF-33, NBF-36, PL30B, PL-36B

Part #	Mfg #	Flange #	Size NPT	Quantity	Price
BEGFLGB34	101011	P00789	3/4"	12	30.88
BEGFLGB1	101012	P00794	1"	12	30.88
BEGFLGB114	101013	P03251	1-1/4"	12	30.88
BEGFLGB112	101014	P00779	1-1/2"	12	30.88

Prices & Specifications are Subject to Change.



www.irrsupply.com

Pumps & Accessories

Hydraulics

Check-Trol™ Isolation Flow Control Flange Sets

- Packaged with an isolation flange of the same size as a pair
- For circulator installations, gives you features of flow control valve, isolation valve and companion flange
- Capscrews and nuts included
- Maximum working pressure: 150 psi
- Maximum operating temperature: 200°F



Flange for NRF/NBF/SSF Wet Rotors (Except NRF-45 & NBF-45), Series PL-30, PL-36, PL-55, Series 100, PR & LR

Part #	Mfg #	Model	Size	Price
BEGCTFS34	101236	CTFS-3/4	3/4" Swt x Flange	109.34
BEGCTFS1	101237	CTFS-1	1" Swt x Flange	140.80
BEGCTFS114	101238	CTFS-1-1/4	1-1/4" Swt x Flange	187.26

High Temperature Check Valves

- For NRF-25 circulator

Part #	Mfg #	Connection	Price
BEGP86596	P86596	1"	7.46

Differential Bypass Valves

- Used in systems where heating loads may be excluded from the circuit as zone valves close
- Controls the excess flow in the system by acting as a bypass
- All brass body with non-ferrous internals
- Maximum working pressure: 150 PSIG
- Maximum operating temperature: 230°F
- 2 to 10 PSI Adjustment range



Part #	Mfg #	Model Number	Body Material	Connection Boiler	Price
BEGDB34	113247	DB-3/4	3/4" MNPT	Brass	134.56

Flo-Control™ Valves

- Prevents gravity flow in forced water systems
- Permits summer-winter operation of indirect water heaters
- Removable top cap
- Manual operating position for vertical lift disc to permit gravity circulation
- Maximum operating temperature: 250°F
- Maximum working pressure: 125 psig



Part #	Mfg #	Model	Description	Construction	Price
BEGSA34	107034	SA3/4	3/4" Straight-Angle	Cast Iron	101.30
BEGSA1	107018	SA1	1" Straight-Angle	Cast Iron	105.84
BEGSA114	107019	SA1-1/4	1-1/4" Straight-Angle	Cast Iron	139.10
BEGSA112	107020	SA1-1/2	1-1/2" Straight-Angle	Cast Iron	213.20
BEGSA2	107021	SA2	2" Straight-Angle	Cast Iron	423.36

All Items May Not Be Stocked In All Branches



www.irrsupply.com

Pumps & Accessories

Pressure Reducing Valves

- Fast fill feature
- Low inlet pressure check valve
- Convenient cleanable strainer
- Maximum operating temperature: 225°F
- Maximum operating pressure: 125 psig

Combination "Dual Units" Pressure Relief & Reducing Valve

- Relief valve pressure setting: 30 psi
- 1/2" NPT Boiler connection



F-3TU & F-8TU

Part #	Mfg #	Model	Components - Relief Plus	Fill Connection	Body Construction	Price
BEGF8	110201	F-8	FB-38	1/2" NPT	Iron/Brass	148.16

Pressure Reducing Valve

- Brass body construction



B-38



B7-12



FB-38



FB-38TU

Part #	Mfg #	Model	Connection	Factory Setting	Adjustable Range	Price
BEGB38	110190	B-38	1/2" NPT	12 psig	10 - 25 psig	87.68
BEGB712	110196	B7-12	3/4" NPT	12 psig	10 - 25 psig	133.04
BEGFB38	110192	FB-38	1/2" NPT	12 psig	10 - 25 psig	78.12
BEGFB38TU	110193	FB-38TU	1/2" Sweat/NPT Union	12 psig	10 - 25 psig	93.24

Circuit SetterPlus® Calibrated Balance Valves

- Pre-balance design capability
- Proportional shut-off
- Memory stop indicated
- Integral valved readout ports
- Maximum design limitations: 175 psig @ 250°F



Part #	Mfg #	Model	Connection	Price
BEGCB12S	117412	CB-1/2S	1/2" Sweat	83.02
BEGCB34S	117413	CB-3/4S	3/4" Sweat	102.98
BEGCB1S	117401	CB-1S	1" Sweat	132.72
BEGCB114S	117402	CB-1-1/4S	1-1/4" Sweat	182.50
BEGCB2S	117404	CB-2S	2" Sweat	273.22

Prices & Specifications are Subject to Change.



www.irrsupply.com

Pumps & Accessories

Hydronics

Copper Red Ring Monoflo® Fittings

- Allows use of a single pipe to serve as both supply and return main
- Connects risers to the main, assuring proper diversion of water to each heating unit regardless of type and its position
- Recommended for most installations, including cast-iron non-ferrous baseboards, free-standing radiation or convectors
- For most applications a second fitting can be used if higher resistance is required
- Maximum operating temperature: 300°F
- Maximum working pressure: 150 psig



Part #	Mfg #	Size	Cv Ratings* - 1 Ftg	Cv Ratings* - 2 Ftg	Price
BEGMT34-12	108119	3/4" x 1/2", Return Only	4.2	-	39.30
BEGMT1-12	108120	1" x 1/2"	14.5	8.7	39.30
BEGMT1-34	108121	1" x 3/4"	14.5	8.7	39.30
BEGMT114-12	108122	1-1/4" x 1/2"	24	15.5	40.82
BEGMT114-34	108123	1-1/4" x 3/4"	24	15.5	40.82

* Cv ratings with side branch plugged

Airtrol® Tank Fittings

- Directs free air to the compression tank
- Restricts thermal circulation to boiler
- Establishes initial tank air level
- Allows compression tank size reduction
- Maximum design limitations: 175 psig @ 250°F



Part #	Mfg #	Model	Tank Diameter	Tank Connection	Boiler Connection	Price
BEGATF12	112010	ATF-12	12", 13", or 14"	1/2" NPTM	3/4" NPTM	145.14

Brazed Plate Heat Exchangers - BPX

- Can be used for radiant floor heating, snow melt, swimming pool and domestic water heating
- Compact design compared to shell and tube exchangers
- Stainless steel plates are vacuum brazed together to form a durable, integral piece that can withstand high pressure and temperature
- Design temperature: 450°F
- Design pressure: 435 psi



Part #	Mfg #	# of Plates	Output	Connection	Price
BEGBP40010	BP400-10	10	60,000 BTU/hr	3/4"	389.40
BEGBP40020	BP400-20	20	125,000 BTU/hr	3/4"	473.44
BEGBP40030	BP400-30	30	175,000 BTU/hr	3/4"	579.88
BEGBP40040	BP400-40	40	225,000 BTU/hr	3/4"	672.34
BEGBP41040	BP410-40	40	600,000 BTU/hr	1"	933.40
BEGBP41050	BP410-50	50	800,000 BTU/hr	1"	1069.30

All Items May Not Be Stocked In All Branches



www.irrsupply.com

Pumps & Accessories

Pump Motors & Accessories

Power Pack Motor



Part #	Mfg #	Phase	Voltage	HP	Price
BEG111034	111034	Single	115	1/12	560.26
BEG111031	111031	Single	115	1/6	803.04
BEG111061	111061	Single	115	1/6	840.40

Hydronics

Motor Coupler



Part #	Mfg #	Description	Price
BEG118473	118473	For PD-35, PD-37, 60 "AA", 1522 (1/2" Shaft Frame)	91.50
BEG118705	118705	Pump Coupler for Series 100, HV, 2", PR	11.88
BEG118723	118723	For 2-1/2", LD-3, HD-3, Obsolete HLD-3, Obsolete HHD-3	54.14

Sleeve

Part #	Mfg #	Description	Price
BEG185024	185024	Sleeve Kit	252.12

Seal Kit



Part #	Mfg #	Description	Price
BEG186862	186862	Seal Kit #1 1-1/4" ID Bronze Fit	298.80

Seal Kit for Three-Piece Circulator

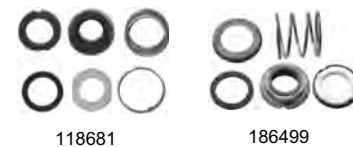

Part #	Mfg #	Description	Price
BEG118681	118681	For Series 100, 1", 1-1/4", 1-1/2", 2", HV, PR, 2-1/2", LD-3, HD-3, PD-35, PD-37, Series 60 "AA" & Series 1522 (Formerly Kit #7)	59.76
BEG186499	186499	For PD-38, PD-39, PD-40, Series 60 "A" & Series 60 "2-1/2 F" (Formerly Kit #2)	237.18

Prices & Specifications are Subject to Change.



www.irrsupply.com

Pumps & Accessories

Hydraulics

Impeller



118431

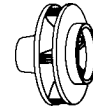

Part #	Mfg #	Description	Price
BEG118668	118668	3-3/8" Steel Impeller	203.54
BEG118431	118431	2-3/4" Bronze Impeller	100.86
BEG118436	118436	3-3/8" Bronze Impeller	246.52
BEG189128	189128	3-3/8" NFI Impeller	168.10

Bearing Assembly



118844



185260



186863

Part #	Mfg #	Description	Price
BEG118844	118844	For 100 Series NFI & BI	203.54
BEG185011	185011	Small Frame BF	2016.90
BEG185260	185260	For PD-38, PD-40, PD-39 Obsolete, 60 "A"; IB or BF	2119.62
BEG185332	185332	For PD-35, PD-37, 60 "AA"; IB, BF or AB	803.04
BEG186863	186863	For PD-35, PD-37, 60 "AA", 1522; IB, BF or AB with Hardware & Gasket	803.04
BEG189034	189034	For Series 100	201.70
BEG189105	189105	For Series PR, 2-1/2", LD-3, HD-3	550.92
BEG189134	189134	Series 100	218.48
BEG189162	189162	Bearing Assembly	392.20
BEG189163	189163	Bearing Assembly	420.18
BEG189165	189165	For HV, 2", 1-1/2" Obsolete IB or BI	457.52

Body Gasket



P04080

Part #	Mfg #	Description	Price
BEGP04080	P04080	Series 100	3.26
BEGP04890	P04890	HV, 2", Obsolete 1", Obsolete 11/4", Obsolete 11/2", Obsolete 2", Obsolete HV	2.62

Ring Motor Mounting Set



Part #	Mfg #	Description	Price
BEG118223	118223	For Series 100, 1", 1-1/4", 1-1/2", 2", HV, PR	42.96
BEG118228	118228	For 1", 1-1/4", 1-1/2", 2", HV, PR, 2-1/2", LD-3, HD-3, PD-35, PD-37, Series 60, Series 1522	59.76

All Items May Not Be Stocked In All Branches

Hydronic Accessories

"00"® Cartridge Circulators

- Unique replaceable cartridge design - field serviceable
- Manufactured in a variety of sizes to match system requirements
- Direct drive - low power consumption
- Residential & light commercial applications
- Universal flange to flange dimension
- Less flange - indicates less the companion flange that determines the connection size
- IFC - Features an Integral Flow Check

EXCLUSIVE DIRT BARRIER
KEEPS DIRTY SYSTEM
WATER OUT OF THE
BEARING CHAMBER

UNIVERSAL FLANGE TO
FLANGE DIMENSIONS.
IDEAL FOR RETROFITS.

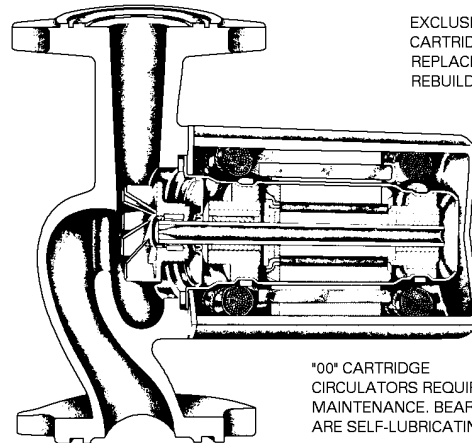

EXCLUSIVE REPLACEABLE
CARTRIDGE DESIGN.
REPLACING THE CARTRIDGE
REBUILDS THE CIRCULATOR

CERAMIC SHAFT FOR
LONGER LIFE AND
EXCELLENT WEAR
RESISTANCE.

UL & CSA LISTED
CIRCULATOR. MOTOR
IS IMPEDANCE PROTECTED

"00" CARTRIDGE
CIRCULATORS REQUIRE NO
MAINTENANCE. BEARINGS
ARE SELF-LUBRICATING.

Model 006 Cartridge Circulators

- For use in circulation of hot & chilled fresh water in open & closed loop applications
- Can be used for domestic hot water recirculation, heat recovery units, water source heat pumps, drain down open loop solar systems & potable water systems
- 125 psi pressure rating
- 220°F temperature rating
- 1/40 HP @ 3250 RPM
- 115V/60Hz/1Ph
- PNP - Indicates with Plumb N Plug cartridge



Part #	Mfg #	Casing	Connections	Includes:	Price
TAC006B	006-B4	Bronze, Sweat	3/4" SWT		381.22
TAC006B4PNP	006-B4-PNP	Bronze, Sweat	3/4" SWT	with Plumb n' Plug	672.32

Model 007 Cartridge Circulators

- For use in hydronic heating systems, chilled fresh water systems & domestic water systems
- Can be used in the typical residential hydronic heating system, to add a zone addition, zoning with circulators & potable water system
- 125 psi Pressure rating
- 240°F Temperature rating
- Flanged
- 1/25 HP @ 3250 RPM
- 115V/60Hz/1Ph



Part #	Mfg #	Casing	Includes:	Price
TAC007FIFC	007-F-IFC	Cast Iron	Removable Integral Flow Check in the Casing at Impeller Inlet	160.06
TAC007	007-F	Cast Iron		158.36
TAC007SF5IFC	007-SF5-IFC	Stainless Steel Pump	with Integral Flow Check	726.62

Prices & Specifications are Subject to Change.

Hydronic Accessories

Hydronics

Model 008 Cartridge Circulators

- For use in hydronic heating systems & open loop fresh water applications
- Cast iron can be used in higher head hydronic systems, radiant in-floor/panel heating systems & closed loop solar systems
- Bronze can be used in higher head heat recovery systems, water source heat pumps & open loop solar systems
- 125 psi pressure rating
- 230°F temperature rating
- Flanged
- 1/25 HP @ 3250 RPM, 115V/60Hz/1Ph



Part #	Mfg #	Casing	Price
TAC008	008-F6	Cast Iron	219.58

Model 009 Cartridge Circulators

- For use in high head hydronic heating systems & open loop fresh water applications
- Cast iron can be used in high head-low floor hydronic heating systems, higher head radiant in-floor/panel heating systems & high head closed loop solar systems
- Bronze can be used in open loop solar systems & light commercial domestic hot water recirculation systems
- 125 psi pressure rating
- 225°F temperature rating
- Flanged
- 1/15 HP @ 3250 RPM, 115V/60Hz/1Ph



Part #	Mfg #	Casing	Price
TAC009	009-F5	Cast Iron	463.74

Model 0010 Cartridge Circulators

- Flow Range: 0-30 gpm
- Head Range: 0-11.5'
- Available in cast iron & bronze for closed or open loop systems
- Ideal where space is at a premium
- 125 psi pressure rating
- 225°F temperature rating
- Flanged
- 1/8 HP @ 3250 RPM, 115V/60Hz/1Ph



Part #	Mfg #	Casing	Price
TAC0010	0010-F3	Cast Iron	451.08

Hydronic Accessories

Model 0010-IFC® Cartridge Circulators with Integral Flow Check

- Flow Range: 0-25 gpm
- Head Range: 0-25'
- Designed to reduce installation costs when zoning with "00" Circulators on large residential/light commercial, high head/medium flow applications
- Available in cast iron & bronze for closed or open loop systems
- Ideal where space is at a premium
- 125 psi pressure rating, 230°F temperature rating
- 3/4", 1", 1-1/4", 1-1/2" Flanged connections
- 1/15 HP @ 3250 RPM, 115V/60Hz/1Ph



Part #	Mfg #	Casing	Includes:	Price
TAC0010FIFC	0010-F-IFC	Cast Iron	Removable Integral Flow Check in the Casing at the Impeller Inlet	542.16

Model 00_-MSF1 3-Speed Service/Radiant Pump Cartridge Circulator with Integral Flow Check

- Ideal replacement circulator for emergency "no-heat" applications
- 4-Bolt universal flange
- Removable high-flow Integral Flow Check
- Self-lubricating
- Thermally protected permanent split capacitor motor

Part #	Mfg #	Casing	Includes:	Price
TAC0010MSFIFC	0010-MSF1-IFC	Cast Iron	Removable Integral Flow Check in the Casing at the Impeller Inlet	527.82
TAC00RMSFIFC	00R-MSF1-IFC	Cast Iron	Removable Integral Flow Check in the Casing at the Impeller Inlet	164.20

Model 0011 Cartridge Circulators

- High velocity/high head for residential & light commercial closed loop hydronic systems & open loop domestic fresh water systems
- High head-medium flow for high pressure drop boilers, fan coil units, heat exchangers, large radiant heating systems & heat recovery units/earth loop systems
- 125 psi pressure rating
- 220°F temperature rating
- Flanged
- 1/8 hp @ 3250 RPM, 115V/60Hz/1Ph



Part #	Mfg #	Casing	Includes	Price
TAC0011	0011-F4	Cast Iron		492.82
TAC0011FIFC	0011-F4-IFC	Cast Iron	Removable Integral Flow Check in the Casing at the Impeller Inlet	625.14

Model 0012 Cartridge Circulators

- High velocity/high flow for residential & light commercial closed loop hydronic systems & open loop domestic fresh water systems
- High flow-medium head for large BTUH heaters, 2" replacement recirculation loops, primary secondary loops, commercial water heaters & light commercial heating & cooling systems
- 125 psi pressure rating
- 220°F temperature rating
- Flanged
- 1/8 HP @ 3250 RPM, 115V/60Hz/1Ph



Part #	Mfg #	Casing	Price
TAC0012	0012-F4	Cast Iron with 1-1/2" Flange	713.32

Prices & Specifications are Subject to Change.

Hydronic Accessories

Hydronics

Model 0014 Cartridge Circulators

- Mid velocity/mid flow for closed loop hydronic systems & open loop fresh water systems
- Medium flow, medium heat for large BTUH boilers, primary & secondary loops, water heaters & heating & cooling systems
- 125 psi pressure rating
- 230°F temperature rating
- Flanged
- 1/8 HP @ 3250 RPM, 115V/60Hz/1Ph



Part #	Mfg #	Casing	Includes:	Price
TAC0014	0014-F1	Cast Iron	HV - High Velocity	577.14
TAC0014FIFC	0014-F1-IFC	Cast Iron Less Flanges	w/Integral Flow Check Valve	675.42

Priority Zoning Circulators

- Combines reliability of "00" circulator with convenience and efficiency of a switching relay
- Low and high voltage strips
- Built-in priority switch
- Ideal for zone or indirect hot water heater
- Universal thermostat compatibility
- UL Listed



Part #	Mfg #	Description	Price
TAC007Z	007-ZF5	Cast Iron for Larger Residential Zones	354.08

Radiant Heating Circulator

- Specially designed for radiant heating applications with higher head and lower flow
- Built in integral flow check (IFC®) located inside pump simplifies piping
- LED Indicator light
- Unique replaceable cartridge-field serviceable



Part #	Mfg #	Casing	HP	Price
TAC00RIFC	00R-F6-IFC	Cast Iron	1/25 hp @ 3250 RPM, with Integral Flow Check	187.18

Freedom Flanges

- Easy-On, Easy-Off with a common adjustable wrench

Ductile Iron Freedom Flanges (Set of 2)



Part #	Mfg #	Flange Size	Flange Sets For:	Price
TACFLGF34	110-251F	3/4"	005, 007-0011, 0013, 0014, 110-113	20.42
TACFLGF1	110-252F	1"	005, 007-0011, 0013, 0014, 110-113	20.42
TACFLGF114	110-253F	1-1/4"	005, 007-0011, 0013, 0014, 110-113	20.42
TACFLGF112	110-254F	1-1/2"	005, 007-0011, 0013, 0014, 110-113	20.42

All Items May Not Be Stocked In All Branches

Hydronic Accessories

Replacement Parts for "00" Cartridge Circulators

Cartridge Assembly

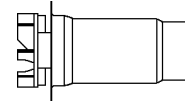

Part #	Mfg #	Description	Price
TAC007042RP	007-042RP	Cartridge Assembly, Complete, 007 Series Cast Iron	161.52
TAC0012011RP	0012-011RP	Cartridge Assembly, Complete, 012 Series Cast Iron	391.50

1400 Series High Capacity In-Line Pumps

- Space saving, close coupled, maintenance free motor
- Permanently lubricated, sealed-for-life bearings motor
- Nu-Tride® coated solid steel shaft
- Noryl® impeller
- Durable, carbon/silicon-carbide mechanical seal
- Precision balanced rotor for quiet operation
- Universal flange to flange dimensions
- Dual electrical knock-outs
- Dual pressure taps, suction/discharge



Part #	Mfg #	Description	Price
TAC240050	1400-50/2	115V Single Phase for 2" 2-Bolt Flanges (add 194-2124F Flange Set)	1074.98

Zone Controls

Zone Circulator Switching Relay

- Universal replaceability & thermostat compatibility
- Indicator lights
- Snap-in PC board to existing enclosure
- Fully enclosed snap-out relay
- UL Approved



Part #	Mfg #	Number of Zones	Power Port Slots	Power Control Plugs	Transformer Voltage (Input)	Maximum Combined Load	Dimensions of Enclosure Width x Height x Depth	Price
TACSR501	SR501	1			120 VAC	7.2A	4-1/4" x 5-1/4" x 2-3/4"	118.14
TACSR501EXP	SR501-EXP*	1		1	120 VAC	5A	4-1/2" x 5-1/4" x 2-3/4"	265.46
TACSR502	SR502	2 with Priority			120 VAC	15A	10-1/4" x 6-3/4" x 2-3/4"	266.54
TACSR503	SR503-2**	3 with Priority			120 VAC	15A	10-1/4" x 6-3/4" x 2-3/4"	288.88
TACSR503EXP	SR503-EXP*	3 with Priority	3	1	120 VAC	20A	10-1/4" x 6-3/4" x 2-3/4"	458.08
TACSR504	SR504-2**	4 with Priority			120 VAC	20A	10-1/4" x 6-3/4" x 2-3/4"	442.12
TACSR504EXP	SR504-EXP*	4 with Priority	3	1	120 VAC	20A	10-1/4" x 6-3/4" x 2-3/4"	476.58
TACSR506	SR506	6 with Priority			120 VAC	20A	11-3/4" x 7-1/2" x 3"	481.24
TACSR506EXP	SR506-EXP*	6 with Priority	3	1	120 VAC	20A	11-3/4" x 7-1/2" x 3"	516.48

* With PowerPort Option

** Not Expandable

Prices & Specifications are Subject to Change.

Hydronic Accessories

Hydronics

Plug-In PowerPort Cards

- Plug into any PowerPort Slot on any -EXP
- Power supply: 24 VAC (powered by -EXP Control)
- Dimensions: 2" x 2"
- 2 Amp relays



Part #	Mfg #	Description	Price
TACPC600	PC600	Post Purge Timer Plug-in Card, 10-420 Second Adjustable Time Delay	104.24
TACPC605	PC605	Priority Protection Plug-in Card, 1 Hour Fixed Time Delay	80.68
TACPC610	PC610	Universal Timer/Pump Exercise Plug-In Card, Independently Adjustable On/Off Delay	121.68

Add-On Power Controls

- For use with all (-EXP) controls



Part #	Mfg #	Description	Price
TACPC700	PC700	Boiler Reset Control	758.98
TACPC702	PC702	2-Stage Boiler Reset Control	1056.84
TACPC705	PC705-2	Variable Speed Pump Injection Mixing Control	1149.92

Zone Valve Controls

- All zone valve controls are relay type DPDT & have single phase motor rating per zone of 1/7 hp (SA) @ 120 VAC



ZVC404



ZVC406

Part #	Mfg #	Number of Zones	Transformer Voltage (Input)	Max Output At 24 VAC	Dimensions of Enclosure			Price
					Width	Height	Depth	
TACZVC403	ZVC403	3 with Priority	120 VAC	40 VA	10-1/4"	6-3/4"	2-3/4"	204.20
TACZVC404EXP	ZVC404-EXP*	4 with Priority	120 VAC	80 VA	11-3/4"	7-1/2"	3"	414.46
TACZVC405	ZVC405	5 with Priority	120 VAC	80 VA	11-3/4"	7-1/2"	3"	258.58
TACZVC406EXP	ZVC406-EXP*	6 with Priority	120 VAC	80 VA	11-3/4"	7-1/2"	3"	471.36

* With PowerPort Option (2 PowerPort Slots, 1 Power Control Plug)

Zone Valves

Zone Sentry Ball Valve Zone Valve

- Provide on-off, normally open or normally closed control in both open and closed hot or chilled water systems
- Utilizes microcircuit based logic to control a gear driven electronic actuator which drives a ball valve



Part #	Mfg #	Description	Price
TACZ075C	Z075C	3/4" SWT	184.40

All Items May Not Be Stocked In All Branches

Hydronic Accessories

Zone Valves (Continued)

Zone Sentry Ball Valve Zone Valve

Part #	Mfg #	Description	Price
TACZ100C	Z100C	1" SWT	212.16

Power Head for Zone Valves

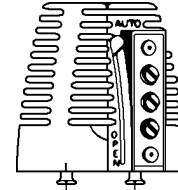

Part #	Mfg #	Description	Price
TAC555050BRP	555-050RP	Power Unit Assembly, Snap Action Switch	170.50

Pressure Reducing Valves

Boiler Pressure Reducing Valves

- To automatically feed water to a hot water heating system whenever pressure in system drops below the pressure setting of the valve



Part #	Mfg #	Description	Construction Material	Size & Type Connection	Maximum Temperature	Price
TAC329	329	Pressure Reducing	Cast Iron	1/2" NPT & Sweat	212°F	95.64
TAC329T	329-T	Pressure Reducing	Cast Iron	1/2" NPT	212°F	100.54

Tempering & Mixing Valves

5000 Series Mixing Valves

- Dual purpose mixing or diverting valve
- High flow, low headloss
- Extended mix temperature range of 85° - 150°F



Part #	Mfg #	Valve Size	Max Flow	Price
TAC5003	5003-C	3/4"	10.6 gpm	244.58
TAC5004	5004-C	1"	22.5 gpm	286.16

Hydronic Accessories

Air Eliminators

4900 Series Air Separator

- Designed for the complete elimination of air from closed loop heating and cooling systems up to a maximum temperature of 240°F and a maximum pressure of 150 psi
- Convenient expansion tank connection tapping



Part #	Mfg #	Description	Price
TAC49075S	49-075S	3/4" CxC	142.94
TAC49100S	49-100S	1" CxC	131.00
TAC49125S	49-125S	1-1/4" CxC	180.85
TAC49100T	49-100T	1" IPS	164.27
TAC49125T	49-125T	1-1/4" IPS	227.73
TAC49150T	49-150T	1-1/2" IPS	305.06

Low Water Cutoffs

- Protection for all types of boilers
- Can act as primary or secondary low water cutoff on low-pressure steam boilers; the primary limit control on hot water boilers
- Can activate an alarm or automatic water feeders



LN - Low Water Cutoffs

- No test button

Part #	Mfg #	Description	Price
TACLTA0243S	LNA0243S-1	Automatic Reset, 24V, 3/4" NPT, Short Probe Electrode LWCO	118.25
TACLTA1203S	LNA1203S-1	Automatic Reset, 120V, 3/4" NPT, Short Probe Electrode LWCO	118.25

Safety Shut-Off Valve

- Valve sits in drip pan under the water heater and shuts off water, gas or oil supply when approximately 7/8" of water accumulates in the pan



Part #	Mfg #	Description	Price
TACWAGS	WAGS7200	Shuts Off Water, Gas, Oil, Electric	352.72

Repair Parts & Accessories

Part #	Mfg #	Description	Price
TAC265-1	265-3	Timer Assembly	209.22

All Items May Not Be Stocked In All Branches

Hydronic Accessories

Brass Uni-Flange Ball Valves

The Isolator® Uni-Flange Ball Valve

- Full port forged brass ball valve
- Bonus wing style "T" handle, bolts and nuts
- Designed for residential and commercial use with all 2 bolt flanged circulator pumps
- HV suffix indicates for high velocity pumps



Part #	Mfg #	Size	WOG	Price
FLGISO34	40403	3/4" IPS	600	35.68
FLGISO1	40404	1" IPS	600	43.40
FLGISO114	40405	1-1/4" IPS	600	51.82
FLGISO112	40406	1-1/2" IPS	600	74.72

The Isolator® Uni-Flange with Drain

- Full port forged brass ball valve with hi-flow hose drain
- Bonus wing style "T" handle, bolts and nuts
- Designed for residential and commercial use with all 2 bolt flanged circulator pumps



Part #	Mfg #	Size	WOG	Price
FLGISO34P	40413P	3/4" IPS Pair	600	60.14
FLGISO1P	40414P	1" IPS Pair	600	73.14
FLGISO114P	40415P	1-1/4" IPS Pair	600	92.36
FLGISO34PC	50413P	3/4" SWT Pair	600	60.14
FLGISO1PC	50414P	1" SWT Pair	600	73.14
FLGISO114PC	50415P	1-1/4" SWT Pair	600	92.36

PRO-PAL® Series

Full Port Forged Brass Ball Valves (Hi-Flow Drain Hose x IPS)

- Hard chrome-plated balls with teflon® seats
- Reversible handle
- High flow hose drain
- Heavy-duty forged brass body
- Designed for residential, commercial, and industrial use with water, oil, or gas



Part #	Mfg #	Size	WOG	Price
FLGPROPAL34T	40613	3/4" IPS	600	31.26

Full Port Forged Brass Ball Valves C x C

- Hi-flow hose drain and reversible handle
- Heavy-duty forged brass body
- Teflon® seats withstand temperatures from -40°F to 400°F



Part #	Mfg #	Size	WOG	Price
FLGPROPAL12C	50612	1/2"	600	24.78
FLGPROPAL34C	50613	3/4"	600	31.26
FLGPROPAL1C	50614	1"	600	44.62
FLGPROPAL114C	50615	1-1/4"	600	67.10

Forged Brass T-Drain C x C

- Hi-flow ball valve drain and reversible handle
- Heavy-duty forged brass body
- Teflon® seats and stem seal



Part #	Mfg #	Size	WOG	Price
FLGTDRAIN34C	50673	3/4"	600	20.70
FLGTDRAIN1C	50674	1"	600	24.18

Hydronics

Hydronic Accessories

Hydronics

Primary & Secondary Loop Full Port Manifold Ball Valve with Reversible Handle

- Designed for residential and commercial use in hydronic heating systems
- Design allows for easy "power purging" of looped system while controlling "ghost flow" when the injection or circulator pump is off and when either the boiler pump or system pump is on
- 58655X4 Includes pro-connect ends



Part #	Mfg #	Size	WOG	Price
FLGPURGET114-1	58654	1-1/4" x 1"	600	93.12
FLGPURGET114	58655	1-1/4" x 1-1/4"	600	98.04

Expansion Tank PR FIP x MIP x FIP x Hose

- Full port forged brass ball valve
- Hi-flow hose drain



Part #	Mfg #	Size	WOG	Price
FLGXPTANKVALVE	41672	1/2"	600	38.90

Brass Shut-Off Pump Mounting Flange SWT x Flange

- Full port ball valves
- 4" Lever handles



Part #	Mfg #	Size	WOG	Price
FLGISO34C	50403	3/4"	600	35.68
FLGISO1C	50404	1"	600	43.40
FLGISO114C	50405	1-1/4"	600	51.82
FLGISO112C	50406	1-1/2"	600	74.72

We have 32 convenient locations proudly serving Western NY, Central NY, and Northern Pennsylvania.

Over 140 years of doing business with integrity.



Hydronic Accessories

Standard Expansion Tanks

SX Extrol Standard Expansion Tanks

- For larger closed heating systems



Part #	Mfg #	Dimensions Dia x Ht	Total Volume	Price
AMTSX30V	SX-30V	15-3/8"x24-3/4"	14.0 gal	226.00
AMTSX40V	SX-40V	15-3/8"x32-1/2"	20.0 gal	241.00
AMTSX60V	SX-60V	15-3/8"x47-1/2"	32.0 gal	338.00

Extrol Standard Expansion Tank



Part #	Mfg #	Model	Vol	Ht x Dia	Price
AMT15	101-1	15	2.0	12.6" x 8"	52.50
AMT30	102-1	30	4.4	15.5" x 11"	64.30
AMT60	103-1	60	7.6	23" x 11"	131.00
AMT90	112-1	90	14	21" x 15.5"	197.00

Fill-Trol Standard Expansion Tank

- Includes built-in automatic fill valve & check valve for reducing supply water pressure & maintaining minimum system pressure
- Factory pre-charged to 12 psig; tank pressure controls system fill



Part #	Mfg #	Dimensions Dia x Ht	Total Volume	Price
AMT109	109	8" x 14-3/4"	2.0 gal	97.50
AMT110	110	11" x 17-3/8"	4.4 gal	113.00

Air Elimination

American Air Purgers



Part #	Mfg #	Dimensions L x H x W	Size	Price
AMT443	443	6" x 4" x 2-1/2"	1"	19.90
AMT444	444	6" x 4" x 2-1/2"	1-1/4"	19.90
AMT445	445	8" x 5" x 3-1/2"	1-1/2"	45.40
AMT446	446	8" x 5" x 3-1/2"	2"	50.30

Air Vents for HVAC Systems

- Float vent up to 150 psi

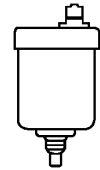

Part #	Mfg #	Description	Price
AMT700C	700-30	1/8" MPS Float Type	9.60

Hammer Arrestor

Mini-Trol

- Non-metallic internals
- Sealed air charge
- 125 PSIG Maximum working pressure
- 1/2" NPTM System connection



Part #	Mfg #	Description	Price
AMT500	500	Mini-trol	53.00

Hydronic Accessories

Hydronics

Low Water Cut-Offs for Hot Water Boilers

GuardDog® PS-850 Electronic LWCO for Hot Water Boilers

- For residential, commercial & industrial applications
- Self-cleaning probe
- High probe sensitivity: 7,000 ohms
- No blow down of control required when mounted directly into boiler tapings
- Provision to add alarm
- Max ambient temp: 120°F
- Max water pressure: 160 psi
- Max water temp: 250°F



Part #	Mfg #	Model #	Description	Price
MCMPS851120	153895	PS-851-120	120V Low Water Reset	314.22
MCMPS851M120	153896	PS-851-M-120	120V Manual Reset	344.14
MCMPS85224	153919	PS-852-24	24V Low Water Cut-Off	314.22
MCMPS852M24	153918	PS-852-M-24	24V Manual Reset	344.14

GuardDog® RB-24 Electronic with Auto Reset for Hot Water Boilers

- For residential applications
- Brass threads
- 15,000 ohms Probe sensitivity
- Compact size
- 3' Harness cable included
- Max ambient temp: 120°F
- Max water temp: 250°F
- Max water pressure: 50 psi



Part #	Mfg #	Model #	Description	Price
MCMRB24	144692	RB-24E	24V	167.58

Guard-Dog® RB-122 Electronic Probe Type with Auto Reset LWCO for Hot Water Boilers

- For residential & (where codes allow) commercial applications
- Max ambient temp 120°F
- Max water pressure 160 psi
- Max water temp 250°F



Part #	Mfg #	Model #	Description	Price
MCMRB122	144676	RB122E	120V	188.80

Low Water Cut-Offs for Steam Boilers - Mechanical

150S Mechanical LWCO for Steam Boilers

- For commercial and industrial low or high pressure boiler application
- Max pressure 150 psi
- 120VAC or 240VAC



Part #	Mfg #	Model #	Description	Price
MCM150S	171702	150S	Combo LWCO/Pump Controller	957.60

All Items May Not Be Stocked In All Branches

Hydronic Accessories

Low Water Cut-Offs for Steam Boilers

PS 800 Electronic Probe Type LWCO for Steam Boilers

- For residential & commercial applications
- Self-cleaning probe
- 15 seconds Delay on Make
- 10 seconds Delay on Break
- 7,000 ohms Probe sensitivity
- No blow down of control required when mounted directly into boiler tapings
- Max ambient temp: 120°F
- Max steam pressure: 15 psi
- Max water temp: 250°F



Hydronics

Part #	Mfg #	Model #	Description	Price
MCMP801120	153875	PS-801-120	120V Auto Reset	291.78
MCMP80224	153917	PS-802-24	24V Auto Reset	291.78
MCMP802M24	153913	PS-802-M24	24V Manual Reset	329.20
MCMP802RX224	153914	PS802-RX2-24	24V Auto Reset, Remote Sensor	345.58

61 Float Type LWCO for Steam Boilers

- For residential & commercial low pressure steam boiler applications
- For boilers of any steaming capacity
- Dual precision switches
- 1" NPT equalizing pipes & blow down valve required
- Max steam pressure 20 psi

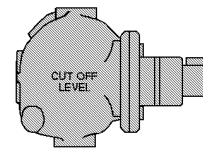

Part #	Mfg #	Model #	Description	Price
MCM61	140100	61	120 or 240 VAC	581.60

67 Mechanical Float Type LWCO for Steam Boilers

- For residential & commercial applications
- For boilers of any steaming capacity
- Quick hook-up fittings provided
- Lever-operated, full port ball valve for easy blow down
- Dual precision switches
- Large float chamber
- Max steam pressure 20 psi



Part #	Mfg #	Model #	Description	Price
MCM67	149400	67	Low Water Cut-Off	471.34

Hydronic Accessories

Hydronics

Low Water Cut-Offs for Hot Water Boilers & Steam Boilers

63 Float Type for Hot Water & Steam Boilers

- For residential, commercial & industrial applications
- Heavy duty construction
- Installs with 1" NPT equalizing pipes
- Includes No. 2 switch
- Max boiler pressure 50 psi
- 120 or 240 VAC



Part #	Mfg #	Model #	Description	Price
MCM63	142400	63	Auto Reset	733.32
MCM63M	143100	63-M	Manual Reset	733.32

Combination Water Feeder/Low Water Cut-Offs

47-2 Combination Mechanical Water Feeder/Low Water Cut-Off

- For steam & hot water boilers w/cold water feed
- Continuous maintenance of minimum safe water level, independent of electrical service
- Proportional feed action
- Quick hook-up fittings provided
- Max water supply pressure 150 psi
- Max inlet water temperature: 120°F
- Max boiler pressure 25 psi

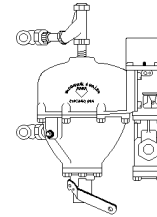

Part #	Mfg #	Model #	Description	Price
MCM472	132800	47-2	No 2 Switch	1167.10

51-2 Combination Mechanical Water Feeder/Low Water Cut-Off

- For low pressure steam & hot water boilers large than 5000 sq ft w/cold water feed
- Max water supply pressure 150 psi
- Max pressure 35 psi

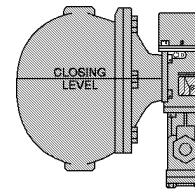

Part #	Mfg #	Model #	Description	Price
MCM512	135000	51-2	51 w/No. 2 Switch	1436.40

Hydronic Accessories

Electronic Water Feeders

WFE Uni-Match® Electronic Water Feeder

- Field adjustable dwell-feed cycles
- Multi-color LED status indicator
- Manual feed button
- Hard-stop limit to minimize changes of flooding the boiler
- Compatible with all electronic & mechanical low water cut-offs
- Includes adapters for connection to 1/2" copper tubing
- Removable strainer (replace after cleaning)
- Max water pressure: 150 psi
- Max boiler pressure: 15 psi
- Max water temp: 120°F
- Max ambient temp: 100°F



Hydronics

Part #	Mfg #	Model #	Description	Price
MCMWF2U24	169550	WFE-24	24V	418.96
MCMWF2U120	169560	WFE-120	120V	418.96

101-A Electronic Water Feeder

- For low pressure steam boilers w/cold water feed
- Eliminates manually adding water
- Can be used with mechanical or electronic low water cut-off controls
- Quick-change replaceable cartridge valve & strainer
- Manual feed button
- Max water pressure 150 psi
- Max boiler pressure 25 psi
- Max water temp 120°F



Part #	Mfg #	Model #	Description	Price
MCM101A	169400	101A-120	120V	615.30
MCM101A24V	169500	101A-24	24V*	710.74

* Includes 24VAC solenoid and separate 50VA transformer

Boiler Control Switches

No. 11 Switch

- For Series 61, 64, 67, 69, 70, 764 & 767 low water cut-off switch replacement
- 2 Single pole, single throw switches provided to control the water feeder & the low water cut-off



Part #	Mfg #	Model #	Description	Price
MCM11	309100	11	Electric Switch	241.06

Blow Down Valves

Series 14-B Full Port Ball Type

- Teflon seats provide bind free, leak tight ball movement
- Easy open handle keeps hands away from hot water & steam
- Gasket & mounting screws included
- Max pressure 30 psi



Part #	Mfg #	Model #	Used With:	Price
MCM14B	310447	14-B	47, 67 & 70	161.84

Prices & Specifications are Subject to Change.

Hydronic Accessories

Hydronics

Liquid Flow Switches

- Do not use liquid flow switches on systems with flow greater than 10' per second

Series FS5 Liquid Flow Switch

- For general purpose applications requiring low flow rate sensitivity
- In-line configuration eliminates need for pipe tee
- For use on 3/4" pipe sizes
- Single pole, double throw snap switch
- Min temp (fluid or ambient) 32°F
- Max temp 225°F - stainless steel models
- Max temp 250°F - brass
- Max operating pressure 150 psi



Part #	Mfg #	Model #	Description	Price
MCMFS5	114760	FS5-3/4	3/4" NPT	396.16
MCMFS51	114780	FS5-1	1" NPT	351.64

Series FS1 High Sensitivity Liquid Flow Switch

- For general purpose applications where high sensitivity is required & moderate or low flow rates are encountered
- For applications requiring water-tight, dust-tight or NEMA 4X rated flow switch
- Single pole, double throw snap switch
- Min temp (fluid or ambient) 32°F
- Max temp 225°F
- Max operating pressure 100 psi
- 1/2" NPT



Part #	Mfg #	Model #	Description	Price
MCMFS1	113200	FS1	Hi Sensitivity	344.14

FS250 General Purpose Liquid Flow Switch

- For starting or stopping electrically-operated equipment such as signal lights, alarms, motors, automatic burners, metering devices, etc.
- EPDM O-Ring sealed
- Single pole, double throw snap switch
- (4) Stainless steel paddles included: 1", 2", 3" & 6"
- Min temp (fluid or ambient) 32°F
- Max temp 250°F
- Max operating pressure 160 psi
- 1" NPTM Pipe connection



Part #	Mfg #	Model #	Description	Price
MCMFS251	120611	FS251	NEMA-1	199.00

Hydronic Accessories

Replacement Parts

Gasket

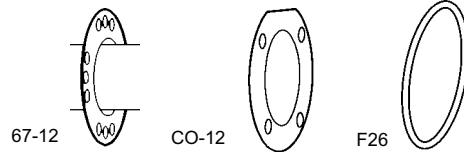

Part #	Mfg #	Model #	Used With:	Price
MCM6712	318800	67-12	61, 64, 67, 70, 80	8.02
MCMCO12	302600	CO-12	42, 61, 63, 64, 65, 42S	10.72
MCMF26	304100	F26	221, 25A, 51, 53, 3155	14.84

Head Mechanism

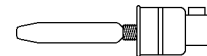

Part #	Mfg #	Model #	Used With:	Price
MCM6667	153825	6667	61, 67, 69, 70, 767	413.00

Strainer Basket Assembly

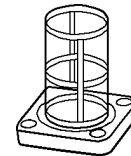

Part #	Mfg #	Model #	Used With:	Price
MCMSA10138	347100	SA101-38	47, 51, 101	75.00

Bellows & Syphon Assembly

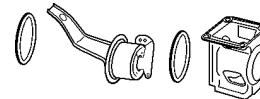

Part #	Mfg #	Model #	Used With:	Price
MCMSA672	344200	SA67-2	61, 67, 69, 70 Syphon Base	188.80

Valve & Strainer Assembly Kit



Part #	Mfg #	Model #	Used With:	Price
MCMSA47101102	341600	SA47-101-102	47, 247, 847	472.02

Cartridge Assembly

Part #	Mfg #	Model #	Description	Price
MCMCTRD101	310453	CTRD-101	Cartridge & Strainer	239.38

Hydronics

Hydronic Accessories

Hydronics

Steam Traps

Series H BearTrap® Float & Thermostatic

- Designed for commercial and industrial heating applications
- Universal 4-port tappings, (2 inlets, 2 outlets) that provide versatility
- Stainless steel internal components
- Resistant to water hammer and corrosion
- Below condensate level seat design prevents steam leakage
- Rugged thermostatic element eliminates air binding
- Maximum operating pressure: 175 psig
- Maximum body design pressure: 250 psig (3/4" - 1-1/4")
- Maximum temperature: 406°F (3/4" - 1-1/4")



Part #	Mfg #	Model	NPT Size	Seat Diff Pressure Rating	Price
HOFFT015H34	404200	FT015H-3	3/4"	15 psi	215.00
HOFFT015H1	404210	FT015H-4	1"	15 psi	250.00

Series 17C Balanced Pressure BearTrap® Thermostatic Steam Traps

- For institutional, commercial, & residential heating system applications where low or moderate water hammer may occur
- Subcooling
- Replaceable Dura-Stat® module
- Stainless steel components
- Resistant to moderate water hammer & chemical attack
- Maximum operating pressure: 25 psig
- 3-Year warranty



Angle w/Short Nipple



Swivel



Vertical

Part #	Mfg #	NPT Size	Description	Price
HOF17CA	401536	1/2"	Angle	78.00
HOF17CV	401551	1/2"	Vertical	104.00
HOF17CS	401545	1/2"	Swivel	109.00

Series 8C Balanced Pressure BearTrap®

- For institutional & commercial heating system applications that require high capacity operation
- Subcooling
- Replaceable Dura-Stat® module
- Stainless steel components
- Resistant to moderate water hammer and chemical attack
- Maximum operating pressure: 125 psig
- 3-Year warranty



Angle 3/4"



Straightaway

Part #	Mfg #	NPT Size	Description	Price
HOF8CA	402003	3/4"	Angle	140.00
HOF8C	402004	3/4"	Straightaway	142.00

All Items May Not Be Stocked In All Branches

Hydronic Accessories

Dura-Stat™ Replacement Module

- To upgrade thermostatic steam traps
- Stainless steel
- Durable and water hammer resistant
- Hoffman Specialties service pkg

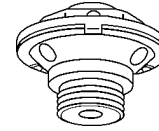

Part #	Mfg #	NPT Size	#	Price
HOF600084	600084	1/2"	A-1105-17C	61.00

62 Model Vacuum Breakers

- For use on closed vessels & piping systems to control induced vacuum within safe limits
- Adjustable from 1/4" - 20" Hg vacuum
- 3/4" NPT straight shank
- Maximum operating temperature: 366°F
- Maximum operating pressure: 150 psig
- Adjustable temp range: 100 to 140°F
- Max pressure 125 psig
- Max hot water supply temp: 235°F



Part #	Mfg #	Model	Straight Shank	Price
HOF62	401446	62	3/4" NPT	95.00

Main Steam Vents

Model 4A Main Steam Air Valve (Non-Vacuum)

- For residential or small 1 & 2 pipe systems
- Float-type thermostatic vent
- Single non-adjustable port
- Install 6-10" above horizontal return & 18" above the boiler water line
- Max operating pressure: 2 psig
- Max pressure: 10 psig



Part #	Mfg #	Model	Straight Shank	Price
HOF4A	401413	4A	1/2" FPT, 3/4" MPT	52.00

Model 75/75H Air Valve (Non-Vacuum)

- For medium & large systems
- Float-type thermostatic vent
- Single non-adjustable port
- 1/2" NPT female & 3/4" NPT male straight shank
- Max pressure: 15 psig



Part #	Mfg #	Model	Max Operating Pressure	Price
HOF75	401434	75	3 psig	116.00
HOF75H	401437	75H	10 psig	126.00

Prices & Specifications are Subject to Change.

Hydronics

Hydronic Accessories

Hydronics

Radiator Steam Vents

Model 1A Air Valve (Non-Vacuum)

- Float-type vent
- Adjustable port for true proportional venting - 6 port settings from slow (1) to fast (6)
- 1/8" NPT angle connection
- Max operating pressure: 1-1/2 psig
- Max pressure: 10 psig



Part #	Mfg #	Model	Straight Shank	Price
HOF1A	401422	1A	1/8" NPT Angle	45.50

Model 40 Air Valve (Non-Vacuum)

- Float-type vent
- Single non-adjustable port
- For ordinary one-pipe system that doesn't require proportional venting
- Max operating pressure: 6 psig
- Max pressure: 10 psig



Part #	Mfg #	Model	Straight Shank	Price
HOF40	401440	40	1/8" NPT Angle	26.50

Convactor Steam Vents

Model 41 Air Valve (Non-Vacuum)

- Single non-adjustable port
- For small steam systems
- Telescopic siphon tube w/angle cut assures drainage
- Max operation pressure: 6 psig
- Max pressure: 10 psig



Part #	Mfg #	Model	Straight Shank	Price
HOF41	401455	41	1/8" NPT	40.00

Water Vents

Model 79 Water Main Vent Valve

- For use on hot or cold or glycol water mains & process applications with specific gravity > 0.7
- Tapped at top for 1/8" NPT safety drain connection
- Removable top
- Built-in check valve
- Max operating pressure: 75 psig
- Max hydrostatic pressure: 200 psig
- Max temperature: 250°F



Part #	Mfg #	Model	Straight Shank	Price
HOF79	401488	79	1/2" FPT, 3/4" MPT	118.00

All Items May Not Be Stocked In All Branches

Hydronic Accessories

Hydronics

Model 508 Water Vent Valve

- For automatic or manual venting systems
- Ideal for use with Model 550 air chamber
- Disc-type vent
- Built-in check valve
- Cartridge with discs can be replaced without draining system
- Max water pressure: 50 psig
- Max pressure: 50 psig



Part #	Mfg #	Model	Straight Shank	Price
HOF508	401475	508	1/8" NPT	13.50

Watchman® Condensate Pumps

- Low height NPT inlet
- Separate NPT connections for secondary vent
- NPT drain connections



Watchman® Series WC® Simplex Condensate Units

- Cast iron receiver
- 1/3 hp Motor
- 20-Year warranty against corrosion

Part #	Mfg #	Model	Pump Cap (gpm)	Receiver Cap (gal)	Price
HOFWC620B	160029	WC-6-20B	9	6	1735.00
HOFWC820B	160030	WC-8-20B	12	9	1815.00

Watchman® Series WC® Duplex Condensate Units

- Cast iron receiver
- 1/3 hp Motor
- 3500 RPM, Single phase, 115V
- Mechanical alternator
- 20-Year warranty against corrosion

Part #	Mfg #	Model	Pump Cap (gpm)	Receiver Cap (gal)	Price
HOFWCD1220BMA	160032	WCD12-20B-MA	18	14	3505.00

Watchman® Replacement Parts



Part #	Mfg #	Description	Price
HOF180001	180001	Pump & Motor Ass'y for WC-8-20B	1200.00
HOF180013	180013	Mechanical Seal Kit for A & B Units	98.00

Prices & Specifications are Subject to Change.

Hydronic Accessories

Hydronics

SPIROTOP®

Brass Quick Air Releasers

- 20-Year limited warranty



Part #	Mfg #	Size	Price
SPTTOP12	VTP 050 FT	1/2" FNPT	88.36

SPIROVENT® JUNIOR

Brass Air Eliminators

- 20-Year limited warranty

Threaded Design



Part #	Mfg #	Size	Price
SPTJR100	VJR 100-TM	1" FNPT with 1/2" Tank	186.30
SPTJR125	VJR 125-TM	1-1/4" FNPT with 1/2" Tank	257.40
SPTJR150	VJR 150-TM	1-1/2" FNPT with 1/2" Tank	335.34
SPTJR200	VJR200-TM	2" FNPT with 1/2" Tank	420.30

Sweat Design

Part #	Mfg #	Size	Price
SPTJS100	VJS 100-TM	1" Sweat with 1/2" Tank	186.30
SPTJS125	VJS 125-TM	1-1/4" Sweat with 1/2" Tank	257.40

SPIROTRAP® Dirt Separators

Brass Dirt Separator

- Ball valve included
- Patented Spirotube® element



Part #	Mfg #	Pipe Size	Price
SPTTDN125FT	TDN-125-FT	1-1/4" IPS	252.90

Parts

Part #	Mfg #	Description	Price
SPTPJR000HA	PJR-000HA	Replacement Head	73.74



Insul-Tarp

- Cross woven polyethylene with 3mil aluminum and polyethylene closed-cell foam core
- -60° to 180°F Temperature range
- Fire rated up to Class A-1
- 45 lbs/in Tensile strength
- 90 psi Bursting strength



Part #	Mfg #	Description	Price
INSULTARP6-25	DRFB625	6' x 25' x 1/2"	175.00
INSULTARP6-50	DRFB650	6' x 50' x 1/2"	350.00
INSULTARP12-50	DRFB1250	12' x 50' x 1/2"	772.40

Radiant Reflective Insul-Tarp

Part #	Mfg #	Description	Price
INSUL16-48	RP1648	16" x 48" Reflective	6.50
INSUL24-48	RP2448	24" x 48" Reflective	5.26

Space Age® FBBF Reflective Insulation

- Two layers of polyethylene bubble film sandwiched between two layers of 99.9% pure aluminum foil
- 5/16" Thick
- Use as primary insulation for buildings

Part #	Mfg #	Description	Price
INSULFOIL16	FBBF16	16" x 125' Double Bubble	131.38
INSULFOIL48	FBBF48	48" x 125' Double Bubble	299.00

Hydronic Controls

Hydronics

Aquastats®

L4006A Immersion Type Aquastat Controls

- Immersion type controllers for limiting or regulating temperatures of liquids in boilers or tanks
- SPST - breaks circuit on temperature rise
- Visible control point scale and external adjustment screw permit easy setting
- Horizontal or vertical insertion of the sensing element
- Remote bulb model may be used to sense air temperature in ducts and in outside air sensing applications



Part #	Mfg #	Temperature Operating Range	Temperature Differential, Midscale	Includes:	Price
HONL4006A1678	L4006A1678	100-240°F	5-30°F Adj	3" Insulation, Stop Factory-Set @240°F, Well Adapter & Heat-Conductive Compound	191.48

L4006E Immersion Type Aquastat Controls

- High limit, manual reset
- Contacts break on temp rise
- Immersion type controllers for limiting or regulating temperatures of liquids in boilers or tanks
- Totally enclosed micro switch™ snap-acting switches operate on temperature rise to setpoint
- Visible control point scale and external adjustment screw permit easy setting
- Horizontal or vertical insertion of the sensing element

Part #	Mfg #	Temperature Operating Range	Includes:	Price
HONL4006E1067	L4006E1067	130-270°F	Stop Factory-Set @240°F, Well Adapter & Heat-Conductive Compound	281.90

Aquastat® Relays

L7224U Electronic Triple Aquastat® Relay

- With Enviracam communication
- Troubleshooting LED's
- Operating range: 110° to 220°F
- Dimensions: 7-1/8" x 4-1/4" x 2-5/8"
- Can replace all L8124A & C models plus L8148A



Part #	Mfg #	Switching Action	Diff Temp	Max Ambient Temp	Includes:	Price
HONL7224U1002	L7224U1002	SPST	5°F to 30°F	150°F	5-1/2' Capillary	317.04

L8148 Aquastat® Relays

- Immersion-type controllers that combine high limit protection with switching relay control of burner & circulator motors
- High limit opens burner circuit only
- Includes transformer & accessory terminals for adding a remote low limit controller
- Requires 24VAC thermostat w/heat anticipator set @0.2 amps
- Includes well adapter & heat-conductive compound
- Mounts horizontally or vertically
- Max Bulb: 40° over selected setpoint up to 265°F
- Max Ambient: 150° including zone valves w/low voltage loads up to 1.2 amps



Part #	Mfg #	Description	Price
HONL8148E1265	L8148E1265	Line Voltage, 180°-240°F High Limit, 4-1/2" Capillary, Vertical Mount	409.53

Prices & Specifications are Subject to Change.

Hydronic Controls

Hydronics

Pressuretrol® Limit Controllers

L4079 Pressuretrol® Limit Controllers

- Use with steam, air, noncombustible gases, and fluids non-corrosive to stainless steel
- Mounts using 1/4" NPT female threads or surface mount through base of case
- Includes siphon loop



Part #	Mfg #	Operating Pressure Range	Max Sustained Op Pressure	Switch Operation	Switching Action & Comments	Price
HONL4079B1033	L4079B1033	2 to 15 psi	50 psi	Manual reset	SPST break on rise; mercury free replacement for L404C1147	289.13

Hydronic Motorized Zone Valves

V8043/V8044 Low Voltage Hydronic Zone Valves

2-Position Normally Closed Straight-Through Valve with End Switch

- For controlling flow of hot & cold water, valve closes when de-energized
- Manual opener included
- With 18" wire leads & auxiliary switch
- 24V, 50/60Hz



Part #	Mfg #	Pipe Size	Capacity (Cv)	Max Close-Off Pressure	End Switch	Electrical Connections	Price
HONV8043E1012	V8043E1012	3/4" SWT	3.5 Cv	20 psi	SPST	18" Leads	175.37

2-Position Normally Closed Straight-Through Motorized Valve

- For controlling flow of hot & cold water
- With end switch, screw terminals & manual opener
- Terminal board w/5 terminals
- 125°F Maximum ambient temperature
- 24V, 50/60Hz



Part #	Mfg #	Pipe Size	Capacity (Cv)	Max Close-Off Pressure	End Switch	Electrical Connections	Price
HONV8043F1036	V8043F1036	3/4" SWT	3.5 Cv	20 psi	SPST	Screw Terminal Block	190.05
HONV8043F1051	V8043F1051	1" SWT	3.5 Cv	20 psi	SPST	Screw Terminal Block	214.32

Hydronic Accessories

Hydronics

Air Vents

Automatic Air Vent for Heating System Applications

- Purges air trapped in closed hot or cold water systems
- Body, cover and float assembly made of thermoplastics
- Includes removable float/valve assembly for easy servicing
- Not for use in steam systems
- NBR Seat disc and O-ring
- Oil resistant seal
- Internal parts made of corrosion-resistant and chemical-resistant materials for use with water systems containing light concentrations of propylene glycol, mineral oils, or petroleum-based oils
- Maintains quiet and efficient operation
- Built-in vacuum breaker
- Leakage guard safeguards operation
- Oil-resistant seal
- Built-in brass shutoff valve for servicing without system shutdown



Part #	Mfg #	Description	Connection	Price
HONEA122A	EA122A1002	Automatic Air Vent	1/8" MNPT	37.86

FM - Boiler Fill Valve

- Fast fill feature
- Built-in check valve
- Regulating pressure range: 4 psi to 60 psi
- Maximum operating pressure: 150 psi
- Especially constructed for expansion tank mounting



FM911 - Combination

Part #	Mfg #	Description	Price
HONFM911	FM911	1/2" NPT Backflow Preventer and Boiler Fill Valve Combo Assembly	176.17

Thermostatic Mixing Valves

AM-1 Series 3-Way Thermostatic Mixing Valves

- Adjusts, maintains and limits the hot water temperature to a desired setting selected by user
- In domestic use, offers scalding protection and bacteria growth control
- Dual purpose mixing or diverting
- Proportional valve
- Nickel-plated brass construction, EPDM o-rings



AM-101R-US-1
Union Sweat

Part #	Mfg #	Pipe Size	Connection	Operating Temperature	Price
HONAM101	AM101-1	3/4"	NPT	70°-145°F	140.32
HONAM102RUS1	AM-102R-US-1	1"	Union Sweat	80°-180°F	225.98

Hydronic Accessories

Hydronics

Thermal Expansion Tanks

Therm-X-Trol Thermal Expansion Tanks

- For use with potable water heaters only
- Non-ASME
- Pre-pressurized, diaphragm type
- Drawn steel domes, welded steel construction
- Rigid poly-propylene liner
- Butyl diaphragm, diaphragm hoop ring mechanically grooved for permanent air-tight seal
- 5-Year limited warranty



ST-5

Part #	Mfg #	Dimensions Dia x Ht	Total Volume	Price
AMTST5	ST-5	8" x 12-5/8"	2.0 gal	69.00
AMTST12	ST-12	11" x 15"	4.4 gal	92.40
AMTST25V	ST-25V	15-3/8"x19-1/4"	10.3 gal	239.00

Standard Expansion Tanks

Extrol Standard Expansion Tank



Part #	Mfg #	Model	Vol	Ht	Dia	Price
AMT15	101-1	15	2.0	12.6"	8"	52.50
AMT30	102-1	30	4.4	15.5"	11"	64.30
AMT60	103-1	60	7.6	23"	11"	131.00



Painted Basement Expansion Tanks

For Closed Type Hot Water Heating Systems

- Working pressure 75 psi

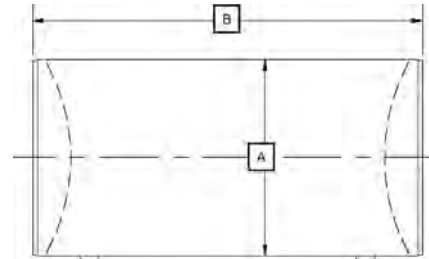

Part #	Mfg #	Capacity	Dia x Length (A x B)	Wt	Price
EXP15	JBXY-17-055	15 gal	12" x 30"	33 lbs	340.60
EXP18	JBXY-17-056	18 gal	12" x 36"	38 lbs	351.86
EXP24	JBXY-17-058	24 gal	12" x 48"	50 lbs	430.82



Steel Headers

Part #	Mfg #	Description	Price
EZHEADER3	SHB120730	1-1/4" w/(3) 3/4" Outlets	49.95
EZHEADER4	SHB120740	1-1/4" w/(4) 3/4" Outlets	60.95

Copper Headers

- 6' Long

Part #	Mfg #	Description	Price
EZHEADERC1-12-72	UCC1005024	1" Cpr, (24) 1/2" Outlets	156.45
EZHEADERC6CC	UCC1257512ER	1-1/4" Cpr,(12) 3/4" Outlets	260.92
EZHEADERC4CC	UCC1257518	1-1/4" Cpr, (18) 3/4" Outlets	238.68

Hydronic Accessories

Air Valves

FV-4M1 Series Automatic Vent Valve (FNPT)

- Provides automatic air venting for hot or cold water distribution systems
- Purges air that may be in water system
- Maximum temperature: 240°F
- Working pressure: 1.45 - 150 psi
- High temperature resistant polyethylene float
- Suitable for glycol systems



Part #	Mfg #	Model	Size	Price
AAV18	0590715	FV4M1	1/8"	15.18

Copper-Flex™ Water Heater Connectors

Copper-Flex™ 7/8" OD Tube (Male Sweat)

Part #	Mfg #	Size	Length	Price
BRAWFC34-18	WC33-18	3/4" x 3/4"	12"	30.00



Boiler/Heating System Stop-Leaks

Boiler Liquid

- For lasting repairs of cracked or leaking steam & hot water heating boilers
- Will not clog system or controls
- Withstands high pressures
- Cannot cause odors, priming or foaming
- Boiler cleaners will not affect repairs made with this product



Part #	Mfg #	Size	Price
HER30115	30115	1 qt	25.68
HER30120	30120	1 gal	78.64

Base Hit II™

- For use on all hydronic systems including those with rubber plastic components
- Hydronic system leak preventer seals leaks throughout entire system
- Works fast & won't clog vents
- Contains silicones



Part #	Mfg #	Size	Price
HER30213	30213	12 oz	38.98

Boiler Solder

- Free flowing powder makes strong repairs on cracked steam or hot water heating boilers
- On contact with air, hardens into a powerful seal which expands & contracts with boiler metal
- Once set, will not be dislodged by boiler cleaners
- For use on all hydronic systems including those with rubber or plastic components



Part #	Mfg #	Size	Price
HER30310	30310	1 lb	31.34

Boiler & Heating Cleaners

Boiler & Heating System Cleaner

- Rust & scale remover & inhibitor
- Prevents foaming
- Recommended for use on all hydronic systems including those with rubber or plastic components



Part #	Mfg #	Size	Price
HER35206	35206	1 qt	30.14
HER35211	35211	1 gal	89.40

POWER FLOW™

- Heating oil energizer from tank to burner
- Improves combustion efficiency, conserves energy & reduces fuel waste
- Melts ice & helps prevents freeze-ups
- Dissolves sludge & disperses water
- Inhibits rust formation in tanks



Part #	Mfg #	Size	Price
HER35302	35302	1 pt	16.76

Hydronics

Prices & Specifications are Subject to Change.



www.irrsupply.com

Hydronic Accessories

Hydronics

Flip-Stick® Soot Destroyer

- For oil, gas, coal & wood heating units
- Patented formula requires no mixing or measuring
- Toss-in pack for clean, effective soot & creosote removal
- Has built-in "corrosion shield" to safeguard steel & stainless steel flue pipes
- Non-explosive



Part #	Mfg #	Size	Price
HER35427	35427	85 gram	6.68



W-R Water Gauge Set

- 5/8" x 12" Standard gauge glass

Part #	Mfg #	Size	Price
PLSGGKIT	1723002	1/2"	34.95

Oil Cleaners

Blot-O™ Air Freshener

- Formulated to eliminate, not mask, odors
- Particularly effective on odors related to fuel oil, gasoline, and petroleum related spills
- Contains no CFC's or other chlorinated ingredients



Part #	Mfg #	Size	Price
HER35150	35151	16 oz	17.26



Accessories

Gauge Glass

- Standard grade
- Working pressure @150°F



Blot-O Plus

- Absorbs more fuel oil per volume than other absorbers in its class
- No annoying dust when applied to spills & swept for removal



Part #	Mfg #	Size	Price
HER35155	35155	19 oz	19.70

Part #	Mfg #	Description	Price
SCH1233B	1233B	5/8" x 10" Water, 210 PSI	1.96
SCH1233C	1233C	5/8" x 12" Water, 205 PSI	2.04

Repair Part



Part #	Mfg #	Description	Price
SCH1228D	1228D	Nut, Ring, Washer for Water Gauges	2.59
SCH1229B	1229B	5/8" Rubber Gauge Glass Washer for 1228B	0.16



Radiator Coin Key Air Valve & Key

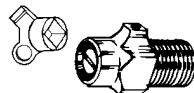

Part #	Mfg #	Description	Price
PLSCOINVENT	R20-001	Vent Valve with Key	2.46
PLSCOINVENTKEY	R20-002	Key Only	0.72

All Items May Not Be Stocked In All Branches

Hydronic Accessories

Gaskets

Part #	Mfg #	Description	Price
SSCB54	B-54	Flange Gasket Fits Bell & Gossett 100 Series 118368, P-518	1.68
SSCBP391	BP-391	Flange Gasket & Bolt Set f/B&G 100	10.00
SSCBP396	BP-396	Set of (2) Circulator Flange Gasket f/Taco/Grundfos	3.90
SSCT42	T-42	Gasket to Fit Taco 007 110-339RP Per Each	2.50
SSCT45	T-45	Circulator Flange Flat Gasket To Fit Taco 110-023RP Per Each	1.82



Freeze Protection Fluids

Noburst® AL Antifreeze

- Non-toxic, non-flammable antifreeze and heat transfer fluid
- Compatible with all metals commonly used in hydronic heating systems including brass, cast iron, steel, solder, copper and aluminum
- Not safe for use where contact with potable water is possible
- 65-75% Propylene glycol



Part #	Mfg #	Description	Price
NOBNOBURSTAL5	AL-MIX-5GAL	5 gal for Aluminum	238.70



Boiler Additives

Squick Boiler Cleaners

- Cleans & protects
- Prevents formulation of insulating scale
- Protects metal
- Prevents priming or surging
- Maximizes efficiency & prolongs boiler life



Part #	Mfg #	Description	Price
SIKSQUICK	SQUICK	For Steam Boilers	18.26

#5 Hydronic Formula Cleaner/Inhibitor

- Cleans & protects boilers & hydronic systems



Part #	Mfg #	Description	Price
SIKHF5	#5	32 oz	19.24

Force & Suction Pump

- Double checked, all brass construction
- Injects chemicals into heating & A/C systems
- Opens clogged drains
- Empties toilets & traps
- Drains plumbing fixtures
- Hose attaches to either end
- Rebuildable



Part #	Mfg #	Description	Price
SIKPUMP	PUMP	All Brass Construction	355.52

**Service Starts Here
with Irr Supply!**

Prices & Specifications are Subject to Change.



www.irrsupply.com

Fireplaces & Stoves

Empire® Fireplace Products

Vented/Vent-Free Slope Glaze Burners

On-Off Millivolt, Standing Pilot/Piezo

Part #	Mfg #	Input BTU	Log Length	Ship Weight	Price
EMPVFSR18	VFSR-18 NG	32,000	18"	24 lbs	619.00
EMPVFSR18LP	VFSR-18 LP	32,000	18"	24 lbs	619.00
EMPVFSR24	VFSR-24 NG	36,000	24"	27 lbs	658.00
EMPVFSR24LP	VFSR-24 LP	36,000	24"	27 lbs	658.00
EMPVFSR30	VFSR-30 NG	38,000	30"	30 lbs	714.00
EMPVFSR30LP	VFSR-30 LP	38,000	30"	30 lbs	714.00

Variable Remote, Standing Pilot/Piezo

Part #	Mfg #	Input BTU	Log Length	Ship Weight	Price
EMPVFSV16	VFSV-16 NG	25,000	16"	18 lbs	762.00
EMPVFSV18	VFSV-18 NG	32,000	18"	24 lbs	815.00
EMPVFSV24	VFSV-24 NG	36,000	24"	27 lbs	851.00
EMPVFSV24LP	VFSV-24 LP	36,000	24"	27 lbs	851.00
EMPVFSV30	VFSV-30 NG	38,000	30"	30 lbs	909.00

Log Set

- Requires slope glaze burner



Charred Oak



Birch



Aged Oak



Refractory Super Sassafras

Part #	Mfg #	Description	Price
EMPLS16C	LS-16C	16" Ceramic Fiber Charred Oak 4-Log	93.00
EMPLS18C	LS-18C	18" Ceramic Fiber Charred Oak 4-Log	108.00
EMPLS18RAO	LS-18RAO	18" Refractory Aged Oak 7-Log	118.00
EMPLS18RSS	LS-18-RSS	18" Super Sassafras 7 Pc Log Set	210.00
EMPLS24B	LS-24B	24" Ceramic Fiber Birch 4-Log	122.00
EMPLS24C	LS-24C	24" Ceramic Fiber Charred Oak 4-Log	122.00
EMPLS24RAO	LS-24RAO	24" Refractory Aged Oak 7-Log	147.00
EMPLS24RSS	LS-24-RSS	24" Super Sassafras 7 Pc Log Set	251.00
EMPLS30C	LS-30C	30" Ceramic Fiber Charred Oak 4-Log	139.00
EMPLS30RAO	LS-30RAO	30" Refractory Aged Oak 7-Log	102.00
EMPLS30RSS	LS-30-RSS	30" Super Sassafras 7 Pc Log Set	285.00

Rock Creek Gas Log Set

- Richly detailed and hand-painted refractory logs artfully stacked
- Slope glaze Vista burner



Part #	Mfg #	Description	Price
EMPLSU24RR	LSU-24-RR	11-Log Rock Creek Log Set	282.00

All Items May Not Be Stocked In All Branches



www.irrsupply.com

Fireplaces & Stoves

Accessories for All Vented/Vent-Free Logs

Part #	Mfg #	Description	Price
EMPEK1	EK-1	Embers Kit	38.00

Cast Iron Stoves

Heritage Cast Iron Vent-Free Stove

- Unique burner system
- Precision-port technology produces vibrant flames
- Ceramic material burner
- Hand-painted 7-piece ceramic log set
- Standing pilot/piezo ignition
- 5-Year limited labor parts warranty



Part #	Mfg #	Input BTUH	Gas Type	Finish	Price
EMPVFP30CA30B	VFP-30-CA30B	32,000	NG	Porc Blk	1830.00
EMPVFP30CA30W	VFP-30-CA30W	32,000	NG	Matte Pewter	1616.00

Heritage Cast Iron Direct Vent Stove

- Unique burner system
- Precision-port technology produces vibrant flames
- Ceramic material burner
- Hand-painted 7-piece ceramic log set
- Standing pilot/piezo ignition
- 3-Year limited parts warranty



Part #	Mfg #	Input BTUH	Gas Type	Finish	Price
EMPDVP30CA30B	DVP-30-CA30B	32,000	NG	Porc Blk	2427.00

Stove Control Option

Part #	Mfg #	Description	Price
EMPTRW	TRW	Wall Thermostat w/Wireless Remote	150.00

Direct Vent Gas Fireplaces

Tahoe Deluxe Direct Vent Gas Fireplace



Brass Leaf Trim

Millivolt Ignition with Standing Pilot/Piezo

Part #	Mfg #	Input BTUH	Gas Type	Ship Weight	Price
EMPDVD32FP31	DVD32FP31 NG *	18,000	NG	96 lbs	1174.00
EMPDVD32FP31LP	DVD32FP31 LP *	18,000	LP	96 lbs	1174.00
EMPDVD36FP31	DVD36FP31 NG *	20,000	NG	103 lbs	1211.00

Prices & Specifications are Subject to Change.

Fireplaces



www.irrsupply.com

Fireplaces & Stoves

Direct Vent Gas Fireplaces (Continued)

Tahoe Deluxe Direct Vent Gas Fireplace
Millivolt Ignition with Standing Pilot/Piezo

Part #	Mfg #	Input BTUH	Gas Type	Ship Weight	Price
EMPDVD36FP31LP	DVD36FP31 LP *	20,000	LP	103 lbs	1211.00
EMPDVD42FP31	DVD42FP31 NG *	25,000	NG	114 lbs	1433.00
EMPDVD42FP33LP	DVD42FP31 LP *	25,000	LP	114 lbs	1512.00

* with FBB-4 Blower

Direct Ignition

Part #	Mfg #	Input BTUH	Gas Type	Ship Weight	Price
EMPDVD32FP51	DVD32FP51 NG	18,000	NG	96 lbs	1313.00
EMPDVD36FP51	DVD36FP51 NG *	20,000	NG	103 lbs	1269.00
EMPDVD42FP51	DVD42FP51 NG	25,000	NG	114 lbs	1494.00

* with FBB-4 Blower

Direct Vent Fireplace Insert

Part #	Mfg #	Input BTUH	Gas Type	Price
EMPDV25IN33L	DV-25IN-33L	25,000	NG	1601.00
EMPDV33IN33L	DV-33IN-33L	33,000	NG	1658.00
EMPDV33IN33LLP	DV-33IN-33L LP	33,000	LP	1658.00
EMPDV35IN33L	DV-35IN-33L	35,000	NG	1897.00
EMPDV35IN33LLP	DV-35IN-33L LP	35,000	LP	1897.00

Direct Vent Contemporary Fireplace Surround Kit

Part #	Mfg #	Description	Price
EMPS256BL	S25-6-BL	6" Wide Matte Black Steel f/DV25IN Models	135.00
EMPS336BL	S33-6-BL	6" Wide Matte Black Steel f/DV33IN Models	122.00
EMPS356BL	S35-6-BL	6" Wide Matte Black Steel f/DV35IN Models	127.00

Direct Vent Accessories

Part #	Mfg #	Description	Price
EMPDVEK10	DVEK-10	10' Flex Extension Kit w/DVVK-4F	150.00
EMPDVEK25	DVEK-25	25' Flex Extension Kit w/DVVK-4FV	285.00
EMPDVF1BL	DVF1BL	3 Pc Black Outer Frame Kit	66.00
EMPDVF2BL	DVF2BL	3 Pc Black Outer Frame Kit	67.00
EMPDVP1SA	DVP-1-SA	32" Ceramic Aged Brick Liner for DVD32FP	119.00
EMPDVP1SH	DVP-1-SH	32" Ceramic Herringbone Brick Liner for DVD32FP	119.00
EMPDVP3SA	DVP-3-SA	42" Ceramic Aged Brick Liner for DVD42FP	121.00

All Items May Not Be Stocked In All Branches

Fireplaces



www.irrsupply.com

Fireplaces & Stoves

Mantel Accessories

Standard Mantel

- Built-in base
- Fit White Mountain Hearth fireplaces without modification



Part #	Mfg #	Description	Price
EMPEMBF1SO	EMBF-1S-O	Light Oak Std Full Mantel w/Base for 32"	778.00
EMPEMBF2SO	EMBF-2S-O	Light Oak Std Full Mantel w/Base for 36"	893.00

Replacement Parts

Part #	Mfg #	Description	Price
EMPFRCB	FRBC-1	Battery Operated Remote Control	126.00
EMPFRTBC	FRBTC-1	Battery Operated Remote Control with Thermostat	223.00
EMPFBB4	FBB-4	Variable-Speed Blower	185.00



Hearthmaster™ Valves

Angle Ball Valve

- 1/2" FIP x 1/2" FIP
- For use with both natural gas and LP gas



Part #	Mfg #	Description	Price
ARR952	952	With Chrome-Plated Flange & #949 Key	17.75

Straight Ball Valve



Part #	Mfg #	Description	Price
ARR954	954	With Chrome-Plated Flange & #949 Key	17.00

Hearthmaster™ Log Lighter Accessories

Cast Zinc Key



Part #	Mfg #	Description	Price
ARR51	949	1/4" Socket 3-1/4" Key	1.58

Fireplaces

Prices & Specifications are Subject to Change.

A/C Sundries

Sprayers

Coil Gun®

- Quick-disconnect feature
- Foam wand to enhance foaming
- 5 Mix ratio settings
- Hose-end sprayer



Part #	Mfg #	Description	Price
CAL47740	4774-0	2 qt Capacity	147.44

No. 50P Poly Sprayer

- Constructed of high-density translucent polyethylene
- Nozzle is adjustable and flow rate controlled by a thumb lever
- Comes with a 7" polyethylene pump



Part #	Mfg #	Description	Price
CAL50P	4770-0	1/2 gal Capacity Sprayer	36.32

No. 200P Poly Sprayer

- Constructed of high-density translucent polyethylene
- Funnel top for easy chemical pouring
- Pressurize with water through a quick disconnect fitting or by pumping
- All-brass hardware



Part #	Mfg #	Description	Price
CAL200P	4771-2	2 gal Capacity Sprayer	165.30

No. 300P Poly Sprayer

- Constructed of high-density translucent polyethylene
- Funnel top for easy chemical pouring
- 10" Celcon pump, brass extension tube w/adjustable nozzle and 5' vinyl hose included



Part #	Mfg #	Description	Price
CAL300P	4772-0	3-1/2 gal Capacity Sprayer	144.12

Multi-Purpose Sprayer

- For small cleaning jobs, such as window units and water coolers



Part #	Mfg #	Description	Price
CAL4768W3	4768-W3	24 oz Sprayer	13.80

Air-Cooled Equipment & Filter Cleaning IAQ Assurance Program

PanPads®

- Eliminates build-up of bacteria and slime growth in air conditioning & refrigeration condensate drain pans



4295-34



4296-24

Part #	Mfg #	Description	Price
CAL429534	4295-34	"5" Size - For up to 5 Ton	11.20
CAL429624	4296-24	"15" Size - For up to 15 Ton	29.02

Scale Removal/Descaling

No. 31-TX Acid Pump

- For circulating strong acids and cleaning solutions



Part #	Mfg #	Description	Price
CAL31TX	4603-0	Acid Pump	351.04

Water Treatment Products

Gel Tabs Drain Pan Treatment

- Protects drain pan against clogs
- Gel formulation locks tab into place
- Completely dissolves
- Up to 3 month of protection
- Eliminates foul and musty odors



Part #	Mfg #	Description	Price
CAL418503	4185-03	Treats up to 3 Tons	37.02
CAL418505	4185-05	Treats up to 5 Tons	43.98

A/C Sundries

A/C Sundries

Gas Leak Detectors

Fluorescent Gas Leak Detector

- Fluorescent formulation for improved visibility & long lasting bubbles
- Use for most refrigerants, natural gas & oxygen systems
- Non-corrosive to metals
- Freeze protected to 0°F
- USDA approved



Part #	Mfg #	Description	Price
CAL418424	4184-24	1 qt Spray	24.00
CAL418408	4184-08	1 gal	52.98

Gas Leak Detector

- High viscosity liquid forms bubbles when daubed on gas leak
- Non-corrosive, non-staining and harmless to skin
- Freeze point well below 0°F
- USDA approved



Part #	Mfg #	Description	Price
CAL418053	4180-53	6 oz w/Dauber	13.52

Refrigerant Leak Sealant

A/C EasySeal

- Prevents refrigerant leaks and seals existing leaks in air conditioning and refrigeration systems
- Eliminates expensive leak search and repair
- Travels with refrigerant to find leaks fast



Part #	Mfg #	Description	Price
CAL405001	4050-01	1.25 oz Pressurized Can	80.30
CAL405006	4050-06	3 oz Pressurized Can	103.54

A/C EasyDry

- Eliminates moisture in system
- Treats up to 5 ton systems
- Compatible with all oils and refrigerants
- Prevents acid from forming
- Compliments the system's drier



Part #	Mfg #	Description	Price
CAL405106	4051-06	3 oz Pressurized Can	103.54
CAL405199	4051-99	Reusable A/C Piercing Valve and Hose	29.66

Insulation Products

Cork Insulation Tape

- Can be used on hot or cold pipes
- Also serves as gasket material or sound deadening material



Part #	Mfg #	Description	Price
CAL4217W3	4217-W3	2" x 1/8" x 30' Roll	28.82

Vacuum Pump Oil

- High-grade 200 SUS viscosity lubricant
- Very low vapor pressure



Part #	Mfg #	Size	Price
VPO1Q	4383-24	1 qt	17.64
VPO1G	4383-07	1 gal	48.08



Ultralite™ Lightweight Equipment Pads

- Concrete pad at weight of plastic
- EPS Core prevents warping and provides solid bottom to resist settling
- Limited lifetime warranty



2" Ultralite™ Equipment Pad

Part #	Mfg #	Size	Price
PADCL2436	UC2436-2	24" x 36" x 2"	39.26

A/C Sundries

Prices & Specifications are Subject to Change.

Equipment Pads

Cladlite™ Lightweight Equipment Pads

- Fiber reinforced cement composite cladding, steel reinforcement, polystyrene foam core
- 20% Of the weight of conventional concrete pads
- Limited lifetime warranty



2" Cladlite™ Equipment Pad

Part #	Mfg #	Size	Price
PADCL2424	2424-2	24" x 24" x 2"	32.68
PADCL2430	2430-2	24" x 30" x 2"	37.14
PADCL3030	3030-2	30" x 30" x 2"	54.66
PADCL3636	3636-2	36" x 36" x 2"	75.18
PADCL3640	3640-2	36" x 40" x 2"	62.10

Anti-Vibration Pads

Rubber/Cork Anti-Vibration Pad

- Elastomeric oil resistant padding
- Withstands 50 lbs per square inch
- Cork is laminated between two corrugated pads

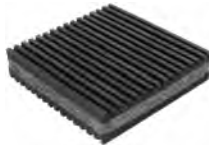

Part #	Mfg #	Size	Price
PADAV2	MP-2C	2" x 2" x 7/8"	0.52
PADAV3	MP-3C	3" x 3" x 7/8"	1.12
PADAV4	MP-4C	4" x 4" x 7/8"	2.26
PADAV6	MP-6C	6" x 6" x 7/8"	4.72
PADAV18	MP-18C	18" x 18" x 7/8"	38.78

Heat Pump Pad™

- Raises the pump a full 8" off the ground
- Precision molded from eco-friendly, recycled polypropylene
- Includes (8) high quality anti-vibration pads
- Base angled to direct melting snow or water from the unit



Part #	Mfg #	Size	Price
PADHP8	HP3636-8	36" x 36" x 8"	90.50

Furnace Mount Block



Part #	Mfg #	Description	Price
PADFMB	FB-1	Furnace Mount Block	5.88

A/C Condenser Mounting Brackets

- No hardware included
- Pre-punched holes for fastening unit to bracket
- 7/16" Holes for wall mounting hardware
- Load capacity dependent upon hardware/wall load limitations
- 3" Bracket width, 16" height



Part #	Mfg #	Description	Price
PADACB30	ACB-30	30" Steel, Pair	54.36
PADACB36	ACB-36	36" Steel, Pair	60.58

Sealants

DiversiGum Sealing Compound

- Non-hardening, for plugging openings through foundations or around refrigeration tube entry



Part #	Mfg #	Description	Price
ACAGUM1	6-202-1	1 lb Slug	4.82
ACAGUM2	6-202-2	2 lb Slug	8.08

Telescoping Tools

Telescopic Inspection Mirror

- American made
- Double ball joint links swivel mirrors for viewing to 360°



Part #	Mfg #	Description	Price
ACAMIRROR2	M-3	2-1/8" x 3-1/2" Rectangular Extends 11-1/4" to 15-1/4"	13.84

Duct Hangers

Duct Strap - Woven Polypropylene

- Webbed, high tensile, abrasion and chemical resistant
- Use for flex duct



Part #	Mfg #	Description	Price
ACADUCTSTRAP	710-100	1-3/4" x 100 yd Roll, Black	18.88

All Items May Not Be Stocked In All Branches

A/C Sundries

Tape

Cork Insulation Tape

- Black
- Adheres firmly to all metals
- Use on hot or cold pipes to stop condensation



Part #	Mfg #	Description	Price
ACACORKTAPE	6-330	1/8" x 2" x 30' Roll	15.52

Foam Insulation Tape

- Black self-adhesive foam tape use on hot or cold pipes
- Fits well around valves & fittings



Part #	Mfg #	Description	Price
ACAFOAMTAPE	6-9718	1/8" x 2" x 30' Roll	12.60

DiversiTech High Rise Pan™

- Allows placement of an air handler 2-3/4" above the outside lip of pan without mounting blocks
- Molded-in network of risers to give a 5" lift
- Kit includes:
 - Condensate Cop™ float switch
 - (6) EVA Anti-vibration pads
 - (1) 3/4" PVC Male adapter



Part #	Mfg #	Description	Price
DIVHK3060	6-HK3060	30" x 60" Drain Pan with Kit	133.68

Condensate Overflow Switches

Wet Switch Flood Detector

- Solid state control designed to help prevent flooding
- Turns system off when detecting moisture due to condensate or drain leaks
- Connects to 24VAC



Part #	Mfg #	Description	Price
DIVWS1	WS-1	Wet Switch	78.18

Nylon Barbed Fittings

Adapter



Part #	Mfg #	Description	Price
VITMA14-14	701-004	1/4" Barb x 1/4" MPT	0.88
VITMA38-38	701-013	3/8" Barb x 3/8" MPT	1.02
VITMA38-12	701-012	3/8" Barb x 1/2" MPT	1.08
VITMA12-34	701-002	1/2" Barb x 3/4" MPT	1.20
VITMA58-34	701-028	5/8" Barb x 3/4" MPT	1.70

90° Elbow



Part #	Mfg #	Description	Price
VIT9012	701-018	1/2" Barb	1.30
VIT9012-34	701-020	1/2" Barb x 3/4" MPT	1.60
VIT9058-34	701-014	5/8" Barb x 3/4" MPT	1.70

Tees



Part #	Mfg #	Description	Price
VITT38	701-038	3/8" Barb	1.58
VITT12	701-034	1/2" Barb	1.70
VITT58	701-039	5/8" Barb	1.70

Hose Mender



Part #	Mfg #	Description	Price
VITCPLG38	701-032	3/8" Barb x Barb	1.04
VITCPLG12	701-029	1/2" Barb x Barb	1.28

Hard Start Kits

- Solid state for all PSC compressors from 1/2 to 10 hp
- Can be used on units that operate on 120 - 240V



DST-5

DST-6

Part #	Mfg #	Description	Price
WAGDST5	DST-5	Starter Power Pack 300% Torque Multiplier	17.84
WAGDST6	DST-6	Torque Plus	27.20

Prices & Specifications are Subject to Change.

A/C Sundries

A/C Sundries

DiversiWhip - Metallic Connectors

- Liquid-tight flexible conduit system
- Three distinct wire colors
- (1) Straight and (1) 90° metallic connectors
- UL & CUI Listed



Part #	Mfg #	Description	Price
ELE12-4	6-12-4	1/2" x 4', #10 THHN	20.43
ELE12-6	6-12-6	1/2" x 6', #10 THHN	24.52
ELE34-4	6-34-4	3/4" x 4', #8 THHN	30.30
ELE34-6	6-34-6	3/4" x 6', #8 THHN	37.80

* S indicates produced with 2 straight connectors

Condensate Drain Pan Cleaners

Pro-Treat® 151 Premium

- Cleans condensate drain pans and humidifiers
- (1) Tablet per 3 tons each month
- EPA Registered



Part #	Mfg #	Description	Price
WAGPT151	PT-151	(100) Tablets per Jar	54.36

Clear Vinyl Tubing

- For air conditioning and refrigeration condensate drains, condensate pump discharge lines and humidifier overflows



Part #	Mfg #	ID	Size	Price
VIT14	7-14	1/4" ID	100'/Roll	0.20
VIT38	7-38	3/8" ID	100'/Roll	0.18
VIT12	7-12	1/2" ID	100'/Roll	0.32
VIT58	7-58	5/8" ID	100'/Roll	0.36
VIT34	7-34	3/4" ID	100'/Roll	0.54

Gorilla Tube™ Premium Clear Vinyl Tubing

- Non toxic clear vinyl chloride
- Extra rigid design resists crimping and kinking due to durometer value of 80 (Shore A) and thicker wall
- Maximum service temperature: 140°F
- Better performance in cold weather climates



Part #	Mfg #	ID	Size	Price
VIT38HD	7-38P	3/8" ID	100'/Roll	32.54
VIT12HD	7-12P	1/2" ID	100'/Roll	53.20
VIT58HD	7-58P	5/8" ID	100'/Roll	68.68
VIT34HD	7-34P	3/4" ID	100'/Roll	89.26

SLIMDUCT™ INC.

Slim Duct Lineset Ducting

Slim Duct SD PVC Trunking



Part #	Mfg #	Size (mm)	Color	Price
SLISD100W	SD-100-W	100	White	36.18

Wall Corner - PVC

- Component to take out pipe from wall
- Will not damage appearance since wall corner closes hole bigger than pipings



Part #	Mfg #	Size (mm)	Color	Price
SLISW100W	SW-100-W	110	White	18.73

Vertical 90° Ell For Turn Up & Down



Part #	Mfg #	Size (mm)	Color	Price
SLISC100W	SC-100-W	100 Vertical	White	18.94

A/C Sundries

A/C Sundries

Vertical 45° Ell For Turn Up & Down



Part #	Mfg #	Size (mm)	Color	Price
SLISCF100W	SCF-100-W	100	White	15.94

**Slim Corners - PVC
90° Flat Surface Elbow**



Part #	Mfg #	Size (mm)	Color	Price
SLISK100W	SK-100-W	110	White	18.62

45° Flat Surface Elbow



Part #	Mfg #	Size (mm)	Color	Price
SLISKF100W	SKF-100-W	106	White	18.62

Slim Joint Straight Fitting - PVC



Part #	Mfg #	Size (mm)	Color	Price
SLISJ100W	SJ-100-W	109	White	7.28

Rear Entry Coupler



Part #	Mfg #	Size (mm)	Color	Price
SLISJA100W	SJA-100-W	100	White	14.45

Flexible Adapter



Part #	Mfg #	Size (mm)	Color	Price
SLISFJ100W	SFJ-100-W	100	White	6.10

Duct End Covers - PVC

- Tapered f/easy taping



Part #	Mfg #	Size (mm)	Color	Price
SLISEN100W	SEN-100-W	56	White	9.10

2" Fixed Offset



Part #	Mfg #	Size (mm)	Color	Price
SLISIF100W	SIF-100-W	100	White	24.40

Free Corner - Flexible Tube Type

- Can be used up to 90° flat bend & for stepping over

Part #	Mfg #	Size (mm)	Color	Price
SLISF100W	SF-100-800-W	100 to 800	White	15.30

Ceiling Cap - ABS

- Suitable for ceiling/wall penetration where no holes can be secured on duct



Part #	Mfg #	Size (mm)	Color	Price
SLISP100W	SP-100-W	135	White	14.55

A/C Sundries

A/C Sundries

Tee



Part #	Mfg #	Size (mm)	Color	Price
SLIST100W	ST-100-W	110	White	38.84



Hard Starts

SPP Series Starters for A/C

Starter Pow-R-Pak

- For ordinary low voltage start problems
- 115-230V



Part #	Mfg #	Description	Price
SUOSPP	SPP	250% Boost, 115/230V	16.36

Condensate Drain Pans

30-OS, 31 & 75 Condensate Drains

- Standard cast aluminum
- Long life heating element
- Mounting legs



30-OS



75

Part #	Mfg #	Capacity	Electric	Price
SUO30	30-OS*	38 oz	120V, 160W	77.62
SUO75	75	75 oz	120V, 320W	233.42

* Indicates NSF listing

Commercial Condensate Evaporator Pans

- UL Approved - File# SA32471
- NSF Approved
- Corrosion resistant stainless steel construction
- Made from top quality materials and components for longer more durable use
- Positive evaporation
- Space saving
- High limit safety and float switch operation
- Available In 120, 208 and 240 volts
- 1-Year warranty from date of installation



Part #	Mfg #	Capacity	Electric	Price
SUOCP807	CP807	7.5 qt	120V, 1000W	256.94
SUOCP807240	CP807-240	7.5 qt	240V, 1000W	256.94
SUOCP815	CP815	15 qt	120V, 1440W	342.74



Eco Pad®

- Molded from recycled materials
- Chemical resistant
- UV Stable



Part #	Mfg #	Size	Price
PADDG1836	92120001	18" x 36" x 2"	35.88
PADDG2424	92120002	24" x 24" x 2"	32.38
PADDG2436	92120003	24" x 36" x 2"	36.66
PADDG3030	92120007	30" x 30" x 2"	38.26
PADDG3040	92120009	30" x 40" x 2"	84.64
PADDG3333	92120011	33" x 33" x 2"	44.18
PADDG3345	92120013	33" x 45" x 2"	52.04
PADDG3636	92120015	36" x 36" x 2"	49.58

A/C Sundries

Alarms

WaterSiren Plus™ Water Alarm

- Low battery alarm chirps to remind you to change the battery
- 6' (1.8m) Sensor wire allows sensor to be placed in hard to reach areas
- Unit can sound for up to 36 hours on a fresh 9V battery
- Put sensor directly on floor or mount siren on wall and extend sensor to area where you are worried about water
- High impact plastic makes this unit durable for years of reliable use



Part #	Mfg #	Description	Price
FRZWS03	WS-03	Basic Alarm, 90dB	73.44
FRZWS04	WS-04	With Alarm Relay Contact, 90dB	73.44

Basic FreezeAlarm™

- Automatically dials to one telephone number when the temperature drops below 45°F/7°C (+3°)
- Plays a pre-recorded voice alarm message
- Continues to call your programmed telephone number until the alarm call out is canceled
- Call-to telephone number can be up to 40 digits long including the "*" key if required
- Dialing indicator light
- Remote sensor
- Operates on Touch Tone™ telephone lines only
- Auxiliary contact for connecting our waterAlarm™ or a motion sensor, smoke detector, moisture sensor, or other device that closes a contact to active the "call out" feature on the FreezeAlarm
- FCC Approved



Part #	Mfg #	Description	Price
FRZFABCCA	FA-B-CCA	Powered by 9-volt Battery	99.00

Intermediate FreezeAlarm™

- Adjustable temperature alarm setpoint with call out
- Power loss call out alarm
- Three telephone number call out, up to 16 digits each
- Dials out in tone or pulse
- Remote access to programming menu and current condition status
- Custom voice message recording
- LED Status indicators
- Battery back-up (9V, not included)



Part #	Mfg #	Description	Price
FRZFAICAA	FA-I-CAA	12 VDC Power Supply	209.95

Deluxe FreezeAlarm™

- Calls up to three phone numbers if the temperature gets out of range, the power goes out or if the back-up battery requires replacing
- Quick Status Check feature allows you to check the current temperature, power and back-up battery status all with a simple, 15 second phone call
- Monitors both a high and low temperature set point at the same time making the perfect for monitoring a deep freezer, walk-in cooler, floral cooler, green house or garage
- Pre-Heat or Cool your home, cottage or cabin with a phone call
- Add our WaterSiren (WS-04) to be alerted by phone of water leaks or flooding
- Add our MiniAlarm Motion Sensor (MA-S01) to be alerted if intruders have broken into your monitored property
- Power Out Timer allows you to select the amount of time the power must be out before it calls you
- Security code prevents unauthorized access
- Listen to temperatures in either Fahrenheit or Celsius degrees



Part #	Mfg #	Description	Price
FRZFAD2	FA-D2	Standard 110 VAC Power, 9V Lithium Battery Backup	375.00

UNIVERSAL®

Carbon Monoxide Alarm

Battery Operated

- Listed to UL2034 standard
- Test/reset button
- Red LED indicates power or alarm
- Audible low battery warning signal
- Product end-of-service life warning
- Tamper-resistant locking feature
- Loud 85 dB alarm
- California State Fire Marshal approved
- Includes
 - Mounting hardware
 - 9V Energizer alkaline battery
- 5-Year limited warranty



Part #	Mfg #	Description	Price
USICD9000	CD-9000	Carbon Monoxide Alarm	34.99

HVAC Sundries

Prices & Specifications are Subject to Change.

Alarms

Smoke and Carbon Monoxide Alarms

Battery Operated Platinum Series

- Separate sensors to detect smoke or carbon monoxide
- Quick Draw® battery drawer - Convenient pull-out drawer for easy battery replacement
- Silencer feature - convenient silencer button with automatic reset allows you to temporarily override smoke alarm - ideal for cooking smoke and fireplaces - eliminates nuisance alarms
- LED Alarm condition indicators
- Loud 85 dB alarm
- End-of-life notification - warns after approximately 6 years of operation from initial power up
- Test/silence button
- Includes 9V super heavy-duty battery
- 5-Year limited warranty



Part #	Mfg #	Description	Price
USICD9775	CD-9775	Smoke/CO Alarm	49.95

Ionization AC Electrical Series

- Separate sensors to detect smoke or carbon monoxide
- Quick Draw® battery drawer - Convenient pull-out drawer for easy battery replacement
- Silencer feature - convenient silencer button with automatic reset allows you to temporarily override smoke alarm - ideal for cooking smoke and fireplaces - eliminates nuisance alarms
- 9V Battery backup in event of power failure
- Low battery audible indicator
- LED Alarm condition and AC power indicators
- Smart interconnect up to 18 units - 12 smoke alarms maximum
- End-of-life notification - warns after approximately 6 years of operation from initial power up
- Mounts on single gang or 3-1/4" octagon junction box
- 120 VAC 0.1 Amp
- 5-3/4" x 1-3/4" x 5-3/4"
- Includes 9V alkaline battery
- 5-Year limited warranty



Part #	Mfg #	Description	Price
USI7795	USI-7795-6CC	CO/Smoke Alarm w/Battery Back-Up	52.00

Carbon Monoxide and Natural Gas Alarm With Battery Backup

- Meets UL2034 and UL1484
- Plug-in 120V AC operated
- 9V Battery backup
- Compact design-covers only one outlet
- Bright, easy-to-read digital display
- Displays peak CO level
- Test/reset button
- (3) LED's Indicate: power, gas, CO
- Product end-of-service life warning
- Includes 9V super heavy duty battery
- Quick activation battery pull tab
- Loud 85dB alarm
- 5-Year limited warranty



Part #	Mfg #	Description	Price
USIMCND401	MCND401	CO/Natural Gas Alarm	49.99

**Can't find what you are looking for?
We have access to hundreds
of vendors and thousands
of items not listed in this catalog**

HVAC Sundries

Alarms

Smoke/Fire and Carbon Monoxide/Natural Gas Alarm

IoPhic® 4-in1-Alarm with Battery Backup

- Listed to UL2034 standard
- 120V AC Wired-in
- Microprocessor virtually eliminates nuisance alarms
- Product end-of-service life warning
- Test/reset button
- Quick Draw® battery drawer - Convenient pull-out drawer for easy battery replacement
- (4) LED's Indicate: power, smoke, CO and gas
- Interconnectable up to (24) Compatible Devices
- Tamper-resistant locking feature
- Battery activation pull tab
- Includes 9V super heavy duty battery
- Loud 85 dB alarm
- 5-Year limited warranty



Part #	Mfg #	Description	Price
USIMDSCN111	MDSCN111	Smoke/Fire/CO/NG	69.99

Smoke and Fire Alarm

Battery Operated

- UL Approved for recreational vehicle usage
- Dual ionization sensing chamber
- Compact size: 4-1/4" x 4-1/4" x 1-1/3"
- Low battery audible indicator
- Alarm and power test button
- Chamber and cover designs protect alarm from insects and contaminants
- Loud 85 dB horn
- Includes:
 - 9 V Battery
 - Round, flat mounting plate and hardware
- 5-Year limited warranty



Part #	Mfg #	Description	Price
USISS770	SS-770-24CC	Ionization Smoke/Fire	5.99

Ionization Smoke and Fire Alarm

Premium Extra Series with Battery Backup

- UL Listed
- Dual ionization sensor
- 120V (60 Hz) Power (other voltages available)
- Silencer feature - convenient silencer button with automatic reset allows you to temporarily override alarm - eliminates nuisance alarms
- 30-Day low battery audible indicator
- Smart Interconnect up to (18) units - with (12) smoke alarms maximum
- Alarm sounds and red LED indicator FLASHES
- Green LED indicator for AC power
- Test button
- Chamber and cover designs protect alarm from insects and contaminants
- Attaches to any standard rectangular or octagon junction box and covers drywall cutout
- Wire harness for easy connection
- Mounts on single, gang or 4" (102mm) octagon junction box
- Loud 85 dB horn
- Includes:
 - 9V Battery
 - Separate large size 5-5/8" (143mm) mounting plate
- 5-Year limited warranty

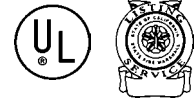

Part #	Mfg #	Description	Price
USISS795	SS-795	Ionization Smoke/Fire	15.99

HVAC Sundries

Heating Sundries

Draft Inducers

- Inline Auto-Draft® inducers
- Quick and easy to install
- Trouble free
- Vari-Draft control permits adjustments to the individual job requirement
- 115V 60Hz



Part #	Mfg #	Smokepipe Size	RPM	Watts	Amps	HP Open	Price
TJEDJ3	DJ-3	3" - 6"	1550	35	4.3	1/70	230.00
TJED3	D-3	5" - 8"	1550	74	.96	1/20	294.00

Fan Proving Switches

- Monitors pressure within the fan housing only
- SPST
- Maximum pressure: 1/2 psi

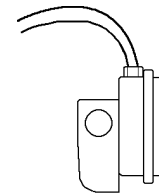

Part #	Mfg #	Description	Price
TJEPS1505	PS1505	Pressure Switch	132.00

Commercial Sidewall Gas Power Venters

HS Series Sidewall Gas Power Venter

- Used for side wall venting residential/light commercial natural gas, LP or oil fired equipment
- Reliable and consistent mechanical draft
- Factory calibrated fan proving switch
- Straight forward installation
- Does not come with vent hood
- Includes UC1 universal control
- UL Approved

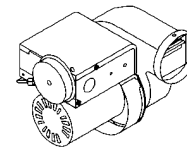

Part #	Mfg #	BTUH Input Ranges	Size (H x W x D)	Inlet/Outlet	Price
TJEHSJ	HS-J	50,000 - 125,000	7-7/8" x 10-1/4" x 7"	4"	540.00
TJEHS1	HS-1	150,000 - 300,000	7-7/8" x 11" x 7"	4"	546.00
TJEHS2	HS-2	350,000 - 600,000	9-1/4" x 11-1/2" x 8-1/2"	6"	778.00
TJEHS3	HS-3	450,000 - 700,000	12-1/2" x 13-1/4" x 11"	8"	1460.00

HVAC Sundries

All Items May Not Be Stocked In All Branches

Heating Sundries

Power Venters

SideShot® Side Wall Vent System

- For oil and gas heating equipment
- No chimney required
- Zero clearance
- Fast, easy installation
- Energy saving
- Safety protection by pressure switch and high limit control



Part #	Mfg #	Description	Price
TJESS1	SS1	Gas and Oil Heating Equipment - Up to 160,000 BTUH, ETL Listed	1540.00
TJESS2	SS2	Oil Vent System - Up to 168,000 BTUH	1224.00

Packaged Side Wall Vent System

- Complete vent system
 - Power Venter
 - 4" Vent Hood (VH1-4)
 - 4" Draft Control (DC4)
- Non-adjustable 45-second, post-purge relay/timer to purge vent system of residual flue gases after burner cycle
- For gas furnaces, boilers, pool heaters, and commercial water heaters
- AGA Certified
- Built-in fan proving switch interlocks with gas valve
- Durable, heavy-duty aluminum vent hood
- Includes everything for installations except vent pipe
- 4" Vent pipe
- 115V, 60 Hz, 3000 RPM, 95 Watts, 1.26 Amps
- 24/115V Switching relay therm protection



Part #	Mfg #	Description	Price
TJEGPAKJT	GPAK-JT	Up To 120,000 BTUH, Includes DC-4 4" Draft Control, 45 Second Fixed Delay	712.00
TJEGPAK1T	GPAK-1T	Up To 250,000 BTUH, Includes DC-4 4" Draft Control, 45 Second Fixed Delay	712.00

Side Wall Vent Hoods

- Heavy duty, corrosive resistant aluminum construction and built-in clearances from combustibles
- All mounting hardware included



Part #	Mfg #	Description	Price
TJEVH13	VH1-3	3" Diameter, 6-3/4" sq Rough-In	154.00
TJEVH14	VH1-4	4" Diameter, 8" sq Rough-In	195.00
TJEVH16	VH1-6	6" Diameter, 9" sq Rough-In	211.00

HVAC Sundries

Heating Sundries

Gas Water Heater Vent Kits

- Vents any brand or type of gas water heater
- Quiet operation
- Safety controls shut heater off if vent system fails
- AGA Design certified, used for side wall venting residential or light commercial gas water heaters
- Kit includes everything for complete installation except vent pipe
- 115V, 60 Hz, 3000 RPM
- 75 Equivalent feet maximum venting
- Post purge times



Part #	Mfg #	Burner Cap BTUH	Watts	Amps	Size (H x W x D)	Inlet/Outlet	Price
TJEVP2	VP-2	Up to 60,000	50	1	10-1/2" x 7-1/2" x 10"	3"	840.00
TJEVP3	VP-3	60,000 - 120,000	95	1.26	7-7/8" x 10-1/4" x 7"	4"	860.00

Accessory Controls

UC1 Universal Control

- Standard interlock for Tjernlund's full line of fixed speed power venters, draft inducers and combustion air in-forcers
- Can be interlocked with virtually any 24 - 120 VAC burner control circuit
- 10 Second prover switch delay to avoid burner start up and wind induced short cycling
- Adjustable pre- and post-purge times
- LED Status / diagnostic indicators



Part #	Mfg #	Description	Price
TJEU1	UC1	UC1 Universal Control	220.00

Multiple Appliance Controller

- Used with UC1 Universal Controller to easily interlock additional 24 VAC, 115 VAC or millivolt controlled appliances with fixed speed auto-draft inducer, power venters, draft inducers or in-forcers
- Activates venter through its connections to the UC1 and relies on the UC1 fan prover safety circuit to allow its interlocked appliances to operate
- Circuit board housed in oversized 18 gauge electrical box with multiple knock-outs for easy wiring connections



Part #	Mfg #	Description	Price
TJEMAC1E	MAC-1E	Connect One Additional Device	240.00

Water Heater Interlock Kit

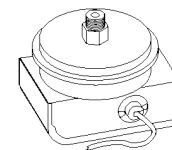

Part #	Mfg #	Description	Price
TJEWHKE	WHKE	Actuates Inducer/Venter and Disables Heater During Malfunction, for use with UC1, MAC-1E or MAC-4E	240.00
TJEWHKI	WHK-I	Instantaneous Water Heater Control	250.00

Heating Sundries

Duct Boosters®

- Fits round or flat forced air heating/cooling ductwork
- Boosts air flow up to 275 CFM



Part #	Mfg #	Description	Price
TJEDB2	DB-2	Original 120V, 1/20 HP, .51A - 6" and 8" Duct	180.00

Dryer Duct Booster

- For residential capacity clothes dryers where duct runs exceed 25'
- Impeller: Reverse inclined, particulate handling
- Components:
 - (1) LB1 Wired fan assembly
 - (1) 16 Gauge galvanized steel mounting bracket
 - (1) Mounting hardware packet



Part #	Mfg #	Description	Price
TJELB1	LB1	160 cfm, 120VAC, 50W, 0.5A	575.00

Replacement Parts

Part #	Mfg #	Description	For:	Price
TJE9501030	950-1030	Fan Prover Kit	GPAK, Power Venters	122.14

Thank you for doing business with us. We appreciate your order.

HVAC Sundries

Heating Sundries

Multi-Port Manifolds

- Provides central distribution point for individual runs to each appliance

Cast - 4 Port

- Female connections
- ASTM A47 32510 Malleable Iron



Part #	Mfg #	Port Sizes	Price
FGPMAN4	4-PORTMAN	3/4" x 4@1/2" x 1/2"	54.46

Mounting Hardware

Gas Outlet Box Kit

- Creates a secure recessed termination point for connection to moveable appliances



Part #	Mfg #	Description	Price
FGPOUTBOX12	XROUTLETBOX-8	Recessed w/1/2" XR Ftg	66.64
FGPOUTBOX34	XROUTLETBOX-11	Recessed w/3/4" XR Ftg	89.70



Furnace/Stove Cements

Furnace/Stove Cement

- Won't crumble when dry
- Contains no asbestos
- High temperature compound for setting up furnaces, ranges and stoves
- Makes joints acid-proof, gas-proof and fireproof



Part #	Mfg #	Size	Price
HER35503	35503	1/2 pt	5.68
HER35509	35509	11 oz	7.48
HER35504	35504	1 pt	5.29
HER35515	35515	1/2 gal	24.58

For Heat's Sake Retort/Furnace Cement

- For sealing and repair of boilers, furnaces flue pipes, stoves, ducts, kilns, chimneys, combustion chambers, and many other furnace and refractory applications
- Unique patented clean'n friendly formula meets OSHA's requirement of less than 0.1% of crystalline silica content
- Applies exceptionally smoothly
- Adheres to most building materials
- When cured, makes positive non-porous fireproof seal
- Will not shrink, crack or crumble
- Contains no oils, asbestos, or crystalline silica
- Available in regular body (non-runny tan colored) cement, & heavy body (firmer consistency, dark gray color)



Part #	Mfg #	Size	Price
HER35610	35610	1 gal	49.86

Hi-Heat Heavy Duty Furnace Cement

- For setting up furnaces, ranges, & stoves
- Withstands 3000°F
- Won't freeze to +10°F
- Ready to use mortar-like compound
- Adheres to all surfaces to make fireproof, gas & acid-proof seal on heating applications



Part #	Mfg #	Size	Price
HER35521	35521	1/2 gal	28.16

Oil Cleaners

Odorout Powder

- Stop fuel oil odors caused by spills, stains, leaks & tank overflow
- Shake Odorout through adjustable opening on spill or leak & odor vanishes quickly & completely
- Removes oil stain from concrete floors as well



Part #	Mfg #	Size	Price
SOSOP1	OP-1	1 lb Shaker Top	13.48



www.irrsupply.com



Heating Sundries

Silicone Sealants

315 RTV Silicone Sealant

- A paste-like, one-part acetoxy cure adhesive/sealant suitable for general industrial uses
- Adheres to clean metal, glass, most types of wood, RTV silicones, vulcanized silicone rubber and ceramics
- Resists weathering, temperature extremes and caustic environments



Part #	Mfg #	Description	Price
CAUHITEMP3C	01000CL72	3 oz Tube Clear	6.66

326 Hi-Temp Red Silicone Sealant

- Provides protective coating where parts must perform up to 600°F
- Used in critical bonding, sealing, potting and encapsulating applications
- Paste grade acetoxy silicone



Part #	Mfg #	Description	Price
CAUHITEMP3R	32603	3 oz	13.76
CAUHITEMP10R	32610	10.1 oz	17.56

363 Acrylic Latex Caulk with Silicone

- For sealing:
 - Around window and door frames
 - Around baseboards
 - Around trim
 - Anywhere a weathertight seal is desired
 - Corner joints
 - Where siding meets trim
- Interior and exterior use
- Flexible resilient bond
- Water resistant



Part #	Mfg #	Description	Price
CAUW10C	36300	10.1 oz Cartridge Clear	7.88
CAUW10W	36301	10.1 oz Cartridge White	6.16
CAUW10A	36305	10.1 oz Cartridge Almond	6.16

370 HVAC/R Silicone Sealant

- One-part sealant formulated for general heating, ventilation, air conditioning, and refrigeration sealing
- Adheres to clean ductwork, other metals and many types of wood
- Meets FDA and USDA requirements for use in federally inspected meat and poultry plants
- Seals wall penetrations



Part #	Mfg #	Description	Price
CAUH10C	37000	10.1 oz Clear	9.68
CAUH10W	37001	10.1 oz White	9.68

Silicone Sealants (Continued)

370 HVAC/R Silicone Sealant

Part #	Mfg #	Description	Price
CAUH10ALUM	37003	10.1 oz Aluminum	9.68

Firestop Sealants

136 Firestop/Draft Sealant

- Prevents spread of fire, smoke and toxic gases
- Non-combustible, inorganic materials



Part #	Mfg #	Description	Price
CAUFS	13605	10.1 oz Cartridge Red	10.14

Adhesives

347 Multi-Purpose Construction Adhesive

- Waterproof; formulated using synthetic rubber and tackifying resins
- For bonding and installation of all types of plastic foams and polystyrene
- Recommended for use in Fire-Rated wall and partition designs



Part #	Mfg #	Description	Price
CAULN10	34700	10.1 oz	8.46

Thermostat Wire

- PVC Jacket, conductors insulated with polypropylene



18 AWG Thermostat Wire - Barostat™

Part #	Mfg #	# Cond	Lgth	Color	Price
ELE182UL	55302-05-07	2	500'	Brown	CALL
ELE183UL	55303-05-07	3	500'	Brown	CALL
ELE184UL	55304-04-07	4	250'	Brown	CALL
ELE185UL	55305-04-07	5	250'	Brown	CALL
ELE186UL	55306-04-07	6	250'	Brown	CALL
ELE188UL	55308-04-07	8	250'	Brown	CALL

HVAC Sundries

Prices & Specifications are Subject to Change.

Tape

Duct Tape

243 Multi-Purpose Duct Tape

- 10 mil Thickness
- Tensile strength: 22 lb/in
- Soft & conformable backing
- Provides high tack & quick grip
- Excellent tear characteristics
- High performance in cold temperatures
- Low VOC



Part #	Mfg #	Size	Color	Price
DUT2-60BLK	243	2" x 60 yds	Black	16.80
DUT2-60	243	2" x 60 yds	Silver	16.80
DUT3-60	243	3" x 60 yds	Silver	31.02

339 Cold Weather Premium UL 181A&B Printed Foil Tape

- 4.8 mil Thickness
- Tensile strength: 23 lb/in
- High performance in both cold and hot weather
- Instant adhesion, superior quick stick
- Premium performance in joining and sealing rigid fiberglass duct board and Class 1 flex duct
- Tear resistant
- Low VOC



Part #	Mfg #	Size	Price
DUT212-60FOIL	339	2-1/2" x 60 yds	34.42

Foil Tape

322 General Purpose Aluminum Foil Tape

- 5 mil Thickness
- Conformability to irregular surfaces
- 2 mil Dead soft aluminum foil backing with synthetic rubber backing & unbleached natural kraft paper liner
- Low VOC content
- UL 723 Testing



Part #	Mfg #	Size	Price
DUT3-50FOIL	322	3" x 50 yds	27.48

367-17 Foilmastic™ High Performance Foil Tape

- Waterproofing/Repair tape UL 181B-FX listed, printed
- 17 mil Thickness
- Tensile strength: 23 lb/in
- All-weather foil tape engineered specifically for flexible duct systems
- Butyl rubber adhesive for airtight seal
- Resistant to UV exposure, mold, humidity and extreme temperatures
- Low VOC



Part #	Mfg #	Size	Price
DUT2-100FM	367-17	2" x 100'	53.58

338 Foil/Scrim/Kraft Tape

- Tested in accordance with UL 723
- 8 mil Thickness
- Tensile strength: 35 lb/in
- Diamond pattern, tear resistant
- Provides excellent adhesion to substrate over wide temperature range
- Extra strength seal to maintain vapor barrier integrity
- Low VOC



Part #	Mfg #	Size	Price
DUTFSK	338	3" x 50 yds	28.32
DUTFSK4	338	4" x 50 yds	54.66

HVAC Sundries

Bath Fans

Decorative Fans

Decorative Bath Fan

- Tapered, polymeric 4" round duct fitting
- Corrosion resistant finish
- Plug-in light fixture assembly
- Plug-in, permanently lubricated motor
- Sturdy keyhole mounting brackets for quick, accurate installation
- Capacity: 120W - (2) 60W
- 5-3/4"H x 8"W x 8-1/4"D Housing

754 Alabaster Glass Globe

- 13-1/8" Alabaster glass globe
- Uses two candelabra style bulbs



Part #	Mfg #	CFM	Sones	Color/Finish	Price
BRO754RB	754RB	70	3.5	Rubbed Bronze	166.08

Bath/Ventilation Ceiling Mount Fan

- Energy Star® qualified
- HVI Certified
- 68 CFM at 0.25" static pressure
- Efficient 26W fluorescent lighting (2-13W GU24 bulbs included)
- White finish with white opal glass globe
- Fits in 2" x 6" ceiling construction; hanger bars included
- 4" Ducting
- Housing dimensions: 8-1/4" x 8" x 5-3/4"



Part #	Mfg #	CFM	Sones	Price
BRO778WHNT	778WHNT	80	2.0	216.10

Bath Fans

Deluxe Ceiling/Wall Fan

- 3" Round duct connector
- 9" x 9-1/4" White polymeric grille
- Torsion spring grille mounting
- Double strength mounting flanges with keyhole slots
- UL Listed for showers and baths with GFCI-protected branch circuit
- 3-5/8"H x 7-1/2"W x 7-1/4"D Housing



Part #	Mfg #	CFM	Sones	Price
BRO671	671	70	6.0	62.08

Combination Bath Fans

Economy Fan/Light

- 4" Round duct connector
- White polymeric grille
- 100W Incandescent light capacity or 13W double twin-tube fluorescent lights (bulbs not included)
- UL Listed for use over bathtubs and shower when connected to a GCFI-protected branch circuit
- Type IC (Insulation contact)
- Mounting ears
- 5-3/4"H x 8-1/4"W x 8" Housing



Part #	Mfg #	CFM	Sones	Price
BRO678	678	50	2.5	91.70
BRO679	679	70	3.5	150.22

Combination Unit with Heater

- 4" Round duct with 2" long tapered sleeve
- 16-3/4" x 10-5/8" White polymeric grille
- 100W Light capacity (bulb not included)
- Housing lined with 1/2" acoustic insulation
- Type IC (Insulation contact)
- Built-in damper prevents backdrafts
- Adjustable, slotted mounting brackets span up to 24"
- 5-3/8"H x 8-1/4"W x 14-1/4"D Housing



Heater/Fan/Light

- 1300W Heater
- Fan and heater function independently or together
- Multi-function control sold separately
- Separate circuit required

Part #	Mfg #	CFM	Sones	Price
BRO655	655	70	4.0	205.88

Round Fan/Light/Night-Light

- 4" Round duct connection
- 100W Light capacity with 7W night-light
- 15" Dia White polymeric grille
- Type IC
- 6"H x 9"W x 9"D Housing
- UL Listed for use over showers and baths when connected to GFCI-protected branch circuit



Part #	Mfg #	CFM	Sones	Price
BRO750	750	100	3.5	230.08

HVAC Sundries

Prices & Specifications are Subject to Change.

Bath Fans

WhisperCeiling™ Ventilating Fans

- Low noise levels
- Low power consumption
- Long run times or continuous operation
- Built-in damper prevents backdraft



Part #	Mfg #	CFM	Sones	Price
PANFV08VQ5	FV-08VQ5	80	<0.3	313.50
PANFV11VQ5	FV-11VQ5	110	<0.3	351.00

WhisperFit™ Ventilating Fan

- Ceiling mount
- Low profile ideal for buildings with smaller ceiling cavities
- Optional 3" duct adapter is included



Part #	Mfg #	CFM	Sones	Price
PANFV08VF2	FV-08VF2	80	0.8	182.00
PANFV11VF2	FV-11VF2	110	1.5	205.00

WhisperFit-Lite™ Low Profile Fan/Light/Night-Light

- Optional 3" duct adapter is included
- (2) 18W Compact fluorescent lamps provide overhead lighting
- 4-Watt night-light
- Energy Star® rated



Part #	Mfg #	CFM	Sones	Price
PANFV11VFL2	FV-11VFL2	110	1.5	301.00

WhisperLite™ Fan/Light

- Low noise level
- Low power consumption
- Long run times or continuous operation
- Energy Star® rated



Part #	Mfg #	CFM	Sones	Price
PANFV08VQL5	FV-08VQL5	80	<0.3	466.50
PANFV11VQL5	FV-11VQL5	110	0.5	514.50

WhisperWarm™ Fan/Heater/Light/Night-Light

- Low noise level
- 30.6W Power consumption
- 1400W Heating element
- 25W Heater fan
- For 4" duct size
- Night light feature
- (2) 18W Compact fluorescent bulb
- UL Listed



Part #	Mfg #	CFM	Sones	Price
PANFV11VHL2	FV11VHL2	110	0.7	502.00

WhisperValue™ Super Low Profile Ventilating Fan



Part #	Mfg #	CFM	Sones	Price
PANFV08VS1	FV-08VS1	80	1.5	196.08

WhisperValue™ Super Low Profile Ventilation Fan/Light



Part #	Mfg #	CFM	Sones	Price
PANFV08VSL1	FV-08VSL1	80	1.5	209.00

HVAC Sundries

Heating Sundries

Venting

634 Black Roof Cap

- Built-in backdraft damper and bird screen
- Steel housing, black electrically bonded epoxy finish



Part #	Mfg #	Description	Price
BRO634	634	3-1/4" x 10" or 8" Round Duct	48.78

636 Black Roof Cap

- Built-in backdraft damper and birdscreen
- Steel black baked enamel finish



Part #	Mfg #	Description	Price
BRO636AL	636AL	Aluminum for 3" or 4" Round Duct	36.36

641 Aluminum Wall Cap

- Built-in backdraft damper and birdscreen
- Aluminum natural finish



Part #	Mfg #	Description	Price
BRO843AL	641	Aluminum for 6" Round Duct	44.00

Roof Ducting Kit

- Black steel with built-in back draft damper and bird screen
- 4" Diameter metal duct connector
- (2) Nylon zip ties
- 3" to 4" Duct adapter
- 8' of 4" Diameter flexible foil ducting conforms to UL181 Class 1
- Not for dryer venting



Part #	Mfg #	Description	Price
BRO443	RVK1A	Roof Vent Kit with Accessories	63.12



PVC Sch 40 Pressure Fittings

Traps (Slip x Slip)



Part #	Mfg #	Description	Price
ACAPT34	5-408	3/4" P-Trap	1.46
ACART34	5-409	3/4" Running Trap	1.46

Safety Supplies

Disposable Shoe Covers

- Fits sizes 5-15
- Blue-spun polypropylene - non-waterproof



Part #	Mfg #	Description	Price
ACYBOOTIES	390-50176	Shoe Covers - Bulk	2.00

All Purpose Cleaning Pads

- For cleaning copper tube and fittings
- Will not rust, use wet or dry



Part #	Mfg #	Description	Price
ACYACP10	ACP-10	Cleaning Pads, 10/Box	14.96

HVAC Sundries

Air Filters

Cut-to-Fit Air Filters

Hammock Filter Roll

- Spun glass media designed for A/C and furnaces equipped with "hammock" grids for frameless filters



Part #	Mfg #	Size	Price
FUFHR24240	HR24240	24" x 240" x 1" Roll	37.80
FUFHR30240	HR30240	30" x 240" x 1" Roll	45.06
FUFHR36240	HR36240	36" x 240" x 1" Roll	50.20

Type 40 Pre-Pleated Panel Air Filters

PrePleat™ 40 High Capacity Pleated Filter

- Pleated panel
- High capacity (30-35%)
- MERV 8
- 100% Recycled materials



Part #	Mfg #	Size	Price
FUF10202P	80255	10" x 20" x 2"	9.72
FUF16202HCP	80255	16" x 20" x 2"	12.06

Model 40 Standard Capacity Pleated Filter



Part #	Mfg #	Size	Price
FUF10201P	80055	10" x 20" x 1"	9.64
FUF12201P	80055	12" x 20" x 1"	10.10
FUF12241P	80055	12" x 24" x 1"	10.48
FUF14201P	80055	14" x 20" x 1"	10.80
FUF14241P	80055	14" x 24" x 1"	10.14
FUF14251P	80055	14" x 25" x 1"	11.88
FUF15201P	80055	15" x 20" x 1"	10.36
FUF16161P	80055	16" x 16" x 1"	9.32
FUF16201P	80055	16" x 20" x 1"	10.12
FUF16241P	80055	16" x 24" x 1"	10.04
FUF16251P	80055	16" x 25" x 1"	10.68
FUF18201P	80055	18" x 20" x 1"	11.42
FUF18241P	80055	18" x 24" x 1"	11.76
FUF18251P	80055	18" x 25" x 1"	10.68
FUF20201P	80055	20" x 20" x 1"	11.28
FUF20241P	80055	20" x 24" x 1"	11.88
FUF20251P	80055	20" x 25" x 1"	12.38
FUF20301P	80055	20" x 30" x 1"	12.34
FUF25251P	80055	25" x 25" x 1"	15.02
FUF12242P	80055	12" x 24" x 2"	9.36
FUF14202P	80055	14" x 20" x 2"	10.68
FUF14252P	80055	14" x 25" x 2"	12.02
FUF24241P	80055	24" x 24" x 1"	13.32
FUF15202P	80055	15" x 20" x 2"	10.98
FUF16202P	80055	16" x 20" x 2"	10.38
FUF16242P	80055	16" x 24" x 2"	11.54
FUF16252P	80055	16" x 25" x 2"	11.86
FUF18202P	80055	18" x 20" x 2"	11.60
FUF18242P	80055	18" x 24" x 2"	12.08
FUF18252P	80055	18" x 25" x 2"	12.80
FUF20202P	80055	20" x 20" x 2"	12.00
FUF20242P	80055	20" x 24" x 2"	12.72
FUF20252P	80055	20" x 25" x 2"	13.70
FUF20302P	80055	20" x 30" x 2"	16.60
FUF24242P	80055	24" x 24" x 2"	13.74
FUF25252P	80055	25" x 25" x 2"	16.30
FUF16204P	80055	16" x 20" x 4"	22.88
FUF16244P	80055	16" x 24" x 4"	29.84
FUF16254P	80055	16" x 25" x 4"	25.34
FUF18244P	80055	18" x 24" x 4"	24.52

Visionary Baths & More

Because your time is valuable...

Visit your local Visionary Baths & More Kitchen and Bath Design Centers to let one of our trained knowledgeable consultants help you with your project.
<http://www.visionarybaths.com>

HVAC Sundries

Air Filters

**Type 40 Pre-Pleated Panel Air Filters
(Continued)**

Model 40 Standard Capacity Pleated Filter

Part #	Mfg #	Size	Price
FUF20204P	80055	20" x 20" x 4"	25.18
FUF20244P	80055	20" x 24" x 4"	25.64
FUF20254P	80055	20" x 25" x 4"	26.48
FUF24244P	80055	24" x 24" x 4"	27.74

HD Disposable Filters

Industrial Grade Fiberglass Filter

- 1-Piece moisture-resistant chipboard frame
- Support grilles on both sides
- UL 900 Class 2 listed

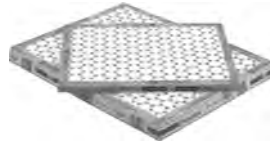

Part #	Mfg #	Size	Price
FUF8161	10255	8" x 16" x 1"	2.90
FUF10101	10255	10" x 10" x 1"	2.96
FUF10201	10255	10" x 20" x 1"	3.40
FUF10202	10255	10" x 20" x 2"	4.48
FUF10241	10255	10" x 24" x 1"	3.58
FUF10251	10255	10" x 25" x 1"	3.64
FUF12121	10255	12" x 12" x 1"	3.12
FUF12161	10255	12" x 16" x 1"	3.46
FUF12201	10255	12" x 20" x 1"	3.56
FUF12241	10255	12" x 24" x 1"	3.72
FUF12242	10255	12" x 24" x 2"	5.00
FUF12251	10255	12" x 25" x 1"	4.12
FUF14141	10255	14" x 14" x 1"	3.40
FUF14201	10255	14" x 20" x 1"	2.92
FUF14202	10255	14" x 20" x 2"	5.18
FUF14241	10255	14" x 24" x 1"	3.92
FUF14251	10255	14" x 25" x 1"	3.12
FUF14252	10255	14" x 25" x 21"	5.70
FUF14301	10255	14" x 30" x 1"	4.68
FUF15201	10255	15" x 20" x 1"	3.78
FUF15202	10255	15" x 20" x 2"	5.28
FUF15251	10255	15" x 25" x 1"	4.08
FUF1530581	10255	15" x 30-5/8" x 1"	4.78
FUF16161	10255	16" x 16" x 1"	3.56
FUF16201	10255	16" x 20" x 1"	3.10
FUF16202	10255	16" x 20" x 2"	4.40
FUF16241	10255	16" x 24" x 1"	3.30
FUF16242	10255	16" x 24" x 2"	4.80
FUF16251	10255	16" x 25" x 1"	3.28
FUF16252	10255	16" x 25" x 2"	4.80

HD Disposable Filters (Continued)

Industrial Grade Fiberglass Filter

Part #	Mfg #	Size	Price
FUF18201	10255	18" x 20" x 1"	3.96
FUF18241	10255	18" x 24" x 1"	4.16
FUF18242	10255	18" x 24" x 2"	4.82
FUF18251	10255	18" x 25" x 1"	4.20
FUF19271	10255	19" x 27" x 1"	4.82
FUF20201	10255	20" x 20" x 1"	3.26
FUF20202	10255	20" x 20" x 2"	4.80
FUF2022141	10255	20" x 22-1/4" x 1"	4.24
FUF20241	10255	20" x 24" x 1"	4.34
FUF20242	10255	20" x 24" x 2"	6.08
FUF20251	10255	20" x 25" x 1"	3.54
FUF20252	10255	20" x 25" x 2"	5.30
FUF20301	10255	20" x 30" x 1"	5.48
FUF22221	10255	22" x 22" x 1"	4.68
FUF24241	10255	24" x 24" x 1"	4.90
FUF24242	10255	24" x 24" x 2"	7.20
FUF24301	10255	24" x 30" x 1"	5.74
FUF25251	10255	25" x 25" x 1"	5.14
FUF25252	10255	25" x 25" x 2"	7.58

Washable Electrostatic Filters

Electrostatic NaturalAire Filter

- MERV 5

Part #	Mfg #	Size	Price
FUF14251E	50855	14" x 25" x 1"	58.02
FUF16201E	50855	16" x 20" x 1"	54.06
FUF16251E	50855	16" x 25" x 1"	60.16
FUF20201E	50855	20" x 20" x 1"	61.52
FUF20251E	50855	20" x 25" x 1"	64.32

HVAC Sundries

Prices & Specifications are Subject to Change.

Air Filters

HD Disposable Filters

Industrial Grade Polyfiber Filter

- 1-Piece moisture-resistant chipboard frame
- Support grilles on both sides
- UL 900 Class 2 listed



Part #	Mfg #	Size	Price
FUF10202PSF	11255	10" x 20" x 2"	5.14
FUF12241PSF	11255	12" x 24" x 1"	4.18
FUF12242PSF	11255	12" x 24" x 2"	5.82
FUF12251PSF	11255	12" x 25" x 1"	4.58
FUF14201PSF	11255	14" x 20" x 1"	4.06
FUF14202PSF	11255	14" x 20" x 2"	5.68
FUF14251PSF	11255	14" x 25" x 1"	4.36
FUF14252PSF	11255	14" x 25" x 2"	6.28
FUF15201PSF	11255	15" x 20" x 1"	4.22
FUF15202PSF	11255	15" x 20" x 2"	5.80
FUF16161PSF	11255	16" x 16" x 1"	4.16
FUF16201PSF	11255	16" x 20" x 1"	3.52
FUF16202PSF	11255	16" x 20" x 2"	6.16
FUF16241PSF	11255	16" x 24" x 1"	4.58
FUF16242PSF	11255	16" x 24" x 2"	6.52
FUF16251PSF	11255	16" x 25" x 1"	3.72
FUF16252PSF	11255	16" x 25" x 2"	6.70
FUF18201PSF	11255	18" x 20" x 1"	4.48
FUF18241PSF	11255	18" x 24" x 1"	4.74
FUF18242PSF	11255	18" x 24" x 2"	6.88
FUF18251PSF	11255	18" x 25" x 1"	4.82
FUF20201PSF	11255	20" x 20" x 1"	4.52
FUF20202PSF	11255	20" x 20" x 2"	6.76
FUF20242PSF	11255	20" x 24" x 2"	7.30
FUF20251PSF	11255	20" x 25" x 1"	4.90
FUF20252PSF	11255	20" x 25" x 2"	7.40
FUF20301PSF	11255	20" x 30" x 1"	7.04
FUF24241PSF	11255	24" x 24" x 1"	5.52
FUF24242PSF	11255	24" x 24" x 2"	8.30

Aluminum Filters

KKM Washable Permanent Aluminum Filter

- Heavy duty, washable, aluminum media, all metal filter
- Suitable for all residential and commercial applications
- Wash with a mild detergent and rinse to remove collected dust

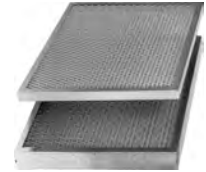

Part #	Mfg #	Size	Price
FUFAL16201	51255	16" x 20" x 1"	40.30
FUFAL16202	51255	16" x 20" x 2"	52.80
FUFAL16251	51255	16" x 25" x 1"	47.14
FUFAL16252	51255	16" x 25" x 2"	60.80
FUFAL20201	51255	20" x 20" x 1"	42.28
FUFAL20202	51255	20" x 20" x 2"	60.10
FUFAL20251	51255	20" x 25" x 1"	54.94
FUFAL20252	51255	20" x 25" x 2"	69.82

Special orders - If you need it we can get it promptly!

Heating Sundries

Accessory Products

Zoom Spout® Oiler

- Contains 4 oz highest quality turbine oil
- Rust and oxidation inhibited
- Parrafin base, non-gumming
- Use on motor bearings and bushings
- Spout extends to 14", wipes dry
- SAE 10 Weight, non detergent



Part #	Mfg #	Description	Price
MAR93240	93240	4 oz Zoom Spout® Oiler	2.56



EZ Traps



100 Series Plain Clear Condensate Trap

- Patented "See-Through" technology
- Watertight lower cap opens for easy access to clean drain pan outlet inside unit
- Remove upper cap to completely clean in seconds
- Cap can be replaced with optional float switch to warn owner if blockage is detected
- 3-Year warranty



Part #	Mfg #	Description	Price
EZT113	EZT-113	3/4" Blow Molded Economy Trap	12.46

100 Series Ultra Waterless Trap Kit

- Eliminates standing water and freezing problems
- Positive or negative pressure systems
- Kit includes:
 - 3/4" UltraTrap
 - 3/4" Cross
 - (2) 3/4" Red caps
 - 3/4" Male adaptor
 - 3/4" Coupler
 - Cleaning brush



Part #	Mfg #	Description	Price
EZT150MKIII	EZT-150 MKIII	Fits 3/4" or 1" Diameter	14.20



Drain Heaters

- Designed for continuous use to protect drains against ice build up which leads to clogging
- Cannot be cut, spliced, extended or altered in any way
- Applications include:
 - Condensate drain pans, tubes and troughs
 - Domestic and commercial refrigeration
 - Air conditioner and heat pump systems

SH200 Series Flexible Braided Aluminum Drain Heaters

- Aluminum construction
- 115V (220V by special order only)



Part #	Mfg #	Watts	Size	Leads	Price
SUOSH201	SH201	15W	18"	23"	20.60
SUOSH202	SH202	45W	29"	23"	26.22

FBP100 Fan Blade Hub Puller

- Heavy duty steel
- 5/8" Steel center shaft
- Four pull fingers
- Alignment tool included
- Has flats for wrench



Part #	Mfg #	Description	Price
SUOFBP100	FBP100	Fan Blade Hub Puller	46.94

2374 Series Adjustable Air Sensing Switches



- Designed to replace a wide variety of air-sensing switches found in residential and light commercial applications including furnaces, electronic air cleaners & humidifiers
- SPDT Switching that can be actuated by positive or negative pressure, or by pressure differential
- Highly accurate, practically insensitive to temperature change
- Operating temperature range: -40°F to 190°F
- Electrical connections: 1/4" Spade
- Air sample line connectors: Will accept 1/8", 1/4" or 3/8" tubing
- UL & CSA Approved
- Includes mounting hardware and adjustment tool



Part #	Mfg #	Description	Price
ROW2374495	2374-495	.25" to 1.0"wc Setpoint Range, SPDT Switching	63.70

Prices & Specifications are Subject to Change.

Heating Sundries

2374 Series Adjustable Air Sensing Switches (Continued)

Part #	Mfg #	Description	Price
ROW2374498	2374-498	.10" to 4.0"wc Setpoint Range, SPDT Switching	63.70

Aluminum Tubing

- 1100 Alloy
- "O" Temper
- Dead soft
- 50' Coils



Part #	OD	Wall Thickness	Price
ALUC14	1/4"	.035	1.05

Tubing

Aluminum Tubing

- Pilot burner gas lines



Part #	Mfg #	Description	Price
MAR79126	79126	1/4" OD x 6-1/2' with Comp Nuts & Sleeves	21.66



Sundries

Dryer Vents



Part #	Size	Price
ACMDVH4	4" Galv	7.38

Aluminum Flex Kit



Part #	Size	Price
ACMDVAFK48	4" x 8'	30.64

Flex Dryer Vent Kit



Part #	Size	Price
ACMDVK4-8	4" x 8'	39.00

Plastic Drainpan



Part #	Description	Price
ACMCP2764	27" x 64" S Plastic Condensate	61.52
ACMCP30-60	30" x 60" S Plastic Condensate	62.52

Plastic Wall Cap with Damper

Part #	Size	Price
ACMDVHP6	6"	38.48



Aluminum Fittings

Aluminum Dryer Vent Hood



Part #	Size	Price
GRADVH4	4"	7.48

Aluminum Dryer Vent Kit

Part #	Size	Price
GRADVK4-8	4"	19.38

Aluminum Wall Cap

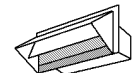

Part #	Size	Price
GRADVHOOD	3-1/4" x 10"	82.62

HVAC Sundries

Heating Sundries

Aluminum Roof Caps w/Damper & Screen

Part #	Size	Price
GRADVH6	Up to 10" Dia	80.14



Replacement Combustion Chamber Kits

- Convenient direct replacement combustion chamber kits

Dunkirk Empire Water Boiler Replacement Chamber Kit

- Kit includes:
 - Ceramic fiber molded front refractory
 - Ceramic fiber molded rear refractory
 - Refractory cement
 - Hardware
 - Complete instructions

Part #	Mfg #	Description	Price
LYN1132	1132	For Empire II	170.40

Weil McLain Models 66, 68 & 68V Oil-Fired Boiler Replacement Chamber Kit

- Kit includes:
 - Ceramic fiber molded front refractory
 - Ceramic fiber wet moldable rear refractory
 - Ceramic fiber blanket-"base liner"
 - Boiler rope gasket
 - Waterglass
 - Complete instructions

Part #	Mfg #	Description	Price
LYN1060	1060	For Models #66, #68 & #68V	145.44

Weil McLain Models WG & WGO "Gold" Boiler Replacement Chamber Kit

- Kit includes:
 - Ceramic fiber molded front refractory with stainless hardware
 - Ceramic fiber rear refractory
 - Ceramic fiber blanket-"base liner"
 - Waterglass
 - Self-adhesive "sticky back" rope gasket
 - Complete instructions

Part #	Mfg #	Description	Price
LYN1072	1072	For "Gold" Oil-Fired	145.44

Instant-Glo "Time Saver"

- Glows in 5 seconds
- Vac-cast from pure Kaowool
- Stainless steel bands
- Quiets combustion noise
- Added Corbel for protection against "hot spots"



Part #	Mfg #	Firing Rate	Price
LYN9	1009	.65 - .85	92.00

Kaowool Wet Blanket

- Soft, moist fiber blanket can be formed to the shape of existing chamber as a liner
- Tough & strong
- Hardens when burner is fired



Part #	Mfg #	Kit Includes:	Price
LYN1032	KIT A	(1) 14" x 48" x 1/2" Blanket	72.00
LYN1034	KIT C	(1) 16" x 48" x 1/2" Blanket (1) 16" x 16" x 1/2" Blanket	111.52

Wet Combustion Chamber Wet Form Golden Glo

- Round chamber with 1/2" minimum bottom thickness



Part #	Mfg #	Description	Price
LYN1039	1039	Firing Rate: .85 - 1.00 10"ID x 15"H	74.56

Burner Head Protector

- Fits 4" OD burner heads



Part #	Mfg #	Description	Price
LYN1046	1046	Fits 3.5" ID Riello	13.76

Heating Sundries

ThermO-Pan®

Return Air Panning

- ThermO-Pan® is a high quality, lightweight alternative to sheet metal in constructing return air ducts between joists
- Consists of corrugated insulation faced with aluminum
- Available in light weight sheets in many sizes
- Significantly reduces duct noises and labor
- Requires no shop fabrication



Part #	Mfg #	Size	Price
TOPPAN16-48	16048	16" x 47-1/2"	6.32
TOPPAN1912-48	19048	19-1/2" x 47-1/2"	7.72
TOPPAN32-36	32036	32" x 35-1/2"	9.76



Roof Flashings

Galvanized Steel Roof Flashing

- 10-3/4" x 14-1/2" x 22 Gauge
- With neoprene seal

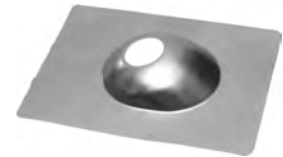

Part #	Mfg #	Trade Size	Price
ELFRF212	626	2-1/2	10.54

ThermO-Frames™

Return Air Grille Dry Wall Frame

- Precision molded polypropylene
- Safety edged
- Frames can be cut for use as a single frame
- Place grille over frame and screw into precision molded frame holes on finished dry wall

Standard - Allows Unfiltered Air Flow



Part #	Mfg #	Description	Price
TOP24630	24630	30" x 6", or 2 @ 14" x 6" For Hart&Cooley Grilles	3.58

Accessories

Duct Seal Compound

- Asbestos-free
- Non-drying, non-toxic
- Permanently soft



Part #	Mfg #	Size	Price
ELFDS1LB	DSC1	1 lb	3.97
ELFS5LB	DSC5	5 lb	15.87

We appreciate your Business!



ThermO-Snap Clamps™

Universal Mounting Bracket

- Pre-mounted brackets provide an easy one-man installation job
- Multi-use applications including copper, PVC and ABS pipe
- Maintenance free - use indoors or out
- Eliminates vibrations and noise call backs
- Easy to re-open for an additional or custom adjustment
- UV Protected



Part #	Mfg #	Description	Price
TOPCLAMP	41118	Residential 1-1/2" OD	6.38

HVAC Sundries

All Items May Not Be Stocked In All Branches

Circuit Breakers

Breakers

Small Frame - Plug On - Single Pole

 Cutler-Hammer



Part #	Mfg #	Volts	Amps	Price
BUICH115	CH115	120VAC	15A	8.00
BUICH120	CH120	120VAC	20A	8.00

Small Frame - Plug On - Double Pole

 Cutler-Hammer



Part #	Mfg #	Volts	Amps	Price
BUICH215	CH215	240VAC	15A	20.00
BUICH220	CH220	240VAC	20A	20.00
BUICH230	CH230	240VAC	30A	20.00

Type CHT Twin Plug-On Breaker

- Use only with loadcenters marked for use with CHT breakers
- Volts: 120VAC
- 10kAIC



Part #	Mfg #	Amps	Wire	Price
BUICHT1515	CHT1515	15/15A	#14-8	32.05
BUICHT2020	CHT2020	20/20A	#14-8	35.94

HOM 1-Pole Branch Circuit Breaker

- P Suffix indicates bulk pack
- C Suffix indicates clamshell package

 SQUARE D
by Schneider Electric



Part #	Mfg #	Volts	Amps	Price
SQDHOM115	HOM115	120/240V	15A	9.22
SQDHOM120	HOM120	120/240V	20A	9.22

Circuit Breakers

HVAC Electrical

HOM 2-Pole Common Trip Branch Circuit Breaker 10,000 AIR



HOM220

Part #	Mfg #	Volts	Amps	Price
SQDHOM215	HOM215	120/240V	15A	22.10
SQDHOM220	HOM220	120/240V	20A	22.10
SQDHOM230	HOM230	120/240V	30A	22.10

HOM 1-Pole Tandem Circuit Breaker



HOMT1515



HOMT2020

Part #	Mfg #	Volts	Amps	Price
SQDHOM1515	HOMT1515	120/240V	15A/15A	23.96
SQDHOM2020	HOMT2020	120/240V	20A/20A	21.84

Type MSQ Plug-In Circuit Breaker

- Amps - continuous current rating @ 40°C
- 3/4" Per Pole
- UL Classified and listed



1-Pole



2-Pole

Part #	Mfg #	Description	Price
MURMQ115	MQ115	15A 1-Pole 120V	17.44
MURMQ120	MQ120	20A 1-Pole 120V	17.44
MURMQ215	MQ215	15A 2-Pole 120/240V Common Trip	38.02
MURMQ220	MQ220	20A 2-Pole 120/240V Common Trip	38.02
MURMQ230	MQ230	30A 2-Pole 120/240V Common Trip	38.02

Tape

Super 33+™ Scotch® Vinyl Plastic Electrical Tape

- 7 mil, Holds in temperatures to 220°F
- PVC tape with high dielectric strength
- Pressure-sensitive rubber based adhesive
- Inhibits corrosion of electrical conductor
- Flame-retardant & conformable
- UL Listed



Part #	Mfg #	Size	Price
3MM33T	06132	3/4" x 66'	6.93

All Items May Not Be Stocked In All Branches

Electrical Sundries

35 Scotch® Vinyl Electrical Color Coding Tape

- 7 mil, Holds in temperatures to 220°F
- Professional use
- Nine fade resistant colors
- Excellent insulating properties
- PVC Backing
- Resists UV rays, abrasion, corrosion, alkalis and acid
- UL Listed

3M



Part #	Mfg #	Size	Color	Price
3MM35GR	10851	3/4" x 66'	Green	5.39
3MM35R	10810	3/4" x 66'	Red	5.39
3MM35W	10828	3/4" x 66'	White	5.39

HVAC Electrical

Contactors

Definite Purpose Contactors



Part #	Mfg #	Description	Price
BUIBUC438UMM20	BUC438UMM20	120V 3-Pole 40A FLA 50A Resistive	41.71

Conduit

PVC Schedule 40 Conduit

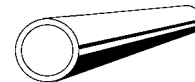

Part #	Mfg #	Size	Price
CONP4012-10		1/2" x 10'	CALL
CONP4034-10		3/4" x 10'	CALL
CONP401-10		1" x 10'	CALL
CONP40114-10		1-1/4" x 10'	CALL

EMT Metal Conduit Fitting - 1-Hole EMT Strap



Part #	Mfg #	Size	Price
CONEMT1HS12	304	1/2" 1-Hole	0.11
CONEMT1HS34	371	3/4" 1-Hole	0.18
CONEMT1HS1	372	1" 1-Hole	0.34

PVC Conduit Strap

Part #	Mfg #	Size	Price
CONPVCCS12		1/2"	0.34
CONPVCCS34		3/4"	0.40
CONPVCCS1		1"	0.49
CONPVCCS114		1-1/4"	0.53

Prices & Specifications are Subject to Change.

Electrical Sundries

HVAC Electrical

Staples

SN 40 Cable Staples

- For armored and metal clad cable 14/2 and 14/3
- For non-metallic sheathed cable 14/2 through 10/3
- For underground feeder 14/2 and 12/2



Part #	Mfg #	Size (W x L)	Box Qty	Price
BRNSN40-1	SN 40 100	1/2" x 1"	100	2.22

Low Voltage Insulated Staple

- For use with bell, speaker, thermostat and telephone wire



Part #	Mfg #	Description	Price
ELET5	T5	#5-BROWN-40BP Brown	2.15

Fittings

Flex/AC/MC Squeeze Connector

- Zinc die-cast



Part #	Mfg #	Trade Size	KO Size	Price
ELFGFSC12	L421	1/2"	1/2"	1.06

Flex/AC/MC 90° Connector

- For aluminum and steel Flex-AC-MC cable
- Zinc die-cast
- Concrete tight when taped
- UL & CSA Listed

* Also for MCI-A cable



850



Part #	Mfg #	Trade Size	KO Size	Price
ELFBX90C38ST	850ST	3/8" Snap-Tite*	1/2"	1.69

Anti-Short Bushing

- Plastic



Part #	Mfg #	Trade Size	Cable Sizes	Price
ELFASO	AS0	5/16"	14/2, 14/3, 12/2	11.74

All Items May Not Be Stocked In All Branches

Electrical Sundries

1-Hole AC/MC Strap

- Plated steel



Part #	Mfg #	Size	Cable Range	Price
ELFBXMC38	310	3/8"	.503 - .580	0.13

Cable Connector

- For NM/SE/MC/AC cable
- For steel and aluminum jacketed cables
- Zinc die-cast



Part #	Mfg #	Trade Size	KO Size	Price
ELFMCS38	8400	3/8"	1/2"	0.83

NM Cable Connector

- For NM cable
- Zinc die-cast
- UL & CSA Listed



Part #	Mfg #	Trade Size	Knockout	Price
ELFRC3812	841	3/8"	1/2"	0.48

Metallic Liquidtite

EFLT Extra Flexible Liquid-Tite Metallic Conduit

- Galvanized steel core
- Abrasion resistant PVC jacket
- Complete protection against liquid and moisture vapor
- Resists sunlight, heat, oil and chemical degradation



Part #	Mfg #	Size	Price
EMCLMC12	LMC12	1/2"	CALL

Straight Zinc Die-Cast Connector

- For metallic and non-metallic liquid-tight conduit - type B



Part #	Mfg #	Trade/KO Size	Price
ELFLTSC12	LT50	1/2"	2.59

90° Zinc Die-Cast Connector

- For metallic and non-metallic liquid-tight conduit - type B



Part #	Mfg #	Trade/KO Size	Price
ELFLT9012	LT9050	1/2"	4.12

Prices & Specifications are Subject to Change.

Electrical Sundries

HVAC Electrical

Fuses

FRN-R Class RK5 Fusetron® Dual-Element Time-Delay Fuse

- Current limiting
- UL Listed, CSA certified



Part #	Mfg #	Volts	Amps	Price
FUSFRNR30	FRN-R-30	250VAC	30A	6.00
FUSFRNR60	FRN-R-60	250VAC	60A	9.48

Wire Markers

Wire Marker Booklet

- Pocket-sized booklet of 450 wire markers
- Self-stick wire markers and matching terminal markers
- Oil, water and abrasion resistant
- Service temperature from -40°F to 250°F



Part #	Mfg #	Description	Price
MOR21254	21254	Tyvek 1-45 Std Marking 10/Legend	14.87

Switches

Indoor General Duty Fusible with Class H Fuse Holder

- NEMA 1
- Insulated groundable neutral
- Convertible to Class R



Part #	Mfg #	Description	Price
MURGHN321N	GHN321N	30A 2-Pole 3-Wire 240V SSW Cartridge	65.10
MURGHN421N	GHN421N	30A 3-Pole 4-Wire 240V SSW Cartridge	110.70
MURGHN422N	GHN422N	60A 3-Pole 4-Wire 240V SSW Cartridge	175.38
MURGHN423N	GHN423N	100A 3-Pole 4-Wire 240V SSW Cartridge	305.44
MURGHN424N	GHN424N	200A 3-Pole 4-Wire 240V SSW Cartridge	578.06

Outdoor General Duty Fusible with Class H Fuse Holder

- NEMA 3R
- Insulated groundable neutral
- Convertible to Class R



Part #	Mfg #	Description	Price
MURGHN321NW	GHN321NW	30A 2-Pole 3-Wire 240V RTSSW Cartridge	110.70
MURGHN421NW	GHN421NW	30A 3-Pole 4-Wire 240V RTSSW Cartridge	165.16
MURGHN422NW	GHN422NW	60A 3-Pole 4-Wire 240V RTSSW Cartridge	238.48
MURGHN423NW	GHN423NW	100A 3-Pole 4-Wire 240V RTSSW Cartridge	440.64
MURGHN424NW	GHN424NW	200A 3-Pole 4-Wire 240V RTSSW Cartridge	746.74

All Items May Not Be Stocked In All Branches

Electrical Sundries

Indoor Main Lug Load Center

- NEMA 1



LC1224L1125

Part #	Mfg #	Description	Price
MURLC1224L1125	LC1224L1125	125A (12)Space (24)Max Circ 21"H x 14-3/8"W x 4"D	83.86
MURLC2040L1125	LC2040L1125	125A (20)Space (40)Max Circ 24"H x 14-3/8"W x 4"D	135.94

Indoor Small Load Center

- NEMA 1
- No door



LC002GS

Part #	Mfg #	Description	Price
MURLC002GS	LC002GS	60A (2)Space (4)Max Circ 9-7/8"H x 5-1/8"W x 2-5/8"D	38.94
MURLC004NS	LC004NS	125A (4)Space (8)Max Circ 12-5/8"H x 6-5/8"W x 3-1/2"D	41.24

Non-Metallic Liquidtite

Liquid-Tite Non-Metallic PVC Conduit

Part #	Mfg #	Size	Per	Price
NMCNMLC12	NMLC12	1/2"	Per/Ft	0.64

Flex-Plus® Electrical Non-Metallic Tubing (ENT)

- Flexible raceway for use in walls, floors and non-plenum ceilings
- Lightweight, hand-bendable



Part #	Mfg #	Size	Color	Price
NMCBFP12	BFP12	1/2" x 120"	BlueStripe Plus Kwikon	0.62
NMCBFP34	BFP34	3/4" x 100"	Blue	1.00

Snap²IT™ Non-Metallic Connector Cord

- For use with non-metallic liquid-tight conduit, type B only
- Produced from UV rated plastic for long outdoor life
- Push-on installation straight



Part #	Mfg #	Trade/KO Size	Price
NMCSC12	NMLT5	1/2"	2.19

Prices & Specifications are Subject to Change.

HVAC Electrical

Electrical Sundries

HVAC Electrical

90° Snap²IT® Non-Metallic Connector

- For use with non-metallic liquid-tight conduit, type B only
- Produced from UV rated plastic for long outdoor life
- Push-on installation



Part #	Mfg #	Trade/KO Size	Price
NMC9012	NMLT905	1/2"	3.47

Devices

TradeMaster® 1-Pole Toggle Switch - Grounding

- 15A, 120V
- Side wire #12 and #14 AWG, push wire #14 AWG
- Green hex head ground screw
- UL/CSA Listed



Part #	Mfg #	Color	Price
PAS660IG	660IG	Ivory	1.42

1-Pole Toggle Switch & Duplex Receptacle Combination - Grounding

- 15A, 120/125V
- NEMA 5-15R
- Side-wire accepts #12 and #14 AWG
- UL/CSA Listed



Part #	Mfg #	Color	Price
PAS691W	691W	White	24.26

1-Pole Toggle Switch & Pilot Light Combination Switch - Non-Grounding

- 15A 120/125V
- Side-wire accepts #12 and #14 AWG
- Long-life red neon lamp in pilot light rated 1/25W 125V



Part #	Mfg #	Color	Price
PAS692IG	692I	Ivory	29.56

TradeMaster® Duplex Receptacle - 15A 125V - Grounding

- NEMA 5-15R
- Quickloop wire looping aid
- Side-wire accepts #12 - #14 AWG solid wire
- Push-wire accepts #14 AWG solid wire
- UL/CSA Listed



Part #	Mfg #	Color	Price
PAS3232I	3232I	Ivory	1.06

Electrical Sundries

Plug & Cord Ends

Extra-Hard Use Specification Grade Plug - 2-Pole 3-Wire

- Nylon housing
- Black & white



Part #	Mfg #	Description	Price
PASFEMALESTPLUG	PS5266X	15A 125V	13.20

Extra-Hard Use Specification Grade Connector - 2-Pole 3-Wire

- Nylon housing
- Black & white



Part #	Mfg #	Description	Price
PASMALESTRPLUG	PS5269X	15A 125V	14.30

Metal Boxes

Square Box for Conduit - Welded 4" x 2-1/8"

- Used in the installation of ceiling or wall lighting fixtures, switches or receptacles
- Used where multiple conductor runs are split into two or more directions
- Combination screw heads
- Per UL 514A, suitable for use without bonding jumper in circuits above or below 250 volts
- Welded with conduit knockouts
- 30.3 Cubic inches

RACO



Part #	Mfg #	Description	Price
RAO232	232	(8) 1/2" & (4) TKO Side, (2) 1/2" & (2) TKO Btm KOs	3.00

4" x 2" Handy/Utility Box for Conduit

- 1-7/8" Deep
- Used for convenience outlets, switch boxes or small junction boxes
- Popular for exposed work applications
- UL Listed steel boxes and are acceptable for use in 2-hour fire rated walls
- Drawn in conduit knockouts



Part #	Mfg #	Description	Price
RAO660	660	(6) 1/2" Side (2) 1/2" Btm (2) 1/2" End KOs	2.12

4" Square Exposed Work Cover

- Covers are used to support switches or receptacles on boxes in surface mount applications
- 6.5 Cubic inches



Part #	Mfg #	Description	Price
RAO808C	808C	4" Work Cover 1 GFCI	2.36

Prices & Specifications are Subject to Change.

Electrical Sundries

HVAC Electrical

Handy Box Cover

- Used to close 4" x 2" handy boxes
- 2-5/16"W x 4-3/16"L



Part #	Mfg #	Description	Price
RAO860	860	Blank	0.60
RAO864	864	Duplex Receptacle	0.53
RAO865	865	Toggle Switch	0.53

Wire Nuts

O/B+ Wire Connector

- Orange with blue skirt
- Accommodates:
 - (2) #22 AWG Wires
 - Up to (3) #12 AWG solid wires
 - (4) #14 AWG Wires



Part #	Mfg #	Description	Price
WNUO/B-100	O/B+BOX	Box of 100	19.60

R/Y+ Wire Connector

- Red with yellow skirt
- Accommodates 2 #18-2 #8-5 #12 AWG



Part #	Mfg #	Description	Price
WNUR/Y-100	R/Y+BOX	Box of 100	29.70

B-CAP® Wire Connector

- B1 Accepts (2) #18 to (3) #12 AWG wire combinations
- B2 Accepts (2) #18 to (5) #12 AWG wire combinations
- Rated for 600V maximum
- Live-action, square-wire spring
- No pre-twisting required
- Easily removable for repeat use
- Shell rated for 105°C
- Flame retardant shell
- UL Listed and CSA certified

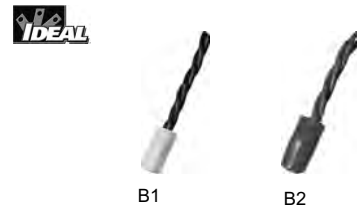

Part #	Mfg #	Description	Price
WNUYEL-100	B1-1	B1 Yellow, 100/Box	14.75
WNURED-100	B2-1	B2 Red, 100/Box	21.91

Electrical Sundries

Screw-On Wire Connector

- Color-coded, ribbed cap
- 221°F Maximum
- UL 94V-2 Flame retardant shell
- UL/CSA Listed



Part #	Mfg #	Description	Price
WNUBLUE-100	23072	Blue #22-#14 AWG 300V Max (100 Box)	7.87
WNUORANGE-100	23073	Orange #22-#14 AWG 600V Max (100 Box)	8.14

B-CAP® Wire Grounding Connector

- For grounding and bonding
- No pre-twisting required
- UL Listed and CSA certified



Part #	Mfg #	Description	Price
WNUGREEN-50	BGR-1	BGR Green, 50/Box	40.30

Wire

Metal Clad (MC) Solid Wire Cable



Part #	Mfg #	AWG Size	Packaging	Price
WREMC14-2	981MC142	14/2	250'	CALL
WREMC12-2	981MC122	12/2	250'	CALL
WREMC12-3	981MC123	12/3	250'	CALL
WREMC10-3		10/3	250'	CALL

THHN Stranded Copper Building Wire

Part #	Mfg #	AWG	Color	Length	Price
WRETHHN10BK	10THHNSTRBLK	#10	Black	500'	CALL
WRETHHN10GR	10THHNSTRGRN	#10	Green	500'	CALL
WRETHHN10RD	10THHNSTRRED	#10	Red	500'	CALL
WRETHHN10W	10THHNSTRWHT	#10	White	500'	CALL
WRETHHN12BK	12THHNSTRBLK2500	#12	Black	2500'	CALL
WRETHHN12GR	12THHNSTRGRN	#12	Green	500'	CALL
WRETHHN12R	12THHNSTRRED	#12	Red	500'	CALL
WRETHHN12W	12THHNSTRWHT	#12	White	500'	CALL

Reach-In

Reach-In Refrigerators & Freezers

Delfield 600XL™ Solid Door Reach-In Refrigerator

- Stainless steel doors and front shroud
- Aluminum sides
- Seamless Delrite® ABS interior liner
- Top mounted refrigeration system
- Maintains 33°F to 40°F
- Factory mounted casters (two and three section only)
- Adjustable epoxy coated wire shelves, rated @250# (three per section)
- Easy read digital thermometer
- 10' Cord and plug attached
- 115V, R-404a
- 79.5" Height, 32.6" depth
- 1-Year parts and labor
- 5-Year compressor warranty
- Limited lifetime liner warranty



Part #	Mfg #	Type	BTU	Capacity (cu ft)	Length	Comp HP	Ship Wgt	Price
DED6025XLS	6025XL-S	1-Sctn, Full Hgt Door	2092	20	25.5"	1/4	274 lbs	CALL
DED6051XLS	6051XL-S	2-Sctn, Full Hgt Doors	2488	43.5	51"	1/3	454 lbs	CALL

Delfield 6100XL™ Solid Door Reach-In Freezer

- Stainless steel doors and front shroud
- Aluminum sides
- Seamless Delrite® ABS interior liner
- Top mounted refrigeration system
- Maintains -5°F to 0°F
- Factory mounted casters (two and three section only)
- Adjustable epoxy coated wire shelves, rated @250# (three per section)
- Easy read digital thermometer
- 10' Cord and plug attached
- 115V, R-404a
- 79.5" Height, 32.6" depth
- 1-Year parts and labor
- 5-Year compressor warranty
- Limited lifetime liner warranty



Part #	Mfg #	Type	BTU	Capacity (cu ft)	Length	Comp HP	Ship Wgt	Price
DED6125XLS	6125XL-S	1-Sctn, Full Hgt Door	1516	20	25.5"	1/2	274 lbs	CALL
DED6151XLS	6151XL-S	2-Sctn, Full Hgt Doors	1923	43.5	51"	3/4	454 lbs	CALL

All Items May Not Be Stocked In All Branches

Ice Machines & Accessories

Indigo™ Series Ice Machines

- Intelligent diagnostics, internal communication system stores data for maintenance
- Easy read display, shows alerts when issues arise, up to 14 customizable languages
- Alpha San® antimicrobial protection in foodzone plastic components
- Patented AuCS® automated cleaning system
- Acoustical ice-sensing technology for cube thickness consistency
- Ice clarity feature adjust water usage to improve ice quality in hard water locations
- Arctic Pure® water filter, water filter minder
- Energy efficient



Indigo™ Series i-300 Ice Cube Machine

- Programmable ice production
- Easy to clean food zone
- DuraTech™ exterior, stainless steel with clear-coat
- Ice storage bin sold separately
- 115V, 16-1/2" x 30" x 24-1/2"
- 5-Year parts and labor warranty on evaporator
- 5-Year parts and 3-year labor warranty on compressor
- 3-Year parts and labor warranty on ice maker



i300 on B-170 Storage Bin

Part #	Mfg #	Ice Shape	Ice in 24/hrs 70° Air/50°F Water	Ice in 24/hrs 90° Air/70°F Water	Description	Price
MEWID0302A	ID-0302A-161	Dice	310 lbs	225 lbs	Air Cooled, Energy Star	CALL
MEWIY0304A	IY-0304A-161	Half-Dice	310 lbs	235 lbs	Air Cooled, Energy Star	CALL
MEWID0303W	ID-0303W-161	Dice	300 lbs	260 lbs	Water Cooled	CALL
MEWIY0305W	IY-0305W-161	Half-Dice	300 lbs	260 lbs	Water Cooled	CALL

Indigo™ Series i-322 Ice Cube Machine

- Programmable ice production
- Easy to clean food zone
- DuraTech™ exterior, stainless steel with clear-coat
- Ice storage bin sold separately
- 115V, 21-1/2"H x 22"W x 24-1/2"D
- 5-Year parts and labor warranty on evaporator
- 5-Year parts and 3-year labor warranty on compressor
- 3-Year parts and labor warranty on ice maker



i322 on B-420 Storage Bin

Part #	Mfg #	Ice Shape	Ice in 24/hrs 70° Air/50°F Water	Ice in 24/hrs 90° Air/70°F Water	Description	Price
MEWID0322A	ID-0322A-161	Dice	350 lbs	230 lbs	Air Cooled, Energy Star	CALL
MEWIY0324A	IY-0324A-161	Half-Dice	350 lbs	230 lbs	Air Cooled, Energy Star	CALL
MEWIY0325W	IY-0325W-161	Half-Dice	350 lbs	290 lbs	Water Cooled	CALL

Ice Machines

Prices & Specifications are Subject to Change.

Ice Machines & Accessories

Indigo™ Series i-450 Ice Cube Machine

- Programmable ice production
- Easy to clean food zone
- DuraTech™ exterior, stainless steel with clear-coat
- Ice storage bin sold separately
- 115V, 21-1/2"H x 30"W x 24-1/2"D
- 5-Year parts and labor warranty on evaporator
- 5-Year parts and 3-year labor warranty on compressor
- 3-Year parts and labor warranty on ice maker



i450 on B-400 Storage Bin

Part #	Mfg #	Ice Shape	Ice in 24/hrs 70° Air/50°F Water	Ice in 24/hrs 90° Air/70°F Water	Description	Price
MEWID0452A	ID-0452A-161	Dice	420 lbs	320 lbs	Air Cooled, Energy Star	CALL
MEWIY0454A	IY-0454A-161	Half-Dice	450 lbs	335 lbs	Air Cooled, Energy Star	CALL
MEWID0453W	ID-0453W-161	Dice	430 lbs	360 lbs	Water Cooled	CALL
MEWIY0455W	IY-0455W-161	Half-Dice	450 lbs	360 lbs	Water Cooled	CALL

Indigo™ Series i-522 Ice Cube Machine

- Programmable ice production
- Easy to clean food zone
- DuraTech™ exterior, stainless steel with clear-coat
- Ice storage bin sold separately
- 115V, 21-1/2"H x 22"W x 24-1/2"D
- 5-Year parts and labor warranty on evaporator
- 5-Year parts and 3-year labor warranty on compressor
- 3-Year parts and labor warranty on ice maker



i522 on B-420 Storage Bin

Part #	Mfg #	Ice Shape	Ice in 24/hrs 70° Air/50°F Water	Ice in 24/hrs 90° Air/70°F Water	Description	Price
MEWIY0524A	IY-0524A-161	Half-Dice	485 lbs	360 lbs	Air Cooled, Energy Star	CALL
MEWIY0525W	IY-0525W-161	Half-Dice	480 lbs	395 lbs	Water Cooled	CALL

Indigo™ Series i-500 Ice Cube Machine

- Programmable ice production
- Easy to clean food zone
- DuraTech™ exterior, stainless steel with clear-coat
- Ice storage bin sold separately
- 115V, 21-1/2"H x 30"W x 24-1/2"D
- 5-Year parts and labor warranty on evaporator
- 5-Year parts and 3-year labor warranty on compressor
- 3-Year parts and labor warranty on ice maker



i500 on B-570 Storage Bin

Part #	Mfg #	Ice Shape	Ice in 24/hrs 70° Air/50°F Water	Ice in 24/hrs 90° Air/70°F Water	Description	Price
MEWID0502A	ID-0502A-161	Dice	530 lbs	390 lbs	Air Cooled, Energy Star	CALL
MEWIY0504A	IY-0504A-161	Half-Dice	560 lbs	410 lbs	Air Cooled, Energy Star	CALL
MEWID0503W	ID-0503W-161	Dice	550 lbs	430 lbs	Water Cooled	CALL
MEWIY0505W	IY-0505W-161	Half-Dice	550 lbs	440 lbs	Water Cooled	CALL

All Items May Not Be Stocked In All Branches

Ice Machines

Ice Machines & Accessories

Indigo™ Series i-600 Ice Cube Machine

- Programmable ice production
- Easy to clean food zone
- DuraTech™ exterior, stainless steel with clear-coat
- Ice storage bin sold separately
- 208/230V, 21-1/2"H x 30"W x 24-1/2"D
- 5-Year parts and labor warranty on evaporator
- 5-Year parts and 3-year labor warranty on compressor
- 3-Year parts and labor warranty on ice maker



i600 on B-570 Storage Bin

Part #	Mfg #	Ice Shape	Ice in 24/hrs 70° Air/50°F Water	Ice in 24/hrs 90° Air/70°F Water	Description	Price
MEWIY0604A	IY-0604A-261	Half-Dice	650 lbs	500 lbs	Air Cooled	CALL
MEWIY0605W	IY-0605W-261	Half-Dice	650 lbs	610 lbs	Water Cooled	CALL

Indigo™ Series i-850 Ice Cube Machine

- Programmable ice production
- Easy to clean food zone
- DuraTech™ exterior, stainless steel with clear-coat
- Ice storage bin sold separately
- 208/230V, 26-1/2"H x 30"W x 24-1/2"D
- 5-Year parts and labor warranty on evaporator
- 5-Year parts and 3-year labor warranty on compressor
- 3-Year parts and labor warranty on ice maker



i850 on B-570 Storage Bin

Part #	Mfg #	Ice Shape	Ice in 24/hrs 70° Air/50°F Water	Ice in 24/hrs 90° Air/70°F Water	Description	Price
MEWIY0854A	IY-0854A-261	Half-Dice	940 lbs	650 lbs	Air Cooled, Energy Star	CALL
MEWIY0855W	IY-0855W-261	Half-Dice	875 lbs	730 lbs	Water Cooled	CALL

Indigo™ Series i-1000 Ice Cube Machine

- Programmable ice production
- Easy to clean food zone
- DuraTech™ exterior, stainless steel with clear-coat
- Ice storage bin sold separately
- 208/230V, 26-1/2"H x 30"W x 24-1/2"D
- 5-Year parts and labor warranty on evaporator
- 5-Year parts and 3-year labor warranty on compressor
- 3-Year parts and labor warranty on ice maker



i1000 on B-570 Storage

Part #	Mfg #	Ice Shape	Ice in 24/hrs 70° Air/50°F Water	Ice in 24/hrs 90° Air/70°F Water	Description	Price
MEWIY1004A	IY-1004A-261	Half-Dice	1,010 lbs	745 lbs	Air Cooled, Energy Star	CALL
MEWIY1005W	IY-1005W-261	Half-Dice	1,010 lbs	870 lbs	Water Cooled	CALL

Ice Machines

Prices & Specifications are Subject to Change.

Ice Machines & Accessories

Indigo™ Series i-1200 Ice Cube Machine

- Programmable ice production
- Easy to clean food zone
- DuraTech™ exterior, stainless steel with clear-coat
- Ice storage bin sold separately
- 208/230V, 26-1/2"H x 30"W x 24-1/2"D
- 5-Year parts and labor warranty on evaporator
- 5-Year parts and 3-year labor warranty on compressor
- 3-Year parts and labor warranty on ice maker



i1200 on B-570 Storage

Part #	Mfg #	Ice Shape	Ice in 24/hrs 70° Air/50°F Water	Ice in 24/hrs 90° Air/70°F Water	Description	Price
MEWIY1205W	IY-1205W-261	Half-Dice	1,170 lbs	1,010 lbs	Water Cooled	CALL

Undercounter Ice Machines

- Slide up and in bin door tucks under ice machine top cover
- Ideal for small-volume ice production, for limited use needs, or as a backup for larger machines
- Designed to fit beneath counters or in areas where floor space or height restrictions prohibit use of larger equipment
- Ice damper maximizes ice storage capacity
- CFC-Free R-404A refrigerant
- Stainless steel exterior with the fit and finish of an appliance
- Pre-wired with a 6' power cord & NEMA 5-15P plug configuration
- 5-Year parts and labor warranty on evaporator
- 5-Year parts and 3-year labor warranty on compressor
- 5-Year parts and labor warranty on all other components (Model 130)
- 3-Year parts and labor warranty on all other components (Model 170, 210, 270)

QM-30 Series Undercounter Ice Machine

- Uses CFC-free R-134A refrigerant
- Stainless steel cabinet
- Front air intake and exhaust
- Pre-wired with a 6' power cord & NEMA 5-15P plug configuration
- Dimensions: 36"H x 19.69"W x 22.34"D
- 3-Year parts and labor warranty



Part #	Mfg #	Cube Size	Condensing Unit	Pounds of Ice Per Day 70°/50°, 90°/70°	Storage Capacity	Electrical	Total Amps	Price
MEWQM30	QM-30A-161	Dice	Air Cooled	65 lbs, 52 lbs	30 lbs	115-1-60	5.3A	CALL

Ice Machines

Ice Machines & Accessories

QM-45 Series Undercounter Ice Machine

- Features an ice storage door that slides up and out of the way for easy access
- Pre-wired with a 6' power cord & NEMA 5-15P plug configuration
- QM45 Available only as an air cooled model with dice shaped cubes
- Dimensions: 36"H x 19-11/16"W x 22-11/32"D



Part #	Mfg #	Cube Size	Condensing Unit	Pounds of Ice Per Day 70°/50°, 90°/70°	Storage Capacity	Electrical	Total Amps	Price
MEWQM45A	QM-45A-161	Dice	Air Cooled	95 lbs, 65 lbs	30 lbs	115-1-60	5.2A	CALL

Q-0130 Series Undercounter Ice Machine

- Dimensions: 38-1/2"H x 26"W x 26-1/2"D



Part #	Mfg #	Cube Size	Condensing Unit	Pounds of Ice Per Day 70°/50°, 90°/70°	Storage Capacity	Electrical	Total Amps	Price
MEWQD0132A	QD-0132A-161	Dice	Air Cooled	135 lbs, 90 lbs	80 lbs	115-1-60	7.0A	CALL
MEWQY0134A	QY-0134A-161	Half-Dice	Air Cooled	135 lbs, 95 lbs	80 lbs	115-1-60	7.0A	CALL
MEWQY0135W	QY-0135W-161	Half-Dice	Water Cooled	135 lbs, 110 lbs	80 lbs	115-1-60	6.3A	CALL

Q-0170 Series Undercounter Ice Machine

- Dimensions: 38-1/2"H x 26"W x 26-1/2"D
- Energy Star rated



Part #	Mfg #	Cube Size	Condensing Unit	Pounds of Ice Per Day 70°/50°, 90°/70°	Storage Capacity	Electrical	Total Amps	Price
MEWQY0174A	QY-0174A-161	Half-Dice	Air Cooled	180 lbs, 135 lbs	80 lbs	115-1-60	7.2A	CALL

Ice Machines

Prices & Specifications are Subject to Change.

Ice Machines & Accessories

Q-0210 Series Undercounter Ice Machine

- Dimensions: 38-1/2"H x 26"W x 26-1/2"D



Part #	Mfg #	Cube Size	Condensing Unit	Pounds of Ice Per Day 70°/50°, 90°/70°	Storage Capacity	Electrical	Total Amps	Price
MEWQD0212A	QD-0212A-161	Dice	Air Cooled	215 lbs, 181 lbs	80 lbs	115-1-60	6.5A	CALL
MEWQY0214A	QY-0214A-161	Half-Dice	Air Cooled	215 lbs, 147 lbs	80 lbs	115-1-60	6.5A	CALL
MEWQY0215W	QY-0215W-161	Half-Dice	Water Cooled	220 lbs, 181 lbs	80 lbs	115-1-60	6.1A	CALL

Q-0270 Series Undercounter Ice Machine

- Dimensions: 38-1/2"H x 30"W x 28-5/32"D



Part #	Mfg #	Cube Size	Condensing Unit	Pounds of Ice Per Day 70°/50°, 90°/70°	Storage Capacity	Electrical	Total Amps	Price
MEWQD0272A	QD-0272A-161	Dice	Air Cooled	280 lbs, 204 lbs	100 lbs	115-1-60	10.7A	CALL
MEWQY0274A	QY-0274A-161	Half-Dice	Air Cooled	280 lbs, 204 lbs	100 lbs	115-1-60	10.7A	CALL
MEWQY0275W	QY-0275W-161	Half-Dice	Water Cooled	290 lbs, 245 lbs	100 lbs	115-1-60	9.9A	CALL

Flake Ice Machines

RF Series Flake Ice Machine

- Heavy load capacity bearing for enhanced reliability
- Stainless steel cabinet
- Easy access door slides up and out of the way
- 3-Year parts warranty
- 2-Year labor warranty
- 5-Year parts and 2-year labor warranty on compressor



RF-0300A on B-570 Bin

Part #	Mfg #	Cube Shape	Condenser Unit	Pounds of Ice Per Day 70°/50°, 90°/70°	Dimensions H x W x D	Electrical	Price
MEWRF0300A	RF-0300A-161	Flake	Air Cooled	311 lbs, 259 lbs	21.85" x 25.2" x 18.5"	115-1-60	CALL
MEWRF0650A161	RF-0650A-161	Flake	Air Cooled	730 lbs, 558 lbs	27.56" x 25.2" x 18.5"	115-1-60	CALL
MEWRF0650A	RF-0650A-261	Flake	Air Cooled	730 lbs, 558 lbs	27.56" x 25.2" x 18.5"	208/230-1	CALL

All Items May Not Be Stocked In All Branches

Ice Machines & Accessories

RF-Series Self-Contained Flake Ice Machine

- Heavy load capacity bearing for enhanced reliability
- Stainless steel cabinet
- Easy access door slides up and out of the way
- 5-Year parts and 2-year labor warranty on compressor
- 3-Year parts and 2-year labor warranty on all other components



Part #	Mfg #	Cube Shape	Condenser Unit	Pounds of Ice Per Day 70°/50°, 90°/70°	Bin Storage	Dimensions H x W x D	Electrical	Price
MEWRF0266A	RF-0266A-161	Flake	Air Cooled	181 lbs, 151 lbs	60 lbs	37.5" x 19.69" x 25.98"	115-1-60	CALL
MEWRF0399A	RF-0399A-161	Flake	Air Cooled	332 lbs, 270 lbs	120 lbs	46.16" x 29.06" x 27.17"	115-1-60	CALL

*Fits under standard counter height

Nugget Ice Makers & Dispensers

RN-400 Series Nugget Ice Machine less Bin

- Nugget ice provides a softer, chewable texture while still providing maximum cooling
- Cylindrical-shaped nugget with 5/8" diameter and average length of approximately 1"
- 26-1/2"H x 22"W x 24-1/2"D
- 5-Year parts and 2-year labor for compressor
- 3-Year parts and 2-year labor warranty on all other components



Part #	Mfg #	Cube Shape	Condenser Unit	Pounds of Ice Per Day 70°/50°, 90°/70°	Electrical	Ship Wt	Price
MEWRN0408A	RN-0408A-161	Nugget	Air Cooled	385 lbs, 294 lbs	115-1-60	183 lbs	CALL

RN-1000 Series Nugget Ice Machine less Bin

- Nugget ice provides a softer, chewable texture while still providing maximum cooling
- Cylindrical-shaped nugget with 5/8" diameter and average length of approximately 1"
- 26-1/2"H x 30"W x 24-1/2"D
- 5-Year parts and 2-year labor for compressor
- 3-Year parts and 2-year labor warranty on all other components



Part #	Mfg #	Cube Shape	Condenser Unit	Pounds of Ice Per Day 70°/50°, 90°/70°	Electrical	Ship Wt	Price
MEWRN1008A	RN-1008A-261	Nugget	Air Cooled	1111 lbs, 822 lbs	208/230-1-60	260 lbs	CALL

Ice Machines

Prices & Specifications are Subject to Change.

Ice Machines & Accessories

Countertop Nugget Ice Maker & Dispenser

- SoftQube® nugget ice
- (3) Dispense settings: ice only, water only, or ice and water
- 1-Handed ice dispense
- (2) Ice activation options: activation arm or touchless
- Large drain pan
- Water and drain connections in back or bottom of unit for flush mounting
- 2-Year parts and labor coverage on all components
- 3-Year additional parts coverage on ice machine compressor



Part #	Mfg #	Cube Shape	Pounds of Ice Per Day 70°/50°, 90°/70°	Storage Capacity	Dimensions H x W x D	Electrical	Activation Type	Price
MEWSN12A	SN-12A-161	Nugget	325 lbs, 253 lbs	12 lbs	35" x 16-1/4" x 24"	115-1-60	Lever	CALL
MEWSN12AT	SN-12AT-161	Nugget	325 lbs, 253 lbs	12 lbs	35" x 16-1/4" x 24"	115-1-60	Sensor	CALL
MEWSN20A	SN-20A-161	Nugget	325 lbs, 253 lbs	20 lbs	42" x 16-1/4" x 24"	115-1-60	Lever	CALL
MEWSN20AT	SN-20AT	Nugget	325 lbs, 253 lbs	20 lbs	42" x 16-1/4" x 24"	115-1-60	Sensor	CALL

Undercounter Ice Makers

SM-50 Undercounter Ice Machine

- Designed to be installed into standard cabinet dimensions 15" or stand alone
- Stainless steel top and sides standard
- Water filter system integrated inside machine with depth filtration and scale inhibitor
- Lighted bin (LED light) with large opening
- Dimensions: 33-1/2"H x 14-3/4"W x 22-3/4"D
- 3-Year parts and labor warranty on entire machine
- 1-Year residential ice machine warranty



Part #	Mfg #	Cube Shape	Condensing Unit	Pounds of Ice Per Day 70°/50°, 90°/70°	Storage Capacity	Dimensions H x W x D	Electrical	Price
MEWSM50A	SM-50A-161	Octagon	Air Cooled	53 lbs, 44 lbs	25 lbs	33.5" x 14.75" x 22.75"	115-1-60	CALL

Ice Machines

Ice Machines & Accessories

Ice Dispensers

- SPA: Designed for ice bucket filling in hotels, motels, and resorts
- SFA: Designed for large container ice filling, accepts 10.5" high container
- Efficient built-in agitator ensures 100% dispensing
- Rocking chute dispense mechanism reduces in-flight ice and ice spillage with quick on/off activation
- Ice only dispense, with coin-op and room card dispense control options
- Polyethylene bin liner and insulation store ice longer
- Stainless steel legs included
- Legs adjust from 6.00" to 7.50"
- Ice machine sold separately
- 5-Year parts and 5-year labor warranty on evaporator
- 5-Year parts and 3-year labor warranty on compressor
- 3-Year parts and labor warranty on all other ice machine and dispenser components



Shown with Ice Machine (sold separately)

Part #	Mfg #	Dimensions H x W x D	Storage Capacity	Electrical	Dispense Operation	For Use with:	Price
MEWSPA160	SPA-160-161	48" x 22" x 31.19"	120 lbs	115-1-60	Optional	22"W Ice Machines	CALL
MEWSPA310	SPA-310-161	54.5" x 30" x 32"	180 lbs	115-1-60	Optional	22"W or 30"W Ice Machines	CALL
MEWSFA191	SFA-191-161	48" x 22" x 31.19"	120 lbs	115-1-60	Optional	22"W Ice Machines	CALL
MEWSFA291	SFA-291-161	54.5" x 30" x 32"	180 lbs	115-1-60	Optional	22"W or 30"W Ice Machines	CALL

Ice Storage Bins

- Liner is 1-piece seamless polyethylene that won't crack, dent, chip, or discolor
- Includes rigid HCFC foam insulation averaging 1-1/2" in thickness
- Full-width bin lid swings up for easy access
- Stainless steel finish on all models

B-Style Ice Storage Bin

- Silent bin door closing
- Soft radius corners
- Durable, corrosion-resistant, attractive base
- (1) Set of stainless steel legs included (6"-8" adjustable)



Part #	Mfg #	ARI/LBS Storage	Cu. Ft. Storage	Dimensions H x W x D	For Machines:	Price
MEWB170	B-170	150 lbs	6.1	25" x 30" x 29-1/2"	300, 450, 500	CALL
MEWB320	B-320	210 lbs	8.9	38" x 22" x 34"	322, 422, QC/QF	CALL
MEWB400	B-400	290 lbs	12.3	38" x 30" x 34"	300, 450, 500, 600, 850, 1000, 1200	CALL
MEWB420	B-420	310 lbs	12.9	50" x 22" x 34"	322, 422	CALL
MEWB570	B-570	430 lbs	17.9	50" x 30" x 34"	300, 450, 500, 600, 850, 1000, 1200	CALL
MEWB970	B-970	710 lbs	29.7	50" x 48" x 34"	1400, 1600, 1800	CALL

Ice Machines

Prices & Specifications are Subject to Change.

Ice Machines & Accessories

C-Style Ice Storage Bin

- Stainless steel exterior metal matches Q-model ice machines
- Rectangular bin door
- Gray ABS to match Q-model ice machines trim
- Bullet design bin legs (6" - 7-3/4" adjustable)



Part #	Mfg #	ARI/LBS Storage	Cu. Ft. Storage	Dimensions H x W x D	For Machines:	Price
MEWC730S	C-730S	560 lbs	23.3	46" x 42" x 31-1/2"	B, J, or Q Series	CALL

Ice Baggers

- Allows you to bag your own ice
- Portable
- Bagger slips over frame of bin door opening
- Galvanized steel construction with polyester powder-coated finish
- Large chute handles high volume of ice while minimizing spillage

Replacement Bag Kit

Part #	Mfg #	Description	Price
MEWK00068	K-00068	Ice Bagger Bag Replacement Kit with 1,000 Bags & Ties	323.00

Automatic Cleaning Systems

AuCS®/IAuCS® Automatic Cleaning System

- Dispenses either cleaner or sanitizer
- Cleaner removes and controls build up of lime scale or other mineral deposits
- Sanitizer controls algae (slime) and other airborne bacteria (yeast)
- 3-Year warranty covering all parts and labor from date of original installation



Part #	Mfg #	Volts	For:	Price
MEWAUCS	AUCS-A	115V	Q280 Through Q1800	670.00
MEWIAUCS115	IAUCS-161	115V	Indigo Ice Machines, Energy Star Rated	670.00
MEWIAUCS230	IAUCS-261	230V	Indigo Ice Machines, Energy Star Rated	670.00

Ice Machines & Accessories

Water Treatment

Arctic Pure® Water Filtration System

- Incorporates state of the art multi-composite carbon block water filtration technology
- Built-in scale inhibitor
- Sanitary, quick-change housing
- Built-in valve-in head design
- 1 Micron particle reduction
- NSF Certified
- 3-Year parts and labor warranty



Part #	Mfg #	Description	Capacity	Price
MEWARPRE	AR-PRE	Pre-filter Assembly	-	273.00
MEWAR10000	AR-10000	Ice Per Day: 0-600 lbs	14,000 gal	379.00
MEWAR20000	AR-20000	Ice Per Day: 601-1000 lbs	20,000 gal	648.00
MEWAR40000	AR-40000	Ice Per Day: 1001-2500 lbs	40,000 gal	1102.00

Cartridge

Part #	Mfg #	Description	Price
MEWK00173	K-00173	Pre-Filter Cartridge	18.92
MEWK00174	K-00174	Primary Filter Cartridge	121.75
MEWK00337	K-00337	AR-PRE Replacement Cartridge	89.58
MEWK00338	K-00338	AR-10000 Replacement Cartridge	96.58
MEWK00339	K-00339	AR-20000/AR-40000 Replacement Cartridge	126.17
MEWK00374	K-00374	AR-2800 Replacement Cartridge	67.42

Accumulators

Part #	Mfg #	Description	Price
MEW7281	000007281	Accumulator	180.00
MEW825047	82-5047-3	Accumulator	438.00
MEW890004	89-0004-3	Suction Accumulator	438.00

Adapters

Part #	Mfg #	Description	Price
MEWK00370	K-00370	Bin Adapter for 30" Q or S Ice Machine to 48" B-970	372.00
MEWK00365	K-00365	Bin Adapter for Use with 22" Head Mounted on 30" Ice Bin	160.00
MEWK00369	K-00369	Bin Adapter for 30" Q or S Ice Machine to 48" B-970 Bin Models 280, 300, 450, and 500 Only	271.00

Augers

Part #	Mfg #	Description	Price
MEW430191	43-0191-3	Agitator Auger Righting 8" OD	34.00
MEW503119	50-3119-1	Dispensing Auger Righting 4" OD	19.03

Ice Machines

Prices & Specifications are Subject to Change.

Ice Machines & Accessories

Bin Doors & Components

Part #	Mfg #	Description	Price
MEW430439	43-0439-3	Bin Door	173.00
MEWK00344	K-00344	Bin Bracket for Arctic	68.00

Capacitors

Part #	Mfg #	Description	Price
MEW21	000000021	Start Capacitor, 60Hz	54.00
MEW28	000000028	Run Capacitor	51.00
MEW201014	20-1014-3	Run Capacitor	40.00
MEW825024	82-5024-3	Run Capacitor 208/230-1-60	52.00
MEW850513	85-0513-3	Start Capacitor 208/230-1-60	47.00
MEW825103	82-5103-3	Start Capacitor 115-1-60	27.00

Cleaning & Sanitizing

Part #	Mfg #	Description	Price
MEW84	000000084	Metal Safe Ice Machine Cleaner 16 oz for SM50A	23.00
MEW940546	94-0546-3	16 oz Ice Machine Cleaner Refill for AuCS-A & AuCS-SO	20.00
MEW940565	94-0565-3	16 oz Bottle Sanitizer Refill for AuCS-A & AuCS-SO	20.00
MEW940580	94-0580-3	1 gal Ice Machine Cleaner Refill for AuCS Systems, 4/Case	61.00
MEW940581	94-0581-3	Sanitizer Gallon Container	62.00
MEWK00206	K-00206	Replacement Sachet for Ice Guardian Slime Inhibitor for Use with Q & S Series Ice Machines	208.00

Coils

Part #	Mfg #	Description	Price
MEW5157	000005157	Solenoid Hot Gas Coil 208/230V	22.00

Compressors

Part #	Mfg #	Description	Price
MEW2366	000002366	Compressor 208/230-1-60	CALL
MEW3919	000003919	Overload Compressor 115-1-60	701.00
MEW3921	000003921	Compressor 115-1-60	655.00
MEW040000435	040000435	Danfoss Compressor 115-1-60	705.00
MEW760056	76-0056-3	Compressor 208/230-1-60	CALL
MEW760162	76-0162-3	Compressor 208/230-1-60	CALL
MEW760291	76-0291-3	Compressor 208/230-1-60	CALL
MEW760294	76-0294-3	Compressor 115-1-60	824.00
MEW762689	76-2689-3	Compressor 208/230-1-60	CALL
MEW762690	76-2690-3	Compressor 208/230-3-60	CALL
MEW762810	76-2810-3	Compressor for J420 & J450 115V 60Hz Replaces 76-2766-3	CALL

All Items May Not Be Stocked In All Branches

Ice Machines & Accessories

Contactors

Part #	Mfg #	Description	Price
MEW200658	20-0658-9	Contactora 115-1-60	28.00
MEW200659	20-0659-9	Contactora 230-1-50/60	28.00

Controls

Part #	Mfg #	Description	Price
MEW1982	000001982	Head Pressure Control	187.00
MEW3284	000003284	Control Board	410.00
MEW4070	000004070	Valve Head Pressure Control	156.00
MEW5624	000005624	Ice Machine Control Board	303.00
MEW8309	000008309	i Model Control Board	444.00
MEW200124	20-0124-3	High Pressure Cut-Out Control	64.00
MEW200126	20-0126-3	Fan Cycle Control, Replaces 23-5535-9	60.00
MEW200127	20-0127-3	Fan Cycle Control	81.00
MEW200619	20-0619-9	Control Board for S-Series	362.00
MEW200905	20-0905-3	Temperature Control	240.00
MEW760160	76-0160-3	Ice Thickness Control, Wire Lead & Connectors Only	39.00
MEW760351	76-0351-3	Control Board for Use with All Voltages	355.00
MEW762782	76-2782-3	Control Board for Use with All Voltages	600.00
MEW762800	76-2800-3	Control Board for Use with All Voltages	596.00
MEW762907	76-2907-3	Control Board for Use with All Voltages	340.00
MEW836809	83-6809-3	Head Pressure Control	186.00

Couplings

Part #	Mfg #	Description	Price
MEW3060	000003060	Coupling Kit with Splined Hubs	269.00
MEW430169	43-0169-3	Lower Bearing Coupling	16.00

Driers

Part #	Mfg #	Description	Price
MEW825016	82-5016-3	Filter Drier for Refrigeration	75.00
MEW825216	82-5216-9	Line Drier for EC18, EC20, EC30, EC40 & SM50	37.00
MEW893025	89-3025-9	Drier, Replaces 89-3022-9, 89-3023-3, 89-3025-3	46.00
MEW893027	89-3027-9	Drier, Replaces 89-3026-3, 89-3027-3	64.00

Filters

Part #	Mfg #	Description	Price
MEW762914	76-2914-3	Air Filter for Q0130, Q0210 & QF400	17.00

Prices & Specifications are Subject to Change.

Ice Machines & Accessories

Fuses

Part #	Mfg #	Description	Price
MEW251100	25-1100-3	7A Fuse for Control Board	35.00
MEW251116	25-1116-9	0.125A Mini-Fuse, 5/Pk	39.00

Gaskets

Part #	Mfg #	Description	Price
MEW440851	44-0851-3	Door Gasket for Stainless Steel Cabinets	83.00
MEW762621	76-2621-3	Evaporator Top Molding & Gasket Assembly	61.00

Hardware

Part #	Mfg #	Description	Price
MEW500001	50-0001-3	Thumb Screw to Mount Ice Chute to Housing	7.00
MEW530512	53-0512-3	Plastic Head Thumb Screw for Water Trough & Water Distributor	8.00

Hinges

Part #	Mfg #	Description	Price
MEW762443	76-2443-3	Door Pivot Hinge Assembly with Spring for Reach-In Cabinets	100.00
MEW762899	76-2899-3	Set of Left & Right Hinges for Storage Bins	75.00

Legs & Feet

Part #	Mfg #	Description	Price
MEWK00345	K-00345	Leg Kit For SN12 & SN20 Countertop Units	99.00

Motors

Part #	Mfg #	Description	Price
MEW6656	000006656	Condenser Fan Motor 115V	79.00
MEW241281	24-1281-3	Fan Motor 115-60	129.00
MEW241287	24-1287-3	Condenser Fan Motor 115-1-50/60	120.00
MEW241292	24-1292-9	Fan Motor 115-60	265.00
MEW241293	24-1293-9	Fan Motor 220-50/60	273.00
MEW241308	24-1308-9	Condenser Fan Motor 115-50/60 (Replaces 24-1308-3)	138.00
MEW762941	76-2941-3	Fan Motor Magnetek 208/230V	509.00
MEW850500	85-0500-3	PTCR Compressor Starter	37.00

Ice Machines

Ice Machines & Accessories

Pins

Part #	Mfg #	Description	Price
MEW430201	43-0201-9	Water Trough Support Pin New Style J (Replaces 43-0201-3)	9.00
MEW5010452	50-10452	9.75 SS Agitator Removal Pin	19.45
MEW762025	76-2025-3	Activating Pin Assembly	52.00

Plugs

Part #	Mfg #	Description	Price
MEW430062	43-0062-9	Water Trough Plug	16.00

Probes

Part #	Mfg #	Description	Price
MEW200065	20-0065-3	Water Level Probe	89.00
MEW200654	20-0654-9	Water Level Probe	17.00
MEW6488	20-0696-3	Thermostat Probe	103.00
MEW200802	20-0802-9	Ice Thickness Control Probe	49.00
MEW251129	25-1129-3	Water Level Probe	58.70
MEW761996	76-1996-3	Ice Thickness Probe	58.00
MEW762061	76-2061-3	Ice Thickness Probe	57.00
MEW762781	76-2781-3	Ice Thickness Probe	57.00

Pumps

Part #	Mfg #	Description	Price
MEW1153	000001153	115V Water Pump	192.00
MEW148027	14-8027-9	Water Pump	288.00
MEW200739	20-0739-9	Water Pump 230-1-60	212.00
MEW200892	20-0892-9	Water Pump 115-1-60	202.00
MEW762306	76-2306-3	Water Pump with Bracket	276.00
MEW762552	76-2552-3	Water Pump 115-1-60	273.00
MEW762601	76-2601-3	Water Pump 220-60	273.00
MEW825112	82-5112-9	Water Pump 115-1-60	213.00

Relays

Part #	Mfg #	Description	Price
MEW2671	000002671	Start Potential Relay 115V 60Hz	31.00
MEW200755	20-0755-9	Start Relay (Copeland CS08 KQE-PFV-255)	44.00
MEW200756	20-0756-9	Start Relay 115-1-50/60	71.00
MEW200757	20-0757-9	Start Relay 230-1-60	82.00
MEW240816	24-0816-3	7-Second Delay Relay	210.00

Prices & Specifications are Subject to Change.

Ice Machines & Accessories

RTV Silicone

Part #	Mfg #	Description	Price
MEW910301	910301-1	10.3 oz Aluminum RTV Silicone	34.00

Sensors

Part #	Mfg #	Description	Price
MEW762375	76-2375-3	Unitized Sensor Board 230V	250.00
MEW762376	76-2376-3	Unitized Sensor Board 115V	250.00

Switches

Part #	Mfg #	Description	Price
MEW1756	000001756	LH Harvest Magnetic Switch	22.00
MEW1757	000001757	RH Harvest Magnetic Switch	26.00
MEW200681	20-0681-9	Magnetic Bin Switch	27.00
MEW200793	20-0793-9	Toggle Switch	11.00
MEW200979	20-0979-3	Hall Effect Switch with Wiring	125.00
MEW230084	23-0084-9	Toggle Switch	25.00
MEW230106	23-0106-3	Micro Switch Push Button	43.00
MEW230111	23-0111-9	Bin Switch	118.00
MEW230134	23-0134-3	Toggle Switch	25.00
MEW230148	23-0148-3	Magnetic Bin Switch	51.00
MEW230151	23-0151-3	Toggle Switch	10.00
MEW235536	23-5536-3	High Pressure Cut Out	151.00

Thermostats

Part #	Mfg #	Description	Price
MEW040000815	040000815	Bin Thermostat Control for SM050	47.00

Troughs

Part #	Mfg #	Description	Price
MEW2106	000002106	Water Trough	34.00
MEW400360	40-0360-9	Water Trough	34.00
MEW400915	40-0915-9	Water Trough	72.00

Tubing

Part #	Mfg #	Description	Price
MEW430322	43-0322-3	Distribution Tube	61.00
MEW762498	76-2498-3	Distribution Tube Assembly	57.00

All Items May Not Be Stocked In All Branches

Ice Machines & Accessories

Valves

Part #	Mfg #	Description	Price
MEW33	000000033	Water Dump Valve, 115-1-60	54.00
MEW375	000000375	Water Inlet Valve with Coil, 115-60	61.00
MEW376	000000376	230V Water Inlet Valve	62.00
MEW1767	000001767	Dump Valve Body With Coil, 115-1-60	66.00
MEW1768	000001768	Dump Valve Body With Coil, 230-1-50/60	66.00
MEW2369	000002369	Head Pressure Control Valve	187.00
MEW2472	000002472	Check Valve Drain Line Replacement Kit f/S320, S420 and S450	17.00
MEW2473	000002473	Check Valve Drain Line Replacement Kit f/S300, S500, S600, S1000, S1200	17.00
MEW2474	000002474	Check Valve Drain Line Replacement Kit f/S1400, S1600, S1800	21.00
MEW2788	000002788	Solenoid Valve w/Electrical Coil 115V 60Hz	150.00
MEW2947	000002947	Expansion Valve for Scotsman Iceomatic Ice Machine	113.00
MEW3190	000003190	Headmaster Head Pressure Control Valve	253.00
MEW7965	000007965	115V Water Inlet Valve Kit	67.00
MEW7966	000007966	208/230V Water Inlet Valve Service Kit	67.00
MEW200313	20-0313-9	Water Inlet Valve with 115V Coil for Q0370	61.00
MEW760017	76-0017-3	Expansion Valve for Q0210, Q0270, S0300 & S0300P	134.00
MEW760018	76-0018-3	Expansion Valve for Q0820, Q0820P, Q0320, Q0320P & J0320	151.00
MEW760019	76-0019-3	Expansion Valve for Q0420, Q0420P, Q0450, Q0450P, S0600C, J0420 & J0450	156.00
MEW760020	76-0020-3	Expansion Valve for Q0600, Q0600P & J0600	164.00
MEW760021	76-0021-3	Expansion Valve for Q0600, IB0600C, Q0800, Q0800P & J0800	164.00
MEW760022	76-0022-3	Expansion Valve for SU1000C, IB800C, IB 1000C, J1000, J1300 & J1800	156.00
MEW760112	76-0112-3	Water Inlet Valve 115V, Replaces 24-0526-3, 24-0527-3 & 24-0528-3	61.00
MEW760113	76-0113-3	Water Inlet Valve with 208/230-50/60 Coil	63.00
MEW760213	76-0213-3	Float Valve Complete Assembly for QM45, Q0210, Q0310, Q0270	74.00
MEW760225	76-0225-3	Expansion Valve for S Model Marine, S Model Quiet Qube	112.00
MEW760286	76-0286-9	Expansion Valve for S0420, S0420P, S0500, S0500P, S0600P	112.00
MEW762508	76-2508-3	Expansion Valve for B0320, B0420, B0450	171.00
MEW762583	76-2583-3	Expansion Valve for B0200, B0250, J0200, J0250, Q0200	171.00
MEW763000	76-3000-1	Hot Gas Valve with 115-60 Danfoss Coil	121.00
MEW763001	76-3001-1	Solenoid Valve, 115-60 Danfoss	139.00
MEW763005	76-3005-1	Solenoid Valve Assembly 115-60-1 Danfoss	151.00
MEW763010	76-3010-1	Solenoid Valve Assembly with Coil for Hot Gas, Replaces 24-0455-3	150.00
MEW763011	76-3011-1	Solenoid Valve with 208/230-50/60 Danfoss Coil	151.00
MEW763012	76-3012-1	Liquid Line Solenoid Valve with 208/230-50/60 Danfoss Coil	163.00
MEW836779	83-6779-3	Harvest Pressure Regulating Valve	109.00
MEW836904	83-6904-9	Round Water Float Valve for E, H, G, B&J Models	49.00
MEW836905	83-6905-9	Float Valve Assembly	54.00
MEW836913	83-6913-3	Square Water Float Valve for B&J 600/800/1000/13/1800	47.00
MEW837206	83-7206-9	Water Regulating Valve	238.00
MEW837212	83-7212-3	Water Regulating Valve, V46AB-29D	281.00

Ice Machines

Prices & Specifications are Subject to Change.

Ice Machines & Accessories

Water Curtains

Part #	Mfg #	Description	Price
MEW400473	40-0473-3	Water Curtain for Q1000, Q1000C, Q1000P, B1000, B1800, IB1000C, J1000, Replaces 602707-1	121.00
MEW400474	40-0474-3	Water Curtain for G1600, G1800, G1800P, J1800, Replaces 602985-1	192.00
MEW400475	40-0475-3	Water Curtain for G1300, G1300P & J1300, Replaces 601399-1	169.00
MEW400477	40-0477-3	Water Curtain, Vac Form	112.00
MEW400478	40-0478-3	Water Curtain for Q200, Q280, Q280P, B0200, B0250, J0200 & J0250, Replaces 600750-1	93.00
MEW400479	40-0479-3	Water Curtain for Q0420 & Q0420P, Replaces 60-3767-1	107.00
MEW400523	40-0523-3	Water Curtain for QDUALC, Replaces 600262-1, 605092-1	116.00
MEW400851	40-0851-3	Water Curtain	113.00
MEW400911	40-0911-3	Water Curtain for Q0420 & Q0420P	131.00
MEW401098	40-1098-9	Water Curtain for S0850, S0850C, S0850P, S1000, S1000C & S1000P	65.00
MEW401118	40-1118-9	Water Curtain for S0320, S0320P, S0420, S0420P, S0450 & S0450P	45.00
MEW401272	40-1272-9	Water Curtain for S1600, S1600P, S1800 & S1800P	164.00
MEW430464	43-0464-3	Water Curtain	98.00
MEW761987	76-1987-3	Water Curtain for E200, E400, G0400 & G0600	138.00
MEW762776	76-2776-3	Water Curtain Hanger	10.00
MEW762802	76-2802-3	Water Curtain Magnet with Attachment Clip	13.00

Water Inlet Fitting Kits

Part #	Mfg #	Description	Price
MEW040000691	040000691	SM050 Evaporator Water Inlet Fitting Kit	14.00

Parts & Accessories

Part #	Mfg #	Description	Price
MEW2056	000002056	Ice Damper Assembly	41.00
MEW2785	000002785	Splash Shield Assembly	83.00
MEW4045	000004045	Bottom Frame Assembly Fits Q210, Q270	37.00
MEW6728	000006728	i Model LCD Display	105.00
MEW7052	000007052	i Model Water Level Probe	44.00
MEW8310	000008310	i Model Thermistor w/Clips	15.00
MEW8660	000008660	i Model Ice Thickness Probe	66.00
MEW040000779	040000779	Water Curtain Paddle for SM050	1.44
MEW400040	40-0040-3	Expansion Valve Insulation Boot	21.00
MEW400720	40-0720-3	Expansion Valve Bulb Insulation Boot	16.00
MEW400882	40-0882-3	Paddle	4.00
MEW870608	87-0608-3	Condenser Water Drain Female Wing Adapter	15.00

Ice Machines

All Items May Not Be Stocked In All Branches

Condensing Units & Coolers

Air-Cooled Condensing Units

BH Indoor/Outdoor Condensing Unit - Hermetic Compressor

- 1/2 - 5 hp Hermetic compressor with oversized condenser
- Shut-off valve in discharge line of hermetic compressor
- HyperCore™ microchannel coil technology
- PSC Motor
- UL Listed



B	Z	T	030	L	6	C	F
Model	Compressor	Application	Equiv. HP	Temp.	Refrigerant	Voltage	Identifier
B = Bohn	H = Hermetic	T = Outdoor	005 = 1/2 HP	H = High	2 = R-22	B = 208/230/1/60	F = Stock
	S = Semi-herm.	N = Indoor	008/009 = 3/4 HP	L = Low	6 = R-404A/507	C = 208/230/3/60	
	Z = Scroll	B = Bohnmizer	010 = 1 HP	M = Medium		D = 460/3/60	
		M = Beacon	01* = 1-1/2 HP	E = Extra Low		G = 230/1/60	
		Microprocessor	02* = 2 HP	X = Medium/Low			
			03* = 3 HP				
			04* = 4 HP				
			05* = 5 HP				
			060 = 6 HP				

BHT Extended Temp R-404A/507 Outdoor Condensing Unit

- 25°F Suction temp
- Hermetic compressor
- Head pressure control valve
- Crankcase heater
- Adjustable low pressure control
- Prepainted galvanized cabinet

Part #	Mfg #	BTUH @95° Ambient	Connect (ID)		Electrical	Compressor	Dimensions D x W x H	Ship Wt	Price
			Liq, Suc						
BOHBHT010X6BFM	BHT010X6BFM	8,850	3/8", 5/8"		208/230-1-60	RS70C1E	28-1/4" x 23-3/4" x 17-1/4"	138 lbs	CALL
BOHBHT025X6BFM	BHT025X6BFM	17,490	3/8", 7/8"		208/230-1-60	CS14K6E	28-1/4" x 37-3/4" x 17-1/4"	208 lbs	CALL
BOHBHT025X6CFM	BHT025X6CFM	17,490	3/8", 7/8"		208/230-3-60	CS14K6E	28-1/4" x 37-3/4" x 17-1/4"	208 lbs	CALL

Reach-In Units

BTO	09	A	G
Model Family	Capacity	Electric Code	Vintage Revision
ADT / BM / BOT / HGT / KMK / LET / LO / SM / TL / VA / WK	x 100 = BTUH (10°F TD)	A = 115/1/60 B = 208-230/1/60 For U(K) { 0 = 115/1/60 1 = 208-230/1/60	U(K) = No Vintage

C High Profile Reach-In Unit Cooler - Air Defrost

- Ideal for refrigerated reach-ins
- Expansion valve fits inside
- Model CK available with BOHN-KOTE® coil for corrosion protection



Part #	Mfg #	BTUH		Fan Qty	Fan CFM	Dimensions L x H x D	OD Connections Liq, Suct, Drain	Net Wt	Price
		10°F TD	+25 SST Voltage						
BOHC17	CK17AG	1,700	115-1-60	1	250	17-1/4" x 8-7/8" x 13-3/4"	3/8", 1/2", 1/2"	12 lbs	CALL

Prices & Specifications are Subject to Change.

Condensing Units & Coolers

TA Thin Profile Reach-In Unit Cooler - Air Defrost

- Thin unit mounts in top of refrigerator
- Drain fitting at 45° to run drain through back or bottom of refrigerator
- Model TAK models available with BOHN-KOTE® coil for corrosion protection



Part #	Mfg #	BTUH 10°F TD +25 SST	Voltage	Fan Qty	Fan CFM	Dimensions L x H x D	OD Connections Liq , Suct , Drain	Net Wt	Price
BOHTAK10	TAK10AG	1,000	115-1-60	1	120	16-1/2" x 4-1/2" x 13-1/2"	3/8", 3/8", 1/2"	10 lbs	CALL
BOHTAK13	TAK13AG	1,300	115-1-60	2	170	20-1/2" x 4-1/2" x 13-1/2"	3/8", 3/8", 1/2"	13 lbs	CALL
BOHTAK17	TAK17AG	1,700	115-1-60	2	210	24" x 4-1/2" x 14-1/2"	3/8", 3/8", 1/2"	17 lbs	CALL
BOHTAK23	TAK23AG	2,300	115-1-60	3	330	31-5/8" x 4-1/2" x 14-1/2"	3/8", 3/8", 1/2"	23 lbs	CALL
BOHTA30	TA30AG	3,000	115-1-60	3	360	40" x 4-1/2" x 14-1/2"	3/8", 1/2", 1/2"	26 lbs	CALL

KMK Standard Mullion Reach-In Unit Cooler

- Ideal for under-counter reach-in refrigeration
- Thin-line design
- Unique fan arrangement which allows air to be drawn into the top of the unit, pulling return air from both sides
- Adaptable for mounting on back wall or ends of beverage cooler
- Finned coil protected by BOHN-KOTE® finish
- Sweat inlet connections



Part #	Mfg #	BTUH 10°F TD +25 SST	Voltage	Fan Qty	Fan CFM	Dimensions L x H x D	OD Connections Liq , Suct , Drain	Net Wt	Price
BOHKMK13	KMK13AG	1,300	115-1-60	2	180	15-15/8" x 17-3/4" x 5-5/8"	3/8", 3/8", 5/8"	15 lbs	CALL

RAMK Reverse Air Mullion Reach-In Unit Cooler

- Ideal for under-counter reach-in refrigeration
- Thin-line design
- Reverse air mullion draws air to the coil at the bottom and discharges the cooled air out the top
- Adaptable for mounting on back wall or ends of beverage cooler
- Finned coil protected by BOHN-KOTE® finish
- Sweat inlet connections



Part #	Mfg #	BTUH 10°F TD +25 SST	Voltage	Fan Qty	Fan CFM	Dimensions L x H x D	OD Connections Liq , Suct , Drain	Net Wt	Price
BOHRAMK13	RAMK13	1,300	115-1-60	2	180	15-5/8" x 17-3/4" x 5-5/8"	3/8", 3/8", 5/8"	15 lbs	CALL
BOHRAMK17	RAMK17	1,700	115-1-60	2	170	15-5/8" x 19-3/4" x 5-5/8"	3/8", 3/8", 5/8"	17 lbs	CALL
BOHRAMK23	RAMK23	2,300	115-1-60	3	255	22" x 19-3/4" x 5-5/8"	3/8", 1/2", 5/8"	23 lbs	CALL

**Refrigeration
Condensing Units**

All Items May Not Be Stocked In All Branches

Condensing Units & Coolers

U Dual-Aire Reach-In Unit Cooler

- Use whenever a small, compact unit is required
- Can be mounted on the ceiling or wall
- Draws air in through the front & discharges out both sides
- Model UK available with BOHN-KOTE® coil for corrosion protection



Part #	Mfg #	BTUH		Fan Qty	Fan CFM	Dimensions L x H x D	OD Connections Liq, Suct, Drain	Net Wt	Price
		10°F TD +25 SST	Voltage						
BOHUK90	UK0090B	850	208/230-1-60	1	190	11-1/2" x 8-1/2" x 8-7/8"	1/2", 3/8", 1/2"	8 lbs	CALL
BOHUK120	UK0120B	1,150	208/230-1-60	1	250	17-1/2" x 8-1/2" x 8-7/8"	1/2", 3/8", 1/2"	8 lbs	CALL
BOHUK150	UK0150B	1,500	208/230-1-60	1	310	17-1/2" x 9-1/2" x 10-7/8"	1/2", 3/8", 1/2"	12 lbs	CALL

VA V-Profile Reach-In Unit Cooler - Air Defrost

- Deluxe unit designed for small reach-ins, back bar & under counter refrigerators
- Ceiling or wall mount
- Standard with sweat inlet connections
- VAK models include BOHN-KOTE® coil for corrosion protection



Part #	Mfg #	Approx BTUH @		Fan Qty	Fan CFM	Dimensions L x H x D	OD Connections Liq, Suct, Drain	Net Wt	Price
		10°F TD	Voltage						
BOHVAK08	VAK08AG	800	115-1-60	1	130	12-1/4" x 6-7/8" x 8-1/8"	3/8", 3/8", 1/2"	7 lbs	CALL
BOHVAK12	VAK12AG	1,200	115-1-60	2	265	18" x 8" x 8-1/8"	3/8", 3/8", 1/2"	12 lbs	CALL

Walk-In Unit Coolers

ADT Low Profile Walk-In Unit Cooler - Air Defrost

- Suitable for use with R-22, R-507, or R-410A
- 15" High unit designed to mount flush with top of cooler
- Front access to electrical and refrigeration components
- Molded plastic fan guard
- Improved drain pan design
- Liquid line solenoid wire harness standard
- Schrader valve on suction header
- Easy front access



PSC Motor - Air Defrost - ADT Low Profile Walk-In Unit Cooler

Part #	Mfg #	BTUH		Fan Qty	Fan CFM	Dimensions L x H x D	Connections Inlet, Suct	Net Wt	Price
		10°F TD +25 SST	Voltage						
BOHADT052A	ADT052AK	5,200	115-1-60	1	700	15" x 15" x 29-1/2"	1/2" OD, 5/8" ID	31 lbs	CALL
BOHADT065A	ADT065AK	6,500	115-1-60	1	650	15" x 15" x 29-1/2"	1/2" OD, 7/8" ID	34 lbs	CALL
BOHADT070A	ADT070AK	7,000	115-1-60	2	1460	15" x 15" x 45-1/2"	1/2" OD, 7/8" ID	45 lbs	CALL
BOHADT090A	ADT090AK	9,000	115-1-60	2	1400	15" x 15" x 45-1/2"	1/2" OD, 7/8" ID	48 lbs	CALL
BOHADT104A	ADT104AK	10,400	115-1-60	2	1400	15" x 15" x 45-1/2"	1/2" OD, 7/8" ID	49 lbs	CALL
BOHADT120AK	ADT120AK	12,000	115-1-60	2	1300	15" x 15" x 45-1/2"	1/2" OD, 7/8" ID	51 lbs	CALL
BOHADT130A	ADT130AK	13,000	115-1-60	2	1300	15" x 15" x 45-1/2"	1/2" OD, 7/8" ID	53 lbs	CALL
BOHADT156A	ADT156AK	15,600	115-1-60	3	2100	15" x 15" x 61-1/2"	1/2" OD, 7/8" ID	67 lbs	CALL
BOHADT208A	ADT208AK	20,800	115-1-60	4	2800	15" x 15" x 77-1/2"	1/2" OD, 1-1/8" ID	82 lbs	CALL

**Refrigeration
Condensing Units**

Prices & Specifications are Subject to Change.

Condensing Units & Coolers

EC Motor - Air Defrost - ADT Low Profile Walk-In Unit Cooler

Part #	Mfg #	BTUH 10°F TD +25 SST	Voltage	Fan Qty	Fan CFM	Dimensions L x H x D	Connections Inlet, Suct	Net Wt	Price
BOHADT052AKEC	ADT052AEK	5,200	115-1-60	1	700	15" x 15" x 29-1/2"	1/2" OD, 5/8" ID	31 lbs	CALL
BOHADT065AKEC	ADT065AEK	6,500	115-1-60	1	650	15" x 15" x 29-1/2"	1/2" OD, 7/8" ID	34 lbs	CALL
BOHADT070AKEC	ADT070AEK	7,000	115-1-60	2	1460	15" x 15" x 45-1/2"	1/2" OD, 7/8" ID	45 lbs	CALL
BOHADT090AKEC	ADT090AEK	9,000	115-1-60	2	1400	15" x 15" x 45-1/2"	1/2" OD, 7/8" ID	48 lbs	CALL
BOHADT104AKEC	ADT104AEK	10,400	115-1-60	2	1400	15" x 15" x 45-1/2"	1/2" OD, 7/8" ID	49 lbs	CALL
BOHADT120AKEC	ADT120AEK	12,000	115-1-60	2	1300	15" x 15" x 45-1/2"	1/2" OD, 7/8" ID	51 lbs	CALL
BOHADT130AKEC	ADT130AEK	13,000	115-1-60	2	1300	15" x 15" x 45-1/2"	1/2" OD, 7/8" ID	53 lbs	CALL

LET Low Profile Walk-In Unit Cooler - Electric Defrost

- Suitable for use with R-22, R-507, or R-410A
- 15" High unit designed to mount flush with top of cooler
- Front access to electrical and refrigeration components
- Molded plastic fan guard
- Improved drain pan design
- Solenoid harness included
- Easy front access



PSC Motor - Electric Defrost - 6 FPI Low Profile Walk-In Unit Cooler

Part #	Mfg #	Approx BTUH @ 10°F TF	Voltage	Fan Qty	Fan CFM	Dimensions L x H x D	Connections Inlet, Suct	Net Wt	Price
BOHLET040BJ	LET040BK	4,000	208/230-1-60	1	700	29-1/2" x 15" x 15"	1/2", 5/8"	26 lbs	CALL
BOHLET065B	LET065BK	6,500	208/230-1-60	2	1,400	45-1/2" x 15" x 15"	1/2", 5/8"	43 lbs	CALL
BOHLET090B	LET090BK	9,000	208/230-1-60	2	1,300	45-1/2" x 15" x 15"	1/2", 7/8"	45 lbs	CALL
BOHLET120B	LET120BK	12,000	208/230-1-60	3	2,100	61-1/2" x 15" x 15"	1/2", 7/8"	60 lbs	CALL
BOHLET140BK	LET140BK	14,000	208/230-1-60	3	1,950	61-1/2" x 15" x 15"	1/2", 7/8"	62 lbs	CALL
BOHLET280BK	LET280BK	28,000	208/230-3-60	6	3,900	109-1/2" x 15" x 15"	1/2", 1-1/8"	124 lbs	CALL

EC Motor - Electric Defrost - 6 FPI Low Profile Walk-In Unit Cooler

Part #	Mfg #	Approx BTUH @ 10°F TF	Voltage	Fan Qty	Fan CFM	Dimensions L x H x D	Connections Inlet, Suct	Net Wt	Price
BOHLET075BKEC	LET075BEK	7,500	208/230-1-60	2	1,300	45-1/2" x 15" x 15"	1/2", 7/8"	45 lbs	CALL
BOHLET090BKEC	LET090BEK	9,000	208/230-1-60	2	1,300	45-1/2" x 15" x 15"	1/2", 7/8"	45 lbs	CALL
BOHLET120BKEC	LET120BEK	20,000	208/230-1-60	5	3,250	93-1/2" x 15" x 15"	1/2", 7/8"	60 lbs	CALL

**Refrigeration
Condensing Units**

All Items May Not Be Stocked In All Branches

Condensing Units

Aftermarket Condensing Units

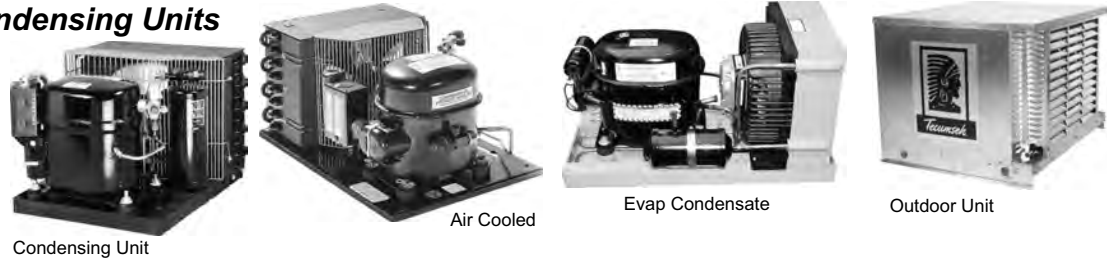

R-134a Evap Condensate High Temperature Condensing Unit

- Rating point 45°F evap. 90°F ambient
- Gray base
- GK Suffix: base unit, fan guard, power cord
- GB Suffix: base unit, fan guard, power cord, receiver tank

Part #	Mfg #	BOM	Volt-Phase	Refrig	HP	Rated BTU/Hr	Line Sizes Dischg, Suc	Starting Torque	Price
TECAEA3425YXAGK	AEA3425YXAGK	32X560-39	115-1-60	R134a	1/5	2,382	1/4" S, 5/16" S	Normal	CALL
TECAEA4430YXAGB	AEA4430YXAGB	32X430-49	115-1-60	R134a	1/4	2,682	1/4" S, 5/16" S	High	CALL
TECAEA4440YXAGB	AEA4440YXAGB	32X360-49	115-1-60	R134a	1/3	3,634	1/4" S, 5/16" S	High	CALL

R-12 Air Cooled High Temperature Condensing Unit

- Rating point 45°F evap. 90°F ambient

Part #	Mfg #	BOM	Volt-Phase	Refrig	HP	Rated BTU/Hr	Line Sizes Dischg, Suc	Starting Torque	Price
TECAEA4430AXAXB	AEA4430AXAXB	2B428-9	115-1-60	R12	1/4	3,080	1/4" F, 3/8" F	High	CALL
TECAEA4440AXAXB	AEA4440AXAXB	2C309-9	115-1-60	R12	1/3	3,790	1/4" F, 3/8" F	High	CALL
TECAJA4461AXAXC	AJA4461AXAXC	2B216-9	115-1-60	R12	1/2	5,675	1/4" F, 1/2" F	High	CALL
TECAJA4461AXDXC	AJA4461AXDXC	2B223-9	208/230-1-60	R12	1/2	5,675	1/4" F, 1/2" F	High	CALL
TECAJA4492AXAXC	AJA4492AXAXC	2A750-9	115-1-60	R12	3/4	8,800	3/8" F, 5/8" F	High	CALL
TECAJA4492AXDXC	AJA4492AXDXC	2A757-9	208/230-1-60	R12	3/4	8,800	3/8" F, 5/8" F	High	CALL
TECAJA4512AXDXC	AJA4512AXDXC	2A1129-9	208/230-1-60	R12	1	11,780	3/8" F, 5/8" F	High	CALL
TECAHA4518AXDXC	AJA4518AXDXC	2B3233-49	208/230-3-60	R12	1-1/2	17,400	3/8" F, 7/8" S	High	CALL

R-12 Air Cooled Medium Temperature Condensing Unit

- Rating point 20°F evap. 90°F ambient

Part #	Mfg #	BOM	Volt-Phase	Refrig	HP	Rated BTU/Hr	Line Sizes Dischg, Suc	Starting Torque	Price
TECAJA7441AXAXC	AJA7441AXAXC	2B218-9	115-1-60	R12	1/2	4,400	1/4" F, 1/2" F	High	CALL
TECAJA7465AXAXE	AJA7465AXAXE	2B714-9	115-1-60	R12	3/4	6,560	3/8" F, 5/8" F	High	CALL

R-12 Air Cooled Low Temperature Condensing Unit

- Rating point -10°F evap. 90°F ambient

Part #	Mfg #	BOM	Volt-Phase	Refrig	HP	Rated BTU/Hr	Line Sizes Dischg, Suc	Starting Torque	Price
TECAEA2415AABXC	AEA2415AABXC	2A380-9	115-1-60	R12	1/3	1,800	1/4" F, 3/8" F	High	CALL

Prices & Specifications are Subject to Change.

Condensing Units

Aftermarket Condensing Units (Continued)

R-12 Air Cooled Low Temperature Condensing Unit

Part #	Mfg #	BOM	Volt-Phase	Refrig	HP	Rated BTU/Hr	Line Sizes Dischg, Suc	Starting Torque	Price
TECAJA2425AXAXB	AJA2425AXAXB	2A275-9	115-1-60	R12	1/2	2,780	1/4" F, 1/2" F	High	CALL
TECAHA2445AXDXC	AJA2445AXDXC	2B1125-49	208/230-1-60	R12	1	4,900	3/8" S, 5/8" S	High	CALL
TECAHA2466AXDXC	AJA2466AXDXC	2B3232-49	208/230-1-60	R12	1-1/2	6,900	3/8" S, 7/8" S	High	CALL

R-22 Air Cooled High Temperature Condensing Unit

- Rating point 45°F evap. 90°F ambient

Part #	Mfg #	BOM	Volt-Phase	Refrig	HP	Rated BTU/Hr	Line Sizes Dischg, Suc	Starting Torque	Price
TECAWG4520EXNXC	AWG4520EXNXC	2B3215-9	208/230-1-60	R22	1-1/2	19,131	3/8" S, 7/8" S	High	CALL
TECAWG4524EXNXM	AWG4524EXNXM	2C2103-9	208/230-1-60	R22	2	24,189	3/8" S, 7/8" S	High	CALL
TECAVA4540EXNXM	AVA4540EXNXM	2B3127-9	208/230-1-60	R22	3	39,386	3/8" S, 7/8" S	High	CALL
TECAGA4563EXNXM	AGA4563EXNXM	2A5058-9	208/230-1-60	R22	5	62,450	1/2" F, 7/8" S	High	CALL

R-22 Air Cooled Commercial Temperature Condensing Unit

- Rating point 20°F evap. 90°F ambient

Part #	Mfg #	BOM	Volt-Phase	Refrig	HP	Rated BTU/Hr	Line Sizes Dischg, Suc	Starting Torque	Price
TECAKA9433EXAXC	AKA9433EXAXC	2C232-9	115-1-60	R22	1/3	3,320	1/4" F, 1/2" F	High	CALL
TECAKA9446EXAXC	AKA9446EXAXC	2C234-9	115-1-60	R22	1/2	4,600	1/4" F, 1/2" F	High	CALL
TECAKA9461EXDXC	AKA9461EXDXC	2B725-9	208/230-1-60	R22	3/4	6,100	3/8" F, 1/2" F	High	CALL
TECAKA9470EXDXC	AKA9470EXDXC	2A1185-9	208/230-1-60	R22	1	7,000	3/8" F, 1/2" F	High	CALL
TECAJA9486EXDXC	AJA9486EXDXC	2A1183-9	208/230-1-60	R22	1	8,600	3/8" F, 5/8" F	High	CALL

R-134a Air Cooled High Temperature Condensing Unit

- Rating point 45°F evap. 90°F ambient

Part #	Mfg #	BOM	Volt-Phase	Refrig	HP	Rated BTU/Hr	Line Sizes Dischg, Suc	Starting Torque	Price
TECAEA4440YXAXB	AEA4440YXAXB	2C372-9	115-1-60	R134a	1/3	3,620	1/4" F, 3/8" F	High	CALL

R-404A Air Cooled Commercial Temperature Condensing Unit

- Rating point 20°F evap. 90°F ambient

Part #	Mfg #	BOM	Volt-Phase	Refrig	HP	Rated BTU/Hr	Line Sizes Dischg, Suc	Starting Torque	Price
TECAEA9422ZXAXC	AEA9422ZXAXC	2C482-9	115-1-60	R404A	1/4	2,200	3/8" F, 3/8" F	High	CALL
TECAKA9429ZXAXC	AKA9429ZXAXC	2D351-9	115-1-60	R404A	1/3	2,850	1/4" F, 1/2" F	High	CALL
TECAKA9440ZXAXC	AKA9440ZXAXC	2D291-1	115-1-60	R404A	1/2	4,050	1/4" F, 1/2" F	High	CALL
TECAKA9440ZXDXC	AKA9440ZXDXC	2D292-1	208/230-1-60	R404A	1/2	4,050	1/4" F, 1/2" F	High	CALL
TECAKA9463ZXDXC	AKA9463ZXDXC	32B777-1	208/230-1-60	R404A	3/4	6,280	3/8" F, 1/2" F	High	CALL
TECAWA9514ZXNXM	AWA9514ZXNXM	2B3238-9	208/230-1-60	R404A	1-1/2	14,053	3/8" S, 7/8" S	High	CALL

All Items May Not Be Stocked In All Branches

Condensing Units

Aftermarket Condensing Units (Continued)

R-404A Air Cooled Commercial Temperature Condensing Unit

Part #	Mfg #	BOM	Volt-Phase	Refrig	HP	Rated BTU/Hr	Line Sizes Dischg, Suc	Starting Torque	Price
TECAWA9518ZXNXM	AWA9518ZXNXM	2C2133-9	208/230-1-60	R404A	2	18,409	3/8" S, 7/8" S	High	CALL
TECAWA9518ZXTXM	AWA9518ZXTXM	2C2134-9	200/230-3-60	R404A	2	18,409	3/8" S, 7/8" S	3 PH	CALL
TECAVA9525ZXTXM	AVA9525ZXTXM	2B3154-9	200/230-3-60	R404A	3	24,517	3/8" S, 7/8" S	3 PH	CALL

R-404A Air Cooled Medium Temperature Condensing Unit

- Rating point 20°F evap. 90°F ambient

Part #	Mfg #	BOM	Volt-Phase	Refrig	HP	Rated BTU/Hr	Line Sizes Dischg, Suc	Starting Torque	Price
TECAWA7512ZDXDC	AWA7512ZDXDC	2B3217-9	208/230-1-60	R404A	1	11,934	3/8" S, 7/8" S	High	CALL

R-404A Air Cooled Low Temperature Condensing Unit

- Rating point -10°F evap. 90°F ambient

Part #	Mfg #	BOM	Volt-Phase	Refrig	HP	Rated BTU/Hr	Line Sizes Dischg, Suc	Starting Torque	Price
TECAJA2429ZXAXB	AJA2429ZXAXB	2D275-9	115-1-60	R404A	1/2	2,890	3/8" F, 1/2" F	High	CALL
TECAWA2448ZDXDC	AWA2448ZDXDC	2B1118-9	208/230-1-60	R404A	1	4,838	3/8" S, 5/8" S	High	CALL
TECAWA2479ZDXDC	AWA2479ZDXDC	2C2114-9	208/230-1-60	R404A	2	7,871	3/8" S, 7/8" S	High	CALL
TECAWA2490ZDXDC	AWA2490ZDXDC	2C2111-9	208/230-1-60	R404A	2	8,790	3/8" S, 5/8" S	High	CALL
TECAVA2510ZXNXC	AVA2510ZXNXC	2C2116-9	208/230-1-60	R404A	2	9,999	3/8" S, 7/8" S	High	CALL
TECAVA2512ZXNXM	AVA2512ZXNXM	2B3140-9	208/230-1-60	R404A	3	11,851	3/8" S, 7/8" S	High	CALL

R-22 Outdoor High Temperature Condensing Unit

- Rating point 45°F evap. 90°F ambient

Part #	Mfg #	BOM	Volt-Phase	Refrig	HP	Rated BTU/Hr	Line Sizes Dischg, Suc	Starting Torque	Price
TECAWG4518EXNHG	AWG4518EXNHG	2H1189-20	208/230-1-60	R22	1-1/2	17,224	3/8" S, 5/8" S	High	CALL
TECAWG4525EXNHG	AWG4525EXNHG	2H1192-20	208/230-1-60	R22	2	23,169	3/8" S, 7/8" S	High	CALL
TECAWG4525EXTHG	AWG4525EXTHG	2H1193-20	200/230-3-60	R22	2	25,114	3/8" S, 7/8" S	3 PH	CALL
TECAVA4544EXNHG	AVA4544EXNHG	2H2121-20	208/230-1-60	R22	3-1/2	43,522	3/8" S, 7/8" S	High	CALL
TECAVA4544EXTHG	AVA4544EXTHG	2H2122-20	200/230-3-60	R22	3-1/2	43,522	3/8" S, 7/8" S	3 PH	CALL
TECAVA4547EXNHG	AVA4547EXNHG	2H2125-20	208/230-1-60	R22	3-1/2	43,522	1/2" S, 7/8" S	High	CALL
TECAVA4547EXTHG	AVA4547EXTHG	2H2126-20	200/230-3-60	R22	3-1/2	43,522	1/2" S, 7/8" S	3 PH	CALL

R-22 Outdoor Commercial Temperature Condensing Unit

- Rating point 20°F evap. 90°F ambient

Part #	Mfg #	BOM	Volt-Phase	Refrig	HP	Rated BTU/Hr	Line Sizes Dischg, Suc	Starting Torque	Price
TECAKA9475EXDHG	AKA9475EXDHG	2H1186-20	208/230-1-60	R22	1	6,943	1/4" S, 3/8" S	High	CALL
TECAJA9484EXDHG	AJA9484EXDHG	2H1188-20	208/230-1-60	R22	1	7,981	1/4" S, 5/8" S	High	CALL

Prices & Specifications are Subject to Change.

Condensing Units

R-404A Outdoor Commercial Temperature Condensing Unit

- Rating point 20°F evap. 90°F ambient

Part #	Mfg #	BOM	Volt-Phase	Refrig	HP	Rated BTU/Hr	Line Sizes Dischg, Suc	Starting Torque	Price
TECAWA9511ZXNHG	AWA9511ZXNHG	2H2118-20	208/230-1-60	R404A	1	10,731	3/8" S, 5/8" S	High	CALL
TECAWA9513ZXNHG	AWA9513ZXNHG	2H3230-20	208/230-1-60	R404A	1-1/2	13,150	3/8" S, 5/8" S	High	CALL
TECAVA9522ZXNHG	AVA9522ZXNHG	2H3146-20	208/230-1-60	R404A	3	22,397	3/8" S, 7/8" S	High	CALL
TECAVA9522ZXTHG	AVA9522ZXTHG	2H3147-20	200/230-3-60	R404A	3	22,397	3/8" S, 7/8" S	3 PH	CALL
TECAVA9532ZXNHG	AVA9532ZXNHG	2H4054-20	208/230-1-60	R404A	4	32,118	1/2" S, 7/8" S	High	CALL
TECAVA9532ZXTHG	AVA9532ZXTHG	2H4055-20	200/230-3-60	R404A	4	32,118	1/2" S, 7/8" S	3 PH	CALL

R-404A Outdoor Low Temperature Condensing Unit

- Rating point -10°F evap. 90°F ambient

Part #	Mfg #	BOM	Volt-Phase	Refrig	HP	Rated BTU/Hr	Line Sizes Dischg, Suc	Starting Torque	Price
TECAWA2481ZXDHG	AWA2481ZXDHG	2H3228-22	208/230-1-60	R404A	2	8,093	3/8" S, 5/8" S	High	CALL
TECAWA2481ZXTHG	AWA2481ZXTHG	2H3229-22	200/230-3-60	R404A	2	8,093	3/8" S, 5/8" S	3 PH	CALL
TECAVA2511ZXNHG	AVA2511ZXNHG	2H2119-22	208/230-1-60	R404A	2-3/4	11,001	3/8" S, 7/8" S	High	CALL
TECAVA2511ZXTHG	AVA2511ZXTHG	2H2120-22	200/230-3-60	R404A	2-3/4	11,001	3/8" S, 7/8" S	3 PH	CALL
TECAVA2514ZXNHG	AVA2514ZXNHG	2H2123-20	208/230-1-60	R404A	3-1/2	13,468	3/8" S, 7/8" S	High	CALL
TECAVA2514ZXTHG	AVA2514ZXTHG	2H2124-20	200/230-3-60	R404A	3-1/2	13,468	3/8" S, 7/8" S	3 PH	CALL

Product descriptions and specifications in this catalog are condensed from manufacturer's literature. For exact information, consult manufacturer's literature prior to installation and service. Contact us if you are not sure about specifications.

Refrigerants

Returnable Cylinders

Part #	Description	Price
REF507100	100 lb R-507 (AZ-50)	CALL
REF404A100	100 lb HP62	CALL
REF402A110	110 lb HP80	CALL
REF407C115	115 lb R407C	CALL
REF22125	125 lb R-22	CALL
REF401A125	125 lb MP39	CALL
REF134A125	125 lb R-134a	CALL

Disposable Cylinders

Part #	Description	Price
REFHP8113	13 lb HP81 R-402B	CALL
REF404A24	24 lb HP62	CALL
REF408A24	24 lb R-408A	CALL
REF410A25	25 lb R-410A	CALL
REF50725	25 lb R-507 (AZ-50)	CALL
REF407C25	25 lb R-407C	CALL
REF407F25	25 lb R-407F Genetron LT	CALL
REF438A25	25 lb R-438A MO99 Dupont	CALL
REF402A27	27 lb HP80	CALL
REF134A30	30 lb R-134a Cold MP	CALL
REF409A30	30 lb R-409A	CALL
REF401B30	30 lb MP66	CALL
REF2230	30 lb R-22	CALL
REF401A30	30 lb MP39	CALL

Icor Disposable Cylinders



Part #	Description	Price
REFHOTSHOT	25 lb R-414B Hot Shot Refrigerant	CALL
REFONESHOT	24 lb R-422A/C One Shot Refrigerant, OS-24	CALL



Rx11-Flush®



- Ozone-safe solvent for flushing refrigeration and air conditioning systems/line sets
- Rinses away particulate, sludge, carbon residues, acids, oils and water



4300-08



4300-09

4300-11

4300-10



4300-50



4300-51



4300-89



4300-15

Part #	Mfg #	Description	Price
CAL430008	4300-08	Rx11-flush Starter Kit	222.68
CAL430009	4300-09	1 lb Canister	109.72
CAL430011	4300-11	2 lb Canister	210.80
CAL430010	4300-10	Start-Up Pack 2+1	482.34
CAL430015	4300-15	13 lb Canister	1133.14
CAL430050	4300-50	Flushing Tool	24.00
CAL430051	4300-51	Flush Gun	65.64
CAL430089	4300-89	Injection Valve	70.52

** Fits Pneu-flush® and Zerol Ice® as well

Refrigerants, Oils & Recovery

Refrigeration Oil & Chemicals

Refrigerants, Oils & Recovery

Refrigeration Oils

Uniqema Emkarate® RL Lubricants

- Polyol ester refrigeration oil
- For use with HFC refrigerants
- Fully miscible & compatible with mineral oils and alkylbenzene lubricants as well as with CFC's, HCFC's and HFC's



4314-64



4314-46



4316-46

Part #	Mfg #	Size	Viscosity	Emkarate RL	Price
CAL431464	4314-64	1 qt	150 SUS	32-3MAF	58.54
CAL431466	4314-66	1 gal	150 SUS	32-3MAF	174.90
CAL431446	4314-46	1 gal	150 SUS	32H	182.88
CAL431646	4316-46	1 gal	300 SUS	68H	190.80

C-3s, C-4s Mineral Refrigeration Oil

- Mineral naphthenic lubricants
- Designed for today's high performance a/c & refrigeration compressors
- Better lubrication for modern compressors which run at higher speed & generate higher temperatures



4303-07



4304-07

Part #	Mfg #	Size	Viscosity	Cal-Lube	Price
CALC3	4303-07	1 gal	150 SUS	C-3	58.40
CALC4	4304-07	1 gal	300 SUS	C-4	58.94

Zerol® Alkylbenzene Refrigeration Oil

- High quality, synthetic alkylbenzene refrigeration oil
- Recommended for use in all refrigeration & AC applications using CFC & HCFC refrigerants
- Excellent clean-up/flushing oil



4310-07



4308-07



4311-07

Part #	Mfg #	Size	Viscosity	Zerol	Price
CAL150	4310-07	1 gal	150 SUS	150	100.24
CAL200TD	4308-07	1 gal	200 SUS	200TD	100.40
CAL300	4311-07	1 gal	300 SUS	300	130.02

Phase III® Refrigeration Oil Test Kits

- For use on POE's, minerals oils, and alkylbenzene
- Tests acid level in refrigeration oil



Part #	Mfg #	Description	Price
CAL4320W8	4320-W8	Phase III Oil Test Kit	27.34



www.irrsupply.com

Refrigeration Recovery

Refrigerant Recovery

RecoverX Refrigerant Recovery Systems

- Recovers most CFC, HCFC & HFC refrigerants
- Vapor, liquid, push/pull capabilities
- 1/2 hp Oil-less compressor
- Automatic shut-off at 15" of vacuum



Part #	Mfg #	Description	Price
RIT95760	95760	RecoverXLT® R60A, 115V/60Hz, Built-In Constant Pressure Regulator	1671.18

1/4" Plus II™ Charging Hoses

1/4" Plus II™ Hose with SealRight™ Low Loss Anti-Blow Back Fitting

- Low loss anti-blowback SealRight™ fitting traps refrigerant in hose when disconnected helping meet non-venting regulations and preventing finger burns
- 45° End for easy installation in tight areas



Part #	Mfg #	Color	Length	Price
RIT22012	22012	Yellow	12"	37.30
RIT22036	22036	Yellow	36"	46.16
RIT22048	22048	Yellow	48"	51.06
RIT22060	22060	Yellow	60"	53.34
RIT22072	22072	Yellow	72"	59.06
RIT22212	22212	Blue	12"	37.30
RIT22236	22236	Blue	36"	46.16
RIT22248	22248	Blue	48"	51.06
RIT22260	22260	Blue	60"	53.34
RIT22272	22272	Blue	72"	59.06
RIT22612	22612	Red	12"	37.30
RIT22636	22636	Red	36"	46.16
RIT22648	22648	Red	48"	51.06
RIT22660	22660	Red	60"	53.34
RIT22672	22672	Red	72"	59.06
RIT22983	22983	R/Y/B	36"	127.72
RIT22984	22984	R/Y/B	48"	141.64
RIT22986	22986	R/Y/B	72"	160.20

9" FlexFlow™ & Low Loss Adapter Hoses

- Easy retrofit of existing "Plus II™" hoses with FlexFlow capabilities
- Flexible hose between valve and fitting for handling in tight areas
- Operating temperature: -20° to 180°F
- UL Recognized assemblies (File SA9737 valves SA10088)



Part #	Mfg #	Description	Price
RIT25002	25002	1/4" Yellow FlexFlow Adapter	51.44

Plus II™ "B" Charging Hose

- Pulls a vacuum much faster than the 1/4" hose
- Minimum burst: 3000 psi
- Maximum working pressure: 600 psi



3/8" Plus II™ "B" Hose with 3/8" Straight Flare x 3/8" Straight Flare Fittings

Part #	Mfg #	Type/Color	Length	Price
RIT14560	14560	Yellow	60"	68.38

Plus II™ Heavy-Duty Combination Charging/Vacuum Hoses

- Pulls a vacuum much faster than the 1/4" hose
- Minimum burst: 3000 psi
- Maximum working pressure: 600 psi

3/8" Plus II™ Heavy-Duty Hose with 3/8" Straight Flare x 1/4" 45° Fittings

Part #	Mfg #	Model	Length	Price
RIT16260	16260	BCA-60	60"	94.02

Pressure Control Hoses

- Replaces regular copper capillary tubing on failure cut out controls & refrigeration pressure controls
- Eliminates capillary failure due to work hardening from vibration
- 1/4" Operates to 600 psi & 180°F
- 3/8" Operates to 500 psi & 180°F
- Hex style fittings with 1/4" SAE thread
- Black hose



Part #	Mfg #	Description	Price
RIT78124	78124	1/4" Str x 90" x 24"L	29.78

Refrigerants, Oils & Recovery

Prices & Specifications are Subject to Change.

Compressors

Compressor Model Number Codes

AE	A	4	4	40	Y	XA	XC
Compressor Family	Release Variant (Generation)	Application	Number of Digits in Rated BTU Capacity	First Two Digits of Rated BTU Capacity	Refrigerant	Voltage	Condensing Units

Compressors

AE
AG
AH
AJ
AK
AN
AV
AW
AZ
RG
RK
SA
SF
TP
HG
TH
TW
VS

A = 1st
B = 2nd
C = 3rd
etc...

In this example (4) total digits, with the first two (40), or 4,000 BTU capacity

See unit information in **Condensing Units Fast Reference**

Primary Application Parameters		
Evap Temperature	Rating Point	Motor Starting Torque
1. Low	-10°F	Normal
2. Low	-10°F	High
3. High	+45°F	Normal
4. High	+45°F	High
5. Air Cond	+45°F	Normal
6. Medium	+20°F	Normal
7. Medium	+20°F	High
8. Air Cond	+49°F	Normal
9. Commercial	+20°F	High
0. Commercial	+20°F	Normal
F. Low – Vapor Inj	-10°F	High
G. Low – Liquid Inj	-10°F	High

Primary Refrigerants
A = R12
B = R410A
C = R407C
E = R22
J = R502
Y = R134a
Z = R404A/R507

Voltage Codes
XA = 115-60-1; 100-50-1
XB = 230-60-1; 200-50-1
XC = 220-240-50-1
XD = 208-230-60-1; 200-50-1
XF = 208-230-60-3; 200-240-50-3
XG = 460-60-3; 380-420-50-3
XH = 575-60-3; 480-520-50-3
XN = 208-230-60-1; 200-220-50-1
XP = 220-60-1; 200-50-1
XT = 200-230-60-3; 200-220-50-3
XU = 100-60-1; 100-50-1
XV = 265-60-1
AB = 115-60-1; 90-50-1
VA = 265-60-1; 220-240-50-1
NA = 208-230-60-1
AA = 115-60-1

NOTE: For explanation of compressor families and codes, contact Tecumseh Products Company.

Compressors

AEA4440YXA XC

- E and G = Evaporative Condensate Units
- S = Shaded Pole Fan Motor (Celseon)
- C = Electrically Commutated Fan Motor (Celseon)
- X = A holding character, reserved for future use

Condensing Unit Features, see chart below

The letters I, O, and Q are eliminated		Fan Cooled	Water Cooled	Air Water Cooled	Receiver Tank	BX Cable	Interconnect Compressor	See B/M	Accumulator
A	Standard Unit	•							
B	Std. Unit W/Receiver Tank	•			•				
C	Std. Unit W/Receiver Tank & BX Cable	•			•	•			
D	Std. Unit W/BX Cable	•				•			
E,F,K	Physical Design Variant (Conduit)	•				•		•	
G,H,J,L,P	Physical Design Variant (Standard)	•						•	
M	Advanced Commercial Design	•			•	•			•
N	Advanced Commercial Design	•				•			•
S	Customer Special							•	
T	Interconnect Compressor						•		
U	Water Cooled - Adv. Commercial Design		•		•	•			•
V	Electrical Special (Conduit Design)	•				•		•	
W	Water Cooled Unit		•		•	•			
X	Interconnect Unit	•			•	•	•		
Y	Air Water Cooled Unit			•		•			
Z	Electrical Special (Standard Unit)	•						•	
Evaporative Condensate Units Plastic Base									
EC	Large Evaporative Condensate Units Black Plastic Base	•							
ED	Large Evaporative Condensate Units Black Plastic Base	•							
EE	Large Evaporative Condensate Units Black Plastic Base	•							
GC	Small - Fan Guard, Power Cord, Receiver Tank, Service Valves				•				
GB	Small - Fan Guard, Power Cord, Receiver Tank				•				
GK	Small - Fan Guard, Power Cord								
GL	Small - Fan Guard								
Outdoor Condensing Units									
HL	Outdoor Condensing Unit with Options	•						•	
Celseon™ Air Cooled Units									
CB	Std. Unit W/EC Fan Motor, Sweat Conns, Power Cord & Receiver Tank	•			•				
CC	Std. Unit W/EC Fan Motor, Sweat Conns, Power Cord, Receiver Tank & Service Valves	•			•				
CK	Std. Unit W/EC Fan Motor, Sweat Conns, Power Cord	•							
CS	Std. Unit W/EC Fan Motor, Sweat Conns, Power Cord & Service Valves	•							
SB	Std. Unit W/SP Fan Motor, Sweat Conns, Power Cord & Receiver Tank	•			•				
SC	Std. Unit W/SP Fan Motor, Sweat Conns, Power Cord, Receiver Tank & Service Valves	•			•				
SK	Std. Unit W/SP Fan Motor, Sweat Conns, Power Cord	•							
SS	Std. Unit W/SP Fan Motor, Sweat Conns, Power Cord & Service Valves	•							

Compressors

Prices & Specifications are Subject to Change.

Compressors

Compressors



R-12 High Temperature Compressor

- Rating point 45° evap. 130 ° cond

Compressors

Part #	Mfg #	BOM	Volt-Phase	Refrig	HP	Rated BTU/Hr	Line Sizes Dischg, Suc	Starting Torque	Price
TECAEA3425AXA	AEA3425AXA	AE170AS-718-J7JO	115-1-60	R12	1/5	2,600	1/4", 5/16"	Normal	CALL
TECAEA4430AXA	AEA4430AXA	AE155AS-238-J7	115-1-60	R12	1/4	3,100	1/4", Vlv	High	CALL
TECAEA3430AXA	AEA3430AXA	AE151AS-277-J7JM	115-1-60	R12	1/4	3,100	1/4", 5/16"	Normal	CALL
TECAEA4440AXA	AEA4440AXA	AE234AS-668-J7JM	115-1-60	R12	1/3	4,100	1/4", 3/8" SAE RL	High	CALL
TECAEA4440AXASTUB	AEA4440AXA	AE234AS-717-J7	115-1-60	R12	1/3	4,100	1/4", 5/16"	High	CALL
TECAEA4448AXA	AEA4448AXA	AE256AS-663-J7JM	115-1-60	R12	1/3+	4,800	1/4", 3/8" SAE RL	High	CALL
TECAJA4461AXA	AJA4461AXA	AJ311AT-141-J7	115-1-60	R12	1/2	6,100	5/16", 1/2" SAE RL	High	CALL
TECAJA4492AXA	AJA4492AXA	AJ100AT-193-J7	115-1-60	R12	3/4	9,150	5/16", 5/8" SAE RL	High	CALL
TECAJA4492AXD	AJA4492AXD	AJ100GT-193-J7	208/230-1-60	R12	3/4	9,150	5/16", 5/8" SAE RL	High	CALL
TECAJA4512AXD	AJA4512AXD	AJ131GT-193-J7	208/230-1-60	R12	1	12,300	5/16", 5/8" SAE RL	High	CALL
TECAHA4518AXD	AHA4518AXD	AH110FF-509-J7	208/230-1-60	R12	1-1/2	18,000	3/8", 7/8" RL	High	CALL
TECAGA4534AXN	AGA4534AXN	AG155ET-017-J7	208/230-1-60	R12	3	33,700	1/2", 1-1/8" RL	High	CALL

R-12 Commercial and Medium Temperature Compressor

- Rating point 20° evap. 130 ° cond

Part #	Mfg #	BOM	Volt-Phase	Refrig	HP	Rated BTU/Hr	Line Sizes Dischg, Suc	Starting Torque	Price
TECAKA9434AXA	AKA9434AXA	AK159AH-038-J7	115-1-60	R12	1/2	3,350	1/4", 1/2" SAE RL	High	CALL
TECAKA9441AXA	AKA9441AXA	AK163AT-038-J7	115-1-60	R12	1/2	4,100	1/4", 1/2" SAE RL	High	CALL
TECAJA7441AXA	AJA7441AXA	AJ530AT-336-J7	115-1-60	R12	1/2	4,400	5/16", 1/2" SAE RL	High	CALL
TECAJA7465AXA	AJA7465AXA	AJ201AT-188-J7	115-1-60	R12	3/4	6,650	5/16", 5/8" SAE RL	High	CALL
TECAJB7465AXD	AJB7465AXD	AJ201GT-188-J7	208/230-1-60	R12	3/4	6,650	5/16", 5/8" SAE RL	High	CALL
TECAHA7480AXD	AHA7480AXD	AH160FF-509-J7	208/230-1-60	R12	1	8,000	3/8", 5/8" RL	High	CALL
TECAHA7514AXD	AHA7514AXD	AH333EF-510-J7	208/230-1-60	R12	1-1/2	18,000	3/8", 7/8" RL	High	CALL

R-12 Low Temperature Compressor

- Rating point -10° evap. 130 ° cond

Part #	Mfg #	BOM	Volt-Phase	Refrig	HP	Rated BTU/Hr	Line Sizes Dischg, Suc	Starting Torque	Price
TECAEA1410AXA	AEA1410AXA	AE232AR-713-J7KJ	115-1-60	R12	1/4	1,050	1/4", 5/16"	Normal	CALL
TECAEA2415AAB	AEA2415AAB	AE334AR-663-J7	115-1-60	R12	1/3	1,525	1/4", Vlv	High	CALL
TECAJA2425AXA	AJA2425AXA	AJ601AT-336-J7	115-1-60	R12	1/2	2,200	5/16", 1/2" SAE RL	High	CALL
TECAHA2445AXD	AHA2445AXD	AH410EF-509-J7	208/230-1-60	R12	1	4,400	3/8", 5/8" RL	High	CALL
TECAHA2466AXD	AHA2466AXD	AH500EF-510-J7	208/230-1-60	R12	1-1/2	6,600	3/8", 7/8" RL	High	CALL

All Items May Not Be Stocked In All Branches

Compressors

R-22 A/C and High Temperature Compressor

- Rating point 45° evap. 130 ° cond
- Note: AE, AK and AJ compressor models are not approved for heat pump applications

Part #	Mfg #	BOM	Volt-Phase	Refrig	HP	Rated BTU/Hr	Line Sizes Dischg, Suc	Starting Torque	Price
TECAKA5483EXD	AKA5483EXD	AK130ET-004-J7	208/230-1-60	R22	3/4	8,300	1/4", 3/8"	Normal	CALL
TECAKA5510EXD	AKA5510EXD	AK100EH-004-J7	208/230-1-60	R22	1	10,000	1/4", 3/8"	Normal	CALL
TECAKA5510EXV	AKA5510EXV	AK100JB-004-J7	265-1-60	R22	1	10,000	1/4", 3/8"	Normal	CALL
TECRKA5512EXD	RKA5512EXD	RK147ET-021-J7	208/230-1-60	R22	1	11,700	5/16", 1/2"	Normal	CALL
TECRKA5512EXV	RKA5512EXV	RK147JB-021-J7	265-1-60	R22	1	11,750	5/16", 1/2"	Normal	CALL
TECAKA5512EXD	RKA5512EXD	AK111EH-004-J7	208/230-1-60	R22	1	12,000	1/4", 3/8"	Normal	CALL
TECAJB5515EXD	AJB5515EXD	AJ600FT-205-J7	208/230-1-60	R22	1-1/4	15,000	5/16", 1/2"	Normal	CALL
TECAJA5518EXV	AJA5518EXV	AJ200JB-206-J7	265-1-60	R22	1-1/2	18,500	5/16", 1/2"	Normal	CALL
TECAWG5519EXN	AWG5519EXN	AW702EH-093-J7	208/230-1-60	R22	1-1/2	18,800	3/8", 3/4"	Normal	CALL
TECAWG5524EXN	AWG5524EXN	AW705EH-093-J7	208/230-1-60	R22	2	24,200	3/8", 3/4"	Normal	CALL
TECAVA5538EXN	AVA5538EXN	AV133ET-030-J7	208/230-1-60	R22	3	38,400	1/2", 7/8"	Normal	CALL
TECAVA5538EXT	AVA5538EXT	AV134RT-035-J7	200/230-3-60	R22	3	38,400	1/2", 7/8"	3 PH	CALL
TECAVA5542EXN	AVA5542EXN	AV144ET-034-J7	208/230-1-60	R22	3-1/2	42,500	1/2", 7/8"	Normal	CALL
TECAVA5542EXT	AVA5542EXT	AV145RT-035-J7	200/230-3-60	R22	3-1/2	42,500	1/2", 7/8"	3 PH	CALL
TECAVA5546EXT	AVA5546EXT	AV169RT-035-J7	200/230-3-60	R22	3-3/4	46,500	1/2", 7/8"	3 PH	CALL
TECAGA5553EXN	AGA5553EXN	AG122ET-003-J7	208/230-1-60	R22	4-1/2	54,000	1/2", 7/8"	Normal	CALL
TECAGC5553EXG	AGC5553EXG	AG122UT-003-J7	460-3-60	R22	4-1/2	54,000	1/2", 7/8"	3 PH	CALL
TECAVB5558EXT	AVB5558EXT	AV190RT-045-J7	200/230-3-60	R22	4-3/4	57,000	1/2", 7/8"	3 PH	CALL
TECAGA5561EXN	AGA5561EXN	AG133ET-001-J7	208/230-1-60	R22	5	61,000	1/2", 7/8"	Normal	CALL
TECAGA5561EXT	AGA5561EXT	AG133RT-003-J7	200/230-3-60	R22	5	61,000	1/2", 7/8"	3 PH	CALL
TECAGC5561EXG	AGC5561EXG	AG133UT-003-J7	460-3-60	R22	5	61,000	1/2", 7/8"	3 PH	CALL
TECAGA5568EXN	AGA5568EXN	AG144ET-002-J7	208/230-1-60	R22	5-1/2	68,000	1/2", 7/8"	Normal	CALL
TECAGA5568EXT	AGA5568EXT	AG144RT-001-J7	200/230-3-60	R22	5-1/2	68,000	1/2", 7/8"	3 PH	CALL

Compressors

R-22 Commercial Temperature Compressor

- Rating point 20° evap. 130 ° cond

Part #	Mfg #	BOM	Volt-Phase	Refrig	HP	Rated BTU/Hr	Line Sizes Dischg, Suc	Starting Torque	Price
TECAEA9422EXA	AEA9422EXA	AE172AR-908-J7	115-1-60	R22	1/4	2,200	1/4", 5/16"	High	CALL
TECAKA9428EXA	AKA9428EXA	AK164AH-038-J7	115-1-60	R22	1/3	2,800	1/4", 1/2" SAE	High	CALL
TECAKA9442EXA	AKA9442EXA	AK165AH-038-J7	115-1-60	R22	1/2	4,200	1/4", 1/2" SAE	High	CALL
TECAKA9442EXD	AKA9442EXD	AK165ET-038-J7	208/230-1-60	R22	1/2	4,200	1/4", 1/2" SAE	High	CALL
TECAKA9455EXD	AKA9455EXD	AK167EH-038-J7	208/230-1-60	R22	3/4	5,500	1/4", 1/2" SAE	High	CALL
TECAKA9462EXD	AKA9462EXD	AK166EH-038-J7	208/230-1-60	R22	3/4	6,200	1/4", 1/2" SAE	High	CALL
TECAJA9484EXD	AJA9484EXD	AJ801ET-418-J7	208/230-1-60	R22	1	8,400	5/16", 1/2"	High	CALL

R-134a High Temperature Compressor

- Rating point 45° evap. 130 ° cond

Part #	Mfg #	BOM	Volt-Phase	Refrig	HP	Rated BTU/Hr	Line Sizes Dischg, Suc	Starting Torque	Price
TECAEA3425YXA	AEA3425YXA	AE530AR-718-J7	115-1-60	R134a	1/5	2,500	1/4", 5/16"	Normal	CALL
TECAEA3430YXA	AEA3430YXA	AE510AR-277-J7	115-1-60	R134a	1/3	3,000	1/4", 5/16"	Normal	CALL
TECAEA4430YXA	AEA4430YXA	AE540AR-238-J7	115-1-60	R134a	1/4	3,000	1/4", Vlv	High	CALL

Prices & Specifications are Subject to Change.

Compressors

Compressors (Continued)

R-134a High Temperature Compressor

Part #	Mfg #	BOM	Volt-Phase	Refrig	HP	Rated BTU/Hr	Line Sizes Dischg, Suc	Starting Torque	Price
TECAEA4440YXA	AEA4440YXA	AE630AR-668-J7	115-1-60	R134a	1/3	3,960	1/4", Vlv	High	CALL
TECAEA4440YXASTUB	AEA4440YXA	AE630AR-717-J7	115-1-60	R134a	1/3	3,960	1/4", 5/16"	High	CALL
TECAEA4448YXA	AEA4448YXA	AE660AR-716-J7	115-1-60	R134a	1/3	4,650	1/4", 5/16"	High	CALL
TECAKA4460YXA	AKA4460YXA	AK168AT-038-J7	115-1-60	R134a	3/4	6,300	1/4", Vlv	High	CALL
TECAKA4476YXA	AKA4476YXA	AK169AH-038-J7	115-1-60	R134a	1/2+	7,680	1/4", 1/2" SAE RL	High	CALL
TECAJA4512YXD	AJA4512YXD	AJ137ET-193-J7	208/230-1-60	R134a	1	12,100	5/16", 5/8" SAE RL	High	CALL

R-134A Low Temperature Compressor

- Rating point -10° evap. 130 ° cond

Part #	Mfg #	BOM	Volt-Phase	Refrig	HP	Rated BTU/Hr	Line Sizes Dischg, Suc	Starting Torque	Price
TECAEA2410YXA	AEA2410YXA	AE600AR-944-J7JM	115-1-60	R134a	1/4	1,020	1/4", 1/4"	High	CALL
TECAEA2413YXA	AEA2413YXA	AE700AR-939-J7	115-1-60	R134a	1/3	1,350	1/4", 5/16"	High	CALL

R-404A Commercial Temperature Compressor

- Rating point 20° evap. 130 ° cond

Part #	Mfg #	BOM	Volt-Phase	Refrig	HP	Rated BTU/Hr	Line Sizes Dischg, Suc	Starting Torque	Price
TECAEA9422ZXA	AEA9422ZXA	AE590AR-908-J7	115-1-60	R404A	1/4	2,200	1/4", 5/16"	High	CALL
TECAKA9427ZXA	AKA9427ZXA	AK174AT-038-J7	115-1-60	R404A	1/4	2,700	1/4", 1/2" SAE RL	High	CALL
TECAKA9438ZXA	AKA9438ZXA	AK175AT-038-J7	115-1-60	R404A	1/2	3,750	1/4", 1/2" SAE RL	High	CALL
TECAKA9438ZXD	AKA9438ZXD	AK175ET-038-J7	208/230-1-60	R404A	1/2	3,750	1/4", 1/2" SAE RL	High	CALL
TECAKA9455ZXA	AKA9455ZXA	AK171AH-038-J7	115-1-60	R404A	3/4	5,450	1/4", 1/2" SAE RL	High	CALL
TECAKA9462ZXD	AKA9462ZXD	AK172ET-038-J7	208/230-1-60	R404A	3/4	6,250	1/4", 1/2" SAE RL	High	CALL
TECAWA9512ZXXN	AWA9512ZXXN	AW611FT-163-J7	208/230-1-60	R404A	1-1/2	14,300	3/8", 7/8" RL	High	CALL
TECAWA9514ZXXN	AWA9514ZXXN	AW617ET-099-J7	208/230-1-60	R404A	1-1/2	14,500	3/8", 5/8"	High	CALL
TECAVA9522ZXT	AVA9522ZXT	AV203RT-001-J7	200/230-3-60	R404A	2	21,600	1/2", 7/8"	3 PH	CALL
TECAVA9522ZXXN	AVA9522ZXXN	AV203ET-001-J7	208/230-1-60	R404A	2	22,000	1/2", 7/8"	High	CALL
TECAVA9528ZXXN	AVA9528ZXXN	AV204ET-066-J7	208/230-1-60	R404A	3	28,100	1/2", 3/4"	High	CALL
TECAVA9528ZXT	AVA9528ZXT	AV204RT-001-J7	200/230-3-60	R404A	3	28,300	1/2", 7/8"	3 PH	CALL

R-404A Medium Temperature Compressor

- Rating point 20° evap. 130 ° cond

Part #	Mfg #	BOM	Volt-Phase	Refrig	HP	Rated BTU/Hr	Line Sizes Dischg, Suc	Starting Torque	Price
TECAWA7512ZXD	AWA7512ZXD	AW611ET-111-J7	208/230-1-60	R404A	1	11,600	3/8", 7/8" RL	High	CALL

All Items May Not Be Stocked In All Branches

Compressors

R-404A Low Temperature Compressor

- Rating point -10° evap. 130 ° cond

Part #	Mfg #	BOM	Volt-Phase	Refrig	HP	Rated BTU/Hr	Line Sizes Dischg, Suc	Starting Torque	Price
TECAEA2411ZXA	AEA2411ZXA	AE820AT-900-J7	115-1-60	R404A	1/4	1,100	1/4", 5/16"	High	CALL
TECAJA2425ZXA	AJA2425ZXA	AJ532AT-336-J7	115-1-60	R404A	1/2	2,450	5/16", 1/2" SAE RL	High	CALL
TECAWA2440ZXD	AWA2440ZXD	AW610ET-111-J7	208/230-1-60	R404A	1	3,775	3/8", 5/8" RL	High	CALL
TECAWA2460ZXD	AWA2460ZXD	AW613EH-111-J7	208/230-1-60	R404A	1-1/2	6,000	3/8", 7/8" RL	High	CALL
TECAWA2460ZXT	AWA2460ZXT	AW613RT-163-J7	200/230-3-60	R404A	1-1/2	6,000	3/8", 7/8" RL	3 PH	CALL
TECAVA2490ZXT	AVA2490ZXT	AV195RT-037-J7	200/230-3-60	R404A	2	9,100	1/2", 7/8"	High	CALL
TECAVA2490ZNX	AVA2490ZNX	AV195ET-037-J7	208/230-1-60	R404A	2	9,500	1/2", 7/8"	High	CALL
TECAVA2512ZXT	AVA2512ZXT	AV180RT-012-J7	200/230-3-60	R404A	3	12,000	1/2", 7/8"	3 PH	CALL
TECAVA2512ZNX	AVA2512ZNX	AV180ET-001-J7	208/230-1-60	R404A	3	12,500	1/2", 7/8"	High	CALL

Compressors

For instructions as to proper installation, servicing, and troubleshooting, please refer to the Manufacturer's literature.

Refrigeration Controls

Commercial Refrigeration Controls

Single Function Pressure Control

- NEMA 1 Enclosure with non-conductive cover
- Front-located captive cover screw
- Super Cap® capillary protection system
- Universal mounting & compact design
- Laser-welded bellows for extended life



SPST - Open Low

Part #	Mfg #	Description	Range PSIG	Differential PSI	Price
RAN0101402	O10-1402	36" Capillary with Flare Nut	(12") - 50	5 - 35	120.00
RAN0101483	O10-1483	36" Capillary with Flare Nut	(10") - 100	10 - 40	129.24
RAN0102054	O10-2054	36" Capillary with Flare Nut	100 - 400	40 - 150	135.44

SPST - Open High

Part #	Mfg #	Description	Range PSIG	Differential PSI	Price
RAN0111711	O11-1711	36" Capillary with Flare Nut	150 - 450	50 - 100	146.20

SPDT - Open High or Low

Part #	Mfg #	Description	Range PSIG	Differential PSI	Price
RAN016527	O16-527	36" Capillary with Flare Nut	(10") - 100	10 - 40	129.50
RAN016107	O16-107	Male Flare	(10") - 100	10 - 40	136.18
RAN016209	O16-209	Male Flare	150 - 450	**Manual Reset	164.42
RAN016108	O16-108	36" Capillary with Flare Nut	100 - 400	40 - 150	134.98
RAN016624	O16-624	36" Capillary with Flare Nut	(12") - 80	5 - 38	114.80

**Locks on pressure increase, pressure must drop approx. 40 psi to be reset.

DPST - Open Low

Part #	Mfg #	Description	Range PSIG	Differential PSI	Price
RAN0207006	O20-7006	36" Capillary with Flare Nut	100 - 400	40 - 150	225.92

Dual Function Pressure Control

- Exclusive "convertible" reset for manual or automatic high pressure reset on some models
- NEMA 1 Enclosure with non-conductive cover
- Front-located captive cover screw
- Super Cap® capillary protection system
- Universal mounting & compact design
- Laser-welded bellows for extended life
- Heavy-duty plated steel frame



Part #	Mfg #	Description	Cut-In Range PSIG	Diff. PSI	Cut-Out Range PSIG	Diff. PSI	Low Pressure (Opens Low)	High Pressure (Opens High)	Price
RAN0121502	O12-1502	36" Capillary w/Flare Nut	(12") - 50	5 - 35	150 - 450	70 Fixed	Automatic	Automatic	270.66
RAN0121549	O12-1549	36" Capillary w/Flare Nut	(10") - 100	10 - 40	150 - 450	70 Fixed	Automatic	Automatic	216.86

All Items May Not Be Stocked In All Branches

Refrigeration Controls

Commercial Refrigeration Controls (Continued)

Dual Function Pressure Control

Part #	Mfg #	Description	Cut-In Range PSIG	Diff. PSI	Cut-Out Range PSIG	Diff. PSI	Low Pressure (Opens Low)	High Pressure (Opens High)	Price
RAN0121594	O12-1594	36" Capillary w/Flare Nut	(10") - 100	*	150 - 450	+	*Manual	+Manual	265.38
RAN0124833	O12-4833	48" Capillary w/Flare Nut	(12") - 50	5 - 35	150 - 450	70 Fixed	Automatic	+Convertible	253.60
RAN0124834	O12-4834	48" Capillary w/Flare Nut	(10") - 100	10 - 40	150 - 450	70 Fixed	Automatic	Convertible	228.76

*Locks open on pressure decrease, pressure must rise approx. 10 psi to be reset.

+Locks open on pressure increase, pressure must drop approx. 70 psi to be reset.

Temperature Controls

ETC Commercial Temperature Controls

- Wide temperature range: -30° to 220°F
- Wide differential adjustment: 1° to 30°F
- LCD Read-out for sensor temperature, control settings & relay status
- High amp output relay
- EEPROM Memory retains control settings during power outages
- Keypad lockout to prevent end-user alteration of settings
- Easy 4-step set up
- Heavy-duty relay 1hp rated



Part #	Mfg #	Number Stages	Enclosure	Input Voltage	0 to 10 Volt Output	Price
RANETC111000	ETC-111000	One	NEMA-1	120/208/240VAC	No	127.28
RANETC112100	ETC-112100-000	One	NEMA 1	24VAC	Yes	181.64
RANETC211000	ETC-211000	Two	NEMA 1	120/208/240VAC	No	288.16

General Range Temperature Controls

- Maximum adjustment accuracy with 7 revolution range adjustment screws
- NEMA 1 enclosure with non-conductive cover
- Front-located captive cover screw
- Universal mounting & compact design
- Laser-welded bellows for extended life



w/Remote Bulb

SPST - Opens Low

Part #	Mfg #	Applications	Range (°F)	Differential (°F)	Description	Price
RAN0101408	O10-1408	Low (Freezer)	-15 - 40	*+3 - 20	72" Capillary Remote Bulb	136.74
RAN0101416	O10-1416	Medium	0 - 55	*+3 - 20	72" Capillary	140.76
RAN0101418	O10-1418	Medium	0 - 55	*+3 - 20	Air Coil	140.76
RAN0101409	O10-1409	Medium	0 - 55	*+3 - 20	72" Capillary Remote Bulb	123.58
RAN0101473	O10-1473	Medium	0 - 55	7 - 55	72" Capillary Remote Bulb	139.38

*+Differential at the low end of range is 6 to 25.

SPST - Ice Bank Control

Part #	Mfg #	Description	Price
RAN018100	O18-100	76" Capillary w/Bulb	150.50

Prices & Specifications are Subject to Change.

Refrigeration Controls

Refrigeration Controls

Wide Range Temperature Controls

- Virtually unaffected by ambient temperature
- Gas-filled, non-position-sensitive bulb
- Adjustable differential
- 17 FLA for both 120 & 240 VAC
- Front-located captive cover screw
- NEMA 1 enclosure with non-conductive cover



SPDT Opens High or Low

Part #	Mfg #	Range (°F)	Differential (°F)	Description	Price
RAN060100	O60-100	-35 - 95	4 - 50	96" Capillary 3/8" x 6" Cross Ambient Bulb	130.18

Temperature Controls

Adaptable Replacement Refrigerator Controls

- Readily adaptable to nearly all commercial refrigerators & freezers
- Break-off shafts are included with installation instructions for easy, fast installation
- Controls have "OFF" position except as noted



Part #	Mfg #	Switch w/Off Position	Diff	--Normal--		Warm	----Cold----		Capillary Length	Price
				OFF (°F)	ON (°F)	ON (°F)	OFF (°F)	ON (°F)		
RANA30180	A30-180	SPST	13	9	22	38	-4	9	42"	84.02
RANA30261	A30-261	SPST	6	--	--	61	32	38	84"	81.34
RANA30262	A30-262	SPST	12	20	32	43	3	15	84"	89.90
RANA30263	A30-263	SPST	22.5	11	33.5	47	.5	23	84"	87.44
RANA30301	A30-301	SPST*	8.5	-3	5.5	20.5	-24	--	84"	82.72
RANA30304	A30-304	SPST	15.5	-6	9.5	19.5	-21.5	--	84"	88.10
RANA30311	A30-311	SPST	14	-14	0	23	-22	--	42"	104.66

*Does not have "Off" position.

Direct Temperature Controls

Direct Replacement Constant Differential Controls

- Constant differential controls for commercial refrigerators, ice machines, vending machines, beverage coolers & water coolers



Part #	Mfg #	Type of Adjust	Diff	Norm OFF	ON	Warm ON	Cold OFF	Cap (In.)	Bulb	OEM	OEM P/N	Price
RANA302210	A30-2210	Dial	8	32	--	42	30	48	--	Wholesale	--	87.66

All Items May Not Be Stocked In All Branches

Refrigeration Controls

Direct Replacement Constant Cut-In Control

- One-for-one replacements for vending machines, automatic beverage dispensers & reach-in coolers
- Reliable off-cycle defrost
- SPST switch with OFF position



Part #	Mfg #	Normal OFF (°F)	Warm OFF (°F)	Cold OFF (°F)	Cut-In (°F)	Capillary Length	Price
RANA121506	A12-1506	15	22	9	38	39 x 3/8 x 1-3/8"	111.88
RANA12700	A12-700	18	26	11.5	37	84"	94.76
RANA12701	A12-701	23.5	31	15	41	84"	97.04
RANA121560	A12-1560	24	29	19	38	72"	102.06

Defrost Termination/Fan Delay Controls

- Terminates defrost & delays the evaporator fan operation on electric heat, hot gas & reverse cycle commercial refrigeration systems
- Prevents warm, moist air from being circulated into the refrigerated space
- Remote bulb sensing
- Factory-fixed low event for fan delay



Part #	Mfg #	Switch Action	Fan "On" Temperature (°F)	Defrost Termination (°F)	Sensing Element Style	Price
RANF25107	F25-107	SPDT	20 Fixed	40 - 75 Adj	60" Capillary with 3/8" x 4" Cross Ambient Bulb	154.24

Direct Replacement Water Cooler Controls

- Small compact design
- Laser-welded bellows for reliability
- Patented switch for high performance



Part #	Mfg #	Normal ON (°F)	Normal OFF (°F)	Differential (°F)	Cold OFF (°F)	Warm ON (°F)	Capillary Length	Price
RANK3001	K-3001	53	46	7	37	61	48"	80.34

Ice, Beverage Dispensing & Thermal Storage Controls

Ice Bin Level Control

- Direct replacement control for ice machine applications
- Provides narrow differential for accurate control of bin level



Part #	Mfg #	Switch	Range (°F)	Differential (°F)	Sensing Element	Price
RANA221129	A22-1129	SPDT	35 - 51	6	48" Capillary	111.04

Refrigeration Controls

Refrigeration Controls

Temperature Controls

A19 Remote Bulb Control

- Wide temperature ranges available
- Constant differential through the entire range
- Compact enclosure
- Variety of sensing element styles
- Unaffected by cross ambient conditions
- Suitable for temperature control in heating, ventilating, and refrigeration



Wide Range - Adjustable Differential

Electrical Ratings

Motor Ratings VAC	120	208	240
AC Full Load Amps	16.0	9.2	8.0
AC Locked Rotor Amps	96.0	55.2	48.0
Non-Inductive Amps	22 A, 120 to 277 VAC		

Pilot Duty - 125 VA, 24 to 600 VAC

Part #	Mfg #	Switch Action	Range	Diff	Bulb & Capillary	Range Adjuster	Price
PENA19ABC24	A19ABC-24C	SPDT	-30° to 100°F	3° - 12°F	3/8" x 4", 8' Cap	Convertible	114.64
PENA19ABC36	A19ABC-36C	SPDT	-30° to 100°F	3° - 12°F	3/8" x 4", 20' Cap	Convertible	198.40
PENA19ABC37	A19ABC-37C	SPDT	-30° to 100°F	3° - 12°F	3/8" x 4", 10' Cap	Screwdriver Slot	168.88

Fixed Differential (Close)

Electrical Ratings

Motor Ratings VAC	120	208	240
AC Full Load Amps	6.0	3.4	3.0
AC Locked Rotor Amps	36.0	20.4	18.0
Non-Inductive Amps	10 A, 24 to 277 VAC		

Pilot Duty - 125 VA, 24 to 277 VAC

Part #	Mfg #	Switch Action	Range	Diff	Bulb & Capillary	Range Adjuster	Price
PENA19AAD5	A19AAD-5C	SPDT Open Low	30° to 50°F	2-1/2°F	3/8" x 2-5/8", 6' Cap	Screwdriver Slot	183.68

A19 Series - Coiled Bulb Space Thermostat

- Wide temperature range
- Maximum bulb temperature: 140°F (60°C)
- NEMA 1 enclosure
- 1-3/8" x 2-1/4" Coiled bulb
- For use with:
 - Return air or space temperature sensing



Cooling

Electrical Ratings

Motor Ratings VAC	120	208	240
AC Full Load Amps	16.0	9.2	8.0
AC Locked Rotor Amps	96.0	55.2	48.0
Non-Inductive Amps	22 A, 120 to 277 VAC		

Pilot Duty - 125 VA, 24 to 600 VAC

Part #	Mfg #	Switch Action	Range	Diff	Bulb & Capillary	Range Adjuster	Price
PENA19BBC2	A19BBC-2C	SPDT	-30° to 100°F	3° to 12°F	1-3/8" x 2-1/4" Coiled	Convertible	169.76

All Items May Not Be Stocked In All Branches

Refrigeration Controls

A419 Series - Electronic Temperature Control with Display

- Single-stage SPDT output relay
- Displays temperature and other function status
- Setpoint range: -30 to 212°F
- Allows the user to quickly change setpoint, differential, and other functions
- Lockable front-panel touchpad
- High-impact thermoplastic
- A99 Sensor included with all models
- For use with:
 - Freezer control in convenience stores
 - Reach-in coolers
 - Boiler control
 - Pump control for cooling towers
 - Compressor lockout (disables the compressor when temperature exceeds limits)
 - Supermarket display cases for produce or meats
 - Restaurant or convenience store walk-in coolers
 - Condenser fan cycling
 - Space and return air temperature



Electrical Ratings

Applied Voltage	120 V N.O. (N.C.)	208 V N.O. (N.C.)	240 V N.O. (N.C.)
Horsepower	1 (1/4)	1 (1/3)	1 (1/2)
Full Load Amps	16.0 (5.8)	9.2 (4.0)	8.0 (4.9)
Locked Rotor Amps	96.0 (34.8)	55.2 (24)	48.0 (29.4)
Non-Inductive Amps	15.0 (10)	10.0 (10)	10.0 (10)

Pilot Duty - 125 VA (N.O. contacts) @ 24 to 240 VAC; 125 VA (N.C. contacts) @ 120 to 240 VAC; 50 VA (N.C. contacts) @ 24 VAC

Part #	Mfg #	Lead Length	Description	Price
PENA419ABC1	A419ABC-1C	6-1/2'	120/240 VAC Line Voltage, NEMA 1 Enclosure	129.94

A99B Series Temperature Sensor

- A99B Series Temperature Sensors are passive PTC
- Applications include temperature sensing for freezers and coolers, as well as in defrost termination sensing, space and return air temperature sensing, and condenser fan cycling
- Splashproof & designed to measure temperature in a variety of refrigeration applications



Part #	Mfg #	Description	Range °F	Cable Length	Price
PENA99BB300C	A99BB-300C	PTC Silicon Sensor with PVC Cable	-40 to 212	9-3/4'	47.72

Water Valve Renewal Kits

Commercial Kit

- Renewal kits for V46A, V46N, V47Am & V47N Series valves
- Kits include:
 - Seat
 - Disc
 - Diaphragms
 - All additional internal parts required to recondition the valves

Part #	Mfg #	Valve Size	Price
PENSTT14A600R	STT14A-600R	3/8"NPT for V46, V47	111.94
PENSTT18A600R	STT18A-600R	2" ASME Flange	685.36

Prices & Specifications are Subject to Change.

Refrigeration Controls

Refrigeration Controls

System 450™ Modular Controls

- Custom control systems for a wide variety of heating, ventilation, air conditioning, refrigeration (HVACR) and commercial/industrial process applications
- Replaces System 350™ control system and System 27
- Each module is designed for use in temperature, pressure and humidity systems
- Backlit LCD and 4-button touchpad user interface
- Up to 3 input sensors and up to 10 outputs (relay or analog)



System 450™ Control Module with Relay Output

- -40° to 150°F Operating temperature
- Output relay contacts: 1/2 hp at 120/240VAC, SPDT
- Dimensions (H x W x D): 5" x 2-3/8" x 2-3/8"

Part #	Mfg #	Switch Action	Description	Price
PENC450CCN1	C450CCN-1C	2 SPDT	Control Module with LCD, Four-Button Touch Pad, Relay Output; Provides Two Relay Outputs (SPDT Line-Voltage Relays) for On/Off Control	237.26

System 450™ Control Module with Proportional Analog Output

Part #	Mfg #	Switch Action	Description	Price
PENC450CQN1	C450CQN-1C	2 Proportional	Control Module with LCD, Four-Button Touch Pad, Analog Output; Provides Two Analog Outputs (0-10VDC or 4-20mA Self-Selecting Signal) for Proportional Control	237.26

System 450™ Relay Output Expansion Module

- -40° to 150°F Operating temperature
- Output relay contacts: 1/2 hp at 120/240VAC, SPDT
- Dimensions (H x W x D): 5" x 2-3/8" x 2-3/8"

Part #	Mfg #	Switch Action	Description	Price
PENC450SCN1	C450SCN-1C	2 SPDT	Relay Output Expansion Module; Provides Two Relay Outputs (SPDT Line-Voltage Relays) for On/Off Control	175.58

System 450™ Proportional Analog Output Expansion Module

Part #	Mfg #	Switch Action	Description	Price
PENC450SQN1	C450SQN-1C	2 Proportional	Analog Output Expansion Module; Provides Two Analog Outputs (0-10VDC or 4-20mA Self-Selecting Signals) for Proportional Control	175.58

System 450™ Power Module

- -40° to 150°F Operating temperature
- Dimensions (H x W x D): 5" x 2-3/8" x 2-3/8"

Part #	Mfg #	Supply Power	Secondary Power	Price
PENC450YNN1	C450YNN-1C	110/120VAC	24VAC	66.44

All Items May Not Be Stocked In All Branches

Refrigeration Controls

Replacement Parts and Accessories

Part #	Mfg #	Description	Price
PENHE67S30N0BT	HE67S3-0N0BT	TrueRH™ Wall Mount Humidity Element w/Silicon Temperature Sensor ±3% RH Accuracy	356.42

Pressure Controls

Lube Oil Pressure Cutout Control (with Time Delay)

- Universal mounting wiring
- Trip-free manual reset
- Ambient compensated time delay
- Non-corrosive refrigerants
- Maximum bellows pressure: 425 psig
- Time delay relay not field replaceable
- For use with:
 - Semi-hermetic compressors



Copeland Compressor

Part #	Mfg #	Time Delay	Circuit Heater VAC	Factory Setting psid	Pressure Connection	Price
PENP45NCA12	P45NCA-12C	120 Sec	120/240	9	36" Cap, 1/4" Flare Nut	327.12

P70 Series - Single Pole Low Pressure Control

- Full adjustability through all pressure ranges
- Minimum differential
- Includes a universal mounting bracket
- For use with:
 - Air conditioning and refrigeration applications
 - Controls of air, water, and oil pressure



Micro-Set™ for R-12, R-22, R134A, R-500, R-502 (R)

Part #	Mfg #	Switch Action	Range PSIG	Diff PSI	Max Over-pressure PSIG	Limited Knob Adj	Pressure Connection	Price
PENP70AB12	P70AB-12C	SPST Open Low	12 to 80	5 - 35	525	Cut Out*	36" Cap, 1/4" Flr Nut	156.52

* Supplied, but not assembled

"All Range" for R-12, R-22, R134A, R-500, R-502 (R)

Part #	Mfg #	Switch Action	Range PSIG	Diff PSI	Max Over-pressure PSIG	Limited Knob Adj	Pressure Connection	Price
PENP70AB1	P70AB-1C	SPST Open Low	20 to 100	7 - 50	325	Cut Out*	1/4" Male Flr Nut	149.66
PENP70AB2	P70AB-2C	SPST Open Low	20 to 100	7 - 50	325	Cut Out*	36" Cap, 1/4" Flr Nut	156.52
PENP70CA1	P70CA-1C	SPST Open High	20 to 100	7 - 50	325	None	36" Cap, 1/4" Flr Nut	168.98

* Supplied, but not assembled

Refrigeration Controls

Prices & Specifications are Subject to Change.

Refrigeration Controls

P70 Series - Single Pole High Pressure Control

- Full adjustability, minimum differential
- Long life contact structure, no bounce on make
- Manual reset models are "trip-free"
- Includes a universal mounting bracket
- For use with:
 - Air conditioning and refrigeration
 - Controls of air, water, and oil pressure



Condenser Fan Cycling Controls for R-12, R-22, R134A, R-500, R-502 (R)

Part #	Mfg #	Switch Action	Range PSIG	Diff PSI	Max Over-pressure PSIG	Limited Knob Adj	Pressure Connection	Price
PENP70AA118	P70AA-118C	SPST Open Low	100 to 400	35 - 200	475	None	36" Cap, 1/4" Flr Nut	150.20

"All Range" for R-12, R-22, R134A, R-500, R-502 (R)

Part #	Mfg #	Switch Action	Range PSIG	Diff PSI	Max Over-pressure PSIG	Limited Knob Adj	Pressure Connection	Price
PENP70DA1	P70DA-1C	DPST Open High	50 to 500	L/O Manual Reset	525	None	36" Cap, 1/4" Flr Nut	174.50

Models for High Pressure Non-Corrosive Refrigerants: R-12, R-22, R134A, R-500, R-502 (R)

Part #	Mfg #	Switch Action	Range PSIG	Diff PSI	Max Over-pressure PSIG	Limited Knob Adj	Pressure Connection	Price
PENP70AA2	P70AA-2C	SPST Opens Low	0 to 150	10 - 70	325	None	36" Cap, 1/4" Flr Nut	160.04
PENP70AA400	P70AA-400C	SPST Opens Low	100 to 470	35 to 200	690	None	36" Cap, 1/4" Flr Nut	150.20
PENP70DA400	P70DA-400C	SPST Opens High	200 to 610	L/O Manual Reset	690	None	36" Cap, 1/4" Flr Ftg	167.30

Refrigeration Controls

P70 Series - Single Pole Dual Pressure Control

- Full adjustability
- Minimum differential
- Long life contact structure, contact break is a hammer blow
- Manual reset models are "trip-free"
- Includes a universal mounting bracket
- Pressure connector: 36" capillary w/ 1/4" flare nut
- For use with:
 - Air conditioning and refrigeration applications
 - Control of air, water, and oil pressure



"All Range" for R-12, R-22, R134A, R-500, R-502 (R)

Part #	Mfg #	Switch Action	Low Pressure Range psig	Low Pressure Diff psig	High Pressure Range psig	High Pressure Diff psig	Limited Knob Adj	Price
PENP70LB1	P70LB-1C	SPST	20 to 100	7 - 50	100 to 500	Fixed Approx 65	Low Cut-Out	292.70

All Items May Not Be Stocked In All Branches

Refrigeration Controls

P72 Series - Two Pole Dual Pressure Controls

- Direct reading scale
- Adjustable differential
- DPST Switch action
- Full adjustability for all non-corrosive refrigerant pressure applications
- Includes universal mounting bracket
- For use with:
 - Polyphase motors
 - Multiple system set-ups
- Pressure connector: 36" Capillary with 1/4" flare nut



Electrical Ratings

Motor Ratings VAC	120 @ 1 Ohm	208 @ 1 Ohm	240 @ 1 Ohm	220 @ 2 Ohms	208 @ 3 Ohms	220 @ 3 Ohms
Horsepower	2	3	3	5	5	5
AC Full Load Amps	24	18.7	17.0	15.0	15.9	15.0
AC Locked Rotor Amps	144	112.2	102.0	90.0	95.4	90.0
AC Non-Inductive Amps	24.0	24.0	24.0	24.0	24.0	24.0
DC Non-Inductive Amp	3	0.5	0.5	0.5	0.5	0.5

Pilot Duty - 125 VA, 120 to 600 VAC and 57.5 VA, 120 to 300 VDC

"All-Range" for R-12, R-22, R134A, R-500, R-502 (R)

- Max bellows overrun pressure psig (kPa): 525 low, 3620 high (525 low, 3620 high)

Part #	Mfg #	Low Press psig (kPa)		High Press psig (kPa)		Knob Adj	Price
		Range	Diff	Range	Diff(Non-Adj)		
PENP72MA1	P72MA-1C	20 to 100	7 - 50	100 to 500	Lockout - Man Reset	None	401.34

Pressure Sensors & Accessories

P100 Series - Encapsulated Pressure Switch

- Compact size and light weight allow for direct mounting
- Encapsulated switch, dust tight
- Manual reset models are "trip-free"
- Electrical connections are made to 48" leads
- 1/4" female flare fitting with built-in Schrader type depressor is standard
- SPST direct mounted
- For use with:
 - All non-corrosive refrigerants
 - Ice machines
 - Food service equipment
 - Low limit, high limit, and fan cycling control in commercial refrigeration
- Pilot Duty – 375 VA at 120/240/277 VAC; 2 amps at 28 VAC/VDC



Electrical Ratings

Ratings VAC	120	240
AC Full Load Amps (FLA)	5.8	2.9
AC Locked Rotor Amps (LRA)	34.8	15.0

Part #	Mfg #	Switch Action	Application	Setting Opens psig	Setting Closes psig	Price
PENP100DA86	P100DA-86C*	Open on Pressure Rise	High Limit	575	L/O Manual Reset	72.96

* Compatible with R410A Refrigerant

Refrigeration Controls

Prices & Specifications are Subject to Change.

Refrigeration Controls

P499 Electronic Pressure Transducer

- Direct-mount
- For use in commercial refrigeration and air conditioning
- Rugged stainless steel construction
- Environmentally sealed electronics



Part #	Mfg #	Description	Price
PENP499RCP107C	P499RCP-107C	0-750 psig, 1/8"-27NPT External Thread (Style 49)	179.08

P499 Electronic Pressure Transducer Kit

- Direct-mount
- For use in commercial refrigeration and air conditioning
- Rugged stainless steel construction
- Environmentally sealed electronics
- Wire harness included (WHA-PKD3-200C)



Part #	Mfg #	Description	Price
PENP499RAP101K	P499RAP-101K	0-100 psig, 1/8"-27NPT External Thread (Style 49), WHA-PKD3-200C Wire Harness	195.00
PENP499RCP105K	P499RCP-105K	0-500 psig, 1/8"-27NPT External Thread (Style 49), WHA-PKD3-200C Wire Harness	199.76
PENP499RAP107K	P499RAP-107K	0-750 psig, 1/8"-27NPT External Thread (Style 49), WHA-PKD3-200C Wire Harness	195.00

Valves

V46 Series - Pressure Actuated Water Regulating Valve

- No close fitting or sliding parts in water passages
- Minimizes chatter or water hammer
- Refrigerant adjustment is not affected by water pressure
- Range spring does not come in contact with cooling water
- 3/8", 1/2", and 3/4" valves may be disassembled and reassembled without detaching from the refrigeration system or without pumping down
- For use with:
 - Ice machines
 - Ice cream machines
 - Computer room air conditioning units
 - Refrigeration cases



Commercial Type, Standard Flow - Non Corrosive Refrigerant

Part #	Mfg #	Pipe Size (NPT)	Inlet And Outlet	Service	Opening Point Range psig	Pressure Element Style	Price
PENV46AA1	V46AA-1C	3/8"	Threaded	All-Range	70 to 260	30" Cap, 1/4" FI Nut	227.64
PENV46AB1	V46AB-1C	1/2"	Threaded	All-Range	70 to 260	30" Cap, 1/4" FI Nut	256.52
PENV46AC1	V46AC-1C	3/4"	Threaded	All-Range	70 to 260	30" Cap, 1/4" FI Nut	309.04
PENV46AD1	V46AD-1C	1"	Threaded	All-Range	70 to 260	30" Cap, 1/4" FI Nut	650.98

All Items May Not Be Stocked In All Branches

Refrigeration Controls

Pneumatic Valves

V-246 Series 2-Way Pressure-Actuated Water-Regulating Valve

- For high-pressure refrigerants
- Regulate water flow to control refrigerant head pressure in systems with water-cooled condensers
- Corrosion-resistant internal parts
- Body rated 150 psig
- Use with standard non-corrosive refrigerants
- Accessible range spring
- Pressure-balanced design
- Element style 5



Part #	Mfg #	Construction	Valve Size and Connection	Price
PENV246GA1001C	V246GA1-001C	Direct Acting, Commercial	3/8" NPT Screw	315.34
PENV246GB1001C	V246GB1-001C	Direct Acting, Commercial	1/2" NPT Screw	342.52
PENV246GC1001C	V246GC1-001C	Direct Acting, Commercial	3/4" NPT Screw	391.42
PENV246GD1001C	V246GD1-001C	Direct Acting, Commercial	1" NPT Screw	633.92
PENV246GE1001C	V246GE1-001C	Direct Acting, Commercial	1-1/4" NPT Screw	739.38



Heatcraft Refrigeration Controls

Beacon System Replacement Part

Part #	Mfg #	Description	Price
BOH28900107	28900107	Temperature Sensor (White)	32.00
BOH28910101	28910101	Beacon II Control Board	582.00

Smart Defrost Kit

- Includes:
 - SDK Control module
 - Temperature sensor cable
 - Pressure transducer cable
 - Transducer
 - Schrader "T" connector
 - (2) Self-tapping screws



Part #	Mfg #	Description	Price
BOHSDK	SDK	Smart Defrost Kit	796.00

Thermostat

SL5708



SL5709



Part #	Mfg #	Description	Price
SUOSL5708L	SL5708	5708L 2 Wire Heater Limit 75°F-40°F Range	49.74
SUOSL5709L	SL5709	5709L 3 Wire Fan & Defrost Termination 55°F-35°F Range	65.58

Prices & Specifications are Subject to Change.

Refrigeration Controls



www.irrsupply.com

Refrigeration Controls

Defrost Controls

Part #	Mfg #	Description	Price
CHA7075819	7075819	Defrost Termination Fan Switch, 3-Wire, 3/8" Tube Mount, Klixon Type	73.00



Electromechanical Time Controls

MIL 72 Series Time Control

- For light commercial use
- SPDT 21A Switch rating @ 250V Res
- True clock face
- Captive triggers with interval of 15 minutes
- Surface, flush, or DIN rail mount



Part #	Mfg #	Type	Input Voltage	Min On/Off	Event On/Off	Control	Price
GRNMIL72ASTUZ120	MIL72A STuZ-120	Synchronous less Override	120VAC	15 min	ON 1/4 hr	24 hr	87.46
GRNMIL72ASTUZ240	MIL72A STuZ-240	Synchronous less Override	208/240VAC	15 min	ON 1/4 hr	24 hr	89.12

* Quartz units also operate on DC voltages down to 12VDC

Time Switches

General Purpose Time Switch

- NEMA 3R Enclosure standard
- Power and status LED indicators
- Real-time clock face with On/Off/Auto override switch
- Ground lug termination



Part #	Mfg #	Switch Program	Carry-Over	Program On/Off Every	Minimum On/Off Time	Switch Output Type	Price
GRNGM40	GM40	24 hr	120V, 208/240V, 277V	15 min	15 min	SPDT/DPDT	132.70

Defrost Controls

DTAV40 Auto Multi-Voltage DT Defrost Timer

- Mechanical
- Automatically detect the appropriate voltage between 120V and 240VAC
- Reduces potential wiring errors and installation time
- Time initiated and temperature, pressure, or time terminated
- LED Indicators for defrost or refrigeration cycles
- 40 Amp



Part #	Mfg #	Voltage	Timer	Battery Backup	Defrost Freq No/Day	Defrost Duration	Min Duration Interval	Price
GRNDTAV40	DTAV40	120V,208/240V	Synchronous	No	1 to 24	15-180 min	15 min	198.92

All Items May Not Be Stocked In All Branches

Refrigeration Controls

24-Hour Timers

Indoor T100 Series HD Mechanical Time Switch

- For loads up to 40A resistive from 120 to 480V providing direct 24-hour time switch control of most loads
- Provides 1 to 12 On/Off operations each day with a minimum On/Off time of 1 hour
- Includes (1) On and (1) Off trippers
- Drawn steel case in gray finish



Part #	Mfg #	Switch	Volts	HP	Price
GRNT101	T101	SPST	125V	2	128.50
GRNT104	T104	DPST	208-277V	5	159.10

Refrigeration Temperature Controls

Remote Temperature Control

- Provide positive control of refrigeration applications where remote control is desired
- Hydraulic action element
- Adjustable element
- Temperature dial evenly calibrated in °F & °C
- Dustproof steel case with top & bottom knockouts
- Easy to wire screw terminals
- Bulb mounting clamp included with all models



Part #	Mfg #	Temp Range	Differential	Switching	Capillary Length	Price
WHR1609101	1609-101	-30° - +90°F	Adj 3.5° - 40°F	Close on Rise	5'	103.47

Refrigeration Controls

Service Starts Here at Irr Supply!

Refrigeration Controls

Time & Energy Controls

4000 Series 24-Hour Timer

- 90 Minute minimum on or off time
- 1 to 7 On/Off operations per day
- Positive, heavy-duty switching is ensured by 40A rating per pole with a switch slider bar
- UL & CSA Listed



NEMA 1 Indoor Metal Enclosure

Part #	Mfg #	Switch Type	HP	AC Line Volts	Price
PAR40010	4001-00	SPST	2	120	118.72
PAR400471	4004-71	DSPT	2	208-277	148.26

9140/9145 Universal Electronic Defrost Timer

- Real-time clock
- Initiate 15 minute manual defrost
- System status indicators
- Lighted display
- 100 Hours of power loss protection for both time and defrost schedule
- Certified to UL873 Standard for temperature-indicating and regulating equipment as refrigeration controllers
- Wires directly to 120VAC, 208VAC or 230VAC power sources without jumpers or switches
- Easy programming, easy set-up, set time, set defrost start and defrost end
- Display shows defrost start time and duration



Part #	Mfg #	Description	Price
PAR914500	9145-00	Time Initiate/Time Terminate w/Metal Enclosure	298.20

Commercial Refrigeration Defrost Controls

600 Series Defrost Control

- Initiation is adjustable from 1 - 8 cycles per day; 3 hr between successive cycles
- 3 - 45 Minutes defrost cycle; 3 minute graduation



Part #	Mfg #	Description	Price
PAR6320	632-00	120V Defrost Control	528.97
PAR63220	632-20	208-277V Defrost Control	539.63

Electronic Refrigeration Control

ERC-2 Electronic Refrigeration Control

- Microprocessor-based controller manages all temperature & defrost functions of commercial refrigeration equipment
- Integrated control unit replaces up to 5 different devices
- High/low temperature alarms
- Includes: (2) NTC thermistor sensors
- Usable with electric heat, hot gas or off-cycle defrost
- Temperature setpoint range: -40° to 60°F
- 120 or 208/240VAC 50/60Hz operation
- UL, NSF Approved



Part #	Mfg #	Description	Price
PARERC2	ERC2-212111-370	NEMA 1 Case with Integrated Display	398.62



Tattle-Tale Control Monitor

- Single use monitoring device for determining which safety control has opened in response to malfunction



TT-24

Part #	Mfg #	Description	Price
WAGTT24	TT-24	24V AC or DC	8.94
WAGTT120	TT-120	120V AC or DC	8.94

Refrigeration Controls

Refrigeration Controls

TA Series Temperature Alarms

- Adjustable alarm temperature range from -10°F - +80°F
- Built-in terminals for remote alarm or telephone dialer connection
- Applications: refrigerators, freezers & environmental areas

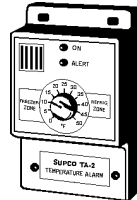

TA2 Single Set Point Temperature Alarm

- For refrigerators and freezers
- Adjustable range from -10°F to +80°F

Part #	Mfg #	Description	Price
SUOTA2	TA2	110 VAC Fahrenheit Model	190.76

TA7 Battery Operated Temperature Alarms

- For sensitive temperature applications in remote areas
- Alarms on rise in temperature only
- Adjustable range from -10°F to +80°F



Part #	Mfg #	Description	Price
SUOTA7	TA7	Fahrenheit Model	78.46

Delay Timers

TD69 Series Delay on Make Timer

- Upon application of power the time delay is initiated
- On completion of selected delay period the load is energized
- For manual reset, turn thermostat off or shut off main power
- 1/4" Male terminal connections



Part #	Mfg #	Delay Period	Price
SUOTD69	TD69	Adj 6 Sec - 8 Min	9.26

TD73 Series Delay on Break Timer

- Upon application of power, current goes through the TD73 & energizes the compressor
- The time delay is initiated when the thermostat opens or when there is a power interruption
- The compressor relay cannot restart until the delay time has expired
- 2" x 2" x 3/4" size
- (2) 1/4" Male terminal connections



Part #	Mfg #	Delay Period	Price
SUOTD73	TD73	Adj 6 Sec - 5 Min	9.26

Defrost Controls

Commercial Refrigeration Defrost Control

- Heavy-duty synchronous motor
- Adjustable defrost initiation frequency: one to six times per day
- Adjustable defrost cycle duration: 4 to 110 minutes in two-minute increments
- Electric heat, hot gas, or off cycle defrost available
- Heavy-duty steel case with electrical knockouts in the sides, back and bottom



Part #	Mfg #	V	SW	Termination Temp		Price
				Time	/Prs	
SUO80450	S804500	120	1NO/1NC	Yes	No	270.16
SUO804520	S804520	240	1NO/1NC	Yes	No	278.73
SUO81410	S814100	120	1NO/2NC	No	Yes	319.75
SUO814120	S814120	240	1NO/2NC	No	Yes	332.19
SUO81450	S814500	120	1NO/1NC	No	Yes	290.37
SUO814520	S814520	240	1NO/1NC	No	Yes	300.64

EDT Series Electronic Adj Defrost Timer

- Replaces most timers on today's refrigerators/freezers



Part #	Mfg #	Description	Price
SUOEDT10	EDT10	115V 1/3 hp 10 Amp Load	43.80

Pressure Switches

- For refrigeration, air conditioning, and heat pump systems
- 1/4" Female SAE connection
- Pressure range: 0 to 650 psi
- Burst pressure: 5000 psi
- Life @ rated load: 100,000 cycles
- 24/120/240V, 50/60Hz



Low Pressure Switch - SPST Open on Fall

Part #	Mfg #	Open	Close	Tolerance	Price
		PSI	PSI		
SUOSLP0520	SLP0520	5	20	+/- 5 psi	24.96
SUOSLP0530	SLP0530	5	20	+/- 5 psi	24.96
SUOSLP1025	SLP1025	10	25	+/- 5 psi	24.96
SUOSLP2045	SLP2045	20	45	+/- 5 psi	24.96

Refrigeration Controls

Prices & Specifications are Subject to Change.

Refrigeration Controls

Pressure Switches (Continued)

Low Pressure Switch - SPST Open on Fall

Part #	Mfg #	Open PSI	Close PSI	Tolerance	Price
SUOSLP2550	SLP2550	25	50	+/- 5 psi	24.96
SUOSLP2565	SLP2565	25	65	+/- 5 psi	24.96
SUOSLP2580	SLP2580	25	80	+/- 5 psi	24.96
SUOSLP4080	SLP4080	40	80	+/- 5 psi	24.96

High Pressure Switch - SPST Open on Rise

Part #	Mfg #	Open PSI	Close PSI	Tolerance	Price
SUOSHP300200	SHP300200	300	200	+/- 15 psi	24.96
SUOSHP350250	SHP350250	350	250	+/- 15 psi	24.96
SUOSHP400300	SHP400300	400	200	+/- 15 psi	24.96
SUOSHP610420	SHP610420	610	420	+/- 15 psi	24.96

Manual Reset HP Switch

Part #	Mfg #	Open PSI	Close PSI	Tolerance	Price
SUOSMR610	SMR610	610	-	+/- 15 psi	37.52

Fan Cycling Switch - SPST Open on Rise

Part #	Mfg #	Open PSI	Close PSI	Tolerance	Price
SUOSFC210275	SFC210275	210	275	+/- 15 psi	24.96
SUOSFC300400	SFC300400	300	400	+/- 15 psi	24.96

Manual Reset High Pressure Switches

- Open on pressure rise
- 1/4" Female SAE connection
- Bistable disc
- Environmentally sealed sensors
- Line mount with mechanical fittings
- Pressure range: 200 - 500 psi
- Burst pressure: 3500 psi
- 24/120/240V, 50/60Hz

Part #	Mfg #	Open PSI	Tolerance	Price
SUOSMR410	SMR410	410	+/- 15 psi	37.52



Head Pressure Controls

ICM326H Single-Phase Head Pressure Control

- 120 or 208/240VAC Line input, 50/60Hz
- Built in transformer
- Helps prevent evaporator freeze-ups, low pressure cut-outs and liquid-slugged compressors in low ambient conditions
- Features: hard start, low temp cutoff, high temperature bypass
- Ideal for line voltage air conditioning and refrigeration



Part #	Mfg #	Description	Price
ICM326HM	ICM326HM	120 or 208/240VAC, Mitsubishi	250.68

ICM326HN Single-Phase Head Pressure Control

- 120 or 208/240VAC Line input, 50/60Hz
- Built in transformer
- Helps prevent evaporator freeze-ups, low pressure cut-outs and liquid-slugged compressors in low ambient conditions
- Features: hard start, low temp cutoff, high temperature bypass
- Ideal for line voltage air conditioning and refrigeration
- RoHS Compliant, lead free design



Part #	Mfg #	Description	Price
ICM326HC	ICM326HNC	120/208/240VAC, RoHS, Clamshell Pkg	222.94

ICM327H Single-Phase Head Pressure Control

- 480VAC Line input, 50/60Hz
- Built in transformer
- Helps prevent evaporator freeze-ups, low pressure cut-outs and liquid-slugged compressors in low ambient conditions
- Features: hard start, low temp cutoff, high temperature bypass
- Ideal for line voltage air conditioning and refrigeration



Part #	Mfg #	Description	Price
ICM327HC	ICM327HC	480VAC, Clamshell Pkg	236.88

All Items May Not Be Stocked In All Branches



www.irrsupply.com

Filter Driers

Catch-All® Filter-Driers

"CSG" Series Catch-All® Filter-Drier

- Combines Catch-All system protection with See-All (SA-13S) easy-to-read system monitoring
- Easy to read system monitoring
- Combined unit replaces (2) field-braze joints with factory-tested leak-free design
- Reduces copper connecting tube and braze material



Part #	Mfg #	Order #	SAE Flare Conn	Volume of Dessicant Cu In	OAL	Surface Filtering Area (sq in)	Dia of Body	Price
SPOCSG083S	CSG-083-S	409993	3/8" ODF	9	-	21	-	80.66
SPOCSG163S	CSG-163-S	409991	3/8" ODF	16	-	33	-	91.94

"C" Series SAE Flare Liquid Line Catch-All® Filter-Drier - Sealed Type

- Maximum rated pressure of 500 psi
- Unexcelled in acid removal
- Will filter out scale, solder particles, carbon, sludge, dirt, or any foreign matter with negligible pressure drop
- Removes moisture from the refrigerant by absorbing and retaining it deep within the desiccant granules



Part #	Mfg #	Order #	SAE Flare Conn	Volume of Dessicant Cu In	OAL	Surface Filtering Area (sq in)	Dia of Body	Price
SPOC032	C-032	400000	1/4"	3	4.19"	9	1.75"	21.12
SPOC032F	C-032-F	400016	1/4" FI Nut	3	3.81"	9	1.75"	21.90
SPOC032FM	C-032-FM	400032	1/4" FI Nut x M	3	3.81"	9	1.75"	21.90
SPOC033	C-033	400088	3/8"	3	4.69"	9	1.75"	22.86
SPOC052	C-052	400200	1/4"	5	4.75"	15	2.44"	26.64
SPOC053	C-053	400288	3/8"	5	5.19"	15	2.44"	26.64
SPOC082	C-082	400416	1/4"	9	5.62"	21	2.62"	32.70
SPOC083	C-083	400472	3/8"	9	6.06"	21	2.62"	32.70
SPOC084	C-084	400536	1/2"	9	6.31"	21	2.62"	34.14
SPOC162	C-162	401000	1/4"	16	6.25"	33	3.00"	41.92
SPOC163	C-163	401048	3/8"	16	6.75"	33	3.00"	41.92
SPOC164	C-164	401128	1/2"	16	6.94"	33	3.00"	45.80
SPOC165	C-165	401216	5/8"	16	7.25"	33	3.00"	47.36
SPOC303	C-303	401328	3/8"	30	9.69"	53	3.00"	74.98
SPOC304	C-304	401360	1/2"	30	9.88"	53	3.00"	74.98
SPOC305	C-305	401408	5/8"	30	10.19"	53	3.00"	74.98
SPOC414	C-414	401624	1/2"	41	9.94"	67	3.50"	109.60
SPOC415	C-415	401656	5/8"	41	10.25"	67	3.50"	109.60

Filter Driers, Shells, Core

Prices & Specifications are Subject to Change.



www.irrsupply.com

Filter Driers

"C" Series ODF Solder Liquid Line Catch-All® Filter-Drier - Sealed Type

- Maximum rated pressure of 500 psi
- Unexcelled in acid removal
- Will filter out scale, solder particles, carbon, sludge, dirt, or any foreign matter with negligible pressure drop
- Removes moisture from the refrigerant by absorbing and retaining it deep within the desiccant granules



Part #	Mfg #	Order #	SAE Flare Conn	Volume of Dessicant Cu In	OAL	Surface Filtering Area(sq in)	Dia of Body	Price
SPOC032CAPT	C-032-CAPT	400072	1/4" Extd Male	3	5.81"	9	1.75"	35.62
SPOC032S	C-032-S	400052	1/4"	3	5.81"	9	1.75"	21.12
SPOC033S	C-033-S	400001	3/8"	3	3.88"	9	1.75"	22.86
SPOC052S	C-052-S	400249	1/4"	5	4.19"	15	2.44"	26.64
SPOC052CAPT	C-052-CAPT	400253	1/4" Extd Male	5	4.19"	15	2.44"	59.38
SPOC053S	C-053-S	400329	3/8"	5	4.31"	15	2.44"	26.64
SPOC082S	C-082-S	400429	1/4"	9	5.12"	21	2.62"	33.72
SPOC083S	C-083-S	400503	3/8"	9	5.25"	21	2.62"	32.70
SPOC084S	C-084-S	400437	1/2"	9	5.44"	21	2.62"	34.14
SPOC162S	C-162-S	401018	1/4"	16	5.75"	33	3.00"	42.92
SPOC163S	C-163-S	401021	3/8"	16	5.88"	33	3.00"	41.92
SPOC164S	C-164-S	401023	1/2"	16	6.00"	33	3.00"	45.80
SPOC165S	C-165-S	401035	5/8"	16	6.31"	33	3.00"	47.36
SPOC303S	C-303-S	401305	3/8"	30	8.88"	53	3.00"	75.96
SPOC304S	C-304-S	401307	1/2"	30	9.00"	53	3.00"	74.98
SPOC305S	C-305-S	401449	5/8"	30	9.25"	53	3.00"	74.98
SPOC307S	C-307-S	401505	7/8"	30	9.80"	53	3.00"	81.94
SPOC414S	C-415-S	401609	5/8"	41	9.35"	67	3.50"	109.60
SPOC415S	C-415-S	401610	5/8"	41	9.35"	67	3.50"	109.60
SPOC417S	C-417-S	401614	7/8"	41	9.81"	67	3.50"	109.60
SPOC419S	C-419-S	401618	1-1/8"	41	9.75"	67	3.50"	118.76
SPOC607S	C-607-S	401837	7/8"	60	16.00"	106	3.00"	147.88
SPOC609S	C-609-S	401865	1-1/8"	60	16.00"	106	3.00"	169.02

"C" Series ODF Solder Suction Line Catch-All® Filter-Drier - Sealed Type

- Includes access pressure tap fitting

Part #	Mfg #	Order #	ODF Solder Conn	Vol of Dessicant	OAL	Dia Of Body	Recommended Tons R-22	Price
SPOC053STHH	C-053-S-T-HH	400214	3/8"	5	4.31"	2.44"	-	41.62
SPOC083STHH	C-083-S-T-HH	400436	3/8"	9	5.44"	2.62"	1.0	47.10
SPOC084STHH	C-084-S-T-HH	400441	1/2"	9	5.44"	2.62"	1.0	47.10
SPOC164STHH	C-164-S-T-HH	401026	1/2"	16	6.00"	3.00"	2.0	67.76
SPOC165STHH	C-165-S-T-HH	401029	5/8"	16	6.31"	3.00"	2.0	70.22
SPOC166STHH	C-166-S-T-HH	401030	3/4"	16	6.75"	3.00"	2.0	75.34
SPOC167STHH	C-167-S-T-HH	401033	7/8"	16	6.93"	3.00"	3.0	75.34
SPOC305STHH	C-305-S-T-HH	401311	5/8"	30	9.25"	3.00"	3.0	110.82
SPOC306STHH	C-306-S-T-HH	401314	3/4"	30	9.65"	3.00"	3.0	116.48
SPOC307STHH	C-307-S-T-HH	401316	7/8"	30	9.80"	3.00"	5.0	116.48
SPOC309STHH	C-309-S-T-HH	401318	1-1/8"	30	9.75"	3.00"	5.0	124.56
SPOC419STHH	C-419-S-T-HH	401619	1-1/8"	41	9.75"	3.50"	7.5	159.02
SPOC4311STHH	C-4311-S-T-HH	401816	1-3/8"	48	10.94"	4.75"	10.0	257.70

All Items May Not Be Stocked In All Branches

Filter Driers, Shells, Core



www.irrsupply.com

Filter Driers

"C" Series Liquid Line & Suction Line Driers - Replaceable Core Type

ODF Solder Replaceable Core Liquid Line/Suction Line Driers

- Maximum rated pressure of 500 psi
- Molded porous core for maximum containment removal
- G - Indicates supplied 1/4" female pipe connection in the end plate & pipe plug
- Bolt and nut attachment of the end plate gives simple trouble-free installation
- Corrosion resistant powder paint protects the exterior of the shell



Part #	Mfg #	Order #	ODF Solder Conn	Core Nbr(s)	OAL	Surface Filtering Area(sq in)	Dia of Body	Recomm(Tons R-22) A/C Field Repl	Price
SPOC485G	C-485-G	402082	5/8"	(1) RCW-48(a)	9.15"	64	6.00"	10.0	383.32

(a) RCW-48, RC-4864 or RC-4864-HH

(b) RCW-100, RC-10098 or RC-10098-HH

HH Style - Sealed Type with HH Cores

- For wax removal
- Charcoal style core for wax removal & clean-up after a hermetic motor burnout



Part #	Mfg #	Order #	Conn	Volume of Dessicant Cu In	OAL	Surface Filtering Area(sq in)	Dia of Body	Price
SPOC052HH	C-052-HH	400232	1/4" SAE	5	4.75"	2.44"	15	34.16
SPOC082HH	C-082-HH	400424	1/4" SAE	9	5.62"	2.62"	21	38.78
SPOC083HH	C-083-HH	400488	3/8" SAE	9	6.06"	2.62"	21	38.78
SPOC162HH	C-162-HH	401008	1/4" SAE	16	6.25"	3.00"	33	49.26
SPOC163HH	C-163-HH	401080	3/8" SAE	16	6.75"	3.00"	33	49.26
SPOC163SHH	C-163-S-HH	401022	3/8" ODF	16	5.88"	3.00"	33	49.26
SPOC164HH	C-164-HH	401152	1/2" SAE	16	6.94"	3.00"	33	53.80
SPOC165HH	C-165-HH	401232	5/8" SAE	16	7.25"	3.00"	33	55.52
SPOC303HH	C-303-HH	401336	3/8" SAE	30	9.69"	3.00"	53	95.00
SPOC304HH	C-304-HH	401376	1/2" SAE	30	9.88"	3.00"	53	95.00

Refrigeration System Sealed Type with HH Core and Capillary Tubing

- For wax and resin materials removal
- Uses "3 stage filtration" to capture even the smallest particles of solid debris

Part #	Mfg #	Order #	Conn	Volume of Dessicant Cu In	OAL	Surface Filtering Area(sq in)	Dia of Body	Price
SPOC052CAPTTTH	C-052-CAP-TT-HH	400219	1/4" ODF Extd	5	-	-	-	54.74

Compact Style Suction Line - Sealed Typed

- Excellent field performance in cleaning severely contaminated systems
- Suitable with HFC, HCFC, and CFC refrigerants
- Molded porous core
- Very smooth, strong, entirely leakproof joint



Part #	Mfg #	Order #	ODF Solder Connection	Overall Length	Dia of Body	----Selection Recomm.(HP)---- R-12, 134A, 404A R-22/407C		Price
SPOC146STTHH	C-146-S-TT-HH	400806	3/4"	4.83"	4.44"	3	2	85.20
SPOC147STTHH	C-147-S-TT-HH	400811	7/8"	4.97"	4.44"	5	3	87.62

Filter Driers, Shells, Core

Prices & Specifications are Subject to Change.



www.irrsupply.com

Filter Driers

Drier Shell

- Internal assembly can be used with or without the secondary filter
- Type of filtration needed depends upon the system requirements or application
- Molded cores simply slide over the center tube, followed by spacer plates
- Seal gasket prevents solid contaminants from bypassing the filter
- Complete line of fitting sizes available with solder connections from 1/2" to 4-1/8"ODF
- Pipe connections from 1/2" to 2"
- UL Listed heavy steel shells
- Epoxy powder coated exterior shell



Part #	Mfg #	Order #	ODF Solder Connection	No of Cores	Volume of Dessicant	Dimensions	Weight	Price
SPOC487G	C-487-G-T/C	402109	7/8" ODF	1	48 cu in	9.30" x 6"	10 lbs	383.32
SPOC489G	C-489-G-T/C	402152	1-1/8" ODF	1	48 cu in	9.50" x 6"	10 lbs	406.26
SPOC967G	C-967-G-T/C	402251	7/8" ODF	2	96 cu in	14.84" x 6"	14 lbs	446.72

Reversible Heat Pump Filter-Driers - Sealed Type

For New Installation and HFC System Use

- Short overall length direction with low pressure
- Sporlan molded core
- Drier operates in either flow
- Core volume is 10 cubic inches
- Core surface filtering area is 18 square inches
- Maximum rated pressure is 650 psig

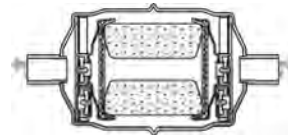

Part #	Mfg #	Order #	ODF Solder Connection	Overall Length	Dia of Body	Selection Recommendation Tons	Price
SPOHPC103	HPC-103	404080	3/8" SAE	6.75"	3.00"	1.0 - 5.0	59.02
SPOHPC103S	HPC-103-S	404101	3/8" ODF	5.88"	3.00"	1.0 - 5.0	59.02
SPOHPC104S	HPC-104-S	404161	1/2" ODF	6.00"	3.00"	1.0 - 5.0	60.02

For Clean-Up After Burn-Out

- Charcoal style core
- Core volume is 14 cubic inches
- Core surface filtering area is 26 square inches
- Maximum rated pressure is 500 psig

Filter Driers, Shells, Core

Part #	Mfg #	Order #	ODF Solder Connection	Overall Length	Dia of Body	Selection Recommendation Tons	Price
SPOHPC163SHH	HPC-163-S-HH	404201	3/8" ODF	6.92"	3.00"	1.0 - 5.0	86.66
SPOHPC164HH	HPC-164-HH	404220	1/2" SAE	7.95"	3.00"	1.0 - 5.0	88.06
SPOHPC165HH	HPC-165-HH	404260	5/8" SAE	8.28"	3.00"	1.0 - 5.0	90.16

All Items May Not Be Stocked In All Branches



www.irrsupply.com

Filter Driers

Suction Filters

Exclusive Bi-Directional Feature less Access Pressure Tap Fitting

- Protects the compressor from dirt
- Suitable for use with all brazing alloys
- Full flow design for low pressure drop
- A relief device opens if the filter plugs
- Maximum corrosion resistance
- Complete line of sizes
- 3.00" Length



With Bypass Relief Feature (Bi-Directional Flow)

Part #	Mfg #	Order #	Conn	Filter Area Sq In	Overall Area Sq In	-----Nominal System HP-----		Notes	Price
						R-22/407C	R-12, 134A, 404A 502, 507		
SPOSF285T	SF-285-T	800037	5/8" ODF	28	8.34"	4	1-1/2	With Access Valve	82.48
SPOSF285FT	SF-285F-T	800049	5/8" SAE	28	8.34"	4	1-1/2	With Access Valve	82.48
SPOSF286T	SF-286-T	800001	3/4" ODF	28	8.79"	5	1-1/2	With Access Valve	89.14
SPOSF287T	SF-287-T	800002	7/8" ODF	28	8.93"	7-1/2	3	With Access Valve	89.14
SPOSF289T	SF-289-T	800006	1-1/8" ODF	28	9.51"	7-1/2	5	With Access Valve	94.80
SPOSF489T	SF-489-T	800120	1-1/8" ODF	48	12.42"	10	5	With Access Valve	137.66
SPOSF4811T	SF-4811-T	800008	1-3/8" ODF	48	13.10"	12	5	With Access Valve	137.66
SPOSF4813T	SF-4813-T	800011	1-5/8" ODF	48	13.44"	15	7	With Access Valve	140.86

Without Bypass Relief Feature (Single Flow Direction)

Part #	Mfg #	Order #	Conn	Filter Area Sq In	Overall Area Sq In	-----Nominal System HP-----		Price
						R-22/407C	R-12, 134A, 404A 502, 507	
SPOSF114	SF-114	800012	1/2" ODF	11	4.36"	1	1/2	42.24

Replaceable Suction Filters

- Recommended for supermarket systems
- Can be used with desiccant cores for clean-up after burnout
- Low pressure drop
- Various fitting sizes up to 3-1/8" line size
- Access valve supplied for pressure drop measurement or charging



Part #	Mfg #	Order #	Filter Conn	Element(s) Part #	Filter Area Sq In	OAL	-----Nominal System HP-----			Price
							R-12/134A	R-22/407C	R-404A, R-502, R-507	
SPORSF489T	RSF-489-T	800501	1-1/8"	(1) RPE-48BD	388	9.37"	8	15	12	352.56
SPORSF4811T	RSF-4811-T	800502	1-3/8"	(1) RPE-48BD	388	9.60"	10	20	15	367.82
SPORSF4813T	RSF-4813-T	800505	1-5/8"	(1) RPE-48BD	388	9.60"	12	25	20	387.22
SPORSF4817T	RSF-4817-T	800506	2-1/8"	(1) RPE-48BD	388	9.60"	20	35	25	431.16
SPORSF9617T	RSF-9617-T	800512	2-1/8"	(2) RPE-48BD	776	15.14"	20	40	30	554.96

Filter Driers, Shells, Core

Prices & Specifications are Subject to Change.



www.irrsupply.com

Filter Driers

Cores Only

For Replaceable Core Catch-All® Filter-Drier

Part #	Mfg #	Description	Price
SPORC4864	RC-4864	48 cu in Activated Core Fits C-480 thru C-19200 & RSF Shells, Molded Desiccant	46.68
SPORC4864HH	RC-4864-HH	48 cu in Activated Charcoal Core Fits C-480 thru C-19200 & RSF Shells, Molded Desiccant	72.54
SPORC10098	RC-10098	100 cu in Activated Core Fits C-30000 & C-40000, Molded Desiccant	129.16
SPORCW48	RCW-48	48 cu in Activated Gold Drier Core Fits C-480 thru C-19200 & RSF Shells, Molded Desiccant	77.50

Suction Filter Element Only

For Replaceable Core Catch-All® Shells

Part #	Mfg #	Description	Price
SPORPE48BD	RPE-48-BD	Fits C-480 thru C-19200	47.90
SPORPE100	RPE-100	Fits C-300000 & C-40000	95.34

Optional Secondary Filters

Part #	Mfg #	Order #	Description	Price
SPOFS960	FS-960	481462	For C-960 Series Catch-All Shells	46.38

Parts & Accessories

Part #	Mfg #	Description	Price
SPO61715	6171-5	100 Mesh Screen	17.88
SPOA685	A-685	Mounting Bracket for C-480 thru C-19200	39.28



SUD Series Copper Driers

Features

- 100% Molecular sieve
- Hermetically sealed
- Copper shells & end tubes
- High capacity
- Easy break off grooved ends



Part #	Mfg #	Description	Price
SUOSUD103	SUD103	1/4"OD Inlet, 1/4" OD Outlet w/1" Plugged Ends	3.86
SUOSUD111	SUD111	1/4"OD 1/4"Flr Inlet, 1/4"OD Outlet Cap, 1" Charging Drier	8.06

Filter Driers, Shells,
Core

All Items May Not Be Stocked In All Branches



www.irrsupply.com

Sightglass

See•All® Moisture & Liquid Indicators

- One indicator for most common refrigerants
- Large full view sight glass
- Replaceable indicator element
- Reliable & accurately calibrated color change points
- Indicator protected from discoloration and dirt
- Double duty plastic cap



Female x Male Flare



Male Flare x Swivel Nut



ODF Solder

Sightglass

Part #	Mfg #	Order #	Connection	Length	Type	Price
SPOSA12	SA-12	700000	1/4"	2.87"	Male Flare	32.48
SPOSA13	SA-13	700078	3/8"	3.37"	Male Flare	33.20
SPOSA14	SA-14	700247	1/2"	3.81"	Male Flare	41.44
SPOSA15	SA-15	700403	5/8"	4.13"	Male Flare	42.92
SPOSA12FM	SA-12FM	700026	1/4"	2.56"	Female x Male Flare	32.48
SPOSA13FM	SA-13FM	700091	3/8"	2.97"	Female x Male Flare	33.20
SPOSA14FM	SA-14FM	700260	1/2"	3.44"	Female x Male Flare	41.44
SPOSA14U	SA-14U	700364	1/2"	3.68"	Male Flare x Swivel Nut	53.90
SPOSA15U	SA-15U	700468	5/8"	3.90"	Male Flare x Swivel Nut	55.78
SPOSA14FU	SA-14FU	700273	1/2"	3.31"	Female Flare x Swivel Nut	53.90
SPOSA12S	SA-12S	700052	1/4"	4.63"	ODF Solder	32.48
SPOSA13S	SA-13S	700130	3/8"	4.63"	ODF Solder	33.20
SPOSA14S	SA-14S	700299	1/2"	4.88"	ODF Solder	41.44
SPOSA15S	SA-15S	700416	5/8"	4.88"	ODF Solder	42.92
SPOSA17S	SA-17S	700507	7/8"	6.32"	ODF Solder	60.72
SPOSA19S	SA-19S	700546	1-1/8"	6.32"	ODF Solder	65.68
SPOSA211	SA-211	700585	1-3/8"	8.00"	ODF Solder	130.80

See•All® Replacement Part

Part #	Mfg #	Description	Price
SPOKSA4	K-SA-4	Replaces Indicator in Fused Glass Styles 1/4" - 1-1/8"	7.28
SPOAC20	AC-20	Removable Cartridge Fits SA-211, SA-213, & SA-217	46.52

Prices & Specifications are Subject to Change.



www.irrsupply.com

Capacitors

Electrolytic Capacitor for Motor Starting Applications



Capacitors

Part #	Mfg #	Microfarad Min-Max	VAC	Dimensions Dia x Length	Price
CAP145125	11913	145 - 175	110/125	1.44" x 2.75"	5.94
CAP161125	11914	161 - 193	110/125	1.44" x 2.75"	6.12
CAP189125	11915	189 - 227	110/125	1.44" x 2.75"	6.30
CAP233125	11918	233 - 292	110/125	1.44" x 3.38"	6.96
CAP270125	11919	270 - 324	110/125	1.44" x 3.38"	7.32
CAP324125	11921	324 - 388	110/125	1.81" x 3.38"	7.50
CAP340125	11922	340 - 408	110/125	1.81" x 3.38"	9.90
CAP400125	11924	400 - 480	110/125	1.81" x 3.38"	9.42
CAP460125	11925	460 - 552	110/125	1.81" x 3.38"	9.36
CAP540125	11926	540 - 648	110/125	1.81" x 4.38"	10.68
CAP590125	11927	590 - 708	110/125	1.81" x 4.38"	11.58
CAP708125	11928	708 - 850	110/125	2.06" x 4.38"	12.66
CAP21250	11938	21 - 25	220/250	1.44" x 2.75"	6.00
CAP72250	11944	72 - 86	220/250	1.81" x 3.38"	8.10
CAP108250	11946	108 - 130	220/250	1.81" x 3.38"	9.42
CAP124250	11948	124 - 156	220/250	1.81" x 3.38"	10.14
CAP145250	11949	145 - 175	220/250	2.06" x 3.38"	11.52
CAP161250	11950	161 - 193	220/250	1.81" x 4.38"	12.54
CAP189250	11951	189 - 227	220/250	2.06" x 4.38"	14.58
CAP216250	11952	216 - 259	220/250	2.06" x 4.38"	23.64
CAP233250	11953	233 - 292	220/250	2.06" x 4.38"	16.56
CAP270250	11954	270 - 324	220/250	2.06" x 4.38"	18.66
CAP72330	11961	72 - 88	330	1.81" x 4.38"	10.14
CAP88330	11962	88 - 108	330	2.06" x 3.38"	10.44
CAP108330	11963	108 - 130	330	2.06" x 4.38"	10.80
CAP130330	11964	130 - 156	330	2.06" x 4.38"	21.00
CAP145330	11966	145 - 175	330	2.56" x 4.38"	14.10
CAP161330	11967	161 - 193	330	2.56" x 4.38"	14.70
CAP189330	11968	189 - 227	330	2.56" x 4.38"	16.08
CAP216330	11969	216 - 259	330	2.56" x 4.38"	16.80

Motor Run Capacitors

- UL & CSA Listed

Single Section Oval Motor Run Capacitor

Part #	Mfg #	Microfarad	Volts	Price
CAP3370	12903	3	370	3.78
CAP4370	12904	4	370	3.84
CAP6370	12906	6	370	4.50
CAP75370	12907	7.5	370	4.50
CAP10370	12908	10	370	4.74
CAP125370	12909	12.5	370	7.26
CAP15370	12910	15	370	7.56
CAP5440	12929	5	440	4.50

All Items May Not Be Stocked In All Branches



www.irrsupply.com

Capacitors

Motor Run Capacitors (Continued)

Single Section Oval Motor Run Capacitor

Part #	Mfg #	Microfarad	Volts	Price
CAP75440	12931	7.5	440	6.06
CAP10440	12932	10	440	7.62
CAP15440	12934	15	440	8.76

Dual Section Oval Motor Run Capacitor

Part #	Mfg #	Microfarad	Volts	Price
CAP255370	12966	25/5	370	17.10
CAP304370	12845	30/4	370	34.80
CAP4575370	12853	45/7.5	370	43.92
CAP555370	12854	55/5	370	39.00
CAP255440	12884	25/5	440	17.04
CAP353440	12985	35/3	440	39.10
CAP403440	12877	40/3	440	41.34



Capacitors

Run Capacitor

Part #	Mfg #	MFD	Voltage	Price
TEC85PR370F20	85PR370F20	25	370	20.36
TEC85PR440E90	85PR440E90	55	440	86.22

Start Capacitor

Part #	Mfg #	MFD	Voltage	Price
TEC85PS110C76	85PS110C76	243-292	110	16.60
TEC85PS110C90	85PS110C90	145-175	110	9.46
TEC85PS110C92	85PS110C92	270-324	110	27.70
TEC85PS165C27	85PS165C27	270-324	165	25.24
TEC85PS165C96	85PS165C96	161-193	165	22.60
TEC85PS165C98	85PS165C98	233-280	165	19.62
TEC85PS250C19	85PS250C19	88-108	250	28.58
TEC85PS330D16	85PS330D16	130-156	330	54.92

Capacitors

Prices & Specifications are Subject to Change.

Capacitors

Motor Run Capacitors

Single Oval Run Capacitor



Part #	Mfg #	Microfareads	Volts	Price
CAP5370	CR5X370	5 mfd	370V	3.48
CAP35370	CD35X370	35 mfd	370V	13.20

Dual Oval Run Capacitor



Part #	Mfg #	Microfareads	Volts	Price
CAP353370	CD35+3X370	35/3 mfd	370V	19.98
CAP505440	CD50+5X440	50/5 mfd	440V	31.08

Single Round Run Capacitor



Part #	Mfg #	Microfareads	Volts	Price
CAP20370	CR20X370R	20 mfd	370V	7.98
CAP25370	CR25X370R	25 mfd	370V	8.58
CAP30370	CR30X370R	30 mfd	370V	11.58
CAP40370	CR40X370R	40 mfd	370V	14.34
CAP45370	CR45X370R	45 mfd	370V	16.02
CAP20440	CR20X440R	20 mfd	440V	9.60
CAP25440	CR25X440R	25 mfd	440V	11.40
CAP30440	CR30X440R	30 mfd	440V	12.96
CAP35440	CR35X440R	35 mfd	440V	14.52
CAP40440	CR40X440R	40 mfd	440V	16.62
CAP45440	CR45X440R	45 mfd	440V	18.72
CAP50440	CR50X440R	50 mfd	440V	19.98
CAP60440	CR60X440R	60 mfd	440V	23.40

Dual Round Run Capacitor



Part #	Mfg #	Microfareads	Volts	Price
CAP305370	CD30+5X370R	30/5 mfd	370V	14.10
CAP355370	CD35+5X370R	35/5 mfd	370V	14.88
CAP405370	CD40+5X370R	40/5 mfd	370V	16.62
CAP455370	CD45+5X370R	45/5 mfd	370V	16.50
CAP8075370	CD80+7.5X370R	80/7.5 mfd	370V	28.28
CAP355440	CD35+5X440R	35/5 mfd	440V	14.70
CAP405440	CD40+5X440R	40/5 mfd	440V	16.20

**Irr Supply is your one stop shop
for all your Plumbing, HVAC,
Refrigeration, and Electrical needs.
Why go anywhere else!**



Chemicals

Coil Cleaners

Nu-Brite®

- Foaming coil cleaner
- Brightens as it cleans
- Safer than acids
- Biodegradable, USDA approved



4291-18 4291-08

Part #	Mfg #	Description	Price
CAL429118	4291-18	18 oz Aerosol	13.96
CAL429108	4291-08	1 gal	36.36

CalClean®

- Heavy duty detergent formulation of surfactants, grease solvents, alkaline cleaners, corrosion inhibitors and water conditioners
- For spray cleaning evaporator coils, air cooled condenser coils, metal filters & fan blades
- Biodegradable, USDA approved



4081-75 4135-08

Part #	Mfg #	Description	Price
CAL408175	4081-75	20 oz Aerosol	19.16
CAL413508	4135-08	1 gal	50.14

Special HD CalClean®

- For removing tobacco tars & other stubborn stains on electronic air filters
- Can be used to clean evaporator coils, air cooled condensers & permanent filters



Part #	Mfg #	Description	Price
CAL414308	4143-08	1 gal	53.40

Foam Brite™

- Ultimate foaming cleaner, cleans condenser coils
- Biodegradable



Part #	Mfg #	Description	Price
CAL417808	4178-08	1 gal	39.66

Alka-Brite®

- Non-acid, alkaline based
- For brightening & cleaning air cooled condensers
- Biodegradable



Part #	Mfg #	Description	Price
CAL412008	4120-08	1 gal	40.28

Cal-Brite®

- Used for cleaning finned coils
- Deep penetrating foaming cleaner removes oxidation & brightens



Part #	Mfg #	Description	Price
CAL413308	4133-08	1 gal	54.32

Evap Pow'r®

- For cleaning indoor evaporator coils
- Cleans & emulsifies
- No-rinse product



4169-24



4168-08

Part #	Mfg #	Description	Price
CAL416924	4169-24	1 qt Spray RTU	25.36
CAL416808	4168-08	1 gal	35.48

Green Clean

- All purpose cleaner
- Rapidly removes grease & other heavy soils
- Non-corrosive



4186-24



4186-08

Part #	Mfg #	Description	Price
CAL418624	4186-24	1 qt Spray	23.66
CAL418608	4186-08	1 gal	44.70

Chemicals

Prices & Specifications are Subject to Change.

Chemicals

Cal-Shield™

- Synergistic liquid formulation based upon DuPont's Teflon® fluoro-additives
- Extends life of finned coils operating in corrosive environments like salt air & in food acids
- Food grade product
- Ready to use spray on application



Part #	Mfg #	Description	Price
CAL414832	4148-32	1 qt Spray	53.62
CAL414808	4148-08	1 gal	129.82

Evap-Fresh®

- Coil cleaner and disinfectant
- Effectively cleans as well as kills mold, slime and bacteria
- "No rinse required" condenser coil cleaner
- One-step cleaner



Part #	Mfg #	Description	Price
CAL416675	4166-75	18 oz Aerosol	19.30
CAL416608	4166-08	1 gal	41.40

Tri-Pow'r™ HD

- General purpose coil cleaner
- Detergency, degreasing & deodorizing capability
- Non-acid, non-toxic & biodegradable



Part #	Mfg #	Description	Price
CAL437188	4371-88	1 gal	28.56

Cal-Green®

- Non-foaming, non-toxic coil cleaner
- Biodegradable and free of dyes, fragrances and masking agents



Part #	Mfg #	Description	Price
CAL419008	4190-08	1 gal	39.40

Evap-Green®

- VOC free coil cleaner
- Biodegradable and free of dyes, fragrances and masking agents



Part #	Mfg #	Description	Price
CAL419108	4191-08	1 gal	36.76

Cal-Spray® Aerosol Coil Cleaners

Evap Foam® No Rinse

- High performance detergent w/special surfactants and alkaline cleaners, foaming
- "No rinse required" condenser coil cleaner
- Spray right side up or upside down
- For cooling or evaporator coils



Part #	Mfg #	Description	Price
CAL417175	4171-75	18 oz Aerosol	17.96

Nu-Blast® Condenser Coil Cleaner

- "No rinse required" condenser coil cleaner
- High pressure blast plus solvent cleaning



Part #	Mfg #	Description	Price
CAL429075	4290-75	18 oz Aerosol	25.76

Air-Cooled Equipment & Filter Cleaning

IAQ Assurance Program

Bio-Fresh® cd

- Kills bacteria, mold, mildew, fungi and yeasts in IAQ applications
- Safe for fogging and may be applied to occupied space
- Formulated for use in air conditioning ventilating systems & ductwork
- Can be applied by spraying, brushing, sponging or fogging



Part #	Mfg #	Size	Price
CAL412634	4126-34	1 qt Spray	26.56
CAL412638	4126-38	1 gal	45.16

Chemicals

All Items May Not Be Stocked In All Branches

Chemicals

Rx-Acid Scavenger®

- Neutralizes or "scavenges" acid in refrigeration, air conditioning systems
- Use after burnouts or normal maintenance
- Normal dosage is 2 fl oz/gallon of system oil



Part #	Mfg #	Description	Price
CAL430102	4301-02	1 Each	46.48

Scale Removal/Descaling

Liquid Scale Dissolver

- Water-cooled equipment scale remover
- Hydrochloric (muriatic) acid with low foaming corrosion inhibitors
- Built-in pH color indicator
- pH Test paper included



4330-08 4330-05

Part #	Mfg #	Size	Price
CAL433008	4330-08	1 gal	39.86
CAL433005	4330-05	5 gal Pail	179.10

Season Start® "Imperial Grade" Scale Remover

- Powdered sulfamic acid formulation that contains the best inhibitors available for protecting all metals including galvanizing
- Contains a built-in pH color indicator as well as wetting & antifoaming agents
- USDA Approved



Part #	Mfg #	Description	Price
CAL436088	4360-88	10 lb Container	169.62

Calci-Solve Descaler/Drain Cleaner

- Removes scale from lines and clears clogged drains
- Includes a special inhibitor that coats the inside of pipes with a protective film



Part #	Mfg #	Size	Price
CAL413424	4134-24	1 qt	19.38
CAL413408	4134-08	1 gal	53.12

Water Treatment Products

Season Treat (Micromet® Plates)

- Patented Micromet® Plate product
- Flow-through package
- To treat small cooling towers and evaporative condensers



Part #	Mfg #	Description	Price
CAL436488	4364-88	1 Canister Season Treat	221.30

No. 85 Algaecide - Algae Prevention

- Polymeric, catatonic biocide that controls the growth of algae, bacteria, and fungi



Part #	Mfg #	Size	Price
CAL410808	4108-08	1 gal	283.52

No. 340 Liquid Scale Inhibitor

- Concentrated, effective in hard, highly alkaline water
- Stable, does not form sludge
- USDA Approved



Part #	Mfg #	Size	Price
CAL434008	4340-08	1 gal	183.10

Freez-Kontr'l® - Closed System Freeze Protector

- Based upon non-toxic propylene glycol
- Provides corrosion & freeze protection for chilled water, hydronic and other closed systems



Part #	Mfg #	Size	Price
CAL418807	4188-07	1 gal	45.88

Chemicals

Chemicals

Ice Machine Maintenance

Ice Guard® AP

- Inhibits growth of a wide variety of slime forming bacteria and algae found in ice machines
- One unit can protect up to a 1200 lb ice maker for 3-6 months
- A drop-in device that is placed directly into the recirculating water sump



Part #	Mfg #	Description	Price
CAL420905	4209-05	Mini Ice Guard®	126.08
CAL420906	4209-06	Ice Guard® Drop-In	146.38

Liquid Ice Machine Cleaner

- Fast acting & safe to use
- Made from food-grade phosphoric acid
- USDA approved



Part #	Mfg #	Description	Price
CAL420747	4207-47	8 fl oz	16.96
CAL420708	4207-08	1 gal	155.28

Nickel-Safe Ice Machine Cleaner

- For removing scale deposits on nickel-plated or tin-plated evaporators
- USDA approved



Part #	Mfg #	Description	Price
CAL428734	4287-34	16 fl oz	17.98
CAL428708	4287-08	1 gal	119.66

Gas Leak Detectors

Cal-Blue® LT Gas Leak Detector

- High viscosity formulation enhances contact time
- Will not effect ultraviolet (black) lights
- Non-corrosive
- Oxygen-safe
- Freeze-protected to -20°F



Part #	Mfg #	Description	Price
CAL418324	4183-24	1 qt Spray	25.14

Cal-Blue® Plus Gas Leak Detector

- Complete, detects smallest leak
- High viscosity liquid stays in contact with applied surface for extended time
- Non-corrosive and will not effect ultraviolet lights
- Freeze protected to 5°F
- USDA approved



Part #	Mfg #	Description	Price
CAL418224	4182-24	1 qt Spray	16.36
CAL418208	4182-08	1 gal	46.64

Specialty Products

Thermo-Trap®

- Heat absorbing paste to isolate heat encountered in soldering, welding, and brazing
- USDA approved



Part #	Mfg #	Description	Price
CALTRAP	4371-36	11 oz Tube	22.72

Degreasing Solvent ef

- Ozone-safe, environmentally friendly
- Volatile solvent
- Provides effective degreasing and cleaning as well as controlled drying with NO residue
- Dielectric strength in excess of 26,000V



Part #	Mfg #	Description	Price
CAL408375	4083-75	17 oz Aerosol	23.00
CAL416207	4162-07	1 gal Can	69.34

Cal-Spray® Aerosol Specialty Products

V-Belt Dressing

- Penetrates and extends modern v-belt life
- Keeps belt pliable
- USDA approved



Part #	Mfg #	Description	Price
CAL408603	4086-03	16 oz Aerosol	34.84

All Items May Not Be Stocked In All Branches

Chemicals

Food Grade Silicone Lubricant

- Sprays non-stick surface on ice machine surfaces, vending machines, coin slots, hot plates, slicing machines and other food processing/packaging equipment
- Contains ingredients approved by FDA for food contact use
- USDA approved



Part #	Mfg #	Description	Price
CAL408403	4084-03	10.75 oz Aerosol	31.56

Pan Spray

- Water proof rubberized coating
- Seals out rust and corrosion
- Repairs leaky condensate pans, cooling towers, swamp coolers, roofing, gutters and down spouts



Part #	Mfg #	Description	Price
CAL429650	4296-50	16 oz Aerosol, White	37.60
CAL429651	4296-51	16 oz Aerosol, Black	37.60

Pump Protector

- Protects seasonally operated pumps against corrosion during shutdowns by winterizing them
- Safe for all types of water pumps



Part #	Mfg #	Description	Price
CAL4299T8	4299-T8	10 oz Aerosol	21.36

Pipe Dri®

- Aerosol insulation
- Provides moisture barrier
- Quickly adheres and dries to hard water proof coating



Part #	Mfg #	Description	Price
CAL429775	4297-75	18 oz Aerosol	26.28

Electrical Contact Cleaner

- Cleans, lubricates, and protects electrical contacts from corrosion
- Safe on nearly all plastics
- Removes grease, dust and oxidation
- Includes extension tube
- USDA approved



Part #	Mfg #	Description	Price
CAL408203	4082-03	16 oz Aerosol	40.34

Insulation Products

Nu-Foam®

- Expanding polyurethane prepolymer foam
- Used as a sealing and insulating product



Part #	Mfg #	Description	Price
CAL429304	4293-04	9 oz Can	14.14
CAL429375	4293-75	20 oz Can	28.54

HIGHSIDE CHEMICALS

Gas Leak Detector

- Use on hot & cold piping & equipment containing most gases such as air, natural gas, all refrigerants, ammonia, SO2, etc



Medium Temp Gas Leak Detector

Part #	Mfg #	Description	Price
HIGLEAK8OZ	22008	8 oz Plastic Dauber Bottle	10.84



Chemicals

Leak Lock Joint Compound

- Resistant to all refrigerants, oils, water and most chemicals, liquids and gases
- Ideal for joining all metals, plastics and other materials
- Will stick to all clean surfaces
- Guarantees a perfect seal under all conditions



Part #	Mfg #	Description	Price
HIGLEAKLOCKTUBE	HS10001	1-1/3 oz Tube	7.30
HIGLEAKLOCK4OZ	HS10004	4 oz Brush Top Plastic Jar	20.10

Chemicals

Prices & Specifications are Subject to Change.

Fan Blades & Accessories

Series 400 Air Moving Components

4-Wing Adapter Heavy-Duty Condenser Fan Blade

- For rigorous HVAC/R low pressure applications
- Accommodates universal hex/round adapter hubs
- High strength aluminum alloy blades, steel blade spiders
- MARS Pack 2
- Maximum RPM: 10"-16" dia is 1,725; 18"-24" dia is 1,140



Part #	Mfg #	Model	RPM	Blade Diameter	Pitch	Blade Depth	Price
LAU41223CW	40076	1223-4CW	825/1075/1625	12"	23°	2.28"	37.58
LAU41223CCW	40077	1223-4CCW	825/1075/1625	12"	23°	2.28"	35.78
LAU41427CW	40084	1426-4CW	825/1075/1625	14"	27°	3.063"	44.36
LAU41427CCW	40085	1426-4CCW	825/1075/1625	14"	27°	3.063"	42.24
LAU41627CW	40090	1626-4CW	825/1075/1625	16"	27°	3.563"	48.88
LAU41633CW	40092	1633-4CW	825/1075/1625	16"	33°	4.281"	41.52
LAU41633CCW	40093	1633-4CCW	825/1075/1625	16"	33°	4.281"	48.88
LAU41827CCW	40097	1827-4CCW	825/1075/1140	18"	27°	4.313"	67.32
LAU41833CW	40098	1833-4CW	825/1075/1140	18"	33°	5.172"	64.12
LAU41833CCW	40099	1833-4CCW	825/1075/1140	18"	33°	5.172"	67.32
LAU42027CW	40102	2027-4CW	825/1075/1140	20"	27°	4.313"	72.50
LAU42027CCW	40103	2027-4CCW	825/1075/1140	20"	27°	4.313"	72.50
LAU42033CW	40104	2033-4CW	825/1075/1140	20"	33°	5.172"	69.06
LAU42227CW	40108	2227-4CW	825/1075/1140	22"	27°	4.313"	84.18
LAU42227CCW	40109	2227-4CCW	825/1075/1140	22"	27°	4.313"	84.18
LAU42427CW	40114	2427-4CW	825/1075/1140	24"	27°	4.313"	88.66
LAU42427CCW	40115	2427-4CCW	825/1075/1140	24"	27°	4.313"	84.44

Universal Hex Hub



Part #	Mfg #	Bore	Price
LAUHUB516	40003	Torin 5/16" Hub	10.70
LAUHUB38	40004	Torin 3/8" Hub	12.34
LAUHUB12	40005	Torin 1/2" Hub	12.22
LAUHUB58	40006	Torin 5/8" Hub	13.34

Fan Blades & Accessories

Bohn Fan Blades & Accessories

Fan Blade

Part #	Mfg #	Dia	Degree	No. Blades	Rot	Price
BOH5140C	5140C	12"	23	5	CW	48.00
BOH5101B	5101B	5-1/2"	24	5	CCW	5.00
BOH5110E	5110E	12"	24	5	CCW	43.00
BOH5132C	5132C	10"	31	6	CW	32.00

Fan Guard

Part #	Mfg #	No. of Guard Size	Ring Legs	Spacing	Price
BOH5054D	5054D	5-1/2"	2	5/16"	15.00
BOH5069E	5069E	10"	3	3/16"	101.00



Accessories & Replacement Parts

Fan Blade

Part #	Mfg #	Hub Mount	Bore Size	Rotation	Blade Dia	Blade Depth	No Blade	Pitch (°)	Replaced	Price
TEC51541	51541-1	No	1/4"	CW	10.8	3.17	4	34	-	18.82
TEC51561	51561-1	No	1/4"	CW	7.75	1.75	5	33	51561, 51531-2	15.50
TEC51563	51563	Yes	5/16"	CW	12	2.18	5	24	51534-1	41.70
TEC51564	51564-1	No	1/4"	CW	9	2.92	5	30	51551, 51564	10.08

Rotolock Valve

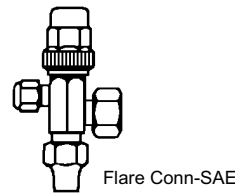
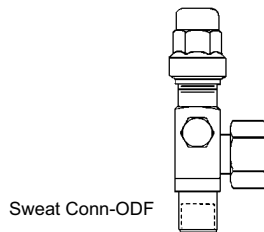

Part #	Mfg #	Size & Connection Type	Mounting Nut	Port Side	Price
TEC31529	31529-1	7/8" ODF	1-1/4"	Right Side	79.08
TEC315272	31527-2	1/2" ODF	1"	Left Side	70.26
TEC315781	31578-1	3/8" SAE	3/4"	Left and Right Side	42.04

Fan Blades & Accessories

Prices & Specifications are Subject to Change.

Fan Blades & Accessories

Flexible Bend-to-Fit Defrost Heater

For Evaporator Coils & Condensate Drain Pans in Commercial Refrigeration

- Heaters constructed of .250" diameter incoloy
- Heaters can be linked together to create additional length

Part #	Mfg #	Description	Price
ACI2045	2045	300W, 120V, 2.5A, 31" Heated Length	119.04

Rain Guards

- 6-3/4" Diameter for protecting condensing unit motors
- Press fit on shaft or mount on studs with plug in bore

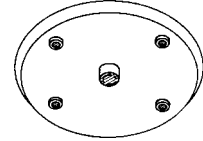

Part #	Mfg #	Description	Price
ACI145	145	1/2" Bore, Nylon	7.16
ACI146	146	5/8" Bore, Nylon	7.16

Fan Blades

Aluminum Hub Type Fan Blade - 5 Blades

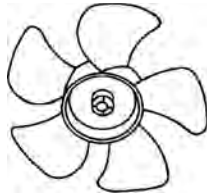

Part #	Mfg #	Dia/Rotation	Pitch	CFM	Price
ACI30614	30614	6" CW	27°	106	11.60
ACI30805	30805P	8" CW	36°	300	14.64
ACI30814	30814P	8" CCW	36°	300	14.64
ACI31005	31005	10" CW	40°	810	17.38
ACI31015	31015	10" CCW	40°	810	17.38
ACI31205	31205	12" CW	25°	990	25.46
ACI31215	31215	12" CCW	25°	990	25.46

Plastic Fan Blades - 3 Blades

Part #	Mfg #	Description	Price
ACI255	255	5-1/2" CCW	4.00

THANK YOU!
We appreciate
your business

Motor Accessories

#135 Rigid Jok Double Ring Motor Mount

- Solid 48 frame
- Includes:
 - Lock-on hanger
 - Lock washer
 - 2-1/2" Bolt

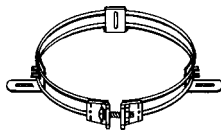

Part #	Mfg #	Description	Price
ACI135	135	3/8" Mounting Holes	17.14

All Items May Not Be Stocked In All Branches

V-Belts

Belts

MARS Accu-Link Adjustable V-Belt

- Allow for compact drives and higher rpm motors
- Oil and heat resistant and static conducting
- Temporary or permanent replacement for conventional rubber belts
- Easy snap and twist assembly



Part #	Mfg #	Type	Length	Pack	Price
PTPA4LS	94671	A/4L	5'	Slv	52.40
PTPB5LS	94672	B/5L	6'	Slv	71.94



Powerflite Belts

Classical Super Gripbelts

- Wrapped construction, neoprene impregnated fabric wrap
- Oil & heat resistant
- Static conducting
- Good for clutching or high shock load applications
- Quiet running



Part #	Mfg #	Size (W x D x L)	Price
BELA21	A21	1/2" x 5/16" x 23.2"	6.60
BELA22	A22	1/2" x 5/16" x 24.2"	6.60
BELA26	A26	1/2" x 5/16" x 28.2"	7.22
BELA27	A27	1/2" x 5/16" x 29.2"	7.30
BELA28	A28	1/2" x 5/16" x 30.2"	7.44
BELA29	A29	1/2" x 5/16" x 31.2"	7.54
BELA30	A30	1/2" x 5/16" x 32.2"	7.64
BELA31	A31	1/2" x 5/16" x 33.2"	7.78
BELA32	A32	1/2" x 5/16" x 34.2"	7.54
BELA33	A33	1/2" x 5/16" x 35.2"	8.06
BELA34	A34	1/2" x 5/16" x 36.2"	8.20
BELA35	A35	1/2" x 5/16" x 37.2"	7.90
BELA36	A36	1/2" x 5/16" x 38.2"	8.08
BELA37	A37	1/2" x 5/16" x 39.2"	8.30
BELA38	A38	1/2" x 5/16" x 40.2"	8.44
BELA39	A39	1/2" x 5/16" x 41.2"	8.62
BELA40	A40	1/2" x 5/16" x 42.2"	8.70
BELA41	A41	1/2" x 5/16" x 43.2"	8.94
BELA42	A42	1/2" x 5/16" x 44.2"	9.06
BELA43	A43	1/2" x 5/16" x 45.2"	9.24
BELA44	A44	1/2" x 5/16" x 46.2"	9.34
BELA45	A45	1/2" x 5/16" x 47.2"	9.48

Powerflite Belts (Continued)

Classical Super Gripbelts

Part #	Mfg #	Size (W x D x L)	Price
BELA46	A46	1/2" x 5/16" x 48.2"	9.52
BELA47	A47	1/2" x 5/16" x 49.2"	10.04
BELA48	A48	1/2" x 5/16" x 50.2"	9.70
BELA49	A49	1/2" x 5/16" x 51.2"	9.88
BELA50	A50	1/2" x 5/16" x 52.2"	10.42
BELA51	A51	1/2" x 5/16" x 53.2"	10.50
BELA52	A52	1/2" x 5/16" x 54.2"	10.66
BELA53	A53	1/2" x 5/16" x 55.2"	10.74
BELA54	A54	1/2" x 5/16" x 56.2"	10.94
BELA55	A55	1/2" x 5/16" x 57.2"	11.02
BELA56	A56	1/2" x 5/16" x 58.2"	10.60
BELA57	A57	1/2" x 5/16" x 59.2"	11.26
BELA58	A58	1/2" x 5/16" x 60.2"	11.40
BELA59	A59	1/2" x 5/16" x 61.2"	11.54
BELA60	A60	1/2" x 5/16" x 62.2"	11.64
BELA61	A61	1/2" x 5/16" x 63.2"	11.78
BELA62	A62	1/2" x 5/16" x 64.2"	11.92
BELA63	A63	1/2" x 5/16" x 65.2"	12.06
BELB38	B38	21/32" x 7/16" x 41.0"	12.20
BELB40	B40	21/32" x 7/16" x 43.0"	12.72
BELB42	B42	21/32" x 7/16" x 45.0"	13.30
BELB43	B43	21/32" x 7/16" x 46.0"	13.58
BELB45	B45	21/32" x 7/16" x 48.0"	14.14
BELB46	B46	21/32" x 7/16" x 49.0"	14.42
BELB47	B47	21/32" x 7/16" x 50.0"	14.60
BELB48	B48	21/32" x 7/16" x 51.0"	14.84
BELB49	B49	21/32" x 7/16" x 52.0"	15.08
BELB50	B50	21/32" x 7/16" x 53.0"	15.32
BELB51	B51	21/32" x 7/16" x 54.0"	15.50
BELB52	B52	21/32" x 7/16" x 55.0"	15.70
BELB53	B53	21/32" x 7/16" x 56.0"	15.78
BELB54	B54	21/32" x 7/16" x 57.0"	15.98
BELB55	B55	21/32" x 7/16" x 58.0"	16.02
BELB56	B56	21/32" x 7/16" x 59.0"	16.08
BELB57	B57	21/32" x 7/16" x 60.0"	16.12
BELB58	B58	21/32" x 7/16" x 61.0"	16.16
BELB59	B59	21/32" x 7/16" x 62.0"	16.50
BELB60	B60	21/32" x 7/16" x 63.0"	16.64
BELB61	B61	21/32" x 7/16" x 64.0"	16.88
BELB62	B62	21/32" x 7/16" x 65.0"	17.06
BELB63	B63	21/32" x 7/16" x 66.0"	17.30
BELB64	B64	21/32" x 7/16" x 67.0"	17.54
BELB68	B68	21/32" x 7/16" x 71.0"	18.28
BELB70	B70	21/32" x 7/16" x 73.0"	18.80

Prices & Specifications are Subject to Change.

V-Belts

V-Belts

Fractional HP (FHP) Belts

- For use in refrigerators, washing machines, pumps, stokers, woodworking machines, etc.
- Features concave sidewalls to give the belt full grip on pulley sides
- Rubber filled cords prevent separation of cores and rubber
- Protective fabric jacket for silent running, oil, and heat-resistance



Part #	Mfg #	Size (W x L)	Price
BEL3L170	3L170	3/8" x 17"	7.12
BEL3L180	3L180	3/8" x 18"	7.12
BEL3L190	3L190	3/8" x 19"	7.12
BEL3L200	3L200	3/8" x 20"	7.12
BEL4L200	4L200	1/2" x 20"	7.50
BEL4L210	4L210	1/2" x 21"	7.50
BEL4L220	4L220	1/2" x 22"	7.50
BEL4L250	4L250	1/2" x 25"	7.50
BEL4L260	4L260	1/2" x 26"	7.58
BEL4L270	4L270	1/2" x 27"	7.72

Product descriptions and specifications in this catalog are condensed from manufacturer's literature. For exact information, consult manufacturer's literature prior to installation and service. Contact us if you are not sure about specifications.

Refrigeration Tools

Refrigerant Recovery

Insta-Tap Refrigerant Recovery Tool

- Evacuates refrigerant before disposal
- Fits 3/16" to 7/8" OD tubing



Part #	Mfg #	Description	Price
WAGQT100	QT-100	Insta-Tap Tool	76.96



Atlas Refrigerant Charging Scale

- 220 lb Weight capacity
- Solid state load cell, sensitivity to .24oz
- Heavy duty plastic storage case
- All metal scale construction
- Hand held remote, auto shut-off after 30 minutes
- Displays in lbs & oz and kilograms
- Operates with a 9V battery (included)



Part #	Mfg #	Description	Price
JBIDS20000	DS-20000	Atlas Charging Scale	426.56

Special orders - If you need it we can get it promptly!

Tools



Refrigeration Tools

1/4" Valve Core Tool

- Hollow handle for storage
- Furnished with (6) extra cores



Part #	Mfg #	Description	Price
JBIA32004	A32004	1/4"	8.50



www.irrsupply.com

Refrigeration Valves

Crankcase Pressure Regulating Valves

- Prevent overloading of compressor motor by limiting crankcase pressure during and after defrost cycles or after normal shutdown period

CRO-4 Adjustable Crankcase Pressure Regulating Valve



Part #	Mfg #	Order #	Adjustment Range	Connection	Strainer	Price
SPOCRO4020	CRO-4-0/20	900002	0/20 psig	1/2" ODF Solder	825-004	228.54

CRO(T)-6 Adjustable Crankcase Pressure Regulating Valve

- (T) Indicates an access valve is located on the inlet connection



Part #	Mfg #	Order #	Adjustment Range	Connection	Strainer	Price
SPOCROT658OD060	CROT-6-0/60	900556	0/60 psig	5/8" ODF	825-5	297.46
SPOCROT678OD060	CROT-6-0/60	900570	0/60 psig	7/8" ODF	825-7	297.46
SPOCROT612SAE060	CROT-6-0/60	900584	0/60 psig	1/2" SAE	NA	297.46
SPOCROT658SAE060	CROT-6-0/60	900591	0/60 psig	5/8" SAE	NA	297.46
SPOCROT658OD30110	CROT-6-30/110	900360	30/110 psig	5/8" ODF	825-5	297.46

CRO(T)-10 Adjustable Crankcase Pressure Regulating Valve

- (T) Indicates an access valve is located on the inlet connection



Part #	Mfg #	Order #	Adjustment Range	Connection	Strainer	Price
SPOCROT10118OD060	CROT-10-0/60	900605	0/60 psig	1-1/8" ODF	825-9	407.44
SPOCROT1078OD30110	CRO-10-30/110	900380	30/110 psig	7/8" ODF	825-7	407.44

Head Pressure Control Valves

Type ORI Head Pressure Regulating Valve

- Inlet strainer (40 mesh)
- Designed for application in the liquid line only
- Hermetic construction

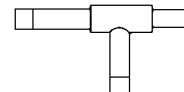

Part #	Mfg #	Order #	Connection	Operating Range	Price
SPOORI10138OD65225	ORI-10-65/225	900882	1-3/8" ODF	65-225 psig	549.86

All Items May Not Be Stocked In All Branches



www.irrsupply.com

Refrigeration Valves

Type OROA-5 Open on Rise of Outlet Pressure

- 5/8" Port size
- 5/8" Discharge connection



Part #	Mfg #	Order #	Condenser Conn	Pressure Setting	Features	Price
SPOOROA585100	OROA-5-100	902905	5/8" ODF	100 psig	With Strainer	338.40
SPOOROA585180	OROA-5-180	902919	5/8" ODF	180 psig		338.40
SPOOROA785180	OROA-5-180	902926	7/8" ODF	180 psig		338.40

LAC Low Ambient Controls



LAC-4-DS

Part #	Mfg #	Order #	Port Size	Connections	Valve Setting	Features	Price
SPOLAC4180	LAC-4-180	903024	1/2"	3/8" ODF	180 psig	With Screen, HP Control	202.58
SPOLAC412100180	LAC-4-DS-100/180	903085	1/2"	1/2" ODF	100/180 psig	With Screen, Dual Setting	215.96

Discharge Bypass Valves

Direct Acting Discharge Bypass Valve with External Equalizer



Part #	Mfg #	Order #	Port Size	Connection	Adjustment Range	Features	Price
SPOADRIE11407538	ADRIE-1-1/4-0/75	905851	5/32"	3/8" ODF	0/75 psig	Straight-Thru	161.90
SPOADRSE238	ADRSE-2-0/80	903399	1/4"	3/8" ODF	0/80 psig		286.00
SPOADRSE2	ADRSE-2-0/80	903406	1/4"	1/2" ODF	0/80 psig		286.00
SPOADRPE312	ADRPE-3-0/80	903525	3/8"	1/2" ODF	0/80 psig		324.66
SPOADRPE3	ADRPE-3-0/80	903532	3/8"	5/8" ODF	0/80 psig		324.66
SPOADRHE658	ADRHE-6-0/80	903574	3/4"	5/8" ODF	0/80 psig		655.70
SPOADRHE678	ADRHE-6 0/80	903581	3/4"	7/8" ODF	0/80 psig		655.70

Refrigeration Valves

Prices & Specifications are Subject to Change.

Refrigeration Valves

Solenoid Valves

Types A3 and E3 Series less Coil

- Normally closed valve position without manual lift
- Hermetic, direct-acting type solenoid valves
- Primarily for refrigeration and air conditioning applications
- E3 Series: extended solder type connections standard
 - Can be installed using either low or no silver content brazing alloy
- Synthetic coated metal gaskets to minimize external leaks
- Used with R-22, R-134A, R-401A, R-402A, R-404A, R-407C, R-502, R-507

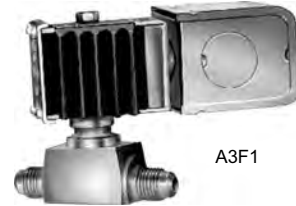

A3F1

Part #	Mfg #	Order #	Connections	Nominal Capacity R-22	Coil	Port Size	Price
SPOA3F1	A3F1	320000	1/4" SAE	1.6	MKC-1	0.101"	96.10
SPOE3S120	E3S120	321700	1/4" ODF	1.6	MKC-1	0.101"	96.10
SPOE3S130	E3S130	322700	3/8" ODF	1.6	MKC-1	0.101"	96.10

Type E5 Series less Coil

- Normally closed valve position without manual lift
- Compact solenoid valve with pilot operated disc construction
- Extended solder type connections standard
- Can be installed using either low or no silver content brazing alloy
- Synthetic coated metal gaskets to minimize external leaks
- Used with R-22, R-134A, R-401A, R-402A, R-404A, R-407C, R-502, R-507



Part #	Mfg #	Order #	Connections	Nominal Capacity R-22	Coil	Port Size	Options:	Price
SPOE5S130	E5S130	324600	3/8" ODF	2.8	MKC-1	0.150"		96.10
SPOE5S130HP	E5S130-HP	407900	3/8" ODF	2.8	MKC-1	0.150"	R410A High Prs	96.10

Types B6 and E6 Series less Coil

- Normally closed valve position
- Compact solenoid valve with pilot operated disc construction
- For refrigeration and air conditioning
- May be mounted horizontally, on side or in vertical line
- E6 Series: extended solder type connections standard
 - Can be installed using either low or no silver content brazing alloy
- Synthetic coated metal gaskets to minimize external leaks
- Used with R-22, R-134A, R-401A, R-402A, R-404A, R-407C, R-502, R-507



B6F1

E6S

Part #	Mfg #	Order #	Connections	Nominal Cap R-22	Coil	Port Size	Options:	Price
SPOB6F1	B6F1	324900	3/8" SAE	4.9	MKC-1	3/16"		113.18
SPOE6S130	E6S130	328400	3/8" ODF	4.9	MKC-1	3/16"		113.18
SPOME6S130	ME6S130	331500	3/8" ODF	4.9	MKC-1	3/16"	Manual Lift	150.56
SPOME6S130HP	ME6S130-HP	331000	3/8" ODF	4.9	MKC-1	3/16"	R-410A High Prs, Manual Lift	150.56
SPOE6S140	E6S140	329100	1/2" ODF	4.9	MKC-1	3/16"		113.18
SPOE6S140HP	E6S140-HP	412200	1/2" ODF	4.9	MKC-1	3/16"	R-410A High Prs	113.18
SPOME6S140	ME6S140	332200	1/2" ODF	4.9	MKC-1	3/16"	Manual Lift	150.56
SPOME6S140HP	ME6S140-HP	407600	1/2" ODF	4.9	MKC-1	3/16"	R-410A High Prs, Manual Lift	150.56

Refrigeration Valves

All Items May Not Be Stocked In All Branches

Refrigeration Valves

Type E9 Series less Coil

- Normally closed unless otherwise noted
- Compact solenoid valve with pilot operated disc construction
- For refrigeration and air conditioning
- Also suitable for suction line service
- May be mounted horizontally, on side or in vertical line
- E9 Series: extended solder type connections standard
 - Can be installed using either low or no silver content brazing alloy
- Synthetic coated metal gaskets to minimize external leaks
- Used with R-22, R-134A, R-401A, R-402A, R-404A, R-407C, R-502, R-507



Part #	Mfg #	Order #	Connections	Nominal Cap R-22	Coil	Port Size	Options:	Price
SPOE9S240	E9S240	336800	1/2" ODF	8.1	MKC-2	9/32"		144.10
SPOE9S240HP	E9S240HP	403300	1/2" ODF	8.1	MKC-2	9/32"	R-410A High Prs	144.10
SPOME9S240	ME9S240	339600	1/2" ODF	8.1	MKC-2	9/32"	Manual Lift	182.94
SPOME9S240HP	ME9S240-HP	339400	1/2" ODF	8.1	MKC-2	9/32"	R-410A High Prs, Manual Lift	182.94
SPOE9S250HP	E9S250HP	340200	5/8" ODF	11.8	MKC-2	9/32"	R-410A High Prs	144.10

Type E10 Series less Coil

- Normally closed unless otherwise noted
- Compact solenoid valve with pilot operated disc construction
- For refrigeration and air conditioning
- Also suitable for suction line service
- May be mounted horizontally, on side or in vertical line
- E10 Series: extended solder type connections standard
 - Can be installed using either low or no silver content brazing alloy
- Synthetic coated metal gaskets to minimize external leaks
- Used with R-22, R-134A, R-401A, R-402A, R-404A, R-407C, R-502, R-507



E10S250

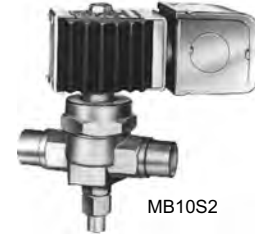

MB10S2

Part #	Mfg #	Order #	Connections	Nominal Cap R-22	Coil	Port Size	Options:	Price
SPOE10S240HP	E10S240HP	352500	1/2" ODF	11.1	MKC-2	5/16"	R-410A High Prs	166.32
SPOE10S250	E10S250	344100	5/8" ODF	11.1	MKC-2	5/16"		170.54
SPOME10S250	ME10S250	346600	5/8" ODF	11.1	MKC-2	5/16"	Manual Lift	208.24

Refrigeration Valves

Refrigeration Valves

Type E14 Series less Coil

- Normally closed unless otherwise noted
- Compact solenoid valve with pilot operated disc construction
- For refrigeration and air conditioning
- Also suitable for suction line service
- May be mounted horizontally, on side or in vertical line
- E14 Series: extended solder type connections standard
 - Can be installed using either low or no silver content brazing alloy
- Synthetic coated metal gaskets to minimize external leaks
- Used with R-22, R-134A, R-401A, R-402A, R-404A, R-407C, R-502, R-507



Part #	Mfg #	Order #	Connections	Nominal Cap R-22	Coil	Port Size	Options:	Price
SPOE14S250	E14S250	350500	5/8" ODF	15.8	MKC-2	7/16"		185.02
SPOE14S250HP	E14S250-HP	410000	5/8" ODF	15.8	MKC-2	7/16"	R-410A High Prs	185.02
SPOME14S250	ME14S250	352800	5/8" ODF	15.8	MKC-2	7/16"	Manual Lift	222.96
SPOME14S250HP	ME14S250-HP	352400	5/8" ODF	15.8	MKC-2	7/16"	R-410A High Prs, Manual Lift	222.96

Type E19 Series less Coil

- Normally closed unless otherwise noted
- Compact solenoid valve with pilot operated disc construction
- For refrigeration and air conditioning
- Also suitable for suction line service
- May be mounted horizontally, on side or in vertical line
- E19 Series: extended solder type connections standard
 - Can be installed using either low or no silver content brazing alloy
- Synthetic coated metal gaskets to minimize external leaks
- Used with R-22, R-134A, R-401A, R-402A, R-404A, R-407C, R-502, R-507



Part #	Mfg #	Order #	Connections	Nominal Cap R-22	Coil	Port Size	Options:	Price
SPOE19S270	E19S270	357600	7/8" ODF	24.2	MKC-2	19/32"		301.14
SPOE19S270HP	E19S270HP	407700	7/8" ODF	24.2	MKC-2	19/32"	R-410A High Prs	301.14
SPOME19S270	ME19S270	359600	7/8" ODF	24.2	MKC-2	19/32"	Manual Lift	339.08
SPOME19S270HP	ME19S270-HP	359100	7/8" ODF	24.2	MKC-2	19/32"	R-410A High Prs, Manual Lift	339.08

Type E25 Series less Coil

- Normally closed unless otherwise noted
- Compact solenoid valve with pilot operated disc construction
- For refrigeration and air conditioning
- Also suitable for suction line service
- May be mounted horizontally, on side or in vertical line
- E25 Series: extended solder type connections standard
 - Can be installed using either low or no silver content brazing alloy
- Synthetic coated metal gaskets to minimize external leaks
- Used with R-22, R-134A, R-401A, R-402A, R-404A, R-407C, R-502, R-507



Part #	Mfg #	Order #	Connections	Nominal Cap R-22	Coil	Port Size	Options:	Price
SPOE25S290	E25S290	364100	1-1/8" ODF	41.4	MKC-2	25/32"		437.72
SPOME25S290	ME25S290	367200	1-1/8" ODF	41.4	MKC-2	25/32"	Manual Lift	475.10

All Items May Not Be Stocked In All Branches



www.irrsupply.com

Refrigeration Valves

Industrial Solenoid Valve

- For air, water, steam, and light oil
- Suitable for most types of industrial applications
- Ideal for water, glycol, most refrigerant oils, steam lines, etc.
- Disc type: for high temperature and steam up to 25 psig
- Teflon diaphragm type: for high temperature and steam over 5 psig but not to exceed 10 psig

Part #	Mfg #	Order #	Type	Connections	Port Size	Diaphragm	SS Insert Seat	Coil	Price
SPOKR184P1	KR184P1	392400	Diaphragm	1/2" NPT	9/16"	Teflon	Yes	MKC-1	224.86
SPOKR246P1	KR246P1	393200	Diaphragm	3/4" NPT	3/4"	Teflon	Yes	MKC-1	275.54

Secondary Coolant Valve - Normally Closed Valve Position

- Control secondary coolant (propylene glycol, ethylene glycol, Pecosol 50, Dynalene HC-40 and others)
- For supermarket refrigeration
- Less coil and manual lift
- Extended ODF copper connections
- Brass body
- R1021E - Used for glycol service



Part #	Mfg #	Connections	Cv	MOPD	Price
SPO14E23C2R1021E	14E23C2-R1021E	7/8" ODF	5	150 PSI	291.60
SPO18E23C2R1021E	18E23C2-R1021E	1-1/8" ODF	5	150 PSI	291.60
SPO22EH5C2R1021E	22EH5C2-R1021E	1-3/8" ODF	12.2	50 PSI	653.14

Secondary Coolant Valve - Normally Open Valve Position

- Control secondary coolant (propylene glycol, ethylene glycol, Pecosol 50, Dynalene HC-40 and others)
- For supermarket refrigeration
- Less coil
- Brass body
- R1021E - Used for glycol service



Part #	Mfg #	Connections	Cv	MOPD	Price
SPO14E23O2R1021E	14E23O2-R1021E	7/8" ODF	5	150 PSI	443.72
SPO18E23O2R1021E	18E23O2-R1021E	1-1/8" ODF	5	150 PSI	443.72
SPO22E25O2R1021E	22E25O2-R1021E	1-3/8" ODF	12.2	50 PSI	825.02

Refrigeration Valves

Prices & Specifications are Subject to Change.



www.irrsupply.com

Refrigeration Valves

Solenoid Coils

- R1021 - Used for glycol service



Part #	Mfg #	Description	Price
SPOAF4C10R1021	AF4C10-R1021	208V 6W Completely Encapsulated w/18" Leads	108.46
SPOCF5C10R1021	CF5C10-R1021	208V 11W Special Enclosure w/18" Leads	154.92
SPOMKC124	MKC-1	24V/50-60Hz	67.74
SPOMKC1120	MKC-1	120V/50-60Hz	67.74
SPOMKC1240	MKC-1	208-240V/50-60Hz	67.74
SPOMKC1120240	MKC-1	120-208-240V Dual Voltage	88.10
SPOMKC224	MKC-2	24V/50-60Hz	81.32
SPOMKC2120	MKC-2	120V/50-60Hz	81.32
SPOMKC2240	MKC-2	208-240V/50-60Hz	81.32
SPOMKC2120240	MKC-2	120-208-240V Dual Voltage 4-Wire Coils	105.70

Kits

Secondary Coolant Valve Parts Kit

Part #	Mfg #	Kit Contents Description	Price
SPO14E23C2R1021ER	14E23C2R1021ER	Parts Kit for 14E23C2-R1021E Normally Closed	102.12
SPO18E23C2R1021ER	18E23C2R1021ER	Parts Kit for 18E23C2-R1021E Normally Closed	102.12
SPO22EH5C2R1021ER	22EH5C2R1021ER	Parts Kit for 22EH3C2-R1021E Normally Closed	221.18
SPO14E23O2R1021ER	14E23O2R1021ER	Parts Kit for 14E23O2-R1021E Normally Open	126.82
SPO18E23O2R1021ER	18E23O2R1021ER	Parts Kit for 18E23O2-R1021E Normally Open	126.82
SPO22E25O2R1021ER	22E25O2R1021ER	Parts Kit for 22EH3O2-R1021E Normally Open	248.84

Normally Closed Disc/Piston Diaphragm Kit

Part #	Mfg #	Kit Contents Description	Price
SPOKSB6E6	KS-B6/E6	(1) Stem & Plunger Assembly, (1) Disc Assembly, (1) Kick Off Spring, (1) Enclosing Tube Gasket	110.82
SPOKSB9E9	KS-B9/E9	(1) Stem & Plunger Assembly, (1) Disc Assembly, (1) Kick Off Spring, (1) Enclosing Tube Gasket	122.64
SPOKSB10E10	KS-B10/E10	(1) Stem & Plunger Assembly, (1) Disc Assembly, (1) Kick Off Spring, (1) Enclosing Tube Gasket	128.24
SPOKSB14E14	KS-B14/E14	(1) Stem & Plunger Assembly, (1) Disc Assembly, (1) Kick Off Spring, (1) Enclosing Tube Gasket	142.18
SPOKSB25E25	KS-B25/E25	(1) Stem & Plunger Assembly, (1) Disc Assembly, (1) Kick Off Spring, (1) Enclosing Tube Gasket	273.14
SPOKSB19E19	KS-B19/E19	(1) Disc or Piston, (1) Operator Assembly, (1) Enclosing Tube O-Rings or Gaskets, (1) Spring (OB33 & OE33 Series Only), (1) Body Flange Gasket (OB33 & OE33 Series Only)	190.66

Refrigeration Valves

All Items May Not Be Stocked In All Branches

Refrigeration Valves

Ball Valves

Integra-Seal® Ball Valve

- Full refrigeration service temperature range: -40° to +325°F
- Forged brass body and steel cap
- Design working pressure: 500 psig
- No synthetic O-ring seals
- Polished brass or chrome plated steel ball

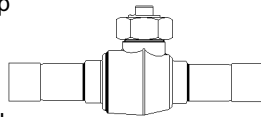

WAS Series (Welded with Access Fitting)

Part #	Mfg #	Connection	Ball Port Dia	Price
SUPBVS38	586WAS-6ST	3/8" ODS	0.50"	63.40
SUPBVS12	586WAS-8ST	1/2" ODS	0.50"	61.36
SUPBVS58	586WAS-10ST	5/8" ODS	0.50"	61.36
SUPBVS78	587WAS-14ST	7/8" ODS	0.75"	81.62
SUPBVS118	591WAS-11ST	1-1/8" ODS	1.00"	119.16
SUPBVS138	592WAS-13ST	1-3/8" ODS	1.50"	197.34
SUPBVS158	593WAS-15ST	1-5/8" ODS	1.50"	201.38
SUPBVS218	594WAS-21ST	2-1/8" ODS	2.01"	376.00

H-V Check Valves

Type 802B Horizontal or Vertical Installation Check Valve

- Horizontal or vertical installation
- Working pressure: up to 500 psig
- All forged brass construction
- Seat material: Teflon
- Specially designed secondary seat backs up primary seat
- Copper gasket between cap and body assures positive shut-off
- Temperature range: -40° to 400°F

H-V Check Valve with Tube Extensions (ODS x ODS)

- Tube extensions permit valve to be silver soldered directly to line without disassembly

Part #	Mfg #	Size	Price
SUP802B6ST	802B-6ST	3/8"	79.42
SUP802B8ST	802B-8ST	1/2"	95.30
SUP803B10ST	803B-10ST	5/8"	119.12
SUP804A14ST	804A-14ST	7/8"	166.76

H-V Globe Line Check Valve (ODS x ODS)

- Horizontal or vertical installation
- Working pressure: up to 500 psig
- All forged brass construction
- Seat material: Teflon
- Special non-metallic bonnet gasket
- Service temperature: 400°F
- Low pressure drop "Y" design

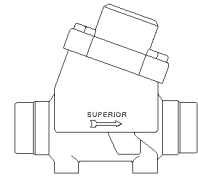

Part #	Mfg #	Size	Price
SUP806C11S	806C-11S	1-1/8"	206.48
SUP807C13S	807C-13S	1-3/8"	336.44
SUP808C15S	808C-15S	1-5/8"	369.28

Packed Angle Valves

600A Series Packed Angle Valve

- Working pressure: 500 psig
- Forged brass body construction
- Seal cap construction: brass with copper or nylon gasket
- Temperature range: -40° to 300°F

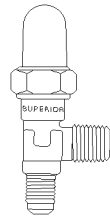

Part #	Mfg #	Btm Inlet	Side Outlet	Socket Tubg	Price
SUP600A4B	600A-4B	1/4"	1/4"	1/4" OD	33.66
SUP600A6C	600A-6C	3/8"	3/8"	3/8" OD	40.04

"Tuffy" Series Diaphragm Packless Line Valves

- Working pressure 1/4" thru 7/8": 500 psig
- Working pressure 1-1/8": 375 psig
- Forged brass body construction
- Seat material: nylon
- Diaphragm construction: stainless steel
- Temperature range: -40° to 275°F

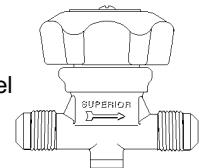

"Tuffy" Line Valve (SAE x SAE)

Part #	Mfg #	Size	Price
SUP2144	214-4	1/4"	55.58
SUP2146	214-6	3/8"	63.54

"Tuffy" Line Valve (ODS x ODS)

Part #	Mfg #	Size	Price
SUP2146S	214-6S	3/8"	63.54

Refrigeration Valves

**"Tuffy" Line Valve with Tube Extensions
(ODS x ODS)**

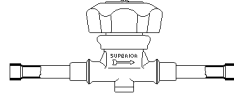

Part #	Mfg #	Size	Price
SUP2144ST	214-4ST	1/4"	72.20

Pressure Relief Valves

"A" Series Straight-Thru Type (NPT x SAE)

Part #	Mfg #	Port		Dia	PSI	Price
		In	Out			
SUP3014400	3014	3/8"	3/8"	3/16"	400	99.44
SUP3020350	3020	1/2"	5/8"	9/32"	350	120.28
SUP3020400	3020	1/2"	5/8"	9/32"	400	120.28
SUP3020425	3020	1/2"	5/8"	9/32"	425	124.28

Refrigeration Valves

Irr Supply is your one stop shop for all your Plumbing, HVAC, Refrigeration, and Electrical needs. Why go anywhere else!

Thermostatic Expansion Valves

Type-ER Thermostatic Expansion Valves

- Thermostatic element is replaceable
- Designed for R-410A air conditioning and heat pump applications
- Ideal for replacing I, BI, BBI and RI (Non-RPB version only) valves
- Element size No. 43, No. 45 and No. 45-5
- Standard tubing length 60"

Type-ER - External Equalizer ODF Solder

Part #	Mfg #	Order #	Nom Cap Tons	Thermostatic Charges	Refrigerant Type	Conn Inlet, Outlet	Application	Price
SPOERZE1GA	ERZE1GA	168790	1	ZGA	R-410A	3/8", 1/2"	A/C	177.16
SPOERZE112GA	ERZE-1-1/2-GA	168784	1-1/2	ZGA	R-410A	3/8", 1/2"	A/C	177.16
SPOERZE6GA	ERZE-6-GA	168794	6	ZGA	R-410A	1/2", 5/8"	A/C	177.16
SPOERZE8GA	ERZE-8-GA	168719	8	ZGA	R-410A	5/8", 7/8"	A/C	255.70
SPOERZE1212GA	ERZE12-1/2-GA	168801	12-1/2	ZGA	R-410A	5/8", 7/8"	A/C	255.70
SPOERZE15GA	ERZE-15-GA	168807	15	ZGA	R-410A	5/8", 1-1/8"	A/C	255.70

Type-RC Thermostatic Expansion Valves

- Balanced port construction
- R-22 Element size is No. 43
- R-410A Element size is No. 45
- Standard tubing length 30"



Type-RC - External Equalizer ODF Solder

Part #	Mfg #	Order #	Nom Cap Tons	Thermostatic Charges	Refrigerant Type	Conn Inlet, Outlet	Application	Price
SPORCVE2GA	RCVE-2-GA	151265	2	VGA	R-22	3/8", 1/2"	A/C	192.82
SPORCVE3GA	RCVE-3-GA	151245	3	VGA	R-22	3/8", 1/2"	A/C	192.82
SPORCVE4GA	RCVE-4-GA	151252	4	VGA	R-22	1/2", 5/8"	A/C	241.10
SPORCVE5GA	RCVE-5-GA	151272	5	VGA	R-22	1/2", 5/8"	A/C	241.10
SPORCZE2GA	RCZE-2-GA	151365	2	ZGA	R-410A	3/8", 1/2"	A/C	229.04
SPORCZE3GA	RCZE-3-GA	151366	3	ZGA	R-410A	3/8", 1/2"	A/C	229.04
SPORCZE4GA	RCZE-4-GA	151368	4	ZGA	R-410A	1/2", 1/2"	A/C	229.04
SPORCZE5GA	RCZE-5-GA	151369	5	ZGA	R-410A	1/2", 5/8"	A/C	229.04
SPORCZE6GA	RCZE-6-GA	151370	6	ZGA	R-410A	1/2", 5/8"	A/C	286.36

Type-F Thermostatic Valves

- Replaceable thermostatic elements
- Designed for small refrigeration systems
- Removable 100 mesh strainer
- Element size No. 43
- Standard tubing length 30"



Type-F - Internal Equalizer SAE Flare

Part #	Mfg #	Order #	Nom Cap Tons	Thermostatic Charges	Refrigerant Type	Conn Inlet, Outlet	Application	Price
SPOFV14C	FV-1/4-C	109212	1/4	C	R-22	1/4", 1/2"	Comm Refrig	121.58
SPOFV12C	FV-1/2-C	109221	1/2	C	R-22	1/4", 1/2"	Comm Refrig	121.58
SPOFV1C	FV-1-C	109263	1	C	R-22	1/4", 1/2"	Comm Refrig	152.02
SPOFJ14C	FJ-1/4-C	109201	1/4	C	R-134a, R-12	1/4", 1/2"	Comm Refrig	121.58

TXV's, Parts, Accessories

Prices & Specifications are Subject to Change.



www.irrsupply.com

Thermostatic Expansion Valves

Type-F Thermostatic Valves (Continued)

Type-F - Internal Equalizer SAE Flare

Part #	Mfg #	Order #	Nom Cap Tons	Thermostatic Charges	Refrigerant Type	Conn Inlet, Outlet	Application	Price
SPOFJ14C14-38	FJ-1/4-C	110209	1/4	C	R-134a, R-12	1/4", 3/8"	Comm Refrig	121.58
SPOFJ12C14-12	FJ-1/2-C	111929	1/2	C	R-134a, R-12	1/4", 1/2"	Comm Refrig	121.58
SPOFJ12C38-12	FJ-1/2-C	109716	1/2	C	R-134a, R-12	3/8", 1/2"	Comm Refrig	121.58
SPOFJ1C	FJ-1-C	111927	1	C	R-134a, R-12	3/8", 1/2"	Comm Refrig	121.58
SPOFS12ZP	FS-1/2-ZP	109327	1/2	ZP40	R-404A	1/4", 1/2"	Low Temp Refrig	121.58
SPOFS1ZP	FS-1-ZP	109329	1	ZP40	R-404A	3/8", 1/2"	Low Temp Refrig	152.02

Type-F - External Equalizer SAE Flare

Part #	Mfg #	Order #	Nom Cap Tons	Thermostatic Charges	Refrigerant Type	Conn Inlet, Outlet	Application	Price
SPOFVE12C	FVE-1/2-C	109242	1/2	C	R-22	1/4", 1/2"	Comm Refrig	133.78
SPOFVE1C	FVE-1-C	109284	1	C	R-22	1/4", 1/2"	Comm Refrig	133.78
SPOFVE112C	FVE-1-1/2-C	109305	1-1/2	C	R-22	3/8", 1/2"	Comm Refrig	133.78
SPOFVE2C	FVE-2-C	109312	2	C	R-22	3/8", 1/2"	Comm Refrig	133.78
SPOFVE3C	FVE-3-C	109326	3	C	R-22	3/8", 1/2"	Comm Refrig	133.78
SPOFJE12C	FJE-1/2-C	109735	1/2	C	R-134a, R-12	3/8", 1/2"	Comm Refrig	133.78
SPOFJE1C	FJE-1-C	111930	1	C	R-134a, R-12	3/8", 1/2"	Comm Refrig	133.78
SPOFJE1ZP	FJE-1-ZP	109761	1	ZP40	R-134a, R-12	3/8", 1/2"	Low Temp Refrig	145.16
SPOFJE112C	FJE-1-1/2-C	109206	1-1/2	C	R-134a, R-12	3/8", 1/2"	Comm Refrig	133.78
SPOFJE2C	FJE-2-C	109207	2	C	R-134a, R-12	3/8", 1/2"	Comm Refrig	133.78
SPOFSE12ZP	FSE-1/2-ZP	109336	1/2	ZP40	R-404A	1/4", 1/2"	Low Temp Refrig	133.78
SPOFSE1C	FSE-1-C	109274	1	C	R-404A	3/8", 1/2"	Comm Refrig	133.78
SPOFSE1ZP	FSE-1-ZP	109337	1	ZP40	R-404A	3/8", 1/2"	Low Temp Refrig	133.78
SPOFSE112ZP	FSE-1-1/2-ZP	109338	1-1/2	ZP40	R-404A	3/8", 1/2"	Low Temp Refrig	133.78

Type-EF Thermostatic Expansion Valves

- Designed for small refrigeration systems such as refrigerated cases, coolers, and freezers where space is limited and an external adjustment is desired
- Insert strainer 50 mesh
- Element size No. 43
- Standard tubing length 30"



Type-EF - Internal Equalizer ODF Solder

Part #	Mfg #	Order #	Nom Cap Tons	Thermostatic Charges	Refrigerant Type	Conn Inlet, Outlet	Application	Price
SPOEFV14C	EFV-1/4-C	109957	1/4	C	R-22	1/4", 1/2"	Comm Refrig	119.26
SPOEFJ14C	EFJ-1/4C	109702	1/4	C	R-134a, R-12	1/4", 1/2"	Comm Refrig	119.26
SPOEFJ12C	EFJ-1/2C	109836	1/2	C	R-134a, R-12	1/4", 1/2"	Comm Refrig	119.26
SPOEFS14C	EFV-1/4-C	109897	1/4	C	R-404A	1/4", 1/2"	Comm Refrig	119.26
SPOEFS14ZP	EFV-1/4-ZP	109903	1/4	ZP40	R-404A	1/4", 1/2"	Low Temp Refrig	149.08
SPOEFS12C	EFV-1/2-C	109281	1/2	C	R-404A	1/4", 1/2"	Comm Refrig	149.08
SPOEFS12ZP	EFV-1/2-ZP	109311	1/2	ZP40	R-404A	1/4", 1/2"	Low Temp Refrig	149.08

All Items May Not Be Stocked In All Branches



www.irrsupply.com

Thermostatic Expansion Valves

Type-EF - External Equalizer ODF Solder

Part #	Mfg #	Order #	Nom Cap Tons	Thermostatic Charges	Refrigerant Type	Conn Inlet, Outlet	Application	Price
SPOEFVE12C	EFVE-1/2-C	109560	1/2	C	R-22	1/4", 1/2"	Comm Refrig	131.16
SPOEFVE1C	EFVE-1-C	109570	1	C	R-22	1/4", 1/2"	Comm Refrig	131.16
SPOEFVE112C	EFVE-1-1/2-C	109967	1-1/2	C	R-22	3/8", 1/2"	Comm Refrig	131.16
SPOEFVE3C	EFVE-3-C	109975	3	C	R-22	3/8", 1/2"	Comm Refrig	131.16
SPOEFJE12C	EFJE-1/2-C	109736	1/2	C	R-134a, R-12	1/4", 1/2"	Comm Refrig	131.16
SPOEFJE1C	EFJE-1-C	109850	1	C	R-134a, R-12	3/8", 1/2"	Comm Refrig	131.16
SPOEFSE14C	EFSE-1/4-C	109645	1/4	C	R-404A	1/4", 1/2"	Comm Refrig	131.16
SPOEFSE12C	EFSE-1/2-C	109631	1/2	C	R-404A	1/4", 1/2"	Comm Refrig	131.16
SPOEFSE12ZP	EFSE-1/2-ZP	109926	1/2	ZP40	R-404A	1/4", 1/2"	Low Temp Refrig	131.16
SPOEFSE1C	EFSE-1-C	110368	1	C	R-404A	3/8", 1/2"	Comm Refrig	163.94
SPOEFSE1ZP	EFSE-1-ZP	109913	1	ZP40	R-404A	3/8", 1/2"	Low Temp Refrig	131.16
SPOEFSE112ZP	EFSE-1-1/2-ZP	109918	1-1/2	ZP40	R-404A	3/8", 1/2"	Low Temp Refrig	163.94

Type-BF Thermostatic Expansion Valves

- Balanced port construction
- Element size No. 43
- Standard tubing length 30"

Type-BF - External Equalizer SAE Flare

- 1/4" External equalizer connection

Part #	Mfg #	Order #	Nom Cap Tons	Thermostatic Charges	Refrigerant Type	Conn Inlet, Outlet	Application	Price
SPOBFVEAAC	BFVE-AA-C	100262	1/2 - 2/3	C	R-22	1/4", 1/2"	Comm Refrig	157.68
SPOBFVEAC	BFVE-A-C	100446	3/4 - 1-1/2	C	R-22	3/8", 1/2"	Comm Refrig	157.68
SPOBFVEBC	BFVE-B-C	100328	1-3/4 - 3	C	R-22	3/8", 1/2"	Comm Refrig	157.68
SPOBFVECC	BFVE-C-C	100488	3-1/4 - 5-1/2	C	R-22	3/8", 1/2"	Comm Refrig	157.68
SPOBFJEAC	BFJE-A-C	100962	1/2 - 1	C	R-134a, R-12	3/8", 1/2"	Comm Refrig	157.68
SPOBFSEAZP	BFSE-A-ZP	100412	1/2 - 1	ZP40	R-404A	3/8", 1/2"	Low Temp Refrig	157.68
SPOBFSEBZP	BFSE-B-ZP	100414	1-1/4 - 2	ZP40	R-404A	3/8", 1/2"	Low Temp Refrig	157.68

Type-EBF Thermostatic Expansion Valves

- Balanced port construction
- 100 Mesh strainer
- Element size No. 43
- Standard tubing length 30"



Type-EBF - Internal Equalizer Extended ODF Solder

Part #	Mfg #	Order #	Nom Cap Tons	Thermostatic Charges	Refrigerant Type	Conn Inlet, Outlet	Application	Price
SPOEBFVAAC	EBFV-AA-C	110034	1/2 - 2/3	C	R-22	3/8", 1/2"	Comm Refrig	158.12

TXVs, Parts, Accessories

Prices & Specifications are Subject to Change.



www.irrsupply.com

Thermostatic Expansion Valves

Type-EBF - External Equalizer Extended ODF Solder

- 1/4" External equalizer connection - pointed toward bottom cap

Part #	Mfg #	Order #	Nom Cap Tons	Thermostatic Charges	Refrigerant Type	Conn Inlet, Outlet	Application	Price
SPOEBFVEAC	EBFVE-A-C	109035	3/4 - 1-1/2	C	R-22	3/8", 1/2"	Comm Refrig	173.94
SPOEBFVEBC	EBFVE-B-C	109055	1-3/4 - 3	C	R-22	3/8", 1/2"	Comm Refrig	173.94
SPOEBFVECC	EBFVE-C-C	109073	3-1/4 - 5-1/2	C	R-22	3/8", 1/2"	Comm Refrig	173.94
SPOEBFJEAAC	EBFJE-AAA-C	109099	1/8 - 1/3	C	R-134a, R-12	3/8", 1/2"	Comm Refrig	217.44
SPOEBFJEAC	EBFJE-AA-C	108247	1/4 - 2/3	C	R-134a, R-12	3/8", 1/2"	Comm Refrig	173.94
SPOEBFJEAC	EBFJE-A-C	108243	1/2 - 1	C	R-134a, R-12	3/8", 1/2"	Comm Refrig	173.94

Type-SBF Thermostatic Expansion Valves

- Balanced port construction
- Ideally suited for small capacity refrigeration applications which operate over widely varying conditions
- Removable 100 mesh strainer that can be cleaned and/or replaced while valve is soldered to the system
- Element size No. 43
- Standard tubing length 30"



Type-SBF - Internal Equalizer Extended ODF Solder with Replaceable Strainer

Part #	Mfg #	Order #	Nom Cap Tons	Thermostatic Charges	Refrigerant Type	Conn Inlet, Outlet	Application	Price
SPOSBFJAAC	SBFJ-AA-C	108548	1/4 - 1/3	C	R-134a, R-12	3/8", 1/2"	Comm Refrig	185.02

Type-SBF - External Equalizer Extended ODF Solder with Replaceable Strainer

Part #	Mfg #	Order #	Nom Cap Tons	Thermostatic Charges	Refrigerant Type	Conn Inlet, Outlet	Application	Price
SPOSBFVEAAC	SBFVE-AA-C	108687	1/2 - 2/3	C	R-22	3/8", 1/2"	Comm Refrig	203.50
SPOSBFVEAC	SBFVE-A-C	108673	3/4 - 1-1/2	C	R-22	3/8", 1/2"	Comm Refrig	203.50
SPOSBFVEBC	SBFVE-B-C	108701	1-3/4 - 3	C	R-22	3/8", 1/2"	Comm Refrig	203.50
SPOSBFVECC	SBFVE-C-C	108715	3-1/4 - 5-1/2	C	R-22	3/8", 1/2"	Comm Refrig	203.50
SPOSBFJEAC	SBFJE-A-C	108549	1/2 - 1	C	R-134a, R-12	3/8", 1/2"	Comm Refrig	203.50
SPOSBFJEBC	SBFJE-B-C	108551	1-1/4 - 1-3/4	C	R-134a, R-12	3/8", 1/2"	Comm Refrig	203.50
SPOSBFSEAC	SBFSE-A-C	108617	1/2 - 1	C	R-404A	3/8", 1/2"	Comm Refrig	203.50
SPOSBFSEAZ	SBFSE-A-Z	108618	1/2 - 1	Z	R-404A	3/8", 1/2"	Low Temp Refrig	203.50
SPOSBFSEAZP	SBFSE-A-ZP	108619	1/2 - 1	ZP40	R-404A	3/8", 1/2"	Low Temp Refrig	203.50
SPOSBFSEBC	SBFSE-B-C	108624	1-1/4 - 2	C	R-404A	3/8", 1/2"	Comm Refrig	203.50
SPOSBFSEBZP	SBFSE-B-ZP	108626	1-1/4 - 2	ZP40	R-404A	3/8", 1/2"	Low Temp Refrig	203.50

TXV's, Parts,
Accessories

All Items May Not Be Stocked In All Branches



www.irrsupply.com

Thermostatic Expansion Valves

Type-S Thermostatic Expansion Valve

- Element size No. 83
- Standard tubing length 5'



Type-S - External Equalizer ODF Solder

- External equalizer has a 1/4" ODF solder connection

Part #	Mfg #	Order #	Nom Cap Tons	Thermostatic Charges	Refrigerant Type	Conn Inlet, Outlet	Application	Price
SPOSVE3C	SVE-3-C	130447	3	C	R-22	1/2", 5/8"	Comm Refrig	218.38
SPOSVE5GA	SVE-5-GA	129271	5	GA	R-22	1/2", 7/8"	A/C	272.98
SPOSVE8GA	SVE-8-GA	129334	8	GA	R-22	5/8", 7/8"	A/C	218.38
SPOSVE10GA	SVE-10-GA	129383	10	GA	R-22	5/8", 7/8"	A/C	272.98

Type-EBS Thermostatic Expansion Valve

- Balanced port construction
- For air conditioning and refrigeration applications
- Inlet has a permanent 12 mesh strainer
- Element size No. 83
- Standard tubing length 5'



Type-EBS - External Equalizer ODF Solder

Part #	Mfg #	Order #	Nom Cap Tons	Thermostatic Charges	Refrigerant Type	Conn Inlet, Outlet	Application	Price
SPOEBSVE8GA	EBSVE-8-GA	163556	8	GA	R-22	5/8", 7/8"	A/C	251.18
SPOEBSVE11GA	EBSVE-11-GA	163773	11	GA	R-22	5/8", 7/8"	A/C	251.18
SPOEBSVE15GA	EBSVE-15-GA	163595	15	GA	R-22	7/8", 1-1/8"	A/C	296.20
SPOEBSVE20GA	EBSVE-20-GA	163607	20	GA	R-22	7/8", 1-3/8"	A/C	370.26

Type-O Thermostatic Expansion Valve

- Balanced port construction
- Inlet has a permanent 12 mesh strainer
- Designed for both refrigeration and air conditioning applications
- Element size No. 83
- Standard tubing length 5'



Type-O - External Equalizer ODF Solder

Part #	Mfg #	Order #	Nom Cap Tons	Thermostatic Charges	Refrigerant Type	Conn Inlet, Outlet	Application	Price
SPOOVE15GA	OVE-15-GA	124226	15	GA	R-22	7/8", 1-1/8"	A/C	330.24
SPOOVE20GA	OVE-20-GA	124233	20	GA	R-22	7/8", 1-3/8"	A/C	330.24
SPOOVE30GA	OVE-30-GA	124240	30	GA	R-22	1-1/8", 1-3/8"	A/C	330.24

TXV's, Parts, Accessories

Prices & Specifications are Subject to Change.

Thermostatic Expansion Valves

Three-Piece Q Conventional Port & BQ Balanced Port Valves

- BQ Balanced Port Q Valve designed for systems with a wide range of operating conditions
- 3-Piece - replaceable body, element and cartridge

Type-Q & BQ TXV Body - 90° Inlet SAE Flare Connection

- Element size No. 43
- Standard tubing length 5'
- Q: Conventional port
- BQ: Balanced port

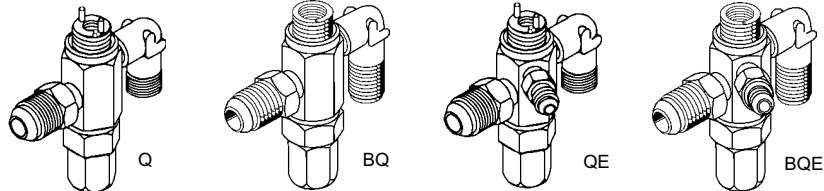

Part #	Mfg #	Order #	Connections	Equalizer	Price
SPOQBODY23	Q BODY	168012	1/4" x 3/8" SAE	Internal Equalizer	80.20
SPOQBODY24	Q BODY	168011	1/4" x 1/2" SAE	Internal Equalizer	71.48
SPOQBODY34	Q BODY	168000	3/8" x 1/2" SAE	Internal Equalizer	71.48
SPOBQBODY24	BQ BODY	168191	1/4" x 1/2" SAE	Internal Equalizer	71.48
SPOBQBODY34	BQ BODY	168190	3/8" x 1/2" SAE	Internal Equalizer	71.48
SPOQEBODY232	QE BODY	168017	1/4" x 3/8" x 1/4" SAE	External Equalizer	82.24
SPOQEBODY242	QE BODY	168016	1/4" x 1/2" x 1/4" SAE	External Equalizer	82.24
SPOQEBODY34	QE BODY	168005	3/8" x 1/2" x 1/4" SAE	External Equalizer	82.24
SPOBQEBODY24	BQE BODY	168184	1/4" x 1/2" x 1/4" SAE	External Equalizer	82.24
SPOBQEBODY342	BQE BODY	168183	3/8" x 1/2" x 1/4" SAE	External Equalizer	82.24

Type-EQ TXV Body - Straight-Thru Extended ODF Solder

- Element size No. 43
- Standard tubing length 5'

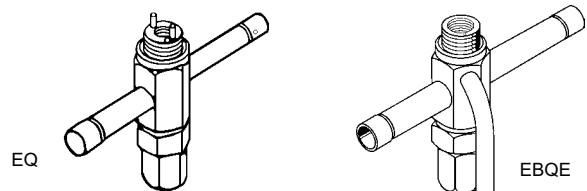

Part #	Mfg #	Order #	Connections	Equalizer	Price
SPOEQBODY34	EQ BODY	168144	3/8" x 1/2" ODF	Internal Equalizer	84.72
SPOEBQEBODY45	EBQE BODY	168187	1/2" x 5/8" x 1/4" ODF	External Equalizer	97.40
SPOEBQEBODY47	EBQE BODY	168188	1/2" x 7/8" x 1/4" ODF	External Equalizer	97.40

Type-SQ TXV Body - Extended ODF Solder with Forged Inlet & Replaceable Strainer

- Element size No. 43
- Knife edge joint
- Standard tubing length 5'

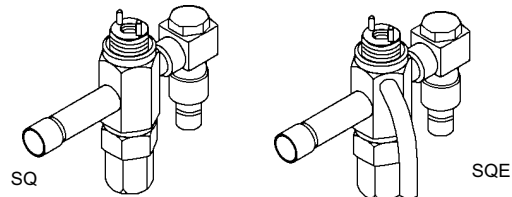

Part #	Mfg #	Order #	Connections	Equalizer	Price
SPOSQBODY34	SQ BODY	168010	3/8" x 1/2" ODF	Internal Equalizer	85.68
SPOSQEBODY342	SQE BODY	168015	3/8" x 1/2" x 1/4" ODF	External Equalizer	98.58

All Items May Not Be Stocked In All Branches



www.irrsupply.com

Thermostatic Expansion Valves

TXV Replaceable Cartridge & ID Tag

- Requires body, element and cartridge

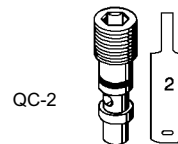

Part #	Mfg #	Order #	Description	Size	Color Code	Price
SPOQC0	QC-0	168070	Cartridge & I.D. Tag	0	Red	14.32
SPOQC1	QC-1	168072	Cartridge & I.D. Tag	1	Yellow	14.32
SPOQC2	QC-2	168074	Cartridge & I.D. Tag	2	Green	14.32
SPOQC3	QC-3	168076	Cartridge & I.D. Tag	3	Blue	14.32
SPOQC4	QC-4	168078	Cartridge & I.D. Tag	4	Pink	14.32
SPOQC5	QC-5	168080	Cartridge & I.D. Tag	5	Black	14.32
SPOQC6	QC-6	168082	Cartridge & I.D. Tag	6	White	14.32
SPOBQCA	BQC-A	168306	Cartridge & I.D. Tag	A	Blue	31.10
SPOBQCAA	BQC-AA	168304	Cartridge & I.D. Tag	AA	Yellow	31.10

Thermostatic TXV Element for Q & BQ

- Requires body, element and cartridge
- 5' Capillary tube length standard

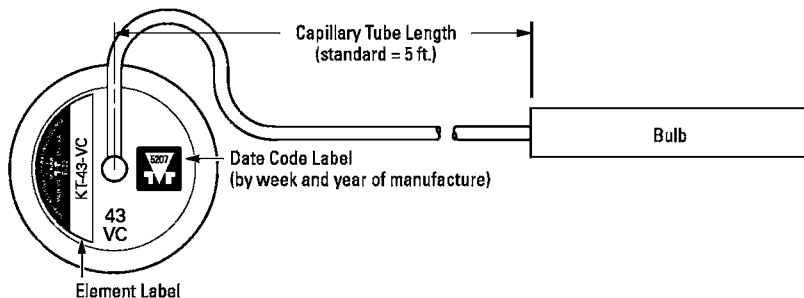

KT	43	V	C
Abbreviation for "Kit"	Element Size Number	Refrigerant Code Ⓞ	Thermostatic Charge

SPORLAN REFRIGERANT CODE

ELEMENT	LABEL	COLOR CODE
F	R-12	Yellow
V	R-22, R-422D	Green
J	R-134a	Blue
X	R-401A	Pink
L	R-402A	Sand
S	R-404A	Orange
V	R-407A	Green
N	R-407C	Light Brown
R	R-408A	Purple
F	R-409A	Yellow
Z	R-410A	Pink
R	R-502	Purple
P	R-507	Teal

Ⓞ While many new refrigerants and refrigerant blends have a unique letter code, many use the same thermostatic element as the traditional refrigerant they replace. Refer to the table below to select the correct thermostatic element.

Part #	Mfg #	Order #	Capillary Tube Length	Refrigeration Type	Application	Price
SPOKT43VC	KT-43-VC	180319	5'	R-22, R-422D, R-407A	Comm Refrig	84.26
SPOKT43VGA	KT-43-VGA	180276	5'	R-22, R-422D, R-407A, R-407C	A/C	84.26
SPOKT43JC30	KT-43-JC	180314	30"	R-134a, R-12	Comm Refrig	65.80
SPOKT43JZP	KT-43-JZP	180354	5'	R-134a, R-12	Low Temp Refrig	84.26
SPOKT43SC30	KT-43-SC	180330	30"	R-404A, R-408A	Comm Refrig	65.80
SPOKT43SZ	KT-43-SZ	180318	5'	R-404A, R-502, R-402A, R-507, R-408A	Low Temp Refrig	84.26
SPOKT43SZP	KT-43-SZP	180060	5'	R-404A, R-502, R-402A, R-507, R-408A	Low Temp Refrig	84.26
SPOKT45ZGA	KT-45-ZGA	181209	30"	R-410A	A/C	118.00

Q Kits in Case

Part #	Mfg #	Description	Price
SPOQKITCOMBO	Q CASE COMBO	Q Type Stocked Sweat and Flare Valves	822.80

Prices & Specifications are Subject to Change.



www.irrsupply.com

Thermostatic Expansion Valves

Three-Piece Q Conventional Port & BQ Balanced Port Valves (Continued)

Q Kits in Case

Part #	Mfg #	Description	Price
SPOBQKITCOMBO	BQ TXV Kit	BQ (Flare/Solder) TXV Kit	821.70

Thermostatic Elements

Thermostatic TXV Element for Types G, EG, X

Part #	Mfg #	Order #	Standard Tubing Length	Thermostatic Charge	Refrigeration Type	Application	Price
SPOKT53VC	KT-53-VC	180483	5'	C	R-22, R-407A, R-422D	Comm Refrig	94.40
SPOKT53VGA	KT-53-VGA	180499	5'	GA	R-22, R-407A, R-422D	A/C	94.40

Thermostatic TXV Element for Types H, O

Part #	Mfg #	Order #	Standard Tubing Length	Thermostatic Charge	Refrigeration Type	Application	Price
SPOKT33VGA	KT-33-VGA	180041	5'	GA	R-22, R-407A, R-422D	A/C	118.32

Thermostatic TXV Element for Types S, C, O, & EBS

Part #	Mfg #	Order #	Standard Tubing Length	Thermostatic Charge	Refrigeration Type	Application	Price
SPOKT83SZP	KT-83-SZP	180064	5'	ZP40	R-404A	Low Temp Refrig	103.80
SPOKT83VC	KT-83-VC	180887	5'	C	R-22, R-407A, R-422D	Comm Refrig	103.80
SPOKT83VCP100	KT-83-VCP100	180891	5'	CP100	R-22, R-407A, R-422D	A/C, 100 psig MOP	103.80
SPOKT83VGA	KT-83-VGA	180905	5'	GA	R-22, R-407A, R-422D	A/C	103.80

Auxiliary Side Connectors

- Permit the conversion of conventional Sporlan refrigerant distributors to hot gas bypass, hot gas defrost, or reverse cycle service

Part #	Mfg #	Order #	Solder Connections			Aux ODF Use With:	Price
			ODM Inlet	ODF Outlet	Solder		
SPOASC74	ASC-7-4	206835	7/8"	7/8"	1/2"	1112, 1113	123.54
SPOASC95	ASC-9-5	206841	1-1/8"	1-1/8"	5/8"	1115, 1116	125.90

TXV's, Parts,
Accessories

Quality people, quality products, excellent service.

All Items May Not Be Stocked In All Branches



www.irrsupply.com

OEM Motors

Bohn Parts & Accessories

Motor

Part #	Mfg #	HP	Voltage	RPM	Notes	Price
BOH5030SS	5030SS	1/150	115/60/1	3000		49.00
BOH5034LS	5034LS	1/20	115/60/1	1550		105.00
BOH5008TS	5008TS	1/20	208-230/60/1	1550		130.00
BOH25300201	25300201	1/20	208-230/60/1	1550		81.00
BOH5008SS	5008SS	1/15	115/60/1	1550		130.00
BOH5036SS	5036SS	1/15	115/60/1	1550		139.00
BOH22617801	22617801	1/15	115-1-60	1625	CCW EC Motor for Unit Cooler	541.00
BOH5036TS	5036TS	1/15	208-230/60/1	1550		161.00
BOH22617701	22617701	1/15	208/230-1-60	1625	CCW EC Motor for Unit Cooler	541.00
BOH7071061	7071061	1/15	208-230/50-60/1	1050		190.00
BOH5036PS	5036PS	1/15	208-230/50-60/1	1550		225.00
BOH25309101	25309101	1/15	208-230/60/1	1800		171.00
BOH25309801	25309801	1/15	208-230/50-60/1	1650	PSC Evaporator Motor	158.00
BOH5002MS	5002MS	1/6	208-230/60/1	1050		319.00
BOH5013TS	5013TS	1/5	208-230/60/1	1550		311.00
BOH5002PS	5002PS	1/2	208-230/60/1	1075		408.00
BOH7072102	7072102	3/4	230-460	1140		736.00

Refrigeration Replacement Parts

Part #	Mfg #	Description	Price
BOH26925101	26925101	3/4" Drain Fitting	21.00



Refrigeration Replacement Motors

Part #	Mfg #	HP	Voltage	RPM	Shaft Dia	Rotation	Price
CHA7070060	7070060	1/20	115-1-60	1400/1550	5/16"	CW	132.00
CHA25300101	25300101S	1/20	115-1-60	1550	5/16"	CWSE	86.00
CHA038688900	38688900	1/20	230-1-60	1550	5/16"	CW	119.00

TXV's, Parts,
Accessories

Prices & Specifications are Subject to Change.



Suction Accumulators/Vibration Absorbers

Suction Accumulators

- Will not trap oil
- Protects the compressor
- Exclusive inlet deflector for improved performance
- Marking of inlet with a metal plate is an exclusive feature that helps prevent errors in hook-up
- Controlled hydrogen copper brazing process provides the ultimate in cleanliness and uniform strength



Heat Pump Suction Accumulators

- 3738EN for R410A

Part #	Mfg #	Description	Diameter	Length	Suction Inlet/Outlet ID Size	Price
RER3702	3702	Vertical	4"	10.6"	5/8"	98.36
RER3738	3738	Vertical	5"	13"	7/8"	130.88
RER3700	3700	Vertical	6"	15"	1-1/8"	176.08
RER3704	3704	Vertical	6"	24.75"	1-5/8"	309.04



Vibration Absorbers

- Pressure & vacuum tested, cleaned, dehydrated & sealed in plastic film
- VAF-1 thru 11 :
Corrugated red brass flexible tubing, bronze wire braid, copper ferrule & tube end
- VAF-82 thru 87 :
Corrugated type 321 SS flexible tubing, type 304 SS braid & ferrule, copper tube end
- UL & CSA Approved

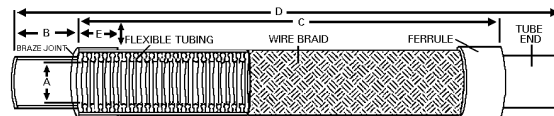

Part #	Mfg #	Copper Tubing OD In	Flex Tubg ID A	Tube End Length B	Flex Tbg L C	Overall Length D	Ferrule Length E	UL Style Nbr	MxWrkg Prs PSIG	Burst Prs PSIG	Price
VIB38	VAF03	3/8"	3/8"	5/8"	7"	8-1/4"	1/2"	P-3	500	2500	35.36
VIB12	VAF04	1/2"	3/8"	3/4"	7-1/2"	9"	1/2"	P-4	500	2500	39.02
VIB58	VAF05	5/8"	1/2"	7/8"	8"	9-3/4"	1/2"	P-5	500	2500	47.40
VIB78	VAF08	7/8"	3/4"	1-1/4"	9"	11-1/2"	5/8"	P-8A	500	2500	61.78
VIB118	VAF09	1-1/8"	1"	1-1/2"	10"	13"	15/16"	P-9A	500	2500	76.84
VIB138	VAF10	1-3/8"	1-1/4"	1-5/8"	11-1/2"	14-3/4"	1"	P-10A	500	2500	109.60
VIB158	VAF11	1-5/8"	1-1/2"	2"	13"	17"	1-1/8"	P-11A	500	2500	154.72
VIB218	VAF82	2-1/8"	2"	2-1/2"	14"	20"	1"	P-82	390	1950	215.24

TXV's, Parts, Accessories

All Items May Not Be Stocked In All Branches



www.irrsupply.com

Refrigeration Sundries

Oil Filters



Part #	Mfg #	Order #	Connection	Lgth	Overall Area(Sq In)	Filtering of Body	Dia PSI	UL Rated Notes	Price
SPOOF303T	OF-303-T	960071	3/8" SAE	9.69"	325	3.00"	500	w/Tap	272.04

Refrigeration Sundries

OmniStat Temperature and Defrost Controller with Digital Display

- Ideally suited for self-contained food service equipment
- Controller consolidates several system control functions and provides a visible display of the operating temperature
- Front push buttons to manually initiate a defrost, silence an alarm, or start the compressor
- Low temperature models feature relays for fans, defrost heaters and the compressor; and provide an added temperature probe connection to accommodate temperature defrost termination and time termination

Part #	Mfg #	Description	Price
SPOOMNIL120	952889	120VAC OmniStat Low Temperature	269.64
SPOOMNIPROBE10	952898	10' Temperature Probe (Sensor) for Omnistat, Stripped Ends	29.08

Irr Supply is your one stop shop for all your Plumbing, HVAC, Refrigeration, and Electrical needs. Why go anywhere else!

Prices & Specifications are Subject to Change.



www.irrsupply.com

Refrigeration Sundries

Refrigeration Sundries

Vacuum/Charging Valves

5/16" Compact Ball Valve for Special R-410A Applications

- Metal valve handle
- Add to hoses for charging and recovery
- Minimum burst: 4000 psi
- Maximum working pressure: 800 psi
- UL Recognized



Part #	Mfg #	Description	Price
RIT93825	93825	5/16" Fe Flare x 1/4" M Flare	49.96

Access Fittings

SealRight™ Quick Coupler

- SealRight™ fitting traps refrigerant in hose when disconnected helping meet non-venting regulations and preventing finger burns
- 1-Piece design attaches quickly
- Works with or without Schraeder core
- Field serviceable



Part #	Mfg #	Description	Price
RIT19109	19109	1/4" Straight SR x 1/4" M Flare	37.90

SealRight™ Repair Assembly Component



Part #	Mfg #	Description	Price
RIT19037	19037	1/4" O-Ring	17.86
RIT19040	19040	1/4" SealRight™ Rebuild Kit	21.14

R-410A Quick Coupler

45° with Schraeder Core in Male End



Part #	Mfg #	Description	Price
RIT19173	19173	5/16" 45° Fe QC x 1/4" M Flare	26.90

Gauge Quick Coupler with CH14 Adjustable Valve Opener



Part #	Mfg #	Description	Price
RIT19110	19110	1/4" Fe QC x 1/8" FNPT	20.50

Acme Coupler - Auto Straight



Part #	Mfg #	Female x Male	Price
RIT19161	19161	1/4" Fe QC x 1/2" Acme Male	22.64
RIT19165	19165	1/2" Acme Female x 1/4" M Flare	25.40

Quick Coupler Gaskets

- Designed for optimum performance with Yellow Jacket® charging hoses
- Works with all refrigerants
- Manufactured to strict tolerances to resist blow-out

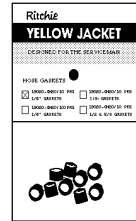

Part #	Mfg #	Description	Price
RIT19011	19011	CH11 Gasket for 3/8" Hose, 10/Pk	36.28
RIT19020	19020	CH20 for 1/4" Hose, 5/16" Hose, and 1/2" Acme Hose, 10/Pk	11.80

Oil Pumps & Injectors

Max-Flow™ Combination Oil Pump & Pumping Tube

- Removes oil for recovery and conversion
- Adds oil to existing systems
- Pumps oil into compressor on the down stroke while system is under pressure making pumping easier with a positive stroke
- Pumps against 200 psi pressure
- Comfort-grip rubber handle
- Universal stopper adjusts to all standard openings in 1, 2-1/2 and 5 gallon oil containers
- Suction transfer hose and fittings included
- Use with alkyl-benzene, ester-based, polyolester, mineral and synthetic oil



Part #	Mfg #	Description	Price
RIT77940	77940	2.6 oz per Stroke	223.10

All Items May Not Be Stocked In All Branches

Refrigeration Sundries

Utility Strap

Hang-N-Strap

- Strong, durable 1" polypropylene webbing



Part #	Mfg #	Description	Price
WAGHS30	HS-30	31" Hang-N-Strap	4.96
WAGHS60	HS-60	60" Hang-N-Strap	6.94

Lash-N-Strap

- Strong, durable nylon webbing rated at 3,000 lbs
- End hooks at 1,200 lbs tensile strength



Part #	Mfg #	Description	Price
WAGHS144	HS-144	144" Lash-N-Strap	42.50



Accessory Products

Chapin Chemical Sprayer Hose

Part #	Mfg #	Description	Price
VIRHOSE	79540	5/8" x 50' Premium Rubber Hose	83.54

Hoze Nozzle

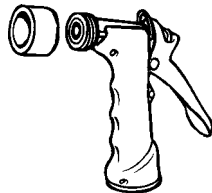

Part #	Mfg #	Description	Price
VIRNOZZLE	79582	Chrome Plated Threaded Front Hose Nozzle	27.98



Capillary Tubing



Capillary Tubing - Short Coils

Part #	Mfg #	Size (Inches)	Price
JBITC3112	TC-31-12	.031 ID x .073 OD x 12' (BC-1, GC-1)	11.85
JBITC4212	TC-42-12	.042 ID x .093 OD x 12' (BC-2, GC-2)	12.25
JBITC4911	TC-49-11	.049 ID x .099 OD x 11' (BC-3, GC-3, GC-7)	11.85
JBITC6410	TC-64-10	.064 ID x .125 OD x 10' (BC-4, GC-4)	12.75

Capillary Tubing - 100' Coils

Part #	Mfg #	Description	Price
JBITC36100	TC-36-100	.036 ID x .087 OD x 100' (GC-6)	56.33
JBITC54100	TC-54-100	.054 ID x .106 OD x 100' (GC-8)	47.10

Access Valves

Copper Tube Extension

- Use flux-free phos-copper solder
- Extension length approximately 2"
- Use with copper fitting
- Install through side of larger line



A31002



A31009

Part #	Mfg #	Description	Price
ACCA31002	A31002	1/8" OD	6.50
ACCA31003	A31003	3/16" OD x 1/8" ID	6.56
ACCA31004	A31004	1/4" OD x 3/16" ID	6.60
ACCA31005	A31005	5/16" OD x 1/4" ID	7.48
ACCA31006	A31006	3/8" OD x 5/16" ID	7.54
ACCA31008	A31008	1/2" OD	18.56
ACCA31009	A31009	Multi Step, 1/8" Ext; 3/16", 1/4" and 5/16" Body Steps	12.68



www.irrsupply.com

Access Valves & Brass Fittings

Refrigeration
Sundries

Copper Braze Tee

- Extra depth slip fit solder cups
- Bend, cut, flare, swage or pinch
- Simple installation anywhere along line



Part #	Mfg #	Description	Price
ACCA31134	A31134	1/4" ODS x 5/16" ODF	12.86
ACCA31135	A31135	5/16" ODS x 3/8" ODF	13.76
ACCA31136	A31136	3/8" ODS x 1/2" ODF	13.28
ACCA31138	A31138	1/2" ODS	14.18
ACCA31140	A31140	5/8" ODS	20.80
ACCA31142	A31142	3/4" ODS	22.06
ACCA31144	A31144	7/8" ODS	27.20

Flare Connection

- Core pre-torqued at 2.9-2.95 in lb
- Torque flare nut to 8-10 ft lbs



A31614



A31734

Part #	Mfg #	Description	Price
ACCA31614	A31614	1/4" Fe SAE Flare Union with Copper Gasket	14.70
ACCA31734	A31734	1/4" Fe SAE Swivel Nut with Depressor	15.62

Swivel Flare Connections

Tee With Depressor



A31851



A31852

Part #	Mfg #	Description	Price
ACCA31851	A31851	1/4" Fe SAE Swivel Nut on Run	19.80
ACCA31852	A31852	1/4" Fe SAE Swivel Nut on Branch	19.30

Tee Without Depressor



A31854



A31864

Part #	Mfg #	Description	Price
ACCA31854	A31854	1/4" Fe SAE Swivel Nut on Branch	18.56
ACCA31864	A31864	1/4" Fe SAE Swivel Nut on Run	19.06

Access Fittings

Access Valves - MPT Connections

- Core pre-torqued at 2.9 - 2.95 in lb



A31482, A31484



A31492

Part #	Mfg #	Description	Price
ACCA31482	A31482	1/8" MPT Half Union	5.04
ACCA31484	A31484	1/4" MPT Half Union	5.86
ACCA31492	A31492	1/8" MPT Elbow	12.98

Access Tee



A31452



A31512, A31514

Part #	Mfg #	Description	Price
ACCA31452	A31452	1/8" MPT Branch	14.66
ACCA31512	A31512	1/8" MPT Run	14.18
ACCA31514	A31514	1/4" MPT Run	16.00

All Items May Not Be Stocked In All Branches



www.irrsupply.com

Access Valves & Brass Fittings

Brass Bodies

Straight



Part #	Mfg #	Size	Price
ACCA31722	A31722	1/8" ODS	7.02
ACCA31724	A31724	1/4" ODS	5.86
ACCA31728	A31728	1/2" ODS	13.20

Multi-Step



A31720



A31729

Part #	Mfg #	Description	Price
ACCA31720	A31720	3/16" x 1/4" or 3/8" Steps	5.28
ACCA31729	A31729	3/16", 1/4", 5/16" or 1/2" ODF Multi-Steps	7.36

Line Piercing Access

Copper Saddle Braze/Tapper

- Quick, clean access to systems under pressure
- Hardened steel piercing needle
- Cap furnished
- Valve core pre-torqued @2.9-2.95 in lbs



Part #	Mfg #	Description	Price
ACCA32904	A32904	1/4" Saddle Valve	12.02

Tools & Replacement Parts

1/4" Valve Core



Part #	Mfg #	Description	Price
ACCA31999	A31999	1/4" Valve Cores (5)	1.76

Depressor



Part #	Mfg #	Description	Price
ACCP90513	P90513	For 1/4" Hoses/Couplers	2.12

Swivel Female Flare x Male Solder Adapter

Part #	Mfg #	Description	Price
FLAUS544	A32700	1/4" x 1/4"	10.00
FLAUS566	A32701	3/8" x 3/8"	10.62
FLAUS588	A32702	1/2" x 1/2"	11.56
FLAUS51010	A32703	5/8" x 5/8"	14.66
FLAUS51212	A32704	3/4" x 3/4"	19.72

SAE 45° Brass Flared Tube Fittings

Long Forged Refrigerator Nut (Flare)

- Increased vibration resistance

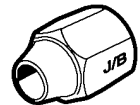

Part #	Mfg #	Size	Price
FLAN44	N4-4	1/4"	35.46
FLAN46	N4-6	3/8"	2.14
FLAN48	N4-8	1/2"	6.58
FLAN410	N4-10	5/8"	12.16

Brass Flared Tube Fittings

Copper Flare Bonnet

- Used with flare nut to cap a fitting



Part #	Mfg #	Size	Price
FLAB14	B1-4	1/4"	1.50
FLAB16	B1-6	3/8"	2.00
FLAB18	B1-8	1/2"	2.18

Copper Flare Gasket

- Used on brass to brass or brass to steel connections

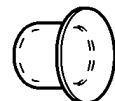

Part #	Mfg #	Size	Price
FLAB24	B2-4	1/4"	0.50
FLAB26	B2-6	3/8"	0.78
FLAB28	B2-8	1/2"	0.96
FLAB210	B2-10	5/8"	1.36

Prices & Specifications are Subject to Change.



www.irrsupply.com

Brass Flare Fittings

Refrigeration
Sundries

Flare Pipe Elbows (SAE Flare x MIP)



Part #	Mfg #	Size	Price
FLAE14A	E1-4A	1/4" SAE x 1/8" MIP	4.18
FLAE14B	E1-4B	1/4" SAE x 1/4" MIP	5.30
FLAE16B	E1-6B	3/8" SAE x 1/4" MIP	6.12
FLAE16C	E1-6C	3/8" SAE x 3/8" MIP	7.54
FLAE16D	E1-6D	3/8" SAE x 1/2" MIP	9.40
FLAE18D	E1-8D	1/2" SAE x 1/2" MIP	10.90
FLAE110D	E1-10D	5/8" SAE x 1/2" MIP	15.88

Flare Pipe Elbows (SAE Flare x SAE Flare)



Part #	Mfg #	Size	Price
FLAE24	E2-4	1/4" SAE	5.24
FLAE26	E2-6	3/8" SAE	7.92

Flare Pipe Elbows (SAE Flare x FIP)



Part #	Mfg #	Size	Price
FLAE36C	E3-6C	3/8" SAE x 3/8" FIP	12.04

Flare Pipe Elbows (Swivel Fem Flare x Flare)

- All parts come in packs of two

Part #	Mfg #	Size	Price
FLAES444	ES4-44	1/4" x 1/4"	15.40

Fusible Pipe Plug



Part #	Mfg #	Size	Temp	Price
FLAFPA21018	FP-A-210	1/8"	210°F	12.60
FLAFPC21038	FP-C-210	3/8"	210°F	17.60

Refrigerant Drum Adapter

- NPS Cylinder x male flare
- Furnished with fiber gasket

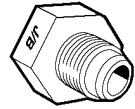

Part #	Mfg #	Size	Price
FLAK11	K1-1	3/4" x 1/4"	14.62
FLAK13	K1-3	3/4" x 3/8"	17.60

Short Forged Refrigeration Nut

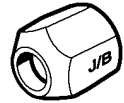

Part #	Mfg #	Size	Price
FLANS44	NS4-4	1/4"	1.76
FLANS45	NS4-5	5/16"	3.06
FLANS46	NS4-6	3/8"	2.00
FLANS48	NS4-8	1/2"	2.60
FLANS410	NS4-10	5/8"	4.02
FLANS412	NS4-12	3/4"	8.14
FLANRS464	NRS4-64	3/8" x 1/4"	4.26
FLANRS486	NRS4-86	1/2" x 3/8"	5.10
FLANRS4108	NRS4-108	5/8" x 1/2"	7.88

Flare Cap

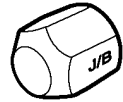

Part #	Mfg #	Size	Price
FLAN54	N5-4	1/4"	1.30
FLAN56	N5-6	3/8"	1.96
FLAN58	N5-8	1/2"	2.74
FLAN510	N5-10	5/8"	6.38

Flare Plug



Part #	Mfg #	Size	Price
FLAP24	P2-4	1/4"	2.34
FLAP26	P2-6	3/8"	2.98

Flare Tee (Flare x Flare x MIP)

Part #	Mfg #	Size	Price
FLAT14A	T1-4A	1/4" x 1/4" x 1/8" MIP	7.16
FLAT14B	T1-4B	1/4" x 1/4" x 1/4" MIP	8.72

All Items May Not Be Stocked In All Branches



www.irrsupply.com

Brass Flare Fittings

Flare Tee (Flare x Flare x Flare)



Part #	Mfg #	Size	Price
FLAT24	T2-4	1/4"	6.84
FLAT26	T2-6	3/8"	8.10
FLAT28	T2-8	1/2"	10.80

Flare x Male Pipe Adapter

- SAE Flare by male pipe



Part #	Mfg #	Size	Price
FLAU14A	U1-4A	1/4" x 1/8" MIP	1.62
FLAU14B	U1-4B	1/4" x 1/4" MIP	2.18
FLAU14C	U1-4C	1/4" x 3/8" MIP	3.62
FLAU14D	U1-4D	1/4" x 1/2" MIP	5.50
FLAU16B	U1-6B	3/8" x 1/4" MIP	3.12
FLAU16C	U1-6C	3/8" x 3/8" MIP	3.56
FLAU16D	U1-6D	3/8" x 1/2" MIP	7.84
FLAU18C	U1-8C	1/2" x 3/8" MIP	5.16
FLAU18D	U1-8D	1/2" x 1/2" MIP	5.10
FLAU18E	U1-8E	1/2" x 3/4" MIP	8.58
FLAU110D	U1-10D	5/8" x 1/2" MIP	6.68
FLAU110E	U1-10E	5/8" x 3/4" MIP	8.78
FLAU112E	U1-12E	3/4" x 3/4" MIP	14.22

Flare Union

- SAE Flare

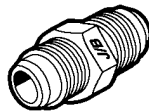

Part #	Mfg #	Size	Price
FLAU24	U2-4	1/4"	2.06
FLAU26	U2-6	3/8"	2.80
FLAU28	U2-8	1/2"	5.26
FLAU210	U2-10	5/8"	7.84
FLAU212	U2-12	3/4"	16.48
FLAUR264	UR2-64	3/8" x 1/4"	4.38
FLAUR284	UR2-84	1/2" x 1/4"	7.42
FLAUR286	UR2-86	1/2" x 3/8"	6.74
FLAUR2106	UR2-106	5/8" x 3/8"	8.60

Adapter (Flare x FIP)

- SAE Flare by female pipe threaded
- Furnished with copper gasket



Part #	Mfg #	Size	Price
FLAU34A	U3-4A	1/4" x 1/8" FIP	2.64

Brass Flared Tube Fittings (Continued) Adapter (Flare x FIP)

Part #	Mfg #	Size	Price
FLAU34B	U3-4B	1/4" x 1/4" FIP	3.54
FLAU34C	U3-4C	1/4" x 3/8" FIP	6.58
FLAU36D	U3-6D	3/8" x 1/2" FIP	8.60
FLAU38D	U3-8D	1/2" x 1/2" FIP	8.10
FLAU310D	U3-10D	5/8" x 1/2" FIP	10.86

Adapter (Fem Flare x Flare)

- SAE Female flare by flare
- Furnished with copper gasket



Part #	Mfg #	Size	Price
FLAUR346	UR3-46	1/4" Fem x 3/8"	6.42
FLAUR364	UR3-64	3/8" Fem x 1/4"	5.78
FLAUR368	UR3-68	3/8" Fem x 1/2"	9.80
FLAUR3810	UR3-810	1/2" Fem x 5/8"	9.60
FLAUR384	UR3-84	1/2" Fem x 1/4"	10.96
FLAUR386	UR3-86	1/2" Fem x 3/8"	9.28
FLAUR3108	UR3-108	5/8" Fem x 1/2"	15.18

Adapter (Flare x Solder)

- SAE Flare by solder
- Furnished with copper gasket

Part #	Mfg #	Size	Price
FLAUS366	US3-66	3/8" x 3/8"	3.36
FLAUS388	US3-88	1/2" x 1/2"	4.66

Union (Fem Flare x Fem Flare)

- SAE Union

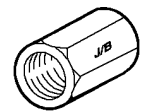

Part #	Mfg #	Size	Price
FLAU44	U4-4	1/4"	8.52
FLAU46	U4-6	3/8"	11.92
FLAU48	U4-8	1/2"	15.96

Union (Swivel Fem Flare)

- SAE Swivel union



Part #	Mfg #	Size	Price
FLAUS44	US4-4	1/4" Fem	6.84
FLAUS46	US4-6	3/8" Fem	7.48
FLAUS48	US4-8	1/2" Fem	10.28
FLAUS410	US4-10	5/8" Fem	12.08

Refrigeration
Sundries

Prices & Specifications are Subject to Change.



www.irrsupply.com

Brass Flare Fittings

Refrigeration
Sundries

Tools & Replacement Parts

O-Ring Quick Seal Cap

- Refrigeration or deep vacuum service
- Finger tight sealing for all male SAE connections



Part #	Mfg #	Description	Price
FLANFT54	NFT5-4-100	1/4" SAE Cap	1.06
FLANFT56	NFT5-6	3/8" SAE Cap	3.50

Tubing Tools

Gauge File and Cutting Tool

- Stainless steel with black etched numbers
- Stainless steel wire plugs
- 14 ID Sizes from .026 to .090
- 22 OD Sizes from .072" - 7/16", 5 - 12mm
- Specially designed file to cut and open tube



Part #	Mfg #	Description	Price
ACCA10971	A10971	Capillary Tube Gauge w/Tube File in Vinyl Pouch	104.46



Piercing Valves

BPV Series Bullet Piercing Valves

- Can install on round suction lines or uneven tubing
- Hex key wrench included
- Requires only 2" clearance area for installation
- Sealing force of 180 inch pounds, torque tested 500 lb



Part #	Mfg #	OD Tubing Size	Price
SUOBPV31	BPV-31	1/4", 5/16", 3/8"	4.86
SUOBPV36	BPV-36	3/16"	6.32
SUOBPV14	BPV-14	1/4"	6.32
SUOBPV56	BPV-56	5/16"	6.32
SUOBPV38	BPV-38	3/8"	6.32
SUOBPV12	BPV-12	1/2"	6.54
SUOBPV58	BPV-58	5/8"	6.54
SUOBPV34	BPV-34	3/4"	33.00
SUOBPV78	BPV-78	7/8"	33.00



BigEZ™ Dye Injection System

- For medium to large systems
- Each cartridge treats up to 16 gallons of lubricant
- No pouring, measuring or spilling of dyes
- Ideal for preventive maintenance programs

BigEZ™ Cartridges



Part #	Mfg #	Description	Price
SPSBEZ4ECS	BEZ-4/ECS	4 oz BigEZ Universal Dye Cartridge for BEZ-400/ECS	268.04

EZ-Ject™ Dye Injection System

- For small to medium systems
- Each cartridge treats up to 2 gallons of lubricant or 25 lbs of refrigerant
- No pouring, measuring or spilling of dyes
- Ideal for preventive maintenance programs

EZ-Ject™ Kit with OPTIMAX Jr™ Flashlight

- Contains:
 - OPTIMAX Jr™ flashlight
 - Dye injector and hose assembly
 - (2) EZ-Ject™ universal dye cartridges
 - Purge fitting
 - 8 oz GLO-AWAY™ dye cleaner
 - Fluorescence-enhancing glasses
 - Plastic case



Part #	Mfg #	Description	Price
SPSOPK50EZE	OPK-50EZ/E	EZ-Ject™ Kit w/OPTIMAX Jr™ Flashlight	145.00

All Items May Not Be Stocked In All Branches

Refrigeration Sundries

Universal Dye Injection Kit

- For all AC&R systems
- Compatible with mineral oil, polyol ester and alkyl benzene lubricants
- Contains:
 - EZ-50 EZ-Ject dye injector assembly
 - EZ-25 Hose assembly with check valve and 1/4" flare low-loss fitting
 - (2) EZ-4/ECS EZ-Ject Universal dye cartridges
 - Service labels



Part #	Mfg #	Description	Price
SPSEZ100E	EZ-100/ECS	Universal Dye Injection Kit	90.00

EZ-Ject™ Cartridges



Part #	Mfg #	Description	Price
SPSEZ4E	EZ-4/ECS	EZ-Ject Universal Dye Cartridges (6 x 0.5 oz)	31.44

GLO-STICK® Capsules

- For small to medium size systems
- Prefilled, disposable capsules
- Will withstand pressures of more than 1000 psi



Glo-Stick® Capsules-Universal Lubricant Systems

- Polyol ester lubricant

Part #	Mfg #	Description	Price
SPSGS101E	GS-101/ECS	Up to 2.9 lbs of Refrigerant or 15 fl oz of Lubricant-Poly Ester (Universal)	11.86
SPSGS1E	GS-1/ECS	Up to 4.9 lbs of Refrigerant or 1.6 qts of Lubricant	19.58
SPSGS2E	GS-2/ECS	5 to 9.9 lbs of Refrigerant or 1.7 qts of Lubricant	27.32
SPSGS3E	GS-3/ECS	10 to 25 lbs of Refrigerant or 3.3 qts to 2 gals of Lubricant	38.66

Lamps for Fluorescent Leak Detection

OPTIMAX Jr™ Mini Flashlight

- Compatible with all leak detection dyes
- 100,000-hour LED bulb
- Over 4 hours of peak performance
- Choice of continuous or momentary illumination
- 3 "AA" Batteries (included)



Part #	Mfg #	Description	Price
SPSOPX500CS	OPX-500CS	Cordless w/UVS-40 Glasses	117.10



Liqui-Vac Sealant

- Sets up quickly - seals to 1 micron
- Remains flexible
- Ready to use
- Resistant to most solvents, withstands temperatures from -100° to 325°F



Part #	Mfg #	Description	Price
AIOVACSEAL	4036	4 oz Brush-In-Cap	32.56



Door Closers

1092 Series Hydraulic Door Closer

- Chrome plated steel construction
- Solid complete with door closer body, hook and screw pack



Part #	Mfg #	Description	Price
RHS40301	40-301	Flush Offset Complete	152.48

Prices & Specifications are Subject to Change.

Refrigeration Sundries

Refrigeration Sundries

Refrigeration Sundries

Hinges

R50/2850 Series Cam-Lift Hinge

- 5-3/4" Height
- Polished chrome finish
- Reversible for left or right hand operation



Part #	Mfg #	Description	Price
RHS43086	43-086	1-5/8" Offset	39.16

Latches

533-D Series Edgemount Complete Latch

- Trigger action snap lock mechanism
- Latch body drilled to accept padlock
- 9-3/8" Length



Part #	Mfg #	Description	Price
RHS40192	40-192	Latch Complete w/Strike	97.22

R35 Series Edgemount Complete Latch

- Polished chrome finish
- 10-1/4" Length



Part #	Mfg #	Description	Price
RHS48001	48-001	Straight Handle less Key Cylinder	74.70

4722 Series Facemount Latch

- Purchase latch and strike individually
- 5-1/4" Length



Part #	Mfg #	Description	Price
RHS50001	50-001	Latch Only, No Strike	62.52
RHS50002	50-002	Adjustable Strike, 1/2" - 1-1/8" Offset	26.92



RTV Silicone

Part #	Mfg #	Description	Price
MEW910301	910301-1	10.3 oz Aluminum RTV Silicone	34.00



ECO Series Condensing Unit Enclosures

- Easy set-up
- Requires no special tools
- Solid base
- Removable top
- Galvanized steel
- Includes:
 - Instructions
 - Fasteners

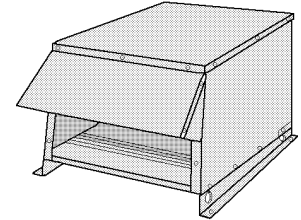

Part #	Mfg #	Size	Price
RDMECO180A	EC0180A	26" x 20"	330.10
RDMECO200A	ECO200A	22"H x 24-1/2"W x 26"D	402.24

Irr Supply is an Employee Owned Company.

All Items May Not Be Stocked In All Branches

Light Bulbs

Linear Fluorescent Light Bulbs

ProLume® Rapid Start Fluorescent Light Bulb

- Eco-Shield®
- Brass pins
- Use 700 series where color rendering is not crucial
- Use 800 series where color matching is critical
- 2-Year guarantee



Part #	Mfg #	Product #	Bulb	Watts	Base	Color	Initial Lumens	Length	Price
LMPF17T8741	F17T8/741/ECO/IC	30103	T8	17W	Med Bi-Pin	4,100	1,350	24"	10.14
LMPF25T8741	F25T8/741/ECO	109344	T8	25W	Bi-Pin	4,100	2,150	36"	3.06
LMPF32T8735	F32T8/735/ECO	109414	T8	32W	Med Bi-Pin	3,500	2,850	48"	5.76
LMPF32T8741	F32T8/741/ECO/IC	30152	T8	32W	Med Bi-Pin	4,100	2,850	48"	6.36
LMPF32T8835HL	F32T8/835/ECO/HL	35156	T8	32W	Bi-Pin	3,500	3,150	48"	7.94
LMPF32T841HL	F32T8/841/ECO/HL	35157	T8	32W	Bi-Pin	4,100	3,150	48"	9.90
LMPF34CWRS	F34CW/ES/ECO	40212	T12	34W	Med Bi-Pin	4,100	2,650	48"	5.16

ProLume® T-5 Programmed Start Fluorescent Light Bulb

- Eco-Shield®
- Miniature Bi-Pin base



Part #	Mfg #	Product #	Bulb	Watts	Base	Color	Initial Lumens	Length	Price
LMPF54T5841HO	F54T5/841/HO/ECO/IC	35083	T5	54W	Min Bi-Pin	4,100	5,000	48"	8.48

Slimline Fluorescent Light Bulb

- LLM - Low mercury major
- CS - CoverShield®

Part #	Mfg #	Product #	Bulb	Watts	Base	Color	Initial Lumens	Length	Price
LMPF96T12CW	F96CWES/ECO	90150	T12	60W	Sgl-Pin	Cool White	-	96"	11.52
LMPF72T12CW	F72DL/M	369850	T6	56W	Sgl-Pin	Daylight LMM	3,800	72"	22.56
LMPF48T12CW	F48DL/M	387019	T6	39W	Sgl-Pin	Daylight LMM	2,500	48"	14.48

High Output (800mA) Fluorescent Light Bulb w/Recessed DC Base

- LMM - Low mercury major

Part #	Mfg #	Product #	Bulb	Watts	Base	Color	Initial Lumens	Length	Price
LMPF48T12CWWHO	F48CWHO/M	369785	T12	60W	Rec DC	4,100 LMM	4,050	48"	12.12
LMPF72T12CWWHO	F72T12/CW/HO	366518	T12	85W	Rec DC	4,100 LMM	6,350	72"	5.57
LMPF96T12CWWHO	F96CWHOES/ECO/CS	90054	T12	95W	Rec DC	4,100	8,000	96"	12.10

Light Bulbs

Light Bulbs

ProLume® U-Bend Rapid Start Fluorescent Light Bulb

- Eco-Shield®

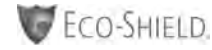

Part #	Mfg #	Product #	Bulb	Watts	Base	Color	Description	Price
LMPFB31835U	FB31/835/ECO	30302	T8	31W	Med Bi-Pin	3,500	1-5/8" 835 Phosphor U-Tube, 22.6"L	16.90
LMPFB31841	FB31/841/ECO	30303	T8	31W	Med Bi-Pin	4,100	1-5/8" 841 Phosphor U-Tube, 22.6"L	20.36
LMPFB32T8735U6	FB32/735/6/ECO/IC	30352	T8	32W	Med Bi-Pin	3,500	6" 735 Phosphor U-Tube, 22.6"L	15.20
LMPFB32741U6	FB32/741/6/ECO/IC	30353	T8	32W	Med Bi-Pin	4,100	6" 741 Phosphor U-Tube, 22.6"L	14.98
LMPFB32841U6	FB32/841/6/ECO/IC	35303	T8	32W	Med Bi-Pin	4,100	6" 841 Phosphor U-Tube, 22.6"L	16.04
LMPFB34T12CWU6	FB34/CW/U6/ES/M	378638	T12	34W	Med Bi-Pin	4,100	6" Cool White Major U-Tube, 22.5"L	24.12

Light Bulbs

Compact Fluorescent Light Bulbs

ProLume® T3 Mini-Spiral Self-Ballasted Compact Fluorescent Light Bulb

- Electronic instant start ballast
- Tri-phosphor coating
- 120V, 60Hz
- Minimum starting temperature: -10°F
- Nickel-plated brass base



Part #	Mfg #	Product #	Bulb	Watts	Base	Color	MOL	Price
LMPCFL1527SPIRAL	CFL15/27	109252	T3	15W	Med Base	2,700	4.94"	10.96
LMPCFL2027SPIRAL	CFL20/27	109254	T3	20W	Med Base	2,700	5.25"	12.28
LMPCFL2341FL	CFL23/41	45253	T3	23W	Med Base	4,100	5.70"	9.46
LMPCFL2727SPIRAL	CFL27/27	109310	T3	27W	Med Base	2,700	5.44"	14.68
LMPCFL3241	CFL32/41	109318	T3	32W	Med Base	4,100	5.56"	15.30
LMPCFL4227SPIRAL	CFL42/27	109328	T3	42W	Med Base	2,700	7.06"	29.52

ProLume® Compact Fluorescent Reflector

- Electronic instant start ballast
- Tri-phosphor coating
- Contains amalgam
- 120V, 60Hz
- Minimum starting temperature: -20°F
- Nickel-plated brass base



46203

Part #	Mfg #	Product #	Bulb	Watts	Base	Color	MOL	Price
LMPCFL2341	CFL23/41/PAR38	46203	PAR38	23W	Med Base	4,100	5.06"	24.46
LMPCFL2330R41	CFL23/30/R41	109286	R40	23W	Med Base	1,300	4.80"	23.94

All Items May Not Be Stocked In All Branches

Light Bulbs

ProLume® Compact Plug-In Fluorescent Light Bulb

- Tri-phosphor coating
- Lead-free glass
- End-of-Life protection
- Operating temperature: 0 to 140°F
- Eco-Shield®
- TCLP Compliant
- 1-Year guarantee

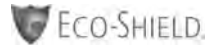

Part #	Mfg #	Product #	Bulb	Watts	Base	Color	MOL	Price
LMPPL7S27ECO	PL7S/27/ECO	109106	1-Tube T4	7W	G23 2-Pin	2,700	5.43"	5.76
LMPPL13S35ECO	PL13S/35/ECO	109128	1-Tube T4	13W	GX23 2-Pin	3,500	7.20"	4.96
LMPPL13S41ECO	PL13S/41/ECO	109130	1-Tube T4	13W	GX23 2-Pin	4,100	7.20"	4.86
LMPPL13D35	PL13D/35/ECO	109148	2-Tube T4	13W	GX23-2 2-pin	3,500	4.65"	10.14
LMPPL26D35ECO	PL26D/35/ECO	109160	2-Tube T5	26W	G24D-3 2-pin	3,500	6.77"	7.56
LMPPL26TE35ECO	PL26T/E/35/ECO	109022	3-Tube T4	26W	GX24q-3 4-Pin	3,500	5.28"	12.86
LMPPL42TE27ECO	PL42T/E/27/ECO	109032	3-Tube T4	42W	GX24q-4 4-Pin	4,100	6.6"	13.44

Incandescent Light Bulbs

A19 Incandescent Light Bulb



Part #	Mfg #	Product #	Bulb	Watts	Base	Color	Description	Price
LMPA40A20	A19FR40	103702	A19	40W	Med Base	325	130V Frost	0.96
LMPA60AFR130	A19SW60/120	6221	A19	60W	Med Base	Soft White	130V Frost	1.26
LMPA75AFR	A19FR75	103706	A19	75W	Med Base	820	130V Frost	1.20
LMPA100AFR	A19SW100/120	6223	A19	100W	Med Base	Soft White	120V Standard Frosted	1.20
LMPA100ARS	A19RS100	6153	A19	100W	Med Base	1,150	130V Rough Service	3.42

A21 Incandescent Light Bulb

Part #	Mfg #	Product #	Bulb	Watts	Base	Color	Description	Price
LMPA150AFR	A21FR150/P10	103040	A21	150W	Med Base	1,350	120V Frost Prism Ultra Life	3.32

General Service Incandescent Flood Light

Part #	Mfg #	Product #	Bulb	Watts	Base	Color	Description	Price
LMPBR6530FL120V	BR30FL65/120	124070	BR30	65W	Med Base	510	120V Flood	5.28
LMPBR6540	BR40FL65	-	BR40	65W	Med Base	750	Flood	4.64
LMP100PAR38FLAMB ER	BR38AMB100	404112	BR38	100W	Med Base	-	130V Amber Flood	12.56

Prices & Specifications are Subject to Change.

Light Bulbs

Light Bulbs

High Intensity Discharge (HID) Light Bulbs

ProLume® Pulse Start Metal Halide Light Bulb

Part #	Mfg #	Product #	Bulb	Watts	Base	Color	Description	Price
LMPMH50WUMEDPS	MH50/U/MED/PS	108228	ED17	50W	Med Base	Clear(4,000)	M110/E	43.00
LMPMH70UMEDPS	MH70/U/MED/PS	108246	ED17	70W	Med Base	Clear(4,000)	M98/E	49.92
LMPMH100MEDPS	MH100/U/MED/PS	108254	ED17	100W	Med Base	Clear(4,000)	M90/E	13.43
LMPMH1000UBT37	MH150/U/MED/PS	108258	ED17	150W	Med Base	Clear(4,000)	M120/E	27.94
LMPMH175UMED	MH175/U/MED/IC	108262	ED17	175W	Med Base	Clear(4,000)	M57/E	51.60
LMPMH175U	MH175/U	108200	ED28	175W	Mogul	Clear(4,000)	M57/E	50.16
LMPMH250U	MH250/U	108204	ED28	250W	Mogul	Clear(4,000)	M58/E	50.16
LMPMH400UED28	MH400/U/ED28	108216	ED28	400W	Mogul	Clear(4,000)	M59/E	13.69
LMPMH400U	MH400/U	108208	ED37	400W	Mogul	Clear(4,000)	M59/E	50.16
LMPMH150UMEDPS	MH1000/U/BT37	108226	BT37	1000W	Mogul	Clear(4,000)	M47/E	34.40
LMPMH1000U	MH1000U	108222	BT56	1000W	Mogul	Clear(4,000)	M47/E	107.28
LMPMH1500BUH	MH1500BUH	108214	BT56	1500W	Mogul	Clear Base Up	M48/E	67.76

ProLume® Mercury Vapor Light Bulb

Part #	Mfg #	Product #	Bulb	Watts	Base	Color	Description	Price
LMPMV175DX	MV175DX	108310	ED28	175W	Mogul	Deluxe White	H39	6.18

ProLume® High Pressure Sodium (HPS) Light Bulb

- Recessed arc tube
- Long life, 24,000 hours average rated life
- Operates on standard HPS ballast
- High luminous efficacy



Part #	Mfg #	Product #	Bulb	Watts	Base	Color	Description	Price
LMPLU50MED	LU50/MED	108104	ED17	50W	Med Base	Clear	S68 Ballast	34.86
LMPLU70MED	LU70/MED	108106	ED17	70W	Med Base	Clear	S62 Ballast	34.86
LMPLU70MOG	LU70	208122	ED23.5	70W	Mogul	Clear	S62 Ballast	9.54
LMPLU100MED	LU100/MED	108108	ED17	100W	Med Base	Clear	S54 Ballast	34.86
LMPLU100MOG	LU100	208184	ED23.5	100W	Mogul	Clear	S54 Ballast	24.44
LMPLU15055MED	LU150/MED	108110	ED17	150W	Med Base	Clear	S55 Ballast	46.48
LMPLU15055	LU150	208126	ED23.5	150W	Mogul	Clear	S55 Ballast	48.88
LMPLU250	LU250	208130	ED18	250W	Mogul	Clear	S50 Ballast	40.74
LMPLU400	LU400	208132	ED18	400W	Mogul	Clear	S51 Ballast	41.58

All Items May Not Be Stocked In All Branches

Light Bulbs

Halogen Light Bulbs

Prism® & HaloXen® PAR Halogen Light Bulb

Part #	Mfg #	Product #	Bulb	Watts	Base	Color	Description	Price
LMPPAR3520HFL	HP20NFL35	107610	PAR20	35W	Med Base	450	30° Flood	14.16
LMPPAR5020HFL	HP20NFL50	107624	PAR20	50W	Med Base	550	30° Narrow Flood	14.16
LMPPAR5030WFL	HP30FL50L	107522	PAR30	50W	Med Base	610	40° Long Neck Flood	11.56
LMPPAR7530HFL	HP30FL75/120	107670	PAR30	75W	Med Base	1,100	40° Short Neck Flood	8.74
LMPPAR7530WFL	HP30FL75L/120	107672	PAR30	75W	Med Base	1,050	40° Long Neck Flood	11.80
LMPPAR90HFL	HP38FL90/120	107696	PAR38	90W	Med Base	1,300	30° Flood	11.80
LMPPARQ25038FL	Q250PAR/FL	15558	PAR38	250W	Med Base	3,600	30° Flood Major	55.16

Tube Guards

Part #	Mfg #	Product #	Bulb	Description	Price
LMPTG4T8	TG32T8CL	91020	T8	4' Clear w/Endcap	5.60
LMPTG4	TG40T12CL	91021	T12	4' Clear w/Endcap	4.42
LMPTG8	TG96T8CL	91020	T8	8' Clear w/Endcap	8.32

Lamp Recycling Boxes

Part #	Mfg #	Description	Price
LMPRECYCLEKIT4	RCYCL/FL146/4FT	91202 Lamp Recycling Box for 4' T12/T8	221.42

Light Bulbs

Thank you for doing business with us. We appreciate your order.

Switches

Ariadni® Toggler® Switches

- Features toggle switch and small slide dimmer
- True 3-way switching
- Shallow 1" deep back cover
- Power failure memory
- Superior RFI suppression
- Rated at 120VAC, 60Hz unless otherwise noted



Ariadni® Toggler® Incandescent/Halogen Dimmer

- Toggle to turn on/off, slider to dim

Part #	Mfg #	Description	Price
LUTAY600PLA	AY-600P-LA	Lt Almond 600W Single-Pole Preset	20.22
LUTAY600PIV	AY-600P-IV	Ivory 600W Single-Pole Preset	20.22
LUTAY600PWH	AY-600P-WH	White 600W Single-Pole Preset	20.22
LUTAY600PAL	AY-600P-AL	Almond 600W Single-Pole Preset Dimmer	21.51
LUTAY10PIV	AY-10P-IV	Ivory 1000W Single-Pole Preset Dimmer	55.20
LUTAY10PLA	AY-10P-LA	Lt Almond 1000W Single-Pole Preset Dimmer	56.30
LUTAY10PWH	AY-10P-WH	White 1000W Single-Pole Preset Dimmer	55.86
LUTAY603PIV	AY-603P-IV	Ivory 600W 3-Way Preset Dimmer	27.50
LUTAY603PLA	AY-603P-LA	Lt Almond 600W 3-Way Preset Dimmer	27.50
LUTAY603PWH	AY-603P-WH	White 600W 3-Way Preset Dimmer	27.50
LUTAY603PAL	AY-603P-AL	Almond 600W 3-Way Preset Dimmer	27.50
LUTAY103PIV	AY-103P-IV	Ivory 1000W 3-Way Preset Dimmer	61.82
LUTAY103PWH	AY-103P-WH	White 1000W 3-Way Preset Dimmer	61.82

Ariadni® Toggler® Fan-Speed Control

- Quiet controls - for use with one ceiling paddle fan
- 3-Speed fan control
- 1.5A Fan



Part #	Mfg #	Description	Price
LUTAYFSQFIV	AYFSQ-F-IV	Ivory	30.91
LUTAYFSQFLA	AYFSQ-F-LA	Lt Almond	32.01
LUTAYFSQFWH	AYFSQ-F-WH	White	32.00

Ariadni® Toggler® Dual Fan/Light Dimmer

- Fan speed control and dimmer
- 3-Quiet fan speeds
- For use with only one ceiling paddle fan
- Toggle to turn light on/off with (2) sliders, one for fan speed control, the other for light dimming
- Single-pole fan control: 120V/1.5A
- Single-pole dimmer: 120V/300W



Part #	Mfg #	Description	Price
LUTAY2LFSQLA	AY2-LFSQ-LA	Lt Almond Fan/Light Control	44.75
LUTAY2LFSQWH	AY2-LFSQ-WH	White Fan/Light Control	44.16

Rotary Fan-Speed Control

- Quiet controls for use with one ceiling paddle fan
- 1.5 Amp fan



Part #	Mfg #	Description	Price
LUTFSQ2FIV	FSQ-2F-IV	Ivory 120V/5A Single-Pole 3-Speed Fan Control	19.43
LUTFSQ2FWH	FSQ-2F-WH	White 120V/5A Single-Pole 3-Speed Fan Control	20.00

Wiring Devices

Switches

Rotary Solid-State Switches

- Mechanical air-gap switch to disconnect load power
- Electrostatic discharge tested
- RFI suppression
- Rated at 120VAC, 60Hz unless otherwise noted



Rotary Incandescent/Halogen Dimmer

Part #	Mfg #	Description	Price
LUTD600PIV	D-600P-IV	Ivory 600W Single-Pole Preset Dimmer	8.10
LUTD600PWH	D-600P-WH	White 600W Single-Pole Preset Dimmer	9.10
LUTD603PIV	D-603P-IV	Ivory 600W 3-Way Preset Dimmer	14.57
LUTD603PWH	D-603P-WH	White 600W 3-Way Preset Dimmer	14.57

Diva® Switches

Diva® Incandescent/Halogen Dimmer

- Paddle turns on/off
- Slide up to brighten; down to dim
- Locator light shines through paddle on select lighter colored models



Part #	Mfg #	Description	Price
LUTDV600PIV	DV-600P-IV	Ivory 600W Single-Pole Preset Dimmer	34.22
LUTDV600PLA	DV-600P-LA	Lt Almond 600W Single-Pole Preset Dimmer	34.22
LUTDV600PWH	DV-600P-WH	White 600W Single-Pole Preset Dimmer	34.22
LUTDV603PIV	DV-603P-IV	Ivory 600W 3-Way Preset Dimmer	40.84
LUTDV603PLA	DV-603P-LA	Lt Almond 600W 3-Way Preset Dimmer	40.84
LUTDV603PWH	DV-603P-WH	White 600W 3-Way Preset Dimmer	40.84

Whole Home Lighting Control System

- Wireless lighting control
- Controls lights from car, patio and bedside
- One system controls 5 areas of light
- Includes:
 - (5) Wall dimmers/inserts
 - (1) Master control
 - (1) Wireless controller
 - (1) Central antenna



Part #	Mfg #	Description	Price
LUTAURORAW	AuroRa	White Aurora Lighting Package	796.67



Pass & Seymour

Toggle Switches

TradeMaster® 1-Pole Toggle Switch - Grounding

- 15A, 120V
- Side wire #12 and #14 AWG, push wire #14 AWG
- Green hex head ground screw
- UL/CSA Listed

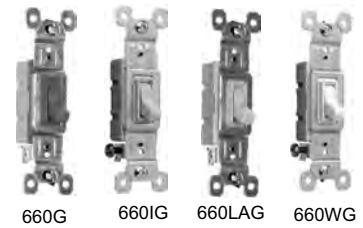

Part #	Mfg #	Color	Price
PAS660G	660G	Brown	1.42
PAS660IG	660IG	Ivory	1.42
PAS660LAG	660LAG	Lt Almond	1.42
PAS660WG	660WG	White	1.42

Wiring Devices

See plates starting later in this section

Switches & Receptacles

TradeMaster® 3-Way Toggle Switch - Grounding

- 15A, 120V
- Side wire #12 and #14 AWG, push wire #14 AWG
- Green hex head ground screw
- UL/CSA Listed

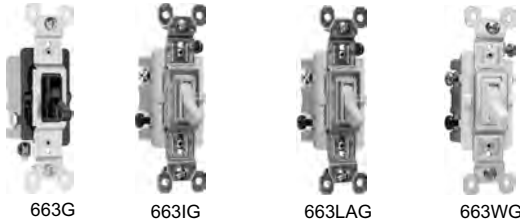

Part #	Mfg #	Color	Price
PAS663G	663G	Brown	2.50
PAS663IG	663IG	Ivory	2.50
PAS663LAG	663LAG	Lt Almond	2.50
PAS663WG	663WG	White	2.50

TradeMaster® 4-Way Toggle Switch - Grounding

- 15A, 120V
- Side wire #12 and #14 AWG, push wire #14 AWG
- Green hex head ground screw
- UL/CSA Listed



Part #	Mfg #	Color	Price
PAS664G	664G	Brown	16.66
PAS664IG	664IG	Ivory	16.66
PAS664LA	664LAG	Lt Almond	16.66
PAS664WG	664WG	White	16.66

Commercial Specification Grade 1-Pole Toggle Switch

- 15A, 120/277V
- Side-wire accepts #14 - #10 AWG copper or copper-clad wire
- UL/CSA/FSUL Listed



Part #	Mfg #	Color	Price
PASCS15AC1I	CS15AC1I	Ivory	5.28

Commercial Specification Grade 1-Pole Toggle Switch

- 20A, 120/277V
- Side-wire accepts #10 - #14 AWG copper or copper-clad wire
- UL/CSA/FSUL Listed



Part #	Mfg #	Color	Price
PASCS20ACI	CS20AC1I	Ivory	6.76
PASCS20AC1W	CS20AC1W	White	7.16

Hard Use Specification Grade 1-Pole Toggle Switch

- 20A, 120/277V
- Screw-pressure-plate back and side-wire accepts #10 - #14 AWG copper or copper-clad wire
- UL/CSA/FSUL Listed



Part #	Mfg #	Color	Price
PASCSB20AC1	CSB20AC1	Brown	9.04
PASCSB20AC1I	CSB20AC1I	Ivory	9.04

Hard Use Specification Grade 2-Pole Toggle Switch

- 20A, 120/277V
- Screw-pressure-plate back and side-wire that accepts #14 - #10 AWG copper or copper-clad wire
- UL/CSA/FSUL Listed



Part #	Mfg #	Color	Price
PASCSB20AC2I	CSB20AC2I	Ivory	31.42
PASCSB20AC2W	CSB20AC2W	White	31.42

Industrial Heavy-Duty Specification Grade Toggle Switch

- 20A 120/277V
- External screw-pressure-plate back and side wired, accepts #14 - #10 AWG copper or copper-clad conductors
- Heavy-gauge 1-piece copper alloy contact arm virtually eliminates contact bounce



Part #	Mfg #	Description	Price
PAS20AHDSPSWI	PS20AC1I	Ivory	10.40

Wiring Devices

All Items May Not Be Stocked In All Branches

Switches & Receptacles

Industrial Extra Heavy-Duty Specification Grade 2-Pole Toggle Switch

- 20A, 120/277V
- External screw-pressure-plate back and side-wire accepts #14 - #10 AWG copper or copper-clad



Part #	Mfg #	Color	Price
PAS20AHDPSWI	PS20AC2I	Ivory	15.68

Industrial Heavy-Duty Specification Grade 3-Way Toggle Switch

- 20A, 120/277V
- External screw-pressure-plate back and side-wire accepts #14 - #10 AWG copper or copper-clad



Part #	Mfg #	Color	Price
PASPS20AC3I	PS20AC3I	Ivory	21.58

Industrial Heavy-Duty Specification Grade 4-Way Toggle Switch

- 20A, 120/277V
- External screw-pressure-plate back and side-wired accepts #14 - #10 AWG copper or copper-clad conductors



Part #	Mfg #	Color	Price
PASPS20AC4I	PS20AC4I	Ivory	85.86

1-Pole Toggle Switch Combination - Grounding

- 15A 120/277V
- Side wire accepts #12 and #14 AWG
- UL Listed



Part #	Mfg #	Color	Price
PAS690IG	690IG	Ivory	18.16
PAS690LAG	690LAG	Lt Almond	18.16
PAS690WG	690WG	White	18.16

1-Pole Toggle Switch & Duplex Receptacle Combination - Grounding

- 15A, 120/125V
- NEMA 5-15R
- Side-wire accepts #12 and #14 AWG
- UL/CSA Listed



Part #	Mfg #	Color	Price
PAS691I	691I	Ivory	24.26
PAS691W	691W	White	24.26

1-Pole Toggle Switch & Pilot Light Combination Switch - Non-Grounding

- 15A 120/125V
- Side-wire accepts #12 and #14 AWG
- Long-life red neon lamp in pilot light rated 1/25W 125V



Part #	Mfg #	Color	Price
PAS692IG	692I	Ivory	29.56
PAS692WG	692W	White	29.56

Double 3-Way Combination Switch - Non-Grounding

- 15A 120/277V
- Side-wire accepts #12 and #14 AWG

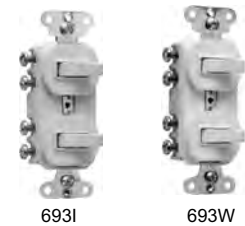

Part #	Mfg #	Color	Price
PAS693I	693I	Ivory	57.20
PAS693W	693W	White	57.20

Wiring Devices

See duplex plates later in this Wiring Devices section

Switches & Receptacles

Decorator/Rocker Switches

TradeMaster® 1-Pole Decorator Switch - Grounding

- 15A, 120/277VAC
- External screw-pressure-plate back and side-wired accepts #12 & #14 AWG
- Push-wire #14 AWG
- UL/CSA Listed, meets NEC 430-104 requirements for kitchen disposal units



Part #	Mfg #	Color	Price
PASTM870	TM870	Brown	4.96
PASTM870I	TM870I	Ivory	4.96
PASTM870LA	TM870LA	Lt Almond	4.96
PASTM870W	TM870W	White	4.96

TradeMaster® 3-Way Decorator Switch - Grounding

- 15A, 120/277VAC
- External screw-pressure-plate back and side-wired accepts #12 & #14 AWG
- Push wire #14 AWG
- UL/CSA Listed, meets NEC 430-104 requirements for kitchen disposal units



Part #	Mfg #	Color	Price
PASTM873LA	TM873LA	Lt Almond	6.46
PASTM873W	TM873W	White	6.46

TradeMaster® 4-Way Decorator Switch - Grounding

- 15A, 120/277VAC
- External screw-pressure-plate back and side-wired accepts #12 & #14 AWG
- Push wire #14 AWG
- UL/CSA Listed, meets NEC 430-104 requirements for kitchen disposal units



Part #	Mfg #	Color	Price
PASTM874LA	TM874LA	Lt Almond	22.28
PASTM874W	TM874W	White	22.28

TradeMaster® Decorator Combination Switch - Grounding

- 15A, 120VAC
- Patented split circuit tab
- External screw-pressure-plate back and side-wired accepts #12 & #14 AWG
- Push-wire #14 AWG
- UL/CSA Listed, meets NEC 430-104 requirements for kitchen disposal units



Part #	Mfg #	Description	Price
PASTM811WCC	TM811WCC	(2) 1-Pole, White	31.44

Switches - Manual Controllers

Maintained Contact 3-Position Switch - 2 Circuit, Center Off

- Oversize silver alloy contacts
- Side-wired terminals accept #14 - #10 AWG
- Durable nylon toggles, bodies and covers
- Fiber terminal insulation barriers standard
- Normally open
- Can be mounted in standard device boxes or in NEMA 1 sheet steel enclosures



Part #	Mfg #	Description	Price
PAS1221IV	1221I	Ivory, 15A 120/277V SPDT	45.40
PAS1226	1226	Brown, 20A 120/277V DPDT	132.30

Canopy Switches

Pressure Sensitive Door and Canopy Switch

- Equipped with wire leads
- Complete with metal box and plate
- Only 14 ounces pressure actuates switch
- Back box cold rolled steel
- Plate is steel with bronze coating



Part #	Mfg #	Description	Price
PASDOORSW	1200	1.516"W x 1.547"D x 4.031"H	21.46

See decorator plates later in this section

All Items May Not Be Stocked In All Branches

Switches & Receptacles

Receptacles

Specification Grade Single Receptacle - 15A 125V

- NEMA 5-15R
- Side wire accepts #10 - #14 AWG solid wire only
- UL/CSA Listed

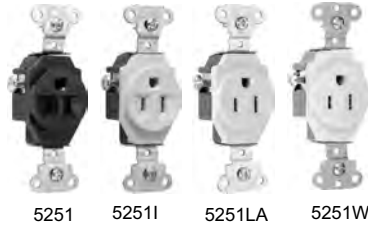

Part #	Mfg #	Color	Price
PAS5251	5251	Brown	6.46
PAS5251I	5251I	Ivory	9.80
PAS5251LA	5251LA	Lt Almond	6.46
PAS5251W	5251W	White	6.46

Specification Grade Single Receptacle - 20A 125V

- NEMA 5-20R
- Side wire accepts #10 - #14 AWG solid wire only
- UL/CSA Listed

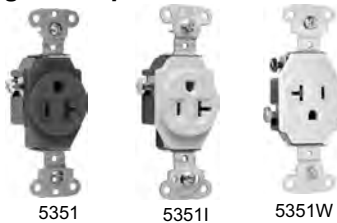

Part #	Mfg #	Color	Price
PAS5351	5351	Brown	7.68
PAS5351I	5351I	Ivory	7.68
PAS5351W	5351W	White	7.68

Hard Use Specification Grade Receptacle - 20A 125V

- Back and side wire
- Corrosion-resistant, plated, and tabbed steel strap locked in to face and back body to resist pulling away from face/body assembly
- 0.032" Thick brass triple-wire power contacts for lasting retention
- Easily accessed break-off, line-contact connecting tab for split-circuit wiring
- Impact-resistant nylon face
- 8-Hole internal screw-pressure-plate back wire terminals accept #10 - #14 AWG solid or stranded copper or copper-clad conductors



Part #	Mfg #	Description	Price
PAS5362I	5362I	Ivory	7.00
PAS5362W	5362W	White	7.00

TradeMaster® Duplex Receptacle - 15A 125V - Grounding

- NEMA 5-15R
- Quickloop wire looping aid
- Side-wire accepts #12 - #14 AWG solid wire
- Push-wire accepts #14 AWG solid wire
- UL/CSA Listed



Part #	Mfg #	Color	Price
PAS3232	3232	Brown	1.06
PAS3232I	3232I	Ivory	1.06
PAS3232LA	3232LA	Lt Almond	1.06
PAS3232WH	3232W	White	1.16

See plates later in Wiring Devices

See duplex plates and decorator plates later in this Wiring Devices section

Wiring Devices

Switches & Receptacles

TradeMaster® Specification Grade Decorator Duplex Receptacle - 15A 125V

- NEMA 5-15R
- Quickloop wire looping aid, extra-large circuit break-off tabs
- Side-access push wire release
- Side wire accepts #12 - #14 AWG solid wire; push wire accepts #14 AWG solid only
- UL/CSA Listed

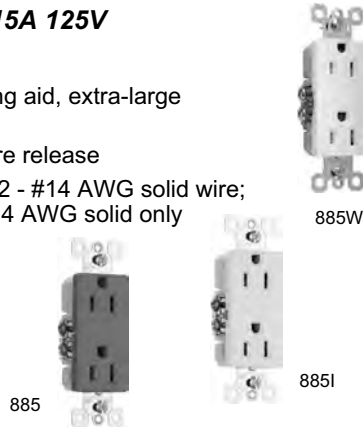

Part #	Mfg #	Color	Price
PAS885	885	Brown	3.56
PAS885I	885I	Ivory	3.56
PAS885LA	885LA	Lt Almond	3.88
PAS885W	885W	White	3.88

Commercial Specification Grade Duplex Receptacle - 20A 125V

- NEMA 5-20R
- Side-wire accepts #10 - #14 AWG solid wire only
- UL/CSA Listed

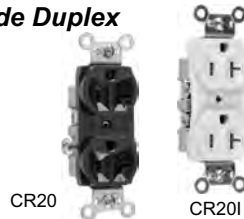

Part #	Mfg #	Color	Price
PASCR20	CR20	Brown	2.80
PASCR20I	CR20I	Ivory	2.80
PASCR20LA	CR20LA	Lt Almond	2.80
PASCR20W	CR20W	White	2.80

Tamper-Resistant Receptacles & Switches

- Meets 2008 National Electrical Code® tamper-resistant requirements

TradeMaster® Tamper-Resistant Duplex Receptacle - 15A 125V - Grounding

- NEMA 5-15R
- Patented shutter system helps prevent improper insertion of foreign objects
- Quickloop wire looping aid, extra-large circuit break-off tabs
- Side-access push-wire release
- Side-wire accepts #12 - #14 AWG solid wire; push-wire accepts #14 AWG solid only
- UL/CSA Listed



Part #	Mfg #	Color	Price
PAS3232TR	3232TR	Brown	2.48
PAS3232TRI	3232TRI	Ivory	2.48
PAS3232TRLA	3232TRLA	Lt Almond	2.48
PAS3232TRW	3232TRW	White	2.48

Tamper-Resistant TradeMaster® Specification Grade Decorator Duplex Receptacle - 15A 125V

- NEMA 5-15R
- Patented shutter system helps prevent improper insertion of foreign objects
- Quickloop wire looping aid, extra-large circuit break-off tabs
- Side-access push wire release
- Side wire accepts #12 - #14 AWG solid wire; push wire accepts #14 AWG solid only
- UL/CSA Listed

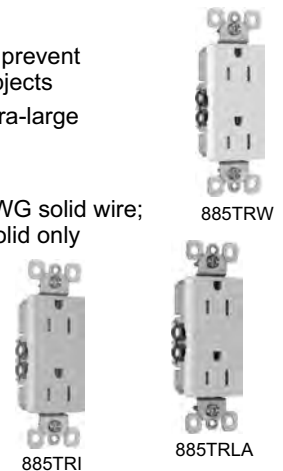

Part #	Mfg #	Color	Price
PAS885TR	885TR	Brown	5.42
PAS885TRI	885TRI	Ivory	5.42
PAS885TRLA	885TRLA	Lt Almond	5.42
PAS885TRW	885TRW	White	5.42

Switches & Receptacles

Tamper-Resistant Combination Switch - 15A 120V

- Patented shutter system helps prevent improper insertion of foreign objects
- Side-wire accepts #12 and #14 AWG

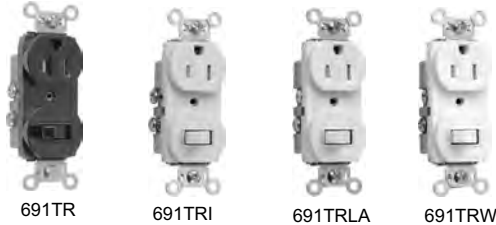

Part #	Mfg #	Color	Price
PAS691TR	691TR	Brown	33.98
PAS691TRI	691TRI	Ivory	33.98
PAS691TRLA	691TRLA	Lt Almond	33.98
PAS691TRW	691TRW	White	33.98

Tamper-Resistant Commercial Grade Duplex Receptacle - 15A 125V

- Patented shutter system helps prevent improper insertion of foreign objects
- Side-wired



Part #	Mfg #	Color	Price
PASTR15	TR15	Brown	6.76
PASTR15I	TR15I	Ivory	6.76
PASTR15LA	TR15LA	Lt Almond	6.76
PASTR15W	TR15W	White	6.76

Tamper-Resistant Commercial Grade Duplex Receptacle - 20A 125V

- Patented shutter system helps prevent improper insertion of foreign objects
- Side-wired



Part #	Mfg #	Color	Price
PASTR20	TR20	Brown	7.62
PASTR20I	TR20I	Ivory	7.62
PASTR20LA	TR20LA	Lt Almond	7.92
PASTR20W	TR20W	White	7.62

Tamper-Resistant Construction Specification Grade Single Receptacle - 15A 125V

- Patented shutter system helps prevent improper insertion of foreign objects
- Back and side wired



Part #	Mfg #	Color	Price
PASTR5251	TR5251	Brown	9.04
PASTR5251I	TR5251I	Ivory	9.04
PASTR5251LA	TR5251LA	Lt Almond	9.04
PASTR5251W	TR5251W	White	9.04

Tamper-Resistant Construction Specification Grade Single Receptacle - 20A 125V

- Patented shutter system helps prevent improper insertion of foreign objects
- Back and side wire



Part #	Mfg #	Color	Price
PASTR5351	TR5351	Brown	13.34
PASTR5351I	TR5351I	Ivory	13.34
PASTR5351LA	TR5351LA	Lt Almond	13.34
PASTR5351W	TR5351W	White	13.34

Tamper-Resistant Hard Use Specification Grade Duplex Receptacle - 20A 125V

- Patented shutter system helps prevent improper insertion of foreign objects
- Back and side wired



Part #	Mfg #	Color	Price
PASTR5362	TR5362	Brown	35.02
PASTR5362I	TR5362I	Ivory	35.02
PASTR5362LA	TR5362LA	Lt Almond	35.02
PASTR5362W	TR5362W	White	35.02

See duplex plates and decorator plates later in this Wiring Devices section

Wiring Devices

Prices & Specifications are Subject to Change.

Switches & Receptacles

Weather-Resistant Tamper-Resistant Receptacle - 15A 125V

- Patented shutter system helps prevent improper insertion of foreign objects
- Side wire accepts #12 - #14 AWG solid wire
- Push wire accepts #14 AWG solid only
- Low profile face
- Traditional contoured face
- High impact-resistant thermoplastic construction
- Safer and more effective than plastic outlet caps
- TR and WR Markings to identify as tamper and weather-resistant
- UL Listed



3232TRWR



3232TRWRI



3232TRWRW



3232TRWRLA

Part #	Mfg #	Color	Price
PAS3232TRWR	3232TRWR	Brown	4.10
PAS3232TRWRI	3232TRWRI	Ivory	4.10
PAS3232TRWRLA	3232TRWRLA	Lt Almond	4.10
PAS3232TRWRW	3232TRWRW	White	4.10

Weather-Resistant Tamper-Resistant Receptacle - 15A 125V

- Patented shutter system helps prevent improper insertion of foreign objects
- Side wire accepts #12 - #14 AWG solid wire
- Push wire accepts #14 AWG solid only
- Low profile face
- Traditional contoured face
- High impact-resistant thermoplastic construction
- Safer and more effective than plastic outlet caps
- TR and WR Markings to identify as tamper and weather-resistant
- UL Listed



Ivory



885TRWRW



Lt Almond

Part #	Mfg #	Color	Price
PAS885TRWR	885TRWR	Brown	6.58
PAS885TRWRI	885TRWRI	Ivory	6.58
PAS885TRWRLA	885TRWRLA	Lt Almond	6.58
PAS885TRWRW	885TRWRW	White	6.58

Weather-Resistant Tamper-Resistant Commercial Grade Receptacle - 20A 125V

- Auto-ground clip assure positive ground
- Side-wired
- (2) Back wire holes for wiring flexibility
- UV-Resistant nylon face for longer life under adverse environmental conditions
- TR and WR Markings to identify as tamper and weather-resistant
- UL Listed

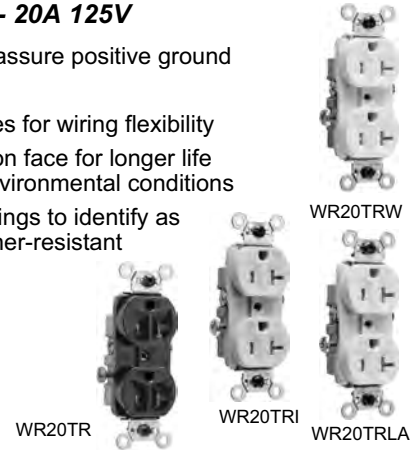

WR20TR

WR20TRI

WR20TRW

WR20TRLA

Part #	Mfg #	Color	Price
PASWR20TR	WR20TR	Brown	11.28
PASWR20TRI	WR20TRI	Ivory	11.28
PASWR20TRLA	WR20TRLA	Lt Almond	11.28
PASWR20TRW	WR20TRW	White	11.28

Safety Outlets/GFCI Receptacles

- SafeLock™ protection: power to the load is disconnected if critical components are damaged and ground fault protection is lost

TradeMaster® Specification Grade GFCI Duplex Receptacle - 2-Pole, 3-Wire - 15A - Grounding

- 125VAC, 60Hz, Class A rated GFCI
- NEMA 5-15R
- SafeLock™ protection
- Side or internal screw-pressure-plate back wire with #10 - #14 AWG solid or stranded copper wire
- (2) Back wire holes per terminal 1595I
- Red LED trip indicator light 1595I
- Includes matching TP26 nylon wallplate
- UL/CSA/FSUL Listed



1595



1595I



1595LA



1595W

Part #	Mfg #	Color	Price
PAS1595	1595	Brown	24.70
PAS1595I	1595I	Ivory	24.70
PAS1595LA	1595LA	Lt Almond	24.70
PAS1595W	1595W	White	24.70

Wiring Devices

All Items May Not Be Stocked In All Branches

Switches & Receptacles

TradeMaster® Specification Grade GFCI Duplex Receptacle - 2-Pole, 3-Wire - 20A - Grounding

- 125VAC, 60Hz, Class A rated GFCI
- NEMA 5-20R
- SafeLock™ protection
- Side or internal screw-pressure-plate back wire with #10 - #14 AWG solid or stranded copper wire
- (2) Back wire holes per terminal
- Red LED trip indicator light
- Includes matching TP26 nylon wallplate
- UL/CSA/FSUL Listed

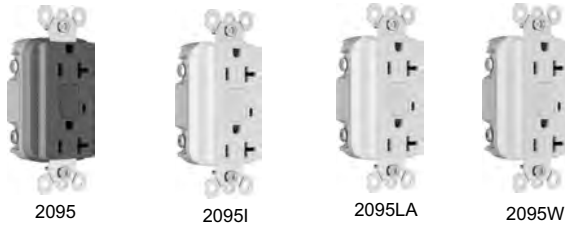

Part #	Mfg #	Color	Price
PAS2095	2095	Brown	28.88
PAS2095I	2095I	Ivory	28.88
PAS2095LA	2095LA	Lt Almond	28.88
PAS2095W	2095W	White	25.08

Specification Grade Dead Front GFCI - 20A

- 125VAC, 60Hz, Class A rated GFCI
- Rated as 1-1/2 hp motor control switch
- SafeLock™ protection
- Side or internal screw-pressure-plate back wire with #10 - #14 AWG solid or stranded copper wire
- (2) Back wire holes per terminal
- Red LED trip indicator light
- Includes matching TP26 nylon wallplate
- UL Listed



Part #	Mfg #	Color	Price
PAS2085I	2085I	Ivory	40.76
PAS2085LA	2085LA	Light Almond	40.76
PAS2085W	2085W	White	40.76

Tamper-Resistant Safety Outlets/GFCI Receptacles

- SafeLock™ protection: power to the load is disconnected if critical components are damaged and ground fault protection is lost
- Meets 2008 National Electrical Code® tamper-resistant requirements

Tamper-Resistant TradeMaster® Specification Grade GFCI Duplex Receptacle - 2-Pole, 3-Wire - 15A - Grounding

- Patented shutter system helps prevent improper insertion of foreign objects
- 125VAC, 60Hz, Class A rated GFCI
- NEMA 5-15R
- SafeLock™ protection
- Side or internal screw-pressure-plate back wire with #10 - #14 AWG solid or stranded copper wire
- (2) Back wire holes per terminal
- Red LED trip indicator light
- Includes matching TP26 nylon wallplate
- UL/CSA/FSUL Listed



Part #	Mfg #	Color	Price
PAS1595TR	1595TR	Brown	31.12
PAS1595TRI	1595TRI	Ivory	31.12
PAS1595TRLA	1595TRLA	Lt Almond	31.12
PAS1595TRW	1595TRW	White	31.12

Wiring Devices

Switches & Receptacles

Tamper-Resistant TradeMaster® Specification Grade GFCI Duplex Receptacle - 2-Pole, 3-Wire - 20A - Grounding

- Patented shutter system helps prevent improper insertion of foreign objects
- 125VAC, 60Hz, Class A rated GFCI
- NEMA 5-20R
- SafeLock™ protection
- Side or internal screw-pressure-plate back wire with #10 - #14 AWG solid or stranded copper wire
- (2) Back wire holes per terminal
- Red LED trip indicator light
- Includes matching TP26 nylon wallplate
- UL/CSA/FSUL Listed



Part #	Mfg #	Color	Price
PAS2095TR	2095TR	Brown	34.44
PAS2095TRI	2095TRI	Ivory	34.44
PAS2095TRLA	2095TRLA	Lt Almond	34.44
PAS2095TRW	2095TRW	White	34.44

Weather-Resistant Tamper-Resistant TradeMaster® Specification Grade GFCI Receptacle - 15A 120V

- Patented shutter system helps prevent improper insertion of foreign objects
- SafeLock™ protection
- Prevents line-load reversal miswire
- Trip indicator red LED light
- Side or internal screw-pressure-plate back wire with #10 - #14 AWG solid or stranded copper wire
- (2) Back wire holes per terminal
- Ground screw has a back wire clamp for easy installation
- Mounting screws are shipped captive in the device and wall plate for easier installation
- High impact-resistant thermoplastic construction
- Extra-long strap
- Meets 2008 National Electrical Code Weather-Resistant requirements
- UL/CSA Listed



Part #	Mfg #	Color	Price
PAS1595TRWR	1595TRWR	Brown	36.82
PAS1595TRWRI	1595TRWRI	Ivory	36.82

Tamper-Resistant Safety Outlets/GFCI Receptacles (Continued)

Weather-Resistant Tamper-Resistant TradeMaster® Specification Grade GFCI Receptacle - 15A 120V

Part #	Mfg #	Color	Price
PAS1595TRWRLA	1595TRWRLA	Lt Almond	36.82
PAS1595TRWRW	1595TRWRW	White	36.82

Weather-Resistant Tamper-Resistant GFCI Receptacle - 20A 120V

- Patented shutter system helps prevent improper insertion of foreign objects
- SafeLock™ protection
- Prevents line-load reversal miswire
- Trip indicator red LED light
- Side or internal screw-pressure-plate back wire with #10 - #14 AWG solid or stranded copper wire
- (2) Back wire holes per terminal
- Ground screw has a back wire clamp for easy installation
- Mounting screws are shipped captive in the device and wall plate for easier installation
- High impact-resistant thermoplastic construction
- Extra-long strap
- Meets 2008 National Electrical Code Weather-Resistant requirements
- UL/CSA Listed

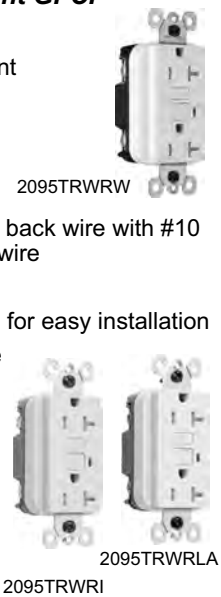

Part #	Mfg #	Color	Price
PAS2095TRWR	2095TRWR	Brown	42.22
PAS2095TRWRI	2095TRWRI	Ivory	42.22
PAS2095TRWRLA	2095TRWRLA	Lt Almond	42.22
PAS2095TRWRW	2095TRWRW	White	42.22

Clock Hanger Receptacles

Clock Hanger Recessed Receptacle

- 15A, 125V
- Smooth wall plate

Part #	Mfg #	Color	Price
PASCLOCKRECPV	S3713I	Ivory	13.04

Wiring Devices

All Items May Not Be Stocked In All Branches

Switches & Receptacles

Flush Receptacle Power Outlets

Flush Receptacle - RV - 2-Pole 3-Wire - Grounding

- AL/CU
- For recreational vehicles



Part #	Mfg #	Description	Price
PAS3830	3830	30A 125V, NEMA TT30	30.34

Flush Receptacle - 2-Pole 3-Wire - Grounding

- AL/CU

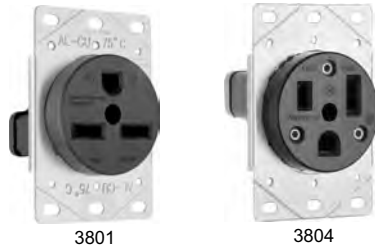

Part #	Mfg #	Description	Price
PAS3801	3801	30A 250V, NEMA 6-30	33.62
PAS3804	3804	50A 250V, NEMA 6-50	33.62

Flush Receptacle - Dryer - 3-Pole 3-Wire Non-Grounding

- AL/CU



Part #	Mfg #	Description	Price
PASDRYERFLUSH3W	3860	30A 125/250V, NEMA 10-30	10.22

Flush Receptacle - Range - 3-Pole 3-Wire Non-Grounding

- AL/CU



Part #	Mfg #	Description	Price
PASRANGEFLUSH3W	3890	50A 125/250V, NEMA 10-50	23.48

Flush Receptacle - Dryer - 3-Pole 4-Wire - Grounding

- AL/CU



Part #	Mfg #	Description	Price
PASDRYERFLUSH4W	3864	30A 125/250V NEMA 14-30	18.50

Flush Receptacle - Range - 3-Pole 4-Wire - Grounding

- AL/CU



Part #	Mfg #	Description	Price
PASRANGEFLUSH4W	3894	50A 125/250V, NEMA 14-50	18.50

Surface Receptacle Power Outlets

Surface Receptacle - 2-Pole 3-Wire - Grounding

- AL/CU



Part #	Mfg #	Description	Price
PAS3852	3852	50A 250V, NEMA 6-50	51.42

Surface Receptacle - Range - 3-Pole 3-Wire Non-Grounding

- AL/CU



Part #	Mfg #	Description	Price
PASRANGESURF3W	385	50A 125/250V, NEMA 10-50	14.82

Wiring Devices

Prices & Specifications are Subject to Change.

Switches & Receptacles

Surface Receptacle - Range - 3-Pole 4-Wire - Grounding

- AL/CU

Part #	Mfg #	Description	Price
PASRANGESURF4W	3854	50A 125/250V, NEMA 14-50	24.50

Surface Receptacle - Dryer - 3-Pole 4-Wire - Grounding

- AL/CU



Part #	Mfg #	Description	Price
PASDRYERSURF4W	3884	30A 125/250V, NEMA 14-30	16.34

Surface Receptacle - 3-Pole 3-Wire - Grounding

- AL/CU



Part #	Mfg #	Description	Price
PASDRYERSURF3W	388	30A 125/250V	14.82

Plugs & Connectors

Angled Power Plug - Miscellaneous Configurations

- 3-Pole
- 3-Wire
- Conforms to NEMA WD-1 and WD-6



Part #	Mfg #	Description	Price
PAS3861	3861	30A or 50A 125/250V	37.62

Angled Power Plug - Dryer/Range



Part #	Mfg #	Description	Price
PASDRYERPLUG4W	3867	30A or 50A 125/250V	55.20

Angled Power Plug - Miscellaneous Configurations

- Conforms to NEMA WD-1 and WD-6



Part #	Mfg #	Description	Price
PAS3869	3869	30A or 50A 250V	59.56

Straight Blade Plugs & Connectors

Extra-Hard Use Specification Grade Plug - 2-Pole 3-Wire

- Nylon housing
- Black and white



PS5266X

PS5269X

Part #	Mfg #	Description	Price
PASMALESTRPLUG	PS5266X	15A 125V	14.30
PASFEMALESTPLUG	PS5269X	15A 125V	13.20

Turnlok Locking Devices

Turnlok NEMA Plug, Connector & Receptacle - 3-Wire 20A

- Visible stamped NEMA configuration and device rating
- Black back, white front body



L520

L520P

L520R

Part #	Mfg #	Description	Price
PASL520C	L520C	125V Connector	48.94
PASL520P	L520P	125V Plug	26.56
PASL520R	L520R	125V Receptacle	32.34

Turnlok NEMA Plug & Receptacle - 3-Wire 30A

- Visible stamped NEMA configuration and device rating
- Black back, white front body



L530P

L530R

Part #	Mfg #	Description	Price
PASL530P	L530P	125V Plug	40.10
PASL530R	L530R	125V Receptacle	48.52

Switches & Receptacles

Turnlok NEMA Plug, Connector & Receptacle - 3-Wire 20A

- Visible stamped NEMA configuration and device rating
- Black back, white front body



Part #	Mfg #	Description	Price
PASL620C	L620C	250V Connector	48.94
PASL620P	L620P	250V Plug	26.56
PASL620R	L620R	250V Receptacle	34.16

Turnlok NEMA Plug, Connector & Receptacle - 3-Wire 30A

- Visible stamped NEMA configuration and device rating
- Black back, white front body



Part #	Mfg #	Description	Price
PASL630C	L630C	250V Connector	80.86
PASL630P	L630P	250V Plug	40.92
PASL630R	L630R	250V Receptacle	52.14

Turnlok NEMA Plug, Connector & Receptacle - 4-Wire 20A

- Visible stamped NEMA configuration and device rating
- Black back, white front body



Part #	Mfg #	Description	Price
PASL1420C	L1420C	125/250V Connector	50.66
PASL1420P	L1420P	125/250V Plug	38.28
PASL1420R	L1420R	125/250V Receptacle	48.52

Turnlok NEMA Plug, Connector & Receptacle - 4-Wire 30A

- Visible stamped NEMA configuration and device rating
- Black back, white front body

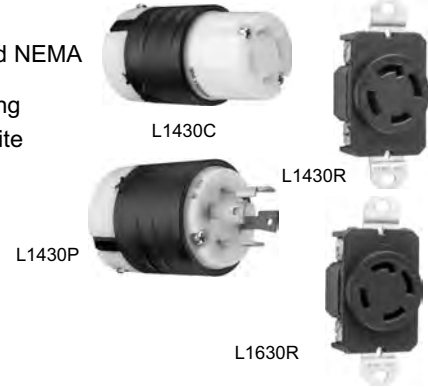

Part #	Mfg #	Description	Price
PASL1430C	L1430C	125/250V Connector	103.96
PASL1430P	L1430P	125/250V Plug	51.16
PASL1430R	L1430R	125/250V Receptacle	65.18
PASL1630C	L1630C	480V 3-Ph Connector	136.22
PASL1630P	L1630P	480V 3-Ph Plug	66.50
PAS1630R	L1630R	480V 3-Ph Receptacle	92.16

Turnlok NEMA Plug & Receptacle - 4-Wire 20A

- Visible stamped NEMA configuration and device rating
- Black back, white front body



Part #	Mfg #	Description	Price
PASL1520P	L1520P	250V 3-Ph Plug	51.24
PASL1520R	L1520R	250V 3-Ph Receptacle	57.78

Turnlok NEMA Plug & Receptacle - 4-Wire 30A

- Visible stamped NEMA configuration and device rating
- Black back, white front body



Part #	Mfg #	Description	Price
PASL1530P	L1530P	250V 3-Ph Plug	54.46
PASL1530R	L1530R	250V 3-Ph Receptacle	78.38

Wiring Devices

Prices & Specifications are Subject to Change.

Wall Plates

Switch Wall Plates

TradeMaster® 1-Gang Toggle Nylon Wall Plate - Standard Size

- Includes color-matching screws
- TradeMaster® preferred for hospital, industrial, institutional and other high-abuse applications



TP1W

Part #	Mfg #	Color	Price
PASTP1	TP1	Brown	0.56
PASTP1I	TP1I	Ivory	0.56
PASTP1LA	TP1LA	Lt Almond	0.56
PASTP1W	TP1W	White	0.56

TradeMaster® 2-Gang Toggle Nylon Wall Plate - Standard Size

- Includes color-matching screws
- TradeMaster® preferred for hospital, industrial, institutional and other high-abuse applications



TP2W

Part #	Mfg #	Color	Price
PASTP2	TP2	Brown	1.14
PASTP2I	TP2I	Ivory	1.14
PASTP2LA	TP2LA	Lt Almond	1.14
PASTP2W	TP2W	White	1.14

TradeMaster® 3-Gang Toggle Nylon Wall Plate - Standard Size

- Includes color-matching screws
- TradeMaster® preferred for hospital, industrial, institutional and other high-abuse applications



TP31W

Part #	Mfg #	Color	Price
PASTP3	TP3	Brown	1.72
PASTP3I	TP3I	Ivory	1.72
PASTP3LA	TP3LA	Lt Almond	1.72
PASTP3W	TP3W	White	1.72

TradeMaster® 4-Gang Toggle Nylon Wall Plate - Standard Size

- Includes color-matching screws
- TradeMaster® preferred for hospital, industrial, institutional and other high-abuse applications



TP4I

Part #	Mfg #	Color	Price
PASTP4	TP4	Brown	3.04
PASTP4I	TP4I	Ivory	3.32
PASTP4LA	TP4LA	Lt Almond	3.32
PASTP4W	TP4W	White	3.04

TradeMaster® 1-Gang Decorator/GFCI Nylon Wall Plate - Standard Size

- Includes color-matching screws
- TradeMaster® preferred for hospital, industrial, institutional and other high-abuse applications

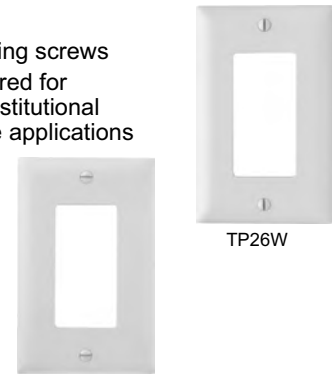

TP26W

TP26I

Part #	Mfg #	Color	Price
PASTP26	TP26	Brown	0.72
PASTP26I	TP26I	Ivory	0.70
PASTP26LA	TP26LA	Lt Almond	0.70
PASTP26W	TP26W	White	0.76

Wall Plates

TradeMaster® 2-Gang Decorator/GFCI Nylon Wall Plate - Standard Size

- Includes color-matching screws
- TradeMaster® preferred for hospital, industrial, institutional and other high-abuse applications

TP262W



TP262I



TP262LA

Part #	Mfg #	Color	Price
PASTP262I	TP262I	Ivory	1.42
PASTP262LA	TP262LA	Lt Almond	1.42
PASTP262W	TP262W	White	1.42

TradeMaster® 3-Gang Decorator/GFCI Nylon Wall Plate - Standard Size

- Includes color-matching screws
- TradeMaster® preferred for hospital, industrial, institutional and other high-abuse applications



TP263W

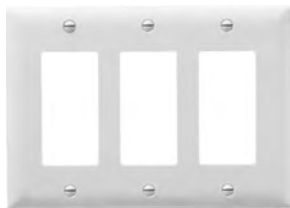

TP263I

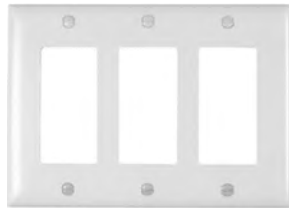

TP263LA

Part #	Mfg #	Color	Price
PASTP263I	TP263I	Ivory	2.08
PASTP263LA	TP263LA	Light Almond	2.08
PASTP263W	TP263W	White	2.08

TradeMaster® 4-Gang Decorator/GFCI Nylon Wall Plate - Standard Size

- Includes color-matching screws
- TradeMaster® preferred for hospital, industrial, institutional and other high-abuse applications



TP264W



TP264I



TP264LA

Part #	Mfg #	Color	Price
PASTP264I	TP264I	Ivory	3.04
PASTP264LA	TP264LA	Lt Almond	3.04
PASTP264W	TP264W	White	3.04

Combination Wall Plates

TradeMaster® 2-Gang Toggle Switch & Duplex Receptacle Combination Nylon Wall Plate - Standard Size

- Includes color-matching screws
- TradeMaster® preferred for hospital, industrial, institutional and other high-abuse applications



TP18W

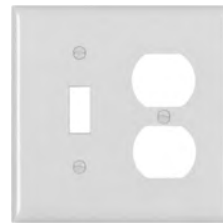

TP18I



TP18LA

Part #	Mfg #	Color	Price
PASTP18I	TP18I	Ivory	1.54
PASTP18LA	TP18LA	Lt Almond	1.42
PASTP18W	TP18W	White	1.42

Wiring Devices

Wall Plates

TradeMaster® 3-Gang Toggle/Toggle/Duplex Combination Nylon Wall Plate - Standard Size

- Includes color-matching screws
- TradeMaster® preferred for hospital, industrial, institutional and other high-abuse applications



TP28I



TP28W

Part #	Mfg #	Color	Price
PASTP28I	TP28I	Ivory	8.34
PASTP28LA	TP28LA	Lt Almond	8.34
PASTP28W	TP28W	White	8.34

TradeMaster® 2-Gang Toggle Switch & Decorator/GFCI Combination Nylon Wall Plate - Standard Size

- Includes color-matching screws
- TradeMaster® preferred for hospital, industrial, institutional and other high-abuse applications



TP126I



TP126LA



TP126W

Part #	Mfg #	Color	Price
PASTP126I	TP126I	Ivory	1.18
PASTP126LA	TP126LA	Lt Almond	1.18
PASTP126W	TP126W	White	1.18

TradeMaster® 3-Gang Toggle Switch & Decorator/GFCI Combination Nylon Wall Plate - Standard Size

- Includes color-matching screws
- TradeMaster® preferred for hospital, industrial, institutional and other high-abuse applications

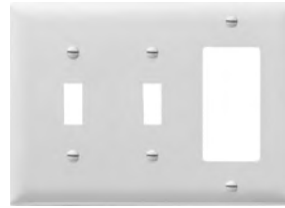

TP226I



TP226LA



TP226LA

Part #	Mfg #	Color	Price
PASTP226I	TP226I	Ivory	12.28
PASTP226LA	TP226LA	Lt Almond	11.26
PASTP226	TP226W	White	15.16

4-Gang Toggle Switch & Decorator/GFCI Combination Thermoset Wall Plate - Standard Size

- Includes color-matching screws



SP326LA



SP326W

Part #	Mfg #	Color	Price
PASSP326LA	SP326LA	Lt Almond	20.14
PASSP326W	SP326W	White	20.14

TradeMaster® 2-Gang Duplex Receptacle & Decorator/GFCI Combination Nylon Wall Plate - Standard Size

- Includes color-matching screws
- TradeMaster® preferred for hospital, industrial, institutional and other high-abuse applications



TP826W

Part #	Mfg #	Color	Price
PASTP826LA	TP826LA	Lt Almond	5.48
PASTP826W	TP826W	White	5.48

Wiring Devices

Wall Plates

Receptacle Wall Plates

2-Gang Power Outlet Receptacle Smooth Wall Plate

- 2.1563" Hole for 2.125" diameter device
- (4) Mounting holes
- Corrosion-resistant alloy



Part #	Mfg #	Description	Price
PASRANGEPLATE	SS703	302 Stainless Steel Smooth	14.52

TradeMaster® 1-Gang Single Receptacle Nylon Wall Plate - Standard Size

- Includes color-matching screws
- TradeMaster® preferred for hospital, industrial, institutional and other high-abuse applications



Part #	Mfg #	Color	Price
PASTP7I	TP7I	Ivory	0.72
PASTP7LA	TP7LA	Lt Almond	0.72
PASTP7W	TP7W	White	0.72

1-Gang Duplex Receptacle Smooth Wall Plate - Jumbo Size

- Includes color-matching screws



Part #	Mfg #	Color	Price
PASSP08I	SPO8I	Ivory	3.44
PASSP08W	SPO8W	White	3.44

TradeMaster® 1-Gang Duplex Receptacle Nylon Wall Plate - Standard Size

- Includes color-matching screws
- TradeMaster® preferred for hospital, industrial, institutional and other high-abuse applications

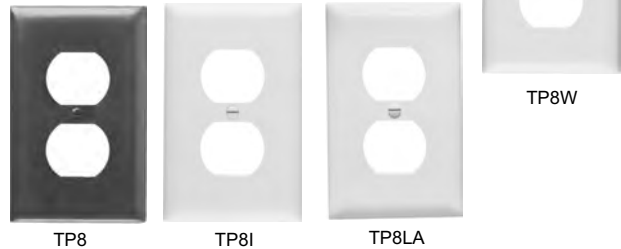

Part #	Mfg #	Color	Price
PASTP8	TP8	Brown	0.70
PASTP8I	TP8I	Ivory	0.70
PASTP8LA	TP8LA	Lt Almond	0.70
PASTP8W	TP8W	White	0.70
PASTP8BK	TP8BK	Black	0.70

TradeMaster® 2-Gang Duplex Receptacle Nylon Wall Plate - Standard Size

- Includes color-matching screws
- TradeMaster® preferred for hospital, industrial, institutional and other high-abuse applications

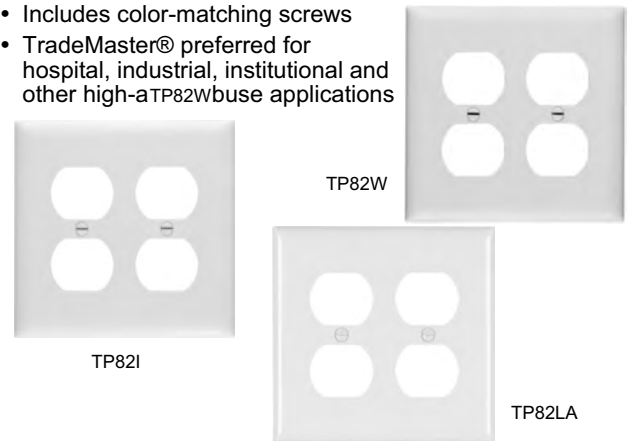

Part #	Mfg #	Color	Price
PASTP82	TP82	Brown	1.42
PASTP82I	TP82I	Ivory	1.42
PASTP82LA	TP82LA	Light Almond	1.68
PASTP82W	TP82W	White	1.42

Wiring Devices

Wall Plates

Device Wall Plates

1-Gang Power Outlet Wall Plate - Standard Size

- (1) Opening



Part #	Mfg #	Description	Price
PASS384C	S384C	Chrome	6.58

Blank Wall Plates

TradeMaster® 1-Gang Blank Nylon Wall Plate - Standard Size

- Box-mounted
- Includes color-matching screws
- TradeMaster® preferred for hospital, industrial, institutional and other high-abuse applications



TP13W



TP13



TP13I



TP13LA

Part #	Mfg #	Color	Price
PASTP13	TP13	Brown	0.78
PASTP13I	TP13I	Ivory	0.78
PASTP13LA	TP13LA	Lt Almond	0.78
PASTP13W	TP13W	White	0.78

TradeMaster® 2-Gang Blank Nylon Wall Plate - Standard Size

- Box-mounted
- Includes color-matching screws
- TradeMaster® preferred for hospital, industrial, institutional and other high-abuse applications



TP23W



TP23I



TP23LA

Part #	Mfg #	Color	Price
PASTP23I	TP23I	Ivory	0.72
PASTP23LA	TP23LA	Lt Almond	0.72
PASTP23W	TP23W	White	0.72

Telephone & CATV Wiring Device Wall Plates - Standard Size

1-Gang Coax Connector Wall Plate

- Mar-resistant wallplate
- Nickel-plated F-type connector threaded at each end
- UL Listed



TPCATVW



TPCATVI



TPCATVLA

Part #	Mfg #	Color	Price
PASTPCATVIV	TPCATVI	Ivory	5.10
PASTPCATVLA	TPCATVLA	Lt Almond	5.10
PASTPCATVWH	TPCATVW	White	5.10

Wiring Devices

Wall Plates

1-Gang Coax Connector Decorator Flush Wall Plate

- Decorator outline
- Face constructed of high-impact thermoplastic
- Zinc-plated steel strap
- Nickel-plated F-type connector
- Threaded on each end



Part #	Mfg #	Color	Price
PASCOAXDECW	26CATVW	White	10.56

1-Gang Modular Telephone Jack Wall Plate

- Mar-resistant wallplate
- 4-Conductor RJ11 modular jack
- Meets FCC Part 68 requirements
- UL Listed

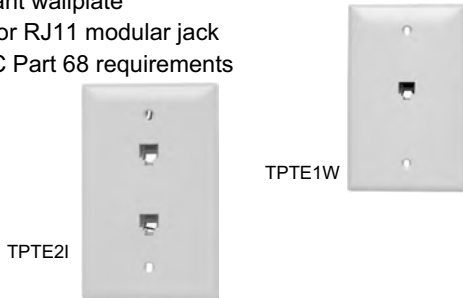

Part #	Mfg #	Description	Price
PASTPTE1I	TPTE1I	(1) Jack, Ivory	4.32
PASTPTE1LA	TPTE1LA	(1) Jack, Lt Almond	4.32
PASTPTE1W	TPTE1W	(1) Jack, White	8.00
PASTPTE2I	TPTE2I	(2) Jacks, Ivory	14.72
PASTPTE2LA	TPTE2LA	(2) Jacks, Lt Almond	14.72
PASTPTE1I	TPTE2W	(2) Jacks, White	4.32

1-Gang Decorator Modular Jack Wall Plate

- Decorator-style rectangular design
- RJ11 Modular jack
- Fits standard single-gang electrical box
- May be used in multi-gang applications
- Face constructed of high-impact thermoplastic
- Brass terminals with nickel-plated steel screws and washers
- Meets FCC Part 68 requirements

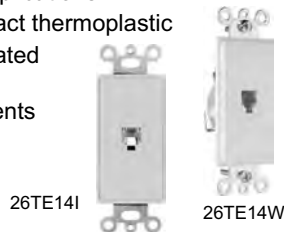

Part #	Mfg #	Color	Price
PAS26TE14-I	26TE14I	Ivory	11.10
PAS26TE14-W	26TE14W	White	11.48

1-Gang Combination Coaxial Connector & Telephone Jack Wall Plate

- High-impact thermoplastic face
- Nickel-plated F-type connector threaded on each end
- 4-Conductor RJ11 modular jack
- Zinc-plated steel strap
- UL Listed



Part #	Mfg #	Color	Price
PASTPTELTVLA	TPTELTVLA	Lt Almond	7.16
PASTPTELTVWH	TPTELTVW	White	8.02

Modular Wall-Mount Telephone Jack Wall Plate

- For hanging phones
- RJ11 Modular jack
- High-impact thermoplastic face plate and back body

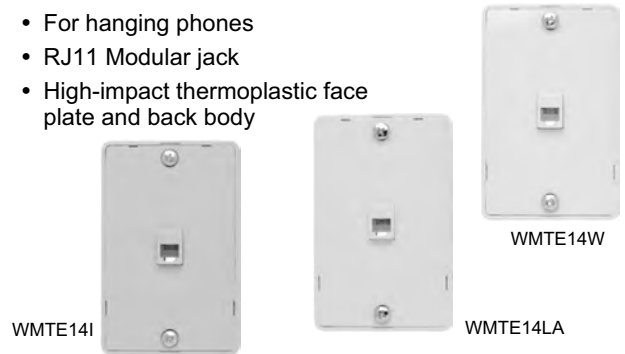

Part #	Mfg #	Color	Price
PASWMTE14I	WMTE14I	Ivory	14.10
PASWMTE14LA	WMTE14LA	Lt Almond	14.10
PASWMTE14WH	WMTE14W	White	14.10



Wiring Devices

Lightning Arrestor/Surge Suppressor

- Installs at electrical panel, electrical disconnect
- Hardwire parallel connections
- Weatherproof
- Model 89114 has indicator light to show surge protection and ground present, and power on



Part #	Mfg #	Description	Price
MOR89114	89114	100,000 Amp Surge Current, 840 Joules Max Energy Dissipation	62.47

Wiring Devices

Electrical Wiring Devices

Voice/Datacom & Wiring Devices

"F" Connector Twist On

- Terminates coaxial cable
- Twist on to prepared cable end



Part #	Mfg #	Type	Price
MOR45080	45080	RG6	0.46



24-Hour Timers

T100 Series Heavy-Duty Mechanical Time Switch

- For loads up to 40A resistive from 120 to 480V providing direct 24-hour time switch control of most loads
- Provides 1 to 12 On/Off operations each day with a minimum On/Off time of 1 hour
- Includes (1) On and (1) Off trippers

Indoor T100 Series HD Mechanical Time Switch

- Drawn steel case in gray finish



Part #	Mfg #	Switch	Volts	HP	Price
TIMT101	T101	SPST	125V	2	130.01
TIMT103	T103	DPST	125V	2	144.48
TIMT104	T104	DPST	208-277V	5	150.91

Outdoor T100 Series HD Mechanical Time Switch



Part #	Mfg #	Description	Price
TIMT101P	T101P	SPST 125V 2 hp, Plastic Case Weatherproof	197.06
TIMT104P	T104P	DPST 208-277V 5 hp, Plastic Case Weatherproof	217.69

Trippers

Part #	Mfg #	Description	Price
TIMTRIPPERS	156T1978A	Tripper Set, (1)On & (1)Off	5.52

In-Wall Timers

Heavy-Duty In-Wall Timer with Astronomic Feature

- Follows daily changes in sunrise/sunset times
- For single-pole and 3-way applications up to 100'
- Controls lighting including fluorescent and heavy-duty loads such as fans and applications
- Up to 6 On/Off settings per day
- Easy-to-set 6 button programming
- LCD Digital clock and readout
- To-the-minute setting accuracy
- Battery back-up
- Random setting feature available to avoid predictable "timer controlled" lock
- Manual override feature
- Use with decorator style wall plate (not included)



Part #	Mfg #	Description	Price
TIMST01C	ST01C	White, Self-Adjusting Timer w/Astro Feature	60.25
TIMST01AC	ST01AC	Almond, Self-Adjusting Timer w/Astro Feature	60.25

Spring Wound Timers

FD Decorator Series Spring Wound Auto-Off Timer

- Energy saving timer uses no electricity to operate
- Designed to replace any standard wall switch, single or multi-gang
- Automatically limits the "on" time of fans, lights, motors, heaters and other consuming loads
- Hold feature allows user to override the automatic shut-off function



Part #	Mfg #	Description	Price
TIMFD15MW	FD15MW	White, 15 Min SPST less Hold	38.16
TIMFD15MHC	FD15MHC	15 Min SPST w/Hold Spring Wound Auto-Off	38.16
TIMFD30M	FD30M	Ivory, 30 Min SPST less Hold	38.16
TIMFD60M	FD60M	Ivory, 60 Min SPST less Hold	38.16

Timers & Photo Controls

Photo Controls

K4000C Series Stem-Mount Thermal-Type Photo Control

- Fits into standard outlet box, post lamp or wall packs
- Equipped with 3/8"-18 threaded side mounting
- Washer gasket and locking nut included
- 9" Leads
- Mechanism: 1-13/16"H x 1-5/16"W x 13/16"D
- Plate: 4-1/2"H x 2-3/4"W



Part #	Mfg #	Watts	Volts	Price
TIMK4021C	K4021C	1800W	120V	16.70

K4100 Series Stem-Mount Thermal-Type Photo Control

- Equipped with light level slide adjustment and 1/2"-14 threaded stem
- Washer gasket and locking nut included
- 1-9/16" Square, 3" long



Part #	Mfg #	Watts	Volts	Price
TIMK4121C	K4121C	1800W	120V	16.82
TIMK4123C	K4123C	3100-4150W	208-277V	37.40

K4200 Series Stem & Swivel-Mount Thermal-Type Photo Control

- Equipped with light level slide adjustment and 1/2"-14 threaded swivel stem
- Washer gasket and locking nut included
- 1-9/16" Square, 5-1/2" long



Part #	Mfg #	Watts	Volts	Price
TIMK4251	K4251	1800W	120V	22.13

LC4500 Series Locking-Mount Thermal-Type Photo Control

- Low cost reliable control for street lighting and other applications requiring a NEMA twist and lock-type plug connection
- Integral housing and lens with UV protection
- Translucent with color coded band for voltage identification
- 2-3/4"H x 3" Diameter



Part #	Mfg #	Watts	Volts	Price
TIMLC4521C	LC4521C	1000W	120V	13.71



Pass & Seymour

Electrical Accessories



FS2



2005



80700-I

Part #	Mfg #	Description	Price
PASFS2	FS2	Fluorescent Starter less Reset, w/2 Pins 14/15/20W	6.04
PASSOCKETEXT	2005	Porcelain Socket Ext Medium	11.98
PASSTAPIV	80700-I	Blank Yoke Insert	8.22

Wiring Devices

Grounding

Grounding

Insulated Metal Grounding Bushing

- With dual rated CU-AI C-clamp grounding lug
- Zinc die-cast



Part #	Mfg #	Trade Size	Ground Min	Wire Max	Price
ELFGB12	450	1/2"	14	4	4.31
ELFGB34	451	3/4"	14	4	4.61
ELFGB1	452	1"	14	4	4.98
ELFGB114	453	1-1/4"	14	4	6.27
ELFGB112	454	1-1/2"	14	2	7.14
ELFGB2	455	2"	14	2	9.59
ELFGB212	456	2-1/2"	14	2/0	14.75
ELFGB3	457	3"	14	2/0	20.10
ELFGB4	459	4"	14	2/0	26.04

Grounding Locknut for Rigid Conduit

- Zinc die-cast



Part #	Mfg #	Trade Size	Price
ELFGLN12	GL50	1/2"	2.03
ELFGLN1	GL100	1"	3.17
ELFGLN114	GL125	1-1/4"	3.95
ELFGLN2	GL200	2"	6.38
ELFGLN4	GL400	4"	24.34

Bare Wire Ground Clamp

- Zinc die-cast



Part #	Mfg #	Pipe Size	Wire Range	Price
ELFGC12-1	720Z	1/2" - 1"	8-2	1.64

Brass Bare Wire Ground Clamp

- Solid brass with steel screws



Part #	Mfg #	Pipe Size	Wire Range	Price
ELFGPC114-2	721B	1-1/4" - 2"	10-2	11.26
ELFGPC212-4	722B	2-1/2" - 4"	10-2	40.08



Grounding Accessories

- 1/2" Deep
- Ceiling pans are often used in the installation of wall or ceiling lighting fixtures
- Not designed for ceiling fan support
- Combination head screws provide for faster installation



Part #	Mfg #	Description	Price
RAO973	973	#10-32 Green Grounding Screws	0.14
RAO983	983	6" #12 Green Ins Solid Grounding Copper Wire	0.73



Ground Rods

Copper Coated Sectional Ground Rod

- Threaded on both ends



Part #	Mfg #	Nom Dia x Length	Price
ELFGRCU58-8	6258S	5/8" x 8'	17.58

Hot Dip Galvanized Ground Rod

- High-strength steel immersed in molten zinc forming a rust-proof barrier
- Corrosion resistant
- Minimum zinc thickness 3.9 mils



Part #	Mfg #	Nom Dia x Length	Price
ELFGRG58-8	GR6258	5/8" x 8'	10.92

Grounding

All Items May Not Be Stocked In All Branches

Lighting

Wallpacks

Tallpack HPS

- Photocontrol for automatic dusk to dawn operation
- Cap included to cover photocell
- Heavy, die cast aluminum back plate with box mounting template
- 1/2" Bottom conduit knockout



Part #	Model #	Description	Price
RABWPTS50	WPTS50	50W High Pressure Sodium Tall Wallpack w/Photocell & Lamp, 120V Bronze	107.73
RABWPTS70	WPTS70	70W High Pressure Sodium Tall Wallpack w/Photocell & Lamp, 120V Bronze	107.73

LED Wallpack

- Full cutoff, fully shielded LED wallpack
- High output LED light engine
- Maintains 70% of its initial lumens at 50,000 hours
- Weatherproof high temperature silicone gaskets
- Dark sky approved
- Mercury, arsenic and UV free
- Bronze, 120-277V
- Lamp supplied with fixture



Part #	Model #	Description	Price
RABWPLED10S	WPLED10S	10W Cool LED, Bronze, Surface Mount	297.00
RABWPLED20	WPLED20	20W Cool LED, with Surface Mount for Recessed Box, Equal to 150W Metal Halide	447.00
RABWPLED26	WPLED26	26W Cool LED, Equal to 175W Metal Halide	504.00
RABWPLED52	WPLED52	52W Cool LED, Bronze, Equal to 250W Metal Halide	747.00

Yard Blaster™ & Down Blaster™ Wallpack



Part #	Model #	Description	Price
RABYLH70	YLH70	70W Metal Halide Fixture w/Lamp, Photocontrol Yard Blaster	186.00
RABYLS70	YLS70	70W High Pressure Sodium Fixture w/Lamp	103.75
RABYLS150	YLS150	150W High Pressure Sodium Fixture w/Lamp	103.74

Accessories for Wallpack

Part #	Model #	Description	Price
RABYARM24	YARM24	24" Mounting Arm for Yard Blaster & Down Blaster	11.97

Prices & Specifications are Subject to Change.

Lighting

Lighting

Vaporproof Ceiling Fixtures

Vaporproof Box Ceiling Fixture

- All brass hardware
- Close-up plugs allow Phillips or slotted screwdrivers
- Junction box with sturdy mounting lugs
- High temperature silicone internal gaskets
- Premium porcelain socket
- Clear heat resistant glass globes standard
- UL Listed - suitable for dwellings and wet locations



VX100

Part #	Model #	Description	Price
RABVX100DG	VX100DG	4" Box Vaporproof Fixture w/Globe & Guard, Silver Color	45.89
RABVX100	VX100	4" Box Vaporproof Fixture w/Clear Globe, Natural	39.90

Vaporproof Wall Bracket Fixture

- Die cast aluminum
- Close-up plugs allow Phillips or slotted screwdrivers
- Junction box with sturdy mounting lugs
- High temperature silicone internal gaskets
- All stainless steel hardware
- Premium porcelain socket
- Clear heat resistant glass globes standard
- UL Listed - suitable for dwellings and wet locations



VXBR100DG

Part #	Model #	Description	Price
RABVXBR100DG	VXBR100DG	4" Box Vaporproof Fixture w/Globe & Die Cast Guard w/Box	57.86

Vaporproof Globes



Part #	Model #	Description	Price
RABGL100	GL100	Threaded Round Bottom Glass Globe 150W Maximum, Clear	7.98

Floodlights

Quartz Floodlight

- Die cast hinged lens frame with thick tempered glass lens and stainless steel lens clip
- High temperature silicone gasket stays in place during relamping
- 1/2" NPS threaded arm with locking swivel fits all standard mounting boxes



QF1500

Part #	Model #	Description	Price
RABQF500	QF500	500W Fixture w/Lamp	27.93

All Items May Not Be Stocked In All Branches

Lighting

Lighting

Sensors

Gotcha!™ Outdoor Sensor

- 500W Switching capacity and 6000V surge protection
- 110° Detection view and adjustable motion detector sensitivity
- Temperature compensation
- Photoelectric control deactivates lights during daylight



Part #	Model #	Description	Price
RABGT500R	GT500R	Sensor w/Par Flood Holders Kit, Black	69.83
RABGT500RW	GT500RW	Sensor w/Par Flood Holders Kit, White	69.83

Luminator™ Outdoor Sensor



LU300



LS300

Part #	Model #	Description	Price
RABLU300	LU300	Motion Sensor w/Par Flood Holders	37.91
RABLU300W	LU300W	Motion Sensor w/Par Flood Holders, White	37.91
RABLS300	LS300	Motion Sensor Only	33.92
RABLS300W	LS300W	Motion Sensor Only, White	33.92

Landscape Lighting

PL Flood Light

- Corrosion and vandal resistant polycarbonate housing and lens
- Anodized aluminum reflector
- 0°F Minimum operating temperature
- Heavy duty cast aluminum mounting arm and swivel with stainless steel screw
- 1/2" Thread
- Lamp included



Part #	Model #	Description	Price
RABPLF26	PLF26	Bronze 26W, 13W Twin Lamp, GX23 Base, NPT 120V Ballast	49.88

Emergency & Exit Lighting

Lighting

Commercial Exit and Emergency Lighting

- UL Listed
- UV-Stable thermoplastic is flame-retardant and meets UL standard 95-VA
- Meets or exceeds NFPA, NEC, and OSHA standards
- 5-Year warranty on housing and electronics



LED Exit/Emergency Combination Unit

- Lead Calcium battery is standard, Nickel Cadmium battery is optional
- (2) 6V, 5.4W Lamps
- EEU-2-16: 16W Remote capable
- UL 924 Listed; damp location listed
- 5-Year pro-rated warranty on battery



EEU-2-RW

Part #	Mfg #	Size (H x W x D)	Price
ASTEE-U-2-RWCOMBOEX	EEU-2-RW	8.5" x 18.3" x 2.8"	118.06
ASTEEU216RWCOMBOREM	EEU-2-16-RW	8.5" x 18.3" x 2.8" Remote Capable	106.71

Fully Adjustable 2-Head Emergency Light

- Lead Calcium battery is standard, Nickel Cadmium battery is optional
- (2) 6V, 5.4W Lamps
- 5-Year pro-rated warranty on battery



Part #	Mfg #	Description	Price
ASTEU3W2HEMLIGHT	EU3-W	12.5"W x 4-7/5"L x 3.8"D	35.33

Thermo-Plastic LED Exit Light

- Universal mount
- Nickel Cadmium battery is standard
- 120/277-60 Dual input transformer
- 7-Year pro-rated warranty on battery



Part #	Mfg #	Description	Price
ASTTPU2RWEM	TP-U2-R-W-EM	7.4"H x 11.4"W x 1.7"D with Red LED Letters (Emergency) & White Housing	46.87

Accessories



Part #	Mfg #	Description	Price
ASTREM1-1HW6A	REM1-1H-W-6-W	6V, 6W Commercial Grade White, Single Remote Head (Lamp)	23.25

Lighting

Strip Lights

Narrow Strip Light

- Suitable for tight spaces like cove and/or task lighting
- Die-formed from code-gauge steel with white polyester finish
- Channel cover secured by captive quarter-turn latch
- Designed for surface or suspended mounting



Part #	Mfg #	Description	# of Lamps	Lgth	Lamp Type	Voltage	Ballast	Price
LITS120TS	S120	T12 Narrow Strip	1	24"	20	120V	Electronic, Rapid Start	25.83
LITS125MV	S125MV	T8 Narrow Strip	1	36"	25	MVOLT	NEMA Prem Instant Start	71.50
LITS132MV	S132MV	T8 Narrow Strip	1	48"	32	MVOLT	NEMA Prem Instant Start	54.31

C Series Strip Light

- Suitable for general purpose applications
- Steel channel (standard) with high-gloss, baked polyester finish
- Channel cover retained by quarter-turn fastener



Part #	Mfg #	Description	# of Lamps	Lgth	Lamp Type	Voltage	Ballast	Price
LITC220	C220	C General Purpose	2	24"	20W T12	120V	1-and/or 2-Lamp Ballasts	41.09

Contractor Select Strip Light

- Ideal where high brightness and good illumination levels are required such as retail, light industrial and warehouses
- Heavy-duty channel, die -formed from code-gauge steel
- Combination endplate/channel connector furnished with each fixture
- Painted parts finished with high-gloss, baked white enamel



Part #	Mfg #	Description	# of Lamps	Lgth	Lamp Type	Volts	Ballast	Price
LITC232MV	C232 MV	T8 Gen Purpose	2	48"	32	120-277V	NEMA Prem Instant Start	46.59
LITTC232MV	TC232MV	T8 Gen Purpose Tandem Double Length	4	96"	32	120-277V	NEMA Prem Instant Start	66.50

General Purpose Industrial Strip Light

- Intended for mounting heights up to 16' requiring low to medium light levels
- Constructed of die-formed cold rolled steel
- Channel cover secured by quarter-turn latch for easy access to wire-way
- Finished with high-gloss baked white enamel



Part #	Mfg #	Description	# of Lamps	Lgth	Wattage	Voltage	Ballast Type	Price
LITTL232MV	TL232 MV	T8 Gen Purp Indus Tandem Double Length	4	96"	32	120-277V	NEMA Prem Instant Start	85.66

Heavy-Duty and Industrial Strip Light

- Intended for mounting heights up to 16' requiring low to medium light levels
- Channel constructed of die-formed cold rolled steel with longitudinal V-grooves in channel
- Screw-on end plates
- Five-stage iron phosphate pretreatment for paint adhesion and corrosion-resistance



Part #	Mfg #	Description	# of Lamps	Lgth	Wattage	Voltage	Ballast Type	Price
LITUN296HO	UN296HO	T12HO HD Indus	2	96"	110W	120V	Electronic Rapid Start	93.10

Prices & Specifications are Subject to Change.

Lighting

Lighting

Flush Mount Lighting

Classic Steel Linear Flush Mount Lighting

- Residential and light commercial
- Baked enamel finish, rugged steel housing
- Milk white acrylic dropped diffuser
- Uses linear T8 lamps
- 120V, 60 Hz Electronic ballast
- Non-dimmable only
- Mounting hardware included
- RE - 120V Residential electronic ballast standard
- 2-Year Mechanical defects warranty

Part #	Mfg #	Nom Size	Finish	Lamps	Price
LIT11231REWH	11231-RE-WH	1" x 2'	White	(2) 17W Linear T8 Fluorescent Lamps Required	154.12
LIT11232REWH	11232-RE-WH	1" x 4'	White	(2) 32W Linear T8 Fluorescent Lamps Required mV	88.31

Square-Basket Wraparound Surface Ceiling Mount Lighting

- Residential and light commercial
- Baked white enamel end plates
- Flat-bottom acrylic prismatic diffuser
- Linear side prisms
- Matches CS series in appearance
- 1-Year guarantee against mechanical defects in manufacture



Part #	Mfg #	Nom Size	Finish	Lamps	Price
LITSB232MV	SB232MV	8-3/8" x 4'	White	(2) 32W Linear T8 mV Fluorescent Lamps	66.33
LITSB432MV	SB432MV	13-3/4" x 4'	White	(4) 32W Linear T8 mV Fluorescent Lamps	89.57

Accessories and Parts

Part #	Mfg #	Description	Price
LITDDM96	DDM96	8' Replacement Lens Only	89.31
LITDGA24	DGA24	2 x 4 Flanged Grid to Drywall Adapter Kit	58.89
LITELB06	ELB06	Battery for PM640-WP	66.40

Recessed Lighting

GT Low-Profile Lensed Troffer

- Low-profile, ideal for restricted plenum
- Hemmed sides, standard steel door frame
- Integral T-bar safety clips are standard



Part #	Mfg #	W x L	Nbr of Lamps	Description	Voltage	Ballast Config	Price
LITGT2UMV	GT2UMV	24" x 48"	(2) 32W U-Lamp	2x2 T8	120-277V	NEMA Prem Instant Start	70.03
LITGT3MV	GT3MV	24" x 48"	(3) 32W	2x4 T8	120-277V	NEMA Prem Instant Start	70.03
LITGT4MV	GT4MV	24" x 48"	(4) 32W	2x4 T8	120-277V	NEMA Prem Instant Start	70.03

All Items May Not Be Stocked In All Branches

Lighting

Prismatic Lens



Part #	Mfg #	Description	Price
ELEPL24	PL24	24" x 48" Prismatic Lens	14.79

PT Contractor Select Parabolic

- For use in open area applications where optical control, visual comfort and light cut-off are important
- Hemmed sides and ends
- Mitered corners and interlocking construction
- Integral T-bar safety clips are standard
- Heavy-gauge hinges
- Spring-action latches
- Semi-specular (diffuse) louver finish



Part #	Mfg #	W x L	Nbr of Lamps	Description	Voltage	Ballast Config	Price
LITPT2UMV	PT2UMV	24" x 24"	(2) 32W U-Lamp	Recess Static	120-277V	NEMA Prem Instant Start	90.77
LITPT3MV	PT3MV	24" x 48"	(3) 32W U-Lamp	Recess Static	120-277V	NEMA Prem Instant Start	90.77

Incandescent Recessed Housing



Part #	Mfg #	Description	Options	Price
LITL3	L3	4" IC/Non-IC Aluminum Housing, Clips	New Construction	24.51
LITL3R	L3R	4" IC/Non-IC Aluminum Housing, Clips	Remodel	32.12
LITL5	L5	5" IC/Non-IC Aluminum Housing, Clips	2"x8" New Construction	19.98
LITL5R	L5R6	5" IC/Non-IC Aluminum Housing, Clips, 6 Pack	Remodel	19.98
LITL7X	L7X	6" IC/Non-IC Aluminum Housing, Clips	2"x8" New Construction	16.53
LITL7XR	L7XR	6" IC/Non-IC Aluminum Housing, Clips	Remodel	18.22
LITLC6	LC6	6" IC/Non-IC Alum Housing, Clips, 6-3/4" Deep, Prem	2"x8" New Construction	16.25
LITLCP	LCP	6" IC/Non-IC Alum Housing, Clips, 5-3/4" Shallow, Prem	2"x6" New Construction	16.67
LITLI6	LI6	6" IC Hi Watt Sloped Ceiling Steel Housing	2"x8" New Construction	40.64
LITLI6AT	LI6AT	6" IC Hi Watt Sloped Ceiling Steel Housing, Sealed Airtight	2"x8" New Construction	44.09

Prices & Specifications are Subject to Change.

Lighting

Lighting

Reality™ LED Recessed Can

- For use with L7X, L7XR and LC6 housings
- LED Module for retrofit or new construction
- Rugged, one-piece, die-cast heat sink design
- Twin torsion springs
- Wet location rated
- ESL - Energy star listed
- 3-Year limited warranty covering defects in materials and workmanship, including LED and driver



Part #	Mfg #	Description	Options	Price
LITREALD6ESL	REAL D6 MW ESL	6" LED Retrofit Module, Energy Star, 700 Lumens, 120V, 3000K	New or Retrofit	179.28

3 Series Residential Recessed Incandescent Lighting Full Reflector Trim



301



3B1W



3E1



3H2O



3W1

Part #	Mfg #	Color	Description	Compatible Housings	Price
LIT301	301	White	4" Open Shallow, Narrow Flg	2" x 6" Construction	18.08
LIT3B1W	3B1W	White	4" Baffle Shallow, Narrow Flg	2" x 6" Construction	19.32
LIT3E1	3E1	White	4" Std Eyeball, Narrow Flg,	2" x 6" Construction	42.82
LIT3H2O	3H2O	White	4" Wetlite, Narrow Drop Flg, w/Lamp	2" x 6" Construction	38.84
LIT3W1	3W1	White	4" Wallwash Eyelid, Narrow Flg	2" x 6" Construction	40.96

5 Series Residential Recessed Incandescent Lighting Full Reflector Trim



5O2



5B2W

Part #	Mfg #	Color	Description	Compatible Housings	Price
LIT502	5O2	White	5" Open Deep, Narrow Flg	2" x 8" Construction	31.10
LIT5B1W	5B1W	White	5" Baffle Shallow, Narrow Flg	2" x 8" Construction	29.18

6 Series Residential Recessed Incandescent Lighting Full Reflector Trim



6O1



6O2



CB1



CB1W



6B3W



CE1



6LD2



6SO1



6SB1W

Part #	Mfg #	Color	Description	Compatible Housings	Price
LIT601	6O1	White	6" Open Downlight, Wide Flg	2" x 8" Construction	18.57
LITCO1	CO1	White	6" Open Downlight, Wide Flg	2" x 6" Construction	33.20
LIT602	6O2	White	6" Deep Open, Narrow Flg	2" x 8" Construction	14.22
LITCO2	CO2	White	6" Deep Open, Narrow Flg	2" x 6" Construction	16.67
LITCB1	CB1	Black	6" Baffle Shallow, Narrow Flg	2" x 6" Construction	18.99
LITCB1W	CB1W	White	6" Baffle Shallow, Narrow Flg	2" x 6" Construction	21.20
LIT6B3W	6B3W	White	6" Metal Baffle, Narrow Flg	2" x 8" Construction	71.53

All Items May Not Be Stocked In All Branches

Lighting

Recessed Lighting (Continued)

6 Series Residential Recessed Incandescent Lighting Full Reflector Trim

Part #	Mfg #	Color	Description	Compatible Housings	Price
LIT6B4W	6B4W	White	6" Baffle, Narrow Flg	2" x 8" Construction	22.63
LITCE1	CE1	White	6" Eyeball Shallow, Narrow Flg	2" x 6" Construction	34.69
LITCLD1	CLD1	White	6" Opal Drop Lens, Narrow Flg	2" x 6" Construction	24.94
LIT6LD2	6LD2	White	6" Prismatic Drop Lens, Narrow Flg	2" x 8" Construction	30.65
LIT6S01	6SO1	White	6" Sloped Open, Narrow Flg	2" x 8" Construction	45.26
LIT6SB1W	6SB1W	White	6" Sloped Baffle, Narrow Flg	2" x 8" Construction	61.38

7 Series Residential Recessed Lighting Full Reflector Trim



Part #	Mfg #	Color	Description	Compatible Housings	Price
LIT7O3	7O3	White	6" Open, Wide Flg	2" x 8" Construction	8.86
LIT7LD1	7LD1	White	6" Lens Drop Oval, Wide Flg	2" x 8" Construction	18.44
LIT7B2W	7B2W	White	6" White Baffle, Narrow Flg	2" x 8" Construction	13.35



Nicor Recessed Lighting

Airtight Housing

- Suitable for new construction in residential and commercial applications
- Integral thermal protector
- Adjustable socket bracket
- 7-1/2" Height allows use in 2" x 8" joist construction
- Supplied with (3) IDEAL® push-in wire connectors
- Heavy gauge captive hanger bars
- UL Listed for direct contact with insulation
- UL Listed for damp location and feed-through
- CUL Listed



Part #	Mfg #	Description	Price
NIC17002A	17002A	6" IC Airtight Housing	15.50

Prices & Specifications are Subject to Change.

Lighting

Lighting

Universal Airtight Housing

- Suitable for residential and commercial new construction
- Integral thermal protector
- Adjustable socket bracket
- 5-1/2" Height allows use in 2" x 6" joist construction
- Supplied with (3) IDEAL® push-in wire connectors
- Heavy gauge captive hanger bars
- Non-IC Insulation must be kept a minimum of 3" from housing
- UL Listed for damp location and feed-through
- CUL Listed



Part #	Mfg #	Description	Price
NIC19000A	19000A	4" 120V Airtight Housing	14.25

Recess Light Trim for 17000 & 17001R

- 75W, BR30/PAR30, 8" OD Maximum lamp



Part #	Mfg #	Description	Price
NIC17511	17511	6" White R30 Baffle Trim	3.42

Recess Light Trim for 19000A & 19001AR

- 50W, R20/PAR20, 5" OD Maximum lamp



Part #	Mfg #	Description	Price
NIC195002W H	19502WH	4" White R20 Baffle Trim	6.70



Outdoor Lighting

TWA Contour® General Purpose Wall Mounted Outdoor Lighting

- For entrances, stairwells, corridors and other pedestrian areas
- Not recommended for applications with frequent exposure to harsh chemicals or commercial cleaning liquids
- Rear housing is die-cast aluminum; front cover is one-piece, UV-resistant, injection-molded polycarbonate, internally painted
- Mount on any flat, non-combustible vertical surface
- LPI - Lamp included



Part #	Mfg #	Lamp Type	Voltage	Ballast	Finish	Price
LITTWA100MLPI	TWA100MLPI	Metal Halide	120-277V	Magnetic Ballast	Dark Bronze	252.17

All Items May Not Be Stocked In All Branches

Lighting

TWP General Purpose Wall Mounted Outdoor Lighting

- For entrances, loading docks, walkways and vehicle ramps
- Not recommended for applications with frequent exposure to harsh chemicals or commercial cleaning fluids
- Die-cast aluminum rear housing
- Corrosion-resistant, captive external hardware includes slotted hex-head and tamperproof fasteners
- LPI - Lamp included; L/LP - less lamp



Part #	Mfg #	Lamp Type	Voltage	Ballast	Finish	Price
LITTWP100M	TWP100M120277	100W Metal Halide	120/277V	Magnetic Ballast	Dark Bronze	230.84
LITTWP150M	TWP150MLPI	150W Metal Halide	120V	Magnetic Ballast	Dark Bronze	398.40

Industrial Bay Lighting

HID Low Bay Lighting

- For retail spaces, light manufacturing areas, storage areas and loading docks
- Enclosed HID lowbay fixture
- White painted aluminum reflector and prismatic acrylic lens
- Balanced vertical and horizontal illumination
- Super CWA pulse start ballasts



Part #	Mfg #	Description	Lamp Source	Wattage	Voltage	Reflector Sz	Price
LITCXD400PPSL	CXD400PPSL	Pulse Start Ballast	Metal Halide	400W	120-277V	20"	257.62

NICOR

Nicor High-Bay

20345 High-Bay Fluorescent Light

- Die formed heavy 20 gauge steel housing construction
- Riveted end plates
- Multiple vents
- (2) Access doors with captive knurled screws
- Class P, 60Hz high-power factor ballasts
- Includes IDEAL® PowerPlug™ and heavy gauge chain mounting kit



Part #	Mfg #	Description	Price
NIC20345	20345	6-Lamp T8 120-277V	213.39

Lighting

Lighting

20546 High-Bay Fluorescent Light

- Riveted end plates
- (2) Access doors with captive knurled screws
- Die formed aluminum construction dissipates heat away from ballasts to extend life
- Slotted reflector moves heat away from lamps and provides uplight component
- Class P, 60Hz high-power factor ballasts
- Includes IDEAL® PowerPlug™ and heavy gauge chain mounting kit



Part #	Mfg #	Description	Price
NIC20546	20546	4-Lamp T5H0 Fluorescent	261.96

20547 High-Bay Fluorescent Light

- Riveted end plates
- (2) Access doors with captive knurled screws
- Die formed aluminum construction dissipates heat away from ballasts to extend life
- Slotted reflector moves heat away from lamps and provides uplight component
- Class P, 60Hz high-power factor ballasts
- Includes IDEAL® PowerPlug™ and heavy gauge chain mounting kit



Part #	Mfg #	Description	Price
NIC20547	20547	Aluminator 6-Lamp T5 54W	263.39

Under Cabinet Lighting

Fluorescent Under Cabinet Light

- Rapid Start electronic ballast
- Slim 1" height
- Steel housing with acrylic lens
- 120V AC, 60Hz Operation
- Conduit connector for Romex cable included
- On/off switch and cool-white lamp included



10365EB

Part #	Mfg #	Description	Price
NIC10364EB	10364EB	12" (1) 8W T5 Lamp	30.42
NIC10365EB	10365EB	21" (1) 13W T5 Lamp	50.54
NIC10366EB	10366EB	24" (2) 8W T5 Lamp	49.26
NIC10367EB	10367EB	33" (1) 8W & (1) 13W T5 Lamp	66.65
NIC10368EB	10368EB	42" (2) 13W T5 Lamp	77.12

Ballasts

HID Ballasts

Metal Halide Ballast Kit



Part #	Mfg #	Watts	Input Voltage	Lamp Type	Taps	ANSI Code	Price
BALMH175	MH-175A-Q-KIT	175W	120-277V	Std Metal Halide	Quad	M57 or H39	91.07
BALMH250	MH-250A-Q-KIT	250W	120-277V	Std Metal Halide	Quad	M58 or H37	117.56
BALMH400	MH-400A-Q-KIT	400W	120-277V	Std Metal Halide	Quad	M59 or H33	152.60

High Pressure Sodium Ballast Kit



HPS-50R-1-KIT



HPS-70X-Q-KIT



HPS-100X-Q-KIT



HPS-150X-Q-KIT



HPS-250A-Q-KIT



HPS-400A-4-KIT

Part #	Mfg #	Watts	Input Voltage	Lamp Type	Taps	ANSI Code	Price
BALHPS50	HPS-50R-1-KIT	50W	120V	High Pressure Sodium	Single	S68	56.86
BALHPS70	HPS-70X-Q-KIT	70W	120-277V	High Pressure Sodium	Quad	S62	80.00
BALHPS100	HPS-100X-Q-KIT	100W	120-277V	High Pressure Sodium	Quad	S54	131.48
BALHPS150	HPS-150X-Q-KIT	150W	120-277V	High Pressure Sodium	Quad	S55	100.00
BALHPS250	HPS-250A-Q-KIT	250W	120-277V	High Pressure Sodium	Quad	S50	102.50
BALHPS400	HPS-400A-4-KIT	400W	480V	High Pressure Sodium	Single	S51	118.54

Fluorescent Ballasts

T8 Electronic Fluorescent Ballast

- UV - Universal voltage input
- IS - Instant start
- N - Normal light output
- TP - Thermally protected
- PIC - Active power factor correction
- P - NEMA Premium series



Part #	Mfg #	Lamps	Input Voltage	Start	Power Factor	Price
BAL2F32T8	KTEB-232-UV-IS-N-LP	(2) Parallel F32T8	120-277VAC±10%	Instant	High	25.39
BAL3F32T8	KTEB-332-UV-IS-N-P	(3) Parallel F32T8	120-277VAC±10%	Instant	High	27.60
BAL4F32T8	KTEB-432-UV-TP-IS-P	(4) Parallel F32T8	120-277VAC±10%	Instant	High	27.60

Prices & Specifications are Subject to Change.

Ballasts

Lighting

T12 Electronic Fluorescent Ballast

- UV - Universal voltage input
- TP - Thermally protected
- PIC - Active power factor correction



KTEB-240-UV-TP-PIC



KTEB-275-UV-TP-PIC

Part #	Mfg #	Lamps	Input Voltage	Start	Power Factor	Price
BAL2F34T12	KTEB-240-UV-TP-PIC	(2) Parallel F40T12	120-277VAC±10%	Rapid	High	20.53
BAL2F96T12	KTEB-275-UV-PIC	(2) Parallel F96T12	120-277VAC±10%	Instant	High	31.79

T12HO Electronic Fluorescent Ballast

- UV - Universal voltage input
- TP - Thermally protected
- PIC - Active power factor correction



Part #	Mfg #	Lamps	Input Voltage	Start	Power Factor	Price
BAL2F96T12HO	KTEB-2110-UV-TP-PIC	(2) Series F96T12HO	120-277VAC±10%	Rapid	High	68.46

CFL Electronic Fluorescent Ballast

- UV - Universal voltage input
- TP - Thermally protected
- PIC - Active power factor correction
- DW - Dual wire connectors



Part #	Mfg #	Lamps	Input Voltage	Start	Power Factor	Price
BAL2L26FL	KTEB-226-UV-TP-PIC-DW	(2) Series CFQ26W/G24q	120-277VAC±10%	Rapid	High	57.80

Circline Electronic Fluorescent Ballast Kit

- TP - Thermally protected
- WS - With circline socket



Part #	Mfg #	Lamps	Input Voltage	Start	Power Factor	Price
BALRS-22-32TP	KTEB-2C72-1-TP-WS	(2) Parallel FC_T9	120V	Rapid	Normal	39.17

Lampholders

Lampholders

Rubber Incandescent Lampholder - Keyless

- 600W, 600V, Medium base
- For temporary lighting
- (2) 6" Long wire leads
- UL Listed



Part #	Mfg #	Color	Price
PASPIGTAIL	201	Black	9.84

4-Terminal Medium Base Lampholder - Keyless

- One-piece keyless
- (4) Terminals with tri-drive screws
- Fits 3-1/4" and 4" boxes
- Cage neck



Part #	Mfg #	Description	Price
PAS274	274	White Porcelain	6.00

Incandescent Lampholder - Keyless

- 660W, 250V, Medium base
- (4) Terminals with tri-drive screws
- Fits 3-1/4" and 4" boxes
- UL/CSA Listed



Part #	Mfg #	Description	Price
PAS276WH	276WH	White Phenolic	4.80
PAS276WH6	276WH6	White Phenolic w/6" Leads	4.76

Incandescent Lampholder with Pullchain

- 250W, 250V, Medium base
- (4) Terminals with tri-drive screws
- Fits 3-1/4" and 4" boxes
- UL/CSA Listed



Part #	Mfg #	Description	Price
PAS280WH	280WH	White Phenolic	5.44

2-Terminal Pullchain Medium Base Lampholder - Keyless

- (2) Terminals with tri-drive screws
- Fits 3-1/4" and 4" boxes
- Cage neck



Part #	Mfg #	Description	Price
PAS284	284	White Porcelain	15.24

Incandescent Lampholder with Pullchain & Grounding Receptacle

- 250W, 125V, Medium base
- (2) Terminals with tri-drive screws
- Fits 3-1/4" and 4" boxes
- UL/CSA Listed



Part #	Mfg #	Description	Price
PAS288	288	White Porcelain	15.34

Lighting

We are continually adding new products. Please call us with your inquiries.

Conduit

EMT Conduit



Part #	Size	Price
CONEMT12-10	1/2" x 10'	CALL
CONEMT34-10	3/4" x 10'	CALL
CONEMT1-10	1" x 10'	CALL
CONEMT114-10	1-1/4" x 10'	CALL
CONEMT112-10	1-1/2" x 10'	CALL
CONEMT2-10	2" x 10'	CALL
CONEMT212-10	2-1/2" x 10'	CALL
CONEMT3-10	3" x 10'	CALL
CONEMT4-10	4" x 10'	CALL

EMT Conduit & Fittings



Conduit Bodies

AnyBODY™ Conduit Body

- Copper-free aluminum die-cast
- 5 Conduit bodies in 1 - ships as an LB, but converts to a T, LL, LR, or C
- Switch covers and threaded flanges as needed to create the style needed

Part #	Mfg #	Trade Size	Price
CONALB12	930	1/2"	9.93
CONALB34	931	3/4"	12.54
CONALB1	932	1"	18.07
CONALB114	933	1-1/4"	29.25
CONALB112	934	1-1/2"	34.70
CONALB2	935	2"	59.01
CONALB3	937	3"	157.87

EMT Fittings

EMT Set Screw Connector

- Zinc die-cast
- Concrete tight
- UL & CSA Listed



Part #	Mfg #	Trade/KO Size	Price
CONEMTCONN12	800	1/2"	0.46

EMT Fittings (Continued)

EMT Set Screw Connector

Part #	Mfg #	Trade/KO Size	Price
CONEMTCONN34	801	3/4"	0.76
CONEMTCONN1	802	1"	1.44
CONEMTCONN114	803	1-1/4"	2.54
CONEMTCONN112	804	1-1/2"	3.46
CONEMTCONN2	805	2"	4.61
CONEMTCONN212	806	2-1/2"	10.50
CONEMTCONN3	807	3"	12.69
CONEMTCONN4	808	4"	19.03

EMT Set Screw Coupling

- Zinc die-cast
- Concrete tight
- UL & CSA Listed



Part #	Mfg #	Trade Size	Price
CONEMTCPLG12	810	1/2"	0.51
CONEMTCPLG34	811	3/4"	0.80
CONEMTCPLG1	812	1"	1.44
CONEMTCPLG114	813	1-1/4"	2.54
CONEMTCPLG112	814	1-1/2"	3.58
CONEMTCPLG2	815	2"	4.79
CONEMTCPLG212	816	2-1/2"	9.28
CONEMTCPLG3	817	3"	10.50
CONEMTCPLG4	818	4"	13.96

EMT Compression Connector

- Zinc die-cast
- UL & CSA Listed concrete tight



Part #	Mfg #	Trade Size	Price
CONEMTCCONN12	820	1/2"	0.76
CONEMTCCONN34	821	3/4"	1.34

Combination Pulling Elbow to Box

- Combination threaded rigid and set-screw EMT to box
- Zinc die-cast
- EMT to Flex



Part #	Mfg #	Trade Size	Price
ELFHE12	9100	1/2"	10.05
ELFMFHE1	9120	1"	13.98

All Items May Not Be Stocked In All Branches

EMT Conduit Fittings

EMT Combination Coupling

- Zinc die-cast
- EMT to Flex



Part #	Mfg #	EMT Size	Flex Size	Price
ELFEBXCC	860	1/2"	3/8"	2.12

EMT 1-Hole Strap

- Plated steel
- Click-on



Part #	Mfg #	Trade Size	Price
CONEMT1HS12	304	1/2"	0.11
CONEMT1HS34	305	3/4"	0.18
CONEMT1HS1	372	1"	0.34
CONEMT1HS114	373	1-1/4" Heavy Duty	0.50
CONEMT1HS112	374	1-1/2"	0.80
CONEMT1HS2	375	2"	0.96

EMT 2-Hole Strap

- Plated steel
- Click-on

Part #	Mfg #	EMT Size	Price
CONEMT2HS1	362	1"	0.24
CONEMT2HS114	363	1-1/4"	0.39
CONEMT2HS112	364	1-1/2"	0.42
CONEMT2HS2	365	2"	0.59
CONRID2HS212	356	2-1/2" Rigid	1.00
CONRID2HS3	357	3" Rigid	1.34
CONRID2HS4	359	4" Rigid	1.71

EMT Conduit & Fittings

**Not all products are available at all branches.
Contact your local branch for availability.**

Rigid Conduit

Galvanized Rigid Conduit (GRC)



Part #	Size	Price
CONRID12-10	1/2" x 10'	CALL
CONRID34-10	3/4" x 10'	22.00
CONRID1-10	1" x 10'	CALL
CONRID114-10	1-1/4" x 10'	CALL
CONRID112-10	1-1/2" x 10'	CALL
CONRID2-10	2" x 10'	CALL
CONRID212-10	2-1/2" x 10'	CALL
CONRID3-10	3" x 10'	CALL
CONRID4-10	4" x 10'	CALL

Electrical



Metal Conduit Fittings

Galvanized Rigid Conduit Couplings



Part #	Size	Price
CONRIDCPLG12	1/2"	1.08
CONRIDCPLG34	3/4"	1.33
CONRIDCPLG1	1"	2.27
CONRIDCPLG114	1-1/4"	2.46
CONRIDCPLG112	1-1/2"	3.11
CONRIDCPLG2	2"	4.11
CONRIDCPLG212	2-1/2"	9.60
CONRIDCPLG3	3"	12.43
CONRIDCPLG4	4"	16.74

Steel Snap-In Blank (Knockout Plugs)

- Plated steel
- For knockouts
- Knock out seal

Part #	Size	Unit Pkg	Price
ELFKOS12	1/2"	100	0.50
ELFKOS34	3/4"	50	0.44
ELFKOS1	1"	50	0.79
ELFKOS114	1-1/4"	25	0.96
ELFKOS112	1-1/2"	25	1.57
ELFKOS2	2"	20	1.91



Rigid-IMC Fittings

Rigid-IMC Conduit Nipple

- Zinc die-cast



Part #	Mfg #	Trade Size	Price
ELFCNIP12	501	1/2"	0.55
ELFCNIP34	502	3/4"	1.19
ELFCNIP1	503	1"	2.14
ELFCNIP114	504	1-1/4"	3.73
ELFCLNIP112	505	1-1/2"	4.88
ELFCNIP2	506	2"	7.47

Rigid-IMC Offset Nipple

- Zinc die-cast
- 3/4" Offset nipples



Part #	Mfg #	Trade Size	Price
ELFOFN12	6A2	1/2"	2.79
ELFOFN34	6A3	3/4"	3.39
ELFOFN1	6A4	1"	9.02
ELFOFN114	6A5	1-1/4"	6.00
ELFOFN112	6A6	1-1/2"	7.69
ELFOFN2	6A7	2"	11.30

Rigid-IMC Conduit Locknut

- Plated steel



Part #	Mfg #	Trade Size	Price
ELFLN12	401	1/2"	0.15
ELFLN34	402	3/4"	0.19
ELFLN1	403	1"	0.33
ELFLN114	404	1-1/4"	0.50
ELFLN112	405	1-1/2"	0.70
ELFLN2	406	2"	0.96
ELFLN212	407	2-1/2"	2.47
ELFLN3	408	3"	2.64
ELFLN4	410	4"	5.05

All Items May Not Be Stocked In All Branches

Rigid-IMC Conduit Ftgs

Rigid-IMC Plastic Insulating Bushing



Part #	Mfg #	Trade Size	Price
ELFFB12	440	1/2"	0.10
ELFFB34	441	3/4"	0.14
ELFFB1	442	1"	0.23
ELFFB114	443	1-1/4"	0.30
ELFFB112	444	1-1/2"	0.39
ELFFB2	445	2"	0.69
ELFFB212	446	2-1/2"	1.37
ELFFB3	447	3"	1.16
ELFFB4	449	4"	2.09

Steel Sealing Locknut

- With PVC molded seal



Part #	Mfg #	Size	Qty	Price
ELFSLN12	SL50	1/2"	50	1.68
ELFSLN1	SL100	1"	25	2.95
ELFSLN114	SL125	1-1/4"	25	4.59
ELFSLN112	SL150	1-1/2"	25	6.01
ELFSLN2	SL200	2"	25	7.77

Reducing Washer

- Plated steel
- Bonding jumper is recommended when using reducing washers to provide a reliable grounding/bonding path



Part #	Mfg #	Size	Price
ELFRW34-12	RW1	3/4" x 1/2"	0.22
ELFRW1-12	RW2	1" x 1/2"	0.30
ELFRW1-34	RW3	1" x 3/4"	0.30
ELFRW114-12	RW4	1-1/4" x 1/2"	0.55
ELFRW114-34	RW5	1-1/4" x 3/4"	0.55
ELFRW114-1	RW6	1-1/4" x 1"	0.55
ELFRW112-12	RW7	1-1/2" x 1/2"	0.68
ELFRW112-34	RW8	1-1/2" x 3/4"	0.68
ELFRW112-1	RW9	1-1/2" x 1"	0.66
ELFRW112-114	RW10	1-1/2" x 1-1/4"	0.61
ELFRW2-34	RW12	2" x 3/4"	0.93
ELFRW2-1	RW13	2" x 1"	0.84
ELFRW2-114	RW14	2" x 1-1/4"	1.40
ELFRW2-112	RW15	2" x 1-1/2"	0.84
ELFRW212-1	RW18	2-1/2" x 1"	1.68
ELFRW212-2	RW21	2-1/2" x 2"	1.40
ELFRW3-2	RW27	3" x 2"	1.78
ELFRW3-212	RW28	3" x 2-1/2"	1.78

90° Pulling Elbow - Threaded Rigid and Set Screw EMT Combination

- With cover and gasket
- Zinc die-cast
- UL & CSA Listed



Part #	Mfg #	Trade Size	Price
ELFCOMBOE12		1/2"	5.36
ELFCOMBOE34	HL7500	3/4"	6.17

Rigid-IMC Pipe Hanger

- Plated steel with bolt and nut



Part #	Mfg #	Trade Sz	Rigid Sz	EMT Sz	Price
ELFMIN12	2000	#0	3/8" x 1/2"	1/2"	0.48
ELFMIN34	2010	#1	3/4"	3/4"	0.54
ELFMIN1	2020	#2	1"	1"	0.71
ELFMIN114TW	2025	#2.5-3"	1-1/4"	1-1/4" 1-1/2"	0.84
ELFMIN112	2040	#4	1-1/2"		1.09
ELFMIN2	2050	#5	2"	2"	1.20
ELFMIN212	2060	#6	2-1/2"	2-1/2"	1.29
ELFMIN3	2070	#7	3"	3"	1.62
ELFMIN4	2090	#9	4"	4"	4.02

Rigid-IMC Reducing Bushing

- Zinc die-cast



Part #	Mfg #	Trade Size	Price
ELFRB34-12	522	3/4" x 1/2"	1.58

Rigid 1-Hole Strap

- Plated steel
- Snap-on



Part #	Mfg #	Trade Size	Price
CONRID1HS12	340	1/2"	0.20
CONRID1HS34	341	3/4"	0.29
CONRID1HS1	342	1"	0.47
CONRID1HS114	343	1-1/4"	0.58
CONRID1HS2	345	2"	1.04

Rigid 2-Hole Strap

- Plated steel
- Click-on



Part #	Mfg #	EMT Size	Price
CONRID2HS1	352	1"	0.27

Rigid/IMC Conduit & Fittings

Prices & Specifications are Subject to Change.

Rigid-IMC Conduit Ftgs

Rigid-IMC Fittings (Continued)

Rigid 2-Hole Strap

Part #	Mfg #	EMT Size	Price
CONRID2HS114	353	1-1/4"	0.39
CONRID2HS112	354	1-1/2"	0.47
CONRID2HS2	355	2"	0.70
CONRID2HS212	356	2-1/2"	1.00
CONRID2HS3	357	3"	1.34
CONRID2HS4	359	4"	1.71

Mast Parts

Zinc Diecast Service Entrance Cable Cap

- Galvanized steel strap



Part #	Mfg #	Description	Price
ELFSEWH	660	(3) 3, 6, 4, 2 Al SEU	10.47
ELFSECAL	662	(3) 1/0 to (3) 4/0 Al SEU	18.15

PVC Service Entrance Cable Cap

- Galvanized steel strap



Part #	Mfg #	Description	Price
ELFSEWHP	PVC660	(2) 3, 6, 4, 2 PVC SEU	8.94
ELFSECP	PVC662	(2) 1/0 to (2) 4/0 PVC SEU	11.71

Clamp-On Service Entrance Cap

- For Rigid/IMC/EMT



Part #	Mfg #	Trade Size	Price
ELFSEC12	140	1/2"	4.90
ELFSEC34	141	3/4"	5.90
ELFSEC114	143	1-1/4"	7.91
ELFSEC112	144	1-1/2"	13.00

Mast Parts (Continued)

Clamp-On Service Entrance Cap

Part #	Mfg #	Trade Size	Price
ELFSEC2	145	2"	15.62
ELFSEC212	146	2-1/2"	57.18
ELFSEC3	147	3"	95.30

Porcelain Wire Holder

- With steel clip



Part #	Mfg #	Description	Price
ELFUPM	610	Fits 1-1/4" - 3" Pipe	16.13

Aluminum Universal Pipe Support

- 10" Bolt
- Sand cast aluminum with steel screw



Part #	Mfg #	Mast Size	Price
ELFTBCS212	2850	2-1/2"	18.13

Rigid/IMC Conduit & Fittings

All Items May Not Be Stocked In All Branches

PVC Conduit

PVC Schedule 40 Conduit

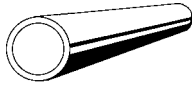

Part #	Size	Price
CONP4012-10	1/2" x 10'	CALL
CONP4034-10	3/4" x 10'	CALL
CONP401-10	1" x 10'	CALL
CONP40114-10	1-1/4" x 10'	CALL
CONP40112-10	1-1/2" x 10'	CALL
CONP402-10	2" x 10'	CALL
CONP40212-10	2-1/2" x 10'	CALL
CONP403-10	3" x 10'	CALL
CONP404-10	4" x 10'	CALL

PVC Schedule 80 Conduit

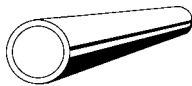

Part #	Size	Price
CONP8012-10	1/2" x 10'	CALL
CONP8034-10	3/4" x 10'	CALL
CONP801-10	1" x 10'	CALL
CONP80114-10	1-1/4" x 10'	CALL
CONP80112-10	1-1/2" x 10'	CALL
CONP802-10	2" x 10'	CALL
CONP80212-10	2-1/2" x 10'	CALL
CONP803-10	3" x 10'	CALL
CONP804-10	4" x 10'	CALL

Electrical



PVC Non-Metallic Conduit Fittings

PVC Sch 40 90° Conduit Elbow



Part #	Size	Price
CONPVC9012	1/2"	0.61
CONPVC9034	3/4"	0.69
CONPVC901	1"	1.07
CONPVC90114	1-1/4"	1.54
CONPVC90112	1-1/2"	2.05
CONPVC902	2"	2.80
CONPVC90212	2-1/2"	4.89
CONPVC903	3"	8.64
CONPVC904	4"	14.85

PVC Sch 40 90° Conduit Elbow with 48" Radius

Part #	Size	Price
CONPVCLS904	4"	79.22
CONPVCLS906	6"	44.26

PVC Sch 80 90° Conduit Elbows



Part #	Size	Price
CONP8090114	1-1/4"	6.77
CONP8090112	1-1/2"	9.65
CONP80902	2"	13.22
CONP8090212	2-1/2"	23.16
CONP80903	3"	44.68
CONP80904	4"	72.80

PVC Sch 40 45° Conduit Elbow

Part #	Size	Price
CONPVC4534	3/4"	0.63
CONPVC451	1"	1.00
CONPVC45114	1-1/4"	1.40
CONPVC45112	1-1/2"	1.91
CONPVC452	2"	2.65
CONPVC45212	2-1/2"	5.16
CONPVC453	3"	8.25
CONPVC454	4"	14.31

PVC Conduit Coupling



Part #	Size	Price
CONPVCCPLG12	1/2"	0.17
CONPVCCPLG34	3/4"	0.20
CONPVCCPLG1	1"	0.30
CONPVCCPLG114	1-1/4"	0.40
CONPVCCPLG112	1-1/2"	0.56
CONPVCCPLG2	2"	0.73
CONPVCCPLG212	2-1/2"	1.29
CONPVCCPLG3	3"	2.14
CONPVCCPLG4	4"	3.29

PVC Conduit & Fittings

Prices & Specifications are Subject to Change.

PVC Conduit Fittings

PVC Conduit Expansion Coupling



Part #	Size	Price
CONPVCEXPCLG12	1/2"	21.32
CONPVCEXPCLG34	3/4"	21.42
CONPVCEXPCLG1	1"	22.27
CONPVCEXPCLG114	1-1/4"	22.95
CONPVCEXPCLG112	1-1/2"	23.29
CONPVCEXPCLG2	2"	26.56
CONPVCEXPCLG212	2-1/2"	34.64
CONPVCEXPCLG3	3"	43.85
CONPVCEXPCLG4	4"	65.98

PVC Conduit Male Adapter



Part #	Size	Price
CONPVCMA12	1/2"	0.21
CONPVCMA34	3/4"	0.38
CONPVCMA1	1"	0.47
CONPVCMA114	1-1/4"	0.61
CONPVCMA112	1-1/2"	0.73
CONPVCMA2	2"	1.05
CONPVCMA212	2-1/2"	1.79
CONPVCMA3	3"	2.62
CONPVCMA4	4"	4.51

PVC Conduit Female Adapter



Part #	Size	Price
CONPVCFEA12	1/2"	0.25
CONPVCFEA34	3/4"	0.40
CONPVCFEA1	1"	0.54
CONPVCFEA114	1-1/4"	0.72
CONPVCFEA112	1-1/2"	0.78
CONPVCFEA2	2"	1.05
CONPVCFEA212	2-1/2"	2.32
CONPVCFEA3	3"	2.89
CONPVCFEA4	4"	3.88

PVC Type LB Conduit Fitting



Part #	Size	Price
CONPVCLB12	1/2"	3.14
CONPVCLB34	3/4"	4.03
CONPVCLB1	1"	4.43
CONPVCLB114	1-1/4"	6.74
CONPVCLB112	1-1/2"	7.86
CONPVCLB2	2"	14.35
CONPVCLB212	2-1/2"	52.11
CONPVCLB3	3"	53.84
CONPVCLB4	4"	59.06

PVC Type T Conduit Fitting



Part #	Size	Price
CONPVCT12	1/2"	4.05
CONPVCT34	3/4"	4.96
CONPVCT1	1"	5.17
CONPVCT114	1-1/4"	8.42
CONPVCT112	1-1/2"	11.09
CONPVCT2	2"	15.75

PVC Conduit Junction Box with Cover



Part #	Size	Price
CONPVC444JBX	4" x 4" x 4"	16.96
CONPVC664JBX	6" x 6" x 4"	20.75
CONPVC666JBX	6" x 6" x 6"	24.23
CONPVC884JBX	8" x 8" x 4"	39.17
CONPVC12126JBX	12" x 12" x 6"	61.72

PVC Conduit FSC Box

Part #	Size	Price
CONPVCFSCBX12	1/2" 1-Gang	8.96
CONPVCFSCBX34	3/4" 1-Gang	9.80
CONPVCFSCBX1	1" 1-Gang	8.56

PVC Conduit & Fittings

All Items May Not Be Stocked In All Branches

PVC Conduit Fittings

PVC Conduit FSE Box

Part #	Size	Price
CONPVCFSEBX12	1/2" 1-Gang	9.13
CONPVCFSEBX34	3/4" 1-Gang	9.80
CONPVCFSEBX1	1" 1-Gang	8.43
CONPVC2FSEBX12	1/2" 2-Gang	11.46
CONPVC2FSEBX34	3/4" 2-Gang	13.76

PVC Conduit FSS Box

Part #	Size	Price
CONPVCFSSBX12	1/2" 1-Gang	9.13
CONPVCFSSBX34	3/4" 1-Gang	9.80
CONPVC2FSSBX2B	1" 2-Gang	13.76

PVC Service Entrance Head



Part #	Size	Price
CONPVCWH1	1"	5.27
CONPVCWH114	1-1/4"	7.08
CONPVCWH112	1-1/2"	8.55
CONPVCWH2	2"	14.24
CONPVCWH212	2-1/2"	72.33
CONPVCWH3	3"	69.93
CONPVCWN4	4"	113.87

PVC Conduit Meter Offset



Part #	Size	Price
CONPVCOMTRA114	1-1/4" Meter Offset	6.74
CONPVCOMTRA2	2" Meter Offset	7.17

PVC Conduit Strap

Part #	Size	Price
CONPVCCS12	1/2"	0.34
CONPVCCS34	3/4"	0.40
CONPVCCS1	1"	0.49
CONPVCCS114	1-1/4"	0.53
CONPVCCS112	1-1/2"	0.62
CONPVCCS2	2"	0.81

PVC Strain Relief with Grommet

Part #	Size	Price
CONPVCSTRRLF12	1/2"	5.43
CONPVCSTRRLF34	3/4"	5.43

Slip Meter Riser Fitting

- Designed to create an expansion joint in the installation of an electrical service entrance



Part #	Size	Price
ELFNM2520	2" KO Size 10/Pk	8.83

Non-Metallic Fittings & Accessories

PVC Cord Grip

Part #	Mfg #	Description	Price
NMCCC12	PLTCC12	1/2" .385-.750 Non Metallic	3.22

Flexible Conduit

Flexible Conduit & Fittings

Flexible Conduit

Liquid-Tite Non-Metallic PVC Conduit



Part #	Mfg #	Size	Per	Price
NMCNMLC12	NMLC12	1/2"	Per/Ft	0.64
NMCNMLC34	NMLC34	3/4"	Per/Ft	0.84
NMCNMLC1	NMLC1	1"	Per/Ft	1.54
NMCNMLC112	NMLC112	1-1/2"	Per/Ft	2.30
NMCNMLC114	NMLC114	1-1/4"	Per/Ft	2.04
NMCNMLC2	NMLC2	2"	Per/Ft	3.33

Flex-Plus® Electrical Non-Metallic Tubing (ENT)

- Flexible raceway for use in walls, floors and non-plenum ceilings
- Lightweight, hand-bendable



Part #	Mfg #	Size	Color	Price
NMCBFP12	BFP12	1/2" x 120"	BlueStripe Plus Kwikon	0.62
NMCBFP34	BFP34	3/4" x 100"	Blue	1.00

Flexible Conduit

RWA Greenfield Aluminum Unjacketed Conduit

- Lightweight aluminum
- Smooth inside and outside
- Flexible with high crush resistance

Part #	Mfg #	Size	Price
EMCAGRF38	AGRF38	3/8"	CALL
EMCAGRF12	AGRF12	1/2"	CALL
EMCAGRF34	AGRF34	3/4"	CALL
EMCAGRF1	AGRF1	1"	CALL
EMCAGRF114	AGRF114	1-1/4"	CALL
EMCAGRF112	AGRF112	1-1/2"	CALL
EMCAGRF2	AGRF2	2"	CALL

EFLT Extra Flexible Liquid-Tite Metallic Conduit

- Galvanized steel core
- Abrasion resistant PVC jacket
- Complete protection against liquid and moisture vapor
- Resists sunlight, heat, oil and chemical degradation



Part #	Mfg #	Size	Price
EMCLMC12	LMC12	1/2"	CALL
EMCLMC34	LMC34	3/4"	CALL
EMCLMC1	LMC1	1"	CALL
EMCLMC114	LMC114	1-1/4"	CALL
EMCLMC112	LMC112	1-1/2"	CALL
EMCLMC2	LMC2	2"	CALL



Non-Metallic Liquid-Tight Cord Connectors

- For use with non-metallic liquid-tight conduit, type B only
- Produced from UV rated plastic for long outdoor life

Snap²IT™ Non-Metallic Connector

- Push-on installation straight



Part #	Mfg #	Trade/KO Size	Price
NMCSC12	NMLT5	1/2"	2.19
NMCSC34	PLTSC34	3/4"	3.16
NMCSC1	PLTSC1	1"	4.51
NMCSC114	PLTSC114	1-1/4"	8.99
NMCSC112	PLTSC112	1-1/2"	11.45

Electrical Connectors

90° Snap²IT® Non-Metallic Connector

- Push-on installation



Part #	Mfg #	Trade/KO Size	Price
NMC9012	NMLT905	1/2"	3.47
NMC9034	NMLT907	3/4"	5.29
NMC901	NMLT9010	1"	10.40

Zinc Liquid-Tight Cord Connectors

- For metallic and non-metallic liquid-tight conduit - type B
- Straight Zinc Die-Cast Connector**



Part #	Mfg #	Trade/KO Size	Price
ELFLTSC38	LT38	3/8" / 1/2"	2.76
ELFLTSC12	LT50	1/2"	2.59
ELFLTSC34	LT75	3/4"	4.17
ELFLTSC1	LT100	1"	7.24
ELFLTSC114	LT125	1-1/4"	11.44
ELFLTSC112	LT150	1-1/2"	16.69
ELFLTSC2	LT200	2"	25.34

90° Zinc Die-Cast Connector



Part #	Mfg #	Trade/KO Size	Price
ELFLT9038	LT9038	3/8" / 1/2"	4.42
ELFLT9012	LT9050	1/2"	4.12
ELFLT9034	LT9075	3/4"	6.47
ELFLT901	LT90100	1"	12.87
ELFLT90114	LT90125	1-1/4"	20.52
ELFLT90112	LT90150	1-1/2"	28.56
ELFLT902	LT90200	2"	41.84

NM Cable Fittings and Supports

Plated Steel NM Cable Connector

- UL & CSA Listed



Part #	Mfg #	Size	Wire Size	Price
ELFTOM12	BT50	1/2"	14/2-8-3	0.92
ELFTOM34	BT75	3/4"	8/2-6/2	1.86
ELFTOM114	BT125	1-1/4"	2/0-3/0	3.51
ELFTOM112	BT150	1-1/2"	4/0	3.84

Gland-Type Service Entrance Cable Connector

- Provides watertight seal around service entrance cable
- Zinc die-cast



Part #	Mfg #	KO Size	Price
ELFWTSEUC1	WTC100	1"	6.97
ELFWTSEUC114	WTC125	1-1/4"	11.20
ELFWTSEUC112	WTC150	1-1/2"	15.93
ELFWTSEUC2	WTC200	2"	18.67

NM Cable Connector

- For NM cable
- Zinc die-cast
- UL & CSA Listed



Part #	Mfg #	Trade Size	Knockout	Price
ELFRC3812	841	3/8"	1/2"	0.48

NM-SEU Cable Connector

- For NM-SEU cable
- Zinc die-cast
- UL & CSA Listed



Part #	Mfg #	Trade Size	Knockout	Price
ELFNWSEUC34	842	3/4"	3/4"	1.16
ELFNWSEUC1	843	1"	1"	1.87
ELFNWSEUC114	844	1-1/4"	1-1/4"	2.78
ELFNWSEUC112	848	1-1/2"	1-1/2"	4.58
ELFNWSEUC2	849	2"	2"	5.37

Prices & Specifications are Subject to Change.

Electrical Connectors

Flexible Conduit & Fittings

NM-SE Cable Connector

- For NM-SE cable
- Zinc die-cast
- UL & CSA Listed



Part #	Mfg #	Trade Size	Knockout	Price
ELFNWOSERC1	843S	1"	1"	1.87
ELFNWOSERC114	844S	1-1/4"	1-1/4"	2.78
ELFNWOSER112	848S	1-1/2"	1-1/2"	4.58
ELFNWOSER2	849S	2"	2"	5.37

CS2 Cable Support

- Supports up to (4) 14/2-10/2 flat (any combo) or (2) 14/3-10/3 (any combo) NM cables



Also see Stacker in the Electrical Tape & Sealants Section

Part #	Mfg #	Description	Price
ELFTBCS2	CS2	Cable Support w/Nail, 500/Pk	15.43

Black Button™ Plastic Push-In Connector

- For NM (non-metallic) cable



NM940

Part #	Mfg #	Trade Size	KO Size	Qty	Price
ELFNMRC12	NM94	3/8"	1/2"	250	0.16
ELFNMRC34	NM95	3/4"	3/4"	50	0.32

UF Connector

- Compression type for underground feeder cable
- Zinc die-cast



Part #	Mfg #	Trade/KO Size	Price
ELFUFC12	UF50	1/2"	8.22
ELFUFC34	UF75	3/4"	4.81

Cable Connector

- For NM/SE/MC/AC cable
- For steel and aluminum jacketed cables
- Zinc die-cast



Part #	Mfg #	Trade Size	KO Size	Price
ELFMCSC38	8400	3/8"	1/2"	0.83

Cord Grips

Low-Profile Strain Relief Cord Connector

- Non-metallic, liquid tight, and oil tight
- Includes sealing ring and locknut
- UL & CSA Listed (UL not applicable for 0.100 - 0.240 wire diameter)



Part #	Mfg #	Trade Size	Cord Range	Price
ELFCG12L	LPCG507	1/2"	.375 - .750	4.48

Metallic Low-Profile Strain Relief Cord Connector

- Zinc die cast, liquid tight, and oil tight
- Includes sealing ring and locknut
- UL & CSA Listed (UL not applicable for 0.100 - 0.240 and .200 - .240 wire diameter)



Part #	Mfg #	Trade Size	Cord Range	Price
ELFCG12S	LPCG50Z	1/2"	.200 - .472	4.48
ELFLPCG75Z	LPCG75Z	3/4"	.385 - .750	4.93

All Items May Not Be Stocked In All Branches

Hangers & Clamps

Clamps

Copperclad Riser Clamps

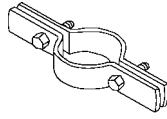

Part #	Mfg #	Size	Price
GRECRC12	410 1/2	1/2"	3.20
GRECRC34	410 3/4	3/4"	3.20
GRECRC1	410 1	1"	3.30
GRECRC112	410 1-1/2	1-1/2"	4.10
GRECRC2	410 2	2"	4.90
GRECRC3	410 3	3"	8.00
GRECRC4	410 4	4"	10.00

Plain Riser Clamps

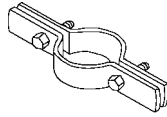

Part #	Mfg #	Size	Price
GREBRC112	108 1-1/2	1-1/2"	3.30
GREBRC2	108 2	2"	3.40
GREBRC3	108 3	3"	4.00
GREBRC4	108 4	4"	5.20
GREBRC6	108 6	6"	8.75
GREBRC8	108 8	8"	20.00

C - Clamps

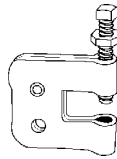

Part #	Mfg #	Size	Price
GREBCC38	122 3/8	3/8" less Locknut	1.33
GREBCC12	122 1/2	1/2" less Locknut	1.95

Top Beam Clamps



Part #	Mfg #	Rod Size	Opening	Price
GREBC38	125 3/8	3/8"	3/4"	1.45
GREBC12	125 1/2	1/2"	3/4"	2.00

Tube & Pipe Hooks

Bright Steel Pipe Hooks



Part #	Mfg #	Size	Length	Price
GRESPH34-4	197 3/4x4	3/4"	4"	0.44
GRESPH12-6	197 1/2x6	1/2"	6"	0.48
GRESPH34-6	197 3/4x6	3/4"	6"	0.49
GRESPH1-6	197 1x6	1"	6"	0.48

Copperclad Tube Hooks



Part #	Mfg #	Size	Length	Price
GRECTH12-4	198 1/2x4	1/2"	4"	0.50
GRECTH34-4	198 3/4x4	3/4"	4"	0.50
GRECTH12-6	198 1/2x6	1/2"	6"	0.57
GRECTH34-6	198 3/4x6	3/4"	6"	0.57
GRECTH1-6	198 1x6	1"	6"	0.57
GRECTH34-8	198 3/4x8	3/4"	8"	0.71

Plastic Coated Tube Hooks



Part #	Mfg #	Size	Length	Price
GREPTH34-4	199 3/4x4	3/4"	4"	1.52
GREPTH12-6	199 1/2x6	1/2"	6"	1.61
GREPTH34-6	199 3/4x6	3/4"	6"	1.61
GREPTH1-6	199 1x6	1"	6"	1.61
GREPTH114-6	199 1-1/4x6	1-1/4"	6"	2.95

Tube, Pipe & EMT Straps

Copperclad Two Hole Copper Tube Strap



Part #	Mfg #	Size	Price
GRECTS12	500WN 1/2	1/2" w/Nails	0.09
GRECTS34	500WN 3/4	3/4" w/Nails	0.10
GRECTS1	500WN 1	1" w/Nails	0.13
GRECTS114	500WN 1-1/4	1-1/4" w/Nails	0.22
GRECTS112	500WN 1-1/2	1-1/2" w/Nails	0.27
GRECTS2	500WN 2	2" w/Nails	0.30

Galvanized Two Hole Pipe Strap



Part #	Mfg #	Size	Price
GREGPS12	600 1/2	1/2"	0.08
GREGPS34	600 3/4	3/4"	0.10
GREGPS1	600 1	1"	0.19
GREGPS114	600 1-1/4	1-1/4"	0.25
GREGPS112	600 1-1/2	1-1/2"	0.34
GREGPS2	600 2	2"	0.50
GREGPS3	600 3	3"	0.90
GREGPS4	600 4	4"	1.35

Hangers & Supports

Prices & Specifications are Subject to Change.

Hangers & Clamps

Ring Hangers

Galvanized IPS Adjustable Swivel Hanger



Part #	Mfg #	Size	Price
GREZSWR12	300 1/2	1/2"	0.98
GREZSWR34	300 3/4	3/4"	0.98
GREZSWR1	300 1	1"	1.03
GREZSWR114	300 1-1/4	1-1/4"	1.06
GREZSWR112	300 1-1/2	1-1/2"	1.02
GREZSWR2	300 2	2"	1.08
GREZSWR212	300 2-1/2	2-1/2"	2.00
GREZSWR3	300 3	3"	2.30
GREZSWR4	300 4	4"	3.20

Copper Tube Adjustable Swivel Hanger



Part #	Mfg #	Size	Price
GRECSWR12	301 1/2	1/2"	1.14
GRECSWR34	301 3/4	3/4"	1.16
GRECSWR1	301 1	1"	1.20
GRECSWR114	301 1-1/4	1-1/4"	1.22
GRECSWR112	301 1-1/2	1-1/2"	1.25
GRECSWR2	301 2	2"	1.35
GRECSWR3	301 3	3"	4.00

Clevis Hangers

Light Clevis Hanger

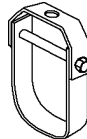

Part #	Mfg #	Size	Price
GREBCH12	104 1/2	1/2"	0.75
GREBCH34	104 3/4	3/4"	0.78
GREBCH1	104 1	1"	0.82
GREBCH114	104 1-1/4	1-1/4"	0.85
GREBCH112	104 1-1/2	1-1/2"	0.93
GREBCH2	104 2	2"	1.03
GREBCH212	104 2-1/2	2-1/2"	1.90
GREBCH3	104 3	3"	2.00
GREBCH4	104 4	4"	2.50
GREBCH6	204 6	6"	5.60

Coppertube Clevis Hanger

- Copper plated

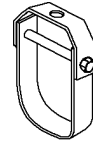

Part #	Mfg #	Size	Price
GRECCH12	406 1/2	1/2"	0.98
GRECCH34	406 3/4	3/4"	1.00
GRECCH1	406 1	1"	1.13
GRECCH114	406 1-1/4	1-1/4"	1.20
GRECCH112	406 1-1/2	1-1/2"	1.27
GRECCH2	406 2	2"	1.45
GRECCH3	406 3	3"	3.77

Split Ring Hangers

Iron Pipe Split Ring Hanger

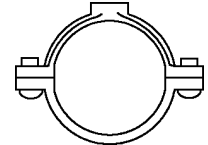

Part #	Mfg #	Size	Rod	Price
GREBSR12	202 1/2	1/2"	3/8"	1.40
GREBSR34	202 3/4	3/4"	3/8"	1.50
GREBSR1	202 1	1"	3/8"	1.70
GREBSR114	202 1-1/4	1-1/4"	3/8"	2.05
GREBSR112	202 1-1/2	1-1/2"	3/8"	2.40
GREBSR2	202 2	2"	3/8"	2.75

Galvanized Pipe Split Ring Hanger

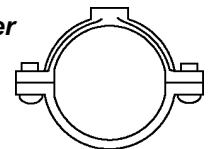

Part #	Mfg #	Size	Rod	Price
GREGSR12	385 1/2	1/2"	3/8"	1.60
GREGSR34	385 3/4	3/4"	3/8"	1.65
GREGSR1	385 1	1"	3/8"	2.05
GREGSR114	385 1-1/4	1-1/4"	3/8"	2.30
GREGSR112	385 1-1/2	1-1/2"	3/8"	2.75
GREGSR2	385 2	2"	3/8"	3.30
GREGSR3	385 3	3"	1/2"	11.00

Copper Tube Split Ring Hanger

- Ductile iron

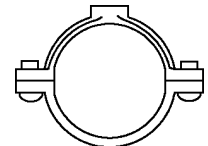

Part #	Mfg #	Size	Rod	Price
GRECSR12	485 1/2	1/2"	3/8"	1.45
GRECSR34	485 3/4	3/4"	3/8"	1.55
GRECSR1	485 1	1"	3/8"	1.75

Hangers & Supports

Hangers & Clamps

Split Ring Hangers (Continued)

Copper Tube Split Ring Hanger

Part #	Mfg #	Size	Rod	Price
GRECSR114	485 1-1/4	1-1/4"	3/8"	2.00
GRECSR112	485 1-1/2	1-1/2"	3/8"	2.40
GRECSR2	485 2	2"	3/8"	2.60
GRECSR212	485 2-1/2	2-1/2"	1/2"	8.00
GRECSR3	485 3	3"	1/2"	12.00

Perforated Hanger Strapping

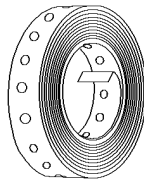

Galvanized/Zinc Plated Steel Perforated Hanger Strapping

- 1/4" Bolt holes

Part #	Mfg #	W	L	Ga	Price
GREGBI34-50LG	971 28	3/4"	50'	28	6.35
GREGBI34-10	971 20	3/4"	10'	20	1.66
GREGBI34-50	971 20	3/4"	50'	20	9.30
GREGBI34-100	971 20	3/4"	100'	20	17.80

Copperclad Perforated Hanger Strapping

Part #	Mfg #	W	L	Ga	Price
GRECBI34-10	972 22	3/4"	10'	22	2.90
GRECBI34-50	972 22	3/4"	50'	22	15.00
GRECBI34-100	972 22	3/4"	100'	22	30.00

Stud Protectors

Stud Protector Plate

Part #	Mfg #	Size	Desc	Price
GRES312-6	935 6	3-1/2" x 6"	16ga 2 Hole	0.56

Stud Guard with Triangular Points



Part #	Mfg #	L	W	Ga	Price
GRESG3-112	530 3	3"	1-1/2"	18	0.13
GRESG6-112	530 6	6"	1-1/2"	18	0.20

Stud Guard With Nail Holes

- 16 Gauge

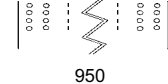
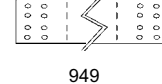
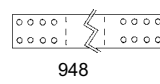

Part #	Mfg #	L	W	Holes	Price
GREFHA112-18	948 18	18"	1-1/2"	16	0.97
GREFHA112-24	948 24	24"	1-1/2"	16	1.42
GREFHA3-18	949 18	18"	3"	16	1.45
GREFHA3-24	949 24	24"	3"	16	2.20
GREFHA5-18	950 18	18"	5"	16	2.30

Hardware

Rod Couplings

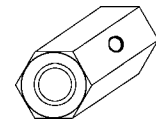

Part #	Mfg #	Size	Price
GRECLG38	151 3/8	3/8"	1.00
GRECLG12	151 1/2	1/2"	1.10

Plain Bolt Plate Flange

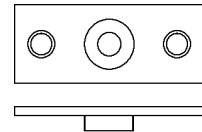

Part #	Mfg #	Tapped Hole Size	Price
GREBFLG38	208 3/8	3/8"	1.05
GREBFLG12	208 1/2	1/2"	1.70

Copperclad Bolt Plate Flange

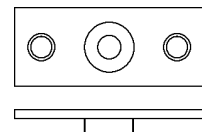

Part #	Mfg #	Tapped Hole Size	Price
GRECLG38	489 3/8	3/8"	1.40

Ductile Iron Bolt Plate Flange

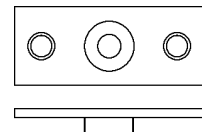

Part #	Mfg #	Tapped Hole Size	Price
GREGFLG38	389 3/8	3/8"	1.30
GREGFLG12	389 1/2	1/2"	1.85

Hangers & Supports

Hangers & Clamps

Side Beam Connector

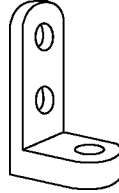

Part #	Mfg #	Tapped Hole Size	Price
GRESBC38	191 3/8	3/8"	1.10

All Thread Rod

- 6' Length



Part #	Mfg #	Tapped Hole Size	Price
GREEROD14	901 1/4	1/4"	4.41
GREEROD38	901 3/8	3/8"	6.72
GREEROD12	901 1/2	1/2"	13.65
GREEROD58	901 5/8	5/8"	19.99

Lag Screw

Part #	Mfg #	Tapped Hole Size	Price
GRELAG38-312	155 3/8X3-1/2	3/8" x 2-1/2"	0.58

Stove Bolt with Nut

Part #	Mfg #	Tapped Hole Size	Price
GRESB14-1	160 1/4X1	1/4" x 1"	0.11

Nuts

- Steel

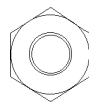

Part #	Mfg #	Size	Price
GREHN14	171 1/4	1/4"	0.03
GREHN38	171 3/8	3/8"	0.05
GREHN12	171 1/2	1/2"	0.12
GREHN58	171 5/8	5/8"	0.22

Washers



Part #	Mfg #	Size	Finish	Price
GREWASHER14	153 1/4	1/4"	Plain	0.02
GREWASHER38	153 3/8	3/8"	Plain	0.04
GREWASHER12	153 1/2	1/2"	Plain	0.13
GREWASHER58	153 5/8	5/8"	Plain	0.17



Wireholders

All-Porcelain Wireholders

- Mounting screw has special head which is leaded into a grooved hole in the base



Part #	Mfg #	Style	Screw	Screw Lgth	Price
POP1941	1941	1941	Hot Galv	3-1/16"	19.20

Clevises

- For dead-ending service drops at either end for general use in commercial and industrial applications
- Hot-dipped galvanized steel components
- Clevis and insulator are completely assembled



4172

Part #	Mfg #	Insulators Hole	Extension	Price
POP4172	4172	5107	4"	12.82
POP4111	4111	5101	4"	13.29

Wedge Grip Clamps

- Install at any point on the conductor
- Aluminum wedge and shell
- Stainless steel solid bail
- Nylon jacketed galvanized steel aircraft strand flexible bail



Part #	Mfg #	Bail Type	Conductor Max ACSR	Bail Lgth	Price
POP1061	1061	Solid	2	6-1/2"	8.32
POP1062	1062	Solid	1/0	6-1/2"	11.16
POP1063	1063	Solid	4/0	6-1/2"	9.06

Line Supplies

Oval Eye Bolts

- (1) Square nut - 1-1/2" x 2" eye, length measured under the eye, galvanized



Part #	Mfg #	Size	Thread Lgth	Price
POP6280	6280	5/8" x 10"	4"	10.09

Hangers & Supports

Wiring Raceway

2000® Series Raceway & Fittings

- 2-Piece single-channel

Plugmold® 2000 Series Prewired Raceway

- 120V 15A
- 12 Gauge insulated solid wire
- Includes (2) end caps



Part #	Mfg #	Description	Price
WIM20GB306	V20GB306	Ivory 3' Strip, 6" Ctr (6) Outlets	50.11
WIM20GB606	V20GB606	Ivory 6' Strip, 6" Ctr (12) Outlets	86.20

500® & 700® Series Raceway & Fittings

- 1-Piece single-channel
- Provides low profile appearance

500® & 700® Series Raceway



Part #	Mfg #	Description	Price
WIMV500	V500	Ivory 500 Series Raceway	1.44
WIMV700	V700	Ivory 700 Series Raceway	1.62

500® Series Raceway Fitting

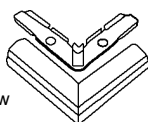

Flat Elbow

Part #	Mfg #	Description	Price
WIMV511	V511	Ivory Flat Elbow	2.06
WIMV517	V517	Ivory Internal Elbow	2.59

500® & 700® Series Raceway Fitting



Support Clip

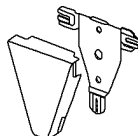

Tee

Part #	Mfg #	Description	Price
WIMV5703	V5703	Ivory 2-1/2" Support Clip	0.57
WIMV5715	V5715	Ivory Tee	4.99
WIM5781	5781	1/2" Male Box Connector	3.85

500® & 700® Series Raceway Device Box

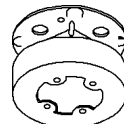

Solid Base Fixture Box

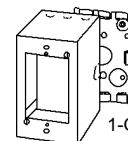

1-G Switch & Box

Part #	Mfg #	Description	Price
WIMV5738A	V5738A	Ivory 5-1/2" Solid Base Fixture Box	13.59
WIMV5744	V5744	Ivory 1-Gang Extra Deep Switch & Receptacle Box	21.38
WIMV5745	V5745	Ivory 1-Gang Combo Device Box	9.13
WIMV5747	V5747	Ivory 1-Gang Shallow Switch & Receptacle Box	7.42
WIMV57472	V57472	Ivory 2-Gang Shallow Switch & Receptacle Box	14.42
WIMV5748	V5748	Ivory 1-Gang Switch & Receptacle Box	8.99
WIMV57482	V57482	Ivory 2-Gang Switch & Receptacle Box	16.19
WIMV5751	V5751	Ivory 1-Gang Flush Extension	8.03
WIMV57512	V57512	Ivory 2-Gang Flush Extension	15.69

Hangers & Supports

400/2300 Series™ Raceway & Fittings

- 2-Piece single- and dual-channel
- Ideal for power or communication installations

400 Series™ Non-Metallic Raceway

- Single compartment
- Small secure low profile raceway
- Accommodates communication and power wiring
- PVC, Adhesive backing for low voltage (under 50V)
- Snap-on cover



Part #	Mfg #	Description	Price
WIM400BAC	400BAC	Ivory 5' 400 Series Raceway	3.86

2300 Series™ Non-Metallic Raceway Device Box

Part #	Mfg #	Description	Price
WIM23471	2347	4-1/2" x 3" x 1-3/8"D Device Box	6.87

Call us or go online to view our full Wiremold offering

Electrical Boxes

Old Work Switch & Outlet Boxes

1-Gang Old Work Switch & Outlet Box with Quick/Click®

- Impact-resistant Noryl thermoplastic construction
- Swing bracket for mounting adjusts from 1-1/4" down to 1/8"
- (2) Auto/Clamp® cable clamps on each end
- UL Listed



Part #	Mfg #	Description	Price
PASBOXOW1G	S118W	18.0 cu in	3.04

1-Gang Deep Old Work Switch & Outlet Box with Quick/Click®

- Swing bracket for mounting, adjusts from 1-1/4" down to 1/8"
- (2) Auto/Clamp® for each end
- Impact-resistant thermoplastic box



Part #	Mfg #	Description	Price
PASBOXOW1GD	S122W	22.0 cu in	6.64

2-Gang Old Work Switch & Outlet Box with Quick/Click®

- Impact-resistant Noryl thermoplastic construction
- Swing bracket for mounting adjusts from 1-1/4" down to 1/8"
- (4) Auto/Clamp® cable clamps on each end
- UL Listed



Part #	Mfg #	Description	Price
PASBOXOW2G	S232W	32.0 cu in	5.64

3-Gang Old Work Switch & Outlet Box with Quick/Click

- Swing-bracket for mounting adjusts from 1-1/4" down to 1/8"
- (6) Auto/Clamp® for each end



Part #	Mfg #	Description	Price
PASOW3GBOX	S352W	52.0 cu in	12.54

Switch & Outlet Boxes

1-Gang Nail-On Switch & Outlet Box with Threaded Mounting Holes

- Impact-resistant Noryl thermoplastic construction
- Captive mounting nails on each end
- (2) Quick/Entries™ on each end
- UL Listed



Part #	Mfg #	Description	Price
PASBOX1G	P118R	18.0 cu in	0.76

1-Gang Deep Nail-On Switch & Outlet Box with Threaded Mounting Holes

- Extra deep for dimmers, GFCIs and thermostats
- Impact-resistant Noryl thermoplastic construction
- Captive mounting nails on each end
- (2) Quick/Entries™ on each end
- UL Listed



Part #	Mfg #	Description	Price
PASBOX1GD	P122R	22.5 cu in	1.48

1-Gang Deep Nail-On Switch & Outlet Box with Quick/Click®

- Extra deep for dimmers, GFCIs and thermostats
- Impact-resistant Noryl thermoplastic construction
- Captive mounting nails on each end
- (2) Quick/Entries™ on each end
- UL Listed



Part #	Mfg #	Description	Price
PASBOX1GDQ	S122R	22.5 cu in	1.08

Nail-On Switch Box

- Switch box with nails

Part #	Mfg #	Description	Price
PASBOX2G	P235RAC	2-Gang	4.72
PASBOX3G	S354RAC	3-Gang	6.78
PASBOX4G	S468RAC	4-Gang	9.28

Junction & Device Boxes

All Items May Not Be Stocked In All Branches

Electrical Boxes

Ceiling Boxes

4" Round Plastic Ceiling Box

- Bar-hanger adjusts for 16" or 24" joist spacing
- Dual threaded mounting holes
- Impact-resistant Noryl thermoplastic construction
- (4) Auto/clamp® cable clamps molded in
- UL Listed for 50 lb maximum weight rating



Part #	Mfg #	Description	Price
PASCBBAR	S120HAC	4" Dia x 2-3/16" D, 20.25 cu in	5.08

Nail-On 4" Round Plastic Ceiling Box

- Bar-hanger adjusts for 16" or 24" joist spacing
- Dual threaded mounting holes
- Impact-resistant Noryl thermoplastic construction
- (2) Captive mounting nails
- (4) Auto/clamp® cable clamps molded in
- UL Listed for 50 lb maximum weight rating



Part #	Mfg #	Description	Price
PASCB	S120RAC	4" Round	3.98

4" Round Ceiling Box

- Construction grade
- Depth-mounting gauge helps align the box at the proper depth relative to ceiling
- Dual mounting accepts fans or fixtures with 2-3/4" or 3-1/2" straps
- Phillips-head screws mount the fan or fixture directly to the metal bracket
- Includes (4) Auto/Clamp®
- UL Listed



Part #	Mfg #	Description	Price
PASCBFAN	S120BFAN	4" Dia x 2-3/16" D, 20.25 cu in	24.18

3-3/4" Round Old Work Ceiling Box with Device Mounting Holes

- Impact-resistant Noryl thermoplastic construction
- Swing bracket for mounting adjusts from 1-1/4" down to 1/8"
- (4) Auto/Clamp® cable clamps molded in
- UL Listed 20 lb maximum weight



Part #	Mfg #	Description	Price
PASBOXOWC	C118WAC	3-3/4" Dia x 2-11/16" D, 18.0 cu in	7.02

3-1/4" Round Ceiling Box

- Bar hanger adjusts to 16" or 24" joist spacing
- Made of high-impact thermoplastic
- Includes Auto/Clamp® feature



Part #	Mfg #	Description	Price
PASCBBAR314	C118HAC	3-1/4" Round Ceiling Box	13.14

3-1/4" Round Ceiling Box

- Includes (2) captive mounting nails and (4) Auto/Clamp®
- Made of high-impact thermoplastic



Part #	Mfg #	Description	Price
PASCB314	C118RAC	3-1/4" Round Ceiling Box	2.80

Shallow Fan Pan Box

- For paddle fixtures
- With rotating dual support
- Direct mount to joist
- Ground screw pre-installed
- Boxes include top knockouts
- Peel-off tape for hands-free installation
- Supplied with hardware
- UL listed for fan and fixture support



Part #	Mfg #	Description	Price
PASSFB	77705	1/2" Shallow Fan Pan Box for Paddle Fixtures	10.44

Floor Boxes

Floor Box

- Solid brass cover plate

Part #	Mfg #	Description	Price
PAS1542TRFBA	1542TRFB A	Tamperproof Floor Box Assembly	147.08

Low-Profile Brass Floor Cover

- Requires minimum of 3/8" hardwood floor thickness
- Includes 885 15A 125V decorator duplex receptacle
- Cover includes captive screws to prevent loss



Part #	Mfg #	Description	Price
PASTM1542FM	TM1542FM	6.5" Dia Low Profile Brass Floor Cover	127.88

Junction & Device Boxes

Prices & Specifications are Subject to Change.

Electrical Boxes

Octagon Boxes

4" Octagon Box - for Conduit

- Used in the installation of ceiling or wall lighting fixtures
- Combination screw heads
- 50 lbs Maximum static fixture support load
- 15.5 cu in
- Drawn with conduit knockouts

1-1/2" Deep



Part #	Mfg #	Description	Price
RAO125	125	(4) 1/2" Side (4) 1/2" Btm KOs	2.17

2-1/8" Deep



Part #	Mfg #	Description	Price
RAO165	165	(4) 1/2" Side (5) 1/2" Btm KOs	3.30
RAO167	167	(2) 1/2" & (2) 3/4" Side (2) 1/2" & (3) 3/4" Btm KOs	3.85

Extension - 1-1/2" Deep



Part #	Mfg #	Description	Price
RAO128	128	Extension (4) 1/2" Side KOs	3.15
RAO130	130	Extension (2) 1/2" Side KOs (2) 3/4" Btm	3.51

Junction & Device Boxes

4" Octagon Box - for Non-Metallic Sheathed Cable

- Boxes are used in the installation of ceiling or wall lighting fixtures
- Extension rings provide a means for adding additional cubic capacity an outlet box for surface conduit
- 15.5 Cubic inches
- Drawn with conduit knockouts
- 1-1/2" Deep

1-1/2" Deep with NMSC Clamp

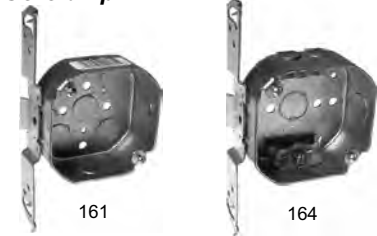

Part #	Mfg #	Description	Price
RAO161	161	(3) 1/2" Side (5) 1/2" Btm KOs & TS Bracket	8.10
RAO164	164	(1) 1/2" & (4) Priouts Side (1) 1/2 Btm KOs & TS Bracket	4.62

2-1/8" Deep with NMSC Clamp

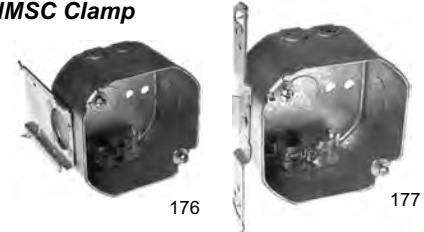

Part #	Mfg #	Description	Price
RAO176	176	(2) 1/2" & (4) Priouts Side (1) 1/2 Btm KOs & J Bracket	8.62
RAO177	177	(1) 1/2" & (4) Priouts Side (1) 1/2 Btm KOs & TS Bracket	5.68

4" x 1-1/2" Octagon Box with Bar Hanger

- Boxes are used in the installation of light fixtures between joints or structural members
- Not designed for ceiling fan support
- Furnished with 3/8"-18 NPS fixture stud
- Bar hanger is adjustable between 14-1/4" to 22-1/2"
- Box is adjustable along entire length of bar



Part #	Mfg #	Description	Price
RAO326	326	(2) 1/2" Side KO & (4) Pri-Out	33.72

Electrical Boxes

4" x 1-1/2" Octagon Ceiling Fan Support Box

- Ceiling fan rated
- Boxes are used in the installation of heavy light fixtures or ceiling fans
- Includes nonmetallic sheathed cable connector, mounting hardware and instructions
- High strength hardened screws



Part #	Mfg #	Description	Price
ELFFBS415	296-1	(4) 1/2" Side & (3) 1/2" Btm KOs	8.57

Square Boxes

Box to T-Bar Fastener

- Snap-on 24" span box hanger with dual height adjustment allows flush or 3/4" offset mount
- (1) BBC Mounting clip with screw
- Zinc plated steel with spring steel hardware included

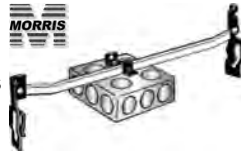

Part #	Mfg #	Description	Price
MOR18054	18054	24" Snap-On T-Bar Box Hanger	17.48

Square Box - for Conduit

- Used in the installation of ceiling or wall lighting fixtures, switches or receptacles
- Used where multiple conductor runs are split into two or more directions
- Combination screw heads
- Per UL 514A, suitable for use without bonding jumper in circuits above or below 250 volts

4" x 1-1/2" Deep

- 50 lbs Maximum static fixture support load
- Drawn on conduit knockouts



Part #	Mfg #	Description	Price
RAO192	192	(8) 1/2" & (4) 3/4" Side (3) 1/2" & (2) 3/4" Btm KOs	1.88

Welded 4" x 2-1/8"

- Welded with conduit knockouts
- 30.3 Cubic inches



Part #	Mfg #	Description	Price
RAO232	232	(8) 1/2" & (4) TKO Side, (2) 1/2" & (2) TKO Btm KOs	3.00
RAO233	233	(8) 1" Side (3) 1/2" & (2) 3/4" Btm KOs	5.15
RAO235	235	(6) 1/2" & (3) TKO Side, (3) 1/2" & (2) TKO Btm KOs with TS Bracket	6.11

4-11/16" x 2-1/8"

- Welded with conduit knockouts



Part #	Mfg #	Description	Price
RAO257	257	(12) TKO Side (1) 1/2", (1) 3/4" & (2) TKO Btm KOs	4.64
RAO258	258	(8) 1" Side (2) 1/2" & (2) 3/4" Btm KOs	5.03

4" x 1-1/2" Square Box - Extension Ring

- Drawn on conduit knockouts



Part #	Mfg #	Description	Price
RAO203	203	(8) 1/2" & (4) 3/4" KOs	3.92

4-11/16" Square Box - Extension Ring

- Drawn on conduit knockouts



Part #	Mfg #	Description	Price
RAO262	262	2-1/8"D (8) 1/2" & (4) 3/4" Side KOs	18.10

Electrical Boxes

Handy/Utility Boxes

4" x 2" Handy/Utility Box for Conduit

- Used for convenience outlets, switch boxes or small junction boxes
- Popular for exposed work applications
- UL Listed steel boxes and are acceptable for use in 2-hour fire rated walls

1-1/2" Deep

- Welded with conduit knockouts



Part #	Mfg #	Description	Price
RAO650	650	(6) 1/2" Side (3) 1/2" Btm (2) 1/2" End KOs	2.60

1-7/8" Deep

- Drawn in conduit knockouts



Part #	Mfg #	Description	Price
RAO660	660	(6) 1/2" Side (2) 1/2" Btm (2) 1/2" End KOs	2.12

2-1/8" Deep

- Welded with conduit knockouts



Part #	Mfg #	Description	Price
RAO670RAC	670RAC	(6) 1/2" Side (3) 1/2" Btm (2) 1/2" End KOs	2.58

1-7/8" Deep Extension

- Welded with conduit knockouts



Part #	Mfg #	Description	Price
RAO665	665	(6) 1/2" Side (2) 1/2" End KOs	7.14

Masonry Boxes

Non-Gangable Masonry Box

- Accommodate the mounting of switches or other devices in masonry wall



Part #	Mfg #	Description	Price
RAO690	690	2-1/2"D 1 Gang (4) Side (2) Btm (2) End KOs	6.16
RAO691	691	2-1/2"D 2 Gang (4) Side (4) Btm (4) End KOs	8.02

Switch Boxes

3" x 2" Switch Box - Gangable - for MC/Armored Cable/Flex Cable

- Used to house wiring devices such as switches or outlets
- Adjustable plaster ears allow use in "old work" applications



3-1/2" Deep

Part #	Mfg #	Description	Price
RAO600	600	(4) 1/2" Side (1) 1/2" Btm (2) 1/2" & (4) Priouts End KOs & Plaster Ears	7.68
RAO604	604	(4) 1/2" Side (1) 1/2" Btm (2) 1/2" & (4) Priouts End KOs w/TS Bracket	7.19

3" x 2" Switch Box - Gangable - for Non-Metallic Sheathed Cable

- Used to house wiring devices such as switches or outlets
- Adjustable plaster ears allow use in "old work" applications

2-1/2" Deep, with NMSC Clamp



Part #	Mfg #	Description	Price
RAO519	519	(1) 1/2" Btm (4) Priouts End KOs & Plaster Ears	3.23
RAO531	531	(1) 1/2" Btm (2) 1/2" & (4) Priouts End KOs, w/TS Bracket & Plaster Ears	5.29

2-1/2" Deep, with Armored Clamp

Part #	Mfg #	Description	Price
RAO518	518	(4) Cable (1) 1/2" Btm End KOs & Plaster Ears	5.53

Junction & Device Boxes

All Items May Not Be Stocked In All Branches

Electrical Boxes

2-3/4" Deep, with NMSC Clamp



Part #	Mfg #	Description	Price
RAO567	567	(4) 1/2" Side (1) 1/2" Btm (2) 1/2" & (4) Priouts End KOs & Plaster Ears	4.84

3-1/2" Deep, with NMSC Clamp



Part #	Mfg #	Description	Price
RAO601	601	(4) 1/2" Side (1) 1/2" Btm (2) 1/2" & (4) Priouts End KOs w/Plaster Ears	4.69

3" x 2" Switch Box - Gangable - for Conduit

- Used to house wiring devices such as switches or outlets
- Adjustable plaster ears allow use in "old work" applications

2-3/4" Deep Gangable



Part #	Mfg #	Description	Price
RAO564	564	(2) 1/2" Side (1) 1/2" Btm (2) 1/2" (4) Priouts End KOs w/TS Bracket, NMSC Clamps	5.05

3" x 2" Switch Box - Non-Gangable - for Non-Metallic Sheathed Cable

- Used to house wiring devices such as switches or outlets

1-1/2" Deep, with NMSC Clamp



Part #	Mfg #	Description	Price
RAO410	410	(4) Priouts End KOs	5.00

3" x 2" Switch Box - Non-Gangable - Old Work

- Used to house wiring devices such as switches or receptacles
- Adjustable plaster ears
- "U" Box support provided
- For 3/4" sheetrock maximum thickness



Part #	Mfg #	Description	Price
RAO508	508	2-1/2" Deep, (2) 1/2" End KOs	15.00

Box Supports

Grip-Loc Old Work Switch Box Support

- Used to mount a 3"x2" switch box with plastic ears into a hollow wall cavity
- Supplied as pair
- 1-7/8" Long legs



Part #	Mfg #	Description	Price
RAO977	977	Grip-Loc	1.63

Electrical Box Covers

4" Square Cover

- Covers are used to close an outlet box
- Raised device covers are used for mounting switches or receptacles
- Angled mounting slots compensate up to 12" for box misalignment



Part #	Mfg #	Description	Price
RAO752	752	Flat, Blank	0.63
RAO753	753	Flat, 1/2" KO in center	0.75
RAO768	768	Mud-Ring - Raised 5/8", For 1 Device	0.92

4" Square Exposed Work Cover

- Covers are used to support switches or receptacles on boxes in surface mount applications
- 6.5 Cubic inches



Part #	Mfg #	Description	Price
RAO800	800C	1 Toggle	1.88
RAO801	801C	1 1.506" Dia Receptacle	2.21
RAO806C	806C	4" Sq Cover (1) Duplex & (1) 1.406" Diameter Hole	4.92
RAO808C	808C	4" Work Cover 1 Gfci	2.36
RAO810	810C	4" Sq Cover 30-50a Recp	2.58
RAO811	811C	4" Sq Cover 30a Recp	2.60

Junction & Device Boxes

Electrical Boxes

Electrical Box Covers (Continued)

4" Square Exposed Work Cover

Part #	Mfg #	Description	Price
RAO812	812C	4" Sq Cover 20a Recp	3.29
RAO813	813C	4" Sq Cover 30-50-60a	7.48
RAO814C	814C	4" Work Cover 1 GFCI & 1 Toggle	2.62

4" Square Raised Surface Cover

- Covers are used to support switches or receptacles on boxes in surface mount applications



Part #	Mfg #	Description	Price
RAO902C	902C	1 Duplex Receptacle, Crushed Corners	1.83
RAO906	906C	1 Duplex & 1 Toggle Switch	3.43
RAO907C	907C	2 Duplex Receptacles	1.88

4" Square Combination Device & Tile Cover

- Used to close an outlet box
- Raised device covers are used for mounting switches or receptacles



Part #	Mfg #	Description	Price
RAO771	771	Single, Raised 1/4"	1.20
RAO772	772	Single, Raised 1/2"	0.82
RAO773	773	Single, Raised 3/4"	0.82
RAO774	774	Single, Raised 1"	1.42
RAO775	775	Single, Raised 1-1/4"	1.68
RAO778	778	Double, Raised 1/2"	1.42

4" Octagon Cover

- Covers are used to close an outlet box
- Raised covers are used for mounting lighting fixtures



Part #	Mfg #	Description	Price
RAO722	722	Flat, Blank	0.63

Handy Box Cover

- Used to close 4" x 2" handy boxes
- 2-5/16"W x 4-3/16"L

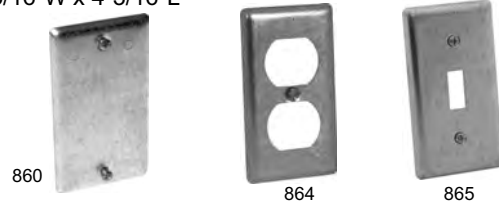

Part #	Mfg #	Description	Price
RAO860	860	Blank	0.60
RAO864	864	Duplex Receptacle	0.53
RAO865	865	Toggle Switch	0.53
RAO832	832	4-11/16" Sq Cover Blank	1.27
RAO863	863	4x2 Hndy Bx Cvr 1.406" Dia	0.77
RAO870	870RAC	4-11/16" Sq Cov 1 Switch	8.13

Ceiling Pans

- 1/2" Deep
- Ceiling pans are often used in the installation of wall or ceiling lighting fixtures
- Not designed for ceiling fan support
- Combination head screws provide for faster installation



Part #	Mfg #	Diameter	Capacity	Price
RAO292	292	3-1/2"	3.9 cu in	2.77

Metal Stud Fasteners & Brackets

Box Support Brackets

- Attaches with screws to either side of metal stud
- Supports 4" square or 4-11/16" boxes
- Brackets may be piggy-backed in series on same side of metal stud

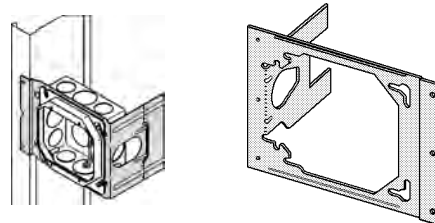

Part #	Mfg #	Metal Stud Size	Price
RAOH23	BB4-4	4", 3-1/2", 2-1/2"	1.81

All Items May Not Be Stocked In All Branches

Electrical Boxes

Fan Boxes

Fan and Fixture Mounting Box

- For new construction
- Mounts fans and fixtures on sloped or cathedral ceilings
- Large, 8" square mounting surface handles newer fans with larger canopies



Part #	Mfg #	Description	Price
ELFCCFB	FB900	Fits Cathedral Ceilings 80° Plus	20.64

Fan and Fixture Mounting Box for Drywall & Hat Channel

- For 1/2" or 5/8" drywall with 3/4" furring strips or hat channel
- Totally self-contained
- Two hour fire rating
- Attaches to joist with center screw



Part #	Mfg #	Description	Price
ELFFB423	FB423	19.5 cu in Press-On Box	7.36

Press-On Fan and Fixture Mounting Box

- Self-contained
- Press-on box with ready-to-tighten center screw



Part #	Mfg #	Description	Price
ELFFB415	FB415	For 1/2" or 5/8" Drywall, 10.3 cu in	5.89
ELFFB426	FB426	For 1/2" or 5/8" Drywall, 16.0 cu in	6.77

L-Shape Fan and Fixture Mounting Box

- Mounts fans and fixtures on single or double joists with shipped-in-place center screw



Part #	Mfg #	Description	Price
ELFPCFB	FB443	For 1/2" or 5/8" Drywall, 17.96 cu in	7.12

Steel Fan and Fixture Mounting Box

- With adjustable mounting bracket
- Heavy-duty plated steel fan/fixture box with fully adjustable mounting bracket
- Adjusts from 16" to 24" on center spacing



FBR4200R



FBR415

Part #	Mfg #	Description	Price
ELFOWFANBOX	FBR4200R	2" Box Depth, 20 cu in for Existing Construction	20.40
ELFFBRS415	FBR415	Steel, 15.6 cu in for New Construction	13.39

Siding Mounting Blocks

Weatherproof FS Electrical Box

- For sided structures
- Non-metallic, one-piece
- Works on 1/2" and 5/8" Dutch Lap and flat siding
- Accommodates GFCI, switches, and outlets
- UV Rated for outdoor applications
- UL & CSA Listed
- Textured finish, can be painted



Part #	Mfg #	Description	Price
ELFFS8141	FS8141	1/2" Lap Siding, Surface Mnt	4.63

Weatherproof FS Outlet Box

- For installing devices on all siding types
- Paintable
- UV Rated plastic



Part #	Mfg #	Description	Price
ELFSB8091F	FS8091F	Electrical Siding Box	7.71

Electrical Boxes

In Box™ Recessed Electrical Box for New Vinyl Siding

- Outer flange covers cut edge of siding
- Fits all siding types
- Includes:
 - Box with weatherproof-in-use cover
 - Installed bug plugs
 - (1) Standard duplex faceplate
 - (1) GFCI faceplate
 - (1) NM Cable connector
 - Installation screws



Vertical, Clear

Part #	Mfg #	Orientation	Cover	Price
ELFDBVS1W	DBVS1W	Vertical	White	17.00

Siding Box Kit

- Provide smooth vertical mounting of fixtures, receptacles, etc on sided structures
- Paintable
- UV Rated plastic for long outdoor life



Part #	Mfg #	Description	Price
ELFSB8081F	8081F	6.5" x 6.5" x 1.125" w/Flange	10.18
ELFSB8081FDBL	8081FDBL	10.5" x 6.5" x 1.125" w/Flange	11.57
ELFSBGF	8091F	6.5" x 6.5" x 1.625" w/Flange	16.51

Siding Mounting Kit with Built-In Box

- Provide smooth vertical mounting of light fixtures on sided structures
- Includes mounting block with built-in electrical box, NM cable connector and (4) screws
- Paintable
- 4" Diameter x 1/2" deep box
- UV Rated plastic for long outdoor life



Part #	Mfg #	Description	Price
ELFSB8141	8141	For Mounting Pancake Box on 1/2" Lap Siding	14.56

Meter Mounting Base

- One-piece, non-metallic
- Paintable
- Gangable
- UV Rated plastic for long outdoor life



MM18

Part #	Mfg #	Description	Price
ELFMM10	MM10	10"H x 7"W	8.33
ELFMMB18	MM18	17-5/8"H x 15-7/8"W	21.60
ELFMMB23	MM23	23"H x 17-5/8"W	30.86

Box Accessories

Ceiling Box Extender

- For set back ceiling boxes
- Extends the box up to 1-1/2"
- Heavy-duty plastic
- UL Listed



Part #	Mfg #	Description	Price
ELFBE1R	BE1R	Fits 3-1/2" and 4" Round or Octagonal Boxes	4.00

Box Cover



Part #	Mfg #	Description	Price
ELFCBCP	CP3540	Round Cover for 3-1/2" & 4" Boxes, Includes Bracket & (2) Screws	1.68

Floor Boxes

861 Series Round Raised Floor Box

- Individual slide cover on flush cover assemblies
- (3) 1/2" Knockouts



861DB



Part #	Mfg #	Description	Price
WIM861DB	861DB	Assembly with 20A Duplex Receptacle and Brass Cover Plate	86.76

All Items May Not Be Stocked In All Branches

Electrical Boxes

Round Outlet Boxes

- UL Listed
- Superior commercial quality die-cast metal construction
- Closure plugs, ground screw and mounting hardware included
- Premium powdercoat finish
- Installation instructions included



RB550S

Part #	Mfg #	Description	Price
EWPBOXR125HG	RB550S	(5) 1/2" Holes, Gray	7.29
EWPBOXR125HB	RB550Z	(5) 1/2" Holes, Bronze	7.29
EWPBOXR125HW	RB550WH	(5) 1/2" Holes, White	7.29

Outlet Box Extensions

Single Gang Outlet Box Extension



Part #	Mfg #	Description	Price
EWPBOXEXT1G	SE450S	(4) 1/2" Holes, Gray	4.40

Weatherproof Boxes

- Baked-on electrostatic, polyester, powder paint for superior scratch and corrosion resistance
- UL Listed for wet and/or damp locations with appropriate cover
- Designed for both interior and exterior applications
- Heavy die cast aluminum

Weatherproof Single-Gang Box

- Closure plugs and mounting lugs furnished with all boxes
- Will accept standard 4-screw mounting covers and single-gang weatherproof covers



SB350S



SB550S

Part #	Mfg #	Description	Price
PASWPB23BR	SB350S	Gray, 3-Hole 1/2" KOs, 18.5 cu in	6.09
EWPBOX1G123HB	SB350W	Bronze, 3-Hole 1/2" KOs, 18.5 cu in	4.77
EWPBOX1G123HW	SB350Z	White, 3-Hole 1/2" KOs, 18.5 cu in	5.78
EWPBOX1G125HG	SB550S	Gray, 5-Hole 1/2" KOs	6.87

Weatherproof 2-Gang Box

- 30.5 cu in
- (2) Closure plugs and mounting lugs furnished with all boxes
- Will accept standard 4-screw mounting covers and single-gang weatherproof covers



DB350S



DB550S

Part #	Mfg #	Description	Price
EWPBOX2G123HG	DB350S	Gray, 3-Hole 1/2" KOs	19.87
EWPBOX2G343HG	DB375S	Gray, 3-Hole 3/4" KOs	21.51
EWPBOX2G125HG	DB550S	Gray, 5-Hole 1/2" KOs	33.00

Weatherproof 1-Gang Deep Box

- Threaded holes
- Closure plugs, ground screw and mounting hardware included



SD375S

Part #	Mfg #	Description	Price
EWPBOX1GD123HG	SD350S	Gray, 3-Hole 1/2" KOs	19.44
EWPBOX1GD343HG	SD375S	Gray, 3-Hole 3/4" KOs	36.70

Weatherproof Covers

2-Gang Horizontal-Mount Weatherproof Cover

- Polycarbonate material for extra strength and durability
- Snap off lid for easy access to top screw holes
- Fits all standard receptacles
- Box or device mount
- Non-metallic gray
- UV Resistant
- UL Marine listed

Carlton[®]



Part #	Mfg #	Description	Price
CONPVCSWCVR2G	E9G2SSN	Red Handle Switch Cover, 2-Gang	33.34
CONPVCSWCVR		Red Handle Switch Cover, 1-Gang	8.08

Junction & Device Boxes

Prices & Specifications are Subject to Change.

Wall Plates & Covers

Multi-Mac® Wall Plate Covers

Single Gang Receptacle Covers - Standard 3" Depth

- UL Listed
- High-impact polycarbonate construction
- Vertical and horizontal universal fit - 16-in-1 configurations
- Base configuration with patented Knock-Out™ technology for custom fitting
- Lockable tab



Part #	Mfg #	Description	Price
EWPINUSE1G	MM410C	2-3/4" Deep, Clear	11.54
EWPINUSE1GD	MM710C	4-3/4" Deep, Clear	18.93

Double Gang Receptacle Covers - Std 3" Depth

- Weatherproof while in use
- Single and double device
- Universal fit - 55-in-1 configurations
- Duplex, GFCI, switch and multi-rounds



Part #	Mfg #	Description	Price
EWPINUSE2G	MM2410C	Clear	19.09

Metal Single Gang Horizontal Flat Cover

- UL Listed
- Heavy duty die cast construction
- Quick-Fit™ key hole mount
- Easy Installation
- Universal-Fit™ adapter technology
- Spring hinge closure



Part #	Mfg #	Description	Price
EWPCVR1GH12IN1G	MX1250S	Gray	4.20
EWPCVR1GH12IN1B	MX1250Z	Bronze	4.20
EWPCVR1GH12IN1W	MX1250W	White	4.20

Metal Double Gang Horizontal Flat Outlet Cover

- UL Listed
- Weatherproof when closed
- Heavy duty die cast construction
- Quick-Fit™ key hole mount
- Easy Installation
- Universal-Fit™ adapter technology
- Spring hinge closure



Part #	Mfg #	Description	Price
EWPCVRDUP2GG	MX2050S	Gray	15.43

Metal Flat Covers

MX Series Metal Single Gang Vertical Flat Covers

- UL Listed
- Heavy duty die-cast metal construction
- Patented Universal-Fit™ adapter technology
- Patented Quick-Fit™ keyhole mounting system allows installation in under a minute
- Premium powdercoat finish
- Spring hinge closure
- Lockable tab
- Vertical and horizontal universal fit - 12-in-1 configurations



Part #	Mfg #	Description	Price
EWPCVR1GV12IN1G	MX1050S	Gray	4.19
EWPCVR1GV12IN1W	MX1050W	White	4.20
EWPCVR1GV12IN1B	MX1050Z	Bronze	4.20

Metal Blank Cover

- Commercial quality die cast metal
- Powdercoat finish
- Includes gasket, mounting hardware and installation instructions
- UL Listed and 2008 NEC® compliant



Part #	Mfg #	Description	Price
EWPCVRBLANK1GG	BC100S	Single Gang, Gray	2.58
EWPCVRBLANK2GG	BC200S	Double Gang, Gray	3.96

All Items May Not Be Stocked In All Branches

Lampholders

Lampholders

Lampholder with Exterior Neoprene Gasket

- Suitable for wet locations
- Heavy-duty die-cast housing
- Positive locking screw on swivel arm and deeply serrated teeth on swivel
- Replaceable porcelain socket
- Pre-wired high temperature 6" leads
- Inside heat resistant gasket
- 75-100W - Par 38 and R-40 lamps
- Painted finishes are powder coated
- UL Listed and CSA approved for wet locations to 90° angle
- Temperature rating: 105°C



Part #	Mfg #	Description	Price
EWPLHG	LT100S	Aluminum Gray	4.53
EWPLHB	LT100Z	Bronze	4.53
EWPLHW	LT100W	White	4.53

Lampholder Covers



LV301Z



LV330S

Part #	Mfg #	Description	Price
EWPCVRLHR1HG	LV310S	Round w/(1) 1/2" Hole, Gray	3.51
EWPCVRR1HB	LV310Z	Round w/(1) 1/2" Hole, Bronze	2.60
EWPCVRLHR1HW	LV310W	Round w/(1) 1/2" Hole, White	2.60
EWPCVRLHR3HG	LV330S	Round w/(3) 1/2" Holes, Gray	4.33
EWPCVRLHR3HB	LV330B	Round w/(3) 1/2" Holes, Bronze	4.86
EWPCVRLHR3HW	LV330W	Round w/(3) 1/2" Holes, White	4.32
EWPCVRLH1HG	LV110S	Vertical Rectangle w/(1) 1/2" Holes, Gray	2.23
EWPCVRLH1HW	LV110W	Vertical Rectangle w/(1) 1/2" Holes, White	3.59

Lampholder Covers (Continued)

Part #	Mfg #	Description	Price
EWPCVRLH3HG	LV130S	Vertical Rectangle w/(3) 1/2" Holes, Gray	4.61
EWPCVRLH3HB	LV130B	Vertical Rectangle w/(3) 1/2" Holes, Bronze	4.62
EWPCVRLH3HW	LV130W	Vertical Rectangle w/(3) 1/2" Holes, White	4.62

Weatherproof Accessories

Closure Plug

Part #	Mfg #	Description	Price
EWPPUG12B	CP450S	1/2" Bronze	0.34
EWPPUG34B	CP475S	3/4" Bronze	0.45

Weatherproof Box Holder

- Zinc die-cast and non-metallic



Part #	Mfg #	Description	Price
EWPF50	FS50	1/2"	4.25

Junction & Device Boxes

Wire & Cable

Romex® Building Cable

See Electrical Connectors Section



Romex Grounded Cable

Part #	AWG/Conductors	Length	Price
WREROM14-2	14/2	250' Box	CALL
WREROM14-2-2	14/2/2	250'	CALL
WREROM14-3	14/3	250' Box	CALL
WREROM12-2	12/2	250' Box	CALL
WREROM12-2-2	12/2/2	250' Box	CALL
WREROM12-3	12/3	250' Box	CALL
WREROM10-2	10/2	250' Box	CALL
WREROM10-3	10/3	250' Box	CALL
WREROM8-2	8/2	125' Reel	CALL
WREROM8-3	8/3	125'	CALL
WREROM6-2	6/2	Cut/Ft (Reel)	CALL
WREROM6-3	6/3	500' Reel	CALL

Underground Feeder Wire

UF - Grounded Underground Feeder Wire

- PVC Insulation for direct burial applications
- Grounded, 600V



Part #	AWG Size	Packaging	Price
WREUF142	14/2	250' Box	CALL
WREUF12-2	12/2	250' Box	CALL
WREUF12-3	12/3	250' Box	CALL
WREUF10-2	10/2	250' Box	CALL
WREUF10-3	10/3	250' Box	CALL
WREUF8-2	8/2	1000' Reel	CALL
WREUF8-3	8/3	250' Box	CALL
WREUF6-2	6/2	250' Box	CALL
WREUF6-3	6/3	Cut/Ft (1000')	CALL

Wire & Cable

Metal Clad Cable

See Flex MC Connectors in Electrical Connectors Section



MC Solid Wire Cable

Part #	AWG Size	Packaging	Price
WREMC14-2	14/2	250'	CALL
WREMC14-3	14/3	250'	CALL
WREMC12-2	12/2	250'	CALL
WREMC12-3	12/3	250'	CALL
WREMC10-2	10/2	250'	CALL
WREMC10-3	10/3	250'	CALL

Copper Wire

Bare Solid Copper Wire



Part #	AWG	Length	Price
WREBARECU6SOL	6	Cut/Ft (315')	CALL
WREBARECU8SOL	8	Cut/Ft (500')	CALL
WREBARECU10	10	Cut/Ft (800')	CALL

Bare Stranded Copper Wire



Part #	AWG	Length	Price
WREBARECU4	#4	200'	CALL
WREBARECU6	#6	315'	CALL

Aluminum Cables

Aluminum URD Underground Cable - Triplex

- Direct burial
- Maximum operating temperature of 90°C in dry and wet locations
- 600V

Part #	Code Word	AWG	Direct Bury Amps	In Duct Amps	Price
WREURD666	Erskine	6	95A	70A	CALL
WREURD224	Stephens	2-2-4		120A	CALL
WREURD2/02/01	Converse	2/0	245A	180A	CALL
WREURD4/04/02/0	Sweetbriar	4/0	315A	240A	CALL
WREURD2502503/0	Pratt	250	345A	265A	CALL
WREURD3503504/0	Wesleyan	350			CALL

Prices & Specifications are Subject to Change.

Wire & Cable

Aluminum URD Underground Cable - Quadruplex

- Direct burial
- Maximum operating temperature of 90°C in dry and wet locations
- 600V

Part #	Code Word	AWG	Direct Bury Amps	In Duct Amps	Price
WREURD2224	Dyke	2-2-2-4	-	115A	CALL

Aluminum XLP/USE-2 Cable

- 1350 Aluminum conductor, 600V, 90°C UL
- General wiring for lighting and power in conduits, ducts or other approved raceways
- Direct burial applications (as Type USE)
- Black crosslinked polyethylene insulation

Part #	Type	AWG/# Cond	Price
WREXPUSE2	Clemson	#2/7-Str	CALL
WREXPUSE2/0	Yale	2/0	CALL
WREXPUSE250MCM	Hofstra	250mcm	CALL
WREXPUSE4	Mercer	#4	CALL
WREXPUSE4/0	Beloit	4/0	CALL

Aluminum Service Entrance SER/SEU Cable

- Gray, sunlight resistant PVC jacket over the complete assembly
- Rated 90°C dry or wet locations
- 600V
- SER Cable with ground; SEU cable without ground

Part #	Type	AWG	Price
WRESER8888	SER	8-8-8-8	CALL
WRESER6666	SER	6-6-6-6	CALL
WRESER2224	SER	2-2-2-4	CALL
WRESER2/02/02/01	SER	2/0-2/0-2/0-1	CALL
WRESER4/04/04/02/0	SER	4/0-4/0-4/0-2/0	CALL
WRESEU666	SEU	6-6-6	CALL
WRESEU2/02/01	SEU	2/0-2/0-1	CALL
WRESEU4/04/02/0	SEU	4/0-4/0-2/0	CALL
WRESEU224	SEU	2-2-4	CALL

Aluminum XHHW Wire

- 600V

Part #	AWG	Amps 75°C	Amps 90°C	Price
WREXHHWAL2	2	90A	100A	CALL
WREXHHW20	2/0	135A	150A	CALL
WREXHHW250	250	205A	230A	CALL
WREXHHWAL350	350	250A	280A	CALL
WREXHHW500	500	310A	350A	CALL
WREXHHW750	750	385A	435A	CALL

All Items May Not Be Stocked In All Branches

Wire & Cable

Portable Cord & Power Cable**Type SO Cord**

- 600V
- Color coded rubber insulation
- Heavy neoprene jacket
- Used in presence of oil, heat, sunlight or chemicals

Part #	AWG	Length	Price
WRESO10-3	10/3	250'	CALL
WRESO10-4CUT	10/4	Cut/Ft (250')	CALL
WRESO12-3	12/3	250'	CALL
WRESO12-4	12/4	250'	CALL
WRESO14-3	14/3	250'	CALL
WRESO14-4	14/4	250'	CALL

Type SJO Cord

- 300V
- Color coded rubber insulation
- Lightweight neoprene jacket

Part #	AWG	Length	Price
WRESJO12-3	12/3	250'	CALL
WRESJO14-3	14/3	250'	CALL
WRESJO14-4	14/4	250'	CALL
WRESJO16-3	16/3	250'	CALL

Type SJOOW Power Cord

- New and replacement power cords for appliances, commercial and industrial equipment
- Rugged, flexible
- Black neoprene
- Temperature rating: -35°F to 194°F
- 300V
- UL Recognized and OSHA acceptable
- CSA Listed

Part #	AWG/Conductor	Price
WRE123SJOOWCORD	12/3	CALL

Wire & Cable

THHN Building Wire

- 90°C 600V Nylon jacketed building wire

THHN Stranded Copper Wire

Part #	AWG	Color	Length	Price
WRETHHN10BK	1/0	Black	-	CALL
WRETHHN20BK	2/0	Black	500'	CALL
WRETHHN30BK	3/0	Black	Cut/Ft (1000')	CALL
WRETHHN40BK	4/0	Black	500'	CALL
WRETHHN2BK	#2	Black	500'	CALL
WRETHHN3BK	#3	Black	500'	CALL
WRETHHN4BK	#4	Black	Cut/Ft (500')	CALL
WRETHHN6BK	#6	Black	500'	CALL
WRETHHN8BK	#8	Black	500'	CALL
WRETHHN10BK	#10	Black	500'	CALL
WRETHHN10BR	#10	Brown	500'	CALL
WRETHHN10GR	#10	Green	500'	CALL
WRETHHN10RD	#10	Red	500'	CALL
WRETHHN10W	#10	White	500'	CALL
WRETHHN12BK	#12	Black	2500'	CALL
WRETHHN12BR	#12	Brown	500'	CALL
WRETHHN12GR	#12	Green	500'	CALL
WRETHHN12RD	#12	Red	2500'	CALL
WRETHHN12W	#12	White	500'	CALL
WRETHHN14BK	#14	Black	500'	CALL
WRETHHN14GR	#14	Green	500'	CALL
WRETHHN14RD	#14	Red	500'	CALL
WRETHHN14W	#14	White	500'	CALL
WRETHHN250BK	250mcm	Black	500'	CALL
WRETHHN350BK	350mcm	Black	Cut/Ft (1000')	CALL
WRETHHN500BK	500mcm	Black	Cut/Ft (500')	CALL

TFFN Fixture Wire

- General purpose wiring in accordance with NEC
- Rated at 600V for installation in conduit or other recognized raceway
- Conductor of soft drawn bare copper
- Primary insulation of PVC with nylon jacket



TFFN Stranded Copper Fixture Wire

Part #	AWG	Color	Price
WRETTFFN16BK	#16	Black	CALL
WRETTFFN16GR	#16	Green	CALL
WRETTFFN16RD	#16	Red	CALL
WRETTFFN16W	#16	White	CALL

Wire, Cable & Accessories

Wire & Cable

Cable

Guy Strand Cable

- Galvanized steel strand

Part #	Mfg #	Description	Price
POPGUYCAB	8721-HS-A-C	5/16" Guy Strand Cable	1.43

Dead-Ends

Guy-Grip® Dead-End

- Galvanized steel strand



Part #	Mfg #	Description	Price
POPGDE1106	GDE1106	5/16" x 31" 7-Wire Black B-Coat	15.26

Anchor Screws



Part #	Mfg #	Description	Price
POPSA4	7702	3/4" x 4' (6) Galv Anchor Screw	39.45



Thermostat Wire/Doorbell Wire

Part #	Mfg #	Description	Price
ELE202UL	20-2THERM	20/2 500'	CALL
ELE204UL	20-4THERM	20/4 250' Reel	CALL

Communications Wire

Part #	Mfg #	Description	Price
WRETELDB	2PRDBPHONE	2 Pair Direct Burial Telephone	CALL
WRETELTC500	TC500	22/ 500' Telephone Cable	CALL

Communications Wire & Cable

Category 5E Riser Rated Cable (CMR)

- 24 Awg, 4 pair
- Enhanced 100mHz
- FEP Insulation
- Unshielded
- PVC Jacket
- Solid/BC

Part #	Mfg #	Length	Color	Price
WRECAT5EBL	CAT5E244BLB	1000'/Box	Blue	CALL
WRECAT5EYW	CAT5EYW	1000'/Box	Yellow	CALL
WRECAT5EPK	CAT5EPK	1000'/Box	Pink	CALL

Coaxial Cable

Part #	Mfg #	Description	Price
WRER6U	RG6U	RG6U Coax Cable Pull Ctn	CALL



Wire & Cable

Pigtail Cord

- 13 Amp, 125 volt
- Replacement cord

Part #	Mfg #	Model	Cord	Length	Price
ELEEC6P	84680	SJT-GY RT	14/3	6'	12.80



www.irrsupply.com

Wire & Cable Accessories

Cable Staples

SN 40 Cable Staples

- For armored and metal clad cable 14/2 and 14/3
- For non-metallic sheathed cable 14/2 through 10/3
- For underground feeder 14/2 and 12/2



Part #	Mfg #	Size (W x L)	Box Qty	Price
BRNSN40-1	SN 40 100	1/2" x 1"	100	2.22
BRNSN40-5	SN 40 500	1/2" x 1"	500	10.43
BRNPP5M	SN 40 5M	1/2" x 1"	5,000 Bucket	103.10
BRNPP10M	SN 40B 10M	1/2" x 1"	10,000 Bucket	182.21

SN 100 Cable Staples

- Low carbon steel
- For armored and metal clad cable 14/2 and 14/3
- For non-metallic sheathed cable 14/2 through 10/3
- For underground feeder 14/2 and 12/2



Part #	Mfg #	Size (W x L)	Box Qty	Price
BRNSN100-1	SN 100 10M	9/16" x 1-1/4"	100	3.25
BRNSN100-5	SN 100 500	9/16" x 1-1/4"	500	22.19

SN 300 Cable Staples

- Zinc plated
- For armored and metal clad cable 8/3
- For non-metallic sheathed cable 8/3 through 6/3
- For underground feeder 10/3
- For SE Cable 8/2 through 6/3



Part #	Mfg #	Size (W x L)	Box Qty	Price
BRNSN300-1	SN300B100	13/16" x 1-3/8"	100	6.54

SN 350 Cable Staples

- Zinc plated low carbon steel
- For SE Cable 4/3 SEU through 2/3 SER



Part #	Mfg #	Size (W x L)	Box Qty	Price
BRNSN350	SN350B-100	1-1/16" x 1-7/16"	100	19.72

Low Voltage Insulated Staple

- For use with bell, speaker, thermostat and telephone wire



Part #	Mfg #	Description	Price
ELET5	T5	#5-BROWN-40BP Brown	2.15



Oxide Inhibiting Joint Compounds

- Penetrox™ A grease
- 230 Value
- 230°F Dropping point
- -15°F Max pour point

Part #	Mfg #	Description	Price
BUYPENA4	PENA4	4 oz Squeeze Bottle	9.50
BUYP8A	P8A	8 oz Squeeze Bottle	13.34

Visit us on the web at
www.irrsupply.com

Flex-AC-MC Fittings

Flex-AC-MC Connectors

Snap²IT™ Cable Connector

- Zinc die-cast, Snap-Tite product
- For MC/AC steel or aluminum cable, continuous corrugated aluminum MC cable, flexible metal conduit steel and aluminum
- Provided with insulated throat



Part #	Mfg #	Description	Price
ELFSNAP2IT38	38AST	3/8" x 1.410" MC Connector	1.10

Flex/AC/MC Squeeze Connector

- Zinc die-cast



Part #	Mfg #	Trade Size	KO Size	Price
ELFGFSC12	L421	1/2"	1/2"	1.06
ELFGFSC34	L422	3/4"	3/4"	2.08
ELFGFSC1	L423	1"	1"	4.63
ELFGFSC114	L424	1-1/4"	1-1/4"	10.30
ELFGFSC112	L425	1-1/2"	1-1/2"	14.19
ELFGFSC2	L426	2"	2"	20.16

Flex/AC/MC Duplex Connector

- Single screw for Flex-AC-MC-NM cable & MCI-A cable
- Zinc die-cast
- UL & CSA Listed



Part #	Mfg #	Trade Size	KO Size	Price
ELFMCDUPCN38	846	3/8"	1/2"	1.55

Flex/AC/MC 90° Connector

- For aluminum and steel Flex-AC-MC cable
- Zinc die-cast
- Concrete tight when taped
- UL & CSA Listed



Part #	Mfg #	Trade Size	KO Size	Price
ELFBX90C38	850	3/8"	1/2"	1.14
ELFBX90C38ST	850ST	3/8"	1/2" Snap-Tite	1.69
ELFGF9012	851	1/2"	1/2"	1.64
ELFGF9034	852	3/4"	3/4"	4.23
ELFGF901	853	1"	1"	10.92
ELFGF90114	854	1-1/4"	1-1/4"	15.45

Flex-AC-MC Connectors (Continued)

Flex/AC/MC 90° Connector

Part #	Mfg #	Trade Size	KO Size	Price
ELFGF90112	855	1-1/2"	1-1/2"	43.94

* Also for MCI-A cable

Anti-Short Bushing

- Plastic



Part #	Mfg #	Trade Size	Cable Sizes	Price
ELFASO	AS0	5/16"	14/2, 14/3, 12/2	11.74

1-Hole AC/MC Strap

- Plated steel



Part #	Mfg #	Size	Cable Range	Price
ELFBXMCS38	310	3/8"	.503 - .580	0.13

Flex-AC-MC Fittings

Snap²IT™ Duplex Cable Connector

- Zinc die-cast
- For MC/HCF and AC/HCF steel and aluminum cable, MC cable continuous corrugated aluminum, flexible metal conduit steel and aluminum, MCI-A cable
- Provided with insulated throat



Part #	Mfg #	Description	Price
ELF404010AST	404010AST	3/8" x 2.398" Duplex Connector w/Red Tinted Inside Clips	2.58

Victor Steel Straps

For Service Entrance Cable Standard Series



Part #	Mfg #	Cable Size & Desc	Price
ELFSEUS6	10052-S	6-3, 6-2 & 8-1	0.24
ELFSEUS2	10056-S	2-3	0.26
ELFSEUS2/0	10060-S	2/0-3, 2/0-2 & 1-1	0.80

Prices & Specifications are Subject to Change.

Electrical Supplies

Electrical Connectors

Victor Steel Straps (Continued)
For Service Entrance Cable

Part #	Mfg #	Cable Size & Desc	Price
ELFSEUS4/0	10061-S	4/0-2	0.60



Terminals

Insulated Disconnect



Part #	Mfg #	Description	Price
ELEDF22	D212	Female 22-18W 1/4" 16/Bag	4.12

Spade Terminal - Insulated

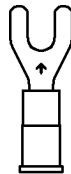

Part #	Mfg #	Description	Price
ELEST22	S211	22-18W 8 Stud (16/Bag)	4.12
ELEST16	S221	16-14W 8 Stud (16/Bag)	4.12

Wire Connectors

Wire Connector - Contractor Pack



Part #	Mfg #	Desc	Pkg Qty	Price
ELEBWNB	C241	Blue	20/Std Pk	4.12
ELEOWNB	C243	Orange	15/Std Pk	4.12

Connectors

Flip Seal NEMA 10-50C Connector

- Re-wireable design
- Rubber housing with phenolic insert
- Molded rubber lip on connector
- Stainless steel screws
- Made in USA



Part #	Mfg #	Description	Price
KHIC1050DF	C1050DF	50A, 3-Pole, 3-Wire Female, 125-250V, NEMA 10-50C	84.40

Flip Seal NEMA 10-50P Plug

- Re-wireable design
- Rubber housing with phenolic insert
- Molded rubber lip on connector
- Stainless steel screws
- Made in USA



Part #	Mfg #	Description	Price
KHIP1050DF	P1050DF	50A, 3-Pole, 3-Wire Grounded, Male, 125-250V, NEMA 10-50P	56.53

Nylon Convertible Connector

- Rugged construction
- High visibility yellow nylon housing
- Integrated cord grip and enclosed terminal screw pockets
- Made in USA



Part #	Mfg #	Description	Price
KHIC515DC	C515DC	15A, 2-Pole, 3-Wire Grounded, Female, 125V, NEMA 5-15C	16.49

Rubber Convertible Connector

- Dust, dirt and weather resistant
- High visibility yellow rubber housing
- Easy interchange of male and female interior assemblies
- Suitable for harsh environments
- Made in USA



Part #	Mfg #	Description	Price
KHIC615DC	C615DC	15A, 2-Pole, 3-Wire Grounded, Female, 125V, NEMA 5-15C	18.21

All Items May Not Be Stocked In All Branches

Electrical Connectors

Rubber Convertible Plug

- Dust, dirt and weather resistant
- High visibility yellow rubber housing
- Easy interchange of male and female interior assemblies
- Suitable for harsh environments
- Made in USA



Part #	Mfg #	Description	Price
KHIP515DC	P515DC	5-15 Plug, 15A, 2-Pole, 3-Wire Grounded, Male, 125V	9.45
KHIP615DC	P615DC	6-15 Plug, 15A, 2-Pole, 3-Wire Grounded, Male, 125V	11.34

3M Wire Connectors

"Performance Plus" Wire Connectors

B/G+ Wire Connector

- Blue with gray skirt
- Accommodates 4 #14-2 #6-3 #8 AWG



Part #	Mfg #	Description	Price
WNUB/G-50	B/G+BOX	Box of 50	29.07

O/B+ Wire Connector

- Orange with blue skirt
- Accommodates:
 - (2) #22 AWG Wires
 - Up to (3) #12 AWG solid wires
 - (4) #14 AWG Wires

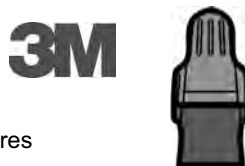

Part #	Mfg #	Description	Price
WNUO/B-100	O/B+BOX	Box of 100	19.60
WNUO/B-500	O/B+BULK	500 Per Container	78.50

R/Y+ Wire Connector

- Red with yellow skirt
- Accommodates 2 #18-2 #8-5 #12 AWG



Part #	Mfg #	Description	Price
WNUR/Y-100	R/Y+BOX	Box of 100	29.70
WNUR/Y-500	R/Y+BULK	500 Per Container	115.50

Wire Connectors

B-CAP® Wire Connector

- B1 Accepts (2) #18 to (3) #12 AWG wire combinations
- B2 Accepts (2) #18 to (5) #12 AWG wire combinations
- Rated for 600V maximum
- Live-action, square-wire spring
- No pre-twisting required
- Easily removable for repeat use
- Shell rated for 105°C
- Flame retardant shell
- UL Listed and CSA certified



B1 B2

Part #	Mfg #	Description	Price
WNUYEL-100	B1-1	B1 Yellow, 100/Box	14.75
WNUYEL-500	B1-B	B1 Yellow, 500/Bag	60.02
WNURED-100	B2-1	B2 Red, 100/Box	21.91
WNURED-500	B2-B	B2 Red, 500/Bag	84.66

Screw-On Wire Connector

- Color-coded, ribbed cap
- 221°F Maximum
- UL 94V-2 Flame retardant shell
- UL/CSA Listed



Part #	Mfg #	Description	Price
WNUGRAY-25	23271	Gray #22-#14 AWG 300V Max (25 Bag)	2.30
WNUBLUE-100	23072	Blue #22-#14 AWG 300V Max (100 Box)	7.87
WNUORANGE-100	23073	Orange #22-#14 AWG 600V Max (100 Box)	8.14

B-CAP® Wire Grounding Connector

- For grounding and bonding
- No pre-twisting required
- UL Listed and CSA certified



Part #	Mfg #	Description	Price
WNUGREEN-50	BGR-1	BGR Green, 50/Box	40.30

Prices & Specifications are Subject to Change.



www.irrsupply.com

Electrical Connectors

Electrical Connectors

Twister® Al/Cu Wire Connector

- Provides a secure connection while preventing aluminum corrosion
- Specially formulated corrosion-resistant compound provides cooler connections and increased conductivity
- Accepts (1) #12 Al soldered with (1) #18 Cu AWG minimum and (1) #10
- Swept wing design for comfort
- Live-action, square-wire spring
- Hexagonal shape for standard nutdriver
- No pre-twisting required
- Shell rated for 105°C
- Flame-retardant shell
- UL Listed and CSA certified



Part #	Mfg #	Description	Price
WNUBLUE-2	30-060	Blue, Card of (2) Direct Burial	4.05
WNUAL/CU-2	30-065	Purple, Card of (2)	7.30

Twister® Screw-On Winged Wire Connector

- Swept-wing design
- Live-action, square-wire spring
- Hexagonal shape
- 600V, 22 thru 8 AWG, (3) #22 to (3) #10
- UL Listed and CSA certified



Part #	Mfg #	Model	Color	Qty	Price
WNU TAN-500	30-641	341	Tan	500/Bag	120.72

Splice Cap Crimp Terminal

- For #18 to #10 AWG wire
- Minimum: 2 #18 AWG
- Maximum: 4 #12 AWG
- Use Buchanan C24 crimp tool
- Designed for fast, permanent, pressure-type connections
- UL Listed and CSA certified



Part #	Mfg #	Description	Price
IDL2006S	2006S	100/Box	28.42

Splice Cap Crimp Connector

- For #14 to #4 AWG wire
- Minimum: (2) #10 AWG wire
- Maximum: (2) #6 AWG wire
- Use Buchanan C24 crimp tool
- Designed for fast, permanent, pressure-type connections
- UL Listed and CSA certified



Part #	Mfg #	Description	Price
IDL2011S	2011S	500/Box	37.18

Splice Cap Insulator for 2006S & 2008S

- Snap-on nylon construction
- Rated at 105° and 600V maximum



Part #	Mfg #	Description	Price
IDL2007	2007	1000/Box	28.56
IDL2014	2014	500/Box	27.81



Wire Connectors

Vinyl Insulated Fork Spade Terminal

- Electro-tin plated
- 221°F, 600V Maximum
- cULus Listed



Part #	Mfg #	Description	Price
MOR10164	10164	12-10 AWG Yellow	17.00

Vinyl Insulated Female Disconnect

- Electro-tin plated
- 167°F, 300V Maximum
- cULus Listed



Part #	Mfg #	Description	Price
MOR10332	10332	12-10 AWG Yellow	10.88

200 Piece Terminal Kit

- High impact reusable plastic box
- Contains:
 - Ring and spade terminals
 - Butt connectors
 - Male and female disconnects
- Terminal assortment is cULus listed



Part #	Mfg #	Description	Price
MOR10816	10816	200 Piece Terminal Kit	30.80

All Items May Not Be Stocked In All Branches

Electrical Connectors

Terminals

Quick Disconnect Solderless Insulated Terminal

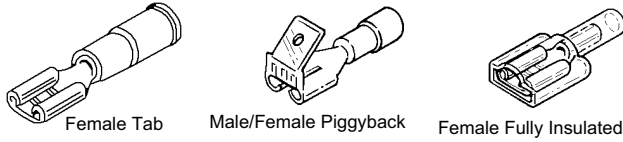

Part #	Mfg #	Description	Price
MAR86501	86501	16-14 3/16 Female Tab, 100/Pk	28.42
MAR86502	86502	16-14 1/4 Female Tab, 100/Pk	28.42
MAR86203	86203	12-10 1/4 Female Tab, 15/Pk	6.76
MAR86503	86503	12-10 1/4 Female Tab, 50/Pk	19.68
MAR86219	86219	22-18 3/16 Female Tab, 20/Pk	7.14
MAR86217	86217	16-14 1/4 Male/Female Piggyback, 12/Pk	6.76
MAR86507	86507	22-18 1/4 Female Fully Insulated, 100/Pk	46.06
MAR86508	86508	16-14 1/4 Female Fully Insulated, 100/Pk	46.06
MAR86520	86520	16-14 1/4 Female Flag, 25/Pk	18.48

Quick Disconnect Solderless Non-Insulated Terminal

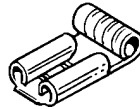

Part #	Mfg #	Description	Price
MAR86229	86229	16-14 1/4 Female Flag, 25/Pk	7.14
MAR86236	86236	12-10 1/4 Female Flag, 13/Pk	7.14

Solderless Insulated Ring Terminal

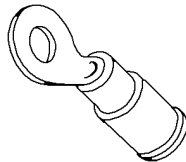

Part #	Mfg #	Description	Price
MAR86255	86255	16-14 #10 Stud 13/64ID, 20/Pk	7.14
MAR86559	86559	12-10 #10 Stud 13/64ID, 50/Pk	24.12

Solderless Insulated Flanged Spade Terminal

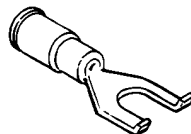

Part #	Mfg #	Description	Price
MAR86294	86294	16-14 #10 Stud 13/64ID, 15/Pk	7.14
MAR86295	86295	12-10 #10 Stud 13/64ID, 12/Pk	6.96

Solderless Insulated Spade Terminal

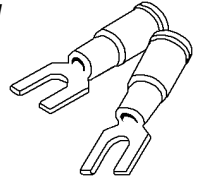

Part #	Mfg #	Description	Price
MAR86600	86600	22-18 #8 Stud 11/64ID, 100/Pk	28.42
MAR86603	86603	16-14 #8 Stud 11/64ID, 100/Pk	31.92
MAR86601	86601	16-14 #10 Stud 13/64ID, 100/Pk	37.14
MAR86302	86302	12-10 #10 Stud 13/64ID, 12/Pk	6.96
MAR86602	86602	12-10 #10 Stud 13/64ID, 100/Pk	24.12

Solderless Butt Connector Terminal

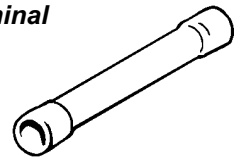

Part #	Mfg #	Description	Price
MAR86629	86629	22-18 Insulated, 100/Pk	28.42
MAR86630	86630	16-14 Insulated, 100/Pk	28.42

Non-Insulated Tab Adapter Terminal

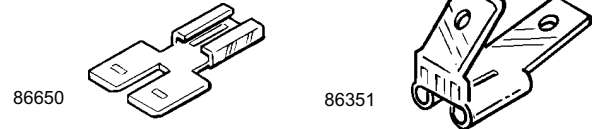

Part #	Mfg #	Description	Price
MAR86650	86650	1/4 2 Male x 1 Female, 100/Pk	26.94
MAR86351	86351	1/4 2 Male x 1 Female, 15/Pk	6.76

Solderless Non-Insulated Compressor Terminal

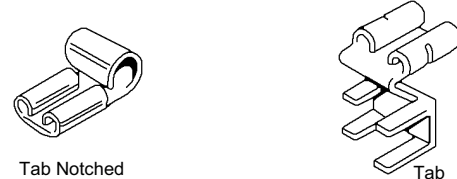

Part #	Mfg #	Description	Price
MAR86358	86358	12-10 1/4 Tab Notched for Bending, 13/Pk	6.96
MAR86359	86359	12-8 1/4 Tab, 8/Pk	6.76
MAR86659	86659	12-8 1/4 Tab, 50/Pk	31.92

Wire Tie Assortment Pack

Part #	Mfg #	Description	Price
MAR86125	86125	(200) 5", (200) 8", (50) 11", Nat	48.44

Mechanical Electrical Connectors

Electrical
Connectors

Dual Rated Mechanical Splicer/Reducer

- For use with aluminum and copper conductors
- Constructed from high strength, tin-plated aluminum
- Rounded bottoms
- Solid center barrier
- Large screw diameters
- Large cable ranges



Part #	Mfg #	# of Screws	Screw Dia	Wire Range	Body Size (H x W x L)	Hex Size	Price
BUYAMS2	AMS-2	2	3/8"	AWG 2 - AWG 14	9/16" x 9/16" x 1-19/32"	S	5.88

Electrical Wire Connectors

Unitap™ Multi-Port Connector with Single-Sided Entry

- UL486B Listed
- Tap connections and in-line splice/reductions are made quickly and easily with the
- Dual-rated AL9CU for any stranded copper or stranded aluminum applications. 600V,90° C
- Clear Plastisol covered AL6061-T6 aluminum body
- Range-taking -reduces number of connectors carried in inventory



Part #	Mfg #	# of Ports	Wire Range (AWG/kcmil)	Size (H x W x L)	Hex Key	Price
BUYBIBS2503	BIBS250-3	3	#10 - 250	2.13 x 2.07 x 2.97	5/16"	46.42

Unitap™ Multi-Port Connector with Double-Sided Entry

- UL486B Listed
- Tap connections and in-line splice/reductions are made quickly and easily with the
- Dual-rated AL9CU for any stranded copper or stranded aluminum applications. 600V,90° C
- Clear Plastisol covered AL6061-T6 aluminum body
- Range-taking -reduces number of connectors carried in inventory



Part #	Mfg #	# of Ports	Wire Range (AWG/kcmil)	Size (H x W x L)	Hex Key	Price
BUYBIBD6003	BIBD600-3	3	#4 - 600	2.75" x 3.00" x 4.97"	3/8"	78.88

Unitap™ Clear Insulated Multitap Connector

- UL486B Listed
- Tap connections and in-line splice/reductions are made quickly and easily with the
- Dual-rated AL9CU for any stranded copper or stranded aluminum applications. 600V,90° C
- Clear Plastisol covered AL6061-T6 aluminum body
- Range-taking -reduces number of connectors carried in inventory



Part #	Mfg #	# of Ports	Wire Range (AWG/kcmil)	Size (H x W x L)	Hex Key	Fig#	Price
BUYBIT020	BIT020	2	#14 - #4	1.25" x 1.16" x 1.16"	1/8"	1	21.46
BUYBIT350	BIT350	2	#10 - 350	2.50" x 2.32" x 2.22"	5/16"	1	45.42

All Items May Not Be Stocked In All Branches

Mechanical Electrical Connectors

Tritap™ Servit® Wire Conductor Connector

- For all combinations of aluminum to aluminum, aluminum to copper and copper to copper, aluminum alloy tin plated. Patented triangular penetration technology contact.
- UL 486B listed, 90°C rated
- No scratch brushing or oxide inhibitor required
- Orients the conductor
- Provides maximum pressure and assures a secure connection of run and tap conductors
- Facilitates piercing the aluminum conductor surface oxides
- Provides a low contact resistance and equal coefficient of expansion
- Inhibits the reformation of oxides by producing a gas-tight seal
- Provides improved retention of minimum to maximum conductor combinations



Electrical Connectors

Part #	Mfg #	Cross Flats	Size (W x L)	Torque	Price
BUYKSA6	KSA6	.75	.56" x 1.28"	165"-lb	4.16
BUYKSA4	KSA4	.81	.62" x 1.38"	165"-lb	5.80
BUYKSA2	KSA2	.94	.69" x 1.58"	275"-lb	6.28
BUYKSA10	KSA1/0	1.00	.75" x 1.92"	385"-lb	7.96
BUYKSA20	KSA2/0	1.12	.88" x 1.92"	385"-lb	12.86
BUYKSA40	KSA4/0	1.49	1.13" x 2.54"	500"-lb	22.04
BUYKSA350	KSA 350	1.69	1.50" x 3.24"	650"-lb	40.40

1-Conductor Universal Terminal

- UL Listed
- For aluminum and copper conductors
- Constructed from high strength aluminum alloy and electro tin-plated to provide low contact resistance



Fig 1



Fig 2

Part #	Mfg #	Wire Range (Alum or COP)	Stud Hole Size	Size (H x W x L)	Torque	Fig#	Price
BUYKA6U	KA6U	14 Str - 6 Str	1/4"	.50" x .50" x 1.06"	45"-lb	1	1.08
BUYKA2U	KA2U	14 Str - 2 Str	1/4"	.55" x .50" x 1.16"	50"-lb	1	1.46
BUYKA26U	KA26U	6 Str - 2/0 Str	1/4"	.80" x .63" x 1.47"	120"-lb	2	2.32
BUYKA29U	KA29U	6 Str - 250 kcmil	5/16"	1.13" x 1.00" x 2.00"	275"-lb	2	4.92
BUYKA31U	KA31U	6 Str - 350 kcmil	3/8"	1.25" x 1.13" x 2.25"	275" lb	2	6.38
BUYKA34U	KA34U	4 Str - 500 kcmil	3/8"	1.58" x 1.51" x .88"	500"-lb	2	12.42

2-Conductor Universal Terminal

- UL Listed
- For aluminum and copper conductors
- Constructed from high strength aluminum alloy and electro tin-plated to provide low contact resistance



Fig 2

Part #	Mfg #	Wire Range (Alum or COP)	Stud Hole Size	Size (H x W x L)	Torque	Fig#	Price
BUYK2A26U	K2A26U	(2) 14 Str - 2/0 Str	1/4"	.79" x 1.25" x 1.47"	120"-lb	2	4.58
BUYK2A29U	K2A29U	(2) 6 Str - 250 kcmil	3/8"	1.20" x 1.66" x 2.56"	275"-lb	2	11.82

Prices & Specifications are Subject to Change.

Mechanical Electrical Connectors

Electrical Connectors

Hylug™ Uninsulated Aluminum Compression Terminal

- UL Listed 600V, 35kV, 90°C
- For aluminum and copper conductors
- 1-Hole design



Part #	Mfg #	Code Conductor	Stud Size	Price
BUYA26A6	YA26A6	2/0 Str	3/8"	10.66
BUYA27A1	YA27A1	3/0 Str	3/8"	14.32
BUYA28A1	YA28A1	4/0 Str	3/8"	16.68
BUYA29A1	YA29A1	250 kcmil	1/2"	17.16
BUYA31A1	YA31A1	350 kcmil	1/2"	20.64
BUYA34A1	YA34A1	500 kcmil	5/8"	40.42
BUYA39A1	YA39A1	700/750 kcmil *	1/2"	45.88

Hylug™ Uninsulated Copper Compression Terminal

- UL Listed 600V, 35kV, 90°C
- 1-Hole design



Part #	Mfg #	Conductor (AWG/MM2)	Stud Size	Tongue Width	Price
BUYA2C	YA2C	#2 / 35	5/16"	2.29"	5.86

Hycrimp™ Line Tap

- For copper, aluminum or ACSR and compact conductors
- Wide range, universal and reversible
- Prefilled with PENETROX™ joint compound



Part #	Mfg #	Groove A (Run) Wire Dia Range	Groove B (Tap) Wire Dia Range	Size (H x W x L)	Price
BUYHO100	YHO100	.162 - .332	.162 - .332	1.12" x .70" x 1.25"	1.68
BUYHO150	YHO150	.260 - .419	.162 - .332	1.12" x .70" x 1.12"	2.18
BUYHD200	YHD200	.398 - .470	.162 - .332	1.44" x .89" x 1.62"	3.28
BUYHD300	YHD300	.336 - .470	.336 - .447	1.42" x .90" x 1.88"	5.84
BUYHD400	YHD400	.461 - .563	.461 - .563	1.49" x .89" x 2.50"	3.28

Loktap™ Compression Connector

- For aluminum to copper and aluminum to aluminum conductors

Part #	Mfg #	Groove A (Run) Wire Dia Range	Groove B (Tap) Wire Dia Range	Size (H x W x L)	Price
BUYHO1	YHO1	.162 - .332	.162 - .332	1.11" x .67" x 1.25"	84.00
BUYHD4	YHD4	.336 - .470	.336 - .477	1.42" x .83" x 1.88"	2.54

All Items May Not Be Stocked In All Branches

Mechanical Electrical Connectors

Splices and Splice Kits

Hylink™ Uninsulated Compression Splice

- UL Listed 600V, 35kV, 90°C
- Highly conductive aluminum tin-plated splice
- For aluminum to aluminum, aluminum to copper and copper to copper
- Accommodates conductors from #12 str through 1,000 kcmil in standard and heavy-duty applications
- Prefilled with PENETROX™ oxide inhibiting compounds
- Color-coded end caps



Part #	Mfg #	Code Conductor	Color Code	Wire Strip Length	Price
BUYYS26A1	YS26A1	2/0 Str	White	1-3/8"	14.46
BUYYS28A1	YS28A1	4/0 Str	White	1-5/8"	17.98
BUYYS2CA1	YS2CA1	2 Str	White	1-1/8"	7.96

In-Line Splice/Reducer

- UL Listed and CSA Certified for direct burial
- EPDM Rubber covered 6061-T6 aluminum connector
- Dual rated AL9CU for copper or aluminum conductor
- Broad range taking capability
- Low installation cost



Part #	Mfg #	Wire Range	Size (H x L)	Hex Size	Torque	Price
BUYUGS350ULDB	UGS350ULDB	12 AWG - 350 kcmil	2.81" x 8.50"	5/16"	350"-lb	32.30

Watertight Underground Splice Kit

- UL Listed for direct burial
- For all aluminum or copper/aluminum combinations
- Kit contains:
 - AMS Splice/reducer
 - (2) Heavy wall heat-shrink sleeves



Part #	Mfg #	Wire Range	Price
BUYUGSKIT2	UGSKIT2	2 Max / 8 Min	11.74

UF Underground Splice Kit

- UL Listed for direct burial
- For all aluminum or copper/aluminum combinations
- Kit contains:
 - UF Splice connector
 - A heavy wall heat-shrink sleeve



Part #	Mfg #	Wire Range (COP)	Price
BUYUGSKIT8	UGSKIT8	8 AWG - 14 AWG	20.46

Unirap™ UV Resistant Nylon Cable Ties

- UL Listed

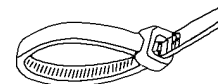

Part #	Mfg #	Length	Strength	Color	Pkq Qty	Price
BUYCT30125CO	CT30125CO	6"	30 lb	Black	100	7.71
BUYCT50175CO	CT50175CO	8"	50 lb	Black	100	7.85
BUYCT50300CO	CT50300CO	113/4"	50 lb	Black	100	9.55
BUYCT50400CO	CT50400CO	15-1/2"	50 lb	Black	100	10.62

Prices & Specifications are Subject to Change.

Installation

**Electrical
Connectors**

Connector Lugs

- Re-useable
- Corrosion proof



One-Bolt Mounting Connector Lug

Part #	Mfg #	Amps	Wire AWG	Price
CYTCL0004A3	CL0004A3	95	4	6.40
CYTCL0201A3	CL0201A3	150	2-1	4.94
CYTCL1020A3	CL1020A3	195	1/0-2/0	6.53
CYTCL3040A3	CL3040A3	260	3/0-4/0	9.25
CYTCL2530A4	CL2530A4	320	250-300	12.02

We have 32 convenient locations proudly serving Western NY, Central NY, and Northern Pennsylvania.

"Service Starts Here" is not just a motto it's how we do business.

Tape & Lubricants

Vinyl Electrical Tape

Super 33+™ Scotch® Vinyl Plastic Electrical Tape

- 7 mil, Holds in temperatures to 220°F
- PVC tape with high dielectric strength
- Pressure-sensitive rubber based adhesive
- Inhibits corrosion of electrical conductor
- Flame-retardant & conformable
- UL Listed



Part #	Mfg #	Size	Price
3MM33T	06132	3/4" x 66'	6.93

35 Scotch® Vinyl Electrical Color Coding Tape

- 7 mil, Holds in temperatures to 220°F
- Professional use
- Nine fade resistant colors
- Excellent insulating properties
- PVC Backing
- Resists UV rays, abrasion, corrosion, alkalis and acid
- UL Listed



Part #	Mfg #	Size	Color	Price
3MM35BL	10836	3/4" x 66'	Blue	5.39
3MM35BR	10885	3/4" x 66'	Brown	5.39
3MM35GR	10851	3/4" x 66'	Green	5.39
3MM35O	10869	3/4" x 66'	Orange	5.39
3MM35R	10810	3/4" x 66'	Red	5.39
3MM35W	10828	3/4" x 66'	White	5.39
3MM35Y	10844	3/4" x 66'	Yellow	6.44

Highland™ Vinyl Electrical Tape

- 7 mil Thick commercial grade vinyl insulation tape
- Flame-retardant, moisture-proof, abrasion resistant, conformable, general purpose
- UL Listed



Part #	Mfg #	Size	Color	Price
3MMHIGHLANDTAPE	HIGHLAND	3/4" x 66'	Black	3.26

Temflex™ 1700 Vinyl Electrical Tape

- Black, 7 mil economy-grade general use
- For less demanding indoor jobs



Part #	Mfg #	Size	Color	Price
3MM1700	69764	3/4" x 60'	Black	1.41

Insulating & Splicing Tape

130C Scotch® Linerless Rubber Splicing Tape

- Highly conformable, linerless Ethylene Propylene Rubber (EPR)
- High-voltage insulating - provides excellent thermal dissipation of splice heat



Part #	Mfg #	Size	Color	Price
3MM130C34	41717	3/4" x 30'	Black	18.97
3MM130C112	41718	1-1/2" x 30'	Black	35.95

2520 Scotch® Varnished Cambric Tape

- Excellent dielectric strength
- Electrical properties are stable up to 105°C
- High puncture and cut-through resistance
- Varnish cambric tape rated for Class A
- Non-corrosive pressure-sensitive adhesive

Part #	Mfg #	Size	Price
3MM2520	2520	3/4" x 60'	36.70

Special Use Tape

Temflex™ 1755 Cotton Friction Tape

- Thickness: 15 mil
- High-quality cotton fabric coated with an electrical-grade rubber adhesive
- High-break strength
- Low stretch
- Ideal for heavy-duty binding



Part #	Mfg #	Size	Color	Price
3MM1755	1755	3/4" x 60'	Black	4.47

Cord Management

3M™ Cable Stacker

- Centers multiple cables on a 2x4 framing member
- Made of reclaimed plastic

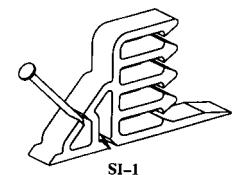

Part #	Mfg #	Description	Price
3MMSTAK-IT-SI-1	SI-1	White, Vertical Stack	0.65

Prices & Specifications are Subject to Change.

Tape & Lubricants

Electrical Products

3M™ Wire Pulling Lubricant Wax

- Used and stored in temperatures up to 194°F
- Good for hot weather applications



Part #	Mfg #	Size	Price
3MMWLX-QT	WLX-QT	1 Quart	17.60
3MMWLX-1	WLX-1	1 Gallon	40.91

Wire Pulling Gel

- Water-soluble translucent white gel
- Easy to handle and apply to wire and cable without runs or drips
- Temperature use range: 20° to 110°F



Part #	Mfg #	Size	Price
3MMWL-QT	WL-QT	1 Quart	15.87
3MMWL-1	WL-1	1 Gallon	38.09

Electrical Tape & Sealants

If you need a product not listed in this catalog, please check with us. We have not listed every product we can get for you.

Load Centers

Load Centers

Indoor Rock Solid Main Breaker Load Center

- NEMA 1
- 1 Ohm
- 22,000 AIC
- Value packs include load center and breakers



LC2040B1200

Part #	Mfg #	Description	Price
MURLC1224B1100	LC1224B1100	100A (12)Space (24)Max Circ 18"H x 14-3/8"W x 4"D	171.72
MURLC2040B1100P	LC2040B1100P	100A (20)Space (40)Max Circ 24"H x 14-3/8"W x 4"D, Value Pack - (6) MP120 Breakers	153.36
MURLC3040B1150	LC3040B1150	150A (30)Space (40)Max Circ 36"H x 14-3/8"W x 4"D	289.80
MURLC3040B1200P	LC3040B1200P	200A (30)Space (40)Max Circ 36"H x 14-3/8"W x 4"D, Value Pack - (6)MP120 & (2)MP230 Breakers	348.60
MURLC4040B1200P	LC4040B1200P	200A (40)Space (40)Max Circ 39"H x 14-3/8"W x 4"D, Value Pack - (8)MP120 & (2)MP230 Breakers	373.00

Indoor Main Lug Load Center

- NEMA 1



Part #	Mfg #	Description	Price
MURLC1224L1125	LC1224L1125	125A (12)Space (24)Max Circ 21"H x 14-3/8"W x 4"D	83.86
MURLC2040L1125	LC2040L1125	125A (20)Space (40)Max Circ 24"H x 14-3/8"W x 4"D	135.94
MURLC2040L1200	LC2040L1200	200A (20)Space (40)Max Circ 30"H x 14-3/8"W x 4"D	190.62
MURLC3040L1200	LC3040L1200	200A (30)Space (40)Max Circ 36"H x 14-3/8"W x 4"D	223.44
MURLC4040L1200	LC4040L1200	200A (40)Space (40)Max Circ 39"H x 14-3/8"W x 4"D	327.00

Indoor Main Lug Load Center with Copper Bus

- NEMA 1

Part #	Mfg #	Description	Price
MURLC1224L3125CU	LC1224L3125CU	125A (12)Space (24)Max Circ 21"H x 14-3/8"W x 3-15/16"D, 3ph	182.96
MURLC4242L3225CU	LC4242L3225CU	225A (42)Space (42)Max Circ 42"H x 14-3/8"W x 3-15/16"D, 3ph	493.66

Outdoor Rock Solid Main Lug Load Center

- NEMA 3R



LW2040L1200

Part #	Mfg #	Description	Price
MURLW1224L1125	LW1224L1125	125A (12)Space (24)Max Circ 20"H x 14-1/4"W x 4-1/2"D	185.04
MURLW2040L1125	LW2040L1125	125A (20)Space (40)Max Circ 29"H x 14-1/4"W x 4-1/2"D	254.88
MURLW2040L1200	LW2040L1200	200A (20)Space (40)Max Circ 29"H x 14-1/4"W x 4-1/2"D	328.32

Prices & Specifications are Subject to Change.

Load Centers

Spa Panel

- GFCI Breaker installed

Part #	Mfg #	Description	Price
MURLW004NRSPA50	LW004NRSPA50	125A (2)Space (4)Max Circ 12-1/4"H x 6-1/8"W x 4-1/4"D, 50A 2-Pole GFCI Breaker	157.36
MURLW004NRSPA60	LW004NRSPA60	125A (2)Space (4)Max Circ 12-1/4"H x 6-1/8"W x 4-1/4"D, 60A 2-Pole GFCI Breaker	164.94

Outdoor Trailer Panel

- Main lug only
- For main breaker application, use MBK breakers
- Hub provision only
- Closure plate included
- Panels through 225 amps require HS type hub

Part #	Mfg #	Description	Price
MURLW0816L1200TR	LW0816L1200TR	200A (8)Space (16)Max Circ 29"H x 14-1/4"W x 4-1/2"D	211.12

Indoor Small Load Center

- NEMA 1
- No door



Part #	Mfg #	Description	Price
MURLC002GS	LC002GS	60A (2)Space (4)Max Circ 9-7/8"H x 5-1/8"W x 2-5/8"D	38.94
MURLC004NS	LC004NS	125A (4)Space (8)Max Circ 12-5/8"H x 6-5/8"W x 3-1/2"D	41.24
MURLC004VS	LC004VS	200A (2)Space (4)Max Circ 19-3/4"H x 8-1/2"W x 4"D	157.46
MURLC008DS	LC008DS	125A (8)Space (16)Max Circ 14-3/4"H x 12-3/8"W x 3-7/8"D w/Door	73.30

Outdoor Small Load Center

- NEMA 3R
- No door

Part #	Mfg #	Description	Price
MURLW002GR	LW002GR	60A (2)Space (4)Max Circ 8-1/4"H x 5-3/8"W x 4-1/2"D	74.90
MURLW004NR	LW004NR	125A (4)Space (8)Max Circ 12-1/4"H x 6-1/8"W x 4-1/4"D	78.08
MURLW008NR	LW008NR	125A (8)Space (16)Max Circ 14-3/4"H x 12-1/8"W x 4-1/8"D w/Door	146.62

Indoor Small Load Center - Enclosed Breaker

- NEMA 1

Part #	Mfg #	Description	Price
MURLC100CS	LC100CS	100A (2)Space (4)Max Circ 17-1/8"H x 7-1/8"W x 4-1/4"D	137.76
MURLC200VS	LC200VS	200A (2)Space (4)Max Circ 19-3/4"H x 8-1/2"W x 4"D	323.90

Power Distribution

All Items May Not Be Stocked In All Branches

Load Centers

Outdoor Small Load Center - Enclosed Breaker

- NEMA 3R

Part #	Mfg #	Description	Price
MURLW100CR	LW100CR	100A (2)Space (4)Max Circ 17-3/8"H x 7-3/8"W x 4-3/8"D	180.54
MURLW200VR	LW200VR	200A (2)Space (4)Max Circ 19-7/8"H x 8-3/8"W x 4-5/8"D	491.26



Cutler-Hammer Breakers

Small Frame - Plug On - Single Pole

Cutler-Hammer



Part #	Mfg #	Description	Price
BUICH115	CH115	15 AMP-120 VAC	8.00
BUICH120	CH120	20 AMP-120 VAC	8.00

Small Frame - Plug On - Double Pole

Cutler-Hammer



Part #	Mfg #	Description	Price
BUICH215	CH215	15 AMP-240 VAC	20.00
BUICH220	CH220	20 AMP-240 VAC	20.00
BUICH230	CH230	30 AMP-240 VAC	20.00
BUICH240	CH240	40 AMP-240 VAC	20.00
BUICH250	CH250	50 AMP-240 VAC	20.00
BUICH260	CH260	60 AMP-240 VAC	20.00
BUICH2100	CH2100	100 Amp 120/240 VAC	71.82

Power Distribution

Type CH Plug-On Ground Fault - Single Pole

- Pole requires (1) 3/4" space
- 10 kAIC
- #14-6 Wire size range

Cutler-Hammer



Part #	Mfg #	Description	Price
BUICH115GF	CH115GF	15 AMP-120 VAC	75.81
BUICH120GF	CH120GF	20 AMP-120 VAC	75.81

Prices & Specifications are Subject to Change.

Circuit Breakers

Type CHT Twin Plug-On Breaker

- Use only with loadcenters marked for use with CHT breakers
- Volts: 120VAC
- 10kAIC



Part #	Mfg #	Amps	Wire	Price
BUICHT1515	CHT1515	15/15A	#14-8	32.05
BUICHT2020	CHT2020	20/20A	#14-8	35.94

Type BR Small Frame - Plug On - Single Pole

Cutler-Hammer



Part #	Mfg #	Description	Price
BUIBR115	BR115	15 AMP-120 VAC	6.40
BUIBR120	BR120	20 AMP-120 VAC	6.38

Type BR Small Frame - Plug On - Double Pole

Cutler-Hammer



Part #	Mfg #	Description	Price
BUIBR215	BR215	15 AMP-240 VAC	15.00
BUIBR220	BR220	20 AMP-240 VAC	15.00
BUIBR230	BR230	30 AMP-240 VAC	15.00
BUIBR240	BR240	40 AMP-240 VAC	15.00
BUIBR250	BR250	50 AMP-240 VAC	15.00
BUIBR2100	BR2100	100 AMP-240 VAC	58.79

Type BR Non CTL Duplex Plug-On Replacement

- For replacement in enclosures manufactured prior to 1968 with unnotched stabs
- Circuit breakers do not have rejection tab
- 10 kAIC
- 120 VAC

Cutler-Hammer



Part #	Mfg #	Description	Price
BUIBR1515	BR1515	15 AMP/15 AMP	24.00
BUIBR2020	BR2020	20 AMP/20 AMP	24.00

All Items May Not Be Stocked In All Branches

Circuit Breakers

Circuit Breakers

Type MP-T Full Size Plug-In Circuit Breaker with Insta-Wire

- Amps - continuous current rating @ 40°C
- 1" Per Pole



Part #	Mfg #	Description	Price
MURMP115	MP115	15A 1-Pole 120V	9.20
MURMP120	MP120	20A 1-Pole 120V	9.20
MURMP215	MP215	15A 2-Pole 120/240V	20.82
MURMP220	MP220	20A 2-Pole 120/240V	20.82
MURMP230	MP230	30A 2-Pole 120/240V	20.82
MURMP240	MP240	40A 2-Pole 120/240V	20.82
MURMP250	MP250	50A 2-Pole 120/240V	20.82
MURMP260	MP260	60A 2-Pole 120/240V	20.82
MURMP270	MP270	70A 2-Pole 120/240V	60.86
MURMP280	MP280	80A 2-Pole 120/240V	88.32
MURMP290	MP290	90A 2-Pole 120/240V	88.32
MURMP2100	MP2100	100A 2-Pole 120/240V	88.32
MURMP2125	MP2125	125A 2-Pole 120/240V	182.30
MURMP315	MP315	15A 3-Pole 240V	121.18
MURMP320	MP320	20A 3-Pole 240V	121.18
MURMP330	MP330	30A 3-Pole 240V	121.18
MURMP340	MP340	40A 3-Pole 240V	121.18
MURMP350	MP350	50A 3-Pole 240V	121.18
MURMP360	MP360	60A 3-Pole 240V	121.18
MURMP3100	MP3100	100A 3-Pole 240V	181.80

Type MH-T Duplex Plug-In Circuit Breaker

- Space saver breakers - two independent 1/2" breaker poles in one unit
- 10kAIC



Part #	Mfg #	Description	Price
MURMP1515	MP1515	15/15A 1-Pole 120V	24.58
MURMP2020	MP2020	20/20A 1-Pole 120V	24.58

Power Distribution

Circuit Breakers

Combination Type Arc-Fault Circuit Interrupter

- UL Listed
- Standard 1" per pole format with plug-in design
- MP-AP/MP-HAT Breaker type



Part #	Mfg #	Description	Price
MURMP115AFC	MP115AFC	15A 1-Pole 120V	82.18
MURMP120AFC	MP120AFC	20A 1-Pole 120V	82.18
MURMP215AFC	MP215AFC	15A 2-Pole 120/240V	168.00
MURMP220AFC	MP220AFC	20A 2-Pole 120/240V	168.00

Ground-Fault Circuit Interrupter

- Plug-In style standard 1" per pole
- MP-GT/MP-HGT Type breaker
- UL Listed and CSA certified



Part #	Mfg #	Description	Price
MURMP115GF	MP115GF	15A 1-Pole 120V	77.30
MURMP120GF	MP120GF	20A 1-Pole 120V	77.30
MURMP215GF	MP215GF	15A 2-Pole 120/240V	217.26
MURMP220GF	MP220GF	20A 2-Pole 120/240V	217.26
MURMP230GF	MP230GF	30A 2-Pole 120/240V	217.26
MURMP240GF	MP240GF	40A 2-Pole 120/240V	217.26

Type MSQ Plug-In Circuit Breaker

- Amps - continuous current rating @ 40°C
- 3/4" Per Pole
- UL Classified and listed



Part #	Mfg #	Description	Price
MURMQ115	MQ115	15A 1-Pole 120V	17.44
MURMQ120	MQ120	20A 1-Pole 120V	17.44
MURMQ215	MQ215	15A 2-Pole 120/240V Common Trip	38.02
MURMQ220	MQ220	20A 2-Pole 120/240V Common Trip	38.02
MURMQ230	MQ230	30A 2-Pole 120/240V Common Trip	38.02
MURMQ240	MQ240	40A 2-Pole 120/240V Common Trip	38.02
MURMQ250	MQ250	50A 2-Pole 120/240V Common Trip	38.02
MURMQ260	MQ260	60A 2-Pole 120/240V Common Trip	38.02

Type MD-T Common Trip Main/Branch Circuit Breaker

Part #	Mfg #	Description	Price
MURMPD2150	MPD2150	150A 2-Pole 120/240V	228.60
MURMPD2200	MPD2200	200A 2-Pole 120/240V	228.60

All Items May Not Be Stocked In All Branches

Circuit Breakers

Main Breaker Kit

- For Rock Solid load center

Part #	Mfg #	Description	Price
MURMBK100M	MBK100M	100A for 2-Pole 120/240V 100&125A Rock Solid Load Centers	98.78
MURMBK150M	MBK150M	150A for 2-Pole 120/240V 150,200&225A Rock Solid Load Centers	167.56
MURMBK200M	MBK200M	200A for 2-Pole 120/240V 200&225A Rock Solid Load Centers	179.36

Safety Switches

Indoor General Duty Fusible with Class H Fuse Holder

- NEMA 1
- Insulated groundable neutral
- Convertible to Class R



Part #	Mfg #	Description	Price
MURGHN321N	GHN321N	30A 2-Pole 3-Wire 240V SSW Cartridge	65.10
MURGHN421N	GHN421N	30A 3-Pole 4-Wire 240V SSW Cartridge	110.70
MURGHN422N	GHN422N	60A 3-Pole 4-Wire 240V SSW Cartridge	175.38
MURGHN423N	GHN423N	100A 3-Pole 4-Wire 240V SSW Cartridge	305.44
MURGHN424N	GHN424N	200A 3-Pole 4-Wire 240V SSW Cartridge	578.06
MURGHN425NH	GHN425NH	400A 3-Pole 4-Wire 240V SSW Cartridge, Height Reduced, Special Order	1464.74

Indoor General Duty Compact Fusible

- NEMA 1
- Insulated groundable neutral

Part #	Mfg #	Description	Price
MURGP321N	GP321N	30A 2-Pole 3-Wire 240V SSW Plug	49.98

Outdoor General Duty Fusible with Class H Fuse Holder

- NEMA 3R
- Insulated groundable neutral
- Convertible to Class R



Part #	Mfg #	Description	Price
MURGHN321NW	GHN321NW	30A 2-Pole 3-Wire 240V RTSSW Cartridge	110.70
MURGHN421NW	GHN421NW	30A 3-Pole 4-Wire 240V RTSSW Cartridge	165.16
MURGHN422NW	GHN422NW	60A 3-Pole 4-Wire 240V RTSSW Cartridge	238.48
MURGHN423NW	GHN423NW	100A 3-Pole 4-Wire 240V RTSSW Cartridge	440.64
MURGHN424NW	GHN424NW	200A 3-Pole 4-Wire 240V RTSSW Cartridge	746.74
MURGHN425NWH	GHN425NWH	400A 3-Pole 4-Wire 240V RTSSW Cartridge, Height Reduced	1927.30

Power Distribution

Prices & Specifications are Subject to Change.

Safety Switches

Indoor General Duty Non-Fusible with Class H Fuse Holder

- NEMA 1
- Less neutral
- Convertible to Class R



Part #	Mfg #	Description	Price
MURGUN321	GUN321	30A 3-Pole 240V SSW	87.28
MURGUN322	GUN322	60A 3-Pole 240V SSW	114.06

Outdoor General Duty Non-Fusible with Class H Fuse Holder

- NEMA 3R
- Less neutral
- Convertible to Class R

Part #	Mfg #	Description	Price
MURGUN321AW	GUN321AW	30A 3-Pole 240V RTSSW	164.58
MURGUN322AW	GUN322AW	60A 3-Pole 240V RTSSW	244.96

Indoor Heavy Duty Fusible with Class H Fuse Holder

- NEMA 1
- Insulated groundable neutral
- Convertible to Class J, R or T

Part #	Mfg #	Description	Price
MURHHN361	HHN361	30A 3-Pole 3-Wire 600V SSW Cartridge Fuse	289.80
MURHHN362	HHN362	60A 3-Pole 3-Wire 600V SSW Cartridge Fuse	345.24

Outdoor Heavy Duty Fusible with Class H Fuse Holder

- NEMA 3R
- Insulated groundable neutral
- Convertible to Class J, R or T



Part #	Mfg #	Description	Price
MURHHN361AW	HHN361AW	30A 3-Pole 3-Wire 600V RTSSW Cartridge Fuse	509.02
MURHHN362AW	HHN362AW	60A 3-Pole 3-Wire 600V RTSSW Cartridge Fuse	596.68

Indoor Heavy Duty Non-Fusible with Class H Fuse Holder

- NEMA 1
- Less neutral
- Convertible to Class J, R or T

Part #	Mfg #	Description	Price
MURHUN361	HUN361	30A 3-Pole 3-Wire 600V SSW Cartridge Fuse	152.88
MURHUN362	HUN362	60A 3-Pole 3-Wire 600V SSW Cartridge Fuse	271.74

Power Distribution

All Items May Not Be Stocked In All Branches

Safety Switches

Outdoor Heavy Duty Non-Fusible with Class H Fuse Holder

- NEMA 3R
- Less neutral
- Convertible to Class J, R or T

Part #	Mfg #	Description	Price
MURHUN361AW	HUN361AW	30A 3-Pole 3-Wire 600V RTSSW Cartridge Fuse	275.36
MURHUN362AW	HUN362AW	60A 3-Pole 3-Wire 600V RTSSW Cartridge Fuse	484.34



Disconnect Boxes

MARS NEMA 3R Pullout Disconnect

- Air conditioner disconnects
- Zinc coated steel
- UL Listed



Part #	Mfg #	Description	Price
ELEDB60	83315	60A Non-Fused Single-Phase	22.96
ELEDB30F	83316	30A Fused Single-Phase	24.19

Midwest Three Phase Pullout Disconnect

- 240V
- Zinc coated steel
- NEMA 3R



Part #	Mfg #	Description	Price
ELEDB603	83321	60A Non-Fused	111.27

Pullout NEMA 3R A/C Disconnect with GFCI Receptacle

- 240V AC, single-phase
- Duplex 15A GFCI receptacle included
- UL & CUL listed



Part #	Mfg #	Description	Price
ELEDB60GFI	83308	60A Non-Fused, Single-Phase	84.00

Power Distribution

Electrical Metering

Meter Mounting Equipment

Universal All-in-One Meter Main

- Universal copper interior breaker panel
- Includes sub-feed lugs
- Ringless
- Rated 22KAIC
- OH or UG service entrance and load exit
- Removable covers
- UL Listed



Part #	Mfg #	Main	Terminals	By-Pass	Circuits	Price
MIKU5168XTL100	U5168XTL100KKPL	100A	4	Horn	8	765.55
MIKU5168XTL150	U5168XTL150KKPL	150A	4	Horn	8	867.15
MIKU5168XTL200	U5168XTL200KKPL*	200A 2P	4	Horn	8	867.15

* National Grid NY Service Area - for Overhead & Underground Service, is a Complete Cable-in-Conduit System

U125_ Series Meter Socket

- 200A/Meter, 300VAC
- (4) Terminals, accepts 5th terminal
- Center wireway
- Ringless
- Horizontal gangs
- Includes aluminum bussing
- UL Listed



Part #	Mfg #	Hub	By-Pass	Gangs	Price
MIKU1252	U1252RKKRGE*	Large	Horn	2	602.53
MIKU1253	U1253RKKRGE*	Large	Horn	3	782.73
MIKU1254	U1254RKKRGE*	Large	Horn	4	1047.17

* Approved for NYSeg, RGE & National Grid NY Service Areas

200 AMP 600 VAC - 4 Terminal Residential Meter Socket

- Ringless
- Single-position
- 4-1/8"D x 8"W x 15-1/2"H

Part #	Mfg #	Amps	Type	Price
MIKU7021	U7021RLTGKKRGE*	200A	OH	156.77

* Approved for NYSeg, RGE & National Grid NY Service Areas

Power Distribution

Thank you for doing business with us. We appreciate your order.

Electrical Metering

National Grid 200 AMP 600 VAC - 5 & 7 Terminal Meter Socket

- Ringless
- Heavy-duty lever bypass



U2047-O



U2048-RL

Part #	Mfg #	Terminals	Service	Hub	Price
MIKU2048	U2048-RL	5 JAW	OH	H.O.	401.65
MIKU2047	U2047-O	5 JAW	UG	Blank	458.37
MIKU2049	U2049-RL	7 JAW	OH	H.O.	504.25

* Approved for NYSeg, RGE & National Grid NY Service Areas

U2448 Series Meter Socket with Heavy-Duty Lever Bypass

- 320A 600VAC
- Ringless
- (4) Terminals, accepts 5th terminal
- UL Listed
- OH/UG service type
- Side wireway



Part #	Mfg #	Terminals	Service	Hub	Price
MIKU2448	U2448-X-RGE	4 JAW	OH/UG	C.P.	715.93

U7040 Series Meter Socket - 1-Gang

- 200A, 600VAC
- Ringless
- (4) Terminals, accepts 5th terminal
- Residential
- 4-1/8" x 11" x 14-5/8"
- UL Listed
- Horn bypass
- Triplex ground
- Small hub opening



Part #	Mfg #	Amps	Type	Price
MIKU7040	U7040RLTGKKRGE*	200A	OH/UG	184.84

* Approved for NYSeg, RGE & Central Hudson Service Areas, Designated for Underground Service

U7487 Series Meter Socket - 1-Gang

- 125A, 600VAC
- Ringless
- (4) Terminals, accepts 5th terminal
- 3-15/16" x 8" x 11-1/2"
- UL Listed



Part #	Mfg #	Description	Price
MIKU7487	U7487-RL-TG-KK	OH/UG, Small Hub Opening, Triplex Ground, Horn By-Pass	106.28

Prices & Specifications are Subject to Change.

Electrical Metering

U9090 Series Meter Socket - 4 Terminal

- Ringless
- Single-position
- 200A, 600VAC, Ringless
- 4-1/2"D x 9"W x 20-3/4"H
- 3/8"-16 Stud line; #6-350 kcmil load
- Approved for national grid NY service area



Part #	Mfg #	Amps	Type	Price
MIKU9090	U9090-O	200	UG	230.51

Commercial Electrical Enclosures

Enclosures - Type 1 - Screw Cover Junction Box and Cover

- Intended for indoor use primarily to provide a degree of protection against limited amounts of falling dirt
- Designed for use as a junction box or pull box
- Covers have teardrop slots
- With knockouts, painted
- Grounding emboss provided with green plated grounding screw
- ANSI 61 gray polyester powder coating inside and out
- NEMA Type 1, UL50 - Type 1, CUL Type 1 (CSA)

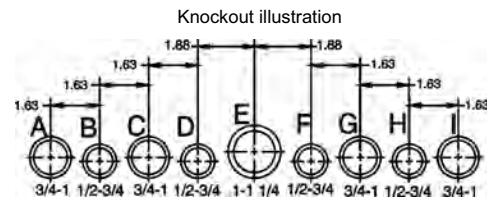

Part #	Mfg #	W x H x D	KO A Side	KO B Side	Price
MIKJBOX6-6-4	664-SC1	6" x 6" x 4"	B-C-D	None	21.76
MIKJBOX8-8-4	884-SC1	8" x 8" x 4"	F-G-H-I	None	32.84
MIKJBOX8-10-6	8106-SC1	8" x 10" x 6"	F-G-H-I	None	41.07
MIKJBOX10-10-4	10104-SC1	10" x 10" x 4"	F-G-H-I	None	39.82
MIKJBOX12-12-4	12124-SC1	12" x 12" x 4"	C-D-E-F-G	C-D-E-F-G	52.73
MIKJBOX12-12-6	12126-SC1	12" x 12" x 6"	C-D-E-F-G	None	62.10

Enclosures - Type 3R - Screw Cover Junction Box and Cover

- Intended for outdoor use primarily to provide a degree of protection against rain, sleet and damage from external ice formation
- Designed for use as a junction box or pull box
- G90U Galvanized steel enclosure and covers
- With concentric knockouts on bottom
- Mounting embosses provided on back of each enclosure
- ANSI 61 gray polyester powder coating
- NEMA Type 3R, UL50 - Type 3R, CUL Type 3R (CSA)

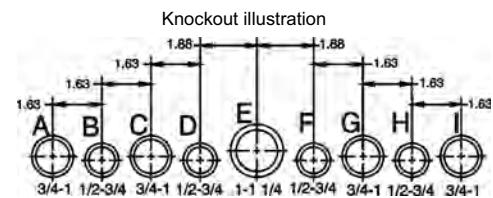

Part #	Mfg #	W x H x D	KO Pattern	Price
MIKJBOXRT6-6-4	664-SC3R	6" x 6" x 4"	B-C-D	33.45
MIKJBOXRT8-8-4	884-SC3R	8" x 8" x 4"	F-G-H-I	43.54

Power Distribution

Electrical Metering

Wireway - Type 1 - Screw Cover Lay-In Wireway less Cover

- Designed to allow long interrupted runs of electrical wiring where moisture and dust are not a problem
- All straight sections and fittings are completely open on one side
- Code gauge steel, with knockouts, painted
- Covers incorporate teardrop slots
- ANSI 61 gray polyester powder paint finish



Part #	Mfg #	H x D x L (in)	KO Clusters /Side	Nbr Clusters	Price
MIKWW6-6-36	6636-GSC1	6" x 6" x 36"	Series 2	1	78.74
MIKWW6-6-60	6660-GSC1	6" x 6" x 60"	Series 3	5	118.23

Wireway - Type 3R - Screw Cover Lay-In Wireway

- Designed to protect long uninterrupted runs of electrical wiring in outdoor installations against rain, sleet, or snow or indoors against dripping water
- 16 Gauge G90U galvanized steel
- With knockouts on bottom
- Screw-in cover fits under drip shield top
- Embossed mounting holes on back
- ANSI 61 gray polyester powder paint finish



Part #	Mfg #	H x D x L (in)	Number of KOs	Price
MIKWWRT6-6-36	6636-GSC3R	6" x 6" x 36"	5	161.92
MIKWWRT6-6-60	6660-GSC3R	6" x 6" x 60"	9	243.33

Wireway Fittings - GE End Cap

- For use with GSC1 and GHC1 wireways
- Closes the end of a wireway section or run
- Concentric knockouts
- GFIT Product family
- Screws not included



Part #	Mfg #	Size	Price
MIK66GE	66GE	6" x 6"	10.44

Interchangeable Unit Hubs

Small Hub "RL" Opening (Standard)



Part #	Mfg #	Size	Price
MIKHUB114	A7515	1-1/4"	12.30
MIKHUB112	A7516	1-1/2"	12.30
MIKHUB2	A7517	2"	12.30
MIKHUB212	A7518	2-1/2"	14.86

Power Distribution

Electrical Metering

Removable Hub Closing Plate



Part#	Mfg #	Application	Price
MIKHUBCL	A7551	Small for UG Feed on All Sockets with RL	8.25

Hub Adapter Plate

- Converts 4" opening to 2-1/2" opening



Part#	Mfg #	Application	Price
MIKHUBAD	S8324	For Sockets with X or R and Hubs Smaller Than 3"	12.30

Transformer Enclosures

CT3R - Commercial Current Transformer Enclosure

- Designed for use as current transformer cabinet or panel enclosure
- NEMA 3R, Outdoor use
- G90 Galvanized steel
- Doors overlap, no center post
- Galvanized lift-off hinges with stainless steel pins
- Padlockable draw latch
- Drip shield top and seam-free sides, front and back



Part #	Mfg #	Dimensions (H x W x L)	Price
MIKTRANS36-36-10	363610-CT3R-H	36" x 36" x 10"	845.44

Outlets

- Type 3R
- Lockable cover
- Single receptacle only power outlet

Part #	Model #	Description	Price
MIKP54	P54	50A 4W Rt Outlet	95.82

Power Distribution

Prices in this catalog are subject to change without notice. Please call us for a quote - Quantity pricing is available.

Power Distribution Accessories

Accessories

Circuit Breaker Accessory

Part #	Mfg #	Description	Price
MURECMBR1	ECMBR1	Main Breaker Retainer Clip for EQ Load Centers	4.06
MURECMBR2	ECMBR2	Main Breaker Retainer Clip for Ultimate Load Centers	10.10

Filler Plate

Part #	Mfg #	Description	Price
MURECQF3	ECQF3	For Branch Breakers and 150-225A Ultimate Main Breaker 5/Bag	2.02

Interchangeable Hub

Part #	Mfg #	Description	Price
MURECHS125	ECHS125	1-1/4" HS Type Conduit Hub	27.26
MURECHS150	ECHS150	1-1/2" HS Type Conduit Hub	22.98
MURECHS200	ECHS200	2" HS Type Conduit Hub	39.14
MURECHS250	ECHS250	2-1/2" HS Type Conduit Hub	61.30

Grounding Bar

- Large connectors rated for (1) #14-1/0 or (2 or 3) #14-10 Cu/Al
- Small connectors rated for (1) #14-6 or (2) #14-12 Cu/Al

Part #	Mfg #	Length	# Large Connectors	#Small Connectors	Price
MURECLX068M	ECLX068M	1-5/8"	0	4	8.06
MURECLX069M	ECLX069M	2-5/16"	2	5	11.08
MURECLX071M	ECLX071M	3-1/2"	3	8	11.08
MURECLX072M	ECLX072M	4-5/8"	4	11	12.12
MURECLX073M	ECLX073M	5-3/4"	5	14	13.12
MURECLX074M	ECLX074M	7"	6	17	17.16
MURECLX075M	ECLX075M	8-1/8"	7	20	19.18

Load Center Conversion Kit

Part #	Mfg #	Description	Price
MURECMLK125	ECMLK125	Main Lug Conversion Kit for 100-125A Ultimate Load Centers	17.16
MURECMLK225	ECMLK225	Main Lug Conversion Kit for 150-225A Ultimate Load Centers	18.16

Neutral Feeder Lug Kit

Part #	Mfg #	Description	Price
MURECLK1-2	ECLK1-2	#2-1/0 Lug Kit for Neutral Bar EQIII	10.10
MURECLK2	ECLK2	#4-2/0 Lug Kit for Neutral Bar	13.12

Prices & Specifications are Subject to Change.

Power Distribution Accessories

Standby Power Manual Transfer Interlock Kit

- For use only on Siemens and Murray products
- Mechanically interlocks two main breakers so both circuit breakers cannot be ON at the same time, converting the panel into a standby power panel
- Durable, corrosion resistant steel
- Remains attached to circuit breakers when cover is removed



Part #	Mfg #	Description	Price
MURECSBPK03	ECSBPK03	Standby Power Interlock Kit - Generator Interlock	210.68

Sub-Feed Lug Kit

Part #	Mfg #	Description	Price
MURECLK2125	ECLK2125	#3-1 AWG Cu, #1/0 AWG Al, 2-Pole 125A	21.18
MURECLK2150	ECLK2150	#14-2/0 AWG Cu, #1/0 AWG Al, 2-Pole 150A	64.60
MURECLK2225	ECLK2225	#2-300 AWG, 2-Pole 225A	100.92



Definite Purpose Contactors

Part #	Mfg #	Description	Price
BUIBUC438UMM10	BUC438UMM10	24V 3-Pole 40A FLA 50A Resistive	35.25
BUIBUC438UMM20	BUC438UMM20	120V 3-Pole 40A FLA 50A Resistive	41.71

Power Distribution Accessories

We appreciate your Business!

Fuses

General Purpose Fuses

FRN-R Class RK5 Fusetron® Dual-Element Time-Delay Fuse

- Current limiting
- UL Listed, CSA certified



Part #	Mfg #	Volts	Amps	Price
FUSFRNR15	FRN-R-15	250VAC	15A	6.92
FUSFRNR20	FRN-R-20	250VAC	20A	8.75
FUSFRNR30	FRN-R-30	250VAC	30A	6.00
FUSFRNR40	FRN-R-40	250VAC	40A	9.26
FUSFRNR50	FRN-R-50	250VAC	50A	9.48
FUSFRNR60	FRN-R-60	250VAC	60A	9.48
FUSFRNR100	FRN-R-100	250VAC	100A	23.77
FUSFRNR400	FRN-R-400	250VAC	400A	91.11

FRS-R Class RK5 Fusetron® Dual-Element Time-Delay Fuse

- Current limiting
- UL Listed, CSA certified



Part #	Mfg #	Volts	Amps	Price
FUSFRSR20	FRS-R-20	600VAC	20A	13.83
FUSFRSR30	FRS-R-30	600VAC	30A	12.24
FUSFRSR200	FRS-R-200	600VAC	200A	61.82
FUSFRSR400	FRS-R-400	600VAC	400A	158.04

NON One-Time General Purpose Fuse

- Non-current limiting
- Class K5: 0 to 60A
- Class H: 65 to 600A
- UL Listed, CSA certified



Part #	Mfg #	Volts	Amps	Price
FUSNON400	NON-400	250VAC	400A	82.51



Fuses

Box Cover Units

- Maximum 15 Amps
- Maximum 125VAC
- UL Listed and CSA certified
- For use with type T plug fuses



Part #	Mfg #	Description	Price
ELESGLESWITCH	620-608	Switch/Fuse Combo/ESSU	21.80
ELESQSWITCH	620-6083	Switch/Fuse Combo Square/ESSY	24.20

Time Delay Plug Fuse



Part #	Mfg #	Description	Price
ELETD15A	626-15T	15A Type T Plug Fuse	5.96

Fuses & Generators

Generators

Fuses & Generators

Guardian Series Generators

Residential Standby Air Cooled Generator

- True Power® electrical technology
- Two line LCD tri-lingual digital Nexus™ controller
- Electronic governor
- External main circuit breaker
- 17kW Model: GFCI Duplex outlet
- System status LED indicators
- Flexible fuel line connector
- Composite mounting pad
- 29"H x 25"W x 48"L
- 3-Year limited warranty
- UL 2200 Listed



Part #	Mfg #	Kilowatts	Price
GNR7KW	5837	7kW	CALL
GNR8KW	5882	8kW	CALL
GNR10KW	5883	10kW	CALL
GNR14KW	5884	14kW	CALL
GNR17KW	5885	17kW	CALL

Transfer Switches



RTS Series

12-Circuit Load Center ATS Transfer Switch

- 27"H x 13"W x 7"D
- 120/240V
- Express install kit included
- NEMA 1 enclosure type
- Withstand rating: 10,000



Part #	Mfg #	Amps	Price
GNRRTS12EZA1	RTSH100A1	100A	905.98
GNRRTSD200A3	RTSD200A3	200A	1794.70

Generator Accessories

Air-Cooled Scheduled Maintenance Kit



Part #	Mfg #	Kilowatts	Size	Price
GNRMAINT7KW	5661	7kW	410cc	33.12
GNRMAINT8KW	5662	8kW	410cc	33.12
GNRMAINT10KW	5663	10kW	530cc	44.16
GNRMAINT12-18KW	5664	12-18kW	760-990cc	41.40



Pro/Tran® Indoor Manual Transfer Switches

- Indoor surface mount transfer switches
- For residential and commercial applications
- 18" Flexible conduit whip
- Rugged powder-coated steel cabinet with six combination 1/2" and 3/4" knockouts

30310A Pro/Tran Load-Side® Transfer Switch

- Listed to UL1008



Part #	Mfg #	Description	Price
RELPRTRSW10	30310A	10 Circuit w/Watt Meter Cord Connected	545.00

31406CRK Pro/Tran Load-Side® Transfer Switch Kit

- Hardwire
- Includes: 31406C, PC3010, PB30 and L1420P



Part #	Mfg #	Description	Price
RELTSFSWKT6	31406CRK	6 Circuit w/Watt Meter	519.00

Transfer Switches

31410CRK Pro/Tran Load-Side® Transfer Switch Kit



Part #	Mfg #	Description	Price
RELTSFSWKT10	31410CRK	10 Circuit w/Watt Meter	698.00

PB30 Power Inlet Box

- Designed for outdoor use
- Can be hardwired directly to Reliance Controls transfer switches or panels
- 7500 Maximum generator running watts
- Maximum generator input 30A@125/250VAC
- NEMA 3R Rain-tight, rust-proof unit



Part #	Mfg #	Dimensions	Price
RELPB30	PB30	6"H x 4"W x 2.63"D	82.58

THP201 PhoneAlert™

- Power failure, freeze and flood home monitoring system
- Phone not included



Part #	Mfg #	Description	Price
RELPNAL	THP201	PhoneAlert	128.00

Fuses & Generators

**Can't find what you are looking for?
We have access to hundreds
of vendors and thousands
of items not listed in this catalog**



www.irrsupply.com

Installation Tools

Conduit Installation

Aluminum Bender with Handle

- Lightweight aluminum construction for easy handling
- Heat treated for extra strength
- Reinforced at stress point for longer life
- Precision-located degree scale, star, arrow and rim notch for perfect bends
- Markings are raised and cast into bender body on both sides for easy visibility
- Deeply serrated step helps prevent slippage when applying maximum leverage
- Grooved internal hook surface helps prevent conduit from slipping
- Flat hook surface provides stable starting point



Part #	Mfg #	Description	Price
IDLBENDER12	74-046	Al Bender w/Handle for 1/2" EMT	58.00
IDLBENDER34	74-047	Al Bender w/Handle for 3/4" EMT	72.50
IDLBENDER1	74-028	Al Bender w/Handle for 1" EMT	132.47



Better Service Thru Better People

Conduit Installation

Powr-Fish® Heavy-Duty Pull-Line

- White with blue tracer for easy identification
- Continuous-fiber polyline great for blowing directly into conduit
- Will not rot or mildew
- Can be left in conduit for future use



Part #	Mfg #	Size	Tensile Strength	Price
IDLPULLLINE	31-338	6,500 Long	190 lb	66.21

All Items May Not Be Stocked In All Branches

Electrical Supplies

Wire Management

Barricade Tape

- 3 mil Non-adhesive reusable polyethylene
- Continuous repeat of warning
- Used above ground to mark off hazards
- CAUTION CAUTION CAUTION legend



Part #	Mfg #	Description	Price
MOR69000	69000	Yellow 3" x 1,000' "Caution Caution..."	40.22

Underground Tape

- 4 mil Non-adhesive polyethylene
- Continuous repeat of warning
- Protects buried utility lines
- Should be installed 12" to 18" below ground level and 12" above pipes and conduits before backfilling
- Formulated to resist degradation from acid and alkali found in soils



Part #	Mfg #	Description	Price
MOR69010	69010	Red 3" x 1000' "Caution Buried Electric Line Below"	44.66



Outdoor Extension Cords

- Heavy-duty with orange vinyl jacket



Part #	Mfg #	Description	Price
ELEEC25	7-ECC50725	25' 15A, SJTW-A 14/3	57.92
ELEEC50	7-ECC50730	50' 15A, SJTW-A 14/3	85.52

Metal Guard Trouble Lights

- Tough plastic handles are heat and shock resistant with 15A, 125V grounding side outlet
- 16/3 AWG type



Part #	Mfg #	Description	Price
ELETL25	7-TLC10625	25' Trouble Light	62.00
ELETL50	7-TLC10630	50' Trouble Light	91.60

See Bulbs in the Light Bulbs Section



Communications

Low Voltage Device Mounting Bracket

- For installations on existing construction
- For low voltage class 2 ONLY
- Non-conductive, smooth plastic
- CAT-6 Listed



LV1

Part #	Mfg #	Description	Price
ELFLV1	LV1	Single-Gang Device	1.43

Non-Metallic Bushing for Metal Studs

- Fits in existing irregular shaped holes in metal studs, alleviating the need to punch more holes, weakening the structural member



Part #	Mfg #	Description	Price
ELFNMBMS	SB130	2" x 4" Stud Size 100/Pk	0.31

Electrical Sundries

Electrical Supplies

Accessories

Jack Chain

- Zinc-plated steel
- 100 Feet per steel reel
- Maximum load limit is 25 pounds



Part #	Mfg #	Description	Price
ELFJC	JC12	1/2" x 100' 12 ga Jack Chain	58.57

S-Hook

- Plated steel
- Maximum load limit is 25 pounds



Part #	Mfg #	Size	Price
ELFSH1	SH1	1-1/4"-.106	0.18

Beam Clamp



Part #	Mfg #	Description	Price
ELFBC	MBC25	1" 125# Malleable Iron, Threaded Rod Size 1/4-20NC	1.86



Insulating Cover for WR Series

- Hinged polyurethane cover
- For installation of WR series tap connectors
- Eliminates tapping
- Drain ports
- Ultraviolet stabilized



Part #	Mfg #	Description	Price
BNYC2	C2	5/8" 'O' Die Tap Connector Cover	1.12

THANK YOU!
We appreciate your business

Electrical Sundries

Electrical Accessories

Ground Rod Clamp

- For copper cable to rod
- High strength
- Copper alloy ground connector
- Joins range of cable to copper clad, galvanized steel, and stainless steel ground rods
- UL467 Listed for direct burial



Part #	Mfg #	Description	Price
ELFGRDCL58	GRC58	5/8" Ground Rod Clamp, Budget	1.72



3

33 Vinyl Electrical Tape	850
3M	850-851, 858, 1043, 1051-1052
3M	
Chemicals.....	1052
Cord Management.....	1051
Insulating & Splicing Tape.....	1051
Shrink Insulation.....	1052
Special Use Tape.....	1051
Vinyl Electrical Tape.....	1051
Wire Connectors.....	858, 1043

A

A/C Accessory Packages Airvector.....	779
A/C Whips DiversiWhips.....	826
Abrasive Pads All Purpose Cleaning.....	841
Abrasive Products Mill-Rose.....	370
ABS Fittings Dearborn Traps.....	274
Accent Kits Moen.....	174
Access Fittings	
JB Industries.....	956
Yellow Jacket.....	728, 954
Access Panels	
Fluidmaster.....	293
Oatey.....	375
Access Valves JB Industries.....	956
Accessories Oil Burner.....	695
Acclaim Tub & Shower Modules.....	228
Accord Tub & Shower Modules.....	228
Accumulators	
Manitowoc.....	871
Refrigeration Research.....	952
Suction.....	952
Acetylene Tanks & Refills	314
Acid Brushes Mill-Rose.....	350
Acid Neutralizers	
AquaPure.....	39
Nu-Calgon.....	925
Acid Test Kits	
Hercules.....	267
Nu-Calgon.....	888
Acme Standex	731-749, 846
Acme-Miami	716, 930
Acme-Miami	
Defrost Heaters.....	930
Fan Blades.....	930
Motor Accessories.....	930

Motor Mounts.....	930
Motors.....	716
Adapters	
Chuck.....	349
Fluidmaster Dishwasher.....	292
JB Industries.....	957
Manitowoc.....	871
Pitless.....	53
Swivel.....	957
Add-A-Shower Components Spring House...	172
Add-A-Showers Spring House.....	172
Add-On Boilers Marathon Heater Co.....	571
Adhesive Imcoa LeakTite.....	773
Adhesive Takeoffs	735
Adhesives	
Boss.....	837
Shower Pan Liner.....	375
Adriani Toggler Switches Lutron.....	968
Advanced Cable Ties Cable Ties.....	361-362
Advantage	
Shower Modules.....	231
Tub & Shower Modules.....	229
Aerators	
Moen.....	179
Plumbest.....	279
Aerosol Coil Cleaners Nu-Calgon.....	924
Aerosol Water Barrier Nu-Calgon.....	927
Air Boosters Field Controls.....	704
Air Cleaner Media Aprilaire.....	627
Air Cleaners	
Airscreen Filters.....	632
Aprilaire.....	626
RGF Environmental.....	629
RGF Environmental PHI Guardian.....	629
Trion.....	630
Air Conditioner ICP.....	484, 514
Air Conditioners	
AirQuest.....	504-510
Coleman UPG.....	522
Comfort-Aire Room.....	523
Heil.....	487
ICP.....	482-486, 488, 490, 501
ICP Packaged.....	514
Mitsubishi Split Ductless.....	579, 583, 585-586
Tempstar.....	496-499
Air Conditioning Accessories Comfort-Aire..	523
Air Distribution Products Standex.....	749
Air Eliminators	
Amtrol.....	799
SpiroTherm.....	810
Taco Inc.....	796

INDEX



Air Filters Precisionaire.....	842-844	A/C Accessory Packages.....	779
Air Flow Meters UEI.....	722	Dampers.....	779
Air Gaps Watts Regulator.....	71	Diffusers.....	779
Air Handler Blocks DiversiTech.....	824	Filter Returns.....	779
Air Handler Pans DiversiTech High Rise.....	825	Alarms	
Air Handlers		Beckett King Fill.....	699
ICP.....	493-494	SUPCO Temperature.....	911
ICP Packaged.....	519	Universal Security Instruments.....	829-831
Unico.....	525-526	Water.....	829
Air Moving Components MARS.....	928	Alarms & Gauges Beckett.....	698
Air Probes Cooper-Atkins.....	730	Alkaline Industrial Multi-Pack Batteries	373
Air Products Corp	778	Allanson	690
Air Pump Hoses Cherne.....	278	Allanson	
Air Pumps Cherne.....	278	Small Can Transformers.....	690
Air Purification RGF Environmental.....	629	Transformers.....	690
Air Purification Systems Field Controls.....	631	Aluminum Products	748
Air Releases SpiroTherm.....	810	Aluminum Cable	1036
Air Sensors Robertshaw Switches.....	845	Aluminum Filters Precisionaire.....	844
Air Separators Taco Inc.....	796	Aluminum Fittings Round.....	846
Air Systems Field Controls.....	705	Aluminum Tubing Holyoke.....	846
Air Tubes Beckett.....	695	Aluminum Wire	1035
Air Valves		Aluminum Wrenches Ridgid.....	325
American Granby Tank.....	50	Amcraft Fiberglass Duct Fabrication Tools.....	352
Brady.....	49	Amcraft Tools	352
Hoffman Specialty Radiator Steam.....	808	American Granby	49-62, 63, 105, 343, 368
Plumbest.....	816	American Granby	
Air Vent		Air Volume Controls.....	49
Amtrol.....	799	Ball Valves.....	63
Oatey.....	376	Brass Pitless Adapters.....	53
Air Vents Honeywell.....	813	Check Valves.....	56, 105
Air Volume Controls Brady.....	49	Fasteners.....	55
Air-Cooled Equipment & Filter Cleaning		Filter Cartridges.....	61-62
Products Nu-Calgon.....	822, 924	Foot Valves.....	58
AirQuest	504-513, 552-558	Gate Valves.....	368
AirQuest		Gauges.....	51
Blower Cabinets.....	513	Hydrants.....	56
Burners.....	558	Insert Fittings.....	52, 60
Condensing Units.....	504-510	Installation Accessories.....	54
Electric Heaters.....	513	Pump Accessories.....	54
Furnaces-Gas.....	552-557	Relief Valves.....	49
Furnaces-Oil.....	558	Sand Separator Filters.....	58
Heat Pumps.....	511	Silicone.....	54
Airscren 500	632	Submersible Pump Accessories.....	50
Airscren Filters		Sump & Sewage Accessories.....	58
Air Cleaners.....	632	Swing Check Valves.....	57
Replacement Media.....	632	Switches.....	54
Airserco	961	Tank Accessories.....	49
Airserco Sealant.....	961	Tank Crosses.....	51-52
Airtec	778	Tank Fittings.....	51
Airtec Ceiling Diffusers.....	778	Tapes/Sealants & Chemicals.....	55
Airvector	779	Tools.....	343
Airvector		Water Filtration.....	58

Product Index



www.irrsupply.com

Product Index

Water System Parts.....	52	Zone Dampers.....	628
Well Point Supplies	52	Aqua Plus Water Heaters.....	615
Amtrol	467, 616, 799, 814	Aquacenter Manifolds Uponor.....	457
Amtrol		Aquanot Flood Alert Zoeller Pump.....	96
Tanks.....	799, 814	AQUAPEX Tubing.....	443
Water Hammers.....	799	AquaPure	
Water Heaters.....	616	Acid Neutralizers.....	39
Anchor Screws Preformed.....	1039	Parts.....	41
Anchor Tools Powers Fasteners.....	363	Solution Tanks.....	41
Anchors		Water Softeners.....	40
Malco.....	361	AquaPure by Cuno	34-43
Powers Fasteners Mechanical.....	362	Aquastats	
Andy Snips Malco.....	319	Honeywell.....	668, 811
Angle Valves Superior Refrigeration Products	941	Honeywell Relays.....	668, 811
Anode Rods AO Smith.....	27	Aquatic	238-248
Anti-Freeze Hercules.....	266	Aquatic	
Anti-Vibration Pads DiversiTech.....	824	Bathtubs.....	246
Antifreeze Noble.....	817	Showers.....	240
AO Smith		Tub & Shower Walls.....	248
Anode Rods.....	27	Tub & Showers.....	238
Blower Assemblies.....	27	Whirlpools.....	247-248
Commercial Gas Water Heaters	19-22	Ariston Electric Mini Tank Water Heaters	
Electric Water Heaters	7-8	BOSCH Water Heaters.....	17
Gas Valves.....	27	Arlington Industries	848, 852-853, 855-856, 990, 1006-1007, 1008-1010, 1013, 1014-1016, 1029-1030, 1040, 1041, 1073-1074
Gas Water Heaters.....	1-5	Arlington Industries	
Hot Surface Igniters.....	27	AC/MC Straps.....	853
Hybrid Electric Water Heaters	6	Accessories.....	848, 1074
Motors	714-715	Anti-Short Bushing.....	852
Parts.....	28	Box Accessories.....	1030
Pilot Burners.....	27	Communications Brackets.....	1073
Storage Tanks.....	22	Conduit Bodies.....	1006
Temperature Controls.....	27	Cord Grips.....	1016
AO Smith Boilers	21-23	EMT Fittings.....	1006
AO Smith Parts	27-28	Fan Boxes.....	1029
AO Smith Water Heaters	1-8, 19-23	Flex/AC/MC Cable Fittings.....	1041
Appliance Connectors		Flex/AC/MC Connectors.....	852
Dormont Flexible Gas.....	438	Grounding.....	990
Dormont Stationary Food Service.....	438	Mast Parts.....	1010
Fittings.....	396	NM Cable Fittings & Supports.....	853, 1015
Appliance Controllers Tjernlund.....	635, 834	NM Liquid-Tight Cord Connectors.....	1014
Applicator Brushes Mill-Rose.....	350	Rigid/IMC Cable Fittings.....	1008
Aprilaire	624-628	Roof Flashings.....	848
Aprilaire		Siding Mounting Blocks.....	1029
Air Cleaner Media.....	627	Zinc Liquid-Tight Cord Connectors.....	853, 1015
Air Cleaners.....	626	Arresters Sioux Chief Water Hammer.....	367
Current Sensing Relays.....	626	Arrestors Amtrol Water Hammer.....	799
Dehumidifiers.....	626		
Humidifier Parts & Accessories.....	625		
Humidifiers.....	624		
Humidistats.....	626		
Water Panels.....	625		
Zone Control Panels.....	628		

INDEX



AstraLite	994
AstraLite	
Emergency Lighting.....	994
Parts.....	994
Auger Bits Lenox Ship Auger.....	338
Augers	
General Wire Spring Co Closet.....	360
General Wire Spring Co Urinal.....	360
Ice.....	871
Ridgid.....	355
Automatic Cleaning Systems Manitowoc.....	870
Auxiliary Side Connectors TXV.....	950
Aviation Snips Lenox.....	339
AY McDonald	81-82, 99, 479-481
AY McDonald	
Back-Up Pumps.....	99
Curb Boxes.....	479
Gas Valves.....	82
Meter Valves.....	81
Plumbing/Water Valves.....	81
Water Pumps.....	99

B

B-Line Fasteners	1028
B-Vent Selkirk Gas Vent.....	762
B-Vent Oval Pipe & Fittings Selkirk	
Metalbestos.....	764-765
B-Vent Pipe & Fittings Selkirk Metalbestos....	762-764
Back-Up Pumps	
AY McDonald.....	99
Zoeller.....	96
Back-Up Sump Pumps Base Products.....	98
Backflow Preventers Watts Regulator.....	67
Backwashing Filters AquaPure.....	41
Backwater Valves Plumbest.....	286
Balance Valves Bell & Gossett.....	785
Balancing Valves Watts.....	63
Ball Valves	
American Granby.....	63
Bell & Gossett Handivalve.....	784
Cimberio.....	80
PVC.....	63
Sioux Chief.....	821
Sioux Chief PEX Barbed.....	366
Superior Refrigeration Products.....	941
Uponor.....	447
Watts PEX.....	79
Watts Regulator.....	74
Webstone.....	797
Webstone PRO-PAL Series.....	797-798

Ballasts

Fluorescent.....	1003
HID.....	1003
Ballcocks	
Flush Valves.....	294
Kohler.....	288
Band-Seal End Caps Mission Rubber.....	478
Band-Seal Specialty Couplings Mission	
Rubber.....	475
Bar Faucets	
Brizo.....	114
Central Brass.....	123, 124
Gerber.....	117
Moen.....	122
Moen Commercial Sani-Stream.....	122
Bar Sinks Elkay Stainless Steel.....	196
Barbed Fittings Nylon.....	825
Baron Wire	
Irrigation Cables.....	92
Multiple Outlet Cords.....	92
Thermostat Wire.....	837
Barrier-Free Shower Floor EL Mustee.....	237
Base Products	98
Base Products Back-Up Sump Pumps.....	98
Baseboard Fittings Uponor ProPEX.....	446
Baseboard Heaters Ouellet.....	646
Baseboard Heating	
Haydon.....	640-641
Smith's Environmental The Heating Edge.....	642
Baseboard Radiation	645
Baseboard Returns Hart & Cooley.....	775
Baseboards	641
Baseraf Accessories & Fittings	645
Baseraf Assemblies Burnham.....	645
Basin & Cover Combinations Topp	
Industries.....	101
Basin Faucets Plumbest.....	123
Basin Grates NDS.....	107
Basin Nuts Plumbest.....	279
Basin Outlets NDS.....	108
Basin Wrenches Ridgid.....	326
Basins	
NDS.....	107
Sump & Sewage.....	101
Basket Strainers	
Dearborn Brass.....	278
Dearborn Brass Plastic Decorator.....	275
McGuire Products.....	272
Plumbest.....	279
Basset	761
Basset	
Brackets.....	761
Strap.....	761

Bath Accessories



Creative Specialties.....	176-177	3-Piece Circulators.....	782
Home Care by Moen.....	177	Airtrol Fittings.....	786
Kohler.....	176	Ball Valves.....	784
Bath Cocks Plumbest.....	281	Brazed Plate Heat Exchangers.....	786
Bath Drains		Calibrated Balance Valves.....	785
Central Brass.....	276	Check-Trol Isolation Flanges.....	784
Dearborn Brass Waste Repair Parts.....	275	Circulator Flanges.....	783
Geberit.....	277	Circulator Pumps.....	782
Gerber.....	273	Close Coupled Circulators.....	783
Bath Fans		Dual Unit Valves.....	785
Broan.....	839	Flo-Control Valves.....	784
Panasonic.....	840	Impellers.....	788
Bath Furnishings Donner.....	176	Power Pack Motors.....	787
Bath Installation Aids Delta.....	171	Pressure Reducing Valves.....	784-785
Bath Supplies Offset.....	281	Pump Motor Accessories.....	787
Bath Waste Assemblies Dearborn Brass.....	271, 275	Wet Rotor Circulators.....	782
Bath Waste Kits Watco.....	276	Bell Hangers Amtrol.....	467
Bath Waste Parts Delta.....	172	Bell Trap Drains Plumbest.....	285
Bath Wastes Watco.....	276	Belts	
Bathroom Cleaners Chemique.....	377	E James Powerflite.....	931-932
Bathtub & Shower Modules Sterling Vikrell...	228	Motors & Armatures.....	931
Bathtub Doors Sterling.....	234	Bemis	256-257
Bathtub Wall Panels Swanstone.....	249	Bemis	
Bathtub Walls Durawall.....	236	Color Direct Seats.....	257
Bathtubs		Commercial Toilet Seats.....	257
Aquatic.....	246	Residential Toilet Seats.....	256
Kohler Experience.....	226	Bibb Seats BrassCraft Faucet Repair.....	182
Kohler ProFlex.....	227	Bin Doors & Components Manitowoc.....	872
Kohler ProFlex Whirlpool.....	226	Bits	
Kohler Select.....	226	Lenox Drill Vari-Bit.....	338
Swanstone.....	250	Lenox Ship Auger.....	338
Batteries Ray-O-Vac.....	373	Malco Power.....	323
Baxi Luna	607-609	Plumbest Power.....	348
Baxi Luna		Black Pipe & Fittings	760
Boiler Accessories.....	609	Black Malleable Iron	
Boilers.....	607-608	Fittings 150#.....	380
Parts & Accessories.....	608	Unions.....	383
Beam Clamps Greenfield Manufacturing Co...	1017	Black Pipe Steel	378
Bearings Bell & Gossett.....	788	Black Steel Fittings	
BearTrap Steam Traps Hoffman Specialty.....	806	Pipe Nipples.....	378-379
Beckett		Tank Nipples.....	379
Accessories.....	695	Blades	
Air Tubes.....	695	Acme-Miami Fan.....	930
Alarms & Gauges.....	698	Lenox Handsaw.....	342
Burners.....	695	Lenox Saw.....	340
CleanCut Oil Pumps.....	697	Blank Wall Plates Pass & Seymour.....	986
King Fill Alarms.....	699	Blow Down Valves McDonnell & Miller.....	803
Oil Controls.....	691	Blower Assemblies AO Smith.....	27
Parts.....	697	Blower Cabinets	
RW Corp.....	691, 695-699	AirQuest.....	513
SpeedFill.....	698	ICP.....	495
Bell & Gossett	782-788	Tempstar.....	503
Bell & Gossett		Blue Monster	

INDEX



Mill-Rose Teflon Tape.....	371	Caulk.....	369
Mill-Rose Thread Sealant Compound.....	268	Caulk Guns.....	370
Bohn	879-882, 929, 951	Firestop Sealants.....	837
Bohn		Foam Sealants.....	761
Condensing Units.....	879	Hand Cleaners.....	368
Parts & Accessories.....	929, 951	Silicone Sealants.....	369, 837
Reach-In Cooler Units.....	879	Spray Adhesives.....	837
Walk-In Unit Coolers.....	881	Tub & Tile Caulk.....	369
Boiler & Furnace Cleaning Items Westwood Products.....	703	Bowl Gaskets Fluidmaster.....	291
Boiler Accessories		Bowl Rings Toilet Parts.....	299
Baxi Luna.....	609	Bowl Setting Bolts	
Weil-McClain.....	620	Fluidmaster.....	291
Boiler Additives Silver King Mfg.....	817	Hercules.....	289
Boiler Brushes Mill-Rose.....	350	Bowl Setting Rings Hercules.....	293
Boiler Cement Hercules.....	836	Box Accessories Arlington Industries.....	1030
Boiler Chemicals Silver King Mfg.....	817	Box Supports Raco.....	1027
Boiler Cleaners		Boxes	
Hercules.....	815	Arlington Industries Fan.....	1029
Silver King Mfg.....	817	Pass & Seymour.....	1022-1023
Boiler Drain Valves		Raco Electrical.....	857, 1024-1025
Matco-Norca.....	78	Reliance Controls Power Inlet.....	1070-1071
Nibco.....	78	Wiremold Floor.....	1030
Watts Regulator.....	79	Brackets	1028
Boiler Fill Valves Honeywell.....	813	Brackets	
Boiler Scale Inhibitors Silver King Mfg.....	817	B-Line.....	1028
Boiler Stop-Leaks Hercules Chemicals.....	815	Basset.....	761
Boiler Switches McDonnell & Miller.....	803	DiversiTech A/C Mounting.....	824
Boiler Valves		DiversiTech Motor.....	718
Watts Pressure Regulators.....	73	Mounting.....	848
Watts Regulator Safety Relief.....	64-65	Sioux Chief.....	364-365
Boilers		Sioux Chief Pipe.....	366
Add-On.....	571	Sioux Chief Stud.....	364-365
Baxi Luna.....	607-608	Underground Riser.....	440
Dunkirk.....	597-606	Watts PEX Stubout.....	363
Viessmann Mfg.....	613-614	Bradford White	9-16, 24-26, 28-31, 693
Weil-McLain Gas.....	589, 591, 622-623	Bradford White	
Weil-McLain Oil.....	593, 596, 619	Commercial Gas Water Heaters.....	10, 24-26
Williamson-Thermoflo.....	609-612	Commercial Oil Water Heaters.....	25
Bolt Caps Plumbest Closet.....	282	Icon Gas Valves.....	28
Bolt Plates Greenfield Manufacturing Co.....	1019	Oil Controls.....	693
Bolt Sets Plumbest Tank-to-Bowl.....	282	Parts & Accessories.....	29
Bolts Hercules Toilet.....	289	Residential Electric Water Heaters.....	15-16
Bonnet Packing Gunk.....	298	Residential Gas Water Heaters.....	9-14
BOSCH Water Heaters	17	Residential Oil Water Heaters.....	15
BOSCH Water Heaters Ariston Electric Mini Tank Water Heaters.....	17	Therm-O-Disc Thermostats.....	31
Boss	368-370, 761, 837	Vent Kits.....	28
Boss		Brass Nipple Sets	390
Adhesives.....	837	Brass Bodies JB Industries.....	957
		Brass Fittings	
		BrassCraft Compression.....	394
		BrassCraft Flare.....	393

Product Index



www.irrsupply.com

Product Index

JB Industries.....	957
Plumbest Hose.....	287
Threaded.....	390
Threaded Imported.....	390
Brass Manifolds Uponor.....	458
Brass Nipples	389
Brass Tube Fittings JB Industries.....	957
Brass Tubular	
Dearborn Brass.....	269-271
McGuire Products.....	272
BrassCraft	182, 294-297, 393-396, 815
BrassCraft	
Appliance Connector Fittings	396
Bibb Seats.....	182
Brass Fittings.....	393-394
Closet Risers.....	296
Faucet Repair.....	182
Lavatory/Sink Risers.....	296
Riser Tube Components.....	297
Stop Valves.....	294-296
Supply Kit Components.....	296
Tub&Shower Rebuild Kits.....	182
Water Heater Connectors	815
Brazing Alloys Harris Group.....	312
Brazing Rods Lenox Tools.....	345
Breakers	
Breakers Unlimited.....	849, 1055
Circuit.....	849
Cuttler-Hammer.....	1055-1056
Breakers Unlimited	849, 851, 1055-1056, 1068
Breakers Unlimited	
Circuit Breakers.....	849, 1055
Contactors.....	1068
Definite Purpose Contactors.....	851
Briscon	852, 1040
Briscon Cable Staples	852, 1040
Brizo	
Bar Faucets.....	114
Finials.....	180
Parts	180
Tub & Shower Faucet Trim.....	141
Tub & Showers	141
Broan	839, 841
Broan	
Bath Fans.....	839
Ventilating & Combo Fans.....	839
Venting.....	841
Brushes	
Applicator.....	350
Boiler.....	350

Cleaning.....	349
DiversiTech.....	369
Flue.....	350
Hercules.....	267
Maintenance.....	350
Mill-Rose.....	349-350
Mill-Rose 6-in-1.....	350
Mill-Rose Fitting.....	349, 351
Bubbler Heads Central Brass.....	162
Burndy	1040, 1046-1049, 1074
Burndy	
Cable Ties.....	1049
Electrical Accessories.....	1074
Electrical Connectors.....	1046
Electrical Multi-ports.....	1046
Electrical Terminals.....	1047-1048
Electrical Wiring Connectors	1046
Oxide Inhibiting Joint Compounds.....	1040
Splice Kits.....	1049
Splicers.....	1046
Burner Controls	
Honeywell.....	664
Honeywell Gas.....	661, 663
Honeywell Oil.....	692
White-Rodgers Gas.....	672, 674
Burner Head Parts Lynn Products Co.....	847
Burners	
AirQuest.....	558
AO Smith Pilot.....	27
Beckett.....	693
Heil.....	542
Honeywell Pilot.....	667
Oil.....	695
Tempstar.....	551
Williamson-Thermoflo	568, 612
Burnham	644-645
Burnham	
Baseray Accessories & Fittings.....	645
Baseray Assemblies.....	645
Radiators.....	644
Bushing Anti-Short.....	852
Bussman Time-Delay Fuses.....	854, 1069
Butt Connectors	1045
BX Wire	1035
Bypass Valves Sporlan.....	935

C

C & S Mfg Corp	761
C Clamps Greenfield Manufacturing Co.....	1017
C&D Valve Core Removal Tools.....	352

INDEX



C&D Valve Manufacturing Co	352	Carbon Monoxide Alarms Universal Security	
C&S Mfg		Instruments.....	829
Basset Brackets.....	761	Carbon Steel Fittings	
Basset Strap.....	761	Black Nipples.....	378-379
Duct Hangers.....	761	Black Tank Nipples.....	379
Cable		CareGiver Easy-Access Showers EL Mustee	237
Aluminum Wire.....	1035	Carlton	
Copper Wire.....	1035	Flexible Conduit.....	855
General Wire Spring Co Replacement	360	Weatherproof Covers.....	1031
Guy Strand.....	1039	Carlton - Thomas & Betts	855, 1014, 1031
MARS.....	1039	Carriers	
MC Wire.....	859, 1035	Watts Drainage Fixture Carriers.....	310
Power.....	1037	Watts Drainage Water Closet	310
Raychem Heating.....	32	Cartridge Tools Moen.....	178
Ridgid Drain.....	356	Cartridges	
Romex.....	1034	AquaPure Water Filter.....	34-36, 38, 41
Underground Feeder Wire	1034	Cuno Systems.....	43
Cable Fittings		Moen Faucet.....	178
Flex/AC/MC.....	1041	Moen PureTouch.....	178
Rigid/IMC.....	1008	Sloan Waterfree Urinal	189
Cable Guides American Granby.....	50	Taco Inc.....	793
Cable Saws Sioux Chief.....	348	Cast Iron Soil Pipe	434-435
Cable Staples Briscon.....	852, 1040	Cast Iron Fittings	
Cable Ties	361-362	Soil No-Hub.....	435
Cable Ties		Soil Service.....	434
3M.....	1051	Cast Iron Lavatories Kohler.....	203
Burndy.....	1049	Cast Iron Sinks Kohler Kitchen.....	198
Nylon.....	361-362	Catch Basin Grates NDS.....	107
Watts Radiant.....	455	Catch Basins NDS.....	107
Cables	92	CATV Wall Plates Pass & Seymour.....	986
Cables Irrigation.....	92	Caulk Boss	369
Cad Cell Honeywell Replacement.....	692	Caulk Guns Boss.....	370
Caddies Plumbest.....	374	Caution Tape Plumbest.....	369
Cal-Spray Aerosols Nu-Calgon.....	926	Ceiling & Floor Plates Plumbest.....	280
Calcium Hypochlorite Pellets Chemicals.....	46	Ceiling Boxes Pass & Seymour.....	1023
Cameras Ridgid Pipe Inspection.....	353-354	Ceiling Diffusers Airtec.....	778
Canopy Switches Pass & Seymour.....	972	Ceiling Pans Raco.....	990, 1028
Capacitor Testers MARS.....	730	Cell Air Cleaners RGF Environmental.....	629
Capacitors		Cells RGF Environmental.....	629
Global.....	684	Cement Carrier Oatey.....	376
Manitowoc.....	872	Cements	
MARS Motor Start.....	920	Hercules Boiler/Stove.....	836
Motor Run.....	920	Oatey.....	261
Run.....	684, 922	Weld-On PVC/CPVC/ABS.....	261
SUPCO.....	922	Central Brass	63, 123, 124, 129, 143, 161-162, 181, 276
Capillary Tubing JB Industries.....	955	Central Brass	
Caps		Bar Faucets.....	123, 124
Hancor.....	464	Bath Drains.....	276
OEM Vent.....	698	Dishwasher Faucets.....	123
Sheet Metal.....	751		
Captive Air Tanks Pentair WellMate.....	84		
Carbon Dioxide Cleaners Westwood			
Products.....	703		



Drinking Faucets.....	162	SUPCO.....	927
Faucet Handles.....	181	Chemique	377
Kitchen Faucets.....	123	Chemique Bathroom & Kitchen Cleaners	377
Laundry Faucets.....	124	Cherne	
Lavatory Faucets.....	129	Accessories.....	278
Parts.....	181	Clog Buster.....	319
Service Sink Faucets.....	161	Mechanical Pipe Plugs.....	277
Spouts.....	181	Pneumatic Pipe Plugs.....	277
Stand Pipes.....	162	Seal Plugs.....	277
Tub & Shower Fittings.....	143	Cherne Industries	277-278, 319
Valves.....	63, 143	Chicago Faucet	
Cerro Line Sets	491, 502, 512	Parts.....	183
Certainteed	772	Service Sink Faucets.....	164
Certainteed		Vacuum Breakers.....	165
Duct Board.....	772	Chicago Faucets	162-165, 183
Duct Liner.....	772	Chicago Faucets	
Duct Wrap.....	772	Inside Sill Fittings.....	164
CGM Inc	370	Metering Lavatory Faucets.....	163
CGM Inc Perma Wet Plug	370	Single-Handle Lavatory Faucets.....	162
Chamber Systems Hancor	106	Sink Faucets.....	164
Chamfering Tools	352	Spouts.....	165
Chandler Refrigeration Division of		Two-Handle Kitchen Faucets.....	163
Heatcraft	908, 951	Two-Handle Lavatory Faucets.....	162
Channel Haydon	468	Chicago Specialties	303
Channel Drains NDS	108	Chicago Specialty	
Charging Ball Valves Yellow Jacket	728, 954	Drum Trap & Extension Covers.....	303
Charging Hose Yellow Jacket	727-728, 889	Econo Plugs.....	303
Charging Manifolds Yellow Jacket	726	Ground Joint Waste Connectors	303
Charging Scales JB Industries	933	Chimney Liner	
Charlotte		Metalbest Flexi-Liner.....	768
Gaskets.....	435	Metalbest Versa-Liner.....	768
Lubricants.....	435	Chimney Liner Kits Metalbest	768
Charlotte Pipe & Foundry	434-435	Chimney Systems Selkirk	766
Charter Plastics	465-466	Chimney Vent Selkirk	764-765
Charter Plastics		Chlorinator Pellets Pentair Water	46
Geothermal Accessories.....	466	Chrome Plated Nipples	392
Geothermal Fittings.....	466	Chuck Adapters	349
Geothermal Pipe.....	465	Cimatec	632
Check Valves		Cimberio	80
American Granby.....	56-57, 105	Cimberio	
Nibco Bronze.....	77	Ball Valves.....	80
Superior Refrigeration Products	941	CimPress Valves.....	80
Chem-Tech Chemical Feed Pumps	59	CimPress Valves Cimberio	80
Chemical Pumps Silver King Mfg	817	CinchClamp Watts PEX Tools	352, 455
Chemical Sprayers		Circuit Breakers	849
MARS Chapin.....	955	Circuit Breakers Murray Electrical	850,
Nu-Calgon.....	822		1057-1058
Chemicals		Circulator Flanges Bell & Gossett	783
3M.....	1052	Circulator Pumps	
Calcium Hypochlorite Pellets.....	46	Bell & Gossett.....	782
Chemique.....	377	Taco Cartridge.....	789, 792-793
DiversiTech.....	781	Circulators	
Silver King Mfg Boiler.....	817	Bell & Gossett 3-Piece.....	782

INDEX



Bell & Gossett Close Coupled.....	783	Oatey.....	375
Bell & Gossett Wet Rotor.....	782	Plumbest.....	283
Clamps		PVC DWV.....	422-423
Greenfield Manufacturing Co.....	1017	Sioux Chief.....	297
Malco Duct and Pipe.....	320	Closet Gaskets	
Mission Rubber Stainless Steel.....	475	Fluidmaster.....	291
Plumbest Steel Hinged Repair.....	287	Hercules.....	293
Sioux Chief Pipe.....	364	Closet Rings Sioux Chief.....	297
Touchdown II Strut.....	365-366	Closet Risers BrassCraft.....	296
Watts Radiant Hose.....	453	Closet Spanner Flanges Mission Rubber.....	475
Wedge Grip.....	1020	Closet Spud Washers Plumbest.....	282
Cleaners		Closet Spuds Plumbest.....	282
Chemique.....	377	Closet Supply Kits McGuire Products.....	273
Coil.....	924	Closet Wedges Sioux Chief.....	368
DiversiTech.....	781, 826	CO Detectors UEI.....	721
Electrical Contact.....	927	Coated Copper Tubing Kamco Products.....	398
Hercules Boiler/Heating System.....	815	Coaxial Cable Priority Wire.....	1039
Hercules Drain/Waste System.....	264	Cock Hole Covers Plumbest Faucet.....	279
Hercules Oil.....	816	Coil Cleaners Nu-Calgon.....	923-924
Nu-Calgon Coil.....	923	Coils	
Oatey Plastic Pipe.....	263	Coleman UPG Vexar Evaporator.....	522
Silver King Mfg Boiler.....	817	ICP Cooling.....	492
Weld-On PVC/CPVC/ABS.....	263	Manitowoc.....	872
Cleaning & Sanitizing Manitowoc.....	872	Sporlan.....	940
Cleaning Brushes Mill-Rose.....	349	Cold Coat Lenox.....	345
Cleaning Pads All Purpose.....	841	Coleman Heating & Cooling	522, 562-564
Cleaning Towels Mill-Rose.....	371	Coleman UPG	
Cleanout Components Watts Drainage.....	308	Air Conditioners.....	522
Cleanout Plugs Plumbest.....	284	Stylecrest Mfg Housing Gas Furnaces.....	562-563
Cleanouts		Stylecrest Mfg Housing Oil Furnaces.....	564
Plumbest.....	284	Collars	
Watts Drainage Floor.....	308	Galv Sheet Meal.....	752
Cleanup Supplies Westwood Products Inc.....	702	Hart & Cooley.....	778
Clevis Hangers Greenfield Manufacturing Co.	1018	Color Direct Seats Bemis.....	257
Clevises Porcelain Products.....	1020	Combustion Air Systems Field Controls.....	704-705
Clic Hangers	470	Combustion Analyzers UEI.....	723
Clip Guns Peter Mangone.....	469-470	Combustion Chamber Kits Lynn Products Co.....	847
Clips Peter Mangone.....	470	Combustion Chambers Lynn Products Co.....	847
Clock Hanger Receptacles Pass & Seymour.....	978	Comfort-Aire	
Clog Buster Drain Flushers.....	319	Air Conditioning Accessories.....	523
Closet Augers Ridgid.....	355	Dehumidifiers.....	524
Closet Bolt Caps Plumbest.....	282	Portable Cooling.....	524
Closet Bolts		Room Air Conditioners.....	523
Fluidmaster.....	291	Comfort-Aire by Heat Controller	523-524
Hercules.....	289	Commercial Gas Boilers Weil-McLain.....	617-618
Plumbest.....	282	Commercial Power Venter	633, 832
Closet Elbows Dearborn Brass Flush.....	271	Commercial Timers Intermatic.....	988
Closet Flange Repair Kit Save-A-Flange.....	368	Communications Wire & Cable.....	1039
Closet Flange Spacers		Communications Brackets Arlington	
Plumbest.....	283	Industries.....	1073
Sioux Chief.....	375	Communications Wire Priority Wire.....	1039
Closet Flanges		Compact Fluorescent Light Bulbs Halco.....	964
Copper DWV.....	405	Compression Fittings	

Product Index



www.irrsupply.com

Product Index

Brass.....	394	3M Wire.....	858, 1043
Mr PEX.....	443	Appliance Fittings.....	396
Compression Joint Sealers Mission Rubber.....	474	Arlington Industries Cord.....	1016
Compression Kits	54	Copper-Flex Water Heater.....	815
Compression Sleeves Plastic.....	394	Dormont Flex Heater.....	438
Compressor Oil Nu-Calgon.....	888	Dormont Flexible Appliance.....	438
Compressors		Dormont Flexible Gas.....	438
ICP Replacement.....	521	Dormont Stationary Gas.....	438
Manitowoc.....	872	Flex/AC/MC.....	852
Tecumseh.....	883-886, 892-895	Fluidmaster Flexible.....	291
Concrete Mixes Sakrete.....	372	Fluidmaster Water Heater.....	292
Condensate Drain Pan Cleaners DiversiTech.....	826	Fluidmaster Water Supply.....	291-292
Condensate Drain Pans SUPCO.....	828	K&H Industries.....	1042
Condensate Drain Treatments Nu-Calgon....	822	Mission Rubber.....	475
Condensate Overflow Switches DiversiTech.....	825	Morris Electrical.....	1044
Condensate Pumps		Pass & Seymour.....	980
DiversiTech.....	781	Plumbest Dishwasher Drain.....	286
Hoffman Specialty Watchman.....	809	Simpson Strong Tie.....	372
Little Giant.....	780-781	Supr-Safe Gas Disconnect.....	438
Mitsubishi.....	588	Wire.....	858-859, 1043
Condensate Traps EZ Trap.....	845	Contact Cleaners Electrical.....	927
Condenser Coil Cleaners Nu-Calgon.....	923	Contactors	
Condenser Pads DiversiTech.....	823-824	Breakers Unlimited.....	1068
Condenser Tube Brushes Mill-Rose.....	349	Breakers Unlimited Definite Purpose.....	851
Condensing Unit Enclosures RDM Products.....	962	Electrical.....	851
Condensing Units		Honeywell.....	658, 671
AirQuest.....	504-510	Manitowoc.....	873
Bohn.....	879	MARS.....	678
Heil.....	487	MARS Definite Purpose.....	678
ICP.....	482-486, 488, 490, 501	Control Flanges Bell & Gossett Check-Trol....	784
Tecumseh.....	883, 885	Control Monitors Tattle-Tale.....	910
Tempstar.....	496-499	Control Panels SJ Electro.....	103
Conduit		Control Products	829
Electrical.....	851	Control Products	
EMT.....	1006	FreezeAlarm.....	829
Flexible.....	853, 855, 1014	Water Alarms.....	829
IMC.....	1008	Control Valves Bell & Gossett.....	784
PVC Sch 40.....	851, 1011	Controllers Omnistat.....	953
PVC Sch 80.....	1011	Controls	
Conduit Bodies Arlington Industries.....	1006	American Granby.....	49
Conduit Cutters Ridgid.....	328	AO Smith Temperature.....	27
Conduit Fittings		Commercial Pressure.....	896
Metallic.....	1008	Commercial Temperature.....	897
Non-metallic.....	851, 1011	Field Controls Draft.....	679, 704
Conduit Installation Ideal.....	1072	Johnson Controls.....	904-905
Conduit Pipe	851, 1006, 1008, 1011	Manitowoc.....	873
Connector Dormont Flex Heater.....	438	Mr. Steam.....	251
Connector Lugs Cytolok.....	1050	Oil Burner.....	691
Connectors		Paragon Electric.....	910
		Paragon Electronic Refrigeration.....	910
		Ranco.....	896-899
		Refrigeration.....	907

INDEX



Reset.....	686	Cord Connectors Arlington Industries.....	853, 1014-1015
SUPCO Defrost.....	911	Cord Grips Arlington Industries.....	1016
White-Rodgers.....	672-676, 909	Cord Management 3M.....	1051
White-Rodgers Hydronic.....	677	Cordless Tools Milwaukee M12.....	317
Convactor Heaters Smith's Environmental		Cords Multiple Outlet.....	92
Profile.....	643	Core Removal Tools C&D Valve.....	352
Convactor Steam Vents Hoffman Specialty...	808	Core Tools Yellow Jacket.....	728, 954
Convertible Jet Pumps Goulds Pump.....	86	Cores Sporlan.....	918
Convertible Pumps Goulds Pump.....	86	Cork Insulation Tape DiversiTech.....	825
Coolers		Corporation Stops AY McDonald.....	479
Bohn Reach-In Unit.....	879	Corporation Valves AY McDonald Couplings.	480
Bohn Walk-In.....	881	Countertop Ice Dispensers Manitowoc.....	868
Cooper Bussman	854, 1069	Countertop Ice Makers Manitowoc.....	868
Cooper-Atkins	729-730	Couplers Crown Engineering.....	700
Cooper-Atkins		Couplings	
Probes.....	730	AY McDonald Corporation Valves.....	480
Refrigerator/Freezer Thermometers.....	729	AY McDonald Service Fittings.....	480
Thermistor Thermometers.....	729	Burner.....	702
Vapor Tension Thermometers.....	729	Fernco Flexible.....	474
Copper		Greenfield Manufacturing Co Threaded	
Nibco Press System Fittings.....	461	Rod.....	1019
Nibco Press System Tools.....	317, 463	Manitowoc.....	873
Sioux Chief Preformed.....	366-367	Matco-Norca Dresser.....	467
Copper Access Fittings Refrigerant.....	48	Mission Rubber Band-Seal.....	475
Copper Cast DWV Fittings	404-407	Mission Rubber Flex-Seal.....	474, 477-478
Copper Cast Pressure Fittings	403-404	PE Underground.....	440
Copper Fittings		Sioux Chief Repair.....	366
Cast DWV.....	404	Cover Tubes BrassCraft.....	296
Cast Pressure.....	403	Coverplates Honeywell Thermostat.....	653
Elkhart.....	412	Covers	
Monoflo.....	786	Raco Electrical Boxes.....	857-858, 1027-1028
Wrot.....	399, 407	Receptacle.....	1032
Wrot DWV.....	405	CPR Valves	934
Copper Headers Urell.....	814	CPVC Valves	63
Copper Manifolds Uponor.....	457	CPVC Cements	
Copper Oil Nozzle Lines	702	Oatey.....	262
Copper Tube Strap Oatey.....	468	Weld-On.....	261
Copper Tubing		CPVC Cleaners Weld-On.....	263
Kamco Products Coated.....	398	CPVC Fittings	63, 425-428
Refrigeration.....	407	CPVC Pipe	425
Type DWV.....	404	CPVC Pipe CTS.....	425
Type K.....	397	CPVC Primers IPS Weld-On.....	263
Type L.....	397	CPVC/CTS Fittings	425
Type M.....	397	CPVC/Sch80 Fittings	427
Copper Tubing Bell Hangers Amtrol.....	467	Crankcase Heaters Raychem.....	33
Copper Wire	1035	Creative Specialties	176-177
Copper Wire THHN Building.....	859	Creative Specialties Bath Accessories.....	176-177
Copper Wrot Pressure Fittings	399-402, 407-411	Crimp Fittings Watts Radiant PEX.....	454
Copper-Flex Water Heater Connectors.....	815	CrimpAll Watts Tools.....	456
Cord Portable.....	1037	Crimpers	
Cord & Plug Ends Electrical Supplies.....	857	Lenox.....	339

Product Index



www.irrsupply.com

Product Index

Malco.....	321
Crimping Tools Ridgid.....	318
Crown Engineering	700-701
Crown Engineering	
Couplers.....	700
Electrode & Ignition Kits.....	700
Oil Burner Filters.....	700
Oil Handling/Filtration Parts.....	700
Tools.....	701
CSST Tubing Gastite.....	439
CTS Pipe CPVC.....	425
Cuno Systems Cartridges.....	43
Curb Box Keys AY McDonald.....	479
Curb Boxes	
AY McDonald.....	479
Jumbo Mfg.....	306
Curb Stops AY McDonald.....	479
Current Sensing Relays Aprilaire.....	626
Curtains	
Manitowoc.....	878
Manitowoc Water.....	878
Custom Cut Manifolds Watts Radiant.....	453
CustomCut	
Watts Copper Manifolds.....	460
Watts Manifolds.....	453
Cutler-Hammer Circuit Breakers.....	849,
	1055-1056
Cutler-Hammer Inc	849,
	1055-1056
Cutter Parts Ridgid Tubing.....	328
Cutter Wheels	
Ridgid Pipe.....	327
Ridgid Tubing.....	328
Cutters	
Gastite Tubing.....	440
Lenox Tubing.....	337
Malco Flex Duct.....	322
Malco Hole.....	321
Ridgid Drain.....	356
Ridgid Pipe.....	326
Ridgid Tubing.....	327
Wal-Rich.....	324
Cutting Oil Hercules.....	267
Cytolok	1050
Cytolok Connector Lugs.....	1050

D

Damper Motors Aprilaire.....	628
Dampers	
Airvector.....	779
Aprilaire Zone.....	628
Galv Sheet Metal.....	745, 758

Hart & Cooley.....	774, 778
Malco.....	321
Dayton Sinks	195
Dayton Sinks by Elkay	195
De-Aerator Westwood Products Oil.....	702
Dead-Ends Preformed.....	1039
Dearborn Brass	269-271,
	273-275, 278,
	302-303
Dearborn Brass	
Brass Bath Wastes.....	271
Decorator Plumbing Supplies.....	275
Drains.....	271, 275
Elbows.....	271
Extension Tubes.....	270
J-Bends.....	269
Outlet Wastes.....	269-270
P-Traps.....	269, 273
Plastic Bath Wastes.....	275
Plastic Extension Tubes.....	274
S-Traps.....	269, 274
Sink Parts.....	303
Sink Strainers.....	278
Sink Traps.....	269
Slip-Joint Connections.....	271
Tailpieces.....	270
Toilet Repair Parts.....	275, 303
Trap Offsets.....	271
Tub & Shower Parts.....	302
Waste Arms.....	270
Waste Repair Parts.....	275
Wastes.....	274
Wrot Plugs.....	271
Decorator Switches Pass & Seymour.....	972
Decrimping Tools Mill-Rose Ringcrusher.....	351
Defrost Controls	
Grasslin.....	908
Heatcraft Refrigeration.....	908
Paragon Electric.....	910
SUPCO.....	911
Defrost Heaters Acme-Miami.....	930
Degreasing Solvents Nu-Calgon.....	373, 926
Dehumidifiers	
Aprilaire.....	626
Comfort-Aire.....	524
Delavan	
Oil Burner Nozzles.....	693-694
Oil Nozzle Accessories.....	694
Delavan Oil Nozzles	693-694
Delay Timers SUPCO.....	911
Delfield	860
Delfield Reach-In Refrigeration.....	860
Delta	167-171

INDEX



Delta		Disconnects	
Bath Waste Parts.....	172	Electrical Terminal.....	1042
Commercial Electronic Faucets.....	159	MARS.....	1061
Commercial Handshowers.....	161	Dishwasher Adapters Fluidmaster.....	292
Commercial Lavatory Faucets.....	159	Dishwasher Drain Connectors Plumbest.....	286
Commercial Metering Faucets.....	160	Dishwasher Faucets Central Brass.....	123
Faucet Handle Accents.....	180	Dishwasher Hose Drain.....	300
Faucet Handles.....	180	Dispensers In-Sink-Erator Hot Water.....	193
Handshowers.....	167, 171	Disposer Flanges Plumbest.....	279
Kitchen Faucets.....	110, 113	Disposer Kits Dearborn Brass Plastic.....	274
Kitchen/Bar Faucets	110-114, 131, 149	Disposers	
Laundry Faucets.....	124	In-Sink-Erator.....	191
Lavatory Faucets	125-127, 159-160	In-Sink-Erator for Septic Systems.....	193
MultiChoice Universal Valve Trim Packs...	138, 160-161	Distribution Boxes	107
MultiChoice Universal Valves.....	138, 140, 160	Diva Switches Lutron.....	969
Parts	172, 180-181	DiversiGum Sealing Compounds.....	824
Roman Tub Rough-In Valves.....	140	DiversiTech	
Roman Tub Trim.....	140	Abrasive Cleaning Pads.....	841
Shower Hoses.....	169	Air Handler Blocks.....	824
Showerheads.....	167, 171	Cladlite Condenser Pads.....	824
Soap/Lotion Dispensers.....	180	Condensate Drain Pan Cleaners.....	826
Specialty Faucets	124, 126	Condensate Pumps.....	781
Tub & Shower/Bidets	138-140, 160-161	Duct Hangers.....	824
Tub Spouts.....	172	Electrical Terminals.....	1042
Water Outlet Components.....	170	Electrical Wire Connectors.....	1042
Delta Parts	171-172, 180-181	Flashlights.....	364
Detectors UEI Carbon Monoxide.....	721	Flood Detectors.....	825
Devices Electrical Supplies.....	856	Fuses.....	1069
Dewatering Pumps Zoeller.....	94	Hand Towels.....	369
Dickens Aluminum Well Caps Maass		Hard Start Kits.....	825
Midwest.....	48	Humidifier Cleaners.....	826
Dickens Pitless Adapters Maass Midwest....	48	HVAC Supplies.....	824
Die Heads Ridgid.....	331	Leak Detector Chemicals.....	364
Dielectric Unions Watts Regulator.....	73	Motor Brackets.....	718
Dies Ridgid Pipe.....	331	Mounting Brackets.....	824
Diffuser Boxes Sheet Metal.....	758	Nylon Barbed Fittings.....	825
Diffusers		Personal Safety Equipment.....	369, 841
Airtec.....	778	Pump Treatment Tablets.....	781
Airtec Ceiling.....	778	Refrigeration Tools.....	933
Airvector.....	779	Tape.....	825
Hart & Cooley.....	774-775	Tools.....	348, 369, 824
Hart & Cooley T-Bar.....	778	Ultralite Condenser Pads.....	823
Digital Multimeters UEI.....	719	Utility Strap.....	955
Digital Spa & Shower Control Moen.....	157	Vinyl Tubing.....	826
Digital Thermostats LuxPro.....	657	DiversiTech Corporation	48, 348, 364, 369, 718, 781, 823-826, 841, 910, 933, 955, 1042, 1069, 1073
Dirt Separators SpiroTherm.....	810	DiversiWhips A/C Whips.....	826
Disc/Piston Diaphragm Kits	940	Diverter Spouts Plumbest.....	281
Discharge Kits American Granby.....	58		
Disconnect Boxes Milbank.....	1062-1063		



Diverters Galv Sheet Metal.....	746	Gerber Pop-Up.....	273
Dole Zone Control Valves.....	49	Gerber PVC & ABS.....	275
Donner Bath Furnishings.....	176	Gerber Schedule 40.....	275
Door Closers Refrigeration Hardware.....	961	Gerber Trim Kits.....	276
Doors		Gerber Trip.....	273
Sterling Shower.....	234	Gerber Trip Lever.....	275
Sterling Tub.....	234	Gerber Trip Lever - Roman.....	275
Dormont		Jumbo Mfg.....	703
EZQuick Water Line Installation Kits	298	Kohler Bath Wastes	289
Flex Gas Connector.....	438	Moen Waste Assemblies	179
Flexible Gas Connectors.....	438	Oatey Residential.....	259
Gas Appliance Pressure Regulators.....	685	Oatey Strainers.....	259
Stationary Gas Connectors.....	438	Plumbest.....	283
Supr-Safe Gas Quik Disconnects.....	438	Plumbest Bell Trap.....	285
Dormont Manufacturing	298, 438, 685	Plumbest CI Cleanouts.....	284
Douglas		Plumbest Cleanout Plugs.....	284
Slip-Joint Pliers.....	352	Plumbest Cleanouts.....	284
Torque Wrenches	352	Plumbest Floor Sinks.....	284
Draft Controls Field Controls.....	679, 704	Plumbest General Purpose.....	284
Draft Inducers		Plumbest Roof.....	285
Field Controls.....	705	Plumbest Shower Stall.....	285
Tjernlund.....	633, 832	Plumbest Shower/Floor.....	285
Drain Augers Ridgid.....	355	Plumbest Sink.....	281
Drain Cable Ridgid.....	356	Plumbest Snap-In.....	285
Drain Cleaner Machines Ridgid.....	355	Sioux Chief Residential.....	297
Drain Cleaners		SPEE-D Channel.....	109
Clog Buster.....	319	Watts Drainage Floor	307
Hercules.....	264	Watts Drainage Roof.....	307
Toilet Plungers.....	372	Dresser Couplings Matco-Norca.....	467
Drain Cleaning General Wire Spring Co D-25		Driers	
Handy.....	360	Manitowoc.....	873
Drain Connectors Mission Rubber Flex-Seal.	478	Sporlan.....	913, 915-917
Drain Cutters Ridgid.....	356	SUPCO Filter.....	918
Drain Heaters SUPCO.....	845	Drill Bits	
Drain Hose Dishwasher.....	300	Lenox Ship Auger.....	338
Drain Machines Ridgid.....	355	Lenox Vari-Bit.....	338
Drain Pans		Malco.....	323
DiversiTech High Rise Pan.....	825	Plumbest.....	348
Plastic.....	846	Drills Malco Turboshear.....	320
Unico.....	530	Drinking Faucets Central Brass.....	162
Drain Pumps Liberty Pumps.....	100	Drip Rails EL Mustee.....	237
Drain Strainers	308	Drive Hooks Sioux Chief.....	364
Drain Valves Watts Regulator Boiler Drain	79	Drum Trap Chicago Specialty.....	303
Drain Vent Caps Plumbest.....	286	Drum Trap Covers Plumbest.....	284
Drainage Products	107	Drum Traps PVC DWV.....	422
Drainage Products NDS.....	107	Drybox Mill-Rose.....	351
Drains		Dryer Duct Fans Tjernlund.....	636, 835
Central Brass Bath.....	276	Dryer Vent Hoods	846
Dearborn Brass Bath Waste Repair Parts .	275	Dryer Vents	
Dearborn Brass Bath Wastes	271, 275	Aluminum.....	846
Geberit Bath.....	277	Galv Sheet Metal.....	846
Gerber Auto Trip.....	275	Dual Unit Valves Bell & Gossett.....	785
Gerber Brass.....	273	Duct	

INDEX



Flex Aluminum.....	748
Galv Sheet Metal.....	736-737, 752
Slim Duct Trunking System.....	826
Duct Adapters Galv Sheet Metal.....	740
Duct Board Certainteed.....	772
Duct Boosters Tjernlund.....	636, 835
Duct Clamps Malco.....	320
Duct Cutters	
Lenox.....	339
Malco Flex.....	322
Duct Fittings Galv Sheet Metal.....	736, 752
Duct Hangers	
C&S Mfg.....	761
DiversiTech.....	824
Duct Insulation Sleeves Dundas Jafine.....	639
Duct Liner Certainteed.....	772
Duct Rings Hart & Cooley.....	774
Duct Sealants Johns-Manville.....	761
Duct Strap	
Basset.....	761
DiversiTech.....	824
Duct Stretchers Malco.....	320
Duct Tape Polyken Technologies.....	838
Duct Tools	
Amcraft Duct Fabrication.....	352
Malco Flex Fiberglass.....	321
Duct Wrap Certainteed.....	772
Ductboard Tools Malco Fiberglass.....	321
Ducting	
Dundas Jafine Flexible Insulated.....	639
Unico.....	527-530
Ductless Split Systems Mitsubishi.....	579, 582-583, 585-586
Dundas Jafine	639
Dundas Jafine	
Duct Insulation Sleeves.....	639
Flexible Insulated Ducting.....	639
Dunkirk	597-606
Dunkirk	
Accessories.....	600-601
Boilers.....	605-606
Gas-Fired Boilers.....	597-604
Oil-Fired Boilers.....	605-606
Duplex Receptacles Pass & Seymour.....	856, 973
Dupont Refrigerant.....	887
Durastone Sinks EL Mustee.....	253
Durawall Bathtub Walls EL Mustee.....	236
Durawall Shower Walls EL Mustee.....	236
Dust Masks DiversiTech.....	369
DWV Fittings	
Cast Copper.....	404
PVC.....	416
Wrot Copper.....	405

DWV Hangers Sioux Chief.....	366
DWV Pipe PVC.....	416
DWV Tubing Copper.....	404
Dye Injection Kits Spectroline Products.....	960
Dyes Norlab.....	373

E

E James Belts	931-932
E James & Co	931-932
E-Granite Sinks Elkay.....	195
E-Z LavGuard2 Truebro Pipe Covers.....	377
Easy Clean Moen Showerheads.....	173
Easy Heat Pipe Tape.....	32
Easy-Cut Jaws Mill-Rose.....	351
EasyHeat	32
EasyHeat	
Freeze Free Pipe Freeze Prevention.....	32
Fused Plug Kits.....	32
Parts & Accessories.....	32
Thermostatically Controlled Devices.....	32
Eco Pad Equipment Pad.....	828
Econo Plugs Chicago Specialty.....	303
Ejectors Zoeller.....	93
EL Mustee	
Bathtub Walls.....	236
CareGiver Easy-Access Showers.....	237
Co-PolyPure Laundry Tubs.....	254
Drip Rails.....	237
Durastone Laundry Tubs.....	253
Laundry Tub Parts & Accessories.....	254
Mop Basin Accessories.....	374
Mop Basins.....	374
Mop Hangers.....	374
Service Sink Hoses.....	374
Shower Doors.....	237
Shower Drains.....	237
Shower Enclosures.....	237
Shower Floors.....	236
Shower Stall Parts.....	237
Shower Walls.....	236
Sinks.....	253
Structural Thermoplastic Laundry Tubs.....	254
Trim Kits.....	236
Elbows Dearborn Brass Closet Flush.....	271
Elcoma	175
Elcoma	
Grab Bars.....	175
Shower Seats.....	175
Electric Baseboard Heaters Ouellet.....	646
Electric Heaters	
AirQuest.....	513

Product Index



www.irrsupply.com

Product Index

Heil.....	495	Electronic Accessories Delta@.....	181
Tempstar.....	503	Electronic Air Cleaners Aprilaire.....	627
Electric Water Heaters		Electrostatic Filters Precisionaire.....	843
AO Smith.....	7-8	Elements Sporlan Thermostatic.....	950
AO Smith Hybrid.....	6	Elkay	195-196, 260, 278
Bradford White Residential.....	15-16		
Electrical		Elkay	
Supplies.....	851, 1013, 1034	E-Granite Sinks.....	195
Wire Terminals.....	1042	Sink Mounting Clips.....	196
Electrical Accessories Pass & Seymour.....	989	Stainless Steel Sinks.....	195-196
Electrical Box Covers Raco.....	857-858, 1027-1028	Strainers.....	278
		Water Coolers.....	260
Electrical Box Extensions Taymac.....	1031	Elkhart Copper Fittings.....	412
Electrical Boxes Raco.....	857, 1024-1027	Elster Perfection	372
		Elster Perfection Tubing.....	372
Electrical Conduit	851	Emergency Lighting AstraLite.....	994
Electrical Connectors Burndy.....	1046	Emerson	
Electrical Contact Cleaners Nu-Calgon.....	927	Belted Fan & Blower Motor.....	710
Electrical Disconnects Mars.....	1061	Condenser Fan Motors.....	708
Electrical Fittings Arlington Industries EMT...	1006	Direct Drive Fan & Blower Motor.....	709
Electrical Multi-ports Burndy.....	1046	Direct Drive Fan Motor.....	708
Electrical Outlet Boxes	1031	Oil Burner Motor.....	711
Electrical Pliers Malco.....	323	Replacement Motors.....	711
Electrical Supplies	851, 859, 1008, 1011-1013, 1034-1039	Rescue Condenser Fan Motor.....	709
		Empire	
Electrical Supplies		Direct Vent Fireplaces.....	819
Breakers Unlimited.....	849, 1055	Fireplace Accessories.....	821
Circuit Breakers.....	849	Fireplace Products.....	818-819
Conduit.....	851	Floor Furnaces.....	578
Conduit Fittings.....	851	Furnaces.....	577
Contactors.....	851	Gas Heaters.....	572
Cutler-Hammer.....	1055-1056	Parts.....	821
Devices.....	856	Vent-Free Stoves.....	819
Fittings.....	852	Wall Furnaces.....	575
Fuses.....	854	Empire Comfort Systems	572-578, 818-821
Metal Boxes.....	857	EMT Conduit	1006
Metallic Liquidtite.....	853	EMT Fittings Arlington Industries.....	1006
Non-Metallic Liquidtite.....	855	Enclosures	
Plug & Cord Ends.....	857	Milbank.....	1064
Safety Switches.....	854	RDM Products Condensing Unit.....	962
Staples.....	852	End Caps Band-Seal Mission Rubber.....	478
Tape.....	850	Endot	441
Wire.....	859	Endot	
Wire Markers.....	854	Prime Poly Pipe.....	413
Wire Nuts.....	858	Water Service Tube.....	413
Electrical Tape 3M.....	1051	Yellow Gas Pipe.....	441
Electrical Wire Connectors DiversiTech.....	1042	Energy Recovery Ventilators Lifebreath.....	638
Electrical Wiring Connectors Burndy.....	1046	Ensemble	
Electrode Insulator Assembly Kits	696	Shower Modules.....	232-233
Electrode Kits Crown Engineering.....	700	Tub & Shower Modules.....	229
		Whirlpool Tub & Shower Modules.....	230
		Entertainment Sinks Sterling Stainless Steel.....	197

INDEX



Epoxy Hercules	266
Equipment Pad Eco Pad.....	828
Equipment Pads DiversiTech.....	824
ERV Lifebreath.....	638
Escutcheons	
BrassCraft.....	296
Dearborn Brass.....	302
Sioux Chief.....	367
ESP Fan Motors	717
Evaporator Coil Cleaners Nu-Calgon.....	923
Evaporator Coils	
Coleman UPG Vexar.....	522
ICP.....	492
Evaporator Pads Aprilaire.....	625
Exit Lighting AstraLite.....	994
Expansion Tanks	
Amtrol.....	799, 814
John Wood Company.....	814
Expansion Tool Kits Milwaukee M12.....	317
Extension Cords Outdoor.....	1073
Extension Covers Chicago Specialty.....	303
Extension Tubes	
Dearborn Brass.....	270
Dearborn Brass Plastic.....	274
Extrol Expansion Tanks.....	799, 814
EZ Seal Quick Kit Heat-Fab.....	770
EZ Trap	
Condensate Traps.....	845
Waterless Trap Kits.....	845
EZ Trap Inc	845
EZQuick Water Line Installation Kits	
Dormont.....	298

F

Fan & Blower Motors Emerson.....	708-711
Fan Blade Puller SUPCO.....	845
Fan Blades	929
Fan Blades	
Acme-Miami.....	930
Heatcraft.....	929
Fan Boxes Arlington Industries.....	1029
Fan Centers Honeywell.....	659
Fan Coils ICP.....	493-494
Fan Controls Honeywell.....	669
Fan Guards Heatcraft.....	929
Fan-Forced Heaters Marley Engineered Products.....	572
Fans	
Broan Ventilating.....	839
Panasonic Ventilating.....	840
Panasonic Ventilating Combos.....	840
Fast-Stat Nordic Electronics.....	657

Fasteners Metal Stud.....	1028
Faucet Cartridges Moen.....	178
Faucet Handles	
BrassCraft.....	182
Central Brass.....	181
Delta.....	180
Delta Accents.....	180
Kohler.....	180
Moen.....	174
Faucet Hole Covers	
Moen Tub/Shower.....	174
Plumbest.....	279
Faucet Parts	
Gerber.....	183, 259
Gunk.....	298
Mansfield.....	259
Faucet Repair Parts BrassCraft.....	182
Faucet Risers BrassCraft.....	296
Faucet Seat Wrenches Plumbest.....	324
Faucet Spouts Chicago Faucets.....	165
Faucet Stems BrassCraft.....	182
Faucet Tools Handle Pullers.....	324
Faucet Washers Gunk.....	299
Faucets	
Brizo Bar/Prep.....	114
Brizo Tub & Shower Trim.....	141
Central Brass Bar.....	123, 124
Central Brass Dishwasher.....	123
Central Brass Drinking.....	162
Central Brass Kitchen.....	123
Central Brass Laundry.....	124
Central Brass Lavatory.....	129
Central Brass Metering Lavatory.....	161
Central Brass Service Sink.....	161
Chicago Faucet Inside Sill.....	164
Chicago Faucet Service Sink.....	164
Chicago Faucets Kitchen.....	163
Chicago Faucets Lavatory.....	162
Chicago Faucets Metering Lavatory.....	163
Chicago Faucets Sink.....	164
Delta.....	124, 126
Delta Commercial.....	159-160
Delta Kitchen.....	110, 113
Delta Lavatory.....	125-126, 159
Delta Lavatory Commercial.....	159
Delta MultiChoice Tub & Shower Rough-Ins.....	138, 140, 160
Delta MultiChoice Tub & Shower Trim.....	138, 160-161
Delta Roman Tub Rough-In Valves.....	140
Delta Roman Tub Trim.....	140
Gerber Bar.....	117
Gerber Kitchen.....	117
Gerber Laundry.....	124



Gerber Lavatory.....	132	UV Air Purification Replacement Lamps ...	631
Gerber Tub & Shower.....	149	Wiring Harnesses	679
Kitchen.....	113	Fill Alarms Beckett King.....	699
Kohler Commercial Touchless Lavatory ...	129	Fill Valves Fluidmaster.....	290
Kohler Kitchen.....	114	Fill-Trol Amtrol Expansion Tanks.....	799
Kohler Laundry.....	115	Filter Cartridges	
Kohler Lavatory.....	127-128	AquaPure Water.....	34-36, 38, 41
Kohler MasterShower Rough-In Valves....	142	Pentek Carbon Block.....	61-62
Kohler Roman Tub Rough-In Valves.....	143	Filter Elements Westwood Products.....	702
Kohler Tub & Shower Rough-In Valves....	141	Filter Housings AquaPure Whole-House	34, 39
Kohler Tub & Shower Trim.....	142	Filter Returns Airvector.....	779
Kohler Valve Repair & Accessories	258	Filter Rolls Precisionaire Hammock.....	842
MIFAB Non-Freeze Wall Hydrants.....	80	Filter-Driers	
Moen Bar.....	122	Sporlan.....	913, 916
Moen Commercial Metering Lavatory.....	137	SUPCO.....	918
Moen Commercial Pantry/Hospital.....	122	Filters	
Moen Commercial Sani-Stream.....	122	Aluminum.....	844
Moen Kitchen.....	120-121	American Granby Pentek.....	61-62
Moen Kitchen Pull-Outs.....	118	AquaPure Backwashing.....	41
Moen Lavatory.....	133, 136	AquaPure Commercial Water	42
Moen M•PACT Lavatory Rough-In Valves.	133	AquaPure Drinking Water	35, 41
Moen M•PACT Lavatory Trim.....	134	AquaPure Hot Water.....	38
Moen M•PACT Roman Tub Rough-Ins.....	158	AquaPure Iron Removal.....	40
Moen M•PACT Roman Tub Trim.....	158	AquaPure Refrigerator.....	38
Moen M•PACT Tub & Shower Rough-In		AquaPure Water Reverse Osmosis	37
Valves.....	151	AquaPure Whole-House Water	34, 39
Moen M•PACT Tub & Shower Trim Kits....	152	Crown Engineering Oil.....	700
Moen Spa Sets.....	157	Crown Engineering Oil Burner.....	700
Moen Tub & Shower.....	156-157	Cuno Systems.....	43
Plumb4orce Kitchen.....	116	General Filters Fuel.....	706
Plumb4orce Lavatory.....	131	Ice Machine.....	46
Plumb4orce Tub & Shower.....	149	Manitowoc.....	873
Plumbest Basin.....	123	Precisionaire.....	842-844
Symmons Single Handle Kitchen	115	Precisionaire Pleated.....	842
Symmons Single Handle Lavatory.....	130, 166	Sand Separator.....	58
Symmons Two Handle Lavatory.....	130, 166	Sporlan.....	918
Touch-Flo.....	62	Trion Media.....	630
Woodford Wall	80	Westwood Products Oil.....	702
Feeder Wire Underground.....	1034	Filtration Systems	
Fernco	474	AquaPure Commercial Water	42
Fernco Flexible Couplings.....	474	AquaPure Drinking Water.....	35, 41
Fiberglass Tools Amcraft Duct Fabrication....	352	AquaPure Hot Water.....	38
Field Controls	631, 679, 704-705, 771	AquaPure Refrigerator.....	38
Field Controls		AquaPure Water Reverse Osmosis	37
Air Boosters.....	704	AquaPure Whole-House Water	34, 39
Air Purification Systems.....	631	Moen.....	122
Combustion Air Systems.....	704-705	Fin Combs Mill-Rose.....	350
Draft Controls.....	679, 704	Finials Brizo.....	180
Draft Inducers.....	705	Fire Alarms Universal Security Instruments....	831
Power Venter Accessories.....	771	Fireplace Accessories Empire.....	821
Power Venters.....	771	Fireplace Products Empire.....	818-819
Thermal Safety Switches.....	705	Fireplaces Empire Direct Vent.....	819
		Firestop Sealants Boss.....	837

INDEX



Firomatic	707	CPVC/Sch80.....	427
Firomatic		Dearborn Brass PVC Fittings.....	274
Fusible Valves.....	707	Electrical.....	852
Hand Pump Parts.....	707	Elkhart Copper.....	412
Tank Valves.....	707	Flex-Seal Connectors.....	478
Valves.....	707	Flex-Seal Couplings.....	474, 477-478
Vent Caps.....	698	Flex/AC/MC Cable.....	852-853, 1041
Firomatic Valves	707	Galv MI Threaded.....	386-388
Fitting Assemblies Uponor.....	447	Galv Round.....	731
Fitting Brushes Mill-Rose.....	349, 351	Galv Round Sheet Metal.....	731-732, 750
Fittings		Galv Sheet Metal.....	733-746, 751-752, 758
Aluminum.....	748	Galv Steel Nipples.....	384
AY McDonald Service Couplings.....	480	Galvanized	386-388
Band-Seal Sewer Couplings.....	478	Galvanized Malleable Iron 150#.....	386
Band-Seal Specialty Couplings.....	475	Gas Appliance Connector.....	396
Bell & Gossett Airtrol Tank.....	786	Gastite Transition.....	440
Black.....	749	Gastite "XR" Series.....	439
Black Malleable Iron 150#.....	380	Geothermal.....	466
Black MI Threaded.....	380-383	Hancor.....	464
Black Sheet Metal.....	748, 760	Imported Threaded Brass.....	390
Black Steel Nipples.....	378-379	Insert.....	48, 52
Black Steel Tank Nipples.....	379	Iron	380-383
Brass	390-392	Merchant Black MI.....	380
Brass Compression.....	394	Metallic Conduit.....	1008
Brass Flared Tube.....	957	Metallic Liquidtite.....	853
Brass Garden Hose.....	287	Monoflo.....	786
Brass Pipe Nipples.....	389	Nibco Press System.....	461
Brass Threaded.....	390-392	Non-metallic Conduit.....	851, 1011
Brass Threaded Import.....	391-392	Non-Metallic Liquidtite.....	855
BrassCraft Brass Flare.....	393	Nylon Barbed.....	825
Caps.....	464	Nylon Insert.....	60-61
Cast Bronze Insert.....	60	Oval Galv Sheet Metal.....	746-748, 759
Cast Copper DWV.....	404-406	PEX Compression.....	443
Cast Copper Pressure.....	403-404	Plastic Trends SDR 35 Gasketed.....	431-433
Cast Iron No-Hub Soil	435-437	Plastic Trends SDR 35 Solvent Weld.....	428-431
Cast Iron Service-Weight	437	Plumbest Brass Hose.....	287
Cast Iron Soil No-Hub.....	435	PVC DWV.....	416-423
Cast Iron Soil Service.....	434	PVC Pressure Sch 40.....	841
Central Brass Tub & Shower.....	143	PVC Sch 40.....	414
Chrome Plated Nipples.....	392	PVC Sch 80.....	423
Chrome-Plated	392	Red Brass Insert.....	60
Chrome-Plated Pipe.....	392	Rigid/IMC Cable.....	1008
CI NH Soil.....	435-437	Selkirk.....	764-765
CI Service Soil.....	434-435	Selkirk B-Vent.....	762-764
CI Specialty Soil.....	437	Selkirk B-Vent Oval.....	764-765
Compression.....	394	Selkirk Chimney Systems.....	766
Copper Access.....	48	Sioux Chief PEX.....	366
Copper Cast Pressure.....	403	Slim Duct Trunking System.....	826
Copper DWV.....	405-407	Straight Couplings.....	480
Copper Wrot.....	399, 407	Tank.....	51
CPVC.....	425-427	TecTite	412
CPVC Sch 80.....	427-428		
CPVC/CTS.....	425		



Uponor PEX Baseboard.....	446	Industrial Grade.....	373
Uponor ProPEX.....	444	Ray-O-Vac.....	373
Uponor ProPEX Engineered Plastic.....	444	Flex Connectors	
Wall Stack Galv Sheet Metal.....	741, 755	BrassCraft Water Heater.....	815
Watts Brass PEX.....	448	Dormont Gas.....	438
Watts Poly Alloy PEX.....	451	Dormont Supr-Safe.....	438
Watts Radiant Onix.....	453	Fluidmaster.....	291-292
Watts Radiant PEX Crimp.....	454	Flex Duct Cutters Malco.....	322
Wrot Copper DWV.....	405	Flex Fittings Mission Rubber.....	474
Wrot Copper Pressure.....	399-402, 407-411	Flex Supplies McGuire Products.....	272
Wyes.....	464	Flex-Seal Connectors Mission Rubber.....	478
Yellow Jacket Access.....	728, 954	Flex-Seal Couplings Mission Rubber.....	474, 477-478
Flake Ice Machines Manitowoc.....	866	Flexible Cable Fittings Arlington Industries....	852-853, 1041
Flame Safeguard		Flexible Conduit	
Honeywell Pressure & Limit Controls.....	669, 812	Carlson.....	855
Honeywell Sensors.....	692	Priority Wire.....	853, 855, 1014
Flame Sensors		Flexible Couplings Fernco.....	474
Honeywell.....	692	Flexible Duct Quietflex.....	639
Robertshaw.....	687	Flexible Insulated Ducting Dundas Jafine....	639
White-Rodgers.....	675	Float Switches DiversiTech.....	825
Flange Connection Gaskets Plumbest.....	288, 467	Float Valves Kohler.....	289
Flange Repair Kit Save-A-Flange Closet.....	368	Flood Alarm Systems Aquanot Series Flood Alert.....	96
Flange Rings Sioux Chief Closet.....	297	Flood Detectors Wet Switch.....	825
Flange Spacers Sioux Chief Closet.....	375	Flood-Guard General Wire Spring Co.....	360
Flanges		Floodlights RAB Electric.....	992
Bell & Gossett Circulator.....	783	Floor & Ceiling Plates	
Black Malleable Iron 125#.....	383	Dearborn Brass.....	275, 303
Galv MI Threaded.....	387	Plumbest.....	280
Isolation.....	784	Sioux Chief.....	368
McGuire Products.....	272	Floor Boxes	
Oatey Closet.....	375	Pass & Seymour.....	1023
Plumbest Closet.....	283	Wiremold.....	1030
Plumbest Garbage Disposer.....	279	Floor Cleanouts Watts Drainage.....	308
Plumbest Urinal.....	283	Floor Drain Components Watts Drainage.....	308
Sioux Chief Closet.....	297	Floor Drains	
Taco Inc.....	792	Jumbo Mfg.....	703
Flappers		Plumbest.....	285
Fluidmaster.....	290	Watts Drainage.....	307
Kohler.....	288	Floor Sink Drains Plumbest.....	284
Plumbest.....	280	Flow Switches McDonnell & Miller Liquid.....	804
Seal-O-Matic Toilet.....	300	Flow-Mate Sump Pumps Zoeller.....	94
Flare Connections JB Industries.....	956	Flue Brushes Mill-Rose.....	350
Flare Fittings BrassCraft Brass.....	393	Fluidmaster	290-293
Flaring Tools		Fluidmaster	
Malco.....	322	Access Panels.....	293
Ridgid.....	330	Ballcocks.....	290
Flashing Oatey.....	311-312	Closet Gaskets.....	291
Flashing Cements Karnak.....	370	Dishwasher Adapters.....	292
Flashing Sealants Hercules.....	266	Flappers.....	290
Flashlight Hercules.....	263	Flexible Connectors.....	291
Flashlights			
DiversiTech.....	364		

INDEX



Flush Valves.....	290
Ice Maker Connectors.....	292
Tank-To-Bowl.....	291
Toilet Cleaning Systems.....	291
Toilet Tank Flush Valves.....	290
Fluorescent Ballasts Keystone Tech.....	1003
Fluorescent Light Bulbs Halco.....	963-964
Flush Balls Kohler.....	288
Flush Mount Lighting Lithonia.....	996
Flush Receptacle Power Outlets Pass & Seymour.....	979
Flush Valves	
Ballcocks.....	294
Fluidmaster.....	290
Plumbest.....	282
Sloan.....	184, 188
Sloan Conversion Kits.....	188
Flusher Fixer Kits Fluidmaster.....	291
Flushing Nu-Calgon System Flushing Products.....	887
Flushmate Sloan Replacement Parts.....	190
Flux	
Hercules.....	265
Oatey.....	312
Fluxes Harris Group.....	313
Foam Core Pipe PVC DWV.....	425
Foam Sealants Boss.....	761
Foil Tape Polyken Technologies.....	838
Folding Tools Malco.....	320
Foot Valves American Granby.....	58
Force Cups Gunk.....	372
Force Pump Silver King Mfg.....	817
Frames Lenox Hacksaw.....	332
Freeze Free Pipe Freeze Prevention	
EasyHeat.....	32
Freeze Protection Control SUPCO.....	684
Freeze Protection Controls Honeywell.....	658
FreezeAlarm Control Products.....	829
Freezer Thermometers Cooper-Atkins.....	729
Frost Proof Yard Hydrants	56
Fuel Filters General Filters.....	706
Full-Flow Unichicks Zoeller.....	97
Functional Devices	685
Functional Devices Relays.....	685
Furnace Blowers & Attic Ventilators	714
Furnace Cement Hercules.....	836
Furnace Controls White-Rodgers.....	673
Furnace Filters Precisionaire.....	842-844
Furnace Mount Blocks DiversiTech.....	824
Furnace Vent Transition Kit Miller.....	559
Furnaces	
AirQuest.....	552-557
AirQuest Gas.....	552-557

AirQuest Oil.....	558
"DV" Direct Vent Units.....	575
Empire.....	577
Empire Wall.....	575
Floor Empire.....	578
Gas.....	559-560
Heil.....	533-541
Heil Gas.....	533-540
Heil Oil.....	541
ICP Oil.....	541-542, 558
Miller.....	561
Pellet.....	569
Stylecrest Mfg Housing Gas.....	562-563
Stylecrest Mfg Housing Oil.....	564
Tempstar.....	543-550
Tempstar Gas.....	543-550
Tempstar Oil.....	551
Williamson-Thermoflo.....	567
Wood & Combination.....	569
Wood-Burning.....	570
Fuse Boxes For Type "T" Plug Fuses.....	1069
Fuses	
DiversiTech.....	1069
Electrical.....	854
Littelfuse.....	1069
Manitowoc.....	874
Fusible Valves Firomatic.....	707

G

Galv Malleable Iron	
Fittings 150#.....	386
Unions.....	388
Galv Steel Nipples Std Wgt.....	384-385
Galvan	990
Galvan Ground Rods.....	990
Galvanized Pipe Steel.....	384
Garbage Disposer Flanges Plumbest.....	279
Garbage Disposers In-Sink-Erator.....	191
Gardian Raychem Heating Cable.....	32
Gas	
Propane Tanks & Refills.....	314
Tanks & Refills.....	314
Gas Appliance Connectors Fittings.....	396
Gas Boilers Weil-McLain.....	589, 591, 622-623
Gas Connectors	
Dormont Flex.....	438
Dormont Flexible.....	438
Dormont Stationary.....	438
Gas Furnaces	
AirQuest.....	552-557
Heil.....	533-540



Miller.....	559-560	Gas Warning Tape.....	373
Stylecrest Mfg Housing.....	562-563	Manifolds.....	836
Tempstar.....	543-550	Mounting Hardware.....	836
Gas Heaters		Transition Fittings.....	440
Empire.....	572	Valves.....	440
Modine.....	565-566	"XR" Fittings.....	439
Gas Leak Detector Chemicals		Gastite Accessories.....	373
DiversiTech.....	364	Gastite from Titeflex Corporation	352, 373,
Hercules.....	267		439-440, 836
Nu-Calgon.....	823	Gate Valves	
Gas Leak Detectors		American Granby.....	368
Highside Chemicals.....	927	Valterra.....	368
Nu-Calgon.....	823, 926	Watts Regulator.....	75
Gas Pressure Test Kit Yellow Jacket.....	728	Gauge Glass Wal-Rich.....	297
Gas Regulators Harris Group Nitrogen.....	319	Gauge Glass Cutters Wal-Rich.....	324
Gas Shut-Off Valves Taco.....	796	Gauge Glass Sets Wal-Rich.....	816
Gas Tanks & Refills Accessories.....	314	Gauges	
Gas Tubing Kamco Products.....	398	Plumbest Pressure.....	288
Gas Valves		Pressure.....	51, 688
AO Smith.....	27	Yellow Jacket.....	727
AY McDonald.....	82	Yellow Jacket Vacuum Pump.....	725
Bradford White Icon.....	28	Gauges & Alarms Beckett.....	698
Honeywell.....	664	Geberit Bath Drains.....	277
Honeywell Burner Controls.....	663	Geberit Mfg Co	277
Honeywell Combination.....	661	Generac	
Honeywell SmartValve.....	665	Generator Accessories.....	1070
Sioux Chief.....	821	Guardian Generators.....	1070
White-Rodgers Pilot.....	674	Transfer Switches.....	1070
Gas Vent		Generac Power Systems	1070
Heat-Fab.....	770	General Filters	706
Selkirk.....	762, 764-766	General Filters Fuel Filters.....	706
Gas Vent Pipe & Fittings Heat-Fab.....	769	General Purpose Electrical Tape.....	55
Gas Warning Tape Gastite.....	373	General Wire Spring Co	360
Gas Water Heaters		General Wire Spring Co	
AO Smith.....	1-5	Augers Closet.....	360
AO Smith Commercial.....	19-22	Augers Urinal.....	360
Bradford White Commercial	10, 24-26	D-25 Handy Drain Cleaning.....	360
Bradford White Residential	9-14	Flood-Guard.....	360
Gas-Fired Boilers Dunkirk.....	597-604	Replacement Cable.....	360
Gaskets		Generator Accessories Generac.....	1070
Bell & Gossett.....	788	Generators	
Charlotte.....	435	Generac.....	1070
Hercules Toilet Bowl Setting.....	293	Honeywell.....	666
Manitowoc.....	874	Genetron Refrigerant.....	887
McDonnell & Miller.....	805	Geothermal Fittings Charter Plastics.....	466
Oil Burner Pump.....	702	Geothermal Pipe Charter Plastics.....	465
Plumbest Flange.....	288, 467	Gerber	
Plumbest Sponge Closet.....	280	Accessories.....	219
Plumbest Tub Faceplate.....	281	Bar Faucets.....	117
Strainer Screen & Cylinder Co.....	817	Commercial Toilets.....	223
Wax Toilet.....	299	Drain Trim Kits.....	276
Gastite		Drains.....	273, 275
Corrugated Stainless Steel Tubing.....	439	Faucet Parts.....	183, 259

INDEX



Faucets	117, 124, 132, 149-150, 183, 259, 273, 275-276
Fixtures	205-208, 215-219, 223-224
Kitchen Faucets.....	117
Laundry Faucets.....	124
Lavatories.....	205-207
Lavatory Cabinets.....	207
Lavatory Faucets.....	132
Toilets.....	215-216
Tub & Shower Faucets.....	149
Tub/Shower Rough-In Valves.....	150
Urinals.....	223
GFCI Receptacles Pass & Seymour.....	976-977
GFI Breakers Murray Electrical.....	1058
GLO-STICK Capsules Spectrolite Products...	961
Global	
Capacitors.....	684
Run Capacitors.....	684
Global Universal Capacitors	684
Globe Stop Valves CPVC.....	63
Globe Valves Sioux Chief.....	821
Goulds Pump	85
Goulds Pump	
Accessories.....	91-92
Convertible Pumps.....	86
Grinder Pumps.....	88
Jet Pumps.....	85-86
Pressure Tanks.....	83
Retention Tanks.....	83
Submersible Effluent Pumps.....	89
Submersible Pumps.....	87
Submersible Sewage Pumps.....	85, 90
Sump Pumps.....	87
Tank Packages.....	86
Tanks.....	83
Wastewater Packages.....	91
Goulds Pumps	83, 85-92
Grab Bars Elcoma.....	175
Granby	
Residential Oil Tanks.....	699
Underground Protected Tanks.....	699
Granby Steel Tanks	699
Grasslin	908
Grasslin	
Defrost Controls.....	908
Time Controls.....	908
Time Switches.....	908
Grates NDS Basin.....	107

Gray Metal	750-761, 846-847
Grease Plumber's Heat-Pruf	312
Grease Interceptors Watts Drainage.....	302
Grease Solvents Nu-Calgon.....	373, 926
Greenfield Manufacturing Co	1017-1020
Greenfield Manufacturing Co	
Beam Clamps.....	1017
Bolt Plates.....	1019
C Clamps.....	1017
Clamps.....	1017
Clevis Hangers.....	1018
Hanger Hardware.....	1019
Nuts.....	1020
Pipe Hooks.....	1017
Pipe Straps.....	1017
Ring Hangers.....	1018
Riser Clamps.....	1017
Rod Couplings.....	1019
Side Beam Connectors.....	1020
Split Ring Hangers.....	1018
Stud Protectors.....	1019
Tube Hooks.....	1017
Tube Straps.....	1017
Washers.....	1020
Grilles	
Hart & Cooley.....	774-777
Hart & Cooley T-Bar.....	778
Grinder Pumps Goulds Pump.....	88
Ground Rods Galvan.....	990
Grounding Arlington Industries.....	990
Guardian	
RGF Environmental Air Purifiers.....	629
RGF Environmental PHI Cell.....	629
Gunk	
Bonnet Packing.....	298
Faucet Parts.....	298
Faucet Washers.....	299
Lubricating Products.....	312
O-Rings.....	298
Toilet Plungers.....	372
Guns Peter Mangone Clip.....	469
Gutter Tools Malco Snap Lock Punches.....	319
Guy Strand Cable Preformed.....	1039

H

H-Struts Haydon.....	468
Hacksaw Blades Lenox.....	342
Hacksaw Frames Lenox.....	332
Hair Interceptors Watts Drainage.....	302
Halco	
Compact Fluorescent Light Bulbs	964

Product Index



www.irrsupply.com

Product Index

Halogen Light Bulbs.....	967	DiversiTech Duct.....	824
High Intensity Discharge Light Bulbs.....	966	Greenfield Manufacturing Co.....	1018
Incandescent Light Bulbs.....	965	Litchfield Clic.....	470
Linear Fluorescent Light Bulbs.....	963	Plumbest Lavatory & Sink.....	282
Recycling Boxes.....	967	Sioux Chief Pipe Hanger.....	366
Tube Guards.....	967	Sioux Chief Tube.....	364-365
Halco Lighting Technologies	963-967	Hard Start Kits DiversiTech.....	825
Halogen Light Bulbs Halco.....	967	Hard Starts SUPCO.....	828
Hammer Drives Powers Fasteners.....	363	Hardware	
Hammers Malco.....	322	Gastite Mounting.....	836
Hammock Filter Rolls Precisionaire.....	842	Greenfield Manufacturing Co Hanger.....	1019
Hancor	106, 428, 464	Manitowoc.....	874
Hancor		Harris Group	312-313, 319
Chamber Systems.....	106	Harris Group	
Dual Wall Fittings.....	464	Brazing Alloys.....	312
Dual Wall Pipe.....	428, 464	Fluxes.....	313
Single Wall Fittings.....	464	Nitrogen Regulators.....	319
Single Wall Pipe.....	464	Solders.....	313
Wall Fittings.....	464	Hart & Cooley	
Hand Cleaners		Commercial T-Bar.....	778
Boss.....	368	Registers & Grilles.....	774
Hercules.....	268	Sundries.....	777
Hand Saws Lenox.....	332	Hart & Cooley Residential Registers & Grilles	774-778
Hand Spinners Ridgid.....	353	Hartell	
Hand Tools		Pump Switches.....	105
Mill-Rose.....	350	Waste Water Pumps.....	105
Ridgid.....	332	Hartell Pumps	105
Hand-Held Showers		Haydon	
Delta.....	168-169	H-Struts.....	468
Delta Swivel Connectors.....	169	Heat Base 750.....	640
Delta Wall Grab Units.....	169	Heat Base 958.....	641
Handle Accents Delta.....	180	Rooftop Support Systems.....	469
Handle Adapter Kits Moen.....	175	Snap-On Accessories.....	640
Handle Extension Kits Moen.....	175	Strut Clamps.....	468
Handles		Touch-Up Paint.....	641
BrassCraft Faucet.....	182	Haydon Baseboard	640-641
Central Brass Faucet.....	181	Haydon Corporation	468-469
Delta Faucet.....	180	HBX Control	
Kohler Faucet.....	180	Reset Controls.....	686
Moen Faucet.....	174	Thermostats.....	686
Handshowers		HBX Control Systems Inc	686
Delta.....	167, 171	Head Mechanisms McDonnell & Miller.....	805
Delta Commercial.....	161	Head Pressure Controls ICM.....	912
Moen.....	173	Head Pressure Regulator Control Valves	935
Moen Spa Sets.....	157	Headers	
Hang-N-Strap Utility.....	955	Copper.....	814
Hanger Hardware Greenfield Manufacturing Co.....	1019	Steel.....	814
Hanger Strap Oatey.....	468	Hearth Connectors Dormont Flexible Gas.....	438
Hanger Strapping Greenfield Manufacturing Co Perforated.....	1019	Heat Exchanger Brushes Mill-Rose.....	349
Hangers		Heat Exchangers Bell & Gossett Brazed Plate.....	786
C&S Mfg Duct.....	761	Heat Fab Gas Vent Pipe & Fittings.....	769
		Heat Pastes Nu-Calgon.....	926

INDEX



Heat Pumps

AirQuest.....	511
Heil.....	489, 491
Mitsubishi Multi-Zone.....	582
Mitsubishi Split Ducted.....	581
Mitsubishi Split Ductless.....	580, 584-587
Tempstar.....	500, 502

Heat Recovery Ventilators Lifebreath..... 637

Heat Shields Mill-Rose..... 351

Heat Shrink & Splice Kits..... 54

Heat Shrink Kits..... 54

Heat Tape Easy Heat..... 32

Heat-Fab..... 769-770

Heat-Fab

EZ Seal Quick Kit.....	770
Gas Vent.....	770
Gas Vent Pipe & Fittings.....	769

Heatcraft..... 907, 929, 951

Heatcraft

Defrost Controls.....	908
Fan Blades.....	929
Fan Guards.....	929
Motors.....	951
Parts & Accessories.....	929, 951
Refrigeration Controls.....	907

Heater Raychem Crankcase..... 33

Heater Connectors Dormont Flexible..... 438

Heaters

Acme-Miami Defrost.....	930
AirQuest Electric.....	513
Empire Gas.....	572
Haydon Baseboard Heating.....	640-641
Heil Electric.....	495
Modine Gas Unit.....	566
Modine Unit.....	565-566
Smith's Environmental Profile Heaters.....	643
Smith's Environmental Quiet-One 2000	
Kickspace.....	643
SUPCO Drain.....	845
Tempstar Electric.....	503

Heating Cable Raychem..... 32

Heil..... 484-491, 501, 533-542

Heil

Blower Cabinets.....	495
Burners.....	542
Condensing Units.....	487
Electric Heaters.....	495
Furnaces-Gas.....	533-540
Furnaces-Oil.....	541
Heat Pumps.....	489, 491

Hercules..... 263-268, 289, 293-294, 815-816, 836

Hercules

Acid Test Kits.....	267
Anti-Freeze.....	266
Boiler & Heating System Cleaners.....	815
Boiler/Heating System Stop-Leaks.....	815
Boiler/Stove Cement.....	836
Bowl Setting Bolts.....	289
Bowl Setting Rings.....	293
Brushes.....	267
Cutting Oil.....	267
Drain & Waste System Cleaners.....	264
Epoxy.....	266
Flashlight.....	263
Flux.....	265
Furnace Cement.....	836
Hand Cleaners.....	268
Leak Detectors.....	267
Lubricants.....	267
Oil Cleaners.....	816
Putty.....	266
PVC Primers/Cleaners.....	263
Roof & Flashing Sealants.....	266
Stove Cement.....	836
Thread Sealants.....	265

Hex Drivers Malco..... 323

Hex Hubs MARS..... 928

Hex Keys Malco..... 323

Hex Wrenches Ridgid..... 325

HID Ballasts Keystone Tech..... 1003

HID Light Bulbs Halco..... 966

High Bay Lighting Lithonia..... 1001

High Efficiency Unit Heaters Modine..... 566

High-Bay Fixtures Nicor..... 1001

Highside Chemicals..... 927

Highside Chemicals Leak Detectors..... 927

Hinges

Manitowoc.....	874
Refrigeration Hardware.....	962

Hoffman Specialty..... 806-809

Hoffman Specialty

Condensate Pumps.....	809
Convactor Steam Vents.....	808
Main Steam Vents.....	807
Main Water Vents.....	808
Radiator Steam Vents.....	808
Steam Traps.....	806
Vacuum Breakers.....	807

Hold-Zit Tie Down Straps..... 372

Hole Covers Plumbest Faucet..... 279

Hole Cutters Malco..... 321



Ice Augers Manitowoc.....	871	Ignition Transformers Allanson.....	690
Ice Baggers Manitowoc.....	870	IMC Conduit	1008
Ice Dispensers Manitowoc.....	869	Imcoa	471-473, 773
Ice Machine Filters Nu-Calgon.....	46	Imcoa	
Ice Machine Maintenance Nu-Calgon.....	926	Adhesives.....	773
Ice Machine Pumps Little Giant.....	781	Insulation Tape.....	773
Ice Machines Manitowoc.....	861, 864	Pipe Insulation.....	471
Ice Maker Connectors Fluidmaster.....	292	Pipe Insulation Flextherm Seam Seal.....	473
Ice Maker Outlet Boxes Oatey.....	376	Unslit Pipe Insulation.....	472
Ice Maker Water Filtration AquaPure.....	38	Immersion Wells White-Rodgers.....	676
Ice Storage Bins Manitowoc.....	869	Impellers Bell & Gossett.....	788
Icemaker Kits Plumbest.....	287	In-Sink-Erator	191-194
ICM		In-Sink-Erator	
Head Pressure Controls.....	912	Food Waste Disposers.....	193
Motor Protection Controls.....	685	Garbage Disposers.....	191
ICM Controls	685, 912	Hot Water Dispensers.....	193
ICOR Refrigerant	887	Parts & Accessories.....	194
ICOR Refrigerants	887	In-Sink-Erator Disposer Kits Dearborn Brass.....	274
ICP		Incandescent Lampholders Pass & Seymour.....	1005
Air Conditioner.....	484, 514	Incandescent Light Bulbs Halco.....	965
Air Handlers.....	493-494	Industrial Grade Flashlights	373
Commercial Pkgd Units.....	515, 517	Inficon	730
Condensing Units.....	482-486, 488, 490, 501	Inficon Refrigerant Leak Detectors	730
Evaporator Coils.....	492	Inlet Boxes Reliance Controls.....	1070-1071
Fan Coils.....	493-494	Insert Fittings	
Oil Furnaces.....	541-542, 558	American Granby.....	52, 60
Packaged Air Conditioners.....	514	Maass Midwest.....	48
Packaged Air Handlers.....	519	Insert Stiffeners AY McDonald.....	481
Packaged Unit Accessories.....	520	Inspection Cameras Ridgid.....	353-354
Packaged Units.....	515, 517	Inspections Mirrors DiversiTech.....	824
Replacement Compressors.....	521	Insta-Tap Tool Refrigerant Recovery.....	933
Ideal		Installation Kits Dormont EZQuick.....	298
Conduit Installation.....	1072	Insul-Tarp	810
Wire Connectors.....	858-859, 1043	Insul-Tarp Radiant Heating Insulation	810
Ideal Industries Inc	858-859, 1043-1044, 1072	Insulated Ducting Dundas Jafine Flexible.....	639
Igniter Systems Hot Surface Igniters.....	683	Insulating Tape 3M.....	1051
Igniter Systems Inc	683	Insulation	
Igniters		Imcoa Imcolock Tubing Insulation.....	471
AO Smith Hot Surface.....	27	Insul-Tarp Radiant Heating.....	810
Honeywell Gas.....	667	Nomaco Pipe.....	473
Hot Surface.....	683	Insulation Foam Nu-Calgon.....	927
R.W. Beckett.....	691	Insulation Products Nu-Calgon.....	823, 927
White-Rodgers Gas.....	672	Insulation Sleeves Dundas Jafine Duct.....	639
Ignition Controls		Insulation Tape	
Honeywell Gas.....	661, 665	Cork.....	825
White-Rodgers Gas.....	674	Foam.....	825
Ignition Modules		Imcoa.....	773
Honeywell Gas.....	664	Insulators Sioux Chief.....	364
White-Rodgers.....	672	Interceptors Watts Drainage.....	302
		Interchangeable Unit Hubs Milbank.....	1065
		Intermatic	909, 988-989
		Intermatic	
		24-Hour Timers.....	909, 988

Product Index



www.irrsupply.com

Product Index

Commercial Spring Wound Timers	988
In-Wall Timers	988
Photo Controls	989
Trippers	988
International Comfort Products	482-487, 489, 491-500, 502-521, 533-558
Intrigue Shower Modules	233
Invensys Refrigeration Pressure Controls	896
IPS	
Cements	261
Primers & Cleaners	263
IPS Corporation Water-Tite	311
IPS Corporation Weld-On	261, 263
Irrigation Cables Baron Wire	92
Isolation Flanges Bell & Gossett Check-Trol..	784
Isolation Valves Noritz	18

J

J-B Products	293, 816
J-B Products Accessories	293, 816
J-Bends Dearborn Brass	269
J-Blocks Arlington Industries	1029
Jaws Ridgid Press Tool	318
JB Industries	933, 955-960
JB Industries	
Access Fittings	956
Access Valves	955
Adapters	957
Brass Bodies	957
Brass Fittings	957
Brass Tube Fittings	957
Capillary Tubing	955
Charging Scales	933
Flare Connections	956
Line Piercing Accesses	957
MPT Connections	956
Refrigeration Tools	933
Swivel Flare Connections	956
Tools & Replacement Parts	957, 960
Tubing Tools	960
Jet Pumps Goulds Pump	85-86
John Wood Company	814
John Wood Company Expansion Tanks	814
Johni-Bolt Hercules	289
Johni-Ring	293
Johnny-Guard Toilet Bases Remece Casting.	377
Johns-Manville	761
Johns-Manville Duct Sealants	761
Johnson Controls	900-907
Johnson Controls	

Modular Controls	902
Parts & Accessories	903
Pressure Controls	903-905
Pressure Sensors	905
Temperature Controls	900
Valve Renewal Kits	901
Water Valves	906-907
Joint Compound Pipe	268
Joint Compounds Burndy Oxide Inhibiting	1040
Joist Reinforcers Metwood	370
Jones Stephens	123, 173, 279-288, 306, 311, 324, 348, 369, 374, 467, 816
Jumbo Manufacturing Co	298, 305-306, 703
Jumbo Mfg	
Curb Boxes	306
Drains	703
Plumbing Specialties	305
Saddle Fittings	305

K

K&H Industries	1042-1043
K&H Industries Connectors	1042
Kamco Products	398
Kamco Products Coated Copper Tubing	398
Kaowool Blankets Lynn Products Co	847
Karnak	370
Karnak Flashing Cements	370
Keys	
Plumbest Water Meter	306
Sioux Chief Log Lighter	821
Keystone Tech	
Fluorescent Ballasts	1003
HID Ballasts	1003
Keystone Technologies LLC	1003-1004
Kickspace Heaters	
Ouellet	647
Quiet-One 2000	643
Kitchen Cleaners Chemique	377
Kitchen Faucets	116
Kitchen Faucets	
Central Brass	123
Chicago Faucets	163
Delta	110, 113
Gerber	117
Kohler	114
Moen	120-121
Moen Accessories	179
Moen Pull-Outs	118

INDEX



Plumb4orce.....	116
Symmons.....	115
Kitchen Sinks	
Elkay.....	195-196
Kohler Cast Iron.....	198
Kohler Stainless Steel.....	198
Moen Stainless Steel.....	198
Stainless.....	197
Sterling Stainless Steel.....	196
Kitchen Sprays Plumbest.....	279
Kits	
Pipe Heating.....	32
Sporlan.....	940
Knee Pads	
DiversiTech.....	369
Plumbest.....	374
Knives	
Lenox Utility.....	339
Malco Utility.....	322
Kohler	
Bath Accessories	176, 180, 258, 288-289
Bathtubs.....	226-227
Cast Iron Kitchen Sinks.....	198
Cast Iron Lavatories.....	203
Commercial Lavatories.....	204
Commercial Toilets.....	220
Commercial Touchless Lavatory Faucets.....	129
Faucet Handles.....	180
Float Valves.....	289
Kitchen Faucets	114-115
Laundry Faucets.....	115
Lavatories	200-205
Lavatory Faucets	127-129
MasterShower Rough-In Valves.....	142
Parts.....	258
Pedestal Lavatories.....	200
Roman Tub Rough-In Valves.....	143
Rough-In Valves.....	141
Sink Accessories.....	288
Sinks	198-199
Stainless Steel Kitchen Sinks.....	198
Toilet Parts.....	288
Toilet Seats.....	255
Toilets	209-213, 220-222, 255
Trip Levers.....	258
Tub & Shower Accessories.....	173
Tub & Shower Faucet Trim.....	142
Tub & Shower Faucets	141-143, 173
Tub & Shower Wastes.....	289
Valve Repair & Accessories.....	258
Vitreous China Urinals.....	221

Whirlpools.....	226
Whirlpools & Bathtubs	226-227
Kon-Trole Condensate Pan & Humidifier Cleaners.....	826

L

Lampholders	
Pass & Seymour.....	1005
TayMac.....	1033
Lamps	
Field Controls UV Replacement.....	631
Spectroline Products Leak Detection.....	961
Landscape Lighting RAB Electric.....	993
Lanterns Ray-O-Vac.....	373
Lash-N-Strap Nylon.....	955
Latch Parts Refrigeration Hardware.....	962
Laundry Chute Doors Hart & Cooley.....	777
Laundry Faucets	
Central Brass.....	124
Delta.....	124
Gerber.....	124
Kohler.....	115
Laundry Tray Pumps Zoeller.....	95
Laundry Tub Parts & Accessories EL	
Mustee.....	254
Laundry Tubs EL Mustee.....	253-254
Lav Guards Truebro.....	377
Lavatories	
Gerber Drop-In.....	206
Gerber Pedestal.....	205
Gerber Vanity Tops.....	207
Gerber Wall Hung.....	207
Kohler.....	201, 203
Kohler Cast Iron.....	203
Kohler Commercial.....	204
Kohler Pedestal.....	200
Lavatory & Sink Hangers Plumbest.....	282
Lavatory Cabinets Gerber Lavanity.....	207
Lavatory Carriers	
Watts Drainage.....	310
Watts Drainage Track.....	310
Lavatory Drains Plumbest.....	281
Lavatory Faucets	
Central Brass.....	129
Central Brass Metering.....	161
Chicago Faucets.....	162
Delta.....	125-126, 159
Delta Commercial.....	159
Delta Commercial Electronic.....	159
Delta Commercial Metering.....	160
Gerber.....	132
Kohler.....	127-128



Kohler Commercial Touchless.....	129	Lifebreath	
Moen.....	133, 136	Energy Recovery Ventilators.....	638
Moen Commercial Metering.....	137	ERV.....	638
Moen M•PACT Rough-In Valves.....	133	Heat Recovery Ventilators.....	637
Moen M•PACT Trim.....	134	HRV.....	637
Plumb4orce.....	131	Weather Hoods.....	638
Symmons.....	130-131, 166	Lift Wires Plumbest Brass.....	280
Lavatory Legs Plumbest.....	282	Light Bulbs	
Lavatory Risers BrassCraft.....	296	Fluorescent.....	963-964
Lavatory Strainers McGuire Products.....	272	Halogen.....	967
Lavatory Supply Kits McGuire Products.....	272	HID High Intensity Discharge.....	966
Leaching Chambers Hancor.....	106	Incandescent.....	965
Lead Ingot Plumbest.....	374	Lighting Lithonia.....	996
Lead Wool Plumbest.....	311	Lighting Control System Lutron.....	969
Leak Detector Chemicals		Lights Metal Trouble.....	1073
DiversiTech.....	364	Limit Controls	
Hercules Gas.....	267	Honeywell.....	669
Nu-Calgon Gas.....	823	Honeywell Pressuretrol.....	812
Leak Detectors		Line Piercing Accesses JB Industries.....	957
Gas.....	823, 926	Line Sets	
Inficon Refrigerant.....	730	Cerro.....	491, 502, 512
UEI Leak.....	721	Mueller.....	491, 502, 512
Yellow Jacket.....	729	Line Supplies Porcelain Products.....	1020
Leak Inhibitors Hercules Boiler.....	815	Line Valves Superior Refrigeration Products...	941
Leak Stoppers Westwood Products.....	702	Line Voltage Monitors ICM.....	685
Leak-Lock Thread Sealants.....	927	Line Voltage Relays	647
Legs Plumbest Lavatory.....	282	Linear Fluorescent Light Bulbs Halco.....	963
Legs & Feet Manitowoc.....	874	Liner Kits	
Lenox		Metalbest Chimney.....	768
Auger Bits.....	338	Metalbest Flexi-Liner Chimney.....	768
Aviation Snips.....	339	Metalbest Versa-Liner Chimney.....	768
Cold Coat.....	345	Linens Oatey Shower Pan.....	375
Hacksaw Frames.....	332	Linesets Mitsubishi.....	588
Hand Saws.....	332	Liquid Wrench Lubricants & Penetrants.....	301
Hole Saws.....	333	LiquiLock Gel Oatey.....	376
Snips.....	339	Litchfield Hangers.....	470
Torches.....	343	Litchfield International	470
Tubing Cutters.....	337	Lithonia	
Utility Knives.....	339	Accessories.....	996
Lenox Tools	313, 332-345	Flush Mount Lighting.....	996
Lenox Tools		High Bay Lighting.....	1001
Brazing Rods.....	345	Outdoor Lighting.....	1000
Lubricants.....	338	Recessed Lighting.....	996
Solder.....	313	Strip Lights.....	995
Levers Mansfield Trip.....	294	Lithonia Lighting	995-1001
Liberty Pumps	99-100	Littelfuse Fuses.....	1069
Liberty Pumps		Littelfuse Inc	1069
Drain Pumps.....	100	Little Giant	780-781
Macerating Toilet.....	100	Little Giant	
Sump Pumps.....	99-100	Condensate Pumps.....	780-781
Transfer Pumps.....	100	Ice Machine Pumps.....	781
Utility Pumps.....	100	Utility Transfer Pumps.....	780
Lifebreath	637-638	Load Centers Murray Electrical.....	855, 1053

INDEX



Lock'N Load Mill-Rose Heavy-Duty Drybox....	351
Locking Connectors Pass & Seymour.....	980
Locking Plugs Pass & Seymour.....	980
Log Lighter Keys Sioux Chief.....	821
Log Lighter Specialties Sioux Chief.....	821
Log Sets Empire.....	818
Low Water Cutoffs	
McDonnell & Miller.....	800-802
Taco.....	796
Lubricants	
Charlotte.....	435
Food Grade Silicone.....	927
Gunk.....	312
Hercules.....	267
Lenox Tools.....	338
Nu-Calgon Oil.....	888
Oatey Pipe Thread.....	268
Lubricants & Penetrants Liquid Wrench.....	301
Lutron	968-969
Lutron	
Adriani Toggler Switches.....	968
Diva Switches.....	969
Rotary Switches.....	969
Whole Home Lighting Control System	969
LuxPro	
Digital Thermostats.....	657
Outdoor Temperature Sensor.....	657
Programmable Thermostats.....	657
LuxPro Products	657
Lynn Products Co	
Burner Head Parts.....	847
Combustion Chamber Kits.....	847
Combustion Chambers.....	847
Kaowool Blankets.....	847
Lynn Products Company	847

M

Maass Midwest	48
Maass Midwest	
Dickens Aluminum Well Caps	48
Dickens Pitless Adapters.....	48
Insert Fittings.....	48
Macerating Toilet Liberty Pumps.....	100
Maintained Contact Switches Pass & Seymour.....	972
Maintenance Brushes Mill-Rose.....	350
Malco	319-323, 361
Malco	
Anchors.....	361
Duct Tools and Accessories.....	320
FasGroov Fiberglass Ductboard Tools.....	321
Fiberglass Ductboard Tools.....	321

Folding Tools.....	320
Hammers.....	322
Hex Keys.....	323
Hole Cutters.....	321
Measuring Tapes.....	322
Nut Drivers.....	323
Pliers.....	323
Power Bits.....	323
Punches.....	319
Screws.....	361
Seamers.....	319
Snips.....	319
Tubing Tools.....	322
TurboShear Drills.....	320
Utility Knives.....	322
Malleable Iron Fittings	
Black 150#.....	380
Galvanized 150#.....	386
Manifold Accessories	
Uponor.....	457-458
Watts Radiant.....	453
Manifolds	
Gastite.....	836
Mr PEX.....	442
Uponor Aquacenter.....	457
Uponor Copper.....	457
Uponor EP.....	457
Watts.....	460
Watts CustomCut.....	453, 460
Watts Radiant Custom Cut.....	453
Yellow Jacket.....	726
Manitowoc	861-878, 962
Manitowoc	
Accumulators.....	871
Adapters.....	871
Automatic Cleaning Systems.....	870
Bin Doors & Components.....	872
Capacitors.....	872
Cleaning & Sanitizing.....	872
Coils.....	872
Compressors.....	872
Contactors.....	873
Controls.....	873
Countertop Ice Dispensers.....	868
Countertop Ice Makers.....	868
Couplings.....	873
Curtains.....	878
Driers.....	873
Filters.....	873
Flake Ice Machines.....	866
Fuses.....	874
Gaskets.....	874
Hardware.....	874



Hinges.....	874	Shaded Pole Motors.....	713
Ice Augers.....	871	Solderless Terminals.....	1045
Ice Baggers.....	870	Terminals.....	1045
Ice Dispensers.....	869	Transformers.....	681
Ice Machines.....	861, 864	Tubing.....	846
Ice Storage Bins.....	869	Unit Bearing Motors.....	713
Legs & Feet.....	874	Wire.....	1039
Motors.....	874	Wire Ties.....	1045
Nugget Ice Makers & Dispensers.....	867	Zoom Spout Oilers.....	845
Parts & Accessories.....	878	Masonry Boxes Raco.....	1026
Pins.....	875	Mast Parts Arlington Industries.....	1010
Plugs.....	875	Matco-Norca	76, 78-79, 467
Probes.....	875		
Pumps.....	875	Matco-Norca	
Relays.....	875-876, 962	Boiler Drain Valves.....	78
Sensors.....	876	Bronze Stop Valves.....	79
Switches.....	876	Dresser Couplings.....	467
Thermostats.....	876	Sillcocks.....	78
Troughs.....	876	Stop & Waste Valves.....	78
Tubing.....	876	Stop Valves.....	78-79
Undercounter Ice Makers.....	868	Valves.....	76
Valves.....	877	MC Wire	859, 1035
Water Treatment.....	871	McCall Refrigeration	860
Wrenches.....	878	McDonnell & Miller	800-805
Manometers UEI Digital Electronic.....	722	McDonnell & Miller	
Mansfield		Liquid Flow Switches.....	804
Faucet Parts.....	259	Low Water Cutoffs.....	800-802
Toilet Parts.....	294	Parts.....	805
Trip Levers.....	294	Switches.....	803
Mansfield Service Parts	259, 294	Valves.....	803
Mantels Empire.....	821	Water Feeders.....	803
Manufactured Home Gas Furnaces Miller.....	560	McGuire Products	272-273
Manufactured Housing Equipment Style		McGuire Products	
Crest.....	562	Flanges.....	272
Marathon Electric Parts & Accessories.....	608	P-Traps.....	272
Marathon Heater Co	571	Strainers.....	272
Marathon Heater Co Add-On Boilers.....	571	Supply Kits.....	272
Marker Booklets Wire.....	854	Wastes.....	273
Marley Engineered Products	572	Measuring Tapes Malco.....	322
Marley Engineered Products Wall Heaters....	572	Mechanical Anchors Powers Fasteners.....	362
MARS		Media Air Cleaners	
Air Moving Components.....	928	Aprilaire.....	626-627
Capacitors.....	920	Trion.....	630
Contactors.....	678	Media Filters Air Bear.....	630
Disconnects.....	1061	Metal Boxes Electrical Supplies.....	857
Electrical & Accessories	845	Metalbest	
Hose Nozzles.....	955	Flexible Aluminum Liner.....	768
Motors.....	711-713	Flexible Aluminum Liner Kits.....	768
Parts & Accessories.....	348, 845, 955	Flexible SS Liner.....	768
Pigtails.....	1039	Metalbestos	
Potential Relays.....	681	Gas Vent.....	762, 764-765
Relays.....	680	Gas Vent Oval Pipe & Fittings.....	764-765
Replacement Cords.....	1039	Gas Vent Pipe & Fittings.....	762-764

INDEX



Meter Mounting Equipment Milbank.....	1062	Milton Roy Hartell	105
Meter Sockets Milbank.....	1062-1063	Milwaukee	
Meter Valves		M12 Lithium-Ion Cordless Tools.....	317
AY McDonald.....	81	ProPEX Expansion Kits.....	317
Nibco Water.....	79	Sawzall.....	317
Metering	165	Milwaukee Tool	317
Metering Faucets		Mini-Brake Malco.....	320
Central Brass Lavatory.....	161	Mini-Trol Amtrol Water Hammers.....	799
Delta.....	160	Mirrors DiversiTech Telescoping.....	824
Delta Electronic.....	159	Mission Rubber	
Symmons.....	165	Clamps.....	475
Metering Lavatory Faucets Chicago Faucets	163	Compression Joint Sealers.....	474
Meters Sensus Metering Systems Water.....	81	Connectors.....	475
Metwood	370	EII Fittings.....	474
Metwood Joist Reinforcers.....	370	End Caps.....	478
MIFAB		Flex Fittings.....	474
Hydrants.....	80	Flex Wye Saddles.....	475
Trap Seal Primer Distribution Units.....	301	Flex-Seal.....	478
Trap Seal Primers.....	301	Flex-Seal Couplings.....	474, 477-478
MIFAB Manufacturing	80, 301	Saddles.....	475
Milbank		Spanner Flanges.....	475
Accessories.....	1066	Specialty Couplings.....	475
Enclosures.....	1064	T-Flex Sewer Saddles.....	475
Interchangeable Unit Hubs.....	1065	Tee Fittings.....	474
Meter Mounting Equipment.....	1062	Mission Rubber Company	474-478
Transformers.....	1066	Mitsubishi	579-588
Milbank Mfg	1062-1066	Mitsubishi	
Mill-Rose	268, 349-351, 370-371	Accessories.....	587
Mill-Rose		Condensate Pumps.....	588
Abrasive Products.....	370	Multi-Zone.....	582
Applicator Brushes.....	350	Refrigerant Tubing Sets.....	588
Brushes.....	349-350	Split Ducted Systems.....	581
Cleaning Brushes.....	349	Split Ductless Systems.....	579, 581-583, 585-586
Cleaning Towels.....	371	Mixing Valves	
Condenser Tube Brushes.....	349	Honeywell Thermostatic.....	813
Drybox.....	351	Symmons.....	145, 147
Easy-Cut Jaws.....	351	Taco Inc.....	795
Fin Combs.....	350	Watts Regulator.....	71
Fitting Brushes.....	349, 351	Modine	565-566
Flue and Boiler Tube Brushes.....	350	Modine	
Heat Exchanger Brushes.....	349	Unit Heater Parts.....	565
Heat Shields.....	351	Unit Heaters.....	565-566
Maintenance Brushes.....	350	Modular Blower Cabinets	
Plumbing Brushes.....	350	AirQuest.....	513
Sealants.....	268, 371	ICP.....	495
Tools.....	350	Tempstar.....	503
Water-Gate Water Shut-Off Tools.....	351	Modular Controls Johnson Controls.....	902
Miller		Moen	
Accessories.....	561	Bar Faucets.....	122
Gas Furnaces.....	559-560	Commercial Lavatory Metering Faucets....	137
Oil Furnaces.....	561	Digital Spa & Shower Control.....	157
Split Systems	559-561	Drains.....	179



Faucet Cartridges.....	178	Aprilaire Damper.....	628
Filters & Parts.....	178	Bell & Gossett Pump.....	787
Handles.....	174	Emerson Belted Fan & Blower.....	710
Handshowers.....	173	Emerson Condenser Fan.....	708
Home Care Accessories.....	177	Emerson Direct Drive Fan.....	708
Kitchen Faucets.....	118-122	Emerson Direct Drive Fan & Blower.....	709
Lavatory Faucets.....	133-137	Emerson Oil Burner.....	711
Lavatory Rough-In Valves.....	133	Emerson Replacement.....	711
Lavatory Trim.....	134	Emerson Rescue Condenser Fan.....	709
M•PACT Tub & Shower Rough-In Valves..	151	Heatcraft.....	951
M•PACT Tub & Shower Trim Kits.....	152	Heatcraft Refrigeration.....	951
Pantry/Hospital Faucets.....	122	Honeywell.....	670
Parts & Accessories.....	174-175, 178-179	Manitowoc.....	874
Roman Tub Faucets.....	158	MARS.....	711-712
Roman Tub Rough-In Valves.....	158	MARS Direct Replacement.....	713
Shower & Bath Accessories.....	173-175, 178-179	MARS Unit Bearing.....	713
Shower Accessories.....	174	Shaded Pole.....	713
Showerheads.....	173	Tecumseh.....	717
Sill Faucets.....	76	Tecumseh Fan.....	717
Sinks.....	198	Motors & Armatures	
Spa Sets.....	157	Accessories.....	955
Stainless Steel Sinks.....	198	Air-Mars.....	928
Tub & Shower Faucets.....	151-158	Belts.....	931
Tub Spouts.....	174	Components.....	678-682
Water Filtration Systems.....	122	Electrical & Accessories.....	348, 845-846, 1039, 1045, 1061
Monoflo Fittings Bell & Gossett Copper Red		Motors.....	712-713, 730, 920-921
Ring.....	786	V-Belts.....	931
Mop Basin Accessories EL Mustee.....	374	Mounting Blocks Arlington Industries.....	1029
Mop Basins EL Mustee Durastone.....	374	Mounting Brackets	
Mop Hangers EL Mustee.....	374	DiversiTech.....	824
Morris Electrical		ThermO Manufacturing.....	848
Voice/Datacom & Wiring Devices.....	988	Mounting Clips Sink.....	196
Wire Connectors.....	1044	Mounting Flanges Webstone.....	798
Wire Management.....	1073	Mr PEX.....	442-443
Wire Marker Booklets.....	854	Mr PEX	
Wiring Devices.....	987	Accessories.....	443
Morris Electrical Products & Tools.....	854, 859, 987-988, 1025, 1043-1044, 1073	Compression Fittings.....	443
Motor & Accessories SUPCO.....	718	Manifold Accessories.....	442
Motor Brackets DiversiTech.....	718	Manifolds.....	442
Motor Couplers Bell & Gossett.....	787	PEX Tubing.....	442
Motor Mounts		Mr. Slim	
Acme-Miami.....	930	Mitsubishi Split Ducted.....	581
Bell & Gossett.....	788	Mitsubishi Split Ductless.....	579, 581, 583, 585-586
Motor Protection Controls ICM.....	685	Mr. Steam.....	251-252
Motors		Mr. Steam	
Acme-Miami.....	716	Controls.....	251
AO Smith Stock.....	714	Parts & Accessories.....	251
		Steambath Generator.....	251
		Towel Warmers.....	252

INDEX



Mueller Line Sets	491, 502, 512
Mueller Industries	491, 502, 512
Mulberry Metal Products	1033
Multi-Mac Receptacle Covers TayMac.....	1032
MultiChoice	
Delta Rough-In Valves.....	138, 140, 160
Delta Tub & Shower Trim.....	138, 160-161
Multimeters	
Digital.....	719
UEI.....	719
Multiple Outlet Cords Baron Wire.....	92
Murray Electric	849-850, 854-855, 1053-1055, 1057-1061
Murray Electrical	
Circuit Breakers.....	850, 1057-1058
Load Centers.....	855, 1053
Safety Switches.....	854, 1059
Mustee EL	236-237, 253-254, 374
M•PACT	
Moen Lavatory Rough-In Valves.....	133
Moen Lavatory Trim.....	134
Moen Roman Tub Rough-In Valves.....	158
Moen Roman Tub Trim.....	158
Moen Tub & Shower Rough-In Valves.....	151
Moen Tub & Shower Trim Kits.....	152

N

NailTites Watts Radiant.....	455
Nashua	838
Natural Gas Alarms Universal Security	
Instruments.....	830
NDS	
Basin Grates.....	107
Basin Outlets.....	108
Basins & Risers.....	107
Catch Basin Grates.....	107
Catch Basins.....	107
Channel Drains.....	108
Drainage Products.....	107
SPEE-D Channel Drains.....	109
NDS - National Diversified Sales	107-109
Need More Info Jumbo - Peterson Vents.....	298
Needle Valves Plumbest Piercing.....	287
Neutralizers AquaPure Acid.....	39
Nibco	
Boiler Drain Valves.....	78
Bronze Check Valves.....	77
Check Valves.....	77-78

Plumbing Valves	78-79
Press System Fittings	317, 461-463
Press System Tools	317
Stop Valves.....	79
Water Metal Valves.....	79
Nicor	999-1002
Nicor	
High-Bay Fixtures.....	1001
Recess Lighting.....	999
Under Cabinet Lighting.....	1002
Nipple Caddies Plumbest.....	374
Nipples	
Black Carbon Steel.....	378-379
Black Carbon Tank Steel.....	379
Black Steel.....	378-379
Brass.....	389-390
Chrome Plated.....	392
Chrome Plated Pipe.....	392
Conduit.....	1008
Galv Steel Sets.....	385
Galvanized Steel.....	384-385
Red Brass.....	389-390
Std Wgt Galv Steel.....	384-385
Nitrogen Regulators Harris Group.....	319
Nitrogen Tanks & Refills	314
NM Liquid-Tight Cord Connectors Arlington Industries.....	
Industries.....	1014
Noble Antifreeze.....	817
Noble Co	817
Nomaco Sheet Insulation.....	473
Nomaco K-Flex	473, 773
Non-Metallic Accessories Priority Wire.....	1013
Non-Metallic Fittings Arlington Industries.....	853, 1015
Non-Metallic Supports Arlington Industries....	853, 1015
Nordic Electronics	657
Nordic Electronics Fast-Stat.....	657
Noritz	17-18
Noritz	
Concentric Stainless Steel Venting.....	18
Isolation Valves.....	18
PVC Venting.....	18
Residential Tankless Water Heaters.....	17
Tankless Water Heater Accessories.....	18
Vent Termination Kits.....	18
Venting.....	18
Norlab	373
Norlab Dyes.....	373
Norwesco	106
Norwesco	
Septic Tank Risers.....	106
Septic Tanks.....	106
Notchers Lenox.....	339
Nozzle Connectors Fill Pipe.....	698



Oil Filters

Crown Engineering..... 700

General Filters..... 706

Sporlan..... 953

Westwood Products..... 702

Oil Furnaces

AirQuest..... 558

Heil..... 541

ICP..... 541-542, 558

Miller..... 561

Stylecrest Mfg Housing..... 564

Tempstar..... 551

Oil Lines Crown Engineering..... 701

Oil Nozzle Accessories Delavan..... 694

Oil Nozzle Lines Copper..... 702

Oil Pump Strainers Crown Engineering..... 701

Oil Pumps

Beckett CleanCut..... 697

Suntec..... 705-706

Oil Pumps & Injectors Yellow Jacket..... 728, 954

Oil Tanks Residential..... 699

Oil Test Kits Refrigeration..... 888

Oil Tubing Kamco Products..... 398

Oil Water Heaters

Bradford White Commercial..... 25

Bradford White Residential..... 15

Oil-Fired Boilers Dunkirk..... 605-606

Oilers

Ridgid Threading Machine..... 331

Zoom Spout..... 845

Old Castle..... 828

Old Work Boxes Pass & Seymour..... 1022-1023

Omnistat Controllers Sporlan..... 953

On-Site Wastewater Products Zoeller..... 97

OneStop Wrench..... 326

Onix

Watts Radiant Fittings..... 453

Watts Radiant Tubing..... 453

Ouellet

Baseboard Heaters..... 646

Kickspace Heaters..... 647

Relays..... 647

Ouellet Electric Heating..... 646-647

Oullett Thermostats..... 647

Outdoor Lighting Lithonia..... 1000

Outdoor Temperature Sensors LuxPro..... 657

Outlet Box Extensions TayMac..... 1031

Outlet Boxes

Arlington Industries Siding Mounting Blocks..... 1029

Oatey Ice Maker..... 376

Oatey Washing Machine..... 376

Pass & Seymour..... 1022

Raco..... 857, 1024-1027

Sioux Chief Ox Box..... 368

TayMac..... 1031

Uponor Washing Machine..... 458

Outlet Wastes

Dearborn Brass..... 269-270

Dearborn Brass Plastic..... 274

Outlets..... 1066

Outlets

Basin..... 108

Pass & Seymour..... 856, 973-974, 976-977, 979

P

P-Traps

Cast Copper DWV..... 405

Dearborn Brass..... 269

Dearborn Brass Plastic..... 273

McGuire Products..... 272

PVC DWV..... 422

Wrot Copper Pressure..... 411

Packaged Air Conditioners ICP..... 514

Packaged Air Handlers ICP..... 519

Packaged Unit Accessories ICP..... 520

Packaged Units ICP..... 515, 517

Packing

Bonnet..... 298

Plumbest..... 311, 374

Packless..... 952

Packless Vibration Absorbers..... 952

Paint Haydon Touch-Up..... 641

Pan Liners Oatey Shower..... 375

Panasonic..... 840

Panasonic Ventilating Bath Fans..... 840

Pans

DiversiTech High Rise Pan..... 825

Oatey Washing Machine..... 375

Oatey Water Heater..... 375

SUPCO Condensate Drain..... 828

Paragon Electronic Refrigeration Controls..... 910

Paragon Electric..... 910

Paragon Electric

Commercial Refrigeration Defrost Controls..... 910

Time & Energy Controls..... 910

Timers..... 910

Pass & Seymour..... 856-857, 969-987, 989, 1005, 1022-1023, 1031, 1033

Pass & Seymour



Blank Wall Plates.....	986	Uponor ProPEX Engineered Plastic Fittings.....	444
Canopy Switches.....	972	Uponor ProPEX Fittings.....	444
Ceiling Boxes.....	1023	PEX Barbed Ball Valves Sioux Chief.....	366
Clock Hanger Receptacles.....	978	PEX Clips Uponor.....	459
Combination Wall Plates.....	983	PEX Fittings	
Decorator/Rocker Switches.....	972	Sioux Chief.....	366
Device Wall Plates.....	986	Watts Brass.....	448
Duplex Receptacles.....	856, 973	Watts Poly Alloy.....	451
Electrical Accessories.....	989	Watts Radiant Crimp.....	454
Floor Boxes.....	1023	PEX Installation Uponor.....	459
Flush Receptacle Power Outlets.....	979	PEX Staplers Peter Mangone.....	470
GFCI Receptacles.....	976	PEX Staples Peter Mangone.....	470
Lampholders.....	1005	PEX Supports Uponor.....	459
Maintained Contact Switches.....	972	PEX Tools Watts.....	352
Old Work Boxes.....	1022-1023	PEX Tubing	
Power Plugs.....	980	Mr PEX.....	442
Receptacle Wall Plates.....	985	Uponor Non-Barrier.....	443
Receptacles.....	856, 973, 979-980	Watts Radiant PEX Non-Barrier.....	452
Straight Blade Plugs & Connectors.....	980	Watts WaterPEX Non-Barrier.....	448
Surface Receptacle Power Outlets.....	979	PEX Tubing Fasteners Watts.....	363
Switch & Outlet Boxes.....	1022	PHI Cells RGF Environmental Guardian.....	629
Switch Wall Plates.....	982	PHI Plug-In RGF Environmental Guardian.....	629
Switches.....	856, 969	Photo Controls Intermatic.....	989
Tamper-Resistant GFCI Receptacles.....	977	Piercing Valves	
Tamper-Resistant Receptacles.....	974	Plumbest.....	287
Telephone & CATV Wall Plates.....	986	SUPCO.....	960
Turnlok Locking Devices.....	980	Pigtail Syphons Plumbest.....	288
Weatherproof Boxes.....	1031	Pigtails MARS.....	1039
Paste Water-Finding.....	698	Pilot Burners	
PE Underground Couplings	440	AO Smith.....	27
Pedestal Lavatories Kohler.....	200	Honeywell.....	667
Pellet Furnaces PSG Distribution.....	569	Pilot Gas Valves	
Penetrating Oil Liquid Wrench.....	301	Honeywell.....	661
Pentair	46, 84	White-Rodgers.....	674
Pentair		Pilot Ignitions Robertshaw.....	682
WellMate Captive Air Tanks.....	84	Pilot Modules	
WellMate Retention Tanks.....	84	Honeywell.....	664
WellMate Tank Accessories.....	84	White-Rodgers.....	672
Pentair Water Chlorinator Pellets.....	46	Pilot Relays Functional Devices.....	685
Perforated Hanger Strapping Greenfield Manufacturing Co.....	1019	Pilot Relite Controls White-Rodgers.....	676
Perma Wet Plug CGM Inc.....	370	Pins Manitowoc.....	875
Peter Mangone		Pipe	
Clip Guns.....	469-470	Aluminum Round.....	748
Clips.....	470	Black.....	748
PEX Staplers.....	470	Black Sheet Metal.....	748, 760
PEX Staples.....	470	Black Steel	378
Reddi-Strip Fastening System.....	470	Cast Iron No Hub Soil	435
Peter Mangone Inc	469-470	Cast Iron Soil.....	434-435
Peterson Vent Strainers.....	298	Copper	397, 404, 407
PEX		CPVC	425
Mill-Rose Decrimping Ringcrusher Tool....	351	CPVC CTS.....	425
		EMT Conduit.....	1006



Galv Button Lock Pipe.....	750	CPVC/CTS.....	425
Galv Sheet Metal.....	731	CPVC/Sch80.....	427
Galvanized Steel.....	384	Galvanized Malleable Iron 150#.....	386
Geothermal.....	465	Imported Threaded Brass.....	390
Hancor Wall.....	428, 464	Plastic Trends SDR 35 Gasketed.....	431
IMC Conduit.....	1008	PVC DWV.....	416
Imcoa Imcolock Insulation.....	471	PVC Sch 40.....	414, 841
Oval Galv Sheet Metal.....	746, 759	PVC Sch 80.....	423
Prime Poly.....	413	SDR 35 Solvent Weld.....	428
PVC.....	414, 416,	Selkirk Chimney Systems.....	766
	423, 425,	Selkirk Gas Vent.....	762, 764-765
	428, 431, 433	Wrot Copper DWV.....	405
PVC Drain Waste & Vent.....	416	Pipe Freeze Protection Raychem Heating	
PVC DWV Foam Core.....	425	Cable.....	32
PVC Sch 40 Conduit.....	851, 1011	Pipe Hangers	
PVC Sch 80 Conduit.....	1011	Greenfield Manufacturing Co.....	1018
PVC Sewer & Drain.....	428, 431	Sioux Chief.....	366
PVC Type 1120 Pressure.....	414, 423, 433	Sioux Chief DWV.....	366
Selkirk Gas Vent.....	762, 764-765	Pipe Hooks	
Yellow Gas.....	441	Greenfield Manufacturing Co.....	1017
Pipe Brackets		Oatey.....	468
Basset.....	761	Pipe Inspecting Ridgid.....	353
Sioux Chief.....	366	Pipe Insulation	
Pipe Clamp Adapters UEI.....	724	Imcoa Flextherm Seam Seal.....	473
Pipe Clamps		Imcoa Imcolock Pluseal Insulation.....	471
Malco.....	320	Imcoa Unslit.....	472
Oatey.....	467	Pipe Joint Compound X-Pando.....	268
Sioux Chief.....	364	Pipe Nipples	
Touchdown II Large Universal.....	365-366	Black Steel.....	378-379
Pipe Connectors Mission Rubber Flex-Seal...	478	Brass.....	389
Pipe Couplings		Chrome Plated.....	392
Mission Rubber Band-Seal.....	475	Galv Steel.....	384
Mission Rubber Flex-Seal.....	474, 477-478	Pipe Plugs	
Pipe Covers Truebro.....	377	Cherne Clean Seal.....	277
Pipe Cutter Wheels Ridgid.....	327	Cherne Mechanical.....	277
Pipe Cutters	343	Cherne Pneumatic.....	277
Pipe Cutters		Sioux Chief.....	367
Lenox.....	339	Pipe Repair Clamps Plumbest Steel Hinged..	287
PlumBest.....	348	Pipe Strap	
Ridgid.....	326	Basset.....	761
Pipe Dies Ridgid.....	331	Oatey Strap.....	468
Pipe Extractors Ridgid.....	329	Pipe Straps Greenfield Manufacturing Co.....	1017
Pipe Fittings		Pipe Tape Easy Heat.....	32
AY McDonald Water Service Couplings....	480	Pipe Taps Ridgid.....	329
Band-Seal Sewer Couplings.....	478	Pipe Thread Sealants	
Black Malleable Iron 150#.....	380	DiversiTech.....	824
Brass Threaded.....	390	Hercules.....	265
BrassCraft Brass Flare.....	393	Oatey.....	268
Cast Copper DWV.....	404	Pipe Tools Ridgid.....	329
Cast Iron Soil No-Hub.....	435	Pitless Adapters	
Cast Iron Soil Service.....	434	American Granby.....	53
Copper Cast Pressure.....	403	Maass Midwest.....	48
Copper Wrot.....	399, 407	Plastic Pipe Cements Oatey.....	261



Plastic Pipe Primers/Cleaners			
Hercules.....	263		
Oatey.....	263		
Plastic Trends Fittings.....	428-433		
Plastic Trends Inc	428-433		
Plastic Tubular Dearborn Brass.....	273-274		
Plates			
Greenfield Manufacturing Co Bolt.....	1019		
Plumbest Floor & Ceiling.....	280		
Sioux Chief.....	365		
Sioux Chief Shield.....	365		
Plenum Square.....	529		
Plenums Galv Sheet Metal.....	733		
Pliers			
Douglas Slip-Joint.....	352		
Malco.....	323		
Unico Clamp.....	531		
Plug & Cord Ends Electrical Supplies.....	857		
Plug Kits EasyHeat.....	32		
Plug Valves AY McDonald Corporation.....	479		
Plug Wrenches Plumbest.....	324		
Plug-In RGF Environmental PHI Cell.....	629		
Plugs			
Cherne Mechanical Pipe.....	277		
Cherne Pneumatic Pipe.....	277		
Clean Seal.....	277		
Manitowoc.....	875		
Pass & Seymour.....	980		
Plumbest Cleanout.....	284		
Sioux Chief Pipe.....	367		
Plumb4orce			
Kitchen Faucets.....	116		
Kitchen/Bar Faucets.....	116		
Lavatory Faucets.....	131		
Tub & Shower Faucets.....	149		
Plumber's Grease			
Heat-Pruf.....	312		
Hercules.....	267		
Plumbest			
Aerators.....	279		
Backwater Valves.....	286		
Basin Faucets.....	123		
Basket Strainers.....	279		
Bath Cocks.....	281		
Bell Trap Drains.....	285		
Caution Tape.....	369		
Cleanout Plugs.....	284		
Cleanouts.....	284		
Closet Bolt Caps.....	282		
Closet Bolts.....	282		
Closet Flange Spacers.....	283		
Closet Flanges.....	283		
Closet Spuds.....	282		
Dishwasher Drain Connectors.....	286		
Disposer Flanges.....	279		
Drains.....	283		
Faucet Hole Covers.....	279		
Flappers.....	280		
Floor & Ceiling Plates.....	280		
Floor Sink Drains.....	284		
Flush Valves.....	282		
General Purpose Drains.....	284		
Hose Fittings.....	287		
Kitchen Sprays.....	279		
Lavatory Legs.....	282		
Lead Ingot.....	374		
Lead Wool.....	311		
Lift Wires.....	280		
Nipple Caddies.....	374		
Nuts and Washers.....	279		
Oakum.....	374		
Packing.....	311, 374		
Plumbest Lavatory & Sink Hangers.....	282		
Roof Drains.....	285		
Saddle Tee Kits.....	286		
Shower Arms.....	281		
Shower Rods.....	281		
Shower Stall Drains.....	285		
Shower/Floor Drains.....	285		
Snap-In Drains.....	285		
Solder Supplies.....	324		
Sponge Closet Gaskets.....	280		
Test Equipment.....	288		
Trip Levers.....	280		
Tub Spouts.....	281		
Urinal Flanges.....	283		
Urinal Spuds.....	282		
Vent Caps.....	286		
Washing Machine Hose.....	286		
Waste Connectors.....	280		
Water Meters.....	288, 306		
Wrenches.....	324		
Plumbing Brushes Mill-Rose.....	350		
Plumbing Fittings			
Brass Compression.....	394		
Dearborn Brass Plastic.....	274		
Plumbing Specialties Jumbo Mfg.....	305		
Plumbing Supplies Dearborn Brass			
Decorator.....	275		
Plumbing/Water Valves AY McDonald.....	81		
Pneumatic Pipe Plugs Cherne.....	277		
Polyken Technologies	838		
Polyken Technologies			
Duct Tape.....	838		
Foil Tape.....	838		
Porcelain Products			

INDEX



Clevises.....	1020
Line Supplies.....	1020
Wedge Grip Clamps.....	1020
Wireholders.....	1020
Porcelain Products Co	1020
Portable Cooling Comfort-Aire.....	524
Portable Cord & Power Cable	1037
Portable Unit Heaters Marley Engineered Products.....	572
Potential Relays SUPCO.....	684
Power Bits Malco.....	323
Power Generators Honeywell.....	666
Power Inlet Boxes Reliance Controls.....	1070-1071
Power Pack Motors Bell & Gossett.....	787
Power Plugs Pass & Seymour.....	980
Power Relays Functional Devices.....	685
Power Threaders Ridgid.....	315
Power Tools	
Milwaukee.....	317
Plumbest Bits.....	348
Power Venter Accessories Field Controls.....	771
Power Venters	
Field Controls.....	771
Tjernlund.....	633-634, 832-833
Powerflite E James Belts	931-932
Powers	77
Powers	
Biltmore Pressure Balancing Valves.....	77
Tempering Valves.....	77
Powers Fasteners	362-363
Powers Fasteners	
Anchor Tools.....	363
Hammer Drives.....	363
Mechanical Anchors.....	362
Precisionaire	842-844
Precisionaire	
Air Filters.....	843-844
Aluminum Filters.....	844
Cut-to-Fit Air Filters.....	842
Electrostatic Filters.....	843
Panel Air Filters.....	842
Preformed	
Anchor Screws.....	1039
Dead-Ends.....	1039
Guy Strand Cable.....	1039
Preformed Copper Sioux Chief.....	366-367
Preformed Line Products	1039
Press System Fittings Nibco.....	461
Press System Tools Nibco.....	317, 463
Press Tools Ridgid.....	318
Pressure Balancing Valves Powers.....	77
Pressure Control Valves Sporlan.....	934

Pressure Controls	
Honeywell Pressuretrol.....	669
ICM.....	912
Invensys.....	896
Johnson Controls.....	903-905
Ranco.....	896
Pressure Fittings Copper Cast.....	403
Pressure Gauges	
American Granby.....	51
Plumbest.....	288
Terrice.....	688
Pressure Hose Yellow Jacket.....	889
Pressure Pipe Type 1120 PVC.....	414, 423, 433
Pressure Reducing Valves	
Bell & Gossett.....	784-785
Taco Inc.....	795
Pressure Regulating Valves Sporlan.....	934
Pressure Regulators	
Dormont Gas Appliance.....	685
Watts Regulator Boiler Feed.....	73
Watts Regulator Water.....	64
Pressure Relief Valves	
American Granby.....	49
Superior Refrigeration Products.....	942
Watts Regulator.....	64-66
Pressure Sensors Johnson Controls.....	905
Pressure Switches	
American Granby.....	54
SUPCO.....	911-912
Pressure Tanks Goulds Pump.....	83
Pressure Testers Westwood Products.....	730
Pressuretrol Honeywell Controllers.....	669, 812
Prime Poly Pipe	413
Prime Poly Pipe Endot.....	413
Primers Weld-On PVC/CPVC/ABS.....	263
Primers/Cleaners	
Hercules.....	263
Oatey.....	263
Priority Wire	
Coaxial Cable.....	1039
Flexible Conduit.....	853, 855, 1014
Non-Metallic Accessories.....	1013
Telephone/Communications Wire.....	1039
Thermostat Wire.....	1039
Priority Wire & Cable Inc	853, 855, 1013, 1014, 1039
Pro-Fab Wood-Burning Furnaces.....	570
Pro-Fab Industries	570
PRO-PAL Webstone Ball Valves.....	797-798
Probes	
Cooper-Atkins.....	730



Cooper-Atkins Air.....	730	Liberty Utility.....	100
Manitowoc.....	875	Little Giant Condensate.....	780-781
UEI Temperature.....	722	Little Giant Ice Machine.....	781
Programmable Thermostats LuxPro.....	657	Little Giant Utility Transfer.....	780
Programmable Timers Intermatic.....	988	Manitowoc.....	875
Propane Gas Tanks	314	Mitsubishi Condensate.....	588
ProPEX		Saniflo Grey Water.....	225
Baseboard Fittings.....	446	Saniflo Shower/Basin System.....	225
Fittings.....	444	Silver King Mfg Chemical.....	817
Uponor Brass Plugs.....	447	Submersible.....	87
Uponor Rings.....	447	Submersible Effluent.....	89
Uponor Washing Machine Outlet Boxes ...	458	Submersible Sewage.....	85, 90
Valves.....	447	Sump.....	87
ProPEX Accessories Uponor.....	458	Suntec Oil.....	705-706
ProPEX Engineered Plastic Fittings	444	Taco Circulator.....	789, 792-793
ProPEX Expansion Kits Milwaukee.....	317	Zoeller.....	93-95
Protectorelay Honeywell Oil Primary.....	692	Zoeller Back-Up.....	96
PSG Distribution		Zoeller Sewage Package Systems.....	96
Pellet Furnaces.....	569	Punches	
Wood & Combination Furnaces.....	569	Lenox.....	339
Pump Saniflo.....	225	Malco.....	319
Pump Accessories American Granby.....	54	Malco Snap Lock for Gutters.....	319
Pump Alarms Zoeller.....	96	Malco Snap Lock Siding.....	319
Pump Motors Bell & Gossett.....	787	PureTouch Moen Replacement Filters.....	178
Pump Oil Vacuum.....	823	Purgers American Air Eliminators.....	799
Pump Parts Taco Inc.....	793	Putty Hercules.....	266
Pump Seals Bell & Gossett.....	787	PVC Cements	
Pump Strainers Crown Engineering.....	701	IPS Weld-On.....	261
Pump Switches		Oatey.....	261
Hartell.....	105	PVC Cleaners Weld-On.....	263
SJE Rhombus.....	102	PVC DWV Fittings	416-423
Pump Tank Accessories American Granby...	49	PVC Fittings	
Pump Treatment Tablets DiversiTech.....	781	Dearborn Brass Plumbing.....	274
Pump Valves		DWV.....	416
American Granby Brady.....	49	Non-metallic Conduit.....	851, 1011
American Granby Pressure Relief.....	49	Plastic Trends.....	428-433
Zoeller Unichecks.....	97	Pressure Sch 40.....	841
Pumps		Sch 40.....	414
AY McDonald Back-Up.....	99	Sch 80.....	423
AY McDonald Sump.....	99	Traps.....	274
AY McDonald Water.....	99	PVC Pipe	
Beckett CleanCut Oil.....	697	Drain Waste & Vent.....	416
Bell & Gossett Circulator.....	782-783	DWV Foam Core.....	425
Chem-Tech Chemical Feed.....	59	Sewer & Drain.....	428, 431
Cherne Air.....	278	Type 1120 Pressure.....	414, 423, 433
DiversiTech Condensate.....	781	PVC Primers IPS Weld-On.....	263
Grinder.....	88	PVC Primers/Cleaners	
Hartell Waste Water.....	105	Hercules.....	263
Hoffman Specialty Condensate.....	809	Oatey.....	263
Jet.....	85-86	PVC Schedule 40 Fittings	414-416
Liberty Drain.....	100	PVC Schedule 80 Fittings	423-425
Liberty Pumps Transfer.....	100	PVC Schedule 80 True Union Valves	63
Liberty Sump.....	99	PVC Venting Noritz.....	18



Q

QMark	572
Quadro Washing Machine Outlet Boxes	376
Quick Connects Gastite Accessories.....	440
Quietflex Flexible Duct.....	639
Quietflex Flex Duct	639
Quik Disconnects Supr-Safe.....	438
Qwik Jon Sewage Removal System.....	95

R

RAB Electric	991-993
RAB Electric	
Floodlights.....	992
Landscape Lighting	993
Sensors.....	993
Vaporproof Ceiling Fixtures.....	992
Vaporproof Globes.....	992
Wallpacks.....	991
Raceway Wiremold	1021
Raco	
Box Supports.....	1027
Ceiling Pans.....	990, 1028
Electrical Box Covers.....	857-858, 1027-1028
Electrical Boxes.....	857, 1024-1027
Masonry Boxes.....	1026
RACO Electrical	857-858, 990, 1024-1028
Radiant Heating Insulation Insul-Tarp.....	810
RadiantPEX Watts Non-Barrier PEX Tubing...	452
Radiator Coin Key Air Valves Plumbest.....	816
Radiator Specialty	
Hoses & Accessories.....	300
Toilet Repair Parts.....	299
Radiator Specialty Co	298-301, 312, 352, 372
Radiator Spud Wrenches Plumbest.....	324
Radiator Steam Vents Hoffman Specialty.....	808
Radiators Burnham.....	644
Rain Caps Galv Sheet Metal.....	746
Rain-R-Shine Oatey Cement.....	262
Ranco	
Commercial Pressure Controls.....	896
Commercial Temperature Controls.....	897
Ranco Controls	896-899
Range Connectors Dormont Flexible.....	438
Ray-O-Vac	373
Ray-O-Vac	

Batteries.....	373
Flashlights & Lanterns.....	373
Raychem	32-33
Raychem	
Crankcase Heaters.....	33
Heating Cable.....	32
WinterGard Components	33
Razorback Wrenches.....	351
RDM Products	962
RDM Products Condensing Unit Enclosures..	962
Reamers Ridgid.....	329
Receptacle Covers TayMac.....	1032
Receptacle Wall Plates Pass & Seymour.....	985
Receptacles Pass & Seymour.....	856, 973-974, 976-980
Recess Lighting Nicor.....	999
Recessed Lighting Lithonia.....	996
Reciprocating Saw Blades Lenox.....	340
Reciprocating Saws Milwaukee Sawzall.....	317
Recycling Boxes Halco.....	967
Reddi-Strip Fastening System Peter	
Mangone.....	470
Reducers Sheet Metal.....	759
Refrigerant	
Dupont.....	887
Honeywell Genetron.....	887
ICOR.....	887
Refrigerant Analyzers Yellow Jacket.....	725
Refrigerant Cooling Modules	526
Refrigerant Leak Detectors Inficon.....	730
Refrigerant Recovery	
Insta-Tap Tool.....	933
Yellow Jacket.....	725, 889
Refrigeration Delfield Reach-In.....	860
Refrigeration & Heating 21/29 Frame	
Replacements	715
Refrigeration Controls	
Heatcraft.....	907
Johnson Controls Pressure	903
Johnson Controls Temperature	900
Paragon Electronic.....	910
Ranco.....	896-899
Refrigeration Fittings Copper Access.....	48
Refrigeration Flush Solvents Nu-Calgon.....	925
Refrigeration Hardware	
Door Closers.....	961
Hinges.....	962
Latch Parts.....	962
Refrigeration Hardware Supply Corp	961-962
Refrigeration Oil Nu-Calgon.....	888
Refrigeration Oil Test Kits Nu-Calgon.....	888
Refrigeration Recovery Nu-Calgon Flushing	
Products.....	887

INDEX



Refrigeration Research	952	Residential Oil Tanks	699
Refrigeration Research Suction		Residential Steambath Generator Mr. Steam	251
Accumulators.....	952	Residential Tankless Water Heaters Noritz...	17
Refrigeration Temperature Controls		Residential Water Heaters Noritz Tankless....	17
Invensys.....	897	Retention Tanks	
Johnson Controls.....	900	Goulds Pump.....	83
White-Rodgers	676, 909	Pentair WellMate.....	84
Refrigeration Tools		Return Air Unico	527, 529
DiversiTech.....	933	Return Air Drops Galv Sheet Metal.....	733
JB Industries.....	933	Return Air Panning ThermO Manufacturing...	848
Refrigeration Tubing Copper.....	407	Return Air Parts Unico.....	527
Refrigerator Thermometers Cooper-Atkins...	729	Return Air Products	758
Register Boots Sheet Metal.....	757	Reverse Osmosis Systems Watts.....	45
Register Boxes Sheet Meal.....	758	Reverse Osmosis Water Filtration AquaPure	37
Registers & Grilles		Reversible Heat Pump Filter Driers	916
Hart & Cooley.....	774	RGF Environmental	629
Hart & Cooley Commercial T-Bar.....	778	RGF Environmental	
Regulators		Air Purification.....	629
Dormont Gas Pressure.....	685	Cell Air Cleaners.....	629
Watts Regulator Water Pressure	64	REME Air Cleaners.....	629
Relays		Replacement Cells.....	629
Aprilaire Current Sensing.....	626	Ridge Tools	315-316, 325-332, 353-359
Functional Devices.....	685	Ridgid	
Honeywell.....	658	Drain Cleaners.....	355
Honeywell Aquastat.....	668, 811	Hand Tools.....	332
Honeywell Hydronic Switching.....	670	Manual Threaders.....	330
Manitowoc.....	875-876, 962	Pipe Cutters.....	326
MARS General Purpose.....	680	Pipe Inspecting.....	353
MARS Potential.....	681	Pipe Tools.....	329-330
Ouellet.....	647	Power Threaders.....	315
SUPCO.....	683-684	Press Tool Jaws.....	318
Taco Inc.....	793	Press Tools.....	318
Tecumseh.....	689	Replacement Drain Cutters & Augers.....	356
Reliance Controls	1070-1071	Threader Oil.....	331
Reliance Controls Power Inlet Boxes.....	1070-1071	Tools.....	325, 329-330
Relief Valves		Torque Wrenches.....	326
American Granby.....	49	Tubing Cutters.....	327
Bell & Gossett.....	784-785	Tubing Tools.....	330
Taco Inc.....	795	Wet/Dry Vacuums.....	316
Watts Regulator.....	64-66	Wrenches.....	325
Watts Regulator Water Pressure	64	Ridgid Tools	318
Remeo Casting	177, 377	Riello	701
Remeo Casting		Riello Parts & Accessories.....	701
Johnny-Guard Toilet Bases.....	377	Ring Hangers Greenfield Manufacturing Co...	1018
Vanity Tops.....	177	Ringcrusher Mill-Rose Decrimping Tools.....	351
Renewal Kits Johnson Controls.....	901	Rings Wal-Rich	297
Repair Clamps Plumbest Steel Hinged.....	287	Riser Brackets Underground.....	440
Repair Plates Jumbo Mfg.....	305	Riser Clamps Greenfield Manufacturing Co....	1017
Replacement Cells RGF Environmental.....	629	Riser Tube Components BrassCraft.....	297
Replacement Cords MARS.....	1039	Risers	
Replacement Media Airscreen Filters.....	632	BrassCraft.....	296
Research Products	624-628		
Reset Controls HBX Control.....	686		

INDEX



BrassCraft Closet.....	296
NDS.....	107
Septic Tank.....	106
Underground Line.....	440
Ritchie Engineering Co See Yellow Jacket.	346-347, 725-729, 889, 954
Ritchie Products - See Yellow Jacket.....	346-347, 725-729, 889, 954
Robertshaw.....	682, 687, 845
Robertshaw	
Air Sensor Switches.....	845
Flame Sensors.....	687
Pilot Ignitions.....	682
Rocker Switches Pass & Seymour.....	972
Rod Couplings Greenfield Manufacturing Co.	1019
Rods Plumbest Shower.....	281
Roman Tub Faucets	
Delta Trim.....	140
Kohler Rough-In Valves.....	143
Moen M•PACT Rough-Ins.....	158
Moen M•PACT Trim.....	158
Romex Wire Electrical.....	1034
Roof & Flashing Sealants Hercules.....	266
Roof Caps Galvanized Aluminum.....	847
Roof Curbs.....	520
Roof Drain Components.....	309
Roof Drain Components Watts Drainage.....	308
Roof Drains	
Plumbest.....	285
Watts Drainage.....	307
Roof Flashing	
Lead.....	312
No-Calk.....	311
Roof Flashings Arlington Industries.....	848
Roofing Cements Karnak.....	370
Roof Support Systems Haydon.....	469
Room Air Conditioners Comfort-Aire.....	523
Ropes Submersible.....	50
Rotary Switches Lutron.....	969
Rough-In Valves	
Delta MultiChoice.....	138, 140, 160
Delta Roman Tub.....	140
Gerber Tub/Shower.....	150
Kohler MasterShower.....	142
Kohler Roman Tub.....	143
Kohler Tub & Shower.....	141
Moen M•PACT Lavatory.....	133
Moen M•PACT Roman Tubs.....	158
Moen M•PACT Tub & Shower.....	151
Round Basin Grates NDS.....	107
Round Boxes Pass & Seymour.....	1023

Round Fittings Galv.....	731
Run Capacitors Global.....	684
RW Beckett Corp.....	691, 695-699

S

S-Traps	
Dearborn Brass.....	269
Dearborn Brass Plastic.....	274
Saddle Fittings Jumbo Mfg.....	305
Saddle Tees Plumbest.....	286
Saf-T Vent Gas Vent Heat-Fab.....	769
Safety & Spill Cleanup Supplies Westwood Products Inc.....	702
Safety Equipment Personal.....	369, 841
Safety Outlets Pass & Seymour.....	976
Safety Relief Valves	
American Granby.....	49
Bell & Gossett.....	784-785
Taco Inc.....	795
Watts Regulator.....	64-66
Safety Switches	
Field Controls.....	705
Murray Electrical.....	854, 1059
Sakrete.....	372
Sakrete	
Concrete Mixes.....	372
Sand Mixes.....	372
Salt Water Softener.....	46
Sand Mixes Sakrete.....	372
Sand Separator Filters American Granby.....	58
Sani-Stream Moen Commercial Bar Faucets..	122
Saniflo.....	225
Saniflo	
Grey Water Pumps.....	225
Macerating Toilet Systems.....	225
Parts & Accessories.....	225
Sink Pump.....	225
Sanitizer Tablets.....	46
Saw Blades	
Lenox.....	332
Lenox Reciprocating.....	340
Saws	
Cable.....	348
Lenox Hole.....	333
Milwaukee Sawzall.....	317
Sawzall Milwaukee.....	317
Scale Inhibitors Silver King Mfg Boiler.....	817
Scale Removal Products Nu-Calgon.....	822, 925
Scale Removal Systems Zoeller.....	97
Scales JB Industries Charging.....	933
Screwdrivers	
Combination.....	348

Product Index



www.irrsupply.com

Product Index

Supco 6 in 1.....	348	Parts.....	81
Screws Malco.....	361	Water Meters.....	81
Seal Plugs Cherne.....	277	Septic Products	107
Seal-O-Matic Toilet Flappers.....	300	Septic Tank In-Sink-Erator Bio-Charge.....	193
Sealant Airserco.....	961	Septic Tank Risers Norwesco.....	106
Sealants		Septic Tanks Norwesco.....	106
DiversiTech.....	824	Service Entrance Cable	1036
Firestop.....	837	Service Sink Faucets	
Foam.....	761	Central Brass.....	161
Hercules Epoxy.....	266	Chicago Faucet.....	164
Hercules Putty.....	266	Setting Hammers Malco.....	322
Hercules Roof & Flashing.....	266	Sewage Basin Accessories Topp Industries.....	101
Hercules Thread.....	265	Sewage Basins Topp Industries.....	101
Johns-Manville Duct.....	761	Sewage Package Systems Zoeller.....	96-97
Mill-Rose Tape.....	268, 371	Sewage Removal Systems Zoeller Pumps....	95
Oatey Thread.....	268	Sewer & Drain Pipe PVC.....	428, 431
Silicone.....	369, 837	Sewer Cleaning Machines Ridgid.....	355
Sealed Unit Parts Co	348, 683-684, 718, 828, 845, 911-912, 918, 922, 927, 960	Sewer Tape Ridgid.....	358
Sealing Compounds DiversiGum.....	824	Shaded Pole Motors MARS.....	713
Sealmaster Tank Balls.....	300	Shallow Well Jet Pumps Goulds Pump.....	85
Seals Bell & Gossett Pump.....	787	Sheet Insulation Nomaco.....	473
Seamers		Sheet Metal Oval Galv Sheet Metal.....	759
Lenox Hand.....	339	Sheet Metal Fabricator Malco.....	320
Malco Hand.....	319	Sheet Metal Fittings	
Seats Bemis Toilet.....	256-257	Galv.....	752
Sectional Machines Ridgid.....	355	Galvanized Round.....	750
SeeSnake micro Inspection Cameras Ridgid.....	353	Sheet Metal Pipe	
SeeSnake micro™ Inspection Cameras		Galv.....	731
Ridgid.....	354	Galv Button Lock.....	750
See-All Replacement Parts	919	Sheet Steel Flat	731, 750
Self-Piercing Valves Plumbest.....	287	Shiplap Kits Malco.....	321
Selkirk		Shoe Covers Sioux Chief.....	841
B-Vent Oval Pipe & Fittings.....	764-765	Shop Towels DiversiTech.....	369
B-Vent Pipe & Fittings.....	762-764	Shower & Tub Modules Sterling Vikrell.....	228
Chimney Systems.....	766	Shower & Whirlpool Modules Sterling Vikrell.....	230
Gas Vent.....	762, 764-765	Shower Accessories	
Metalbestos.....	762-768	Delta Swivel Connectors.....	169
Sensible Products	348	Delta Volume Controls.....	169
Sensible Products Slide Driver.....	348	Delta Wall Bars.....	170
Sensor Faucets Symmons.....	165	Delta Water Diverters.....	171
Sensors		Moen.....	174
Flame.....	687	Shower Arms	
Honeywell Flame.....	692	Moen.....	174
Honeywell Temperature.....	652	Plumbest.....	281
Manitowoc.....	876	Shower Doors	
Pressure.....	905	EL Mustee.....	237
RAB Electric.....	993	Sterling.....	234
Sensus Metering Systems	81	Shower Drain Connectors Mission Rubber....	475
Sensus Metering Systems		Shower Drains	
		EL Mustee.....	237
		Oatey.....	259
		Plumbest.....	285
		Sioux Chief.....	297

INDEX



Shower Elbows Delta.....	170	Silicone Sealants Boss.....	369, 837
Shower Ells Kohler.....	173	Sill Faucets Moen.....	76
Shower Enclosures EL Mustee Durastall.....	237	Sillcocks	
Shower Faucets		Matco-Norca.....	78
Kohler MasterShower Rough-In.....	142	Moen.....	76
Kohler Rough-In Valves.....	141	Silver King Mfg	817
Kohler Trim.....	142	Silver King Mfg	
Moen.....	156-157	Boiler Additives.....	817
Moen Hand-Held.....	173	Boiler Cleaners.....	817
Moen Handshower Spa Sets.....	157	Boiler Scale Inhibitors.....	817
Moen M•PACT Rough-In Valves.....	151	Chemical Pumps.....	817
Moen M•PACT Trim Kits.....	152	Force Pump.....	817
Shower Floors EL Mustee Fiberglass.....	236	Suction Pumps.....	817
Shower Hose Delta.....	169	Simpson Strong Tie	372
Shower Modules Sterling Vikrell.....	231	Simpson Strong Tie Wood Connectors	372
Shower Mounts		Sink Accessories Kohler.....	288
Delta Arm.....	170	Sink Drains Plumbest.....	281
Delta Wall	170	Sink Faucets	
Shower Pan Liner Adhesives Oatey.....	375	Chicago Faucets.....	164
Shower Pan Liners Oatey.....	375	Plumbest.....	173
Shower Parts Dearborn Brass.....	302	Sink Hangers Plumbest.....	282
Shower Pumps Saniflo.....	225	Sink Hole Covers Dearborn Brass.....	303
Shower Rods Plumbest.....	281	Sink Mounting Clips Elkay.....	196
Shower Seats Elcoma.....	175	Sink Parts Dearborn Brass.....	303
Shower Stall Drains Plumbest.....	285	Sink Pump Saniflo.....	225
Shower Stall Parts EL Mustee.....	237	Sink Risers BrassCraft.....	296
Shower Strainers Oatey.....	259	Sink Strainers	
Shower Systems Symmons Single Handle.....	146	Dearborn Brass.....	278
Shower Wall Panels Swanstone.....	250	Dearborn Brass Plastic Decorator Basket.....	275
Shower Walls Durawall EL Mustee.....	236	Kohler.....	288
Showerheads		McGuire Products.....	272
Delta.....	167, 171	Plumbest Kitchen.....	279
Kohler.....	173	Sink Traps Dearborn Brass.....	269
Moen.....	173	Sinks	
Showers		EL Mustee Durastone.....	253
Aquatic.....	240	Elkay Dayton Stainless Steel.....	195
Delta Hand-Held.....	167	Elkay E-Granite.....	195
Delta Hand-Held Arm-Mount.....	169	Elkay Stainless Steel Bar.....	196
Delta Hand-Held w/Wall Grab Bars.....	169	Elkay Stainless Steel Kitchen.....	195-196
Delta Hand-Held Wall Mount.....	168	Gerber Drop-In.....	206
Shrink Insulation 3M.....	1052	Gerber Pedestal Lavatory.....	205
Shut-Off Valves		Hospitality.....	195
Taco.....	796	Kohler Cast Iron Kitchen.....	198
Watts Regulator Washing Machine	75	Kohler Stainless Steel Kitchen.....	198
Side Beam Connectors Greenfield		Moen Stainless Steel.....	198
Manufacturing Co.....	1020	Specialty Kitchen.....	197
Siding Mounting Blocks Arlington Industries.....	1029	Sterling Stainless Steel Entertainment	
Siding Tools Malco Punches.....	319	Sinks.....	197
Siemens Controls	1067-1068	Sterling Stainless Steel Kitchen Sinks	196
Siemens Controls Accessories.....	1067	Sioux Chief	297, 348,
Sight Glasses Sporlan.....	919		364-368, 821,
Silicone American Granby.....	54		841
Silicone Lubricants Nu-Calgon.....	927	Sioux Chief	



Brass Valves.....	368	Malco.....	319
Lavatory/Sink/Tub Parts.....	367	Soap Dispensers Moen.....	179
Log Lighter Specialties.....	821	Soap/Lotion Dispensers Delta.....	180
Ox Box Outlet Boxes.....	368	Soil Pipe Cast Iron.....	434-435
PEX Fittings.....	366	Soil Pipe Cutters Ridgid.....	327
Pipe Hangers & Fasteners.....	364	Soil Pipe Fittings	
Preformed Copper.....	366-367	Cast Copper DWV.....	404
Residential Drainage.....	297	Cast Iron No-Hub.....	435
Saws.....	348	Cast Iron Service.....	434
Shoe Covers.....	841	Wrot Copper DWV.....	405
Toilet Parts.....	368	Solder Lenox Tools.....	313
Touchdown II Pipe Clamps.....	365-366	Solder Supplies	
Tube Brackets.....	364-365	Hercules Flux.....	265
Water Hammer Arresters.....	367	Lenox Torches.....	343
SJ Electro Control Panels.....	103	Mill-Rose.....	351
SJE Pumpmaster® Plus Pump Switch	102	Mill-Rose Water-Gate.....	351
SJE Rhombus	102-104	Oatey Flux.....	312
SJE Rhombus		Plumbest.....	324
Pump Switches.....	102	Solders Harris Group.....	313
Tank Alarm Systems.....	104	Solenoid Air Valves	907
Sleeves		Solenoid Valves Sporlan.....	936
Bell & Gossett.....	787	Solution Tanks AquaPure.....	41
Dundas Jafine Duct Insulation.....	639	Solvents Shower Pan Liner.....	375
Uponor.....	459	Soot Cutters Crown Engineering.....	701
Slenderized Radiators Burnham.....	644	SOS Products	46, 836
Slide Driver Sensible Products.....	348	SOS Products	
Slim Duct Trunking System.....	826	Oil Cleaners.....	836
Slim Duct Inc	826-828	Water Softener Salt.....	46
Slip Nuts Dearborn Brass.....	275, 303	Sound Attenuators	529
Slip-Joint Connections Dearborn Brass.....	271	Southaven Stainless Steel Kitchen Sinks.....	196-197
Slip-Joint Nuts Plumbest.....	279-280	Spa Sets Moen Faucets.....	157
Slip-Joint Pliers Douglas.....	352	Spade Terminals Insulated.....	1042
Slip-Joint Washers Plumbest.....	279-280	Spanner Flanges Mission Rubber Closet.....	475
Sloan		Special Fan Motors	717
Flush Valves.....	184, 188	Special Use Tape 3M.....	1051
Flushmate Replacement Parts.....	190	Specialty Tools	348
Optima Plus Retro Fit Conversion Kits.....	188	Specialty Faucets Delta.....	126
Parts.....	190	Specialty Products Nu-Calgon.....	373, 926
WES Waterfree Urinal Accessories.....	189	Spectrolite Products	960-961
Sloan Valve	184-190	Spectrolite Products	
Small Can Transformers Allanson.....	690	BigEZ Dye Injection Kits.....	960
SmartValve Honeywell.....	665	EZ-Ject Dye Injection Kits.....	960
Smith's Environmental		GLO-STICK Capsules.....	961
Convactor Heaters.....	643	Leak Detection Lamps.....	961
Heaters.....	643	SPEE-D Channel Drains NDS.....	109
Heating Edge Baseboard.....	642	SpeedFill Beckett.....	698
Kickspace Heaters.....	643	SpiroTherm	810
The Heating Edge Baseboard Heating.....	642	SpiroTherm	
Smoke Alarms Universal Security Instruments.....	830-831	Air Eliminators.....	810
Smoke Testers Westwood Products.....	703	Air Releases.....	810
SnapClip Watts PEX Fasteners.....	363	Dirt Separators.....	810
Snips		Parts.....	810
Lenox.....	339	Valves.....	810

INDEX



Spirotop SpiroTherm.....	810	Spuds	
Spirovent SpiroTherm.....	810	Plumbest Closet.....	282
Splice Kits	54	Plumbest Urinal.....	282
Splice Kits Burndy.....	1049	Square D	849-850
Splicers Burndy.....	1046	Stack Boots Sheet Metal.....	757
Splicing Tape 3M.....	1051	Stackhead	
Split Ducted Systems Mitsubishi.....	581	Galv Sheet Metal.....	743
Split Ductless Systems Mitsubishi.....	581	Oval Galv Sheet Metal.....	747
Split Ring Hangers Greenfield Manufacturing Co.....	1018	Stainless Steel Clamps Mission Rubber.....	475
Sporlan		Stainless Steel Kitchen Sinks Sterling.....	197
Catch-All Filter-Driers.....	913	Stainless Steel Sinks	
Coils.....	940	Elkay Bar.....	196
Cores.....	918	Elkay Dayton.....	195
Crankcase Pressure Regulating Valves....	934	Elkay Kitchen.....	195-196
Discharge Bypass Valves.....	935	Kohler Kitchen.....	198
Filter-Driers.....	916	Moen.....	198
Filters.....	918	Sterling Entertainment.....	197
Kits.....	940	Sterling Kitchen.....	196
Oil Filters.....	953	Stainless Steel Venting Noritz.....	18
Omnistat Controllers.....	953	Stand Off Clips	470
Parts & Accessories.....	918	Stand Pipes Central Brass.....	162
Parts & Kits.....	949	Standex Air Distribution Products.....	749
Pressure Control Valves.....	934	Staple Guns Watts Radiant Heating.....	456
See•All Moisture & Liquid Indicators.....	919	Staplers Peter Mangone PEX.....	470
Solenoid Valves.....	936	Staples	
Suction Filter Elements.....	918	Briscon Cable.....	852, 1040
Suction Filters.....	917	Electrical.....	852
Thermostatic Elements.....	950	Peter Mangone PEX.....	470
Thermostatic Expansion Valve Bodies.....	948	Watts Radiant.....	456
Thermostatic Expansion Valves.....	943-948	Starlite Igniter Systems Hot Surface.....	683
Thermostatic TXV Elements.....	949	Steam Traps Hoffman Specialty.....	806
TXV Side Connectors.....	950	Steam Vents	
Sporlan Valves	913-918, 919, 934-940, 943-950, 953	Hoffman Specialty Convector.....	808
		Hoffman Specialty Main.....	807
Spouts		Steam/Hot Water Unit Heaters Modine.....	566
Central Brass.....	181	Steambath Generator Mr. Steam.....	251
Chicago Faucets.....	165	Steel Fittings	
Dearborn Brass Tub.....	302	Black Steel Nipples.....	378-379
Delta Diverter.....	171	Black Steel Tank Nipples.....	379
Kohler Tub.....	173	Steel Headers Urell.....	814
Plumbest Tub.....	281	Steel Pipe	
Plumbest Tub Diverter.....	281	Black.....	378
Spray Adhesives Boss.....	837	Galvanized.....	384
Sprayers		Steel Straps Victor.....	1041
MARS Chapin Chemical.....	955	Sterling	
Nu-Calgon.....	822	Parts.....	197
Sprays Plumbest Kitchen.....	279	Shower Doors.....	234
Spring House	172	Stainless Steel Entertainment Sinks.....	197
Spring House		Stainless Steel Kitchen Sinks.....	196-197
Portofino Add-A-Shower Components.....	172	Tub Doors.....	234
Portofino Add-A-Showers.....	172	Vikrell Shower Modules.....	231
		Vikrell Tub & Showers.....	228
		Vikrell Whirlpool & Showers.....	230

Product Index



www.irrsupply.com

Product Index

Whirlpools	230	Haydon.....	468
Sterling Plumbing Group	196-197,	Sioux Chief Touchdown II.....	365-366
	228-235	Struts Haydon.....	468
Stock Motors AO Smith.....	714	Stub-Outs	
Stop & Waste Valves Matco-Norca.....	78	Gastite.....	440
Stop Valves		Sioux Chief.....	366
BrassCraft Dual Outlet.....	296	Uponor.....	446
BrassCraft Multi-Turn.....	294	Stubout Brackets Watts PEX.....	363
BrassCraft Water Ball.....	295	Stubout Elbows Watts Copper.....	363
Matco-Norca.....	78-79	Stud Guards Greenfield Manufacturing Co.....	1019
Matco-Norca Bronze.....	79	Stud Protectors Greenfield Manufacturing Co.....	1019
Nibco.....	79	Stud Shoes Simpson Strong Tie.....	372
Sioux Chief Brass.....	368	Style Crest Manufactured Housing Equipment.....	562
Watts Regulator.....	304	Submersible Effluent Pumps Goulds Pump..	89
Storage Tanks AO Smith.....	22	Submersible Pump Accessories American	
Stove Builders Int'l by PSG	569	Granby.....	50
Stove Cement Hercules.....	836	Submersible Pumps	
Stoves Empire Vent-Free.....	819	Goulds Pump.....	87
Straight Blade Connectors Pass & Seymour.....	980	Zoeller.....	94
Straight Blade Plugs Pass & Seymour.....	980	Submersible Sewage Pumps Goulds Pump..	85, 90
Strainer Screen & Cylinder Co	817	Suction Accumulators Refrigeration	
Strainer Screen & Cylinder Co Gaskets.....	817	Research.....	952
Strainer Wrenches Plumbest.....	324	Suction Filter Elements Sporlan.....	918
Strainers		Suction Filters Sporlan.....	917
Dearborn Brass.....	278	Suction Pumps Silver King Mfg.....	817
Dearborn Brass Plastic Decorator Basket.....	275	Sump & Sewage Accessories American	
Drain.....	308	Granby.....	58
Elkay.....	278	Sump Basins Topp Industries.....	101
Kohler Sink.....	288	Sump Pumps	
McGuire Products.....	272	AY McDonald.....	99
Oatey Drain.....	259	Back-Up.....	96, 98-99
Peterson Vent.....	298	Goulds Pump.....	87
Plumbest Kitchen Sink.....	279	Liberty Pumps.....	99-100
Watts Regulator Commercial "Y"	72	Zoeller.....	93-94, 96
Strap		Sundries	846
Basset.....	761	Suntec	705-706
DiversiTech.....	955	Suntec Fuel Pumps.....	705-706
Duct.....	824	SUPCO	348, 683-684,
Hang-N-Strap Utility.....	955		718, 828,
Lash-N-Strap.....	955		845, 907,
Oatey Hanger.....	468		911-912, 918,
Wrot Copper Pressure.....	411		922, 927, 960
Strap Wrenches Ridgid.....	325	Supco 6 in 1 Screwdrivers	348
Strapping Greenfield Manufacturing Co		SUPCO	
Perforated Hanger.....	1019	Accessories.....	918
Straps		Capacitors.....	922
AC/MC.....	853	Chemicals.....	927
CPVC.....	427	Condensate Drain Pans.....	828
EMT.....	851	Defrost Controls.....	911
PVC Conduit.....	851, 1013	Delay Timers.....	911
Strip Heaters	520	Drain Heaters.....	845
Strip Lights Lithonia.....	995	Filter-Driers.....	918
Strut Clamps		Freeze Protection Control.....	684

INDEX



Hard Starts.....	828	Manitowoc.....	876
Leak Lock.....	927	McDonnell & Miller.....	803
Motors & Accessories.....	718	McDonnell & Miller Liquid Flow.....	804
Piercing Valves.....	960	Pass & Seymour.....	856, 969, 972
Pressure Switches.....	911-912	Pressure.....	912
Relays & Hard Starts.....	683	Robertshaw Air Sensing.....	845
Run.....	922	Safety.....	854
Temperature Alarms.....	911	Square-D Pressure.....	54
Tools.....	845	SUPCO Pressure.....	911
SuperEvac Systems Yellow Jacket.....	725	Tjernlund Fan Proving.....	633, 832
Superior Refrigeration Products	941-942	Switching Relays Honeywell Hydronic.....	670
Superior Refrigeration Products		Swivel Flare Connections JB Industries.....	956
Ball Valves.....	941	SX-Extrol Amtrol Standard Expansion Tanks..	799
H-V Check Valves.....	941	Symmons	115-116, 130-131, 144-148, 165-166, 182
H-V Pressure Relief Valves.....	942		
Line Valves.....	941	Symmons	
Packed Angle Valves.....	941	Kitchen Faucets.....	115
Supply Air Unico.....	528-529	Lavatory Faucets.....	130, 166
Supply Air Parts Unico.....	528	Mixing Valves.....	147
Supply Boxes Oatey Washing Machine Outlet	376	Parts.....	182
Supply Kit Components BrassCraft.....	296	Repair Parts.....	148, 182
Supply Kits McGuire Products.....	272	Scot Metering Faucets.....	165
Supports		Single Handle Kitchen Faucets	115
Electrical Box.....	1027	Single Handle Lavatory Faucets.....	130, 166
Rooftop.....	469	Single Handle Shower Systems.....	146
Supr-Safe Gas Quik Disconnects.....	438	Single Handle Tub & Shower Systems.....	144
Sure Seal Inline Trap Sealers.....	301	Temptrol Pressure-Balancing Mixing	
Sure Seal Mfg	301	Valves.....	145
Sure Vent		Tools.....	147
Oatey Air Valves.....	376	Two Handle Lavatory Faucets.....	130, 166
Oatey Wall Boxes.....	376	Ultra-Sense Sensor Faucets	165
Surface Receptacle Power Outlets Pass &		Syphons Plumbest Pigtail.....	288
Seymour.....	979	System Flushing Products Nu-Calgon.....	887
Swanstone	249-250, 259		
Swanstone			
Bathtub Wall Panels.....	249		
Shower Wall Panels.....	250		
Tub Wall Panels.....	249		
Veritek Bathtubs.....	250		
Window Trim Kits.....	259		
Swing Check Valves American Granby.....	57, 105		
Switch Boxes			
Pass & Seymour.....	1022		
Raco.....	1026-1027		
Switch Wall Plates Pass & Seymour.....	982		
Switches			
Condensate Overflow.....	825		
Field Controls Safety.....	705		
Generac Transfer.....	1070		
Grasslin Time.....	908		
Lutron Diva.....	969		
Lutron Rotary.....	969		
Lutron Toggle.....	968		

T

T&P Valves Watts Regulator.....	65
T-Flex Sewer Saddles Mission Rubber.....	475
Taco Inc	
Air Eliminators.....	796
Circulators.....	789, 792-793
Freedom Flanges.....	792
Low Water Cutoffs.....	796
Parts.....	793
Pressure Reducing Valves.....	795
Repair Parts & Accessories.....	796
Safety Shut-Off Valves.....	796
Tempering & Mixing Valves.....	795
Zone Controls.....	793
Zone Valve Power Head.....	795
Zone Valves.....	794

Product Index



www.irrsupply.com

Product Index

Taco Pumps & Accessories	789-796	Tape Measurers Malco.....	322
Tailpieces		Tattle-Tale Control Monitor.....	910
Dearborn Brass.....	270	TayMac	1031-1033
Dearborn Brass Plastic.....	274	TayMac	
Takeoffs		Lampholder Parts.....	1033
Galv Sheet Metal.....	734, 751	Lampholders.....	1033
Self Adhesive.....	735	Multi-Mac Receptacle Covers.....	1032
Tamper-Resistant GFCI Receptacles Pass & Seymour.....	977	Outlet Box Extensions.....	1031
Tamper-Resistant Receptacles Pass & Seymour.....	974	Outlet Boxes.....	1031
Tank Air Valves American Granby.....	50	Receptacle Covers.....	1032
Tank Alarm Systems SJE Rhombus.....	104	Weatherproof Accessories	1033
Tank Balls		TecTite Fittings	412
Sealmaster.....	300	Tecumseh	689, 717, 883-886, 892-895, 921, 929
Triple Seal.....	300	Tecumseh	
Tank Crosses American Granby.....	51-52	Aftermarket Condensing Units.....	883
Tank Fittings Bell & Gossett Airtrol.....	786	Compressors.....	883-886, 892-895
Tank Gauges OEM.....	698	Condensing Units.....	885
Tank Mounting Brackets American Granby...	49	Fan Motors.....	717
Tank Nipples Black Steel.....	379	Fan Overloads.....	689
Tank Packages Goulds Pump.....	86	Motors.....	717
Tank Tees American Granby.....	51	Parts & Accessories.....	689, 921, 929
Tank Valves Firomatic.....	707	Relays.....	689
Tank-To-Bowl Fluidmaster.....	291	Tees Sheet Metal.....	751, 759
Tank-to-Bowl Bolts Sets Plumbest.....	282	Teflon Mil-Rose Tape.....	268, 371
Tanks		Teflon Thread Sealants and Packing	
Acetylene.....	314	Mill-Rose.....	268, 371
Amtrol.....	799, 814	Telephone Wall Plates Pass & Seymour.....	986
Amtrol Fill-Trol Expansion.....	799	Temperature Alarms SUPCO.....	911
AO Smith Storage.....	22	Temperature Controls	
Chlorine Solution.....	41	Invensys.....	897
Extrol Expansion.....	799, 814	Johnson Controls.....	900
Goulds Pump.....	83	Ranco.....	897
Granby.....	699	White-Rodgers.....	909
John Wood Expansion	814	Temperature Probes UEI.....	722
Nitrogen.....	314	Temperature Sensors	901
Oil Residential.....	699	Temperature Sensors	
Pentair WellMate Captive Air	84	Honeywell.....	652
Pentair WellMate Retention	84	LuxPro Outdoor.....	657
SX-Extrol Expansion.....	799	Tempering & Mixing Valves Taco Inc.....	795
Therm-X-Trol Expansion.....	814	Tempering Valves Powers.....	77
Tape		Tempering/Mixing Valves Watts Regulator....	71
3M.....	1051	Tempstar	496-500, 502-503, 543-551
Cork Insulation.....	825	Tempstar	
DiversiTech.....	825	Blower Cabinets.....	503
Electrical.....	850	Burners.....	551
Flat Sewer.....	358	Condensing Units.....	496-499
Mill-Rose Teflon.....	268, 371	Electric Heaters.....	503
Pipe.....	32		
Plumbest Caution.....	369		
Polyken Technologies Duct.....	838		
Polyken Technologies Foil.....	838		

INDEX



Furnaces-Gas.....	543-550	Honeywell Commercial.....	658
Furnaces-Oil.....	551	Honeywell Wireless.....	651
Heat Pumps.....	500, 502	Manitowoc.....	876
Tensioning Tools Malco.....	321	Oullett.....	647
Terminals		Programmable.....	657
Burndy Electrical.....	1047-1048	White-Rodgers.....	654-656
Electrical Wire.....	1042	Thermowells Terrice.....	687
MARS.....	1045	THHN Wire Copper.....	859, 1038
MARS Solderless.....	1045	Thomas & Betts	855, 1014, 1031
Westwood Products.....	703	Thread Cutting Oil Hercules.....	267
Termination Kits Noritz Vent.....	18	Thread Sealants	
Test Equipment		Blue Monster Teflon Tape.....	371
Inficon Refrigerant.....	730	DiversiTech.....	824
Plumbest.....	288	Hercules.....	265
Tattle-Tale.....	910	Leak Lock.....	927
UEI.....	719-722	Mill-Rose Compound.....	268
Yellow Jacket.....	728	Oatey.....	268
Test Plugs Sioux Chief.....	367	Threaded Fittings Brass.....	390
Therm-X-Trol Expansion Tanks.....	814	Threader Oil Ridgid.....	331
Thermistor Thermometers Cooper-Atkins.....	729	Threaders	
ThermO Manufacturing	848	Ridgid Manual.....	330
ThermO Manufacturing		Ridgid Power.....	315
ThermO-Frames.....	848	Tie Down Straps Hold-Zip.....	372
ThermO-Pan Return Air Panning.....	848	Tie Tools Malco.....	322
ThermO-Snap Clamps.....	848	Ties Burndy Cable.....	1049
ThermO-Frames ThermO Manufacturing.....	848	Time Controls Grasslin.....	908
Thermocouples Honeywell.....	666	Time Switches Grasslin.....	908
Thermometers		Time-Delay Fuses Bussman.....	854, 1069
Cooper-Atkins.....	729	Timers	
Terrice.....	687	Grasslin.....	908
UEI.....	720-721	Grasslin Defrost.....	908
Thermostat Coverplates Honeywell.....	653	Intermatic.....	909, 988-989
Thermostat Guards Honeywell.....	651	Paragon Electric.....	910
Thermostat Wire	837	Paragon Electric Defrost Controls.....	910
Thermostat Wire		SUPCO Delay.....	911
Baron Wire.....	837	TITE-SEAL Tank Balls.....	300
Priority Wire.....	1039	Titeflex Corporation	352, 373, 439-440, 836
Thermostatic Elements Sporlan.....	950	Tjernlund	
Thermostatic Expansion Valve Bodies		Accessory Controls.....	635, 834
Sporlan.....	948	Draft Inducers.....	633, 832
Thermostatic Expansion Valves Sporlan.....	943-948	Dryer Duct Fans.....	636, 835
Thermostatic Mixing Valves Honeywell.....	813	Duct Boosters.....	636, 835
Thermostatic Steam Traps Hoffman		Fan Proving Switches.....	633, 832
Specialty.....	806	Power Venters.....	633-634, 832-833
Thermostatic TXV Elements Sporlan.....	949	Replacement Parts.....	636, 835
Thermostatically Controlled Devices		Side Wall Vent Hoods.....	634, 833
EasyHeat.....	32	Water Heater Vent Kits.....	635, 834
Thermostats		Tjernlund Products Inc	633-636, 832-835
Bradford White Therm-O-Disc.....	31	Toggle Switches Pass & Seymour.....	856, 969
Digital.....	657		
HBX Control.....	686		
Honeywell.....	648-650, 652		
Honeywell Accessories.....	653		

Product Index



www.irrsupply.com

Product Index

Toilet Liberty Pumps Macerating	100	Crown Engineering.....	701
Toilet Augers Ridgid	355	DiversiTech.....	369
Toilet Bases Johnny-Guard	377	DiversiTech Refrigerant Recovery.....	933
Toilet Bolts		DiversiTech Screwdrivers.....	348
Fluidmaster.....	291	DiversiTech Telescoping.....	824
Hercules.....	289	Douglas.....	352
Toilet Cleaning Systems Fluidmaster	291	Fiberglass Flex Duct.....	321
Toilet Connectors Fluidmaster	291	JB Industries.....	957, 960
Toilet Flanges Oatey	375	Lenox.....	332-333, 336-340, 342-343
Toilet Flappers Seal-O-Matic	300	Malco.....	319-323
Toilet Gaskets		Malco Ductboard.....	321
Fluidmaster.....	291	Malco Tubing.....	322
Hercules.....	293	Mill-Rose.....	351
Toilet Parts		Milwaukee.....	317
Fluidmaster.....	290-293	Nibco Press System.....	317, 463
Fluidmaster Fill Valves.....	290	Plumbest.....	324
Fluidmaster Flappers.....	290	Powers Fasteners Anchor.....	363
Kohler.....	258, 288-289	Ridgid.....	318, 325-326, 329-330, 332
Mansfield.....	294	Sioux Chief.....	348
Mansfield Kilgore.....	259, 294	Specialty.....	348
Plumbest.....	280	SUPCO.....	845
Sioux Chief.....	368	Symmons.....	147
Sloan Flush Valves.....	184, 188	Uponor Installation.....	459
Tank Balls.....	300	Water Shut-Off Tools.....	351
TITE-SEAL.....	300	Watts PEX.....	352
Wax Gaskets.....	299	Watts Radiant.....	455
Toilet Plungers Gunk	372	Top Industries	
Toilet Repair Parts		Basin & Cover Combinations.....	101
Dearborn Brass.....	275, 303	Sewage Basing Accessories.....	101
Radiator Specialty.....	299	Sewage Basins.....	101
Toilet Risers BrassCraft	296	Top Industries Inc	101
Toilet Seats		Torches	
Bemis Commercial Plastic.....	257	Lenox.....	343
Bemis Residential Plastic.....	256	Plumbest Pencil.....	324
Bemis Residential Wood.....	256	Torque Arrestors American Granby	50
Kohler.....	255	Torque Wrenches	
Toilet Supply Kits McGuire Products	273	Douglas.....	352
Toilet Tank Levers Plumbest	280	Ridgid.....	326
Toilets		Totes Oatey Cement Carrier	376
Gerber Accessories.....	219	Touch-Flo	62
Gerber Commercial Floor Mount Spud.....	223	Touch-Flo Faucets	62
Gerber Commercial Wall Mount Spud.....	223	Touchdown II Strut Clamps	366
Gerber Gravity Fed.....	216	Touchless Lavatory Faucets Kohler	
Gerber Ultra Flush Pressure Assist.....	215	Commercial.....	129
Kohler.....	209-210, 221	Towel Warmers Mr. Steam	252
Kohler Commercial.....	220	Towels Shop	369
Saniflo Macerating System.....	225	Transducers Johnson Controls	906
Zoeller Qwik Jon.....	95	Transfer Pumps	
Tool Boxes Mill-Rose Drybox	351	Little Giant Utility.....	780
Tools		Zoeller.....	93
Amcraft Fiberglass Duct Fabrication.....	352		
American Granby.....	343		
Chamfering.....	352		



Transfer Switches Generac.....	1070	Kohler MasterShower Rough-In.....	142
Transformers		Kohler Trim.....	142
Allanson.....	690	Moen.....	156-157
Honeywell.....	660	Moen M•PACT Rough-In Valves.....	151
MARS.....	681	Moen M•PACT Trim Kits.....	152
Milbank.....	1066	Plumb4orce.....	149
Service.....	690	Tub & Shower Fittings Central Brass.....	143
Transition Fittings Gastite.....	440	Tub & Shower Modules Sterling Vikrell.....	228
Trap Covers		Tub & Shower Parts BrassCraft Rebuild Kits.....	182
Plumbest Drum.....	284	Tub & Shower Rough-In Valves Delta	
Truebro.....	377	MultiChoice.....	138, 140, 160
Trap Offsets Dearborn Brass.....	271	Tub & Shower Systems Symmons Single	
Trap Seal Primer Distribution Units MIFAB..	301	Handle.....	144
Trap Seal Primers		Tub & Shower Walls Aquatic.....	248
MIFAB.....	301	Tub & Shower Wrench Plumbest.....	324
Watts Drainage.....	307	Tub & Showers Aquatic.....	238
Trap Sealers Sure Seal.....	301	Tub & Tile Caulk Boss.....	369
Traps		Tub Doors Sterling.....	234
Dearborn Brass Plastic.....	274	Tub Parts Dearborn Brass.....	302
Dearborn Tubular Brass.....	269	Tub Spouts	
EZ Trap Condensate.....	845	Dearborn Brass.....	302
McGuire Products.....	272	Delta.....	172
Trerice		Delta Diverter.....	171
Industrial Thermometers.....	687	Kohler.....	173
Pressure Gauges.....	688	Moen.....	174
Thermowells.....	687	Plumbest.....	281
Trerice Gauges	687-688	Tub Valve Connectors Sioux Chief.....	367
Trim Kohler.....	142	Tub Wall Panels Swanstone.....	249
Trion		Tub Walls Durawall.....	236
Media Air Cleaners.....	630	Tube Benders Yellow Jacket.....	346
Media Filters.....	630	Tube Brackets Sioux Chief.....	364-365
Trion Air Cleaners	630	Tube Guards Halco.....	967
Trip Levers		Tube Hangers	
Kohler.....	258	Amtrol.....	467
Mansfield.....	294	Sioux Chief.....	364
Plumbest.....	280	Tube Hooks Greenfield Manufacturing Co.....	1017
Triple Seal Tank Balls	300	Tube Insulators Sioux Chief.....	364
Trippers Intermatic.....	988	Tube Slicers Malco Sure Grip.....	322
Tritap Servit Connectors Burndy.....	1047	Tube Strap Wrot Copper Pressure.....	411
Trojan UV Ultraviolet Water Systems.....	44	Tube Straps Greenfield Manufacturing Co.....	1017
Trojan UV Technologies	44	Tubing	
Trouble Lights Metal Guard/Extension Cord...	1073	Capillary.....	955
Troughs Manitowoc.....	876	Clear Vinyl.....	826
Truebro	377	Copper.....	397, 404
Truebro		Copper Refrigeration.....	407
Lav Guards.....	377	CPVC CTS.....	425
Pipe Covers.....	377	Elster Perfection.....	372
Trunking System Slim Duct.....	826	Gastite Corrugated Stainless Steel.....	439
Tub & Shower Faucets		Kamco Products Coated Copper	398
Brizo Trim.....	141	Manitowoc.....	876
Delta MultiChoice Trim.....	138, 160-161	MARS.....	846
Gerber.....	149	PEX.....	442
Kohler Commercial.....	141	Premium Gorilla Tube Clear Vinyl.....	826



Unico.....	529
Uponor AQUAPEX.....	443
Watts Radiant Onix.....	453
Watts Radiant PEX Non-Barrier.....	452
Watts Water PEX Non-Barrier.....	448
Tubing Cutter Parts Ridgid.....	328
Tubing Cutter Wheels Ridgid.....	328
Tubing Cutters	
Gastite.....	440
Lenox.....	337
Ridgid.....	327
Tubing Fasteners	
Watts PEX.....	363
Watts Radiant.....	455
Tubing Insulation Imcoa Imcolock Pluseal Insulation.....	471
Tubing Stiffeners AY McDonald Insert.....	481
Tubing Tools	
Ridgid.....	330
Yellow Jacket.....	346
Tubs	
Kohler Experience.....	226
Kohler ProFlex.....	227
Kohler ProFlex Whirlpool.....	226
Kohler Select.....	226
Tubular Brass McGuire Products.....	272
Tubular Brass Dearborn Brass.....	269-271
Tubular Plastic Dearborn Brass.....	273-274
Tuf-Tite	107
Tuf-Tite	
Distribution Boxes.....	107
Drainage & Septic Products.....	107
TurboShear Malco Drills.....	320
Turnlok Locking Devices Pass & Seymour... TXV.....	980 943

U

UEI	
Accessories.....	722
Air Flow Meters.....	722
CO Detectors.....	721
Combustion Analyzers.....	723
Digital Thermometers.....	720
Infrared Thermometers.....	720
Leak Detectors.....	721
Manometers.....	722
Multimeters.....	719
Multimeters Clamp-On Digital.....	719
Pipe Clamp Adapters.....	724
Replacement Parts & Supplies.....	724
Temperature & Humidity Testers.....	721
Temperature Probes.....	722

Test Equipment.....	719
UEI - Universal Enterprises Inc	719-724
UL-80	
Horizontal Tanks.....	699
Vertical Tanks.....	699
Ultraviolet Water Systems Trojan UV.....	44
Under Cabinet Lighting Nicor.....	1002
Undercounter Ice Makers Manitowoc.....	868
Underground Line Risers	440
Underground Riser Brackets	440
Underground Tanks Granby.....	699
Unichecks Zoeller Pump Valves.....	97
Unico	525-532
Unico	
Accessories.....	530
Air Handlers.....	525-526
For Square Plenum.....	529-530
Return Air.....	527, 529
Return Air Parts.....	527
Supply Air.....	528-529
Supply Air Parts.....	528
Tubing.....	529
Unions	
Black Malleable Iron.....	383
CPVC Sch 80.....	428
Sch 40 PVC.....	416
Sch 80 PVC.....	425
Unit Bearing Motors MARS.....	713
Unit Coolers	
Bohn Reach-In.....	879
Bohn Walk-In.....	881
Unit Heaters	
Marley Engineered Products.....	572
Modine.....	565-566
Modine Commercial & Industrial.....	566
Unitap Connectors Burndy.....	1046
Unitary Products Group - Coleman	522, 562-564
Universal Integrated Gas Combustion	
Blower Controls Honeywell.....	664
Universal Security Instruments	
Carbon Monoxide Alarms.....	829
Fire Alarms.....	831
Natural Gas Alarms.....	830
Smoke Alarms.....	830-831
Universal Security Instruments - USI	829-831
Uponor	443-447, 457-459
Uponor	
Aquacenter Manifold Accessories.....	457
Aquacenter Manifolds.....	457
Baseboard Fittings.....	446
Brass PEX Plugs.....	447
Copper Manifolds.....	457

INDEX



EP Manifolds.....	457
Fitting Assemblies.....	447
Installation Aids.....	459
Manifold Accessories.....	458
ProPEX.....	444
ProPEX Accessories.....	458
ProPEX PEX.....	444
ProPEX Rings.....	447
ProPEX Valves.....	447
Tubing.....	443
Urell	814
Urell	
Copper Headers.....	814
Steel Headers.....	814
Urinal Carriers Watts Drainage.....	310
Urinal Flanges Plumbest.....	283
Urinal Spuds Plumbest.....	282
Urinals	
Gerber.....	223
Kohler Vitreous China.....	221
US Brand Motors by Nidec	708-711
Utility Knives Malco.....	322
Utility Pumps	
Liberty Pumps.....	100
Little Giant Transfer.....	780
Zoeller.....	93, 95
Utility Strap	
DiversiTech.....	955
Hold-Zit.....	372
UV Parts & Accessories	62
UV Air Purification Systems Field Controls...	631
UV Parts & Accessories	62
UV Replacement Lamps Field Controls.....	631

V

V-Belts	
E James Powerflite.....	931-932
Motors & Armatures.....	931
Vacuum Ball Valves Yellow Jacket.....	728, 954
Vacuum Breakers	
Chicago Faucet.....	165
Delta.....	170
Hoffman Specialty.....	807
Sioux Chief.....	368
Sloan.....	190
Watts Regulator.....	70
Vacuum Gauges Yellow Jacket.....	725
Vacuum Pump Oil Nu-Calgon.....	823, 888
Vacuums Ridgid Wet/Dry.....	316
Valterra Gate Valves.....	368
Valve Bodies Thermostatic Expansion.....	948

Valve Renewal Kits Johnson Controls.....	901
Valves	929
Valves	
American Granby Ball.....	63
American Granby Brady.....	49
American Granby Check.....	56, 105
American Granby Foot.....	58
American Granby Gate.....	368
American Granby Swing Check.....	57
AO Smith Gas.....	27
AY McDonald Gas Meter.....	82
AY McDonald Water Service.....	479
Ball.....	797
Bell & Gossett.....	784-785
Bell & Gossett Circuit Setter.....	785
Bell & Gossett Dual Unit.....	785
Bell & Gossett Flo-Control.....	784
Bell & Gossett Handivalve Ball.....	784
Bradford White Icon Gas.....	28
BrassCraft Stop.....	294-296
Bypass.....	935
Central Brass.....	63, 143
Check.....	56-57, 105
CPVC.....	63
CPVC Globe Stop.....	63
Delta MultiChoice Rough-In.....	138, 140, 160
Delta Roman Tub Rough-In.....	140
Firomatic.....	707
Foot.....	58
Gastite.....	440
Gerber Rough-In.....	150
Honeywell Burner Controls.....	663
Honeywell Gas.....	661, 664
Honeywell SmartValve.....	665
Honeywell Thermostatic Mixing.....	813
Isolation.....	18
JB Industries Access.....	955
Johnson Controls.....	906-907
Kohler MasterShower Tub & Shower Rough-In.....	142
Kohler Roman Tub.....	143
Kohler Tub & Shower Rough-In.....	141
Manitowoc.....	877
Matco-Norca.....	76
Matco-Norca Boiler Drain.....	78
Matco-Norca Sillcocks.....	78
Matco-Norca Stop.....	78-79
McDonnell & Miller Blow Down.....	803
Mixing.....	145
Nibco Boiler Drain.....	78
Nibco Bronze Check.....	77
Nibco Stop.....	79
Nibco Water Meter.....	79



Oatey Air Vent.....	376	Remeo Casting.....	177
Plumbest Backwater.....	286	Vapor Tension Thermometers Cooper-Atkins	729
Plumbest Brass Piercing.....	287	Vaporproof	
Plumbest Radiator Coin Key Air.....	816	RAB Electric Ceiling Fixtures.....	992
Powers.....	77	RAB Electric Globes.....	992
Pressure Balancing.....	77	Vaporproof Ceiling Fixtures RAB Electric.....	992
Pressure Control.....	934	Vaporproof Globes RAB Electric.....	992
Pressure Regulating.....	934	Vari-Bits Lenox.....	338
PVC Sch 80.....	63	Vent Caps	698
Relief.....	49	Vent Caps	
Sioux Chief Brass.....	368	Firomatic.....	698
Sioux Chief Gas.....	821	OEM.....	698
Solenoid.....	936	Plumbest Drain.....	286
SpiroTherm.....	810	Vent Hoods Tjernlund.....	634, 833
SUPCO Piercing.....	960	Vent Kits Bradford White.....	28
Superior Refrigeration Products Ball.....	941	Vent Termination Kits Noritz.....	18
Superior Refrigeration Products Check.....	941	Vent Valves Oatey.....	376
Superior Refrigeration Products Line.....	941	Ventilating Fans	
Superior Refrigeration Products Packed Angle.....	941	Broan.....	839
Superior Refrigeration Products Pressure Relief.....	942	Panasonic.....	840
Swing Check.....	57, 105	Ventilators Residential.....	637-638
Symmons Mixing.....	147	Venting	
Taco Mixing.....	795	Concentric Stainless Steel.....	18
Taco Pressure Reducing.....	795	Gas.....	768
Taco Zone.....	794	Noritz.....	18
Thermostatic Expansion.....	943-948	PVC.....	18
Uponor ProPEX.....	447	Tjernlund Power Venters.....	633-634, 832-833
Water & Gas Shut-Off.....	796	Tjernlund Water Heater.....	635, 834
Watts Ball.....	79	Venting Controls Tjernlund.....	635, 834
Watts Regulator.....	71	Vents	
Watts Regulator Air.....	815	Hoffman Specialty Main Steam.....	807
Watts Regulator Backflow Preventers.....	67	Hoffman Specialty Main Water.....	808
Watts Regulator Balancing.....	63	Hoffman Specialty Radiator Steam.....	808
Watts Regulator Ball.....	74	Hoffman Specialty Steam Convector.....	808
Watts Regulator Boiler Drain Shut-Off.....	79	Veritek Bathtubs Swanstone.....	250
Watts Regulator Boiler Pressure Regulators.....	73	Vertical Tanks UL-80.....	699
Watts Regulator Gate.....	75	Vertical Tanks UL-80.....	699
Watts Regulator Pressure Regulators.....	64	Vibration Absorbers Packless.....	952
Watts Regulator Pressure Relief.....	66	Victor Steel Straps.....	1041
Watts Regulator Safety Relief.....	64-65	Victor Specialties	1041
Watts Regulator Stop.....	304	Viessmann Mfg	
Watts Regulator T&P Relief.....	65	Accessories.....	614
Watts Regulator Washing Machine.....	75	Parts.....	615
Webstone PRO-PAL Series.....	797-798	Vitodens Boilers.....	613
White-Rodgers Gas.....	674	Vitogas Boilers.....	614
Yellow Jacket Vacuum/Charging.....	728, 954	Viessmann Mfg Co Inc	613-615
Zoeller Pump.....	97	Vikrell Shower Modules Sterling.....	231
Vanity Tops	207	Vikrell Tub & Shower Modules Sterling.....	228
Vanity Tops		Vikrell Whirlpool & Shower Modules Sterling	230
Gerber.....	207	Vinyl Tubing	
		Clear.....	826
		Premium Gorilla Tube Clear.....	826

INDEX



Voice/Datacom & Wiring Devices Morris
 Electrical..... 988

W

Wal-Rich
 Gauge Glass..... 297
 Gauge Glass Cutters..... 324
 Gauge Glass Sets..... 816
 Rings..... 297
 Washers..... 297
Wal-Rich Corporation 297, 324, 816
Wall Bars Delta..... 170
Wall Caps Aluminum..... 846
Wall Faucets Woodford..... 80
Wall Furnaces Empire..... 575, 577
Wall Heaters Marley Engineered Products..... 572
Wall Hydrants
 MIFAB Non-Freeze..... 80
 Non-Freeze..... 80
Wall Pipe Hancor..... 428, 464
Wall Plates Pass & Seymour..... 982-983, 985-986
Wall Stack Galv Sheet Metal..... 741, 755
Wallpacks RAB Electric..... 991
Walls Tub & Shower..... 248
Warning Tape Gastite Gas..... 373
Washers
 BrassCraft Bibb Seat..... 182
 Faucet..... 299
 Flanged Poly Tailpiece..... 280
 Greenfield Manufacturing Co..... 1020
 Plumbest..... 279
 Plumbest Closet Spud..... 282
 Plumbest Slip-Joint..... 279-280
 Wal-Rich..... 297
Washing Machine Connectors Mission
 Rubber Hose Grip..... 475
Washing Machine Hose
 Filler..... 301
 Plumbest..... 286
Washing Machine Outlet Boxes
 Oatey..... 376
 Uponor..... 458
Washing Machine Pans Oatey..... 375
Washing Machine Valves Watts Regulator... 75
Waste Arms Dearborn Brass..... 270
Waste Cleaners Hercules..... 264
Waste Connectors
 Ground Joint..... 303
 Plumbest..... 280
Waste Kits Bath..... 276
Waste Repair Parts Dearborn Brass..... 275

Waste Water Pumps Hartell..... 105
Waste-Mate Sump Pumps Zoeller..... 94
Wastes
 Bath..... 276
 Dearborn Brass Outlet..... 269-270
 Dearborn Brass Plastic Outlet..... 274
 Geberit Bath..... 277
 Kohler Bath..... 289
 McGuire Products..... 273
Wastewater Packages Goulds Pump..... 91
Wastewater Products On-Site..... 97
Watchman Hoffman Specialty Condensate
 Pumps..... 809
Watco
 Bath Waste Kits..... 276
 Bath Wastes..... 276
 Parts & Accessories..... 276
Watco Manufacturing Company 276
Water Alarms Control Products..... 829
Water Closet Carriers Watts Drainage..... 310
Water Cooler Carriers Watts Drainage..... 310
Water Coolers
 Elkay..... 260
 No Lead..... 260
Water Dispensers In-Sink-Erator Hot Water... 193
Water Diverters Delta..... 171
Water Feeder Valves Watts Regulator 73
Water Feeders McDonnell & Miller..... 803
Water Filter Cartridges AquaPure..... 34-36, 38, 41
Water Filters
 AquaPure Iron Removal..... 40
 Cuno Systems..... 43
Water Filtration American Granby..... 58
Water Filtration Systems
 AquaPure..... 34-35, 37-39, 41-42
 AquaPure Refrigerator..... 38
 AquaPure Reverse Osmosis..... 37
 Moen..... 122
Water Hammer Arresters Sioux Chief..... 367
Water Hammers Amtrol..... 799
Water Heater Connectors
 Copper-Flex..... 815
 Fluidmaster..... 292
Water Heater Drain Valves Watts Regulator.. 79
Water Heater Pans Oatey..... 375
Water Heater Relief Valves Watts Regulator. 65
Water Heater Stands Oatey..... 375
Water Heaters
 Amtrol..... 616
 AO Smith Commercial Gas..... 19-22
 AO Smith Electric..... 7-8
 AO Smith Gas..... 1-5



AO Smith Hybrid Electric.....	6	Radiant	452-456
Aqua Plus.....	615	Radiant Hose Clamps.....	453
Bradford White Commercial Gas	10, 24-26	Radiant Manifold Accessories.....	453
Bradford White Commercial Oil	25	Radiant Onix Fittings.....	453
Bradford White Residential Electric	15-16	Radiant Onix Tubing.....	453
Bradford White Residential Gas	9-14	Radiant Tools.....	455
Bradford White Residential Oil	15	Radiant Tubing Fasteners.....	455
Noritz Tankless.....	17	RadiantPEX Non-Barrier Tubing.....	452
Tjernlund Interlock Kits.....	635, 834	Reverse Osmosis Systems.....	45
Tjernlund Vent Kits.....	635, 834	SnapClip PEX Fasteners.....	363
Weil McLain.....	615	WaterPEX Non-Barrier Tubing.....	448
Weil-McLain.....	615	Watts Drainage	80, 302, 307-310
Water Meter Keys Plumbest.....	306	Watts Drainage	
Water Meter Valves Nibco.....	79	Cleanout Components.....	308
Water Meters		Fixture Carriers.....	310
Plumbest.....	288, 306	Floor Cleanouts.....	308
Sensus Metering Systems.....	81	Floor Drains.....	307
Water Outlet Components Delta.....	170	Interceptors.....	302
Water Panels Aprilaire.....	625	Non-Freeze Wall Hydrants	80
Water Pressure Controls American Granby...	51	Parts.....	310
Water Proofing Spray Nu-Calgon.....	927	Roof Drains.....	307
Water Pumps AY McDonald.....	99	Trap Seal Primers.....	307
Water Service Fittings AY McDonald		Water Closet Carriers	310
Couplings.....	480	Watts Radiant Hydronic Accessories.....	453
Water Service Products AY McDonald.....	479	Watts Regulator	63-76, 79, 304, 815
Water Service Tube Endot.....	413	Watts Regulator	
Water Softener Parts AquaPure.....	41	Air Gaps.....	71
Water Softener Salt SOS Products.....	46	Air Valves.....	815
Water Softeners AquaPure.....	40	Backflow Preventers.....	67
Water Storage Tanks AO Smith.....	22	Ball Valves.....	74
Water Supply Connectors Fluidmaster.....	291-292	Commercial Y-Strainers.....	72
Water Systems Ultraviolet.....	44	Dielectric Unions.....	73
Water Systems Parts American Granby.....	52	Frostproof Hydrants.....	75
Water Treatment Manitowoc.....	871	Gate Valves.....	75
Water Treatment Parts AquaPure.....	41	Pressure Relief Valves.....	66
Water Treatment Products Nu-Calgon.....	822, 925	Safety Relief Valves.....	64-65
Water Valves Johnson Controls.....	906	Stop Valves.....	304
Water Vents Hoffman Specialty Main.....	808	Tempering/Mixing Valves.....	71
Water-Finding Paste OEM.....	698	Vacuum Breakers.....	70
Water-Tite by IPS Corporation	311	Washing Machine Valves	75
Water/Plumbing Valves AY McDonald.....	81	Water Pressure Regulators.....	64
Waterless Trap Kits EZ Trap.....	845	Watts Water Technologies	45, 79, 352, 363, 448-452, 460
WaterPEX Watts Non-Barrier PEX Tubing.....	448	Wax Gaskets	
Watts		Hercules.....	293
Balancing Valves.....	63	Toilet Parts.....	299
Ball Valves.....	79	Weather Hoods Lifebreath.....	638
Brass PEX Fittings.....	448	Weatherproof Boxes Pass & Seymour.....	1031
Copper Stubout Elbows.....	363	Weatherproof Covers Carlon.....	1031
CustomCut Manifolds.....	453, 460	Webstone	
Manifolds.....	460		
PEX Fasteners.....	363		
PEX Tools.....	352		
Poly Alloy PEX Fittings.....	451		

INDEX



Ball Valves.....	797	Sterling.....	230
Mounting Flanges.....	798	White-Rodgers	654-656, 672-677, 909
Webstone Company	797-798	White-Rodgers	
Wedge Grip Clamps Porcelain Products.....	1020	Flame Sensors.....	675
Wedges Sioux Chief Closet.....	368	Furnace Controls.....	673
Weil McLain	615	Gas Valves.....	674-675
Weil McLain Water Heaters	615	Hydronic Controls.....	676-677
Weil-McLain		Hydronic Temperature Controls.....	676
Boilers	589-596, 615, 617-623	Igniters.....	672
Gas Boilers.....	589, 591, 622-623	Ignition Modules.....	672
Oil Boilers.....	593, 619	Immersion Wells.....	676
Ultra Series 3 Boiler.....	592, 618	Pilot Relite Controls.....	676
Water Heaters	615	Refrigeration Temperature Controls	676, 909
Weld-On		Thermostats.....	654-656
PVC/CPVC/ABS Cements.....	261	Zone Valves.....	677
PVC/CPVC/ABS Cleaners.....	263	Williamson-Thermoflo	
PVC/CPVC/ABS Primers.....	263	Boilers	609-612
Weld-On by IPS Corporation	261, 263	Burners.....	568, 612
Well Accessories Maass Midwest.....	48	Furnaces.....	567
Well Assemblies Honeywell.....	670	Oil Furnaces	567-568
Well Caps Dickens Aluminum.....	48	Window Trim Kits Swanstone.....	259
Well Point Supplies American Granby.....	52	Winter Watchman Honeywell.....	658
WellMate Captive Air Tanks Pentair.....	84	WinterGard	
WellMate Retention Tanks Pentair.....	84	Raychem Component Kits.....	33
WellMate Tank Accessories Pentair.....	84	Raychem Heating Cable.....	32
Westwood Products		Wire	
Boiler & Furnace Cleaning Items.....	703	Aluminum.....	1035
Carbon Dioxide Cleaners.....	703	Copper.....	1035
Filter Elements.....	702	Electrical Supplies.....	859
Leak Stoppers.....	702	MARS.....	1039
Nylo-Flex Burner Couplings.....	702	MC.....	859
Oil Burner Pump Gaskets.....	702	MC/BX.....	1035
Oil De-Aerator.....	702	Romex.....	1034
Oil Filter Elements.....	702	Shielded.....	1035
Pressure Testers.....	730	Thermostat.....	837
Smoke Testers.....	703	THHN.....	859, 1038
Terminals.....	703	Underground Feeder.....	1034
Wrenches.....	702	Wire & Cable	859, 1034-1039
Westwood Products Inc	702-703, 730	Wire & Cable Communications.....	1039
Westwood Products Inc Safety & Spill		Wire Connectors	1046
Cleanup Supplies.....	702	Wire Connectors	
Wet Switch Flood Detectors.....	825	3M.....	858, 1043
Wet/Dry Vacuums Ridgid.....	316	DiversiTech.....	1042
Wheels		Ideal.....	858-859, 1043
Ridgid Pipe Cutter.....	327	Morris Electrical.....	1044
Ridgid Tubing Cutter.....	328	Wire Management Morris Electrical.....	1073
Whips DiversiWhips.....	826	Wire Marker Booklets Morris Electrical.....	854
Whirlpool & Shower Modules Sterling Vikrell	230	Wire Markers Electrical.....	854
Whirlpools		Wire Nuts Electrical Supplies.....	858
Aquatic.....	247-248	Wire Terminals Electrical.....	1042
Kohler ProFlex.....	226		



Wire Ties MARS.....	1045
Wireholders Porcelain Products.....	1020
Wireless Thermostats Honeywell.....	651
Wiremold	
Floor Boxes.....	1030
Raceway.....	1021
Wiremold Legrand	1021, 1030
Wiring Devices Morris Electrical.....	987-988
Wiring Harnesses Field Controls.....	679
Wood & Combination Furnaces PSG	
Distribution.....	569
Wood Connectors Simpson Strong Tie.....	372
Wood-Burning Furnaces Pro-Fab.....	570
Woodford	80
Woodford Wall Faucets.....	80
Workhorse Towels DiversiTech.....	369
Workhorse® Flashlights	373
Wrenches	
Douglas Torque.....	352
Manitowoc.....	878
Mill-Rose Razorback.....	351
Plumbest.....	324
Ridgid.....	325
Ridgid Torque.....	326
Westwood Products.....	702
Wrot Plugs Dearborn Brass.....	271
Wyes	
Hancor.....	464
Sheet Metal.....	759

X

X-Pando Pipe Joint Compound.....	268
X-Pando Products Company	268

Y

Y-Strainers Watts Regulator Commercial	72
Yard Hydrant Repair Kit	56
Yellow Gas Pipe Endot.....	441
Yellow Jacket	346-347, 725-729, 889, 954
Yellow Jacket	
Access Fittings.....	728, 954
Charging Hose.....	727-728, 889
FlexFlow Charging Hose.....	889
Gauges.....	727
Leak Detectors.....	729
Manifolds.....	726
Oil Pumps & Injectors.....	728, 954
Pressure Hose.....	889

Refrigerant Analyzers.....	725
Refrigerant Recovery.....	889
SuperEvac Systems.....	725
Test Equipment.....	728
Tubing Tools.....	346
Vacuum Gauges.....	725
Vacuum/Charging Valves.....	728, 954

Z

Zinc Liquid-Tight Cord Connectors Arlington Industries.....	853, 1015
Zoeller	
Back-Up Pumps.....	96
Dewatering Pumps.....	94
Ejectors.....	93
Full-Flow Unichecks.....	97
On-Site Wastewater Products.....	97
Pedestal Pumps.....	93
Qwik Jon Systems.....	95
Scale Removal Systems.....	97
Sewage Package Systems.....	96-97
Sump Pumps.....	94, 96
Utility Pumps.....	93, 95
Zoeller Pump Co	93-97
Zone Control Panels Aprilaire.....	628
Zone Control Valves Dole.....	49
Zone Controls	
Honeywell.....	652
Taco Inc.....	793
Zone Dampers Aprilaire.....	628
Zone Valves	
Honeywell Motorized.....	812
Taco.....	794
Taco Power Head.....	795
White-Rodgers.....	677
Zoom Spout Oilers MARS.....	845

INDEX



IRR SUPPLY CENTERS, INC.

Central Office
908 Niagara Falls Blvd.
No. Tonawanda, NY 14120
(716) 692-1600

Eastern Regional Office
59 Chenango Bridge Road
Binghamton, NY 13901
(607) 772-8800

L.A. Hazard Division
1695 Overhead Road
Derby, NY 14047
(716) 627-2364

PLUMBING, HEATING, COOLING, ELECTRICAL AND REFRIGERATION DISTRIBUTORS
"Over 100 Years of Service"

APPLICATION FOR CREDIT

THE INFORMATION REQUESTED ON THIS FILE IS FOR THE PURPOSE OF OBTAINING CREDIT ACCOUNT PRIVILEGES FROM IRR SUPPLY CENTERS, INC., INCLUDING ITS JORDAN SUPPLY COMPANY, NORTHRUP SUPPLY COMPANY, AND L. A. HAZARD DIVISIONS ("IRR"). APPLICANT AND ANY GUARANTORS FOR THEMSELVES AND THEIR OFFICERS AND/OR MEMBERS AUTHORIZE IRR TO CONDUCT ANY INVESTIGATIONS DEEMED NECESSARY TO AUTHORIZE OPENING OR CONTINUATION OF THE ACCOUNT INCLUDING CREDIT INVESTIGATIONS OF THE APPLICANT, GUARANTORS, OFFICERS AND/OR MEMBERS OR PARTNERS OF THE APPLICANT.

PLEASE PRINT _____ DATE _____
 COMPANY NAME _____ (hereafter "APPLICANT")
 STREET ADDRESS _____ COUNTY _____
 CITY _____ STATE _____ ZIP _____
 BILLING ADDRESS IF DIFFERENT _____
 PHONE # _____ CONTACT PERSON _____
 FAX # _____ ACCOUNTS PAYABLE CONTACT _____
 CELL PHONE # _____ E-MAIL _____
 TYPE OF OWNERSHIP - PLEASE CHECK ONE: _____ Corporation _____ Partnership
 _____ Sole Proprietorship _____ Limited Liability Co. (LLC)

APPLICANTS: Owners/Officers/Members or Partners' Names, Addresses, Phone #(s) and Social Security #(s):
 _____ () _____ SS# ____-____-_____
 _____ () _____ SS# ____-____-_____

IF TAX EXEMPT, PLEASE SUBMIT FULLY COMPLETED APPROPRIATE TAX FORM SOCIAL SECURITY # OR FEDERAL TAX ID# _____
 AMOUNT OF CREDIT DESIRED _____ ARE PO #'S REQUIRED? _____
 TYPE OF BUSINESS _____ DATE STARTED _____
 CURRENT LICENSE # _____ TYPE _____
 ESTIMATED ANNUAL SALES _____ NO. OF EMPLOYEES: Office _____ Shop _____
 BANK _____ ADDRESS _____
 ACCT # _____ TYPE OF ACCOUNT _____
 ACCOUNTANT _____

PROPERTY OWNED	VALUE	AMT OWED	MORTGAGEE
Home _____			
Business _____			

IF APPLICANT RENTS BUSINESS LOCATION, IDENTIFY LANDLORD:

TRADE REFERENCES/Suppliers with whom you have established credit. Please indicate: Addresses with Zip Codes, Phone #'s and Fax #s.

1. _____	2. _____	3. _____
_____	_____	_____
_____	_____	_____
PHONE (____) _____	PHONE (____) _____	PHONE (____) _____
FAX (____) _____	FAX (____) _____	FAX (____) _____
E-MAIL _____	E-MAIL _____	E-MAIL _____

ATTACH YOUR LATEST FINANCIAL STATEMENT. IF ONE IS NOT AVAILABLE, PLEASE COMPLETE THE FOLLOWING:

ASSETS	LIABILITIES/NET WORTH
Cash in bank _____	Loans Payable _____
Accts Receivable _____	Accts Payable _____
Land, Bldgs. _____	Other Liabilities _____
Equipment _____	Net Worth _____

The information provided on this application is for the purpose of obtaining credit and is warranted to be true. I/we hereby authorize IRR to investigate the information and sources provided in order to verify my/our credit and financial responsibility.

GUARANTY AND INDEMNITY AGREEMENT

In consideration of the sale of merchandise by IRR to the applicant the undersigned hereby unconditionally guarantees to IRR the payment of any existing or future indebtedness which the APPLICANT owes to IRR in any manner whatsoever without limitation as to amount (the "Debt"). This guaranty shall be a continuing guaranty independent of and in addition to any other security, collateral or guaranty held by IRR and shall not be impaired by any neglect, failure or omission to realize upon any security or guaranty or by the release of all or any portion of such security or guaranty or by any extension of credit in excess of the initial credit limit or by renewal, modification, compromise or discharge of the Debt or any part thereof with any party obligated on this Debt. The liability of the undersigned shall be direct, immediate and absolute and not be conditional or contingent upon the pursuit or prosecution by IRR of any other remedy or remedies whatsoever, and IRR shall have against the undersigned any and all rights and remedies it might have against the APPLICANT. The undersigned consents to IRR obtaining a consumer credit report on undersigned for the purpose of evaluating the creditworthiness of APPLICANT in connection with an application for business credit. Facsimile signature shall be as binding as an original signature. The venue for any disputes between the parties must be Erie or Niagara County New York.

Dated this _____ day of _____, 20 _____

Signature of Guarantor(s):

1. _____	SS# _____
Signature _____	
Print Name _____	
2. _____	SS# _____
Signature _____	
Print Name _____	
3. _____	SS# _____
Signature _____	
Print Name _____	

Witness: _____

Have you had any past dealings with IRR / Northrup / Jordan Supply / L.A. Hazard? Please describe.

When? _____ Where? _____
 Details _____

THIS IS TO CERTIFY THAT APPLICANT IS FINANCIALLY ABLE TO MEET ANY COMMITMENTS MADE HEREIN AND TO PAY YOUR INVOICES ACCORDING TO TERMS. APPLICANT AGREES TO PAY A SERVICE CHARGE OF 2% PER MONTH ON ALL PAST DUE BALANCES. APPLICANT ALSO AGREES TO PAY ALL COST OF COLLECTION, INCLUDING REASONABLE ATTORNEY'S FEE, (25% OF BALANCE DUE) SHOULD THE ACCOUNT BE REFERRED FOR COLLECTION. PERSON(S) EXECUTING THIS APPLICATION WARRANT THAT THEY ARE AUTHORIZED BY THE APPLICANT TO EXECUTE THE APPLICATION ON ITS BEHALF. THE UNDERSIGNED CONSENTS TO IRR OBTAINING A CONSUMER CREDIT REPORT ON UNDERSIGNED FOR THE PURPOSE OF EVALUATING THE CREDITWORTHINESS OF APPLICANT IN CONNECTION WITH AN APPLICATION FOR BUSINESS CREDIT. FACSIMILE SIGNATURE SHALL BE AS BINDING AS AN ORIGINAL SIGNATURE. THE VENUE FOR ANY DISPUTES BETWEEN THE PARTIES MUST BE ERIE OR NIAGARA COUNTY NEW YORK.

Signed _____ Title _____ Date _____

Please return completed application to the branch of IRR Supply where your account is to be maintained.

*** ONLY SIGNED APPLICATIONS WILL BE ACCEPTED ***

To be completed by IRR: Branch _____ Salesman _____ Manager's Approval _____



**Plumbing, Heating, Cooling, Refrigeration
and Electrical Distributors**



Better Service Thru Better People
An Employee Owned Company

Let us get to know you!

We would like to include you in our E-Mail list.

The types of e-mails you can expect to receive:

1. Our Irr Supply Monthly Product Flyer
2. Vendor "New" Product Announcements
3. Periodic Vendor Product Specials
Exclusive to E-Mail Accounts

In addition, by providing your e-mail address, you will receive a \$5.00 coupon good for your next purchase at Irr Supply.

Register Here

Customer Name _____

Customer Account # _____

Address _____

E-Mail Address _____

Irr Supply Branch _____

E-mail to: marketing2@irrsupply.com

Or Fax to Marketing Dept. at (716) 692-1611

Thanks for allowing us to serve you!



Plumbing, Heating, Cooling, Refrigeration, and Electrical Distributors



An Employee Owned Company



www.irrsupply.com

Better Service Thru Better People

SERVING WNY & NORTHERN PA

R	BATAVIA	29 Evans St, 14020	585-343-5085
	BUFFALO	1572 Main St, 14209	716-882-2100
R	BUFFALO	400 Smith St, 14210	716-826-3400
	BUFFALO	1674 Kenmore Ave, 14216	716-876-7225
	BUFFALO	2477 Broadway, 14227	716-895-1200
	CLARENCE	5605 Harris Hill Rd, 14221	716-741-4124
	DEPEW	5635 Transit Rd, 14043	716-684-5800
	DERBY	1695 Overhead Rd, 14047	716-627-2364
	EAST AURORA	558 Buffalo Rd, 14052	716-652-2900
	ERIE, PA	1108 West 12th St, 16501	814-454-8100
R	ERIE, PA	1645 West 26th S, 16508	814-455-8026
	FREDONIA	186 East Main St, 14063	716-673-1300
	JAMESTOWN	2184 Foote Ave Ext, NYS Rt 60, 14701	716-484-9166
R	KENMORE	1667 Military Rd, 14217	716-871-8970
	LOCKPORT	6707 Lincoln Ave, 14094	716-433-1777
	NIAGARA FALLS	8890 Porter Rd, 14304	716-297-9400
	NORTH TONAWANDA	908 Niagara Falls Blvd, 14120	716-694-4800
R	OLEAN	631 North Union St Ext, 14760	716-372-2191
	ORCHARD PARK	3689 California Rd, 14127	716-662-4906
	ROCHESTER	1800 E Main St, 14609	585-288-6880
R	ROCHESTER	845 Maple St, 14611	585-235-2030
	SPRINGVILLE	10211 Edies Rd, 14141	716-592-5112

SERVING CENTRAL NY & NORTHERN PA

	AUBURN	1 Lexington Ave, 13021	315-252-7581
R	BINGHAMTON	59 Chenango Bridge Rd, 13901	607-772-0222
	ENDICOTT	24 Delaware Ave, 13760	607-754-4404
R	ELMIRA	1006 Sullivan, 14901	607-734-2246
R	GENEVA	1902 State Route 14, 14456	315-789-4944
	HORSEHEADS	811 South Main St, 14845	607-739-5658
R	ILION	143 Central Ave, 13357	315-894-5669
	LIVERPOOL	118 Salina St, 13088	315-451-3200
	ONEONTA	5 Commercial Dr, 13820	607-432-4433
R	SYRACUSE	112 Plum St, 13204	315-476-7429

R - Offers Full Line of Refrigeration Products

Premier Kitchen and Bath Selection Centers

visionary baths
and more

www.visionarybaths.com

1 Lexington Ave
Auburn, NY 13021
315-252-7581

59 Chenango Bridge Rd
Binghamton, NY 13901
607-772-6205

908 Niagara Falls Blvd
No. Tonawanda, NY 14120
716-692-3200

5 Commercial Drive
Oneonta, NY 13820
607-432-4433

3689 California Rd
Orchard Park, NY 14127
716-667-2700

5605 Harris Hill Rd
Williamsville, NY 14221
716-741-4131